

MARKS PUBLISHED FOR OPPOSITION

The following marks are published in compliance with section 12(a) of the Trademark Act of 1946. Applications for the registration of marks in more than one class have been filed as provided in section 30 of said act as amended by Public Law 772, 87th Congress, approved Oct. 9, 1962, 76 Stat. 769. Opposition under section 13 may be filed within thirty days of the date of this publication. See rules 2.101 to 2.105.

A separate fee of two hundred dollars for opposing each mark in each class must accompany the opposition.

SECTION 1.— INTERNATIONAL CLASSIFICATION

The short titles associated below with the international class numbers are terms designed merely for quick identification and are not an official part of the international classification. The full names of international classes are given in section 6.1 of the trademark rules of practice.

The designation "U.S. Cl." appearing in this section refers to the U.S. class in effect prior to Sep. 1, 1973 rather than the international class which applies to applications filed on or after that date. For adoption of international classification see notice in the OFFICIAL GAZETTE of Jun. 26, 1973 (911 O.G. TM 210).

Application in more than one class

SN 76-173,667. QUESTAIR TECHNOLOGIES INC., BURNABY, BRITISH COLUMBIA, CANADA, FILED 11-30-2000.

The logo for QuestAir features the word "Quest" in a bold, sans-serif font, followed by "Air" in a similar font. A small, solid black circle is positioned below the letter "i" in "Air".

CLASS 11—ENVIRONMENTAL CONTROL APPARATUS

FOR OXYGEN CONCENTRATORS AND HYDROGEN PURIFIERS FOR USE WITH FUEL CELLS FOR RECOVERING AND GENERATING ENERGY USED IN A WIDE RANGE OF INDUSTRIAL SYSTEMS, INCLUDING FOR THE PRODUCTION OF DOMESTIC PRODUCTS AND ELECTRONIC DEVICES; GAS SEPARATION PROCESSING SYSTEMS, NAMELY, SEPARATORS FOR THE CLEANING AND PURIFICATION OF GASES FOR COMMERCIAL, INDUSTRIAL, MILITARY, AVIATION, ADVANCED ENGINES, SYSTEMS AND CHEMICAL PROCESSES, MEDICAL AND PERSONAL USE; OXYGEN CONCENTRATORS FOR USE WITH FUEL CELLS USED IN HEATING, VENTILATION, AIR CONDITIONING, LIGHTING, AND POWER SYSTEMS FOR BUILDINGS; OXYGEN CONCENTRATORS FOR USE WITH FUEL CELLS USED IN HOUSEHOLD APPLIANCES; HYDROGEN PURIFIERS FOR USE IN CHEMICAL SEPARATION AND ELECTROCHEMICAL APPLICATIONS; CARBON MONOXIDE CLEAN UP SYSTEMS COMPRISING ADSORBENT BEDS IN THE NATURE OF CARBON MONOXIDE FILTERS, EXPANSION CHAMBERS, FEED COMPRESSORS AND VACUUM PUMPS; GAS DRYING SYSTEMS COMPRISING INDUSTRIAL AIR DRYERS, GAS INCINERATORS AND COMBUSTION CHAMBERS; HYDROGEN REFUELING SYSTEMS FOR USE IN CHEMICAL SEPARATION AND ELECTROCHEMICAL APPLICATIONS COMPRISING HYDROGEN PURIFIERS FOR SEPARATING CHEMICALS FROM FUEL; OXYGEN CONCENTRATORS AND HYDROGEN PURIFIERS FOR USE WITH REFUELING SYSTEMS FOR FUEL CELLS AND INTERNAL COMBUSTION ENGINES FOR LAND VEHICLES, AIRCRAFT AND AVIATION EQUIPMENT (U.S. CLS. 13, 21, 23, 31 AND 34).

PRIORITY CLAIMED UNDER SEC. 44(D) ON CANADA APPLICATION NO. 1,061,457, FILED 6-1-2000, REG. NO. TMA669,395, DATED 8-8-2006, EXPIRES 8-8-2021.

COLOR IS NOT CLAIMED AS A FEATURE OF THE MARK.

CLASS 7—MACHINERY

FOR OXYGEN CONCENTRATORS AND HYDROGEN PURIFIERS FOR USE WITH FUEL CELLS AS PART OF INDUSTRIAL MACHINES (U.S. CLS. 13, 19, 21, 23, 31, 34 AND 35).

CLASS 37—CONSTRUCTION AND REPAIR

FOR CUSTOMER SUPPORT SERVICES, NAMELY, PROVIDING INFORMATION IN THE FIELD OF REPAIR, INSTALLATION AND MAINTENANCE OF OXYGEN CONCENTRATORS (U.S. CLS. 100, 103 AND 106).
ALEX KEAM, EXAMINING ATTORNEY

SN 76-491,294. SECURITY SOFTWARE, INC., AVENTURA, FL. FILED 2-21-2003.

CASH PASS

PRIORITY CLAIMED UNDER SEC. 44(D) ON ERPN CMNTY TM OFC APPLICATION NO. 002846848, FILED 9-5-2002.

NO CLAIM IS MADE TO THE EXCLUSIVE RIGHT TO USE "CASH", APART FROM THE MARK AS SHOWN.

CLASS 9—ELECTRICAL AND SCIENTIFIC APPARATUS

FOR ENCODED SMART CARDS AND ENCODED ELECTRONIC CHIP CARDS CONTAINING PROGRAMMING FOR CARRYING OUT ELECTRONIC CASH TRANSACTIONS (U.S. CLS. 21, 23, 26, 36 AND 38).

CLASS 36—INSURANCE AND FINANCIAL

FOR FINANCIAL TRANSACTIONS, NAMELY, ELECTRONIC DEBIT TRANSACTIONS, ELECTRONIC CREDIT TRANSACTIONS, ELECTRONIC CASH TRANSACTIONS, AND CREDIT CARD TRANSACTIONS (U.S. CLS. 100, 101 AND 102).

CYNTHIA SLOAN, EXAMINING ATTORNEY

SN 76-492,941. HUNTER MCDONNELL PIPELINE SERVICES INC., BITTERN LAKE, CANADA, FILED 2-25-2003.

HM

OWNER OF CANADA REG. NO. TMA526663, DATED 4-17-2000, EXPIRES 4-17-2015.

COLOR IS NOT CLAIMED AS A FEATURE OF THE MARK.

CLASS 9—ELECTRICAL AND SCIENTIFIC APPARATUS

FOR PIPELINE PIGS, PIPELINE PIG TRACKING AND PIPE LOCATING EQUIPMENT, NAMELY, RADIO TRANSMITTERS, RADIO RECEIVERS AND GEOPHONES (U.S. CLS. 21, 23, 26, 36 AND 38).

FIRST USE 3-0-1995; IN COMMERCE 0-0-2001.

CLASS 42—SCIENTIFIC, COMPUTER AND LEGAL SERVICES

FOR LOCATING AND MARKING PLACEMENT OF UNDERGROUND UTILITY PIPELINES; PIPELINE AND PIPELINE FACILITY INSPECTION SERVICES; AND CONSULTING SERVICES IN THE FIELD OF PIPELINE AND PIPELINE FACILITY INSPECTION SERVICES (U.S. CLS. 100 AND 101).

FIRST USE 3-0-1996; IN COMMERCE 0-0-2001.

GIANCARLO CASTRO, EXAMINING ATTORNEY

SN 76-510,751. SCHIKI GMBH, P.A. ALPINA TREUHAND AG, 6052 HERGISWIL, SWITZERLAND, FILED 4-30-2003.

SWISS SPA SYSTEMS

PRIORITY CLAIMED UNDER SEC. 44(D) ON SWITZERLAND APPLICATION NO. 51068/2003, FILED 4-2-2003, REG. NO. 51068, DATED 7-10-2003, EXPIRES 7-10-2013.

NO CLAIM IS MADE TO THE EXCLUSIVE RIGHT TO USE SWISS OR SYSTEMS, APART FROM THE MARK AS SHOWN.

CLASS 3—COSMETICS AND CLEANING PREPARATIONS

FOR COSMETICS, NAMELY DEPILATION CREAMS (U.S. CLS. 1, 4, 6, 50, 51 AND 52).

CLASS 8—HAND TOOLS

FOR BATTERY-POWERED ELECTRICAL DEPILATORY APPLIANCES (U.S. CLS. 23, 28 AND 44).

KAREN BRACEY, EXAMINING ATTORNEY

SN 76-526,036. ASSOCIATION FOR FINANCIAL PROFESSIONALS, INC., BETHESDA, MD. FILED 6-30-2003.



OWNER OF U.S. REG. NOS. 2,427,473, 2,672,489 AND OTHERS.

NO CLAIM IS MADE TO THE EXCLUSIVE RIGHT TO USE "LEARNING SYSTEM", APART FROM THE MARK AS SHOWN.

COLOR IS NOT CLAIMED AS A FEATURE OF THE MARK.

CLASS 16—PAPER GOODS AND PRINTED MATTER

FOR PRINTED INSTRUCTIONAL, EDUCATIONAL, AND TEACHING MANUALS AND MATERIALS IN THE FIELDS OF CASH, TREASURY AND FINANCIAL MANAGEMENT (U.S. CLS. 2, 5, 22, 23, 29, 37, 38 AND 50).

FIRST USE 10-11-2002; IN COMMERCE 10-11-2002.

CLASS 41—EDUCATION AND ENTERTAINMENT

FOR EDUCATIONAL SERVICES, NAMELY PROVIDING COURSES OF INSTRUCTION IN THE FIELDS OF CASH, TREASURY AND FINANCIAL MANAGEMENT; PROVIDING ONLINE EDUCATIONAL AND INTERACTIVE COURSES OF INSTRUCTION IN THE FIELDS OF CASH, TREASURY AND FINANCIAL MANAGEMENT (U.S. CLS. 100, 101 AND 107).

FIRST USE 10-11-2002; IN COMMERCE 10-11-2002.

RUDY R. SINGLETON, EXAMINING ATTORNEY

SN 76-526,037. ASSOCIATION FOR FINANCIAL PROFESSIONALS, INC., BETHESDA, MD. FILED 6-30-2003.

AFP LEARNING SYSTEM

OWNER OF U.S. REG. NOS. 2,427,473, 2,672,489 AND OTHERS.

NO CLAIM IS MADE TO THE EXCLUSIVE RIGHT TO USE "LEARNING SYSTEM", APART FROM THE MARK AS SHOWN.

CLASS 16—PAPER GOODS AND PRINTED MATTER

FOR PRINTED INSTRUCTIONAL, EDUCATIONAL, AND TEACHING MANUALS AND MATERIALS IN THE FIELDS OF CASH, TREASURY AND FINANCIAL MANAGEMENT (U.S. CLS. 2, 5, 22, 23, 29, 37, 38 AND 50).
FIRST USE 10-11-2002; IN COMMERCE 10-11-2002.

CLASS 41—EDUCATION AND ENTERTAINMENT

FOR EDUCATIONAL SERVICES, NAMELY PROVIDING COURSES OF INSTRUCTION IN THE FIELDS OF CASH, TREASURY AND FINANCIAL MANAGEMENT; PROVIDING ONLINE EDUCATIONAL AND INTERACTIVE COURSES OF INSTRUCTION IN THE FIELDS OF CASH, TREASURY AND FINANCIAL MANAGEMENT (U.S. CLS. 100, 101 AND 107).

FIRST USE 10-11-2002; IN COMMERCE 10-11-2002.
RUDY R. SINGLETON, EXAMINING ATTORNEY

SN 76-546,178. MARATHON MEDIA, PARIS, FRANCE, FILED 9-22-2003.

PRIORITY CLAIMED UNDER SEC. 44(D) ON FRANCE APPLICATION NO. 033216662, FILED 3-21-2003, REG. NO. 033216662, DATED 3-21-2003, EXPIRES 3-21-2013.

NO CLAIM IS MADE TO THE EXCLUSIVE RIGHT TO USE "MYSTERY", APART FROM THE MARK AS SHOWN. THE NAME MARTIN MYSTERY DOESN'T IDENTIFY A LIVING INDIVIDUAL.

THE COLOR(S) PURPLE AND GREEN IS/ARE CLAIMED AS A FEATURE OF THE MARK.

THE MARK CONSISTS OF EACH LETTER APPEARS IN THE COLOR PURPLE AND EACH LETTER IS OUTLINED IN THE COLOR GREEN.

CLASS 3—COSMETICS AND CLEANING PREPARATIONS

FOR HAND AND BODY SOAPS; PERFUMERY, ESSENTIAL OILS FOR PERSONAL USE, COSMETICS, HAIR LOTIONS; DENTRIFICES; SACHETS (U.S. CLS. 1, 4, 6, 50, 51 AND 52).

CLASS 9—ELECTRICAL AND SCIENTIFIC APPARATUS

FOR AUDIO TAPE PLAYERS, TELEVISIONS, COMPUTERS, VIDEO TAPE RECORDERS, PHOTOGRAPHIC CAMERAS AND VIDEO TAPE CAMERAS; BLANK MAGNETIC DATA CARRIERS; BLANK DIGITAL VIDEO DISCS, BLANK COMPACT DISCS, BLANK COMPUTER DISCS; DATA PROCESSORS (U.S. CLS. 21, 23, 26, 36 AND 38).

CLASS 16—PAPER GOODS AND PRINTED MATTER

FOR WRITING PAPER, BOND PAPER, WRAPPING PAPER; CARDBOARD; PAPER COVERS FOR DISKS, VIDEO DISKS AND VIDEO CASSETTES; STATIONERY PADS; SIGNBOARDS OF PAPER OR CARDBOARD; PAPER BAGS, PAPER OR PLASTIC BAGS FOR HOUSEHOLD USE, GROCERY BAGS, LUNCH BAGS, SMALL BAGS FOR PAPER PACKAGING; WRITING PAPER, POSTCARDS; ENVELOPES; POSTAGE STAMPS; VISITING CARDS; CALENDARS; PRINTED LABELS; PAPER FLAGS; POSTERS; GRAPHIC PRINTS; PAINTINGS AND PICTURES FRAMED OR UNFRAMED; LEAFLETS IN THE FIELD OF MUSIC AND TELEVISION SERIES; PROSPECTUSES FEATURING INFORMATION ON MUSIC AND ABOUT TELEVISION SERIES; PRINTED PUBLICATIONS, NAMELY, JOURNALS, PAMPHLETS, BROCHURES, MANUALS, MAGAZINES IN THE FIELD OF MUSIC AND TELEVISION SERIES; PAINTBRUSHES, PRINTED MATTER, NAMELY, YOUTH AND TEEN-AGER MAGAZINES, BOOKS AND JOURNALS FEATURING INFORMATION ON MUSIC AND ABOUT TELEVISION SERIES; TYPEWRITERS; OFFICE REQUISITES, NAMELY, CORRECTING FLUID FOR TYPE, RUBBER BANDS, STAPLERS, PENS, PENCILS; BOOKBINDING MATERIAL, NAMELY, BOOKBINDINGS, BOOKBINDING WIRE, BOOKBINDING TAPE; STATIONERY, GLUES FOR STATIONERY PURPOSES; WRAPPING SHEETS OF PLASTICS; PHOTOGRAPHS; MATERIAL FOR ARTISTS, NAMELY, ARTISTS' BRUSHES, ARTISTS' PASTELS, ARTISTS' PENS, ARTISTS' PENCILS (U.S. CLS. 2, 5, 22, 23, 29, 37, 38 AND 50).

CLASS 18—LEATHER GOODS

FOR LEATHER AND IMITATIONS OF LEATHER SOLD IN BULK; HANDBAGS; BACKPACKS; TRUNKS AND VALISES; TRAVELLING CASES; UMBRELLAS AND PARASOLS (U.S. CLS. 1, 2, 3, 22 AND 41).

CLASS 25—CLOTHING

FOR CLOTHING, NAMELY, T-SHIRTS, SHIRTS, PANTS, SHORTS, JACKETS, SWEATSHIRTS, BANDANAS, SOCKS, TIES, DRESSES, SKIRTS, PARKAS, GLOVES, SCARVES, BELTS; FOOTWEAR; HEADGEAR, NAMELY, CAPS, BANDANAS, HEADBANDS (CLOTHING) (U.S. CLS. 22 AND 39).

CLASS 28—TOYS AND SPORTING GOODS

FOR GAMES AND PLAYTHINGS, NAMELY, ACTION SKILL GAMES BOARD GAMES, CARD GAMES, MANIPULATIVE GAMES, PARLOUR GAMES, PINBALL GAMES, DOLLS, MECHANICAL TOYS, PLUSH TOYS, POSITIONAL TOY FIGURES; GYMNASTIC APPARATUS; SPORTING ARTICLES, NAMELY, SKATEBOARDS, SOCCER BALLS, BASKET BALLS, BEACH BALLS, TENNIS RACKETS, TABLE TENNIS RACKETS, BEACH RACKETS, SKIS; DECORATIONS FOR CHRISTMAS TREES; PLAYING CARDS (U.S. CLS. 22, 23, 38 AND 50).

CLASS 35—ADVERTISING AND BUSINESS

FOR DIRECT MAIL ADVERTISING; ARRANGING FOR NEWSPAPER SUBSCRIPTIONS FOR OTHERS; BUSINESS INQUIRIES AND INVESTIGATIONS; DOCUMENT REPRODUCTION; COMPUTERIZED FILE MANAGEMENT; REMOTE DATA PROCESSING SERVICES (U.S. CLS. 100, 101 AND 102).

CLASS 38—COMMUNICATION

FOR RADIO BROADCASTING; COMMUNICATIONS BY TELEGRAMS AND TELEPHONE; COMMUNICATION BY VIDEO TELEPHONE, BY TELEVISION BROADCASTING; BROADCASTING SERIES OF CARTOON PROGRAMS VIA A GLOBAL COMPUTER NETWORK; ELECTRONIC TRANSMISSION OF MESSAGES; TRANSMISSION OF TELEGRAMS; RADIO AND TELEVISION INFORMATION BROADCASTING VIA INTERNET, VIA THE RADIO AND VIA THE TELEVISION; TRANSMISSION OF INFORMATION BY COMPUTER TERMINAL, ELECTRONIC TRANSMISSION OR BY FACSIMILE; PROVIDE MULTIPLE USER ACCESS TO THE INTERNET (U.S. CLS. 100, 101 AND 104).

CLASS 40—MATERIAL TREATMENT

FOR PRINTING SERVICES (U.S. CLS. 100, 103 AND 106).

CLASS 41—EDUCATION AND ENTERTAINMENT

FOR PUBLICATION OF BOOKS; ENTERTAINMENT IN THE NATURE OF AIR SHOWS, ENTERTAINMENT IN THE NATURE OF FASHION SHOWS, RADIO AND TELEVISION ENTERTAINMENT IN THE NATURE OF ON-GOING YOUTH AND CHILDREN SHOWS; PRODUCTION OF RADIO AND TELEVISION PROGRAMS; PRODUCTION AND SCREENING OF MOTION PICTURE FILMS; MODELLING FOR ARTISTS; RENTAL OF CINEMA FILMS, OF SOUND OR VIDEOGRAPHIC RECORDINGS AND OF SHOW SCENERY; ENTERTAINMENT IN THE NATURE OF COMPETITIONS FOR YOUTH AND CHILDREN IN THE ARTISTIC FIELD; BOOKING OF SEATS FOR SHOWS; PROVIDING AN ONLINE COMPUTER DATABASE IN THE FIELD OF EDUCATION AND OF ENTERTAINMENT AND GAMES; NEWS AGENCIES, NAMELY, GATHERING AND DISSEMINATION OF NEWS; NEWS REPORTING SERVICES; VIDEOTAPING; AUDIO-VISUAL RECORDING AND PRODUCTION IN THE FIELDS OF KARAOKE PERFORMANCES AND AUDIO BOOK, PERSONAL VIDEO DISCS, INTERACTIVE VIDEO GAMES AND VIDEO BAND RECORDINGS; ARRANGING MUSICAL WORKS (U.S. CLS. 100, 101 AND 107).

DAVID TAYLOR, EXAMINING ATTORNEY

SN 76-548,870. ACUITY BRANDS, INC., ATLANTA, GA. FILED 9-12-2003.

BIG ORANGE

NO CLAIM IS MADE TO THE EXCLUSIVE RIGHT TO USE "ORANGE", APART FROM THE MARK AS SHOWN.

CLASS 3—COSMETICS AND CLEANING PREPARATIONS

FOR ALL PURPOSE CLEANERS AND DEGREASING PREPARATIONS NOT USED IN MANUFACTURING PROCESSES FOR INDUSTRIAL, COMMERCIAL, RESIDENTIAL, AND INSTITUTIONAL APPLICATIONS (U.S. CLS. 1, 4, 6, 50, 51 AND 52).

FIRST USE 0-0-1984; IN COMMERCE 0-0-1984.

CLASS 5—PHARMACEUTICALS

FOR ODOR NEUTRALIZING PREPARATIONS FOR PROFESSIONAL, COMMERCIAL, INDUSTRIAL AND RESIDENTIAL USE; ROOM DEODORIZERS (U.S. CLS. 6, 18, 44, 46, 51 AND 52).

FIRST USE 0-0-1984; IN COMMERCE 0-0-1984.

STANLEY I. OSBORNE, EXAMINING ATTORNEY

SN 76-592,178. ST. LAWRENCE OUTFITTERS INC., MALORYTOWN, ONTARIO, CANADA, FILED 5-14-2004.



PRIORITY CLAIMED UNDER SEC. 44(D) ON CANADA APPLICATION NO. 1,215,316, FILED 4-30-2004, REG. NO. 675368, DATED 11-14-2006, EXPIRES 11-14-2021.

THE MARK CONSISTS OF A DESIGN OF A GOOSE INSIDE OF A MAPLE LEAF.

CLASS 9—ELECTRICAL AND SCIENTIFIC APPARATUS

FOR PRE-RECORDED DVD VIDEOS DEALING WITH HUNTING (U.S. CLS. 21, 23, 26, 36 AND 38).

CLASS 41—EDUCATION AND ENTERTAINMENT

FOR HUNTING TOURS AND HUNT GUIDING (U.S. CLS. 100, 101 AND 107).

RAMONA ORTIGA, EXAMINING ATTORNEY

SN 76-619,596. GHETTO PANDA DESIGNS INC., TORONTO, ONTARIO, CANADA, FILED 11-8-2004.



PRIORITY CLAIMED UNDER SEC. 44(D) ON CANADA APPLICATION NO. 1215998, FILED 5-6-2004, REG. NO. TMA676839, DATED 11-14-2006, EXPIRES 11-14-2021.

THE LINING IS A FEATURE OF THE MARK AND DOES NOT INDICATE COLOR.

THE MARK INCLUDES A PICTURE OF A BEAR, A BRICK WALL AND THE TERMS GHETTO AND PANDA IN STYLIZED FORMAT.

CLASS 9—ELECTRICAL AND SCIENTIFIC APPARATUS

FOR PRE-RECORDED AUDIOS AND VIDEOS IN THE FIELD OF MUSIC, DRAMA, COMEDY, FASHION, DOCUMENTARIES, LIVE ACTIONS, COMMERCIALS, THEME SONGS, MUSIC VIDEOS, LIVE PERFORMANCES AND PERFORMANCE ART (U.S. CLS. 21, 23, 26, 36 AND 38).

CLASS 14—JEWELRY

FOR JEWELRY (U.S. CLS. 2, 27, 28 AND 50).

CLASS 18—LEATHER GOODS

FOR BAGS, NAMELY HANDBAGS, PURSES, KNAPSACKS, BACK-PACKS, GYM BAGS, TOTE BAGS, TRAVEL BAGS, AND TOILETRY BAGS SOLD EMPTY (U.S. CLS. 1, 2, 3, 22 AND 41).

CLASS 20—FURNITURE AND ARTICLES NOT OTHERWISE CLASSIFIED

FOR PORTABLE BEDS FOR PETS; PLASTIC SCULPTURES; SCULPTURES OF PLASTER, WAX, OR WOOD; SOFT SCULPTURE WALL DECORATIONS; DECORATIVE MOBILES; PILLOWS AND FURNITURE SCREENS (U.S. CLS. 2, 13, 22, 25, 32 AND 50).

CLASS 25—CLOTHING

FOR MENSWEAR, NAMELY JACKET, COATS, PANTS, SHIRTS, HATS, GLOVES, SHOES; WOMENSWEAR, NAMELY JACKET, COATS, PANTS, SHIRTS, HATS, GLOVES, SHOES (U.S. CLS. 22 AND 39).

CLASS 41—EDUCATION AND ENTERTAINMENT

FOR MUSIC PUBLISHING; CREATION, PRODUCTION AND RECORDING OF MUSICAL AND DRAMATIC PERFORMANCES; VIDEO PRODUCTIONS; STILL AND MOTION PICTURE PHOTOGRAPHY SERVICES; AND ENTERTAINMENT SERVICES IN THE NATURE OF LIVE PERFORMANCES BY INDIVIDUAL OR GROUPED MUSICIANS, ACTORS, SPEAKERS OR PERFORMERS (U.S. CLS. 100, 101 AND 107).

CLASS 42—SCIENTIFIC, COMPUTER AND LEGAL SERVICES

FOR INTERIOR DESIGNING AND HOME DECORATION; AND GRAPHIC DESIGN SERVICES (U.S. CLS. 100 AND 101).

JACQUELINE A. LAVINE, EXAMINING ATTORNEY

SN 76-623,105. YKK CORPORATION, TOKYO, JAPAN, FILED 12-3-2004.

ReEarth

OWNER OF JAPAN REG. NO. 5029169, DATED 3-2-2007, EXPIRES 3-2-2017.

CLASS 18—LEATHER GOODS

FOR BAG AND POUCH FITTINGS, NAMELY, SHOULDER PADS FOR SHOULDER BELTS AND STRAPS, LENGTH ADJUSTERS FOR SHOULDER BELTS AND STRAPS, HANDLES FOR BAGS AND POUCHES, GRIPS FOR BAGS AND POUCHES, FRAMES FOR BAGS AND POUCHES, HOOKS FOR BELTS AND STRAPS ATTACHED TO BAGS AND POUCHES; HOLDERS FOR BAGS AND POUCHES; PATCHES FOR BELTS AND STRAPS ATTACHED TO BAGS AND POUCHES; BAGS AND POUCHES, NAMELY, GARMENT BAGS FOR TRAVEL, HANDBAGS, NET BAGS FOR SHOPPING, RUCKSACKS, SATCHELS, SCHOOL BAGS, SCHOOL SATCHELS, SHOPPING BAGS, SLING BAGS FOR CARRYING INFANTS, TRAVELING BAGS, TRAVELING TRUNKS, LUGGAGE, VALETS AND WHEELED SHOPPING BAGS; GRIPS FOR BAGS AND POUCHES AND FRAMES FOR BAGS AND POUCHES (U.S. CLS. 1, 2, 3, 22 AND 41).

CLASS 26—FANCY GOODS

FOR BAG AND POUCH FITTINGS, NAMELY BUCKLES NOT OF PRECIOUS METAL; SLIDE FASTENERS; HOOK AND LOOP FASTENERS; ADJUSTABLE FASTENERS; BUTTONS; SNAP BUTTONS; PRESS BUTTONS; STUD BUTTONS; HOOKS AND EYES; EYELETS FOR CLOTHES; EYELETS FOR SHOES; BUCKLES FOR SUSPENDERS; BUCKLES, NAMELY, BELT BUCKLES NOT OF PRECIOUS METAL, BUCKLES FOR CLOTHING ACCESSORIES, AND SHOE BUCKLES; BUCKLES FOR SUSPENDERS; STRAP HOLDERS; SWIVEL HOOKS; SNAP HOOKS; CORD STOPPERS; CORD END STOPPERS; RIBBONS; ELASTIC RIBBONS; TAPES; WEBBING IN THE NATURE OF WOVEN FABRIC TAPES; PATCHES FOR DECORATION OF TEXTILE ARTICLES; BRAIDS; PINS; NEEDLES (U.S. CLS. 37, 39, 40, 42 AND 50).

JAY BESCH, EXAMINING ATTORNEY

SN 76-623,569. FARMER DIRECT CO-OPERATIVE LTD., REGINA, SASKATCHEWAN, CANADA, FILED 12-1-2004.



PRIORITY CLAIMED UNDER SEC. 44(D) ON CANADA APPLICATION NO. 1219619, FILED 6-1-2004, REG. NO. TMA691421, DATED 7-5-2007, EXPIRES 7-5-2022.

CLASS 29—MEATS AND PROCESSED FOODS

FOR MEAT AND PROCESSED MEAT PRODUCTS, NAMELY, BEEF, BISON, PORK AND CHICKEN; FISH, NAMELY, TUNA, SALMON, NORTHERN CARP, WALLEY, PICKEREL, TROUT, BASS, WHITEFISH, SHRIMP, CRAB, LOBSTER; SPECIALTY MEATS; PULSES (U.S. CL. 46).

CLASS 31—NATURAL AGRICULTURAL PRODUCTS

FOR AGRICULTURAL PRODUCTS, NAMELY, UNPROCESSED CEREALS, GRAINS AND PLANT SEEDS, NAMELY, OILSEEDS (U.S. CLS. 1 AND 46).

CLASS 35—ADVERTISING AND BUSINESS

FOR RETAIL STORE AND WHOLESALE DISTRIBUTORSHIP SERVICES FEATURING UNPROCESSED AGRICULTURAL SEEDS FOR CEREAL, GRAINS, PLANT SEEDS, OILSEED AND PULSE FIELD CROPS; COOPERATIVE ADVERTISING AND MARKETING, AND LOGISTICS MANAGEMENT IN THE FIELD OF FARM GRAINS AND VALUE-ADDED FOOD PRODUCTS (U.S. CLS. 100, 101 AND 102).

CLASS 42—SCIENTIFIC, COMPUTER AND LEGAL SERVICES

FOR INSPECTING AGRICULTURAL PRODUCTS IN THE NATURE OF FOOD FOR THE PURPOSE OF CERTIFYING COMPLIANCE THEREOF WITH THE CANADIAN ORGANIC, NOP AND EEC REGULATION 2092/91 ORGANIC STANDARDS (U.S. CLS. 100 AND 101).

RENEE MCCRAY, EXAMINING ATTORNEY

SN 76-646,453. DEUTSCHE MESSE AG, D-30521 HANNOVER, FED REP GERMANY, FILED 9-6-2005.

SN 76-641,719. PRIMORIS, INC., GREENWOOD VILLAGE, CO. FILED 6-28-2005.

SATURN

THE MARK CONSISTS OF STANDARD CHARACTERS WITHOUT CLAIM TO ANY PARTICULAR FONT, STYLE, SIZE, OR COLOR.

CLASS 7—MACHINERY

FOR WAREWASHING EQUIPMENT, NAMELY, COMMERCIAL DISH WASHING MACHINES, POT WASHERS, UNDERCOUNTER AND UPRIGHT DISHWASHING MACHINES; AND FOOD WASTE DISPOSALS; ELECTRIC FOOD PREPARATION EQUIPMENT, NAMELY, CHOPPERS, BLENDERS, SLICERS, MIXERS, AND FOOD PROCESSORS (U.S. CLS. 13, 19, 21, 23, 31, 34 AND 35).

CLASS 11—ENVIRONMENTAL CONTROL APPARATUS

FOR COMMERCIAL FOOD COOKING AND PREPARATION EQUIPMENT, NAMELY, GAS AND ELECTRIC RANGES, GAS AND ELECTRIC OVENS AND CONVECTION OVENS, ELECTRIC MICROWAVE OVENS, GAS AND ELECTRIC DEEP FAT FRYERS; GAS AND ELECTRIC COUNTERTOP COOKING EQUIPMENT, NAMELY GRILLS, GRIDDLES, HOTPLATES, BROILERS, CHEESEMELTERS, SALAMANDERS, CHARBROILERS, TILTING SKILLETS, FOOD STEAMERS, KETTLES, TILTING KETTLES, AND EQUIPMENT STANDS THEREFOR; ELECTRIC TOASTERS; REFRIGERATORS, FREEZERS, UNDERCOUNTER REFRIGERATORS, FREEZERS AND PREPARATION TOPS UNITS FOR PIZZA AND SANDWICHES SOLD AS A COMPONENT THEREOF, REFRIGERATED MERCHANDISE DISPLAY CASES, WALK-IN COOLERS, WALK-IN FREEZERS; ICE MACHINES TO PRODUCE AND HOLD ICE; VENTILATION HOODS FOR RANGE AND FRYER COOKING EQUIPMENT; CABINETS USED TO CONTROL TEMPERATURE AND HUMIDITY FOR HEATING AND PROOFING FOOD GOODS (U.S. CLS. 13, 21, 23, 31 AND 34).

SANJEEV VOHRA, EXAMINING ATTORNEY

domotex

THE MARK CONSISTS OF STANDARD CHARACTERS WITHOUT CLAIM TO ANY PARTICULAR FONT, STYLE, SIZE, OR COLOR.

OWNER OF FED REP GERMANY REG. NO. 2049113, DATED 11-9-1993, RENEWED AS REG. NO. 2049113, DATED 7-29-2003, EXPIRES 7-31-2013.

OWNER OF FED REP GERMANY REG. NO. 1001802, DATED 5-8-1980, RENEWED AS REG. NO. 1001802, DATED 5-1-1999, EXPIRES 4-30-2009.

OWNER OF FED REP GERMANY REG. NO. 1129410, DATED 10-21-1988, RENEWED AS REG. NO. 1129410, DATED 4-1-1998, EXPIRES 3-29-2008.

OWNER OF U.S. REG. NOS. 2,844,226 AND 3,123,815.

CLASS 16—PAPER GOODS AND PRINTED MATTER

FOR PRINTED MATTER, NAMELY, MAGAZINES IN THE FIELD OF CARPETS AND FLOOR COVERINGS AND IN THE FIELD OF TRADE FAIRS AND EXHIBITIONS RELATING TO CARPETS AND FLOOR COVERINGS, CATALOGS IN THE FIELD OF CARPETS AND FLOOR COVERINGS AND IN THE FIELD OF TRADE FAIRS AND EXHIBITIONS RELATING TO CARPETS AND FLOOR COVERINGS, PROSPECTUSES IN THE FIELD OF CARPETS AND FLOOR COVERINGS AND IN THE FIELD OF TRADE FAIRS AND EXHIBITIONS RELATING TO CARPETS AND FLOOR COVERINGS, POSTERS AND PHOTOGRAPHS; PRINTED INSTRUCTIONAL, EDUCATIONAL AND TEACHING MATERIALS IN THE FIELD OF CARPETS AND FLOOR COVERINGS AND IN THE FIELD OF TRADE FAIRS AND EXHIBITIONS RELATING TO CARPETS AND FLOOR COVERINGS (U.S. CLS. 2, 5, 22, 23, 29, 37, 38 AND 50).

FIRST USE 1-15-1990; IN COMMERCE 1-15-1991.

CLASS 35—ADVERTISING AND BUSINESS

FOR ARRANGING AND CONDUCTING OF TRADE FAIRS AND EXHIBITIONS FOR COMMERCIAL OR ADVERTISING PURPOSES IN THE FIELD OF CARPETS AND FLOOR COVERINGS; CONSULTANCY IN THE CONDUCTING AND ORGANIZATION OF COMMERCIAL EXHIBITIONS AND TRADE FAIRS; CONDUCTING AN ON-LINE TRADE SHOW EXHIBITION, IN THE FIELD OF CARPETS AND FLOOR COVERINGS; ARRANGING AND CONDUCTING BUSINESS CONFERENCES; RENTAL OF ADVERTISING SPACE AND EXHIBITION STANDS FOR ADVERTISING PURPOSES; PUBLIC RELATIONS; DIRECT MARKETING ADVERTISING FOR OTHERS, CONDUCTING MARKET RESEARCH AND MARKET ANALYSIS; PRODUCT DEMONSTRATION FOR CULTURAL, TEACHING AND EDUCATIONAL PURPOSES (U.S. CLS. 100, 101 AND 102).

FIRST USE 1-15-1990; IN COMMERCE 1-15-1991.

CLASS 41—EDUCATION AND ENTERTAINMENT

FOR ARRANGING AND CONDUCTING OF CONFERENCES AND SYMPOSIA FOR CULTURAL, TEACHING AND EDUCATIONAL PURPOSES; CONGRESSES, SYMPOSIUMS AND COMPETITIONS FOR CULTURAL, TEACHING AND EDUCATIONAL PURPOSES; PUBLICATION OF JOURNALS, CATALOGS, BROCHURES; ORGANIZATION, ARRANGING AND CONDUCTING OF EDUCATIONAL EXHIBITIONS IN THE FIELD OF CARPETS AND FLOOR COVERINGS (U.S. CLS. 100, 101 AND 107).

FIRST USE 1-15-1990; IN COMMERCE 1-15-1991.
JOHN SCHUYLER YARD, EXAMINING ATTORNEY

CLASS 12—VEHICLES

FOR TRUCK ACCESSORIES THAT ARE IN THE SHAPE OF TESTICLES, NAMELY TRAILER HITCH COVERS (U.S. CLS. 19, 21, 23, 31, 35 AND 44).

FIRST USE 1-1-1993; IN COMMERCE 1-1-1993.

CLASS 20—FURNITURE AND ARTICLES NOT OTHERWISE CLASSIFIED

FOR NON-METAL AND NON-LEATHER KEY CHAINS THAT ARE IN SHAPE OF TESTICLES (U.S. CLS. 2, 13, 22, 25, 32 AND 50).

FIRST USE 1-1-1993; IN COMMERCE 1-1-1993.
ROBERT STRUCK, EXAMINING ATTORNEY

SN 76-648,149. ATOMIC PROPS & EFFECTS, LTD. LLC, ST. PAUL, MN. FILED 10-7-2005.

RED 24

THE MARK CONSISTS OF STANDARD CHARACTERS WITHOUT CLAIM TO ANY PARTICULAR FONT, STYLE, SIZE, OR COLOR.

CLASS 9—ELECTRICAL AND SCIENTIFIC APPARATUS

FOR WOMAN'S FASHION ACCESSORIES, NAMELY, CELL PHONE HOLDERS (U.S. CLS. 21, 23, 26, 36 AND 38).

CLASS 18—LEATHER GOODS

FOR WOMAN'S FASHION ACCESSORIES, NAMELY, PURSES AND WALLETS (U.S. CLS. 1, 2, 3, 22 AND 41).

CLASS 25—CLOTHING

FOR WOMEN'S FASHION ACCESSORIES, NAMELY, BELTS, SCARVES, HATS, SHIRTS AND PANTS (U.S. CLS. 22 AND 39).

INGRID C. EULIN, EXAMINING ATTORNEY

SN 76-649,263. DAVID HAM, SANTEE, CA. FILED 10-21-2005.



THE COLOR(S) RED, BLACK AND WHITE IS/ARE CLAIMED AS A FEATURE OF THE MARK.

THE COLOR RED APPEARS IN THE OUTLINE OF THE LETTERING IN THE MARK AND THE DESIGN FEATURE BEHIND THE MARK. THE COLOR BLACK APPEARS IN THE LETTERING IN THE MARK. THE COLOR WHITE APPEARS IN THE BACKGROUND OF THE MARK.

SN 76-649,859. STANLEY, JAMES M., NAPLES, FL. FILED 11-7-2005.



NO CLAIM IS MADE TO THE EXCLUSIVE RIGHT TO USE "DOOR" AND "MAHOGANY IMPACT SYSTEMS", APART FROM THE MARK AS SHOWN.

CLASS 6—METAL GOODS

FOR METAL DOOR BOLTS (U.S. CLS. 2, 12, 13, 14, 23, 25 AND 50).

FIRST USE 1-31-2005; IN COMMERCE 1-31-2005.

CLASS 19—NON-METALLIC BUILDING MATERIALS

FOR WOOD DOORS; NON-METAL DOORS (U.S. CLS. 1, 12, 33 AND 50).

FIRST USE 1-31-2005; IN COMMERCE 1-31-2005.
ANNE MADDEN, EXAMINING ATTORNEY

SN 76-650,079. W. S. SPOTSWOOD & SONS, INC., SPRINGFIELD, VA. FILED 11-9-2005.

GOVTOOLS

THE MARK CONSISTS OF STANDARD CHARACTERS WITHOUT CLAIM TO ANY PARTICULAR FONT, STYLE, SIZE, OR COLOR.

CLASS 37—CONSTRUCTION AND REPAIR

FOR CONSULTING SERVICES IN THE FIELD OF SELECTION, IMPLEMENTATION AND USE OF BUILDING HARDWARE AND CONSTRUCTION GOODS (U.S. CLS. 100, 103 AND 106).

FIRST USE 11-10-2005; IN COMMERCE 11-10-2005.

CLASS 42—SCIENTIFIC, COMPUTER AND LEGAL SERVICES

FOR CONSULTING SERVICES IN THE FIELD OF DESIGN OF BUILDING HARDWARE AND CONSTRUCTION GOODS (U.S. CLS. 100 AND 101).

FIRST USE 11-10-2005; IN COMMERCE 11-10-2005.
PATRICIA EVANKO, EXAMINING ATTORNEY

SN 76-652,194. YAMAHA CORPORATION, SHIZUOKA 430, JAPAN, FILED 12-19-2005.

DISKLAVIERRADIO

THE MARK CONSISTS OF STANDARD CHARACTERS WITHOUT CLAIM TO ANY PARTICULAR FONT, STYLE, SIZE, OR COLOR.

OWNER OF U.S. REG. NOS. 1,756,737 AND 2,586,495.

CLASS 15—MUSICAL INSTRUMENTS

FOR PIANOS; AUTOMATICALLY PLAYING PIANOS (U.S. CLS. 2, 21 AND 36).

CLASS 38—COMMUNICATION

FOR STREAMING OF AUDIO MATERIAL ON THE INTERNET; STREAMING OF AUDIO MATERIAL THROUGH THE MUSICAL INSTRUMENTS CONNECTED DIRECTLY TO THE INTERNET; INTERNET RADIO STREAMING SERVICES, NAMELY, STREAMING OF AUDIO MATERIAL ON THE INTERNET ESPECIALLY THROUGH BUILT IN COMPUTERS IN MUSICAL INSTRUMENTS (U.S. CLS. 100, 101 AND 104).

CLASS 41—EDUCATION AND ENTERTAINMENT

FOR PRESENTATION OF LIVE SHOW PERFORMANCES ON-LINE VIA A GLOBAL COMPUTER NETWORK; ENTERTAINMENT SERVICES, NAMELY, PROVIDING INFORMATION IN THE FIELD OF MUSIC; ENTERTAINMENT SERVICES, NAMELY, PROVIDING PRERECORDED MUSIC; PROVIDING NON-DOWNLOADABLE DIGITAL MUSIC FROM A GLOBAL COMPUTER NETWORK; PROVIDING AN ON-LINE COMPUTER DATABASE FEATURING INFORMATION REGARDING SOUND DATA; PROVIDING AN ON-LINE COMPUTER DATABASE FEATURING INFORMATION REGARDING MUSIC, IMAGES AND COMPUTER GAMES VIA A GLOBAL COMPUTER NETWORK, CELLULAR PHONES, AND OTHER COMMUNICATION MEDIA (U.S. CLS. 100, 101 AND 107).

DAWN HAN, EXAMINING ATTORNEY

SN 76-654,050. KURARAY CO., LTD., OKAYAMA PREFECTURE, JAPAN, FILED 1-25-2006.

TIRRONINA

PRIORITY CLAIMED UNDER SEC. 44(D) ON JAPAN APPLICATION NO. 2005-114352, FILED 12-6-2005, REG. NO. 4962479, DATED 6-16-2006, EXPIRES 6-16-2016.

CLASS 12—VEHICLES

FOR VESSELS, NAMELY, SHIPS, BOATS AND STRUCTURAL PARTS THEREFOR; AIRCRAFT, NAMELY, AIRPLANES AND STRUCTURAL PARTS THEREFOR; RAILWAY VEHICLES, NAMELY, TRAINS AND STRUCTURAL PARTS THEREFOR; AUTOMOBILES AND STRUCTURAL PARTS THEREFOR; TWO-WHEELED MOTOR VEHICLES, NAMELY, MOTORCYCLES AND STRUCTURAL PARTS THEREFOR; BICYCLES AND STRUCTURAL PARTS THEREFOR; VEHICLE SEAT COVERS OF TEXTILE (U.S. CLS. 19, 21, 23, 31, 35 AND 44).

CLASS 18—LEATHER GOODS

FOR LEATHER SOLD IN BULK; IMITATION LEATHER SOLD IN BULK; BAGS, NAMELY, FOLDING BRIEFCASES, SHOULDER BAGS, GLADSTONE BAGS, BRIEFCASES, SUITCASES, CARRY-ON BAGS, TRUNKS, HANDBAGS, BOSTON BAGS, SCHOOLCHILDREN'S BACKPACKS, RUCKSACKS, ATTACHE CASES, TOTE BAGS, TRAVELING BAGS, LEATHER SHOPPING BAGS, SATCHELS, SCHOOL BAGS, SCHOOL SATCHELS, BACKPACKS, KNAPSACKS, AND SPORTS BAGS; POUCHES, NAMELY, JAPANESE CHARM BAGS IN THE NATURE OF OMAMORI-IRE, BUSINESS CARD CASES, PURSES, KEY CASES, WALLETS, JAPANESE UTILITY POUCHES IN THE NATURE OF SHINGEN-BUKURO, PASS CASES, AND NAME CARD CASES; PURSE CLASPS ON PURSE FRAMES; VANITY CASES, SOLD EMPTY; UMBRELLAS AND THEIR PARTS, NAMELY, HANDLES AND COVERS; WALKING STICKS; CANES; HANDLES OF CANES AND WALKING-STICKS; SADDLERY; CLOTHING FOR DOMESTIC ANIMALS; LEATHER CLOTH, NAMELY, LEATHER AND IMITATION LEATHER (U.S. CLS. 1, 2, 3, 22 AND 41).

CLASS 20—FURNITURE AND ARTICLES NOT OTHERWISE CLASSIFIED

FOR FURNITURE; CUSHIONS; ZABUTON, NAMELY, JAPANESE FLOOR CUSHIONS; PILLOWS; MATTRESSES; PORTABLE BEDS FOR HOUSEHOLD PETS; SLEEPING BAGS FOR CAMPING; FUTONS; WINDOW BLINDS OF TEXTILE; FITTED FUTON COVERS; SEAT COVERS OF TEXTILE, NAMELY FABRIC CHAIR MATS IN THE NATURE OF A PILLOW OR SEAT LINER (U.S. CLS. 2, 13, 22, 25, 32 AND 50).

CLASS 24—FABRICS

FOR WOVEN FABRICS; KNITTED FABRICS; FELT AND NON-WOVEN TEXTILE FABRICS; OILCLOTH; GUMMED WATERPROOF CLOTH; RUBBERIZED CLOTH; PERSONAL ARTICLES OF WOVEN TEXTILE NOT FOR WEAR, NAMELY, TOWELS AND HANDKERCHIEFS; MOSQUITO NETS; BED SHEETS; QUILTS; UNFITTED FABRIC FUTON COVERS; FABRIC QUILT COVERS; UNSTUFFED FUTON TICKS; PILLOWCASES; BED BLANKETS; TABLE NAPKINS OF TEXTILE; DISH CLOTHS; SHOWER CURTAINS; CLOTH BANNERS AND CLOTH FLAGS; TOILET SEAT COVERS OF TEXTILE; WALL HANGINGS OF TEXTILE; FABRIC FOR VERTICAL BLINDS; CURTAINS OF TEXTILE; TABLE CLOTHS NOT OF PAPER; DRAPERIES; BED SPREADS; SHROUDS FOR WRAPPING CORPSES; JAPANESE SHROUDS FOR DRESSING A CORPSE FOR FUNERAL IN THE FORM OF KYOKATABIRA KIMONO (U.S. CLS. 42 AND 50).

CLASS 25—CLOTHING

FOR CLOTHING, NAMELY, OUTERWEAR, NAMELY, RAINWEAR AND SNOW PANTS, DRESSES; CHILDREN'S WEARS, NAMELY, JUMPSUITS, SHIRTS AND PANTS, LIVERIES, NAMELY, LIVERY UNIFORMS, JACKETS, JOGGING PANTS, SWEAT PANTS, SUITS, SKIRTS, SKI JACKETS, SKI PANTS, TROUSERS, SMOCKS; FORMALWEAR, NAMELY, TUXEDOS, TUXEDO SHIRTS, CUMMERBUNDS, BOW TIES, VESTS, GOWNS, AND TIES FOR CLOTHING, COATS, MANTLES, RAINWEAR, SNOW PANTS, SWEATERS, CARDIGANS, VESTS AND WAISTCOATS, SHIRTS, BLOUSES, NIGHTGOWNS, NEGLIGEEES; NIGHTWEAR, NAMELY, NIGHT GOWNS AND NIGHT SHIRTS, PAJAMAS, AND ROBES, UNDERWEAR; SWIMWEAR, SWIMMING CAPS; JAPANESE TRADITIONAL CLOTHING, NAMELY, JAPANESE KIMONOS; APRONS FOR WEAR, COLLAR PROTECTORS FOR WEAR, SOCKS, STOCKINGS, SHAWLS, SCARVES, GLOVES AND MITTENS, NECKTIES, NECKERCHIEFS, MUFFLERS, EAR MUFFS; HEADGEAR, NAMELY, CAPS, HATS AND VISORS; GARTERS, SUSPENDERS, WAISTBANDS, BELTS FOR CLOTHING; FOOTWEAR; MASQUERADE COSTUMES; CLOTHES FOR SPORTS, NAMELY, SHORTS, SHIRTS, ANORAKS, WIND AND RAIN RESISTANT JACKETS, SKI SUITS, JACKETS, VESTS, SPORTS TEAM UNIFORMS, HOSIERY AND STOCKINGS, WRISTBANDS; GYMNASTIC WEAR, NAMELY, TIGHTS AND PULL-OVERS, ALL FOR SPORTS; FOOTWEAR FOR SPORTS, NAMELY, GOLF SHOES, SOCCER SHOES, SKI BOOTS, GYMNASTIC SHOES, TENNIS SHOES, CLIMBING BOOTS, BASKETBALL SNEAKERS, VOLLEYBALL SHOES, HANDBALL SHOES, BOWLING SHOES, BOXING SHOES, HOCKEY SHOES, BASEBALL SHOES, RUGBY SHOES, FOOTWEAR FOR TRACK AND FIELD ATHLETICS, AND HORSE-RIDING BOOTS (U.S. CLS. 22 AND 39).

CLASS 28—TOYS AND SPORTING GOODS

FOR TOYS, NAMELY, STUFFED TOYS; DOLLS; TOYS FOR DOMESTIC PETS; SPORTS EQUIPMENT, NAMELY, BALLS FOR SPORTS, PROTECTIVE PADDING FOR PLAYING FOOTBALL, HOCKEY AND BASEBALL; GOLF BAGS, AND RACKET CASES FOR TENNIS AND BADMINTON; WARMTH-KEEPING ATHLETIC SUPPORTERS; GLOVES FOR SPORTS AND GAMES, NAMELY, BASEBALL BATTING GLOVES, BASEBALL GLOVES, BATTING GLOVES, BOWLING GLOVES, BOXING GLOVES, GAUNTLETS (GLOVES FOR ARCHERY), GOALKEEPER'S GLOVES, GOLF GLOVES, HANDBALL GLOVES, HOCKEY GLOVES, KARATE GLOVES, RACQUET BALL GLOVES, SKY DIVING GLOVES, SOFTBALL GLOVES, SWIMMING GLOVES, WATERSKI GLOVES, WEIGHT LIFTING GLOVES, WINDSURFING GLOVES, WORK-OUT GLOVES (U.S. CLS. 22, 23, 38 AND 50).

DAWN HAN, EXAMINING ATTORNEY

CLASS 9—ELECTRICAL AND SCIENTIFIC APPARATUS

FOR ELECTRONIC BIBLES THAT ARE DOWNLOADABLE OR RECORDED ON COMPUTER MEDIA; ELECTRONIC BOOKS FEATURING RELIGIOUS ISSUES THAT ARE DOWNLOADABLE OR RECORDED ON COMPUTER MEDIA; ELECTRONIC BIBLICAL REFERENCES THAT ARE DOWNLOADABLE OR RECORDED ON COMPUTER MEDIA (U.S. CLS. 21, 23, 26, 36 AND 38).

CLASS 16—PAPER GOODS AND PRINTED MATTER

FOR BIBLES, BIBLE STUDY GUIDES, BIBLE REFERENCE BOOKS, BOOKS ABOUT BIBLICAL ISSUES (U.S. CLS. 2, 5, 22, 23, 29, 37, 38 AND 50).

DORITT L. CARROLL, EXAMINING ATTORNEY

SN 76-658,565. CHURCH BUILDERS MINISTRIES, INC., DBA BELIEVERS CENTER OF ALBUQUERQUE, ALBUQUERQUE, NEW MEXICO, MEXICO, FILED 4-17-2006.

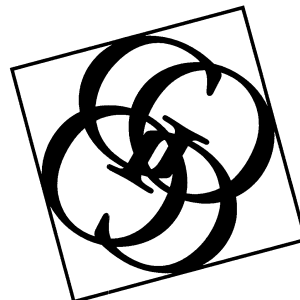

THE MARK CONSISTS OF A TILTED SQUARE WITH THE WORDS "GO GO" INSIDE THE SQUARE WITH THE LETTERS INTERLOCKING TO CREATE A STYLIZED DISPLAY OF THE WORDS "GO GO."

CLASS 16—PAPER GOODS AND PRINTED MATTER

FOR PUBLICATIONS— NAMELY STUDY GUIDES, MANUALS, NEWSLETTERS, MAGAZINES, ALL IN THE FIELD OF CHRISTIAN RELIGION (U.S. CLS. 2, 5, 22, 23, 29, 37, 38 AND 50).

FIRST USE 10-0-1992; IN COMMERCE 4-0-1993.

CLASS 25—CLOTHING

FOR T-SHIRTS (U.S. CLS. 22 AND 39).

FIRST USE 10-0-1992; IN COMMERCE 4-0-1993.
RENEE SERVANCE, EXAMINING ATTORNEY

SN 76-654,877. THOMAS NELSON, INC., NASHVILLE, TN. FILED 2-10-2006.



EDITORIAL CARIBE

NO CLAIM IS MADE TO THE EXCLUSIVE RIGHT TO USE "EDITORIAL CARIBE", APART FROM THE MARK AS SHOWN.

THE ENGLISH TRANSLATION OF THE WORDING "EDITORIAL CARIBE" IN THE MARK IS CARIBBEAN PUBLISHERS.

SN 76-659,285. TOUR EAST HOLIDAYS (CANADA) INC., TORONTO, ONTARIO, CANADA, FILED 4-28-2006.

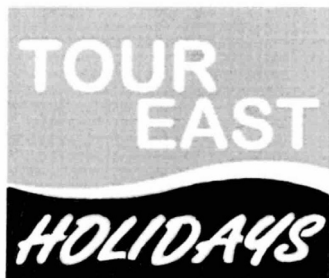

OWNER OF CANADA REG. NO. TMA662789, DATED 4-19-2006, EXPIRES 4-19-2021.

NO CLAIM IS MADE TO THE EXCLUSIVE RIGHT TO USE "TOUR" AND "HOLIDAYS", APART FROM THE MARK AS SHOWN.

CLASS 16—PAPER GOODS AND PRINTED MATTER

FOR PRINTED MATERIALS, NAMELY, TRAVEL BROCHURES, TRAVEL FLYERS AND TRAVEL PAMPHLETS, PENS (U.S. CLS. 2, 5, 22, 23, 29, 37, 38 AND 50).

CLASS 25—CLOTHING

FOR T-SHIRTS (U.S. CLS. 22 AND 39).

CLASS 39—TRANSPORTATION AND STORAGE

FOR TRAVEL AGENCY SERVICES, NAMELY, MAKING RESERVATIONS AND BOOKINGS FOR TRANSPORTATION AND TOURS; ARRANGING TRAVEL TOURS; TRAVEL BOOKING AGENCY SERVICES; TRAVEL INFORMATION SERVICES; WHOLESALE TRAVEL AGENCY SERVICES, NAMELY, ASSEMBLING TOUR PACKAGES THAT COVER TRANSPORTATION, SIGHT-SEEING, TOURS, MEALS AND TEMPORARY LODGINGS (U.S. CLS. 100 AND 105).

CLASS 43—HOTEL AND RESTAURANT SERVICES

FOR TRAVEL AGENCY SERVICES, NAMELY, MAKING RESERVATIONS AND BOOKINGS FOR TEMPORARY LODGING; WHOLESALE TRAVEL AGENCY SERVICES, NAMELY, MAKING RESERVATIONS AND BOOKINGS FOR TEMPORARY LODGINGS (U.S. CLS. 100 AND 101).

ALLISON HOLTZ, EXAMINING ATTORNEY

SN 76-661,931. BLANKLEY, ALISON LEIGH, LOS ANGELES, CA. FILED 6-21-2006.

Hazel Brown

THE MARK CONSISTS OF STANDARD CHARACTERS WITHOUT CLAIM TO ANY PARTICULAR FONT, STYLE, SIZE, OR COLOR.

THE NAME(S), PORTRAIT(S), AND/OR SIGNATURE(S) SHOWN IN THE MARK DOES NOT IDENTIFY A PARTICULAR LIVING INDIVIDUAL.

CLASS 18—LEATHER GOODS

FOR HANDBAGS, LUGGAGE, WALLETS (U.S. CLS. 1, 2, 3, 22 AND 41).
FIRST USE 7-0-2004; IN COMMERCE 7-0-2004.

CLASS 25—CLOTHING

FOR PANTS, SKIRTS, DRESSES, BLOUSES, T-SHIRTS, COATS, JACKETS, UNDERWEAR, SOCKS, HATS (U.S. CLS. 22 AND 39).
FIRST USE 7-0-2004; IN COMMERCE 7-0-2004.
SCOTT BIBB, EXAMINING ATTORNEY

SN 76-663,526. COLLINS, ANNE FRANCES, ENGLAND, UNITED KINGDOM, FILED 7-24-2006.



PRIORITY CLAIMED UNDER SEC. 44(D) ON ERPNTY TM OFC APPLICATION NO. 5077151, FILED 4-26-2006, REG. NO. 005077151, DATED 4-3-2007, EXPIRES 4-26-2016.

THE MARK CONSISTS OF THE WORDING COLLINSIAN CONCEPTS, CLASSROOM IN A SUITCASE CRIASC ARRANGED IN A SQUARE WITHIN WHICH THE STYLIZED LETTERS KD APPEAR WITH AN ANGLED CROWN ABOVE THE UPPER LEFT HAND CORNER OF THE LETTER D.

CLASS 9—ELECTRICAL AND SCIENTIFIC APPARATUS

FOR AN ELECTRONIC AID FOR TEACHING IN THE FIELD OF MUSIC COMPRISING A SENSOR AND DISPLAY FOR VISUALLY SHOWING FORM VARIATIONS OF MUSICAL NOTATION (U.S. CLS. 21, 23, 26, 36 AND 38).

CLASS 16—PAPER GOODS AND PRINTED MATTER

FOR BOOKS, BROCHURES, GUIDES AND MAGAZINES, ALL IN THE FIELD OF TEACHING MUSIC AND PRINTED INSTRUCTIONAL AND TEACHING MATERIAL IN THE FIELD OF MUSIC INSTRUCTION (U.S. CLS. 2, 5, 22, 23, 29, 37, 38 AND 50).

LINDA ESTRADA, EXAMINING ATTORNEY

SN 76-664,175. ELKIN,LARRY M., SCARSDALE, NY. FILED 8-4-2006.

PALISADES HUDSON ASSET MANAGEMENT, INC.

THE MARK CONSISTS OF STANDARD CHARACTERS WITHOUT CLAIM TO ANY PARTICULAR FONT, STYLE, SIZE, OR COLOR.

NO CLAIM IS MADE TO THE EXCLUSIVE RIGHT TO USE ASSET MANAGEMENT, INC., APART FROM THE MARK AS SHOWN.

CLASS 35—ADVERTISING AND BUSINESS

FOR TAX AND BUSINESS CONSULTATION SERVICES (U.S. CLS. 100, 101 AND 102).
FIRST USE 11-12-1997; IN COMMERCE 11-12-1997.

CLASS 36—INSURANCE AND FINANCIAL

FOR ESTATE PLANNING AND INVESTMENT CONSULTATION (U.S. CLS. 100, 101 AND 102).
FIRST USE 11-12-1997; IN COMMERCE 11-12-1997.
STEPHANIE ALI, EXAMINING ATTORNEY

SN 76-664,388. CROSS COUNTRY HOME SERVICES, INC., FT. LAUDERDALE, FL. FILED 8-9-2006.

ALWAYS WORKING

THE MARK CONSISTS OF STANDARD CHARACTERS WITHOUT CLAIM TO ANY PARTICULAR FONT, STYLE, SIZE, OR COLOR.

CLASS 35—ADVERTISING AND BUSINESS

FOR PROVIDING HOMEOWNER AND HOME-RELATED ASSISTANCE PROGRAMS, NAMELY, REFERRAL SERVICES IN THE FIELD OF HOME MAINTENANCE AND REPAIR (U.S. CLS. 100, 101 AND 102).

CLASS 36—INSURANCE AND FINANCIAL

FOR PROVIDING HOME WARRANTY AND HOME SERVICE CONTRACTS IN THE FIELD OF HOME MAINTENANCE AND REPAIR (U.S. CLS. 100, 101 AND 102).
SUSAN STIGLITZ, EXAMINING ATTORNEY

SN 76-664,624. RHINO-HIDE, L.L.C., LAKELAND, FL. FILED 8-15-2006.

ROCKET BOND

THE MARK CONSISTS OF STANDARD CHARACTERS WITHOUT CLAIM TO ANY PARTICULAR FONT, STYLE, SIZE, OR COLOR.

OWNER OF U.S. REG. NOS. 2,985,122, 3,250,159 AND OTHERS.

NO CLAIM IS MADE TO THE EXCLUSIVE RIGHT TO USE "BOND", APART FROM THE MARK AS SHOWN.

CLASS 1—CHEMICALS

FOR ADHESIVE AND REPAIR MATERIALS, NAMELY POLYURETHANE ADHESIVES, INDUSTRIAL ADHESIVES FOR USE IN COATING AND SEALING, EPOXY GLUE FOR GENERAL BONDING AND REPAIR PURPOSES, FILLER FOR AUTOMOTIVE BODY REPAIR, SYNTHETIC POLYMER MODIFIED RESIN COMPOUND FOR USE IN CEMENTITIOUS REPAIRS; REPAIR MATERIALS, NAMELY ADHESIVE FOR SHOE SOLE REPAIR (U.S. CLS. 1, 5, 6, 10, 26 AND 46).

CLASS 3—COSMETICS AND CLEANING PREPARATIONS

FOR ADHESIVE MATERIALS, NAMELY HAIR BONDING GLUE FOR AFFIXING FALSE HAIR (U.S. CLS. 1, 4, 6, 50, 51 AND 52).

CLASS 16—PAPER GOODS AND PRINTED MATTER

FOR ADHESIVE MATERIALS NAMELY, BONDING ADHESIVE FOR HOUSEHOLD PURPOSES (U.S. CLS. 2, 5, 22, 23, 29, 37, 38 AND 50).

CLASS 19—NON-METALLIC BUILDING MATERIALS

FOR ADHESIVE AND REPAIR MATERIALS, NAMELY ADHESIVE MORTAR FOR BUILDING PURPOSES (U.S. CLS. 1, 12, 33 AND 50).
REBECCA POVARCHUK, EXAMINING ATTORNEY

SN 76-664,644. SAUL-ROBINSON, KERI, BROOKLYN, NY. AND WILLIAMS, NKINGE, BROOKLYN, NY. FILED 8-16-2006.

WHEREIZ

THE MARK CONSISTS OF STANDARD CHARACTERS WITHOUT CLAIM TO ANY PARTICULAR FONT, STYLE, SIZE, OR COLOR.

CLASS 42—SCIENTIFIC, COMPUTER AND LEGAL SERVICES

FOR COMPUTER SERVICES, NAMELY, CREATING INDEXES OF INFORMATION, SITES AND OTHER RESOURCES AVAILABLE ON COMPUTER NETWORKS (U.S. CLS. 100 AND 101).

CLASS 45—PERSONAL SERVICES

FOR INTERNET BASED SOCIAL NETWORKING SERVICES (U.S. CLS. 100 AND 101).
MICHAEL SOUDERS, EXAMINING ATTORNEY

SN 76-664,645. SAUL-ROBINSON, KERI, BROOKLYN, NY. AND WILLIAMS, NKINGE, BROOKLYN, NY. FILED 8-16-2006.

THE BEST OF EVERYTHING

THE MARK CONSISTS OF STANDARD CHARACTERS WITHOUT CLAIM TO ANY PARTICULAR FONT, STYLE, SIZE, OR COLOR.

CLASS 42—SCIENTIFIC, COMPUTER AND LEGAL SERVICES

FOR COMPUTER SERVICES, NAMELY CREATING INDEXES OF INFORMATION, SITES AND OTHER RESOURCES AVAILABLE ON COMPUTER NETWORKS (U.S. CLS. 100 AND 101).

CLASS 45—PERSONAL SERVICES

FOR INTERNET BASED SOCIAL NETWORKING SERVICES (U.S. CLS. 100 AND 101).
MICHAEL SOUDERS, EXAMINING ATTORNEY

SN 76-665,312. LANGUAGE COMPUTER CORPORATION, RICHARDSON, TX. FILED 8-29-2006.

POWER ANSWER

THE MARK CONSISTS OF STANDARD CHARACTERS WITHOUT CLAIM TO ANY PARTICULAR FONT, STYLE, SIZE, OR COLOR.

NO CLAIM IS MADE TO THE EXCLUSIVE RIGHT TO USE "ANSWER", APART FROM THE MARK AS SHOWN.

CLASS 9—ELECTRICAL AND SCIENTIFIC APPARATUS

FOR COMPUTER SOFTWARE AND SOFTWARE DEVELOPMENT TOOLS THAT IMPLEMENT AND INTEGRATE MULTILINGUAL NATURAL LANGUAGE PROCESSING AND INFORMATION EXTRACTION ARCHITECTURES FOR QUESTION ANSWERING, SUMMARIZATION, KNOWLEDGE ACQUISITION, INFORMATION/RESOURCE DISCOVERY AND TEXT UNDERSTANDING (U.S. CLS. 21, 23, 26, 36 AND 38).
FIRST USE 0-0-2002; IN COMMERCE 0-0-2002.

CLASS 42—SCIENTIFIC, COMPUTER AND LEGAL SERVICES

FOR PROVIDING INFORMATION TECHNOLOGY SERVICES, NAMELY, RESEARCHING, DEVELOPING, IMPLEMENTING, INTEGRATING, MANAGING AND MAINTAINING AUTOMATED ONLINE, OPEN-DOMAIN, KNOWLEDGE MANAGEMENT SOFTWARE SYSTEMS THAT IMPLEMENT AND INTEGRATE MULTILINGUAL NATURAL LANGUAGE PROCESSING AND INFORMATION EXTRACTION ARCHITECTURES FOR QUESTION ANSWERING, SUMMARIZATION, KNOWLEDGE ACQUISITION, INFORMATION/RESOURCES DISCOVERY AND TEXT UNDERSTANDING (U.S. CLS. 100 AND 101).

FIRST USE 0-0-2002; IN COMMERCE 0-0-2002.
RUSS HERMAN, EXAMINING ATTORNEY

SN 76-665,313. LANGUAGE COMPUTER CORPORATION, RICHARDSON, TX. FILED 8-29-2006.

**LANGUAGE
COMPUTER** 

NO CLAIM IS MADE TO THE EXCLUSIVE RIGHT TO USE "LANGUAGE COMPUTER", APART FROM THE MARK AS SHOWN.

CLASS 9—ELECTRICAL AND SCIENTIFIC APPARATUS

FOR COMPUTER SOFTWARE AND SOFTWARE DEVELOPMENT TOOLS THAT IMPLEMENT AND INTEGRATE MULTILINGUAL NATURAL LANGUAGE PROCESSING AND INFORMATION EXTRACTION ARCHITECTURES FOR QUESTION ANSWERING, SUMMARIZATION, KNOWLEDGE ACQUISITION, INFORMATION/RESOURCE DISCOVERY AND TEXT UNDERSTANDING (U.S. CLS. 21, 23, 26, 36 AND 38).
FIRST USE 12-15-2002; IN COMMERCE 12-15-2002.

CLASS 42—SCIENTIFIC, COMPUTER AND LEGAL SERVICES

FOR PROVIDING INFORMATION TECHNOLOGY SERVICES, NAMELY, RESEARCHING, DEVELOPING, IMPLEMENTING, INTEGRATING, MANAGING AND MAINTAINING AUTOMATED ONLINE, OPEN-DOMAIN, KNOWLEDGE MANAGEMENT SOFTWARE SYSTEMS THAT IMPLEMENT AND INTEGRATE MULTILINGUAL NATURAL LANGUAGE PROCESSING AND INFORMATION EXTRACTION ARCHITECTURES FOR QUESTION ANSWERING, SUMMARIZATION, KNOWLEDGE ACQUISITION, INFORMATION/RESOURCES DISCOVERY AND TEXT UNDERSTANDING (U.S. CLS. 100 AND 101).

FIRST USE 0-0-2002; IN COMMERCE 0-0-2002.
RUSS HERMAN, EXAMINING ATTORNEY

SN 76-665,433. BBMECHANICS, INC., DBA BROADBAND MECHANICS, WALNUT CREEK, CA. FILED 8-31-2006.

PEOPLEAGGREGATOR

THE MARK CONSISTS OF STANDARD CHARACTERS WITHOUT CLAIM TO ANY PARTICULAR FONT, STYLE, SIZE, OR COLOR.

CLASS 9—ELECTRICAL AND SCIENTIFIC APPARATUS

FOR DOWNLOADABLE COMPUTER SOFTWARE FOR USE IN INTER-CONNECTING SOCIAL NETWORKS AND COMMUNITIES ON THE INTERNET; FOR USE IN CREATING A SOCIAL NETWORKING COMMUNITY ON THE INTERNET (U.S. CLS. 21, 23, 26, 36 AND 38).
FIRST USE 6-29-2006; IN COMMERCE 6-27-2007.

CLASS 42—SCIENTIFIC, COMPUTER AND LEGAL SERVICES

FOR COMPUTER SERVICES, NAMELY HOSTING ONLINE WEB FACILITIES FOR OTHERS FOR SOCIAL NETWORKING (U.S. CLS. 100 AND 101).

FIRST USE 6-29-2006; IN COMMERCE 6-29-2006.
KATHRYN COWARD, EXAMINING ATTORNEY

SN 76-665,739. PORT SONOMA ASSOCIATES LLC, SANTA ROSA, CA. FILED 9-8-2006.



NO CLAIM IS MADE TO THE EXCLUSIVE RIGHT TO USE "PORT SONOMA", APART FROM THE MARK AS SHOWN.

CLASS 36—INSURANCE AND FINANCIAL

FOR REAL PROPERTY MANAGEMENT SERVICES (U.S. CLS. 100, 101 AND 102).

CLASS 37—CONSTRUCTION AND REPAIR

FOR REAL ESTATE DEVELOPMENT SERVICES (U.S. CLS. 100, 103 AND 106).
JORDAN BAKER, EXAMINING ATTORNEY

SN 76-665,874. SHUSTER LABORATORIES, INC., CANTON, MA. FILED 9-8-2006.



OWNER OF U.S. REG. NOS. 1,341,396, 2,529,494 AND OTHERS.

NO CLAIM IS MADE TO THE EXCLUSIVE RIGHT TO USE "QUALITY TESTED" AND "LABS", APART FROM THE MARK AS SHOWN.

CLASS 35—ADVERTISING AND BUSINESS

FOR REVIEW OF ASSOCIATED PRODUCTION AND DISTRIBUTION FACILITIES, CONTENT, PACKAGING, LABELING AND DISTRIBUTION, ASSOCIATED WITH DIETARY SUPPLEMENT TESTING SERVICES, FOR INCREASING CONSUMER CONFIDENCE IN THE QUALITY OF THE DIETARY SUPPLEMENTS AND HERBAL/BOTANICAL PRODUCTS OF OTHERS (U.S. CLS. 100, 101 AND 102).
FIRST USE 1-31-2005; IN COMMERCE 1-31-2005.

CLASS 42—SCIENTIFIC, COMPUTER AND LEGAL SERVICES

FOR DIETARY SUPPLEMENT TESTING SERVICES, NAMELY, ANALYTICAL, PHYSICAL, CHEMICAL, MICROBIOLOGICAL, AND SENSORY TESTING OF THE DIETARY SUPPLEMENTS AND HERBAL/BOTANICAL PRODUCTS OF OTHERS (U.S. CLS. 100 AND 101).
FIRST USE 1-31-2005; IN COMMERCE 1-31-2005.
AMEETA JORDAN, EXAMINING ATTORNEY

SN 76-666,273. MISTER CARTOON HOLDINGS LLC, LOS ANGELES, CA. FILED 9-19-2006.

MR. CARTOON

THE MARK CONSISTS OF STANDARD CHARACTERS WITHOUT CLAIM TO ANY PARTICULAR FONT, STYLE, SIZE, OR COLOR.

CLASS 3—COSMETICS AND CLEANING PREPARATIONS

FOR GENERAL PURPOSE CLEANING, POLISHING, AND ABRASIVE LIQUIDS AND POWDERS; SCOURING PREPARATIONS, NAMELY, SCOURING LIQUIDS AND POWDERS; HAND SOAPS; LIQUID SOAPS FOR HANDS, FACE AND BODY; PERFUMERY; PERFUMES; TOILET WATER; ESSENTIAL OILS FOR PERSONAL USE; COSMETICS; HAIR LOTIONS; DENTIFRICES; DEODORANTS FOR PERSONAL USE; CLEANSING MILK FOR TOILETRY PURPOSES; TALCUM POWDER; COSMETIC OILS FOR THE BODY; COSMETIC CREAMS; MAKE-UP; SHAVING PRODUCTS, NAMELY, SHAVING LATHER, SHAVING GELS, AFTER SHAVE LOTIONS, SHAVING SOAPS; COSMETIC KITS COMPRISED OF LIPSTICK, MASCARA AND LIP GLOSS; SKIN CLEANERS; HAIR SHAMPOO; BATH OILS (U.S. CLS. 1, 4, 6, 50, 51 AND 52).

CLASS 5—PHARMACEUTICALS

FOR NUTRITIONAL PRODUCTS, NAMELY SUPPLEMENTS, NUTRITIONAL OILS FOR SKIN CARE, NUTRITIONAL SUPPLEMENTS IN LOTION FORM SOLD AS A COMPONENT OF NUTRITIONAL SKIN CARE PRODUCTS (U.S. CLS. 6, 18, 44, 46, 51 AND 52).

CLASS 9—ELECTRICAL AND SCIENTIFIC APPARATUS

FOR OPTICAL WARE AND EYE CARE PRODUCTS, NAMELY, EYEGLASSES, COMPUTER SCREENS, COMPUTER SCREEN FILTERS, COMPUTER GLARE REDUCER SCREENS, COMPUTER GOGGLES, SPECTACLES, EYEGLASS LENSES, EYEGLASS FRAMES, EYEGLASS CASES AND POUCHES, EYEGLASS RETENTION BANDS, SUNGLASSES, BINOCULARS, OPTICAL LENSES, MICROSCOPES, TELESCOPES, SAFETY GOGGLES, SPORTS GOGGLES, NIGHT VISION GOGGLES; PRE-RECORDED VIDEO CASSETTES, COMPACT DISCS, CD-ROM DISCS AND DVD DISCS FEATURING DRAWING INSTRUCTIONAL, TATTOO ART DOCUMENTARIES; COMPUTER GAMES EQUIPMENT, NAMELY, COMPUTER GAME SOFTWARE IN THE FORM OF CARTRIDGES, CASSETTES, DISCS, AND TAPES, INTERACTIVE MULTIMEDIA COMPUTER GAME PROGRAMS AND INTERACTIVE VIDEO GAMES PROGRAMS IN THE NATURE OF CARTRIDGES, CASSETTES, DISCS AND TAPES (U.S. CLS. 21, 23, 26, 36 AND 38).

CLASS 12—VEHICLES

FOR VEHICLES FOR LOCOMOTION BY LAND, AIR OR WATER, NAMELY, AUTOMOBILES, AIR-CUSHION HOVERCRAFT VEHICLES, AIRPLANES, BOATS, SEA PLANES, VANS, TRUCKS, MOTORCYCLES, BICYCLES AND GO-CARTS; PARTS FOR LAND AND AIR VEHICLES, NAMELY TIRES AND WHEEL RIMS (U.S. CLS. 19, 21, 23, 31, 35 AND 44).

CLASS 14—JEWELRY

FOR JEWELRY, NAMELY, SILVER AND GOLD JEWELRY, JEWELRY MADE OF PRECIOUS METALS AND STONES, BRACELETS, EARRINGS, RINGS, NECKLACES, TOE RINGS, CUFFLINKS, TIE TACKS, PINS AND WATCHES (U.S. CLS. 2, 27, 28 AND 50).

CLASS 18—LEATHER GOODS

FOR PURSES AND ACCESSORIES, NAMELY, SHOULDER BAGS, WALLETS, BACKPACKS, BRIEF-CASE-TYPE PORTFOLIOS, KNAPSACKS, RUCKSACKS, HANDBAGS, LUGGAGE, TRAVEL BAGS, BEACH BAGS, GARMENT BAGS FOR TRAVEL, GYM BAGS, DUFFEL BAGS, ATTACHE CASES, SHOPPING BAGS MADE OF MESH, TEXTILE AND LEATHER, SACHELS AND UMBRELLAS (U.S. CLS. 1, 2, 3, 22 AND 41).

CLASS 25—CLOTHING

FOR BELTS FOR CLOTHING (U.S. CLS. 22 AND 39).

CLASS 26—FANCY GOODS

FOR BELT BUCKLES FOR CLOTHING; BELT BUCKLES OF PRECIOUS METAL FOR CLOTHING (U.S. CLS. 37, 39, 40, 42 AND 50).

CLASS 37—CONSTRUCTION AND REPAIR

FOR VEHICLE DETAILING AND CUSTOMIZING SERVICES, NAMELY, RECONDITIONING AUTOMOBILE BODIES, UNDERCARRIAGES AND INTERIORS, CUSTOMIZING AUTOMOBILE PAINT JOBS AND RE-DESIGN (U.S. CLS. 100, 103 AND 106).

SUZANNE BLANE, EXAMINING ATTORNEY

SN 76-668,001. CORDIS CORPORATION, MIAMI LAKES, FL. FILED 10-23-2006.

IDEAS MAKING A DIFFERENCE

THE MARK CONSISTS OF STANDARD CHARACTERS WITHOUT CLAIM TO ANY PARTICULAR FONT, STYLE, SIZE, OR COLOR.

CLASS 9—ELECTRICAL AND SCIENTIFIC APPARATUS

FOR COMPUTER SOFTWARE FOR MEDICAL IMAGING AND USED IN CONJUNCTION WITH MEDICAL DIAGNOSTIC MAPPING SYSTEMS AND ELECTROPHYSIOLOGY NAVIGATION AND ABLATION SYSTEMS (U.S. CLS. 21, 23, 26, 36 AND 38).

CLASS 10—MEDICAL APPARATUS

FOR MEDICAL DEVICES, NAMELY, CATHETERS, GUIDEWIRES, INFUSION PUMPS, TEMPORARY PAGING LEADS, PATCHES USED IN CONNECTION WITH MEDICAL CATHETERS, SHEATHS, MEDICAL CABLES, ULTRASOUND GENERATORS, MEDICAL IMAGING APPARATUS, MEDICAL DIAGNOSTIC MAPPING AND ABLATION APPARATUS (U.S. CLS. 26, 39 AND 44).

KHANH LE, EXAMINING ATTORNEY

SN 76-669,167. COLUMBIA COLLEGE CHICAGO, CHICAGO, IL. FILED S.R. 11-17-2006; AM. P.R. 5-23-2007.



NO CLAIM IS MADE TO THE EXCLUSIVE RIGHT TO USE "CHICAGO", APART FROM THE MARK AS SHOWN. THE COLOR(S) BLACK, WHITE AND YELLOW IS/ARE CLAIMED AS A FEATURE OF THE MARK.

THE BACKGROUND OF THE MARK IS BLACK, THE LETTERS IN THE WORDS "THE," "CHICAGO" AND "ENSEMBLE" ARE WHITE, THE LETTERS OF THE WORD "JAZZ" ARE YELLOW, AND THE CURVED LINE TO THE LEFT OF THE WORDING THAT REPRESENTS THE SILHOUETTE OF A BASS IS WHITE."

CLASS 20—FURNITURE AND ARTICLES NOT OTHERWISE CLASSIFIED

FOR NON-METAL AND NON-LEATHER KEY CHAINS (U.S. CLS. 2, 13, 22, 25, 32 AND 50). FIRST USE 6-18-2006; IN COMMERCE 6-18-2006.

CLASS 21—HOUSEWARES AND GLASS

FOR MUGS (U.S. CLS. 2, 13, 23, 29, 30, 33, 40 AND 50). FIRST USE 6-18-2006; IN COMMERCE 6-18-2006.

CLASS 26—FANCY GOODS

FOR NOVELTY BUTTONS (U.S. CLS. 37, 39, 40, 42 AND 50). FIRST USE 6-18-2006; IN COMMERCE 6-18-2006.

SARA THOMAS, EXAMINING ATTORNEY

SN 76-669,974. RENNA'S PIZZA FRANCHISING, LLC, JACKSONVILLE, FL. FILED 12-4-2006.



NO CLAIM IS MADE TO THE EXCLUSIVE RIGHT TO USE "PIZZA", APART FROM THE MARK AS SHOWN.

CLASS 35—ADVERTISING AND BUSINESS

FOR RESTAURANT FRANCHISING (U.S. CLS. 100, 101 AND 102).

CLASS 39—TRANSPORTATION AND STORAGE

FOR PIZZA DELIVERY (U.S. CLS. 100 AND 105).

CLASS 43—HOTEL AND RESTAURANT SERVICES

FOR RESTAURANT SERVICES; RESTAURANTS; FAST-FOOD RESTAURANTS; TAKE-OUT RESTAURANT SERVICES; CARRY-OUT RESTAURANTS; RESTAURANTS FEATURING HOME DELIVERY (U.S. CLS. 100 AND 101).

MELVIN AXILBUND, EXAMINING ATTORNEY



SN 76-670,925. HERSTYLER, HENDERSON, NV. FILED 12-29-2006.



CLASS 3—COSMETICS AND CLEANING PREPARATIONS

FOR HAIR CARE PRODUCTS, NAMELY, CONDITIONERS, SHAMPOO, HAIR CREAM, HAIR SPRAY, AND HAIR SERUM (U.S. CLS. 1, 4, 6, 50, 51 AND 52).

FIRST USE 5-1-2005; IN COMMERCE 5-1-2005.

CLASS 9—ELECTRICAL AND SCIENTIFIC APPARATUS

FOR ELECTRIC HAIR CURLERS ELECTRIC IRONS FOR STYLING HAIR ELECTRIC HAND-HELD HAIR STYLING IRONS (U.S. CLS. 21, 23, 26, 36 AND 38).

FIRST USE 5-1-2005; IN COMMERCE 5-1-2005.
ANTHONY RINKER, EXAMINING ATTORNEY



SN 76-671,851. VARGO MATERIAL HANDLING, INC., HILLIARD, OH. FILED 1-26-2007.

VARGO

THE MARK CONSISTS OF STANDARD CHARACTERS WITHOUT CLAIM TO ANY PARTICULAR FONT, STYLE, SIZE, OR COLOR.
SEC. 2(F).

CLASS 35—ADVERTISING AND BUSINESS

FOR MANUFACTURER REPRESENTATIVES IN THE FIELD OF MATERIAL HANDLING EQUIPMENT, NAMELY, AUTOMATED GUIDED VEHICLE SYSTEMS, AUTOMATIC IDENTIFICATION EQUIPMENT AND SYSTEMS, AUTOMATIC STORAGE AND RETRIEVAL SYSTEMS, BAILERS, COMPACTORS, SHREDDERS, CAROUSELS, CONVEYOR COMPONENTS AND SYSTEMS, CONVEYOR CONTROL SYSTEMS, ELECTRIFIED MONORAIL SYSTEMS, ELECTRONIC SCANNING AND DATA CAPTURE SYSTEMS, HAND TRUCKS, MOBILE CARTS, HOISTS AND CRANES, PNEUMATIC TUBE SYSTEMS, SHELVING, CONTAINERS, STORAGE CONTAINERS, PALLETS, LIFT TABLES, AIR CURTAINS, PALLET JACKS, SCALES, STRAPPING, PACKAGING, CARTS, DOLLIES, LADDERS, STACKING AND STORAGE BINS, SHOP FURNITURE AND SHELVING (U.S. CLS. 100, 101 AND 102).

FIRST USE 3-1-1972; IN COMMERCE 3-1-1972.

CLASS 37—CONSTRUCTION AND REPAIR

FOR PLANNING CONSTRUCTION OF MATERIALS HANDLING SYSTEMS; INSTALLATION OF MATERIALS HANDLING SYSTEMS; INSTALLATION OF WAREHOUSE STORAGE AND RETRIEVAL SYSTEMS; INSTALLATION OF CONVEYORS; INSTALLATION OF SORTING SYSTEMS; INSTALLATION OF DATA CAPTURE SYSTEMS, NAMELY, ELECTRONIC SCANNING; INSTALLATION OF AUTOMATIC IDENTIFICATION SYSTEMS; INSTALLATION OF MONORAIL SYSTEMS; INSTALLATION OF PNEUMATIC TUBE SYSTEMS; DISTRIBUTION CENTER AND WAREHOUSE CONSTRUCTION PLANNING AND SUPERVISION (U.S. CLS. 100, 103 AND 106).

FIRST USE 6-3-1978; IN COMMERCE 6-3-1978.
LESLIE RICHARDS, EXAMINING ATTORNEY



SN 76-672,800. J&J TECHNOLOGY, LLC, NASHVILLE, TN. FILED S.R. 2-16-2007; AM. P.R. 8-20-2007.

ENVIRONMENTAL 1

THE MARK CONSISTS OF STANDARD CHARACTERS WITHOUT CLAIM TO ANY PARTICULAR FONT, STYLE, SIZE, OR COLOR.

NO CLAIM IS MADE TO THE EXCLUSIVE RIGHT TO USE "ENVIRONMENTAL", APART FROM THE MARK AS SHOWN.

CLASS 3—COSMETICS AND CLEANING PREPARATIONS

FOR CLEANING PRODUCTS, NAMELY CARPET AND UPHOLSTERY CLEANERS, FLOOR CLEANERS, SPOT AND SPRAY CLEANERS FOR CLOTHING AND FABRICS; LAUNDRY DETERGENT, PRE-SOAK AND STAIN REMOVER, DISH WASHING DETERGENT, CLEANING PREPARATIONS FOR VEHICLES; WATER-LESS CAR WASH CLEANING PREPARATIONS; INTERIOR, EXTERIOR AND FLOOR WOOD CLEANER; METAL POLISH AND REFINISHER; METAL POLISH, MARINE AND FIBERGLASS REFINISHER; TUB AND TILE CLEANER AND REFINISHER; HOUSE WASH, NAMELY, MULTI-SURFACE EXTERIOR CLEANER FOR HOUSES AND OTHER STRUCTURES; CLEANER FOR EXTERIOR AND INTERIOR BUILDING WALLS AND SURFACES, ALUMINUM AND VINYL SIDING CLEANER; CONCRETE AND ASPHALT CLEANER; GLASS CLEANER; GLASS PAINT REMOVER; JEWELRY CLEANER AND FINISHER, MOLD AND MILDEW CLEANER, MULTI PURPOSE CLEANER FOR HOUSEHOLD, COMMERCIAL AND INDUSTRIAL USE, MULTI-PURPOSE CLEANER FOR KITCHENS AND BATHROOMS, DEGREASING PREPARATIONS, NOT FOR USE IN MANUFACTURING PROCESSES, FOR USE IN THE HOUSEHOLD, COMMERCIAL AND INDUSTRIAL FIELDS; CLEANING PREPARATIONS FOR USE ON MARINE VEHICLES, HAND AND SKIN CLEANSER; ANTI-MICROBIAL AND ANTI-FUNGAL ALL PURPOSE CLEANING PREPARATIONS FOR HOUSEHOLD USE AND FOR USE IN COMMERCIAL, INSTITUTIONAL AND INDUSTRIAL AREAS, PREPARATIONS FOR CLEANING COMMERCIAL, INDUSTRIAL AND MILITARY VEHICLES SUCH AS TRUCKS, BUSES, TRANSPORT VEHICLES, RAILROAD CARS AND AIRPLANES (U.S. CLS. 1, 4, 6, 50, 51 AND 52).

CLASS 3—COSMETICS AND CLEANING PREPARATIONS

FOR CLEANING PRODUCTS, NAMELY CARPET AND UPHOLSTERY CLEANERS, FLOOR CLEANERS, SPOT AND SPRAY CLEANERS FOR CLOTHING AND FABRICS; LAUNDRY DETERGENT, PRE-SOAK AND STAIN REMOVER, DISH WASHING DETERGENT, CLEANING PREPARATIONS FOR VEHICLES; WATER-LESS CAR WASH CLEANING PREPARATIONS; INTERIOR, EXTERIOR AND FLOOR WOOD CLEANER; METAL POLISH AND REFINISHER; METAL POLISH, MARINE AND FIBERGLASS REFINISHER; TUB AND TILE CLEANER AND REFINISHER; HOUSE WASH, NAMELY, MULTI-SURFACE EXTERIOR CLEANING FOR HOUSES AND OTHER STRUCTURES; CLEANER FOR EXTERIOR AND INTERIOR BUILDING WALLS AND SURFACES, ALUMINUM AND VINYL SIDING CLEANER; CONCRETE AND ASPHALT CLEANER; GLASS CLEANER; GLASS PAINT REMOVER; JEWELRY CLEANER AND FINISHER, MOLD AND MILDEW CLEANER, MULTI PURPOSE CLEANER FOR HOUSEHOLD, COMMERCIAL AND INDUSTRIAL USE, MULTI-PURPOSE CLEANER FOR KITCHENS AND BATHROOMS, DEGREASING PREPARATIONS, NOT FOR USE IN MANUFACTURING PROCESSES, FOR USE IN THE HOUSEHOLD, COMMERCIAL AND INDUSTRIAL FIELDS; CLEANING PREPARATIONS FOR USE ON MARINE VEHICLES, HAND AND SKIN CLEANSER; ANTI-MICROBIAL AND ANTI-FUNGAL ALL PURPOSE CLEANING PREPARATIONS FOR HOUSEHOLD USE AND FOR USE IN COMMERCIAL, INSTITUTIONAL AND INDUSTRIAL AREAS, PREPARATIONS FOR CLEANING COMMERCIAL, INDUSTRIAL AND MILITARY VEHICLES SUCH AS TRUCKS, BUSES, TRANSPORT VEHICLES, RAILROAD CARS AND AIRPLANES (U.S. CLS. 1, 4, 6, 50, 51 AND 52).

CLASS 5—PHARMACEUTICALS

FOR ENVIRONMENTALLY FRIENDLY INSECTICIDES AND PESTICIDES FOR DOMESTIC AND AGRICULTURAL USE; LIQUID DISINFECTANT USED TO KILL AND PREVENT FUNGI AND MOLD; ANTIBACTERIAL SKIN SANITIZER GEL; ANTIBACTERIAL HANDWASH; ANTIMICROBIAL AND ANTI-FUNGAL SANITIZERS FOR HOUSEHOLD USE AND FOR USE IN COMMERCIAL, INSTITUTIONAL AND INDUSTRIAL AREAS; ALL PURPOSE DISINFECTANTS (U.S. CLS. 6, 18, 44, 46, 51 AND 52).

ELISSA GARBER KON, EXAMINING ATTORNEY

CLASS 5—PHARMACEUTICALS

FOR ENVIRONMENTALLY FRIENDLY INSECTICIDES AND PESTICIDES FOR DOMESTIC AND AGRICULTURAL USE; LIQUID DISINFECTANT USED TO KILL AND PREVENT FUNGI AND MOLD; ANTIBACTERIAL SKIN SANITIZER GEL; ANTIBACTERIAL HANDWASH; ANTIMICROBIAL AND ANTI-FUNGAL SANITIZERS FOR HOUSEHOLD USE AND FOR USE IN COMMERCIAL, INSTITUTIONAL AND INDUSTRIAL AREAS; ALL PURPOSE DISINFECTANTS (U.S. CLS. 6, 18, 44, 46, 51 AND 52).

ELISSA GARBER KON, EXAMINING ATTORNEY

SN 76-672,802. J&J TECHNOLOGY, LLC, NASHVILLE, TN. FILED 2-16-2007.



NO CLAIM IS MADE TO THE EXCLUSIVE RIGHT TO USE "ENVIRONMENTAL", APART FROM THE MARK AS SHOWN.

THE COLOR(S) GREEN AND WHITE IS/ARE CLAIMED AS A FEATURE OF THE MARK.

THE MARK CONSISTS OF A SHADED GREEN CIRCLE, WITH A GREEN AND WHITE NUMBER ONE IN THE CENTER AND THE WORD ENVIRONMENTAL SUPERIMPOSED ACROSS THE NUMBER ONE, IN WHITE.

SN 76-672,878. MERIT AUDIO VISUAL, INC., DBA MERIT SOFTWARE, NEW YORK, NY. FILED 2-12-2007.

PUNCH

THE MARK CONSISTS OF STANDARD CHARACTERS WITHOUT CLAIM TO ANY PARTICULAR FONT, STYLE, SIZE, OR COLOR.

CLASS 9—ELECTRICAL AND SCIENTIFIC APPARATUS

FOR EDUCATIONAL SOFTWARE FOR TEACHING WRITING AND READING (U.S. CLS. 21, 23, 26, 36 AND 38).

FIRST USE 0-0-1993; IN COMMERCE 0-0-1993.

CLASS 16—PAPER GOODS AND PRINTED MATTER

FOR WORKSHEETS FOR USE IN TEACHING WRITING AND READING (U.S. CLS. 2, 5, 22, 23, 29, 37, 38 AND 50).

FIRST USE 8-0-2005; IN COMMERCE 8-0-2005.
SALLY SHIH, EXAMINING ATTORNEY

CLASS 43—HOTEL AND RESTAURANT SERVICES

FOR RESTAURANT, CAFÉ, LOUNGE, AND BAR SERVICES FEATURING ALCOHOLIC BEVERAGES (U.S. CLS. 100 AND 101).

CORY BOONE, EXAMINING ATTORNEY

SN 76-673,170. LENNAR PACIFIC PROPERTIES MANAGEMENT, INC., MIAMI, FL. FILED 2-26-2007.

SN 76-674,113. BETTER IDEAS INVESTMENTS, LLC, CORONA, CA. FILED 3-15-2007.

LENNAR

THE MARK CONSISTS OF STANDARD CHARACTERS WITHOUT CLAIM TO ANY PARTICULAR FONT, STYLE, SIZE, OR COLOR.

OWNER OF U.S. REG. NOS. 2,606,292, 2,689,911 AND 3,108,401.
SEC. 2(F).

CLASS 36—INSURANCE AND FINANCIAL

FOR REAL ESTATE LISTING SERVICES; REAL ESTATE MANAGEMENT, NAMELY, THE OPERATION, MAINTENANCE, BROKERAGE, AND RENTAL OF MID AND HIGH-RISE CONDOMINIUM PROPERTIES FOR BOTH RESIDENTIAL, BUSINESS, AND RETAIL USE (U.S. CLS. 100, 101 AND 102).

CLASS 37—CONSTRUCTION AND REPAIR

FOR REAL ESTATE DEVELOPMENT OF MID AND HIGH-RISE BUILDINGS FOR BOTH RESIDENTIAL, BUSINESS, AND RETAIL USE, NAMELY, CONSTRUCTION CONSULTING IN THE NATURE OF SITE SELECTION AND CONSTRUCTION PLANNING; CONSTRUCTION MANAGEMENT AND SUPERVISION; AND CONSTRUCTION SERVICES, NAMELY, PLANNING, LAYING OUT AND CUSTOM CONSTRUCTION OF MID AND HIGH-RISE PROPERTIES (U.S. CLS. 100, 103 AND 106).

MEGAN WHITNEY, EXAMINING ATTORNEY

SN 76-674,048. JUDAKEN ENTERPRISES WORLDWIDE, INC., LOS ANGELES, CA. FILED 3-14-2007.

CRIMSON LOUNGE

THE MARK CONSISTS OF STANDARD CHARACTERS WITHOUT CLAIM TO ANY PARTICULAR FONT, STYLE, SIZE, OR COLOR.

NO CLAIM IS MADE TO THE EXCLUSIVE RIGHT TO USE "LOUNGE", APART FROM THE MARK AS SHOWN.

CLASS 41—EDUCATION AND ENTERTAINMENT

FOR NIGHTCLUB SERVICES FEATURING MUSIC AND DANCING (U.S. CLS. 100, 101 AND 107).

SURFACE IMPRESSIONS

THE MARK CONSISTS OF STANDARD CHARACTERS WITHOUT CLAIM TO ANY PARTICULAR FONT, STYLE, SIZE, OR COLOR.

NO CLAIM IS MADE TO THE EXCLUSIVE RIGHT TO USE "SURFACE", APART FROM THE MARK AS SHOWN.

CLASS 2—PAINTS

FOR SEALER COATINGS FOR HOUSEHOLD USE, FOR USE ON LEATHER, METAL SURFACES, PAINT, VINYL, STONE SURFACES, CERAMICS, CONCRETE, AND TERRA COTTA; KITS COMPRISED OF SEALER COATINGS FOR HOUSEHOLD USE, FOR USE ON LEATHER, METAL SURFACES, PAINT, VINYL, STONE SURFACES, CERAMICS, CONCRETE, AND TERRA COTTA (U.S. CLS. 6, 11 AND 16).

CLASS 3—COSMETICS AND CLEANING PREPARATIONS

FOR CLEANING PREPARATIONS FOR HOUSEHOLD PURPOSES, NAMELY, LEATHER CLEANER, METAL CLEANER, PAINT CLEANER, PLASTIC CLEANER, VINYL CLEANER, STONE SURFACE CLEANER; KITS COMPRISED OF CLEANING PREPARATIONS FOR HOUSEHOLD PURPOSES, NAMELY, LEATHER CLEANER, METAL CLEANER, PAINT CLEANER, PLASTIC CLEANER, VINYL CLEANER, STONE SURFACE CLEANER (U.S. CLS. 1, 4, 6, 50, 51 AND 52).

MICHAEL GAAFAR, EXAMINING ATTORNEY

SN 76-674,132. WALGREEN CO., DEERFIELD, IL. FILED 3-15-2007.

PARTY IN A BUCKET

THE MARK CONSISTS OF STANDARD CHARACTERS WITHOUT CLAIM TO ANY PARTICULAR FONT, STYLE, SIZE, OR COLOR.

CLASS 29—MEATS AND PROCESSED FOODS

FOR DRIED BEEF AND PROCESSED NUTS (U.S. CL. 46).

CLASS 30—STAPLE FOODS

FOR POPCORN (U.S. CL. 46).
MICHAEL ENGEL, EXAMINING ATTORNEY

SN 76-674,583. COSSETTA'S, INC., ST. PAUL, MN. FILED 3-26-2007.

SN 76-675,384. SAFEWAY INC., PLEASANTON, CA. FILED 4-11-2007.

EVENTI

THE MARK CONSISTS OF STANDARD CHARACTERS WITHOUT CLAIM TO ANY PARTICULAR FONT, STYLE, SIZE, OR COLOR.

CLASS 29—MEATS AND PROCESSED FOODS

FOR PRE-PACKAGED DINNERS CONSISTING MAINLY OF MEAT, SEAFOOD OR POULTRY SERVED WITH PASTA, VEGETABLES, FRUIT OR SEEDS OR COMBINATIONS THEREOF (U.S. CL. 46).
FIRST USE 10-27-1996; IN COMMERCE 8-9-1999.

CLASS 43—HOTEL AND RESTAURANT SERVICES

FOR RESTAURANT SERVICES (U.S. CLS. 100 AND 101).
FIRST USE 10-27-1996; IN COMMERCE 8-9-1999.
GIANCARLO CASTRO, EXAMINING ATTORNEY

SN 76-674,637. SPECTRUS INC., CHARLEVOIX, MI. FILED 3-27-2007.



OWNER OF U.S. REG. NO. 2,927,267.

CLASS 9—ELECTRICAL AND SCIENTIFIC APPARATUS

FOR LUMINOUS SIGNS AND COMPONENTS THEREOF, NAMELY, EDGELIT PANELS (U.S. CLS. 21, 23, 26, 36 AND 38).
FIRST USE 3-26-2003; IN COMMERCE 3-26-2003.

CLASS 11—ENVIRONMENTAL CONTROL APPARATUS

FOR LIGHTING FIXTURE COMPONENTS, NAMELY, EDGELIT LUMINAIRES, LIGHT REFLECTORS, REFRACTORS, AND LAMP GLOBES FOR USE WITH LIGHTING FIXTURES (U.S. CLS. 13, 21, 23, 31 AND 34).
FIRST USE 3-26-2003; IN COMMERCE 3-26-2003.

CLASS 17—RUBBER GOODS

FOR POLYMERIC SHEET GOODS; NAMELY, EXTRUDED, MOLDED, AND FORMED POLYMERIC SHEET MATERIAL FOR FURTHER INDUSTRIAL OR MANUFACTURING APPLICATIONS (U.S. CLS. 1, 5, 12, 13, 35 AND 50).
FIRST USE 3-26-2003; IN COMMERCE 3-26-2003.
CAROLINE WOOD, EXAMINING ATTORNEY

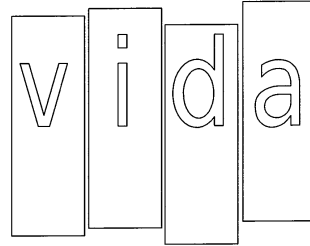

OWNER OF U.S. REG. NO. 3,216,882.
THE ENGLISH TRANSLATION OF "VIDA" IN THE MARK IS "LIFE."

CLASS 35—ADVERTISING AND BUSINESS

FOR RETAIL GROCERY STORE, PHARMACY AND DRUGSTORE SERVICES; RETAIL STORE SERVICES FEATURING CONVENIENCE STORE ITEMS AND GASOLINE; RETAIL STORE SERVICES FEATURING A FULL LINE OF GROCERIES, PREPARED FOODS, PHARMACEUTICAL GOODS AND OTHER SUPERMARKET PRODUCTS (U.S. CLS. 100, 101 AND 102).

CLASS 40—MATERIAL TREATMENT

FOR PHOTOGRAPHIC FILM DEVELOPMENT AND PRINTING SERVICES (U.S. CLS. 100, 103 AND 106).
ZHALEH DELANEY, EXAMINING ATTORNEY

SN 76-675,897. VI-JON, INC., ST. LOUIS, MO. FILED 4-23-2007.

GERM-X-TEND

THE MARK CONSISTS OF STANDARD CHARACTERS WITHOUT CLAIM TO ANY PARTICULAR FONT, STYLE, SIZE, OR COLOR.
OWNER OF U.S. REG. NO. 2,139,736.

CLASS 3—COSMETICS AND CLEANING PREPARATIONS

FOR HAND DISINFECTING SOAPS WITH GERMICIDAL AND ANTI-BACTERIAL PROPERTIES AND GERMICIDAL, ANTI-BACTERIAL, AND ANTI-MICROBIAL HAND AND LOTION SOAP, NOT FOR VETERINARY USE (U.S. CLS. 1, 4, 6, 50, 51 AND 52).

CLASS 5—PHARMACEUTICALS

FOR HAND SANITIZING AND DISINFECTING PREPARATION WITH ANTI-MICROBIAL PROPERTIES, NOT FOR VETERINARY USE (U.S. CLS. 6, 18, 44, 46, 51 AND 52).
DAVID MILLER, EXAMINING ATTORNEY

SN 77-002,566. THE UNIVERSITY OF TULSA, TULSA, OK. FILED 9-19-2006.



OWNER OF U.S. REG. NOS. 2,075,741, 2,119,208 AND 2,372,294.

NO CLAIM IS MADE TO THE EXCLUSIVE RIGHT TO USE "THE UNIVERSITY OF TULSA", APART FROM THE MARK AS SHOWN.

CLASS 25—CLOTHING

FOR CLOTHING, NAMELY, T-SHIRTS, SHORTS, JACKETS, SOCKS, BELTS, SCARVES, GLOVES, SWEATERS, SWEATSHIRTS, TIES, RAINWEAR, PANTS, FOOTWEAR, JERSEYS, AND HEADWEAR (U.S. CLS. 22 AND 39).

CLASS 41—EDUCATION AND ENTERTAINMENT

FOR EDUCATIONAL SERVICES, NAMELY, PROVIDING INSTRUCTION AT THE COLLEGE LEVEL AND DISTRIBUTING COURSE MATERIAL THEREWITH; ENTERTAINMENT IN THE NATURE OF FOOTBALL, BASKETBALL, SOCCER, TENNIS, AND VOLLEYBALL COMPETITION (U.S. CLS. 100, 101 AND 107).

FIRST USE 8-23-2005; IN COMMERCE 8-23-2005. DAVID I, EXAMINING ATTORNEY

SN 77-002,806. TCIP, LLC, JACKSON, WY. FILED 9-19-2006.

Tahoe Churnin' Man Wild
Cherrycran

THE MARK CONSISTS OF STANDARD CHARACTERS WITHOUT CLAIM TO ANY PARTICULAR FONT, STYLE, SIZE, OR COLOR.

NO CLAIM IS MADE TO THE EXCLUSIVE RIGHT TO USE "CHURNING", APART FROM THE MARK AS SHOWN.

CLASS 29—MEATS AND PROCESSED FOODS

FOR DAIRY AND NON-DAIRY WHIPPED TOPPINGS; DAIRY BASED BEVERAGES; DAIRY-BASED FOOD BEVERAGES; TOPPINGS FOR ICE CREAM IN THE NATURE OF FRUIT TOPPING, NUT TOPPING AND PEANUT BUTTER TOPPING (U.S. CL. 46).

CLASS 30—STAPLE FOODS

FOR ICE CREAM; ICE MILK; CONFECTIONERY ICES NAMELY FROZEN YOGURT; FROZEN CONFECTIONS; SORBET; SHERBET; TOPPINGS FOR ICE CREAM IN THE NATURE OF CHOCOLATE TOPPINGS, FUDGE TOPPINGS, CARAMEL TOPPINGS, MARSHMALLOW TOPPING, BUTTERSCOTCH TOPPING, CANDY TOPPINGS AND CANDY SPRINKLE TOPPING (U.S. CL. 46). MICHAEL LEWIS, EXAMINING ATTORNEY

SN 77-003,045. CLARK & WAMBERG, LLC, NORTH BARRINGTON, IL. FILED 9-20-2006.



OWNER OF U.S. REG. NOS. 3,040,341 AND 3,182,127. NO CLAIM IS MADE TO THE EXCLUSIVE RIGHT TO USE "PARTNERS" AND "COMPREHENSIVE COMPENSATION", APART FROM THE MARK AS SHOWN.

CLASS 35—ADVERTISING AND BUSINESS

FOR HUMAN RESOURCE CONSULTATION SERVICES FOR OTHERS (U.S. CLS. 100, 101 AND 102). FIRST USE 7-19-2006; IN COMMERCE 7-19-2006.

CLASS 36—INSURANCE AND FINANCIAL

FOR FINANCIAL ADVISORY SERVICES AND THE DESIGN, IMPLEMENTATION AND ADMINISTRATION OF EXECUTIVE BENEFIT AND COMPENSATION PLANS (U.S. CLS. 100, 101 AND 102). FIRST USE 7-19-2006; IN COMMERCE 7-19-2006. MICHAEL KAZAZIAN, EXAMINING ATTORNEY

SN 77-003,063. UNIVERSAL INSTRUMENTS CORPORATION, BINGHAMTON, NY. FILED 9-20-2006.

UNOVIS SOLUTIONS

THE MARK CONSISTS OF STANDARD CHARACTERS WITHOUT CLAIM TO ANY PARTICULAR FONT, STYLE, SIZE, OR COLOR.

NO CLAIM IS MADE TO THE EXCLUSIVE RIGHT TO USE "SOLUTIONS", APART FROM THE MARK AS SHOWN.

CLASS 7—MACHINERY

FOR ELECTRONICS ASSEMBLY MACHINES THAT COMPLEMENT AND ENHANCE STANDARD SURFACE MOUNT EQUIPMENT FOR THE AUTOMOTIVE, COMPONENT ASSEMBLY, TELECOMMUNICATIONS, AND MEDICAL MARKETS, NAMELY, SEMICONDUCTOR MANUFACTURING MACHINES, COMPONENT AND PRINTED CIRCUIT BOARD ASSEMBLY MACHINES IN THE NATURE OF MANUFACTURING MACHINES FOR PERFORMING ONE OR MORE OF THE FOLLOWING FUNCTIONS, NAMELY, ORIENTING, FEEDING, MOUNTING AND BONDING ELECTRONIC SEMICONDUCTOR COMPONENTS TOGETHER AND ONTO PRINTED CIRCUIT BOARDS, SEMICONDUCTOR WAFER PROCESSING MACHINES AND SEMICONDUCTOR SUBSTRATES MANUFACTURING MACHINES; SEMICONDUCTOR MANUFACTURING MACHINES FEATURING COMPONENT AND DIE FEEDERS, CONVEYORS, PROCESS PERIPHERALS AND FLEXIBLE PROCESS CELLS; SEMICONDUCTOR MANUFACTURING MACHINES FOR USE IN FLIP CHIP AND DIE BONDING, HYBRID MODULE ASSEMBLY, AND MECHANICAL ASSEMBLY UTILIZING SURFACE MOUNT AND INSERTION MOUNT EQUIPMENT (U.S. CLS. 13, 19, 21, 23, 31, 34 AND 35).

CLASS 9—ELECTRICAL AND SCIENTIFIC APPARATUS

FOR ELECTRICAL CONTROLLERS AND COMPUTER SOFTWARE FOR USE IN CONTROLLING ELECTRONICS AND SEMICONDUCTOR COMPONENT ASSEMBLY MACHINES, ALL FOR USE BY CUSTOMERS IN THE AUTOMOTIVE, COMPONENT ASSEMBLY, TELECOMMUNICATIONS, AND MEDICAL MARKETS; COMPUTER SOFTWARE FOR DETERMINING OPTIMUM PROCESSES FOR ASSEMBLING ELECTRONICS AND SEMICONDUCTOR COMPONENTS, FOR USE BY CUSTOMERS IN THE AUTOMOTIVE, COMPONENT ASSEMBLY, TELECOMMUNICATIONS, AND MEDICAL MARKETS; COMPUTER BASED APPARATUS FOR DESIGNING THE LAYOUT OF ELECTRONIC CIRCUITS; ELECTRICAL CONTROLLERS AND COMPUTER SOFTWARE FOR USE IN CONTROLLING SEMICONDUCTOR MANUFACTURING MACHINES THAT PERFORM FLIP CHIP AND DIE BONDING, HYBRID MODULE ASSEMBLY, AND MECHANICAL ASSEMBLY UTILIZING SURFACE MOUNT AND INSERTION MOUNT EQUIPMENT (U.S. CLS. 21, 23, 26, 36 AND 38).

CLASS 40—MATERIAL TREATMENT

FOR CONSULTING FOR OTHERS IN THE FIELD OF ELECTRONICS ASSEMBLY AND PROCESSES FOR ASSEMBLING SEMICONDUCTOR COMPONENTS; PROVIDING INFORMATION TO OTHERS IN THE FIELD OF ELECTRONICS AND SEMICONDUCTOR COMPONENT ASSEMBLY RELATED TO FLIP CHIP AND DIE BONDING, HYBRID MODULE ASSEMBLY, AND MECHANICAL ASSEMBLY (U.S. CLS. 100, 103 AND 106).

CLASS 42—SCIENTIFIC, COMPUTER AND LEGAL SERVICES

FOR RESEARCH AND DEVELOPMENT IN THE FIELD OF SURFACE MOUNT AND INSERTION MOUNT ELECTRONICS ASSEMBLY EQUIPMENT; ENGINEERING SERVICES IN THE FIELD OF ELECTRONICS ASSEMBLY EQUIPMENT FOR CUSTOMERS IN THE AUTOMOTIVE, SEMICONDUCTOR COMPONENT ASSEMBLY, TELECOMMUNICATIONS, AND MEDICAL MARKETS; DESIGN, DEVELOPMENT AND TESTING OF NEW PRODUCTS FOR OTHERS IN THE FIELD OF ELECTRONICS ASSEMBLY EQUIPMENT (U.S. CLS. 100 AND 101).

NELSON SNYDER, EXAMINING ATTORNEY

SN 77-003,131. UNIVERSAL INSTRUMENTS CORPORATION, BINGHAMTON, NY. FILED 9-20-2006.



THE MARK CONSISTS OF A STRIPED PYRAMID WITH A SHADOW SITUATED TO THE LEFT OF THE WORD "UNOVIS". THE WORD "UNOVIS" APPEARS TO BE CUT IN HALF AND PARTIALLY SEPARATED TOP AND BOTTOM.

CLASS 7—MACHINERY

FOR ELECTRONICS ASSEMBLY MACHINES THAT COMPLEMENT AND ENHANCE STANDARD SURFACE MOUNT EQUIPMENT FOR THE AUTOMOTIVE, COMPONENT ASSEMBLY, TELECOMMUNICATIONS, AND MEDICAL MARKETS, NAMELY, SEMICONDUCTOR MANUFACTURING MACHINES, COMPONENT AND PRINTED CIRCUIT BOARD ASSEMBLY MACHINES IN THE NATURE OF MANUFACTURING MACHINES FOR PERFORMING ONE OR MORE OF THE FOLLOWING FUNCTIONS, NAMELY, ORIENTING, FEEDING, MOUNTING AND BONDING ELECTRONIC SEMICONDUCTOR COMPONENTS TOGETHER AND ONTO PRINTED CIRCUIT BOARDS, SEMICONDUCTOR WAFER PROCESSING MACHINES AND SEMICONDUCTOR SUBSTRATES MANUFACTURING MACHINES; SEMICONDUCTOR MANUFACTURING MACHINES FEATURING COMPONENT AND DIE FEEDERS, CONVEYORS, PROCESS PERIPHERALS AND FLEXIBLE PROCESS CELLS; SEMICONDUCTOR MANUFACTURING MACHINES FOR USE IN FLIP CHIP AND DIE BONDING, HYBRID MODULE ASSEMBLY, AND MECHANICAL ASSEMBLY UTILIZING SURFACE MOUNT AND INSERTION MOUNT EQUIPMENT (U.S. CLS. 13, 19, 21, 23, 31, 34 AND 35).

CLASS 9—ELECTRICAL AND SCIENTIFIC APPARATUS

FOR ELECTRICAL CONTROLLERS AND COMPUTER SOFTWARE FOR USE IN CONTROLLING ELECTRONICS AND SEMICONDUCTOR COMPONENT ASSEMBLY MACHINES, ALL FOR USE BY CUSTOMERS IN THE AUTOMOTIVE, COMPONENT ASSEMBLY, TELECOMMUNICATIONS, AND MEDICAL MARKETS; COMPUTER SOFTWARE FOR DETERMINING OPTIMUM PROCESSES FOR ASSEMBLING ELECTRONICS AND SEMICONDUCTOR COMPONENTS, FOR USE BY CUSTOMERS IN THE AUTOMOTIVE, COMPONENT ASSEMBLY, TELECOMMUNICATIONS, AND MEDICAL MARKETS; COMPUTER BASED APPARATUS FOR DESIGNING THE LAYOUT OF ELECTRONIC CIRCUITS; ELECTRICAL CONTROLLERS AND COMPUTER SOFTWARE FOR USE IN CONTROLLING SEMICONDUCTOR MANUFACTURING MACHINES THAT PERFORM FLIP CHIP AND DIE BONDING, HYBRID MODULE ASSEMBLY, AND MECHANICAL ASSEMBLY UTILIZING SURFACE MOUNT AND INSERTION MOUNT EQUIPMENT (U.S. CLS. 21, 23, 26, 36 AND 38).

CLASS 40—MATERIAL TREATMENT

FOR CONSULTING FOR OTHERS IN THE FIELD OF ELECTRONICS ASSEMBLY AND PROCESSES FOR ASSEMBLING SEMICONDUCTOR COMPONENTS; PROVIDING INFORMATION TO OTHERS IN THE FIELD OF ELECTRONICS AND SEMICONDUCTOR COMPONENT ASSEMBLY RELATED TO FLIP CHIP AND DIE BONDING, HYBRID MODULE ASSEMBLY, AND MECHANICAL ASSEMBLY (U.S. CLS. 100, 103 AND 106).

CLASS 42—SCIENTIFIC, COMPUTER AND LEGAL SERVICES

FOR RESEARCH AND DEVELOPMENT IN THE FIELD OF SURFACE MOUNT AND INSERTION MOUNT ELECTRONICS ASSEMBLY EQUIPMENT; ENGINEERING SERVICES IN THE FIELD OF ELECTRONICS ASSEMBLY EQUIPMENT FOR CUSTOMERS IN THE AUTOMOTIVE, SEMICONDUCTOR COMPONENT ASSEMBLY, TELECOMMUNICATIONS, AND MEDICAL MARKETS; DESIGN, DEVELOPMENT AND TESTING OF NEW PRODUCTS FOR OTHERS IN THE FIELD OF ELECTRONICS ASSEMBLY EQUIPMENT (U.S. CLS. 100 AND 101).

NELSON SNYDER, EXAMINING ATTORNEY

SN 77-003,890. 153 AGRO PRODUCT KOREA CO., LTD., SEOUL, REPUBLIC OF KOREA, FILED 9-21-2006.

LOVE LETTER

THE COLOR(S) RED, GREEN AND BLACK IS/ARE CLAIMED AS A FEATURE OF THE MARK.

THE MARK CONSISTS OF RED LETTERING OUTLINED IN GREEN AND THEN IN BLACK.

CLASS 16—PAPER GOODS AND PRINTED MATTER

FOR PAPER SACKS FOR WRAPPING; PLASTIC SACKS FOR WRAPPING; CORRUGATED CARDBOARD BOXES; BOXES MADE OF PAPER (U.S. CLS. 2, 5, 22, 23, 29, 37, 38 AND 50).

SN 77-003,182. CINTRON BEVERAGE GROUP, LLC, PHILADELPHIA, PA. FILED 9-20-2006.

CLASS 29—MEATS AND PROCESSED FOODS

FOR MEATS; POULTRY; SAUSAGE; EGGS; PICKLED VEGETABLES; CUBED RADISH KIMCHI, NAMELY, FERMENTED VEGETABLES; PICKLED RADISHES; SOUP (U.S. CL. 46).

Enhance Your Life

THE MARK CONSISTS OF STANDARD CHARACTERS WITHOUT CLAIM TO ANY PARTICULAR FONT, STYLE, SIZE, OR COLOR.

CLASS 14—JEWELRY

FOR (INTENT TO USE) KEY CHAINS OF PRECIOUS METAL (U.S. CLS. 2, 27, 28 AND 50).

CLASS 18—LEATHER GOODS

FOR (INTENT TO USE) GYM BAGS; SPORTS BAGS (U.S. CLS. 1, 2, 3, 22 AND 41).

CLASS 21—HOUSEWARES AND GLASS

FOR (INTENT TO USE) BEER MUGS; COFFEE CUPS; DRINKING GLASSES; GLASS MUGS; MUGS (U.S. CLS. 2, 13, 23, 29, 30, 33, 40 AND 50).

CLASS 25—CLOTHING

FOR (INTENT TO USE) POLO SHIRTS; SHIRTS; SHORT-SLEEVED OR LONG-SLEEVED T-SHIRTS; SHORT-SLEEVED SHIRTS; SPORT SHIRTS; SPORTS SHIRTS; SPORTS SHIRTS WITH SHORT SLEEVES; T-SHIRTS (U.S. CLS. 22 AND 39).

CLASS 32—LIGHT BEVERAGES

FOR (USE) ENERGY DRINKS; SPORTS DRINKS (U.S. CLS. 45, 46 AND 48).
FIRST USE 8-15-2006; IN COMMERCE 8-15-2006.
RAY THOMAS, EXAMINING ATTORNEY

CLASS 30—STAPLE FOODS

FOR MEAT TENDERIZERS FOR HOUSEHOLD PURPOSES; SEASONINGS; CONDIMENTS, NAMELY, KETCHUP AND MUSTARD; PIZZAS; SPAGHETTI; OAT-MEAL; SANDWICHES; MACARONI; PASTA; VANILLA; BEVERAGES MADE OF TEA AND COFFEE; SPICED SALT; CELERY SALT, SALT FOR COOKING; SALAD DRESSINGS (U.S. CL. 46).

CLASS 35—ADVERTISING AND BUSINESS

FOR RETAIL STORE SERVICES AND ONLINE RETAIL STORE SERVICES ALL FEATURING EDIBLE FOOD PRODUCTS AND INGREDIENTS; RESTAURANT MANAGEMENT SERVICES FOR OTHERS (U.S. CLS. 100, 101 AND 102).

CLASS 43—HOTEL AND RESTAURANT SERVICES

FOR RESTAURANT SERVICES; TAKE OUT RESTAURANT SERVICES; CAFETERIA SERVICES (U.S. CLS. 100 AND 101).

BILL DAWE, EXAMINING ATTORNEY

SN 77-004,352. PSS WORLD MEDICAL, INC., JACKSONVILLE, FL. FILED 9-21-2006.

CARDEX

THE MARK CONSISTS OF STANDARD CHARACTERS WITHOUT CLAIM TO ANY PARTICULAR FONT, STYLE, SIZE, OR COLOR.

CLASS 10—MEDICAL APPARATUS

FOR CONSUMABLE PRODUCTS FOR USE WITH ELECTRO-CARDIOGRAM EQUIPMENT, NAMELY, CARDIAC ELECTRODES (U.S. CLS. 26, 39 AND 44).

CLASS 16—PAPER GOODS AND PRINTED MATTER

FOR CONSUMABLE PRODUCTS FOR USE WITH ELECTRO-CARDIOGRAM EQUIPMENT, NAMELY, ELECTROCARDIOGRAPH PAPER (U.S. CLS. 2, 5, 22, 23, 29, 37, 38 AND 50).

STEVEN PEREZ, EXAMINING ATTORNEY

SN 77-005,276. BOUDREAU, MICHELLE, BEVERLY HILLS, CA. FILED 9-22-2006.

MICHELLE BOUDREAU

THE MARK CONSISTS OF STANDARD CHARACTERS WITHOUT CLAIM TO ANY PARTICULAR FONT, STYLE, SIZE, OR COLOR.

CLASS 3—COSMETICS AND CLEANING PREPARATIONS

FOR ASTRINGENTS FOR COSMETIC PURPOSES; BATH OILS FOR COSMETIC PURPOSES; BODY AND BEAUTY CARE COSMETICS; CLEANSING CREAMS; COCOA BUTTER FOR COSMETIC PURPOSES; CONCEALERS; COSMETIC CREAMS; COSMETIC CREAMS FOR SKIN CARE; COSMETIC MILKS; COSMETIC OILS; COSMETIC OILS FOR THE EPIDERMIS; COSMETIC PADS; COSMETIC PENCILS; COSMETIC PREPARATIONS AGAINST SUNBURN; COSMETIC PREPARATIONS FOR BODY CARE; COSMETIC PREPARATIONS FOR EYE LASHES; COSMETIC PREPARATIONS FOR SKIN RENEWAL; COSMETIC PREPARATIONS FOR THE CARE OF MOUTH AND TEETH; COSMETIC ROUGES; COSMETIC SOAPS; COSMETIC SUN-PROTECTING PREPARATIONS; COSMETICS; COSMETICS NAMELY, COMPACTS; COSMETICS, NAMELY LIP PRIMER; EYE MAKE-UP; EYE MAKE-UP REMOVER; FACE CREAMS FOR COSMETIC USE; FACIAL MAKE-UP; LOTIONS FOR FACE AND BODY CARE; MAKE UP FOUNDATIONS; MAKE UP REMOVING PREPARATIONS; MAKE-UP; MAKE-UP PENCILS; MAKE-UP POWDER; MAKE-UP PRODUCTS FOR THE FACE AND BODY; MAKE-UP REMOVER; MAKE-UP REMOVING LOTIONS; NAIL VARNISH FOR COSMETIC PURPOSES; NON-MEDICATED LIP CARE PREPARATIONS; NON-MEDICATED SKIN CARE PREPARATIONS; NON-MEDICATED SKIN CREAMS; NUTRITIONAL OILS FOR COSMETIC PURPOSES; PENCILS FOR COSMETIC PURPOSES; SHAMPOOS; SKIN CARE PRODUCTS, NAMELY, NON-MEDICATED SKIN SERUM; SKIN CLEANSERS; SKIN CLEANSING CREAM; SKIN CLEANSING LOTION; SKIN CONDITIONERS; SKIN CREAMS; SKIN CREAMS IN LIQUID AND IN SOLID FORM; SKIN LOTIONS; SKIN MASKS; SKIN MOISTURIZER; SKIN TEXTURIZERS; SKIN TONERS (U.S. CLS. 1, 4, 6, 50, 51 AND 52).

CLASS 14—JEWELRY

FOR BRACELETS; BRACELETS OF PRECIOUS METAL; CLIP EARRINGS; COSTUME JEWELRY; DIAMONDS; EARRINGS; GEMSTONES; JEWEL PENDANTS; JEWELRY; JEWELRY CHAINS; JEWELRY FOR THE HEAD; JEWELRY WATCHES; NECKLACES; PENDANTS; PRECIOUS GEMSTONES; RINGS BEING JEWELRY; SEMI-PRECIOUS GEMSTONES; SYNTHETIC DIAMONDS (U.S. CLS. 2, 27, 28 AND 50).

CLASS 25—CLOTHING

FOR BELTS; BLOUSES; COATS FOR MEN AND WOMEN; DRESS SHIRTS; FOOTWEAR FOR MEN AND WOMEN; HEADWEAR; MEN AND WOMEN JACKETS, COATS, TROUSERS, VESTS; PANTS; SHIRTS; SHOES; SHORT-SLEEVED OR LONG-SLEEVED T-SHIRTS; SPORT SHIRTS; SWEATERS; TOPS; WOMEN'S SHOES; WOMEN'S UNDERWEAR; WRAPS (U.S. CLS. 22 AND 39).

CLASS 41—EDUCATION AND ENTERTAINMENT

FOR ENTERTAINMENT IN THE NATURE OF ONGOING TELEVISION PROGRAMS IN THE FIELD OF TELEVISION VARIETY SHOWS AND INFOMERCIALS; ENTERTAINMENT IN THE NATURE OF VISUAL AND AUDIO PERFORMANCES, AND MUSICAL, VARIETY, NEWS AND COMEDY SHOWS; ENTERTAINMENT IN THE NATURE OF VARIETY SHOWS AND INFOMERCIALS; ENTERTAINMENT NAMELY, PRODUCTION OF VARIETY SHOWS AND INFOMERCIALS; ENTERTAINMENT SERVICES, NAMELY, PERSONAL APPEARANCES BY A CELEBRITY; ENTERTAINMENT SERVICES, NAMELY, HOSTING OF TELEVISION VARIETY SHOWS AND INFOMERCIALS (U.S. CLS. 100, 101 AND 107).

KATHERINE CHANG, EXAMINING ATTORNEY

SN 77-005,811. DECATHLON, VILLENEUVE D'ASCQ, FRANCE, FILED 9-22-2006.

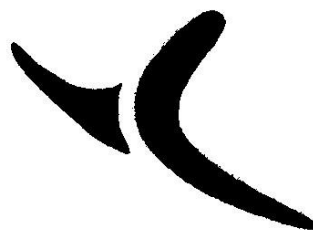

OWNER OF FRANCE REG. NO. 063418145, DATED 3-22-2006, EXPIRES 3-21-2016.

CLASS 9—ELECTRICAL AND SCIENTIFIC APPARATUS

FOR DVD PLAYERS, MP3 MUSIC PLAYERS, AMPLIFIERS; PRE-RECORDED VIDEO TAPES, PRE-RECORDED CD-ROM, VIDEO CASSETTES, AND AUDIO AND VIDEO COMPACT DISKS, ALL FEATURING FITNESS, MUSCULAR TRAINING, BOXING, JUDO; AUDIO AND VIDEO RECEIVERS; PRE-RECORDED MAGNETIC DISKS, PRE-RECORDED OPTICAL DISKS, AND PRE-RECORDED OPTICAL COMPACT DISKS, ALL FEATURING FITNESS, MUSCULAR TRAINING, BOXING, JUDO; WALKIE-TALKIES; RADIOS; CELLULAR PHONES; ELECTRONIC PERSONAL ASSISTANTS; COMMERCIAL SAFETY NETS FOR PROTECTION AGAINST ACCIDENTS; SAFETY RESTRAINTS; PROTECTION DEVICES FOR PERSONAL USE AGAINST ACCIDENTS, NAMELY PROTECTIVE GOGGLES, PROTECTIVE HELMETS; PROTECTIVE HELMETS FOR SPORTS; PROTECTIVE MASKS; KNEE PADS FOR WORKERS; PROTECTIVE CLOTHING, NAMELY, MITTENS, FOOT PROTECTORS, PROTECTIVE PLASTRONS; SCALES; OPTICAL SPECTACLES; SUNGLASSES; SPECTACLE CASES; GLOBAL POSITIONING SYSTEM; PHOTOGRAPHIC CAMERAS; PEDOMETERS; SPEEDOMETERS (U.S. CLS. 21, 23, 26, 36 AND 38).

CLASS 27—FLOOR COVERINGS

FOR MATS, NAMELY FLOOR MATS, DOOR MATS, BEACH MATS; GYMNASIUM MATS; TRAINING MATS, NAMELY GYMNASIUM EXERCISE MATS; NON-SLIP MATS NAMELY TATAMIS; LINOLEUM FOR USE ON FLOORS; FLOOR COVERINGS; PROTECTIVE FLOOR MATS (U.S. CLS. 19, 20, 37, 42 AND 50).

JORDAN BAKER, EXAMINING ATTORNEY

CLASS 29—MEATS AND PROCESSED FOODS

FOR PROCESSED FRUITS AND NUTS, NAMELY, CANNED, BOTTLED, FROZEN, DEHYDRATED, VACUUM-PACKED, ASEPTICALLY-PACKAGED, SLICED AND DICED, ALMONDS, APPLES, CHERRIES, KIWI FRUIT, ORANGES, NECTARINES, PEACHES, PISTACHIO NUTS, PLUMS, POMEGRANATES, TABLE GRAPES (EXCLUDING DEHYDRATED GRAPES), WINE GRAPES, AND OTHER FRUITS (U.S. CL. 46).

CLASS 32—LIGHT BEVERAGES

FOR LIGHT BEVERAGES, NAMELY, JUICE CONCENTRATES AND SINGLE-STRENGTH JUICES FROM FRUITS AND VEGETABLES (U.S. CLS. 45, 46 AND 48).

AISHA CLARKE, EXAMINING ATTORNEY

SN 77-005,921. ETCHEGARAY FARMS, LLC, VISALIA, CA. FILED 9-23-2006.

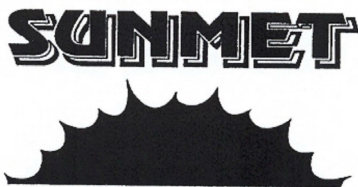

OWNER OF U.S. REG. NO. 2,042,707.
THE MARK CONSISTS OF THE WORD SUNMET, STYLIZED TO CREATE A SHADOW EFFECT, PLACED ABOVE A SEMI-CIRCLE STYLIZED SO AS TO APPEAR TO BE A SUNBURST.

CLASS 29—MEATS AND PROCESSED FOODS

FOR PROCESSED FRUITS AND NUTS NAMELY, CANNED, BOTTLED, FROZEN, DEHYDRATED, VACUUM-PACKED, ASEPTICALLY-PACKAGED, SLICED AND DICED, ALMONDS, APPLES, CHERRIES, KIWI FRUIT, ORANGES, NECTARINES, PEACHES, PISTACHIO NUTS, PLUMS, POMEGRANATES, TABLE GRAPES (EXCLUDING DEHYDRATED GRAPES), WINE GRAPES, AND OTHER FRUITS (U.S. CL. 46).

CLASS 32—LIGHT BEVERAGES

FOR LIGHT BEVERAGES, NAMELY JUICE CONCENTRATES AND SINGLE-STRENGTH JUICES FROM FRUITS AND VEGETABLES (U.S. CLS. 45, 46 AND 48).

AISHA CLARKE, EXAMINING ATTORNEY

SN 77-005,923. ETCHEGARAY FARMS, LLC, VISALIA, CA. FILED 9-23-2006.

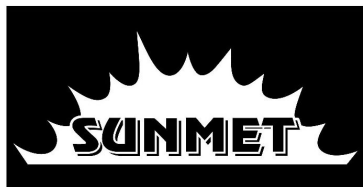

OWNER OF U.S. REG. NO. 2,042,707.
THE MARK CONSISTS OF THE WORD SUNMET, STYLIZED TO CREATE A SHADOW EFFECT, PLACED WITHIN A SEMI-CIRCLE STYLIZED SO AS TO APPEAR TO BE A SUNBURST.

SN 77-006,230. UNIVERSAL INSTRUMENTS CORPORATION, BINGHAMTON, NY. FILED 9-25-2006.

UNOVIS

THE MARK CONSISTS OF STANDARD CHARACTERS WITHOUT CLAIM TO ANY PARTICULAR FONT, STYLE, SIZE, OR COLOR.

CLASS 7—MACHINERY

FOR ELECTRONICS ASSEMBLY MACHINES THAT COMPLEMENT AND ENHANCE STANDARD SURFACE MOUNT EQUIPMENT FOR THE AUTOMOTIVE, COMPONENT ASSEMBLY, TELECOMMUNICATIONS, AND MEDICAL MARKETS, NAMELY, SEMICONDUCTOR MANUFACTURING MACHINES, COMPONENT AND PRINTED CIRCUIT BOARD ASSEMBLY MACHINES IN THE NATURE OF MANUFACTURING MACHINES FOR PERFORMING ONE OR MORE OF THE FOLLOWING FUNCTIONS, NAMELY, ORIENTING, FEEDING, MOUNTING AND BONDING ELECTRONIC SEMICONDUCTOR COMPONENTS TOGETHER AND ONTO PRINTED CIRCUIT BOARDS, SEMICONDUCTOR WAFER PROCESSING MACHINES AND SEMICONDUCTOR SUBSTRATES MANUFACTURING MACHINES; SEMICONDUCTOR MANUFACTURING MACHINES FEATURING COMPONENT AND DIE FEEDERS, CONVEYORS, PROCESS PERIPHERALS AND FLEXIBLE PROCESS CELLS; SEMICONDUCTOR MANUFACTURING MACHINES FOR USE IN FLIP CHIP AND DIE BONDING, HYBRID MODULE ASSEMBLY, AND MECHANICAL ASSEMBLY UTILIZING SURFACE MOUNT AND INSERTION MOUNT EQUIPMENT (U.S. CLS. 13, 19, 21, 23, 31, 34 AND 35).

CLASS 9—ELECTRICAL AND SCIENTIFIC APPARATUS

FOR ELECTRICAL CONTROLLERS AND COMPUTER SOFTWARE FOR USE IN CONTROLLING ELECTRONICS AND SEMICONDUCTOR COMPONENT ASSEMBLY MACHINES, ALL FOR USE BY CUSTOMERS IN THE AUTOMOTIVE, COMPONENT ASSEMBLY, TELECOMMUNICATIONS, AND MEDICAL MARKETS; COMPUTER SOFTWARE FOR DETERMINING OPTIMUM PROCESSES FOR ASSEMBLING ELECTRONICS AND SEMICONDUCTOR COMPONENTS, FOR USE BY CUSTOMERS IN THE AUTOMOTIVE, COMPONENT ASSEMBLY, TELECOMMUNICATIONS, AND MEDICAL MARKETS; COMPUTER BASED APPARATUS FOR DESIGNING THE LAYOUT OF ELECTRONIC CIRCUITS; ELECTRICAL CONTROLLERS AND COMPUTER SOFTWARE FOR USE IN CONTROLLING SEMICONDUCTOR MANUFACTURING MACHINES THAT PERFORM FLIP CHIP AND DIE BONDING, HYBRID MODULE ASSEMBLY, AND MECHANICAL ASSEMBLY UTILIZING SURFACE MOUNT AND INSERTION MOUNT EQUIPMENT (U.S. CLS. 21, 23, 26, 36 AND 38).

CLASS 40—MATERIAL TREATMENT

FOR CONSULTING FOR OTHERS IN THE FIELD OF ELECTRONICS ASSEMBLY AND PROCESSES FOR ASSEMBLING SEMICONDUCTOR COMPONENTS; PROVIDING INFORMATION TO OTHERS IN THE FIELD OF ELECTRONICS AND SEMICONDUCTOR COMPONENT ASSEMBLY RELATED TO FLIP CHIP AND DIE BONDING, HYBRID MODULE ASSEMBLY, AND MECHANICAL ASSEMBLY (U.S. CLS. 100, 103 AND 106).

CLASS 42—SCIENTIFIC, COMPUTER AND LEGAL SERVICES

FOR RESEARCH AND DEVELOPMENT IN THE FIELD OF SURFACE MOUNT AND INSERTION MOUNT ELECTRONICS ASSEMBLY EQUIPMENT; ENGINEERING SERVICES IN THE FIELD OF ELECTRONICS ASSEMBLY EQUIPMENT FOR CUSTOMERS IN THE AUTOMOTIVE, SEMICONDUCTOR COMPONENT ASSEMBLY, TELECOMMUNICATIONS, AND MEDICAL MARKETS; DESIGN, DEVELOPMENT AND TESTING OF NEW PRODUCTS FOR OTHERS IN THE FIELD OF ELECTRONICS ASSEMBLY EQUIPMENT (U.S. CLS. 100 AND 101).

NELSON SNYDER, EXAMINING ATTORNEY

CLASS 6—METAL GOODS

FOR METAL GOODS, NAMELY, TELEVISION WALL MOUNTS; METAL DOOR ACCESSORIES AND DOOR HARDWARE, NAMELY, KEYS AND KEY CYLINDERS; SHELVING HARDWARE, NAMELY, METAL SCREWS; GATE HARDWARE, NAMELY, METAL HINGES; METAL MAILBOXES, METAL POSTS, METAL MENDING PLATES, METAL PICTURE HANGERS, WIRE, SCREEN WIRE, METAL SCAFFOLDING, METAL PUMP JACKS BEING COMPONENT PARTS OF METAL SCAFFOLDING, METAL SKYLIGHTS, NON-LUMINOUS AND NON-MECHANICAL METAL SIGNS, METAL HOUSE NUMBERS AND LETTERS; METAL HOOKS AND HOOK-AND-LOOP TYPE FASTENERS, NAMELY, METAL BARS AND CHAINS FOR STORAGE PURPOSES; METAL PET DOORS (U.S. CLS. 2, 12, 13, 14, 23, 25 AND 50).

CLASS 19—NON-METALLIC BUILDING MATERIALS

FOR NON-METAL SKYLIGHTS, NON-METAL MILLWORK EXCLUSIVE OF CABINETS; NON-METAL WINDOW SHUTTERS AND DOORS; FIREPLACE MANTELS; WOOD MOLDINGS; STAIR PARTS, NAMELY, STAIR TREADS; NON-METAL POSTS; NON-METAL SCAFFOLDING (U.S. CLS. 1, 12, 33 AND 50).

CLASS 20—FURNITURE AND ARTICLES NOT OTHERWISE CLASSIFIED

FOR FURNITURE AND FURNISHINGS, NAMELY, ACCENT FURNITURE, BEDROOM FURNITURE, KITCHEN FURNITURE, KITCHEN CABINETS, COUNTERTOPS, HOME OFFICE FURNITURE, CASUAL DINING FURNITURE, ENTERTAINMENT STANDS, ENTERTAINMENT CENTERS, FOLDING TABLES, FOLDING CHAIRS, BAR STOOLS, BOOKCASES, SHELVING, WIRE SHELVES, READY-TO-FINISH FURNITURE, BATHROOM FURNITURE, BATHROOM CABINETS, MEDICINE CABINETS, FURNITURE PARTS, NAMELY, DRAWER SLIDES, DOORS FOR ARMOIRES AND CABINET DOORS, VANITY TOPS; DECORATIVE MILLWORK, MOLDING, AND GINGERBREAD TRIM, BEING FURNITURE PARTS, NAMELY, ARM RESTS, CHAIR LEGS, CABINET DOORS, DOORS FOR ARMOIRES, DRAWER SLIDES, TABLE LEAVES, AND VANITY TOPS; WOODEN DOWELS; PET FURNITURE, NAMELY, PET PERCHES; PORTABLE BEDS FOR PETS, PLAYHOUSES FOR PETS, PORTABLE PET KENNELS; NON-METAL MAILBOXES; NON-METAL HOUSE NUMBERS AND LETTERS; NON-METAL WINDOW AND DOOR TRIM; NON-METAL TELEVISION WALL MOUNTS; NON-METAL FIREPLACE BRACKETS (U.S. CLS. 2, 13, 22, 25, 32 AND 50).

WOODROW HARTZOG, EXAMINING ATTORNEY

SN 77-006,233. LF, LLC, WILMINGTON, DE. FILED 9-25-2006.

PROJECT SOURCE

THE MARK CONSISTS OF STANDARD CHARACTERS WITHOUT CLAIM TO ANY PARTICULAR FONT, STYLE, SIZE, OR COLOR.

SN 77-006,533. RECKITT & COLMAN (OVERSEAS) LIMITED, HULL, UNITED KINGDOM, FILED 9-25-2006.

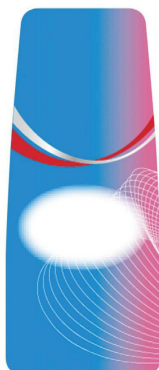

THE COLOR(S) RED, WHITE SILVER AND BLUE IS/ARE CLAIMED AS A FEATURE OF THE MARK.

THE MARK CONSISTS OF THE DESIGN OF A LABEL FEATURING A BLUE BACKGROUND ON WHICH APPEARS TWO INTERSECTING ARCS, ONE IN RED, ONE IN SILVER, A WHITE OVAL FIELD WITH GRADATED BLUE SHADING AT THE EDGES AND A SERIES OF CURVED WHITE LINES WHICH INTERSECT TO FORM A STYLIZED GRID.

CLASS 3—COSMETICS AND CLEANING PREPARATIONS

FOR NON-MEDICATED SKIN CLEANSER; NON-MEDICATED PREPARATIONS FOR COVERING AND CONCEALING ACNE BLEMISHES; MEDICATED SOAP; COSMETICS; PERFUMERY; SKIN SOAPS; SHAMPOOS; NON-MEDICATED TOILETRIES; FACIAL WIPES AND PADS IMPREGNATED WITH CLEANING PREPARATIONS FOR PERSONAL USE (U.S. CLS. 1, 4, 6, 50, 51 AND 52).

CLASS 5—PHARMACEUTICALS

FOR MEDICATED SKIN CARE PREPARATIONS, NAMELY MEDICATED SKIN CREAM; FACIAL WIPES AND PADS IMPREGNATED WITH MEDICATED CLEANING PREPARATIONS FOR PERSONAL USE (U.S. CLS. 6, 18, 44, 46, 51 AND 52).

DAVID TAYLOR, EXAMINING ATTORNEY

SN 77-008,289. GLOBAL HEALTH COUNCIL, INC., WHITE RIVER JUNCTION, VT. FILED 9-27-2006.

Campaign for Children's Lives

THE MARK CONSISTS OF STANDARD CHARACTERS WITHOUT CLAIM TO ANY PARTICULAR FONT, STYLE, SIZE, OR COLOR.

NO CLAIM IS MADE TO THE EXCLUSIVE RIGHT TO USE "CHILDREN'S", APART FROM THE MARK AS SHOWN.

CLASS 16—PAPER GOODS AND PRINTED MATTER

FOR NEWSLETTERS IN THE FIELD OF CHILDREN'S HEALTH ISSUES (U.S. CLS. 2, 5, 22, 23, 29, 37, 38 AND 50).

CLASS 44—MEDICAL, BEAUTY AND AGRICULTURAL SERVICES

FOR PROVIDING NEWS AND INFORMATION CONCERNING CHILDREN'S HEALTH ISSUES TO THE PUBLIC, PATIENTS AND HEALTH CARE PROFESSIONALS VIA NEWSLETTERS AND A GLOBAL COMPUTER NETWORK (U.S. CLS. 100 AND 101).

SHAUNIA CARLYLE, EXAMINING ATTORNEY

SN 77-009,584. CIPAR, INC., WILMINGTON, DE. FILED 9-28-2006.

TRITON SPINCAST SYSTEM

THE MARK CONSISTS OF STANDARD CHARACTERS WITHOUT CLAIM TO ANY PARTICULAR FONT, STYLE, SIZE, OR COLOR.

NO CLAIM IS MADE TO THE EXCLUSIVE RIGHT TO USE "SYSTEM", APART FROM THE MARK AS SHOWN.

CLASS 17—RUBBER GOODS

FOR INTERIOR LININGS MADE OF NON-METAL MATERIAL FOR THE INSIDE OF PIPES TO PREVENT CORROSION AND CURE LEAKS (U.S. CLS. 1, 5, 12, 13, 35 AND 50).

CLASS 42—SCIENTIFIC, COMPUTER AND LEGAL SERVICES

FOR PROVIDING A DIAGNOSTIC SERVICE ON WATER PIPES TO DETERMINE PIPE STRENGTH AND WATER FLOW CHARACTERISTICS (U.S. CLS. 100 AND 101).

GEORGIA CARTY, EXAMINING ATTORNEY

SN 77-009,967. REALSELF, INC., SEATTLE, WA. FILED 9-28-2006.

REALSELF

THE MARK CONSISTS OF STANDARD CHARACTERS WITHOUT CLAIM TO ANY PARTICULAR FONT, STYLE, SIZE, OR COLOR.

CLASS 35—ADVERTISING AND BUSINESS

FOR PROVIDING ONLINE CONSUMER PRODUCT REVIEWS AND TESTIMONIALS REGARDING PRODUCTS RELATED TO AGING, COSMETIC SURGERY, AND BEAUTY (U.S. CLS. 100, 101 AND 102).

FIRST USE 4-0-2006; IN COMMERCE 4-0-2006.

CLASS 41—EDUCATION AND ENTERTAINMENT

FOR PROVIDING ON-LINE BLOGS AND PHOTOGRAPHS IN THE FIELDS OF AGING, COSMETIC SURGERY AND BEAUTY (U.S. CLS. 100, 101 AND 107).

FIRST USE 4-0-2006; IN COMMERCE 4-0-2006.

CLASS 44—MEDICAL, BEAUTY AND AGRICULTURAL SERVICES

FOR PROVIDING ONLINE NEWS AND INFORMATION IN THE FIELDS OF AGING, COSMETIC SURGERY AND BEAUTY; PROVIDING ONLINE CUSTOMER TESTIMONIALS ABOUT COSMETIC SURGERY AND RELATED BEAUTY SERVICES (U.S. CLS. 100 AND 101).

FIRST USE 4-0-2006; IN COMMERCE 4-0-2006.
KIMBERLY FRYE, EXAMINING ATTORNEY

SN 77-012,095. SIBEAM, INC., SUNNYVALE, CA. FILED 10-2-2006.



NO CLAIM IS MADE TO THE EXCLUSIVE RIGHT TO USE "WIRELESS HD", APART FROM THE MARK AS SHOWN.

CLASS 35—ADVERTISING AND BUSINESS

FOR ASSOCIATION SERVICES, NAMELY, PROMOTING THE INTERESTS OF MANUFACTURERS THAT CREATE GLOBAL MILLIMETER WAVE WIRELESS NETWORKING GOODS AND SERVICES (U.S. CLS. 100, 101 AND 102).

CLASS 42—SCIENTIFIC, COMPUTER AND LEGAL SERVICES

FOR TESTING, ANALYSIS AND EVALUATION OF THE GOODS AND SERVICES OF OTHERS IN THE FIELD OF OTHERS IN THE FIELD OF INTEROPERABILITY OF GLOBAL MILLIMETER WAVE WIRELESS NETWORKING GOODS AND SERVICES FOR USE IN BOTH CONSUMER AND COMMERCIAL PRODUCTS FOR THE PURPOSE OF CERTIFICATION (U.S. CLS. 100 AND 101).

ESTHER A. BORSUK, EXAMINING ATTORNEY

SN 77-012,526. FOSTORIA INDUSTRIES, INC., FOSTORIA, OH. FILED 10-3-2006.

FOSTORIA

THE MARK CONSISTS OF STANDARD CHARACTERS WITHOUT CLAIM TO ANY PARTICULAR FONT, STYLE, SIZE, OR COLOR.

SEC. 2(F).

CLASS 9—ELECTRICAL AND SCIENTIFIC APPARATUS

FOR COMMERCIAL AND INDUSTRIAL ELECTRICAL AND SCIENTIFIC APPARATUS, NAMELY, ELECTRICAL APPARATUS FOR LIGHTING AND PARTS THEREFOR, NAMELY, ELECTRIC CONDUCTOR GUARDS; ELECTRIC OR ELECTRONIC CONTROLS FOR CONTROLLING POWER TO HEAVY INDUSTRIAL AND LABORATORY EQUIPMENT; ELECTRIC OR ELECTRONIC CONTROLS FOR INSTALLATION OF INFRA-RED ELECTRIC AND GAS HEATERS, OVENS AND FURNACES, AND REPLACEMENT PARTS THEREOF (U.S. CLS. 21, 23, 26, 36 AND 38).

FIRST USE 0-0-1934; IN COMMERCE 0-0-1934.

CLASS 11—ENVIRONMENTAL CONTROL APPARATUS

FOR COMMERCIAL AND INDUSTRIAL ENVIRONMENT CONTROL APPARATUS, NAMELY, ELECTRIC LAMPS; LIGHTS FOR LOCALIZED WORK AREAS AND DISPLAYS; ACCENT LIGHTING EQUIPMENT, NAMELY, MACHINE TOOL LIGHTS, PORTABLE UTILITY LIGHTS AND DOCK LIGHTS; SEWING MACHINE LIGHT FIXTURES; LIGHT SHADES FOR PROTECTING AGAINST GLARE; LIGHT GUARDS FOR PROTECTING LIGHTS; ELECTRIC COMFORT HEATERS AND ELECTRIC SPACE HEATERS; BROODER HEATERS; INFRARED RADIATING ELECTRIC AND GAS OVEN FOR HEATING, CURING, AND DRYING PROCESSES AND CONTROLS THEREFOR; ELECTRIC AND GAS OVEN FOR PAINT AND ENAMEL CURING, BAKING AND DRYING, AUTOMOTIVE REFINISHING, WATER REMOVING, WATER DRYOFF, THERMAL DEGREASING, SOLDERING, BRAZING, PRE-HEATING, ADHESIVE DRYING, FRIT DRYING, PORCELAINIZING, PLASTIC CURING, TEXTILE DRYING AND CURING, PRINT DRYING, HEAT SETTING, COATING AND THREAD DRYING, DRYING PRINTED AND FLOCKED FABRICS, CARPET DRYING NONWOVENS, CURING AND DRYING PAPER FELTS, PRE-DRYING, WOOD DRYING AND CURING, SHOE DRYING; CONTAINER STERILIZERS; ELECTRIC AND GAS OVEN SYSTEMS FOR COOKING, BAKING, BROILING, TOASTING, DRYING AND REHEATING AND REPLACEMENT PARTS THEREFOR; BRACKETS FOR MOUNTING ELECTRIC LIGHTING; ADJUSTABLE ELECTRIC LAMP SUPPORTS, NAMELY, LAMP BASES (U.S. CLS. 13, 21, 23, 31 AND 34).

FIRST USE 0-0-1934; IN COMMERCE 0-0-1934.

CHRISTINA SOBRAL, EXAMINING ATTORNEY

SN 77-013,621. FOSTORIA INDUSTRIES, INC., FOSTORIA, OH. FILED 10-4-2006.



SEC. 2(F) "FASTORIA".

CLASS 9—ELECTRICAL AND SCIENTIFIC APPARATUS

FOR COMMERCIAL AND INDUSTRIAL ELECTRICAL AND SCIENTIFIC APPARATUS, NAMELY, ELECTRICAL APPARATUS FOR LIGHTING AND PARTS THEREFOR, NAMELY, ELECTRIC CONDUCTOR GUARDS; ELECTRIC OR ELECTRONIC CONTROLS FOR CONTROLLING POWER TO HEAVY INDUSTRIAL AND LABORATORY EQUIPMENT; ELECTRIC OR ELECTRONIC CONTROLS FOR INSTALLATION OF INFRA-RED ELECTRIC AND GAS HEATERS, OVENS AND FURNACES, AND REPLACEMENT PARTS THEREOF (U.S. CLS. 21, 23, 26, 36 AND 38).

FIRST USE 0-0-1934; IN COMMERCE 0-0-1934.

CLASS 11—ENVIRONMENTAL CONTROL APPARATUS

FOR COMMERCIAL AND INDUSTRIAL ENVIRONMENTAL CONTROL APPARATUS, NAMELY, ELECTRIC LAMPS; LIGHTS FOR LOCALIZED WORK AREAS AND DISPLAYS; ACCENT LIGHTING EQUIPMENT, NAMELY, MACHINE TOOL LIGHTS, PORTABLE UTILITY LIGHTS AND DOCK LIGHTS; SEWING MACHINE LIGHT FIXTURES; LIGHT SHADES FOR PROTECTING AGAINST GLARE; LIGHT GUARDS FOR PROTECTING LIGHTS; ELECTRIC COMFORT HEATERS AND ELECTRIC SPACE HEATERS; BROODER HEATERS; INFRARED RADIATING ELECTRIC AND GAS OVEN FOR HEATING, CURING, AND DRYING PROCESSES AND CONTROLS THEREFOR; ELECTRIC AND GAS OVEN FOR PAINT AND ENAMEL CURING, BAKING AND DRYING, AUTOMOTIVE REFINISHING, WATER REMOVING, WATER DRYOFF, THERMAL DEGREASING, SOLDERING, BRAZING, PRE-HEATING, ADHESIVE DRYING, FRIT DRYING, PORCELAINIZING, PLASTIC CURING, TEXTILE DRYING AND CURING, PRINT DRYING, HEAT SETTING, COATING AND THREAD DRYING, DRYING PRINTED AND FLOCKED FABRICS, CARPET DRYING NONWOVENS, CURING AND DRYING PAPER FELTS, PRE-DRYING, WOOD DRYING AND CURING, SHOE DRYING; CONTAINER STERILIZERS; ELECTRIC AND GAS OVEN SYSTEMS FOR COOKING, BAKING, BROILING, TOASTING, DRYING AND REHEATING AND REPLACEMENT PARTS THEREFOR; BRACKETS FOR MOUNTING ELECTRIC LIGHTING; ADJUSTABLE ELECTRIC LAMP SUPPORTS, NAMELY, LAMP BASES (U.S. CLS. 13, 21, 23, 31 AND 34).

FIRST USE 0-0-1939; IN COMMERCE 0-0-1939.

CHRISTINA SOBRAL, EXAMINING ATTORNEY

SN 77-016,508. RPNY LLC, NEW YORK, NY. FILED 10-8-2006.

RPNY Tennis

THE MARK CONSISTS OF STANDARD CHARACTERS WITHOUT CLAIM TO ANY PARTICULAR FONT, STYLE, SIZE, OR COLOR.

NO CLAIM IS MADE TO THE EXCLUSIVE RIGHT TO USE "TENNIS", APART FROM THE MARK AS SHOWN.

CLASS 37—CONSTRUCTION AND REPAIR

FOR CUSTOM TENNIS RACQUET STRINGING SERVICES (U.S. CLS. 100, 103 AND 106).

FIRST USE 5-1-2004; IN COMMERCE 5-1-2004.

CLASS 40—MATERIAL TREATMENT

FOR CUSTOM MANUFACTURE OF TENNIS RACQUET GRIPS (U.S. CLS. 100, 103 AND 106).
FIRST USE 5-1-2004; IN COMMERCE 5-1-2004.
FRED MANDIR, EXAMINING ATTORNEY

SN 77-016,512. RPNY LLC, NEW YORK, NY. FILED 10-8-2006.



NO CLAIM IS MADE TO THE EXCLUSIVE RIGHT TO USE "TENNIS", APART FROM THE MARK AS SHOWN.

"THE COLOR(S) BLACK AND ORANGE IS/ARE CLAIMED AS A FEATURE OF THE MARK."

"THE MARK CONSISTS OF TWO STYLIZED TENNIS RACQUETS, ONE BLACK AND ONE ORANGE. ALL WORDING IS IN BLACK"

CLASS 37—CONSTRUCTION AND REPAIR

FOR CUSTOM TENNIS RACQUET STRINGING SERVICES (U.S. CLS. 100, 103 AND 106).

FIRST USE 5-1-2004; IN COMMERCE 5-1-2004.

CLASS 40—MATERIAL TREATMENT

FOR CUSTOM MANUFACTURE OF TENNIS RACQUET GRIPS (U.S. CLS. 100, 103 AND 106).

FIRST USE 5-1-2004; IN COMMERCE 5-1-2004.

FRED MANDIR, EXAMINING ATTORNEY

SN 77-017,116. CANTOR FITZGERALD SECURITIES, NEW YORK, NY. FILED 10-9-2006.

CANTOR FITZGERALD MORNING NEWS

THE MARK CONSISTS OF STANDARD CHARACTERS WITHOUT CLAIM TO ANY PARTICULAR FONT, STYLE, SIZE, OR COLOR.

OWNER OF U.S. REG. NOS. 2,682,691, 2,703,811 AND 3,018,837.

NO CLAIM IS MADE TO THE EXCLUSIVE RIGHT TO USE "MORNING NEWS", APART FROM THE MARK AS SHOWN.

CLASS 9—ELECTRICAL AND SCIENTIFIC APPARATUS

FOR DOWNLOADABLE ELECTRONIC PUBLICATIONS IN THE NATURE OF NEWSLETTERS IN THE FIELDS OF BUSINESS, COMPANIES, INVESTMENT, FINANCIAL MARKETS, SECURITIES, COMMODITIES, FUTURES, OPTIONS, STOCKS, BONDS, DERIVATIVES, FOREIGN EXCHANGE AND OTHER FINANCIAL INSTRUMENTS (U.S. CLS. 21, 23, 26, 36 AND 38).

CLASS 36—INSURANCE AND FINANCIAL

FOR FINANCIAL SERVICES, NAMELY, PROVISION OF FINANCIAL AND SECURITIES INFORMATION; FINANCIAL INFORMATION PROVIDED BY ELECTRONIC MEANS; PROVIDING INFORMATION IN THE FIELDS OF INVESTMENTS, FINANCIAL MARKETS, SECURITIES, COMMODITIES, FUTURES, OPTIONS, STOCKS, BONDS, DERIVATIVES, FOREIGN EXCHANGE AND OTHER FINANCIAL INSTRUMENTS (U.S. CLS. 100, 101 AND 102).

CHERYL CLAYTON, EXAMINING ATTORNEY

CLASS 41—EDUCATION AND ENTERTAINMENT

FOR TRAINING OF PHYSICIANS AND MEDICAL PERSONNEL IN THE USE OF CRYOTHERAPY AND CRYOSURGERY; TRAINING OF PHYSICIANS AND MEDICAL PERSONNEL IN THE USE OF CRYOTHERAPY AND CRYOSURGICAL EQUIPMENT, NAMELY SURGICAL AND TREATMENT PROBES, CATHETERS AND ENDOSCOPES; TRAINING OF PHYSICIANS AND MEDICAL PERSONNEL IN THE USE OF CRYOSURGICAL AND CRYOTHERAPY DEVICE CONTROL SYSTEMS, NAMELY, APPARATUSES FOR CONTROLLING THE FLOW OF CRYOGENS, BLEEDER AND PRESSURE REDUCTION VALVES FOR MAINTAINING PRESSURE IN CRYOTHERAPY AND CRYOSURGICAL DEVICES AND DELIVERY SYSTEMS, RIGID AND FLEXIBLE MEDICAL ENDOSCOPES, CATHETERS, LUMEN BLOCKING BALLOONS AND SHIELDS FOR GASTRIC BLOCKING, NASOGASTRIC TUBES, SUCTION DEVICES FOR CRYOGENS REMOVAL AND ENDOSCOPY CAMERAS; TRAINING OF PHYSICIANS AND MEDICAL PERSONNEL IN THE USE OF THERAPY AND SURGICAL DELIVERY SYSTEMS FOR DELIVERING CRYOGENS, NAMELY RIGID AND FLEXIBLE MEDICAL ENDOSCOPES, CATHETERS, LUMEN BLOCKING BALLOONS AND SHIELDS FOR GASTRIC BLOCKING, NASOGASTRIC TUBES, SUCTION DEVICES FOR CRYOGENS REMOVAL AND ENDOSCOPY CAMERAS; TRAINING OF PHYSICIANS AND MEDICAL PERSONNEL IN PERFORMING MEDICAL PROCEDURES INVOLVING CRYOTHERAPY AND CRYOSURGERY; AND TRAINING OF PHYSICIANS AND MEDICAL PERSONNEL IN PERFORMING MEDICAL PROCEDURES INVOLVING ABDOMINAL, BLADDER, PANCREATIC, KIDNEY, LUNG, STOMACH, ESOPHAGEAL AND UPPER AND LOWER GASTROINTESTINAL TISSUE IDENTIFICATION, SEPARATION, ABLATION OR ERADICATION (U.S. CLS. 100, 101 AND 107).

SN 77-018,446. CSA MEDICAL, INC., BALTIMORE, MD. FILED 10-11-2006.

CSA

THE MARK CONSISTS OF STANDARD CHARACTERS WITHOUT CLAIM TO ANY PARTICULAR FONT, STYLE, SIZE, OR COLOR.

CLASS 9—ELECTRICAL AND SCIENTIFIC APPARATUS

FOR VIDEO MONITORS, COMPUTERS FOR CONTROLLING CRYOTHERAPY AND CRYOSURGERY DEVICES AND CRYOTHERAPY DELIVERY SYSTEMS AND PRINTERS (U.S. CLS. 21, 23, 26, 36 AND 38).

CLASS 44—MEDICAL, BEAUTY AND AGRICULTURAL SERVICES

FOR MEDICAL PROCEDURES, NAMELY PERFORMING CRYOTHERAPY AND CRYOSURGERY; PERFORMING MEDICAL PROCEDURES INVOLVING ABDOMINAL, BLADDER, PANCREATIC, KIDNEY, LUNG, STOMACH, ESOPHAGEAL, UPPER AND LOWER GASTROINTESTINAL TISSUE IDENTIFICATION, SEPARATION, ABLATION OR ERADICATION OF UNWANTED LESIONS USING ENDOSCOPIC SURGERY (U.S. CLS. 100 AND 101).

RENEE SERVANCE, EXAMINING ATTORNEY

CLASS 10—MEDICAL APPARATUS

FOR CRYOSURGICAL APPARATUS FOR USE IN PERFORMING ABLATIVE SURGERY; MEDICAL DEVICES, NAMELY CRYOTHERAPY AND CRYOSURGICAL DEVICES, NAMELY SURGICAL AND TREATMENT PROBES, CATHETERS AND ENDOSCOPES; CRYOSURGICAL AND CRYOTHERAPY DEVICE CONTROL SYSTEMS, NAMELY APPARATUSES FOR CONTROLLING THE FLOW OF CRYOGENS, BLEEDER AND PRESSURE REDUCTION VALVES FOR MAINTAINING PRESSURE IN CRYOTHERAPY AND CRYOSURGICAL DEVICES AND DELIVERY SYSTEMS, RIGID AND FLEXIBLE MEDICAL ENDOSCOPES, CATHETERS, LUMEN BLOCKING BALLOONS AND SHIELDS FOR GASTRIC BLOCKING, NASOGASTRIC TUBES, SUCTION DEVICES FOR CRYOGENS REMOVAL AND ENDOSCOPY CAMERAS; CRYOSURGICAL TOOLS OR UNITS USED TO DESTROY TISSUE DURING SURGICAL PROCEDURES, NAMELY CATHETERS FOR THE INTRODUCTION OF A CRYOGEN TO A TARGET TISSUE; AND THERAPY AND SURGICAL DELIVERY SYSTEMS AND COMPONENTS THERE OF FOR DELIVERING CRYOGENS TO A PATIENT, NAMELY SURGICAL AND TREATMENT PROBES, CATHETERS AND ENDOSCOPES (U.S. CLS. 26, 39 AND 44).

SN 77-018,591. CSA MEDICAL, INC., BALTIMORE, MD. FILED 10-11-2006.



NO CLAIM IS MADE TO THE EXCLUSIVE RIGHT TO USE "MEDICAL", APART FROM THE MARK AS SHOWN. THE MARK CONSISTS OF DOTS ARRANGED IN A CONICAL SHAPE WITH AN INCOMPLETE OVAL AT THE BASE OF THE CONE. THE WORDING "CSA MEDICAL" IS DISPLAYED UNDER DESIGN.

CLASS 9—ELECTRICAL AND SCIENTIFIC APPARATUS

FOR VIDEO MONITORS, COMPUTERS FOR CONTROLLING CRYOTHERAPY AND CRYOSURGERY DEVICES AND CRYOTHERAPY DELIVERY SYSTEMS AND PRINTERS (U.S. CLS. 21, 23, 26, 36 AND 38).

CLASS 10—MEDICAL APPARATUS

FOR CRYOSURGICAL APPARATUS FOR USE IN PERFORMING ABLATIVE SURGERY; MEDICAL DEVICES, NAMELY CRYOSURGICAL AND CRYOTHERAPY DEVICES, NAMELY CATHETERS AND SURGICAL AND TREATMENT PROBES; CRYOSURGICAL TOOLS OR UNITS USED TO DESTROY TISSUE DURING SURGICAL PROCEDURES, NAMELY CATHETERS FOR THE INTRODUCTION OF A CRYOGEN TO A TARGET TISSUE; THERAPY AND SURGICAL DELIVERY SYSTEMS AND COMPONENTS THEREOF FOR DELIVERING CRYOGENS TO A PATIENT, NAMELY, SURGICAL AND TREATMENT PROBES, CATHETERS, ENDOSCOPES; CRYOSURGERY AND CRYOTHERAPY DEVICE CONTROL SYSTEMS, NAMELY APPARATUS FOR CONTROLLING THE FLOW OF CRYOGENS, BLEEDER AND PRESSURE REDUCTION VALVES FOR MAINTAINING PRESSURE IN CRYOTHERAPY AND CRYOSURGICAL DEVICES AND DELIVERY SYSTEMS, RIGID AND FLEXIBLE MEDICAL ENDOSCOPES, CATHETERS, LUMEN BLOCKING BALLOONS AND SHIELDS FOR GASTRIC BLOCKING, NASOGASTRIC TUBES, SUCTION DEVICES FOR CRYOGENS REMOVAL AND ENDOSCOPY CAMERAS (U.S. CLS. 26, 39 AND 44).

RENEE SERVANACE, EXAMINING ATTORNEY

SN 77-018,987. MEDASSIST, INCORPORATED, LOUISVILLE, KY. FILED 10-11-2006.

MEDASSIST

THE MARK CONSISTS OF STANDARD CHARACTERS WITHOUT CLAIM TO ANY PARTICULAR FONT, STYLE, SIZE, OR COLOR.

OWNER OF U.S. REG. NO. 2,384,496.

CLASS 35—ADVERTISING AND BUSINESS

FOR ACCOUNTS RECEIVABLE SERVICES; ADMINISTRATION, BILLING AND RECONCILIATION OF ACCOUNTS ON BEHALF OF OTHERS; MANAGEMENT AND OPERATION OF TELEPHONE CALL CENTERS FOR OTHERS; CREDIT CARD REGISTRATION; REGISTERING PATIENTS ON BEHALF OF MEDICAL PROVIDERS; VERIFICATION OF PATIENT INSURANCE (U.S. CLS. 100, 101 AND 102).

FIRST USE 4-30-1990; IN COMMERCE 4-30-1990.

CLASS 36—INSURANCE AND FINANCIAL

FOR CREDIT AND FINANCIAL CONSULTATION; CREDIT CARD SERVICES; INSURANCE CLAIMS PROCESSING (U.S. CLS. 100, 101 AND 102).

FIRST USE 4-30-1990; IN COMMERCE 4-30-1990.

CLASS 45—PERSONAL SERVICES

FOR ASSISTING MEDICAL PATIENTS WITH FORMS AND APPLICATIONS FOR GOVERNMENT ASSISTANCE AND CHARITY PROGRAMS (U.S. CLS. 100 AND 101).

FIRST USE 4-30-1990; IN COMMERCE 4-30-1990.
CORY BOONE, EXAMINING ATTORNEY

SN 77-020,631. FEDERATION EMPLOYMENT AND GUIDANCE SERVICE, INC. (F.E.G.S.), NEW YORK, NY. FILED 10-13-2006.



The logo for "positive SPACE" features a stylized lowercase "p" inside a square, followed by the word "positive" in a sans-serif font and "SPACE" in a larger, bold, sans-serif font.

CLASS 35—ADVERTISING AND BUSINESS

FOR PROVIDING PUBLIC ADVOCACY SERVICES TO PROMOTE AWARENESS TO INDIVIDUALS, FAMILIES AND GROUPS DEALING WITH HIV/AIDS AND OTHER SEXUALLY TRANSMITTED DISEASES IN THE FIELDS OF EMPLOYMENT, PREVENTION, TRAINING, BEHAVIORAL HEALTH, HOUSING, RESIDENTIAL AND HOMECARE NEEDS (U.S. CLS. 100, 101 AND 102).

FIRST USE 11-29-2004; IN COMMERCE 11-29-2004.

CLASS 41—EDUCATION AND ENTERTAINMENT

FOR PROVIDING EDUCATIONAL AND OUTREACH SERVICES, NAMELY, CONDUCTING CLASSES, SEMINARS, CONFERENCES, WORKSHOPS AND TUTORING FOCUSING ON PREVENTION AND TREATMENT OF HIV/AIDS AND OTHER SEXUALLY TRANSMITTED DISEASES (U.S. CLS. 100, 101 AND 107).

FIRST USE 11-29-2004; IN COMMERCE 11-29-2004.

CLASS 44—MEDICAL, BEAUTY AND AGRICULTURAL SERVICES

FOR PROVIDING A THERAPIES PROGRAM TO INDIVIDUALS WITH HIV/AIDS, NAMELY, MASSAGE, ACUPUNCTURE AND CHIROPRACTIC CARE; MENTAL HEALTH COUNSELING (U.S. CLS. 100 AND 101).

FIRST USE 11-29-2004; IN COMMERCE 11-29-2004.

CLASS 45—PERSONAL SERVICES

FOR PROVIDING SUPPORT GROUPS FOR INDIVIDUALS, FAMILIES AND GROUPS DEALING WITH HIV/AIDS AND OTHER SEXUALLY TRANSMITTED DISEASES (U.S. CLS. 100 AND 101).

FIRST USE 11-29-2004; IN COMMERCE 11-29-2004.

DEIRDRE ROBERTSON, EXAMINING ATTORNEY

SN 77-020,692. GOTTBETTER & PARTNERS, LLP, NEW YORK, NY. FILED 10-13-2006.



The logo for "Gottbetter & Partners, LLP" features the name in a serif font, with a blue triangle symbol between "&" and "Partners".

NO CLAIM IS MADE TO THE EXCLUSIVE RIGHT TO USE "& PARTNERS, LLP", APART FROM THE MARK AS SHOWN.

THE COLOR(S) BLACK, WHITE AND BLUE IS/ARE CLAIMED AS A FEATURE OF THE MARK.

THE MARK CONSISTS OF THE WORDING GOTTBETTER AND PARTNERS, LLP IN BLACK, THE AMPERSAND IN WHITE, AND THE TRIANGLE IN BLUE.

CLASS 36—INSURANCE AND FINANCIAL

FOR FINANCIAL ADVISORY SERVICES (U.S. CLS. 100, 101 AND 102).

FIRST USE 8-0-2003; IN COMMERCE 8-0-2003.

CLASS 42—SCIENTIFIC, COMPUTER AND LEGAL SERVICES

FOR LEGAL SERVICES IN THE AREAS OF CORPORATE AND SECURITIES LAW, MERGERS AND ACQUISITIONS, CORPORATE TRANSACTIONS, AND INTELLECTUAL PROPERTY (U.S. CLS. 100 AND 101).

FIRST USE 8-0-2003; IN COMMERCE 8-0-2003.
SUE LAWRENCE, EXAMINING ATTORNEY

SN 77-023,108. PROSCI, INC., LOVELAND, CO. FILED 10-17-2006.

CENTERSERVE

THE MARK CONSISTS OF STANDARD CHARACTERS WITHOUT CLAIM TO ANY PARTICULAR FONT, STYLE, SIZE, OR COLOR.

CLASS 9—ELECTRICAL AND SCIENTIFIC APPARATUS

FOR COMPUTER SOFTWARE FOR SCHEDULING CALL-CENTER PERSONNEL FOR OTHERS; DOWNLOADABLE ELECTRONIC PUBLICATIONS IN THE NATURE OF NEWSLETTERS, BOOKS, PAMPHLETS, USER MANUALS, AND MAGAZINES IN THE FIELD OF TELEPHONE CALL CENTERS AND OTHER SPECIALIZED TELECOMMUNICATIONS APPLICATIONS RECORDED ON COMPUTER MEDIA, NAMELY, THE MANAGEMENT OF TELEPHONE CALL CENTERS (U.S. CLS. 21, 23, 26, 36 AND 38).

CLASS 16—PAPER GOODS AND PRINTED MATTER

FOR NEWSLETTERS AND A SERIES OF NON-FICTION BOOKS IN THE FIELD OF TELEPHONE CALL CENTERS AND OTHER SPECIALIZED TELECOMMUNICATIONS APPLICATIONS, NAMELY, THE MANAGEMENT OF TELEPHONE CALL CENTERS (U.S. CLS. 2, 5, 22, 23, 29, 37, 38 AND 50).

DAHLIA GEORGE, EXAMINING ATTORNEY

SN 77-023,499. CONSTELLATION ENERGY GROUP, INC., BALTIMORE, MD. FILED 10-18-2006.

BGE HOME FOR YOUR BUSINESS

THE MARK CONSISTS OF STANDARD CHARACTERS WITHOUT CLAIM TO ANY PARTICULAR FONT, STYLE, SIZE, OR COLOR.

OWNER OF U.S. REG. NOS. 1,964,556, 2,596,900 AND OTHERS.

NO CLAIM IS MADE TO THE EXCLUSIVE RIGHT TO USE "FOR YOUR BUSINESS", APART FROM THE MARK AS SHOWN.

CLASS 35—ADVERTISING AND BUSINESS

FOR ON-LINE RETAIL STORE SERVICES, AND TELEPHONE ORDERING SERVICES IN THE FIELD OF HUMIDIFIERS, INDOOR AIR QUALITY SYSTEMS, DEHUMIDIFIERS, PLUMBING EQUIPMENT AND SYSTEMS, ELECTRICAL SYSTEMS, SURGE PROTECTION SYSTEMS, THERMOSTATS, AND HEATING, VENTILATION AND AIR CONDITIONING (HVAC) EQUIPMENT AND SYSTEMS; BUSINESS CONSULTING SERVICES FOR WHOLESALE, INDUSTRIAL AND COMMERCIAL CUSTOMERS IN THE FIELDS OF DESIGN, MAINTENANCE, UPGRADE AND OPERATIONS OF BUILDING AUTOMATION SYSTEMS, ENERGY POWER MONITORING AND CONTROL, HEATING, VENTILATION AND AIR CONDITIONING (HVAC), LIGHTING, ELECTRICAL AND ENVIRONMENTAL SYSTEMS, POWER DESIGN AND CONSTRUCTION; BUSINESS MANAGEMENT OF ALL BUILDING AND COMMERCIAL MECHANICAL, ELECTRICAL AND ELECTRONIC SYSTEMS FOR OTHERS (U.S. CLS. 100, 101 AND 102).

CLASS 37—CONSTRUCTION AND REPAIR

FOR INSTALLATION, MAINTENANCE AND REPAIR OF BUILDING AND COMMERCIAL MECHANICAL SYSTEMS AND HEATING, AIR CONDITIONING AND PLUMBING SYSTEMS; INSTALLATION OF AUTOMATED ELECTRONIC LIGHTING AND ENERGY CONTROLS; INSTALLATION, MAINTENANCE AND REPAIR OF BUILDING AUTOMATION AND ENERGY SYSTEMS, ELECTRICAL, HEATING, VENTILATION AND AIR CONDITIONING (HVAC) EQUIPMENT AND MAJOR APPLIANCES FOR WHOLESALE, INDUSTRIAL AND COMMERCIAL CUSTOMERS; PIPE FITTING INSTALLATION AND INDUSTRIAL CONSTRUCTION AND PIPE FITTING CONTRACTOR SERVICES; INSTALLATION, MAINTENANCE AND REPAIR OF ELECTRONIC EQUIPMENT, HUMIDIFIERS, INDOOR AIR QUALITY SYSTEMS, DEHUMIDIFIERS, PLUMBING SYSTEMS, ELECTRICAL SYSTEMS, SURGE PROTECTION SYSTEMS, THERMOSTATS, AND HEATING, VENTILATION AND AIR CONDITIONING EQUIPMENT AND SYSTEMS; PLUMBING SERVICES; ELECTRICAL CONTRACTING SERVICES; INSTALLATION OF LIGHTING, HEATING, COOLING AND REFRIGERATION SYSTEMS; INSTALLATION AND REPAIR OF ELECTRICAL AND ELECTRONIC DEVICES AND EQUIPMENT, NAMELY COMMERCIAL UTILITY SYSTEMS, HEATING, COOLING, LIGHTING, REFRIGERATION SYSTEMS, AND ELECTRIC POWER SYSTEMS INCLUDING GENERATION, TRANSMISSION, AND DISTRIBUTION FACILITIES (U.S. CLS. 100, 103 AND 106).

BARBARA GAYNOR, EXAMINING ATTORNEY

SN 77-024,742. OILDOM PUBLISHING COMPANY OF TEXAS, INC., HOUSTON, TX. FILED 10-19-2006.

REHAB ZONE

THE MARK CONSISTS OF STANDARD CHARACTERS WITHOUT CLAIM TO ANY PARTICULAR FONT, STYLE, SIZE, OR COLOR.

NO CLAIM IS MADE TO THE EXCLUSIVE RIGHT TO USE "REHAB", APART FROM THE MARK AS SHOWN.

CLASS 35—ADVERTISING AND BUSINESS

FOR PUTTING ON TRADESHOW EXHIBITS FOR PIPELINE REHABILITATION TECHNOLOGY (U.S. CLS. 100, 101 AND 102).

FIRST USE 12-1-2001; IN COMMERCE 12-1-2001.

CLASS 41—EDUCATION AND ENTERTAINMENT

FOR PROVIDING EDUCATIONAL SERVICES IN THE FIELD OF PIPELINE REHABILITATION, NAMELY, ORGANIZING AND CONDUCTING EXHIBITIONS AT SHOWS AND CONFERENCES AND DISTRIBUTING EDUCATIONAL MATERIALS IN CONNECTION THEREWITH (U.S. CLS. 100, 101 AND 107).

FIRST USE 12-1-2001; IN COMMERCE 12-1-2001.
ANDREA HACK, EXAMINING ATTORNEY

SN 77-026,693. FREMANTLE MEDIA NORTH AMERICA, INC., BURBANK, CA. FILED 10-23-2006.

AMERICAN IDOL

THE MARK CONSISTS OF STANDARD CHARACTERS WITHOUT CLAIM TO ANY PARTICULAR FONT, STYLE, SIZE, OR COLOR.

CLASS 29—MEATS AND PROCESSED FOODS

FOR CHILDREN'S COMBINATION MEAL CONSISTING OF CHICKEN NUGGETS SERVED WITH FRENCH FRIED POTATOES AND A SOFT DRINK FOR CONSUMPTION ON OR OFF THE PREMISES (U.S. CL. 46).

CLASS 30—STAPLE FOODS

FOR CHILDREN'S COMBINATION MEAL CONSISTING OF A HAMBURGER SANDWICH SERVED WITH FRENCH FRIED POTATOES AND A SOFT DRINK FOR CONSUMPTION ON OR OFF THE PREMISES (U.S. CL. 46).

CLASS 43—HOTEL AND RESTAURANT SERVICES

FOR RESTAURANT SERVICES (U.S. CLS. 100 AND 101).
JEFF DEFORD, EXAMINING ATTORNEY

SN 77-026,714. IVOCLAR VIVADENT, INC., AMHERST, NY. FILED 10-23-2006.

IPS E.MAX ZIRLINER

THE MARK CONSISTS OF STANDARD CHARACTERS WITHOUT CLAIM TO ANY PARTICULAR FONT, STYLE, SIZE, OR COLOR.

OWNER OF U.S. REG. NOS. 1,928,460 AND 3,076,872.

CLASS 5—PHARMACEUTICALS

FOR MATERIALS FOR USE IN DENTISTRY, NAMELY MATERIALS FOR THE MANUFACTURE OF DENTAL IMPRESSIONS, MODELS, CROWNS AND BRIDGES, INLAYS, DENTURES, ARTIFICIAL TEETH; DENTAL ALLOYS; DENTAL FILLING MATERIALS; MATERIALS FOR THE RESTORATION OF DAMAGED TEETH; DENTAL CERAMIC STRATUM; COLOR STAINS FOR USE IN DENTISTRY; PRECIOUS METAL ALLOYS AND NON-PRECIOUS METAL ALLOYS FOR DENTAL TECHNOLOGY; INVESTMENT MATERIALS FOR USE IN DENTISTRY, NAMELY PHOSPHATE BONDED DENTAL CASTING INVESTMENT MATERIAL; OPAQUE MATERIALS FOR USE IN DENTISTRY, NAMELY, OPAQUE DENTAL CERAMICS; INGOTS MADE OF RESIN, METAL OR CERAMIC FOR USE IN DENTISTRY; DENTAL VENEERS (U.S. CLS. 6, 18, 44, 46, 51 AND 52).

CLASS 10—MEDICAL APPARATUS

FOR APPARATUS AND INSTRUMENTS FOR DENTAL TECHNOLOGY, NAMELY ARTIFICIAL TEETH, CROWNS AND BRIDGES, TOOTH PINS, PREFABRICATED PARTS FOR CROWNS, BRIDGES AND PONTICS (U.S. CLS. 26, 39 AND 44).

SCOTT SISUN, EXAMINING ATTORNEY

SN 77-026,781. BAYS BROWN LABORATORIES, INC., LOUISVILLE, KY. FILED 10-23-2006.

FONT

THE MARK CONSISTS OF STANDARD CHARACTERS WITHOUT CLAIM TO ANY PARTICULAR FONT, STYLE, SIZE, OR COLOR.

CLASS 3—COSMETICS AND CLEANING PREPARATIONS

FOR NON-MEDICATED SKIN PRODUCTS, NAMELY, CREAMS, LOTIONS, GELS, TONERS, CLEANERS AND PEELS (U.S. CLS. 1, 4, 6, 50, 51 AND 52).

CLASS 5—PHARMACEUTICALS

FOR MEDICATED SKIN PRODUCTS, NAMELY, CREAMS, LOTIONS, GELS, TONERS, CLEANERS AND PEELS (U.S. CLS. 6, 18, 44, 46, 51 AND 52).

CHRISTOPHER BUONGIORNO, EXAMINING ATTORNEY

SN 77-027,701. FEDERATION EMPLOYMENT AND GUIDANCE SERVICE, INC. (F.E.G.S.), NEW YORK, NY. FILED 10-24-2006.



OWNER OF U.S. REG. NOS. 2,527,085, 2,850,217 AND OTHERS.

CLASS 35—ADVERTISING AND BUSINESS

FOR PROVIDING PUBLIC ADVOCACY SERVICES TO PROMOTE AWARENESS TO INDIVIDUALS, FAMILIES AND GROUPS DEALING WITH HIV/AIDS AND OTHER SEXUALLY TRANSMITTED DISEASES IN THE FIELDS OF EMPLOYMENT, PREVENTION, TRAINING, BEHAVIORAL HEALTH, HOUSING, RESIDENTIAL AND HOMECARE NEEDS (U.S. CLS. 100, 101 AND 102).

FIRST USE 7-1-2006; IN COMMERCE 7-1-2006.

CLASS 41—EDUCATION AND ENTERTAINMENT

FOR PROVIDING EDUCATIONAL AND OUTREACH SERVICES, NAMELY, CONDUCTING CLASSES, SEMINARS, CONFERENCES, WORKSHOPS AND TUTORING FOCUSING ON PREVENTION AND TREATMENT OF HIV/AIDS AND OTHER SEXUALLY TRANSMITTED DISEASES (U.S. CLS. 100, 101 AND 107).

FIRST USE 7-1-2006; IN COMMERCE 7-1-2006.

CLASS 44—MEDICAL, BEAUTY AND AGRICULTURAL SERVICES

FOR PROVIDING A THERAPIES PROGRAM TO INDIVIDUALS WITH HIV/AIDS, NAMELY, MASSAGE, ACUPUNCTURE AND CHIROPRACTIC CARE; MENTAL HEALTH COUNSELING (U.S. CLS. 100 AND 101).

FIRST USE 7-1-2006; IN COMMERCE 7-1-2006.

CLASS 45—PERSONAL SERVICES

FOR PROVIDING SUPPORT GROUPS FOR INDIVIDUALS, FAMILIES AND GROUPS DEALING WITH HIV/AIDS AND OTHER SEXUALLY TRANSMITTED DISEASES (U.S. CLS. 100 AND 101).

FIRST USE 7-1-2006; IN COMMERCE 7-1-2006.

DEIRDRE ROBERTSON, EXAMINING ATTORNEY

SN 77-027,812. CARGILL, INCORPORATED, WAYZATA, MN. FILED 10-24-2006.

Nature's Extra

THE MARK CONSISTS OF STANDARD CHARACTERS WITHOUT CLAIM TO ANY PARTICULAR FONT, STYLE, SIZE, OR COLOR.

CLASS 30—STAPLE FOODS

FOR MALT, SORGHUM, RICE AND BUCKWHEAT EXTRACTS USED AS INGREDIENTS FOR FOOD (U.S. CL. 46).

CLASS 31—NATURAL AGRICULTURAL PRODUCTS

FOR MALT FOR BREWING AND DISTILLING (U.S. CLS. 1 AND 46).

JAMES LOVELACE, EXAMINING ATTORNEY

SN 77-029,486. VICTOROV, VICTOR, SAINT-PETERSBURG, RUSSIAN FED., FILED 10-25-2006.

FlyGrid.Net

THE MARK CONSISTS OF STANDARD CHARACTERS WITHOUT CLAIM TO ANY PARTICULAR FONT, STYLE, SIZE, OR COLOR.

CLASS 9—ELECTRICAL AND SCIENTIFIC APPARATUS

FOR COMPUTER UTILITY SOFTWARE, DOWNLOADABLE COMPUTER SOFTWARE AND OTHER COMPUTER SOFTWARE FOR CUSTOMIZED DATA MANAGEMENT, NAMELY, MANAGEMENT OF TABULAR, NESTED AND HIERARCHICAL DATA (U.S. CLS. 21, 23, 26, 36 AND 38).

FIRST USE 6-15-2004; IN COMMERCE 3-7-2005.

CLASS 42—SCIENTIFIC, COMPUTER AND LEGAL SERVICES

FOR APPLICATION SERVICE PROVIDER FEATURING SOFTWARE FOR CUSTOMIZED DATA MANAGEMENT, NAMELY, MANAGEMENT OF TABULAR, NESTED AND HIERARCHICAL DATA; PROVIDING A WEBSITE THAT FEATURES TECHNICAL OPERATING INFORMATION AND SUPPORT FOR THE SOFTWARE PROGRAMS FOR CUSTOMIZED DATA MANAGEMENT, NAMELY, MANAGEMENT OF TABULAR, NESTED AND HIERARCHICAL DATA; OPERATING A WEBSITE FOR PROVIDING INTERACTIVE TECHNICAL SUPPORT SERVICES RELATING THERETO (U.S. CLS. 100 AND 101).

FIRST USE 6-15-2004; IN COMMERCE 3-7-2005.

JAY FLOWERS, EXAMINING ATTORNEY

SN 77-031,414. UNITED PARCEL SERVICE OF AMERICA, INC., ATLANTA, GA. FILED 10-27-2006.

TUPPY

THE MARK CONSISTS OF STANDARD CHARACTERS WITHOUT CLAIM TO ANY PARTICULAR FONT, STYLE, SIZE, OR COLOR.

CLASS 28—TOYS AND SPORTING GOODS

FOR STUFFED TOYS, PARLOR GAMES AND PLAY FIGURES (U.S. CLS. 22, 23, 38 AND 50).

CLASS 35—ADVERTISING AND BUSINESS

FOR ADVERTISING AND BUSINESS SERVICES, NAMELY BUSINESS MANAGEMENT; FRANCHISING SERVICES, NAMELY OFFERING TECHNICAL ASSISTANCE AND THE ESTABLISHMENT AND OPERATION OF RETAIL MAILING, SHIPPING, PACKAGING, FAXING AND ELECTRONIC COMMUNICATIONS OUTLETS; RETAIL STORE SERVICES OFFERING STAMPS AND OFFICE SUPPLIES; PHOTOCOPY SERVICES AND DOCUMENT REPRODUCTION SERVICES (U.S. CLS. 100, 101 AND 102).

CLASS 36—INSURANCE AND FINANCIAL

FOR CHARITABLE FUND RAISING SERVICES (U.S. CLS. 100, 101 AND 102).

SN 77-033,960. MID-MISSOURI BANCSHARES, INC., SPRINGFIELD, MO. FILED 11-1-2006.

CLASS 39—TRANSPORTATION AND STORAGE

FOR FREIGHT FORWARDING; PACKAGING ARTICLES FOR TRANSPORTATION; TRANSPORTATION AND DELIVERY OF PERSONAL PROPERTY BY AIR, RAIL, BOAT AND MOTOR VEHICLE; WAREHOUSING, STORAGE, PACKING, DELIVERY AND RETURNS WITH RESPECT TO THE FOREGOING; ARRANGING SHIP CHARTERS FOR OTHERS; DOCUMENT BOX RENTAL, DOCUMENT FORWARDING AND RECEIPT AND DELIVERY OF DOCUMENTS FOR OTHERS (U.S. CLS. 100 AND 105).

TINA KUAN, EXAMINING ATTORNEY

MID-MISSOURI TECH CENTER,
LLC

THE MARK CONSISTS OF STANDARD CHARACTERS WITHOUT CLAIM TO ANY PARTICULAR FONT, STYLE, SIZE, OR COLOR.

NO CLAIM IS MADE TO THE EXCLUSIVE RIGHT TO USE "TECH CENTER" AND " LLC", APART FROM THE MARK AS SHOWN.

SEC. 2(F).

CLASS 35—ADVERTISING AND BUSINESS

FOR DATA PROCESSING SERVICES; MAIL SORTING, HANDLING AND RECEIVING (U.S. CLS. 100, 101 AND 102).

FIRST USE 7-0-2001; IN COMMERCE 7-0-2001.

SN 77-031,530. FONALITY, INC., CULVER CITY, CA. FILED 10-27-2006.

CLASS 36—INSURANCE AND FINANCIAL

FOR BANKING SERVICES, NAMELY, WIRE TRANSFER SERVICES, BANKING SERVICES IN THE FIELD OF OVERDRAFT PROTECTION, CHECK AND DRAFT STOP PAYMENT, RE-PRESENTING AND COLLECTING NSF CHECKS RETURNED TO PAYEES; PROVIDING LOCK BOX FACILITIES FOR CUSTOMERS; FINANCIAL RESEARCH; FINANCIAL SERVICES, NAMELY, ISSUANCE OF CERTIFICATES OF DEPOSIT (U.S. CLS. 100, 101 AND 102).

FIRST USE 7-0-2001; IN COMMERCE 7-0-2001.

POINT-AND-CLICK OPEN SOURCE

THE MARK CONSISTS OF STANDARD CHARACTERS WITHOUT CLAIM TO ANY PARTICULAR FONT, STYLE, SIZE, OR COLOR.

NO CLAIM IS MADE TO THE EXCLUSIVE RIGHT TO USE "OPEN SOURCE", APART FROM THE MARK AS SHOWN.

CLASS 39—TRANSPORTATION AND STORAGE

FOR PHYSICAL STORAGE OF DOCUMENT FILES AND CANCELLED CHECKS (U.S. CLS. 100 AND 105).

FIRST USE 7-0-2001; IN COMMERCE 7-0-2001.

BERNICE MIDDLETON, EXAMINING ATTORNEY

CLASS 9—ELECTRICAL AND SCIENTIFIC APPARATUS

FOR COMPUTER HARDWARE AND SOFTWARE IN THE FIELD OF TELECOMMUNICATIONS, NAMELY, PRIVATE BRANCH EXCHANGE (PBX) SYSTEMS COMPRISED OF TELEPHONES, IP TELEPHONES, COMPUTER SERVERS, AND TELEPHONE SWITCHBOARDS AND EXCHANGERS; COMPUTER SOFTWARE PROGRAMS FOR USE IN INTEGRATING COMPUTER TELEPHONY IN THE FIELD OF COMPUTER NETWORKS; COMPUTER SOFTWARE PROGRAMS FOR MANAGING AND INTEGRATING CALL CENTER QUEUES; COMPUTER SOFTWARE FOR ENABLING VOICE-OVER-INTERNET-PROTOCOL (VOIP) COMMUNICATIONS (U.S. CLS. 21, 23, 26, 36 AND 38).

SN 77-035,008. APAJA ONLINE ENTERTAINMENT OY, HELSINKI, FINLAND, FILED 11-2-2006.

Playray

CLASS 38—COMMUNICATION

FOR INTERNET TELEPHONY SERVICES; TELEPHONY SERVICES, NAMELY, LOCAL AND LONG DISTANCE TELEPHONE SERVICE, VOICE OVER INTERNET PROTOCOL (VOIP) AND NON-VOICE OVER THE NET PHONE SERVICES PROVIDED VIA THE INTERNET; COMMUNICATIONS SERVICES, NAMELY, TRANSMITTING STREAMED SOUND AND AUDIO-VISUAL RECORDINGS VIA THE INTERNET; TELECOMMUNICATION SERVICES, NAMELY, TRANSMISSION OF VOICE VIA THE INTERNET, TELEPHONY SERVICES, NAMELY MANAGING AND INTEGRATING CALL CENTER QUEUES (U.S. CLS. 100, 101 AND 104).

ELIZABETH KAJUBI, EXAMINING ATTORNEY

THE MARK CONSISTS OF STANDARD CHARACTERS WITHOUT CLAIM TO ANY PARTICULAR FONT, STYLE, SIZE, OR COLOR.

OWNER OF U.S. REG. NO. 3,046,293.

CLASS 38—COMMUNICATION

FOR PROVIDING ON-LINE FORUMS AND BULLETIN BOARDS FOR TRANSMISSION OF MESSAGES AMONG COMPUTER USERS CONCERNING ONLINE AND COMPUTER GAMING (U.S. CLS. 100, 101 AND 104).

FIRST USE 6-4-2004; IN COMMERCE 6-4-2004.

CLASS 41—EDUCATION AND ENTERTAINMENT

FOR ENTERTAINMENT SERVICES, NAMELY, PROVIDING ONLINE COMPUTER GAMES THAT MAY BE ACCESSED NETWORK-WIDE BY NETWORK USERS; PROVIDING ONLINE INFORMATION ABOUT COMPUTER GAMES (U.S. CLS. 100, 101 AND 107).

FIRST USE 6-4-2004; IN COMMERCE 6-4-2004.

JANICE L. MCMORROW, EXAMINING ATTORNEY

SN 77-035,013. PROMARK BRANDS INC., MERIDIAN, ID. FILED 11-2-2006.

CLASS 44—MEDICAL, BEAUTY AND AGRICULTURAL SERVICES

FOR MEDICAL INFORMATION SERVICES NAMELY PROVIDING INFORMATION TO PATIENTS AND THE GENERAL PUBLIC REGARDING GENERAL PATIENT ACCESS TO VARIOUS MEDICINES, OVERALL HEALTHCARE AND PRESCRIPTION DRUG COVERAGE; ONLINE INFORMATION SERVICES NAMELY PROVIDING INFORMATION TO PATIENTS AND THE GENERAL PUBLIC REGARDING GENERAL PATIENT ACCESS TO VARIOUS MEDICINES, OVERALL HEALTHCARE, HEALTH AND WELLNESS PROGRAMS, AND PRESCRIPTION DRUG COVERAGE VIA A GLOBAL COMPUTER NETWORK (U.S. CLS. 100 AND 101).

FIRST USE 5-19-2006; IN COMMERCE 5-19-2006.

BENJAMIN ALLEN, EXAMINING ATTORNEY

ANYTIME SELECTIONS

THE MARK CONSISTS OF STANDARD CHARACTERS WITHOUT CLAIM TO ANY PARTICULAR FONT, STYLE, SIZE, OR COLOR.

NO CLAIM IS MADE TO THE EXCLUSIVE RIGHT TO USE "SELECTIONS", APART FROM THE MARK AS SHOWN.

CLASS 29—MEATS AND PROCESSED FOODS

FOR FROZEN MEALS CONSISTING OF MEAT, FISH, POULTRY, VEGETABLES OR CHEESE (U.S. CL. 46).

CLASS 30—STAPLE FOODS

FOR FROZEN MEALS CONSISTING OF PASTRY, BREAD, DOUGH, PASTA OR RICE; QUESADILLAS; CALZONES; SANDWICHES (U.S. CL. 46).

ROBERT C. CLARK JR., EXAMINING ATTORNEY

SN 77-035,464. PFIZER INC., NEW YORK, NY. FILED 11-2-2006.



OWNER OF U.S. REG. NOS. 626,088 AND 3,125,531. NO CLAIM IS MADE TO THE EXCLUSIVE RIGHT TO USE "COMMUNITY" AND "HEALTH" AND "NETWORK", APART FROM THE MARK AS SHOWN.

THE STIPPLING IS A FEATURE OF THE MARK.

THE MARK CONSISTS OF A SCENE WHICH DEPICTS A COMMUNITY WITH HOUSES, TREES AND PEOPLE.

CLASS 16—PAPER GOODS AND PRINTED MATTER

FOR PRINTED MATERIALS NAMELY, NEWSLETTERS ON THE TOPICS OF ACCESS TO MEDICINES, HEALTHCARE AND PRESCRIPTION DRUG COVERAGE (U.S. CLS. 2, 5, 22, 23, 29, 37, 38 AND 50).

FIRST USE 10-7-2005; IN COMMERCE 10-7-2005.

SN 77-037,993. FIBERNET TELECOM GROUP, INC., NEW YORK, NY. FILED 11-6-2006.



THE MARK CONSISTS OF TWO CIRCULAR DESIGNS STACKED ONE ON TOP OF THE OTHER. THE BOTTOM CIRCULAR DESIGN FUNCTIONS AS A SHADOW FOR THE TOP CIRCULAR DESIGN.

CLASS 38—COMMUNICATION

FOR COMMUNICATIONS SERVICES, NAMELY, PROVIDING BROADBAND CONNECTIVITY FOR DATA, VOICE AND VIDEO TRANSMISSION ON ITS FIBER OPTIC NETWORKS IN MAJOR METROPOLITAN AREAS; PROVIDING ACCESS MANAGEMENT SERVICES, NAMELY, MANAGEMENT OF TELECOMMUNICATION NETWORKS IN BUILDINGS (U.S. CLS. 100, 101 AND 104).

FIRST USE 10-11-2005; IN COMMERCE 10-11-2005.

CLASS 42—SCIENTIFIC, COMPUTER AND LEGAL SERVICES

FOR COMPUTER COLOCATION SERVICES, NAMELY, PROVIDING CUSTOMERS WITH THE ABILITY TO LOCATE THEIR COMMUNICATIONS AND NETWORKING EQUIPMENT AT CARRIER POINT FACILITIES; COMPUTER NETWORK DESIGN SERVICES FOR OTHERS (U.S. CLS. 100 AND 101).

FIRST USE 10-11-2005; IN COMMERCE 10-11-2005.

KIMBERLY FRYE, EXAMINING ATTORNEY

SN 77-039,124. A COW ON RODEO, LLC, BEVERLY HILLS, CA. FILED 11-7-2006.

SN 77-040,008. CENZIC, INC., SANTA CLARA, CA. FILED 11-8-2006.

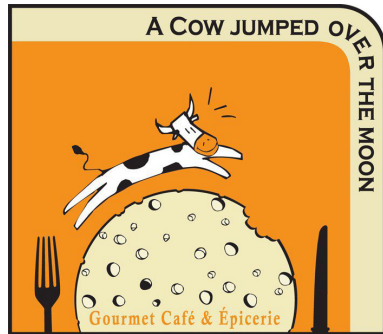

NO CLAIM IS MADE TO THE EXCLUSIVE RIGHT TO USE "GOURMET CAFE AND EPICERIE", APART FROM THE MARK AS SHOWN.

"THE COLOR(S) BLACK, WHITE, YELLOW, ORANGE IS/ ARE CLAIMED AS A FEATURE OF THE MARK."

"THE MARK CONSISTS OF A BLACK AND WHITE COW JUMPING OVER A YELLOW WHEEL OF CHEESE WITH BLACK KNIFE ON THE RIGHT SIDE AND A BLACK FORK ON THE LEFT SIDE ON AN ORANGE BACKGROUND WITH THE WORDS "A COW JUMPED OVER THE MOON" ON THE UPPER RIGHT CORNER WRITTEN IN BLACK IN A YELLOW BACKGROUND AND THE WORDS "GOURMET CAFE AND EPICERIE" IN YELLOW ON THE WHEEL OF CHEESE."

"THE FOREIGN WORDING IN THE MARK TRANSLATES INTO ENGLISH AS GROCERY STORE."

CLASS 29—MEATS AND PROCESSED FOODS

FOR CHEESES (U.S. CL. 46).
FIRST USE 6-1-2006; IN COMMERCE 6-1-2006.

CLASS 33—WINES AND SPIRITS

FOR ALCOHOLIC BEVERAGES, NAMELY WINES (U.S. CLS. 47 AND 49).
FIRST USE 6-1-2006; IN COMMERCE 6-1-2006.

CLASS 35—ADVERTISING AND BUSINESS

FOR RETAIL BAKERY SHOP SERVICES; RETAIL STORE SERVICES FEATURING A RANGE OF SPECIALTY FOOD AND DRINK PRODUCTS AND INGREDIENTS; AND FRANCHISE SERVICES, NAMELY, OFFERING TECHNICAL AND BUSINESS MANAGEMENT ASSISTANCE IN THE ESTABLISHMENT AND OPERATION OF RESTAURANTS COMBINED WITH RETAIL BAKERY SHOPS AND RETAIL STORES FEATURING FOOD AND DRINK PRODUCTS (U.S. CLS. 100, 101 AND 102).
FIRST USE 6-1-2006; IN COMMERCE 6-1-2006.

CLASS 43—HOTEL AND RESTAURANT SERVICES

FOR PROVISION OF FOOD AND DRINKS IN RESTAURANT, COFFEE SHOPS, BARS, CATERING SERVICES, RESTAURANTS AND COFFEE HOUSE SERVICES (U.S. CLS. 100 AND 101).
FIRST USE 6-1-2006; IN COMMERCE 6-1-2006.
CAROLYN CATALDO, EXAMINING ATTORNEY

NO WEBSITE LEFT BEHIND

THE MARK CONSISTS OF STANDARD CHARACTERS WITHOUT CLAIM TO ANY PARTICULAR FONT, STYLE, SIZE, OR COLOR.

CLASS 9—ELECTRICAL AND SCIENTIFIC APPARATUS

FOR COMPUTER UTILITY SOFTWARE FOR USE IN SOFTWARE TESTING WORK; COMPUTER SOFTWARE FOR PROTECTING, SECURING, MONITORING, AND MANAGING COMPUTER AND COMMUNICATIONS NETWORKS, SOFTWARE, NETWORK TRAFFIC, NETWORK ACCESS, AND DATA; COMPUTER SOFTWARE FOR IDENTIFYING AND CORRECTING FAULTS AND ERRORS, NAMELY, WEB APPLICATIONS FAULTS AND ERRORS OVER COMPUTER AND COMMUNICATIONS NETWORKS (U.S. CLS. 21, 23, 26, 36 AND 38).

CLASS 42—SCIENTIFIC, COMPUTER AND LEGAL SERVICES

FOR COMPUTER CONSULTING SERVICES; COMPUTER SOFTWARE DESIGN AND DEVELOPMENT SERVICES FOR OTHERS; TECHNICAL CONSULTING IN THE FIELDS OF COMPUTER, DATA, APPLICATION AND NETWORK SECURITY; TECHNICAL SUPPORT SERVICES, NAMELY, TROUBLESHOOTING OF SECURITY RELATED PROBLEMS IN WEB SOFTWARE AND APPLICATIONS (U.S. CLS. 100 AND 101).

BERNICE MIDDLETON, EXAMINING ATTORNEY

SN 77-040,300. WATERFIELD, J. RANDALL, IRVINE, CA. AND WATERFIELD, RICHARD R., IRVINE, CA. FILED 11-9-2006.

Waterfield Technologies

THE MARK CONSISTS OF STANDARD CHARACTERS WITHOUT CLAIM TO ANY PARTICULAR FONT, STYLE, SIZE, OR COLOR.

NO CLAIM IS MADE TO THE EXCLUSIVE RIGHT TO USE "TECHNOLOGIES", APART FROM THE MARK AS SHOWN.

CLASS 35—ADVERTISING AND BUSINESS

FOR CONSULTATION IN THE FIELD OF CUSTOMER SERVICE; COMMERCIAL ASSISTANCE RELATING TO SYSTEM IMPLEMENTATION AND SYSTEM INTEGRATION; SALES INTERMEDIARY AND ADVISORY SERVICES IN THE FIELD OF SELLING COMPUTER SOFTWARE (U.S. CLS. 100, 101 AND 102).
FIRST USE 11-1-2003; IN COMMERCE 11-1-2003.

CLASS 42—SCIENTIFIC, COMPUTER AND LEGAL SERVICES

FOR TECHNICAL SUPPORT SERVICES, NAMELY, TROUBLESHOOTING OF COMPUTER SOFTWARE PROBLEMS; TECHNOLOGY CONSULTATION IN THE FIELD OF COMMUNICATIONS TECHNOLOGY; INTEGRATION OF COMPUTER SYSTEMS AND NETWORKS (U.S. CLS. 100 AND 101).

FIRST USE 11-1-2003; IN COMMERCE 11-1-2003.
ESTHER A. BORSUK, EXAMINING ATTORNEY

SN 77-041,102. INTERNET BRANDS, INC., EL SEGUNDO, CA. FILED 11-10-2006.



SN 77-041,017. MANIFATTURA MARIO COLOMBO & C. S.P.A., MONZA (MILAN), ITALY, FILED 11-9-2006.



OWNER OF ITALY REG. NO. 753336, DATED 7-14-1998, EXPIRES 6-5-2008.

THE MARK CONSISTS OF A RECTANGULAR FRAME ENCOMPASSING THE WORDS TEN YARDS IN UPPER CASE BLOCK LETTERS, WITH THE WORD TEN IN LARGER TYPE, APPEARING ABOVE THE WORD YARDS. AT THE LEFT OF THESE WORDS THERE IS AN IRREGULAR FIGURE MADE OF CURVED LINES SUPERIMPOSED ON A CIRCUMFERENCE.

CLASS 18—LEATHER GOODS

FOR TRUNKS; SUITCASES; TRAVELING BAGS; COSMETIC BAGS SOLD EMPTY; BACKPACKS; HANDBAGS; OVERNIGHT BAGS; DUFFEL BAGS; BRIEFCASES; BILLFOLDS; WALLETS; PURSES; FANNY PACKS; UMBRELLAS; TOTE BAGS; AND ALL-PURPOSE SPORTS BAGS (U.S. CLS. 1, 2, 3, 22 AND 41).

CLASS 25—CLOTHING

FOR CLOTHING ARTICLES FOR MEN, WOMEN AND CHILDREN, NAMELY, TROUSERS, JUMPERS, PULL-OVERS, COATS, RAINCOATS, JACKETS, SWEAT-SHIRTS, WAISTCOATS, CARDIGANS, SKIRTS, SHIRTS, SHORTS, OVERALLS, ANORAKS, HEADWEAR, GLOVES, SCARVES, BOOTS, SHOES AND SLIPPERS (U.S. CLS. 22 AND 39).

CLASS 28—TOYS AND SPORTING GOODS

FOR SPORTSGEAR NOT INCLUDED IN OTHER CLASSES, NAMELY SKIS; TENNIS RACKETS AND TENNIS BALLS; SURF SKIS; SURFBOARDS; SKATEBOARDS; ROLLER SKATES AND ICE SKATES (U.S. CLS. 22, 23, 38 AND 50).

ALICE BENMAMAN, EXAMINING ATTORNEY

NO CLAIM IS MADE TO THE EXCLUSIVE RIGHT TO USE "INTERNET BRANDS", APART FROM THE MARK AS SHOWN.

THE MARK CONSISTS OF THE LETTERS IB WITH A SERIES OF ARROWS IN CIRCULAR MOTION ABOVE THE I AND THE WORDS INTERNET BRANDS TO THE SIDE OF THE LETTERS.

CLASS 35—ADVERTISING AND BUSINESS

FOR ONLINE ORDERING SERVICES IN THE FIELD OF MOTOR VEHICLES; PROVIDING AN ONLINE DIRECTORY INFORMATION SERVICE FEATURING INFORMATION REGARDING INNS, BED AND BREAKFASTS, RENTAL OF VACATION HOMES, CONDOMINIUMS, CABINS, AND VILLAS (U.S. CLS. 100, 101 AND 102).

FIRST USE 9-8-2005; IN COMMERCE 9-8-2005.

CLASS 36—INSURANCE AND FINANCIAL

FOR HOME MORTGAGE LENDING SERVICES (U.S. CLS. 100, 101 AND 102).

FIRST USE 4-7-2006; IN COMMERCE 4-7-2006.

CLASS 39—TRANSPORTATION AND STORAGE

FOR LEASING OF MOTOR VEHICLES VIA ELECTRONIC COMMUNICATIONS NETWORKS (U.S. CLS. 100 AND 105).

FIRST USE 4-3-2006; IN COMMERCE 4-3-2006.

CLASS 41—EDUCATION AND ENTERTAINMENT

FOR PUBLICATION OF ON-LINE TRAVEL GUIDES; ENTERTAINMENT SERVICES, NAMELY, PROVIDING ON-LINE REVIEWS OF CRUISE SHIPS, MUSEUMS, HISTORIC AND CULTURAL SITES, AND TOURIST ATTRACTIONS (U.S. CLS. 100, 101 AND 107).

FIRST USE 9-8-2005; IN COMMERCE 9-8-2005.

CLASS 43—HOTEL AND RESTAURANT SERVICES

FOR PROVIDING ON-LINE REVIEWS OF RESTAURANTS, HOTELS AND BARS (U.S. CLS. 100 AND 101).

FIRST USE 9-8-2005; IN COMMERCE 9-8-2005.
BARBARA A. GOLD, EXAMINING ATTORNEY

SN 77-045,385. WMS GAMING INC., WAUKEGAN, IL.
FILED 11-16-2006.

ADAPTIVE GAMING

THE MARK CONSISTS OF STANDARD CHARACTERS WITHOUT CLAIM TO ANY PARTICULAR FONT, STYLE, SIZE, OR COLOR.

NO CLAIM IS MADE TO THE EXCLUSIVE RIGHT TO USE "GAMING", APART FROM THE MARK AS SHOWN.

CLASS 9—ELECTRICAL AND SCIENTIFIC APPARATUS

FOR GAMING MACHINES THAT GENERATE OR DISPLAY WAGER OUTCOMES; GAMING SOFTWARE THAT GENERATES OR DISPLAYS WAGER OUTCOMES OF GAMING MACHINES (U.S. CLS. 21, 23, 26, 36 AND 38).

CLASS 41—EDUCATION AND ENTERTAINMENT

FOR ENTERTAINMENT SERVICES, NAMELY, PROVIDING FOR CONSUMER PLAY GAMING MACHINES THAT GENERATE OR DISPLAY WAGER OUTCOMES AND GAMING SOFTWARE THAT GENERATES OR DISPLAYS WAGER OUTCOMES (U.S. CLS. 100, 101 AND 107).

DOMINICK J. SALEMI, EXAMINING ATTORNEY

SN 77-046,699. KENDALL, KURT, LONDONDERRY, NH.
FILED 11-17-2006.



THE COLOR(S) RED, WHITE, GOLD, BROWN AND BLACK IS/ARE CLAIMED AS A FEATURE OF THE MARK.

THE MARK CONSISTS OF THE STYLIZED NUMBERS AND DASHES "7-20-4" ON A RECTANGULAR BACKGROUND DESIGN. THE COLOR WHITE APPEARS IN THE NUMBERS "7" AND "20" AND "4", AND COLOR BLACK APPEARS PARTIALLY OUTLINING THE NUMBERS AND DASHES AND IN THE BACKGROUND RECTANGULAR BANNER. THE COLOR RED APPEARS IN THE BACKGROUND RECTANGULAR BANNER AND IN THE DASHES BETWEEN THE NUMBERS. THE COLOR GOLD APPEARS IN THE BACKGROUND RECTANGULAR BANNER AND IN THE DASHES BETWEEN THE NUMBERS, AND THE COLOR BROWN APPEARS PARTIALLY OUTLINING THE DASHES AND IN THE BACKGROUND RECTANGULAR BACKGROUND.

CLASS 16—PAPER GOODS AND PRINTED MATTER

FOR PAPER BANNERS (U.S. CLS. 2, 5, 22, 23, 29, 37, 38 AND 50).

CLASS 34—SMOKERS' ARTICLES

FOR CIGAR BANDS; CIGAR BOXES NOT OF PRECIOUS METAL; CIGAR CUTTERS; CIGAR HUMIDIFIERS; CIGAR TUBES; CIGARS (U.S. CLS. 2, 8, 9 AND 17).

ANDREA K. NADELMAN, EXAMINING ATTORNEY

SN 77-047,973. BOXES ANYTIME, LLC, MINNEAPOLIS, MN.
FILED 11-20-2006.

SKYWAY BOXES

THE MARK CONSISTS OF STANDARD CHARACTERS WITHOUT CLAIM TO ANY PARTICULAR FONT, STYLE, SIZE, OR COLOR.

NO CLAIM IS MADE TO THE EXCLUSIVE RIGHT TO USE "BOXES", APART FROM THE MARK AS SHOWN.

CLASS 16—PAPER GOODS AND PRINTED MATTER

FOR PAPER AND CARDBOARD BOXES (U.S. CLS. 2, 5, 22, 23, 29, 37, 38 AND 50).

CLASS 35—ADVERTISING AND BUSINESS

FOR ONLINE AND TRADITIONAL RETAIL STORE SERVICES FEATURING BOXES (U.S. CLS. 100, 101 AND 102).

KHANH LE, EXAMINING ATTORNEY

SN 77-048,617. NORM THOMPSON OUTFITTERS, INC.,
HILLSBORO, OR. FILED 11-21-2006.

GETTING OFF THE BEATEN PATH

THE MARK CONSISTS OF STANDARD CHARACTERS WITHOUT CLAIM TO ANY PARTICULAR FONT, STYLE, SIZE, OR COLOR.

CLASS 25—CLOTHING

FOR CLOTHING, NAMELY, PANTS, CHINOS, SPORT PANTS, ATHLETIC TRAINING PANTS, SWEATPANTS, SKI-PANTS, OVERALLS, CAPRIS, YOGA PANTS, SKIRTS, DRESSES, SHORTS, SKORTS, SHIRTS, BLOUSES, SWEATERS, TURTLENECKS, CREWNECKS, POLOS, T-SHIRTS, KNIT SHIRTS, SWEATSHIRTS, PULLOVERS, SPORT TOPS, CARDIGANS, TANK TOPS, CAMISOLES, JACKETS, PARKAS, COATS, VESTS, SWIMSUITS, SOCKS, UNDERWEAR, SPORT BRASIERES, ROBES, GLOVES, PAJAMAS, AND BELTS; FOOTWEAR; AND HEADGEAR, NAMELY, CAPS, HATS, SCARVES, BANDANAS, AND BERETS (U.S. CLS. 22 AND 39).

CLASS 35—ADVERTISING AND BUSINESS

FOR MAIL ORDER CATALOG AND ON-LINE RETAIL STORE SERVICES FEATURING A WIDE VARIETY OF HOUSEHOLD, OUTDOOR RECREATION, AND CONSUMER GOODS, NAMELY, CLOTHING, FOOTWEAR, HATS AND OTHER HEADGEAR, JEWELRY, HAIR ACCESSORIES, WATCHES, SUNGLASSES AND STRAPS FOR SUNGLASSES, LUGGAGE, BAGS, TRAVEL ACCESSORIES, HOUSEWARES AND KITCHEN UTENSILS, HOUSEHOLD FURNISHINGS, LINENS, BLANKETS, AND PILLOWS, OPTICAL, DIRECTIONAL, AND WEATHER MONITORING APPARATUS, CONSUMER ELECTRONICS, CLOCKS, EXERCISE EQUIPMENT, MATS, AND CUSHIONS, TOYS, GAMES, AND PUZZLES, BOOKS, MUSICAL INSTRUMENTS, COLLECTIBLES, PENS AND PAPERWEIGHTS, BODY CARE PRODUCTS, LIGHTING, HEATING, AND WATER SUPPLY APPARATUS, PET PRODUCTS, HAND AND POCKET TOOLS, OUTDOOR FURNITURE AND FURNISHINGS, CAMPING AND RECREATIONAL EQUIPMENT, SURVIVAL AND SAFETY ITEMS, AUTOMOBILE ACCESSORIES, FOOD AND BEVERAGE PRODUCTS (U.S. CLS. 100, 101 AND 102).

REGINA DRUMMOND, EXAMINING ATTORNEY

SN 77-051,647. CHARLES, WILLIAM A., BOONVILLE, CA. FILED 11-28-2006.

Charles Ranch Vineyards

THE MARK CONSISTS OF STANDARD CHARACTERS WITHOUT CLAIM TO ANY PARTICULAR FONT, STYLE, SIZE, OR COLOR.

NO CLAIM IS MADE TO THE EXCLUSIVE RIGHT TO USE "RANCH VINEYARDS", APART FROM THE MARK AS SHOWN.

CLASS 31—NATURAL AGRICULTURAL PRODUCTS

FOR FRESH FRUIT AND FRESH WINE GRAPES (U.S. CLS. 1 AND 46).

FIRST USE 0-0-2001; IN COMMERCE 0-0-2001.

CLASS 33—WINES AND SPIRITS

FOR GRAPE WINE (U.S. CLS. 47 AND 49).

DOMINICK J. SALEMI, EXAMINING ATTORNEY

SN 77-049,424. MARS, INCORPORATED, MCLEAN, VA. FILED 11-22-2006.

JABS

THE MARK CONSISTS OF STANDARD CHARACTERS WITHOUT CLAIM TO ANY PARTICULAR FONT, STYLE, SIZE, OR COLOR.

CLASS 5—PHARMACEUTICALS

FOR NUTRITIONALLY FORTIFIED ENERGY BARS FOR USE AS A MEAL REPLACEMENT; NUTRITIONALLY FORTIFIED ENERGY MIXES FOR USE AS A MEAL REPLACEMENT (U.S. CLS. 6, 18, 44, 46, 51 AND 52).

CLASS 29—MEATS AND PROCESSED FOODS

FOR SOY-BASED BEVERAGES USED AS MILK SUBSTITUTES; SNACK FOODS, NAMELY, SOY-BASED, MEAT-BASED AND FRUIT BASED; VEGETABLE-BASED FOOD BEVERAGES; DAIRY-BASED FOOD BEVERAGES (U.S. CL. 46).

CLASS 30—STAPLE FOODS

FOR WHEAT-BASED AND RICE-BASED SNACK BARS, WHEAT-BASED AND RICE-BASED SNACK FOODS; FOOD BEVERAGES NOT BEING DAIRY-BASED OR VEGETABLE-BASED (U.S. CL. 46).

CLASS 32—LIGHT BEVERAGES

FOR NON-ALCOHOLIC BEVERAGES, NAMELY, CARBONATED BEVERAGES AND NON-CARBONATED SOFT DRINKS, FRUIT DRINKS; SOY-BASED BEVERAGES NOT BEING MILK SUBSTITUTES (U.S. CLS. 45, 46 AND 48).

JOHN WILKE, EXAMINING ATTORNEY

SN 77-053,886. EKNOWLEDGE, INC., CORONA, CA. FILED 11-30-2006.



THE MARK CONSISTS OF A GLOBE WITH A LOWER-CASE E AT ITS CENTER AND WITH A SWIRLING RING AROUND THE GLOBE, THE GLOBE BEING NEXT TO THE WORD EKNOWLEDGE.

CLASS 9—ELECTRICAL AND SCIENTIFIC APPARATUS

FOR DIGITAL MEDIA, NAMELY, CDS, DVDS, AND DOWNLOADABLE AUDIO, VIDEO AND MULTIMEDIA FILES, ALL FEATURING EDUCATIONAL MATERIALS, LECTURES, INTERACTIVE COURSES AND DIAGNOSTICS IN THE FIELD OF EXAM PREPARATION AND HUMAN RESOURCE ISSUES (U.S. CLS. 21, 23, 26, 36 AND 38).

CLASS 41—EDUCATION AND ENTERTAINMENT

FOR PROVIDING ON-LINE AND ELECTRONIC TRAINING; NAMELY LECTURES, COURSES, INTERACTIVE AND MULTI-MEDIA TRAINING, AND DIAGNOSTICS IN THE FIELD OF EXAM PREPARATION, TUTORING, GENERAL BUSINESS AND HUMAN RESOURCE ISSUES (U.S. CLS. 100, 101 AND 107).

MICHAEL ENGEL, EXAMINING ATTORNEY

SN 77-054,407. GOLD CANYON CANDLES, L.L.C., CHANDLER, AZ. FILED 11-30-2006.

GOLD CANYON

THE MARK CONSISTS OF STANDARD CHARACTERS WITHOUT CLAIM TO ANY PARTICULAR FONT, STYLE, SIZE, OR COLOR.

OWNER OF U.S. REG. NO. 2,257,821.

CLASS 3—COSMETICS AND CLEANING PREPARATIONS

FOR SCENTED ROOM SPRAYS, POTPOURRI, AND POTPOURRI SACHETS; PERSONAL CARE PRODUCTS, NAMELY, SHOWER GELS, HAND, BODY, AND FOOT LOTIONS, SKIN EXFOLIATING LOTIONS AND HAND SOAP; BATH ADDITIVES, NAMELY, LIQUID BATH SOAPS, BATH OILS, BATH LOTIONS, BATH GELS, AND AFTER BATH BODY SPRAYS (U.S. CLS. 1, 4, 6, 50, 51 AND 52).

FIRST USE 9-0-2002; IN COMMERCE 9-0-2002.

CLASS 5—PHARMACEUTICALS

FOR AIR FRESHENERS, HAND SANITIZERS (U.S. CLS. 6, 18, 44, 46, 51 AND 52).

FIRST USE 9-0-2004; IN COMMERCE 9-0-2004.

CLASS 21—HOUSEWARES AND GLASS

FOR CANDLE HOLDERS, AND CANDLE ACCESSORIES, NAMELY, CANDLE-HOLDER DISHES FOR USE IN WARMING POTPOURRI AND SACHET (U.S. CLS. 2, 13, 23, 29, 30, 33, 40 AND 50).

FIRST USE 1-0-2006; IN COMMERCE 1-0-2006.

DAVID H. STINE, EXAMINING ATTORNEY

SN 77-055,564. CLEANTECH NETWORK LLC, HOWELL, MI. FILED 12-1-2006.

CLEANTECH INNOVATION INSTITUTE

THE MARK CONSISTS OF STANDARD CHARACTERS WITHOUT CLAIM TO ANY PARTICULAR FONT, STYLE, SIZE, OR COLOR.

OWNER OF U.S. REG. NOS. 3,089,736, 3,125,962 AND OTHERS.

NO CLAIM IS MADE TO THE EXCLUSIVE RIGHT TO USE "INSTITUTE", APART FROM THE MARK AS SHOWN. SEC. 2(F).

CLASS 35—ADVERTISING AND BUSINESS

FOR ADVERTISING AND ADVERTISEMENT SERVICES; ADVERTISING AND COMMERCIAL INFORMATION SERVICES, VIA THE INTERNET; ADVERTISING AND MARKETING; ADVERTISING AND PUBLICITY SERVICES; ADVERTISING SERVICES, NAMELY, PROMOTING AND MARKETING THE GOODS AND SERVICES OF OTHERS THROUGH ALL PUBLIC COMMUNICATION MEANS; BUSINESS ADVICE AND ANALYSIS OF MARKETS; BUSINESS ADVICE AND INFORMATION; BUSINESS EVALUATION OF VENTURE CAPITAL FUNDING SERVICES AND TECHNOLOGY TO FACILITATE THE VENTURE CAPITAL FUNDING OF EMERGING AND START-UP COMPANIES IN THE FIELDS OF ENERGY GENERATION, ENERGY STORAGE, ENERGY INFRASTRUCTURE, ENERGY EFFICIENCY, TRANSPORTATION, TRANSPORTATION LOGISTICS, WATER PURIFICATION, WATER MANAGEMENT, AIR QUALITY, NANOTECHNOLOGY, MANUFACTURING, AGRICULTURE, NUTRITION, MATERIALS RECOVERY, MATERIAL RECYCLING, ENVIRONMENTAL INFORMATION TECHNOLOGY, AND ENABLING TECHNOLOGIES; BUSINESS SERVICES, NAMELY, MATCHING POTENTIAL PRIVATE INVESTORS WITH ENTREPRENEURS NEEDING FUNDING; BUSINESS SERVICES, NAMELY, PROCURING QUALIFIED AND CREDENTIALLED THIRD-PARTY EXPERTS, PROFESSIONALS AND OTHER QUALIFIED PERSONNEL, AND DOCUMENTATION AND INFORMATION ALL ON BEHALF OF OTHERS; BUSINESS SERVICES, NAMELY, REGISTERING, SCREENING, CREDENTIALING, AND ORGANIZING THIRD-PARTY VENDORS, SUPPLIERS, AND CONTRACTORS, AND DOCUMENTATION AND INFORMATION ON BEHALF OF OTHERS; COMMERCIAL INFORMATION IN THE FIELD OF VENTURE CAPITAL FUNDING SERVICES AND TECHNOLOGY TO FACILITATE THE VENTURE CAPITAL FUNDING OF EMERGING AND START-UP COMPANIES IN THE FIELDS OF ENERGY GENERATION, ENERGY STORAGE, ENERGY INFRASTRUCTURE, ENERGY EFFICIENCY, TRANSPORTATION, TRANSPORTATION LOGISTICS, WATER PURIFICATION, WATER MANAGEMENT, AIR QUALITY, NANOTECHNOLOGY, MANUFACTURING, AGRICULTURE, NUTRITION, MATERIALS RECOVERY, MATERIAL RECYCLING, ENVIRONMENTAL INFORMATION TECHNOLOGY, AND ENABLING TECHNOLOGIES; DEMONSTRATION OF PRODUCTS; DEVELOPMENT OF CONCEPTS FOR BUSINESS ECONOMY; INFORMATION IN BUSINESS MATTERS; PROGNOSIS ON ECONOMIC AFFAIRS; PROMOTING AND CONDUCTING TRADE SHOWS IN THE FIELD OF VENTURE CAPITAL FUNDING SERVICES AND TECHNOLOGY TO FACILITATE THE VENTURE CAPITAL FUNDING OF EMERGING AND START-UP COMPANIES IN THE FIELDS OF ENERGY GENERATION, ENERGY STORAGE, ENERGY INFRASTRUCTURE, ENERGY EFFICIENCY, TRANSPORTATION, TRANSPORTATION LOGISTICS, WATER PURIFICATION, WATER MANAGEMENT, AIR QUALITY, NANOTECHNOLOGY, MANUFACTURING, AGRICULTURE, NUTRITION, MATERIALS RECOVERY, MATERIAL RECYCLING, ENVIRONMENTAL INFORMATION TECHNOLOGY, AND ENABLING TECHNOLOGIES; PROMOTION OF BUSINESS OPPORTUNITIES (U.S. CLS. 100, 101 AND 102).

CLASS 41—EDUCATION AND ENTERTAINMENT

FOR ARRANGING OF EXHIBITIONS, SEMINARS AND CONFERENCES; CONDUCTING WORKSHOPS AND SEMINARS IN VENTURE CAPITAL FUNDING SERVICES AND TECHNOLOGY TO FACILITATE THE VENTURE CAPITAL FUNDING OF EMERGING AND START-UP COMPANIES IN THE FIELDS OF ENERGY GENERATION, ENERGY STORAGE, ENERGY INFRASTRUCTURE, ENERGY EFFICIENCY, TRANSPORTATION, TRANSPORTATION LOGISTICS, WATER PURIFICATION, WATER MANAGEMENT, AIR QUALITY, NANOTECHNOLOGY, MANUFACTURING, AGRICULTURE, NUTRITION, MATERIALS RECOVERY, MATERIAL RECYCLING, ENVIRONMENTAL INFORMATION TECHNOLOGY, AND ENABLING TECHNOLOGIES; EDUCATIONAL AND ENTERTAINMENT SERVICES, NAMELY, PROVIDING MOTIVATIONAL AND EDUCATIONAL SPEAKERS (U.S. CLS. 100, 101 AND 107).

CARYN GLASSER, EXAMINING ATTORNEY

SN 77-058,494. THE FROG HOUSE, INC., NEWPORT BEACH, CA. FILED 12-6-2006.



NO CLAIM IS MADE TO THE EXCLUSIVE RIGHT TO USE "NEWPORT BEACH, CA", APART FROM THE MARK AS SHOWN.

THE STIPPLING SHOWN IN THE DRAWING REPRESENTS SHADING IN THE MARK.

CLASS 25—CLOTHING

FOR WEARING APPAREL, NAMELY, T-SHIRTS, SWEATSHIRTS, HATS, JACKETS, SWIMMING TRUNKS, SHORTS, SWIMWEAR, SHOES, PANTS AND BELTS (U.S. CLS. 22 AND 39).

CLASS 28—TOYS AND SPORTING GOODS

FOR SPORTING GOODS, NAMELY, SURFBOARDS, WETSUITS, BODY BOARDS, SKATEBOARDS, AND SURFBOARD RACKS, LEASHES AND TRACTION PADS (U.S. CLS. 22, 23, 38 AND 50).

CLASS 35—ADVERTISING AND BUSINESS

FOR RETAIL STORE SERVICES FEATURING WEARING APPAREL AND SPORTING GOODS (U.S. CLS. 100, 101 AND 102).

DAVID MILLER, EXAMINING ATTORNEY

SN 77-059,907. FUJITSU LIMITED, KANAGAWA-KEN, 211-8588, JAPAN, FILED 12-8-2006.

FSTJ

THE MARK CONSISTS OF STANDARD CHARACTERS WITHOUT CLAIM TO ANY PARTICULAR FONT, STYLE, SIZE, OR COLOR.

CLASS 9—ELECTRICAL AND SCIENTIFIC APPARATUS

FOR DOWNLOADABLE ELECTRONIC PUBLICATIONS FEATURING RESEARCH IN COMMUNICATIONS, ELECTRONICS AND RELATED FIELDS; ELECTRONIC PUBLICATIONS FEATURING RESEARCH IN COMMUNICATIONS, ELECTRONICS AND RELATED FIELDS RECORDED ON COMPUTER MEDIA (U.S. CLS. 21, 23, 26, 36 AND 38).

CLASS 16—PAPER GOODS AND PRINTED MATTER

FOR PRINTED MATTER AND PRINTED PUBLICATIONS, NAMELY BOOKS, NEWSLETTERS AND PAPERS FEATURING RESEARCH IN COMMUNICATIONS, ELECTRONICS AND RELATED FIELDS (U.S. CLS. 2, 5, 22, 23, 29, 37, 38 AND 50).

CLASS 41—EDUCATION AND ENTERTAINMENT

FOR PROVIDING ON-LINE, NON-DOWNLOADABLE ELECTRONIC PUBLICATIONS FEATURING RESEARCH IN COMMUNICATIONS, ELECTRONICS AND RELATED FIELDS (U.S. CLS. 100, 101 AND 107).

JEFF DEFORD, EXAMINING ATTORNEY

SN 77-060,242. VALOIS SAS, 27110 LE NEUBOURG, FRANCE, FILED 12-8-2006.

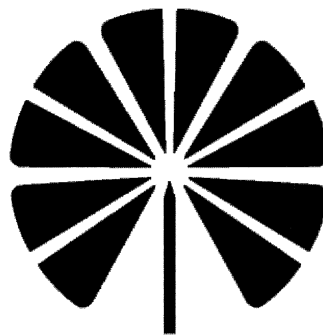
**CLASS 8—HAND TOOLS**

FOR HAND TOOLS, NAMELY, HAND-OPERATED PUMPS THAT EJECT OR TO SPRAY PREPARATIONS FROM CONTAINERS (U.S. CLS. 23, 28 AND 44).

CLASS 10—MEDICAL APPARATUS

FOR MEDICAL APPLICATORS, NAMELY, AEROSOL DISPENSERS FOR MEDICAL USE; AND MEDICAL APPARATUS, NAMELY, VAPORIZER FOR UPPER RESPIRATORY CONDITIONS (U.S. CLS. 26, 39 AND 44).

CLASS 21—HOUSEWARES AND GLASS

FOR DISPENSERS, ATOMIZERS AND VAPORIZERS FOR PERFUMERY PURPOSES, ALL SOLD EMPTY (U.S. CLS. 2, 13, 23, 29, 30, 33, 40 AND 50).
RAY THOMAS, EXAMINING ATTORNEY

SN 77-061,283. COMMUNITY CONNECT INC., NEW YORK, NY. FILED 12-11-2006.

ASIANAVE.COM

THE MARK CONSISTS OF STANDARD CHARACTERS WITHOUT CLAIM TO ANY PARTICULAR FONT, STYLE, SIZE, OR COLOR.

OWNER OF U.S. REG. NOS. 2,516,416 AND 2,521,736.

CLASS 35—ADVERTISING AND BUSINESS

FOR PROVIDING COMMERCIAL ADVERTISING SERVICES, NAMELY, PROMOTING THE GOODS AND SERVICES OF OTHERS THROUGH THE DISSEMINATION OF THEIR ADVERTISING MATERIALS VIA A GLOBAL COMPUTER NETWORK; PROVIDING ONLINE INTERACTIVE EMPLOYMENT COUNSELING AND RECRUITMENT SERVICES; PROVIDING NEWS AND INFORMATION CONCERNING EMPLOYMENT OPPORTUNITIES, CAREER DEVELOPMENT, POLITICS, AND POLITICAL PUBLIC AFFAIRS TO INDIVIDUALS OF COMMON CULTURAL HERITAGE VIA A GLOBAL COMPUTER NETWORK (U.S. CLS. 100, 101 AND 102).

CLASS 38—COMMUNICATION

FOR ELECTRONIC MAIL SERVICES; PROVIDING ONLINE CHAT ROOMS FOR TRANSMISSION OF MESSAGES AMONG COMPUTER USERS CONCERNING EMPLOYMENT OPPORTUNITIES, CAREER DEVELOPMENT, POLITICS, POLITICAL PUBLIC AFFAIRS, NEWS AND CURRENT EVENTS INFORMATION CONCERNING POPULAR CULTURE, MUSIC AND ENTERTAINMENT TO INDIVIDUALS OF COMMON CULTURAL HERITAGE (U.S. CLS. 100, 101 AND 104).

CLASS 41—EDUCATION AND ENTERTAINMENT

FOR ENTERTAINMENT SERVICES, NAMELY, PROVIDING WEB SITES FEATURING MUSICAL PERFORMANCES, FILM CLIPS, PHOTOGRAPHS, AND OTHER MULTIMEDIA MATERIALS; PROVIDING NEWS AND INFORMATION CONCERNING POPULAR CULTURE, MUSIC, ENTERTAINMENT, AND CURRENT EVENTS REPORTING TO INDIVIDUALS OF COMMON CULTURAL HERITAGE VIA A GLOBAL COMPUTER NETWORK (U.S. CLS. 100, 101 AND 107).

CLASS 42—SCIENTIFIC, COMPUTER AND LEGAL SERVICES

FOR COMPUTER SERVICES, NAMELY, PROVIDING SEARCH ENGINES FOR OBTAINING DATA ON A GLOBAL COMPUTER NETWORK; HOSTING THE WEB SITES OF OTHERS ON A COMPUTER SERVER FOR A GLOBAL COMPUTER NETWORK (U.S. CLS. 100 AND 101).

CLASS 45—PERSONAL SERVICES

FOR ONLINE DATING SERVICES; PROVIDING ONLINE INFORMATION ABOUT FASHION AND STYLE (U.S. CLS. 100 AND 101).

DAVID YONTEF, EXAMINING ATTORNEY

SN 77-062,002. CAPITOL NEWS COMPANY, LLC, ARLINGTON, VA. FILED 12-12-2006.

THE POLITICO

THE MARK CONSISTS OF STANDARD CHARACTERS WITHOUT CLAIM TO ANY PARTICULAR FONT, STYLE, SIZE, OR COLOR.

CLASS 16—PAPER GOODS AND PRINTED MATTER

FOR NEWSPAPER REPORTING ON THE ACTIVITIES OF THE LEGISLATIVE AND EXECUTIVE BRANCHES OF THE FEDERAL GOVERNMENT, OFFICIALS AND EMPLOYEES OF THE EXECUTIVE AND LEGISLATIVE BRANCHES OF THE FEDERAL GOVERNMENT, MEMBERS OF CONGRESS AND THEIR CAMPAIGNS, AND OTHER MATTERS OF INTEREST TO PEOPLE WHO WORK FOR OR WITH THE FEDERAL GOVERNMENT (U.S. CLS. 2, 5, 22, 23, 29, 37, 38 AND 50).

FIRST USE 1-23-2007; IN COMMERCE 1-23-2007.

CLASS 41—EDUCATION AND ENTERTAINMENT

FOR PROVIDING NEWS AND INFORMATION VIA THE INTERNET IN THE NATURE OF CURRENT EVENT REPORTING ABOUT THE ACTIVITIES OF THE LEGISLATIVE AND EXECUTIVE BRANCHES OF THE FEDERAL GOVERNMENT, OFFICIALS AND EMPLOYEES OF THE EXECUTIVE AND LEGISLATIVE BRANCHES OF THE FEDERAL GOVERNMENT, MEMBERS OF CONGRESS AND THEIR CAMPAIGNS, AND OTHER MATTERS OF INTEREST TO PEOPLE WHO WORK FOR OR WITH THE FEDERAL GOVERNMENT (U.S. CLS. 100, 101 AND 107).

FIRST USE 1-23-2007; IN COMMERCE 1-23-2007.

SANI KHOURI, EXAMINING ATTORNEY

SN 77-062,258. ZEROPOINT CLEAN TECH, INC., POTSDAM, NY. FILED 12-12-2006.

ETHANOL ACCELERATOR

THE MARK CONSISTS OF STANDARD CHARACTERS WITHOUT CLAIM TO ANY PARTICULAR FONT, STYLE, SIZE, OR COLOR.

NO CLAIM IS MADE TO THE EXCLUSIVE RIGHT TO USE "ETHANOL", APART FROM THE MARK AS SHOWN.

CLASS 7—MACHINERY

FOR MACHINES FOR GASIFICATION OF DRIED DISTILLERS GRAINS INTO METHANOL, ETHANOL, DIESEL AND OTHER ALTERNATIVE FUELS (U.S. CLS. 13, 19, 21, 23, 31, 34 AND 35).

CLASS 40—MATERIAL TREATMENT

FOR CONSULTING IN THE FIELD OF EXTRACTION OF CORN OIL, CONVERSION OF CORN OIL TO BIODIESEL, GASIFICATION OF DRIED DISTILLERS GRAINS, CONVERSION OF CORN OIL INTO SYNGAS, AND RELIQUIFICATION OF SYNGAS INTO METHANOL, ETHANOL, DIESEL AND OTHER FUEL PRODUCTS (U.S. CLS. 100, 103 AND 106).

CLASS 42—SCIENTIFIC, COMPUTER AND LEGAL SERVICES

FOR DESIGN AND DEVELOPMENT FOR OTHERS OF MACHINES FOR EXTRACTION OF CORN OIL, CONVERSION OF CORN OIL TO BIODIESEL, GASIFICATION OF DRIED DISTILLERS GRAINS, CONVERSION OF CORN OIL INTO SYNGAS, AND RELIQUIFICATION OF SYNGAS INTO METHANOL, ETHANOL, DIESEL AND OTHER FUEL PRODUCTS (U.S. CLS. 100 AND 101).
RENEE SERVANCE, EXAMINING ATTORNEY

CLASS 42—SCIENTIFIC, COMPUTER AND LEGAL SERVICES

FOR COMPUTER SERVICES, NAMELY, PROVIDING TEMPORARY ACCESS TO NON-DOWNLOADABLE SOFTWARE ON A GLOBAL COMPUTER NETWORK FOR USE IN DATA AND DATABASE MANAGEMENT AND LEGAL COMPLIANCE IN THE FIELD OF SPECIAL EDUCATION AND CHILD CARE; APPLICATION SERVICE PROVIDER (ASP) FEATURING SOFTWARE FOR USE IN DATA AND DATABASE MANAGEMENT AND LEGAL COMPLIANCE IN THE FIELD OF SPECIAL EDUCATION AND CHILD CARE; DESIGN, DEVELOPMENT AND IMPLEMENTATION OF SOFTWARE FOR USE IN DATA AND DATABASE MANAGEMENT AND LEGAL COMPLIANCE IN THE FIELD OF SPECIAL EDUCATION AND CHILD CARE; DEVELOPMENT OF SOFTWARE FOR USE IN DATA AND DATABASE MANAGEMENT AND LEGAL COMPLIANCE IN THE FIELD OF SPECIAL EDUCATION AND CHILD CARE; CONSULTING SERVICES IN THE FIELD OF USE AND IMPLEMENTATION OF SOFTWARE FOR USE IN DATA AND DATABASE MANAGEMENT AND LEGAL COMPLIANCE IN THE FIELD OF SPECIAL EDUCATION AND CHILD CARE; DEVELOPMENT OF CUSTOM SOFTWARE FOR USE IN DATA AND DATABASE MANAGEMENT AND LEGAL COMPLIANCE IN THE FIELD OF SPECIAL EDUCATION AND CHILD CARE; AND DATABASE DEVELOPMENT SERVICES (U.S. CLS. 100 AND 101).

FIRST USE 8-1-2002; IN COMMERCE 8-1-2002.
JOHN WILKE, EXAMINING ATTORNEY

SN 77-062,538. ENTERPRISES COMPUTING SERVICES, INC., WOODSTOCK, GA. FILED 12-12-2006.

SN 77-062,445. ENTERPRISES COMPUTING SERVICES, INC., WOODSTOCK, GA. FILED 12-12-2006.

Bright Idea



THE MARK CONSISTS OF STANDARD CHARACTERS WITHOUT CLAIM TO ANY PARTICULAR FONT, STYLE, SIZE, OR COLOR.

THE MARK CONSISTS OF LIGHT BULB WITH THE WORDS ECS INSIDE AND THE WORD BRIGHT TO THE RIGHT OF THE LIGHT BULB AND THE WORD IDEA UNDERNEATH.

CLASS 9—ELECTRICAL AND SCIENTIFIC APPARATUS

FOR COMPUTER SOFTWARE FOR USE IN DATA AND DATABASE MANAGEMENT AND LEGAL COMPLIANCE IN THE FIELD OF SPECIAL EDUCATION AND CHILD CARE, AND USER MANUALS SOLD THEREWITH AS A UNIT (U.S. CLS. 21, 23, 26, 36 AND 38).

FIRST USE 8-1-2002; IN COMMERCE 8-1-2002.

CLASS 9—ELECTRICAL AND SCIENTIFIC APPARATUS

FOR COMPUTER SOFTWARE FOR USE IN DATA AND DATABASE MANAGEMENT AND LEGAL COMPLIANCE IN THE FIELD OF SPECIAL EDUCATION AND CHILD CARE, AND USER MANUALS SOLD THEREWITH AS A UNIT (U.S. CLS. 21, 23, 26, 36 AND 38).

FIRST USE 8-1-2002; IN COMMERCE 8-1-2002.

CLASS 35—ADVERTISING AND BUSINESS

FOR DATA MANAGEMENT SERVICES (U.S. CLS. 100, 101 AND 102).

FIRST USE 8-1-2002; IN COMMERCE 8-1-2002.

CLASS 35—ADVERTISING AND BUSINESS

FOR DATABASE MANAGEMENT SERVICES (U.S. CLS. 100, 101 AND 102).

FIRST USE 8-1-2002; IN COMMERCE 8-1-2002.

CLASS 42—SCIENTIFIC, COMPUTER AND LEGAL SERVICES

FOR COMPUTER SERVICES, NAMELY, PROVIDING TEMPORARY ACCESS TO NON-DOWNLOADABLE SOFTWARE ON A GLOBAL COMPUTER NETWORK FOR USE IN DATA AND DATABASE MANAGEMENT AND LEGAL COMPLIANCE IN THE FIELD OF SPECIAL EDUCATION AND CHILD CARE; APPLICATION SERVICE PROVIDER (ASP) FEATURING SOFTWARE FOR USE IN DATA AND DATABASE MANAGEMENT AND LEGAL COMPLIANCE IN THE FIELD OF SPECIAL EDUCATION AND CHILD CARE; DESIGN, DEVELOPMENT AND IMPLEMENTATION OF SOFTWARE FOR USE IN DATA AND DATABASE MANAGEMENT AND LEGAL COMPLIANCE IN THE FIELD OF SPECIAL EDUCATION AND CHILD CARE; DEVELOPMENT OF SOFTWARE FOR USE IN DATA AND DATABASE MANAGEMENT AND LEGAL COMPLIANCE IN THE FIELD OF SPECIAL EDUCATION AND CHILD CARE; CONSULTING SERVICES IN THE FIELD OF USE AND IMPLEMENTATION OF SOFTWARE FOR USE IN DATA AND DATABASE MANAGEMENT AND LEGAL COMPLIANCE IN THE FIELD OF SPECIAL EDUCATION AND CHILD CARE; AND DATABASE DEVELOPMENT SERVICES (U.S. CLS. 100 AND 101).

FIRST USE 8-1-2002; IN COMMERCE 8-1-2002.
JOHN WILKE, EXAMINING ATTORNEY

SN 77-063,503. EXCEL-TECH LTD., OAKVILLE, CANADA, FILED 12-13-2006.

POLYHYPSNOGRAPHY

THE MARK CONSISTS OF STANDARD CHARACTERS WITHOUT CLAIM TO ANY PARTICULAR FONT, STYLE, SIZE, OR COLOR.

CLASS 9—ELECTRICAL AND SCIENTIFIC APPARATUS

FOR SOFTWARE FOR DIAGNOSING AND TREATING SLEEP DISORDERS (U.S. CLS. 21, 23, 26, 36 AND 38).

CLASS 10—MEDICAL APPARATUS

FOR MEDICAL DIAGNOSTIC APPARATUS FOR DIAGNOSING AND TREATING SLEEP DISORDERS (U.S. CLS. 26, 39 AND 44).

CLASS 42—SCIENTIFIC, COMPUTER AND LEGAL SERVICES

FOR SCIENTIFIC RESEARCH RELATED TO SLEEP DISORDERS (U.S. CLS. 100 AND 101).

CLASS 44—MEDICAL, BEAUTY AND AGRICULTURAL SERVICES

FOR MEDICAL DIAGNOSTIC SERVICES DIAGNOSING AND TREATING SLEEP DISORDERS (U.S. CLS. 100 AND 101).

BARBARA A. GOLD, EXAMINING ATTORNEY

SN 77-062,775. BUSCHOW, JESSICA, GLEN SPEY, NY. FILED 12-12-2006.

mr.BLACK dance den

THE MARK CONSISTS OF STANDARD CHARACTERS WITHOUT CLAIM TO ANY PARTICULAR FONT, STYLE, SIZE, OR COLOR.

NO CLAIM IS MADE TO THE EXCLUSIVE RIGHT TO USE DANCE, APART FROM THE MARK AS SHOWN.

THE NAME MR. BLACK IDENTIFIES A LIVING INDIVIDUAL WHOSE CONSENT IS OF RECORD.

CLASS 35—ADVERTISING AND BUSINESS

FOR PROMOTING THE PARTIES AND SPECIAL EVENTS OF OTHERS (U.S. CLS. 100, 101 AND 102).

FIRST USE 1-1-2006; IN COMMERCE 1-3-2006.

CLASS 41—EDUCATION AND ENTERTAINMENT

FOR ENTERTAINMENT SERVICES, NAMELY, CONDUCTING PARTIES; NIGHT CLUBS; ORGANIZATION OF DANCING EVENTS (U.S. CLS. 100, 101 AND 107).

FIRST USE 1-1-2006; IN COMMERCE 1-3-2006.

CLASS 43—HOTEL AND RESTAURANT SERVICES

FOR BAR SERVICES (U.S. CLS. 100 AND 101).

FIRST USE 1-1-2006; IN COMMERCE 1-3-2006.
KATHERINE E. HALMEN, EXAMINING ATTORNEY

SN 77-063,975. PHEASANT BONANZA HUNT CLUB AND KENNEL, INC., OMAHA, NE. FILED 12-14-2006.

Pheasant Bonanza Hunt Club and Kennel

THE MARK CONSISTS OF STANDARD CHARACTERS WITHOUT CLAIM TO ANY PARTICULAR FONT, STYLE, SIZE, OR COLOR.

NO CLAIM IS MADE TO THE EXCLUSIVE RIGHT TO USE "PHEASANT" OR "HUNT CLUB AND KENNEL", APART FROM THE MARK AS SHOWN.

CLASS 41—EDUCATION AND ENTERTAINMENT

FOR RECREATIONAL SERVICES, NAMELY, PROVIDING HUNTING PRESERVES (U.S. CLS. 100, 101 AND 107).

FIRST USE 1-10-2005; IN COMMERCE 1-10-2005.

CLASS 43—HOTEL AND RESTAURANT SERVICES

FOR KENNEL SERVICES (U.S. CLS. 100 AND 101).

FIRST USE 1-10-2005; IN COMMERCE 1-10-2005.
HENRY S. ZAK, EXAMINING ATTORNEY

SN 77-064,319. SPECTRA ENERGY CORP., HOUSTON, TX.
FILED 12-14-2006.

SN 77-064,923. DIGITAL NOW, INC, HERNDON, VA. FILED
12-15-2006.

SPECTRA ENERGY

Ð E X S Æ R

THE MARK CONSISTS OF STANDARD CHARACTERS WITHOUT CLAIM TO ANY PARTICULAR FONT, STYLE, SIZE, OR COLOR.

NO CLAIM IS MADE TO THE EXCLUSIVE RIGHT TO USE "ENERGY", APART FROM THE MARK AS SHOWN.

CLASS 40—MATERIAL TREATMENT

FOR OIL, NATURAL GAS AND NATURAL GAS LIQUIDS PRODUCTION SERVICES (U.S. CLS. 100, 103 AND 106).

CLASS 42—SCIENTIFIC, COMPUTER AND LEGAL SERVICES

FOR OIL, NATURAL GAS AND NATURAL GAS LIQUIDS EXPLORATION (U.S. CLS. 100 AND 101).
BENJAMIN OKEKE, EXAMINING ATTORNEY

SN 77-064,354. SPECTRA ENERGY CORP., HOUSTON, TX.
FILED 12-14-2006.



NO CLAIM IS MADE TO THE EXCLUSIVE RIGHT TO USE "ENERGY", APART FROM THE MARK AS SHOWN.

CLASS 40—MATERIAL TREATMENT

FOR OIL, NATURAL GAS AND NATURAL GAS LIQUIDS PRODUCTION SERVICES (U.S. CLS. 100, 103 AND 106).

CLASS 42—SCIENTIFIC, COMPUTER AND LEGAL SERVICES

FOR OIL, NATURAL GAS AND NATURAL GAS LIQUIDS EXPLORATION (U.S. CLS. 100 AND 101).
BENJAMIN OKEKE, EXAMINING ATTORNEY

CLASS 9—ELECTRICAL AND SCIENTIFIC APPARATUS

FOR COMPUTER SOFTWARE FOR USE IN CONNECTION WITH PERSONALIZED INTERACTIVE USE OF DIGITAL CONTENT, MEDIA, AND IMAGES AND PHOTOS, VIDEOS, TEXT AND DOCUMENTS; COMPUTER SOFTWARE FOR USE IN STORING, ORGANIZING, SEARCHING, RETRIEVING, EDITING, MANIPULATING, ENHANCING, DISTRIBUTING AND PRINTING DIGITAL CONTENT, MEDIA, AND IMAGES AND PHOTOS, VIDEOS, TEXT AND DOCUMENTS; COMPUTER SOFTWARE CONTAINING INTERACTIVE ENTERTAINMENT PRODUCT FOR USE IN CUSTOMIZING THE ABILITY TO VIEW, PLAY AND LISTEN TO IMAGES, AUDIO, VIDEO AND AUDIOVISUAL CONTENT BY SELECTING AND ARRANGING THE DISPLAY AND PERFORMANCE IN THE FIELDS OF AUDIO, MUSIC, VIDEO, ART AND ENTERTAINMENT (U.S. CLS. 21, 23, 26, 36 AND 38).

CLASS 38—COMMUNICATION

FOR PROVISION OF ACCESS TO DIGITAL CONTENT, MEDIA, AND IMAGES AND ELECTRONICALLY-STORED DATA, INFORMATION, COMPUTER FILES, PHOTOGRAPHS, VIDEOS, TEXT AND DOCUMENTS STORED ELECTRONICALLY IN CENTRAL FILES (U.S. CLS. 100, 101 AND 104).

CLASS 39—TRANSPORTATION AND STORAGE

FOR NETWORK BASED AND WIRELESS BASED STORAGE OF DIGITAL CONTENT, MEDIA, AND IMAGES AND ELECTRONICALLY-STORED DATA, INFORMATION, COMPUTER FILES, PHOTOGRAPHS, VIDEOS, TEXT AND DOCUMENTS; PROVIDING ONLINE STORAGE OF DIGITAL CONTENT, MEDIA, AND IMAGES AND ELECTRONICALLY-STORED DATA, INFORMATION, COMPUTER FILES, PHOTOGRAPHS, VIDEOS, TEXT AND DOCUMENTS; ELECTRONIC STORAGE OF DIGITAL CONTENT, MEDIA, AND IMAGES AND ELECTRONICALLY-STORED DATA, INFORMATION, COMPUTER FILES, PHOTOGRAPHS, VIDEOS, TEXT AND DOCUMENTS; COMPUTER SERVICES, NAMELY, STORAGE OF RESOURCES AVAILABLE ON COMPUTER NETWORKS (U.S. CLS. 100 AND 105).

CLASS 40—MATERIAL TREATMENT

FOR PHOTOFINISHING; PRINTING OF IMAGES; ELECTRONIC IMAGING, SCANNING, DIGITIZING, ALTERATION AND RETOUCHING OF DIGITAL CONTENT, MEDIA, AND IMAGES AND PHOTOS AND VIDEOS; PRINTING SERVICES, NAMELY, PRINTING OF PHOTOGRAPHIC FILM AND DIGITAL IMAGES ONTO PHOTOGRAPHIC PAPER AND CLOTHING, BAGS, BLANKETS, MERCHANDISE; CUSTOM MANUFACTURE OF MEDIA ACCESSORIES, NAMELY, POST CARDS, GREETING CARDS, AND CALENDARS (U.S. CLS. 100, 103 AND 106).

CLASS 42—SCIENTIFIC, COMPUTER AND LEGAL SERVICES

FOR PROVIDING ELECTRONIC SERVICES ENABLING USERS TO MANAGE, ANNOTATE, SAVE, SHARE, SEARCH FOR, BROWSE AND RELOCATE INFORMATION AVAILABLE ON THE INTERNET AND ON OTHER PUBLIC AND PRIVATE COMPUTER NETWORKS AND COMPUTERS, NAMELY, PROVIDING TEMPORARY USE OF ONLINE NON-DOWNLOADABLE HOSTED SOFTWARE FOR USE TO MANAGE, ANNOTATE, SAVE, SHARE, SEARCH FOR, BROWSE AND RELOCATE INFORMATION AVAILABLE ON THE INTERNET AND ON OTHER PUBLIC AND PRIVATE COMPUTER NETWORKS AND COMPUTERS; COMPUTER SERVICES, NAMELY, CREATING INDEXES OF RESOURCES AVAILABLE ON COMPUTER NETWORKS; PROVIDING CUSTOMIZED ON-LINE WEBPAGES FEATURING USER-DEFINED INFORMATION; HOSTING COMPUTER SOFTWARE APPLICATIONS OF OTHERS; TRANSFER SERVICE FOR CONTENT, MEDIA, AND IMAGES FROM A DIGITAL CAPTURE DEVICE TO A COMPUTER OR NETWORK; TRANSFER SERVICE FOR CONTENT, MEDIA, AND IMAGES FROM ONE MEDIA TO A COMPUTER OR NETWORK (U.S. CLS. 100 AND 101).

HOWARD SMIGA, EXAMINING ATTORNEY

SN 77-065,129. ORGANIC MATERIALS REVIEW INSTITUTE, EUGENE, OR. FILED 12-15-2006.



OWNER OF U.S. REG. NOS. 2,915,668, 2,956,532 AND 3,110,824.

NO CLAIM IS MADE TO THE EXCLUSIVE RIGHT TO USE SEEDS, APART FROM THE MARK AS SHOWN.

THE MARK CONSISTS OF THE WORDS OMRI SEEDS ALONG WITH THREE SEEDS ABOVE THE WORDS.

CLASS 35—ADVERTISING AND BUSINESS

FOR PROVIDING AN ONLINE DATABASE LISTING SEED SUPPLY COMPANIES WHOSE STANDARDS AND PRACTICES CONFORM TO THE USDA NATIONAL ORGANIC PROGRAM RULE ALLOWING THE USE OF THE TERM ORGANIC BY THOSE COMPANIES (U.S. CLS. 100, 101 AND 102).

CLASS 44—MEDICAL, BEAUTY AND AGRICULTURAL SERVICES

FOR PROVIDING AN ONLINE DATABASE FEATURING INFORMATION FOR FINDING AND DETERMINING THE AVAILABILITY OF ORGANIC SEED VARIETIES (U.S. CLS. 100 AND 101).

CLASS 45—PERSONAL SERVICES

FOR REVIEW OF SEED SUPPLYING COMPANIES' STANDARDS AND PRACTICES PER USDA NATIONAL ORGANIC PROGRAM RULE TO ALLOW THE USE OF THE TERM ORGANIC BY THOSE COMPANIES (U.S. CLS. 100 AND 101).

MATTHEW EINSTEIN, EXAMINING ATTORNEY

SN 77-065,264. CARSED MARKETING INC., NASSAU, BAHAMAS, FILED 12-15-2006.

SEXTUBE

THE MARK CONSISTS OF STANDARD CHARACTERS WITHOUT CLAIM TO ANY PARTICULAR FONT, STYLE, SIZE, OR COLOR.

CLASS 38—COMMUNICATION

FOR ELECTRONIC DELIVERY OF IMAGES AND PHOTOGRAPHS VIA A GLOBAL COMPUTER NETWORK; PROVIDING ACCESS TO DATABASES FEATURING THIRD-PARTY WEB CONTENT CONTAINING ADULT RELATED PICTURES, VIDEO CLIPS AND OTHER ADULT ENTERTAINMENT OVER A GLOBAL COMPUTER NETWORK (U.S. CLS. 100, 101 AND 104).

FIRST USE 2-1-2006; IN COMMERCE 2-1-2006.

CLASS 41—EDUCATION AND ENTERTAINMENT

FOR ONLINE ENTERTAINMENT SERVICES, NAMELY, PROVIDING WEB SITES FEATURING ADULT CONTENT (U.S. CLS. 100, 101 AND 107).

FIRST USE 2-10-2006; IN COMMERCE 2-10-2006.

DAVID MILLER, EXAMINING ATTORNEY

SN 77-065,662. APPROVED AERONAUTICS, LLC, POMONA, CA. FILED 12-15-2006.



THE MARK CONSISTS OF A DESIGN OF AN AIRCRAFT TAKING OFF OF THE SIDE OF A STYLIZED LETTER "A".

CLASS 6—METAL GOODS

FOR METAL HARDWARE FOR AIRCRAFT, NAMELY, CAPTIVE SCREWS, NUTS, WASHERS, SPRINGS, PULLS, LATCHES, LOCKS, CLIPS, LOOP CLAMPS, BRACKETS AND METAL PLATES (U.S. CLS. 2, 12, 13, 14, 23, 25 AND 50).

FIRST USE 12-31-2001; IN COMMERCE 12-31-2001.

CLASS 7—MACHINERY

FOR AIRCRAFT ENGINE PARTS, NAMELY, AIR DUCTS, SEALS AND GASKETS; HYDRAULIC LANDING GEAR PUMPS (U.S. CLS. 13, 19, 21, 23, 31, 34 AND 35).

FIRST USE 12-31-2001; IN COMMERCE 12-31-2001.

CLASS 12—VEHICLES

FOR SPARE PARTS FOR AIRCRAFT SEATS, NAMELY, ESCUTCHEONS, ARM CAPS, SEAT BACKS, BUSHINGS, DECORATIVE TRIM, SPRINGS AND SEAT BELT COMPONENT PARTS (U.S. CLS. 19, 21, 23, 31, 35 AND 44).

FIRST USE 12-31-2001; IN COMMERCE 12-31-2001.

CLASS 17—RUBBER GOODS

FOR AIRCRAFT ENGINE PARTS, NAMELY, INSULATION BLANKETS (U.S. CLS. 1, 5, 12, 13, 35 AND 50).

FIRST USE 12-31-2001; IN COMMERCE 12-31-2001.

MICHAEL ENGEL, EXAMINING ATTORNEY

SN 77-068,807. THE CONCENTRATE MANUFACTURING COMPANY OF IRELAND, TA SEVEN-UP INTERNATIONAL, HAMILTON, BERMUDA, FILED 12-20-2006.

MALABAR TRADERS

THE MARK CONSISTS OF STANDARD CHARACTERS WITHOUT CLAIM TO ANY PARTICULAR FONT, STYLE, SIZE, OR COLOR.

CLASS 29—MEATS AND PROCESSED FOODS

FOR TAPENADES; DIPS; POTATO CHIPS; SHELLED NUTS (U.S. CL. 46).

CLASS 30—STAPLE FOODS

FOR TORTILLA CHIPS; RICE-BASED SNACK FOODS; FLATBREAD; BREAKFAST CEREALS; PROTEIN-BASED, NUTRIENT-DENSE SNACK BARS; TRAIL MIX CONSISTING PRIMARILY OF SEEDS, NUTS, DRIED FRUIT AND/OR GRANOLA (U.S. CL. 46).

CLASS 32—LIGHT BEVERAGES

FOR SOFT DRINKS; NON-ALCOHOLIC MALT BEVERAGES; FRUIT JUICE; FRUIT DRINKS (U.S. CLS. 45, 46 AND 48).

GIANCARLO CASTRO, EXAMINING ATTORNEY

SN 77-065,676. APPROVED AERONAUTICS, LLC, POMONA, CA. FILED 12-15-2006.

APPROVED AERONAUTICS, LLC

THE MARK CONSISTS OF STANDARD CHARACTERS WITHOUT CLAIM TO ANY PARTICULAR FONT, STYLE, SIZE, OR COLOR.

NO CLAIM IS MADE TO THE EXCLUSIVE RIGHT TO USE "AERONAUTICS, LLC", APART FROM THE MARK AS SHOWN.

CLASS 6—METAL GOODS

FOR METAL HARDWARE FOR AIRCRAFT, NAMELY, CAPTIVE SCREWS, NUTS, WASHERS, SPRINGS, PULLS, LATCHES, LOCKS, CLIPS, LOOP CLAMPS, BRACKETS AND METAL PLATES (U.S. CLS. 2, 12, 13, 14, 23, 25 AND 50).

FIRST USE 12-31-2001; IN COMMERCE 12-31-2001.

CLASS 7—MACHINERY

FOR AIRCRAFT ENGINE PARTS, NAMELY, AIR DUCTS, SEALS AND GASKETS; HYDRAULIC LANDING GEAR PUMPS (U.S. CLS. 13, 19, 21, 23, 31, 34 AND 35).

FIRST USE 12-31-2001; IN COMMERCE 12-31-2001.

CLASS 12—VEHICLES

FOR SPARE PARTS FOR AIRCRAFT SEATS, NAMELY, ESCUTCHEONS, ARM CAPS, SEAT BACKS, BUSHINGS, DECORATIVE TRIM, SPRINGS AND SEAT BELT COMPONENT PARTS (U.S. CLS. 19, 21, 23, 31, 35 AND 44).

FIRST USE 12-31-2001; IN COMMERCE 12-31-2001.

CLASS 17—RUBBER GOODS

FOR AIRCRAFT ENGINE PARTS, NAMELY, INSULATION BLANKETS (U.S. CLS. 1, 5, 12, 13, 35 AND 50).

FIRST USE 12-31-2001; IN COMMERCE 12-31-2001.

MICHAEL ENGEL, EXAMINING ATTORNEY

SN 77-069,936. BIGELOW MERCHANDISING, LLC, COLUMBUS, OH. FILED 12-21-2006.



NO CLAIM IS MADE TO THE EXCLUSIVE RIGHT TO USE REMEDIES, APART FROM THE MARK AS SHOWN.

THE PORTION OF THE MARK COMPRISED OF A CROSS DESIGN IS NOT DISPLAYED IN THE COLOR RED OR A COLORABLE IMITATION THEREOF AND IS NOT USED AND WILL NOT BE USED IN THE COLOR RED OR A COLORABLE IMITATION THEREOF.

CLASS 3—COSMETICS AND CLEANING PREPARATIONS

FOR NON-MEDICATED PERSONAL CARE PRODUCTS, NAMELY AFTER SHAVE CREAM, GEL AND EMULSION, AFTER SHAVE BALM, AFTER SHAVE LOTION, ALUM BLOCK FOR USE AFTER SHAVING, ANTIPERSPIRANT, FACIAL ASTRINGENT FOR COSMETIC PURPOSES, BATH BEADS, BATH GEL, BATH OIL, BATH CRYSTALS, BLUSH, BODY BALM, BODY CLEANSER, BODY CREAM, BODY LOTION, BODY MOISTURIZER, NON-MEDICATED BODY OINTMENT, NON-MEDICATED BODY SALVE, BODY SCRUB, BODY WASH, CLEANSING CREAM, COLD CREAM, COLOGNE, COSMETICS, DENTIFRICE, DEODORANT, DEPILATORIES, DUSTING POWDER, ESSENTIAL OIL FOR PERSONAL USE, EYE CREAM, EYE GEL, EYELINER, EYE SHADOW, FACE CLEANSER, FACE CREAM, FACE GEL, FACE LOTION, FACE MASK, FACE MIST, FACE MOISTURIZER, FACE POWDER, FACE SCRUB, SKIN SERUM, FACE TONER, FACE WASH, FOOT CREAM, FOOT POWDER, FOOT SALVE, FRAGRANCE FOR PERSONAL USE, HAIR BLEACHES, HAIR CONDITIONER, HAIR DETANGLER, HAIR POMADE, HAIR SHAMPOO, HAIR STYLING PREPARATIONS, HAIR WAXES, HAND CLEANSER, HAND CREAM, HAND LOTION, LIP BALM, LIP BUFFER, LIP EXFOLIATOR, NON-MEDICATED LIP SALVE, LIP SHINE, LIP STICK, LIQUID SKIN CLEANSER, MAKE UP REMOVER, MASCARA, MASSAGE CREAM, MASSAGE OIL, MOUTHWASH, NAIL CREAM, NAIL POLISH, NOSE BALM, PERFUME, POST SUN TANNING CREAM, POST SUN TANNING LOTION, PUMICE STONE FOR PERSONAL USE, SCENTED ROOM SPRAY, NON-MEDICATED BODY SALVE, NAMELY, ROSE SALVE, TOILET WATER, NAMELY, ROSE WATER, SHAVING BALM, SHAVING CREAM, SHAVING GEL, SHAVE LATHER, SHOWER GEL, SKIN CREAM, SKIN LOTION, SKIN TONIC, SKIN WASH, SOAP, MEDICATED SOAP, SUN CARE LOTION, GEL, CREAMS AND SPRAYS, TALCUM POWDER (U.S. CLS. 1, 4, 6, 50, 51 AND 52).

CLASS 5—PHARMACEUTICALS

FOR ACNE TREATMENT PREPARATIONS, ALOE-VERA GEL FOR FIRST-AID USE, ANTI-ITCH LOTION, ANTI-ITCH CREAM, ANTI-ITCH OINTMENT, ANTISEPTIC GEL, ASPIRIN, MEDICATED BLEMISH PADS FOR TREATMENT OF BLEMISHES, BLEMISH TREATMENT PREPARATIONS, MEDICATED BODY LOTION, MEDICATED CHEST BALM, COLD SORE TREATMENT PREPARATIONS, COUGH AND COLD TREATMENT PREPARATIONS, DANDRUFF SHAMPOO, MEDICINAL ELIXIRS AND INGESTIBLES FOR THE TREATMENT OF COLD, COUGH, FLU AND INDIGESTION, MEDICATED FOOT POWDER, INSECT REPELLANT, LINIMENT OIL SPRAY, LINIMENTS, MEDICATED LIP SALVE, THROAT AND COUGH LOZENGES, MENTHOLATED BODY LOTION, MEDICATED MOUTHWASH, NUTRITIONAL SUPPLEMENTS, NUTRITIONALLY FORTIFIED BEVERAGES, STYPTIC PENCIL, VITAMINS (U.S. CLS. 6, 18, 44, 46, 51 AND 52).

CLASS 8—HAND TOOLS

FOR NAIL CLIPPERS, NAIL FILE, NAIL SCISSORS, RAZOR BLADES, NON-ELECTRIC RAZORS AND TWEEZERS (U.S. CLS. 23, 28 AND 44).

CLASS 16—PAPER GOODS AND PRINTED MATTER

FOR CARDBOARD GIFT BOXES, GIFT WRAPPING PAPER, PAPER AND PLASTIC SHOPPING BAGS AND TISSUE PAPER (U.S. CLS. 2, 5, 22, 23, 29, 37, 38 AND 50).

CLASS 18—LEATHER GOODS

FOR COSMETIC BAGS SOLD EMPTY, TOILETRY CASES SOLD EMPTY (U.S. CLS. 1, 2, 3, 22 AND 41).

CLASS 21—HOUSEWARES AND GLASS

FOR COSMETIC BRUSHES, HAIR BRUSHES, HAIR COMBS, SHAVE BRUSHES, NON-ELECTRIC TOOTHBRUSHES AND SHOE POLISHING MITTS (U.S. CLS. 2, 13, 23, 29, 30, 33, 40 AND 50).

CLASS 35—ADVERTISING AND BUSINESS

FOR RETAIL STORE SERVICES, MAIL ORDER SERVICES, AND ONLINE RETAIL STORE SERVICES ALL FEATURING COSMETICS, TOILETRIES, SPA, SKIN AND BEAUTY CARE PRODUCTS AND PHARMACEUTICALS (U.S. CLS. 100, 101 AND 102).

TARAH HARDY, EXAMINING ATTORNEY

SN 77-069,975. OVERHEAD DOOR CORPORATION, LEWISVILLE, TX. FILED 12-21-2006.

COURTYARD COLLECTION

THE MARK CONSISTS OF STANDARD CHARACTERS WITHOUT CLAIM TO ANY PARTICULAR FONT, STYLE, SIZE, OR COLOR.

NO CLAIM IS MADE TO THE EXCLUSIVE RIGHT TO USE "COLLECTION", APART FROM THE MARK AS SHOWN.

CLASS 6—METAL GOODS

FOR RESIDENTIAL METAL GARAGE DOORS (U.S. CLS. 2, 12, 13, 14, 23, 25 AND 50).

CLASS 19—NON-METALLIC BUILDING MATERIALS

FOR RESIDENTIAL WOODEN GARAGE DOORS (U.S. CLS. 1, 12, 33 AND 50).

WON TEAK OH, EXAMINING ATTORNEY

SN 77-069,989. OVERHEAD DOOR CORPORATION, LEWISVILLE, TX. FILED 12-21-2006.

HOMEPLACE SERIES

THE MARK CONSISTS OF STANDARD CHARACTERS WITHOUT CLAIM TO ANY PARTICULAR FONT, STYLE, SIZE, OR COLOR.

NO CLAIM IS MADE TO THE EXCLUSIVE RIGHT TO USE "SERIES", APART FROM THE MARK AS SHOWN.

CLASS 6—METAL GOODS

FOR RESIDENTIAL METAL GARAGE DOORS (U.S. CLS. 2, 12, 13, 14, 23, 25 AND 50).

CLASS 19—NON-METALLIC BUILDING MATERIALS

FOR RESIDENTIAL WOODEN GARAGE DOORS (U.S. CLS. 1, 12, 33 AND 50).
WON TEAK OH, EXAMINING ATTORNEY

SN 77-070,210. CLAYTON CORPORATION, DBA CONVENIENCE PRODUCTS, FENTON, MO. FILED 12-22-2006.

THE SAFEST FOAM TO SEAL
YOUR HOME

THE MARK CONSISTS OF STANDARD CHARACTERS WITHOUT CLAIM TO ANY PARTICULAR FONT, STYLE, SIZE, OR COLOR.

CLASS 1—CHEMICALS

FOR ADHESIVES IN THE NATURE OF A FIRE-RETARDANT FOAM FOR RESIDENTIAL AND COMMERCIAL BUILDING, CONSTRUCTION, REPAIR AND MAINTENANCE USES (U.S. CLS. 1, 5, 6, 10, 26 AND 46).

CLASS 17—RUBBER GOODS

FOR SEALANTS, EXPANSION JOINT FILLERS AND INSULATION MATERIALS THAT ARE IN THE NATURE OF A FIRE-RETARDANT FOAM FOR RESIDENTIAL AND COMMERCIAL BUILDING, CONSTRUCTION, REPAIR AND MAINTENANCE USES (U.S. CLS. 1, 5, 12, 13, 35 AND 50).

BONNIE LUKEN, EXAMINING ATTORNEY

SN 77-070,819. HONGLING, LIANG, FO SHAN CITY, GUANDONG, CHINA, FILED 12-22-2006.



THE MARK CONSISTS OF THE WORD GODI AND A PLANT DESIGN ON A RECTANGULAR BACKGROUND.

CLASS 11—ENVIRONMENTAL CONTROL APPARATUS

FOR TAP WATER FAUCETS; WATER FOUNTAINS; PRESSURE WATER TANKS; ANTI-SPLASH TAP NOZZLES; BATH TUBS; BATH ENCLOSURES; SITZ BATHS; PORTABLE TURKISH BATH CABINETS; PORTABLE TOILETS; WATER CLOSETS; SHOWERS; HAND DRYING APPARATUS FOR WASHROOMS; TOILET BOWLS; TOILET SEATS; SOLAR HEATING COLLECTORS; URINALS; SOLAR WATER HEATERS; HEATERS FOR BATHS; ELECTROMAGNETIC STOVES; MICROWAVE OVENS FOR COOKING; ELECTRIC TOASTER OVENS; REFRIGERATORS; AIR CONDITIONING INSTALLATIONS; DRINKING FOUNTAINS; ELECTRIC RADIATORS FOR HEATING BUILDINGS (U.S. CLS. 13, 21, 23, 31 AND 34).

CLASS 20—FURNITURE AND ARTICLES NOT OTHERWISE CLASSIFIED

FOR BATHROOM VANITIES; BATHTUB AND SHOWER RAILS NOT MADE OF METAL; BATHROOM CABINETS WITH MIRRORS; BATHROOM CHAIRS; BEDROOM FURNITURE; FURNITURE CABINETS; FURNITURE, NAMELY, DRESSERS; FURNITURE FOR DISPLAYING KNICKKNACKS; CHESTS OF DRAWERS (U.S. CLS. 2, 13, 22, 25, 32 AND 50).
DAVID H. STINE, EXAMINING ATTORNEY

SN 77-071,270. EXCEL-TECH LTD., OAKVILLE, CANADA, FILED 12-26-2006.

PHG

THE MARK CONSISTS OF STANDARD CHARACTERS WITHOUT CLAIM TO ANY PARTICULAR FONT, STYLE, SIZE, OR COLOR.

CLASS 9—ELECTRICAL AND SCIENTIFIC APPARATUS

FOR SOFTWARE FOR DIAGNOSING AND TREATING SLEEP DISORDERS (U.S. CLS. 21, 23, 26, 36 AND 38).

CLASS 10—MEDICAL APPARATUS

FOR MEDICAL DIAGNOSTIC APPARATUS FOR DIAGNOSING AND TREATING SLEEP DISORDERS (U.S. CLS. 26, 39 AND 44).

CLASS 42—SCIENTIFIC, COMPUTER AND LEGAL SERVICES

FOR SCIENTIFIC RESEARCH RELATED TO SLEEP DISORDERS (U.S. CLS. 100 AND 101).

CLASS 44—MEDICAL, BEAUTY AND AGRICULTURAL SERVICES

FOR MEDICAL DIAGNOSTIC SERVICES DIAGNOSING AND TREATING SLEEP DISORDERS (U.S. CLS. 100 AND 101).

BARBARA A. GOLD, EXAMINING ATTORNEY

SN 77-072,213. WHOLESOME & HEARTY FOODS COMPANY, IRVINE, CA. FILED 12-27-2006.

SN 77-072,947. XENOSEP TECHNOLOGIES LLC, BOONTON, NJ. FILED 12-28-2006.

CHIEF FOOD OFFICER

THE MARK CONSISTS OF STANDARD CHARACTERS WITHOUT CLAIM TO ANY PARTICULAR FONT, STYLE, SIZE, OR COLOR.

CLASS 29—MEATS AND PROCESSED FOODS

FOR FROZEN OR REFRIGERATED ENTREES CONSISTING PRIMARILY OF SOY-BASED MEAT SUBSTITUTES; MEAT SUBSTITUTES (U.S. CL. 46).

CLASS 30—STAPLE FOODS

FOR FROZEN OR REFRIGERATED ENTREES CONSISTING PRIMARILY OF RICE, YEAST-BASED PASTA OR GRAINS (U.S. CL. 46).

CLASS 35—ADVERTISING AND BUSINESS

FOR SALES PROMOTION SERVICES, NAMELY, ORGANIZING, CONDUCTING, AND SPONSORING PROMOTIONS AND CONTESTS IN THE PACKAGED FOODS INDUSTRY (U.S. CLS. 100, 101 AND 102).

CLASS 41—EDUCATION AND ENTERTAINMENT

FOR ENTERTAINMENT SERVICES, NAMELY, ORGANIZING, CONDUCTING, AND SPONSORING CONTESTS IN THE PACKAGED FOODS INDUSTRY (U.S. CLS. 100, 101 AND 107).

PAMELA HIRSCHMAN, EXAMINING ATTORNEY

SN 77-072,687. STIRRINGS, LLC, FALL RIVER, MA. FILED 12-28-2006.



OWNER OF U.S. REG. NO. 3,087,636.
THE MARK CONSISTS OF A STYLIZED CURVED LINE PLACED ABOVE THE WORD, "STIRRINGS" IN STYLIZED TEXT.

CLASS 30—STAPLE FOODS

FOR SALT; SPICE BLENDS; SUGAR (U.S. CL. 46).
FIRST USE 6-9-2005; IN COMMERCE 6-15-2005.

CLASS 32—LIGHT BEVERAGES

FOR NON-ALCOHOLIC BEVERAGES, NAMELY, CARBONATED BEVERAGES; NON-ALCOHOLIC COCKTAIL MIXES (U.S. CLS. 45, 46 AND 48).
FIRST USE 6-2-2005; IN COMMERCE 6-10-2005.
BONNIE LUKEN, EXAMINING ATTORNEY

VALUSEP

THE MARK CONSISTS OF STANDARD CHARACTERS WITHOUT CLAIM TO ANY PARTICULAR FONT, STYLE, SIZE, OR COLOR.

CLASS 7—MACHINERY

FOR SEPARATING EQUIPMENT, APPARATUS AND INSTRUMENTS USED IN CONNECTION WITH A MANUFACTURING PROCESS, NAMELY SINGLE USE/DISPOSABLE FILTRATION AND SOLID-PHASE EXTRACTION COLUMNS, CARTRIDGES, SYRINGE-DRIVEN FILTERS, VACUUM FILTERS, PIPETTE FILTERS AND DISK FILTERS, ALL USED IN CONNECTION WITH THE SEPARATION OF CHEMICAL OR MOLECULAR SUBSTANCES OR COMPONENTS FROM ONE ANOTHER (U.S. CLS. 13, 19, 21, 23, 31, 34 AND 35).

CLASS 9—ELECTRICAL AND SCIENTIFIC APPARATUS

FOR SEPARATING EQUIPMENT, APPARATUS AND INSTRUMENTS USED IN CONNECTION WITH A MANUFACTURING PROCESS, NAMELY, CHROMATOGRAPHIC COLUMNS AND CHROMATOGRAPHIC PLATES; EQUIPMENT, APPARATUS AND INSTRUMENTS, NAMELY, CHROMATOGRAPHIC COLUMNS AND CHROMATOGRAPHIC PLATES AND SINGLE USE/DISPOSABLE FILTRATION AND SOLID-PHASE EXTRACTION COLUMNS, CARTRIDGES, SYRINGE-DRIVEN FILTERS, VACUUM FILTERS, PIPETTE FILTERS AND DISK FILTERS, ALL USED IN CONNECTION WITH THE SEPARATION OF CHEMICAL OR MOLECULAR SUBSTANCES OR COMPONENTS FROM ONE ANOTHER, IN LABORATORY AND RESEARCH FACILITIES (U.S. CLS. 21, 23, 26, 36 AND 38).

KAPIL BHANOT, EXAMINING ATTORNEY

SN 77-074,310. BOWEN, CALID, COLUMBUS, OH. AND YOUBOTY, ASHTON, COLUMBUS, OH. FILED 1-2-2007.



NO CLAIM IS MADE TO THE EXCLUSIVE RIGHT TO USE RECORDS, APART FROM THE MARK AS SHOWN.

THE COLOR(S) BLACK, RED, GRAY AND BROWN IS/ARE CLAIMED AS A FEATURE OF THE MARK.

THE MARK CONSISTS OF AN ANIMATED CHARACTER HOLDING A MICROPHONE UP IN THE AIR WITH ITS LEFT HAND. THE CHARACTER IS WEARING A BLACK HOODED SWEATSHIRT, WITH A RED BASEBALL CAP, GREY JEANS, AND BLACK AND RED BOOTS. THE CHARACTER'S HAND IS BROWN, AND GREY CHAINS ARE HANGING FROM ITS LEFT ARM. THE CHARACTER IS STANDING ON TOP OF THE WORDS BROKEN CHAINZ RECORDS WHICH IS IN BLACK AND GREY STYLIZED PRINT.

CLASS 9—ELECTRICAL AND SCIENTIFIC APPARATUS

FOR MUSICAL SOUND RECORDINGS; MUSICAL VIDEO RECORDINGS (U.S. CLS. 21, 23, 26, 36 AND 38).

CLASS 41—EDUCATION AND ENTERTAINMENT

FOR AUDIO RECORDING AND PRODUCTION; EDITING OR RECORDING OF SOUNDS AND IMAGES; MUSIC PUBLISHING SERVICES; PRODUCTION OF SOUND AND MUSIC VIDEO RECORDINGS; PROVIDING VOICE OVERS FOR TAPES, RECORDS AND OTHER RECORDED MEDIA; RECORD MASTER PRODUCTION; RECORD PRODUCTION; RECORDING STUDIOS; RENTAL OF SOUND RECORDINGS; SOUND RECORDING STUDIOS (U.S. CLS. 100, 101 AND 107).
TOBY BULLOFF, EXAMINING ATTORNEY

SN 77-074,904. MARK R. BURNINGHAM, SONOMA, CA. FILED 1-3-2007.

WINES GONE WILD

THE MARK CONSISTS OF STANDARD CHARACTERS WITHOUT CLAIM TO ANY PARTICULAR FONT, STYLE, SIZE, OR COLOR.

NO CLAIM IS MADE TO THE EXCLUSIVE RIGHT TO USE "WINES", APART FROM THE MARK AS SHOWN.

CLASS 33—WINES AND SPIRITS

FOR (BASED ON USE IN COMMERCE) RED WINE; (BASED ON INTENT TO USE) SPARKLING WINE; WHITE WINE (U.S. CLS. 47 AND 49).
FIRST USE 1-15-2006; IN COMMERCE 10-1-2006.

CLASS 41—EDUCATION AND ENTERTAINMENT

FOR ENTERTAINMENT SERVICES, NAMELY WINE AND FOOD TASTINGS (U.S. CLS. 100, 101 AND 107).
NAPOLEON SHARMA, EXAMINING ATTORNEY

SN 77-075,724. LINK SOURCE, LLC, GOLDEN, CO. FILED 1-4-2007.



THE COLOR(S) WHITE, BLACK AND ORANGE IS/ARE CLAIMED AS A FEATURE OF THE MARK.

THE MARK CONSISTS OF THE WORD LINK IN BLACK WITH WHITE TRIM WITH AN ORANGE BACKGROUND WITH BLACK OUTLINE TRIM FORMING THE LEFT SIDE OF A RECTANGLE WITH ROUNDED CORNERS, FOLLOWED BY THE LETTERS "LS" STYLIZED IN ORANGE WITH WHITE TRIM WITH A BLACK BACKGROUND AND WHITE TRIM IN A OVAL SHAPE WITH AN ORANGE BACKGROUND AND BLACK TRIM ON THE TOP AND BOTTOM OF THE OVAL SHAPE, FOLLOWED BY THE WORD SOURCE IN BLACK WITH WHITE TRIM WITH AN ORANGE BACKGROUND WITH BLACK OUTLINE TRIM FORMING THE RIGHT SIDE OF A RECTANGLE WITH ROUNDED CORNERS.

CLASS 37—CONSTRUCTION AND REPAIR

FOR INSTALLATION, MAINTENANCE, CONFIGURATION AND REPAIR OF DATA AND VOICE CABLE AND WIRELESS SYSTEMS AND EQUIPMENT (U.S. CLS. 100, 103 AND 106).
FIRST USE 5-24-2002; IN COMMERCE 5-24-2002.

CLASS 42—SCIENTIFIC, COMPUTER AND LEGAL SERVICES

FOR DESIGN FOR OTHERS IN THE FIELD OF DATA AND VOICE CABLE AND WIRELESS NETWORKS AND NETWORKING EQUIPMENT (U.S. CLS. 100 AND 101).
FIRST USE 5-24-2002; IN COMMERCE 5-24-2002.
APRIL ROACH, EXAMINING ATTORNEY

SN 77-075,760. LIBERTY HARDWARE MFG. CORP., WINSTON-SALEM, NC. FILED 1-4-2007.

EXPRESSO

THE MARK CONSISTS OF STANDARD CHARACTERS WITHOUT CLAIM TO ANY PARTICULAR FONT, STYLE, SIZE, OR COLOR.

CLASS 6—METAL GOODS

FOR METAL PULLS AND KNOBS FOR CABINETS (U.S. CLS. 2, 12, 13, 14, 23, 25 AND 50).

CLASS 21—HOUSEWARES AND GLASS

FOR BATH ACCESSORIES, NAMELY TOWEL BARS, TOWEL RINGS, TOILET TISSUE HOLDERS, AND TOOTHBRUSH-TUMBLER HOLDERS (U.S. CLS. 2, 13, 23, 29, 30, 33, 40 AND 50).
MARCIE MILONE, EXAMINING ATTORNEY

SN 77-080,130. MARS, INCORPORATED, MCLEAN, VA. FILED 1-10-2007.

MARS BOTANICAL

THE MARK CONSISTS OF STANDARD CHARACTERS WITHOUT CLAIM TO ANY PARTICULAR FONT, STYLE, SIZE, OR COLOR.

OWNER OF U.S. REG. NOS. 986,077, 2,108,485 AND OTHERS.

NO CLAIM IS MADE TO THE EXCLUSIVE RIGHT TO USE "BOTANICAL", APART FROM THE MARK AS SHOWN.

CLASS 42—SCIENTIFIC, COMPUTER AND LEGAL SERVICES

FOR SCIENTIFIC RESEARCH AND DEVELOPMENT; BASIC AND CLINICAL RESEARCH AND DEVELOPMENT IN THE FIELD OF PLANT NUTRITIONAL SCIENCE, NATURAL PRODUCTS SCIENCE, FOOD SCIENCE, HUMAN FOOD NUTRITION, AND MEDICINE; DESIGN AND TESTING FOR NEW PRODUCT DEVELOPMENT; HUMAN FOOD SAFETY TESTING AND CONSULTATION; TESTING, INSPECTION, AND RESEARCH OF PHARMACEUTICALS AND FOODSTUFFS FOR HUMANS; PHARMACEUTICAL RESEARCH AND DEVELOPMENT; PHARMACEUTICAL PRODUCT EVALUATION; DEVELOPMENT OF PHARMACEUTICAL PREPARATIONS AND MEDICINES; CONDUCTING EARLY EVALUATIONS IN THE FIELD OF NEW PHARMACEUTICALS; PROVIDING AND DISSEMINATING INFORMATION AND DATA RELATING TO LIFE SCIENCES RESEARCH, PLANT NUTRITIONAL SCIENCE (U.S. CLS. 100 AND 101).

CLASS 44—MEDICAL, BEAUTY AND AGRICULTURAL SERVICES

FOR PROVIDING AND DISSEMINATING HEALTH INFORMATION AND DATA RELATING TO THE HEALTH BENEFITS OF FLAVANOLS (U.S. CLS. 100 AND 101).

ROBERT STRUCK, EXAMINING ATTORNEY

SN 77-080,863. FULD & COMPANY, CAMBRIDGE, MA. FILED 1-11-2007.

DECISIONS BUILT ON INTELLIGENCE

THE MARK CONSISTS OF STANDARD CHARACTERS WITHOUT CLAIM TO ANY PARTICULAR FONT, STYLE, SIZE, OR COLOR.

CLASS 35—ADVERTISING AND BUSINESS

FOR BUSINESS CONSULTING SERVICES IN THE FIELD OF COMPETITIVE INTELLIGENCE (U.S. CLS. 100, 101 AND 102).

FIRST USE 6-2-2003; IN COMMERCE 6-2-2003.

CLASS 42—SCIENTIFIC, COMPUTER AND LEGAL SERVICES

FOR EDUCATIONAL SERVICES, NAMELY WORKSHOPS AND COURSES IN THE FIELD OF COMPETITIVE INTELLIGENCE (U.S. CLS. 100 AND 101).

FIRST USE 6-2-2003; IN COMMERCE 6-2-2003.
SIMON TENG, EXAMINING ATTORNEY

SN 77-082,051. GIDWANI, VINOD T., GLENVIEW, IL. FILED 1-12-2007.

i luv my doc

THE MARK CONSISTS OF STANDARD CHARACTERS WITHOUT CLAIM TO ANY PARTICULAR FONT, STYLE, SIZE, OR COLOR.

CLASS 16—PAPER GOODS AND PRINTED MATTER

FOR COMPUTER PROGRAM MANUALS FOR WEB-BASED SOFTWARE FOR PERFORMING OFFICE FUNCTIONS IN THE HEALTHCARE INDUSTRY, NAMELY BILLING, SCHEDULING, ACCOUNTING, SUBMITTING AND ISSUING PRESCRIPTIONS, FACILITATING COMMUNICATION BETWEEN HEALTHCARE PROFESSIONALS AND PATIENTS, MAINTAINING PERSONAL HEALTHCARE RECORDS, AND PROVIDING HEALTHCARE INFORMATION AND LITERATURE (U.S. CLS. 2, 5, 22, 23, 29, 37, 38 AND 50).

CLASS 42—SCIENTIFIC, COMPUTER AND LEGAL SERVICES

FOR PROVIDING USE OF INTERACTIVE, NON-DOWNLOADABLE COMPUTER SOFTWARE TO PERFORM OFFICE FUNCTIONS IN THE HEALTHCARE INDUSTRY, NAMELY, BILLING, SCHEDULING, ACCOUNTING, SUBMITTING AND ISSUING OF PRESCRIPTIONS, TO FACILITATE COMMUNICATION BETWEEN HEALTHCARE PROVIDERS, AND BETWEEN HEALTHCARE PROVIDERS AND PATIENTS, TO MAINTAIN PERSONAL HEALTHCARE RECORDS, TO PROVIDE HEALTHCARE INFORMATION AND LITERATURE, TO MAINTAIN ELECTRONIC MEDICAL RECORDS, TO MAKE REFERRALS AND TO BETTER MANAGE PATIENT OUTCOMES; COMPUTER PROGRAMMING; COMPUTER PROGRAMMING IN THE MEDICAL FIELD; COMPUTER SOFTWARE DESIGN; MAINTENANCE OF COMPUTER SOFTWARE; DATA CONVERSION OF COMPUTER PROGRAM DATA OR INFORMATION; DUPLICATING COMPUTER PROGRAMS; MONITORING AND TECHNICAL SUPPORT OF THE COMPUTER SYSTEMS OF OTHERS AND PROVIDING BACK-UP COMPUTER PROGRAMS AND FACILITIES; REPAIR OF DAMAGED COMPUTER PROGRAMS; UPDATING OF COMPUTER PROGRAMS FOR THIRD PARTIES (U.S. CLS. 100 AND 101).

KIMBERLY FRYE, EXAMINING ATTORNEY

SN 77-082,191. SCHMAP LIMITED, HONG KONG, HONG KONG, FILED 1-12-2007.

Schmapplets

THE MARK CONSISTS OF STANDARD CHARACTERS WITHOUT CLAIM TO ANY PARTICULAR FONT, STYLE, SIZE, OR COLOR.

OWNER OF U.S. REG. NO. 3,077,833.

CLASS 9—ELECTRICAL AND SCIENTIFIC APPARATUS

FOR COMPUTER SOFTWARE FOR VIEWING, SEARCHING AND EDITING DIGITAL INFORMATION FROM A COMPUTER DATABASE IN RELATION TO ITS POSITION ON A DIGITAL MAP, DIGITAL DIAGRAM OR DIGITAL IMAGE (U.S. CLS. 21, 23, 26, 36 AND 38).

FIRST USE 12-21-2006; IN COMMERCE 12-21-2006.

CLASS 35—ADVERTISING AND BUSINESS

FOR PROVIDING GEOGRAPHIC INFORMATION AND MAP IMAGES IN THE FIELD OF CONSUMER-ORIENTED BUSINESS VIA GLOBAL INFORMATION NETWORKS (U.S. CLS. 100, 101 AND 102).

FIRST USE 12-21-2006; IN COMMERCE 12-21-2006.

CLASS 39—TRANSPORTATION AND STORAGE

FOR PROVISION OF INFORMATION RELATING TO TRAVEL AND TRAVEL MAPS VIA GLOBAL INFORMATION NETWORKS (U.S. CLS. 100 AND 105).

FIRST USE 12-21-2006; IN COMMERCE 12-21-2006.

CLASS 42—SCIENTIFIC, COMPUTER AND LEGAL SERVICES

FOR PROVIDING NON-DOWNLOADABLE COMPUTER SOFTWARE FOR VIEWING, SEARCHING AND EDITING DIGITAL INFORMATION FROM A COMPUTER DATABASE IN RELATION TO ITS POSITION ON A DIGITAL MAP, DIGITAL DIAGRAM OR DIGITAL IMAGE (U.S. CLS. 100 AND 101).

FIRST USE 12-21-2006; IN COMMERCE 12-21-2006.

KELLEY WELLS, EXAMINING ATTORNEY

SN 77-082,318. 121MEDIA, INC., NEW YORK, NY. FILED 1-12-2007.

PHORM

THE MARK CONSISTS OF STANDARD CHARACTERS WITHOUT CLAIM TO ANY PARTICULAR FONT, STYLE, SIZE, OR COLOR.

CLASS 9—ELECTRICAL AND SCIENTIFIC APPARATUS

FOR SOFTWARE AND COMPUTER HARDWARE SYSTEMS FOR ELECTRONICALLY DELIVERING MARKETING CONTENT TO A NETWORKED COMPUTER; SOFTWARE AND COMPUTER HARDWARE SYSTEMS FOR MONITORING WEB-BROWSING BEHAVIOR OF A NETWORKED COMPUTER (U.S. CLS. 21, 23, 26, 36 AND 38).

CLASS 35—ADVERTISING AND BUSINESS

FOR INTERNET ADVERTISING SERVICES; BUSINESS-INFORMATION SERVICES RELATING TO TRACKING AND MONITORING WEB-BROWSING BEHAVIOR OF NETWORKED COMPUTERS (U.S. CLS. 100, 101 AND 102).

BRENDAN REGAN, EXAMINING ATTORNEY

SN 77-082,321. 121MEDIA, INC., NEW YORK, NY. FILED 1-12-2007.

FIDEO

THE MARK CONSISTS OF STANDARD CHARACTERS WITHOUT CLAIM TO ANY PARTICULAR FONT, STYLE, SIZE, OR COLOR.

"THE FOREIGN WORDING IN THE MARK TRANSLATES INTO ENGLISH AS NOODLE."

CLASS 9—ELECTRICAL AND SCIENTIFIC APPARATUS

FOR SOFTWARE AND COMPUTER HARDWARE SYSTEMS FOR ELECTRONICALLY DELIVERING MARKETING CONTENT TO A NETWORKED COMPUTER; SOFTWARE AND COMPUTER HARDWARE SYSTEMS FOR MONITORING WEB-BROWSING BEHAVIOR OF A NETWORKED COMPUTER (U.S. CLS. 21, 23, 26, 36 AND 38).

CLASS 35—ADVERTISING AND BUSINESS

FOR INTERNET ADVERTISING SERVICES; BUSINESS-INFORMATION SERVICES RELATING TO TRACKING AND MONITORING WEB-BROWSING BEHAVIOR OF NETWORKED COMPUTERS (U.S. CLS. 100, 101 AND 102).

BRENDAN REGAN, EXAMINING ATTORNEY

SN 77-082,323. 121MEDIA, INC., NEW YORK, NY. FILED 1-12-2007.

QANDA

THE MARK CONSISTS OF STANDARD CHARACTERS WITHOUT CLAIM TO ANY PARTICULAR FONT, STYLE, SIZE, OR COLOR.

CLASS 9—ELECTRICAL AND SCIENTIFIC APPARATUS

FOR SOFTWARE AND COMPUTER HARDWARE SYSTEMS FOR ELECTRONICALLY DELIVERING MARKETING CONTENT TO A NETWORKED COMPUTER; SOFTWARE AND COMPUTER HARDWARE SYSTEMS FOR MONITORING WEB-BROWSING BEHAVIOR OF A NETWORKED COMPUTER (U.S. CLS. 21, 23, 26, 36 AND 38).

CLASS 35—ADVERTISING AND BUSINESS

FOR INTERNET ADVERTISING SERVICES; BUSINESS-INFORMATION SERVICES RELATING TO TRACKING AND MONITORING WEB-BROWSING BEHAVIOR OF NETWORKED COMPUTERS (U.S. CLS. 100, 101 AND 102).

BRENDAN REGAN, EXAMINING ATTORNEY

SN 77-082,342. RODMAN & RENSHAW, LLC, NEW YORK, NY. FILED 1-12-2007.

LIFE SCIENCES FINANCIAL INSIGHT IS IN OUR DNA

THE MARK CONSISTS OF STANDARD CHARACTERS WITHOUT CLAIM TO ANY PARTICULAR FONT, STYLE, SIZE, OR COLOR.

CLASS 35—ADVERTISING AND BUSINESS

FOR ARRANGING AND CONDUCTING BUSINESS CONFERENCES IN THE FIELDS OF HEALTHCARE, BIOTECHNOLOGY AND LIFE SCIENCES; CONSULTING SERVICES IN THE FIELD OF BUSINESS MERGERS AND ACQUISITIONS IN THE FIELDS OF HEALTHCARE, BIOTECHNOLOGY AND LIFE SCIENCES (U.S. CLS. 100, 101 AND 102).

CLASS 36—INSURANCE AND FINANCIAL

FOR INVESTMENT BANKING SERVICES IN THE FIELDS OF HEALTHCARE, BIOTECHNOLOGY AND LIFE SCIENCES; BROKERAGE OF SHARES OF STOCKS AND OTHER SECURITIES IN THE FIELDS OF HEALTHCARE, BIOTECHNOLOGY AND LIFE SCIENCES; FINANCIAL INVESTMENT SERVICES IN THE FIELD OF HEALTHCARE, BIOTECHNOLOGY AND LIFE SCIENCES; FINANCIAL SERVICES, NAMELY ASSISTING OTHERS WITH THE COMPLETION OF FINANCIAL TRANSACTIONS FOR STOCKS, BONDS, SECURITIES AND EQUITIES IN THE FIELDS OF HEALTHCARE, BIOTECHNOLOGY AND LIFE SCIENCES; CONSULTING SERVICES IN THE FIELD OF CORPORATE FINANCE IN THE FIELDS OF HEALTHCARE, BIOTECHNOLOGY AND LIFE SCIENCES (U.S. CLS. 100, 101 AND 102).

ELISSA GARBER KON, EXAMINING ATTORNEY

SN 77-082,412. ILLINOIS HERITAGE ASSOCIATION, CHAMPAIGN, IL. FILED 1-12-2007.



NO CLAIM IS MADE TO THE EXCLUSIVE RIGHT TO USE "ILLINOIS HERITAGE ASSOCIATION", APART FROM THE MARK AS SHOWN.

CLASS 16—PAPER GOODS AND PRINTED MATTER

FOR PRINTED MATERIALS, NAMELY, NEWSLETTERS, INFORMATIONAL BROCHURES, FLYERS AND PRINTED EDUCATIONAL MATERIALS IN THE FIELD OF STATE AND NATIONAL MANAGEMENT ASSISTANCE FOR CULTURAL ORGANIZATIONS REGARDING PRESERVATION AND INTERPRETATION OF CULTURAL ARTIFACTS AND HISTORICAL DOCUMENTS AND TELECOMMUNICATION TRANSMISSIONS ASSOCIATED WITH HISTORICAL DOCUMENTS (U.S. CLS. 2, 5, 22, 23, 29, 37, 38 AND 50).

FIRST USE 3-23-2006; IN COMMERCE 3-23-2006.

CLASS 35—ADVERTISING AND BUSINESS

FOR ONLINE RETAIL STORES FEATURING ARCHIVAL SUPPLIES; PROMOTING BOOKS PUBLISHED BY OTHERS THROUGH ALL PUBLIC COMMUNICATION MEANS; BUSINESS CONSULTATION SERVICES DIRECTED TO NONPROFIT AGENCIES REGARDING OPERATIONS OF THEIR ENTITIES; PROVIDING INFORMATION ONLINE IN THE FIELD OF STATE AND NATIONAL MANAGEMENT ASSISTANCE FOR CULTURAL ORGANIZATIONS REGARDING PRESERVATION AND INTERPRETATION OF CULTURAL ARTIFACTS AND HISTORICAL DOCUMENTS (U.S. CLS. 100, 101 AND 102).

FIRST USE 12-28-2006; IN COMMERCE 12-28-2006.

CLASS 41—EDUCATION AND ENTERTAINMENT

FOR EDUCATIONAL SERVICES, NAMELY WORKSHOPS AND CLASSES IN THE FIELD OF OPERATING NONPROFIT ORGANIZATIONS, RESEARCH COLLECTION MANAGEMENT AND CARE, EXHIBIT PLANNING, EDUCATIONAL PROGRAMMING AND HISTORIC PRESERVATION; LIBRARY SERVICES, NAMELY, A REFERENCE AND CIRCULATION LIBRARY CONTAINING SPECIALIZED PRACTICAL AND TECHNICAL INFORMATION ABOUT ADMINISTRATION, MANAGEMENT AND CARE OF COLLECTIONS, HISTORIC PRESERVATION, AND HISTORICAL RESEARCH; PROVIDING NEWSLETTERS VIA E-MAIL IN THE FIELD OF STATE AND NATIONAL MANAGEMENT ASSISTANCE FOR CULTURAL ORGANIZATIONS REGARDING PRESERVATION AND INTERPRETATION OF CULTURAL ARTIFACTS AND HISTORICAL DOCUMENTS AND TELECOMMUNICATION TRANSMISSIONS ASSOCIATED WITH HISTORICAL DOCUMENTS (U.S. CLS. 100, 101 AND 107).

FIRST USE 12-27-2006; IN COMMERCE 12-27-2006.

DAVID YONTEF, EXAMINING ATTORNEY

SN 77-082,836. BUTCHER & PACKER SUPPLY COMPANY, DETROIT, MI. FILED 1-15-2007.

BUTCHER & PACKER SUPPLY COMPANY

THE MARK CONSISTS OF STANDARD CHARACTERS WITHOUT CLAIM TO ANY PARTICULAR FONT, STYLE, SIZE, OR COLOR.

NO CLAIM IS MADE TO THE EXCLUSIVE RIGHT TO USE "SUPPLY COMPANY", APART FROM THE MARK AS SHOWN.

SEC. 2(F).

CLASS 30—STAPLE FOODS

FOR SPICES AND SPICE BLENDS FOR FOOD (U.S. CL. 46).

FIRST USE 0-0-1937; IN COMMERCE 0-0-1937.

CLASS 35—ADVERTISING AND BUSINESS

FOR RETAIL STORE SERVICES, ON-LINE RETAIL STORE SERVICES, MAIL ORDER RETAIL STORE SERVICES, WHOLESALE STORE SERVICES, ON-LINE WHOLESALE STORE SERVICES, AND MAIL ORDER WHOLESALE SERVICES IN THE FIELDS OF FOOD PROCESSING EQUIPMENT, FOOD PREPARATION EQUIPMENT, FOOD ADDITIVES, MARINADES, SPICES AND CLOTHING (U.S. CLS. 100, 101 AND 102).

FIRST USE 0-0-1937; IN COMMERCE 0-0-1937.
MARTHA FROMM, EXAMINING ATTORNEY

CLASS 41—EDUCATION AND ENTERTAINMENT

FOR EDUCATIONAL SERVICES, NAMELY, CONDUCTING CLASSES, SEMINARS, CONFERENCES AND WORKSHOPS IN THE FIELD OF BUSINESS MANAGEMENT AND DISTRIBUTION OF COURSE MATERIALS IN CONNECTION THEREWITH (U.S. CLS. 100, 101 AND 107).

SCOTT BIBB, EXAMINING ATTORNEY

SN 77-082,862. CHICAGO PARTNERS, L.L.C., CHICAGO, IL. FILED 1-15-2007.

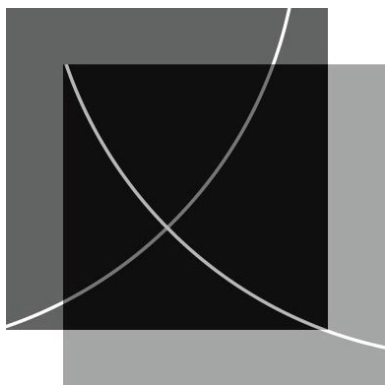

THE MARK CONSISTS OF TWO SHADED AND OVERLAPPING SQUARES, WITH A CURVED X DESIGN.

CLASS 36—INSURANCE AND FINANCIAL

FOR CONSULTATION SERVICES IN THE FIELDS OF ECONOMICS, FINANCE AND ACCOUNTING; FINANCIAL ANALYSIS AND CONSULTATION (U.S. CLS. 100, 101 AND 102).

CLASS 45—PERSONAL SERVICES

FOR EXPERT WITNESS SERVICES IN THE FIELDS OF ECONOMICS, FINANCE AND ACCOUNTING (U.S. CLS. 100 AND 101).

NANCY CLARKE, EXAMINING ATTORNEY

SN 77-083,167. HAINES, STEPHEN, SAN DIEGO, CA. FILED 1-15-2007.

HAINES CENTRE FOR STRATEGIC MANAGEMENT

THE MARK CONSISTS OF STANDARD CHARACTERS WITHOUT CLAIM TO ANY PARTICULAR FONT, STYLE, SIZE, OR COLOR.

OWNER OF U.S. REG. NOS. 2,397,183 AND 2,486,525.

NO CLAIM IS MADE TO THE EXCLUSIVE RIGHT TO USE "CENTRE FOR STRATEGIC MANAGEMENT", APART FROM THE MARK AS SHOWN.

CLASS 35—ADVERTISING AND BUSINESS

FOR CONSULTING SERVICES IN THE FIELD OF BUSINESS MANAGEMENT (U.S. CLS. 100, 101 AND 102).

SN 77-083,650. MARKOW, HILARY, CHICAGO, IL. AND THOMA, MARGARET, CHICAGO, IL. FILED 1-16-2007.

I Nosh Therefore I Am

THE MARK CONSISTS OF STANDARD CHARACTERS WITHOUT CLAIM TO ANY PARTICULAR FONT, STYLE, SIZE, OR COLOR.

CLASS 21—HOUSEWARES AND GLASS

FOR MUGS (U.S. CLS. 2, 13, 23, 29, 30, 33, 40 AND 50).
FIRST USE 11-8-2006; IN COMMERCE 12-5-2006.

CLASS 25—CLOTHING

FOR TOPS (U.S. CLS. 22 AND 39).
FIRST USE 11-8-2006; IN COMMERCE 12-5-2006.
MARCIE MILONE, EXAMINING ATTORNEY

SN 77-083,816. GREENWALD, MICHELLE, RYE, NH. FILED 1-16-2007.

Visual  zed

THE MARK CONSISTS OF THE LETTERS VISUAL FOLLOWED BY A PICTURE OF AN EYE FOLLOWED BY THE LETTERS ZED.

CLASS 9—ELECTRICAL AND SCIENTIFIC APPARATUS

FOR ELECTRONIC PUBLICATIONS, NAMELY, BOOKS FEATURING EDUCATIONAL AND INSTRUCTIONAL MATERIAL ON A WIDE VARIETY OF TOPICS RECORDED ON COMPUTER MEDIA (U.S. CLS. 21, 23, 26, 36 AND 38).

CLASS 16—PAPER GOODS AND PRINTED MATTER

FOR SERIES OF NON-FICTION EDUCATION AND INSTRUCTION BOOKS ON A WIDE VARIETY OF TOPICS (U.S. CLS. 2, 5, 22, 23, 29, 37, 38 AND 50).
VIVIAN MICZNIK FIRST, EXAMINING ATTORNEY

SN 77-084,106. MIC TALK, INC., HOLMDEL, NJ. FILED 1-16-2007.

SN 77-084,704. SCHMAP LIMITED, HONG KONG, HONG KONG, FILED 1-17-2007.

MIC TALK

THE MARK CONSISTS OF STANDARD CHARACTERS WITHOUT CLAIM TO ANY PARTICULAR FONT, STYLE, SIZE, OR COLOR.

NO CLAIM IS MADE TO THE EXCLUSIVE RIGHT TO USE "MIC" APART FROM THE MARK AS SHOWN FOR SIRENS, AUDIO SPEAKERS, TWO-WAY RADIOS AND BUILDING AMPLIFIERS., APART FROM THE MARK AS SHOWN.

CLASS 9—ELECTRICAL AND SCIENTIFIC APPARATUS

FOR PUBLIC SAFETY HARDWARE AND EQUIPMENT, NAMELY, SIRENS, AUDIO SPEAKERS, MOBILE COMPUTER DATA TERMINALS, MOBILE VIDEO RECORDERS, TWO-WAY RADIOS, HEADSETS FOR TWO-WAY RADIOS, REFLECTIVE VEHICLE DECALS TO AVOID ACCIDENTS, AND IN BUILDING AMPLIFIERS (U.S. CLS. 21, 23, 26, 36 AND 38).

CLASS 11—ENVIRONMENTAL CONTROL APPARATUS

FOR SAFETY LIGHTING, NAMELY, LIGHT BARS FOR VEHICLES, NAMELY, POLICE VEHICLES, FIRE VEHICLES AND EMS VEHICLES, AND CUSTOM ELECTRIC LIGHTING FIXTURES (U.S. CLS. 13, 21, 23, 31 AND 34).

JULIE WATSON, EXAMINING ATTORNEY

SN 77-084,107. MIC TALK, INC., HOLMDEL, NJ. FILED 1-16-2007.

MIC TALK

THE MARK CONSISTS OF STANDARD CHARACTERS WITHOUT CLAIM TO ANY PARTICULAR FONT, STYLE, SIZE, OR COLOR.

CLASS 35—ADVERTISING AND BUSINESS

FOR GPS TRACKING OF VEHICLES FOR COMMERCIAL PURPOSES (U.S. CLS. 100, 101 AND 102).

CLASS 38—COMMUNICATION

FOR COMMERCIAL MOBILE RADIO COMMUNICATION SERVICES; RADIO AND TELEVISION BROADCASTING SERVICES; SATELLITE TRANSMISSION SERVICES; SERVICES FOR THE REMOTE OPERATIONS OF FACILITIES USING RADIO COMMUNICATIONS; EMERGENCY NOTIFICATION AND RESPONSE BROADCASTING SERVICES, NAMELY, TRANSMISSION OF VOICE, DATA AND DOCUMENTS, IN THE FIELD OF SEARCH AND RESCUE OPERATIONS AND POLICE AND FIRE FIGHT OPERATIONS; PROVIDING BROADBAND AND WIRELESS COMMUNICATION SERVICES FOR VOICE AND DATA TO OTHERS (U.S. CLS. 100, 101 AND 104).

JULIE WATSON, EXAMINING ATTORNEY

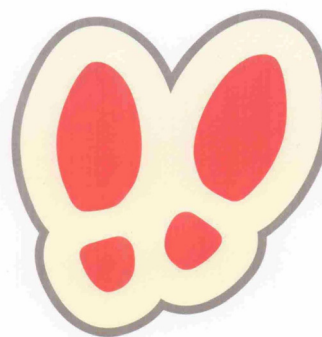

THE COLOR(S) RED, YELLOW, AND GREY IS/ARE CLAIMED AS A FEATURE OF THE MARK.

THE MARK CONSISTS OF A PAIR OF RED FOOTPRINTS WITH A YELLOW BORDER AND A GREY OUTER STROKE.

CLASS 9—ELECTRICAL AND SCIENTIFIC APPARATUS

FOR COMPUTER SOFTWARE FOR VIEWING, SEARCHING AND EDITING DIGITAL INFORMATION FROM A COMPUTER DATABASE IN RELATION TO ITS POSITION ON A DIGITAL MAP, DIGITAL DIAGRAM OR DIGITAL IMAGE (U.S. CLS. 21, 23, 26, 36 AND 38).

FIRST USE 8-1-2005; IN COMMERCE 8-1-2005.

CLASS 35—ADVERTISING AND BUSINESS

FOR PROVIDING GEOGRAPHIC INFORMATION AND MAP IMAGES IN THE FIELD OF CONSUMER-ORIENTED BUSINESS VIA GLOBAL INFORMATION NETWORKS (U.S. CLS. 100, 101 AND 102).

FIRST USE 8-1-2005; IN COMMERCE 8-1-2005.

CLASS 39—TRANSPORTATION AND STORAGE

FOR PROVISION OF INFORMATION RELATING TO TRAVEL AND TRAVEL MAPS VIA GLOBAL INFORMATION NETWORKS (U.S. CLS. 100 AND 105).

FIRST USE 8-1-2005; IN COMMERCE 8-1-2005.

CLASS 42—SCIENTIFIC, COMPUTER AND LEGAL SERVICES

FOR PROVIDING NON-DOWNLOADABLE COMPUTER SOFTWARE FOR VIEWING, SEARCHING AND EDITING DIGITAL INFORMATION FROM A COMPUTER DATABASE IN RELATION TO ITS POSITION ON A DIGITAL MAP, DIGITAL DIAGRAM OR DIGITAL IMAGE (U.S. CLS. 100 AND 101).

FIRST USE 8-1-2005; IN COMMERCE 8-1-2005.

KELLEY WELLS, EXAMINING ATTORNEY

SN 77-085,338. KAYAK SOFTWARE CORPORATION, NORWALK, CT. FILED 1-18-2007.



THE MARK CONSISTS OF A DESIGN OF A STYLIZED KAYAK.

CLASS 35—ADVERTISING AND BUSINESS

FOR ONLINE REFERRAL SERVICES IN THE TRAVEL COMMUNITY; ADVERTISING SERVICES, NAMELY DISSEMINATION OF ADVERTISING FOR OTHERS VIA THE INTERNET; PROVIDING ADVERTISING SPACE AND RENTAL OF ADVERTISING SPACE ON THE INTERNET. (U.S. CLS. 100, 101 AND 102).
FIRST USE 2-7-2006; IN COMMERCE 2-7-2006.

CLASS 38—COMMUNICATION

FOR PROVIDING ONLINE COMMUNICATIONS LINKS THAT TRANSFER THE WEBSITE USER TO OTHERS' LOCAL AND GLOBAL WEB PAGES AND WEB SITES; PROVIDING ON-LINE CHAT ROOMS AND ON-LINE BULLETIN BOARDS FOR TRANSMISSION OF MESSAGES AMONG COMPUTER USERS IN THE TRAVEL COMMUNITY (U.S. CLS. 100, 101 AND 104).
FIRST USE 2-7-2006; IN COMMERCE 2-7-2006.

CLASS 39—TRANSPORTATION AND STORAGE

FOR PROVIDING TRAVEL INFORMATION OVER GLOBAL COMPUTER NETWORKS, NAMELY PROVIDING SEARCH SERVICES FOR TRAVEL LISTINGS, TRAVEL INFORMATION AND RELATED TOPICS, AND FOR MAKING RESERVATIONS AND BOOKINGS FOR TRANSPORTATION; TRAVEL INFORMATION SERVICES, NAMELY, PROVIDING ON-LINE PRICE COMPARISONS OF TRAVEL AND LODGING SERVICES, AND PROVIDING A NON-DOWNLOADABLE SEARCHABLE DIRECTORY OF TRAVEL INFORMATION FOR OBTAINING DATA AND INFORMATION FROM OTHERS VIA THE INTERNET. (U.S. CLS. 100 AND 105).
FIRST USE 2-7-2006; IN COMMERCE 2-7-2006.

CLASS 41—EDUCATION AND ENTERTAINMENT

FOR PROVIDING ONLINE PUBLICATIONS IN THE NATURE OF GUIDES AND DIRECTORIES FEATURING SCHEDULES, LISTINGS, ADVERTISEMENTS, REVIEWS, POSTINGS, LOCATIONS, OR SOLICITATIONS, ALL IN THE FIELD OF TRAVEL FOR USE BY TRAVELERS AVAILABLE ELECTRONICALLY VIA COMPUTER NETWORKS, GLOBAL INFORMATION NETWORKS AND WIRELESS NETWORKS; PROVIDING ON-LINE INFORMATION, NAMELY, SCHEDULES, LISTINGS, REVIEWS, POSTINGS, AND LOCATIONS; ALL IN THE FIELD OF ENTERTAINMENT. (U.S. CLS. 100, 101 AND 107).
FIRST USE 2-7-2006; IN COMMERCE 2-7-2006.

CLASS 42—SCIENTIFIC, COMPUTER AND LEGAL SERVICES

FOR PROVIDING AN INTERNET SEARCH ENGINE TO ASSIST TRAVELERS TO LOCATE AND COMPARE PRICES AND RATINGS FOR TRAVEL RESERVATIONS; PROVIDING NON-DOWNLOADABLE COMPUTER SOFTWARE TO PRESENT TRAVEL INFORMATION, NAMELY, GEOGRAPHIC MAPS, TRAVEL ROUTE INFORMATION AND RECOMMENDATIONS, AND TRAVEL INFORMATION GUIDES. (U.S. CLS. 100 AND 101).
FIRST USE 2-7-2006; IN COMMERCE 2-7-2006.
TINA KUAN, EXAMINING ATTORNEY

SN 77-085,388. SEIKO EPSON KABUSHIKI KAISHA, TA SEIKO EPSON CORPORATION, SHINJUKU-KU, TOKYO, JAPAN, FILED 1-18-2007.

DBINDER

THE MARK CONSISTS OF STANDARD CHARACTERS WITHOUT CLAIM TO ANY PARTICULAR FONT, STYLE, SIZE, OR COLOR.

PRIORITY CLAIMED UNDER SEC. 44(D) ON JAPAN APPLICATION NO. 2006-073515, FILED 8-7-2006, REG. NO. 5044755, DATED 4-27-2007, EXPIRES 4-27-2017.

CLASS 9—ELECTRICAL AND SCIENTIFIC APPARATUS

FOR COMPUTER SOFTWARE FOR USE WITH ELECTRONIC DISPLAY SYSTEM FOR STORING AND DISPLAYING SHEET INFORMATION IN THE NATURE OF WORKPLACE MATERIALS, CONFERENCE MATERIALS, ACCOUNTING DATA, HANDOUTS, PROFESSIONAL MATERIALS IN THE FIELD OF MEDICINE, LAW, ACCOUNTING AND THE LIKE, TEXTS, SPECIALIZED BOOKS AND TREATISES CONCERNING EDUCATIONAL RELATED MATTERS AND ELECTRONIC PUBLICATIONS SUCH AS NEWSPAPERS AND MAGAZINES; COMPUTER SOFTWARE FOR PAGE RECOGNITION AND RENDERING FOR USE IN VIEWING, PRINTING, NAVIGATING, EDITING, ANNOTATING AND INDEXING ELECTRONIC DOCUMENTS, FILLING INLAND SUBMITTING FORMS ON-LINE, AND TRANSFERRING ELECTRONIC DOCUMENTS VIA A LOCAL OR GLOBAL COMMUNICATIONS NETWORK; COMPUTER E-COMMERCE SOFTWARE TO ALLOW USERS TO PERFORM ELECTRONIC BUSINESS TRANSACTIONS VIA A LOCAL OR GLOBAL COMMUNICATIONS NETWORK; COMPUTER SOFTWARE FOR THE ENCRYPTION AND ACCESS CONTROL OF ELECTRONIC DOCUMENTS; AND INSTRUCTIONAL BOOKS AND MANUALS SOLD AS A UNIT THEREWITH; COMPUTER SOFTWARE FOR USE IN AUTHORIZING, DOWNLOADING, TRANSMITTING, RECEIVING, EDITING, EXTRACTING, ENCODING, DECODING, PLAYING, STORING AND ORGANIZING DATA; COMPUTER SOFTWARE FOR DISPLAYING, STORING, PROCESSING, EDITING, DOWNLOADING, REPLAYING, AND TRANSMITTING DATA, AND FOR ACCESS CONTROL AND DATA ENCRYPTION OF ELECTRONIC DOCUMENTS, AND FOR SYNCHRONIZING DATA FOR COMPUTERS AND PERSONAL DIGITAL ASSISTANTS; ELECTRONIC DISPLAY SYSTEM CONSISTING OF COMPUTER HARDWARE (U.S. CLS. 21, 23, 26, 36 AND 38).

CLASS 42—SCIENTIFIC, COMPUTER AND LEGAL SERVICES

FOR TECHNICAL SUPPORT SERVICES, NAMELY, TROUBLESHOOTING OF SOFTWARE PROBLEMS FOR PERSONAL DIGITAL ASSISTANTS; COMPUTER SOFTWARE DESIGN FOR OTHERS IN THE FIELD OF PERSONAL DIGITAL ASSISTANTS; PROVIDING ONLINE NON-DOWNLOADABLE SOFTWARE FOR DISPLAYING, STORING, PROCESSING, EDITING, DOWNLOADING, REPLAYING, AND TRANSMITTING DATA, AND FOR ACCESS CONTROL AND DATA ENCRYPTION OF ELECTRONIC DOCUMENTS, AND FOR SYNCHRONIZING DATA FOR COMPUTERS AND PERSONAL DIGITAL ASSISTANTS; PROVIDING TEMPORARY USE OF ON-LINE NON-DOWNLOADABLE SOFTWARE FOR DISPLAYING, STORING, PROCESSING, EDITING, DOWNLOADING, REPLAYING, AND TRANSMITTING DATA, AND FOR ACCESS CONTROL AND DATA ENCRYPTION OF ELECTRONIC DOCUMENTS, AND FOR SYNCHRONIZING DATA FOR COMPUTERS AND PERSONAL DIGITAL ASSISTANTS; RENTAL OF COMPUTERS; TECHNICAL SUPPORT SERVICES, NAMELY, TROUBLESHOOTING OF COMPUTER PROBLEMS (U.S. CLS. 100 AND 101).

VIVIAN MICZNIK FIRST, EXAMINING ATTORNEY

SN 77-086,810. BUTLER, SHINE, STERN & PARTNERS, LLC, SAUSALITO, CA. FILED 1-19-2007.

**BUTLER, SHINE, STERN &
PARTNERS**

THE MARK CONSISTS OF STANDARD CHARACTERS WITHOUT CLAIM TO ANY PARTICULAR FONT, STYLE, SIZE, OR COLOR.

NO CLAIM IS MADE TO THE EXCLUSIVE RIGHT TO USE "& PARTNERS", APART FROM THE MARK AS SHOWN.

CLASS 35—ADVERTISING AND BUSINESS

FOR (BASED ON SECTION 1(A)) ADVERTISING AGENCIES; ADVERTISING, MARKETING, AND PROMOTION SERVICES AND RELATED CONSULTING; PREPARING ADVERTISEMENTS AND MARKETING MATERIALS FOR OTHERS; PREPARATION AND REALIZATION OF MEDIA AND ADVERTISING PLANS AND CONCEPTS; DISSEMINATION OF ADVERTISING FOR OTHERS VIA AN ONLINE COMMUNICATIONS NETWORK ON THE INTERNET; MARKET AND MEDIA RESEARCH SERVICES; DIRECT MAIL CONSULTING SERVICES; DEVELOPMENT OF MARKETING STRATEGIES AND CONCEPTS; PROVIDING INFORMATION IN THE FIELDS OF ADVERTISING, MARKETING, BRANDING, AND MARKET TRENDS; BUSINESS CONSULTATION REGARDING LAUNCHING OF NEW PRODUCTS; (BASED ON SECTION 1(B)) POST-PRODUCTION EDITING SERVICES FOR VIDEO AND AUDIO COMMERCIALS AND MARKETING MATERIALS; PRODUCTION AND DISTRIBUTION OF AUDIO AND VIDEO COMMERCIALS AND MARKETING MATERIALS; PREPARING AUDIO-VISUAL PRESENTATIONS FOR USE IN ADVERTISING AND MARKETING (U.S. CLS. 100, 101 AND 102).

FIRST USE 4-30-2005; IN COMMERCE 4-30-2005.

CLASS 41—EDUCATION AND ENTERTAINMENT

FOR (BASED ON SECTION 1(A)) PROVIDING ONLINE PUBLICATIONS IN THE NATURE OF NEWSLETTERS AND ONLINE JOURNALS, NAMELY, BLOGS IN THE FIELDS OF ADVERTISING, MARKETING, BRANDING, AND MARKET TRENDS; PROVIDING NEWSLETTERS IN THE FIELDS OF ADVERTISING, MARKETING, BRANDING, AND MARKET TRENDS VIA E-MAIL; (BASED ON SECTION 1(B)) VIDEO EDITING; PRODUCTION OF VIDEO AND CREATION OF VISUAL EFFECTS FOR OTHERS FOR USE IN DVDS, DOWNLOADABLE CONTENT FOR PORTABLE MEDIA PLAYERS, TELEVISION PROGRAMS, FILMS, AND ON WEBSITES; PRODUCTION OF VIDEO DISCS FOR OTHERS; AUDIO AND VIDEOTAPE, VIDEO DISC, AND DIGITAL VIDEO RECORDING AND PRODUCTION (U.S. CLS. 100, 101 AND 107).

FIRST USE 4-30-2005; IN COMMERCE 4-30-2005.

CLASS 42—SCIENTIFIC, COMPUTER AND LEGAL SERVICES

FOR PRODUCT DEVELOPMENT CONSULTATION; RESEARCH AND DEVELOPMENT FOR NEW PRODUCTS FOR OTHERS; COMMERCIAL ART DESIGN; GRAPHIC DESIGN SERVICES; DESIGNING WEBSITES FOR ADVERTISING PURPOSES (U.S. CLS. 100 AND 101).

FIRST USE 4-30-2005; IN COMMERCE 4-30-2005.
GINA FINK, EXAMINING ATTORNEY

SN 77-086,976. KIA KAHA DESIGN LIMITED, WELLINGTON, NEW ZEALAND, FILED 1-19-2007.

KIA KAHA

THE MARK CONSISTS OF STANDARD CHARACTERS WITHOUT CLAIM TO ANY PARTICULAR FONT, STYLE, SIZE, OR COLOR.

THE FOREIGN WORDING IN THE MARK TRANSLATES INTO ENGLISH AS "FOREVER STRONG" OR "BE STRONG".

CLASS 18—LEATHER GOODS

FOR ATHLETIC BAGS, ATTACHE CASES, BACKPACKS, BEACH BAGS, BILLFOLDS, BOOK BAGS, BRIEFCASES, BUSINESS CARD CASES, COIN PURSES, COSMETIC BAGS SOLD EMPTY, COSMETIC CASES SOLD EMPTY, CREDIT CARD CASES, DUFFEL BAGS, FOOTLOCKERS, GARMENT BAGS FOR TRAVEL, GOLF UMBRELLAS, GYM BAGS, HANDBAGS, KEY CASES, LUGGAGE, POCKETBOOKS, PURSES, SATCHELS, SHAVING BAGS SOLD EMPTY, SUIT BAGS, SUITCASES, TOILETRY CASES SOLD EMPTY, TOTE BAGS, UMBRELLAS, AND WALLETS (U.S. CLS. 1, 2, 3, 22 AND 41).

CLASS 25—CLOTHING

FOR CLOTHING, NAMELY, BATHING SUITS, BATHROBES, BEANIES, BELTS, BLOUSES, BOOTS, CARDIGANS, COATS, DRESSES, HATS, HOODED SWEATSHIRTS, HOSIERY, JACKETS, JERSEYS, LINGERIE, LOUNGEWEAR, NIGHTWEAR, PANTS, SCARVES, SHIRTS, SHOES, SHORTS, SKIRTS, SLEEPWEAR, SLIPPERS, SOCKS, SUITS, SUSPENDERS, SWEATERS, T-SHIRTS, TIES, AND UNDERGARMENTS (U.S. CLS. 22 AND 39).

CLASS 35—ADVERTISING AND BUSINESS

FOR RETAIL STORES FEATURING CLOTHING AND ACCESSORIES; ONLINE RETAIL STORE SERVICES FEATURING CLOTHING AND ACCESSORIES; MAIL ORDER CATALOG SERVICES FEATURING CLOTHING AND ACCESSORIES; AND WHOLESALE DISTRIBUTORSHIPS FEATURING CLOTHING AND ACCESSORIES (U.S. CLS. 100, 101 AND 102).

SN 77-086,982. KIA KAHA DESIGN LIMITED, WELLINGTON, NEW ZEALAND, FILED 1-19-2007.

CLASS 42—SCIENTIFIC, COMPUTER AND LEGAL SERVICES

FOR DESIGN FOR OTHERS IN THE FIELD OF FASHION, CLOTHING, HANDBAGS, AND FASHION ACCESSORIES (U.S. CLS. 100 AND 101).

GEORGE LORENZO, EXAMINING ATTORNEY

CHARMAINE LOVE

SN 77-086,979. KIA KAHA DESIGN LIMITED, WELLINGTON, NEW ZEALAND, FILED 1-19-2007.



THE MARK CONSISTS OF A DEPICTION OF A MOUNTAIN AND A HAMMERHEAD SHARK.

THE MARK CONSISTS OF STANDARD CHARACTERS WITHOUT CLAIM TO ANY PARTICULAR FONT, STYLE, SIZE, OR COLOR.

THE NAME(S), PORTRAIT(S), AND/OR SIGNATURE(S) SHOWN IN THE MARK IDENTIFIES CHARMAINE LOVE, WHOSE CONSENT(S) TO REGISTER IS MADE OF RECORD.

CLASS 18—LEATHER GOODS

FOR ATHLETIC BAGS, ATTACHE CASES, BACKPACKS, BEACH BAGS, BILLFOLDS, BOOK BAGS, BRIEFCASES, BUSINESS CARD CASES, COIN PURSES, COSMETIC BAGS SOLD EMPTY, COSMETIC CASES SOLD EMPTY, CREDIT CARD CASES, DUFFEL BAGS, FOOTLOCKERS, GARMENT BAGS FOR TRAVEL, GOLF UMBRELLAS, GYM BAGS, HANDBAGS, KEY CASES, LUGGAGE, POCKETBOOKS, PURSES, SATCHELS, SHAVING BAGS SOLD EMPTY, SUIT BAGS, SUITCASES, TOILETRY CASES SOLD EMPTY, TOTE BAGS, UMBRELLAS, AND WALLETS (U.S. CLS. 1, 2, 3, 22 AND 41).

CLASS 18—LEATHER GOODS

FOR ATHLETIC BAGS, ATTACHE CASES, BACKPACKS, BEACH BAGS, BILLFOLDS, BOOK BAGS, BRIEFCASES, BUSINESS CARD CASES, COIN PURSES, COSMETIC BAGS SOLD EMPTY, COSMETIC CASES SOLD EMPTY, CREDIT CARD CASES, DUFFEL BAGS, FOOTLOCKERS, GARMENT BAGS FOR TRAVEL, GOLF UMBRELLAS, GYM BAGS, HANDBAGS, KEY CASES, LUGGAGE, POCKETBOOKS, PURSES, SATCHELS, SHAVING BAGS SOLD EMPTY, SUIT BAGS, SUITCASES, TOILETRY CASES SOLD EMPTY, TOTE BAGS, UMBRELLAS, AND WALLETS (U.S. CLS. 1, 2, 3, 22 AND 41).

CLASS 25—CLOTHING

FOR CLOTHING, NAMELY, BATHING SUITS, BATHROBES, BEANIES, BELTS, BLOUSES, BOOTS, CARDIGANS, COATS, DRESSES, HATS, HOODED SWEATSHIRTS, HOSE, JACKET, JERSEYS, LINGERIE, LOUNGEWEAR, NIGHTWEAR, PANTS, SCARVES, SHIRTS, SHOES, SHORTS, SKIRTS, SLEEPWEAR, SLIPPERS, SOCKS, SUITS, SUSPENDERS, SWEATERS, T-SHIRTS, TIES, AND UNDERGARMENTS (U.S. CLS. 22 AND 39).

CLASS 25—CLOTHING

FOR CLOTHING, NAMELY, BATHING SUITS, BATHROBES, BEANIES, BELTS, BLOUSES, BOOTS, CARDIGANS, COATS, DRESSES, HATS, HOODED SWEATSHIRTS, HOSE, JACKET, JERSEYS, LINGERIE, LOUNGEWEAR, NIGHTWEAR, PANTS, SCARVES, SHIRTS, SHOES, SHORTS, SKIRTS, SLEEPWEAR, SLIPPERS, SOCKS, SUITS, SUSPENDERS, SWEATERS, T-SHIRTS, TIES, AND UNDERGARMENTS (U.S. CLS. 22 AND 39).

CLASS 35—ADVERTISING AND BUSINESS

FOR RETAIL STORES FEATURING CLOTHING AND ACCESSORIES; ONLINE RETAIL STORE SERVICES FEATURING CLOTHING AND ACCESSORIES; MAIL ORDER CATALOG SERVICES FEATURING CLOTHING AND ACCESSORIES; AND WHOLESALE DISTRIBUTORSHIPS FEATURING CLOTHING AND ACCESSORIES (U.S. CLS. 100, 101 AND 102).

CLASS 35—ADVERTISING AND BUSINESS

FOR RETAIL STORES FEATURING CLOTHING AND ACCESSORIES; ONLINE RETAIL STORE SERVICES FEATURING CLOTHING AND ACCESSORIES; MAIL ORDER CATALOG SERVICES FEATURING CLOTHING AND ACCESSORIES; AND WHOLESALE DISTRIBUTORSHIPS FEATURING CLOTHING AND ACCESSORIES (U.S. CLS. 100, 101 AND 102).

CLASS 42—SCIENTIFIC, COMPUTER AND LEGAL SERVICES

FOR DESIGN FOR OTHERS IN THE FIELD OF FASHION, CLOTHING, HANDBAGS, AND FASHION ACCESSORIES (U.S. CLS. 100 AND 101).

GEORGE LORENZO, EXAMINING ATTORNEY

CLASS 42—SCIENTIFIC, COMPUTER AND LEGAL SERVICES

FOR DESIGN FOR OTHERS IN THE FIELD OF FASHION, CLOTHING, HANDBAGS, AND FASHION ACCESSORIES (U.S. CLS. 100 AND 101).

GEORGE LORENZO, EXAMINING ATTORNEY

SN 77-086,987. KIA KAHA DESIGN LIMITED, WELLINGTON, NEW ZEALAND, FILED 1-19-2007.

CHARMAINE
LOVE

THE NAME(S), PORTRAIT(S), AND/OR SIGNATURE(S) SHOWN IN THE MARK IDENTIFIES CHARMAINE LOVE, WHOSE CONSENT(S) TO REGISTER IS MADE OF RECORD.

THE MARK CONSISTS OF THE WORDS CHARMAINE LOVE WITH THE WORD CHARMAINE ON TOP, THE WORD LOVE CENTERED BELOW, AND CURVED SCROLLS MIRRORING EACH OTHER ON EITHER SIDE OF THE WORD LOVE.

CLASS 18—LEATHER GOODS

FOR ATHLETIC BAGS, ATTACHE CASES, BACKPACKS, BEACH BAGS, BILLFOLDS, BOOK BAGS, BRIEFCASES, BUSINESS CARD CASES, COIN PURSES, COSMETIC BAGS SOLD EMPTY, COSMETIC CASES SOLD EMPTY, CREDIT CARD CASES, DUFFEL BAGS, FOOTLOCKERS, GARMENT BAGS FOR TRAVEL, GOLF UMBRELLAS, GYM BAGS, HANDBAGS, KEY CASES, LUGGAGE, POCKETBOOKS, PURSES, SATCHELS, SHAVING BAGS SOLD EMPTY, SUIT BAGS, SUITCASES, TOILETRY CASES SOLD EMPTY, TOTE BAGS, UMBRELLAS, AND WALLETS (U.S. CLS. 1, 2, 3, 22 AND 41).

CLASS 25—CLOTHING

FOR CLOTHING, NAMELY, BATHING SUITS, BATHROBES, BEANIES, BELTS, BLOUSES, BOOTS, CARDIGANS, COATS, DRESSES, HATS, HOODED SWEATSHIRTS, HOSIERY, JACKETS, JERSEYS, LINGERIE, LOUNGEWEAR, NIGHTWEAR, PANTS, SCARVES, SHIRTS, SHOES, SHORTS, SKIRTS, SLEEPWEAR, SLIPPERS, SOCKS, SUITS, SUSPENDERS, SWEATERS, T-SHIRTS, TIES, AND UNDERGARMENTS (U.S. CLS. 22 AND 39).

CLASS 35—ADVERTISING AND BUSINESS

FOR RETAIL STORES FEATURING CLOTHING AND ACCESSORIES; ONLINE RETAIL STORE SERVICES FEATURING CLOTHING AND ACCESSORIES; MAIL ORDER CATALOG SERVICES FEATURING CLOTHING AND ACCESSORIES; AND WHOLESALE DISTRIBUTORSHIPS FEATURING CLOTHING AND ACCESSORIES (U.S. CLS. 100, 101 AND 102).

CLASS 42—SCIENTIFIC, COMPUTER AND LEGAL SERVICES

FOR DESIGN FOR OTHERS IN THE FIELD OF FASHION, CLOTHING, HANDBAGS, AND FASHION ACCESSORIES (U.S. CLS. 100 AND 101).
GEORGE LORENZO, EXAMINING ATTORNEY

SN 77-087,064. BUTLER, SHINE, STERN & PARTNERS, LLC, SAUSALITO, CA. FILED 1-19-2007.

INFLUX

THE MARK CONSISTS OF STANDARD CHARACTERS WITHOUT CLAIM TO ANY PARTICULAR FONT, STYLE, SIZE, OR COLOR.

CLASS 35—ADVERTISING AND BUSINESS

FOR ADVERTISING AGENCIES; ADVERTISING, MARKETING, AND PROMOTION SERVICES AND RELATED CONSULTING; PREPARING ADVERTISEMENTS FOR OTHERS; PREPARATION AND REALIZATION OF MEDIA AND ADVERTISING PLANS AND CONCEPTS; DEVELOPMENT OF MARKETING STRATEGIES AND CONCEPTS; MARKET AND MEDIA RESEARCH SERVICES; PROVIDING INFORMATION IN THE FIELDS OF ADVERTISING, MARKETING, BRANDING, AND MARKET TRENDS; BUSINESS CONSULTATION REGARDING LAUNCHING OF NEW PRODUCTS (U.S. CLS. 100, 101 AND 102).

FIRST USE 4-30-2005; IN COMMERCE 4-30-2005.

CLASS 41—EDUCATION AND ENTERTAINMENT

FOR PROVIDING ONLINE PUBLICATIONS IN THE NATURE OF NEWSLETTERS AND ONLINE JOURNALS, NAMELY, BLOGS IN THE FIELDS OF ADVERTISING, MARKETING, BRANDING, AND MARKET TRENDS; PROVIDING NEWSLETTERS IN THE FIELDS OF ADVERTISING, MARKETING, BRANDING, AND MARKET TRENDS VIA E-MAIL (U.S. CLS. 100, 101 AND 107).

FIRST USE 4-30-2005; IN COMMERCE 4-30-2005.

CLASS 42—SCIENTIFIC, COMPUTER AND LEGAL SERVICES

FOR PRODUCT DEVELOPMENT CONSULTATION; RESEARCH AND DEVELOPMENT FOR NEW PRODUCTS FOR OTHERS (U.S. CLS. 100 AND 101).

FIRST USE 4-30-2005; IN COMMERCE 4-30-2005.

GINA FINK, EXAMINING ATTORNEY

SN 77-087,098. BUTLER, SHINE, STERN & PARTNERS, LLC, SAUSALITO, CA. FILED 1-19-2007.

BSSP

THE MARK CONSISTS OF STANDARD CHARACTERS WITHOUT CLAIM TO ANY PARTICULAR FONT, STYLE, SIZE, OR COLOR.

CLASS 35—ADVERTISING AND BUSINESS

FOR (BASED ON SECTION 1(A)) ADVERTISING AGENCIES; ADVERTISING, MARKETING, AND PROMOTION SERVICES AND RELATED CONSULTING; PREPARING ADVERTISEMENTS AND MARKETING MATERIALS FOR OTHERS; PREPARATION AND REALIZATION OF MEDIA AND ADVERTISING PLANS AND CONCEPTS; DISSEMINATION OF ADVERTISING FOR OTHERS VIA AN ONLINE COMMUNICATIONS NETWORK ON THE INTERNET; MARKET AND MEDIA RESEARCH SERVICES; DIRECT MAIL CONSULTING SERVICES; DEVELOPMENT OF MARKETING STRATEGIES AND CONCEPTS; PROVIDING INFORMATION IN THE FIELDS OF ADVERTISING, MARKETING, BRANDING, AND MARKET TRENDS; BUSINESS CONSULTATION REGARDING LAUNCHING OF NEW PRODUCTS; (BASED ON SECTION 1(B)) POST-PRODUCTION EDITING SERVICES FOR VIDEO AND AUDIO COMMERCIALS AND MARKETING MATERIALS; PRODUCTION AND DISTRIBUTION OF AUDIO AND VIDEO COMMERCIALS AND MARKETING MATERIALS; PREPARING AUDIO-VISUAL PRESENTATIONS FOR USE IN ADVERTISING AND MARKETING (U.S. CLS. 100, 101 AND 102).

FIRST USE 4-30-2005; IN COMMERCE 4-30-2005.

CLASS 41—EDUCATION AND ENTERTAINMENT

FOR (BASED ON SECTION 1(A)) PROVIDING ONLINE PUBLICATIONS IN THE NATURE OF NEWSLETTERS AND ONLINE JOURNALS, NAMELY, BLOGS IN THE FIELDS OF ADVERTISING, MARKETING, BRANDING, AND MARKET TRENDS; PROVIDING NEWSLETTERS IN THE FIELDS OF ADVERTISING, MARKETING, BRANDING, AND MARKET TRENDS VIA E-MAIL; (BASED ON SECTION 1(B)) VIDEO EDITING; PRODUCTION OF VIDEO AND CREATION OF VISUAL EFFECTS FOR OTHERS FOR USE IN DVDS, DOWNLOADABLE CONTENT FOR PORTABLE MEDIA PLAYERS, TELEVISION PROGRAMS, FILMS, AND ON WEBSITES; PRODUCTION OF VIDEO DISCS FOR OTHERS; AUDIO AND VIDEOTAPE, VIDEO DISC, AND DIGITAL VIDEO RECORDING AND PRODUCTION (U.S. CLS. 100, 101 AND 107).

FIRST USE 4-30-2005; IN COMMERCE 4-30-2005.

CLASS 42—SCIENTIFIC, COMPUTER AND LEGAL SERVICES

FOR PRODUCT DEVELOPMENT CONSULTATION; RESEARCH AND DEVELOPMENT FOR NEW PRODUCTS FOR OTHERS; COMMERCIAL ART DESIGN; GRAPHIC DESIGN SERVICES; DESIGNING WEBSITES FOR ADVERTISING PURPOSES (U.S. CLS. 100 AND 101).

FIRST USE 4-30-2005; IN COMMERCE 4-30-2005.
GINA FINK, EXAMINING ATTORNEY

SN 77-087,124. BUTLER, SHINE, STERN & PARTNERS, LLC, SAUSALITO, CA. FILED 1-19-2007.

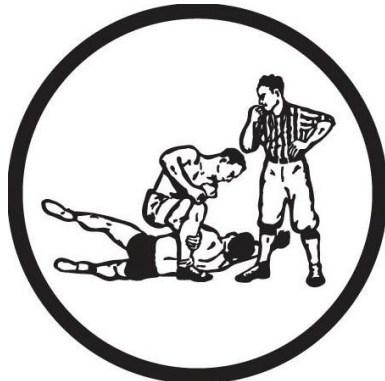

THE MARK CONSISTS OF THE IMAGE OF TWO WRESTLERS AND A REFEREE IN A CIRCLE.

CLASS 35—ADVERTISING AND BUSINESS

FOR (BASED ON SECTION 1(A)) ADVERTISING AGENCIES; ADVERTISING, MARKETING, AND PROMOTION SERVICES AND RELATED CONSULTING; PREPARING ADVERTISEMENTS AND MARKETING MATERIALS FOR OTHERS; PREPARATION AND REALIZATION OF MEDIA AND ADVERTISING PLANS AND CONCEPTS; DISSEMINATION OF ADVERTISING FOR OTHERS VIA AN ONLINE COMMUNICATIONS NETWORK ON THE INTERNET; MARKET AND MEDIA RESEARCH SERVICES; DIRECT MAIL CONSULTING SERVICES; DEVELOPMENT OF MARKETING STRATEGIES AND CONCEPTS; PROVIDING INFORMATION IN THE FIELDS OF ADVERTISING, MARKETING, BRANDING, AND MARKET TRENDS; BUSINESS CONSULTATION REGARDING LAUNCHING OF NEW PRODUCTS; (BASED ON SECTION 1(B)) POST-PRODUCTION EDITING SERVICES FOR VIDEO AND AUDIO COMMERCIALS AND MARKETING MATERIALS; PRODUCTION AND DISTRIBUTION OF AUDIO AND VIDEO COMMERCIALS AND MARKETING MATERIALS; PREPARING AUDIO-VISUAL PRESENTATIONS FOR USE IN ADVERTISING AND MARKETING (U.S. CLS. 100, 101 AND 102).

FIRST USE 4-30-2005; IN COMMERCE 4-30-2005.

CLASS 41—EDUCATION AND ENTERTAINMENT

FOR (BASED ON SECTION 1(A)) PROVIDING ONLINE PUBLICATIONS IN THE NATURE OF NEWSLETTERS AND ONLINE JOURNALS, NAMELY, BLOGS IN THE FIELDS OF ADVERTISING, MARKETING, BRANDING, AND MARKET TRENDS; PROVIDING NEWSLETTERS IN THE FIELDS OF ADVERTISING, MARKETING, BRANDING, AND MARKET TRENDS VIA E-MAIL; (BASED ON SECTION 1(B)) VIDEO EDITING; PRODUCTION OF VIDEO AND CREATION OF VISUAL EFFECTS FOR OTHERS FOR USE IN DVDS, DOWNLOADABLE CONTENT FOR PORTABLE MEDIA PLAYERS, TELEVISION PROGRAMS, FILMS, AND ON WEBSITES; PRODUCTION OF VIDEO DISCS FOR OTHERS; AUDIO AND VIDEOTAPE, VIDEO DISC, AND DIGITAL VIDEO RECORDING AND PRODUCTION (U.S. CLS. 100, 101 AND 107).

FIRST USE 4-30-2005; IN COMMERCE 4-30-2005.

CLASS 42—SCIENTIFIC, COMPUTER AND LEGAL SERVICES

FOR PRODUCT DEVELOPMENT CONSULTATION; RESEARCH AND DEVELOPMENT FOR NEW PRODUCTS FOR OTHERS; COMMERCIAL ART DESIGN; GRAPHIC DESIGN SERVICES; DESIGNING WEBSITES FOR ADVERTISING PURPOSES (U.S. CLS. 100 AND 101).

FIRST USE 4-30-2005; IN COMMERCE 4-30-2005.
GINA FINK, EXAMINING ATTORNEY

SN 77-087,144. BUTLER, SHINE, STERN & PARTNERS, LLC,
SAUSALITO, CA. FILED 1-19-2007.

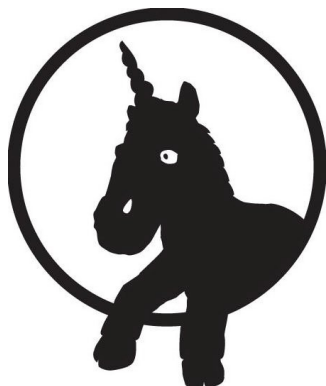

THE MARK CONSISTS OF THE IMAGE OF A UNICORN
IN A CIRCLE.

CLASS 35—ADVERTISING AND BUSINESS

FOR ADVERTISING AGENCIES; ADVERTISING, MARKETING, AND PROMOTION SERVICES AND RELATED CONSULTING; PREPARING ADVERTISEMENTS FOR OTHERS; PREPARATION AND REALIZATION OF MEDIA AND ADVERTISING PLANS AND CONCEPTS; DEVELOPMENT OF MARKETING STRATEGIES AND CONCEPTS; MARKET AND MEDIA RESEARCH SERVICES; PROVIDING INFORMATION IN THE FIELDS OF ADVERTISING, MARKETING, BRANDING, AND MARKET TRENDS; BUSINESS CONSULTATION REGARDING LAUNCHING OF NEW PRODUCTS (U.S. CLS. 100, 101 AND 102).

FIRST USE 4-30-2005; IN COMMERCE 4-30-2005.

CLASS 41—EDUCATION AND ENTERTAINMENT

FOR PROVIDING ONLINE PUBLICATIONS IN THE NATURE OF NEWSLETTERS AND ONLINE JOURNALS, NAMELY, BLOGS IN THE FIELDS OF ADVERTISING, MARKETING, BRANDING, AND MARKET TRENDS; PROVIDING NEWSLETTERS IN THE FIELDS OF ADVERTISING, MARKETING, BRANDING, AND MARKET TRENDS VIA E-MAIL (U.S. CLS. 100, 101 AND 107).

FIRST USE 4-30-2005; IN COMMERCE 4-30-2005.

CLASS 42—SCIENTIFIC, COMPUTER AND LEGAL SERVICES

FOR PRODUCT DEVELOPMENT CONSULTATION; RESEARCH AND DEVELOPMENT FOR NEW PRODUCTS FOR OTHERS (U.S. CLS. 100 AND 101).

FIRST USE 4-30-2005; IN COMMERCE 4-30-2005.

GINA FINK, EXAMINING ATTORNEY

SN 77-087,148. BUTLER, SHINE, STERN & PARTNERS, LLC,
SAUSALITO, CA. FILED 1-19-2007.

CLEAVER

THE MARK CONSISTS OF STANDARD CHARACTERS WITHOUT CLAIM TO ANY PARTICULAR FONT, STYLE, SIZE, OR COLOR.

CLASS 35—ADVERTISING AND BUSINESS

FOR ADVERTISING AGENCIES; ADVERTISING, MARKETING, AND PROMOTION SERVICES; PREPARING ADVERTISEMENTS FOR OTHERS; PREPARATION AND REALIZATION OF MEDIA AND ADVERTISING PLANS AND CONCEPTS; POST-PRODUCTION EDITING SERVICES FOR VIDEO AND AUDIO COMMERCIALS AND MARKETING MATERIALS; PRODUCTION AND DISTRIBUTION OF AUDIO AND VIDEO COMMERCIALS AND MARKETING MATERIALS; PREPARING AUDIO-VISUAL PRESENTATIONS FOR USE IN ADVERTISING AND MARKETING (U.S. CLS. 100, 101 AND 102).

CLASS 41—EDUCATION AND ENTERTAINMENT

FOR VIDEO EDITING; PRODUCTION OF VIDEO AND CREATION OF VISUAL EFFECTS FOR OTHERS FOR USE IN DVDS, DOWNLOADABLE CONTENT FOR PORTABLE MEDIA PLAYERS, TELEVISION PROGRAMS, FILMS, AND ON WEBSITES; PRODUCTION OF VIDEO DISCS FOR OTHERS; AUDIO AND VIDEO-TAPE, VIDEO DISC, AND DIGITAL VIDEO RECORDING AND PRODUCTION (U.S. CLS. 100, 101 AND 107).

GINA FINK, EXAMINING ATTORNEY

SN 77-087,645. KELLER COLLEGE SERVICES, LLC, CO-
LUMBIA, MD. FILED 1-22-2007.



NO CLAIM IS MADE TO THE EXCLUSIVE RIGHT TO USE "COLLEGE SERVICES", APART FROM THE MARK AS SHOWN.

THE COLOR(S) BLACK, ROYAL BLUE AND WHITE IS/ARE CLAIMED AS A FEATURE OF THE MARK.

THE MARK CONSISTS OF A WHITE BOX WITH A ROYAL BLUE BORDER CONTAINING A GRADUATION CAP AND TASSEL IN WHITE WITH BLACK OUTLINING AND A ROYAL BLUE CENTER, HANGING FROM THE TOP LEFT CORNER OF THE LETTERS KCS, APPEARING IN ROYAL BLUE; THE WORDING KELLER COLLEGE SERVICES APPEARS IN WHITE WITHIN A ROYAL BLUE BAND.

CLASS 36—INSURANCE AND FINANCIAL

FOR FINANCIAL SERVICES, NAMELY TUITION-RELATED FINANCIAL AID PLANNING (U.S. CLS. 100, 101 AND 102).

FIRST USE 9-30-2006; IN COMMERCE 10-12-2006.

CLASS 41—EDUCATION AND ENTERTAINMENT

FOR EDUCATIONAL SERVICES, NAMELY CONDUCTING SEMINARS AND WORKSHOPS IN THE FIELD OF SCHOOL PLACEMENT AND FINANCIAL ASSISTANCE; AND PERSONAL SERVICES, NAMELY ONE-ON-ONE COUNSELING IN THE FIELD OF EDUCATIONAL INSTITUTION SELECTION, EDUCATIONAL INSTITUTION APPLICATIONS AND CAREER COUNSELING (U.S. CLS. 100, 101 AND 107).

FIRST USE 9-30-2006; IN COMMERCE 10-12-2006.
JOANNA DUKOVIC, EXAMINING ATTORNEY

SN 77-087,716. FOURTH UTILITY, LLC, THE, CHARLOTTE, NC. FILED 1-22-2007.

SN 77-088,080. NATIONAL COUNCIL FOR INTERIOR DESIGN QUALIFICATION, INC., WASHINGTON, DC. FILED 1-22-2007.

WORK BETTER

THE MARK CONSISTS OF STANDARD CHARACTERS WITHOUT CLAIM TO ANY PARTICULAR FONT, STYLE, SIZE, OR COLOR.

NO CLAIM IS MADE TO THE EXCLUSIVE RIGHT TO USE "WORK", APART FROM THE MARK AS SHOWN.



CLASS 35—ADVERTISING AND BUSINESS

FOR RENTAL OF OFFICE MACHINERY AND EQUIPMENT, NAMELY, RENTAL OF COPY MACHINES, RENTAL OF EMPLOYEES, NAMELY, SECRETARIES AND CONCIERGES (U.S. CLS. 100, 101 AND 102).

FIRST USE 6-0-2004; IN COMMERCE 9-0-2006.

CLASS 36—INSURANCE AND FINANCIAL

FOR RENTAL OF OFFICE SPACE, NAMELY, ACCESS TO CONFERENCE ROOMS AND LOBBY RECEPTION (U.S. CLS. 100, 101 AND 102).

FIRST USE 6-0-2004; IN COMMERCE 9-0-2006.

CLASS 41—EDUCATION AND ENTERTAINMENT

FOR SOCIAL CLUB AMENITIES, NAMELY, PROVIDING SPACE AND EQUIPMENT SUCH AS TELEVISIONS AND GAMES FOR SOCIAL GATHERINGS WITHIN THE WORK SPACE (U.S. CLS. 100, 101 AND 107).

FIRST USE 6-0-2004; IN COMMERCE 9-0-2006.

RAY THOMAS, EXAMINING ATTORNEY

SN 77-088,001. HIVE7.COM, INC., SUNNYVALE, CA. FILED 1-22-2007.

WEB WIDE WORLD

THE MARK CONSISTS OF STANDARD CHARACTERS WITHOUT CLAIM TO ANY PARTICULAR FONT, STYLE, SIZE, OR COLOR.

CLASS 35—ADVERTISING AND BUSINESS

FOR ON-LINE RETAIL STORE SERVICES PROVIDING A WIDE VARIETY OF VIRTUAL GOODS AND SERVICES TO BE USED IN A VIRTUAL ENVIRONMENT; PROVIDING ADVERTISING, MARKETING AND PROMOTIONAL SERVICES FOR OTHERS IN A VIRTUAL ENVIRONMENT (U.S. CLS. 100, 101 AND 102).

CLASS 41—EDUCATION AND ENTERTAINMENT

FOR ENTERTAINMENT SERVICES, NAMELY, PROVIDING AN ON-LINE GAME FEATURING A VIRTUAL ENVIRONMENT; AND PROVIDING AN ON-LINE COMPUTER GAME FEATURING GAMING, SKILL-BASED AND CHANCE-BASED GAMES, AND DATING GAMES (U.S. CLS. 100, 101 AND 107).

REBECCA GILBERT, EXAMINING ATTORNEY

CLASS 9—ELECTRICAL AND SCIENTIFIC APPARATUS

FOR DOWNLOADABLE ELECTRONIC NEWSLETTERS IN THE FIELD OF INTERIOR DESIGN (U.S. CLS. 21, 23, 26, 36 AND 38).

FIRST USE 10-31-2006; IN COMMERCE 10-31-2006.

CLASS 16—PAPER GOODS AND PRINTED MATTER

FOR MONOGRAPHS, BROCHURES, STUDY GUIDES, MANUALS, LOG BOOKS, AND RESEARCH REPORTS IN THE FIELD OF INTERIOR DESIGN; BOOKS FEATURING MODEL LEGISLATION IN THE FIELD OF INTERIOR DESIGN; BOOKS FEATURING MODEL REGULATORY BOARD RULES AND REGULATIONS IN THE FIELD OF INTERIOR DESIGN (U.S. CLS. 2, 5, 22, 23, 29, 37, 38 AND 50).

FIRST USE 10-31-2003; IN COMMERCE 10-31-2003.

CLASS 35—ADVERTISING AND BUSINESS

FOR ASSOCIATION SERVICES, NAMELY, PROMOTING THE INTERESTS OF REGULATORY BOARDS AND AGENCIES IN THE FIELD OF INTERIOR DESIGN, AND PROMOTING PUBLIC AWARENESS OF THE NEED TO PROTECT THE PUBLIC HEALTH, WELFARE AND SAFETY AS IT RELATES TO INTERIOR DESIGN; ADMINISTRATION OF LICENSURE AND CERTIFICATION PROGRAMS FOR INTERIOR DESIGN PROFESSIONALS (U.S. CLS. 100, 101 AND 102).

FIRST USE 10-31-2003; IN COMMERCE 10-31-2003.

CLASS 41—EDUCATION AND ENTERTAINMENT

FOR PREPARATION AND ADMINISTRATION OF EXAMINATIONS AND TESTS IN THE FIELD OF INTERIOR DESIGN; CREATION AND ADMINISTRATION OF EDUCATIONAL PROGRAMS TO ASSIST ENTRY-LEVEL INTERIOR DESIGNERS IN OBTAINING AND DOCUMENTING PROFESSIONAL EXPERIENCE (U.S. CLS. 100, 101 AND 107).

FIRST USE 10-31-2003; IN COMMERCE 10-31-2003.

CLASS 42—SCIENTIFIC, COMPUTER AND LEGAL SERVICES

FOR ESTABLISHING AND UPDATING LICENSURE AND CERTIFICATION STANDARDS FOR INTERIOR DESIGN PROFESSIONALS; PROVIDING INFORMATION IN THE FIELD OF INTERIOR DESIGN VIA THE INTERNET (U.S. CLS. 100 AND 101).

FIRST USE 10-31-2003; IN COMMERCE 10-31-2003.

APRIL ROACH, EXAMINING ATTORNEY

SN 77-088,088. NATIONAL COUNCIL FOR INTERIOR DESIGN QUALIFICATION, INC., WASHINGTON, DC. FILED 1-22-2007.

SN 77-088,117. NATIONAL COUNCIL FOR INTERIOR DESIGN QUALIFICATION, INC., WASHINGTON, DC. FILED 1-22-2007.

NCIDQ

THE MARK CONSISTS OF STANDARD CHARACTERS WITHOUT CLAIM TO ANY PARTICULAR FONT, STYLE, SIZE, OR COLOR.

CLASS 9—ELECTRICAL AND SCIENTIFIC APPARATUS

FOR DOWNLOADABLE ELECTRONIC NEWSLETTERS IN THE FIELD OF INTERIOR DESIGN (U.S. CLS. 21, 23, 26, 36 AND 38).
FIRST USE 10-31-2006; IN COMMERCE 10-31-2006.

CLASS 16—PAPER GOODS AND PRINTED MATTER

FOR MONOGRAPHS, BROCHURES, STUDY GUIDES, MANUALS, LOG BOOKS, AND RESEARCH REPORTS IN THE FIELD OF INTERIOR DESIGN; BOOKS FEATURING MODEL LEGISLATION IN THE FIELD OF INTERIOR DESIGN; BOOKS FEATURING MODEL REGULATORY BOARD RULES AND REGULATIONS IN THE FIELD OF INTERIOR DESIGN (U.S. CLS. 2, 5, 22, 23, 29, 37, 38 AND 50).
FIRST USE 4-30-1974; IN COMMERCE 4-30-1974.

CLASS 35—ADVERTISING AND BUSINESS

FOR ASSOCIATION SERVICES, NAMELY, PROMOTING THE INTERESTS OF REGULATORY BOARDS AND AGENCIES IN THE FIELD OF INTERIOR DESIGN, AND PROMOTING PUBLIC AWARENESS OF THE NEED TO PROTECT THE PUBLIC HEALTH, WELFARE AND SAFETY AS IT RELATES TO INTERIOR DESIGN; ADMINISTRATION OF LICENSURE AND CERTIFICATION PROGRAMS FOR INTERIOR DESIGN PROFESSIONALS (U.S. CLS. 100, 101 AND 102).
FIRST USE 4-30-1974; IN COMMERCE 4-30-1974.

CLASS 41—EDUCATION AND ENTERTAINMENT

FOR PREPARATION AND ADMINISTRATION OF EXAMINATIONS AND TESTS IN THE FIELD OF INTERIOR DESIGN; CREATION AND ADMINISTRATION OF EDUCATIONAL PROGRAMS TO ASSIST ENTRY-LEVEL INTERIOR DESIGNERS IN OBTAINING AND DOCUMENTING PROFESSIONAL EXPERIENCE (U.S. CLS. 100, 101 AND 107).
FIRST USE 4-30-1974; IN COMMERCE 4-30-1974.

CLASS 42—SCIENTIFIC, COMPUTER AND LEGAL SERVICES

FOR ESTABLISHING AND UPDATING LICENSURE AND CERTIFICATION STANDARDS FOR INTERIOR DESIGN PROFESSIONALS; PROVIDING INFORMATION IN THE FIELD OF INTERIOR DESIGN VIA THE INTERNET (U.S. CLS. 100 AND 101).
FIRST USE 4-30-1974; IN COMMERCE 4-30-1974.
APRIL ROACH, EXAMINING ATTORNEY

THE MARK OF A PROFESSIONAL

THE MARK CONSISTS OF STANDARD CHARACTERS WITHOUT CLAIM TO ANY PARTICULAR FONT, STYLE, SIZE, OR COLOR.

CLASS 35—ADVERTISING AND BUSINESS

FOR ASSOCIATION SERVICES, NAMELY, PROMOTING THE INTERESTS OF REGULATORY BOARDS AND AGENCIES IN THE FIELD OF INTERIOR DESIGN, AND PROMOTING PUBLIC AWARENESS OF THE NEED TO PROTECT THE PUBLIC HEALTH, WELFARE AND SAFETY AS IT RELATES TO INTERIOR DESIGN; ADMINISTRATION OF LICENSURE AND CERTIFICATION PROGRAMS FOR INTERIOR DESIGN PROFESSIONALS (U.S. CLS. 100, 101 AND 102).
FIRST USE 8-31-2004; IN COMMERCE 8-31-2004.

CLASS 41—EDUCATION AND ENTERTAINMENT

FOR PREPARATION AND ADMINISTRATION OF EXAMINATIONS AND TESTS IN THE FIELD OF INTERIOR DESIGN; CREATION AND ADMINISTRATION OF EDUCATIONAL PROGRAMS TO ASSIST ENTRY-LEVEL INTERIOR DESIGNERS IN OBTAINING AND DOCUMENTING PROFESSIONAL EXPERIENCE (U.S. CLS. 100, 101 AND 107).
FIRST USE 8-31-2004; IN COMMERCE 8-31-2004.

CLASS 42—SCIENTIFIC, COMPUTER AND LEGAL SERVICES

FOR ESTABLISHING AND UPDATING LICENSURE AND CERTIFICATION STANDARDS FOR INTERIOR DESIGN PROFESSIONALS; PROVIDING INFORMATION IN THE FIELD OF INTERIOR DESIGN VIA THE INTERNET (U.S. CLS. 100 AND 101).
FIRST USE 8-31-2004; IN COMMERCE 8-31-2004.
APRIL ROACH, EXAMINING ATTORNEY

SN 77-088,341. SOUTH CONE, INC., CARLSBAD, CA. FILED 1-22-2007.

The logo features the word "reef" in a light green, rounded font above the word "redemption" in a darker green, rounded font. A blue vertical line is positioned to the right of the "o" in "redemption", and a blue horizontal line is positioned above the "o".

OWNER OF U.S. REG. NOS. 1,693,142, 2,354,028 AND OTHERS.

THE COLOR(S) GREEN AND BLUE IS/ARE CLAIMED AS A FEATURE OF THE MARK.

THE MARK CONSISTS OF A FANCIFUL RENDITION OF THE LITERAL ELEMENT WITH A CROSS APPEARING WITHIN THE LETTER "O". THE WORDING REEF REDEMPTION IS WRITTEN IN THE COLOR GREEN; THE LETTER "O" IN REDEMPTION CONTAINS A CROSS CONSISTING OF A BLUE VERTICAL LINE AND A GREEN HORIZONTAL LINE.

CLASS 25—CLOTHING

FOR BATHING SUITS; BIKINIS; BLOUSES; BOARD-SHORTS; BOXER SHORTS; FLEECE SHORTS; FOOTWEAR; HEADWEAR; JACKETS; JEANS; MUSCLE TOPS; PANTS; SANDALS; SARONGS; SHIRTS; SHOES; SHORTS; SKIRTS; SWIM TRUNKS; SWIM WEAR; T-SHIRTS; WALKING SHORTS (U.S. CLS. 22 AND 39).

CLASS 36—INSURANCE AND FINANCIAL

FOR CHARITABLE FUND RAISING (U.S. CLS. 100, 101 AND 102).
RICHARD WHITE, EXAMINING ATTORNEY

SN 77-089.306. CARLSON HOSPITALITY GROUP, INC.,
MINNEAPOLIS, MN. FILED 1-23-2007.

LARIMAR SPA

THE MARK CONSISTS OF STANDARD CHARACTERS WITHOUT CLAIM TO ANY PARTICULAR FONT, STYLE, SIZE, OR COLOR.

NO CLAIM IS MADE TO THE EXCLUSIVE RIGHT TO USE "SPA", APART FROM THE MARK AS SHOWN.

CLASS 3—COSMETICS AND CLEANING PREPARATIONS

FOR COSMETICS AND TOILET PREPARATIONS FOR BODY CARE, BODY SOAPS, HAIR CARE PREPARATIONS, NON-MEDICATED SKIN CARE PREPARATIONS, COLOGNES AND PERFUMES, AFTER SHAVE LOTION, BATH OIL, MOUTHWASH, TOOTHPASTE AND DEODORANTS (U.S. CLS. 1, 4, 6, 50, 51 AND 52).

CLASS 35—ADVERTISING AND BUSINESS

FOR RETAIL GIFT SHOP SERVICES FEATURING COSMETICS AND TOILET PREPARATIONS, FLOWERS AND OTHER GIFTS (U.S. CLS. 100, 101 AND 102).

CLASS 44—MEDICAL, BEAUTY AND AGRICULTURAL SERVICES

FOR HEALTH SPA SERVICES, NAMELY, COSMETIC BODY CARE SERVICES; HEALTH SPA SERVICES FEATURING MASSAGES, FACIALS, BODY TREATMENTS, MANICURES, PEDICURES, NAIL CARE, HAIR STYLING; HEALTH SPA SERVICES FOR HEALTH AND WELLNESS OF THE BODY AND SPIRIT OFFERED AT A HEALTH RESORT. (U.S. CLS. 100 AND 101).
BENJAMIN ALLEN, EXAMINING ATTORNEY

SN 77-089.310. CARLSON HOSPITALITY GROUP, INC.,
MINNEAPOLIS, MN. FILED 1-23-2007.

LARIMAR

THE MARK CONSISTS OF STANDARD CHARACTERS WITHOUT CLAIM TO ANY PARTICULAR FONT, STYLE, SIZE, OR COLOR.

CLASS 3—COSMETICS AND CLEANING PREPARATIONS

FOR COSMETICS AND TOILET PREPARATIONS FOR BODY CARE, BODY SOAPS, HAIR CARE PREPARATIONS, NON-MEDICATED SKIN CARE PREPARATIONS, COLOGNES AND PERFUMES, AFTER SHAVE LOTION, BATH OIL, MOUTHWASH, TOOTHPASTE AND DEODORANTS (U.S. CLS. 1, 4, 6, 50, 51 AND 52).

CLASS 35—ADVERTISING AND BUSINESS

FOR RETAIL GIFT SHOP SERVICES FEATURING COSMETICS AND TOILET PREPARATIONS, FLOWERS AND OTHER GIFTS (U.S. CLS. 100, 101 AND 102).

CLASS 44—MEDICAL, BEAUTY AND AGRICULTURAL SERVICES

FOR HEALTH SPA SERVICES, NAMELY, COSMETIC BODY CARE SERVICES; HEALTH SPA SERVICES FEATURING MASSAGES, FACIALS, BODY TREATMENTS, MANICURES, PEDICURES, NAIL CARE, HAIR STYLING; HEALTH SPA SERVICES FOR HEALTH AND WELLNESS OF THE BODY AND SPIRIT OFFERED AT A HEALTH RESORT. (U.S. CLS. 100 AND 101).
BENJAMIN ALLEN, EXAMINING ATTORNEY

SN 77-090.021. COMPONENT HARDWARE GROUP, INC.,
LAKEWOOD, NJ. FILED 1-24-2007.

CHG

THE MARK CONSISTS OF STANDARD CHARACTERS WITHOUT CLAIM TO ANY PARTICULAR FONT, STYLE, SIZE, OR COLOR.

CLASS 6—METAL GOODS

FOR HARDWARE, NAMELY METAL CASTERS, METAL SHELF BRACKETS AND METAL CLAMPS FOR GLASS (U.S. CLS. 2, 12, 13, 14, 23, 25 AND 50).
FIRST USE 10-1-1992; IN COMMERCE 10-1-1992.

CLASS 11—ENVIRONMENTAL CONTROL APPARATUS

FOR PLUMBING FIXTURES, NAMELY FAUCETS (U.S. CLS. 13, 21, 23, 31 AND 34).
FIRST USE 1-31-1996; IN COMMERCE 1-31-1996.

CLASS 20—FURNITURE AND ARTICLES NOT OTHERWISE CLASSIFIED

FOR HARDWARE, NAMELY PLASTIC CASTERS (U.S. CLS. 2, 13, 22, 25, 32 AND 50).
FIRST USE 1-1-2000; IN COMMERCE 1-1-2000.
AISHA SALEM, EXAMINING ATTORNEY

SN 77-090,156. ROHM AND HAAS COMPANY, PHILADELPHIA, PA. FILED 1-24-2007.

SN 77-090,646. NURI ENTERPRISES, KARACHI, PAKISTAN, FILED 1-25-2007.

SILVADUR

THE MARK CONSISTS OF STANDARD CHARACTERS WITHOUT CLAIM TO ANY PARTICULAR FONT, STYLE, SIZE, OR COLOR.

CLASS 1—CHEMICALS

FOR CHEMICALS FOR USE IN THE MANUFACTURE OF BIOCIDES, GERMICIDES AND FUNGICIDES (U.S. CLS. 1, 5, 6, 10, 26 AND 46).

CLASS 3—COSMETICS AND CLEANING PREPARATIONS

FOR ALL PURPOSE CLEANING PREPARATIONS; CLEANING, POLISHING, SCOURING AND ABRASIVE PREPARATIONS FOR HOUSEHOLD, COMMERCIAL, INDUSTRIAL AND INSTITUTIONAL USE; DETERGENTS, NAMELY, DETERGENT SOAP, DISH DETERGENT AND LAUNDRY DETERGENTS; ADDITIVE FOR FRESHENING LAUNDRY; BLEACHING PREPARATIONS FOR HOUSEHOLD, COMMERCIAL, INDUSTRIAL AND INSTITUTIONAL USE; FLOOR CLEANERS; CLEANERS FOR CARPET, FABRIC AND UPHOLSTERY; CLEANING PREPARATIONS FOR CLEANING HARD AND SOFT SURFACES; ABRASIVE CLOTHS, CLEANING WIPES, SPONGES, CLOTHS AND PADS IMPREGNATED WITH NON-DISINFECTANT CHEMICALS FOR HOUSEHOLD, COMMERCIAL, INDUSTRIAL AND INSTITUTIONAL USE (U.S. CLS. 1, 4, 6, 50, 51 AND 52).

CLASS 5—PHARMACEUTICALS

FOR BIOCIDES, GERMICIDES AND FUNGICIDES; ALL PURPOSE DISINFECTING PREPARATIONS; DISINFECTANT AND SANITIZING SPRAY; DISINFECTANT AND SANITIZING PREPARATIONS FOR HOUSEHOLD, COMMERCIAL, INDUSTRIAL AND INSTITUTIONAL USE; SURFACE DISINFECTANT AND SANITIZER; DEODORIZERS AND SANITIZERS FOR BATHROOMS AND TOILETS; ROOM DEODORIZERS; ODOR NEUTRALIZING PREPARATIONS FOR USE ON HARD AND SOFT SURFACES, CARPETS, FABRICS AND UPHOLSTERIES; FRESHENERS AND DEODORIZERS FOR CARPETS, FABRICS AND UPHOLSTERY; AIR FRESHENERS; CLEANING WIPES, SPONGES, MOPS, CLOTHS AND PADS IMPREGNATED WITH DISINFECTING CHEMICALS FOR HOUSEHOLD, COMMERCIAL, INDUSTRIAL AND INSTITUTIONAL USE; ADHESIVE BANDAGES; BANDAGES FOR SKIN WOUNDS AND DRESSINGS; FOOTWEAR DEODORIZERS (U.S. CLS. 6, 18, 44, 46, 51 AND 52).

SHANNON TWOHIG, EXAMINING ATTORNEY

NURI

THE MARK CONSISTS OF STANDARD CHARACTERS WITHOUT CLAIM TO ANY PARTICULAR FONT, STYLE, SIZE, OR COLOR.

THE ENGLISH TRANSLATION OF NURI IS FIRE, LIGHT, FLAMING LIGHT.

CLASS 24—FABRICS

FOR CHILDREN'S TOWELS; TERRY TOWELS; TEXTILE FABRICS FOR HOME AND COMMERCIAL INTERIORS; TOWEL SETS (U.S. CLS. 42 AND 50).

CLASS 25—CLOTHING

FOR BODY SUITS; BOXER SHORTS; CHILDREN'S AND INFANTS' CLOTH BIBS; COATS OF DENIM; DENIM JACKETS; DENIMS; DRESS SHIRTS; GOLF SHIRTS; KNIT SHIRTS; MEN AND WOMEN JACKETS, COATS, TROUSERS, VESTS; OPEN-NECKED SHIRTS; PIQUE SHIRTS; POLO SHIRTS; SHIRTS; SHORT-SLEEVED OR LONG-SLEEVED T-SHIRTS; SHORT-SLEEVED SHIRTS; SHORTS; SLEEPING GARMENTS; UNDER GARMENTS (U.S. CLS. 22 AND 39).

ALYSSA PALADINO, EXAMINING ATTORNEY

SN 77-091,071. CAPZLES, INC., CULVER CITY, CA. FILED 1-25-2007.

CAPZLES

THE MARK CONSISTS OF STANDARD CHARACTERS WITHOUT CLAIM TO ANY PARTICULAR FONT, STYLE, SIZE, OR COLOR.

CLASS 9—ELECTRICAL AND SCIENTIFIC APPARATUS

FOR DOWNLOADABLE SOFTWARE TO ENABLE UPLOADING, POSTING, SHOWING, DISPLAYING, TAGGING, BLOGGING, SHARING OR OTHERWISE PRESENTING ELECTRONIC MEDIA OR INFORMATION OVER THE INTERNET OR OTHER COMMUNICATIONS NETWORK; DOWNLOADABLE COMPUTER SOFTWARE FOR USE IN DATABASE MANAGEMENT; DOWNLOADABLE COMPUTER SOFTWARE FOR UPLOADING, MANIPULATING, AND ENHANCING DIGITAL CONTENT, DOCUMENTS, PHOTOGRAPHS, IMAGES, VIDEO, AND AUDIO; DOWNLOADABLE COMPUTER SOFTWARE FOR LINKING METADATA TAGS WITH PHOTOGRAPHIC AND OTHER MEDIA FILES TO ENABLE SEARCH ENGINE RETRIEVAL AND DATABASE SOFTWARE COLLECTIONS OF FILES AND THEIR ON-LINE SHARING, AND FOR LINKING METADATA TAGS WITH WEB PAGES VISITED, TO CREATE LINKS WHICH USERS CAN MAINTAIN FOR THEMSELVES AND SHARE WITH ON-LINE GROUPS AND WEBSITE TAGGING; DOWNLOADABLE COMPUTER SOFTWARE DEVELOPMENT TOOLS FOR CREATION OF SOCIAL COMMUNITY, SOCIAL NETWORKING, BUILDING SOCIAL NETWORKING APPLICATIONS AND FOR ALLOWING DATA RETRIEVAL, UPLOAD, ACCESS AND MANAGEMENT; APPLICATION PROGRAMMING INTERFACE (API) FOR USE WITH THIRD-PARTY SOFTWARE AND FOR USE WITH ONLINE SERVICES FOR SOCIAL NETWORKING, BUILDING SOCIAL NETWORKING APPLICATIONS AND FOR ALLOWING DATA RETRIEVAL, UPLOAD, ACCESS AND MANAGEMENT (U.S. CLS. 21, 23, 26, 36 AND 38).

FIRST USE 1-17-2006; IN COMMERCE 2-17-2006.

CLASS 35—ADVERTISING AND BUSINESS

FOR ADVERTISING AND ADVERTISEMENT, PROMOTION AND MARKETING SERVICES FOR THIRD PARTIES THAT PROVIDE ELECTRONIC MEDIA OR INFORMATION OVER THE INTERNET AND OTHER COMMUNICATIONS NETWORKS; ADVERTISING SERVICES, NAMELY, PROVIDING CLASSIFIED ADVERTISING SPACE ON A GLOBAL COMPUTER NETWORK; PROMOTING THE GOODS AND SERVICES OF OTHERS VIA THE INTERNET; PROVIDING ON-LINE COMPUTER DATABASES AND ON-LINE SEARCHABLE DATABASES FEATURING CLASSIFIED LISTINGS AND WANT ADS (U.S. CLS. 100, 101 AND 102).

FIRST USE 1-17-2006; IN COMMERCE 2-17-2006.

CLASS 45—PERSONAL SERVICES

FOR ONLINE SOCIAL NETWORKING SERVICES (U.S. CLS. 100 AND 101).

FIRST USE 1-17-2006; IN COMMERCE 2-17-2006.
LYDIA BELZER, EXAMINING ATTORNEY

SN 77-093,694. SUSAN M. KANTOR, MINNEAPOLIS, MN. FILED 1-29-2007.

ARISTOCRITIC

THE MARK CONSISTS OF STANDARD CHARACTERS WITHOUT CLAIM TO ANY PARTICULAR FONT, STYLE, SIZE, OR COLOR.

CLASS 16—PAPER GOODS AND PRINTED MATTER

FOR PRINTED COLUMNS ON THE SUBJECT OF CELEBRITIES, FAMOUS PEOPLE AND ROYALTY. (U.S. CLS. 2, 5, 22, 23, 29, 37, 38 AND 50).

CLASS 41—EDUCATION AND ENTERTAINMENT

FOR PROVIDING A WEBSITE FEATURING NEWS REPORTS AND INFORMATION ABOUT CELEBRITIES, FAMOUS PEOPLE, AND ROYALTY; AND PROVIDING NON-DOWNLOADABLE ON-LINE JOURNALS FEATURING NEWS, AND INFORMATION ABOUT CELEBRITIES, FAMOUS PEOPLE, AND ROYALTY. (U.S. CLS. 100, 101 AND 107).

DAVID C. REIHNER, EXAMINING ATTORNEY

SN 77-094,783. MUELLER & CO., LLP, ELGIN, IL. FILED 1-30-2007.

ProfitMax

THE MARK CONSISTS OF STANDARD CHARACTERS WITHOUT CLAIM TO ANY PARTICULAR FONT, STYLE, SIZE, OR COLOR.

CLASS 35—ADVERTISING AND BUSINESS

FOR ACCOUNT AUDITING; ACCOUNTING CONSULTATION; ACCOUNTING SERVICES; ASSISTANCE, ADVISORY SERVICES AND CONSULTANCY WITH REGARD TO BUSINESS PLANNING, BUSINESS ANALYSIS, BUSINESS MANAGEMENT, AND BUSINESS ORGANIZATION; BUSINESS MANAGEMENT CONSULTANCY AND ADVISORY SERVICES; BUSINESS MANAGEMENT PLANNING; PROFESSIONAL BUSINESS CONSULTATION; TAX AND TAXATION PLANNING, ADVICE, INFORMATION AND CONSULTANCY SERVICES; TAX PREPARATION (U.S. CLS. 100, 101 AND 102).

FIRST USE 11-1-2005; IN COMMERCE 11-1-2005.

CLASS 36—INSURANCE AND FINANCIAL

FOR FINANCIAL CONSULTATION; FINANCIAL FORECASTING (U.S. CLS. 100, 101 AND 102).

FIRST USE 11-1-2005; IN COMMERCE 11-1-2005.
MARY CRAWFORD, EXAMINING ATTORNEY

SN 77-095,787. STEWART SURFBOARDS, INC., SAN CLEMENTE, CA. FILED 1-31-2007.



OWNER OF U.S. REG. NO. 2,081,779.

CLASS 25—CLOTHING

FOR CLOTHING; NAMELY, SHIRTS, T-SHIRTS, TANK TOPS, SWEATERS, SWEATSHIRTS, VESTS, JACKETS, COATS, PANTS, SHORTS, BOXER SHORTS, SWEATPANTS, SWIMWEAR, BOARD SHORTS; HEADWEAR, NAMELY, HATS, CAPS AND VISORS AND HEAD BANDS; AND FOOTWEAR, NAMELY, BEACH FOOTWEAR (U.S. CLS. 22 AND 39).

FIRST USE 7-1-1985; IN COMMERCE 7-1-1985.

CLASS 28—TOYS AND SPORTING GOODS

FOR SURFBOARDS, SURFBOARD LEASHES, SNOWBOARDS, BODYBOARDS, SKATEBOARDS, WAKEBOARDS, AND BAGS ESPECIALLY DESIGNED FOR SURFBOARDS (U.S. CLS. 22, 23, 38 AND 50).

FIRST USE 1-15-1978; IN COMMERCE 1-15-1980.
WON TEAK OH, EXAMINING ATTORNEY

SN 77-099,156. NIGHT OWL BABY INC, INDIANAPOLIS, IN.
FILED 2-5-2007.



NO CLAIM IS MADE TO THE EXCLUSIVE RIGHT TO USE "BABY", APART FROM THE MARK AS SHOWN.

THE MARK CONSISTS OF AN OWL PERCHED ON A LINE. JUST UNDER THE PERCH, THE WORDS NIGHT OWL BABY ARE CENTERED. THE OWL HAS A SMALL HEART ON THE RIGHT SIDE OF ITS CHEST WHEN LOOKING AT THE MARK.

CLASS 14—JEWELRY

FOR BRACELETS; EARRINGS; NECKLACES; RINGS BEING JEWELRY (U.S. CLS. 2, 27, 28 AND 50).

CLASS 16—PAPER GOODS AND PRINTED MATTER

FOR CARDS, NAMELY, NOTE CARDS, THANK YOU CARDS; INVITATION CARDS; STATIONERY (U.S. CLS. 2, 5, 22, 23, 29, 37, 38 AND 50).

CLASS 25—CLOTHING

FOR HATS; INFANT AND TODDLER ONE PIECE CLOTHING; JACKETS; PANTS; SHIRTS; SHOES; SOCKS; SWEAT SHIRTS; T-SHIRTS (U.S. CLS. 22 AND 39).

ROBIN MITTLER, EXAMINING ATTORNEY

SN 77-099,250. SNOW TIME, INC., YORK, PA. FILED 2-5-2007.

LIBERTY MOUNTAIN RESORT & CONFERENCE CENTER

THE MARK CONSISTS OF STANDARD CHARACTERS WITHOUT CLAIM TO ANY PARTICULAR FONT, STYLE, SIZE, OR COLOR.

NO CLAIM IS MADE TO THE EXCLUSIVE RIGHT TO USE "RESORT & CONFERENCE CENTER", APART FROM THE MARK AS SHOWN.

SEC. 2(F).

CLASS 41—EDUCATION AND ENTERTAINMENT

FOR SKI, SNOW BOARD AND SNOW TUBING REPORTS; SKI AND SNOW BOARD INSTRUCTION; PROVIDING SKI, SNOW BOARD AND SNOW TUBING SLOPES (U.S. CLS. 100, 101 AND 107).

FIRST USE 4-1-2000; IN COMMERCE 4-1-2000.

CLASS 43—HOTEL AND RESTAURANT SERVICES

FOR RESORT LODGING SERVICES; PROVIDING MEETING FACILITIES FOR SOCIAL OR GENERAL PURPOSE (U.S. CLS. 100 AND 101).

FIRST USE 4-1-2000; IN COMMERCE 4-1-2000.

CAROL SPILS, EXAMINING ATTORNEY

SN 77-100,680. KABUSHIKI KAISHA SEGA, DBA SEGA CORPORATION, OHTA-KU, TOKYO, JAPAN, FILED 2-6-2007.

SEGA AMUSEMENT WORKS, LLC.

THE MARK CONSISTS OF STANDARD CHARACTERS WITHOUT CLAIM TO ANY PARTICULAR FONT, STYLE, SIZE, OR COLOR.

OWNER OF U.S. REG. NOS. 1,050,573, 2,315,166 AND OTHERS.

NO CLAIM IS MADE TO THE EXCLUSIVE RIGHT TO USE "AMUSEMENT WORKS, LLC.", APART FROM THE MARK AS SHOWN.

CLASS 28—TOYS AND SPORTING GOODS

FOR ARCADE VIDEO GAME MACHINES; AMUSEMENT GAME MACHINES; ARCADE GAME MACHINES, NAMELY, MEDAL GAME MACHINES, PRIZE-DISPENSING GAME MACHINES AND REDEMPTION GAME MACHINES; STUFFED TOYS; ACTION FIGURES (U.S. CLS. 22, 23, 38 AND 50).

CLASS 35—ADVERTISING AND BUSINESS

FOR BUSINESS MANAGEMENT AND ADMINISTRATION OF AMUSEMENT FACILITIES (U.S. CLS. 100, 101 AND 102).

CLASS 41—EDUCATION AND ENTERTAINMENT

FOR PROVIDING AMUSEMENT FACILITIES; RENTAL OF AMUSEMENT MACHINES AND APPARATUS (U.S. CLS. 100, 101 AND 107).

CLASS 43—HOTEL AND RESTAURANT SERVICES

FOR RESTAURANTS; CAFES (U.S. CLS. 100 AND 101).
MARIAM MAHMOUDI, EXAMINING ATTORNEY

CLASS 25—CLOTHING

FOR HATS AND SCARVES (U.S. CLS. 22 AND 39).
AMY HELLA, EXAMINING ATTORNEY

SN 77-101,004. IRIS GIN, M.D. AND RODNEY GIN, M.D.
MEDICAL CORPORATION, LOS GATOS, CA. FILED 2-6-
2007.

SN 77-105,939. DODGE-REGUPOL DELAWARE, INC., WIL-
MINGTON, DE. FILED 2-13-2007.



THE MARK CONSISTS OF THE WORD "KALIA" IN
STYLIZED LETTERS.

THE FOREIGN WORDING IN THE MARK TRANSLATES
INTO ENGLISH AS BEAUTY.

CLASS 5—PHARMACEUTICALS

FOR MEDICATED SKIN CARE PREPARATIONS (U.S.
CLS. 6, 18, 44, 46, 51 AND 52).

CLASS 44—MEDICAL, BEAUTY AND AGRICULTURAL SERVICES

FOR MEDICAL SERVICES, NAMELY, DERMATOL-
OGY (U.S. CLS. 100 AND 101).
HENRY S. ZAK, EXAMINING ATTORNEY

SN 77-105,016. ELISSA MARGULIES, FORT LAUDERDALE,
FL. AND MICHAEL MARGULIES, FORT LAUDERDALE,
FL. FILED 2-12-2007.



NO CLAIM IS MADE TO THE EXCLUSIVE RIGHT TO
USE "FASHION", APART FROM THE MARK AS SHOWN.
THE MARK CONSISTS OF THE WORDS GLOBAL
GLAMOUR FASHION IN EDWARDIAN SCRIPT.

CLASS 9—ELECTRICAL AND SCIENTIFIC APPARATUS

FOR SUNGLASSES (U.S. CLS. 21, 23, 26, 36 AND 38).

CLASS 14—JEWELRY

FOR JEWELRY (U.S. CLS. 2, 27, 28 AND 50).

CLASS 18—LEATHER GOODS

FOR HANDBAGS (U.S. CLS. 1, 2, 3, 22 AND 41).



THE MARK CONSISTS OF STANDARD CHARACTERS
WITHOUT CLAIM TO ANY PARTICULAR FONT, STYLE,
SIZE, OR COLOR.

OWNER OF U.S. REG. NO. 2,187,158.

CLASS 17—RUBBER GOODS

FOR PACKING MATERIALS OF RUBBER AND PLAS-
TIC FOR SHIPPING CONTAINERS. RUBBER FOR USE
IN THE MANUFACTURE OF SEALS AND GASKETS,
RUBBER SHOCK ABSORBERS FOR INDUSTRIAL MA-
CHINERY (U.S. CLS. 1, 5, 12, 13, 35 AND 50).
FIRST USE 3-3-1989; IN COMMERCE 3-3-1989.

CLASS 19—NON-METALLIC BUILDING MATERIALS

FOR PROTECTIVE ROOFING MEMBRANES (U.S.
CLS. 1, 12, 33 AND 50).
FIRST USE 3-3-1989; IN COMMERCE 3-3-1989.

CLASS 27—FLOOR COVERINGS

FOR RUBBER SHEETS AND TILES FOR RUNNING
TRACK AND MULTIPURPOSE INDOOR AND OUT-
DOOR SPORTING SURFACES, ROOF GARDENS, TER-
RACES, PATIOS, BALCONY SURFACES, PEDESTRIAN
AND ROOFTOP WALKWAYS, FLOORING UNDERLAY-
MENT, AND BUILDING AND CIVIL ENGINEERING
PROTECTIVE AND VIBRATION ABSORPTION SUR-
FACES (U.S. CLS. 19, 20, 37, 42 AND 50).
FIRST USE 3-3-1989; IN COMMERCE 3-3-1989.
FLORENTINA BLANDU, EXAMINING ATTORNEY

SN 77-106,484. INTELLIGENTZ CORPORATION, AUSTIN,
TX. FILED 2-13-2007.



NO CLAIM IS MADE TO THE EXCLUSIVE RIGHT TO
USE "PARTS.COM", APART FROM THE MARK AS
SHOWN.

CLASS 35—ADVERTISING AND BUSINESS

FOR MARKETING SERVICES, NAMELY, PROVIDING INFORMATIONAL WEB PAGES DESIGNED TO GENERATE SALES TRAFFIC VIA HYPERLINKS TO OTHER WEB SITES; PROMOTING THE GOODS AND SERVICES OF OTHERS BY PROVIDING HYPERTEXT LINKS TO THE WEBSITES OF OTHERS; PROVIDING A WEBSITE WHICH FEATURES ADVERTISEMENTS FOR THE GOODS AND SERVICES OF OTHERS ON A GLOBAL COMPUTER NETWORK; PROVIDING ON-LINE DIRECTORY INFORMATION SERVICES ALSO FEATURING HYPERLINKS TO OTHER WEBSITES; ONLINE AUCTION SERVICES (U.S. CLS. 100, 101 AND 102).

FIRST USE 3-30-1999; IN COMMERCE 3-30-1999.

CLASS 42—SCIENTIFIC, COMPUTER AND LEGAL SERVICES

FOR COMPUTER SERVICES, NAMELY, PROVIDING SOFTWARE INTERFACES AVAILABLE OVER A NETWORK IN ORDER TO CREATE A PERSONALIZED ON-LINE INFORMATION SERVICE; EXTRACTION AND RETRIEVAL OF INFORMATION AND DATA MINING BY MEANS OF GLOBAL COMPUTER NETWORKS; CREATING INDEXES OF INFORMATION, INDEXES OF WEB SITES AND INDEXES OF OTHER INFORMATION SOURCES IN CONNECTION WITH GLOBAL COMPUTER NETWORKS (U.S. CLS. 100 AND 101).

FIRST USE 3-30-1999; IN COMMERCE 3-30-1999.
KATHERINE E. HALMEN, EXAMINING ATTORNEY

SN 77-106,723. BANIA, JR., DON, HAMEL, MN. FILED 2-13-2007.

Breaking My Neck Screwed
My Head On Straight!

THE MARK CONSISTS OF STANDARD CHARACTERS WITHOUT CLAIM TO ANY PARTICULAR FONT, STYLE, SIZE, OR COLOR.

CLASS 16—PAPER GOODS AND PRINTED MATTER

FOR (BASED ON INTENT TO USE IN COMMERCE) BOOK COVERS; BUMPER STICKERS (U.S. CLS. 2, 5, 22, 23, 29, 37, 38 AND 50).

CLASS 41—EDUCATION AND ENTERTAINMENT

FOR (BASED ON USE IN COMMERCE) EDUCATIONAL AND ENTERTAINMENT SERVICES IN THE NATURE OF MOTIVATIONAL PUBLIC SPEAKING (U.S. CLS. 100, 101 AND 107).

FIRST USE 3-18-2006; IN COMMERCE 3-18-2006.
LYDIA BELZER, EXAMINING ATTORNEY

SN 77-107,458. SAVVIER, LP, CARLSBAD, CA. FILED 2-14-2007.

BENDER BALL

THE MARK CONSISTS OF STANDARD CHARACTERS WITHOUT CLAIM TO ANY PARTICULAR FONT, STYLE, SIZE, OR COLOR.

NO CLAIM IS MADE TO THE EXCLUSIVE RIGHT TO USE "BALL", APART FROM THE MARK AS SHOWN.

CLASS 9—ELECTRICAL AND SCIENTIFIC APPARATUS

FOR EXERCISE VIDEOS AND DVDS FOR INSTRUCTION IN THE USE OF A FLEXIBLE FITNESS OR EXERCISE BALL (U.S. CLS. 21, 23, 26, 36 AND 38).

FIRST USE 12-11-2006; IN COMMERCE 12-11-2006.

CLASS 28—TOYS AND SPORTING GOODS

FOR A FLEXIBLE FITNESS OR EXERCISE BALL EDUCATIONAL KIT CONSISTING OF A FLEXIBLE FITNESS OR EXERCISE BALL FOR EXERCISING, AN INSTRUCTIONAL PRERECORDED VIDEO TAPE OR DVD, AND/OR A PRINTED INSTRUCTIONAL MANUAL RELATING TO THE FLEXIBLE FITNESS OR EXERCISE BALL (U.S. CLS. 22, 23, 38 AND 50).

FIRST USE 12-11-2006; IN COMMERCE 12-11-2006.

CLASS 41—EDUCATION AND ENTERTAINMENT

FOR TRAINING IN THE USE OF A FLEXIBLE FITNESS OR EXERCISE BALL; PHYSICAL FITNESS INSTRUCTION AND CONSULTATION RELATING TO A FLEXIBLE FITNESS OR EXERCISE BALL; TRAINING AND EDUCATION IN SPECIFIC EXERCISE ROUTINES THAT CONSIST OF AND COMPRISE A SERIES OF EXERCISES THAT INCORPORATE A FLEXIBLE FITNESS OR EXERCISE BALL, AND DISTRIBUTING INSTRUCTIONAL MATERIALS IN CONNECTION THEREWITH (U.S. CLS. 100, 101 AND 107).

FIRST USE 12-11-2006; IN COMMERCE 12-11-2006.
MATTHEW MCDOWELL, EXAMINING ATTORNEY

SN 77-108,338. LEE, ADRIAN, SAN JOSE, CA. FILED 2-15-2007.

REGISTER

THE MARK CONSISTS OF A BACKWARD "R" AND A BACKWARD "S" AND NO "E".

CLASS 16—PAPER GOODS AND PRINTED MATTER

FOR PRINT MEDIA, NAMELY POST CARDS, POSTERS, STATIONERY, STICKERS, PHOTOGRAPHS, UNMOUNTED PHOTOGRAPHS (U.S. CLS. 2, 5, 22, 23, 29, 37, 38 AND 50).

FIRST USE 12-31-2006; IN COMMERCE 12-31-2006.

CLASS 25—CLOTHING

FOR CLOTHING, NAMELY T-SHIRTS, SWEATERS, SWEAT-SHIRTS, SHIRTS, PANTS, JEANS, SKIRTS, VESTS, JACKETS, BELTS, HATS. (U.S. CLS. 22 AND 39).
FIRST USE 12-31-2006; IN COMMERCE 12-31-2006.
BRENDAN REGAN, EXAMINING ATTORNEY

SN 77-109,710. THE MOODSTERS COMPANY, MINNEAPOLIS, MN. FILED 2-16-2007.

THE MOODSTERS GOOD MOOD FOODS

THE MARK CONSISTS OF STANDARD CHARACTERS WITHOUT CLAIM TO ANY PARTICULAR FONT, STYLE, SIZE, OR COLOR.

NO CLAIM IS MADE TO THE EXCLUSIVE RIGHT TO USE "FOODS", APART FROM THE MARK AS SHOWN.

CLASS 5—PHARMACEUTICALS

FOR NUTRITIONAL AND DIETARY SUPPLEMENTS; VITAMIN, MINERAL AND NUTRIENT FORTIFIED DRINKS; VITAMIN, MINERAL AND NUTRIENT FORTIFIED DRINKS MIXES; ADHESIVE BANDAGES; PAIN RELIEF MEDICATION; COUGH SYRUP; COLD REMEDIES, NAMELY, PREPARATIONS FOR TREATING COLDS (U.S. CLS. 6, 18, 44, 46, 51 AND 52).

CLASS 29—MEATS AND PROCESSED FOODS

FOR FOOD PRODUCTS, NAMELY, MILK, MILK PRODUCTS EXCLUDING ICE CREAM, ICE MILK AND FROZEN YOGURT; CHEESE, COTTAGE CHEESE, YOGURT, EGGS, MEAT, FISH AND POULTRY; PROCESSED FRUITS AND PROCESSED VEGETABLES; JELLIES, JAMS, FRUIT SAUCES, NAMELY, CRANBERRY SAUCE AND APPLESAUCE; EDIBLE OILS AND FATS; NUTRITION BAR, NAMELY, PROTEIN BASED NUTRIENT-DENSE SNACK BARS; PACKAGED MEALS CONSISTING PRIMARILY OF MEAT, FISH, POULTRY OR VEGETABLES; FROZEN MEALS CONSISTING PRIMARILY OF MEAT, FISH, POULTRY OR VEGETABLE; SOUP, SOUP MIXES; FRUIT BASED SNACK FOODS, POTATO BASED SNACK FOODS, SOY BASED SNACK FOODS AND VEGETABLE BASED SNACK FOODS (U.S. CL. 46).

CLASS 30—STAPLE FOODS

FOR FOOD PRODUCTS, NAMELY, TEA, COCOA, COFFEE, PROCESSED CEREAL AND BREAKFAST CEREAL; NUTRITION BARS, NAMELY, READY TO EAT CEREAL DERIVED FOOD BARS; BREADS, CRACKERS, PASTRIES; PACKAGED MEALS CONSISTING PRIMARILY OF RICE OR PASTA; FROZEN MEALS CONSISTING PRIMARILY OF RICE OR PASTA; MIXES FOR MAKING BAKERY GOODS; CEREAL BASED SNACK FOODS, CORN BASED SNACK FOODS, RICE BASED SNACK FOODS; WHEAT BASED SNACK FOOD; FRUIT SAUCES EXCLUDING CRANBERRY AND APPLESAUCE; MILK PRODUCTS, NAMELY, ICE CREAM, ICE MILK AND FROZEN YOGURT (U.S. CL. 46).

CLASS 41—EDUCATION AND ENTERTAINMENT

FOR EDUCATIONAL SERVICES, NAMELY, CONDUCTING PROGRAMS IN THE FIELD OF NUTRITION AND CHILDREN'S EMOTIONAL INTELLIGENCE; PROVIDING NEWSLETTERS IN THE FIELD OF NUTRITION AND CHILDREN'S EMOTIONAL INTELLIGENCE VIA EMAIL; ENTERTAINMENT SERVICES IN THE NATURE OF ON-GOING TELEVISION PROGRAMS IN THE FIELD OF CHILDREN'S EMOTIONAL INTELLIGENCE AND NUTRITION; PROVIDING ON-LINE COMPUTER GAMES; PRESENTATION OF LIVE SHOW PERFORMANCES; PROVIDING A WEBSITE FEATURING INFORMATION RELATING TO EMOTIONAL EDUCATION FOR CHILDREN (U.S. CLS. 100, 101 AND 107).

CLASS 44—MEDICAL, BEAUTY AND AGRICULTURAL SERVICES

FOR PROVIDING A WEBSITE FEATURING INFORMATION RELATING TO NUTRITION; PROVIDING ON-LINE ELECTRONIC INTERACTIVE INFORMATION SERVICES IN THE FIELDS OF CHILDREN'S EMOTIONAL HEALTH AND NUTRITION; PROVIDING ON-LINE SEARCHABLE DATABASES IN THE FIELDS OF CHILDREN'S EMOTIONAL HEALTH AND NUTRITION; PROVIDING A WEBSITE FEATURING INFORMATION RELATING TO NUTRITION FOR CHILDREN (U.S. CLS. 100 AND 101).

ALYSSA PALADINO, EXAMINING ATTORNEY

SN 77-110,838. FLOOR COVERING ASSOCIATES, INC., SHOREWOOD, IL. FILED 2-19-2007.



THE MARK CONSISTS OF THE LETTERS F C A IN A BOLD FONT OUTLINED IN A THIN LINE, THE LETTER A SLANTING IN TOWARD THE F AND C.

CLASS 35—ADVERTISING AND BUSINESS

FOR RETAIL STORE SERVICES FEATURING FLOORING MATERIALS INCLUDING CARPETING, RUGS, TILE, VINYL AND OTHER MATERIALS (U.S. CLS. 100, 101 AND 102).

FIRST USE 12-6-1976; IN COMMERCE 12-6-1976.

CLASS 37—CONSTRUCTION AND REPAIR

FOR CARPETING, TILE, HARDWOOD AND VINYL FLOORING INSTALLATION SERVICES (U.S. CLS. 100, 103 AND 106).

FIRST USE 12-6-1976; IN COMMERCE 12-6-1976.
DOMINICK J. SALEMI, EXAMINING ATTORNEY

SN 77-112,396. TENSAR INTERNATIONAL CORPORATION,
ATLANTA, GA. FILED 2-21-2007.

SN 77-112,835. YOU'VE GOT TO BE BEADING, INC.,
MYSTIC, CT. FILED 2-21-2007.

TRIAx

THE MARK CONSISTS OF STANDARD CHARACTERS WITHOUT CLAIM TO ANY PARTICULAR FONT, STYLE, SIZE, OR COLOR.

CLASS 17—RUBBER GOODS

FOR PLASTIC SHEET MATERIALS FOR CONSTRUCTION AND GENERAL USE; PLASTIC MESH MATERIALS FOR ASPHALT AND CONCRETE REINFORCEMENT, AND CONSTRUCTION OF CIVIL ENGINEERING STRUCTURES (U.S. CLS. 1, 5, 12, 13, 33 AND 50).

CLASS 19—NON-METALLIC BUILDING MATERIALS

FOR SOIL REINFORCEMENT MESH AND SOIL STABILIZATION MESH MADE OF PLASTIC; PLASTIC BUILDING MESH AND PLASTIC FILM FOR ROOFING, FENCING, PENNING AND ENCLOSING LIVESTOCK FIELDS AND PASTURES; SOIL EROSION STRUCTURES, NAMELY, GABIONS AND MATTRESSES CONSTRUCTED OF PLASTIC MESH; PLASTIC MESH MATERIAL FOR FENCING AND GARDEN APPLICATION, AND CONSTRUCTION OF CIVIL ENGINEERING STRUCTURES (U.S. CLS. 1, 12, 33 AND 50).

CLASS 37—CONSTRUCTION AND REPAIR

FOR CONSTRUCTION OF CIVIL ENGINEERING STRUCTURES, NAMELY, BASE REINFORCEMENT IN ROADBEDS, FOUNDATION IMPROVEMENT, STABILIZED SOIL STRUCTURES, EMBANKMENTS, SLOPES AND WALLS, EROSION CONTROL SYSTEMS, UNDERGROUND MINE SCREENING AND DEBRIS CONTROL SYSTEMS, FENCING, AND ENCLOSURE AND CONTAINMENT SYSTEMS (U.S. CLS. 100, 103 AND 106).

WENDY GOODMAN, EXAMINING ATTORNEY



NO CLAIM IS MADE TO THE EXCLUSIVE RIGHT TO USE "BEADING", APART FROM THE MARK AS SHOWN.

"THE NAME(S), PORTRAIT(S), AND/OR SIGNATURE(S) SHOWN IN THE MARK DOES NOT IDENTIFY A PARTICULAR LIVING INDIVIDUAL."

THE MARK CONSISTS OF A LINE DRAWING OF THE PROFILE OF A WOMAN'S FACE, HER HAIR EXHIBITING A DISTINCT BOBBED CUT, AND A FRONTAL VIEW OF THE GARMENT NECKLINE, TOGETHER WITH THE WORDS YOU'VE GOT TO BE BEADING! AND A SWIRL CULMINATING IN A PSEUDO-HEART SHAPE UNDERLYING THE WORDS; THE LINE DRAWING AND THE WORDS MAY BE BLACK-ON-WHITE OR WHITE-ON-BLACK; AND THE WORDS MAY APPEAR TO THE TOP, BOTTOM, LEFT OR RIGHT OF THE LINE DRAWING;

CLASS 14—JEWELRY

FOR KITS FOR THE MANUFACTURE OF JEWELRY CONSISTING PRIMARILY OF BEADS, PRECIOUS AND SEMI-PRECIOUS STONES, CHARMS, AND ORNAMENTS (U.S. CLS. 2, 27, 28 AND 50).

CLASS 35—ADVERTISING AND BUSINESS

FOR RETAIL SERVICES, NAMELY, RETAIL STORE AND ONLINE RETAIL STORE SERVICES FEATURING BEADS, JEWELRY, AND JEWELRY-MAKING SUPPLIES (U.S. CLS. 100, 101 AND 102).

Laurie Mayes, Examining Attorney

SN 77-113,736. LEADERSHIP OXYGEN LLC, WEST PALM BEACH, FL. FILED 2-22-2007.

LEADERSHIP OXYGEN

THE MARK CONSISTS OF STANDARD CHARACTERS WITHOUT CLAIM TO ANY PARTICULAR FONT, STYLE, SIZE, OR COLOR.

NO CLAIM IS MADE TO THE EXCLUSIVE RIGHT TO USE LEADERSHIP, APART FROM THE MARK AS SHOWN.

CLASS 9—ELECTRICAL AND SCIENTIFIC APPARATUS

FOR CDS AND DVDS IN THE FIELD OF BUSINESS LEADERSHIP DEVELOPMENT AND TRAINING (U.S. CLS. 21, 23, 26, 36 AND 38).

CLASS 16—PAPER GOODS AND PRINTED MATTER

FOR PRINTED PUBLICATIONS, NAMELY, BOOKS IN THE FIELD OF BUSINESS LEADERSHIP DEVELOPMENT AND TRAINING (U.S. CLS. 2, 5, 22, 23, 29, 37, 38 AND 50).

CLASS 35—ADVERTISING AND BUSINESS

FOR CONSULTATION SERVICES IN THE FIELD OF BUSINESS LEADERSHIP DEVELOPMENT (U.S. CLS. 100, 101 AND 102).

CLASS 41—EDUCATION AND ENTERTAINMENT

FOR EDUCATION SERVICES, NAMELY, SEMINARS IN THE FIELD OF BUSINESS LEADERSHIP DEVELOPMENT AND TRAINING; CONSULTATION SERVICES IN THE FIELD OF BUSINESS LEADERSHIP TRAINING (U.S. CLS. 100, 101 AND 107).

SCOTT BIBB, EXAMINING ATTORNEY

SN 77-114,012. HIT THE GROUND RUNNING LLC, SAN FRANCISCO, CA. FILED 2-22-2007.

JOB SPA EMPLOYEE ENGAGEMENT

THE MARK CONSISTS OF STANDARD CHARACTERS WITHOUT CLAIM TO ANY PARTICULAR FONT, STYLE, SIZE, OR COLOR.

NO CLAIM IS MADE TO THE EXCLUSIVE RIGHT TO USE "JOB" AND "EMPLOYEE ENGAGEMENT", APART FROM THE MARK AS SHOWN.

CLASS 35—ADVERTISING AND BUSINESS

FOR BUSINESS CONSULTATION; CONSULTING SERVICES IN THE FIELD OF HUMAN RESOURCES DEVELOPMENT, NAMELY FOR THE PROMOTION OF EMPLOYEE RETENTION, CAREER GROWTH, AND INCREASED PRODUCTIVITY FOR EMPLOYEES AND EMPLOYERS (U.S. CLS. 100, 101 AND 102).

FIRST USE 8-1-2006; IN COMMERCE 10-1-2006.

CLASS 42—SCIENTIFIC, COMPUTER AND LEGAL SERVICES

FOR PROVIDING ON-LINE NON-DOWNLOADABLE SOFTWARE, NAMELY, PROVIDING ONLINE NON-DOWNLOADABLE COMPUTER SOFTWARE DEVELOPMENT TOOLS (U.S. CLS. 100 AND 101).

FIRST USE 8-1-2006; IN COMMERCE 10-1-2006.
ROBERT LAVACHE, EXAMINING ATTORNEY

SN 77-114,904. EIGHTH DAY SOUND SYSTEMS, INC., HIGHLAND HEIGHTS, OH. FILED 2-23-2007.

EIGHTH DAY SOUND

THE MARK CONSISTS OF STANDARD CHARACTERS WITHOUT CLAIM TO ANY PARTICULAR FONT, STYLE, SIZE, OR COLOR.

NO CLAIM IS MADE TO THE EXCLUSIVE RIGHT TO USE "SOUND", APART FROM THE MARK AS SHOWN.

CLASS 37—CONSTRUCTION AND REPAIR

FOR INSTALLATION OF SOUND, VIDEO, AND STAGING EQUIPMENT (U.S. CLS. 100, 103 AND 106).

FIRST USE 12-31-1980; IN COMMERCE 12-31-1980.

CLASS 41—EDUCATION AND ENTERTAINMENT

FOR SPECIAL EVENT PLANNING; RENTAL OF PORTABLE STAGES AND PLATFORMS; RENTAL OF STAGE SCENERY; AUDIO RECORDING AND PRODUCTION; PRODUCTION OF SOUND AND MUSIC VIDEO RECORDINGS; LIGHTING PRODUCTION; THEATRE PRODUCTION; MULTIMEDIA ENTERTAINMENT SOFTWARE PRODUCTION SERVICES; RENTAL AND LEASING OF AUDIO AND VIDEO EQUIPMENT; PROVIDING AUDIO PRODUCTION (U.S. CLS. 100, 101 AND 107).

FIRST USE 10-10-1980; IN COMMERCE 10-10-1980.

KAREN K. BUSH, EXAMINING ATTORNEY

SN 77-116,214. UNITED 1 INTERNATIONAL LABORATORIES, L.L.C., OKLAHOMA CITY, OK. FILED 2-26-2007.

UNITED 1 INTERNATIONAL LABORATORIES

THE MARK CONSISTS OF STANDARD CHARACTERS WITHOUT CLAIM TO ANY PARTICULAR FONT, STYLE, SIZE, OR COLOR.

NO CLAIM IS MADE TO THE EXCLUSIVE RIGHT TO USE "INTERNATIONAL LABORATORIES", APART FROM THE MARK AS SHOWN.

CLASS 40—MATERIAL TREATMENT

FOR CUSTOM MANUFACTURE OF AEROSOL PRODUCTS, BODY LOTION AND NON-ALCOHOLIC BEVERAGES FOR OTHERS (U.S. CLS. 100, 103 AND 106).

CLASS 42—SCIENTIFIC, COMPUTER AND LEGAL SERVICES

FOR PRODUCT RESEARCH AND DEVELOPMENT, SPECIFICALLY, THE RESEARCH AND DEVELOPMENT OF AEROSOL PRODUCTS, BODY LOTIONS AND NON-ALCOHOLIC BEVERAGES (U.S. CLS. 100 AND 101).

DAVID COLLIER, EXAMINING ATTORNEY

SN 77-116,623. SCRAPBLOG, INC., CORAL GABLES, FL.
FILED 2-26-2007.

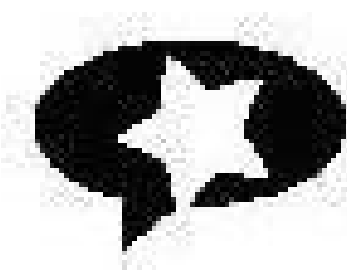

CLASS 9—ELECTRICAL AND SCIENTIFIC APPARATUS

FOR COMPUTER SOFTWARE FOR CREATING, DESIGNING, MANIPULATING, EDITING, ORGANIZING, PUBLISHING, SEARCHING, UPLOADING, DOWNLOADING, IMPORTING, AND DISTRIBUTING MULTIMEDIA SCRAPBOOKS AND PHOTO BOOKS COMPRISED OF PHOTOS, VIDEOS, AND AUDIO CONTENT, AND OTHER USER-GENERATED MULTIMEDIA CONTENT; COMPUTER SOFTWARE THAT ENABLES USERS TO SHARE MULTIMEDIA SCRAPBOOKS AND PHOTO BOOKS COMPRISED OF PHOTOS, VIDEOS, AND AUDIO CONTENT, AND OTHER USER-GENERATED MULTIMEDIA CONTENT, WITH THIRD PARTIES VIA A GLOBAL COMPUTER NETWORK; COMPUTER SOFTWARE THAT ENABLES USERS TO POST AND SHARE COMMENTS AND BLOGS RELATING TO MULTIMEDIA SCRAPBOOKS AND PHOTO BOOKS COMPRISED OF PHOTOS, VIDEOS, AND AUDIO CONTENT, AND OTHER USER-GENERATED MULTIMEDIA CONTENT, WITH THIRD PARTIES VIA A GLOBAL COMPUTER NETWORK; COMPUTER SOFTWARE TOOLS FOR USERS TO CREATE MULTIMEDIA CONTENT ONLINE; PRERECORDED DVDS AND CDS FEATURING MULTIMEDIA SCRAPBOOKS, PHOTO BOOKS, PHOTOS, VIDEOS, AND AUDIO CONTENT, AND OTHER USER-GENERATED MULTIMEDIA CONTENT; ELECTRONIC MANUALS DISTRIBUTED WITH THE FOREGOING (U.S. CLS. 21, 23, 26, 36 AND 38).

CLASS 16—PAPER GOODS AND PRINTED MATTER

FOR PRINTED MATTER AND GOODS, NAMELY, PHOTO BOOKS, SCRAPBOOKS, SCRAPBOOK ALBUMS, SCRAPBOOK PAGES, GREETING CARDS, NOTE CARDS, AND CALENDARS (U.S. CLS. 2, 5, 22, 23, 29, 37, 38 AND 50).

CLASS 41—EDUCATION AND ENTERTAINMENT

FOR ENTERTAINMENT AND EDUCATIONAL SERVICES, NAMELY, PROVIDING ONLINE COMPUTER DATABASES FEATURING MULTIMEDIA SCRAPBOOKS AND PHOTO BOOKS COMPRISED OF PHOTOS, VIDEOS, AND AUDIO CONTENT, AND OTHER USER-GENERATED MULTIMEDIA CONTENT (U.S. CLS. 100, 101 AND 107).

CLASS 42—SCIENTIFIC, COMPUTER AND LEGAL SERVICES

FOR PROVIDING ONLINE NON-DOWNLOADABLE SOFTWARE FOR CREATING, DESIGNING, MANIPULATING, EDITING, ORGANIZING, PUBLISHING, SEARCHING, UPLOADING, DOWNLOADING, IMPORTING, AND DISTRIBUTING MULTIMEDIA SCRAPBOOKS AND PHOTO BOOKS COMPRISED OF PHOTOS, VIDEOS, AND AUDIO CONTENT, AND OTHER USER-GENERATED MULTIMEDIA CONTENT; PROVIDING ONLINE NON-DOWNLOADABLE SOFTWARE THAT ENABLES USERS TO SHARE MULTIMEDIA SCRAPBOOKS AND PHOTO BOOKS COMPRISED OF PHOTOS, VIDEOS, AND AUDIO CONTENT, AND OTHER USER-GENERATED MULTIMEDIA

CONTENT, WITH THIRD PARTIES VIA A GLOBAL COMPUTER NETWORK; PROVIDING ONLINE NON-DOWNLOADABLE SOFTWARE THAT ENABLES USERS TO POST AND SHARE COMMENTS AND BLOGS RELATING TO MULTIMEDIA SCRAPBOOKS AND PHOTO BOOKS COMPRISED OF PHOTOS, VIDEOS, AND AUDIO CONTENT, AND OTHER USER-GENERATED MULTIMEDIA CONTENT, WITH THIRD PARTIES VIA A GLOBAL COMPUTER NETWORK; COMPUTER SERVICES, NAMELY, PROVIDING SOFTWARE TOOLS FOR USERS TO CREATE MULTIMEDIA CONTENT ONLINE; HOSTING OF DIGITAL CONTENT ONLINE; HOSTING COMPUTER SOFTWARE APPLICATIONS OF OTHERS; PROVIDING AN INTERACTIVE WEBSITE THROUGH WHICH USERS CREATE, DESIGN, MANIPULATE, EDIT, ORGANIZE, PUBLISH, SEARCH, UPLOAD, DOWNLOAD, IMPORT, AND DISTRIBUTE MULTIMEDIA SCRAPBOOKS AND PHOTO BOOKS COMPRISED OF PHOTOS, VIDEOS, AND AUDIO CONTENT, AND OTHER USER-GENERATED MULTIMEDIA CONTENT; PROVIDING AN INTERACTIVE WEBSITE THROUGH WHICH USERS SHARE MULTIMEDIA SCRAPBOOKS AND PHOTO BOOKS COMPRISED OF PHOTOS, VIDEOS, AND AUDIO CONTENT, AND OTHER USER-GENERATED MULTIMEDIA CONTENT, WITH THIRD PARTIES VIA A GLOBAL COMPUTER NETWORK; PROVIDING A WEBSITE FEATURING USER-GENERATED MULTIMEDIA CONTENT ONLINE (U.S. CLS. 100 AND 101).

JASON BLAIR, EXAMINING ATTORNEY

SN 77-116,869. HYPERTRONICS CORPORATION, HUDSON, MA. FILED 2-27-2007.



THE MARK CONSISTS OF A STYLIZED WORD ECONNEK, AND A BLACK AND WHITE STYLIZED CIRCLE.

CLASS 35—ADVERTISING AND BUSINESS

FOR BUSINESS MARKETING SERVICES FOR OTHERS; DISTRIBUTORSHIP SERVICES FEATURING ELECTRO-MECHANICAL GOODS, NAMELY, CABLES AND CONNECTORS (U.S. CLS. 100, 101 AND 102).

CLASS 40—MATERIAL TREATMENT

FOR CUSTOM MANUFACTURE FOR OTHERS OF ELECTRO-MECHANICAL GOODS, NAMELY, CABLES AND CONNECTORS (U.S. CLS. 100, 103 AND 106).

SOPHIA S. KIM, EXAMINING ATTORNEY

SN 77-116,932. EIGHTH DAY SOUND SYSTEMS, INC., HIGHLAND HEIGHTS, OH. FILED 2-27-2007.



NO CLAIM IS MADE TO THE EXCLUSIVE RIGHT TO USE "SOUND", APART FROM THE MARK AS SHOWN.

CLASS 37—CONSTRUCTION AND REPAIR

FOR INSTALLATION OF SOUND, VIDEO, AND STAGING EQUIPMENT (U.S. CLS. 100, 103 AND 106).
FIRST USE 12-31-1981; IN COMMERCE 12-31-1981.

CLASS 41—EDUCATION AND ENTERTAINMENT

FOR SPECIAL EVENT PLANNING; RENTAL OF PORTABLE STAGES AND PLATFORMS; RENTAL OF STAGE SCENERY; AUDIO RECORDING AND PRODUCTION; PRODUCTION OF SOUND AND MUSIC VIDEO RECORDINGS; LIGHTING PRODUCTION; THEATRE PRODUCTION; MULTIMEDIA ENTERTAINMENT SOFTWARE PRODUCTION SERVICES; RENTAL AND LEASING OF AUDIO AND VIDEO EQUIPMENT; PROVIDING AUDIO PRODUCTION (U.S. CLS. 100, 101 AND 107).

FIRST USE 12-31-1981; IN COMMERCE 12-31-1981.
KAREN K. BUSH, EXAMINING ATTORNEY

SN 77-117,179. UNITED STATES STEEL CORPORATION, PITTSBURGH, PA. FILED 2-27-2007.



NO CLAIM IS MADE TO THE EXCLUSIVE RIGHT TO USE INDUSTRIAL PORT COMPLEX, APART FROM THE MARK AS SHOWN.

THE COLOR(S) RED, WHITE, AND GRAY IS/ARE CLAIMED AS A FEATURE OF THE MARK.

THE MARK CONSISTS OF THE UPPER CASE LETTERS "KIPC" IN GRAY SEATED ATOP A RED HORIZONTAL BAR CONTAINING THE WORDS "KEYSTONE INDUSTRIAL PORT COMPLEX" IN WHITE WITH A GRAY ARC ABOVE THE "K" IN KIPC.

CLASS 35—ADVERTISING AND BUSINESS

FOR REAL ESTATE MARKETING SERVICES IN THE FIELD OF INDUSTRIAL PROPERTY DEVELOPMENT (U.S. CLS. 100, 101 AND 102).

FIRST USE 1-10-2006; IN COMMERCE 1-10-2006.

CLASS 36—INSURANCE AND FINANCIAL

FOR REAL ESTATE MANAGEMENT SERVICES, NAMELY, MANAGEMENT OF INDUSTRIAL PROPERTIES (U.S. CLS. 100, 101 AND 102).

FIRST USE 1-10-2006; IN COMMERCE 1-10-2006.

CLASS 37—CONSTRUCTION AND REPAIR

FOR REAL ESTATE DEVELOPMENT SERVICES, NAMELY, DEVELOPMENT OF INDUSTRIAL PROPERTIES (U.S. CLS. 100, 103 AND 106).

FIRST USE 1-10-2006; IN COMMERCE 1-10-2006.

AHSEN KHAN, EXAMINING ATTORNEY

SN 77-117,606. DOVETEL COMMUNICATIONS, LLC, BREMEN, GA. FILED 2-27-2007.



THE MARK CONSISTS OF THE WORD SYNCGLOBAL WITH THE "O" IN THE FORM OF A GLOBE OF THE EARTH AND A BANNER EXTENDING FROM THE TOP OF THE "S" TO THE GLOBE.

CLASS 35—ADVERTISING AND BUSINESS

FOR DISTRIBUTORSHIP SERVICES IN THE FIELD OF ELECTRICAL AND COMPUTER HARDWARE AND SOFTWARE IN THE FIELD OF TELECOMMUNICATION NETWORKS (U.S. CLS. 100, 101 AND 102).

CLASS 37—CONSTRUCTION AND REPAIR

FOR INSTALLATION AND MAINTENANCE OF TELECOMMUNICATION NETWORKS (U.S. CLS. 100, 103 AND 106).

CLASS 42—SCIENTIFIC, COMPUTER AND LEGAL SERVICES

FOR DESIGN AND DEVELOPMENT OF TELECOMMUNICATION NETWORKS; ENGINEERING SERVICES, NAMELY ENGINEERING IN THE FIELD OF TELECOMMUNICATION NETWORKS (U.S. CLS. 100 AND 101).

REBECCA GILBERT, EXAMINING ATTORNEY

SN 77-117,720. LILY B., INC., LOS ANGELES, CA. FILED 2-27-2007.

FABWRAP

THE MARK CONSISTS OF STANDARD CHARACTERS WITHOUT CLAIM TO ANY PARTICULAR FONT, STYLE, SIZE, OR COLOR.

CLASS 16—PAPER GOODS AND PRINTED MATTER

FOR FABRIC GIFT BAGS; GIFT WRAP PAPER; GIFT WRAPPING PAPER; PAPER FOR WRAPPING AND PACKAGING; TREATED PAPER FOR WRAPPING FLOWERS AND FLORAL DISPLAYS; WRAPPING PAPER (U.S. CLS. 2, 5, 22, 23, 29, 37, 38 AND 50).

CLASS 21—HOUSEWARES AND GLASS

FOR FABRIC BOXES FOR STORING GREETING CARDS (U.S. CLS. 2, 13, 23, 29, 30, 33, 40 AND 50).

CLASS 24—FABRICS

FOR FABRIC TABLE RUNNERS; FABRIC TABLE TOPPERS; GIFT WRAP OF FABRIC (U.S. CLS. 42 AND 50).

CLASS 45—PERSONAL SERVICES

FOR GIFT WRAPPING (U.S. CLS. 100 AND 101).
JOHN GARTNER, EXAMINING ATTORNEY

SN 77-117,894. ALL WAYS ZEN, AUSTIN, TX. FILED 2-28-2007.

ALL WAYS ZEN

THE MARK CONSISTS OF STANDARD CHARACTERS WITHOUT CLAIM TO ANY PARTICULAR FONT, STYLE, SIZE, OR COLOR.

NO CLAIM IS MADE TO THE EXCLUSIVE RIGHT TO USE "ZEN", APART FROM THE MARK AS SHOWN.

CLASS 9—ELECTRICAL AND SCIENTIFIC APPARATUS

FOR PRE-RECORDED CDS, AND DVDS FEATURING MIND-BODY-SPIRIT WELLNESS NAMELY, TAI CHI, QIGONG, MARTIAL ARTS, NATURAL HEALING ARTS, YOGA, MEDITATION, METAPHYSICS, PHILOSOPHY, MIND-BODY SCIENCE, SELF HELP AND STRESS MANAGEMENT; ELECTRONIC PUBLICATIONS, NAMELY BOOKS FEATURING MIND-BODY-SPIRIT WELLNESS NAMELY TAI CHI, QIGONG, MARTIAL ARTS, NATURAL HEALING ARTS, YOGA, MEDITATION, METAPHYSICS, PHILOSOPHY, MIND-BODY SCIENCE, SELF HELP AND STRESS MANAGEMENT, RECORDED ON COMPUTER MEDIA (U.S. CLS. 21, 23, 26, 36 AND 38).

CLASS 41—EDUCATION AND ENTERTAINMENT

FOR HEALTH AND FITNESS EDUCATIONAL SERVICES, NAMELY CONDUCTING WORKSHOPS AND RETREATS IN THE FIELD OF MIND-BODY-SPIRIT WELLNESS NAMELY TAI CHI, QIGONG, MARTIAL ARTS, NATURAL HEALING ARTS, YOGA, MEDITATION, METAPHYSICS, PHILOSOPHY, MIND-BODY SCIENCE, SELF HELP AND STRESS MANAGEMENT (U.S. CLS. 100, 101 AND 107).

SCOTT BIBB, EXAMINING ATTORNEY

SN 77-118,270. SONIC INNOVATIONS, INC., SALT LAKE CITY, UT. FILED 2-28-2007.

VELOCITY

THE MARK CONSISTS OF STANDARD CHARACTERS WITHOUT CLAIM TO ANY PARTICULAR FONT, STYLE, SIZE, OR COLOR.

CLASS 9—ELECTRICAL AND SCIENTIFIC APPARATUS

FOR HEARING AID ACCESSORIES, NAMELY, COMPUTER SOFTWARE FOR PROGRAMMING HEARING AIDS AND BATTERIES (U.S. CLS. 21, 23, 26, 36 AND 38).

CLASS 10—MEDICAL APPARATUS

FOR HEARING AIDS; HEARING AID ACCESSORIES, NAMELY, CASES SPECIALLY ADAPTED FOR HEARING AIDS (U.S. CLS. 26, 39 AND 44).

JAY BESCH, EXAMINING ATTORNEY

SN 77-118,383. PS COMMERCIAL PLAY, LLC, CHATTANOOGA, TN. FILED 2-28-2007.

PLAY & PARK STRUCTURES

THE MARK CONSISTS OF STANDARD CHARACTERS WITHOUT CLAIM TO ANY PARTICULAR FONT, STYLE, SIZE, OR COLOR.

OWNER OF U.S. REG. NO. 2,432,941.
NO CLAIM IS MADE TO THE EXCLUSIVE RIGHT TO USE "PLAY", APART FROM THE MARK AS SHOWN.

SEC. 2(F) AS TO "PARK STRUCTURES".

CLASS 28—TOYS AND SPORTING GOODS

FOR PLAYGROUND EQUIPMENT, NAMELY, SLIDES, LADDERS, TUNNELS, PLATFORMS, BRIDGES, BARS, SWINGS, BALANCE BEAMS, TRAPEZE, CHAINS FOR CLIMBING, PLAYHOUSES, POLES, TEETER-TOTTERS, SPRING MOUNTED RIDING TOYS AND PLATFORMS, CLIMBING AND CRAWLING TUBES, SEESAWS, RINGS, STEPS, STAIRS, TOWERS, PANELS, CAT-WALKS, RAMPS, TALKING TUBES, STEERING WHEELS, LOG ROLLS, TRACK RIDERS, CLIMBING WALLS, PAINT PANELS, PLASTIC BUBBLE PANELS, WATER TROUGHS, SAND TROUGHS, WATER ACTIVITY CENTERS, SAND BOXES, CHILDREN'S ACTIVITY GAMES, SCOOP DIGGERS, BENCHES, SEATS, TABLES, BASKET BALL BACKSTOPS AND POSTS, BALL TOSS FUNNELS AND POSTS AND VOLLEY BALL NETS AND POSTS AND VARIOUS COMBINATIONS THEREOF; AND PLAYGROUND EQUIPMENT IN THE SHAPE OF BOATS, TREE HOUSES, AUTOMOBILES, TRAINS, CASTLES, HOUSES, SCHOOLHOUSES, CATS, TOOL SHOPS, HOTELS, DINERS, BANKS, ICE CREAM PARLORS, SPACE SHIPS, HELICOPTERS AND AIRPLANES (U.S. CLS. 22, 23, 38 AND 50).

FIRST USE 10-1-2006; IN COMMERCE 10-1-2006.

CLASS 35—ADVERTISING AND BUSINESS

FOR RETAIL STORE SERVICES AND DISTRIBUTORSHIP SERVICES IN THE FIELD OF PLAYGROUND EQUIPMENT (U.S. CLS. 100, 101 AND 102).
FIRST USE 10-1-2006; IN COMMERCE 10-1-2006.
ELISSA GARBER KON, EXAMINING ATTORNEY

SN 77-119,177. HANDS ON GOURMET LLC, SAN FRANCISCO, CA. FILED 2-28-2007.

HANDS ON GOURMET

THE MARK CONSISTS OF STANDARD CHARACTERS WITHOUT CLAIM TO ANY PARTICULAR FONT, STYLE, SIZE, OR COLOR.

NO CLAIM IS MADE TO THE EXCLUSIVE RIGHT TO USE "GOURMET", APART FROM THE MARK AS SHOWN.

CLASS 41—EDUCATION AND ENTERTAINMENT

FOR ENTERTAINMENT SERVICES, NAMELY, CONDUCTING PARTIES; PARTY PLANNING; PARTY PLANNING CONSULTATION; SPECIAL EVENT PLANNING; SPECIAL EVENT PLANNING CONSULTATION (U.S. CLS. 100, 101 AND 107).
FIRST USE 10-26-2005; IN COMMERCE 10-26-2005.

CLASS 43—HOTEL AND RESTAURANT SERVICES

FOR CATERING OF FOOD AND DRINKS; PREPARATION OF FOOD AND BEVERAGES; PROVIDING OF FOOD AND DRINK FOR PATIENTS AND GUESTS; SERVING FOOD AND DRINKS; SOMMELIER SERVICES, NAMELY, PROVIDING ADVICE ON WINE AND WINE AND FOOD PAIRING (U.S. CLS. 100 AND 101).

FIRST USE 10-26-2005; IN COMMERCE 10-26-2005.
JENNIFER HETU, EXAMINING ATTORNEY

SN 77-119,469. ELANNAN, DDS, ERICA N., ST. AUGUSTINE, FL. FILED 3-1-2007.

DR. E's TEETHEFFEX

THE MARK CONSISTS OF STANDARD CHARACTERS WITHOUT CLAIM TO ANY PARTICULAR FONT, STYLE, SIZE, OR COLOR.

NO CLAIM IS MADE TO THE EXCLUSIVE RIGHT TO USE "DR.", APART FROM THE MARK AS SHOWN.

THE NICKNAME, DR. E., IDENTIFIES DR. ERICA ELANNAN, A LIVING INDIVIDUAL WHOSE CONSENT IS OF RECORD.

CLASS 10—MEDICAL APPARATUS

FOR PACIFIERS FOR BABIES; TEETHING RINGS; TEETHING RINGS INCORPORATING BABY RATTLES (U.S. CLS. 26, 39 AND 44).

CLASS 21—HOUSEWARES AND GLASS

FOR MANUAL TOOTHBRUSHES (U.S. CLS. 2, 13, 23, 29, 30, 33, 40 AND 50).

CLASS 25—CLOTHING

FOR NURSE'S APPAREL, NAMELY, BRASSIERES (U.S. CLS. 22 AND 39).

CLASS 28—TOYS AND SPORTING GOODS

FOR PLUSH TOYS (U.S. CLS. 22, 23, 38 AND 50).
GEORGIA CARTY, EXAMINING ATTORNEY

SN 77-120,342. LINOTYPE GMBH, BAD HOMBURG V.D.H., FED REP GERMANY, FILED 3-1-2007.

FONTCLOUD

THE MARK CONSISTS OF STANDARD CHARACTERS WITHOUT CLAIM TO ANY PARTICULAR FONT, STYLE, SIZE, OR COLOR.

CLASS 35—ADVERTISING AND BUSINESS

FOR PROVIDING ONLINE RETAIL SERVICES IN THE FIELD OF TYPEFACE FONTS AND ORNAMENTAL DESIGNS (U.S. CLS. 100, 101 AND 102).
FIRST USE 1-29-2007; IN COMMERCE 1-29-2007.

CLASS 42—SCIENTIFIC, COMPUTER AND LEGAL SERVICES

FOR PROVIDING ONLINE SERVICES, NAMELY, PROVIDING INFORMATION IN THE FIELD OF TYPEFACE FONTS AND ORNAMENTAL DESIGNS (U.S. CLS. 100 AND 101).

FIRST USE 1-29-2007; IN COMMERCE 1-29-2007.
GRETTA YAO, EXAMINING ATTORNEY

SN 77-120,687. EMPLOYAID, INC., RIDGEFIELD, CT. FILED 3-2-2007.

employaid
Your lifeline at work.

THE MARK CONSISTS OF STYLIZED TEXT OF THE WORDING "EMPLOYAID YOUR LIFELINE AT WORK." THE STIPPLING IN THE DRAWING IS FOR SHADING PURPOSES ONLY.

CLASS 9—ELECTRICAL AND SCIENTIFIC APPARATUS

FOR DOWNLOADABLE PODCASTS FEATURING COURSES, SEMINARS AND WORKSHOPS IN THE FIELD OF EMPLOYEE COMMUNICATION SKILLS VIA THE INTERNET AND WIRELESS DEVICES (U.S. CLS. 21, 23, 26, 36 AND 38).

CLASS 41—EDUCATION AND ENTERTAINMENT

FOR EDUCATION SERVICES, NAMELY, PROVIDING CLASSES, SEMINARS, WORKSHOPS, CONFERENCES IN THE FIELD OF COMMUNICATION SKILLS; EDUCATIONAL SERVICES, NAMELY, CONDUCTING CLASSES, SEMINARS, CONFERENCES, WORKSHOPS IN THE FIELD OF COMMUNICATION SKILLS; PROVIDING ON-LINE TRAINING CONFERENCES, COURSES, SEMINARS, WORKSHOPS IN THE FIELD OF COMMUNICATION SKILLS; TRAINING SERVICES IN THE FIELD OF COMMUNICATION SKILLS (U.S. CLS. 100, 101 AND 107).

ELLEN PERKINS, EXAMINING ATTORNEY

SN 77-120,858. THE MAIN EVENT GROUP, L.L.C., NAPERVILLE, IL. FILED 3-2-2007.

**RIDE-N-DRIVE Key-n-Vin Tag
Event**

THE MARK CONSISTS OF STANDARD CHARACTERS WITHOUT CLAIM TO ANY PARTICULAR FONT, STYLE, SIZE, OR COLOR.

NO CLAIM IS MADE TO THE EXCLUSIVE RIGHT TO USE "KEY AND VIN TAG" FOR CLASS 020, APART FROM THE MARK AS SHOWN.

CLASS 20—FURNITURE AND ARTICLES NOT OTHERWISE CLASSIFIED

FOR PLASTIC KEY TAGS (U.S. CLS. 2, 13, 22, 25, 32 AND 50).

CLASS 35—ADVERTISING AND BUSINESS

FOR ADVERTISING FLYER DISTRIBUTION (U.S. CLS. 100, 101 AND 102).

TINA BROWN, EXAMINING ATTORNEY

SN 77-120,910. VENTYX INC., ATLANTA, GA. FILED 3-2-2007.

**A NEW VIEW OF SERVICE
DELIVERY**

THE MARK CONSISTS OF STANDARD CHARACTERS WITHOUT CLAIM TO ANY PARTICULAR FONT, STYLE, SIZE, OR COLOR.

NO CLAIM IS MADE TO THE EXCLUSIVE RIGHT TO USE "SERVICE", APART FROM THE MARK AS SHOWN.

CLASS 9—ELECTRICAL AND SCIENTIFIC APPARATUS

FOR COMPUTER APPLICATION SOFTWARE FOR BUSINESS MANAGEMENT IN THE FIELDS OF PUBLIC AND PRIVATE UTILITIES AND ENERGY COMPANIES, MANUFACTURING, CONSUMER PRODUCTS, HEALTH CARE, EDUCATION, CABLE AND TELECOMMUNICATIONS, GOVERNMENT, TRANSPORTATION AND THIRD PARTY SERVICE PROVIDERS (U.S. CLS. 21, 23, 26, 36 AND 38).

CLASS 37—CONSTRUCTION AND REPAIR

FOR INSTALLATION OF COMPUTER SYSTEMS FOR USE IN CONNECTION WITH BUSINESS MANAGEMENT IN THE FIELDS OF PUBLIC AND PRIVATE UTILITIES AND ENERGY COMPANIES, MANUFACTURING, CONSUMER PRODUCTS, HEALTH CARE, EDUCATION, CABLE AND TELECOMMUNICATIONS, GOVERNMENT, TRANSPORTATION AND THIRD PARTY SERVICE PROVIDERS (U.S. CLS. 100, 103 AND 106).

CLASS 41—EDUCATION AND ENTERTAINMENT

FOR COMPUTER TRAINING SERVICES IN THE FIELD OF APPLICATION SOFTWARE FOR BUSINESS MANAGEMENT IN THE FIELDS OF PUBLIC AND PRIVATE UTILITIES AND ENERGY COMPANIES, MANUFACTURING, CONSUMER PRODUCTS, HEALTH CARE, EDUCATION, CABLE AND TELECOMMUNICATIONS, GOVERNMENT, TRANSPORTATION AND THIRD PARTY SERVICE PROVIDERS (U.S. CLS. 100, 101 AND 107).

CLASS 42—SCIENTIFIC, COMPUTER AND LEGAL SERVICES

FOR COMPUTER SERVICES, NAMELY, THE DESIGN, DEVELOPMENT, PROGRAMMING, SUPPORT AND UPDATING OF COMPUTER SOFTWARE FOR BUSINESS MANAGEMENT IN THE FIELDS OF PUBLIC AND PRIVATE UTILITIES AND ENERGY COMPANIES, MANUFACTURING, CONSUMER PRODUCTS, HEALTH CARE, EDUCATION, CABLE AND TELECOMMUNICATIONS, GOVERNMENT, TRANSPORTATION AND THIRD PARTY SERVICE PROVIDERS; APPLICATION SERVICE PROVIDER FEATURING COMPUTER APPLICATION SOFTWARE FOR BUSINESS MANAGEMENT IN THE FIELDS OF PUBLIC AND PRIVATE UTILITIES AND ENERGY COMPANIES, MANUFACTURING, CONSUMER PRODUCTS, HEALTH CARE, EDUCATION, CABLE AND TELECOMMUNICATIONS, GOVERNMENT, TRANSPORTATION AND THIRD PARTY SERVICE PROVIDERS (U.S. CLS. 100 AND 101).

NAAKWAMA ANKRAH, EXAMINING ATTORNEY

SN 77-121,294. TRACKNET MEDIA GROUP, LLC, LOUISVILLE, KY. FILED 3-2-2007.

TrackNet Media Group

THE MARK CONSISTS OF STANDARD CHARACTERS WITHOUT CLAIM TO ANY PARTICULAR FONT, STYLE, SIZE, OR COLOR.

NO CLAIM IS MADE TO THE EXCLUSIVE RIGHT TO USE "MEDIA GROUP", APART FROM THE MARK AS SHOWN.

CLASS 38—COMMUNICATION

FOR AUDIO AND VIDEO BROADCASTING OF HORSE RACES (U.S. CLS. 100, 101 AND 104).

CLASS 41—EDUCATION AND ENTERTAINMENT

FOR ENTERTAINMENT SERVICES, NAMELY, ORGANIZING AND CONDUCTING HORSE RACES; HORSE RACE BETTING SERVICES DELIVERED ONLINE OR THROUGH COMPUTERIZED BETTING SYSTEMS; BETTING, PARIMUTUEL WAGERING AND SPORTS WAGERING SERVICES, NAMELY, ONLINE, INTERNET AND ELECTRONIC WAGERING SERVICES, TELEPHONE AND TELEVISION ACCOUNT WAGERING SERVICES, AND INTERTRACK, ON-TRACK AND OFF-TRACK WAGERING SERVICES ON SPORTING EVENTS (U.S. CLS. 100, 101 AND 107).

DAWN HAN, EXAMINING ATTORNEY

SN 77-121,944. WOMAN SET FREE, HEATH, TX. FILED 3-5-2007.



SN 77-121,518. COMPREHENSIVE NETWORK, INC., BROOKLYN, NY. FILED 3-2-2007.

COMPREHENSIVE NETWORK

THE MARK CONSISTS OF STANDARD CHARACTERS WITHOUT CLAIM TO ANY PARTICULAR FONT, STYLE, SIZE, OR COLOR.

NO CLAIM IS MADE TO THE EXCLUSIVE RIGHT TO USE "NETWORK", APART FROM THE MARK AS SHOWN.

CLASS 35—ADVERTISING AND BUSINESS

FOR PROFESSIONAL STAFFING, PLACEMENT AND MANAGEMENT SERVICES RENDERED TO HEALTH, REHABILITATION, THERAPY, EDUCATION AND BUSINESS PRACTITIONERS (U.S. CLS. 100, 101 AND 102).

FIRST USE 1-1-1987; IN COMMERCE 1-1-1987.

CLASS 41—EDUCATION AND ENTERTAINMENT

FOR TRANSLATION SERVICES; LANGUAGE AND SIGN LANGUAGE INTERPRETING; CONTINUING EDUCATIONAL SERVICES, NAMELY, PROVIDING PROGRAMS, LECTURES, WORKSHOPS AND COURSES OF INSTRUCTION IN THE FIELDS OF SPEECH PATHOLOGY, SIGN LANGUAGE INTERPRETING, OCCUPATIONAL THERAPY, PHYSICAL THERAPY, NURSING, MENTAL HEALTH AND PSYCHOLOGY; SUPPLEMENTAL EDUCATIONAL SERVICES, NAMELY, PROVIDING MONOLINGUAL AND BILINGUAL TUTORING AND REMEDIATION IN THE FIELDS OF READING, MATH, SCIENCE AND LANGUAGE ARTS; AND BILINGUAL COUNSELING IN THE FIELDS OF SPECIAL EDUCATION AND VOCATIONAL GUIDANCE (U.S. CLS. 100, 101 AND 107).

FIRST USE 1-1-1987; IN COMMERCE 1-1-1987.

CLASS 45—PERSONAL SERVICES

FOR SOCIAL WORK IN THE NATURE OF CASE MANAGEMENT SERVICES, NAMELY, COORDINATION OF LEGAL, SOCIAL AND PSYCHOLOGICAL SERVICES FOR CHILDREN WHO PARTICIPATE IN EARLY INTERVENTION PROGRAMS FOR CHILDREN OF SCHOOL AGE OR YOUNGER WHO ARE DISCOVERED TO HAVE OR TO BE AT RISK OF DEVELOPING A HANDICAPPING CONDITION OR OTHER SPECIAL NEED THAT MAY AFFECT THEIR DEVELOPMENT; SOCIAL WORK IN THE NATURE OF CASE MANAGEMENT SERVICES, NAMELY, COORDINATION OF LEGAL, SOCIAL AND PSYCHOLOGICAL SERVICES FOR AT-RISK CHILDREN, NAMELY, SUBSTANCE ABUSE, DROPOUT PREVENTION, AND EATING DISORDERS (U.S. CLS. 100 AND 101).

FIRST USE 1-1-1987; IN COMMERCE 1-1-1987.
JEFFERY COWARD, EXAMINING ATTORNEY

THE COLOR(S) SILVER AND BLACK IS/ARE CLAIMED AS A FEATURE OF THE MARK.

THE MARK CONSISTS OF A SILHOUTTE SHAPE IN SILVER OF FEMALE UPPER TORSO, HEAD, ARMS AND HANDS, WITH THE ARMS AND HANDS RAISED WITH BLACK SHACKLES AROUND THE EACH WRIST WITH BLACK BROKEN CHAINS HANGING FROM EACH BLACK SHACKLE.

CLASS 16—PAPER GOODS AND PRINTED MATTER

FOR NEWSLETTERS, PAMPHLETS, BROCHURES, BULLETINS, PRINTED REPORTS, INFORMATIONAL LETTERS, STUDY GUIDES, WORKBOOKS, AND PRINTED EDUCATIONAL AND INSTRUCTIONAL MATERIALS, ALL IN THE FIELD OF CHRISTIANITY, RELIGION, THEOLOGY, SPIRITUALITY AND WOMEN'S CHRISTIAN MINISTRIES (U.S. CLS. 2, 5, 22, 23, 29, 37, 38 AND 50).

FIRST USE 4-0-2006; IN COMMERCE 11-0-2006.

CLASS 41—EDUCATION AND ENTERTAINMENT

FOR EDUCATIONAL SERVICES, NAMELY, PROVIDING WORKSHOPS, PRESENTATIONS, SEMINARS, CLASSES, AND SPIRITUAL INSTRUCTION RELATING TO A WOMEN'S MINISTRY PROGRAM FOR SPIRITUAL GROWTH AND DEVELOPMENT OF EACH WOMAN IN CONNECTION WITH THEIR RELATIONSHIP WITH GOD AND THE DISTRIBUTION OF COURSE MATERIALS IN CONNECTION THEREWITH; PROVIDING INFORMATION VIA A GLOBAL COMMUNICATIONS NETWORK IN THE FIELD OF EDUCATIONAL SERVICES RELATED TO WOMEN'S MINISTRIES (U.S. CLS. 100, 101 AND 107).

FIRST USE 4-0-2006; IN COMMERCE 11-0-2006.

JULIE GUTTADAURO, EXAMINING ATTORNEY

SN 77-121,975. INNOVATION RESEARCH AND TRAINING, INC., DURHAM, NC. FILED 3-5-2007.

Media Detective

THE MARK CONSISTS OF STANDARD CHARACTERS WITHOUT CLAIM TO ANY PARTICULAR FONT, STYLE, SIZE, OR COLOR.

NO CLAIM IS MADE TO THE EXCLUSIVE RIGHT TO USE "MEDIA", APART FROM THE MARK AS SHOWN.

CLASS 16—PAPER GOODS AND PRINTED MATTER

FOR PRINTED INSTRUCTIONAL EDUCATION, TRAINING AND TEACHING MATERIAL IN THE FIELDS OF MEDIA LITERACY AND SUBSTANCE ABUSE PREVENTION (U.S. CLS. 2, 5, 22, 23, 29, 37, 38 AND 50).

CLASS 41—EDUCATION AND ENTERTAINMENT

FOR EDUCATION SERVICES PROVIDING TRAINING, WORKSHOPS AND CLASSES IN THE FIELDS OF MEDIA LITERACY AND SUBSTANCE ABUSE PREVENTION WITH DISTRIBUTION OF COURSE MATERIALS IN CONNECTION THEREWITH (U.S. CLS. 100, 101 AND 107).

DAVID TAYLOR, EXAMINING ATTORNEY

SN 77-122,291. BAZZINI HOLDINGS, LLC, AVOCA, PA. FILED 3-5-2007.

OWNER OF U.S. REG. NO. 1,582,815.
THE MARK CONSISTS OF THE WORD BARRICINI IN SCRIPTED FORM.

CLASS 29—MEATS AND PROCESSED FOODS

FOR CANDIED NUTS; CANDIED FRUIT (U.S. CL. 46).
FIRST USE 8-1-1927; IN COMMERCE 8-1-1927.

CLASS 30—STAPLE FOODS

FOR CANDY (U.S. CL. 46).
FIRST USE 8-1-1927; IN COMMERCE 8-1-1927.
KAPIL BHANOT, EXAMINING ATTORNEY

SN 77-122,442. ERE MEDIA, INC., NEW YORK, NY. FILED 3-5-2007.

NO CLAIM IS MADE TO THE EXCLUSIVE RIGHT TO USE "EXPO", APART FROM THE MARK AS SHOWN.

THE COLOR(S) BLUE AND BLACK IS/ARE CLAIMED AS A FEATURE OF THE MARK.

THE MARK CONSISTS OF THE WORD "ERE", RENDERED IN BLACK BOLD HELVETICA FONT, WITH FIVE SOLID BLUE CIRCLES OF INCREASING SIZE ABOVE THE WORD ARRANGED IN A HALF CIRCLE, FOLLOWED BY THE WORD "EXPO" RENDERED IN BLUE BOLD HELVETICA FONT, WITH AN X THAT EXTENDS DOWN AND WITH FIVE SOLID BLACK CIRCLES OF DECREASING SIZE BELOW THE WORD ARRANGED IN A HALF CIRCLE.

CLASS 35—ADVERTISING AND BUSINESS

FOR ARRANGING AND CONDUCTING BUSINESS CONFERENCES (U.S. CLS. 100, 101 AND 102).
FIRST USE 6-23-2006; IN COMMERCE 6-23-2006.

CLASS 41—EDUCATION AND ENTERTAINMENT

FOR ARRANGING AND CONDUCTING EDUCATIONAL CONFERENCES; ARRANGING OF EXHIBITIONS, SEMINARS AND CONFERENCES; ARRANGING OF SEMINARS AND CONFERENCES; EDUCATION IN THE FIELD OF RECRUITING RENDERED THROUGH VIDEO CONFERENCE; EDUCATIONAL SERVICES, NAMELY, CONDUCTING SEMINARS, CONFERENCES, CLASSES OR WORKSHOPS IN THE FIELD OF RECRUITING AND DISTRIBUTION OF COURSE MATERIAL IN CONNECTION THEREWITH; EDUCATIONAL SERVICES, NAMELY, DEVELOPING, ARRANGING, AND CONDUCTING EDUCATIONAL CONFERENCES AND PROGRAMS AND PROVIDING COURSES OF INSTRUCTION IN THE FIELD OF RECRUITING; EDUCATIONAL SERVICES, NAMELY, CONDUCTING SEMINARS, CONFERENCES, CLASSES OR WORKSHOPS IN THE FIELD OF RECRUITING (U.S. CLS. 100, 101 AND 107).

FIRST USE 6-23-2006; IN COMMERCE 6-23-2006.
KEVON CHISOLM, EXAMINING ATTORNEY

SN 77-122,856. MARGERY MELCHIODE, DALLAS, TX. FILED 3-6-2007.

THE COLOR(S) GREEN, PURPLE, AND ORANGE IS/ARE CLAIMED AS A FEATURE OF THE MARK.

THE MARK CONSISTS OF THE WORDS, "THE PURPLE TANGERINE," IN STYLIZED FORM, WITH THE WORD, "THE" DEPICTED IN GREEN, AND OUTLINED IN ORANGE; WITH THE WORD, "PURPLE," APPEARING IN PURPLE, AND OUTLINED IN ORANGE, AND WITH THE WORD, "TANGERINE," APPEARING IN ORANGE, AND OUTLINED IN PURPLE.

CLASS 25—CLOTHING

FOR NECKWEAR; SHAWLS; SCARVES; HOODS; BLOUSES; SKIRTS; T-SHIRTS; SHOES; BELTS (U.S. CLS. 22 AND 39).

FIRST USE 6-1-2005; IN COMMERCE 6-1-2005.

CLASS 35—ADVERTISING AND BUSINESS

FOR RETAIL CLOTHING BOUTIQUES; RETAIL GIFT SHOPS; ON-LINE RETAIL STORE SERVICES FEATURING CLOTHING, SHOES, FASHION ACCESSORIES, AND AFGHANS (U.S. CLS. 100, 101 AND 102).

FIRST USE 6-1-2005; IN COMMERCE 6-1-2005.
KELLY MCCOY, EXAMINING ATTORNEY

SN 77-123,528. SCANA CORPORATION, COLUMBIA, SC.
FILED 3-6-2007.

SN 77-123,704. SYSTEM OF EMPORIUM, TOKYO, JAPAN,
FILED 3-6-2007.



OWNER OF U.S. REG. NO. 2,603,662.

CLASS 35—ADVERTISING AND BUSINESS

FOR PROVIDING CONSUMER INFORMATION IN THE FIELD OF POWER GENERATION AND TRANSMISSION VIA THE INTERNET (U.S. CLS. 100, 101 AND 102).

CLASS 36—INSURANCE AND FINANCIAL

FOR ELECTRONIC PAYMENT, NAMELY, ELECTRONIC PROCESSING AND TRANSMISSION OF BILL PAYMENT DATA (U.S. CLS. 100, 101 AND 102).

CLASS 39—TRANSPORTATION AND STORAGE

FOR PUBLIC UTILITY SERVICES (U.S. CLS. 100 AND 105).
GRETTA YAO, EXAMINING ATTORNEY

SN 77-123,531. SCANA CORPORATION, COLUMBIA, SC.
FILED 3-6-2007.



OWNER OF U.S. REG. NOS. 1,954,921 AND 2,221,862.

CLASS 35—ADVERTISING AND BUSINESS

FOR PROVIDING CONSUMER INFORMATION IN THE FIELD OF POWER GENERATION AND TRANSMISSION VIA THE INTERNET (U.S. CLS. 100, 101 AND 102).

CLASS 36—INSURANCE AND FINANCIAL

FOR ELECTRONIC PAYMENT, NAMELY, ELECTRONIC PROCESSING AND TRANSMISSION OF BILL PAYMENT DATA (U.S. CLS. 100, 101 AND 102).

CLASS 39—TRANSPORTATION AND STORAGE

FOR PUBLIC UTILITY SERVICES (U.S. CLS. 100 AND 105).
GRETTA YAO, EXAMINING ATTORNEY

SYSTEM OF EMPORIUM

THE MARK CONSISTS OF STANDARD CHARACTERS WITHOUT CLAIM TO ANY PARTICULAR FONT, STYLE, SIZE, OR COLOR.

CLASS 14—JEWELRY

FOR JEWELRY; PRECIOUS GEMSTONES; COSTUME JEWELRY; WATCHES, WATCH BANDS; WATCHES AND WATCHBANDS MADE OF PRECIOUS METAL OR COATED THEREWITH. (U.S. CLS. 2, 27, 28 AND 50).

CLASS 18—LEATHER GOODS

FOR LUGGAGE, HANDBAGS, TOTE BAGS, ALL PURPOSE ATHLETIC BAGS, TRAVEL BAGS, ATHLETIC BAGS, MULTI-PURPOSE LEATHER CARRY-ON BAGS, BACKPACKS, POCKETBOOKS AND BRIEFCASES (U.S. CLS. 1, 2, 3, 22 AND 41).

CLASS 25—CLOTHING

FOR APPAREL, NAMELY, JEANS, PANTS, SHORTS, TOPS, SHIRTS, BLOUSES, VESTS, SINGLET, TURTLE-NECKS, POLO SHIRTS, T-SHIRTS, SWEATSHIRTS; OUTERWEAR, NAMELY, COATS, JACKETS AND PARKAS; HEADWEAR, NAMELY, HATS, CAPS, AND VISORS; BELTS, SKIRTS, DRESSES, SUITS, OVERALLS AND FOOTWEAR IN ADULT, CHILDREN'S AND INFANTS' SIZES, WOMEN'S HEAD SCARVES (U.S. CLS. 22 AND 39).

JAY BESCH, EXAMINING ATTORNEY

SN 77-123,935. TANA, NICHOLAS D., TEMPE, AZ. FILED 3-6-2007.

Bony Macaroni and Sidekick Stick

THE MARK CONSISTS OF STANDARD CHARACTERS WITHOUT CLAIM TO ANY PARTICULAR FONT, STYLE, SIZE, OR COLOR.

CLASS 9—ELECTRICAL AND SCIENTIFIC APPARATUS

FOR VIDEO GAME CARTRIDGES; COMPUTER GAME CASSETTES; COMPUTER GAME EQUIPMENT, NAMELY, JOYSTICKS AND COMPUTER MICE; MOTION PICTURE FILMS ABOUT ACTION ADVENTURE; PRERECORDED VIDEO TAPES AND VIDEO DISCS FEATURING CHILDREN'S ANIMATED MOTION PICTURES AND CHILDREN'S ANIMATED TELEVISION SERIES; CD-ROMS FEATURING COMPUTER GAMES; PRERECORDED AUDIO CASSETTES FEATURING MUSIC AND STORIES; MOUSE PADS; COMPUTER SOFTWARE FOR USE AS A SCREEN SAVER; VIRTUAL REALITY SOFTWARE IN THE FIELD OF VIDEO GAMES; SUNGLASSES AND SUNGLASS CASES; DECORATIVE MAGNETS; AND PROTECTIVE AND SAFETY HELMETS FOR CATCHERS AND FOOTBALL PLAYERS; GRADUATED RULERS (U.S. CLS. 21, 23, 26, 36 AND 38).

CLASS 16—PAPER GOODS AND PRINTED MATTER

FOR COMIC BOOKS, COLORING BOOKS, CHILDREN'S BOOKS, SERIES OF FICTION BOOKS, TRADING CARDS, POSTERS, CARTOON PRINTS, NEWSPAPER CARTOONS, CHILDREN'S ACTIVITY BOOKS, NEWSPAPER COMIC STRIPS, PAPER PARTY BAGS, BALL-POINT PENS, PAPER BANNERS, BOOK COVERS, BOOK HOLDERS, BUMPER STICKERS, CALENDARS, GREETING CARDS, PEN AND PENCIL CASES, PAPER PARTY DECORATIONS, ERASERS, HANGING FOLDERS, GIFT WRAPPING PAPER, PAPER PARTY HATS, MAGAZINES IN THE FIELD OF ENTERTAINMENT, MARKERS, MERCHANDISE BAGS, NEWSLETTERS FEATURING INFORMATION ABOUT ANIMATION FILMS, PAPER NAPKINS, PAPER TABLECLOTHS, NOTEBOOKS, PENCILS, PENCIL SHARPENERS, PICTURES, RUBBER STAMPS, SCRAPBOOK ALBUMS, STAMP ALBUMS, STAMP PADS, PAPER FLAGS, PAPER PENNANTS, STICKERS AND WRITING TABLETS (U.S. CLS. 2, 5, 22, 23, 29, 37, 38 AND 50).
REBECCA EISINGER, EXAMINING ATTORNEY

SN 77-124,480. EAST COAST KARATE, INC., CANTON, OH.
FILED 3-7-2007.

MMAFIT

SN 77-124,338. TRANSNATIONAL ROOFING PRODUCTS COMPANY, REYNOLDSBURG, OH. FILED 3-7-2007.

STAFAST

THE MARK CONSISTS OF STANDARD CHARACTERS WITHOUT CLAIM TO ANY PARTICULAR FONT, STYLE, SIZE, OR COLOR.

THE MARK CONSISTS OF STANDARD CHARACTERS WITHOUT CLAIM TO ANY PARTICULAR FONT, STYLE, SIZE, OR COLOR.

CLASS 1—CHEMICALS

FOR BUTYL-BASED ADHESIVE FOR SEAM BONDING EPDM ROOFING MEMBRANES; NEOPRENE-BASED ADHESIVE FOR BONDING EPDM ROOFING MEMBRANES TO ROOF SUBSTRATUM; COMBINATION NEOPRENE AND BUTYL-BASED ADHESIVE FOR SEAM BONDING EPDM ROOFING MEMBRANES AND BONDING EPDM ROOFING MEMBRANES TO ROOF SUBSTRATUM; ADHESIVE FOR SECURING THERMAL INSULATION SHEETS TO ROOF SUBSTRATUM; AND PRIMER FOR THE PREPARATION OF EPDM ROOFING MEMBRANES FOR ADHESIVE BONDING BUT NOT INCLUDING MATERIALS THAT WOULD BE INGREDIENTS USED IN THE MANUFACTURE OF FINISHED ADHESIVE PRODUCTS (U.S. CLS. 1, 5, 6, 10, 26 AND 46).

FIRST USE 1-12-1989; IN COMMERCE 1-12-1989.

CLASS 19—NON-METALLIC BUILDING MATERIALS

FOR BUILDING ROOF COVERINGS, SYSTEMS AND ACCESSORIES THEREFOR; NAMELY, VULCANIZED ELASTOMERIC ROOFING MEMBRANES FABRICATED FROM ETHYLENE PROPYLENE DIENE MONOMER (EPDM); PREFORMED AND STRIP FORM ROOF FLASHING FABRICATED FROM NEOPRENE OR EPDM MATERIAL IN BOTH CURED AND UNCURED STATES; POURABLE SEALER; NAMELY, AN EPOXY MATERIAL USED TO SEAL OPEN SPACES AROUND PIPES ON ROOFS BUT NOT INCLUDING MATERIALS THAT WOULD BE INGREDIENTS USED IN THE MANUFACTURE OF FINISHED ADHESIVE PRODUCTS (U.S. CLS. 1, 12, 33 AND 50).

FIRST USE 1-12-1989; IN COMMERCE 1-12-1989.
KENNETH E. SHARPERSON, EXAMINING ATTORNEY

CLASS 9—ELECTRICAL AND SCIENTIFIC APPARATUS

FOR PRE-RECORDED DIGITAL AUDIO TAPE FEATURING SPORTS AND INSTRUCTION IN SPORTS, MARTIAL ARTS AND PHYSICAL FITNESS; PRE-RECORDED DIGITAL VIDEO DISKS FEATURING SPORTS AND INSTRUCTION IN SPORTS, MARTIAL ARTS AND PHYSICAL FITNESS; PRE-RECORDED VIDEO CASSETTES FEATURING SPORTS AND INSTRUCTION IN SPORTS, MARTIAL ARTS AND PHYSICAL FITNESS; PRE-RECORDED VIDEO TAPES FEATURING MARTIAL ARTS AND PHYSICAL FITNESS INSTRUCTION (U.S. CLS. 21, 23, 26, 36 AND 38).

CLASS 25—CLOTHING

FOR BASEBALL CAPS, BOXER SHORTS, GLOVES, GOLF CAPS, GYM SHORTS, GYM SUITS, HEAD SWEATBANDS, HOODS, JACKETS, JOGGING OUTFITS, JOGGING PANTS, JOGGING SUITS, JUDO SUITS, KARATE SUITS, LINGERIE, MARTIAL ARTS UNIFORMS, NIGHT SHIRTS, NIGHTIES, PAJAMAS, POLO SHIRTS, SHIRTS, SHORT-SLEEVED OR LONG-SLEEVED T-SHIRTS, SHORT-SLEEVED SHIRTS, SPORTS SHIRTS, SPORTS JACKETS, SWEAT PANTS, SWEAT SHIRTS, SWEAT SHORTS, SWEAT SUITS, SWEATBANDS, T-SHIRTS, TANK TOPS, TEDDIES AND WARM-UP SUITS (U.S. CLS. 22 AND 39).

CLASS 41—EDUCATION AND ENTERTAINMENT

FOR INSTRUCTION IN THE FIELDS OF MARTIAL ARTS AND PHYSICAL FITNESS (U.S. CLS. 100, 101 AND 107).

REBECCA EISINGER, EXAMINING ATTORNEY

SN 77-124,638. ESTHER D. HARRIS, LITHONIA, GA. FILED 3-7-2007.



THE COLOR(S) BROWN, GOLD, RED, AND PURPLE IS/ ARE CLAIMED AS A FEATURE OF THE MARK.
 THE COLOR BROWN APPEARS IN THE DESIGN OF THE PAPER GROCERY BAG; THE COLOR PURPLE APPEARS IN THE LETTERING "HGS" AND THE THREE STONES ON THE CROWN; THE COLOR GOLD APPEARS IN THE DESIGN OF THE CROWN, CROSS, AND HALO; THE COLOR RED APPEARS IN THE DESIGN OF THE RIBBON DRAPED AROUND THE CROSS.

CLASS 20—FURNITURE AND ARTICLES NOT OTHERWISE CLASSIFIED

FOR PILLOWS (U.S. CLS. 2, 13, 22, 25, 32 AND 50).

CLASS 24—FABRICS

FOR BED BLANKETS (U.S. CLS. 42 AND 50).

CLASS 27—FLOOR COVERINGS

FOR PERSONAL SITTING MATS (U.S. CLS. 19, 20, 37, 42 AND 50).
 JOHN KELLY, EXAMINING ATTORNEY

SN 77-124,988. OPTISCAN BIOMEDICAL CORPORATION, HAYWARD, CA. FILED 3-7-2007.

OptiScan

THE MARK CONSISTS OF STANDARD CHARACTERS WITHOUT CLAIM TO ANY PARTICULAR FONT, STYLE, SIZE, OR COLOR.

CLASS 10—MEDICAL APPARATUS

FOR MEDICAL DEVICES, NAMELY, MONITORS TO DETERMINE THE CONCENTRATION OF GLUCOSE AND OTHER CONSTITUENTS IN THE HUMAN BODY, AND DISPOSABLE CARTRIDGES FOR USE THEREWITH (U.S. CLS. 26, 39 AND 44).

CLASS 44—MEDICAL, BEAUTY AND AGRICULTURAL SERVICES

FOR PROVIDING MEDICAL INFORMATION IN THE FIELDS OF MANAGEMENT AND MEASUREMENT OF GLUCOSE AND OTHER CONSTITUENTS IN THE HUMAN BODY AND IN THE DIAGNOSIS AND TREATMENT OF DIABETES (U.S. CLS. 100 AND 101).
 FRANK LATTUCA, EXAMINING ATTORNEY

SN 77-125,249. BLOOMSBURY PUBLISHING PLC, LONDON, UNITED KINGDOM, FILED 3-8-2007.

WALKER & COMPANY

THE MARK CONSISTS OF STANDARD CHARACTERS WITHOUT CLAIM TO ANY PARTICULAR FONT, STYLE, SIZE, OR COLOR.
 NO CLAIM IS MADE TO THE EXCLUSIVE RIGHT TO USE "COMPANY", APART FROM THE MARK AS SHOWN.

CLASS 9—ELECTRICAL AND SCIENTIFIC APPARATUS

FOR COMPUTER SOFTWARE, NAMELY SOFTWARE FOR USE IN DOWNLOADING, STORING, REPRODUCING AND ORGANIZING AUDIO, VIDEO, STILL AND MOVING IMAGES AND DATA; ANIMATED CARTOONS RECORDED ON VIDEO DISKS AND VIDEO TAPES; ELECTRONIC DATABASES RELATED TO PUBLISHING RECORDED ON COMPUTER MEDIA; DESKTOP PUBLISHING SOFTWARE; EDUCATIONAL SOFTWARE FEATURING INSTRUCTION ON A VARIETY OF TOPICS; GAME SOFTWARE; COMPUTER MOUSE MATS; DOWNLOADABLE ELECTRONIC PUBLICATIONS OF MAGAZINES AND JOURNALS ON A VARIETY OF TOPICS (U.S. CLS. 21, 23, 26, 36 AND 38).

CLASS 16—PAPER GOODS AND PRINTED MATTER

FOR MAGAZINES, CATALOGS, EVENT PROGRAMS AND JOURNALS ON A VARIETY OF TOPICS; PHOTOGRAPHS; STATIONERY; PRINTED INSTRUCTIONAL, EDUCATIONAL, AND TEACHING MATERIALS ON A VARIETY OF TOPICS; PRINTING BLOCKS; BOOK BINDING MATERIALS; POSTERS; CARDS, NAMELY, POSTCARDS; GREETINGS CARDS; PRINTED INVITATIONS; DIARIES; CALENDARS; PHOTOGRAPH ALBUMS; PRINTS AND FRAMED PRINTS; NOTEPADS; CRAYONS; STICKERS; TRANSFERS (DECALCOMANIAS); STAMPS; PERSONAL ORGANIZERS; ADDRESS BOOKS; NOTE BOOKS (U.S. CLS. 2, 5, 22, 23, 29, 37, 38 AND 50).

CLASS 41—EDUCATION AND ENTERTAINMENT

FOR MULTIMEDIA PUBLISHING OF BOOKS, MAGAZINES, JOURNALS, SOFTWARE, GAMES, MUSIC, AND ELECTRONIC PUBLICATIONS; PUBLISHING OF BOOKS, MAGAZINES, JOURNALS, REVIEWS AND ELECTRONIC PUBLICATIONS; LANGUAGE TEACHING; ENTERTAINMENT SERVICES NAMELY PROVIDING A WEB SITE FEATURING, PHOTOGRAPHIC, AUDIO, VIDEO AND PROSE PRESENTATIONS ON A VARIETY OF FICTION AND NON-FICTION TOPICS INCLUDING MUSIC, CONCERTS, FILM, VIDEOS, THEATRE, RADIO, TELEVISION, NEWS, SPORTS, GAMES AND CULTURAL EVENTS AND ENTERTAINMENT-RELATED PROGRAMS (U.S. CLS. 100, 101 AND 107).
 JOHN HWANG, EXAMINING ATTORNEY

SN 77-125,586, VRETS, LLC, COLORADO SPRINGS, CO.
FILED 3-8-2007.



NO CLAIM IS MADE TO THE EXCLUSIVE RIGHT TO USE REAL ESTATE TRAINING, APART FROM THE MARK AS SHOWN.

THE MARK CONSISTS OF OF THE WORDS "VRETS REAL ESTATE TRAINING" WITH A CHECKMARK SERVING AS A STYLIZED "V" FOR "VRETS" WITH A STYLIZED BUILDING AND STYLIZED COMPUTER, AND A BAR THROUGH "REAL ESTATE."

CLASS 9—ELECTRICAL AND SCIENTIFIC APPARATUS

FOR COMPACT DISKS AND DVDS FEATURING PRERECORDED INSTRUCTION MATERIALS IN THE FIELD OF REAL ESTATE TRAINING (U.S. CLS. 21, 23, 26, 36 AND 38).

FIRST USE 2-6-2007; IN COMMERCE 3-2-2007.

CLASS 41—EDUCATION AND ENTERTAINMENT

FOR EDUCATIONAL SERVICES NAMELY CONDUCTING PROGRAMS IN THE FIELD OF REAL ESTATE AND PROVIDING OF TRAINING IN THE FIELD OF REAL ESTATE (U.S. CLS. 100, 101 AND 107).

FIRST USE 2-6-2007; IN COMMERCE 3-2-2007.
PAUL CROWLEY, EXAMINING ATTORNEY

SN 77-125,643, GOAT FUNCTION, LLC, BOULDER, CO.
FILED 3-8-2007.

TECHNICALLY CORRECT : ALWAYS APPROPRIATE

THE MARK CONSISTS OF STANDARD CHARACTERS WITHOUT CLAIM TO ANY PARTICULAR FONT, STYLE, SIZE, OR COLOR.

CLASS 18—LEATHER GOODS

FOR ALL-PURPOSE CARRYING BAGS; CARRY-ALL BAGS; CARRY-ON BAGS; DUFFEL BAGS; DUFFLE BAGS; GARMENT BAGS FOR TRAVEL; LEATHER BAGS; SUITCASES AND WALLETS; MESSENGER BAGS; OVERNIGHT BAGS; ROLL BAGS; SHAVING BAGS SOLD EMPTY; SHOULDER BAGS; SLING BAGS; SMALL BAGS FOR MEN; TRAVEL BAGS (U.S. CLS. 1, 2, 3, 22 AND 41).

FIRST USE 6-1-2006; IN COMMERCE 1-20-2007.

CLASS 25—CLOTHING

FOR DENIM JACKETS; DOWN JACKETS; HATS; HEAVY JACKETS; JACKETS; MEN AND WOMEN JACKETS; COATS, TROUSERS, VESTS; RAINPROOF JACKETS; SKI JACKETS; SLEEVED OR SLEEVELESS JACKETS; SPORTS JACKETS; TOBOGGAN HATS, PANTS AND CAPS; WIND RESISTANT JACKETS; WOOLLY HATS (U.S. CLS. 22 AND 39).

FIRST USE 6-1-2006; IN COMMERCE 1-20-2007.
PAUL CROWLEY, EXAMINING ATTORNEY

SN 77-125,820, ADVANCED INTEGRATED SOLUTIONS,
BREA, CA. FILED 3-8-2007.

Advanced Integrated Solutions

THE MARK CONSISTS OF STANDARD CHARACTERS WITHOUT CLAIM TO ANY PARTICULAR FONT, STYLE, SIZE, OR COLOR.

OWNER OF U.S. REG. NO. 2,543,879.

NO CLAIM IS MADE TO THE EXCLUSIVE RIGHT TO USE INTEGRATED SOLUTIONS, APART FROM THE MARK AS SHOWN.

CLASS 41—EDUCATION AND ENTERTAINMENT

FOR TRAINING IN THE USE OF COMPUTER NETWORKS, COMPUTER SERVERS, COMPUTER EQUIPMENT, COMPUTER SOFTWARE, AND COMPUTER ADMINISTRATION SYSTEMS, AND THE DISTRIBUTION OF WRITTEN MATERIALS IN CONNECTION THEREWITH (U.S. CLS. 100, 101 AND 107).

FIRST USE 3-30-1998; IN COMMERCE 3-30-1998.

CLASS 42—SCIENTIFIC, COMPUTER AND LEGAL SERVICES

FOR COMPUTER SERVICES FOR OTHERS, NAMELY, DESIGN AND DEVELOPMENT OF COMPUTER NETWORKS, COMPUTER PROJECT MANAGEMENT, MONITORING THE COMPUTER SYSTEMS OF OTHERS FOR TECHNICAL PURPOSES, UPDATING OF COMPUTER SOFTWARE, AND COMPUTER SYSTEM ADMINISTRATION; STRATEGIC PLANNING, NAMELY, CONSULTATION SERVICES IN THE FIELDS OF SELECTION, IMPLEMENTATION AND USE OF COMPUTER HARDWARE AND SOFTWARE SYSTEMS FOR OTHERS; INTEGRATION OF COMPUTER SYSTEMS AND NETWORKS; COMPUTER SERVICES FOR OTHERS, NAMELY REDESIGNING, MIGRATING, AND PROVIDING TRANSITIONAL COMPUTER HARDWARE AND SOFTWARE FOR USE DURING MIGRATIONS, ALL FOR COMPUTER NETWORKS; COMPUTER CONSULTATION; COMPUTER SOFTWARE CONSULTATION; TECHNICAL SUPPORT SERVICES, NAMELY, TROUBLESHOOTING OF COMPUTER HARDWARE AND SOFTWARE PROBLEMS; DESIGN, DEVELOPMENT AND TECHNICAL SUPPORT OF THE COMPUTER SERVERS OF OTHERS; COMPUTER TECHNICAL SUPPORT SERVICES, NAMELY, PROVIDING SOFTWARE, HARDWARE, EQUIPMENT AND INTEGRATION SUPPORT SERVICES VIA TELEPHONE, E-MAIL, AND IN PERSON (U.S. CLS. 100 AND 101).

FIRST USE 3-30-1998; IN COMMERCE 3-30-1998.

JAMES MACFARLANE, EXAMINING ATTORNEY

SN 77-125,850, ADVANCED INTEGRATED SOLUTIONS,
BREA, CA. FILED 3-8-2007.

AI S

THE MARK CONSISTS OF STANDARD CHARACTERS WITHOUT CLAIM TO ANY PARTICULAR FONT, STYLE, SIZE, OR COLOR.

OWNER OF U.S. REG. NO. 2,562,859.

CLASS 41—EDUCATION AND ENTERTAINMENT

FOR TRAINING IN THE USE OF COMPUTER NETWORKS, COMPUTER SERVERS, COMPUTER EQUIPMENT, COMPUTER SOFTWARE, AND COMPUTER ADMINISTRATION SYSTEMS, AND THE DISTRIBUTION OF WRITTEN MATERIALS IN CONNECTION THEREWITH (U.S. CLS. 100, 101 AND 107).

FIRST USE 3-30-1998; IN COMMERCE 3-30-1998.

CLASS 42—SCIENTIFIC, COMPUTER AND LEGAL SERVICES

FOR COMPUTER SERVICES FOR OTHERS, NAMELY, DESIGN AND DEVELOPMENT OF COMPUTER NETWORKS, COMPUTER PROJECT MANAGEMENT, MONITORING THE COMPUTER SYSTEMS OF OTHERS FOR TECHNICAL PURPOSES, UPDATING OF COMPUTER SOFTWARE, AND COMPUTER SYSTEM ADMINISTRATION; STRATEGIC PLANNING, NAMELY, CONSULTATION SERVICES IN THE FIELDS OF SELECTION, IMPLEMENTATION AND USE OF COMPUTER HARDWARE AND SOFTWARE SYSTEMS FOR OTHERS; INTEGRATION OF COMPUTER SYSTEMS AND NETWORKS; COMPUTER SERVICES FOR OTHERS, NAMELY REDESIGNING, MIGRATING, AND PROVIDING TRANSITIONAL COMPUTER HARDWARE AND SOFTWARE FOR USE DURING MIGRATIONS, ALL FOR COMPUTER NETWORKS; COMPUTER CONSULTATION; COMPUTER SOFTWARE CONSULTATION; TECHNICAL SUPPORT SERVICES, NAMELY, TROUBLESHOOTING OF COMPUTER HARDWARE AND SOFTWARE PROBLEMS; DESIGN, DEVELOPMENT AND TECHNICAL SUPPORT OF THE COMPUTER SERVERS OF OTHERS; COMPUTER TECHNICAL SUPPORT SERVICES, NAMELY, PROVIDING SOFTWARE, HARDWARE, EQUIPMENT AND INTEGRATION SUPPORT SERVICES VIA TELEPHONE, E-MAIL, AND IN PERSON (U.S. CLS. 100 AND 101).

FIRST USE 3-30-1998; IN COMMERCE 3-30-1998.

JAMES MACFARLANE, EXAMINING ATTORNEY

SN 77-126,539. BLOOMSBURY PUBLISHING PLC, LONDON, UNITED KINGDOM, FILED 3-9-2007.

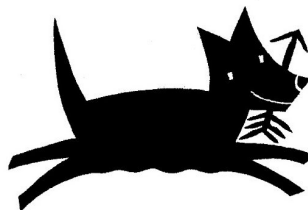

THE MARK CONSISTS OF A DOG WITH AN ARROW IN ITS MOUTH.

CLASS 9—ELECTRICAL AND SCIENTIFIC APPARATUS

FOR COMPUTER SOFTWARE, NAMELY SOFTWARE FOR USE IN DOWNLOADING, STORING, REPRODUCING AND ORGANIZING AUDIO, VIDEO, STILL AND MOVING IMAGES AND DATA; ANIMATED CARTOONS RECORDED ON VIDEO DISKS AND VIDEO TAPES; ELECTRONIC DATABASES RELATED TO PUBLISHING RECORDED ON COMPUTER MEDIA; DESKTOP PUBLISHING SOFTWARE; EDUCATIONAL SOFTWARE FEATURING INSTRUCTION ON A VARIETY OF TOPICS; GAME SOFTWARE; COMPUTER MOUSE MATS; DOWNLOADABLE ELECTRONIC PUBLICATIONS OF MAGAZINES AND JOURNALS ON A VARIETY OF TOPICS (U.S. CLS. 21, 23, 26, 36 AND 38).

SN 77-126,434. GILLZNFINZ.COM, LLC, JOHNS ISLAND, SC. FILED 3-9-2007.

GILLZNFINZ

THE MARK CONSISTS OF STANDARD CHARACTERS WITHOUT CLAIM TO ANY PARTICULAR FONT, STYLE, SIZE, OR COLOR.

CLASS 38—COMMUNICATION

FOR STREAMING OF AUDIO AND VIDEO MATERIAL ON THE INTERNET (U.S. CLS. 100, 101 AND 104).

CLASS 41—EDUCATION AND ENTERTAINMENT

FOR ENTERTAINMENT SERVICES, NAMELY PROVIDING A WEBSITE FEATURING PHOTOGRAPHIC, AUDIO, VIDEO AND PROSE PRESENTATIONS FEATURING FISHING; PRODUCTION OF PROGRAMMING CONCERNING FISHING STREAMED OVER THE INTERNET (U.S. CLS. 100, 101 AND 107).

SETH A. RAPPAPORT, EXAMINING ATTORNEY

CLASS 16—PAPER GOODS AND PRINTED MATTER

FOR MAGAZINES, CATALOGS, EVENT PROGRAMS AND JOURNALS ON A VARIETY OF TOPICS; PHOTOGRAPHS; STATIONERY; PRINTED INSTRUCTIONAL, EDUCATIONAL, AND TEACHING MATERIALS ON A VARIETY OF TOPICS; PRINTING BLOCKS; BOOK BINDING MATERIALS; POSTERS; CARDS, NAMELY, POSTCARDS; GREETINGS CARDS; PRINTED INVITATIONS; DIARIES; CALENDARS; PHOTOGRAPH ALBUMS; PRINTS AND FRAMED PRINTS; NOTEPADS; WRITING INSTRUMENTS AND CRAYONS; STICKERS; TRANSFERS (DECALCOMANIAS); STAMPS; PERSONAL ORGANIZERS; ADDRESS BOOKS; NOTE BOOKS; PEN AND PENCIL HOLDERS (U.S. CLS. 2, 5, 22, 23, 29, 37, 38 AND 50).

CLASS 41—EDUCATION AND ENTERTAINMENT

FOR MULTIMEDIA PUBLISHING OF BOOKS, MAGAZINES, JOURNALS, SOFTWARE, GAMES, MUSIC, AND ELECTRONIC PUBLICATIONS; PUBLISHING OF BOOKS, MAGAZINES, JOURNALS, REVIEWS AND ELECTRONIC PUBLICATIONS; LANGUAGE TEACHING; ENTERTAINMENT SERVICES NAMELY PROVIDING A WEB SITE FEATURING, PHOTOGRAPHIC, AUDIO, VIDEO AND PROSE PRESENTATIONS ON A VARIETY OF FICTION AND NON-FICTION TOPICS INCLUDING MUSIC, CONCERTS, FILM, VIDEOS, THEATRE, RADIO, TELEVISION, NEWS, SPORTS, GAMES AND CULTURAL EVENTS AND ENTERTAINMENT-RELATED PROGRAMS (U.S. CLS. 100, 101 AND 107).

JOHN HWANG, EXAMINING ATTORNEY

SN 77-126,564. GECKOLOGIC GMBH, ASSLAR, HESSEN, FED REP GERMANY, FILED 3-9-2007.

Gecko

THE MARK CONSISTS OF STANDARD CHARACTERS WITHOUT CLAIM TO ANY PARTICULAR FONT, STYLE, SIZE, OR COLOR.

CLASS 7—MACHINERY

FOR SOLAR-POWERED ELECTRICITY GENERATORS (U.S. CLS. 13, 19, 21, 23, 31, 34 AND 35).

CLASS 9—ELECTRICAL AND SCIENTIFIC APPARATUS

FOR APPARATUS FOR CONVERTING ELECTRONIC RADIATION TO ELECTRICAL ENERGY, NAMELY PHOTOVOLTAIC SOLAR MODULES (U.S. CLS. 21, 23, 26, 36 AND 38).

EMILY CARLSEN, EXAMINING ATTORNEY

SN 77-126,983. BLOOMSBURY PUBLISHING PLC, LONDON, UNITED KINGDOM, FILED 3-9-2007.



THE MARK CONSISTS OF DOG HEAD WITH ARROW IN ITS MOUTH.

CLASS 9—ELECTRICAL AND SCIENTIFIC APPARATUS

FOR COMPUTER SOFTWARE, NAMELY SOFTWARE FOR USE IN DOWNLOADING, STORING, REPRODUCING AND ORGANIZING AUDIO, VIDEO, STILL AND MOVING IMAGES AND DATA; ANIMATED CARTOONS RECORDED ON VIDEO DISKS AND VIDEO TAPES; ELECTRONIC DATABASES RELATED TO PUBLISHING RECORDED ON COMPUTER MEDIA; DESKTOP PUBLISHING SOFTWARE; EDUCATIONAL SOFTWARE FEATURING INSTRUCTION ON A VARIETY OF TOPICS; GAME SOFTWARE; COMPUTER MOUSE MATS; DOWNLOADABLE ELECTRONIC PUBLICATIONS OF MAGAZINES AND JOURNALS ON A VARIETY OF TOPICS (U.S. CLS. 21, 23, 26, 36 AND 38).

CLASS 16—PAPER GOODS AND PRINTED MATTER

FOR MAGAZINES, CATALOGS, EVENT PROGRAMS AND JOURNALS ON A VARIETY OF TOPICS; PHOTOGRAPHS; STATIONERY; PRINTED INSTRUCTIONAL, EDUCATIONAL, AND TEACHING MATERIALS ON A VARIETY OF TOPICS; PRINTING BLOCKS; BOOK BINDING MATERIALS; POSTERS; CARDS, NAMELY, POSTCARDS; GREETINGS CARDS; PRINTED INVITATIONS; DIARIES; CALENDARS; PHOTOGRAPH ALBUMS; PRINTS AND FRAMED PRINTS; NOTEPADS; WRITING INSTRUMENTS AND CRAYONS; STICKERS; TRANSFERS (DECALCOMANIAS); STAMPS; PERSONAL ORGANIZERS; ADDRESS BOOKS; NOTE BOOKS; PEN AND PENCIL HOLDERS (U.S. CLS. 2, 5, 22, 23, 29, 37, 38 AND 50).

CLASS 41—EDUCATION AND ENTERTAINMENT

FOR MULTIMEDIA PUBLISHING OF BOOKS, MAGAZINES, JOURNALS, SOFTWARE, GAMES, MUSIC, AND ELECTRONIC PUBLICATIONS; PUBLISHING OF BOOKS, MAGAZINES, JOURNALS, REVIEWS AND ELECTRONIC PUBLICATIONS; LANGUAGE TEACHING; ENTERTAINMENT SERVICES NAMELY PROVIDING A WEBSITE FEATURING, PHOTOGRAPHIC, AUDIO, VIDEO AND PROSE PRESENTATIONS ON A VARIETY OF FICTION AND NON-FICTION TOPICS INCLUDING MUSIC, CONCERTS, FILM, VIDEOS, THEATRE, RADIO, TELEVISION, NEWS, SPORTS, GAMES AND CULTURAL EVENTS AND ENTERTAINMENT-RELATED PROGRAMS (U.S. CLS. 100, 101 AND 107).

JOHN HWANG, EXAMINING ATTORNEY

SN 77-127,060. BLOOMSBURY PUBLISHING PLC, LONDON, UNITED KINGDOM, FILED 3-9-2007.

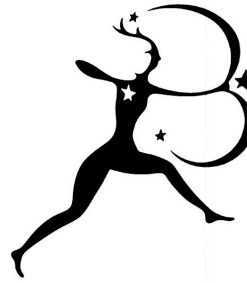

THE MARK CONSISTS OF WOMAN SHOOTING AN ARROW.

CLASS 9—ELECTRICAL AND SCIENTIFIC APPARATUS

FOR COMPUTER SOFTWARE, NAMELY SOFTWARE FOR USE IN DOWNLOADING, STORING, REPRODUCING AND ORGANIZING AUDIO, VIDEO, STILL AND MOVING IMAGES AND DATA; ANIMATED CARTOONS RECORDED ON VIDEO DISKS AND VIDEO TAPES; ELECTRONIC DATABASES RELATED TO PUBLISHING RECORDED ON COMPUTER MEDIA; DESKTOP PUBLISHING SOFTWARE; EDUCATIONAL SOFTWARE FEATURING INSTRUCTION ON A VARIETY OF TOPICS; GAME SOFTWARE; COMPUTER MOUSE MATS; DOWNLOADABLE ELECTRONIC PUBLICATIONS OF MAGAZINES AND JOURNALS ON A VARIETY OF TOPICS (U.S. CLS. 21, 23, 26, 36 AND 38).

CLASS 16—PAPER GOODS AND PRINTED MATTER

FOR MAGAZINES, CATALOGS, EVENT PROGRAMS AND JOURNALS ON A VARIETY OF TOPICS; PHOTOGRAPHS; STATIONERY; PRINTED INSTRUCTIONAL, EDUCATIONAL, AND TEACHING MATERIALS ON A VARIETY OF TOPICS; PRINTING BLOCKS; BOOK BINDING MATERIALS; POSTERS; CARDS, NAMELY, POSTCARDS; GREETINGS CARDS; PRINTED INVITATIONS; DIARIES; CALENDARS; PHOTOGRAPH ALBUMS; PRINTS AND FRAMED PRINTS; NOTEPADS; WRITING INSTRUMENTS AND CRAYONS; STICKERS; TRANSFERS (DECALCOMANIAS); STAMPS; PERSONAL ORGANIZERS; ADDRESS BOOKS; NOTE BOOKS; PEN AND PENCIL HOLDERS (U.S. CLS. 2, 5, 22, 23, 29, 37, 38 AND 50).

CLASS 41—EDUCATION AND ENTERTAINMENT

FOR MULTIMEDIA PUBLISHING OF BOOKS, MAGAZINES, JOURNALS, SOFTWARE, GAMES, MUSIC, AND ELECTRONIC PUBLICATIONS; PUBLISHING OF BOOKS, MAGAZINES, JOURNALS, REVIEWS AND ELECTRONIC PUBLICATIONS; LANGUAGE TEACHING; ENTERTAINMENT SERVICES, NAMELY PROVIDING A WEBSITE FEATURING, PHOTOGRAPHIC, AUDIO, VIDEO AND PROSE PRESENTATIONS ON A VARIETY OF FICTION AND NON-FICTION TOPICS INCLUDING MUSIC, CONCERTS, FILM, VIDEOS, THEATRE, RADIO, TELEVISION, NEWS, SPORTS, GAMES AND CULTURAL EVENTS AND ENTERTAINMENT-RELATED PROGRAMS (U.S. CLS. 100, 101 AND 107).

JOHN HWANG, EXAMINING ATTORNEY

CLASS 16—PAPER GOODS AND PRINTED MATTER

FOR MAGAZINES, CATALOGS, EVENT PROGRAMS AND JOURNALS ON A VARIETY OF TOPICS; PHOTOGRAPHS; STATIONERY; PRINTED INSTRUCTIONAL, EDUCATIONAL, AND TEACHING MATERIALS ON A VARIETY OF TOPICS; PRINTING BLOCKS; BOOK BINDING MATERIALS; POSTERS; CARDS, NAMELY, POSTCARDS; GREETINGS CARDS; PRINTED INVITATIONS; DIARIES; CALENDARS; PHOTOGRAPH ALBUMS; PRINTS AND FRAMED PRINTS; NOTEPADS; WRITING INSTRUMENTS AND CRAYONS; STICKERS; TRANSFERS (DECALCOMANIAS); STAMPS; PERSONAL ORGANIZERS; ADDRESS BOOKS; NOTE BOOKS; PEN AND PENCIL HOLDERS (U.S. CLS. 2, 5, 22, 23, 29, 37, 38 AND 50).

CLASS 41—EDUCATION AND ENTERTAINMENT

FOR MULTIMEDIA PUBLISHING OF BOOKS, MAGAZINES, JOURNALS, SOFTWARE, GAMES, MUSIC, AND ELECTRONIC PUBLICATIONS; PUBLISHING OF BOOKS, MAGAZINES, JOURNALS, REVIEWS AND ELECTRONIC PUBLICATIONS; LANGUAGE TEACHING; ENTERTAINMENT SERVICES, NAMELY PROVIDING A WEB SITE FEATURING, PHOTOGRAPHIC, AUDIO, VIDEO AND PROSE PRESENTATIONS ON A VARIETY OF FICTION AND NON-FICTION TOPICS INCLUDING MUSIC, CONCERTS, FILM, VIDEOS, THEATRE, RADIO, TELEVISION, NEWS, SPORTS, GAMES AND CULTURAL EVENTS AND ENTERTAINMENT-RELATED PROGRAMS (U.S. CLS. 100, 101 AND 107).

JOHN HWANG, EXAMINING ATTORNEY

SN 77-127,106. BLOOMSBURY PUBLISHING PLC, LONDON, UNITED KINGDOM, FILED 3-9-2007.

SN 77-127,968. E.R. SQUIBB & SONS, L.L.C., PRINCETON, NJ, FILED 3-12-2007.



THE MARK CONSISTS OF A LION WITH A MANE MADE UP OF "W"'S.

CLASS 9—ELECTRICAL AND SCIENTIFIC APPARATUS

FOR COMPUTER SOFTWARE, NAMELY, SOFTWARE FOR USE IN DOWNLOADING, STORING, REPRODUCING AND ORGANIZING AUDIO, VIDEO, STILL AND MOVING IMAGES AND DATA; ANIMATED CARTOONS RECORDED ON VIDEO DISKS AND VIDEO TAPES; ELECTRONIC DATABASES RELATED TO PUBLISHING RECORDED ON COMPUTER MEDIA; DESKTOP PUBLISHING SOFTWARE; EDUCATIONAL SOFTWARE FEATURING INSTRUCTION ON A VARIETY OF TOPICS; GAME SOFTWARE; COMPUTER MOUSE MATS; DOWNLOADABLE ELECTRONIC PUBLICATIONS OF MAGAZINES AND JOURNALS ON A VARIETY OF TOPICS (U.S. CLS. 21, 23, 26, 36 AND 38).

MAKING A DIFFERENCE IN PATIENTS' LIVES

THE MARK CONSISTS OF STANDARD CHARACTERS WITHOUT CLAIM TO ANY PARTICULAR FONT, STYLE, SIZE, OR COLOR.

CLASS 16—PAPER GOODS AND PRINTED MATTER

FOR PRINTED MATERIAL, NAMELY, PAMPHLETS AND BROCHURES REGARDING HEALTH EDUCATION, HEALTH AWARENESS AND HEALTH ISSUES (U.S. CLS. 2, 5, 22, 23, 29, 37, 38 AND 50).

CLASS 41—EDUCATION AND ENTERTAINMENT

FOR PROVIDING EDUCATIONAL SERVICES, NAMELY, EDUCATIONAL CONFERENCES, FAIRS AND LECTURES IN THE FIELDS OF HEALTH, HEALTH AWARENESS AND HEALTH ISSUES (U.S. CLS. 100, 101 AND 107).

CLASS 44—MEDICAL, BEAUTY AND AGRICULTURAL SERVICES

FOR PROVIDING INFORMATION TO PHYSICIANS, HEALTH CARE PROFESSIONALS AND PATIENTS ON THE TOPIC OF HEALTH ISSUES AND HEALTH AWARENESS (U.S. CLS. 100 AND 101).

APRIL ROACH, EXAMINING ATTORNEY

SN 77-128,160. HANDRAIL DESIGN, INC., COLUMBIA, PA.
FILED 3-12-2007.

SN 77-128,621. WING HOP FUNG GINSENG, INC., LOS
ANGELES, CA. FILED 3-12-2007.

OPTIK

THE MARK CONSISTS OF STANDARD CHARACTERS
WITHOUT CLAIM TO ANY PARTICULAR FONT, STYLE,
SIZE, OR COLOR.

CLASS 6—METAL GOODS

FOR METAL GUARD RAILS (U.S. CLS. 2, 12, 13, 14, 23,
25 AND 50).

CLASS 19—NON-METALLIC BUILDING MATERIALS

FOR NON-METAL GUARDRAILS (U.S. CLS. 1, 12, 33
AND 50).
GRETTA YAO, EXAMINING ATTORNEY

SN 77-128,578. THE PACIFIC COASTAL COMPANY LLC,
HUNTINGTON BEACH, CA. FILED 3-12-2007.

THE PACIFIC POINT

THE MARK CONSISTS OF STANDARD CHARACTERS
WITHOUT CLAIM TO ANY PARTICULAR FONT, STYLE,
SIZE, OR COLOR.

OWNER OF U.S. REG. NOS. 3,198,991, 3,201,969 AND
3,208,304.

CLASS 36—INSURANCE AND FINANCIAL

FOR REAL ESTATE SERVICES, NAMELY, REAL
ESTATE MANAGEMENT, REAL ESTATE LEASING,
AND RENTAL OF COMMERCIAL REAL ESTATE,
NAMELY, INDUSTRIAL, OFFICE, AND RETAIL SPACE;
AND RENTAL OF RESIDENTIAL REAL ESTATE,
NAMELY, HOMES, AND APARTMENTS (U.S. CLS. 100,
101 AND 102).

CLASS 37—CONSTRUCTION AND REPAIR

FOR REAL ESTATE DEVELOPMENT, NAMELY,
PLANNING AND LAYING OUT OF RESIDENTIAL,
RETAIL AND COMMERCIAL COMMUNITIES; AND
REAL ESTATE SITE SELECTION (U.S. CLS. 100, 103
AND 106).

DAWN FELDMAN, EXAMINING ATTORNEY

WHF

THE MARK CONSISTS OF STANDARD CHARACTERS
WITHOUT CLAIM TO ANY PARTICULAR FONT, STYLE,
SIZE, OR COLOR.

CLASS 5—PHARMACEUTICALS

FOR DIETARY HEALTH FOOD SUPPLEMENTS, HER-
BAL EXTRACTS FOR MEDICAL PURPOSES; HERBAL
PRODUCTS IN THE NATURE OF FOOD SUPPLE-
MENTS; MEDICINAL ORIENTAL HERB EXTRACTS;
GINSENG FOR MEDICINAL USE; GINSENG AS FOOD
SUPPLEMENTS (U.S. CLS. 6, 18, 44, 46, 51 AND 52).

CLASS 29—MEATS AND PROCESSED FOODS

FOR PROCESSED SEAFOOD, NAMELY, SHELLFISH,
FISH, FISH PARTS, SEA CUCUMBER, SQUIDS; READY
TO EAT NUTS, DRIED FRUITS FOR SNACKS (U.S. CL.
46).

CLASS 30—STAPLE FOODS

FOR STAPLE FOODS, NAMELY, COOKIES, CRACK-
ERS, CANDIES, CAKES, MOONCAKES, TEAS, SPICES,
PROCESSED HERBS AND HERB TEAS (U.S. CL. 46).

CLASS 35—ADVERTISING AND BUSINESS

FOR WHOLESALE AND RETAIL DISTRIBUTORSHIPS
FEATURING; WINES AND SPIRITS, ORIENTAL ARTS
AND CRAFTS, BEAUTY CARE PRODUCTS AND COS-
METICS, ORIENTAL FOODSTUFFS, HERBS, HERBAL
PRODUCTS, GINSENG, HEALTH FOOD SUPPLE-
MENTS, TRADITIONAL CHINESE MEDICINES AND
HEALTH FOOD SUPPLEMENTS, TEAS, HERBAL TEAS,
PROCESSED SEAFOOD, ORIENTAL SNACK FOODS,
COOKWARE, KITCHEN APPLIANCES (U.S. CLS. 100,
101 AND 102).

THEODORE MCBRIDE, EXAMINING ATTORNEY

SN 77-128,632. THE PACIFIC COASTAL COMPANY LLC,
HUNTINGTON BEACH, CA. FILED 3-12-2007.

THE PACIFIC COURT

THE MARK CONSISTS OF STANDARD CHARACTERS
WITHOUT CLAIM TO ANY PARTICULAR FONT, STYLE,
SIZE, OR COLOR.

OWNER OF U.S. REG. NOS. 3,198,991, 3,201,969 AND
3,208,304.

CLASS 36—INSURANCE AND FINANCIAL

FOR REAL ESTATE SERVICES, NAMELY, REAL
ESTATE MANAGEMENT, REAL ESTATE LEASING,
AND RENTAL OF COMMERCIAL REAL ESTATE,
NAMELY, INDUSTRIAL, OFFICE, AND RETAIL SPACE;
AND RENTAL OF RESIDENTIAL REAL ESTATE,
NAMELY, HOMES, AND APARTMENTS (U.S. CLS. 100,
101 AND 102).

CLASS 37—CONSTRUCTION AND REPAIR

FOR REAL ESTATE DEVELOPMENT, NAMELY, PLANNING AND LAYING OUT OF RESIDENTIAL, RETAIL AND COMMERCIAL COMMUNITIES; AND REAL ESTATE SITE SELECTION (U.S. CLS. 100, 103 AND 106).

DAWN FELDMAN, EXAMINING ATTORNEY

SN 77-128,714. ADVOCASE, LLC, CLIFTON PARK, NY. FILED 3-12-2007.



THE MARK CONSISTS OF ADVOCASE, WRITTEN WITH AN ARROW EXTENDING FROM THE "V". THE "A" AND THE "C" ARE IN UPPER CASE.

CLASS 41—EDUCATION AND ENTERTAINMENT

FOR EDUCATION SERVICES, NAMELY, PROVIDING CLASSES, SEMINARS, WORKSHOPS IN THE FIELD OF INSURANCE (U.S. CLS. 100, 101 AND 107).
FIRST USE 11-25-2005; IN COMMERCE 1-1-2006.

CLASS 45—PERSONAL SERVICES

FOR CASE MANAGEMENT SERVICES, NAMELY, THE COORDINATION OF NECESSARY MEDICAL SERVICES, VOCATIONAL ISSUES AND EDUCATIONAL SERVICES FOR PERSONS INJURED AT WORK (U.S. CLS. 100 AND 101).

FIRST USE 11-25-2005; IN COMMERCE 1-1-2006.
SAIMA MAKHDOOM, EXAMINING ATTORNEY

SN 77-128,800. DROP CARDS, INC., PARSIPPANY, NJ. FILED 3-12-2007.



THE MARK CONSISTS OF STANDARD CHARACTERS WITHOUT CLAIM TO ANY PARTICULAR FONT, STYLE, SIZE, OR COLOR.

CLASS 16—PAPER GOODS AND PRINTED MATTER

FOR TRADING CARDS; NON-MAGNETICALLY ENCODED PREPAID PURCHASE CARDS FOR MUSIC DOWNLOADS, RINGTONES AND OTHER DIGITAL MEDIA VIA PROMOTIONAL WEBSITES (U.S. CLS. 2, 5, 22, 23, 29, 37, 38 AND 50).

FIRST USE 4-1-2005; IN COMMERCE 8-1-2005.

CLASS 35—ADVERTISING AND BUSINESS

FOR ADVERTISING, MARKETING AND PROMOTION SERVICES; ON-LINE ADVERTISING AND MARKETING SERVICES (U.S. CLS. 100, 101 AND 102).

FIRST USE 4-1-2005; IN COMMERCE 8-1-2005.
MICHAEL LITZAU, EXAMINING ATTORNEY

SN 77-129,460. WARLICK, KEITH, LOS ANGELES, CA. FILED 3-13-2007.



THE MARK CONSISTS OF STANDARD CHARACTERS WITHOUT CLAIM TO ANY PARTICULAR FONT, STYLE, SIZE, OR COLOR.

NO CLAIM IS MADE TO THE EXCLUSIVE RIGHT TO USE "SENIOR" AND "LLC", APART FROM THE MARK AS SHOWN.

CLASS 35—ADVERTISING AND BUSINESS

FOR ADVERTISING THROUGH ALL PUBLIC COMMUNICATION MEANS; ELECTRONIC BILLBOARD ADVERTISING; PRODUCTION OF TELEVISION COMMERCIALS; ENTERTAINMENT IN THE NATURE OF ON-GOING TELEVISION PROGRAMS IN THE FIELD OF NEWS AND SENIOR LIFESTYLE INFORMATION. (U.S. CLS. 100, 101 AND 102).

CLASS 41—EDUCATION AND ENTERTAINMENT

FOR ENTERTAINMENT IN THE NATURE OF ON-GOING TELEVISION PROGRAMS IN THE FIELD OF NEWS AND SENIOR LIFESTYLE INFORMATION; PRODUCTION OF RADIO AND TELEVISION PROGRAMS; RADIO PROGRAM SYNDICATION (U.S. CLS. 100, 101 AND 107).

SCOTT SISUN, EXAMINING ATTORNEY

SN 77-130,004. POLSTEIN, JASON M, MIAMI, FL. AND POLSTEIN, MATTHEW E, MIAMI, FL. AND POLSTEIN, MICHAEL A, MIAMI, FL. AND POLSTEIN, CAROLE, MIAMI, FL. AND POLSTEIN, LAUREN R, MIAMI, FL. FILED 3-13-2007.

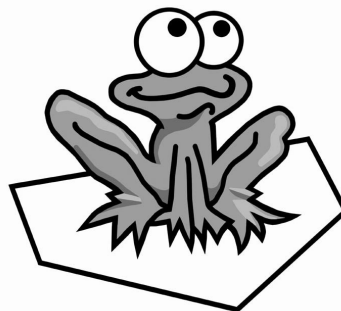

THE MARK CONSISTS OF IMAGE OF A FROG SITTING ON TOP OF A BASEBALL/SOFTBALL HOME PLATE.

CLASS 9—ELECTRICAL AND SCIENTIFIC APPARATUS

FOR PROTECTIVE FACE-SHIELDS FOR PROTECTIVE HELMETS; BASEBALL BATTING HELMETS; PROTECTIVE HELMETS FOR SPORTS; SPORTS HELMETS (U.S. CLS. 21, 23, 26, 36 AND 38).

FIRST USE 0-0-2003; IN COMMERCE 0-0-2003.

CLASS 28—TOYS AND SPORTING GOODS

FOR SOFTBALL BATS (U.S. CLS. 22, 23, 38 AND 50).
FIRST USE 10-1-2006; IN COMMERCE 10-1-2006.
DANIEL RUSSELL, EXAMINING ATTORNEY

SN 77-130,023. ABS-CBN INTERNATIONAL, REDWOOD CITY, CA. FILED 3-13-2007.



THE MARK CONSISTS OF THE SYLIZED WORD MYX INSIDE A DESIGN COMPRISED OF TWO CIRCLES.

CLASS 38—COMMUNICATION

FOR TELEVISION BROADCASTING SERVICES; TELEVISION BROADCASTING SERVICES VIA CABLE AND SATELLITE (U.S. CLS. 100, 101 AND 104).

FIRST USE 2-28-2007; IN COMMERCE 2-28-2007.

CLASS 41—EDUCATION AND ENTERTAINMENT

FOR PRODUCTION AND PROGRAMMING OF TELEVISION SHOWS; PRODUCTION OF AWARD SHOWS, DANCE SHOWS AND MUSIC SHOWS; ENTERTAINMENT IN THE NATURE OF ON-GOING PROGRAMS IN THE FIELDS OF MUSIC, MUSIC VIDEOS, FILMS, LIFESTYLE, LIVE ACTION, ENTERTAINMENT, POP CULTURE, NEWS AND ENTERTAINMENT NEWS, ASIAN CULTURE, ROMANCE, RELATIONSHIPS, AND VARIETY DISTRIBUTED OVER TELEVISION, SATELLITE, AND VIA A GLOBAL COMPUTER NETWORK; PROVIDING ONLINE INFORMATION IN THE FIELDS OF MUSIC, MUSIC VIDEOS, FILMS, ENTERTAINMENT, CURRENT EVENT NEWS AND ENTERTAINMENT NEWS, ENTERTAINMENT REGARDING ROMANCE AND RELATIONSHIPS VIA A GLOBAL COMPUTER NETWORK (U.S. CLS. 100, 101 AND 107).

FIRST USE 2-28-2007; IN COMMERCE 2-28-2007.
MICHELE SWAIN, EXAMINING ATTORNEY

SN 77-130,235. FORGASH, JOSHUA A, ORANGE, CA. FILED 3-13-2007.



NO CLAIM IS MADE TO THE EXCLUSIVE RIGHT TO USE "BUMPER", APART FROM THE MARK AS SHOWN.

THE COLOR(S) DARK BROWN AND LIGHT BEIGE IS/ARE CLAIMED AS A FEATURE OF THE MARK.

THE MARK CONSISTS OF A DARK BROWN BACKGROUND, LIGHT BEIGE TEXT, AND A LIGHT BEIGE CIRCLE ON THE LEFTMOST SIDE. THE COLOR LIGHT BEIGE APPEARS IN THE WORDING BUMPER BLOGS AND IN THE CIRCLE DESIGN. THE COLOR DARK BROWN APPEARS IN THE DESIGN BACKGROUND. THE TEXT IS BOOKMAN FONT.

CLASS 16—PAPER GOODS AND PRINTED MATTER

FOR BUMPER STICKERS; DECORATIVE STICKERS FOR HELMETS; STICKERS (U.S. CLS. 2, 5, 22, 23, 29, 37, 38 AND 50).

CLASS 40—MATERIAL TREATMENT

FOR IMPRINTING MESSAGES ON WEARING APPAREL, ACCESSORIES AND MUGS; IMPRINTING MESSAGES ON T-SHIRTS (U.S. CLS. 100, 103 AND 106).

ARETHA SOMERVILLE, EXAMINING ATTORNEY

SN 77-130,275. SPLASH CORPORATION, METRO MANILA, PHILIPPINES, FILED 3-13-2007.

THERAHERB

THE MARK CONSISTS OF STANDARD CHARACTERS WITHOUT CLAIM TO ANY PARTICULAR FONT, STYLE, SIZE, OR COLOR.

CLASS 5—PHARMACEUTICALS

FOR (USE) HERBAL MEDICINAL TEAS AND CAPSULES; (INTENT-TO-USE) DIET CAPSULES; DIET PILLS; DIETARY DRINK MIX FOR USE AS A MEAL REPLACEMENT; DIETARY FOOD SUPPLEMENTS; DIETARY SUPPLEMENT DRINKS; DIETARY SUPPLEMENTS; FOOD SUPPLEMENTS; HERBAL SUPPLEMENTS; MEAL REPLACEMENT AND DIETARY SUPPLEMENT DRINK MIXES; MEAL REPLACEMENT BARS, DRINKS, POWDERS AND SHAKES; NUTRITIONAL SUPPLEMENTS; VITAMIN AND MINERAL SUPPLEMENTS; AND VITAMINS (U.S. CLS. 6, 18, 44, 46, 51 AND 52).

FIRST USE 7-29-2005; IN COMMERCE 1-14-2006.

CLASS 29—MEATS AND PROCESSED FOODS

FOR (USE) UNFLAVORED AND FLAVORED VIRGIN COCONUT OIL; (INTENT-TO-USE) EDIBLE OILS AND FATS IN ORIGINAL FORM; EDIBLE FATS AND OIL MODIFIED WITH FLAVOR AND OTHER FOOD INGREDIENTS (U.S. CL. 46).

FIRST USE 7-29-2005; IN COMMERCE 1-14-2006.
JULIE GUTTADAURO, EXAMINING ATTORNEY

SN 77-130,423. MYEZ CARCARE, LLC, RIVER RIDGE, LA. FILED 3-14-2007.

SN 77-130,770. LOGOS TECHNOLOGIES, INC., ARLINGTON, VA. FILED 3-14-2007.



NO CLAIM IS MADE TO THE EXCLUSIVE RIGHT TO USE "EZ CARCARE", APART FROM THE MARK AS SHOWN.

THE COLOR(S) RED AND BLACK IS/ARE CLAIMED AS A FEATURE OF THE MARK.

THE MARK CONSISTS OF MY IN RED, EZ IN BLACK, CAR IN RED, CARE IN BLACK, YOUR ELECTRONIC GLOVE BOX IN BLACK, PLUS! IN RED, ALL SHOWN BENEATH TWO CURVED RED LINES DEPICTING THE OUTLINE OF A CAR.

CLASS 35—ADVERTISING AND BUSINESS

FOR BUSINESS MANAGEMENT SERVICES, NAMELY, MAINTAINING AND TRACKING VEHICLE MAINTENANCE RECORDS AND VEHICLE INFORMATION FOR OTHERS (U.S. CLS. 100, 101 AND 102).

CLASS 36—INSURANCE AND FINANCIAL

FOR PROVIDING PREPAID VEHICLE MAINTENANCE SERVICE PLANS (U.S. CLS. 100, 101 AND 102).
CARYN GLASSER, EXAMINING ATTORNEY

SN 77-130,499. ELEN, CARINE, NEW PALTZ, NY. AND WILE, SUSAN, NEW PALTZ, NY. FILED 3-14-2007.

HYBRID REVOLUTION GEAR

THE MARK CONSISTS OF STANDARD CHARACTERS WITHOUT CLAIM TO ANY PARTICULAR FONT, STYLE, SIZE, OR COLOR.

NO CLAIM IS MADE TO THE EXCLUSIVE RIGHT TO USE "GEAR", APART FROM THE MARK AS SHOWN.

CLASS 18—LEATHER GOODS

FOR BACKPACKS WHICH TRANSFORM INTO A JACKET AND A PILLOW (U.S. CLS. 1, 2, 3, 22 AND 41).
FIRST USE 3-4-2007; IN COMMERCE 3-4-2007.

CLASS 25—CLOTHING

FOR JACKETS WITH SELF-CONTAINED BACKPACKS THAT TRANSFORM INTO A BACKPACK AND A PILLOW (U.S. CLS. 22 AND 39).
FIRST USE 3-4-2007; IN COMMERCE 3-4-2007.
KEVON CHISOLM, EXAMINING ATTORNEY



NO CLAIM IS MADE TO THE EXCLUSIVE RIGHT TO USE "TECHNOLOGIES", APART FROM THE MARK AS SHOWN.

THE COLOR(S) DARK RED AND BLACK IS/ARE CLAIMED AS A FEATURE OF THE MARK.

THE MARK CONSISTS OF THE TEXTUAL NAME IS SURROUNDED BY A MOBIUS STRIP SO THAT THE PART OF THE STRIP IN FRONT OF THE TEXT IS DARK RED AND RUNS DIAGONALLY FROM LOWER LEFT TO UPPER RIGHT, AND THE PART OF THE STRIP THAT RUNS BEHIND THE TEXT IS APPROXIMATELY HORIZONTAL WITH ONLY THE CLOSEST EDGE COLORED DARK RED—THE FACE OF THE STRIP BEHIND THE TEXT HAVING NO COLOR.

THE FOREIGN WORDING IN THE MARK TRANSLATES INTO ENGLISH AS THE RATIONAL PRINCIPLE THAT GOVERNS AND DEVELOPS THE UNIVERSE.

CLASS 9—ELECTRICAL AND SCIENTIFIC APPARATUS

FOR ELECTRIC AND ELECTRONIC VIDEO SURVEILLANCE INSTALLATIONS (U.S. CLS. 21, 23, 26, 36 AND 38).

FIRST USE 12-12-2006; IN COMMERCE 12-12-2006.

CLASS 42—SCIENTIFIC, COMPUTER AND LEGAL SERVICES

FOR TECHNOLOGY CONSULTATION IN THE FIELD OF PHYSICAL SCIENCES (U.S. CLS. 100 AND 101).

FIRST USE 12-12-2006; IN COMMERCE 12-12-2006.

JILL PRATER, EXAMINING ATTORNEY

SN 77-131,096. DELUXEYEWEAR, INC., DELRAY BEACH, FL. FILED 3-14-2007.

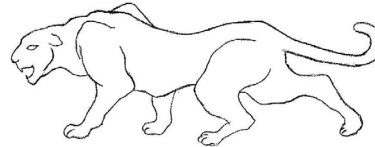

THE MARK CONSISTS OF SKETCH OF A PANTHER.

CLASS 9—ELECTRICAL AND SCIENTIFIC APPARATUS

FOR EYEWEAR; FRAMES FOR SPECTACLES AND SUNGLASSES; SUNGLASSES, OPHTHALMIC FRAMES; EYEWEAR CASES (U.S. CLS. 21, 23, 26, 36 AND 38).

CLASS 18—LEATHER GOODS

FOR LEATHER PURSES, LEATHER WALLETS (U.S. CLS. 1, 2, 3, 22 AND 41).

CLASS 25—CLOTHING

FOR T-SHIRTS; POLO SHIRTS; SHIRTS; PANTS; JEANS; SHORTS; SWIMSUITS; HATS; JOGGING SUITS; TIES; UNDERWEAR; UNDERSHIRTS; RUNNING SHOES; BOOTS; BELTS (U.S. CLS. 22 AND 39).

HEATHER BIDDULPH, EXAMINING ATTORNEY

SN 77-131,143. SIGNALINK TECHNOLOGIES INC., KELOWNA, CANADA, FILED 3-14-2007.

Vigil-Link

THE MARK CONSISTS OF STANDARD CHARACTERS WITHOUT CLAIM TO ANY PARTICULAR FONT, STYLE, SIZE, OR COLOR.

CLASS 9—ELECTRICAL AND SCIENTIFIC APPARATUS

FOR HOME AND OFFICE AUTOMATION SYSTEMS COMPRISING WIRELESS AND WIRED CONTROLLERS, CONTROLLED DEVICES, AND SOFTWARE FOR LIGHTING, HVAC, SECURITY, SAFETY AND OTHER HOME AND OFFICE MONITORING AND CONTROL APPLICATIONS (U.S. CLS. 21, 23, 26, 36 AND 38).

CLASS 45—PERSONAL SERVICES

FOR CONTROL OF BUILDING ENVIRONMENTAL ACCESS AND SECURITY SYSTEMS (U.S. CLS. 100 AND 101).

THOMAS MANOR, EXAMINING ATTORNEY

SN 77-131,208. ROSENBERG, GAIL, NEW YORK, NY. FILED 3-14-2007.

WEAR THE ENERGY

THE MARK CONSISTS OF STANDARD CHARACTERS WITHOUT CLAIM TO ANY PARTICULAR FONT, STYLE, SIZE, OR COLOR.

CLASS 3—COSMETICS AND CLEANING PREPARATIONS

FOR COSMETICS (U.S. CLS. 1, 4, 6, 50, 51 AND 52).

CLASS 14—JEWELRY

FOR JEWELRY (U.S. CLS. 2, 27, 28 AND 50).

CLASS 25—CLOTHING

FOR BELTS; BIBS NOT OF CLOTH OR PAPER; CAPS; INFANT AND TODDLER ONE PIECE CLOTHING; JERSEYS; SHORT SETS; TOPS; JACKET; SOCKS AND STOCKINGS; PANTS; SKIRTS AND DRESSES; UNDER GARMENTS; SLEEPING GARMENTS; SWEAT SHIRTS; ATHLETIC FOOTWEAR; SWEAT SUITS (U.S. CLS. 22 AND 39).

ELLEN PERKINS, EXAMINING ATTORNEY

SN 77-131,265. GTMS, WEST JORDAN, UT. FILED 3-14-2007.



THE MARK CONSISTS OF STYLIZED TEXT AND AN IMAGE THAT REPRESENTS A SATELLITE ANTENNA.

CLASS 37—CONSTRUCTION AND REPAIR

FOR INSTALLING SATELLITE DISHES; SATELLITE DISH INSTALLATION AND REPAIR (U.S. CLS. 100, 103 AND 106).

FIRST USE 8-25-2006; IN COMMERCE 8-25-2006.

CLASS 42—SCIENTIFIC, COMPUTER AND LEGAL SERVICES

FOR PLANNING, DEVELOPMENT AND TECHNICAL SUPPORT OF ELECTRONIC COMMUNICATIONS NETWORKS; TECHNICAL SUPPORT, NAMELY, MONITORING OF NETWORK SYSTEMS; CUSTOM DESIGN AND ENGINEERING OF TELEPHONY SYSTEMS; ENGINEERING SERVICES, NAMELY, ENGINEERING FOR THE SATELLITE TELECOMMUNICATIONS INDUSTRY; TECHNOLOGY CONSULTATION IN THE FIELD OF SATELLITE TELECOMMUNICATIONS, CONTENT MANAGEMENT, AND SYSTEM ENGINEERING (U.S. CLS. 100 AND 101).

FIRST USE 8-25-2006; IN COMMERCE 8-25-2006.
JENNIFER HETU, EXAMINING ATTORNEY

SN 77-131,392. MITCHELL INTERNATIONAL, INC., SAN DIEGO, CA. FILED 3-14-2007.

CLAIMIQ

THE MARK CONSISTS OF STANDARD CHARACTERS WITHOUT CLAIM TO ANY PARTICULAR FONT, STYLE, SIZE, OR COLOR.

CLASS 9—ELECTRICAL AND SCIENTIFIC APPARATUS

FOR COMPUTER PROGRAMS FOR USE IN INSURANCE CLAIM REVIEW, AUDITING AND ADJUSTMENT AND MANUALS THEREFORE, SOLD AS A UNIT (U.S. CLS. 21, 23, 26, 36 AND 38).

FIRST USE 12-31-2000; IN COMMERCE 12-31-2000.

CLASS 42—SCIENTIFIC, COMPUTER AND LEGAL SERVICES

FOR APPLICATION SERVICE PROVIDER (ASP) FEATURING SOFTWARE IN THE FIELD OF INSURANCE CLAIM REVIEW, AUDITING AND ADJUSTMENT; APPLICATION SERVICE PROVIDER, NAMELY, HOSTING INSURANCE CLAIM SOFTWARE FOR OTHERS (U.S. CLS. 100 AND 101).

FIRST USE 12-31-2000; IN COMMERCE 12-31-2000.
AHSEN KHAN, EXAMINING ATTORNEY

SN 77-131,924. ALZHEIMER'S COMMUNITY CARE, INC., WEST PALM BEACH, FL. FILED 3-15-2007.



THE COLOR(S) TEAL IS/ARE CLAIMED AS A FEATURE OF THE MARK.

THE MARK CONSISTS OF TWO STYLIZED PEOPLE, ONE FIGURE HAS AN ARM AROUND THE OTHER. THE FIGURE ON THE LEFT IS DARK TEAL, THE FIGURE ON THE RIGHT IS LIGHT TEAL.

CLASS 41—EDUCATION AND ENTERTAINMENT

FOR EDUCATION SERVICES, NAMELY PROVIDING CLASSES AND SEMINARS IN THE FIELD OF CARE OF ALZHEIMER'S PATIENTS (U.S. CLS. 100, 101 AND 107).
FIRST USE 7-1-2004; IN COMMERCE 7-1-2004.

CLASS 43—HOTEL AND RESTAURANT SERVICES

FOR PROVIDING SPECIALIZED ELDER DAY CARE FEATURING STRUCTURED AND RECREATIONAL ACTIVITIES (U.S. CLS. 100 AND 101).
FIRST USE 7-1-2004; IN COMMERCE 7-1-2004.

CLASS 44—MEDICAL, BEAUTY AND AGRICULTURAL SERVICES

FOR FAMILY NURSING CARE IN THE NATURE OF COUNSELING IN CRISIS INTERVENTION AND SUPPORT GROUPS FOR ALZHEIMER'S PATIENTS, CAREGIVERS AND THE COMMUNITY (U.S. CLS. 100 AND 101).

FIRST USE 7-1-2004; IN COMMERCE 7-1-2004.
THOMAS MANOR, EXAMINING ATTORNEY

SN 77-131,730. BUTLER, SHINE, STERN & PARTNERS, LLC, SAUSALITO, CA. FILED 3-15-2007.



THE MARK CONSISTS OF THE IMAGE OF A BOY AND A GIRL HOLDING MEAT CLEAVERS IN A CIRCLE ABOVE THE WORD CLEAVER.

CLASS 35—ADVERTISING AND BUSINESS

FOR ADVERTISING AGENCIES; ADVERTISING, MARKETING, AND PROMOTION SERVICES; PREPARING ADVERTISEMENTS FOR OTHERS; PREPARATION AND REALIZATION OF MEDIA AND ADVERTISING PLANS AND CONCEPTS; POST-PRODUCTION EDITING SERVICES FOR VIDEO AND AUDIO COMMERCIALS AND MARKETING MATERIALS; PRODUCTION AND DISTRIBUTION OF AUDIO AND VIDEO COMMERCIALS AND MARKETING MATERIALS; PREPARING AUDIO-VISUAL PRESENTATIONS FOR USE IN ADVERTISING AND MARKETING (U.S. CLS. 100, 101 AND 102).

CLASS 41—EDUCATION AND ENTERTAINMENT

FOR VIDEO EDITING; PRODUCTION OF VIDEO AND CREATION OF VISUAL EFFECTS FOR OTHERS FOR USE IN DVDS, DOWNLOADABLE CONTENT FOR PORTABLE MEDIA PLAYERS, TELEVISION PROGRAMS, FILMS, AND ON WEBSITES; PRODUCTION OF VIDEO DISCS FOR OTHERS; AUDIO AND VIDEO-TAPE, VIDEO DISC, AND DIGITAL VIDEO RECORDING AND PRODUCTION (U.S. CLS. 100, 101 AND 107).
GINA FINK, EXAMINING ATTORNEY

SN 77-132,084. AMERICAN HALAL CORP., INC., STAMFORD, CT. FILED 3-15-2007.

Teyyib

THE MARK CONSISTS OF STANDARD CHARACTERS WITHOUT CLAIM TO ANY PARTICULAR FONT, STYLE, SIZE, OR COLOR.

THE FOREIGN WORDING IN THE MARK TRANSLATES INTO ENGLISH AS PURE, ETHICAL, WHOLESOME, GOOD.

CLASS 29—MEATS AND PROCESSED FOODS

FOR FRESH AND FROZEN CHICKEN, BEEF; PRE-PACKAGED DINNERS CONSISTING PRIMARILY OF MEAT, SEAFOOD, POULTRY WITH PASTA, RICE AND VEGETABLES; FROZEN OR PREPARED MEALS CONSISTING PRIMARILY OF MEAT, FISH, POULTRY AND VEGETABLES; PROCESSED FRUITS CONSISTING OF APPLES, ORANGES, BANANAS, APRICOTS, DATES; HUMMUS; PROCESSED VEGETABLES, SALAD, SALAMI, BOLOGNA, TURKEY, CHEESE (U.S. CL. 46).

CLASS 30—STAPLE FOODS

FOR PIZZA, SPAGHETTI, BAKERY DESSERTS; WHEAT BASED SNACK FOODS; PROCESSED GRAINS; FROZEN ENTREES CONSISTING PRIMARILY OF PASTA OR RICE (U.S. CL. 46).
RONALD AIKENS, EXAMINING ATTORNEY

SN 77-132,318. UPSTAGING, INC., SYCAMORE, IL. FILED 3-15-2007.

UPSTAGING INC.

THE MARK CONSISTS OF STANDARD CHARACTERS WITHOUT CLAIM TO ANY PARTICULAR FONT, STYLE, SIZE, OR COLOR.
NO CLAIM IS MADE TO THE EXCLUSIVE RIGHT TO USE INC., APART FROM THE MARK AS SHOWN.

CLASS 39—TRANSPORTATION AND STORAGE

FOR TRUCK TRANSPORT SERVICES FOR THE ENTERTAINMENT INDUSTRY (U.S. CLS. 100 AND 105).
FIRST USE 10-31-1973; IN COMMERCE 10-31-1973.

CLASS 41—EDUCATION AND ENTERTAINMENT

FOR ENTERTAINMENT SERVICES, NAMELY, LIGHTING AND LIGHTING PRODUCTION SERVICES (U.S. CLS. 100, 101 AND 107).
FIRST USE 10-31-1973; IN COMMERCE 10-31-1973.
CURTIS FRENCH, EXAMINING ATTORNEY

SN 77-132,334. COMMUNITY MAINSTREAMING ENTERPRISES, INC., GARDEN CITY, NY. FILED 3-15-2007.

SWEET COMFORT BAKERY & CAFÉ

THE MARK CONSISTS OF STANDARD CHARACTERS WITHOUT CLAIM TO ANY PARTICULAR FONT, STYLE, SIZE, OR COLOR.
NO CLAIM IS MADE TO THE EXCLUSIVE RIGHT TO USE "BAKERY & CAFE", APART FROM THE MARK AS SHOWN.

CLASS 35—ADVERTISING AND BUSINESS

FOR RETAIL BAKERY SHOPS (U.S. CLS. 100, 101 AND 102).

CLASS 43—HOTEL AND RESTAURANT SERVICES

FOR CAFE-RESTAURANTS (U.S. CLS. 100 AND 101).
CURTIS FRENCH, EXAMINING ATTORNEY

SN 77-132,353. UPSTAGING, INC., SYCAMORE, IL. FILED 3-15-2007.

UPSTAGING INC.

NO CLAIM IS MADE TO THE EXCLUSIVE RIGHT TO USE "INC.", APART FROM THE MARK AS SHOWN.

CLASS 39—TRANSPORTATION AND STORAGE

FOR TRUCK TRANSPORT SERVICES FOR THE ENTERTAINMENT INDUSTRY (U.S. CLS. 100 AND 105).
FIRST USE 3-1-1978; IN COMMERCE 3-1-1978.

CLASS 41—EDUCATION AND ENTERTAINMENT

FOR ENTERTAINMENT SERVICES, NAMELY, LIGHTING AND LIGHTING PRODUCTION SERVICES (U.S. CLS. 100, 101 AND 107).
FIRST USE 3-1-1978; IN COMMERCE 3-1-1978.
CURTIS FRENCH, EXAMINING ATTORNEY

SN 77-132,614. DEDICATED OPERATIONAL CONTRACTING, LLC, CROFTON, MD. FILED 3-15-2007.

DOC Sports Surface Contractors

THE MARK CONSISTS OF STANDARD CHARACTERS WITHOUT CLAIM TO ANY PARTICULAR FONT, STYLE, SIZE, OR COLOR.
NO CLAIM IS MADE TO THE EXCLUSIVE RIGHT TO USE "SPORTS SURFACE CONTRACTORS", APART FROM THE MARK AS SHOWN.

CLASS 31—NATURAL AGRICULTURAL PRODUCTS

FOR LAWN/TURF; TURF (U.S. CLS. 1 AND 46).

CLASS 37—CONSTRUCTION AND REPAIR

FOR CONSTRUCTION CONSULTANCY; CONSTRUCTION MANAGEMENT; CONSTRUCTION OF SPORTS SURFACES, TRACKS, NATURAL AND ARTIFICIAL TURF, SPORTS SURFACES; CONSTRUCTION SUPERVISION; CONSULTATION IN BUILDING CONSTRUCTION SUPERVISION; CONSULTING SERVICES FOR THE CONSTRUCTION OF WATER TREATMENT AND PURIFICATION PLANTS, SOLID WASTE TREATMENT PLANTS AND OTHER MUNICIPAL INFRASTRUCTURE FACILITIES; GENERAL CONSTRUCTION CONTRACTING; RENTAL OF CONSTRUCTION EQUIPMENT; RENTAL OF CONSTRUCTION MACHINES AND APPARATUS (U.S. CLS. 100, 103 AND 106).

CORY BOONE, EXAMINING ATTORNEY

SN 77-132,813. COMERCIO MAS, S.A. DE C.V., COLONIA ZEDEC SANTA FE, MEXICO, FILED 3-16-2007.

**CLASS 35—ADVERTISING AND BUSINESS**

FOR ADVERTISING SERVICES, NAMELY, PROMOTING THE GOODS AND SERVICES OF OTHERS OVER THE INTERNET (U.S. CLS. 100, 101 AND 102).

CLASS 38—COMMUNICATION

FOR AUDIO AND VIDEO BROADCASTING SERVICES OVER THE INTERNET (U.S. CLS. 100, 101 AND 104).

CLASS 41—EDUCATION AND ENTERTAINMENT

FOR ENTERTAINMENT SERVICES, NAMELY, PROVIDING A WEBSITE FEATURING NON-DOWNLOADABLE AUDIO AND VIDEO CLIPS FEATURING MUSICAL PERFORMANCES, COMEDY, NEWS AND USER-GENERATED VIDEOS. (U.S. CLS. 100, 101 AND 107).

CLASS 42—SCIENTIFIC, COMPUTER AND LEGAL SERVICES

FOR APPLICATION SERVICE PROVIDER FEATURING SOFTWARE TO ENABLE UPLOADING, POSTING, DISPLAYING, TAGGING, BLOGGING, SHARING OR OTHERWISE PROVIDING ELECTRONIC MEDIA OR INFORMATION OVER THE INTERNET (U.S. CLS. 100 AND 101).

ROBERT LAVACHE, EXAMINING ATTORNEY

SN 77-132,788. COMERCIO MAS, S.A. DE C.V., COLONIA ZEDEC SANTA FE, MEXICO, FILED 3-16-2007.

GYGGGS

THE MARK CONSISTS OF STANDARD CHARACTERS WITHOUT CLAIM TO ANY PARTICULAR FONT, STYLE, SIZE, OR COLOR.

CLASS 35—ADVERTISING AND BUSINESS

FOR ADVERTISING SERVICES, NAMELY, PROMOTING THE GOODS AND SERVICES OF OTHERS OVER THE INTERNET (U.S. CLS. 100, 101 AND 102).

CLASS 38—COMMUNICATION

FOR AUDIO AND VIDEO BROADCASTING SERVICES OVER THE INTERNET (U.S. CLS. 100, 101 AND 104).

CLASS 41—EDUCATION AND ENTERTAINMENT

FOR ENTERTAINMENT SERVICES, NAMELY, PROVIDING A WEBSITE FEATURING NON-DOWNLOADABLE AUDIO AND VIDEO CLIPS FEATURING MUSICAL PERFORMANCES, COMEDY, NEWS AND USER-GENERATED VIDEOS. (U.S. CLS. 100, 101 AND 107).

CLASS 42—SCIENTIFIC, COMPUTER AND LEGAL SERVICES

FOR APPLICATION SERVICE PROVIDER FEATURING SOFTWARE TO ENABLE UPLOADING, POSTING, DISPLAYING, TAGGING, BLOGGING, SHARING OR OTHERWISE PROVIDING ELECTRONIC MEDIA OR INFORMATION OVER THE INTERNET (U.S. CLS. 100 AND 101).

ROBERT LAVACHE, EXAMINING ATTORNEY

SN 77-132,892. GENERATION SCHOOLS NETWORK INC., BROOKLYN, NY. FILED 3-16-2007.

GENERATION SCHOOLS

THE MARK CONSISTS OF STANDARD CHARACTERS WITHOUT CLAIM TO ANY PARTICULAR FONT, STYLE, SIZE, OR COLOR.

NO CLAIM IS MADE TO THE EXCLUSIVE RIGHT TO USE "SCHOOLS", APART FROM THE MARK AS SHOWN.

CLASS 35—ADVERTISING AND BUSINESS

FOR MANAGEMENT AND OPERATION OF PUBLIC SCHOOLS, CHARTER SCHOOLS AND SCHOOL DISTRICTS FOR OTHERS; CONSULTING FOR OTHERS IN THE OPERATION AND MANAGEMENT OF PUBLIC SCHOOLS, CHARTER SCHOOLS AND SCHOOL DISTRICTS IN THE FIELD OF ELEMENTARY, MIDDLE AND HIGH SCHOOL EDUCATION (U.S. CLS. 100, 101 AND 102).

CLASS 36—INSURANCE AND FINANCIAL

FOR CHARITABLE FUND RAISING (U.S. CLS. 100, 101 AND 102).

CLASS 41—EDUCATION AND ENTERTAINMENT

FOR EDUCATIONAL SERVICES IN THE NATURE OF COURSES AND INSTRUCTION AT THE ELEMENTARY, JUNIOR HIGH AND HIGH SCHOOL LEVEL; EDUCATION SERVICES, NAMELY, MENTORING IN THE FIELD OF GENERAL AND SPECIAL EDUCATION; DEVELOPMENT AND DISSEMINATION OF EDUCATIONAL MATERIALS IN THE FIELD OF GENERAL AND SPECIAL EDUCATION; GENERAL AND SPECIAL EDUCATION CONSULTATION; TRAINING SERVICES IN THE FIELD OF GENERAL AND SPECIAL EDUCATION; PROVIDING CLASSES, SEMINARS AND MENTORING IN THE FIELD OF PROFESSIONAL TEACHING; CONSULTING SERVICES IN THE FIELD OF EDUCATION (U.S. CLS. 100, 101 AND 107).

JILL C. ALT, EXAMINING ATTORNEY

SN 77-133,105. BATH & BODY WORKS BRAND MANAGEMENT, INC., REYNOLDSBURG, OH. FILED 3-16-2007.

BRAZILIAN RAIN

THE MARK CONSISTS OF STANDARD CHARACTERS WITHOUT CLAIM TO ANY PARTICULAR FONT, STYLE, SIZE, OR COLOR.

CLASS 3—COSMETICS AND CLEANING PREPARATIONS

FOR PERSONAL CARE PRODUCTS, NAMELY, AFTER SHAVE, AFTER SHAVE BALM, AGE SPOT LIGHTENER CREAM, ANTIPERSPIRANT, ASTRINGENT FOR THE FACE AND SKIN FOR COSMETIC PURPOSES, BATH BEADS, BATH SKIN CREAM, BATH FOAM, BATH MILK, BATH OIL, BATH SALTS, NON-MEDICATED BATH SOAKS, BLEMISH CORRECTOR CREAM, BLEMISH STICK CREAM, BODY BALM, BODY SOAP BAR, BODY BUTTER FOR COSMETIC PURPOSES, BODY CREAM, BODY ESSENCE, BODY GEL, BODY GLITTER, BODY LOTION, BODY LUSTER CREAM, BODY MASK, BODY MIST, BODY OIL, BODY PAINT, BODY POWDER, BODY SCRUB, BODY SMOOTHER LOTION, BODY SOAP, BODY SPLASH, BODY WASH, BUBBLE BATH, BUFFING SKIN BAR, COLOGNE, CREAM BODY WASH, CREAM SKIN CLEANSER, CUTICLE CREAM, CUTICLE CREAM STICK, CUTICLE OIL PEN, DEODORANT, ESSENTIAL OILS, EXFOLIATOR FOR THE FEET, EYE SUN BLOCK, EYE CREAM, EYE GEL, EYE MASK, FACE BALM, FACE SUN BLOCK, FACE CLEANSER, FACE CREAM, FACE GEL, FACE LOTION, FACE MASK, FACE MIST, FACE MOISTURIZER, FACE POLISHER, FACE POWDER, FACE SCRUB, FACE SOAP, FACE WASH, PRE-MOISTENED COSMETIC WIPES, FIRING SKIN LOTION TREATMENT, FOAM BATH, NON-MEDICATED FOOT CREAM, FOOT LOTION, FOOT POWDER, FOOT SCRUB, NON-MEDICATED FOOT SOAK, FOOT SPRAY, GEL FACE WASH, GLYCERIN SOAP, HAIR CONDITIONER, HAIR DETANGLER, HAIR DYE, HAIR GEL, HAIR GLITTER, HAIR INHIBITOR LOTION, HAIR MASCARA, HAIR MIST, HAIR POMADE, HAIR RECONSTRUCTOR, HAIR REMOVING CREAM, HAIR REPAIR CONDITIONER, HAIR RINSE, HAIR SHAMPOO, HAIR SHINE SERUM, HAIR SPRAY, HAIR STRAIGHTENER CREAM, HAIR STYLING MOUSSE, HAND BALM, HAND CLEANSING SPRAY, HAND CREAM, HAND EXFOLIATOR, HAND LOTION, HAND RENEWER LOTION, HAND SOAP, HAND WASH, LEG BRONZING CREAM, LEG REFRESHER SPRAY, LIP BALM, LIP SUN BLOCK, LIP

GLOSS, LIP PAINT, NON-MEDICATED LIP PROTECTOR, LIP SHINE, LIP TINT, NON-MEDICATED LIP TREATMENT PREPARATION, MASSAGE CREAM, MASSAGE LOTION, MASSAGE OIL, MINERAL BATH SALTS, MOOD ENHANCING MASSAGE OINTMENT, MOOD ENHANCING BODY MIST, MOOD ENHANCING SKIN CREAM, NAIL ENAMEL CORRECTOR PEN, NAIL CREAM, NAIL POLISH, NAIL POLISH REMOVER, NAIL STENCILS, NIGHT EYE CREAM, NIGHT NOURISHING CREAM, OIL BLOTTING SHEETS FOR THE SKIN, OIL BODY SPRAY, PENETRATING BODY RUB, PERFUME, PERFUME OILS, SCENTED LINEN SPRAY, POST-SUNTANNING LOTION FOR THE BODY, POTPOURRI, POWDER FOR THE FEET, PRE-SUNTANNING LOTION FOR THE BODY, PULSE POINT SKIN CREAM, PUMICE STONES FOR PERSONAL USE, REFILLS FOR ELECTRIC ROOM FRAGRANCE DISPENSERS, ROOM FRAGRANCE SPRAY, SACHETS, SALT BODY SCRUB, SEA SALT BODY EXFOLIATOR, SELF TANNING PREPARATION, SHAVING CREAM, SHEA BUTTER HAND CREAM, SHEA BUTTER TREATMENT BODY CREAM STICK, SHOWER CREAM, SHOWER FOAM, SHOWER GEL, SHOWER SCRUB, SKIN BRONZING CREAM, SKIN CREAM, SKIN EXFOLIATOR, SKIN LOTION, SKIN MATTIFIER CREAM, SKIN MOISTURIZER, SKIN POLISHER, SKIN SCRUB, SKIN SERUM, SMOOTHING BODY OIL, SOAP, STYLING FOAM, SUGAR BODY SCRUB, SUN SCREEN, SUNBLOCK FOR THE BODY, SUNBLOCK FOR THE FACE, SUNLESS TANNING CREAM, SUNLESS TANNING LOTION FOR THE BODY, SUNLESS TANNING LOTION FOR THE FACE, SUNTAN LOTION FOR THE BODY, SUNTAN LOTION FOR THE FACE, TALCUM POWDER (U.S. CLS. 1, 4, 6, 50, 51 AND 52).

CLASS 4—LUBRICANTS AND FUELS

FOR CANDLES (U.S. CLS. 1, 6 AND 15).

CLASS 11—ENVIRONMENTAL CONTROL APPARATUS

FOR ELECTRIC FRAGRANCE DISPENSERS (U.S. CLS. 13, 21, 23, 31 AND 34).

GISELLE AGOSTO, EXAMINING ATTORNEY

SN 77-133,162. BMI HOCKEY, L.L.C., BLOOMINGTON, IL. FILED 3-16-2007.



NO CLAIM IS MADE TO THE EXCLUSIVE RIGHT TO USE "PT", APART FROM THE MARK AS SHOWN.

THE COLOR(S) NAVY, SILVER, GOLD AND WHITE IS/ ARE CLAIMED AS A FEATURE OF THE MARK.

THE MARK CONSISTS OF A NAVY CIRCLE WITH NAVY WITH SILVER OUTLINE OF LETTERS "P" AND "T" IN THE FORM OF LIGHTENING BOLTS INSIDE. CIRCLING THE LETTERS ARE CURVED NAVY AND SILVER BARS.

CLASS 25—CLOTHING

FOR HATS; SHIRTS; JERSEYS (U.S. CLS. 22 AND 39).
FIRST USE 7-19-2006; IN COMMERCE 7-19-2006.

CLASS 28—TOYS AND SPORTING GOODS

FOR HOCKEY STICKS (U.S. CLS. 22, 23, 38 AND 50).
FIRST USE 7-19-2006; IN COMMERCE 7-19-2006.

CLASS 41—EDUCATION AND ENTERTAINMENT

FOR ENTERTAINMENT IN THE NATURE OF HOCKEY GAMES (U.S. CLS. 100, 101 AND 107).
FIRST USE 7-19-2006; IN COMMERCE 7-19-2006.
SANJEEV VOHRA, EXAMINING ATTORNEY

SN 77-133,457. MARK ANTHONY INTERNATIONAL SRL,
ROCKLEY, CHRIST CHURCH, BARBADOS, FILED 3-16-
2007.



OWNER OF U.S. REG. NOS. 2,501,401, 3,125,866 AND
OTHERS.

NO CLAIM IS MADE TO THE EXCLUSIVE RIGHT TO
USE "PREMIUM MALT COCKTAIL", APART FROM THE
MARK AS SHOWN.

THE MARK CONSISTS OF THE WORDS MIKE-ARITA
PREMIUM MALT COCKTAIL IN STYLIZED FONT, WITH
THE WORD MIKE APPEARING WITHIN A STYLIZED
DRAWING OF A LEMON, AND THE LETTER A IN MIKE-
ARITA REPRESENTED BY A STYLIZED DRAWING OF A
SWIZZLE STICK.

SN 77-133,301. MARK ANTHONY INTERNATIONAL SRL,
ROCKLEY, CHRIST CHURCH, BARBADOS, FILED 3-16-
2007.

MIKE'S MIKE-ARITA PREMIUM
MALT COCKTAIL

CLASS 18—LEATHER GOODS

FOR BAGS, NAMELY, ALL-PURPOSE CARRYING
BAGS, DUFFLE BAGS, GYM BAGS, BRIEFCASES,
BEACH BAGS, FANNY PACKS AND BACK PACKS
(U.S. CLS. 1, 2, 3, 22 AND 41).

CLASS 25—CLOTHING

FOR CLOTHING, NAMELY, SHIRTS, BLOUSES, T-
SHIRTS, JACKETS, WINDSHIRTS, VESTS, SWEATERS,
SWEATSHIRTS, HATS, CAPS (U.S. CLS. 22 AND 39).

CLASS 32—LIGHT BEVERAGES

FOR FLAVORED BREWED MALT-BASED ALCO-
HOLIC BEVERAGES IN THE NATURE OF BEER (U.S.
CLS. 45, 46 AND 48).

CLASS 33—WINES AND SPIRITS

FOR ALCOHOLIC FLAVORED MALT COOLERS (U.S.
CLS. 47 AND 49).
ANTHONY RINKER, EXAMINING ATTORNEY

THE MARK CONSISTS OF STANDARD CHARACTERS
WITHOUT CLAIM TO ANY PARTICULAR FONT, STYLE,
SIZE, OR COLOR.

OWNER OF U.S. REG. NOS. 2,501,401, 3,125,866 AND
OTHERS.

CLASS 18—LEATHER GOODS

FOR BAGS, NAMELY, ALL-PURPOSE CARRYING
BAGS, DUFFLE BAGS, GYM BAGS, BRIEFCASES,
BEACH BAGS, FANNY PACKS AND BACK PACKS
(U.S. CLS. 1, 2, 3, 22 AND 41).

CLASS 25—CLOTHING

FOR CLOTHING, NAMELY, SHIRTS, BLOUSES, T-
SHIRTS, JACKETS, WINDSHIRTS, VESTS, SWEATERS,
SWEATSHIRTS, HATS, CAPS (U.S. CLS. 22 AND 39).
ANTHONY RINKER, EXAMINING ATTORNEY

SN 77-133,916. VIP FRANCHISE GROUP, LLC, CLIFTON, NJ,
FILED 3-18-2007.

V.I.P. CLEANERS

THE MARK CONSISTS OF STANDARD CHARACTERS
WITHOUT CLAIM TO ANY PARTICULAR FONT, STYLE,
SIZE, OR COLOR.

NO CLAIM IS MADE TO THE EXCLUSIVE RIGHT TO
USE "CLEANERS", APART FROM THE MARK AS SHOWN.

CLASS 35—ADVERTISING AND BUSINESS

FOR FRANCHISING, NAMELY, OFFERING TECHNICAL ASSISTANCE IN THE ESTABLISHMENT AND/OR OPERATION OF BUSINESSES PROVIDING DRY CLEANING, CLOTHING REPAIR, CLEANING OF CLOTHING, CLOTHING IRONING, LAUNDERING, PRESSING OF CLOTHING AND CLOTHING WASHING, AND WASHING OF CLOTH, FABRIC, LINEN AND TEXTILES, AND LEATHER CLEANING (U.S. CLS. 100, 101 AND 102).

FIRST USE 6-1-2004; IN COMMERCE 6-1-2004.

CLASS 37—CONSTRUCTION AND REPAIR

FOR CLEANING OF CLOTHING; DRY CLEANING; LEATHER CLEANING AND REPAIR; CLOTHING REPAIR (U.S. CLS. 100, 103 AND 106).

FIRST USE 6-1-2004; IN COMMERCE 6-1-2004.

CLASS 39—TRANSPORTATION AND STORAGE

FOR LAUNDRY PICK-UP AND DELIVERY SERVICES (U.S. CLS. 100 AND 105).

FIRST USE 6-1-2004; IN COMMERCE 6-1-2004.
BRIAN PINO, EXAMINING ATTORNEY

SN 77-133,952. SCHERING CORPORATION, KENILWORTH, NJ. FILED 3-19-2007.



THE MARK CONSISTS OF PERFECTLY CLEAR DAY WITH A HUMAN FIGURE.

CLASS 5—PHARMACEUTICALS

FOR ANTI-ALLERGY PREPARATIONS; ANTIHISTAMINE PREPARATIONS; AND DECONGESTANT PREPARATIONS (U.S. CLS. 6, 18, 44, 46, 51 AND 52).

CLASS 16—PAPER GOODS AND PRINTED MATTER

FOR PRINTED MATERIALS, NAMELY, NEWSLETTERS AND BROCHURES IN THE FIELD OF ALLERGY TREATMENT (U.S. CLS. 2, 5, 22, 23, 29, 37, 38 AND 50).
ANGELA GAW, EXAMINING ATTORNEY

SN 77-134,400. BINCO, LLC, CHICAGO, IL. FILED 3-19-2007.

CUCINA VIVA

THE MARK CONSISTS OF STANDARD CHARACTERS WITHOUT CLAIM TO ANY PARTICULAR FONT, STYLE, SIZE, OR COLOR.

OWNER OF U.S. REG. NO. 2,504,532.

THE FOREIGN WORDING IN THE MARK TRANSLATES INTO ENGLISH AS LIVELY KITCHEN.

CLASS 29—MEATS AND PROCESSED FOODS

FOR EDIBLE OILS, ROASTED VEGETABLES, DRIED VEGETABLES, OLIVE OIL, CHEESE, NAMELY MOZZARELLA, CANNED TOMATOES, AND BUTTER (U.S. CL. 46).

FIRST USE 4-1-2000; IN COMMERCE 4-1-2000.

CLASS 30—STAPLE FOODS

FOR PASTA, GNOCCHI, VINEGAR, ITALIAN SAUCES, BREADSTICKS, FLAT BREADS, NAMELY CROSTINI AND BRUSCHETTA (U.S. CL. 46).

FIRST USE 4-1-2000; IN COMMERCE 4-2-2000.

AMY BROZENIC, EXAMINING ATTORNEY

SN 77-134,498. CALLAHAN, GLENN C., CARMEL, CA. FILED 3-19-2007.

bioflex

THE MARK CONSISTS OF STANDARD CHARACTERS WITHOUT CLAIM TO ANY PARTICULAR FONT, STYLE, SIZE, OR COLOR.

CLASS 4—LUBRICANTS AND FUELS

FOR RENEWABLE FUELS (U.S. CLS. 1, 6 AND 15).

CLASS 35—ADVERTISING AND BUSINESS

FOR RETAIL VEHICLE FUEL SUPPLY SERVICES (U.S. CLS. 100, 101 AND 102).
AMEETA JORDAN, EXAMINING ATTORNEY

SN 77-134,821. REIS, KEVIN C., COVINGTON, GA. FILED 3-19-2007.

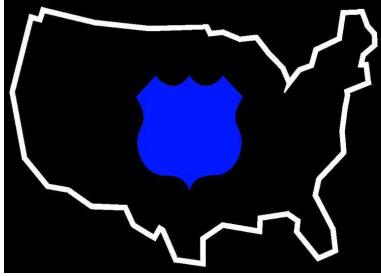

NO CLAIM IS MADE TO THE EXCLUSIVE RIGHT TO USE THE OUTLINE OF THE USA, APART FROM THE MARK AS SHOWN.

THE COLOR(S) BLACK, BLUE AND WHITE IS/ARE CLAIMED AS A FEATURE OF THE MARK.

THE RECTANGULAR BACKGROUND IS BLACK. THE OUTLINE OF THE MAP OF THE USA IS WHITE. THE BADGE IS BLUE.

CLASS 16—PAPER GOODS AND PRINTED MATTER

FOR DECALS (U.S. CLS. 2, 5, 22, 23, 29, 37, 38 AND 50). FIRST USE 12-31-2006; IN COMMERCE 12-31-2006.

CLASS 25—CLOTHING

FOR POLO SHIRTS; SHORT-SLEEVED OR LONG-SLEEVED T-SHIRTS; SPORT SHIRTS; TOBOGGAN HATS, PANTS AND CAPS (U.S. CLS. 22 AND 39).

FIRST USE 12-31-2006; IN COMMERCE 12-31-2006. IRA J. GOODSAD, EXAMINING ATTORNEY

SN 77-135,121. ACADIA OUTDOORS HOLDINGS C.V., AMSTELVEEN, NETHERLANDS, FILED 3-20-2007.



THE MARK CONSISTS OF A RECTANGLE POSITIONED HORIZONTALLY OVER WHICH APPEARS A LIZARD, AND ABOVE THIS DESIGN THE WORD TUKEKE IN STYLIZED CAPITAL LETTERS.

CLASS 18—LEATHER GOODS

FOR SUITCASES; TRUNKS; VANITY CASES SOLD EMPTY; ATTACHE CASES; SATCHELS; TOILETRY CASES SOLD EMPTY; TOOL BAGS SOLD EMPTY; TRAVELING BAGS; KNAPSACKS; BACKPACKS; HANDBAGS; LEATHER SHOPPING BAGS; MESH SHOPPING BAGS; SHOPPING BAGS MADE OF SKIN; PURSES; WALLETS; SPORTS BAGS; LEATHER CASES; LEATHER AND IMITATION LEATHER BAGS; LEATHER BAGS FOR MERCHANDISE PACKAGING; POUCHES OF LEATHER; TRAVELLING CASES OF LEATHER (U.S. CLS. 1, 2, 3, 22 AND 41).

CLASS 22—CORDAGE AND FIBERS

FOR CANVAS TARPULINS; AWNINGS; TENTS; SAILS (U.S. CLS. 1, 2, 7, 19, 22, 42 AND 50).

CLASS 25—CLOTHING

FOR OVERCOATS; ANORAKS; CAPES; FUR CLOAKS; SKI JACKETS; WIND RESISTANT JACKETS; WIND-JACKETS; JACKETS; LEATHER JACKETS; SLEEVED OR SLEEVELESS JACKETS; RAINPROOF JACKETS; BLAZERS; MEN'S SUITS; CLOTH BIBS; OVERALLS; TROUSERS; BREECHES; SHORTS; LADIES' SUITS; SKIRTS; DRESSES; BLOUSES; SHIRTS; SINGLET; T-SHIRTS; TANK TOPS; PULLOVERS; SWEATERS; SWEAT SHIRTS; WAISTCOATS; VESTS; SKI SUITS; TRACK SUITS; SWIM WEAR; PANTYHOSE; SOCKS; STOCKINGS; TIGHTS; HOSIERY; FOOTWEAR; GLOVES; MITTENS; COATS; BELTS MADE OF LEATHER; HEADGEAR, NAMELY, HATS AND CAPS; HOODS (U.S. CLS. 22 AND 39).

TASNEEM HUSSAIN, EXAMINING ATTORNEY

SN 77-135,401. K.I.S. LIMITED, HUNG HOM, KOWLOON, HONG KONG, FILED 3-20-2007.

THERMOGREEN

THE MARK CONSISTS OF STANDARD CHARACTERS WITHOUT CLAIM TO ANY PARTICULAR FONT, STYLE, SIZE, OR COLOR.

CLASS 8—HAND TOOLS

FOR SHAVERS AND EPILATORS (U.S. CLS. 23, 28 AND 44).

CLASS 11—ENVIRONMENTAL CONTROL APPARATUS

FOR THIN RADIATORS, FOLDING RADIATORS, NARROW AND FOLDING PARTITIONS, HEATING LAMP SHADES, HAIR DRYERS (U.S. CLS. 13, 21, 23, 31 AND 34).

CLASS 21—HOUSEWARES AND GLASS

FOR HAIR BRUSHES (U.S. CLS. 2, 13, 23, 29, 30, 33, 42 AND 50). JOHN WILKE, EXAMINING ATTORNEY

SN 77-135,684. SONY KABUSHIKI KAISHA, TA SONY CORPORATION, TOKYO, JAPAN, FILED 3-20-2007.

FETech

THE MARK CONSISTS OF STANDARD CHARACTERS WITHOUT CLAIM TO ANY PARTICULAR FONT, STYLE, SIZE, OR COLOR.

CLASS 9—ELECTRICAL AND SCIENTIFIC APPARATUS

FOR FIELD EMISSION DISPLAY MONITORS FOR PROFESSIONAL USE IN THE FIELD OF BROADCASTING, CINEMATOGRAPHIC AND GAME PROGRAMMING; FIELD EMISSION DISPLAY MONITORS USED AS A PART OF VIDEO CAMERAS; FIELD EMISSION DISPLAY MONITORS USED AS A PART OF NAVIGATION DEVICES FOR IN-CAR USE; FIELD EMISSION DISPLAY MONITORS USED AS A PART OF NAVIGATION DEVICES FOR IN-FLIGHT USE; FIELD EMISSION DISPLAY MONITORS USED AS A PART OF ENTERTAINMENT DEVICES FOR IN-CAR USE; FIELD EMISSION DISPLAY MONITORS USED AS A PART OF ENTERTAINMENT DEVICES FOR IN-FLIGHT USE; FIELD EMISSION DISPLAY MONITORS USED AS MONITORS FOR PERSONAL COMPUTERS; FIELD EMISSION DISPLAY MONITORS FOR TELEVISIONS (U.S. CLS. 21, 23, 26, 36 AND 38).

CLASS 10—MEDICAL APPARATUS

FOR FIELD EMISSION DISPLAY MONITORS FOR MEDICAL USE (U.S. CLS. 26, 39 AND 44).

CLASS 42—SCIENTIFIC, COMPUTER AND LEGAL SERVICES

FOR RESEARCH AND DEVELOPMENT OF FIELD EMISSION DISPLAY MONITORS; RESEARCH AND DEVELOPMENT OF FIELD EMISSION DISPLAY TECHNOLOGIES (U.S. CLS. 100 AND 101).

HOWARD FRIEDMAN, EXAMINING ATTORNEY

SN 77-135,865. CLEANTECH GROUP LLC, HOWELL, MI. FILED 3-20-2007.

CLEANTECH INVESTMENT MONITOR

THE MARK CONSISTS OF STANDARD CHARACTERS WITHOUT CLAIM TO ANY PARTICULAR FONT, STYLE, SIZE, OR COLOR.

OWNER OF U.S. REG. NOS. 3,089,736, 3,125,962 AND OTHERS.

NO CLAIM IS MADE TO THE EXCLUSIVE RIGHT TO USE "INVESTMENT", APART FROM THE MARK AS SHOWN.

CLASS 9—ELECTRICAL AND SCIENTIFIC APPARATUS

FOR DOWNLOADABLE ELECTRONIC PUBLICATIONS IN THE NATURE OF REPORTS AND NEWSLETTERS IN THE FIELD OF VENTURE CAPITAL AND INVESTMENT IN THE FOLLOWING INDUSTRIES: ENERGY GENERATION, ENERGY STORAGE, ENERGY INFRASTRUCTURE, ENERGY EFFICIENCY, TRANSPORTATION, TRANSPORTATION LOGISTICS, WATER PURIFICATION, WATER MANAGEMENT, AIR QUALITY, NANOTECHNOLOGY, MANUFACTURING, INDUSTRIAL, AGRICULTURE, NUTRITION, MATERIALS RECOVERY, MATERIALS RECYCLING, ENVIRONMENTAL INFORMATION TECHNOLOGY AND ENABLING TECHNOLOGIES (U.S. CLS. 21, 23, 26, 36 AND 38).

CLASS 16—PAPER GOODS AND PRINTED MATTER

FOR PRINTED REPORTS FEATURING VENTURE CAPITAL NEWS AND DEAL TRACKING, NEW TECHNOLOGIES AND INVESTMENT IN THE FIELDS OF ENERGY GENERATION, ENERGY STORAGE, ENERGY INFRASTRUCTURE, ENERGY EFFICIENCY, TRANSPORTATION, TRANSPORTATION LOGISTICS, WATER PURIFICATION, WATER MANAGEMENT, AIR QUALITY, NANOTECHNOLOGY, MANUFACTURING, INDUSTRIAL, AGRICULTURE, NUTRITION, MATERIALS RECOVERY, MATERIALS RECYCLING, ENVIRONMENTAL INFORMATION TECHNOLOGY AND ENABLING TECHNOLOGIES; RESEARCH REPORTS FEATURING VENTURE CAPITAL NEWS AND DEAL TRACKING, NEW TECHNOLOGIES AND INVESTMENT IN THE FIELDS OF ENERGY GENERATION, ENERGY STORAGE, ENERGY INFRASTRUCTURE, ENERGY EFFICIENCY, TRANSPORTATION, TRANSPORTATION LOGISTICS, WATER PURIFICATION, WATER MANAGEMENT, AIR QUALITY, NANOTECHNOLOGY, MANUFACTURING, INDUSTRIAL, AGRICULTURE, NUTRITION, MATERIALS RECOVERY, MATERIALS RECYCLING, ENVIRONMENTAL INFORMATION TECHNOLOGY AND ENABLING TECHNOLOGIES (U.S. CLS. 2, 5, 22, 23, 29, 37, 38 AND 50).

SKYE YOUNG, EXAMINING ATTORNEY

SN 77-135,938. MONTEREY GOURMET FOODS, INC., SALINAS, CA. FILED 3-20-2007.



NO CLAIM IS MADE TO THE EXCLUSIVE RIGHT TO USE "KITCHEN ORGANIC", APART FROM THE MARK AS SHOWN.

THE MARK CONSISTS OF A SLIGHTLY ARC SHAPE HORIZONTAL BANNER CONTAINING THE WORDS, "EMERALD VALLEY," CENTERED BETWEEN THE TWO WORDS ARE VARIOUS VEGETABLES, INCLUDING A TOMATO; HEAD OF GARLIC; AND A CHILI PEPPER IN THE FOREGROUND. IN THE BACKGROUND IS AN ONION, PARSLEY, AND A CHILI PEPPER. IMMEDIATELY BELOW AND CENTERED UNDER THE TOP BANNER IS THE WORD, "KITCHEN" WITH SHADED FIELDS IN THE BACKGROUND. BELOW "KITCHEN" IS A SECOND ARC SHAPED BANNER CONTAINING THE WORD, "ORGANIC." THE ENDS OF THIS BANNER ARE FOLDED UNDER AT EACH END FOR A THREE DIMENSIONAL RIBBON EFFECT.

CLASS 29—MEATS AND PROCESSED FOODS

FOR BEAN DIP; HUMMUS; DIPS; SNACK DIPS (U.S. CL. 46).

FIRST USE 6-1-1983; IN COMMERCE 6-1-1983.

CLASS 30—STAPLE FOODS

FOR SALSA; BEAN PASTE (U.S. CL. 46).

FIRST USE 6-1-1983; IN COMMERCE 6-1-1983.
RONALD AIKENS, EXAMINING ATTORNEY

SN 77-136,218. RANDALL, CATHERINE J., TUSCALOOSA, AL. FILED 3-21-2007.

HIGHLY QUALIFIED PARENT

THE MARK CONSISTS OF STANDARD CHARACTERS WITHOUT CLAIM TO ANY PARTICULAR FONT, STYLE, SIZE, OR COLOR.

NO CLAIM IS MADE TO THE EXCLUSIVE RIGHT TO USE "PARENT", APART FROM THE MARK AS SHOWN.

CLASS 16—PAPER GOODS AND PRINTED MATTER

FOR BOOKS, BROCHURES AND SYNDICATED COLUMNS IN THE FIELD OF PARENTING (U.S. CLS. 2, 5, 22, 23, 29, 37, 38 AND 50).

CLASS 41—EDUCATION AND ENTERTAINMENT

FOR EDUCATIONAL SERVICES, NAMELY, PROVIDING LECTURES, SEMINARS AND WORKSHOPS IN THE FIELD OF PARENTING, AND DISTRIBUTING COURSE MATERIALS IN CONNECTION THEREWITH (U.S. CLS. 100, 101 AND 107).

ARETHA SOMERVILLE, EXAMINING ATTORNEY

SN 77-136,292. PRAXIS RESOURCE PARTNERS, L.L.C., HERNDON, VA. FILED 3-21-2007.



NO CLAIM IS MADE TO THE EXCLUSIVE RIGHT TO USE "RESOURCE PARTNERS, LLC", APART FROM THE MARK AS SHOWN.

"THE COLOR(S) BLACK, GREY, WHITE AND GOLD IS/ARE CLAIMED AS A FEATURE OF THE MARK."

"THE MARK CONSISTS OF A GREY SHIELD WITH A WHITE AND BLACK BORDER, AND WITH THE STYLIZED BLACK LETTERS PRP SUPERIMPOSED ON THE SHIELD TOGETHER WITH BLACK AND WHITE STYLIZED DROPS, BELOW WHICH ARE THE BLACK LETTERS PRAXIS WITH GREY HIGHLIGHTS, AND A STYLIZED GOLD DROP DOTTING THE I, FOLLOWED BY THE BLACK LETTERS RESOURCE PARTNERS, LLC."

CLASS 4—LUBRICANTS AND FUELS

FOR SYNTHETIC GASOLINE, ELECTRICAL ENERGY, LIQUEFIED PETROLEUM GAS (U.S. CLS. 1, 6 AND 15).

CLASS 40—MATERIAL TREATMENT

FOR GASIFICATION OF COAL; GENERATION OF ELECTRICAL ENERGY; GENERATION OF SYNTHETIC GASOLINE FOR OTHERS; GENERATION OF LIQUEFIED PETROLEUM GAS FOR OTHERS (U.S. CLS. 100, 103 AND 106).

ANDREA HACK, EXAMINING ATTORNEY

SN 77-136,501. MTD PRODUCTS INC, VALLEY CITY, OH. FILED 3-21-2007.



OWNER OF U.S. REG. NOS. 2,064,409, 2,066,180 AND 2,068,347.

"THE COLOR(S) SILVER AND BLUE IS/ARE CLAIMED AS A FEATURE OF THE MARK."

"THE MARK CONSISTS OF THE COLOR SILVER IN THE WORDING "CUB CADET" AND IN THE OUTER RECTANGLE DESIGN. THE COLOR BLUE APPEARS IN THE INSIDE RECTANGLE DESIGN AS BACKGROUND TO THE WORDING IN THE MARK."

CLASS 7—MACHINERY

FOR POWER OPERATED LAWN AND GARDEN EQUIPMENT, NAMELY, RIDING LAWN MOWERS, ZERO TURN MOWERS, WALK-BEHIND MOWERS, GARDEN TILLERS, SNOWTHROWERS, LOG SPLITTERS, HEDGE TRIMMERS, STRING TRIMMERS, CHIPPER SHREDDER VACUUMS FOR CLEARING DEBRIS (U.S. CLS. 13, 19, 21, 23, 31, 34 AND 35).

FIRST USE 10-0-2005; IN COMMERCE 10-0-2005.

CLASS 12—VEHICLES

FOR UTILITY VEHICLES AND TRACTORS, NAMELY, COMPACT TRACTORS AND UTILITY TRACTORS (U.S. CLS. 19, 21, 23, 31, 35 AND 44).

FIRST USE 10-0-2005; IN COMMERCE 10-0-2005.

NATALIE POLZER, EXAMINING ATTORNEY

SN 77-136,539. MONTEREY GOURMET FOODS, INC., SALINAS, CA. FILED 3-21-2007.

EMERALD VALLEY KITCHEN ORGANIC

THE MARK CONSISTS OF STANDARD CHARACTERS WITHOUT CLAIM TO ANY PARTICULAR FONT, STYLE, SIZE, OR COLOR.

NO CLAIM IS MADE TO THE EXCLUSIVE RIGHT TO USE "KITCHEN ORGANIC", APART FROM THE MARK AS SHOWN.

CLASS 29—MEATS AND PROCESSED FOODS

FOR BEAN DIP; HUMMUS; DIPS; SNACK DIPS; SNACK FOOD DIPS (U.S. CL. 46).

FIRST USE 6-1-1983; IN COMMERCE 6-1-1983.

CLASS 30—STAPLE FOODS

FOR SALSA; BEAN PASTE (U.S. CL. 46).
FIRST USE 6-1-1983; IN COMMERCE 6-1-1983.
RONALD AIKENS, EXAMINING ATTORNEY

SN 77-136,792. NIAGARA COUNTY, LOCKPORT, NY.
FILED 3-21-2007.



**NIAGARA COUNTY
BICENTENNIAL
1808 - 2008**

NO CLAIM IS MADE TO THE EXCLUSIVE RIGHT TO USE "NIAGARA COUNTY BICENTENNIAL 1808-2008", APART FROM THE MARK AS SHOWN.

THE MARK CONSISTS OF A WATERFALL WITH FIREWORKS ABOVE IT AND THE WORDS NIAGARA COUNTY BICENTENNIAL 1808-2008.

CLASS 16—PAPER GOODS AND PRINTED MATTER

FOR POSTERS (U.S. CLS. 2, 5, 22, 23, 29, 37, 38 AND 50).

CLASS 25—CLOTHING

FOR CLOTHING, NAMELY T-SHIRTS, SWEATSHIRTS, SHORTS, JACKETS, CAPS, HATS AND VISORS (U.S. CLS. 22 AND 39).
MARCIE MILONE, EXAMINING ATTORNEY

SN 77-136,935. BPOSH, LLC, NEW YORK, NY. FILED 3-21-2007.

Bee Posh

THE MARK CONSISTS OF STANDARD CHARACTERS WITHOUT CLAIM TO ANY PARTICULAR FONT, STYLE, SIZE, OR COLOR.

CLASS 20—FURNITURE AND ARTICLES NOT OTHERWISE CLASSIFIED

FOR HOME FURNISHINGS, NAMELY, BEAN BAG CHAIRS, PILLOW CHAIRS, PILLOWS AND PICTURE FRAMES (U.S. CLS. 2, 13, 22, 25, 32 AND 50).

CLASS 25—CLOTHING

FOR MEN'S, WOMEN'S AND CHILDREN'S CLOTHING, NAMELY, SHIRTS, SKIRTS, DRESSES, PANTS, SWEATERS AND JACKETS (U.S. CLS. 22 AND 39).

CLASS 28—TOYS AND SPORTING GOODS

FOR TOYS; NAMELY PLUSH AND STUFFED ANIMALS (U.S. CLS. 22, 23, 38 AND 50).
SUSAN RICHARDS, EXAMINING ATTORNEY

SN 77-137,113. CAHILL CORPORATION, FORT COLLINS, CO. FILED 3-21-2007.



St. Peter's Fly Shop

NO CLAIM IS MADE TO THE EXCLUSIVE RIGHT TO USE "FLY SHOP", APART FROM THE MARK AS SHOWN.
THE MARK CONSISTS OF THE LETTER "P" DISPLAYED ON A TABLE ENCIRCLED BY A FISHING LINE AND FLY, ABOVE THE WORDING "ST. PETER'S FLY SHOP".

CLASS 25—CLOTHING

FOR CLOTHING, NAMELY, CAPS, SHIRTS, PANTS, SWEATERS, JACKETS, AND FISHING VESTS (U.S. CLS. 22 AND 39).
FIRST USE 8-15-1992; IN COMMERCE 8-15-1992.

CLASS 28—TOYS AND SPORTING GOODS

FOR FISHING EQUIPMENT; NAMELY, RODS, REELS, TACKLE BOXES, ROD CASES, REEL CASES, LINES, LEADERS, CREELS, NETS, HOOKS AND SYNTHETIC LURE BODIES; FISHING LURES; SPORTSMAN'S FISHING BAGS; FLY FISHING COMPONENTS; NAMELY, FUR, HAIR, FEATHERS, SYNTHETIC MATERIALS, RIBBONS AND BEADS, FLY BOXES AND FLIES, AND TUBE-TYPE FLOATS (U.S. CLS. 22, 23, 38 AND 50).
FIRST USE 8-15-1992; IN COMMERCE 8-19-1992.

CLASS 35—ADVERTISING AND BUSINESS

FOR RETAIL STORE, ON-LINE RETAIL STORE AND MAIL ORDER SERVICES FEATURING FLY FISHING PRODUCTS AND CLOTHING (U.S. CLS. 100, 101 AND 102).
FIRST USE 8-15-1992; IN COMMERCE 8-15-1992.
KATHERINE STOIDES, EXAMINING ATTORNEY

SN 77-137,170. SMITH, EDWARD NATHANIEL, SILVER SPRING, MD. FILED 3-21-2007.

SN 77-137,341. NHN CORPORATION, GYEONGGI-DO, REPUBLIC OF KOREA, FILED 3-22-2007.



THE COLOR(S) BLUE, BLACK AND WHITE IS/ARE CLAIMED AS A FEATURE OF THE MARK.

THE MARK CONSISTS OF A SHEILD WITH TWO WHITE AND BLUE ARGYLE PANELS, A BLACK PANEL WITH WHITE MONKEY HEAD OUTLINES OVERLAPPED BY A BIGGER MONKEY HEAD, AND A BLACK PANEL WITH "DOMONKEYSEE" WRITTEN DIAGONALLY IN WHITE. THE SHIELD IS OUTLINED WITH A BLUE LINE WITH BLACK LINES ON EITHER SIDE. IT HAS A FIVE POINT BLACK CROWN ON THE TOP SEPARATED FROM THE SHIELD BY A BLUE BAR. TWO BRANCHES WITH FOUR POINTS EXTEND AND CURL UP SYMMETRICALLY FROM THE BOTTOM ON EITHER SIDE. A SMALLER VERSION OF THE CREST RESTS AT THE BOTTOM OF THE ORIGINAL ON A WHITE BACKGROUND SEPARATED BY A BLACK BAR. THE SMALLER VERSION HAS TWO BLACK PANELS AND TWO WHITE PANELS AND NO SMALLER VERSION AT THE BOTTOM.

CLASS 25—CLOTHING

FOR KNIT SHIRTS; NIGHT SHIRTS; OPEN-NECKED SHIRTS; POLO SHIRTS; SHORT-SLEEVED OR LONG-SLEEVED T-SHIRTS; SHORT-SLEEVED SHIRTS; SLEEP SHIRTS; SPORT SHIRTS; SPORTS SHIRTS WITH SHORT SLEEVES; SWEAT SHIRTS; T-SHIRTS; DENIMS; JOGGING PANTS; PANTS; SWEAT PANTS; TRACK PANTS; ATHLETIC SHOES; BEACH SHOES; RUNNING SHOES; TENNIS SHOES; TRAINING SHOES; WOMEN'S SHOES; BRIEFS; LADIES' UNDERWEAR; THERMAL UNDERWEAR; THONGS; UNDERWEAR; WOMEN'S UNDERWEAR; HATS; HEADGEAR, NAMELY, HATS, CAPS; BELTS; BELTS MADE OF LEATHER; BELTS OF TEXTILE; FABRIC BELTS; LEATHER BELTS; SUSPENDER BELTS FOR MEN; WAIST BELTS (U.S. CLS. 22 AND 39).

CLASS 26—FANCY GOODS

FOR BELT BUCKLES; BELT BUCKLES NOT OF PRECIOUS METAL; BELT BUCKLES OF PRECIOUS METAL; BELT CLASPS (U.S. CLS. 37, 39, 40, 42 AND 50).
SAIMA MAKHDOOM, EXAMINING ATTORNEY



THE COLOR(S) GREEN, LIGHT GREEN, WHITE, ORANGE AND YELLOW IS/ARE CLAIMED AS A FEATURE OF THE MARK.

THE MARK CONSISTS OF THE WORD GO STOP IN WHITE SURROUNDED BY LIGHT GREEN AND THEN GREEN WITH A FLOWER IN ORANGE WITH A GREEN AND YELLOW CENTER SURROUNDED BY LIGHT GREEN AND GREEN.

CLASS 9—ELECTRICAL AND SCIENTIFIC APPARATUS

FOR COMPUTER GAME SOFTWARE AND COMPUTER GAME PROGRAMS THAT MAY BE DOWNLOADED FROM A GLOBAL COMPUTER NETWORK (U.S. CLS. 21, 23, 26, 36 AND 38).

CLASS 41—EDUCATION AND ENTERTAINMENT

FOR ENTERTAINMENT SERVICES, NAMELY, PROVIDING ON-LINE COMPUTER GAMES; PROVIDING A WEB SITE THROUGH WHICH ONLINE COMPUTER GAME PLAYERS CAN LOCATE OTHER ONLINE COMPUTER GAME PLAYERS AND PLAY ONLINE GAMES OVER COMMUNICATIONS NETWORKS; PROVIDING A WEB SITE FEATURING ON-LINE COMPUTER GAMES (U.S. CLS. 100, 101 AND 107).

MATTHEW MCDOWELL, EXAMINING ATTORNEY

SN 77-137,526. AUDIO AND VIDEO LABS, INC., PENNSAUKEN, NJ. FILED 3-22-2007.

JUDO

THE MARK CONSISTS OF STANDARD CHARACTERS WITHOUT CLAIM TO ANY PARTICULAR FONT, STYLE, SIZE, OR COLOR.

CLASS 35—ADVERTISING AND BUSINESS

FOR ADVERTISING AND MARKETING; ADVERTISING, MARKETING AND PROMOTION SERVICES; BUSINESS CONSULTATION AND MANAGEMENT REGARDING MARKETING ACTIVITIES AND LAUNCHING OF NEW PRODUCTS; BUSINESS MARKETING CONSULTING SERVICES; BUSINESS MARKETING SERVICES; DEVELOPMENT OF MARKETING STRATEGIES AND CONCEPTS; ELECTRONIC COMMERCE SERVICES, NAMELY, PROVIDING INFORMATION ABOUT PRODUCTS VIA TELECOMMUNICATION NETWORKS FOR ADVERTISING AND SALES PURPOSES; GENERAL BUSINESS MERCHANDISING SERVICES, NAMELY, MARKETING; INFORMATION MANAGEMENT SERVICES, NAMELY, SHIPMENT PROCESSING, PREPARING SHIPPING DOCUMENTS AND INVOICES, TRACKING DOCUMENTS, PACKAGES AND FREIGHT OVER COMPUTER NETWORKS, INTRANETS AND INTERNETS; ORDER FULFILLMENT SERVICES; PROMOTION AND MARKETING SERVICES AND RELATED CONSULTING; PROVIDING BUSINESS MARKETING INFORMATION (U.S. CLS. 100, 101 AND 102).

CLASS 40—MATERIAL TREATMENT

FOR CUSTOMIZED PRINTING OF COMPANY NAMES AND LOGOS FOR PROMOTIONAL AND ADVERTISING PURPOSES OF THE GOODS OF OTHERS; DESIGN PRINTING FOR OTHERS; DESKTOP PUBLISHING FOR OTHERS; DIGITAL ON-DEMAND PRINTING SERVICES OF BOOKS AND OTHER DOCUMENTS; LETTERPRESS PRINTING; LITHOGRAPHIC PRINTING; OFFSET PRINTING; PATTERN PRINTING; PHOTOGRAPHIC PRINTING; PHOTOGRAPHIC SLIDE AND/OR PRINT PROCESSING; PHOTOGRAVURE PRINTING; PORTRAIT PRINTING; PRINTING; PRINTING OF ADVERTISING MATTER; PRINTING OF BOOKS, PRINTING OF PATTERNS ON TEXTILES; SCREEN PRINTING; SILK SCREEN PRINTING; STATIONERY PRINTING SERVICES (U.S. CLS. 100, 103 AND 106).

CLASS 42—SCIENTIFIC, COMPUTER AND LEGAL SERVICES

FOR APPLICATION SERVICE PROVIDER (ASP), NAMELY, HOSTING COMPUTER SOFTWARE APPLICATIONS OF OTHERS; DESIGN, CREATION, HOSTING AND MAINTENANCE OF INTERNET SITES FOR THIRD PARTIES; DESIGN, CREATION, HOSTING, MAINTENANCE OF WEBSITES FOR OTHERS; HOSTING OF DIGITAL CONTENT ON THE INTERNET; WEB SITE HOSTING SERVICES (U.S. CLS. 100 AND 101).
CHRISTOPHER OTT, EXAMINING ATTORNEY

SN 77-137,793. BACK, THOMAS M., CLEVELAND, OH.
FILED 3-22-2007.

TMB Optical

THE MARK CONSISTS OF STANDARD CHARACTERS WITHOUT CLAIM TO ANY PARTICULAR FONT, STYLE, SIZE, OR COLOR.

NO CLAIM IS MADE TO THE EXCLUSIVE RIGHT TO USE "OPTICAL", APART FROM THE MARK AS SHOWN.

CLASS 9—ELECTRICAL AND SCIENTIFIC APPARATUS

FOR BODY-TUBES FOR TELESCOPES; MIRROR AND STAR DIAGONALS; OPTICAL LENSES; OPTICAL OR TELESCOPIC LENS SIGHTS; TELESCOPES (U.S. CLS. 21, 23, 26, 36 AND 38).

FIRST USE 7-30-1998; IN COMMERCE 7-30-1998.

CLASS 42—SCIENTIFIC, COMPUTER AND LEGAL SERVICES

FOR DESIGN OF OPTICAL AND MICROOPTICAL COMPONENTS (U.S. CLS. 100 AND 101).
FIRST USE 7-30-1998; IN COMMERCE 7-30-1998.
KELLY BOULTON, EXAMINING ATTORNEY

SN 77-137,997. FLEETPRIDE, INC., THE WOODLANDS, TX.
FILED 3-22-2007.

PRIMAPOWER

THE MARK CONSISTS OF STANDARD CHARACTERS WITHOUT CLAIM TO ANY PARTICULAR FONT, STYLE, SIZE, OR COLOR.

CLASS 7—MACHINERY

FOR STARTERS FOR MOTORS AND ENGINES, AND ALTERNATORS FOR LAND VEHICLES (U.S. CLS. 13, 19, 21, 23, 31, 34 AND 35).

CLASS 9—ELECTRICAL AND SCIENTIFIC APPARATUS

FOR ELECTRICAL PRODUCTS FOR HEAVY DUTY TRUCKS, NAMELY, BATTERIES, JUMPER CABLES, ELECTRICAL PLUG DEVICES ENABLING CONNECTION AND DISCONNECTION OF POWER, ELECTRICAL CABLES (U.S. CLS. 21, 23, 26, 36 AND 38).
YAT SYE, LEE, EXAMINING ATTORNEY

SN 77-138,020. MOUNT ROSE PUBLISHING, INC., RENO, NV.
FILED 3-22-2007.

NEVADA APPEAL

THE MARK CONSISTS OF STANDARD CHARACTERS WITHOUT CLAIM TO ANY PARTICULAR FONT, STYLE, SIZE, OR COLOR.

NO CLAIM IS MADE TO THE EXCLUSIVE RIGHT TO USE "NEVADA", APART FROM THE MARK AS SHOWN.

CLASS 16—PAPER GOODS AND PRINTED MATTER

FOR DAILY NEWSPAPER (U.S. CLS. 2, 5, 22, 23, 29, 37, 38 AND 50).

FIRST USE 0-0-1947; IN COMMERCE 0-0-1947.

CLASS 41—EDUCATION AND ENTERTAINMENT

FOR PROVIDING ON-LINE PUBLICATIONS IN THE NATURE OF DAILY NEWSPAPERS FEATURING CURRENT EVENTS, POLITICS, POLICY, SPORTS, BUSINESS, TECHNOLOGY, ENTERTAINMENT, ARTS, LEISURE, AND TRAVEL; PROVIDING ON-LINE PUBLICATIONS IN THE NATURE OF DAILY NEWSPAPERS FEATURING INFORMATION IN THE FIELDS OF CURRENT EVENTS, POLITICS, POLICY, SPORTS, BUSINESS, TECHNOLOGY, ENTERTAINMENT, ARTS, LEISURE AND TRAVEL VIA ELECTRONIC MAIL (U.S. CLS. 100, 101 AND 107).

FIRST USE 10-0-2001; IN COMMERCE 10-0-2001.
MICHAEL SOUDERS, EXAMINING ATTORNEY

SN 77-138,087. RE21 REALTY, INC., LEESBURG, VA. FILED 3-22-2007.

MAX4

THE MARK CONSISTS OF STANDARD CHARACTERS WITHOUT CLAIM TO ANY PARTICULAR FONT, STYLE, SIZE, OR COLOR.

CLASS 35—ADVERTISING AND BUSINESS

FOR MATCHING CONSUMERS WITH REAL ESTATE PROFESSIONALS IN THE FIELD OF REAL ESTATE SERVICES VIA COMPUTER NETWORK; PROVIDING REAL ESTATE LEADS FOR PROSPECTIVE PURCHASERS; REAL ESTATE ADVERTISING SERVICES; REAL ESTATE AUCTIONS; REAL ESTATE MARKETING SERVICES IN THE FIELD OF RESIDENTIAL PROPERTY; REAL ESTATE MARKETING SERVICES, NAMELY, ON-LINE SERVICES FEATURING TOURS OF RESIDENTIAL AND COMMERCIAL REAL ESTATE; REAL ESTATE SALES MANAGEMENT (U.S. CLS. 100, 101 AND 102).

CLASS 36—INSURANCE AND FINANCIAL

FOR APPRAISAL OF REAL ESTATE; APPRAISALS FOR INSURANCE CLAIMS OF REAL ESTATE; ASSESSMENT AND MANAGEMENT OF REAL ESTATE; FINANCIAL INVESTMENT IN THE FIELD OF REAL ESTATE; FINANCIAL VALUATION OF PERSONAL PROPERTY AND REAL ESTATE; LAND ACQUISITION, NAMELY, REAL ESTATE BROKERAGE; LEASING OF REAL ESTATE; PROVIDING INFORMATION IN THE FIELD OF REAL ESTATE BY MEANS OF LINKING THE WEB SITE TO OTHER WEB SITES FEATURING REAL ESTATE INFORMATION; PROVIDING INFORMATION IN THE FIELD OF REAL ESTATE VIA THE INTERNET; PROVIDING REAL ESTATE LISTINGS AND REAL ESTATE INFORMATION VIA THE INTERNET; REAL ESTATE ACQUISITION SERVICES; REAL ESTATE AGENCIES; REAL ESTATE APPRAISAL; REAL ESTATE BROKERAGE; REAL ESTATE CONSULTANCY; REAL ESTATE CONSULTATION; REAL ESTATE EQUITY SHARING, NAMELY, MANAGING AND ARRANGING FOR CO-OWNERSHIP OF REAL ESTATE; REAL ESTATE ESCROW SERVICES; REAL ESTATE INVESTMENT; REAL ESTATE LENDING SERVICES; REAL ESTATE LISTING; REAL ESTATE MANAGEMENT; REAL ESTATE MANAGEMENT CONSULTATION; REAL ESTATE MULTIPLE LISTING SERVICES; REAL ESTATE PROCUREMENT FOR OTHERS; REAL ESTATE SERVICES, NAMELY, RENTAL OF VACATION HOMES, CONDOMINIUMS, CABINS, AND VILLAS USING PAY PER CLICK ADVERTISING ON A GLOBAL COMPUTER NETWORK; REAL ESTATE SYNDICATION; REAL ESTATE TIME-SHARING; REAL ESTATE TRUSTEE SERVICES; REAL ESTATE VALUATION SERVICES; REAL ESTATE VALUATIONS; VACATION REAL ESTATE TIME SHARE EXCHANGE SERVICES; VACATION REAL ESTATE TIME-SHARING; VACATION REAL ESTATE TIMESHARE SERVICES (U.S. CLS. 100, 101 AND 102).

HEATHER THOMPSON, EXAMINING ATTORNEY

SN 77-138,105. PACIFIC COAST FEATHER COMPANY, SEATTLE, WA. FILED 3-22-2007.

LUXURA

THE MARK CONSISTS OF STANDARD CHARACTERS WITHOUT CLAIM TO ANY PARTICULAR FONT, STYLE, SIZE, OR COLOR.

CLASS 20—FURNITURE AND ARTICLES NOT OTHERWISE CLASSIFIED

FOR PILLOWS, FIBER BEDS AND POLYESTER FIBER SOLD AS A COMPONENT OF PILLOWS AND FIBER BEDS (U.S. CLS. 2, 13, 22, 25, 32 AND 50).

CLASS 24—FABRICS

FOR COMFORTERS, MATTRESS PADS, BED BLANKETS AND POLYESTER FIBER SOLD AS A COMPONENT OF COMFORTERS, MATTRESS PADS AND BED BLANKETS (U.S. CLS. 42 AND 50).

DARRYL SPRUILL, EXAMINING ATTORNEY

SN 77-138,113. MAUI WOWI, INC., GREENWOOD VILLAGE, CO. FILED 3-22-2007.

SN 77-138,135. AMERICAN MANAGEMENT ASSOCIATION INTERNATIONAL, NEW YORK, NY. FILED 3-22-2007.



OWNER OF U.S. REG. NOS. 1,923,970, 3,150,464 AND OTHERS.

NO CLAIM IS MADE TO THE EXCLUSIVE RIGHT TO USE "HAWAIIAN COFFEES & SMOOTHIES", APART FROM THE MARK AS SHOWN.

THE COLOR(S) BROWN, YELLOW, ORANGE, RED, GREEN, AND BLACK IS/ARE CLAIMED AS A FEATURE OF THE MARK.

THE MARK CONSISTS OF A FANCIFUL REPRESENTATION OF A SURFBOARD IN SHADES OF BROWN WITH THE WORDS, "MAUI WOWI" ON IT IN SHADES OF RED, ORANGE AND YELLOW AND OUTLINED IN BLACK, THE "I'S" IN "MAUI" AND "WOWI" BEING REPLACED WITH STYLIZED PALM TREES HAVING TRUNKS IN SHADES OF RED, ORANGE AND YELLOW, AND FRONDS OF GREEN, BOTH THE TRUNK AND FRONDS OUTLINED IN BLACK, AND THE WORD "HAWAIIAN" IN YELLOW OUTLINED IN BLACK UNDER THE WORDS, "MAUI WOWI," AND A FANCIFUL REPRESENTATION OF A PIECE OF DRIFTWOOD IN SHADES OF BROWN HANGING FROM THE SURFBOARD AND HAVING THE WORDS, "COFFEES & SMOOTHIES" ON IT IN YELLOW OUTLINED IN BLACK, THE "O'S" IN "COFFEES" AND "SMOOTHIES" UNDERScoreD IN YELLOW WITH BLACK OUTLINES.

CLASS 30—STAPLE FOODS

FOR FROZEN CONFECTIONS; FROZEN FRUIT BARS; COFFEE; AND COFFEE-BASED BEVERAGES CONTAINING MILK (U.S. CL. 46).

FIRST USE 3-31-1997; IN COMMERCE 3-31-1997.

CLASS 32—LIGHT BEVERAGES

FOR NON-ALCOHOLIC BEVERAGES, NAMELY, BLENDED FROZEN FRUIT DRINKS CONTAINING FRUIT, FRUIT JUICES AND OTHER NATURAL INGREDIENTS; BOTTLED DRINKING WATER (U.S. CLS. 45, 46 AND 48).

FIRST USE 3-31-1997; IN COMMERCE 3-31-1997.

CLASS 35—ADVERTISING AND BUSINESS

FOR MOBILE AND STAND ALONE CARTS AND FOOD KIOSKS FEATURING FROZEN FRUIT BARS, BLENDED FROZEN DRINKS, COFFEE AND COFFEE-BASED BEVERAGES CONTAINING MILK, BOTTLED WATER AND SNACKS (U.S. CLS. 100, 101 AND 102).

FIRST USE 3-31-1997; IN COMMERCE 3-31-1997.

CLASS 43—HOTEL AND RESTAURANT SERVICES

FOR RESTAURANT SERVICES FEATURING FROZEN FRUIT BARS, BLENDED FROZEN FRUIT DRINKS, COFFEE AND COFFEE-BASED BEVERAGES CONTAINING MILK, BOTTLED WATER AND SNACKS (U.S. CLS. 100 AND 101).

FIRST USE 3-31-1997; IN COMMERCE 3-31-1997.
DANNEAN HETZEL, EXAMINING ATTORNEY



THE MARK CONSISTS OF THE WORD CONSULTING-WORLD IN SPECIAL SCRIPT SUPERIMPOSED OVER A STYLIZED IMAGE OF THE WORLD.

CLASS 16—PAPER GOODS AND PRINTED MATTER

FOR EDUCATIONAL BOOKS RELATING TO BUSINESS MANAGEMENT; PRINTED INFORMATIONAL MATERIALS IN THE FORM OF BROCHURES RELATING TO BUSINESS MANAGEMENT; PAMPHLETS RELATING TO BUSINESS MANAGEMENT; CATALOGS FOR USE IN THE FIELD OF BUSINESS MANAGEMENT; SEMINAR PROGRAM MATERIALS, NAMELY COURSE OUTLINES AND NOTEBOOKS CONTAINING INSTRUCTIONAL PROGRAMS, QUESTION AND ANSWER SHEETS AND FACTUAL MATERIAL FOR USE AS TEACHING DEVICES ALL FOR USE IN THE FIELD OF BUSINESS MANAGEMENT (U.S. CLS. 2, 5, 22, 23, 29, 37, 38 AND 50).

CLASS 41—EDUCATION AND ENTERTAINMENT

FOR EDUCATIONAL SERVICES, NAMELY, PROVIDING ON-LINE COURSES IN THE FIELD OF BUSINESS MANAGEMENT VIA THE INTERNET; EDUCATION SERVICES, NAMELY CONDUCTING SEMINARS IN THE FIELD OF BUSINESS MANAGEMENT; ORGANIZING EXHIBITIONS FOR EDUCATIONAL PURPOSES IN THE FIELD OF BUSINESS MANAGEMENT (U.S. CLS. 100, 101 AND 107).

ERNEST SHOSHO, EXAMINING ATTORNEY

SN 77-138,320. HACK, NANCY ROBIN, DELRAY BEACH, FL. FILED 3-22-2007.

Move Forward in Reverse

THE MARK CONSISTS OF STANDARD CHARACTERS WITHOUT CLAIM TO ANY PARTICULAR FONT, STYLE, SIZE, OR COLOR.

CLASS 35—ADVERTISING AND BUSINESS

FOR MATCHING BORROWERS WITH POTENTIAL LENDERS IN THE FIELD OF CONSUMER AND MORTGAGE LENDING (U.S. CLS. 100, 101 AND 102).

CLASS 36—INSURANCE AND FINANCIAL

FOR FINANCIAL SERVICES, NAMELY, MORTGAGE PLANNING; FINANCIAL SERVICES, NAMELY, THE PURCHASE OF RESIDENTIAL MORTGAGES ON BEHALF OF OTHERS AND THE ISSUANCE OF MORTGAGE-BACKED SECURITIES; MORTGAGE BANKING; MORTGAGE BANKING SERVICES, NAMELY, ORIGINATION, ACQUISITION, SERVICING, SECURITIZATION AND BROKERAGE OF MORTGAGE LOANS; MORTGAGE BROKERAGE; MORTGAGE LENDING; MORTGAGE PROCUREMENT FOR OTHERS; MORTGAGE SERVICES, NAMELY, BUYER PRE-QUALIFICATION OF MORTGAGES FOR MORTGAGE BROKERS AND BANKS (U.S. CLS. 100, 101 AND 102).

GISELLE AGOSTO, EXAMINING ATTORNEY

SN 77-138,513. THE THRIFT ALLIANCE, NASHVILLE, TN. FILED 3-23-2007.

THRIFTSMART

THE MARK CONSISTS OF STANDARD CHARACTERS WITHOUT CLAIM TO ANY PARTICULAR FONT, STYLE, SIZE, OR COLOR.

CLASS 35—ADVERTISING AND BUSINESS

FOR RETAIL THRIFT STORE SERVICES FEATURING CLOTHING, SHOES, BOOKS, APPLIANCES, FURNITURE AND HOME ACCESSORIES; ISSUING GIFT CERTIFICATES WHICH MAY BE REDEEMED FOR GOODS (U.S. CLS. 100, 101 AND 102).

FIRST USE 3-0-2005; IN COMMERCE 3-0-2005.

CLASS 36—INSURANCE AND FINANCIAL

FOR STORED VALUE CARD SERVICES; CHARITABLE FUNDRAISING SERVICES, NAMELY, THE DONATION OF THRIFT STORE PROCEEDS TO CHARITABLE ORGANIZATIONS (U.S. CLS. 100, 101 AND 102).

FIRST USE 3-0-2005; IN COMMERCE 3-0-2005.

DAVID MURRAY, EXAMINING ATTORNEY

SN 77-138,541. ORIGENE TECHNOLOGIES, INC., ROCKVILLE, MD. FILED 3-23-2007.

TurboFectin

THE MARK CONSISTS OF STANDARD CHARACTERS WITHOUT CLAIM TO ANY PARTICULAR FONT, STYLE, SIZE, OR COLOR.

CLASS 1—CHEMICALS

FOR REAGENTS FOR SCIENTIFIC OR MEDICAL RESEARCH USE (U.S. CLS. 1, 5, 6, 10, 26 AND 46).

CLASS 5—PHARMACEUTICALS

FOR BIOLOGICAL AND CHEMICAL PREPARATIONS AND REAGENTS FOR MEDICAL OR VETERINARY USE (U.S. CLS. 6, 18, 44, 46, 51 AND 52).

WILLIAM VERHOSEK, EXAMINING ATTORNEY

SN 77-138,772. LACY, CHRISTOPHER LINWOOD, WOODBRIDGE, VA. FILED 3-23-2007.

Fart Neutral

THE MARK CONSISTS OF STANDARD CHARACTERS WITHOUT CLAIM TO ANY PARTICULAR FONT, STYLE, SIZE, OR COLOR.

CLASS 9—ELECTRICAL AND SCIENTIFIC APPARATUS

FOR DECORATIVE MAGNETS (U.S. CLS. 21, 23, 26, 36 AND 38).

CLASS 16—PAPER GOODS AND PRINTED MATTER

FOR BUMPER STICKERS; BLANK CARDS (U.S. CLS. 2, 5, 22, 23, 29, 37, 38 AND 50).

CLASS 25—CLOTHING

FOR SHORT-SLEEVED OR LONG-SLEEVED T-SHIRTS; HATS (U.S. CLS. 22 AND 39).

PATRICIA EVANKO, EXAMINING ATTORNEY

SN 77-138,848. JONATHAN B. LEVINE, DMD, P.C., NEW YORK, NY. FILED 3-23-2007.

SMILE LIFT

THE MARK CONSISTS OF STANDARD CHARACTERS WITHOUT CLAIM TO ANY PARTICULAR FONT, STYLE, SIZE, OR COLOR.

CLASS 3—COSMETICS AND CLEANING PREPARATIONS

FOR ORAL CARE PRODUCTS, NAMELY, TOOTH WHITENING GELS, LIQUIDS AND CREAMS, TOOTH WHITENING MAINTENANCE PRODUCTS, NAMELY, TOOTH WHITENING GELS, LIQUIDS AND CREAMS, LIP-GLOSS, LIPSTICK, LIP BALM, TOOTHPASTES, BREATH FRESHENERS, NAMELY, NON-MEDICATED DILUTED BREATH SPRAYS USED AS MOUTHWASH, AND NON-MEDICATED CONCENTRATED BREATH SPRAYS, NON-MEDICATED MOUTHWASHES, NON-MEDICATED ORAL BREATH FRESHENING SPRAYS AND BREATH FRESHENING CONFECTIONERY, NAMELY, DISSOLVABLE BREATH MINTS AND CHEWING GUM (U.S. CLS. 1, 4, 6, 50, 51 AND 52).

CLASS 44—MEDICAL, BEAUTY AND AGRICULTURAL SERVICES

FOR DENTIST SERVICES (U.S. CLS. 100 AND 101).
JUSTINE D. PARKER, EXAMINING ATTORNEY

SN 77-138,851. MCNAUGHTON, DEBORAH L, PLACENTIA, CA. AND WEINSTEIN, MELINDA D, PLACENTIA, CA. FILED 3-23-2007.

Rich and Thin

THE MARK CONSISTS OF STANDARD CHARACTERS WITHOUT CLAIM TO ANY PARTICULAR FONT, STYLE, SIZE, OR COLOR.

CLASS 16—PAPER GOODS AND PRINTED MATTER

FOR POCKET MEMORANDUM BOOKS; BOOKS IN THE FIELD OF PERSONAL FINANCE; BLANK JOURNAL BOOKS; JOURNALS CONCERNING PERSONAL FINANCE; CHARTS IN THE FIELD OF PERSONAL FINANCE (U.S. CLS. 2, 5, 22, 23, 29, 37, 38 AND 50).

CLASS 21—HOUSEWARES AND GLASS

FOR NON-METAL PIGGY BANKS (U.S. CLS. 2, 13, 23, 29, 30, 33, 40 AND 50).
IRA J. GOODSAD, EXAMINING ATTORNEY

SN 77-138,865. JONATHAN B. LEVINE, DMD, P.C., NEW YORK, NY. FILED 3-23-2007.

SMILEOLOGY

THE MARK CONSISTS OF STANDARD CHARACTERS WITHOUT CLAIM TO ANY PARTICULAR FONT, STYLE, SIZE, OR COLOR.

CLASS 3—COSMETICS AND CLEANING PREPARATIONS

FOR ORAL CARE PRODUCTS, NAMELY, TOOTH WHITENING GELS, LIQUIDS AND CREAMS, TOOTH WHITENING MAINTENANCE PRODUCTS, NAMELY, TOOTH WHITENING GELS, LIQUIDS AND CREAMS, LIP-GLOSS, LIPSTICK, LIP BALM, TOOTHPASTES, BREATH FRESHENERS, NAMELY, NON-MEDICATED DILUTED BREATH SPRAYS USED AS MOUTHWASH, AND NON-MEDICATED CONCENTRATED BREATH SPRAYS, NON-MEDICATED MOUTHWASHES, NON-MEDICATED ORAL BREATH FRESHENING SPRAYS AND BREATH FRESHENING CONFECTIONERY, NAMELY, DISSOLVABLE BREATH MINTS AND CHEWING GUM (U.S. CLS. 1, 4, 6, 50, 51 AND 52).

CLASS 44—MEDICAL, BEAUTY AND AGRICULTURAL SERVICES

FOR DENTIST SERVICES (U.S. CLS. 100 AND 101).
JUSTINE D. PARKER, EXAMINING ATTORNEY

SN 77-138,921. CHABAD OF CALIFORNIA, LOS ANGELES, CA. FILED 3-23-2007.

**CLASS 4—LUBRICANTS AND FUELS**

FOR CANDLE AND CANDLE KITS CONSISTING OF CANDLES AND INSTRUCTIONS FOR LIGHTING CANDLES (U.S. CLS. 1, 6 AND 15).
FIRST USE 6-0-2006; IN COMMERCE 6-0-2006.

CLASS 41—EDUCATION AND ENTERTAINMENT

FOR RELIGIOUS INSTRUCTION SERVICES (U.S. CLS. 100, 101 AND 107).
FIRST USE 6-0-2006; IN COMMERCE 6-0-2006.
TINA KUAN, EXAMINING ATTORNEY

SN 77-138,970. CLACK CORPORATION, WINDSOR, WI. FILED 3-23-2007.

CLACK

THE MARK CONSISTS OF STANDARD CHARACTERS WITHOUT CLAIM TO ANY PARTICULAR FONT, STYLE, SIZE, OR COLOR.

CLASS 1—CHEMICALS

FOR WATER TREATMENT CHEMICALS AND GRANULAR FILTERING MEDIA FOR HOME, COMMERCIAL, AND INDUSTRIAL USE (U.S. CLS. 1, 5, 6, 10, 26 AND 46).

CLASS 11—ENVIRONMENTAL CONTROL APPARATUS

FOR WATER TREATMENT EQUIPMENT, NAMELY, TANKS, VALVES, PIPING, FILTERS AND FILTER CARTRIDGES, CONTROLS, FILTRATION UNITS, AND STERILIZATION UNITS (U.S. CLS. 13, 21, 23, 31 AND 34).

CLASS 40—MATERIAL TREATMENT

FOR PLASTIC PARTS MOLDING TO ORDER AND/OR SPECIFICATION OF OTHERS (U.S. CLS. 100, 103 AND 106).
JOHN DALIER, EXAMINING ATTORNEY

SN 77-139,095. VORTEX POLYMERS, INC., CARSON, CA.
FILED 3-23-2007.

SN 77-139,239. HOVANES, MICHAEL E., REDMOND, WA.
FILED 3-23-2007.

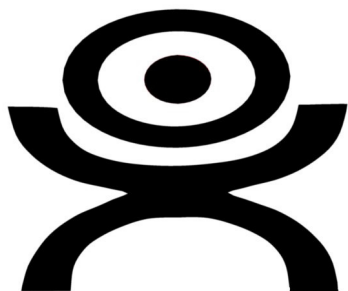

THE MARK CONSISTS OF A DESIGN REPRESENTING A PERSON WITH A BODY SHAPED LIKE A CURVED LETTER "X," AN OVAL SHAPED HEAD, AND A ROUND BALL FOR AN EYE.

CLASS 1—CHEMICALS

FOR CHEMICALS FOR USE IN INDUSTRY INCLUDING ADHESIVE CHEMICALS, COATING CHEMICALS AND SEALANT CHEMICALS FOR USE IN THE CONSTRUCTION, CONCRETE, AND MASONRY INDUSTRIES FOR PROTECTIVE AND DECORATIVE PURPOSES ON FLOORS AND OTHER SURFACES (U.S. CLS. 1, 5, 6, 10, 26 AND 46).

FIRST USE 9-1-2006; IN COMMERCE 1-15-2007.

CLASS 2—PAINTS

FOR FLOOR COATING SYSTEMS COMPRISED OF CONCRETE FLOOR RE-SURFACING PAINT, CONCRETE RE-SURFACING MOISTURE BARRIER COATING, EPOXY COATING FOR RE-SURFACING CONCRETE INDUSTRIAL FLOORS, EPOXY COATING FOR USE ON CONCRETE INDUSTRIAL FLOORS, ACIDIC COATINGS, NAMELY, STAINS FOR EXTERIOR AND INTERIOR USE ON A VARIETY OF SUBSTRATES, COATINGS IN THE NATURE OF INDUSTRIAL SEALANTS FOR WATERPROOFING AND SURFACE HARDENING, SEALER COATINGS FOR USE IN THE CONCRETE INDUSTRY AND GARAGE FLOOR COATINGS IN THE NATURE OF INDUSTRIAL SEALANTS FOR WATERPROOFING AND SURFACE HARDENING; COATINGS FOR USE ON CONCRETE, WOOD, SYNTHETIC AND OTHER SURFACES, NAMELY, PRIMERS FOR PREPARING SURFACES TO BE PAINTED, INDUSTRIAL SEALANTS FOR WATERPROOFING AND SURFACE HARDENING AND STAINS AND CLEAR FINISHES FOR EXTERIOR AND INTERIOR USE ON A VARIETY OF SUBSTRATES FOR POOL DECKS, PATIOS, GARAGES, DRIVEWAYS, WALKWAYS, DECKS, BALCONIES, SHOWROOMS, WAREHOUSES, AIRPORT HANGERS, RESTAURANTS, MEDICAL CENTERS, OFFICE COMPLEXES AND OTHER SURFACES (U.S. CLS. 6, 11 AND 16).

FIRST USE 9-1-2006; IN COMMERCE 11-30-2006.
DAVID YONTEF, EXAMINING ATTORNEY

COLLABRIX

THE MARK CONSISTS OF STANDARD CHARACTERS WITHOUT CLAIM TO ANY PARTICULAR FONT, STYLE, SIZE, OR COLOR.

CLASS 9—ELECTRICAL AND SCIENTIFIC APPARATUS

FOR COMPUTER SOFTWARE FOR FACILITATING CROSS PLATFORM COMMUNICATIONS; COMPUTER SOFTWARE FOR ELECTRONIC MESSAGE DISSEMINATION; COMPUTER SOFTWARE FOR INTEGRATING MESSAGE DISSEMINATION SOFTWARE WITH OTHER PARTY APPLICATIONS (U.S. CLS. 21, 23, 26, 36 AND 38).

CLASS 38—COMMUNICATION

FOR COMPUTER DATA MESSAGING SERVICES; COMPUTER DATA MESSAGING SERVICES FOR FACILITATING CROSS PLATFORM COMMUNICATIONS SOFTWARE (U.S. CLS. 100, 101 AND 104).

JORDAN BAKER, EXAMINING ATTORNEY

SN 77-139,517. THNG, RICK, SAN FRANCISCO, CA. FILED
3-24-2007.

IMPREZZIV

THE MARK CONSISTS OF STANDARD CHARACTERS WITHOUT CLAIM TO ANY PARTICULAR FONT, STYLE, SIZE, OR COLOR.

OWNER OF U.S. REG. NO. 2,123,987.

CLASS 40—MATERIAL TREATMENT

FOR PRINTING AND CUSTOM MANUFACTURE OF PRINTED MATERIALS SUCH AS MARKETING BROCHURES, POSTERS, POINT OF SALES MATERIALS, STATIONARY, DIRECT MAILERS AND PROMOTIONAL MATERIALS FOR OTHERS (U.S. CLS. 100, 103 AND 106).

FIRST USE 12-1-2002; IN COMMERCE 12-1-2002.

CLASS 42—SCIENTIFIC, COMPUTER AND LEGAL SERVICES

FOR GRAPHICS DESIGN AND LOGO DESIGN SERVICES (U.S. CLS. 100 AND 101).

FIRST USE 12-1-2002; IN COMMERCE 12-1-2002.
KIMBERLY FRYE, EXAMINING ATTORNEY

SN 77-139,523. DAVID ROBERT ZABALZA, STOCKTON, CA.
FILED 3-24-2007.

Black Until Proven Innocent

THE MARK CONSISTS OF STANDARD CHARACTERS WITHOUT CLAIM TO ANY PARTICULAR FONT, STYLE, SIZE, OR COLOR.

CLASS 9—ELECTRICAL AND SCIENTIFIC APPARATUS

FOR PRE-RECORDED CDS, VIDEO TAPES, LASER DISKS AND DVDS FEATURING MUSIC; SOUND RECORDINGS FEATURING MUSIC; AUDIO RECORDINGS FEATURING MUSIC (U.S. CLS. 21, 23, 26, 36 AND 38).

FIRST USE 2-10-2007; IN COMMERCE 2-10-2007.

CLASS 41—EDUCATION AND ENTERTAINMENT

FOR ENTERTAINMENT, NAMELY LIVE MUSIC CONCERTS; ENTERTAINMENT, NAMELY LIVE PERFORMANCES BY MUSICAL BANDS (U.S. CLS. 100, 101 AND 107).

FIRST USE 2-10-2007; IN COMMERCE 2-10-2007.
TASHIA BUNCH, EXAMINING ATTORNEY

SN 77-139,556. THE SANDER GROUP INC, TOMBALL, TX.
FILED 3-24-2007.

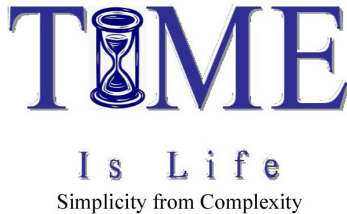

THE COLOR(S) BLUE, BLACK AND WHITE IS/ARE CLAIMED AS A FEATURE OF THE MARK.

THE MARK CONSISTS OF THE WORDING TIME IS LIFE AND AN HOURGLASS DESIGN IN BLUE LETTERING WITH A BLACK SHADOW AND BLACK TRIM. THE WORDING SIMPLICITY FROM COMPLEXITY IS BLACK. THE BACKGROUND IS WHITE.

CLASS 9—ELECTRICAL AND SCIENTIFIC APPARATUS

FOR HOURGLASSES (U.S. CLS. 21, 23, 26, 36 AND 38).

CLASS 16—PAPER GOODS AND PRINTED MATTER

FOR TIME PLANNERS; DAY PLANNERS; DAILY PLANNERS; DESKTOP PLANNERS (U.S. CLS. 2, 5, 22, 23, 29, 37, 38 AND 50).

CLASS 35—ADVERTISING AND BUSINESS

FOR ADVERTISING AND BUSINESS MANAGEMENT CONSULTANCY; PROVIDING INFORMATION IN THE FIELD OF TIME MANAGEMENT FOR BUSINESS PURPOSES (U.S. CLS. 100, 101 AND 102).

CLASS 45—PERSONAL SERVICES

FOR PROVIDING INFORMATION IN THE FIELD OF TIME MANAGEMENT TO INDIVIDUALS FOR PERSONAL PURPOSES (U.S. CLS. 100 AND 101).
GINA FINK, EXAMINING ATTORNEY

SN 77-139,565. SALON SECREST, BROOKLYN, NY. FILED 3-24-2007.

SALON SECRETS

THE MARK CONSISTS OF STANDARD CHARACTERS WITHOUT CLAIM TO ANY PARTICULAR FONT, STYLE, SIZE, OR COLOR.

NO CLAIM IS MADE TO THE EXCLUSIVE RIGHT TO USE "SALON", APART FROM THE MARK AS SHOWN.

CLASS 40—MATERIAL TREATMENT

FOR CUSTOM MANUFACTURE AND FITTING OF WIGS (U.S. CLS. 100, 103 AND 106).
FIRST USE 6-16-1997; IN COMMERCE 6-30-1997.

CLASS 44—MEDICAL, BEAUTY AND AGRICULTURAL SERVICES

FOR HAIR AND BEAUTY SERVICES, NAMELY, HAIR WEAVING, HAIR CUTTING, HAIR REPLACEMENT, HAIR ADDITION, AND HAIR EXTENSION SERVICES, HAIR SALON SERVICES, NAMELY, TREATMENTS TO PROTECT HAIR FROM AFFECTS OF EXPOSURE TO SUNLIGHT, HEAT, HUMIDITY AND HAIR STYLING, BEAUTY SALON, HAIR COLORING; SERVICES OF MAKE UP ARTIST; COSMETOLOGY SERVICES, COSMETICIAN SERVICES (U.S. CLS. 100 AND 101).

FIRST USE 6-16-1997; IN COMMERCE 6-30-1997.
MARK T. MULLEN, EXAMINING ATTORNEY

SN 77-139,671. FAYE ALAINE TAIT, PHOENIX, AZ. FILED 3-25-2007.

Mombomb

THE MARK CONSISTS OF STANDARD CHARACTERS WITHOUT CLAIM TO ANY PARTICULAR FONT, STYLE, SIZE, OR COLOR.

CLASS 14—JEWELRY

FOR JEWELRY (U.S. CLS. 2, 27, 28 AND 50).

CLASS 25—CLOTHING

FOR DENIM JACKETS; DENIMS; DRESS SHIRTS; MEN AND WOMEN JACKETS, COATS, TROUSERS, VESTS; SHORT-SLEEVED OR LONG-SLEEVED T-SHIRTS (U.S. CLS. 22 AND 39).

CLASS 35—ADVERTISING AND BUSINESS

FOR MAIL ORDER SERVICES FEATURING WOMENS CLOTHING AND ACCESSORIES; VENDING IN THE FIELD OF WOMENS CLOTHING AND ACCESSORIES (U.S. CLS. 100, 101 AND 102).

CLASS 40—MATERIAL TREATMENT

FOR IMPRINTING MESSAGES ON T-SHIRTS (U.S. CLS. 100, 103 AND 106).

CLASS 42—SCIENTIFIC, COMPUTER AND LEGAL SERVICES

FOR DRESS DESIGN (U.S. CLS. 100 AND 101).
DAVID MILLER, EXAMINING ATTORNEY

SN 77-139,702. GRAND SLAM CUSTOMER SERVICE, LLC,
RIVERWOODS, IL. FILED 3-25-2007.

G.R.A.N.D.S.L.A.M.

THE MARK CONSISTS OF STANDARD CHARACTERS WITHOUT CLAIM TO ANY PARTICULAR FONT, STYLE, SIZE, OR COLOR.

CLASS 16—PAPER GOODS AND PRINTED MATTER

FOR SERIES OF BOOKS, NEWSLETTERS, BROCHURES AND JOURNALS FEATURING INFORMATION AND ADVICE REGARDING SALES AND MARKETING TECHNIQUES AND RETAIL CUSTOMER SERVICE (U.S. CLS. 2, 5, 22, 23, 29, 37, 38 AND 50).

CLASS 35—ADVERTISING AND BUSINESS

FOR BUSINESS MARKETING CONSULTING SERVICES; CONSULTING SERVICES FOR OTHERS IN THE FIELDS OF SALES AND MARKETING TECHNIQUES AND RETAIL CUSTOMER SERVICE; AND PROVIDING BUSINESS METHODS ASSESSMENTS AND CUSTOMER EXPERIENCE ASSESSMENTS (U.S. CLS. 100, 101 AND 102).

CLASS 41—EDUCATION AND ENTERTAINMENT

FOR EDUCATIONAL SERVICES, NAMELY CONDUCTING SEMINARS, WORKSHOPS, LECTURES AND TRAINING COURSES IN THE FIELDS OF SALES AND MARKETING TECHNIQUES AND RETAIL CUSTOMER SERVICE (U.S. CLS. 100, 101 AND 107).
ZACHARY BELLO, EXAMINING ATTORNEY

SN 77-139,826. LUCY MARY SCHWARTZER, INDIAN WELLS, CA. FILED 3-26-2007.

LIPS BY LUCY

THE MARK CONSISTS OF STANDARD CHARACTERS WITHOUT CLAIM TO ANY PARTICULAR FONT, STYLE, SIZE, OR COLOR.

OWNER OF U.S. REG. NOS. 3,034,042, 3,034,088 AND OTHERS.

CLASS 3—COSMETICS AND CLEANING PREPARATIONS

FOR NON-MEDICATED SKIN AND HAIR CARE PREPARATIONS (U.S. CLS. 1, 4, 6, 50, 51 AND 52).

CLASS 18—LEATHER GOODS

FOR HANDBAGS AND PURSES (U.S. CLS. 1, 2, 3, 22 AND 41).

CLASS 25—CLOTHING

FOR LINGERIE AND JEANS (U.S. CLS. 22 AND 39).
ODESSA BIBBINS, EXAMINING ATTORNEY

SN 77-139,837. LUCY MARY SCHWARTZER, INDIAN WELLS, CA. FILED 3-26-2007.

LOOKS BY LUCY

THE MARK CONSISTS OF STANDARD CHARACTERS WITHOUT CLAIM TO ANY PARTICULAR FONT, STYLE, SIZE, OR COLOR.

OWNER OF U.S. REG. NOS. 3,034,042, 3,034,088 AND OTHERS.

CLASS 3—COSMETICS AND CLEANING PREPARATIONS

FOR NON-MEDICATED SKIN AND HAIR CARE PREPARATIONS (U.S. CLS. 1, 4, 6, 50, 51 AND 52).

CLASS 18—LEATHER GOODS

FOR HANDBAGS AND PURSES (U.S. CLS. 1, 2, 3, 22 AND 41).

CLASS 25—CLOTHING

FOR LINGERIE AND JEANS (U.S. CLS. 22 AND 39).
ODESSA BIBBINS, EXAMINING ATTORNEY

SN 77-139,885. BENE, CATHERINE H., YORK, PA. AND BENE, DAVID J., YORK, PA. FILED 3-26-2007.

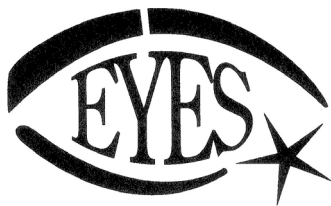

NO CLAIM IS MADE TO THE EXCLUSIVE RIGHT TO USE "EYES", APART FROM THE MARK AS SHOWN.

THE MARK CONSISTS OF STYLIZED REPRESENTATION OF AN EYE WITH THE WORD EYES IN THE CENTER AND A FIVE POINTED STAR TO THE LOWER RIGHT.

CLASS 35—ADVERTISING AND BUSINESS

FOR RETAIL STORE SERVICES FEATURING EYEGLASSES (U.S. CLS. 100, 101 AND 102).
FIRST USE 3-2-2006; IN COMMERCE 3-2-2006.

CLASS 44—MEDICAL, BEAUTY AND AGRICULTURAL SERVICES

FOR OPHTHALMOLOGY SERVICES; OPTICIAN SERVICES; EYEGLASS FITTING (U.S. CLS. 100 AND 101).
FIRST USE 3-2-2006; IN COMMERCE 3-2-2006.
H. M. FISHER, EXAMINING ATTORNEY

SN 77-139,989. A&C LICENSING LLC, NEW YORK, NY. FILED 3-26-2007.

CALYPSO ST. BARTH

THE MARK CONSISTS OF STANDARD CHARACTERS WITHOUT CLAIM TO ANY PARTICULAR FONT, STYLE, SIZE, OR COLOR.

OWNER OF U.S. REG. NO. 2,705,622.

NO CLAIM IS MADE TO THE EXCLUSIVE RIGHT TO USE "ST. BARTH", APART FROM THE MARK AS SHOWN.

CLASS 3—COSMETICS AND CLEANING PREPARATIONS

FOR SKIN SOAP; BODY SOAP; HAND CREAM; BODY CREAM; PERFUME; ESSENTIAL OILS FOR PERSONAL USE (U.S. CLS. 1, 4, 6, 50, 51 AND 52).

CLASS 25—CLOTHING

FOR CLOTHING, NAMELY, WOMEN'S AND CHILDREN'S CLOTHING, NAMELY, BATHING SUITS, T SHIRTS, SHIRTS, BLOUSES, SKIRTS, PANTS, SWEATERS, SCARVES, SARONGS AND HATS (U.S. CLS. 22 AND 39).

NAPOLÉON SHARMA, EXAMINING ATTORNEY

SN 77-140,106. TWO DRAGONFLY LLC, PEMBROKE PINES, FL. FILED 3-26-2007.



TWO DRAGONFLY

CLASS 24—FABRICS

FOR LABELS OF CLOTH; TEXTILE FABRICS FOR THE MANUFACTURE OF CLOTHING (U.S. CLS. 42 AND 50).

CLASS 25—CLOTHING

FOR TOPS; ATHLETIC SHOES; BEACH SHOES; BELTS; CANVAS SHOES; CAPS; CHILDREN'S CLOTH EATING BIBS; CLOTH BIBS; CLOTHING, NAMELY, WRAP-AROUNDS; LEATHER BELTS; TIES; WOMEN'S SHOES; WRAPS (U.S. CLS. 22 AND 39).

CLASS 35—ADVERTISING AND BUSINESS

FOR MAIL ORDER SERVICES FEATURING CLOTHING, JEWELRY, SHOES; RETAIL CLOTHING BOUTIQUES; ONLINE RETAIL CONSIGNMENT STORES FEATURING CLOTHING, JEWELRY, SHOES (U.S. CLS. 100, 101 AND 102).

BENJAMIN OKEKE, EXAMINING ATTORNEY

SN 77-140,192. THE THRIFT ALLIANCE, NASHVILLE, TN. FILED 3-26-2007.



THE MARK CONSISTS OF THE PHRASE "THRIFT" IN LOWER CASE LETTERS AND THE PHRASE "SMART" IN BOLD, UPPER CASE LETTERS AND DRAWING OF A LIGHT BULB.

CLASS 35—ADVERTISING AND BUSINESS

FOR RETAIL THRIFT STORE SERVICES FEATURING CLOTHING, SHOES, BOOKS, APPLIANCES, FURNITURE AND HOME ACCESSORIES; ISSUING GIFT CERTIFICATES WHICH MAY BE REDEEMED FOR GOODS (U.S. CLS. 100, 101 AND 102).

FIRST USE 3-0-2005; IN COMMERCE 3-0-2005.

CLASS 36—INSURANCE AND FINANCIAL

FOR STORED VALUE CARD SERVICES; CHARITABLE FUNDRAISING SERVICES, NAMELY, THE DONATION OF THRIFT STORE PROCEEDS TO CHARITABLE ORGANIZATIONS (U.S. CLS. 100, 101 AND 102).

FIRST USE 3-0-2005; IN COMMERCE 3-0-2005.

DAVID MURRAY, EXAMINING ATTORNEY

SN 77-140,199. THE THRIFT ALLIANCE, NASHVILLE, TN.
FILED 3-26-2007.

SN 77-140,223. FOR EVERY BODY, LLC, PROVO, UT. FILED
3-26-2007.

SAVE. GIVE. SMILE.

THE MARK CONSISTS OF STANDARD CHARACTERS WITHOUT CLAIM TO ANY PARTICULAR FONT, STYLE, SIZE, OR COLOR.

CLASS 35—ADVERTISING AND BUSINESS

FOR RETAIL THRIFT STORE SERVICES FEATURING CLOTHING, SHOES, BOOKS, APPLIANCES, FURNITURE AND HOME ACCESSORIES; ISSUING GIFT CERTIFICATES WHICH MAY BE REDEEMED FOR GOODS (U.S. CLS. 100, 101 AND 102).

FIRST USE 3-0-2005; IN COMMERCE 3-0-2005.

CLASS 36—INSURANCE AND FINANCIAL

FOR STORED VALUE CARD SERVICES; CHARITABLE FUNDRAISING SERVICES, NAMELY, THE DONATION OF THRIFT STORE PROCEEDS TO CHARITABLE ORGANIZATIONS (U.S. CLS. 100, 101 AND 102).

FIRST USE 3-0-2005; IN COMMERCE 3-0-2005.

DAVID MURRAY, EXAMINING ATTORNEY

SN 77-140,210. CITIGROUP INC., NEW YORK, NY. FILED 3-
26-2007.

CITI CHAIRMAN

THE MARK CONSISTS OF STANDARD CHARACTERS WITHOUT CLAIM TO ANY PARTICULAR FONT, STYLE, SIZE, OR COLOR.

OWNER OF U.S. REG. NOS. 1,181,467, 3,013,851 AND OTHERS.

CLASS 35—ADVERTISING AND BUSINESS

FOR PROMOTING THE SALE OF CREDIT CARD ACCOUNTS THROUGH THE ADMINISTRATION OF INCENTIVE AWARD PROGRAMS (U.S. CLS. 100, 101 AND 102).

CLASS 36—INSURANCE AND FINANCIAL

FOR CREDIT CARD SERVICES (U.S. CLS. 100, 101 AND 102).

TOBY BULLOFF, EXAMINING ATTORNEY

HOLIDAY TRADITIONS

THE MARK CONSISTS OF STANDARD CHARACTERS WITHOUT CLAIM TO ANY PARTICULAR FONT, STYLE, SIZE, OR COLOR.

CLASS 3—COSMETICS AND CLEANING PREPARATIONS

FOR POTPOURRI (U.S. CLS. 1, 4, 6, 50, 51 AND 52).

CLASS 4—LUBRICANTS AND FUELS

FOR CANDLES (U.S. CLS. 1, 6 AND 15).

CLASS 21—HOUSEWARES AND GLASS

FOR CANDLE HOLDERS (U.S. CLS. 2, 13, 23, 29, 30, 33, 40 AND 50).

DANIEL CAPSHAW, EXAMINING ATTORNEY

SN 77-140,258. DIAZ, HEMES, III, NORTH LAS VEGAS, NV.
FILED 3-26-2007.

LCI.com

THE MARK CONSISTS OF STANDARD CHARACTERS WITHOUT CLAIM TO ANY PARTICULAR FONT, STYLE, SIZE, OR COLOR.

OWNER OF U.S. REG. NO. 3,151,703.

CLASS 37—CONSTRUCTION AND REPAIR

FOR LANDSCAPE INSTALLATION FOR OTHERS INCLUDING SOD, TREES, FLOWERS, BUSHES, CACTUS AND PLANTS (U.S. CLS. 100, 103 AND 106).

CLASS 44—MEDICAL, BEAUTY AND AGRICULTURAL SERVICES

FOR LANDSCAPE MAINTENANCE FOR OTHERS ON PLANT MATERIAL INCLUDING TREES, BUSHES, SOD, FLOWERS, CACTUS AND ALL LIVING PLANTS (U.S. CLS. 100 AND 101).

TARAH HARDY, EXAMINING ATTORNEY

SN 77-140,567. SIMPSON BIOTECH CO., LTD., TAIPEI, TAIWAN, FILED 3-26-2007.

HEPASIM

THE MARK CONSISTS OF STANDARD CHARACTERS WITHOUT CLAIM TO ANY PARTICULAR FONT, STYLE, SIZE, OR COLOR.

CLASS 5—PHARMACEUTICALS

FOR DIETARY AND NUTRITIONAL FOOD SUPPLEMENTS, NAMELY, MYCELIUM OF MUSHROOMS, CHINESE CATERPILLAR FUNGUS, GLOSSY GANODERMA IN THE FORM OF DRY POWDER, LIQUID AND CAPSULES; DIETARY AND NUTRITIONAL FOOD SUPPLEMENTS INCLUDING MUSHROOMS, CORDYCEPS SINENSIS, ANTRODIA CAMPHORATA, ANTRODIA CINNAMOMEA, AGARICUS BLAZEI MURRILL, GANODERMA LUCIDUM, TREMATES VERSICOLOR, LENTINULA EDODES, GRIFOLA FRONDOSA AND PHELLINUS LINTEUS IN THE FORM OF DRY POWDER, LIQUID AND CAPSULES (U.S. CLS. 6, 18, 44, 46, 51 AND 52).

FIRST USE 7-4-2003; IN COMMERCE 3-7-2006.

CLASS 32—LIGHT BEVERAGES

FOR AERATED WATER; PREPARATION FOR MAKING AERATED WATER; APERITIFS, NON-ALCOHOLIC; MALT WORT; NON-ALCOHOLIC BEVERAGES; PREPARATION FOR MAKING BEVERAGES; WHEY BEVERAGES; CIDER; POWDERS FOR EFFERVESCING BEVERAGES; NON-ALCOHOLIC FRUIT EXTRACTS; NON-ALCOHOLIC FRUIT JUICE BEVERAGES; ISOTONIC BEVERAGES; SARSAPARILLA; SYRUPS FOR BEVERAGES; VEGETABLE JUICES; CHINESE CATERPILLAR FUNGUS BEVERAGES; GLOSSY GANODERMA BEVERAGES; BEVERAGE MADE OF MUSHROOM; NON-ALCOHOLIC HERBAL BEVERAGES; CONCENTRATED HERBAL BEVERAGES; HERB EXTRACT BEVERAGES; ANTRODIA CAMPHORATA BEVERAGES; ANTRODIA CINNAMOMEA BEVERAGES (U.S. CLS. 45, 46 AND 48).

FIRST USE 7-4-2003; IN COMMERCE 3-7-2006.
JILL C. ALT, EXAMINING ATTORNEY

SN 77-140,682. APPLE INC., CUPERTINO, CA. FILED 3-26-2007.

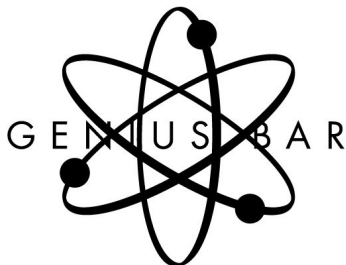

OWNER OF U.S. REG. NO. 2,869,102.
THE MARK CONSISTS OF THE WORDS GENIUS BAR AND A STYLIZED ATOMIC MODEL DESIGN.

CLASS 35—ADVERTISING AND BUSINESS

FOR RETAIL STORE SERVICES FEATURING COMPUTERS, COMPUTER SOFTWARE, COMPUTER PERIPHERALS AND CONSUMER ELECTRONIC DEVICES, AND DEMONSTRATION OF PRODUCTS RELATING THERETO (U.S. CLS. 100, 101 AND 102).

FIRST USE 5-19-2001; IN COMMERCE 5-19-2001.

CLASS 37—CONSTRUCTION AND REPAIR

FOR MAINTENANCE, INSTALLATION AND REPAIR OF COMPUTER HARDWARE, COMPUTER PERIPHERALS AND CONSUMER ELECTRONIC DEVICES (U.S. CLS. 100, 103 AND 106).

FIRST USE 5-19-2001; IN COMMERCE 5-19-2001.

CLASS 42—SCIENTIFIC, COMPUTER AND LEGAL SERVICES

FOR SUPPORT SERVICES, NAMELY, TROUBLESHOOTING OF COMPUTER HARDWARE, COMPUTER PERIPHERAL, COMPUTER SOFTWARE AND CONSUMER ELECTRONIC DEVICES; MAINTENANCE, INSTALLATION AND REPAIR OF COMPUTER SOFTWARE (U.S. CLS. 100 AND 101).

FIRST USE 5-19-2001; IN COMMERCE 5-19-2001.

ANGELA GAW, EXAMINING ATTORNEY

SN 77-140,714. 4004 INCORPORATED, PORT WASHINGTON, NY. FILED 3-26-2007.

Wonderwall

THE MARK CONSISTS OF STANDARD CHARACTERS WITHOUT CLAIM TO ANY PARTICULAR FONT, STYLE, SIZE, OR COLOR.

CLASS 9—ELECTRICAL AND SCIENTIFIC APPARATUS

FOR SUNGLASSES; EYEWEAR ACCESSORIES, NAMELY, STRAPS, NECK CORDS AND HEAD STRAPS WHICH RESTRAIN EYEWEAR FROM MOVEMENT ON A WEARER (U.S. CLS. 21, 23, 26, 36 AND 38).

CLASS 14—JEWELRY

FOR JEWELRY, NECKLACES, EARRINGS, BRACELETS, AND RINGS BEING JEWELRY (U.S. CLS. 2, 27, 28 AND 50).

CLASS 18—LEATHER GOODS

FOR WALLETS, BOOKBAGS, CARRY ALL BAGS, TOTE BAGS, HANDBAGS, MESSENGER BAGS, POCKETBOOKS, DUFFEL BAGS, OVERNIGHT BAGS, BACKPACKS, PURSES (U.S. CLS. 1, 2, 3, 22 AND 41).

CLASS 25—CLOTHING

FOR PANTS, JEANS, SHIRTS, SKIRTS, SHORTS, DRESSES, SWEATERS, HOSIERY, JACKETS, OUTERWEAR IN THE NATURE OF PARKAS AND RAINCOATS, COATS, FOOTWEAR, HEADWEAR, GLOVES, SCARVES, SOCKS, TRACKSUITS, SWIMWEAR, BEACHWEAR, SANDALS, SLIPPERS, PAJAMAS, BELTS, UNDERWEAR (U.S. CLS. 22 AND 39).

JAMES MACFARLANE, EXAMINING ATTORNEY

SN 77-140,744. MARCASIANO INC, NEW YORK, NY. FILED 3-26-2007.

SN 77-140,888. KAREN THOMPSON, LLC, LAHASKA, PA. FILED 3-26-2007.

MADE WITH LOVE IN BRAZIL

THE MARK CONSISTS OF STANDARD CHARACTERS WITHOUT CLAIM TO ANY PARTICULAR FONT, STYLE, SIZE, OR COLOR.

NO CLAIM IS MADE TO THE EXCLUSIVE RIGHT TO USE "IN BRAZIL", APART FROM THE MARK AS SHOWN.

CLASS 14—JEWELRY

FOR BRACELETS; EARRINGS; NECKLACES (U.S. CLS. 2, 27, 28 AND 50).
FIRST USE 7-5-2005; IN COMMERCE 7-5-2005.

CLASS 25—CLOTHING

FOR BLOUSES; DRESSES; JACKETS; PANTS; SHORTS; SKIRTS; TANK TOPS (U.S. CLS. 22 AND 39).
FIRST USE 7-5-2005; IN COMMERCE 7-5-2005.
AHSEN KHAN, EXAMINING ATTORNEY

SN 77-140,884. AIMOLA, DAVID D., NORWOOD, MA. FILED 3-26-2007.

VACATIONS RULE

THE MARK CONSISTS OF STANDARD CHARACTERS WITHOUT CLAIM TO ANY PARTICULAR FONT, STYLE, SIZE, OR COLOR.

CLASS 21—HOUSEWARES AND GLASS

FOR BEVERAGE GLASSWARE, BOTTLE OPENERS, PORTABLE BEVERAGE COOLERS AND INSULATED SLEEVES FOR BEVERAGE CANS AND BOTTLES (U.S. CLS. 2, 13, 23, 29, 30, 33, 40 AND 50).

CLASS 25—CLOTHING

FOR CLOTHING AND SPORTSWEAR, NAMELY, JACKETS, SWEATSUITS, SHORTS, SWIMWEAR, SHIRTS, T-SHIRTS, SWEATSHIRTS, TANKTOPS, SPORTS SHIRTS, COATS, VESTS, SWEATERS, HEADBANDS, PANTS, BELTS, MUFFS, NECKBANDS, SCARFS, WRISTBANDS, NECKWEAR, HEADWEAR, NAMELY, CAPS AND HATS AND HANDWEAR, NAMELY, GLOVES AND MITTENS, SPORTS JERSEYS, SPORT CAPS, SHOES, ATHLETIC SHOES, BOOTS, SLIPPERS, SANDALS, FLEECE GOODS, NAMELY, FLEECE SHIRTS, FLEECE SHORTS, FLEECE PANTS, AND FLEECE JACKETS (U.S. CLS. 22 AND 39).
JOHN WILKE, EXAMINING ATTORNEY

WISHES FOR WOMEN

THE MARK CONSISTS OF STANDARD CHARACTERS WITHOUT CLAIM TO ANY PARTICULAR FONT, STYLE, SIZE, OR COLOR.

NO CLAIM IS MADE TO THE EXCLUSIVE RIGHT TO USE "WOMEN", APART FROM THE MARK AS SHOWN.

CLASS 25—CLOTHING

FOR CLOTHING, NAMELY SLEEP WEAR AND LOUNGE WEAR (U.S. CLS. 22 AND 39).

CLASS 36—INSURANCE AND FINANCIAL

FOR CHARITABLE DONATIONS OF A PERCENTAGE OF PROFITS TO WOMEN'S CAUSES (U.S. CLS. 100, 101 AND 102).

C. DIONNE CLYBURN, EXAMINING ATTORNEY

SN 77-141,042. SB WORLDWIDE, LLC, BATTLE CREEK, MI. FILED 3-27-2007.

SUNDAY BOYFRIEND

THE MARK CONSISTS OF STANDARD CHARACTERS WITHOUT CLAIM TO ANY PARTICULAR FONT, STYLE, SIZE, OR COLOR.

CLASS 25—CLOTHING

FOR CLOTHING, NAMELY, PANTS, SHORTS, SWEATSHIRTS, T-SHIRTS, UNDERWEAR, PAJAMAS, JACKETS AND HATS (U.S. CLS. 22 AND 39).

CLASS 45—PERSONAL SERVICES

FOR ONLINE SOCIAL NETWORKING SERVICES (U.S. CLS. 100 AND 101).
BRENDAN REGAN, EXAMINING ATTORNEY

SN 77-141,046. 4004 INCORPORATED, PORT WASHINGTON, NY. FILED 3-27-2007.



THE MARK CONSISTS OF A STYLIZED NUMERAL 3.

CLASS 9—ELECTRICAL AND SCIENTIFIC APPARATUS

FOR SUNGLASSES; EYEWEAR ACCESSORIES, NAMELY, STRAPS, NECK CORDS AND HEAD STRAPS WHICH RESTRAIN EYEWEAR FROM MOVEMENT ON A WEARER (U.S. CLS. 21, 23, 26, 36 AND 38).

CLASS 14—JEWELRY

FOR JEWELRY, NECKLACES, EARRINGS, BRACELETS, AND RINGS BEING JEWELRY (U.S. CLS. 2, 27, 28 AND 50).

CLASS 18—LEATHER GOODS

FOR WALLETS, BOOKBAGS, CARRY ALL BAGS, TOTE BAGS, HANDBAGS, MESSENGER BAGS, DUFFEL BAGS, OVERNIGHT BAGS, BACKPACKS, PURSES (U.S. CLS. 1, 2, 3, 22 AND 41).

CLASS 25—CLOTHING

FOR PANTS, JEANS, SHIRTS, SHORTS, SWEATERS, SWEATSHIRTS, SWEATPANTS, HOSIERY, JACKETS, PARKAS, RAINCOATS, COATS, FOOTWEAR, HEADWEAR, GLOVES, SCARVES, SOCKS, TRACKSUITS, SWIMWEAR, BEACHWEAR, SLIPPERS, PAJAMAS, BELTS, UNDERWEAR (U.S. CLS. 22 AND 39).

JAMES MACFARLANE, EXAMINING ATTORNEY

CLASS 42—SCIENTIFIC, COMPUTER AND LEGAL SERVICES

FOR (BASED ON INTENT TO USE) INFORMATION TECHNOLOGY CONSULTING SERVICES RELATING TO SYSTEMS AUTOMATION AND COMPUTER PROCESSING IN THE FIELDS OF LIFE AND HEALTH AND PROPERTY AND CASUALTY INSURANCE; INFORMATION TECHNOLOGY SUPPORT SERVICES, NAMELY, SOFTWARE APPLICATION CUSTOMIZATION, DEVELOPMENT, TESTING, INTEGRATION, CONVERSION, AND MAINTENANCE FOR THE INSURANCE INDUSTRY (U.S. CLS. 100 AND 101).

ANDREA HACK, EXAMINING ATTORNEY

SN 77-141,140. ENGLISH RIGHT NOW! LLC, LOS ANGELES, CA. FILED 3-27-2007.

SN 77-141,087. JMV SERVICES, INC., DALLAS, TX. FILED 3-27-2007.



THE MARK CONSISTS OF THE LETTERS ITS IN A STYLIZED FORMAT IN A PARTIAL OVAL DESIGN.

CLASS 35—ADVERTISING AND BUSINESS

FOR (BASED ON USE IN COMMERCE) BUSINESS CONSULTING SERVICES RELATING TO OPERATIONS MANAGEMENT IN THE FIELDS OF LIFE AND HEALTH AND PROPERTY AND CASUALTY INSURANCE; OUTSOURCING SERVICES IN THE FIELDS OF LIFE AND HEALTH AND PROPERTY AND CASUALTY INSURANCE AND SOFTWARE APPLICATION DEVELOPMENT; EMPLOYMENT HIRING, RECRUITING, PLACEMENT, AND STAFFING SERVICES FOR THE INSURANCE INDUSTRY (U.S. CLS. 100, 101 AND 102).

FIRST USE 1-1-1998; IN COMMERCE 1-1-1998.

CLASS 41—EDUCATION AND ENTERTAINMENT

FOR (BASED ON USE IN COMMERCE) EDUCATIONAL SERVICES, NAMELY, CONDUCTING TRAINING COURSES IN THE FIELD OF INSURANCE (U.S. CLS. 100, 101 AND 107).

FIRST USE 11-1-2005; IN COMMERCE 11-1-2005.

INGLES YA!

THE MARK CONSISTS OF STANDARD CHARACTERS WITHOUT CLAIM TO ANY PARTICULAR FONT, STYLE, SIZE, OR COLOR.

THE FOREIGN WORDING IN THE MARK TRANSLATES INTO ENGLISH AS ENGLISH RIGHT NOW!

CLASS 9—ELECTRICAL AND SCIENTIFIC APPARATUS

FOR DIGITAL MATERIALS, NAMELY, CDS, DVDS, DOWNLOADABLE AUDIO AND VIDEO FILES FEATURING ENGLISH LANGUAGE INSTRUCTION; DIGITAL MEDIA, NAMELY, CDS, DVDS, DOWNLOADABLE AUDIO AND VIDEO FILES FEATURING ENGLISH LANGUAGE INSTRUCTION; MULTIMEDIA SOFTWARE RECORDED ON CD-ROM FEATURING ENGLISH LANGUAGE INSTRUCTION; PRE-RECORDED CDS, VIDEO TAPES, LASER DISKS AND DVDS FEATURING ENGLISH LANGUAGE INSTRUCTION; PRE-RECORDED AUDIO CASSETTES FEATURING ENGLISH LANGUAGE INSTRUCTION; PRERECORDED AUDIO TAPES FEATURING ENGLISH LANGUAGE INSTRUCTION; PRERECORDED DIGITAL AUDIO TAPE FEATURING ENGLISH LANGUAGE INSTRUCTION; PRERECORDED VIDEO CASSETTES FEATURING ENGLISH LANGUAGE INSTRUCTION (U.S. CLS. 21, 23, 26, 36 AND 38).

CLASS 16—PAPER GOODS AND PRINTED MATTER

FOR EDUCATIONAL PUBLICATIONS, NAMELY, TRAINING MANUALS IN THE FIELD OF ENGLISH LANGUAGE INSTRUCTION; MANUALS IN THE FIELD OF ENGLISH LANGUAGE INSTRUCTION; WORKBOOKS DIRECTED TO ENGLISH LANGUAGE INSTRUCTION (U.S. CLS. 2, 5, 22, 23, 29, 37, 38 AND 50).

NAAKWAMA ANKRAH, EXAMINING ATTORNEY

SN 77-141,166. SOURCE/INC., CHICAGO, IL. FILED 3-27-2007.

MINING THE CULTURE FOR THE
VALUES AND SYMBOLS THAT
BUILD POWERFUL BRANDS

THE MARK CONSISTS OF STANDARD CHARACTERS WITHOUT CLAIM TO ANY PARTICULAR FONT, STYLE, SIZE, OR COLOR.

CLASS 35—ADVERTISING AND BUSINESS

FOR BUSINESS CONSULTATION IN THE NATURE OF PROVIDING MARKETING CONSULTATION AND PROVIDING CONSULTATION REGARDING CORPORATE IDENTITY AND BRAND IDENTITY DESIGN; PREPARING AUDIO-VISUAL PRESENTATION FOR USE IN ADVERTISING; MARKET RESEARCH AND ANALYSIS; BRAND NAMING FOR OTHERS; DESIGN OF SALES AND MARKETING COLLATERAL GRAPHICS MATERIAL FOR OTHERS; PLANNING AND DESIGN OF IN-STORE MERCHANDISING CONCEPTS FOR OTHERS (U.S. CLS. 100, 101 AND 102).

FIRST USE 12-20-2005; IN COMMERCE 12-20-2005.

CLASS 42—SCIENTIFIC, COMPUTER AND LEGAL SERVICES

FOR PRODUCT DEVELOPMENT CONSULTATION; PACKAGING DESIGN FOR OTHERS; ARCHITECTURAL GRAPHIC DESIGN FOR OTHERS (U.S. CLS. 100 AND 101).

FIRST USE 12-20-2005; IN COMMERCE 12-20-2005.
JAY FLOWERS, EXAMINING ATTORNEY

SN 77-141,214. WHITEWOOD TRANSPORT, INC., BILLINGS, MT. FILED 3-27-2007.



CLASS 35—ADVERTISING AND BUSINESS

FOR TRANSPORTATION LOGISTICS SERVICES, NAMELY, ARRANGING THE TRANSPORTATION OF GOODS FOR OTHERS; TRANSPORTATION LOGISTICS SERVICES, NAMELY, PLANNING AND SCHEDULING SHIPMENTS FOR USERS OF TRANSPORTATION SERVICES (U.S. CLS. 100, 101 AND 102).

FIRST USE 11-1-2005; IN COMMERCE 11-1-2005.

CLASS 39—TRANSPORTATION AND STORAGE

FOR FREIGHT BROKERAGE; FREIGHT TRANSPORTATION BY TRUCK (U.S. CLS. 100 AND 105).
FIRST USE 11-1-2005; IN COMMERCE 11-1-2005.
WILLIAM VERHOSEK, EXAMINING ATTORNEY

SN 77-141,234. 360JMG, LLC, WASHINGTON, DC. FILED 3-27-2007.

Evolving Brand

THE MARK CONSISTS OF STANDARD CHARACTERS WITHOUT CLAIM TO ANY PARTICULAR FONT, STYLE, SIZE, OR COLOR.

NO CLAIM IS MADE TO THE EXCLUSIVE RIGHT TO USE "BRAND", APART FROM THE MARK AS SHOWN.

CLASS 35—ADVERTISING AND BUSINESS

FOR ADVERTISING AGENCIES; ADVERTISING AGENCIES, NAMELY, PROMOTING THE GOODS AND SERVICES OF OTHERS; ADVERTISING AND ADVERTISEMENT SERVICES; ADVERTISING AND BUSINESS MANAGEMENT CONSULTANCY; ADVERTISING AND BUSINESS SERVICES, NAMELY SECURING AIRTIME ON ALL FORMS OF MEDIA COMMUNICATIONS STATIONS, SYSTEMS, NETWORKS, AND SERVICES FOR THE PURPOSE OF PROMOTING THE GOODS AND SERVICES OF OTHERS; ADVERTISING AND COMMERCIAL INFORMATION SERVICES, VIA THE INTERNET; ADVERTISING AND MARKETING; ADVERTISING AND PROMOTION SERVICES AND RELATED CONSULTING; ADVERTISING AND PUBLICITY SERVICES; ADVERTISING AND PUBLICITY SERVICES, NAMELY, PROMOTING THE GOODS, SERVICES, BRAND IDENTITY AND COMMERCIAL INFORMATION AND NEWS OF THIRD PARTIES THROUGH PRINT, AUDIO, VIDEO, DIGITAL AND ON-LINE MEDIUM; ADVERTISING BY TRANSMISSION OF ON-LINE PUBLICITY FOR THIRD PARTIES THROUGH ELECTRONIC COMMUNICATIONS NETWORKS; ADVERTISING CONSULTATION; ADVERTISING FLYER DISTRIBUTION; ADVERTISING PARTICULARLY SERVICES FOR THE PROMOTION OF GOODS; ADVERTISING SERVICES; ADVERTISING SERVICES, NAMELY PROVIDING ADVERTISING SPACE IN A PERIODICAL; ADVERTISING SERVICES, NAMELY, CREATING CORPORATE AND BRAND IDENTITY FOR OTHERS; ADVERTISING SERVICES, NAMELY, CREATING CORPORATE LOGOS FOR OTHERS; ADVERTISING SERVICES, NAMELY, PROMOTING AND MARKETING THE GOODS AND SERVICES OF OTHERS THROUGH ALL PUBLIC COMMUNICATION MEANS; ADVERTISING THROUGH ALL PUBLIC COMMUNICATION MEANS; ADVERTISING VIA ELECTRONIC MEDIA AND SPECIFICALLY THE INTERNET; ADVERTISING, MARKETING AND PROMOTION SERVICES; CREATING AND UPDATING ADVERTISING MATERIAL; CREATION OF MARKETING TOOLS DESIGNED TO INCREASE A CLIENT COMPANY'S KNOWLEDGE OF CUSTOMER NEEDS, AND ITS COMPETITORS' PRODUCTS AND SERVICES, PRICING, ADVERTISING STRATEGY AND SALES STRATEGY; DESIGN OF ADVERTISING MATERIALS FOR OTHERS; DIRECT MAIL ADVERTISING; DIRECT MARKETING ADVERTISING FOR OTHERS; DISSEMINATION OF ADVERTISEMENTS AND OF ADVERTISING MATERIAL; DISSEMINATION OF ADVERTISING FOR OTHERS VIA AN ON-LINE COMMUNICATIONS NETWORK ON THE INTERNET; DISSEMINATION OF ADVERTISING FOR OTHERS VIA THE INTERNET; DISSEMINATION OF ADVERTISING MATERIAL; DISSEMINATION OF ADVERTISING MATTER; DISTRIBUTION OF PRODUCTS FOR ADVERTISING PURPOSES; ELECTRONIC BILLBOARD ADVERTISING; ISSUING AND UPDATING OF ADVERTISING TEXTS; LAYOUT SERVICES FOR

ADVERTISING PURPOSES; MEDIA BUYING ADVICE, NAMELY, ADVISING THE CLIENT HOW MUCH MEDIA TIME, AND AT WHAT TIMES THE CLIENT SHOULD BE PURCHASING ADVERTISING; MEDIA PLANNING, NAMELY, ADVISING THE CLIENT ON THE CORRECT TIMES AND STATIONS TO ADVERTISE BASED ON MEDIA ANALYSIS OF THE MARKET FOR THAT MEDIA; ON-LINE ADVERTISING AND MARKETING SERVICES; PLACING ADVERTISEMENTS FOR OTHERS; PREPARATION AND REALIZATION OF MEDIA AND ADVERTISING PLANS AND CONCEPTS; PREPARATION OF CUSTOM ADVERTISEMENTS FOR OTHERS; PREPARATION OF CUSTOM OR NON-CUSTOM ADVERTISING FOR BUSINESSES FOR DISTRIBUTION VIA THE WEB, CD OR DVD FOR OPTIONAL UPLOAD OR DOWNLOAD TO A COMPUTER; PREPARING ADVERTISEMENTS FOR OTHERS; PREPARING AND PLACING ADVERTISEMENTS FOR OTHERS; PREPARING AND PLACING OF ADVERTISEMENTS; PREPARING AND PLACING OUTDOOR ADVERTISEMENTS FOR OTHERS; PROMOTING THE GOODS AND SERVICES OF OTHERS BY DISTRIBUTING ADVERTISING MATERIALS THROUGH A VARIETY OF METHODS; PROMOTING, ADVERTISING AND MARKETING OF THE ON-LINE WEBSITES OF OTHERS; PROMOTION, ADVERTISING AND MARKETING OF ON-LINE WEBSITES; RENTAL OF ADVERTISING SPACE; PUBLIC RELATIONS; BUSINESS MARKETING AND DIRECT MAIL CONSULTING SERVICES; BUSINESS MARKETING CONSULTING SERVICES; BUSINESS MARKETING SERVICES; COOPERATIVE ADVERTISING AND MARKETING; CREATIVE MARKETING DESIGN SERVICES; DEVELOPMENT OF MARKETING STRATEGIES AND CONCEPTS; MARKETING CONSULTING; MARKETING PLAN DEVELOPMENT; PROMOTION AND MARKETING SERVICES AND RELATED CONSULTING (U.S. CLS. 100, 101 AND 102).

CLASS 42—SCIENTIFIC, COMPUTER AND LEGAL SERVICES

FOR CREATION AND MAINTENANCE OF WEB SITES FOR OTHERS; DESIGN OF HOMEPAGES AND WEB-SITES (U.S. CLS. 100 AND 101).
PATRICIA EVANKO, EXAMINING ATTORNEY

SN 77-141,240. GEOGRAPHIC RESEARCH, INC., NEW YORK, NY. FILED 3-27-2007.

Powerful Data, Professional Results

THE MARK CONSISTS OF STANDARD CHARACTERS WITHOUT CLAIM TO ANY PARTICULAR FONT, STYLE, SIZE, OR COLOR.

CLASS 35—ADVERTISING AND BUSINESS

FOR COLLECTION, PREPARATION, COMPOSITION, STORAGE, PROCESSING, ACQUISITION AND PROVISION OF BUSINESS INFORMATION, DATA, STATISTICS AND INDICES; PROVIDING BUSINESS AND MARKETING RESEARCH SERVICES TO ACADEMIC, GOVERNMENT, HEALTH, NON-PROFIT AND CORPORATE CLIENTS (U.S. CLS. 100, 101 AND 102).
FIRST USE 10-16-2006; IN COMMERCE 10-16-2006.

CLASS 42—SCIENTIFIC, COMPUTER AND LEGAL SERVICES

FOR PROVIDING ON-LINE NON-DOWNLOADABLE SOFTWARE WHICH GENERATES MAPS AND REPORTS CONTAINING STATISTICAL DATA; PROVIDING COMPUTER MAPPING AND GEOGRAPHIC RESEARCH SERVICES TO ACADEMIC, GOVERNMENT, HEALTH, NON-PROFIT AND CORPORATE CLIENTS (U.S. CLS. 100 AND 101).
FIRST USE 10-16-2006; IN COMMERCE 10-16-2006.
PATRICIA EVANKO, EXAMINING ATTORNEY

SN 77-141,385. MERCURY COMPUTER SYSTEMS, INC., CHELMSFORD, MA. FILED 3-27-2007.

EchoCore

THE MARK CONSISTS OF STANDARD CHARACTERS WITHOUT CLAIM TO ANY PARTICULAR FONT, STYLE, SIZE, OR COLOR.

CLASS 9—ELECTRICAL AND SCIENTIFIC APPARATUS

FOR CUSTOM FIELD PROGRAMMABLE GATE ARRAYS AND OTHER DIGITAL LOGIC CIRCUIT ELEMENTS (U.S. CLS. 21, 23, 26, 36 AND 38).

CLASS 42—SCIENTIFIC, COMPUTER AND LEGAL SERVICES

FOR DESIGNING FOR OTHERS CUSTOMIZED FIELD PROGRAMMABLE GATE ARRAYS AND OTHER DIGITAL LOGIC CIRCUIT ELEMENTS (U.S. CLS. 100 AND 101).
REBECCA GILBERT, EXAMINING ATTORNEY

SN 77-141,399. TRADITIONAL MEDICINALS, INC., SEBAS-
TOPOL, CA. FILED 3-27-2007.

WHEN NATURE CALLS

THE MARK CONSISTS OF STANDARD CHARACTERS WITHOUT CLAIM TO ANY PARTICULAR FONT, STYLE, SIZE, OR COLOR.

CLASS 5—PHARMACEUTICALS

FOR DIETARY SUPPLEMENTS; LAXATIVES (U.S. CLS. 6, 18, 44, 46, 51 AND 52).

CLASS 30—STAPLE FOODS

FOR HERB TEA (U.S. CL. 46).
CURTIS FRENCH, EXAMINING ATTORNEY

SN 77-141,406. IGNITION CAPITAL INC., LANGLEY, CANADA, FILED 3-27-2007.

SN 77-141,533. NICK'S GARAGE, INC., DBA NICK ORSO'S BODY SHOP AND SERVICE CENTER, SYRACUSE, NY, FILED 3-27-2007.

Manutech

THE MARK CONSISTS OF STANDARD CHARACTERS WITHOUT CLAIM TO ANY PARTICULAR FONT, STYLE, SIZE, OR COLOR.

CLASS 6—METAL GOODS

FOR METAL CASTING FORMS FOR CONCRETE; CLAD STEEL PLATES AND SHEETS; COLD-FINISHED STEEL BARS; HOLLOW STEEL BARS; STEEL FRAMES FOR BUILDING; STEEL IN SHEET, ROD, BAR AND/OR BILLET FORM; STEEL RODS; FASTENERS, NAMELY, METAL BARS AND CHAINS; METAL LATCH BARS (U.S. CLS. 2, 12, 13, 14, 23, 25 AND 50).

CLASS 19—NON-METALLIC BUILDING MATERIALS

FOR BLOCKS OF CONCRETE; CONCRETE; CONCRETE BEAMS; CONCRETE BLOCKS; CONCRETE BOLLARDS; CONCRETE BUILDING MATERIALS NAMELY, BLOCKS, BRICKS, POSTS, SLABS, PANELS; CONCRETE DRAINAGE STRUCTURES, NAMELY, STORM MANHOLES; CONCRETE DRAINAGE STRUCTURES, NAMELY, TRENCH DRAINS; CONCRETE FLOORS; CONCRETE PANELS; CONCRETE PATCHING COMPOUND MADE OF A TAR BASE; CONCRETE PIPES; CONCRETE RETAINING WALLS; CONCRETE ROAD PAVEMENT BOARDS; CONCRETE SCULPTURES; CONCRETE VAULTS; CONCRETE WALLS; CONCRETE WALLS FOR BUILDING; CONTAINMENT SYSTEMS FOR LARGE SCALE LIQUID SPILLS OR RELEASES, NAMELY, BERMS MADE OF POLYMER CONCRETE, VINYL, OR FIBERGLASS; DRAIN PIPES MADE OF CONCRETE; FLOOR PATCHING MATERIALS, NAMELY, CONCRETE SEALERS; INDUSTRIAL CONCRETE FOR USE IN CIVIL ENGINEERING WORKS; NON-METAL CASTING FORMS FOR CONCRETE; REFRACTORY CONCRETE; SLABS OF CONCRETE; TAR-BASED CONCRETE AND ASPHALT PATCHING COMPOUND; WALL SYSTEM CONSISTING OF REINFORCED, DRY-STACKED, ENGINEERED CONCRETE BLOCK WITH INSULATING CORE AND COATED WITH SURFACE BOND CEMENT (U.S. CLS. 1, 12, 33 AND 50).

CLASS 37—CONSTRUCTION AND REPAIR

FOR SCAFFOLDING, EARTHWORKS OR CONCRETE CONSTRUCTION; MAINTENANCE AND REPAIR OF BUILDINGS; PLANNING AND LAYING OUT OF FACTORY BUILDINGS; RENTAL OF BUILDING EQUIPMENT; RENTAL OF BUILDING SCAFFOLDS, WORKING AND BUILDING PLATFORMS; RENTAL OF CONSTRUCTION AND BUILDING EQUIPMENT; REPAIR AND MAINTENANCE OF BUILDING SCAFFOLDS, WORKING AND BUILDING PLATFORMS; REPAIR AND MAINTENANCE OF BUILDINGS IN CASE OF DEMOLITION; REPAIR OF BUILDINGS; RESIDENTIAL AND BUILDING CONSTRUCTION CONSULTING; RESIDENTIAL AND COMMERCIAL BUILDING CONSTRUCTION; BUILDING REINFORCING; BUILDING SEALING AND CAULKING SERVICES; CONSTRUCTION AND RENOVATION OF BUILDINGS; CONSTRUCTION AND REPAIR OF BUILDINGS; CONSULTATION IN BUILDING CONSTRUCTION SUPERVISION; CUSTOM CONSTRUCTION AND BUILDING RENOVATION; INFORMATION CONCERNING RENTAL OF EQUIPMENT FOR CONSTRUCTIONS AND BUILDINGS; INSTALLATION SERVICES OF BUILDING SCAFFOLDS, WORKING AND BUILDING PLATFORMS; LEASING OF BUILDING MACHINERY (U.S. CLS. 100, 103 AND 106).
LINDA E. BLOHM, EXAMINING ATTORNEY

NICK ORSO'S

THE MARK CONSISTS OF STANDARD CHARACTERS WITHOUT CLAIM TO ANY PARTICULAR FONT, STYLE, SIZE, OR COLOR.

THE NAME(S), PORTRAIT(S), AND/OR SIGNATURE(S) SHOWN IN THE MARK DOES NOT IDENTIFY A PARTICULAR LIVING INDIVIDUAL.

CLASS 36—INSURANCE AND FINANCIAL

FOR APPRAISALS FOR INSURANCE CLAIMS OF PERSONAL PROPERTY (U.S. CLS. 100, 101 AND 102).
FIRST USE 10-1-1982; IN COMMERCE 8-31-1997.

CLASS 37—CONSTRUCTION AND REPAIR

FOR VEHICLE REPAIR AND MAINTENANCE; VEHICLE REPAIR CONSULTATION; AUTOMOTIVE REFINISHING; VEHICLE PAINTING (U.S. CLS. 100, 103 AND 106).
FIRST USE 10-1-1982; IN COMMERCE 8-31-1997.

CLASS 39—TRANSPORTATION AND STORAGE

FOR VEHICLE TOWING; RENTAL OF VEHICLES (U.S. CLS. 100 AND 105).
FIRST USE 10-1-1982; IN COMMERCE 8-31-1997.
LINDSEY RUBIN, EXAMINING ATTORNEY

SN 77-141,558. CHOXOTICA, INC., TAMPA, FL. FILED 3-27-2007.

CHOXOTICA

THE MARK CONSISTS OF STANDARD CHARACTERS WITHOUT CLAIM TO ANY PARTICULAR FONT, STYLE, SIZE, OR COLOR.

CLASS 30—STAPLE FOODS

FOR CHOCOLATE (U.S. CL. 46).

CLASS 35—ADVERTISING AND BUSINESS

FOR RETAIL STORES FEATURING CHOCOLATE (U.S. CLS. 100, 101 AND 102).
WON TEAK OH, EXAMINING ATTORNEY

SN 77-141,610. AMERICAN TEXTILE COMPANY, DUESNE, PA. FILED 3-27-2007.

SN 77-141,748. KOHL'S ILLINOIS, INC., AURORA, IL. FILED 3-27-2007.

FOREVER CLEAN

THE MARK CONSISTS OF STANDARD CHARACTERS WITHOUT CLAIM TO ANY PARTICULAR FONT, STYLE, SIZE, OR COLOR.

CLASS 20—FURNITURE AND ARTICLES NOT OTHERWISE CLASSIFIED

FOR BED PILLOW (U.S. CLS. 2, 13, 22, 25, 32 AND 50).

CLASS 24—FABRICS

FOR MATTRESS PAD (U.S. CLS. 42 AND 50).
HANNO RITTNER, EXAMINING ATTORNEY

SN 77-141,716. LAHAM, RICK, WICHITA, KS. FILED 3-27-2007.



THE COLOR(S) RED, BLUE, LIGHT BLUE, YELLOW, ORANGE, BROWN, PEACH, WHITE, GREY IS/ARE CLAIMED AS A FEATURE OF THE MARK.

THE MARK CONSISTS OF A HERO WITH A RED CAPE, BLUE PANTS, LIGHT BLUE SHIRT, YELLOW CIRCLE ON CHEST (FRONT) OF SHIRT WITH AN ORANGE "Z" THEREON, ORANGE GLOVES, BROWN HAIR, PEACH SKIN, WHITE BELT, GREY SHOES.

CLASS 25—CLOTHING

FOR HATS; CAP VISORS; GOLF CAPS; POLO SHIRTS; SHIRTS; SHORT-SLEEVED SHIRTS; SWEAT SHIRTS; T-SHIRTS; PANTS; JEANS; SHORTS; SHOES (U.S. CLS. 22 AND 39).

CLASS 38—COMMUNICATION

FOR INTERNET SERVICE PROVIDER (ISP); INTERNET TELEPHONY SERVICES; PROVIDING MULTIPLE USER DIAL-UP AND DEDICATED ACCESS TO THE INTERNET; PROVIDING REMOTE INTERNET ACCESS; PROVIDING VOICE COMMUNICATION SERVICES VIA THE INTERNET; STREAMING OF AUDIO MATERIAL ON THE INTERNET; STREAMING OF VIDEO MATERIAL ON THE INTERNET; VOICE OVER INTERNET PROTOCOL (VOIP) SERVICES (U.S. CLS. 100, 101 AND 104).

FIRST USE 3-13-2007; IN COMMERCE 3-13-2007.
ARETHA SOMERVILLE, EXAMINING ATTORNEY

FIRST MOMENTS

THE MARK CONSISTS OF STANDARD CHARACTERS WITHOUT CLAIM TO ANY PARTICULAR FONT, STYLE, SIZE, OR COLOR.

OWNER OF U.S. REG. NO. 2,448,165.

CLASS 24—FABRICS

FOR WASHCLOTHS (U.S. CLS. 42 AND 50).
FIRST USE 6-0-2006; IN COMMERCE 6-0-2006.

CLASS 25—CLOTHING

FOR SKORTS, SLEEP AND PLAYS, NAMELY, SLEEPWEAR AND PLAYSUITS, JACKETS, SOCKS, BOOTIES, HEADWEAR, DRESSES, CLOTH BIBS, JUMPERS, SWEATERS, PANTS, SHORTS, TOPS, SKIRTS (U.S. CLS. 22 AND 39).

FIRST USE 3-23-2007; IN COMMERCE 3-23-2007.
WON TEAK OH, EXAMINING ATTORNEY

SN 77-141,904. STECHER, MARY SUSAN, BELLINGHAM, WA. FILED 3-27-2007.

Smart Women About Money

THE MARK CONSISTS OF STANDARD CHARACTERS WITHOUT CLAIM TO ANY PARTICULAR FONT, STYLE, SIZE, OR COLOR.

CLASS 35—ADVERTISING AND BUSINESS

FOR GENERAL BUSINESS NETWORKING REFERRAL SERVICES, NAMELY, PROMOTING THE GOODS AND SERVICES OF OTHERS BY PASSING BUSINESS LEADS AND REFERRALS AMONG GROUP MEMBERS (U.S. CLS. 100, 101 AND 102).

CLASS 42—SCIENTIFIC, COMPUTER AND LEGAL SERVICES

FOR COMPUTER SERVICES, NAMELY, HOSTING AND MAINTAINING AN ONLINE WEBSITE FOR OTHERS TO EDUCATE THEMSELVES ON PERSONAL FINANCIAL PLANNING (U.S. CLS. 100 AND 101).
WILLIAM VERHOSEK, EXAMINING ATTORNEY

SN 77-141,910. GGP ITALY, S.P.A., CASTELFRANCO VENE-
TO, ITALY, FILED 3-27-2007.

SN 77-141,999. UNITED ALLIANCE ENTERTAINMENT
GROUP, LLC, OCALA, FL. FILED 3-27-2007.

CASTELGARDEN

THE MARK CONSISTS OF STANDARD CHARACTERS
WITHOUT CLAIM TO ANY PARTICULAR FONT, STYLE,
SIZE, OR COLOR.

OWNER OF ITALY REG. NO. 00940329, DATED 10-8-2004,
EXPIRES 4-21-2014.

CLASS 7—MACHINERY

FOR LAWN MOWERS; SMALL MOTORIZED MA-
CHINE TOOLS FOR GARDENING AND AGRICUL-
TURE, NAMELY MOTOR SAWS, GRASS TRIMMERS,
BRUSHCUTTERS, HEDGE CUTTERS (U.S. CLS. 13, 19,
21, 23, 31, 34 AND 35).

CLASS 8—HAND TOOLS

FOR HAND TOOLS AND INSTRUMENTS FOR GAR-
DENING, HORTICULTURE, AND AGRICULTURE,
NAMELY SAWS, GRASS TRIMMERS, HAND OPER-
ATED HEDGE CUTTERS AND BRUSHCUTTERS (U.S.
CLS. 23, 28 AND 44).

CLASS 12—VEHICLES

FOR LAWN TRACTORS FOR GARDENING AND
AGRICULTURE (U.S. CLS. 19, 21, 23, 31, 35 AND 44).
THEODORE MCBRIDE, EXAMINING ATTORNEY

SN 77-141,983. ZENEDGE, INC., POMONA, NY. FILED 3-27-
2007.



THE MARK CONSISTS OF THE LETTERS "Z" AND "E"
MERGED CREATING A TRIBLE EFFECT.

CLASS 25—CLOTHING

FOR JACKETS; PANTS; SHIRTS; SHOES (U.S. CLS. 22
AND 39).

CLASS 32—LIGHT BEVERAGES

FOR ENERGY DRINKS; SPORTS DRINKS (U.S. CLS.
45, 46 AND 48).
WILLIAM VERHOSEK, EXAMINING ATTORNEY

RADIANCE RECORDS

THE MARK CONSISTS OF STANDARD CHARACTERS
WITHOUT CLAIM TO ANY PARTICULAR FONT, STYLE,
SIZE, OR COLOR.

NO CLAIM IS MADE TO THE EXCLUSIVE RIGHT TO
USE "RECORDS", APART FROM THE MARK AS SHOWN.

CLASS 9—ELECTRICAL AND SCIENTIFIC APPARATUS

FOR AUDIO RECORDINGS FEATURING MUSIC
PERFORMANCES (U.S. CLS. 21, 23, 26, 36 AND 38).

CLASS 41—EDUCATION AND ENTERTAIN- MENT

FOR PRODUCTION OF SOUND AND MUSIC VIDEO
RECORDINGS (U.S. CLS. 100, 101 AND 107).

BARBARA A. LOUGHRAN, EXAMINING ATTORNEY

SN 77-142,143. BIOCHEMICS, INC., DANVERS, MA. FILED
3-28-2007.

LS2

THE MARK CONSISTS OF STANDARD CHARACTERS
WITHOUT CLAIM TO ANY PARTICULAR FONT, STYLE,
SIZE, OR COLOR.

CLASS 3—COSMETICS AND CLEANING PRE- PARATIONS

FOR NON-MEDICATED TOPICAL SKIN-CARE PRE-
PARATIONS (U.S. CLS. 1, 4, 6, 50, 51 AND 52).

CLASS 5—PHARMACEUTICALS

FOR MEDICATED TOPICAL SKIN-CARE PREPARA-
TIONS (U.S. CLS. 6, 18, 44, 46, 51 AND 52).

REBECCA EISINGER, EXAMINING ATTORNEY

SN 77-142,155. BIOCHEMICS, INC., DANVERS, MA. FILED
3-28-2007.

LS2 ACHIEVE

THE MARK CONSISTS OF STANDARD CHARACTERS
WITHOUT CLAIM TO ANY PARTICULAR FONT, STYLE,
SIZE, OR COLOR.

CLASS 3—COSMETICS AND CLEANING PREPARATIONS

FOR NON-MEDICATED TOPICAL SKIN-CARE PREPARATIONS (U.S. CLS. 1, 4, 6, 50, 51 AND 52).

CLASS 5—PHARMACEUTICALS

FOR MEDICATED TOPICAL SKIN-CARE PREPARATIONS (U.S. CLS. 6, 18, 44, 46, 51 AND 52).
REBECCA EISINGER, EXAMINING ATTORNEY

CLASS 41—EDUCATION AND ENTERTAINMENT

FOR EDUCATIONAL SERVICES, NAMELY, CONDUCTING CLASSES, SEMINARS, CONFERENCES, AND WORKSHOPS IN THE FIELD OF FINANCIAL PLANNING AND MANAGEMENT, AND DISTRIBUTING COURSE MATERIALS IN CONNECTION THEREWITH (U.S. CLS. 100, 101 AND 107).
GINA FINK, EXAMINING ATTORNEY

SN 77-142,259. FISMART, LLC, BIRMINGHAM, AL. FILED 3-28-2007.

ARMS

THE MARK CONSISTS OF STANDARD CHARACTERS WITHOUT CLAIM TO ANY PARTICULAR FONT, STYLE, SIZE, OR COLOR.

CLASS 36—INSURANCE AND FINANCIAL

FOR FINANCIAL SERVICES, NAMELY, FINANCIAL PLANNING, FINANCIAL MANAGEMENT, ESTATE PLANNING, INVESTMENT PLANNING, AND FINANCIAL INVESTMENT IN THE FIELD OF SECURITIES, REAL ESTATE, COMMODITIES, AND COLLECTIBLES (U.S. CLS. 100, 101 AND 102).

CLASS 41—EDUCATION AND ENTERTAINMENT

FOR EDUCATIONAL SERVICES, NAMELY, CONDUCTING CLASSES, SEMINARS, CONFERENCES, AND WORKSHOPS IN THE FIELD OF FINANCIAL PLANNING AND MANAGEMENT, AND DISTRIBUTING COURSE MATERIALS IN CONNECTION THEREWITH (U.S. CLS. 100, 101 AND 107).
GINA FINK, EXAMINING ATTORNEY

SN 77-142,302. FISMART, LLC, BIRMINGHAM, AL. FILED 3-28-2007.

03

THE MARK CONSISTS OF STANDARD CHARACTERS WITHOUT CLAIM TO ANY PARTICULAR FONT, STYLE, SIZE, OR COLOR.

CLASS 36—INSURANCE AND FINANCIAL

FOR FINANCIAL SERVICES, NAMELY, FINANCIAL PLANNING, FINANCIAL MANAGEMENT, ESTATE PLANNING, INVESTMENT PLANNING, AND FINANCIAL INVESTMENT IN THE FIELD OF SECURITIES, REAL ESTATE, COMMODITIES, AND COLLECTIBLES (U.S. CLS. 100, 101 AND 102).

SN 77-142,315. WWP PRODUCTIONS, LLC, PLYMOUTH, MN. FILED 3-28-2007.

WWP

THE MARK CONSISTS OF STANDARD CHARACTERS WITHOUT CLAIM TO ANY PARTICULAR FONT, STYLE, SIZE, OR COLOR.

CLASS 14—JEWELRY

FOR JEWELRY, NAMELY, BRACELETS, NECKLACES, RINGS, EARRINGS, CUFF-LINKS, ANKLE BRACELETS, CHOKERS, TOE RINGS, BROOCHES, CHARITY BRACELETS, CHARMS, PENDANTS, CHAINS, LAPEL PINS, CROSSES; WATCHES; JEWELRY FOR THE HEAD (U.S. CLS. 2, 27, 28 AND 50).

CLASS 18—LEATHER GOODS

FOR HANDBAGS; WALLETS; TOTE BAGS; BRIEFCASES; SPORT BAGS; GYM BAGS; BACKPACKS; EVENING HANDBAGS; TRAVEL BAGS; CLUTCHES; COIN PURSES; DUFFLE BAGS; SUITCASES; OVERNIGHT BAGS; WRISTLET BAGS; UMBRELLAS (U.S. CLS. 1, 2, 3, 22 AND 41).

CLASS 25—CLOTHING

FOR CLOTHING, NAMELY, LONG-SLEEVED TOPS, SHORT-SLEEVED TOPS, BLOUSES, VESTS, BLAZERS, PULLOVERS, SWEATERS, CARDIGANS, SWEATSHIRTS, SHIRTS, T-SHIRTS, PANTS, JEANS, CAPRI PANTS, SKIRTS, DRESSES, SHORTS, SOCKS, PAJAMAS, SUITS, JUMPSUITS, LOUNGWEAR, SKI WEAR, JACKETS, COATS, PARKAS; UNDERCLOTHING, NAMELY, BODICES, CAMISOLES, BRASSIERES, UNDERWEAR; DRESSING GOWNS; BATHROBES; BEACH CLOTHING, NAMELY BATHING SUITS, COVER UPS, SARONGS; SCARVES, SHAWLS; MITTENS; GLOVES; BELTS; FOOTWEAR, NAMELY, SHOES, BOOTS, SLIPPERS, ATHLETIC SHOES, SANDALS, BEACH SHOES, FLIP FLOPS; HEADWEAR, NAMELY, HATS, EAR BANDS, CAPS, BERETS (U.S. CLS. 22 AND 39).
REBECCA GILBERT, EXAMINING ATTORNEY

SN 77-142,317. AMERICAN STANDARD INTERNATIONAL INC., NEW YORK, NY. FILED 3-28-2007.

SN 77-142,341. FISMART, LLC, BIRMINGHAM, AL. FILED 3-28-2007.

GREEN TEA

THE MARK CONSISTS OF STANDARD CHARACTERS WITHOUT CLAIM TO ANY PARTICULAR FONT, STYLE, SIZE, OR COLOR.

CLASS 11—ENVIRONMENTAL CONTROL APPARATUS

FOR FAUCETS; PLUMBING FITTINGS, NAMELY BATH AND SHOWER VALVES; TOILETS; SINKS (U.S. CLS. 13, 21, 23, 31 AND 34).

CLASS 20—FURNITURE AND ARTICLES NOT OTHERWISE CLASSIFIED

FOR FURNITURE, NAMELY, VANITIES, CONSOLES, CABINETS, TABLES, SHELVES AND MIRRORS FOR THE BATHROOM (U.S. CLS. 2, 13, 22, 25, 32 AND 50).
AISHA SALEM, EXAMINING ATTORNEY

SN 77-142,326. FISMART, LLC, BIRMINGHAM, AL. FILED 3-28-2007.

DECLARATION OF FINANCIAL INDEPENDENCE

THE MARK CONSISTS OF STANDARD CHARACTERS WITHOUT CLAIM TO ANY PARTICULAR FONT, STYLE, SIZE, OR COLOR.

CLASS 36—INSURANCE AND FINANCIAL

FOR FINANCIAL SERVICES, NAMELY, FINANCIAL PLANNING, FINANCIAL MANAGEMENT, ESTATE PLANNING, INVESTMENT PLANNING, AND FINANCIAL INVESTMENT IN THE FIELD OF SECURITIES, REAL ESTATE, COMMODITIES, AND COLLECTIBLES (U.S. CLS. 100, 101 AND 102).

CLASS 41—EDUCATION AND ENTERTAINMENT

FOR EDUCATIONAL SERVICES, NAMELY, CONDUCTING CLASSES, SEMINARS, CONFERENCES, AND WORKSHOPS IN THE FIELD OF FINANCIAL PLANNING AND MANAGEMENT, AND DISTRIBUTING COURSE MATERIALS IN CONNECTION THEREWITH (U.S. CLS. 100, 101 AND 107).
GINA FINK, EXAMINING ATTORNEY

PUNCH LIST

THE MARK CONSISTS OF STANDARD CHARACTERS WITHOUT CLAIM TO ANY PARTICULAR FONT, STYLE, SIZE, OR COLOR.

CLASS 36—INSURANCE AND FINANCIAL

FOR FINANCIAL SERVICES, NAMELY, FINANCIAL PLANNING, FINANCIAL MANAGEMENT, ESTATE PLANNING, INVESTMENT PLANNING, AND FINANCIAL INVESTMENT IN THE FIELD OF SECURITIES, REAL ESTATE, COMMODITIES, AND COLLECTIBLES (U.S. CLS. 100, 101 AND 102).

CLASS 41—EDUCATION AND ENTERTAINMENT

FOR EDUCATIONAL SERVICES, NAMELY, CONDUCTING CLASSES, SEMINARS, CONFERENCES, AND WORKSHOPS IN THE FIELD OF FINANCIAL PLANNING AND MANAGEMENT, AND DISTRIBUTING COURSE MATERIALS IN CONNECTION THEREWITH (U.S. CLS. 100, 101 AND 107).
GINA FINK, EXAMINING ATTORNEY

SN 77-142,345. WWP PRODUCTIONS, LLC, PLYMOUTH, MN. FILED 3-28-2007.

WOMEN WITH PURPOSE

THE MARK CONSISTS OF STANDARD CHARACTERS WITHOUT CLAIM TO ANY PARTICULAR FONT, STYLE, SIZE, OR COLOR.

NO CLAIM IS MADE TO THE EXCLUSIVE RIGHT TO USE WOMEN, APART FROM THE MARK AS SHOWN.

CLASS 14—JEWELRY

FOR JEWELRY, NAMELY, BRACELETS, NECKLACES, RINGS, EARRINGS, CUFF-LINKS, ANKLE BRACELETS, CHOKERS, TOE RINGS, BROOCHES, CHARITY BRACELETS, CHARMS, PENDANTS, CHAINS, LAPEL PINS, CROSSES; WATCHES; JEWELRY FOR THE HEAD (U.S. CLS. 2, 27, 28 AND 50).

CLASS 18—LEATHER GOODS

FOR HANDBAGS; WALLETS; TOTE BAGS; BRIEFCASES; SPORT BAGS; GYM BAGS; BACKPACKS; EVENING HANDBAGS; TRAVEL BAGS; CLUTCHES; COIN PURSES; DUFFLE BAGS; SUITCASES; OVERNIGHT BAGS; WRISTLET BAGS; UMBRELLAS (U.S. CLS. 1, 2, 3, 22 AND 41).

CLASS 25—CLOTHING

FOR CLOTHING, NAMELY, LONG-SLEEVED TOPS, SHORT-SLEEVED TOPS, BLOUSES, VESTS, BLAZERS, PULLOVERS, SWEATERS, CARDIGANS, SWEAT-SHIRTS, SHIRTS, T-SHIRTS, PANTS, JEANS, CAPRI PANTS, SKIRTS, DRESSES, SHORTS, SOCKS, PAJAMAS, SUITS, JUMPSUITS, LOUNGEWEAR, SKI WEAR, JACKETS, COATS, PARKAS; UNDERCLOTHING, NAMELY, BODICES, CAMISOLES, BRASSIERES, UNDERWEAR; DRESSING GOWNS; BATHROBES; BEACH CLOTHING, NAMELY BATHING SUITS, COVER UPS, SARONGS; SCARVES, SHAWLS; MITTENS; GLOVES; BELTS; FOOTWEAR, NAMELY, SHOES, BOOTS, SLIPPERS, ATHLETIC SHOES, SANDALS, BEACH SHOES, FLIP FLOPS; HEADWEAR, NAMELY, HATS, EAR BANDS, CAPS, BERETS (U.S. CLS. 22 AND 39).

REBECCA GILBERT, EXAMINING ATTORNEY

CLASS 36—INSURANCE AND FINANCIAL

FOR FINANCIAL SERVICES, NAMELY, FINANCIAL PLANNING, FINANCIAL MANAGEMENT, ESTATE PLANNING, INVESTMENT PLANNING, AND FINANCIAL INVESTMENT IN THE FIELD OF SECURITIES, REAL ESTATE, COMMODITIES, AND COLLECTIBLES (U.S. CLS. 100, 101 AND 102).

CLASS 41—EDUCATION AND ENTERTAINMENT

FOR EDUCATIONAL SERVICES, NAMELY, CONDUCTING CLASSES, SEMINARS, CONFERENCES, AND WORKSHOPS IN THE FIELD OF FINANCIAL PLANNING AND MANAGEMENT, AND DISTRIBUTING COURSE MATERIALS IN CONNECTION THEREWITH (U.S. CLS. 100, 101 AND 107).

GINA FINK, EXAMINING ATTORNEY

SN 77-142,364. FISMART, LLC, BIRMINGHAM, AL. FILED 3-28-2007.

ASK

THE MARK CONSISTS OF STANDARD CHARACTERS WITHOUT CLAIM TO ANY PARTICULAR FONT, STYLE, SIZE, OR COLOR.

CLASS 36—INSURANCE AND FINANCIAL

FOR FINANCIAL SERVICES, NAMELY, FINANCIAL PLANNING, FINANCIAL MANAGEMENT, ESTATE PLANNING, INVESTMENT PLANNING, AND FINANCIAL INVESTMENT IN THE FIELD OF SECURITIES, REAL ESTATE, COMMODITIES, AND COLLECTIBLES (U.S. CLS. 100, 101 AND 102).

CLASS 41—EDUCATION AND ENTERTAINMENT

FOR EDUCATIONAL SERVICES, NAMELY, CONDUCTING CLASSES, SEMINARS, CONFERENCES, AND WORKSHOPS IN THE FIELD OF FINANCIAL PLANNING AND MANAGEMENT, AND DISTRIBUTING COURSE MATERIALS IN CONNECTION THEREWITH (U.S. CLS. 100, 101 AND 107).

GINA FINK, EXAMINING ATTORNEY

SN 77-142,579. FISMART, LLC, BIRMINGHAM, AL. FILED 3-28-2007.

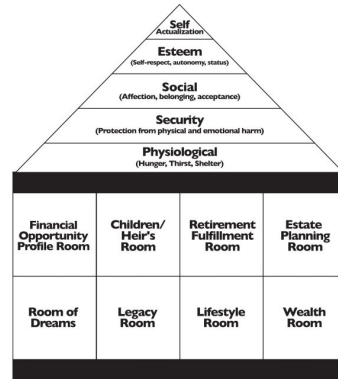

THE MARK CONSISTS OF A DESIGN OF A HOUSE WITH SEPARATE ROOMS.

CLASS 36—INSURANCE AND FINANCIAL

FOR FINANCIAL SERVICES, NAMELY, FINANCIAL PLANNING, FINANCIAL MANAGEMENT, ESTATE PLANNING, INVESTMENT PLANNING, AND FINANCIAL INVESTMENT IN THE FIELD OF SECURITIES, REAL ESTATE, COMMODITIES, AND COLLECTIBLES (U.S. CLS. 100, 101 AND 102).

CLASS 41—EDUCATION AND ENTERTAINMENT

FOR EDUCATIONAL SERVICES, NAMELY, CONDUCTING CLASSES, SEMINARS, CONFERENCES, AND WORKSHOPS IN THE FIELD OF FINANCIAL PLANNING AND MANAGEMENT, AND DISTRIBUTING COURSE MATERIALS IN CONNECTION THEREWITH (U.S. CLS. 100, 101 AND 107).

GINA FINK, EXAMINING ATTORNEY

SN 77-142,377. FISMART, LLC, BIRMINGHAM, AL. FILED 3-28-2007.

SUCCESS OF FAILURE

THE MARK CONSISTS OF STANDARD CHARACTERS WITHOUT CLAIM TO ANY PARTICULAR FONT, STYLE, SIZE, OR COLOR.

SN 77-142,591. ASSOCIATED SPACE DESIGN, INC., ATLANTA, GA. FILED 3-28-2007.

ASD

THE MARK CONSISTS OF STANDARD CHARACTERS WITHOUT CLAIM TO ANY PARTICULAR FONT, STYLE, SIZE, OR COLOR.

CLASS 37—CONSTRUCTION AND REPAIR

FOR RESIDENTIAL AND BUILDING CONSTRUCTION CONSULTING; CONSTRUCTION PLANNING; LAND DEVELOPMENT SERVICES, NAMELY, PLANNING AND LAYING OUT OF RESIDENTIAL AND/OR COMMERCIAL COMMUNITIES (U.S. CLS. 100, 103 AND 106).

CLASS 42—SCIENTIFIC, COMPUTER AND LEGAL SERVICES

FOR ARCHITECTURAL DESIGN; COMMERCIAL ART DESIGN; DESIGN OF HOMEPAGES AND WEBSITES; GRAPHIC DESIGN SERVICES; DESIGN OF SPECIALTY INTERIOR AND EXTERIOR ENVIRONMENT SETTINGS; PACKAGING DESIGN FOR OTHERS; INTERIOR DECORATION CONSULTATION; INTERIOR DECORATING; LAND USE PLANNING SERVICES; GRAPHIC ILLUSTRATION SERVICES FOR OTHERS; GRAPHIC ART DESIGN (U.S. CLS. 100 AND 101).
RICHARD A. STRASER, EXAMINING ATTORNEY

SN 77-142,625. BLOOMSBURY PUBLISHING PLC, LONDON, UNITED KINGDOM, FILED 3-28-2007.

 Walker & Company

NO CLAIM IS MADE TO THE EXCLUSIVE RIGHT TO USE COMPANY, APART FROM THE MARK AS SHOWN. THE MARK CONSISTS OF THE WORDS "WALKER & COMPANY" PRECEDED BY A CIRCLE WITH W'S AROUND IT.

CLASS 9—ELECTRICAL AND SCIENTIFIC APPARATUS

FOR COMPUTER SOFTWARE, NAMELY SOFTWARE FOR USE IN DOWNLOADING, STORING, REPRODUCING AND ORGANIZING AUDIO, VIDEO, STILL AND MOVING IMAGES AND DATA; ANIMATED CARTOONS RECORDED ON VIDEO DISKS AND VIDEO TAPES; ELECTRONIC DATABASES RELATED TO PUBLISHING RECORDED ON COMPUTER MEDIA; DESKTOP PUBLISHING SOFTWARE; EDUCATIONAL SOFTWARE FEATURING INSTRUCTION ON A VARIETY OF TOPICS; GAME SOFTWARE; COMPUTER MOUSE MATS; DOWNLOADABLE ELECTRONIC PUBLICATIONS OF MAGAZINES AND JOURNALS ON A VARIETY OF TOPICS (U.S. CLS. 21, 23, 26, 36 AND 38).

CLASS 16—PAPER GOODS AND PRINTED MATTER

FOR MAGAZINES, CATALOGS, EVENT PROGRAMS AND JOURNALS ON A VARIETY OF TOPICS; PHOTOGRAPHS; STATIONERY; PRINTED INSTRUCTIONAL, EDUCATIONAL, AND TEACHING MATERIALS ON A VARIETY OF TOPICS; PRINTING BLOCKS; BOOK BINDING MATERIALS; POSTERS; CARDS, NAMELY, POSTCARDS; GREETINGS CARDS; PRINTED INVITATIONS; DIARIES; CALENDARS; PHOTOGRAPH ALBUMS; PRINTS AND FRAMED PRINTS; NOTEPADS; CRAYONS; STICKERS; TRANSFERS (DECALCOMANIAS); STAMPS; PERSONAL ORGANIZERS; ADDRESS BOOKS; NOTE BOOKS (U.S. CLS. 2, 5, 22, 23, 29, 37, 38 AND 50).

CLASS 41—EDUCATION AND ENTERTAINMENT

FOR MULTIMEDIA PUBLISHING OF BOOKS, MAGAZINES, JOURNALS, SOFTWARE, GAMES, MUSIC, AND ELECTRONIC PUBLICATIONS; PUBLISHING OF BOOKS, MAGAZINES, JOURNALS, REVIEWS AND ELECTRONIC PUBLICATIONS; LANGUAGE TEACHING; ENTERTAINMENT SERVICES NAMELY PROVIDING A WEB SITE FEATURING, PHOTOGRAPHIC, AUDIO, VIDEO AND PROSE PRESENTATIONS ON A VARIETY OF FICTION AND NON-FICTION TOPICS INCLUDING MUSIC, CONCERTS, FILM, VIDEOS, THEATRE, RADIO, TELEVISION, NEWS, SPORTS, GAMES AND CULTURAL EVENTS AND ENTERTAINMENT-RELATED PROGRAMS (U.S. CLS. 100, 101 AND 107).

JOHN HWANG, EXAMINING ATTORNEY

SN 77-142,790. ERGODYNE CORPORATION, ST. PAUL, MN. FILED 3-28-2007.

SOURCED

THE MARK CONSISTS OF STANDARD CHARACTERS WITHOUT CLAIM TO ANY PARTICULAR FONT, STYLE, SIZE, OR COLOR.

CLASS 9—ELECTRICAL AND SCIENTIFIC APPARATUS

FOR PROTECTIVE WORK GLOVES; PROTECTIVE CLOTHING (U.S. CLS. 21, 23, 26, 36 AND 38).

CLASS 25—CLOTHING

FOR RAIN BOOTS; RAIN COATS; RAIN JACKETS; RAIN SLICKERS; RAIN TROUSERS (U.S. CLS. 22 AND 39).

DAVID C. REIHNER, EXAMINING ATTORNEY

SN 77-142,819. XEROX CORPORATION, STAMFORD, CT. FILED 3-28-2007.

SN 77-142,895. CHASIN' TAIL RANCH, LLC, HARTFORD, SD. FILED 3-28-2007.

TRANSIENT DOCUMENT

Chasin' Tail

THE MARK CONSISTS OF STANDARD CHARACTERS WITHOUT CLAIM TO ANY PARTICULAR FONT, STYLE, SIZE, OR COLOR.

THE MARK CONSISTS OF STANDARD CHARACTERS WITHOUT CLAIM TO ANY PARTICULAR FONT, STYLE, SIZE, OR COLOR.

NO CLAIM IS MADE TO THE EXCLUSIVE RIGHT TO USE "DOCUMENT", APART FROM THE MARK AS SHOWN.

CLASS 41—EDUCATION AND ENTERTAINMENT

FOR HORSE TRAINING (U.S. CLS. 100, 101 AND 107).

CLASS 2—PAINTS

FOR COPYING INKS, DRY INKS, THERMOCHROMIC PRINTING INKS, THERMOGRAPHIC INKS, TYPOGRAPHIC INKS, TONER (U.S. CLS. 6, 11 AND 16).

CLASS 44—MEDICAL, BEAUTY AND AGRICULTURAL SERVICES

FOR HORSE BREEDING AND STUD SERVICES (U.S. CLS. 100 AND 101).

ALEX KEAM, EXAMINING ATTORNEY

CLASS 16—PAPER GOODS AND PRINTED MATTER

FOR PAPER, PRINTING PAPER, COPYING PAPER, COATED PAPER, RECYCLED PAPER, DUPLICATING PAPER (U.S. CLS. 2, 5, 22, 23, 29, 37, 38 AND 50).

ANDREW RHIM, EXAMINING ATTORNEY

SN 77-142,933. CHASIN' TAIL RANCH, LLC, HARTFORD, SD. FILED 3-28-2007.



THE MARK CONSISTS OF THE WORDS AND THE OUTLINE OF A HORSE.

CLASS 41—EDUCATION AND ENTERTAINMENT

FOR HORSE TRAINING (U.S. CLS. 100, 101 AND 107).

CLASS 44—MEDICAL, BEAUTY AND AGRICULTURAL SERVICES

FOR HORSE BREEDING AND STUD SERVICES (U.S. CLS. 100 AND 101).

ALEX KEAM, EXAMINING ATTORNEY

SN 77-142,846. INGENEUS INC., BELIZE CITY, BELIZE, FILED 3-28-2007.

SPITKIT

THE MARK CONSISTS OF STANDARD CHARACTERS WITHOUT CLAIM TO ANY PARTICULAR FONT, STYLE, SIZE, OR COLOR.

PRIORITY CLAIMED UNDER SEC. 44(D) ON BELIZE APPLICATION NO. 4114.06, FILED 9-28-2006, REG. NO. 4114.06, DATED 1-29-2007, EXPIRES 9-28-2016.

CLASS 1—CHEMICALS

FOR TEST KITS COMPRISING DIAGNOSTIC REAGENTS, PROCESSING CHEMICALS, SAMPLE COLLECTION DEVICES AND CONTAINERS FOR SCIENTIFIC OR RESEARCH USE (U.S. CLS. 1, 5, 6, 10, 26 AND 46).

SN 77-143,039. BLINDS BY NOON, SHUTTERS REAL SOON, SUWANEE, GA. FILED 3-28-2007.

CLASS 5—PHARMACEUTICALS

FOR TEST KITS COMPRISING DIAGNOSTIC REAGENTS, PROCESSING CHEMICALS, SAMPLE COLLECTION DEVICES AND CONTAINERS FOR CLINICAL OR MEDICAL LABORATORY USE (U.S. CLS. 6, 18, 44, 46, 51 AND 52).

MATTHEW PAPPAS, EXAMINING ATTORNEY

SELECTVIEW

THE MARK CONSISTS OF STANDARD CHARACTERS WITHOUT CLAIM TO ANY PARTICULAR FONT, STYLE, SIZE, OR COLOR.

CLASS 19—NON-METALLIC BUILDING MATERIALS

FOR INTERIOR NON-METAL WINDOW SHUTTERS, NON-METAL EXTERIOR BUILDING SHUTTERS, NON-METAL ROLL SHUTTERS (U.S. CLS. 1, 12, 33 AND 50).
FIRST USE 3-22-2007; IN COMMERCE 3-22-2007.

CLASS 20—FURNITURE AND ARTICLES NOT OTHERWISE CLASSIFIED

FOR WINDOW BLINDS, WINDOW SHADES (U.S. CLS. 2, 13, 22, 25, 32 AND 50).
FIRST USE 3-22-2007; IN COMMERCE 3-22-2007.
NATALIE POLZER, EXAMINING ATTORNEY

SN 77-143,050. IAMEDIA, INC., MISSOULA, MT. FILED 3-28-2007.

BEING OF SERVICE

THE MARK CONSISTS OF STANDARD CHARACTERS WITHOUT CLAIM TO ANY PARTICULAR FONT, STYLE, SIZE, OR COLOR.

CLASS 14—JEWELRY

FOR JEWELRY (U.S. CLS. 2, 27, 28 AND 50).

CLASS 16—PAPER GOODS AND PRINTED MATTER

FOR BLANK JOURNAL BOOKS; BLANK WRITING JOURNALS; NOTE PAD HOLDERS; NOTE PADS; ADHESIVE NOTE PADS; NOTE CARDS; POSTERS; PRINTS; STICKERS; DECALS; SCHOOL SUPPLY KITS CONTAINING VARIOUS COMBINATIONS OF SELECTED SCHOOL SUPPLIES, NAMELY, WRITING INSTRUMENTS, PENS, PENCILS, MECHANICAL PENCILS, ERASERS, MARKERS, CRAYONS, HIGHLIGHTERS, FOLDERS, NOTEBOOKS, PAPER, GRADUATED RULERS, PROTRACTORS, PAPER CLIPS, PENCIL SHARPENERS, WRITING GRIPS, GLUE AND BOOK MARKS; SCHOOL WRITING BOOKS; BOOKMARKS; WIRE-BOUND NOTEBOOKS; LETTER PAPER (U.S. CLS. 2, 5, 22, 23, 29, 37, 38 AND 50).
ALICE SUE CARRUTHERS, EXAMINING ATTORNEY

SN 77-143,126. NANOLIFE HOLDINGS, SARL, GENEVE, SWITZERLAND, FILED 3-28-2007.

NANOLIFE

THE MARK CONSISTS OF STANDARD CHARACTERS WITHOUT CLAIM TO ANY PARTICULAR FONT, STYLE, SIZE, OR COLOR.

CLASS 10—MEDICAL APPARATUS

FOR DIAGNOSTIC APPARATUS FOR MEDICAL USE, NAMELY, ELECTROMAGNETIC MEDICAL DIAGNOSTIC IMAGING APPARATUS, MRI DIAGNOSTIC APPARATUS, ULTRASONIC MEDICAL DIAGNOSTIC APPARATUS AND X-RAY DIAGNOSTIC APPARATUS; RADIOLOGICAL APPARATUS FOR MEDICAL PURPOSES (U.S. CLS. 26, 39 AND 44).

CLASS 41—EDUCATION AND ENTERTAINMENT

FOR EDUCATIONAL SERVICES, NAMELY, PROVIDING MEDICAL SCHOOL LECTURES AND COURSES, PROVIDING PHARMACY SCHOOL LECTURES AND COURSES; MEDICAL TRAINING AND TEACHING; ORGANIZATION OF CONFERENCES AND SYMPOSIA IN THE FIELD OF MEDICAL SCIENCE; PROVIDING CONTINUING MEDICAL EDUCATION COURSES FOR PHYSICIANS AND HEALTH CARE PROFESSIONALS; COORDINATING AND PROVIDING SPEAKERS AND LECTURERS IN THE FIELDS OF CANCER PREVENTION, DIAGNOSIS AND TREATMENT; ORGANIZATION OF SEMINARS, WORKING GROUPS, RESEARCH GROUPS AND CONVENTIONS IN THE FIELD OF MEDICINE; AND PUBLISHING AND ISSUING SCIENTIFIC PAPERS IN RELATION TO MEDICAL TECHNOLOGY (U.S. CLS. 100, 101 AND 107).

CLASS 42—SCIENTIFIC, COMPUTER AND LEGAL SERVICES

FOR MEDICAL AND SCIENTIFIC RESEARCH SERVICES IN THE FIELD OF CANCER TREATMENT AND DIAGNOSIS; PROVIDING INFORMATION ON THE SUBJECT OF CANCER TREATMENT AND DIAGNOSIS; DESIGNING AND CONDUCTING CLINICAL RESEARCH AND CLINICAL TRIALS IN THE FIELD OF CANCER TREATMENT AND DIAGNOSIS; PHARMACEUTICAL RESEARCH AND DEVELOPMENT; TESTING OR RESEARCH ON MEDICAL MACHINES, APPARATUS AND INSTRUMENTS; COMPUTER PROGRAMMING IN THE MEDICAL FIELD; MEDICAL LABORATORIES; SCIENTIFIC INVESTIGATIONS FOR MEDICAL PURPOSES; RESEARCH, ANALYSIS, AND DEVELOPMENT OF NEW TECHNOLOGY FOR OTHERS IN THE FIELD OF NANOTECHNOLOGY AND ANTIMATTER (U.S. CLS. 100 AND 101).

CLASS 44—MEDICAL, BEAUTY AND AGRICULTURAL SERVICES

FOR MEDICAL AND HOSPITAL SERVICES, NAMELY, PREVENTING, DIAGNOSING AND TREATING CANCER, RADIOLOGICAL SERVICES, ONCOLOGY SERVICES; MEDICAL CLINICS; OUTPATIENT TREATMENT; MEDICAL SERVICES, NAMELY PATIENT EVALUATION AND DIAGNOSTICS; MEDICAL SERVICES, NAMELY PATIENT CONSULTATION AND COUNSELING; HEALTHCARE SERVICES, NAMELY, HEALTH MAINTENANCE, HEALTHCARE INFORMATION SERVICES, MEDICAL TESTING, WELLNESS SERVICES, MEDICAL IMAGING, PREVENTIVE HEALTH CARE AND FOLLOW UP (U.S. CLS. 100 AND 101).
COLLEEN KEARNEY, EXAMINING ATTORNEY

SN 77-143,385. NAN YANG FABRIC CO., LTD, AMBOL KHOA-YOI, THAILAND, FILED 3-29-2007.

SN 77-143,495. UNIVERSAL TRADEMARKS, CORP., ZONA LIBRE DE PANAMA, PANAMA, FILED 3-29-2007.

CAREPLUS

THE MARK CONSISTS OF STANDARD CHARACTERS WITHOUT CLAIM TO ANY PARTICULAR FONT, STYLE, SIZE, OR COLOR.

CLASS 24—FABRICS

FOR TEXTILE USED AS LINING FOR CLOTHING; COTTON BASE MIXED FABRICS; COTTON FABRIC; JERSEY FABRICS FOR CLOTHING; KNITTED FABRICS; KNITTED FABRICS OF COTTON YARN; SEMI-SYNTHETIC FIBER FABRICS; SYNTHETIC FIBER FABRICS; WOVEN FABRICS (U.S. CLS. 42 AND 50).

CLASS 25—CLOTHING

FOR CAPS; HATS; HEADBANDS; JACKETS; KNIT SHIRTS; NON-DISPOSABLE CLOTH TRAINING PANTS; PANTS; SHIRTS; SHORT-SLEEVED OR LONG-SLEEVED T-SHIRTS; T-SHIRTS; UNDERCLOTHES; UNDERPANTS; UNDERSHIRTS (U.S. CLS. 22 AND 39).

JOHN HWANG, EXAMINING ATTORNEY

SN 77-143,401. PMI NUTRITION INTERNATIONAL, LLC, SHOREVIEW, MN. FILED 3-29-2007.

PRILIEVE

THE MARK CONSISTS OF STANDARD CHARACTERS WITHOUT CLAIM TO ANY PARTICULAR FONT, STYLE, SIZE, OR COLOR.

CLASS 5—PHARMACEUTICALS

FOR MEDICATED ANIMAL FEED (U.S. CLS. 6, 18, 44, 46, 51 AND 52).

CLASS 31—NATURAL AGRICULTURAL PRODUCTS

FOR ANIMAL FEED (U.S. CLS. 1 AND 46).
ALICE BENMAMAN, EXAMINING ATTORNEY

CAPATAZ

THE MARK CONSISTS OF STANDARD CHARACTERS WITHOUT CLAIM TO ANY PARTICULAR FONT, STYLE, SIZE, OR COLOR.

THE FOREIGN WORDING IN THE MARK TRANSLATES INTO ENGLISH AS "FOREMAN."

CLASS 32—LIGHT BEVERAGES

FOR NON-ALCOHOLIC RUM FLAVORED BEVERAGE (U.S. CLS. 45, 46 AND 48).

CLASS 33—WINES AND SPIRITS

FOR RUM (U.S. CLS. 47 AND 49).
THEODORE MCBRIDE, EXAMINING ATTORNEY

SN 77-143,498. BRENNARD, JIM, BRENTWOOD, TN. FILED 3-29-2007.



NO CLAIM IS MADE TO THE EXCLUSIVE RIGHT TO USE "FOR ALL YOUR PET NEEDS", APART FROM THE MARK AS SHOWN.

THE COLOR(S) PURPLE, LIGHT PURPLE, ORANGE, RED, WHITE, GRAY, BLACK, LIGHT PEACH AND LIGHT BROWN IS/ARE CLAIMED AS A FEATURE OF THE MARK.

THE MARK CONSISTS OF AN ANIMATED VETERINARIAN HOLDING A PUPPY; BOTH ARE ENCLOSED IN A CIRCLE. NEITHER IS IN LIKENESS OF A LIVING PERSON OR PET. SKIN COLOR IS LIGHT PEACH, GRAY HAIR, AND WEARS A WHITE LAB COAT, A WHITE TIE, AND A GRAY SHIRT. THE PUPPY IS LIGHT BROWN. BLACK IS USED TO OUTLINE AND SHADOW. THE BACKGROUND BEHIND THE VET IS ORANGE WITH "DOC BOB" IN RED OUTLINED IN WHITE. THE OUTER RIM OF THE CIRCLE IS PURPLE WITH THE WORDS "FOR ALL YOUR PET NEEDS" IN A LIGHTER SHADE OF PURPLE REPEATED 3 TIMES AROUND THE CIRCLE.

CLASS 20—FURNITURE AND ARTICLES NOT OTHERWISE CLASSIFIED

FOR BEDS FOR HOUSEHOLD PETS (U.S. CLS. 2, 13, 22, 25, 32 AND 50).

CLASS 21—HOUSEWARES AND GLASS

FOR CAGES FOR PETS (U.S. CLS. 2, 13, 23, 29, 30, 33, 40 AND 50).
 IRA J. GOODSAD, EXAMINING ATTORNEY

CLASS 41—EDUCATION AND ENTERTAINMENT

FOR EDUCATIONAL SERVICES, NAMELY COURSES, SEMINARS AND CONFERENCES ON THE SUBJECT OF SPECIFIC FINANCIAL TECHNIQUES, PRODUCTS AND PROCEDURES FOR RETIREMENT INCOME RISK PLANNING AND MANAGEMENT AND HEALTH RISK FINANCING, AND DISTRIBUTING COURSE MATERIALS IN CONNECTION THEREWITH (U.S. CLS. 100, 101 AND 107).
 ALICE BENMAMAN, EXAMINING ATTORNEY

SN 77-143,615. ROLLING FILMS, L.L.C., AUSTIN, TX. FILED 3-29-2007.

ROLLING FILMS

THE MARK CONSISTS OF STANDARD CHARACTERS WITHOUT CLAIM TO ANY PARTICULAR FONT, STYLE, SIZE, OR COLOR.
 NO CLAIM IS MADE TO THE EXCLUSIVE RIGHT TO USE "FILMS", APART FROM THE MARK AS SHOWN.

SN 77-143,734. GEODYNAMICS, INC., MILLSAP, TX. FILED 3-29-2007.

CONNEX

THE MARK CONSISTS OF STANDARD CHARACTERS WITHOUT CLAIM TO ANY PARTICULAR FONT, STYLE, SIZE, OR COLOR.

CLASS 9—ELECTRICAL AND SCIENTIFIC APPARATUS

FOR CINEMATOGRAPHIC FILMS ACTION, ADVENTURE, DRAMA, FAMILY AND OTHER STORIES; MOTION PICTURE FILMS ABOUT ACTION, ADVENTURE, DRAMA, FAMILY AND OTHER STORIES (U.S. CLS. 21, 23, 26, 36 AND 38).

CLASS 13—FIREARMS

FOR PERFORATING EQUIPMENT FOR USE IN WELLS, NAMELY, EXPLOSIVE EQUIPMENT FOR COMPLETING OIL AND GAS WELLS, NAMELY FRACTURING CHARGES AND SHAPED CHARGES FOR PERFORATING GUNS (U.S. CLS. 2 AND 9).

CLASS 41—EDUCATION AND ENTERTAINMENT

FOR MOTION PICTURE FILM PRODUCTION (U.S. CLS. 100, 101 AND 107).
 ESTHER A. BORSUK, EXAMINING ATTORNEY

CLASS 40—MATERIAL TREATMENT

FOR OIL WELL PROSPECTING, NAMELY, THE USE OF EXPLOSIVE PERFORATING EQUIPMENT FOR COMPLETING OIL AND GAS WELLS (U.S. CLS. 100, 103 AND 106).
 GIANCARLO CASTRO, EXAMINING ATTORNEY

SN 77-143,702. JAMES VALENTINO LLC, NEW YORK, NY. FILED 3-29-2007.

Can you afford the rest of your life?

SN 77-143,892. GEOFRESH MARKETING, LLC, FRESNO, CA. FILED 3-29-2007.

THE MARK CONSISTS OF STANDARD CHARACTERS WITHOUT CLAIM TO ANY PARTICULAR FONT, STYLE, SIZE, OR COLOR.

GeoFresh

CLASS 16—PAPER GOODS AND PRINTED MATTER

FOR A SERIES OF BOOKS, WRITTEN ARTICLES, HANDOUTS, WORKSHEETS, MANUALS, AND BROCHURES ON THE SUBJECT OF SPECIFIC FINANCIAL TECHNIQUES, PRODUCTS, AND PROCEDURES FOR RETIREMENT INCOME PLANNING AND MANAGEMENT AND HEALTH RISK FINANCING (U.S. CLS. 2, 5, 22, 23, 29, 37, 38 AND 50).

THE MARK CONSISTS OF STANDARD CHARACTERS WITHOUT CLAIM TO ANY PARTICULAR FONT, STYLE, SIZE, OR COLOR.

CLASS 29—MEATS AND PROCESSED FOODS

FOR DRIED MEAT; DRIED VEGETABLES; FOOD PACKAGE COMBINATIONS CONSISTING PRIMARILY OF CHEESE, MEAT AND/OR PROCESSED FRUIT; FREEZE-DRIED TOFU PIECES (KOHRI-DOFU); FROZEN FRUITS; FRUIT AND SOY BASED SNACK FOOD; FRUIT AND VEGETABLE SALADS; FRUIT CHIPS; FRUIT CONSERVES; FRUIT LEATHERS; FRUIT PASTE; FRUIT PECTIN; FRUIT PEELS; FRUIT PRESERVES; FRUIT PULPS; FRUIT RINDS; FRUIT SALADS; FRUIT TOPPING; FRUIT-BASED FOOD BEVERAGE; FRUIT-BASED SNACK FOOD; FRUIT-BASED SPREADS; FRUITS PRESERVED IN ALCOHOL; GLAZED FRUITS; PICKLED FRUITS; PRESERVED, DRIED AND COOKED OLIVES; PRESERVED, DRIED, COOKED AND GRILLED VEGETABLES; PROCESSED FRUIT- AND NUT-BASED FOOD BARS; PROCESSED FRUITS; PROCESSED VEGETABLES AND FRUITS; SHEETS OF DRIED LAVER (HOSHI-NORI); SLICED FRUITS; CANNED OR BOTTLED VEGETABLES; FROZEN VEGETABLES; PICKLED VEGETABLES; PRE-CUT VEGETABLE SALAD; PRESERVED VEGETABLES IN OIL; PROCESSED GARLIC; PROCESSED GINSENG FOR USE AS A VEGETABLE; PROCESSED VEGETABLES; SLICED VEGETABLES; UNFORMED TEXTURED VEGETABLE PROTEIN FOR USE AS A MEAT EXTENDER; VEGETABLE CHIPS; VEGETABLE JUICE FOR COOKING; VEGETABLE MOUSSE; VEGETABLE OILS; VEGETABLE OILS AND FATS; VEGETABLE PASTE; VEGETABLE PROTEIN BITS HAVING A BACON FLAVOR; VEGETABLE PUREE; VEGETABLE SALADS (U.S. CL. 46).

CLASS 30—STAPLE FOODS

FOR DOUGH-BASED POCKETS WITH FILLING CONSISTING PRIMARILY OF MEATS, POULTRY, FISH, FRUITS AND VEGETABLES AND CHEESE; FRUIT CAKES; FRUIT COBBLERS; FRUIT COULI; FRUIT FLAVOURINGS, EXCEPT ESSENCES; FRUIT ICE; FRUIT ICE BAR; FRUIT ICES; FRUIT PIES; FRUIT TEAS; FRUIT TURNOVERS; TEA-BASED BEVERAGES WITH FRUIT FLAVORING; UNPOPPED POPCORN (U.S. CL. 46).

CLASS 31—NATURAL AGRICULTURAL PRODUCTS

FOR FRESH ANCHOVIES; FRESH APPLES; FRESH APRICOTS; FRESH ARTICHOKE; FRESH ASPARAGUS; FRESH AVOCADOS; FRESH BANANAS; FRESH BEAN SPROUTS; FRESH BEANS; FRESH BEETS; FRESH BLUEBERRIES; FRESH CABBAGE; FRESH COCONUTS; FRESH CORN; FRESH CUT GARLANDS; FRESH DATES; FRESH FRUITS; FRESH GARLIC; FRESH GINGER; FRESH HERBS; FRESH LEMONS; FRESH MANGOS; FRESH MUSHROOMS; FRESH NUTS; FRESH OATS; FRESH OLIVES; FRESH ONIONS; FRESH ORANGES; FRESH PAPAYAS; FRESH PEACHES; FRESH PEPPERS; FRESH POTATOES; FRESH QUINCE; FRESH SWEET POTATOES; FRESH TOMATOES; FRESH TRUFFLES; FRESH VEGETABLES; FRESH WHEAT; FRESH YAMS; FRESH ZUCCHINI; YOUNG FRESH SOYBEANS IN THE POD (EDA-MAME); DRIED CORN HUSKS; DRIED FLOWER ARRANGEMENTS; FRUIT SEEDS; LIVING FRUIT PLANTS; RAW FRUITS; SEEDS FOR FRUIT AND VEGETABLES; UNPROCESSED FRUITS (U.S. CLS. 1 AND 46).

CLASS 32—LIGHT BEVERAGES

FOR AERATED FRUIT JUICES; FROZEN FRUIT BEVERAGES; FROZEN FRUIT-BASED BEVERAGES; FRUIT BEVERAGES; FRUIT DRINKS; FRUIT FLAVORED SOFT DRINKS; FRUIT JUICE BASES; FRUIT JUICE CONCENTRATES; FRUIT JUICES; FRUIT NECTARS; FRUIT PUNCH; FRUIT-BASED SOFT DRINKS FLAVORED WITH TEA; FRUIT-FLAVORED BEVERAGES; FRUIT-FLAVORED DRINKS; FRUIT-FLAVORED BEVERAGES; ICED FRUIT BEVERAGES; NON-ALCOHOLIC BEVERAGES CONTAINING FRUIT JUICES; NON-ALCOHOLIC FRUIT EXTRACTS USED IN THE PREPARATION OF BEVERAGES; NON-ALCOHOLIC FRUIT JUICE BEVERAGES (U.S. CLS. 45, 46 AND 48).

AMEETA JORDAN, EXAMINING ATTORNEY

SN 77-143,966. THE INTREPID WINE COMPANY INC., BRIDGEHAMPTON, NY. FILED 3-29-2007.

THE INTREPID WINE COMPANY

THE MARK CONSISTS OF STANDARD CHARACTERS WITHOUT CLAIM TO ANY PARTICULAR FONT, STYLE, SIZE, OR COLOR.

NO CLAIM IS MADE TO THE EXCLUSIVE RIGHT TO USE "WINE COMPANY", APART FROM THE MARK AS SHOWN.

CLASS 29—MEATS AND PROCESSED FOODS

FOR CHEESE; OLIVE OIL (U.S. CL. 46).

CLASS 33—WINES AND SPIRITS

FOR WINE; GRAPPA; COOKING WINE; APERITIF WINES; APERITIFS; APERITIFS WITH A WINE BASE (U.S. CLS. 47 AND 49).

SCOTT SISUN, EXAMINING ATTORNEY

SN 77-144,045. VIASYS HEALTHCARE GMBH, CONSHOHOCKEN, PA. FILED 3-29-2007.

CORSCREEN

THE MARK CONSISTS OF STANDARD CHARACTERS WITHOUT CLAIM TO ANY PARTICULAR FONT, STYLE, SIZE, OR COLOR.

CLASS 9—ELECTRICAL AND SCIENTIFIC APPARATUS

FOR COMPUTER HARDWARE AND COMPUTER SOFTWARE FOR MEASURING, EVALUATING, VISUALIZING AND GENERATING THE ELECTRICAL AND ELECTRONIC SIGNALS AND DATA OUTPUT OF MEDICAL APPARATUS, NAMELY, AN ELECTROCARDIOGRAM (ECG) MACHINE (U.S. CLS. 21, 23, 26, 36 AND 38).

CLASS 10—MEDICAL APPARATUS

FOR MEDICAL APPARATUS AND INSTRUMENTS FOR MEASURING, EVALUATING AND VISUALIZING THE ELECTRICAL AND ELECTRONIC SIGNALS AND DATA OUTPUT OF A PHYSIOLOGICAL SYSTEM, NAMELY, ELECTROCARDIOGRAM (ECG) AND STRESS SCREENING MONITORS AND MACHINES (U.S. CLS. 26, 39 AND 44).

MARY CRAWFORD, EXAMINING ATTORNEY

SN 77-144,074. SIGNUM INTERNATIONAL S.A.R.L., LUXEMBOURG, LUXEMBOURG, FILED 3-29-2007.

SN 77-144,112. SPECIALTY NUTRITION PRODUCTS, LLC, BOCA RATON, FL. FILED 3-29-2007.



OWNER OF U.S. REG. NOS. 2,051,783, 2,931,518 AND OTHERS.

NO CLAIM IS MADE TO THE EXCLUSIVE RIGHT TO USE "BABY", APART FROM THE MARK AS SHOWN.

THE MARK CONSISTS OF THE LETTERS EF IN A STYLIZED FONT WITHIN A BLACK RECTANGLE AND FILLED IN WITH A SWIRL DESIGN, NEXT TO THE WORDS BABY GENIUS IN A STYLIZED FONT.

CLASS 35—ADVERTISING AND BUSINESS

FOR PERSONNEL PLACEMENT AND RECRUITMENT SERVICES, NAMELY, RECRUITING, SCREENING, EVALUATING AND PLACING CANDIDATES FOR THE EDUCATIONAL INSTITUTIONS OF OTHERS (U.S. CLS. 100, 101 AND 102).

CLASS 41—EDUCATION AND ENTERTAINMENT

FOR LANGUAGE INSTRUCTION; TEACHING AND TRAINING SERVICES IN THE FIELD OF CHILDREN'S LANGUAGE EDUCATIONAL SERVICES THROUGH PLAY GROUPS (U.S. CLS. 100, 101 AND 107).

JORDAN BAKER, EXAMINING ATTORNEY

SN 77-144,102. JEEN INTERNATIONAL CORPORATION, FAIRFIELD, NJ. FILED 3-29-2007.

JEEPLEX

THE MARK CONSISTS OF STANDARD CHARACTERS WITHOUT CLAIM TO ANY PARTICULAR FONT, STYLE, SIZE, OR COLOR.

CLASS 3—COSMETICS AND CLEANING PREPARATIONS

FOR NON-MEDICATED SKIN CARE PREPARATIONS (U.S. CLS. 1, 4, 6, 50, 51 AND 52).

FIRST USE 10-21-1999; IN COMMERCE 10-21-1999.

CLASS 5—PHARMACEUTICALS

FOR VITAMINS AND ANTI-OXIDANTS USED IN THE MANUFACTURE OF PERSONAL CARE, COSMETIC AND PHARMACEUTICAL PRODUCTS (U.S. CLS. 6, 18, 44, 46, 51 AND 52).

FIRST USE 10-21-1999; IN COMMERCE 10-21-1999.
DANIEL CAPSHAW, EXAMINING ATTORNEY

STRONG RESEARCH

THE MARK CONSISTS OF STANDARD CHARACTERS WITHOUT CLAIM TO ANY PARTICULAR FONT, STYLE, SIZE, OR COLOR.

NO CLAIM IS MADE TO THE EXCLUSIVE RIGHT TO USE "RESEARCH", APART FROM THE MARK AS SHOWN.

CLASS 35—ADVERTISING AND BUSINESS

FOR WHOLESALE DISTRIBUTORSHIPS FEATURING DIETARY AND NUTRITIONAL SUPPLEMENTS, VITAMINS, HEALTH FOODS, SPORTS NUTRITION PRODUCTS, FITNESS PRODUCTS AND APPAREL, COSMETICS, BODY CARE, DIAGNOSTIC EXERCISE AND AROMATHERAPY PRODUCTS; ON-LINE RETAIL STORE SERVICES FEATURING DIETARY AND NUTRITIONAL SUPPLEMENTS, VITAMINS, HEALTH FOODS, SPORTS NUTRITION PRODUCTS, FITNESS PRODUCTS AND APPAREL, COSMETICS, BODY CARE, DIAGNOSTIC EXERCISE AND AROMATHERAPY PRODUCTS; PROVIDING CONSUMER INFORMATION IN THE FIELD OF HEALTH, FITNESS, NUTRITION AND DIETARY SUPPLEMENTS (U.S. CLS. 100, 101 AND 102).

CLASS 41—EDUCATION AND ENTERTAINMENT

FOR PROVIDING NEWSLETTERS IN THE FIELD OF HEALTH, FITNESS, NUTRITION AND DIETARY SUPPLEMENTS VIA E-MAIL (U.S. CLS. 100, 101 AND 107).

MARGERY A. TIERNEY, EXAMINING ATTORNEY

SN 77-144,335. WOODWARD, DAVID, JUNCTION CITY, KS. FILED 3-29-2007.

EVER

CLASS 35—ADVERTISING AND BUSINESS

FOR RETAIL CONVENIENCE STORES (U.S. CLS. 100, 101 AND 102).

CLASS 37—CONSTRUCTION AND REPAIR

FOR CAR WASHING; VEHICLE SERVICE STATIONS (U.S. CLS. 100, 103 AND 106).

BERYL GARDNER, EXAMINING ATTORNEY

SN 77-144,536. TACO BELL CORP., IRVINE, CA. FILED 3-30-2007.



OWNER OF U.S. REG. NOS. 2,105,501, 2,816,454 AND OTHERS.

NO CLAIM IS MADE TO THE EXCLUSIVE RIGHT TO USE "TACO", APART FROM THE MARK AS SHOWN.

THE MARK CONSISTS OF THE WORDS TACO BELL UNDER SUN RAYS AND BELL DESIGN.

CLASS 30—STAPLE FOODS

FOR TACOS, TOSTADAS, BURRITOS, TORTILLAS, PREPARED FRIED FLOUR TORTILLA CONFECTIONS, AND BURRITOS CONSISTING OF EGGS, BACON, SAUSAGE, SEASONED GROUND BEEF, CHEESE, POTATOES, ONIONS, BELL PEPPERS, JALAPENOS, TOMATOES, GUACAMOLE, AND/OR SALSA FOR CONSUMPTION ON OR OFF THE PREMISES (U.S. CL. 46).

FIRST USE 3-15-2007; IN COMMERCE 3-15-2007.

CLASS 43—HOTEL AND RESTAURANT SERVICES

FOR RESTAURANT SERVICES (U.S. CLS. 100 AND 101).

FIRST USE 3-15-2007; IN COMMERCE 3-15-2007.

KARANENDRA S. CHHINA, EXAMINING ATTORNEY

SN 77-144,977. GLAXO GROUP LIMITED, GREENFORD, MIDDLESEX, UNITED KINGDOM, FILED 3-30-2007.

ARE YOU LOSING IT?

THE MARK CONSISTS OF STANDARD CHARACTERS WITHOUT CLAIM TO ANY PARTICULAR FONT, STYLE, SIZE, OR COLOR.

CLASS 41—EDUCATION AND ENTERTAINMENT

FOR PROVIDING INFORMATION IN THE FIELD OF PHYSICAL FITNESS (U.S. CLS. 100, 101 AND 107).

CLASS 44—MEDICAL, BEAUTY AND AGRICULTURAL SERVICES

FOR PROVIDING INFORMATION IN THE FIELD OF WEIGHT LOSS AND NUTRITION (U.S. CLS. 100 AND 101).

COLLEEN KEARNEY, EXAMINING ATTORNEY

SN 77-145,027. HYPERTRONICS CORPORATION, HUDSON, MA. FILED 3-30-2007.



THE MARK CONSISTS OF ECONNEK FITS YOUR DESIGN, FITS YOUR SCHEDULE AND MISCELLANEOUS DESIGN.

CLASS 35—ADVERTISING AND BUSINESS

FOR BUSINESS MARKETING SERVICES FOR OTHERS; DISTRIBUTORSHIP SERVICES FEATURING ELECTRO-MECHANICAL GOODS, NAMELY, CABLES AND CONNECTORS (U.S. CLS. 100, 101 AND 102).

CLASS 40—MATERIAL TREATMENT

FOR CUSTOM MANUFACTURE FOR OTHERS OF ELECTRO-MECHANICAL GOODS, NAMELY, CABLES AND CONNECTORS (U.S. CLS. 100, 103 AND 106).

SOPHIA S. KIM, EXAMINING ATTORNEY

SN 77-145,214. JACKSON, CURTIS, NEW YORK, NY. FILED 3-30-2007.

G-UNOT

THE MARK CONSISTS OF STANDARD CHARACTERS WITHOUT CLAIM TO ANY PARTICULAR FONT, STYLE, SIZE, OR COLOR.

OWNER OF U.S. REG. NOS. 2,787,451, 2,992,615 AND 3,003,854.

CLASS 9—ELECTRICAL AND SCIENTIFIC APPARATUS

FOR MUSICAL SOUND RECORDINGS; AUDIO-VISUAL RECORDINGS, NAMELY, COMPACT DISCS, TAPE CASSETTES, AUDIO CASSETTES, AUDIO TAPES, AUDIO DISCS, RECORDS, CD-ROMS, VIDEO TAPES, VIDEO CASSETTES, VIDEO DISCS, PHONOGRAPHIC RECORDS, DVDS, DATS, MP3S, AND LASER DISCS, ALL FEATURING MUSIC; DOWNLOADABLE MUSICAL SOUND RECORDINGS; DOWNLOADABLE VIDEO RECORDINGS FEATURING MUSIC; DOWNLOADABLE TELEPHONE RING TONES FEATURING MUSIC (U.S. CLS. 21, 23, 26, 36 AND 38).

CLASS 25—CLOTHING

FOR CLOTHING, NAMELY, HATS, T-SHIRTS, JACKETS, SHIRTS, SWEATSHIRTS, SWEAT PANTS, JERSEYS, JEANS, PANTS AND SHORTS (U.S. CLS. 22 AND 39).

CLASS 41—EDUCATION AND ENTERTAINMENT

FOR ENTERTAINMENT SERVICES, NAMELY, LIVE MUSICAL PERFORMANCES, PRODUCTION OF MUSIC RECORDINGS, SHOWS AND VIDEOS FEATURING MUSICAL PERFORMANCES, MUSIC SHOWS AND EVENTS BEFORE A LIVE AUDIENCE, WHICH MAY BE BROADCAST LIVE OR RECORDED FOR LATER BROADCAST (U.S. CLS. 100, 101 AND 107).

SHANNON TWOHIG, EXAMINING ATTORNEY

SN 77-146,771. DISABOOM, INC., GREENWOOD VILLAGE, CO. FILED 4-2-2007.



THE MARK CONSISTS OF THE WORD "DISABOOM" IN LOWER CASE, SERIF TYPE WITH AN ELLIPTICAL SPIRAL WRAPPING AROUND THE STEM OF THE "B".

CLASS 35—ADVERTISING AND BUSINESS

FOR PROVIDING CONSUMER INFORMATION IN THE FIELD OF PERSONAL CARE AND HEALTH CARE PRODUCTS; ADVERTISING SERVICES, NAMELY PROVIDING ADVERTISING SPACE ON A WEBSITE; ASSOCIATION SERVICES, NAMELY, PROMOTING THE INTERESTS OF PERSONS WITH DISABILITIES; PROVIDING CONSUMER INFORMATION FOR CONSUMERS WITH DISABILITIES; DISPLAYING ADVERTISEMENTS OF OTHERS; MARKETING SERVICES, NAMELY PROVIDING INFORMATIONAL WEB PAGES DESIGNED TO GENERATE SALES TRAFFIC VIA ADVERTISEMENTS AND HYPERLINKS TO OTHER WEB SITES; PROMOTING THE GOODS AND SERVICES OF OTHERS BY PROVIDING ADVERTISING WITH HYPERTEXT LINKS TO WEBSITES OF OTHERS; PROVIDING AND RENTAL OF ADVERTISING SPACE; PROVIDING CONSUMER PRODUCT INFORMATION; PROVIDING ONLINE DIRECTORY INFORMATION SERVICES ALSO FEATURING HYPERLINKS TO OTHER WEB SITES; PROMOTING THE GOODS AND SERVICES OF OTHERS BY MEANS OF OPERATING AN ONLINE SHOPPING MALL WITH LINKS TO THE RETAIL WEB SITES OF OTHERS; PROVIDING AN ONLINE DIRECTORY INFORMATION SERVICES FEATURING INFORMATION TO HELP LOCATE PEOPLE, PLACES, ORGANIZATIONS, NAMELY, PHONE NUMBERS, HOME PAGES, AND ELECTRONIC EMAIL ADDRESSES; PROVIDING AN ONLINE PRODUCT DEMONSTRATION THROUGH A VIRTUAL PRODUCT EXPO; PROMOTING THE GOODS AND SERVICES OF OTHERS THROUGH ONLINE ORDERING AND CATALOGING OF THOSE GOODS AND SERVICES; PROVIDING A WEB SITE WHERE USERS CAN POST RATINGS, REVIEWS AND RECOMMENDATIONS ON PRODUCTS AND SERVICES FOR PEOPLE WITH DISABILITIES; PROVIDING A WEB SITE WHERE USERS CAN POST RATINGS, REVIEWS AND RECOMMENDATIONS ON PRODUCTS AND SERVICES; PROVIDING A WEB SITE THAT ENABLES USERS TO POST ITEMS FOR SALE THROUGH ONLINE CLASSIFIED ADVERTISEMENTS (U.S. CLS. 100, 101 AND 102).

CLASS 36—INSURANCE AND FINANCIAL

FOR PROVIDING INFORMATION IN THE FIELD OF FINANCIAL MANAGEMENT (U.S. CLS. 100, 101 AND 102).

CLASS 38—COMMUNICATION

FOR PROVIDING ONLINE CHAT ROOMS AND ELECTRONIC BULLETIN BOARDS FOR TRANSMISSION OF MESSAGES AMONG COMPUTER USERS CONCERNING TOPICS OF INTEREST TO PERSONS WITH DISABILITIES AND THEIR FAMILY MEMBERS; PROVIDING ONLINE CHAT ROOMS AND ELECTRONIC BULLETIN BOARDS FOR TRANSMISSION OF MESSAGES AND INFORMATION CONCERNING LIFE SKILLS AND EVENTS AND ACTIVITIES FOR PERSONS WITH DISABILITIES; PROVIDING ONLINE CHAT ROOMS FOR TRANSMISSION OF MESSAGES AMONG COMPUTER USERS CONCERNING TOPICS OF GENERAL INTEREST; PROVIDING ONLINE FORUMS FOR TRANSMISSION OF MESSAGES AMONG COMPUTER USERS CONCERNING TOPICS OF INTEREST TO PERSONS WITH DISABILITIES AND THEIR FAMILY MEMBERS; PROVIDING COMPUTER BULLETIN BOARD AND MESSAGE BOARDS FOR TRANSMISSION OF MESSAGES AMONG USERS IN THE FIELD OF GENERAL INTEREST (U.S. CLS. 100, 101 AND 104).

CLASS 39—TRANSPORTATION AND STORAGE

FOR PROVIDING LINKS TO WEB SITES OF OTHERS FEATURING TRAVEL; PROVIDING INFORMATION IN THE FIELD OF TRAVEL; PROVIDING A WEB SITE WHERE USERS CAN POST RATINGS, REVIEWS AND RECOMMENDATIONS OF TRAVEL SERVICES PROVIDERS (U.S. CLS. 100 AND 105).

CLASS 41—EDUCATION AND ENTERTAINMENT

FOR PROVIDING INFORMATION IN THE FIELD OF FITNESS; PROVIDING INFORMATION IN THE FIELDS OF CURRENT EVENTS NEWS, NAMELY, NATIONAL AND INTERNATIONAL, AND ENTERTAINMENT, NAMELY, MUSIC AND SPORTS; ONLINE JOURNALS, NAMELY, BLOGS FEATURING TOPICS OF INTEREST TO PEOPLE WITH DISABILITIES, THEIR FAMILIES AND CARETAKERS; PROVIDING A WEB SITE WHERE USERS CAN POST RATINGS, REVIEWS AND RECOMMENDATIONS ON EVENTS AND ACTIVITIES IN THE FIELD OF ENTERTAINMENT; PROVIDING LINKS TO THE WEB SITES OF OTHERS FEATURING CURRENT EVENTS NEWS, SPORTS, HOROSCOPES AND REFERENCE LIBRARY MATERIALS (U.S. CLS. 100, 101 AND 107).

CLASS 42—SCIENTIFIC, COMPUTER AND LEGAL SERVICES

FOR PROVIDING RESEARCH INFORMATION IN THE FIELD OF SCIENTIFIC AND MEDICAL RESEARCH DATA; PROVIDING RESEARCH INFORMATION REGARDING CLINICAL TRIALS AND RECENT MEDICAL RESEARCH; PROVIDING LINKS TO THE WEBSITES OF OTHERS FEATURING WEATHER (U.S. CLS. 100 AND 101).

CLASS 43—HOTEL AND RESTAURANT SERVICES

FOR PROVIDING A WEB SITE WHERE USERS CAN POST RATINGS, REVIEWS AND RECOMMENDATIONS OF RESTAURANTS AND HOTELS (U.S. CLS. 100 AND 101).

CLASS 44—MEDICAL, BEAUTY AND AGRICULTURAL SERVICES

FOR PROVIDING INFORMATION IN THE FIELD OF HEALTH; PROVIDING MEDICAL INFORMATION; PROVIDING HEALTH INFORMATION; PROVIDING MEDICAL AND HEALTH INFORMATION RELATED TO DISABILITIES (U.S. CLS. 100 AND 101).

CLASS 45—PERSONAL SERVICES

FOR ONLINE SOCIAL NETWORKING SERVICES; PROVIDING INFORMATION REGARDING SUPPORT SERVICES AND SUPPORT GROUPS FOR PERSONS WITH DISABILITIES AND THEIR FAMILIES; PROVIDING ON-LINE INFORMATION IN THE FIELD OF SELF-HELP AND PERSONAL EMPOWERMENT SUBJECT MATTERS (U.S. CLS. 100 AND 101).

CHARLOTTE CORWIN, EXAMINING ATTORNEY

SN 77-146,989. AMES TRUE TEMPER PROPERTIES, INC., WILMINGTON, DE. FILED 4-3-2007.

TRUE TEMPER MASTER GARDENER SERIES

THE MARK CONSISTS OF STANDARD CHARACTERS WITHOUT CLAIM TO ANY PARTICULAR FONT, STYLE, SIZE, OR COLOR.

OWNER OF U.S. REG. NOS. 283,564, 3,101,032 AND OTHERS.

NO CLAIM IS MADE TO THE EXCLUSIVE RIGHT TO USE "MASTER GARDENER SERIES", APART FROM THE MARK AS SHOWN.

CLASS 8—HAND TOOLS

FOR MANUALLY OPERATED HAND TOOLS, NAMELY, SHOVELS, RAKES, HOES, SPADES, CULTIVATORS, FORKS, SCOOPS, FRUIT PICKERS, WEEDERS, SCRAPERS, SPOONS, EDGERS, POST HOLE DIGGERS, HOOKS, LUTES, COME-A-LONG, SOD CUTTER AND REMOVER, CONCRETE FLOATS, BULB PLANTER, HAND TROWELS, HAND SPADES, HAND CULTIVATORS, HAND WEEDERS, BULB PLANTERS, HAND TRANSPLATERS, PLANTER'S AND LANDSCAPER'S MULTI-PURPOSE TOOL AND KNIFE, PRUNERS, GRASS SHEARS, HEDGE SHEARS, LOPPERS, SAWS, POLE TREE TRIMMERS, GARDEN SCISSORS, FLORAL SHEARS, BUSH HOOKS, BANK BLADES, WEED CUTTERS, GRASS WHIPS, GRASS HOOKS, FLORAL SNIPS, BOW SAWS, FOLDING SAWS, DOUBLE-EDGE SAWS, REPLACEMENT BLADES, MACHETE CORN KNIVES, AND WEED HOOKS (U.S. CLS. 23, 28 AND 44).

CLASS 12—VEHICLES

FOR CARTS; WHEELBARROWS (U.S. CLS. 19, 21, 23, 31, 35 AND 44).

CLASS 17—RUBBER GOODS

FOR WATERING HOSES (U.S. CLS. 1, 5, 12, 13, 35 AND 50).

CLASS 21—HOUSEWARES AND GLASS

FOR POTS (U.S. CLS. 2, 13, 23, 29, 30, 33, 40 AND 50). ANNE E. GUSTASON, EXAMINING ATTORNEY

SN 77-147,068. SCJ VENDING CORP., WOODBURY, NY. FILED 4-3-2007.

BOX OF NICE

THE MARK CONSISTS OF STANDARD CHARACTERS WITHOUT CLAIM TO ANY PARTICULAR FONT, STYLE, SIZE, OR COLOR.

CLASS 16—PAPER GOODS AND PRINTED MATTER

FOR GIFT WRAPPED NOTES AND BOXES CONTAINING PRINTED WORDS OR PHRASES (U.S. CLS. 2, 5, 22, 23, 29, 37, 38 AND 50).

CLASS 35—ADVERTISING AND BUSINESS

FOR ON-LINE RETAIL STORE AND TELEPHONE RETAIL STORE SERVICES FEATURING GIFT WRAPPED NOTES AND BOXES CONTAINING PRINTED WORDS OR PHRASES (U.S. CLS. 100, 101 AND 102).

CAROLINE WOOD, EXAMINING ATTORNEY

SN 77-147,069. SONIC INNOVATIONS, INC., SALT LAKE CITY, UT. FILED 4-3-2007.

OVERDRIVE SYSTEM

THE MARK CONSISTS OF STANDARD CHARACTERS WITHOUT CLAIM TO ANY PARTICULAR FONT, STYLE, SIZE, OR COLOR.

NO CLAIM IS MADE TO THE EXCLUSIVE RIGHT TO USE "SYSTEM", APART FROM THE MARK AS SHOWN.

CLASS 9—ELECTRICAL AND SCIENTIFIC APPARATUS

FOR HEARING AID ACCESSORIES, NAMELY, COMPUTER SOFTWARE FOR PROGRAMMING HEARING AIDS AND BATTERIES (U.S. CLS. 21, 23, 26, 36 AND 38).

CLASS 10—MEDICAL APPARATUS

FOR HEARING AIDS; HEARING AID ACCESSORIES, NAMELY, CASES SPECIALLY ADAPTED FOR HEARING AIDS (U.S. CLS. 26, 39 AND 44).

JAY BESCH, EXAMINING ATTORNEY

SN 77-147,536. 4004 INCORPORATED, PORT WASHINGTON, NY. FILED 4-3-2007.

SN 77-147,629. TRADITIONAL MEDICINALS, INC., SEBASTOPOL, CA. FILED 4-3-2007.

Everyone Loves The Longball

THE MARK CONSISTS OF STANDARD CHARACTERS WITHOUT CLAIM TO ANY PARTICULAR FONT, STYLE, SIZE, OR COLOR.

CLASS 9—ELECTRICAL AND SCIENTIFIC APPARATUS

FOR SUNGLASSES (U.S. CLS. 21, 23, 26, 36 AND 38).

CLASS 18—LEATHER GOODS

FOR WALLETS, BOOKBAGS, CARRY ALL BAGS, TOTE BAGS, HANDBAGS, MESSENGER BAGS, DUFFEL BAGS, OVERNIGHT BAGS, BACKPACKS, (U.S. CLS. 1, 2, 3, 22 AND 41).

CLASS 25—CLOTHING

FOR PANTS, JEANS, SHIRTS, SKIRTS, SHORTS, DRESSES, SWEATERS, HOSIERY, JACKETS, OUTERWEAR IN THE NATURE OF PARKAS AND RAINCOATS, COATS, FOOTWEAR, HEADWEAR, GLOVES, SCARVES, SOCKS, TRACKSUITS, SWIMWEAR, BEACHWEAR, SLIPPERS, PAJAMAS, BELTS, UNDERWEAR (U.S. CLS. 22 AND 39).

JAMES MACFARLANE, EXAMINING ATTORNEY

SN 77-147,567. 4004 INCORPORATED, PORT WASHINGTON, NY. FILED 4-3-2007.

Everybody Loves The Longball

THE MARK CONSISTS OF STANDARD CHARACTERS WITHOUT CLAIM TO ANY PARTICULAR FONT, STYLE, SIZE, OR COLOR.

CLASS 9—ELECTRICAL AND SCIENTIFIC APPARATUS

FOR SUNGLASSES (U.S. CLS. 21, 23, 26, 36 AND 38).

CLASS 18—LEATHER GOODS

FOR WALLETS, BOOKBAGS, CARRY ALL BAGS, TOTE BAGS, HANDBAGS, MESSENGER BAGS, DUFFEL BAGS, OVERNIGHT BAGS, BACKPACKS, UMBRELLAS, GOLF UMBRELLAS (U.S. CLS. 1, 2, 3, 22 AND 41).

CLASS 25—CLOTHING

FOR PANTS, JEANS, SHIRTS, SKIRTS, SHORTS, DRESSES, SWEATERS, HOSIERY, JACKETS, OUTERWEAR IN THE NATURE OF PARKAS AND RAINCOATS, COATS, FOOTWEAR, HEADWEAR, GLOVES, SCARVES, SOCKS, TRACKSUITS, SWIMWEAR, BEACHWEAR, SLIPPERS, PAJAMAS, BELTS, UNDERWEAR (U.S. CLS. 22 AND 39).

JAMES MACFARLANE, EXAMINING ATTORNEY

THE CIRCLE OF GOOD INTENT

THE MARK CONSISTS OF STANDARD CHARACTERS WITHOUT CLAIM TO ANY PARTICULAR FONT, STYLE, SIZE, OR COLOR.

CLASS 5—PHARMACEUTICALS

FOR DIETARY SUPPLEMENTS; HERBAL SUPPLEMENTS; LAXATIVES; PREPARATIONS FOR TREATING COLDS; COUGH DROPS; COUGH LOZENGES; COUGH SYRUPS; COUGH TREATMENT PREPARATIONS; THROAT LOZENGES; DIURETICS (U.S. CLS. 6, 18, 44, 46, 51 AND 52).

CLASS 30—STAPLE FOODS

FOR GREEN TEA; HERB TEA; TEA; TEA BAGS; YERBA MATE (U.S. CL. 46).

CURTIS FRENCH, EXAMINING ATTORNEY

SN 77-147,998. PARK, PETE O., REDWOOD CITY, CA. FILED 4-3-2007.

Jetsetrix

THE MARK CONSISTS OF STANDARD CHARACTERS WITHOUT CLAIM TO ANY PARTICULAR FONT, STYLE, SIZE, OR COLOR.

CLASS 35—ADVERTISING AND BUSINESS

FOR PROVIDING CONSUMER INFORMATION SERVICES AND MAKING REFERRALS IN THE FIELD OF ENTERTAINMENT SERVICES FOR PRODUCTS, SERVICES, EVENTS, ACTIVITIES, FACILITIES AND LOCATIONS (U.S. CLS. 100, 101 AND 102).

FIRST USE 12-20-2006; IN COMMERCE 3-1-2007.

CLASS 41—EDUCATION AND ENTERTAINMENT

FOR ENTERTAINMENT SERVICES, NAMELY, CONDUCTING PARTIES FOR THE PURPOSE OF DATING AND SOCIAL INTRODUCTION FOR ADULTS; ENTERTAINMENT SERVICES, NAMELY, PROVIDING ONLINE REVIEWS OF VENUES, NIGHTCLUBS, BARS, LOUNGES; PROVIDING A WEB SITE WHERE USERS CAN POST RATINGS, REVIEWS AND RECOMMENDATIONS ON EVENTS AND ACTIVITIES IN THE FIELD OF ENTERTAINMENT AND EDUCATION (U.S. CLS. 100, 101 AND 107).

FIRST USE 12-20-2006; IN COMMERCE 3-1-2007.
BRIDGETT SMITH, EXAMINING ATTORNEY

SN 77-148,450. CHANG, DANIELLE, NEW YORK, NY.
FILED 4-4-2007.

SN 77-149,435. CONWEST RESOURCES, INC., SAN FRAN-
CISCO, CA. FILED 4-5-2007.

XIAO BAO

THE MARK CONSISTS OF STANDARD CHARACTERS WITHOUT CLAIM TO ANY PARTICULAR FONT, STYLE, SIZE, OR COLOR.

THE ENGLISH TRANSLATION OF XIAO BAO IS LITTLE SWEETIES OR LITTLE DARLINGS.

CLASS 9—ELECTRICAL AND SCIENTIFIC APPARATUS

FOR CHILDREN'S EDUCATIONAL MUSIC CDS AND DVDS; CHILDREN'S EDUCATIONAL SOFTWARE (U.S. CLS. 21, 23, 26, 36 AND 38).

CLASS 41—EDUCATION AND ENTERTAINMENT

FOR EDUCATION SERVICES, NAMELY, PROVIDING CLASSES, LESSONS AND PLAYGROUPS IN THE FIELDS OF CHINESE LANGUAGE AND CULTURE; EDUCATION SERVICES, NAMELY, PROVIDING LIVE AND ON-LINE CLASSES AND LESSONS IN THE FIELD OF CHINESE LANGUAGE AND CULTURE (U.S. CLS. 100, 101 AND 107).

FIRST USE 6-1-2006; IN COMMERCE 6-1-2006.
REBECCA EISINGER, EXAMINING ATTORNEY

SN 77-149,167. NEALANDERS INTERNATIONAL INC., MIS-
SISSAUGA, ONTARIO, CANADA, FILED 4-5-2007.

LOTTIE & BECK FOODS

THE MARK CONSISTS OF STANDARD CHARACTERS WITHOUT CLAIM TO ANY PARTICULAR FONT, STYLE, SIZE, OR COLOR.

NO CLAIM IS MADE TO THE EXCLUSIVE RIGHT TO USE "FOODS", APART FROM THE MARK AS SHOWN.

CLASS 29—MEATS AND PROCESSED FOODS

FOR INSTANT POTATOES, UNFLAVORED AND UNSWEETENED GELATINS, PACKAGED MAIN MEAL MIXES HAVING A POTATO BASE WITH SPICE AND/OR SAUCE MIXES SOLD AS A UNIT (U.S. CL. 46).

CLASS 30—STAPLE FOODS

FOR INSTANT CAPPUCCINO, FLAVORED AND SWEETENED GELATINS, PUDDING, INSTANT PUDDING MIXES, INSTANT STUFFING MIXES CONTAINING BREADS, FREEZER POPS, NAMELY, FLAVORED ICES, FROSTING, SEASONING COATING MIX FOR FOODS, PACKAGED CASSEROLE FOOD PRODUCTS CONSISTING MAINLY OF MACARONI AND TOMATO SAUCE MIX, MACARONI AND CHEESE, CAKE MIXES, COOKIE MIXES, BROWNIE MIXES, MUFFIN MIXES AND PANCAKE MIXES; PACKAGED MAIN MEAL MIXES HAVING A CEREAL OR PASTA BASE WITH SPICE AND/OR SAUCE MIXES SOLD AS A UNIT (U.S. CL. 46).

CYNTHIA SLOAN, EXAMINING ATTORNEY



OWNER OF U.S. REG. NOS. 1,986,918, 2,753,779 AND OTHERS.

NO CLAIM IS MADE TO THE EXCLUSIVE RIGHT TO USE "ENTERTAINMENT", APART FROM THE MARK AS SHOWN.

THE MARK CONSISTS OF A FALCON HEAD WHICH MORPHS INTO THE STYLIZED WORD FALCON ABOVE THE WORD ENTERTAINMENT.

CLASS 35—ADVERTISING AND BUSINESS

FOR ON-LINE RETAIL STORE SERVICES FEATURING ADULT ENTERTAINMENT IN THE NATURE OF DOWNLOADABLE VIDEO FEATURING ADULT CONTENT, ADULT TOYS, DVDS FEATURING ADULT CONTENT, AND AMATEUR ADULT ENTERTAINMENT CONTENT; PROVIDING A WEBSITE TO SOLICIT ACTORS AND MODELS FOR EMPLOYMENT; PROVIDING CONSUMER PRODUCT INFORMATION ON ADULT TOYS (U.S. CLS. 100, 101 AND 102).

FIRST USE 2-28-2007; IN COMMERCE 2-28-2007.

CLASS 41—EDUCATION AND ENTERTAINMENT

FOR PROVIDING A WEBSITE FEATURING INFORMATION ON ADULT GAY ENTERTAINMENT CONTENT (U.S. CLS. 100, 101 AND 107).

FIRST USE 2-28-2007; IN COMMERCE 2-28-2007.
AHSEN KHAN, EXAMINING ATTORNEY

SN 77-149,527. BLOOMSBURY PUBLISHING PLC, LONDON,
UNITED KINGDOM, FILED 4-5-2007.

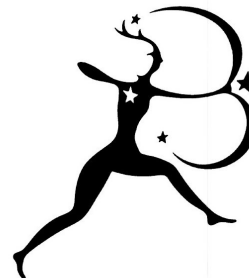

THE MARK CONSISTS OF A WOMAN WITH A BOW AND ARROW.

CLASS 9—ELECTRICAL AND SCIENTIFIC APPARATUS

FOR DATA RECORDINGS NAMELY AUDIO, VIDEO, STILL AND MOVING IMAGES AND TEXT ON A VARIETY OF TOPICS; VIDEO CASSETTES, AUDIOCASSETTES, COMPACT DISCS, AND CD ROMS ALL ON A VARIETY OF TOPICS; DOWNLOADABLE ELECTRONIC BOOKS AND AUDIO BOOKS ON A VARIETY OF TOPICS; DOWNLOADABLE MP3 FILES, MP3 RECORDINGS, ONLINE DISCUSSION BOARDS, WEB CASTS, POD CASTS FEATURING MUSIC, AUDIO BOOKS; ELECTRONIC PUBLICATIONS, NAMELY, BOOK, MAGAZINE, MANUAL ON A VARIETY OF TOPICS RECORDED ON COMPUTER MEDIA (U.S. CLS. 21, 23, 26, 36 AND 38).

FIRST USE 1-1-2003; IN COMMERCE 1-1-2003.

CLASS 16—PAPER GOODS AND PRINTED MATTER

FOR PUBLICATIONS, NAMELY, BOOKS, MAGAZINES, JOURNALS, BROCHURES, BOOKLETS, AND TEACHING MATERIALS ON A VARIETY OF TOPICS (U.S. CLS. 2, 5, 22, 23, 29, 37, 38 AND 50).

FIRST USE 1-1-2003; IN COMMERCE 1-1-2003.

CLASS 41—EDUCATION AND ENTERTAINMENT

FOR PROVISION OF EDUCATION, INSTRUCTION, INFORMATION AND TRAINING IN RELATION TO LITERATURE, WRITING AND DRAMATIC WORKS; PUBLICATION OF ELECTRONIC BOOKS, AUDIO BOOKS AND JOURNALS ON-LINE; THE PROVISION OF DISCUSSION FORUMS RELATED TO LITERATURE, WRITING, MUSIC AND FILMS; PROVIDING ON-LINE PUBLICATIONS IN THE NATURE OF BOOKS, MAGAZINES, AND JOURNALS ON A VARIETY OF TOPICS; PROVISION OF INFORMATION AND ADVISORY SERVICES RELATING TO LITERATURE, DRAMATIC WORKS FOR THEATRE OR BROADCAST, AUTHORSHIP, MUSIC AND FILM; ENTERTAINMENT SERVICES, NAMELY, PROVIDING ON-LINE REVIEWS OF MOVIES, BOOKS, MUSIC, COMPUTER GAMES; ENTERTAINMENT SERVICES NAMELY PROVIDING A WEBSITE ON A VARIETY OF FICTION AND NON-FICTION TOPICS INCLUDING MUSIC, CONCERTS, FILM, VIDEOS, THEATRE, RADIO, TELEVISION, NEWS, SPORTS, GAMES AND CULTURAL EVENTS AND ENTERTAINMENT-RELATED PROGRAMS (U.S. CLS. 100, 101 AND 107).

FIRST USE 1-1-2003; IN COMMERCE 1-1-2003.
JOHN HWANG, EXAMINING ATTORNEY

SN 77-149,784. JOHNSON & JOHNSON, NEW BRUNSWICK, NJ. FILED 4-5-2007.

THE ITCH STOPS HERE

THE MARK CONSISTS OF STANDARD CHARACTERS WITHOUT CLAIM TO ANY PARTICULAR FONT, STYLE, SIZE, OR COLOR.

CLASS 3—COSMETICS AND CLEANING PREPARATIONS

FOR FACE AND SKIN CARE PRODUCTS, NAMELY, PREMOISTENED WIPES, CREAMS, LOTIONS, MOISTURIZERS AND WASHES (U.S. CLS. 1, 4, 6, 50, 51 AND 52).

CLASS 5—PHARMACEUTICALS

FOR MEDICATED SKIN RASH PREPARATIONS AND SOLUTIONS, NAMELY, CREAMS, LOTIONS, OINTMENTS, COOLING SPRAYS, POISON PLANT SCRUBS AND TREATMENT SPRAYS (U.S. CLS. 6, 18, 44, 46, 51 AND 52).

STEVEN JACKSON, EXAMINING ATTORNEY

SN 77-151,604. SEPARATION TECHNOLOGIES LLC, TROUTVILLE, VA. FILED 4-9-2007.



THE MARK CONSISTS OF A FOOTPRINT.

CLASS 1—CHEMICALS

FOR FLY ASH FOR GENERAL MANUFACTURING USE (U.S. CLS. 1, 5, 6, 10, 26 AND 46).

CLASS 19—NON-METALLIC BUILDING MATERIALS

FOR CONCRETE; BUILDING MATERIALS, NAMELY, FLY ASH (U.S. CLS. 1, 12, 33 AND 50).

JENNIFER VASQUEZ, EXAMINING ATTORNEY

SN 77-151,937. MASON COMPANIES, INC., CHIPPEWA FALLS, WI. FILED 4-9-2007.

SHOE CENSUS

THE MARK CONSISTS OF STANDARD CHARACTERS WITHOUT CLAIM TO ANY PARTICULAR FONT, STYLE, SIZE, OR COLOR.

NO CLAIM IS MADE TO THE EXCLUSIVE RIGHT TO USE "SHOE", APART FROM THE MARK AS SHOWN.

CLASS 16—PAPER GOODS AND PRINTED MATTER

FOR PRINT PUBLICATIONS, NAMELY, PRINTED PERIODICALS IN THE FIELD OF MARKET RESEARCH FOR THE FOOTWEAR INDUSTRY (U.S. CLS. 2, 5, 22, 23, 29, 37, 38 AND 50).

FIRST USE 3-5-2007; IN COMMERCE 3-5-2007.

CLASS 35—ADVERTISING AND BUSINESS

FOR CONDUCTING MARKET RESEARCH SURVEYS IN THE FIELD OF FOOTWEAR (U.S. CLS. 100, 101 AND 102).

FIRST USE 3-5-2007; IN COMMERCE 3-5-2007.
JIM RINGLE, EXAMINING ATTORNEY

SN 77-152,786. AVIDITY HEALTH CARE SOLUTIONS, INC., PHOENIX, AZ. FILED 4-10-2007.

The NEOS HSA

THE MARK CONSISTS OF STANDARD CHARACTERS WITHOUT CLAIM TO ANY PARTICULAR FONT, STYLE, SIZE, OR COLOR.

NO CLAIM IS MADE TO THE EXCLUSIVE RIGHT TO USE "HSA", APART FROM THE MARK AS SHOWN.

CLASS 36—INSURANCE AND FINANCIAL

FOR ADMINISTRATION OF HEALTH SAVINGS ACCOUNTS (U.S. CLS. 100, 101 AND 102).

FIRST USE 1-1-2007; IN COMMERCE 1-1-2007.

CLASS 42—SCIENTIFIC, COMPUTER AND LEGAL SERVICES

FOR APPLICATION SERVICE PROVIDER (ASP) FEATURING SOFTWARE FOR SELF-SERVICE HEALTH SAVINGS ACCOUNT MANAGEMENT BY USERS AND FOR SELF-SERVICE HEALTHCARE PLAN MANAGEMENT BY USERS (U.S. CLS. 100 AND 101).

FIRST USE 1-1-2007; IN COMMERCE 1-1-2007.
JASON LOTT, EXAMINING ATTORNEY

SN 77-154,086. J. C. PENNEY PRIVATE BRANDS, INC., PLANO, TX. FILED 4-11-2007.



OWNER OF U.S. REG. NOS. 949,595, 3,147,476 AND OTHERS.

NO CLAIM IS MADE TO THE EXCLUSIVE RIGHT TO USE "STUDIO" AND "HOME COLLECTION", APART FROM THE MARK AS SHOWN.

THE MARK CONSISTS OF THE WORD "STUDIO" WITH A STYLIZED "O" COMBINED WITH THE WORD "BY" AND "JCPENNEY" WITHIN A RECTANGLE FOLLOWED BY THE WORDS "HOME COLLECTION".

CLASS 11—ENVIRONMENTAL CONTROL APPARATUS

FOR LAMPS (U.S. CLS. 13, 21, 23, 31 AND 34).
FIRST USE 2-26-2006; IN COMMERCE 2-26-2006.

CLASS 20—FURNITURE AND ARTICLES NOT OTHERWISE CLASSIFIED

FOR DECORATIVE PILLOWS; DRAPERY HARDWARE, NAMELY, TRAVERSE RODS, CURTAIN HOOKS, CURTAIN RODS AND FINIALS (U.S. CLS. 2, 13, 22, 25, 32 AND 50).

FIRST USE 2-26-2006; IN COMMERCE 2-26-2006.

CLASS 21—HOUSEWARES AND GLASS

FOR BATHROOM ACCESSORIES, NAMELY, PLASTIC CUPS, SOAP DISHES, SOAP DISPENSERS, WASTE PAPER BASKETS (U.S. CLS. 2, 13, 23, 29, 30, 33, 40 AND 50).

FIRST USE 2-26-2006; IN COMMERCE 2-26-2006.

CLASS 24—FABRICS

FOR CURTAINS, DRAPERIES, BED SHEETS, CONTOUR SHEETS, COMFORTERS, PILLOW SHAMS, BEDSKIRTS, TOWELS (U.S. CLS. 42 AND 50).

FIRST USE 2-26-2006; IN COMMERCE 2-26-2006.

CLASS 27—FLOOR COVERINGS

FOR RUGS (U.S. CLS. 19, 20, 37, 42 AND 50).

FIRST USE 2-26-2006; IN COMMERCE 2-26-2006.
MIDGE BUTLER, EXAMINING ATTORNEY

SN 77-154,115. ELECTROLUX HOME CARE PRODUCTS LTD., CLEVELAND, OH. FILED 4-11-2007.



THE MARK CONSISTS OF SPHERE-SHAPED CHARACTER WITH STAR-SHAPED SUNGLASSES AND A HALO.

CLASS 7—MACHINERY

FOR VACUUM CLEANER BAGS AND FILTERS (U.S. CLS. 13, 19, 21, 23, 31, 34 AND 35).

CLASS 40—MATERIAL TREATMENT

FOR PROVIDING INFORMATION IN THE FIELD OF HOUSEHOLD ODOR ELIMINATION (U.S. CLS. 100, 103 AND 106).

ANDREA HACK, EXAMINING ATTORNEY

SN 77-154,210. ELECTROLUX HOME CARE PRODUCTS LTD., CLEVELAND, OH. FILED 4-11-2007.

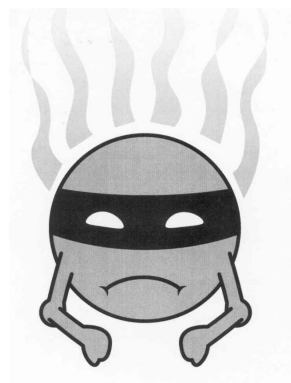

THE MARK CONSISTS OF SPHERE-SHAPED CHARACTER WEARING A MASK WITH VAPORS OVERHEAD.

CLASS 7—MACHINERY

FOR VACUUM CLEANERS BAGS AND FILTERS (U.S. CLS. 13, 19, 21, 23, 31, 34 AND 35).

CLASS 40—MATERIAL TREATMENT

FOR PROVIDING INFORMATION IN THE FIELD OF HOUSEHOLD ODOR ELIMINATION (U.S. CLS. 100, 103 AND 106).
ANDREA HACK, EXAMINING ATTORNEY

SN 77-155,468. MARSICO, ROBERT, LAS VEGAS, NV. AND MARSICO, MARILYN, LAS VEGAS, NV. FILED 4-12-2007.

ZIG ZAG

THE MARK CONSISTS OF STANDARD CHARACTERS WITHOUT CLAIM TO ANY PARTICULAR FONT, STYLE, SIZE, OR COLOR.

CLASS 30—STAPLE FOODS

FOR COFFEE (U.S. CL. 46).

CLASS 43—HOTEL AND RESTAURANT SERVICES

FOR COFFEE HOUSES (U.S. CLS. 100 AND 101).
AMY MCMENAMIN, EXAMINING ATTORNEY

SN 77-155,707. TADASHI SHOJI, VERNON, CA. FILED 4-12-2007.



THE COLOR(S) SAGE, WHITE AND BLACK IS/ARE CLAIMED AS A FEATURE OF THE MARK.

THE MARK CONSISTS OF A STYLIZED WORD "EXACTLY" IN WHITE WITH STYLIZED WORDS "BY TADASHI" IN BLACK UNDERNEATH AND ALIGNED TO THE RIGHT. THE BACKGROUND OF THE MARK IS IN SAGE COLOR.

CLASS 24—FABRICS

FOR CLOTH LABELS (U.S. CLS. 42 AND 50).

CLASS 25—CLOTHING

FOR UNIFORMS (U.S. CLS. 22 AND 39).

CLASS 35—ADVERTISING AND BUSINESS

FOR ARRANGING AND CONDUCTING TRADE SHOW EXHIBITIONS IN THE FIELD OF CLOTHING APPAREL; ORGANIZING EXHIBITIONS FOR MARKETING CLOTHING APPAREL; ARRANGING AND CONDUCTING OF FAIRS AND EXHIBITIONS FOR BUSINESS AND ADVERTISING PURPOSES; FASHION SHOW EXHIBITIONS FOR COMMERCIAL PURPOSES (U.S. CLS. 100, 101 AND 102).

RUDY R. SINGLETON, EXAMINING ATTORNEY

SN 77-158,260. VSM GROUP AKTIEBOLAG, HUSKVARNA, SWEDEN, FILED 4-17-2007.



NO CLAIM IS MADE TO THE EXCLUSIVE RIGHT TO USE "EMBROIDERIES", APART FROM THE MARK AS SHOWN.

THE MARK CONSISTS OF THE WORDS MY EMBROIDERIES WITH A FLOWER DESIGN.

CLASS 9—ELECTRICAL AND SCIENTIFIC APPARATUS

FOR DIGITAL MATERIALS, NAMELY, DOWNLOADABLE GRAPHICS FILES FEATURING DESIGNS FOR EMBROIDERING (U.S. CLS. 21, 23, 26, 36 AND 38).

CLASS 35—ADVERTISING AND BUSINESS

FOR ON-LINE RETAIL STORE SERVICES FEATURING DOWNLOADABLE EMBROIDERY DESIGNS (U.S. CLS. 100, 101 AND 102).

CLASS 38—COMMUNICATION

FOR PROVIDING ON-LINE CHAT ROOMS AND ELECTRONIC BULLETIN BOARDS FOR TRANSMISSION OF MESSAGES AMONG USERS IN THE FIELD OF SEWING AND EMBROIDERY (U.S. CLS. 100, 101 AND 104).

CLASS 41—EDUCATION AND ENTERTAINMENT

FOR EDUCATION SERVICES, NAMELY, PROVIDING TUTORING IN THE FIELD OF SEWING AND EMBROIDERY (U.S. CLS. 100, 101 AND 107).

ANDREA HACK, EXAMINING ATTORNEY

SN 77-159,280. SEPARATION TECHNOLOGIES LLC, TROUTVILLE, VA. FILED 4-18-2007.

THE MARK CONSISTS OF STYLIZED ECOTHERM MARK WITH MODIFIED RECYCLING SYMBOL IN "O".

CLASS 1—CHEMICALS

FOR TREATED FLY ASH FOR GENERAL MANUFACTURING USE (U.S. CLS. 1, 5, 6, 10, 26 AND 46).

CLASS 19—NON-METALLIC BUILDING MATERIALS

FOR TREATED FLY ASH FOR GENERAL CONSTRUCTION USE (U.S. CLS. 1, 12, 33 AND 50).
JENNIFER VASQUEZ, EXAMINING ATTORNEY

SN 77-160,517. AMERICAN MANAGEMENT ASSOCIATION INTERNATIONAL, NEW YORK, NY. FILED 4-19-2007.

EDGEWISE

THE MARK CONSISTS OF STANDARD CHARACTERS WITHOUT CLAIM TO ANY PARTICULAR FONT, STYLE, SIZE, OR COLOR.

CLASS 9—ELECTRICAL AND SCIENTIFIC APPARATUS

FOR DOWNLOADABLE PRERECORDED AUDIO AND VIDEO PROGRAMS IN THE FIELD OF BUSINESS MANAGEMENT (U.S. CLS. 21, 23, 26, 36 AND 38).

CLASS 16—PAPER GOODS AND PRINTED MATTER

FOR EDUCATIONAL BOOKS RELATING TO BUSINESS MANAGEMENT; PRINTED INFORMATIONAL MATERIALS IN THE FORM OF BROCHURES RELATING TO BUSINESS MANAGEMENT; PAMPHLETS RELATING TO BUSINESS MANAGEMENT; CATALOGS FOR USE IN THE FIELD OF BUSINESS MANAGEMENT; SEMINAR PROGRAM MATERIALS, NAMELY COURSE OUTLINES AND NOTEBOOKS CONTAINING INSTRUCTIONAL PROGRAMS, QUESTION AND ANSWER SHEETS AND FACTUAL MATERIAL FOR USE AS TEACHING DEVICES ALL FOR USE IN THE FIELD OF BUSINESS MANAGEMENT (U.S. CLS. 2, 5, 22, 23, 29, 37, 38 AND 50).

CLASS 35—ADVERTISING AND BUSINESS

FOR PROVIDING INFORMATION IN THE FIELD OF BUSINESS MANAGEMENT VIA WEBSITES ON A GLOBAL COMPUTER NETWORK (U.S. CLS. 100, 101 AND 102).

CLASS 38—COMMUNICATION

FOR DIGITAL MEDIA DISTRIBUTION SERVICES, NAMELY, STREAMING PRERECORDED AND LIVE AUDIO AND VIDEO PROGRAMS IN THE FIELD OF BUSINESS MANAGEMENT ON THE INTERNET (U.S. CLS. 100, 101 AND 104).

CLASS 41—EDUCATION AND ENTERTAINMENT

FOR EDUCATIONAL SERVICES, NAMELY, PROVIDING ON-LINE COURSES IN THE FIELD OF BUSINESS MANAGEMENT VIA THE INTERNET; EDUCATION SERVICES, NAMELY CONDUCTING SEMINARS IN THE FIELD OF BUSINESS MANAGEMENT; ORGANIZING EXHIBITIONS FOR EDUCATIONAL PURPOSES IN THE FIELD OF BUSINESS MANAGEMENT; EDUCATIONAL SERVICES, NAMELY, PROVIDING ONLINE PRERECORDED AND LIVE AUDIO AND VIDEO PROGRAMS IN THE FIELD OF BUSINESS MANAGEMENT (U.S. CLS. 100, 101 AND 107).

ERNEST SHOSHO, EXAMINING ATTORNEY

SN 77-160,606. ALLERGAN, INC., IRVINE, CA. FILED 4-19-2007.

KEEP THE WISDOM. LOSE THE LINES.

THE MARK CONSISTS OF STANDARD CHARACTERS WITHOUT CLAIM TO ANY PARTICULAR FONT, STYLE, SIZE, OR COLOR.

CLASS 16—PAPER GOODS AND PRINTED MATTER

FOR INFORMATIONAL BROCHURES, PATIENT MATERIALS, IN-OFFICE MATERIALS, ADVERTISEMENTS, WEBSITES, CORPORATE COLLATERAL, FLIPCHARTS, FLYERS AND NEWS RELEASES CONCERNING FACIAL AESTHETIC PRODUCTS (U.S. CLS. 2, 5, 22, 23, 29, 37, 38 AND 50).

CLASS 44—MEDICAL, BEAUTY AND AGRICULTURAL SERVICES

FOR PROVIDING A WEBSITE FEATURING MEDICAL INFORMATION IN THE FIELD OF FACIAL AESTHETICS (U.S. CLS. 100 AND 101).

ELI HELLMAN, EXAMINING ATTORNEY

SN 77-161,440. WOODSON, CHARLES, DENVER, CO. FILED 4-20-2007.

SN 77-163,065. KABUSHIKI KAISHA SQUARE ENIX, DBA/ AKA SQUARE ENIX CO., LTD., TOKYO, JAPAN, FILED 4-23-2007.

CHARLES WOODSON

THE MARK CONSISTS OF STANDARD CHARACTERS WITHOUT CLAIM TO ANY PARTICULAR FONT, STYLE, SIZE, OR COLOR.

THE NAME "CHARLES WOODSON" IDENTIFIES A LIVING INDIVIDUAL WHOSE CONSENT IS OF RECORD.

CLASS 21—HOUSEWARES AND GLASS

FOR COFFEE CUPS, MUGS (U.S. CLS. 2, 13, 23, 29, 30, 33, 40 AND 50).

CLASS 25—CLOTHING

FOR CLOTHING, NAMELY, T-SHIRTS, CAPS, SWEATSHIRTS, JERSEYS, JACKETS (U.S. CLS. 22 AND 39).

CLASS 33—WINES AND SPIRITS

FOR WINE (U.S. CLS. 47 AND 49).
DOMINIC FATHY, EXAMINING ATTORNEY



OWNER OF JAPAN REG. NO. 5004350, DATED 11-17-2006, EXPIRES 11-17-2016.

CLASS 9—ELECTRICAL AND SCIENTIFIC APPARATUS

FOR COMPUTER GAME SOFTWARE; VIDEO GAME SOFTWARE (U.S. CLS. 21, 23, 26, 36 AND 38).

CLASS 16—PAPER GOODS AND PRINTED MATTER

FOR COMPUTER GAME STRATEGY GUIDE BOOKS; VIDEO GAME STRATEGY GUIDEBOOKS (U.S. CLS. 2, 5, 22, 23, 29, 37, 38 AND 50).
SCOTT BIBB, EXAMINING ATTORNEY

SN 77-161,680. PROPEL SOFTWARE CORPORATION, SAN JOSE, CA. FILED 4-20-2007.

SN 77-164,543. THINKFUN INC., ALEXANDRIA, VA. FILED 4-24-2007.

PROPEL

THE MARK CONSISTS OF STANDARD CHARACTERS WITHOUT CLAIM TO ANY PARTICULAR FONT, STYLE, SIZE, OR COLOR.

OWNER OF U.S. REG. NOS. 2,041,848, 2,467,518 AND 2,474,494.

CLASS 9—ELECTRICAL AND SCIENTIFIC APPARATUS

FOR DOWNLOADABLE SOFTWARE FOR ACCELERATING AND OPTIMIZING DATA FLOW IN A TELECOMMUNICATIONS NETWORK (U.S. CLS. 21, 23, 26, 36 AND 38).

FIRST USE 12-7-2002; IN COMMERCE 12-7-2002.

CLASS 42—SCIENTIFIC, COMPUTER AND LEGAL SERVICES

FOR SUBSCRIPTION TO A COMPUTER SERVICE, NAMELY, A SERVICE THAT ACCELERATES AND OPTIMIZES DATA FLOW IN A TELECOMMUNICATIONS NETWORK (U.S. CLS. 100 AND 101).

FIRST USE 12-7-2002; IN COMMERCE 12-7-2002.
REBECCA GAN, EXAMINING ATTORNEY

RIVER CROSSING

THE MARK CONSISTS OF STANDARD CHARACTERS WITHOUT CLAIM TO ANY PARTICULAR FONT, STYLE, SIZE, OR COLOR.

OWNER OF U.S. REG. NO. 2,791,518.

CLASS 9—ELECTRICAL AND SCIENTIFIC APPARATUS

FOR COMPUTER GAME PROGRAMS; DOWNLOADABLE COMPUTER GAME PROGRAMS OFFERED VIA HANDHELD COMPUTERS, WIRELESS TELEPHONES AND MOBILE AND WIRELESS DEVICES (U.S. CLS. 21, 23, 26, 36 AND 38).

CLASS 41—EDUCATION AND ENTERTAINMENT

FOR PROVIDING ONLINE COMPUTER GAME PROGRAMS OFFERED VIA HANDHELD COMPUTERS, WIRELESS TELEPHONES AND MOBILE AND WIRELESS DEVICES; PROVIDING ONLINE COMPUTER GAMES (U.S. CLS. 100, 101 AND 107).

FIRST USE 9-0-2004; IN COMMERCE 9-0-2004.
EDWARD NELSON, EXAMINING ATTORNEY

SN 77-164,551. THINKFUN INC., ALEXANDRIA, VA. FILED
4-24-2007.

SN 77-164,766. LEVINE, RUSSELL, SAN DIEGO, CA. FILED
4-24-2007.

TIPOVER

THE MARK CONSISTS OF STANDARD CHARACTERS WITHOUT CLAIM TO ANY PARTICULAR FONT, STYLE, SIZE, OR COLOR.

OWNER OF U.S. REG. NO. 3,004,857.

CLASS 9—ELECTRICAL AND SCIENTIFIC APPARATUS

FOR COMPUTER GAME PROGRAMS; DOWNLOADABLE COMPUTER GAME PROGRAMS OFFERED VIA HANDHELD COMPUTERS, WIRELESS TELEPHONES AND MOBILE AND WIRELESS DEVICES (U.S. CLS. 21, 23, 26, 36 AND 38).

CLASS 41—EDUCATION AND ENTERTAINMENT

FOR PROVIDING ONLINE COMPUTER GAME PROGRAMS OFFERED VIA HANDHELD COMPUTERS, WIRELESS TELEPHONES AND MOBILE AND WIRELESS DEVICES; PROVIDING ONLINE COMPUTER GAMES (U.S. CLS. 100, 101 AND 107).

FIRST USE 9-0-2004; IN COMMERCE 9-0-2004.
EDWARD NELSON, EXAMINING ATTORNEY

ZOE CHEER

THE MARK CONSISTS OF STANDARD CHARACTERS WITHOUT CLAIM TO ANY PARTICULAR FONT, STYLE, SIZE, OR COLOR.

CLASS 25—CLOTHING

FOR CLOTHING, NAMELY CHEERLEADING AND ACTIVE WEAR CONSISTING OF BRASSIERES, BRIEFS AND UNDERGARMENTS, GYM SUITS, BODY SUITS, DRESSES, JOGGING SUITS, PANTS, SHIRTS, TEE-SHIRTS AND TOPS, SWEAT SHIRTS, SWEATERS, SWEAT AND WARM-UP SUITS, SKIRTS, SKORTS, SHORTS, SOCKS AND ATHLETIC SHOES (U.S. CLS. 22 AND 39).

FIRST USE 4-1-2007; IN COMMERCE 4-1-2007.

CLASS 28—TOYS AND SPORTING GOODS

FOR POM-POMS (U.S. CLS. 22, 23, 38 AND 50).
FIRST USE 4-1-2007; IN COMMERCE 4-1-2007.
BARBARA A. LOUGHRAN, EXAMINING ATTORNEY

SN 77-164,593. BRINKER INTERNATIONAL HOLDINGS,
L.P., DALLAS, TX. FILED 4-24-2007.

SN 77-165,641. FAULTLESS STARCH/BON AMI COMPANY,
KANSAS CITY, MO. FILED 4-25-2007.

LET'S PLAY RESTAURANT

THE MARK CONSISTS OF STANDARD CHARACTERS WITHOUT CLAIM TO ANY PARTICULAR FONT, STYLE, SIZE, OR COLOR.

NO CLAIM IS MADE TO THE EXCLUSIVE RIGHT TO USE "RESTAURANT", APART FROM THE MARK AS SHOWN.

CLASS 35—ADVERTISING AND BUSINESS

FOR PROMOTING THE SALE OF RESTAURANT, BAR AND CATERING SERVICES THROUGH THE ADMINISTRATION OF A PREFERRED CUSTOMER REWARD PROGRAM FEATURING CUSTOMER INCENTIVES, REWARDS, GIFT CARDS, DISCOUNTS AND SPECIAL OFFERS ASSOCIATED WITH RESTAURANT, BAR AND CATERING SERVICES (U.S. CLS. 100, 101 AND 102).

CLASS 43—HOTEL AND RESTAURANT SERVICES

FOR RESTAURANT, BAR AND CATERING SERVICES (U.S. CLS. 100 AND 101).
KEVON CHISOLM, EXAMINING ATTORNEY

LAVENDER DE PROVENCE

THE MARK CONSISTS OF STANDARD CHARACTERS WITHOUT CLAIM TO ANY PARTICULAR FONT, STYLE, SIZE, OR COLOR.

NO CLAIM IS MADE TO THE EXCLUSIVE RIGHT TO USE "LAVENDER", APART FROM THE MARK AS SHOWN.

THE FOREIGN WORDING IN THE MARK TRANSLATES INTO ENGLISH AS OF PROVENCE.

CLASS 3—COSMETICS AND CLEANING PREPARATIONS

FOR (BASED ON INTENT TO USE) SCENTED ROOM SPRAYS; BODY LOTIONS (U.S. CLS. 1, 4, 6, 50, 51 AND 52).

CLASS 4—LUBRICANTS AND FUELS

FOR (BASED ON USE IN COMMERCE) CANDLES (U.S. CLS. 1, 6 AND 15).
FIRST USE 10-1-2006; IN COMMERCE 10-1-2006.
GIANCARLO CASTRO, EXAMINING ATTORNEY

SN 77-165,649. FAULTLESS STARCH/BON AMI COMPANY, KANSAS CITY, MO. FILED 4-25-2007.

VANILLA TARTE

THE MARK CONSISTS OF STANDARD CHARACTERS WITHOUT CLAIM TO ANY PARTICULAR FONT, STYLE, SIZE, OR COLOR.

NO CLAIM IS MADE TO THE EXCLUSIVE RIGHT TO USE "VANILLA", APART FROM THE MARK AS SHOWN.

CLASS 3—COSMETICS AND CLEANING PREPARATIONS

FOR (BASED ON INTENT TO USE) SCENTED ROOM SPRAYS; BODY LOTIONS (U.S. CLS. 1, 4, 6, 50, 51 AND 52).

CLASS 4—LUBRICANTS AND FUELS

FOR (BASED ON USE IN COMMERCE) CANDLES (U.S. CLS. 1, 6 AND 15).

FIRST USE 10-1-2006; IN COMMERCE 10-1-2006. GIANCARLO CASTRO, EXAMINING ATTORNEY

SN 77-166,211. MEDCO HEALTH SOLUTIONS, INC., FRANKLIN LAKES, NJ. FILED 4-26-2007.

MEDCO LABOR COALITION

THE MARK CONSISTS OF STANDARD CHARACTERS WITHOUT CLAIM TO ANY PARTICULAR FONT, STYLE, SIZE, OR COLOR.

OWNER OF U.S. REG. NOS. 2,894,558, 3,061,048 AND OTHERS.

NO CLAIM IS MADE TO THE EXCLUSIVE RIGHT TO USE "LABOR COALITION", APART FROM THE MARK AS SHOWN.

CLASS 35—ADVERTISING AND BUSINESS

FOR PROVIDING INFORMATION IN THE FIELD OF PHARMACEUTICAL COST MANAGEMENT AS PROVIDED TO PHARMACY BENEFIT MANAGEMENT SERVICES CLIENTS, CONSULTANTS AND BROKERS (U.S. CLS. 100, 101 AND 102).

CLASS 36—INSURANCE AND FINANCIAL

FOR PHARMACY BENEFIT MANAGEMENT SERVICES FOR ORGANIZED LABOR; ADMINISTRATION OF PHARMACY BENEFIT PLANS (U.S. CLS. 100, 101 AND 102).

CLASS 41—EDUCATION AND ENTERTAINMENT

FOR CONDUCTING AND ARRANGING SEMINARS AND CONFERENCES IN THE FIELD OF PHARMACY BENEFIT MANAGEMENT (U.S. CLS. 100, 101 AND 107).

CLASS 44—MEDICAL, BEAUTY AND AGRICULTURAL SERVICES

FOR PROVIDING INFORMATION IN THE FIELD OF HEALTHCARE AS PROVIDED TO PHARMACY BENEFIT MANAGEMENT SERVICES CLIENTS, CONSULTANTS AND BROKERS (U.S. CLS. 100 AND 101). KHANH LE, EXAMINING ATTORNEY

SN 77-166,700. AUTOMATIC BAR CONTROLS, INC., VACAVILLE, CA. FILED 4-26-2007.



CLASS 7—MACHINERY

FOR DISPENSING MACHINES, NAMELY, BEVERAGE DISPENSING MACHINES, LIQUOR DISPENSING MACHINES AND CONDIMENT DISPENSING MACHINES, AND PARTS FOR EACH OF THE FOREGOING; MIXING MACHINES, NAMELY, BEVERAGE MIXERS (U.S. CLS. 13, 19, 21, 23, 31, 34 AND 35).

CLASS 11—ENVIRONMENTAL CONTROL APPARATUS

FOR ENVIRONMENTAL CONTROL DISPENSING EQUIPMENT, NAMELY, REFRIGERATED BEVERAGE DISPENSING UNITS, REFRIGERATED LIQUOR DISPENSING UNITS, HEATED BEVERAGE DISPENSING UNITS; AND HEATED CONDIMENT DISPENSING UNITS (U.S. CLS. 13, 21, 23, 31 AND 34).

CLASS 20—FURNITURE AND ARTICLES NOT OTHERWISE CLASSIFIED

FOR STORAGE AND DISPLAY EQUIPMENT, NAMELY BEVERAGE RACKS, LIQUOR RACKS, BEVERAGE CABINETS, LIQUOR CABINETS, AND CONDIMENT CABINETS (U.S. CLS. 2, 13, 22, 25, 32 AND 50). MELVIN AXILBUND, EXAMINING ATTORNEY

SN 77-166,784. SCJ VENDING CORP., WOODBURY, NY. FILED 4-26-2007.

THE WX

THE MARK CONSISTS OF STANDARD CHARACTERS WITHOUT CLAIM TO ANY PARTICULAR FONT, STYLE, SIZE, OR COLOR.

CLASS 35—ADVERTISING AND BUSINESS

FOR ONLINE RETAIL STORE SERVICES FEATURING PRODUCT GUARANTEES, WARRANTIES AND EXTENDED SERVICE CONTRACTS (U.S. CLS. 100, 101 AND 102).

CLASS 36—INSURANCE AND FINANCIAL

FOR PROVIDING INFORMATION CONCERNING PRODUCT GUARANTEES AND WARRANTIES VIA THE INTERNET OR A GLOBAL COMPUTER NETWORK (U.S. CLS. 100, 101 AND 102).

CAROLINE WOOD, EXAMINING ATTORNEY

CLASS 9—ELECTRICAL AND SCIENTIFIC APPARATUS

FOR FOOTBALL HELMETS, TELEPHONES, CELL PHONE COVERS, CELL PHONE STRAPS, PREPAID MAGNETIC ENCODED TELEPHONE CALLING CARDS, MAGNETIC CODED CHARGE CARDS, DECORATIVE MAGNETS, PRERECORDED COMPACT DISCS, TAPES, VIDEOTAPES AND DVD'S FEATURING THE SPORT OF FOOTBALL, COMPUTER GAME SOFTWARE AND DISKS AND VIDEO GAME CARTRIDGES, COMPUTER MOUSE PADS, CAMERA CASES, SUNGLASSES, EYEGLASS CASES, EYEGLASS CHAINS, BINOCULARS, DECORATIVE LIGHT SWITCH PLATE COVERS (U.S. CLS. 21, 23, 26, 36 AND 38).

SN 77-167,121. MEXICAN & AMERICANS THINKING TOGETHER-FOUNDATION, INC., SAN ANTONIO, TX. FILED 4-27-2007.

MATT LEGAL WORKERS

THE MARK CONSISTS OF STANDARD CHARACTERS WITHOUT CLAIM TO ANY PARTICULAR FONT, STYLE, SIZE, OR COLOR.

NO CLAIM IS MADE TO THE EXCLUSIVE RIGHT TO USE "LEGAL WORKERS", APART FROM THE MARK AS SHOWN.

CLASS 35—ADVERTISING AND BUSINESS

FOR JOB PLACEMENT; CAREER PLACEMENT; EMPLOYMENT HIRING, RECRUITING, PLACEMENT, STAFFING AND CAREER NETWORKING SERVICES; PROVIDING CAREER INFORMATION VIA PUBLICATIONS, AUDIO AND VIDEO TRANSMISSIONS AND A GLOBAL COMPUTER NETWORK; EMPLOYMENT COUNSEL AND RECRUITING (U.S. CLS. 100, 101 AND 102).

CLASS 41—EDUCATION AND ENTERTAINMENT

FOR CAREER COUNSELING (U.S. CLS. 100, 101 AND 107).

JESSICA A. POWERS, EXAMINING ATTORNEY

CLASS 16—PAPER GOODS AND PRINTED MATTER

FOR POSTERS, CALENDARS, TRADING CARDS, SERIES OF BOOKS RELATING TO FOOTBALL, MAGAZINES RELATING TO FOOTBALL, NEWSLETTERS RELATING TO FOOTBALL, NOTEPADS, STICKERS, BUMPER STICKERS, PAPER PENNANTS AND GREETING CARDS; PRINTED TICKETS TO SPORTS GAMES AND EVENTS; NON-MAGNETICALLY CODED PREPAID PHONE CARDS, PENS AND PENCILS, PENCIL CASES, RUB ON DECORATIVE TRANSFERS, NOTE PAPER, PICTORIAL PRINTS, PICTURE POSTCARDS, ART PICTURES, STATIONERY, ENVELOPES, STATIONERY-TYPE PORTFOLIOS, PHOTO ALBUMS, SCRAPBOOK ALBUMS, CALENDARS, THREE-RING BINDERS, CHECKBOOK COVERS, TISSUE PAPER, WRAPPING PAPER, PAPER TABLE CLOTHS, PAPER NAPKINS, PAPER PARTY HATS, PAPER PARTY INVITATIONS, PAPER GIFT CARDS; PAPER GIFT BAGS, PAPER GIFT BOXES, PAPER PARTY DECORATIONS, COLLECTIBLE CARDS; COLLECTIBLE CARD HOLDERS, SOUVENIR PROGRAMS FOR SPORTS EVENTS (U.S. CLS. 2, 5, 22, 23, 29, 37, 38 AND 50).

CLASS 21—HOUSEWARES AND GLASS

FOR BEVERAGE GLASSWARE, CUPS, MUGS, BOTTLE OPENERS, FOAM DRINK HOLDERS, INSULATED SLEEVE HOLDERS FOR BEVERAGE CANS, NEOPRENE ZIPPERED BOTTLE HOLDERS, ICE BUCKETS AND BEER BUCKETS (U.S. CLS. 2, 13, 23, 29, 30, 33, 40 AND 50).

CLASS 24—FABRICS

FOR TOWELS, BED BLANKETS, PILLOW CASES (U.S. CLS. 42 AND 50).

SN 77-167,476. MINNESOTA VIKINGS FOOTBALL, LLC, EDEN PRAIRIE, MN. FILED 4-27-2007.

YOU MADE THE TEAM

THE MARK CONSISTS OF STANDARD CHARACTERS WITHOUT CLAIM TO ANY PARTICULAR FONT, STYLE, SIZE, OR COLOR.

CLASS 25—CLOTHING

FOR MEN'S, WOMEN'S AND CHILDREN'S CLOTHING, NAMELY, FLEECE TOPS AND BOTTOMS, CAPS, VISORS, HEADWEAR, T-SHIRTS, SWEATSHIRTS, SHORTS, TANK TOPS, SWEATERS, PANTS, JACKETS, TURTLENECKS, GOLF SHIRTS, WOVEN SHIRTS, KNIT SHIRTS, JERSEYS, WRISTBANDS, WARM UP SUITS, SWIMWEAR, WIND RESISTANT JACKETS, RAINCOATS, PARKAS, PONCHOS, GLOVES, TIES, SUSPENDERS, BELTS, CLOTH BABY BIBS, SLEEPWEAR, NAMELY, ROBES, NIGHT SHIRTS AND PAJAMAS, MITTENS, KNIT HATS AND CAPS, SCARVES, APRONS, HEADBANDS, EAR MUFFS, UNDERWEAR, SOCKS, SHOES, ATHLETIC SHOES, BOOTS, SNEAKERS AND SLIPPERS (U.S. CLS. 22 AND 39).

CLASS 28—TOYS AND SPORTING GOODS

FOR TOYS AND SPORTING GOODS, NAMELY, PLUSH TOYS, STUFFED ANIMALS, PLAY FIGURES, GOLF BALLS, GOLF BAGS, GOLF CLUBS, GOLF CLUB COVERS, BOWLING BAGS, FOOTBALLS, TOY BANKS, BOARD GAMES RELATING TO FOOTBALL, CHRISTMAS TREE ORNAMENTS EXCLUDING CONFECTIONERY OR ILLUMINATION ARTICLES, BALLOONS, JIGSAW PUZZLES, TOY AND DECORATIVE WIND-SOCKS, KITES, TOY MODEL TRUCKS, BILLIARD BALLS, DART BOARDS, PLAYING CARDS, TOY REPLICA MINIATURE FOOTBALL HELMETS (U.S. CLS. 22, 23, 38 AND 50).

CLASS 41—EDUCATION AND ENTERTAINMENT

FOR ENTERTAINMENT SERVICES, NAMELY PRESENTATIONS IN THE NATURE OF PROFESSIONAL FOOTBALL GAMES AND EXHIBITIONS (U.S. CLS. 100, 101 AND 107).

MICHAEL TANNER, EXAMINING ATTORNEY

SN 77-167,478. MINNESOTA VIKINGS FOOTBALL, LLC, EDEN PRAIRIE, MN. FILED 4-27-2007.

EVERYTHING PURPLE

THE MARK CONSISTS OF STANDARD CHARACTERS WITHOUT CLAIM TO ANY PARTICULAR FONT, STYLE, SIZE, OR COLOR.

CLASS 9—ELECTRICAL AND SCIENTIFIC APPARATUS

FOR FOOTBALL HELMETS, TELEPHONES, CELL PHONE COVERS, CELL PHONE STRAPS, PREPAID MAGNETIC ENCODED TELEPHONE CALLING CARDS, MAGNETIC CODED CHARGE CARDS, DECORATIVE MAGNETS, PRERECORDED COMPACT DISCS, TAPES, VIDEOTAPES AND DVD'S FEATURING THE SPORT OF FOOTBALL, COMPUTER GAME SOFTWARE AND DISKS AND VIDEO GAME CARTRIDGES, COMPUTER MOUSE PADS, CAMERA CASES, SUNGLASSES, EYEGLASS CASES, EYEGLASS CHAINS, BINOCULARS, DECORATIVE LIGHT SWITCH PLATE COVERS (U.S. CLS. 21, 23, 26, 36 AND 38).

CLASS 16—PAPER GOODS AND PRINTED MATTER

FOR POSTERS, CALENDARS, TRADING CARDS, SERIES OF BOOKS RELATING TO FOOTBALL, MAGAZINES RELATING TO FOOTBALL, NEWSLETTERS RELATING TO FOOTBALL, NOTEPADS, STICKERS, BUMPER STICKERS, PAPER PENNANTS AND GREETING CARDS; PRINTED TICKETS TO SPORTS GAMES AND EVENTS; NON-MAGNETICALLY CODED PREPAID PHONE CARDS, PENS AND PENCILS, PENCIL CASES, RUB ON DECORATIVE TRANSFERS, NOTE PAPER, PICTORIAL PRINTS, PICTURE POSTCARDS, ART PICTURES, STATIONERY, ENVELOPES, STATIONERY-TYPE PORTFOLIOS, PHOTO ALBUMS, SCRAPBOOK ALBUMS, CALENDARS, THREE-RING BINDERS, CHECKBOOK COVERS, TISSUE PAPER, WRAPPING PAPER, PAPER TABLE CLOTHS, PAPER NAPKINS, PAPER PARTY HATS, PAPER PARTY INVITATIONS, PAPER GIFT CARDS; PAPER GIFT BAGS, PAPER GIFT BOXES, PAPER PARTY DECORATIONS, COLLECTIBLE CARDS; COLLECTIBLE CARD HOLDERS, SOUVENIR PROGRAMS FOR SPORTS EVENTS (U.S. CLS. 2, 5, 22, 23, 29, 37, 38 AND 50).

CLASS 21—HOUSEWARES AND GLASS

FOR BEVERAGE GLASSWARE, CUPS, MUGS, BOTTLE OPENERS, FOAM DRINK HOLDERS, INSULATED SLEEVE HOLDERS FOR BEVERAGE CANS, NEOPRENE ZIPPERED BOTTLE HOLDERS, ICE BUCKETS AND BEER BUCKETS (U.S. CLS. 2, 13, 23, 29, 30, 33, 40 AND 50).

CLASS 24—FABRICS

FOR TOWELS, BED BLANKETS, PILLOW CASES (U.S. CLS. 42 AND 50).

CLASS 25—CLOTHING

FOR MEN'S, WOMEN'S AND CHILDREN'S CLOTHING, NAMELY, FLEECE TOPS AND BOTTOMS, CAPS, VISORS, HEADWEAR, T-SHIRTS, SWEATSHIRTS, SHORTS, TANK TOPS, SWEATERS, PANTS, JACKETS, TURTLENECKS, GOLF SHIRTS, WOVEN SHIRTS, KNIT SHIRTS, JERSEYS, WRISTBANDS, WARM UP SUITS, SWIMWEAR, WIND RESISTANT JACKETS, RAINCOATS, PARKAS, PONCHOS, GLOVES, TIES, SUSPENDERS, BELTS, CLOTH BABY BIBS, SLEEPWEAR, NAMELY, ROBES, NIGHT SHIRTS AND PAJAMAS, MITTENS, KNIT HATS AND CAPS, SCARVES, APRONS, HEADBANDS, EAR MUFFS, UNDERWEAR, SOCKS, SHOES, ATHLETIC SHOES, BOOTS, SNEAKERS AND SLIPPERS (U.S. CLS. 22 AND 39).

CLASS 28—TOYS AND SPORTING GOODS

FOR TOYS AND SPORTING GOODS, NAMELY, PLUSH TOYS, STUFFED ANIMALS, PLAY FIGURES, GOLF BALLS, GOLF BAGS, GOLF CLUBS, GOLF CLUB COVERS, BOWLING BAGS, FOOTBALLS, TOY BANKS, BOARD GAMES RELATING TO FOOTBALL, CHRISTMAS TREE ORNAMENTS EXCLUDING CONFECTIONERY OR ILLUMINATION ARTICLES, BALLOONS, JIGSAW PUZZLES, TOY AND DECORATIVE WIND-SOCKS, KITES, TOY MODEL TRUCKS, BILLIARD BALLS, DART BOARDS, PLAYING CARDS, TOY REPLICA MINIATURE FOOTBALL HELMETS (U.S. CLS. 22, 23, 38 AND 50).

CLASS 41—EDUCATION AND ENTERTAINMENT

FOR ENTERTAINMENT SERVICES, NAMELY PRESENTATIONS IN THE NATURE OF PROFESSIONAL FOOTBALL GAMES AND EXHIBITIONS (U.S. CLS. 100, 101 AND 107).

MICHAEL TANNER, EXAMINING ATTORNEY

SN 77-167,884. MERCURY COMPUTER SYSTEMS, INC., CHELMSFORD, MA. FILED 4-27-2007.

VISAGE IMAGING

THE MARK CONSISTS OF STANDARD CHARACTERS WITHOUT CLAIM TO ANY PARTICULAR FONT, STYLE, SIZE, OR COLOR.

OWNER OF U.S. REG. NO. 3,107,713.

NO CLAIM IS MADE TO THE EXCLUSIVE RIGHT TO USE "IMAGING", APART FROM THE MARK AS SHOWN.

CLASS 9—ELECTRICAL AND SCIENTIFIC APPARATUS

FOR COMPUTER SOFTWARE FOR MEDICAL IMAGING (U.S. CLS. 21, 23, 26, 36 AND 38).

CLASS 44—MEDICAL, BEAUTY AND AGRICULTURAL SERVICES

FOR MEDICAL IMAGING SERVICES (U.S. CLS. 100 AND 101).
REBECCA GILBERT, EXAMINING ATTORNEY

SN 77-168,469. REPASKY, THOMAS HENRY, MOUNTAIN VIEW, CA. AND REPASKY, SUSAN ISABELLA, MOUNTAIN VIEW, CA. FILED 4-29-2007.

webtoes

THE MARK CONSISTS OF STANDARD CHARACTERS WITHOUT CLAIM TO ANY PARTICULAR FONT, STYLE, SIZE, OR COLOR.

SN 77-168,051. CRAWFORD & COMPANY, ATLANTA, GA. FILED 4-27-2007.

CRAWFORD CMS2

THE MARK CONSISTS OF STANDARD CHARACTERS WITHOUT CLAIM TO ANY PARTICULAR FONT, STYLE, SIZE, OR COLOR.
OWNER OF U.S. REG. NOS. 1,819,880 AND 1,821,260.

CLASS 41—EDUCATION AND ENTERTAINMENT

FOR BOOK AND REVIEW PUBLISHING (U.S. CLS. 100, 101 AND 107).

CLASS 9—ELECTRICAL AND SCIENTIFIC APPARATUS

FOR COMPUTER SOFTWARE FOR USE WITH CLAIMS ADJUSTMENT IN THE FIELD OF INSURANCE, INSURANCE CLAIMS ADMINISTRATION AND INSURANCE CLAIMS PROCESSING (U.S. CLS. 21, 23, 26, 36 AND 38).

CLASS 42—SCIENTIFIC, COMPUTER AND LEGAL SERVICES

FOR DESIGN OF HOMEPAGES AND WEBSITES (U.S. CLS. 100 AND 101).
ELIZABETH HUGHITT, EXAMINING ATTORNEY

CLASS 36—INSURANCE AND FINANCIAL

FOR INSURANCE SERVICES, NAMELY, CLAIMS ADMINISTRATION SERVICES AND INSURANCE CLAIMS PROCESSING (U.S. CLS. 100, 101 AND 102).
DEIRDRE ROBERTSON, EXAMINING ATTORNEY

SN 77-170,120. GRANBY INDUSTRIES LIMITED PARTNERSHIP, OAKVILLE, CANADA, FILED 5-1-2007.

PROTEC 20

THE MARK CONSISTS OF STANDARD CHARACTERS WITHOUT CLAIM TO ANY PARTICULAR FONT, STYLE, SIZE, OR COLOR.

SN 77-168,101. MUSCOGEE (CREEK) NATION, DBA GAMING OPERATIONS AUTHORITY BOARD, TULSA, OK. FILED 4-27-2007.

CLASS 2—PAINTS

FOR POLYURETHANE COATING FOR USE ON THE EXTERIOR OF STEEL STORAGE TANKS (U.S. CLS. 6, 11 AND 16).

RIVER SPIRIT

THE MARK CONSISTS OF STANDARD CHARACTERS WITHOUT CLAIM TO ANY PARTICULAR FONT, STYLE, SIZE, OR COLOR.

CLASS 6—METAL GOODS

FOR STEEL STORAGE TANKS FOR COMMERCIAL AND RESIDENTIAL USE, SOLD EMPTY (U.S. CLS. 2, 12, 13, 14, 23, 25 AND 50).
LEIGH CAROLINE CASE, EXAMINING ATTORNEY

CLASS 41—EDUCATION AND ENTERTAINMENT

FOR CASINOS; CONDUCTING AND PROVIDING FACILITIES FOR SPECIAL EVENTS FEATURING CASINO AND GAMING CONTESTS AND TOURNAMENTS; ENTERTAINMENT, NAMELY LIVE PERFORMANCES BY MUSICAL BANDS (U.S. CLS. 100, 101 AND 107).

SN 77-170,130. GRANBY INDUSTRIES LIMITED PARTNERSHIP, OAKVILLE, CANADA, FILED 5-1-2007.

GREENSHIELD

CLASS 43—HOTEL AND RESTAURANT SERVICES

FOR HOTEL SERVICES (U.S. CLS. 100 AND 101).
KATHY DE JONGE, EXAMINING ATTORNEY

THE MARK CONSISTS OF STANDARD CHARACTERS WITHOUT CLAIM TO ANY PARTICULAR FONT, STYLE, SIZE, OR COLOR.

CLASS 2—PAINTS

FOR POLYURETHANE COATING AND POWDER PAINT COATING FOR USE ON THE EXTERIOR OF STEEL STORAGE TANKS (U.S. CLS. 6, 11 AND 16).

CLASS 6—METAL GOODS

FOR STEEL STORAGE TANKS FOR COMMERCIAL AND RESIDENTIAL USE, SOLD EMPTY (U.S. CLS. 2, 12, 13, 14, 23, 25 AND 50).

LEIGH CAROLINE CASE, EXAMINING ATTORNEY

SN 77-170,145. GRANBY INDUSTRIES LIMITED PARTNER-SHIP, OAKVILLE, CANADA, FILED 5-1-2007.

ECOGARD

THE MARK CONSISTS OF STANDARD CHARACTERS WITHOUT CLAIM TO ANY PARTICULAR FONT, STYLE, SIZE, OR COLOR.

CLASS 6—METAL GOODS

FOR STEEL STORAGE TANKS FOR COMMERCIAL AND RESIDENTIAL USE, SOLD EMPTY (U.S. CLS. 2, 12, 13, 14, 23, 25 AND 50).

CLASS 9—ELECTRICAL AND SCIENTIFIC APPARATUS

FOR LEAK DETECTION AND CATCHMENTS SYSTEMS FOR USE IN STEEL STORAGE TANKS, NAMELY, LIQUID OR GAS SENSORS, CONTROL UNITS, AND ALARMS (U.S. CLS. 21, 23, 26, 36 AND 38).

LEIGH CAROLINE CASE, EXAMINING ATTORNEY

SN 77-170,947. L.A.W.LIMITED,L.C., ALBUQUERQUE, NM. FILED 5-2-2007.

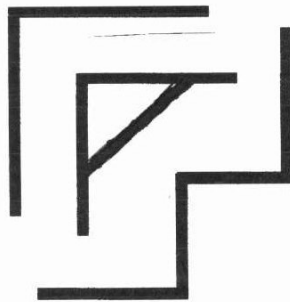

CLASS 14—JEWELRY

FOR JEWELRY (U.S. CLS. 2, 27, 28 AND 50).

CLASS 21—HOUSEWARES AND GLASS

FOR CERAMIC SCULPTURES, VASES, VESSELS, BOWLS, PLATES AND POTS; DECORATIVE CERAMIC TILES NOT FOR USE AS BUILDING MATERIALS (U.S. CLS. 2, 13, 23, 29, 30, 33, 40 AND 50).

TRACY CROSS, EXAMINING ATTORNEY

SN 77-171,074. THUY, LCC, NEW YORK, NY. FILED 5-2-2007.

Thuy

THE NAME THUY DOES NOT IDENTIFY A LIVING INDIVIDUAL. THE MARK CONSISTS OF THE STYLIZED WORDING 'THUY'.

CLASS 25—CLOTHING

FOR WEARING APPAREL, NAMELY, APRONS, BLOUSES, CAMISOLES, DRESSES, GYMWEAR; HOSIERY, JEANS, KNITWEAR; LINGERIE, LOUNGEWEAR, PANTS, SHIRTS, SHORTS, SKIRTS, SLEEPWEAR, SUITS, SWEATERS, SWEAT SHIRTS AND PANTS, SWIMWEAR, TANKTOPS, T-SHIRTS AND UNDERWEAR; OUTERWEAR, NAMELY, COATS, JACKETS, PARKAS, RAINWEAR, SHAWLS AND VESTS; ACCESSORIES, NAMELY, BELTS, GLOVES, SCARVES AND SUSPENDERS; FOOTWEAR; HEADWEAR, NAMELY, CAPS, HATS, AND VISORS (U.S. CLS. 22 AND 39).

FIRST USE 12-5-2006; IN COMMERCE 1-1-2007.

CLASS 35—ADVERTISING AND BUSINESS

FOR CATALOG, MAIL ORDER, RETAIL, WHOLESALE AND ON-LINE STORE SERVICES FEATURING CLOTHING AND ACCESSORIES (U.S. CLS. 100, 101 AND 102).

FIRST USE 12-5-2006; IN COMMERCE 1-1-2007.

JOHN HWANG, EXAMINING ATTORNEY

SN 77-172,561. GREAT GLORIOUS GRAPEVINE, INC., MALAD, ID. FILED 5-3-2007.

Great Glorious Grapevine

THE MARK CONSISTS OF STANDARD CHARACTERS WITHOUT CLAIM TO ANY PARTICULAR FONT, STYLE, SIZE, OR COLOR.

CLASS 9—ELECTRICAL AND SCIENTIFIC APPARATUS

FOR DOWNLOADABLE MP3 FILES, MP3 RECORDINGS, ONLINE DISCUSSION BOARDS, WEB CASTS, POD CASTS FEATURING MUSIC, AUDIO BOOKS AND NEWS BROADCASTS; PRE-RECORDED CDS, VIDEO TAPES, LASER DISKS AND DVDS FEATURING MUSIC AND LIVE PERFORMANCES (U.S. CLS. 21, 23, 26, 36 AND 38).

CLASS 25—CLOTHING

FOR JACKETS; PANTS; T-SHIRTS (U.S. CLS. 22 AND 39).

CLASS 35—ADVERTISING AND BUSINESS

FOR PROVIDING ON-LINE DIRECTORY INFORMATION SERVICES ALSO FEATURING HYPERLINKS TO OTHER WEB SITES (U.S. CLS. 100, 101 AND 102).
FIRST USE 5-1-1991; IN COMMERCE 6-21-1995.

CLASS 41—EDUCATION AND ENTERTAINMENT

FOR ENTERTAINMENT NAMELY, LIVE PERFORMANCES BY A MUSICAL BAND; ENTERTAINMENT, NAMELY LIVE MUSIC CONCERTS (U.S. CLS. 100, 101 AND 107).
REBECCA GAN, EXAMINING ATTORNEY

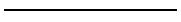

SN 77-172,762. OTG MANAGEMENT, INC., PHILADELPHIA, PA. FILED 5-4-2007.

OTGI

THE MARK CONSISTS OF STANDARD CHARACTERS WITHOUT CLAIM TO ANY PARTICULAR FONT, STYLE, SIZE, OR COLOR.

CLASS 35—ADVERTISING AND BUSINESS

FOR MANAGEMENT AND OPERATION OF RETAIL STORES AND KIOSKS FOR OTHERS FEATURING COMPUTERS AND INFORMATION TECHNOLOGY EQUIPMENT AT AIRPORTS (U.S. CLS. 100, 101 AND 102).

CLASS 42—SCIENTIFIC, COMPUTER AND LEGAL SERVICES

FOR INFORMATION TECHNOLOGY CONSULTING SERVICES; COMPUTER SERVICES, NAMELY, REMOTE AND ON-SITE MANAGEMENT OF COMPUTER AND INFORMATION TECHNOLOGY APPLICATIONS FOR OTHERS (U.S. CLS. 100 AND 101).
KARANENDRA S. CHHINA, EXAMINING ATTORNEY



SN 77-172,765. OTG MANAGEMENT, INC., PHILADELPHIA, PA. FILED 5-4-2007.

OTGInteractive

THE MARK CONSISTS OF STANDARD CHARACTERS WITHOUT CLAIM TO ANY PARTICULAR FONT, STYLE, SIZE, OR COLOR.

CLASS 35—ADVERTISING AND BUSINESS

FOR MANAGEMENT AND OPERATION OF RETAIL STORES AND KIOSKS FOR OTHERS FEATURING COMPUTERS AND INFORMATION TECHNOLOGY EQUIPMENT AT AIRPORTS (U.S. CLS. 100, 101 AND 102).

CLASS 42—SCIENTIFIC, COMPUTER AND LEGAL SERVICES

FOR INFORMATION TECHNOLOGY CONSULTING SERVICES; COMPUTER SERVICES, NAMELY, REMOTE AND ON-SITE MANAGEMENT OF COMPUTER AND INFORMATION TECHNOLOGY APPLICATIONS FOR OTHERS (U.S. CLS. 100 AND 101).
KARANENDRA S. CHHINA, EXAMINING ATTORNEY

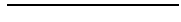

SN 77-174,725. MIDWEST PRINTING, INCORPORATED, WHEATON, IL. FILED 5-7-2007.

Glidulator

THE MARK CONSISTS OF STANDARD CHARACTERS WITHOUT CLAIM TO ANY PARTICULAR FONT, STYLE, SIZE, OR COLOR.

CLASS 6—METAL GOODS

FOR DISPENSING CAPS MADE PRIMARILY OF METAL TO DELIVER GRADUATED AMOUNTS OF MATERIALS FROM CONTAINERS (U.S. CLS. 2, 12, 13, 14, 23, 25 AND 50).

CLASS 20—FURNITURE AND ARTICLES NOT OTHERWISE CLASSIFIED

FOR DISPENSING CAPS MADE PRIMARILY NOT FROM METAL TO DELIVER GRADUATED AMOUNTS OF MATERIALS FROM CONTAINERS (U.S. CLS. 2, 13, 22, 25, 32 AND 50).
JANICE L. MCMORROW, EXAMINING ATTORNEY

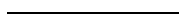

SN 77-175,510. AMERICAN HARDWARE MANUFACTURERS ASSOCIATION, SCHAUMBURG, IL. FILED 5-8-2007.



OWNER OF U.S. REG. NOS. 2,354,581 AND 2,402,551.

CLASS 35—ADVERTISING AND BUSINESS

FOR ARRANGING AND CONDUCTING BUSINESS CONFERENCES FOR NON-COMPUTER RELATED HARDWARE MANUFACTURERS AND THEIR TRADE CUSTOMERS; PROMOTING AND CONDUCTING TRADE SHOWS FOR NON-COMPUTER RELATED HARDWARE MANUFACTURERS AND THEIR TRADE CUSTOMERS; PREPARING BUSINESS REPORTS FOR TECHNOLOGY APPLICATIONS FOR NON-COMPUTER RELATED HARDWARE MANUFACTURERS TO PROMOTE GREATER UNDERSTANDING AND UTILIZATION OF TECHNOLOGY IN THE MARKETPLACE (U.S. CLS. 100, 101 AND 102).

FIRST USE 4-22-2007; IN COMMERCE 4-22-2007.

CLASS 41—EDUCATION AND ENTERTAINMENT

FOR ARRANGING AND CONDUCTING EDUCATIONAL CONFERENCES FOR NON-COMPUTER RELATED HARDWARE MANUFACTURERS AND THEIR TRADE CUSTOMERS (U.S. CLS. 100, 101 AND 107).

FIRST USE 4-22-2007; IN COMMERCE 4-22-2007.
PRISCILLA MILTON, EXAMINING ATTORNEY

SN 77-175,780. CARNIVAL CORPORATION, MIAMI, FL.
FILED 5-8-2007.

CARNIVAL ELATION

THE MARK CONSISTS OF STANDARD CHARACTERS WITHOUT CLAIM TO ANY PARTICULAR FONT, STYLE, SIZE, OR COLOR.

OWNER OF U.S. REG. NOS. 1,495,405, 3,189,529 AND OTHERS.

CLASS 39—TRANSPORTATION AND STORAGE

FOR CRUISE SHIP SERVICES (U.S. CLS. 100 AND 105).

CLASS 41—EDUCATION AND ENTERTAINMENT

FOR ENTERTAINMENT SERVICES, NAMELY, CASINO SERVICES, ORGANIZING AND CONDUCTING STAGE SHOWS, NIGHTCLUB SHOWS, CONTESTS, DANCES AND PARTIES (U.S. CLS. 100, 101 AND 107).

CLASS 43—HOTEL AND RESTAURANT SERVICES

FOR HOTEL SERVICES AND RESTAURANT SERVICES (U.S. CLS. 100 AND 101).

MARCIE MILONE, EXAMINING ATTORNEY

SN 77-175,777. CARNIVAL CORPORATION, MIAMI, FL.
FILED 5-8-2007.

CARNIVAL FASCINATION

THE MARK CONSISTS OF STANDARD CHARACTERS WITHOUT CLAIM TO ANY PARTICULAR FONT, STYLE, SIZE, OR COLOR.

OWNER OF U.S. REG. NOS. 1,495,405, 3,189,529 AND OTHERS.

CLASS 39—TRANSPORTATION AND STORAGE

FOR CRUISE SHIP SERVICES (U.S. CLS. 100 AND 105).

CLASS 41—EDUCATION AND ENTERTAINMENT

FOR ENTERTAINMENT SERVICES, NAMELY, CASINO SERVICES, ORGANIZING AND CONDUCTING STAGE SHOWS, NIGHTCLUB SHOWS, CONTESTS, DANCES AND PARTIES (U.S. CLS. 100, 101 AND 107).

CLASS 43—HOTEL AND RESTAURANT SERVICES

FOR HOTEL SERVICES AND RESTAURANT SERVICES (U.S. CLS. 100 AND 101).

MARCIE MILONE, EXAMINING ATTORNEY

SN 77-175,787. CARNIVAL CORPORATION, MIAMI, FL.
FILED 5-8-2007.

CARNIVAL ECSTASY

THE MARK CONSISTS OF STANDARD CHARACTERS WITHOUT CLAIM TO ANY PARTICULAR FONT, STYLE, SIZE, OR COLOR.

OWNER OF U.S. REG. NOS. 1,495,405, 3,189,529 AND OTHERS.

CLASS 39—TRANSPORTATION AND STORAGE

FOR CRUISE SHIP SERVICES (U.S. CLS. 100 AND 105).

CLASS 41—EDUCATION AND ENTERTAINMENT

FOR ENTERTAINMENT SERVICES, NAMELY, CASINO SERVICES, ORGANIZING AND CONDUCTING STAGE SHOWS, NIGHTCLUB SHOWS, CONTESTS, DANCES AND PARTIES (U.S. CLS. 100, 101 AND 107).

CLASS 43—HOTEL AND RESTAURANT SERVICES

FOR HOTEL SERVICES AND RESTAURANT SERVICES (U.S. CLS. 100 AND 101).

MARCIE MILONE, EXAMINING ATTORNEY

SN 77-175,793. CARNIVAL CORPORATION, MIAMI, FL.
FILED 5-8-2007.

SN 77-175,804. CARNIVAL CORPORATION, MIAMI, FL.
FILED 5-8-2007.

CARNIVAL SENSATION

THE MARK CONSISTS OF STANDARD CHARACTERS WITHOUT CLAIM TO ANY PARTICULAR FONT, STYLE, SIZE, OR COLOR.

OWNER OF U.S. REG. NOS. 1,495,405, 3,189,529 AND OTHERS.

CLASS 39—TRANSPORTATION AND STORAGE

FOR CRUISE SHIP SERVICES (U.S. CLS. 100 AND 105).

CLASS 41—EDUCATION AND ENTERTAINMENT

FOR ENTERTAINMENT SERVICES, NAMELY, CASINO SERVICES, ORGANIZING AND CONDUCTING STAGE SHOWS, NIGHTCLUB SHOWS, CONTESTS, DANCES AND PARTIES (U.S. CLS. 100, 101 AND 107).

CLASS 43—HOTEL AND RESTAURANT SERVICES

FOR HOTEL SERVICES AND RESTAURANT SERVICES (U.S. CLS. 100 AND 101).
MARCIE MILONE, EXAMINING ATTORNEY

SN 77-175,798. CARNIVAL CORPORATION, MIAMI, FL.
FILED 5-8-2007.

CARNIVAL PARADISE

THE MARK CONSISTS OF STANDARD CHARACTERS WITHOUT CLAIM TO ANY PARTICULAR FONT, STYLE, SIZE, OR COLOR.

OWNER OF U.S. REG. NOS. 1,495,405, 3,189,529 AND OTHERS.

CLASS 39—TRANSPORTATION AND STORAGE

FOR CRUISE SHIP SERVICES (U.S. CLS. 100 AND 105).

CLASS 41—EDUCATION AND ENTERTAINMENT

FOR ENTERTAINMENT SERVICES, NAMELY, CASINO SERVICES, ORGANIZING AND CONDUCTING STAGE SHOWS, NIGHTCLUB SHOWS, CONTESTS, DANCES AND PARTIES (U.S. CLS. 100, 101 AND 107).

CLASS 43—HOTEL AND RESTAURANT SERVICES

FOR HOTEL SERVICES AND RESTAURANT SERVICES (U.S. CLS. 100 AND 101).
MARCIE MILONE, EXAMINING ATTORNEY

CARNIVAL IMAGINATION

THE MARK CONSISTS OF STANDARD CHARACTERS WITHOUT CLAIM TO ANY PARTICULAR FONT, STYLE, SIZE, OR COLOR.

OWNER OF U.S. REG. NOS. 1,495,405, 3,189,529 AND OTHERS.

CLASS 39—TRANSPORTATION AND STORAGE

FOR CRUISE SHIP SERVICES (U.S. CLS. 100 AND 105).

CLASS 41—EDUCATION AND ENTERTAINMENT

FOR ENTERTAINMENT SERVICES, NAMELY, CASINO SERVICES, ORGANIZING AND CONDUCTING STAGE SHOWS, NIGHTCLUB SHOWS, CONTESTS, DANCES AND PARTIES (U.S. CLS. 100, 101 AND 107).

CLASS 43—HOTEL AND RESTAURANT SERVICES

FOR HOTEL SERVICES AND RESTAURANT SERVICES (U.S. CLS. 100 AND 101).
MARCIE MILONE, EXAMINING ATTORNEY

SN 77-176,613. HARRAH'S LICENSE COMPANY, LLC, LAS VEGAS, NV. FILED 5-9-2007.

Total Concierge

THE MARK CONSISTS OF STANDARD CHARACTERS WITHOUT CLAIM TO ANY PARTICULAR FONT, STYLE, SIZE, OR COLOR.

OWNER OF U.S. REG. NOS. 2,209,160, 2,830,063 AND OTHERS.

NO CLAIM IS MADE TO THE EXCLUSIVE RIGHT TO USE "CONCIERGE", APART FROM THE MARK AS SHOWN.

CLASS 41—EDUCATION AND ENTERTAINMENT

FOR CASINO SERVICES FEATURING DISCOUNTS AND COMPLEMENTARY SERVICES FOR FREQUENT PATRONS THROUGH THE USE OF AN IDENTIFICATION CARD (U.S. CLS. 100, 101 AND 107).

CLASS 43—HOTEL AND RESTAURANT SERVICES

FOR HOTEL SERVICES, NAMELY, A FREQUENT GUEST REWARD PROGRAM WITH ADDED FEATURES WHICH ALLOW PARTICIPANTS TO EARN FREE OR DISCOUNTED LODGING, COMPLEMENTARY SERVICES AND OTHER TRAVEL-RELATED BENEFITS (U.S. CLS. 100 AND 101).
JULIE THOMAS, EXAMINING ATTORNEY

SN 77-176,891. MONZON, VICTOR J., MIAMI, FL. FILED 5-9-2007.

SN 77-177,301. FINISHRICH MEDIA, LLC, NEW YORK, NY. FILED 5-10-2007.

MONZ

THE MARK CONSISTS OF STANDARD CHARACTERS WITHOUT CLAIM TO ANY PARTICULAR FONT, STYLE, SIZE, OR COLOR.

CLASS 36—INSURANCE AND FINANCIAL

FOR APPRAISAL OF REAL ESTATE; APPRAISALS FOR INSURANCE CLAIMS OF REAL ESTATE; ASSESSMENT AND MANAGEMENT OF REAL ESTATE; ESTATE PLANNING; ESTATE TRUST MANAGEMENT; EVALUATION OF REAL PROPERTY; FINANCIAL INVESTMENT IN THE FIELD OF REAL ESTATE; FINANCIAL SERVICES, NAMELY, ESTATE SETTLEMENT SERVICES; FINANCIAL VALUATION OF PERSONAL PROPERTY AND REAL ESTATE; HOUSING SERVICES, NAMELY, REAL PROPERTY ACQUISITION AND CONSUMER FINANCING TO FACILITATE HOME OWNERSHIP; LAND ACQUISITION, NAMELY, REAL ESTATE BROKERAGE; LEASING OF REAL ESTATE; LEASING OF REAL PROPERTY; PROVIDING INFORMATION IN THE FIELD OF REAL ESTATE BY MEANS OF LINKING THE WEB SITE TO OTHER WEB SITES FEATURING REAL ESTATE INFORMATION; PROVIDING INFORMATION IN THE FIELD OF REAL ESTATE VIA THE INTERNET; PROVIDING ONLINE INFORMATION IN THE FIELD CHARITABLE MONETARY GIVING THROUGH FINANCIAL AND ESTATE PLANNING; PROVIDING REAL ESTATE LISTINGS AND REAL ESTATE INFORMATION VIA THE INTERNET; REAL ESTATE ACQUISITION SERVICES; REAL ESTATE AGENCIES; REAL ESTATE APPRAISAL; REAL ESTATE BROKERAGE; REAL ESTATE CONSULTANCY; REAL ESTATE CONSULTATION; REAL ESTATE EQUITY SHARING, NAMELY, MANAGING AND ARRANGING FOR CO-OWNERSHIP OF REAL ESTATE; REAL ESTATE ESCROW SERVICES; REAL ESTATE INVESTMENT; REAL ESTATE LENDING SERVICES; REAL ESTATE LISTING; REAL ESTATE MANAGEMENT; REAL ESTATE MANAGEMENT CONSULTATION; REAL ESTATE MULTIPLE LISTING SERVICES; REAL ESTATE PROCUREMENT FOR OTHERS; REAL ESTATE SERVICES, NAMELY, RENTAL OF VACATION HOMES, CONDOMINIUMS, CABINS, AND VILLAS USING PAY PER CLICK ADVERTISING ON A GLOBAL COMPUTER NETWORK; REAL ESTATE SYNDICATION; REAL ESTATE TIME-SHARING; REAL ESTATE TRUSTEE SERVICES; REAL ESTATE VALUATION SERVICES; REAL ESTATE VALUATIONS; VACATION REAL ESTATE TIME SHARE EXCHANGE SERVICES; VACATION REAL ESTATE TIME-SHARING; VACATION REAL ESTATE TIMESHARE SERVICES (U.S. CLS. 100, 101 AND 102).

CLASS 37—CONSTRUCTION AND REPAIR

FOR HOUSING SERVICES, NAMELY, DEVELOPMENT OF REAL PROPERTY, NAMELY, REPAIR, IMPROVEMENT, AND NEW CONSTRUCTION; HOUSING SERVICES, NAMELY, REPAIR, IMPROVEMENT, AND CONSTRUCTION OF RESIDENTIAL REAL PROPERTY; REAL ESTATE DEVELOPMENT; REAL ESTATE SITE SELECTION (U.S. CLS. 100, 103 AND 106).

HOWARD SMIGA, EXAMINING ATTORNEY

FIGHT FOR YOUR MONEY

THE MARK CONSISTS OF STANDARD CHARACTERS WITHOUT CLAIM TO ANY PARTICULAR FONT, STYLE, SIZE, OR COLOR.

CLASS 9—ELECTRICAL AND SCIENTIFIC APPARATUS

FOR A SERIES OF PRE-RECORDED CD-ROMS, AUDIO CASSETTE TAPES, VIDEOTAPES AND DVDS FEATURING INVESTMENT ADVICE AND FINANCIAL PLANNING (U.S. CLS. 21, 23, 26, 36 AND 38).

CLASS 16—PAPER GOODS AND PRINTED MATTER

FOR A SERIES OF NON-FICTION BOOKS IN THE FIELDS OF INVESTMENT ADVICE AND FINANCIAL PLANNING; NEWSLETTERS IN THE FIELDS OF INVESTMENT ADVICE AND FINANCIAL PLANNING (U.S. CLS. 2, 5, 22, 23, 29, 37, 38 AND 50).

CLASS 41—EDUCATION AND ENTERTAINMENT

FOR EDUCATIONAL SERVICES, NAMELY, CONDUCTING SEMINARS IN THE FIELDS OF INVESTMENT ADVICE AND FINANCIAL PLANNING (U.S. CLS. 100, 101 AND 107).

JULIE GUTTADAURO, EXAMINING ATTORNEY

SN 77-177,610. PROMINIC TECHNOLOGIES, INC., CHAMPAIGN, IL. FILED 5-10-2007.



THE MARK CONSISTS OF AN OVAL WITH THE WORD PROMINIC FEATURED ACROSS THE TOP. THE INSIDE IS A FIELD OF SQUARES, WHICH CREATES THE ILLUSION OF A HORIZON.

CLASS 9—ELECTRICAL AND SCIENTIFIC APPARATUS

FOR COMPUTER SOFTWARE FOR USE IN COMPUTER NETWORK INSTALLATION AND FOR USE IN MANAGING AND CREATING ELECTRONIC DATABASES (U.S. CLS. 21, 23, 26, 36 AND 38).

FIRST USE 10-1-1996; IN COMMERCE 10-1-1996.

CLASS 42—SCIENTIFIC, COMPUTER AND LEGAL SERVICES

FOR DESIGN OF COMPUTER NETWORKS AND SOFTWARE FOR OTHERS FOR THE USE IN COMPUTER WORK STATION SYSTEMS; COMPUTER SERVICE, NAMELY, ACTING AS AN APPLICATION SERVICE PROVIDER IN THE FIELD OF KNOWLEDGE MANAGEMENT TO HOST COMPUTER APPLICATION SOFTWARE FOR SEARCHING AND RETRIEVING INFORMATION FROM DATABASES AND COMPUTER NETWORKS (U.S. CLS. 100 AND 101).

FIRST USE 10-1-1996; IN COMMERCE 10-1-1996.
JOHN KELLY, EXAMINING ATTORNEY

SN 77-177,634. PROMINIC TECHNOLOGIES, INC., CHAMPAIGN, IL. FILED 5-10-2007.

Prominic.NET

THE MARK CONSISTS OF STANDARD CHARACTERS WITHOUT CLAIM TO ANY PARTICULAR FONT, STYLE, SIZE, OR COLOR.

CLASS 9—ELECTRICAL AND SCIENTIFIC APPARATUS

FOR COMPUTER SOFTWARE FOR USE IN COMPUTER NETWORK INSTALLATION AND FOR USE IN MANAGING AND CREATING ELECTRONIC DATABASES (U.S. CLS. 21, 23, 26, 36 AND 38).

FIRST USE 7-11-1996; IN COMMERCE 7-11-1996.

CLASS 42—SCIENTIFIC, COMPUTER AND LEGAL SERVICES

FOR COMPUTER SERVICE, NAMELY, ACTING AS AN APPLICATION SERVICE PROVIDER IN THE FIELD OF KNOWLEDGE MANAGEMENT TO HOST COMPUTER APPLICATION SOFTWARE FOR CREATING SEARCHABLE DATABASES OF INFORMATION AND DATA (U.S. CLS. 100 AND 101).

FIRST USE 7-11-1996; IN COMMERCE 7-11-1996.
JOHN KELLY, EXAMINING ATTORNEY

SN 77-178,412. DEX MEDIA, INC., ENGLEWOOD, CO. FILED 5-11-2007.

POWERED BY DEX

THE MARK CONSISTS OF STANDARD CHARACTERS WITHOUT CLAIM TO ANY PARTICULAR FONT, STYLE, SIZE, OR COLOR.

CLASS 16—PAPER GOODS AND PRINTED MATTER

FOR PRINTED TELEPHONE DIRECTORIES (U.S. CLS. 2, 5, 22, 23, 29, 37, 38 AND 50).

CLASS 35—ADVERTISING AND BUSINESS

FOR TELEPHONE DIRECTORY AND ADVERTISING SERVICES, NAMELY, PROMOTING THE GOODS AND SERVICES OF OTHERS VIA THE PREPARATION AND DISSEMINATION OF ADVERTISEMENTS AND LISTINGS AND VIA CONSULTING SERVICES RELATED THERETO, AND PLACING SUCH ADVERTISEMENTS AND LISTINGS IN PRINTED PUBLICATIONS AND DIRECTORIES, AND IN ON-LINE PUBLICATIONS AND DIRECTORIES; COMPUTER SERVICES, NAMELY, PROVIDING ON-LINE TELEPHONE DIRECTORIES AND SHOPPER INFORMATION GUIDES VIA THE GLOBAL COMPUTER NETWORK; BUSINESS MARKETING AND DIRECT MAIL CONSULTING SERVICES (U.S. CLS. 100, 101 AND 102).

CLASS 41—EDUCATION AND ENTERTAINMENT

FOR PUBLICATION OF TELEPHONE DIRECTORIES (U.S. CLS. 100, 101 AND 107).

CLASS 42—SCIENTIFIC, COMPUTER AND LEGAL SERVICES

FOR COMPUTER SERVICES AND WEBSITE CONSULTING SERVICES, NAMELY, DESIGNING, DEVELOPING, HOSTING, AND MAINTAINING THE WEBSITES OF OTHERS ON A COMPUTER SERVER FOR A GLOBAL COMPUTER NETWORK; CONSULTING AND ADVICE IN THE FIELD OF DESIGNING, DEVELOPING, HOSTING, MAINTAINING, AND MANAGING ONLINE COMMERCE WEBSITES; CREATING INDEXES OF SEARCHABLE INFORMATION, WEBSITES, KEYWORDS, AND OTHER RESOURCES AVAILABLE ON A GLOBAL COMPUTER NETWORK (U.S. CLS. 100 AND 101).

JILL PRATER, EXAMINING ATTORNEY

SN 77-179,186. NAVAJO AGRICULTURAL PRODUCTS INDUSTRY, FARMINGTON, NM. FILED 5-11-2007.



"THE COLOR(S) GREEN, WHITE AND GRAY IS/ARE CLAIMED AS A FEATURE OF THE MARK."

"THE MARK CONSISTS OF AGRICULTURAL FIELDS IN GREEN; THE WHITE STRIPES REPRESENT ROWS OF CROPS; AND GRAY APPEARS IN THE MOUNTAINS IN THE BACKGROUND AND THE BRAND NAME NAVAJO PRIDE."

CLASS 30—STAPLE FOODS

FOR WHITE FLOUR; WHEAT FLOUR, FRY BREAD MIX (U.S. CL. 46).

FIRST USE 10-1-2003; IN COMMERCE 10-1-2003.

CLASS 31—NATURAL AGRICULTURAL PRODUCTS

FOR UNPROCESSED PINTO AND GARBANZO BEANS; UNPROCESSED CORN; UNPROCESSED BLUE CORN; UNPROCESSED ONIONS; UNPROCESSED POTATOES; UNPROCESSED WHEAT; UNPROCESSED SMALL GRAINS; UNPROCESSED PUMPKIN AND SQUASH; UNPROCESSED POPCORN; FRESH FRUIT, NAMELY APPLES, CHERRIES, AND APRICOTS; LIVE-STOCK FEED (U.S. CLS. 1 AND 46).

FIRST USE 10-1-2003; IN COMMERCE 10-1-2003.
KATHLEEN M. VANSTON, EXAMINING ATTORNEY

CLASS 11—ENVIRONMENTAL CONTROL APPARATUS

FOR ELECTRICAL FAN THAT HAS A SPACE AT THE BASE OF THE FAN TO SHOW UP TO FOUR DIFFERENT ELECTRONIC MESSAGES (U.S. CLS. 13, 21, 23, 31 AND 34).

CLASS 28—TOYS AND SPORTING GOODS

FOR RADAR DEVICE IN THE FORM OF A BASEBALL THAT DISPLAYS THE SPEED OF A PITCH (U.S. CLS. 22, 23, 38 AND 50).

C. DIONNE CLYBURN, EXAMINING ATTORNEY

SN 77-180,911. JONATHAN B. LEVINE, DMD, P.C., NEW YORK, NY. FILED 5-15-2007.

SN 77-181,595. MEADWESTVACO CORPORATION, GLEN ALLEN, VA. FILED 5-15-2007.

SMILE ADDICT

THE MARK CONSISTS OF STANDARD CHARACTERS WITHOUT CLAIM TO ANY PARTICULAR FONT, STYLE, SIZE, OR COLOR.

CLASS 3—COSMETICS AND CLEANING PREPARATIONS

FOR ORAL CARE PRODUCTS, NAMELY, TOOTH WHITENING GELS, LIQUIDS AND CREAMS, TOOTH WHITENING MAINTENANCE PRODUCTS, NAMELY, TOOTH WHITENING GELS, LIQUIDS AND CREAMS, LIP-GLOSS, LIPSTICK, LIP BALM, TOOTHPASTES, BREATH FRESHENERS, NAMELY, NON-MEDICATED DILUTED BREATH SPRAYS USED AS MOUTHWASH, AND NON-MEDICATED CONCENTRATED BREATH SPRAYS, NON-MEDICATED MOUTHWASHES, NON-MEDICATED ORAL BREATH FRESHENING SPRAYS AND BREATH FRESHENING CONFECTIONERY, NAMELY, DISSOLVABLE BREATH MINTS AND CHEWING GUM (U.S. CLS. 1, 4, 6, 50, 51 AND 52).

CLASS 44—MEDICAL, BEAUTY AND AGRICULTURAL SERVICES

FOR DENTIST SERVICES (U.S. CLS. 100 AND 101).
JUSTINE D. PARKER, EXAMINING ATTORNEY

SN 77-181,326. TRS QUALITY, INC., FORT WORTH, TX. FILED 5-15-2007.

PRESIDIAN

THE MARK CONSISTS OF STANDARD CHARACTERS WITHOUT CLAIM TO ANY PARTICULAR FONT, STYLE, SIZE, OR COLOR.

OWNER OF U.S. REG. NOS. 3,228,831, 3,228,833 AND OTHERS.

DAY | RUNNER

OWNER OF U.S. REG. NOS. 1,946,378, 3,045,735 AND OTHERS.

THE MARK CONSISTS OF THE WORDS DAY RUNNER WITH A VERTICAL LINE SEPARATING THE TWO WORDS.

CLASS 16—PAPER GOODS AND PRINTED MATTER

FOR APPOINTMENT BOOKS; DESK CALENDARS; FILE FOLDERS; PAPER HANG TAGS; STORAGE CONTAINERS MADE OF PAPER; WALL CALENDARS (U.S. CLS. 2, 5, 22, 23, 29, 37, 38 AND 50).

CLASS 20—FURNITURE AND ARTICLES NOT OTHERWISE CLASSIFIED

FOR PLASTIC BOXES; PLASTIC HANG TAGS (U.S. CLS. 2, 13, 22, 25, 32 AND 50).

TEJBIR SINGH, EXAMINING ATTORNEY

SN 77-182,018. YARASH ENTERPRISES, LLC, BRIARCLIFF MANOR, NY. FILED 5-15-2007.

YARASH

THE MARK CONSISTS OF STANDARD CHARACTERS WITHOUT CLAIM TO ANY PARTICULAR FONT, STYLE, SIZE, OR COLOR.

THE FOREIGN WORDING IN THE MARK TRANSLATES INTO ENGLISH AS DISPOSSESS, DISINHERIT OR INHERIT.

CLASS 3—COSMETICS AND CLEANING PREPARATIONS

FOR PERFUME, EAU DE PARFUM, EAU DE TOILETTE AND COLOGNE (U.S. CLS. 1, 4, 6, 50, 51 AND 52).

CLASS 25—CLOTHING

FOR CLOTHING, NAMELY SHIRTS, T-SHIRTS, JERSEYS, SWEATERS, BLOUSES, PANTS, SHORTS, UNDERGARMENTS, HATS, SHOES, BOOTS, SLIPPERS, SLEEPWEAR, ROBES, JUMPERS, SWIMWEAR, SKIRTS, DRESSES AND JACKETS (U.S. CLS. 22 AND 39).

ANDREA SAUNDERS, EXAMINING ATTORNEY

SN 77-183,444. WOLVERINE OUTDOORS, INC., ROCKFORD, MI. FILED 5-17-2007.

COPPERTEC

THE MARK CONSISTS OF STANDARD CHARACTERS WITHOUT CLAIM TO ANY PARTICULAR FONT, STYLE, SIZE, OR COLOR.

CLASS 24—FABRICS

FOR FABRIC FOR THE MANUFACTURE OF FOOTWEAR AND CLOTHING (U.S. CLS. 42 AND 50).

CLASS 25—CLOTHING

FOR FOOTWEAR; CLOTHING, NAMELY, SHIRTS, SWEATSHIRTS, SWEATERS, PANTS, SHORTS, SKIRTS, JACKETS, VESTS, COATS, HATS, GLOVES, UNDERWEAR, SCARVES, SOCKS AND BELTS (U.S. CLS. 22 AND 39).

WANDA KAY PRICE, EXAMINING ATTORNEY

SN 77-183,292. NEW YORK FOOTBALL GIANTS, INC., EAST RUTHERFORD, NJ. FILED 5-17-2007.



OWNER OF U.S. REG. NOS. 1,174,597, 3,005,335 AND OTHERS.

THE MARK CONSISTS OF A STYLIZED DESIGN OF THE WORDS "NY GIANTS".

SEC. 2(F) AS TO "NY".

SN 77-184,595. SHAKLEE CORPORATION, PLEASANTON, CA. FILED 5-18-2007.

CLASS 16—PAPER GOODS AND PRINTED MATTER

FOR CALENDARS, SERIES OF BOOKS RELATING TO FOOTBALL, MAGAZINES RELATING TO FOOTBALL, NEWSLETTERS RELATING TO FOOTBALL, PRINTED TICKETS TO SPORTS GAMES AND EVENTS, PICTORIAL PRINTS, SOUVENIR PROGRAMS FOR SPORTS EVENTS (U.S. CLS. 2, 5, 22, 23, 29, 37, 38 AND 50).

FIRST USE 6-0-2005; IN COMMERCE 6-0-2005.

REJUVETROL 1000

THE MARK CONSISTS OF STANDARD CHARACTERS WITHOUT CLAIM TO ANY PARTICULAR FONT, STYLE, SIZE, OR COLOR.

CLASS 3—COSMETICS AND CLEANING PREPARATIONS

FOR NON-MEDICATED SKIN CARE PREPARATIONS, LOTIONS FOR FACE AND BODY CARE; NON-MEDICATED BATH PREPARATIONS; OILS FOR TOILETRY PURPOSES; DEODORANT FOR PERSONAL USE; HAIR CARE PREPARATIONS; SHAVING PREPARATIONS; COSMETICS; SUN BLOCK AND SUNSCREEN PREPARATIONS; SELF-TANNING PREPARATIONS; DENTIFICES; ALL-PURPOSE HOUSEHOLD AND INDUSTRIAL CLEANING PREPARATIONS; LAUNDRY CARE PRODUCTS, NAMELY, LAUNDRY SOAP AND LAUNDRY FABRIC SOFTENER; DISHWASHING DETERGENTS; AND PREPARATIONS FOR CLEANING METALS (U.S. CLS. 1, 4, 6, 50, 51 AND 52).

CLASS 5—PHARMACEUTICALS

FOR DIETARY AND NUTRITIONAL SUPPLEMENTS; HERBAL SUPPLEMENTS; FOOD SUPPLEMENTS; MEAL REPLACEMENT AND DIETARY SUPPLEMENT DRINK MIXES; MEDICATED SKIN CARE PREPARATIONS; LAXATIVES; ANTIBACTERIAL CLEANER (U.S. CLS. 6, 18, 44, 46, 51 AND 52).

JILL C. ALT, EXAMINING ATTORNEY

CLASS 25—CLOTHING

FOR MEN'S, WOMEN'S AND CHILDREN'S CLOTHING, NAMELY, FLEECE TOPS AND BOTTOMS, HEADWEAR, CAPS, VISORS, SHIRTS, T-SHIRTS, SWEATSHIRTS, AND JACKETS (U.S. CLS. 22 AND 39).

FIRST USE 9-0-2005; IN COMMERCE 9-0-2005.

CLASS 28—TOYS AND SPORTING GOODS

FOR GOLF BAGS, GOLF BALLS, CHRISTMAS TREE ORNAMENTS, TOY FOOTBALLS, AND TOY CARS (U.S. CLS. 22, 23, 38 AND 50).

FIRST USE 9-0-2005; IN COMMERCE 9-0-2005.

CLASS 41—EDUCATION AND ENTERTAINMENT

FOR EDUCATION AND ENTERTAINMENT SERVICES IN THE NATURE OF ORGANIZING AND PRESENTING PROFESSIONAL FOOTBALL GAMES AND EXHIBITIONS; PROVIDING SPORTS AND ENTERTAINMENT INFORMATION VIA A GLOBAL COMPUTER NETWORK OR A COMMERCIAL ON-LINE SERVICE; FAN CLUB SERVICES; EDUCATIONAL SERVICES, NAMELY, PHYSICAL EDUCATION PROGRAMS AND SEMINARS IN THE FIELD OF FOOTBALL (U.S. CLS. 100, 101 AND 107).

FIRST USE 9-0-2005; IN COMMERCE 9-0-2005.

KATHERINE E. HALMEN, EXAMINING ATTORNEY

SN 77-187,905. CLEANTECH GROUP LLC, HOWELL, MI.
FILED 5-23-2007.

CLEANTECH

THE MARK CONSISTS OF STANDARD CHARACTERS WITHOUT CLAIM TO ANY PARTICULAR FONT, STYLE, SIZE, OR COLOR.

OWNER OF U.S. REG. NOS. 3,089,736, 3,125,962 AND OTHERS.
SEC. 2(F).

CLASS 9—ELECTRICAL AND SCIENTIFIC APPARATUS

FOR DOWNLOADABLE ELECTRONIC PUBLICATIONS IN THE NATURE OF REPORTS IN THE FIELD OF VENTURE CAPITAL AND INVESTMENT IN THE FOLLOWING INDUSTRIES ENERGY GENERATION, ENERGY STORAGE, ENERGY INFRASTRUCTURE, ENERGY EFFICIENCY, TRANSPORTATION, TRANSPORTATION LOGISTICS, WATER PURIFICATION, WATER MANAGEMENT, AIR QUALITY, NANOTECHNOLOGY, MANUFACTURING, INDUSTRIAL, AGRICULTURE, NUTRITION, MATERIALS RECOVERY, MATERIALS RECYCLING, ENVIRONMENTAL INFORMATION TECHNOLOGY AND ENABLING TECHNOLOGIES (U.S. CLS. 21, 23, 26, 36 AND 38).

FIRST USE 4-15-2002; IN COMMERCE 4-15-2002.

CLASS 16—PAPER GOODS AND PRINTED MATTER

FOR NEWSLETTERS IN THE FIELD OF VENTURE CAPITAL AND INVESTMENT AS THEY RELATE TO ENERGY GENERATION, ENERGY STORAGE, ENERGY INFRASTRUCTURE, ENERGY EFFICIENCY, TRANSPORTATION, TRANSPORTATION LOGISTICS, WATER PURIFICATION, WATER MANAGEMENT, AIR QUALITY, NANOTECHNOLOGY, MANUFACTURING, INDUSTRIAL, AGRICULTURE, NUTRITION, MATERIALS RECOVERY, MATERIALS RECYCLING, ENVIRONMENTAL INFORMATION TECHNOLOGY AND ENABLING TECHNOLOGIES; PRINTED REPORTS FEATURING VENTURE CAPITAL NEWS AND DEAL TRACKING, NEW TECHNOLOGIES AND INVESTMENT IN THE FIELDS OF ENERGY GENERATION, ENERGY STORAGE, ENERGY INFRASTRUCTURE, ENERGY EFFICIENCY, TRANSPORTATION, TRANSPORTATION LOGISTICS, WATER PURIFICATION, WATER MANAGEMENT, AIR QUALITY, NANOTECHNOLOGY, MANUFACTURING, INDUSTRIAL, AGRICULTURE, NUTRITION, MATERIALS RECOVERY, MATERIALS RECYCLING, ENVIRONMENTAL INFORMATION TECHNOLOGY AND ENABLING TECHNOLOGIES; RESEARCH REPORTS FEATURING VENTURE CAPITAL NEWS AND DEAL TRACKING, NEW TECHNOLOGIES AND INVESTMENT IN THE FIELDS OF ENERGY GENERATION, ENERGY STORAGE, ENERGY INFRASTRUCTURE, ENERGY EFFICIENCY, TRANSPORTATION, TRANSPORTATION LOGISTICS, WATER PURIFICATION, WATER MANAGEMENT, AIR QUALITY, NANOTECHNOLOGY, MANUFACTURING, INDUSTRIAL, AGRICULTURE, NUTRITION, MATERIALS RECOVERY, MATERIALS RECYCLING, ENVIRONMENTAL INFORMATION TECHNOLOGY AND ENABLING TECHNOLOGIES (U.S. CLS. 2, 5, 22, 23, 29, 37, 38 AND 50).

FIRST USE 4-15-2002; IN COMMERCE 4-15-2002.

CLASS 35—ADVERTISING AND BUSINESS

FOR GENERAL BUSINESS NETWORKING REFERRAL SERVICES, NAMELY, PROMOTING THE GOODS AND SERVICES OF OTHERS BY PASSING BUSINESS LEADS AND REFERRALS AMONG GROUP MEMBERS; ARRANGING AND CONDUCTING BUSINESS CONFERENCES; ARRANGING AND CONDUCTING MARKETING PROMOTIONAL EVENTS FOR OTHERS; INFOMEDIARY SERVICES, NAMELY FACILITATING TRANSACTIONS BETWEEN BUYERS AND SELLERS THROUGH PROVIDING BUYERS WITH INFORMATION ABOUT SELLERS, GOODS, AND/OR SERVICES (U.S. CLS. 100, 101 AND 102).

FIRST USE 4-15-2002; IN COMMERCE 4-15-2002.

CLASS 41—EDUCATION AND ENTERTAINMENT

FOR PROVIDING NEWSLETTERS IN THE FIELD OF VENTURE CAPITAL AND INVESTMENT AS THEY RELATE TO ENERGY GENERATION, ENERGY STORAGE, ENERGY INFRASTRUCTURE, ENERGY EFFICIENCY, TRANSPORTATION, TRANSPORTATION LOGISTICS, WATER PURIFICATION, WATER MANAGEMENT, AIR QUALITY, NANOTECHNOLOGY, MANUFACTURING, AGRICULTURE, NUTRITION, MATERIALS RECOVERY, MATERIAL RECYCLING, ENVIRONMENTAL INFORMATION TECHNOLOGY AND ENABLING TECHNOLOGIES VIA E-MAIL VIA E-MAIL; EDUCATIONAL AND ENTERTAINMENT SERVICES, NAMELY, PROVIDING MOTIVATIONAL AND EDUCATIONAL SPEAKERS; ARRANGING AND CONDUCTING EDUCATIONAL CONFERENCES (U.S. CLS. 100, 101 AND 107).

FIRST USE 4-15-2002; IN COMMERCE 4-15-2002.

SKYE YOUNG, EXAMINING ATTORNEY

SN 77-192,063. ELECTROLUX HOME PRODUCTS, INC.,
CLEVELAND, OH. FILED 5-29-2007.

LUX-CARE DRY

THE MARK CONSISTS OF STANDARD CHARACTERS WITHOUT CLAIM TO ANY PARTICULAR FONT, STYLE, SIZE, OR COLOR.

NO CLAIM IS MADE TO THE EXCLUSIVE RIGHT TO USE "DRY", APART FROM THE MARK AS SHOWN.

CLASS 7—MACHINERY

FOR DISHWASHING MACHINES; CLOTHES WASHING MACHINES (U.S. CLS. 13, 19, 21, 23, 31, 34 AND 35).

CLASS 11—ENVIRONMENTAL CONTROL APPARATUS

FOR LAUNDRY CENTERS, NAMELY COMBINATION CLOTHES DRYING MACHINE AND WASHING MACHINE; CLOTHES DRYERS (U.S. CLS. 13, 21, 23, 31 AND 34).

KATHERINE STOIDES, EXAMINING ATTORNEY

SN 77-192,072. ELECTROLUX HOME PRODUCTS, INC., CLEVELAND, OH. FILED 5-29-2007.

SN 77-203,059. L&L HOLDING COMPANY, LLC, NEW YORK, NY. FILED 6-11-2007.

LUXURY-CARE DRY

THE MARK CONSISTS OF STANDARD CHARACTERS WITHOUT CLAIM TO ANY PARTICULAR FONT, STYLE, SIZE, OR COLOR.
NO CLAIM IS MADE TO THE EXCLUSIVE RIGHT TO USE "DRY", APART FROM THE MARK AS SHOWN.

CLASS 7—MACHINERY

FOR DISHWASHING MACHINES; CLOTHES WASHING MACHINES (U.S. CLS. 13, 19, 21, 23, 31, 34 AND 35).

CLASS 11—ENVIRONMENTAL CONTROL APPARATUS

FOR LAUNDRY CENTERS, NAMELY COMBINATION CLOTHES DRYING MACHINE AND WASHING MACHINE; CLOTHES DRYERS (U.S. CLS. 13, 21, 23, 31 AND 34).
KATHERINE STOIDES, EXAMINING ATTORNEY

SN 77-202,424. WM. WRIGLEY JR. COMPANY, CHICAGO, IL. FILED 6-11-2007.

STIMULATE YOUR SENSES

THE MARK CONSISTS OF STANDARD CHARACTERS WITHOUT CLAIM TO ANY PARTICULAR FONT, STYLE, SIZE, OR COLOR.

CLASS 3—COSMETICS AND CLEANING PREPARATIONS

FOR BREATH FRESHENING CONFECTIONARY, NAMELY, DISSOLVABLE BREATH STRIPS, BREATH MINTS, CANDY AND GUM (U.S. CLS. 1, 4, 6, 50, 51 AND 52).

CLASS 30—STAPLE FOODS

FOR BUBBLE GUM; CHEWING GUM; CANDY; CANDY MINTS (U.S. CL. 46).
MORGAN WYNNE, EXAMINING ATTORNEY

INFINITE POTENTIAL

THE MARK CONSISTS OF STANDARD CHARACTERS WITHOUT CLAIM TO ANY PARTICULAR FONT, STYLE, SIZE, OR COLOR.

CLASS 35—ADVERTISING AND BUSINESS

FOR ACCOUNTING SERVICES (U.S. CLS. 100, 101 AND 102).

CLASS 36—INSURANCE AND FINANCIAL

FOR REAL ESTATE SERVICES, NAMELY, ACQUISITION, LEASING, PURCHASING, MANAGEMENT, DISPOSITION OF COMMERCIAL AND RESIDENTIAL REAL ESTATE AND LAND; REAL ESTATE PORTFOLIO MANAGEMENT AND PROPERTY ASSET MANAGEMENT; REAL ESTATE FINANCING SERVICES, NAMELY, FINANCING FOR THE ACQUISITION, DISPOSITION AND DEVELOPMENT NEEDS OF REAL ESTATE OWNERS, USERS AND DEVELOPERS (U.S. CLS. 100, 101 AND 102).

CLASS 37—CONSTRUCTION AND REPAIR

FOR REAL ESTATE CONSTRUCTION AND DEVELOPMENT SERVICES, NAMELY, PLANNING, LAYING OUT AND CUSTOM CONSTRUCTION OF RESIDENTIAL AND COMMERCIAL BUILDINGS (U.S. CLS. 100, 103 AND 106).

CLASS 42—SCIENTIFIC, COMPUTER AND LEGAL SERVICES

FOR ARCHITECTURAL DESIGN OF COMMERCIAL AND RESIDENTIAL PROPERTIES (U.S. CLS. 100 AND 101).
GEORGIA CARTY, EXAMINING ATTORNEY

SN 77-203,067. AMERICAN INTERNATIONAL GROUP, INC., NEW YORK, NY. FILED 6-11-2007.

AIG TRAVEL

THE MARK CONSISTS OF STANDARD CHARACTERS WITHOUT CLAIM TO ANY PARTICULAR FONT, STYLE, SIZE, OR COLOR.

OWNER OF U.S. REG. NOS. 1,151,229, 1,273,845 AND OTHERS.

NO CLAIM IS MADE TO THE EXCLUSIVE RIGHT TO USE "TRAVEL", APART FROM THE MARK AS SHOWN.

CLASS 36—INSURANCE AND FINANCIAL

FOR INSURANCE UNDERWRITING IN THE FIELD OF TRAVEL INSURANCE; TRAVEL ASSISTANCE SERVICES, NAMELY, ARRANGING FOR PAYMENT FOR EMERGENCY MEDICAL ASSISTANCE, EMERGENCY EXPENSES FOR ACCOMMODATIONS AND MEALS, AND ARRANGING FOR EMERGENCY FINANCIAL ASSISTANCE FOR TRAVEL INSURANCE CUSTOMERS (U.S. CLS. 100, 101 AND 102).

FIRST USE 5-1-2006; IN COMMERCE 5-1-2006.

CLASS 39—TRANSPORTATION AND STORAGE

FOR COORDINATING TRAVEL ARRANGEMENTS FOR INDIVIDUALS AND GROUPS; ARRANGING FOR EMERGENCY MEDICAL EVACUATION BY ANY AVAILABLE MEANS OF TRANSPORTATION (U.S. CLS. 100 AND 105).

FIRST USE 5-1-2006; IN COMMERCE 5-1-2006.
BRIDGETT SMITH, EXAMINING ATTORNEY

SN 77-207,181. AMERICAN INTERNATIONAL GROUP, INC., NEW YORK, NY. FILED 6-15-2007.

AIG UNITED GUARANTY'S
MORTGAGE BASICS

THE MARK CONSISTS OF STANDARD CHARACTERS WITHOUT CLAIM TO ANY PARTICULAR FONT, STYLE, SIZE, OR COLOR.

OWNER OF U.S. REG. NOS. 1,172,557, 2,367,552 AND 2,418,886.

NO CLAIM IS MADE TO THE EXCLUSIVE RIGHT TO USE "GUARANTY'S MORTGAGE BASICS", APART FROM THE MARK AS SHOWN.

CLASS 36—INSURANCE AND FINANCIAL

FOR INSURANCE UNDERWRITING IN THE FIELD OF MORTGAGE GUARANTY INSURANCE (U.S. CLS. 100, 101 AND 102).

FIRST USE 12-1-2003; IN COMMERCE 12-1-2003.

CLASS 41—EDUCATION AND ENTERTAINMENT

FOR TRAINING SERVICES IN THE FIELD OF MORTGAGE LENDING (U.S. CLS. 100, 101 AND 107).

FIRST USE 12-1-2003; IN COMMERCE 12-1-2003.
BRIDGETT SMITH, EXAMINING ATTORNEY

SN 77-208,643. MANHEIM AUCTIONS, INC., ATLANTA, GA. FILED 6-18-2007.



OWNER OF U.S. REG. NOS. 1,699,332, 3,328,428 AND OTHERS.

NO CLAIM IS MADE TO THE EXCLUSIVE RIGHT TO USE "LITTLE ROCK" OR THE REPRESENTATION OF THE OUTLINE OF ARKANSAS, APART FROM THE MARK AS SHOWN.

THE COLOR(S) GOLD, BLUE, MAROON, BROWN, GREY, BLACK AND WHITE IS/ARE CLAIMED AS A FEATURE OF THE MARK.

THE MARK CONSISTS OF A GOLD "M" OVER A BLUE CIRCULAR BACKGROUND AND WITHIN TWO GOLD OUTER RINGS. THE COLOR BROWN OUTLINES THE MARK. TO THE RIGHT OF THE M IS THE WORD "MANHEIM" IN THE COLOR BLACK. A BLACK LINE SEPARATES THE ABOVE DESIGN AND THE WORD "MANHEIM" AND THE WORDS "LITTLE ROCK" IN THE COLOR BLACK AND DESIGN OF A GEOGRAPHICAL OUTLINE OF THE STATE OF ARKANSAS IN THE COLOR WHITE WITH A MAROON STAR ON A MAROON BACKGROUND, INSIDE CONCENTRIC WHITE AND GREY SQUARES TO THE RIGHT OF THE WORDS "LITTLE ROCK".

CLASS 35—ADVERTISING AND BUSINESS

FOR AUTOMOBILE AUCTION SERVICES; AUTOMOBILE AUCTION SERVICES PROVIDED VIA THE INTERNET (U.S. CLS. 100, 101 AND 102).

CLASS 36—INSURANCE AND FINANCIAL

FOR AUTOMOBILE FINANCING SERVICES (U.S. CLS. 100, 101 AND 102).

GRETTA YAO, EXAMINING ATTORNEY

SN 77-209,996. WM. WRIGLEY JR. COMPANY, CHICAGO, IL. FILED 6-19-2007.

5

THE MARK CONSISTS OF STANDARD CHARACTERS WITHOUT CLAIM TO ANY PARTICULAR FONT, STYLE, SIZE, OR COLOR.

CLASS 3—COSMETICS AND CLEANING PREPARATIONS

FOR BREATH FRESHENING CONFECTIONARY, NAMELY, DISSOLVABLE BREATH STRIPS, BREATH MINTS, CANDY AND GUM (U.S. CLS. 1, 4, 6, 50, 51 AND 52).

CLASS 30—STAPLE FOODS

FOR BUBBLE GUM; CHEWING GUM; CANDY MINTS; CANDY (U.S. CL. 46).

MORGAN WYNNE, EXAMINING ATTORNEY

SN 77-216,540. WILLIAMS, VENUS, PORT WASHINGTON, NY. FILED 6-27-2007.



THE MARK CONSISTS OF FOUR ROMAN NUMERAL ONES ARRANGED IN A CHEVRON DESIGN REPRESENTING A STYLIZED DEPICTION OF BOTH A LETTER V AND THE NUMBER ELEVEN.

CLASS 9—ELECTRICAL AND SCIENTIFIC APPARATUS

FOR SUNGLASSES (U.S. CLS. 21, 23, 26, 36 AND 38).

CLASS 14—JEWELRY

FOR JEWELRY, NECKLACES, EARRINGS, BRACELETS, AND RINGS BEING JEWELRY (U.S. CLS. 2, 27, 28 AND 50).

CLASS 18—LEATHER GOODS

FOR WALLETS, BOOKBAGS, CARRY ALL BAGS, TOTE BAGS, HANDBAGS, MESSENGER BAGS, POCKETBOOKS, CLUTCH PURSES, OVERNIGHT BAGS, BACKPACKS, PURSES, DUFFEL BAGS, UMBRELLAS (U.S. CLS. 1, 2, 3, 22 AND 41).

CLASS 25—CLOTHING

FOR PANTS, JEANS, SHIRTS, SKIRTS, SHORTS, DRESSES, SWEATERS, LINGERIE, HOSIERY, JACKETS, OUTERWEAR IN THE NATURE OF PARKAS AND RAINCOATS, COATS, FOOTWEAR, HEADWEAR, GLOVES, SCARVES, SOCKS, TRACKSUITS, SWIMWEAR, BEACHWEAR, BODYWEAR, SLIPPERS, PAJAMAS, BELTS, UNDERWEAR, BRAS (U.S. CLS. 22 AND 39).

JAMES MACFARLANE, EXAMINING ATTORNEY

SN 78-066,165. MDS INC., ONTARIO, CANADA, FILED 5-29-2001.



NO CLAIM IS MADE TO THE EXCLUSIVE RIGHT TO USE "PROTEOMICS", APART FROM THE MARK AS SHOWN.

COLOR IS NOT CLAIMED AS A FEATURE OF THE MARK.

CLASS 9—ELECTRICAL AND SCIENTIFIC APPARATUS

FOR COMPUTER PROGRAMS RELATING TO ASSAYS FOR THE DIAGNOSIS OF DISEASES, NAMELY COMPUTER PROGRAMS WHICH UTILIZE DATA FROM A PATIENT SPECIMEN ASSAY AND COMPARE IT TO VALUES WHICH ARE CONSIDERED TO BE NORMAL, AND COMPUTER PROGRAMS FOR AUTOMATICALLY PERFORMING ALL OR A PORTION OF THE DISEASE DIAGNOSTIC PROCESS; COMPUTER PROGRAMS RELATING TO CHEMICAL MARKERS FOR DISEASE STATES, NAMELY COMPUTER PROGRAMS FOR MONITORING SEVERAL DISEASE STATES USING TWO OR MORE CHEMICAL MARKERS IN EACH ASSAY AND FOR COMPARING THE CONCENTRATION OF EACH MARKER WITH A DATABASE; COMPUTER PROGRAMS FOR PERFORMING DIAGNOSTICS FOR DISEASES BY ANALYZING THE RESULTS OF AN ASSAY AND PROVIDING AN INDICATION OF POSSIBLE DISEASE STATES; COMPUTER PROGRAMS RELATING TO DETERMINING TARGETS FOR DRUGS, NAMELY COMPUTER PROGRAMS FOR INSPECTING AND ANALYZING DATABASES OF BIOLOGICAL PROCESSES AND PREDICTING POTENTIAL DRUG TARGETS; COMPUTER PROGRAMS RELATING TO DETERMINING PROTEIN AND PEPTIDE SEQUENCES, NAMELY COMPUTER PROGRAMS FOR ACCEPTING ANALYSIS RESULTS AND FOR DETERMINING THEREFROM WHICH BIOLOGICAL SUBSTANCES ARE PRESENT AND THE STRUCTURE OF SUCH BIOLOGICAL SUBSTANCES (U.S. CLS. 21, 23, 26, 36 AND 38).

CLASS 42—SCIENTIFIC, COMPUTER AND LEGAL SERVICES

FOR MEDICAL RESEARCH, NAMELY DEVELOPING ASSAYS FOR THE DIAGNOSIS OF DISEASES (U.S. CLS. 100 AND 101).

NELSON SNYDER, EXAMINING ATTORNEY

SN 78-163,548. JOYA GLOBAL CORP., UNIONDALE, NY. FILED 9-12-2002.



NO CLAIM IS MADE TO THE EXCLUSIVE RIGHT TO USE "THEJEWISHEXCHANGE" IN CLASSES 35 AND 36, APART FROM THE MARK AS SHOWN.

COLOR IS NOT CLAIMED AS A FEATURE OF THE MARK.

CLASS 9—ELECTRICAL AND SCIENTIFIC APPARATUS

FOR PRE-RECORDED SOUND RECORDINGS FEATURING MUSIC, MUSICAL PERFORMANCES, INSTRUMENTAL MUSIC, VOCAL MUSIC, EDUCATIONAL MATERIALS, DIGITAL CAMERAS AND DOWN LOADERS, NAMELY, DEVICES THAT DOWNLOAD AND PLAY AUDIO AND VIDEO CLIPS FROM THE INTERNET AND OTHER SOURCES; COMPUTER GAME PROGRAMS, DOWNLOADABLE ELECTRONIC GAME PROGRAMS AND PUZZLES; ELECTRONIC GAMES, NAMELY, SOFTWARE GAMES RECORDED ON CD-ROM AND DIGITAL VIDEO DISCS FOR COMPUTERS AND FOR CONSOLE AND INDIVIDUAL PORTABLE GAMING SYSTEMS (U.S. CLS. 21, 23, 26, 36 AND 38).

CLASS 16—PAPER GOODS AND PRINTED MATTER

FOR PUBLICATIONS AND PRINTED MATERIALS, NAMELY BOOKS, TRADE MAGAZINES, CATALOGUES, BROCHURES, PAMPHLETS FEATURING ART, CULTURE, ARCHEOLOGY, CURRENT NEWS, BIBLE LEARNING, SELF-HELP, SPIRITUALITY, COOKING, ISRAEL AND JUDAISM; POSTERS; CALENDARS, PRINTED TICKETS FOR CULTURAL EVENTS, SPORTING EVENTS, MUSICAL CONCERTS AND OTHER ENTERTAINMENT EVENTS (U.S. CLS. 2, 5, 22, 23, 29, 37, 38 AND 50).

CLASS 28—TOYS AND SPORTING GOODS

FOR ELECTRONIC GAMES, NAMELY, STAND ALONE VIDEO GAME MACHINES, HANDHELD UNITS FOR PLAYING ELECTRONIC GAMES (U.S. CLS. 22, 23, 38 AND 50).

CLASS 35—ADVERTISING AND BUSINESS

FOR ONLINE RETAIL AND MAIL ORDER SERVICES IN THE FIELD OF GENERAL CONSUMER MERCHANDISE, NAMELY BOOKS, MUSIC PRODUCTS, FOOD, WINE, EDUCATIONAL MATERIALS, SOFTWARE, ARTWORK, ISRAELI PRODUCTS, SILVER PRODUCTS, CANDLES, JEWELRY, VIDEOS, DVDS, JEWISH RELATED PRODUCTS, AND RELIGIOUS PRODUCTS; PROMOTING THE GOODS AND SERVICES OF OTHERS BY MEANS OF OPERATING AN ON-LINE SHOPPING MALL WITH LINKS TO THE RETAIL WEB SITES OF RESTAURANTS AND VENDORS FEATURING FOOD AND FOOD PRODUCTS; ELECTRONIC COMMERCE SERVICES, NAMELY, GIFT REGISTRY SERVICES, ISSUING DIGITAL GIFT CERTIFICATE SERVICES, PROVIDING ONLINE RETAIL, MAIL ORDER BUSINESS MANAGEMENT; TICKET AGENCY SERVICES RENDERED VIA THE INTERNET, WIRELESS COMMUNICATION DEVICES, AND TELEPHONES FOR CULTURAL EVENTS, SPORTING EVENTS, MUSIC EVENTS AND OTHER ENTERTAINMENT EVENTS; MARKETING AND PROMOTION SERVICES FOR OTHERS IN THE FIELDS OF CULTURAL EVENTS, SPORTING EVENTS, MUSIC EVENTS AND OTHER ENTERTAINMENT EVENTS; ONLINE BUSINESS TO BUSINESS COMMERCE SERVICES IN THE FIELD OF GENERAL CONSUMER MERCHANDISE, NAMELY, WHOLESALE STORE AND ONLINE SERVICES FEATURING BOOKS, MUSIC PRODUCTS, FOOD, WINE, EDUCATIONAL MATERIALS, SOFTWARE, ARTWORK, ISRAELI PRODUCTS, SILVER PRODUCTS, CANDLES, JEWELRY, VIDEOS, DVDS, JEWISH RELATED PRODUCTS AND RELIGIOUS PRODUCTS; ADVERTISING, MARKETING, AND PROMOTING THE GOODS, SERVICES AND WEBSITES OF OTHERS VIA THE INTERNET AND WIRELESS COMMUNICATION DEVICES; ONLINE DIRECTORY SERVICES, INDICES AND SEARCHABLE DATABASES TO HELP LOCATE PEOPLE, PLACES, ORGANIZATIONS, PHONE NUMBERS, HOME PAGES AND ELECTRONIC MAIL ADDRESSES; REAL ESTATE REFERRAL SERVICES; PROVIDING CONSUMER PRODUCT INFORMATION VIA THE INTERNET AND WIRELESS COMMUNICATIONS DEVICES (U.S. CLS. 100, 101 AND 102).

CLASS 36—INSURANCE AND FINANCIAL

FOR PROVIDING ONLINE INFORMATION IN THE FIELDS OF REAL ESTATE, FINANCIAL INFORMATION AND STOCK QUOTES VIA WIRELESS COMMUNICATION DEVICES AND THE INTERNET (U.S. CLS. 100, 101 AND 102).

CLASS 38—COMMUNICATION

FOR BROADCASTING AND DELIVERY OF AUDIO, VIDEO, AND/OR MULTI-MEDIA CONTENT BY MEANS OF RADIO, CELLULAR AND WIRELESS COMMUNICATION, THE INTERNET, ELECTRONIC COMMUNICATION NETWORKS OR COMPUTER NETWORKS; ELECTRONIC TRANSMISSION OF DATA, IMAGES AND DOCUMENTS VIA A GLOBAL COMPUTER NETWORK; AND GLOBAL COMPUTER NETWORK BROADCASTING SERVICES. (U.S. CLS. 100, 101 AND 104).

CLASS 41—EDUCATION AND ENTERTAINMENT

FOR ENTERTAINMENT SERVICES, NAMELY, PROVIDING ON-LINE COMPUTER GAMES; PROVIDING NEWS IN THE NATURE OF CURRENT EVENTS REPORTING AND SPORTS INFORMATION, PROVIDING ENTERTAINMENT EVENTS INFORMATION, EXERCISE TRAINING INFORMATION, FOOD TASTING INFORMATION, AND ENTERTAINMENT EVENTS INFORMATION FOR FAMILIES AND CHILDREN VIA THE INTERNET AND WIRELESS COMMUNICATIONS DEVICES; FILTERING RELEVANT NEWS CONTENT AND PROVIDING ONLINE CUSTOMIZED NEWS REPORTS FOR REGISTERED USERS VIA THE INTERNET AND WIRELESS COMMUNICATION DEVICES (U.S. CLS. 100, 101 AND 107).

CLASS 42—SCIENTIFIC, COMPUTER AND LEGAL SERVICES

FOR ONLINE SERVICES PROVIDING WEATHER, INDEXES OF INFORMATION SITES AND A WIDE RANGE OF GENERAL INTEREST INFORMATION, NAMELY, PROVIDING INFORMATION IN THE FIELD OF FOOD INSPECTION FOR THE PURPOSE OF CERTIFYING THE KOSHER QUALITY THEREOF VIA THE INTERNET AND WIRELESS COMMUNICATION DEVICES; CALENDARING SERVICES RENDERED VIA THE INTERNET AND WIRELESS COMMUNICATIONS DEVICES FEATURING A LIBRARY OF CALENDARS AND DATES THAT CAN BE ADDED TO AND INTEGRATED INTO A PERSONAL CALENDAR WITH AUTOMATIC UPDATES (U.S. CLS. 100 AND 101).

CLASS 43—HOTEL AND RESTAURANT SERVICES

FOR RESERVATION AND BOOKING SERVICES FOR TRAVELERS ACCOMMODATIONS, HOTELS, TEMPORARY LODGING, PROVIDING FOOD AND DRINK; PROVIDING INFORMATION IN THE FIELD OF FOOD PREPARATION VIA THE INTERNET AND WIRELESS COMMUNICATIONS DEVICES (U.S. CLS. 100 AND 101).
BARBARA RUTLAND, EXAMINING ATTORNEY

SN 78-278.121. DAYS HEALTHCARE U.K. LIMITED, BRIDGEND, MID GLAMORGAN, UNITED KINGDOM, FILED 7-24-2003.

STRIDER

PRIORITY CLAIMED UNDER SEC. 44(D) ON ERPN CMNTY TM OFC APPLICATION NO. 3163151, FILED 4-1-2003, REG. NO. 003163151, DATED 4-19-2006, EXPIRES 4-1-2013.

CLASS 10—MEDICAL APPARATUS

FOR INVALID HOISTS; INVALID LIFTS; MEDICAL PATIENT TREATMENT CHAIRS; INVALID WALKERS; CRUTCHES; AIR MATTRESSES FOR MEDICAL PURPOSES; CANES FOR MEDICAL PURPOSES; CERVICAL PILLOWS FOR MEDICAL USE; MEDICAL HOSIERY, NAMELY, SUPPORT PANTYHOSE; HOSPITAL BEDS; BACK RESTS FOR MEDICAL PURPOSES; MATTRESS ELEVATORS FOR MEDICAL PURPOSES; PERCHING STOOLS FOR MEDICAL PURPOSES; FOOT AND LEG RESTS FOR MEDICAL PURPOSES; TOILETS ADAPTED FOR MEDICAL PATIENTS OR FOR USE BY HANDICAPPED PERSONS; HAND RAIL KITS FOR TOILETS INCLUDING GRAB RAILS, HANDLES AND SUPPORTS; TOILET SEATS ADAPTED FOR USE BY DISABLED PERSONS; RAISED AND ELEVATED TOILET SEATS ADAPTED FOR USE BY DISABLED PERSONS AND PARTS AND FITTINGS THEREFOR; SANITARY COVERS FOR TOILET SEATS; TOILETS WITH AUTOMATIC SANITARY COVERS; RAISED AND ELEVATED TOILET SEATS AND PARTS AND FITTINGS THEREFOR; PRESSURE RELIEF PADS AND CUSHIONS FOR MEDICAL PURPOSES AND HEATING CUSHIONS FOR MEDICAL PURPOSES (U.S. CLS. 26, 39 AND 44).

SN 78-323,688. ADVENTUS INTELLECTUAL PROPERTY INC., MISSISSAUGA, ONTARIO, CANADA, FILED 11-5-2003.

EHC

THE MARK CONSISTS OF STANDARD CHARACTERS WITHOUT CLAIM TO ANY PARTICULAR FONT, STYLE, SIZE, OR COLOR.

PRIORITY CLAIMED UNDER SEC. 44(D) ON CANADA APPLICATION NO. 1177072, FILED 5-9-2003, REG. NO. TMA663181, DATED 4-24-2006, EXPIRES 2-24-2021.

CLASS 12—VEHICLES

FOR WHEELCHAIRS; MOTORIZED WHEELCHAIRS; MOTORIZED SCOOTERS; HOSPITAL CARTS; AND CHAIR LIFTS (U.S. CLS. 19, 21, 23, 31, 35 AND 44).
SOPHIA S. KIM, EXAMINING ATTORNEY

CLASS 1—CHEMICALS

FOR CHEMICAL PREPARATIONS, NAMELY, DEGRADATION AGENTS FOR THE DECONTAMINATION OF SOIL, SEDIMENT, SLUDGE OR WATER (U.S. CLS. 1, 5, 6, 10, 26 AND 46).

CLASS 40—MATERIAL TREATMENT

FOR CONSULTING SERVICES RELATING TO DECONTAMINATION OF SOIL, SEDIMENT, SLUDGE AND WATER (U.S. CLS. 100, 103 AND 106).
JOHN GARTNER, EXAMINING ATTORNEY

SN 78-294,122. TEQUILA CUERVO LA ROJENA, S.A. DE C.V., ZAPOPAN JALISCO, CODIGO 45070, MEXICO, FILED 8-29-2003.

MAESTRO

SN 78-335,529. BIRRANA ENGINEERING PTY LTD, SOUTH AUSTRALIA, AUSTRALIA, FILED 12-3-2003.

CLASS 32—LIGHT BEVERAGES

FOR NON-ALCOHOLIC COCKTAIL MIXES (U.S. CLS. 45, 46 AND 48).

CLASS 33—WINES AND SPIRITS

FOR TEQUILA; ALCOHOLIC COCKTAIL MIXES CONTAINING TEQUILA (U.S. CLS. 47 AND 49).
SCOTT BIBB, EXAMINING ATTORNEY

BIRRANA

SN 78-299,395. WWW.ENGAGE, CHICAGO, IL. FILED 9-11-2003.

ENGAGE

THE MARK CONSISTS OF STANDARD CHARACTERS WITHOUT CLAIM TO ANY PARTICULAR FONT, STYLE, SIZE, OR COLOR.

PRIORITY CLAIMED UNDER SEC. 44(D) ON AUSTRALIA APPLICATION NO. 965221, FILED 8-8-2003, REG. NO. 965221, DATED 8-8-2003, EXPIRES 8-8-2013.

OWNER OF AUSTRALIA REG. NO. 994572, DATED 3-23-2004, EXPIRES 3-23-2014.

CLASS 36—INSURANCE AND FINANCIAL

FOR CHARITABLE FUNDRAISING SERVICES (U.S. CLS. 100, 101 AND 102).
FIRST USE 12-23-2002; IN COMMERCE 12-23-2002.

CLASS 41—EDUCATION AND ENTERTAINMENT

FOR EDUCATIONAL SERVICES, SPECIFICALLY ORGANIZING AND PROVIDING SEMINARS ON ISSUES RELEVANT TO PROFESSIONAL WOMEN, INCLUDING PHILANTHROPY AND CAREER TOPICS (U.S. CLS. 100, 101 AND 107).
FIRST USE 12-23-2002; IN COMMERCE 12-23-2002.
ANDREA SAUNDERS, EXAMINING ATTORNEY

CLASS 12—VEHICLES

FOR TRAILERS FOR TRANSPORTING HEAVY EQUIPMENT; GOOSENECK HITCHES FOR TRAILERS; REPLACEMENT PARTS, ACCESSORIES AND ATTACHMENTS FOR TRUCKS, MINING VEHICLES AND TRAILERS, NAMELY, BRAKE OIL COOLERS, BRAKES, FINAL DRIVES, TRANSMISSIONS, DIFFERENTIALS, AXLES, WHEELS AND SUSPENSION SYSTEMS (U.S. CLS. 19, 21, 23, 31, 35 AND 44).

CLASS 37—CONSTRUCTION AND REPAIR

FOR MAINTENANCE AND REPAIR SERVICES FOR VARIOUS TYPES OF MACHINERY, INCLUDING, THE MAINTENANCE AND REPAIR OF TRAILERS, BRAKE OIL COOLERS, BRAKES, FINAL DRIVES, TRANSMISSIONS, DIFFERENTIALS, AXLES, WHEELS AND SUSPENSION SYSTEMS (U.S. CLS. 100, 103 AND 106).

JILL C. ALT, EXAMINING ATTORNEY

SN 78-358,341. PLASTIC WELDING TECHNOLOGIES INTERNATIONAL, INC., DIAMOND SPRINGS, CA. FILED 1-27-2004.

PLASTIC WELDING TECHNOLOGIES

THE MARK CONSISTS OF STANDARD CHARACTERS WITHOUT CLAIM TO ANY PARTICULAR FONT, STYLE, SIZE, OR COLOR.
SEC. 2(F).

CLASS 35—ADVERTISING AND BUSINESS

FOR RETAIL STORE SERVICES FEATURING CONSTRUCTION EQUIPMENT; WHOLESALE STORE SERVICES FEATURING CONSTRUCTION EQUIPMENT; ON-LINE RETAIL STORE AND WHOLESALE STORE SERVICES FEATURING CONSTRUCTION EQUIPMENT (U.S. CLS. 100, 101 AND 102).

FIRST USE 12-0-2001; IN COMMERCE 12-0-2001.

CLASS 37—CONSTRUCTION AND REPAIR

FOR RENTAL OF HAND AND POWER TOOLS AND CONSTRUCTION EQUIPMENT; REPAIR OF HAND AND POWER TOOLS AND CONSTRUCTION EQUIPMENT (U.S. CLS. 100, 103 AND 106).

FIRST USE 12-0-2001; IN COMMERCE 12-0-2001.
CARRIE GENOVESE, EXAMINING ATTORNEY

SN 78-377,114. CHEAPFLIGHTS LIMITED, LONDON, UNITED KINGDOM, FILED 3-2-2004.



NO CLAIM IS MADE TO THE EXCLUSIVE RIGHT TO USE CHEAPFLIGHTS, APART FROM THE MARK AS SHOWN.

CLASS 35—ADVERTISING AND BUSINESS

FOR COMPILING AND ANALYZING AIRLINE FLIGHT DATA AND INFORMATION; ELECTRONICALLY DISTRIBUTING ADVERTISING AND PROMOTIONAL MATERIALS, NAMELY, AIRLINE FLIGHT AND TRAVEL INFORMATION FEATURING DATE, PRICE AND PROVIDER INFORMATION; PROVIDING LINKS TO WEB SITES OF OTHERS FEATURING SHOPPING; PRICE COMPARISON SERVICES FOR TRAVEL PRODUCTS (U.S. CLS. 100, 101 AND 102).

CLASS 36—INSURANCE AND FINANCIAL

FOR PROVIDING LINKS TO WEB SITES OF OTHERS FEATURING PERSONAL FINANCE; PROVISION OF DATABASES FEATURING TRAVEL INFORMATION FOR TRAVELERS, NAMELY, INTERACTIVE COMPUTER DATABASE SEARCHING SERVICE IN THE FIELD OF TRAVEL INSURANCE (U.S. CLS. 100, 101 AND 102).

CLASS 39—TRANSPORTATION AND STORAGE

FOR TRAVEL SERVICES, NAMELY, TRAVEL AND TOUR INFORMATION; TRAVEL AGENCY, NAMELY, THE PROVISION OF A SERVICE ENABLING THE MAKING OF TRAVEL RESERVATIONS AND BOOKINGS FOR TRANSPORTATION; BOOKING AND TICKET SERVICES, NAMELY, THE PROVISION OF SERVICES ENABLING THE BOOKING OF TRAVEL AND TOUR TICKETS; CAR HIRE SERVICES, NAMELY, THE MAKING OF CAR HIRE RESERVATIONS AND BOOKINGS FOR CAR RENTALS; HOLIDAY SERVICES FEATURING THE PROVISION OF SERVICES FOR TRAVELERS AND HOLIDAY MAKERS, NAMELY, THE ORGANIZATION OF EXCURSIONS, SIGHTSEEING, TOURS, HOLIDAY TOURS AND TRAVEL; VEHICLE ROUTE PLANNING SERVICES, NAMELY, THE PROVISION OF MAPS AND TRAVEL PLANNING TOOLS FEATURING TRAVEL TIMES, DEPARTURE AND DESTINATION POINTS; PROVISION OF DATABASES FEATURING TRAVEL INFORMATION FOR TRAVELERS, NAMELY, INTERACTIVE COMPUTER DATABASE SEARCHING SERVICE IN THE FIELDS OF AIRLINE FLIGHTS, TOURS AND CAR HIRE; TRAVEL CONSULTANCY AND ADVISORY SERVICES FOR ALL THE FOREGOING; STORING, NAMELY, THE ELECTRONIC STORAGE OF FLIGHTS, ACCOMMODATIONS AND TOURS DATA AND INFORMATION INCLUDING PRICES, AVAILABILITY AND PROVIDERS; PROVIDING LINKS TO WEB SITES OF OTHERS FEATURING TRAVEL (U.S. CLS. 100 AND 105).

CLASS 41—EDUCATION AND ENTERTAINMENT

FOR THE ORGANIZATION OF COMPETITIONS, NAMELY, THE ORGANIZATION AND ARRANGING OF COMPETITIONS REQUIRING SKILL IN THE TRAVEL PRODUCTS FIELD; NEWS REPORTING SERVICES FOR TRAVELERS, NAMELY, NEWS OF TRAVEL DEALS AND OFFERS; PROVIDING LINKS TO WEB SITES OF OTHERS FEATURING ENTERTAINMENT (U.S. CLS. 100, 101 AND 107).

CLASS 42—SCIENTIFIC, COMPUTER AND LEGAL SERVICES

FOR COMPUTER SERVICES, NAMELY, PROVIDING SEARCH ENGINES FOR MAKING PRICE COMPARISON FOR TRAVEL PRODUCTS; CREATING INDEXES OF INFORMATION, SITES AND OTHER RESOURCES AVAILABLE ON A GLOBAL COMPUTER NETWORK; DESIGN OF HOMEPAGES AND WEB SITES; COMPUTER PROGRAMMING FOR OTHERS; RESEARCH AND DESIGN SERVICES RELATING TO COMPUTER SOFTWARE AND COMPUTER HARDWARE, NAMELY, CUSTOMIZATION OF SOFTWARE TO SUIT INDIVIDUAL COMPUTER USER PROFILES; WEATHER REPORT SERVICES, COMPUTER GRAPHIC DESIGN SERVICES, WEB SITE DESIGN SERVICES FOR ADVERTISING PURPOSES; PROVIDING AN ON-LINE COMPUTER DATABASE IN THE FIELD OF WEATHER INFORMATION FOR TRAVELERS; RETRIEVING AIRLINE

FLIGHT DATA AND INFORMATION VIA ACTING AS AN APPLICATION SERVICE PROVIDER IN THE FIELD OF KNOWLEDGE MANAGEMENT TO HOST COMPUTER APPLICATION SOFTWARE FOR SEARCHING AND RETRIEVING INFORMATION FROM DATABASES AND COMPUTER NETWORKS; MAINTAINING AND INDEXING INFORMATION MATERIALS, NAMELY, PROVIDING CUSTOMIZED ON-LINE WEB PAGES FEATURING USER-DEFINED INFORMATION MATERIALS, SEARCH ENGINES AND ON-LINE WEB LINKS TO OTHER WEB SITES; COMPUTER SERVICES, NAMELY, PROVIDING AND OPERATING SEARCH ENGINES, NAMELY, PROVIDING SEARCH ENGINES FOR OBTAINING DATA ON A GLOBAL COMPUTER NETWORK; COMPUTER SERVICES, NAMELY, PROVIDING AND OPERATING BOOKING SEARCH ENGINES, NAMELY, PROVIDING BOOKING SEARCH ENGINE SERVICES FOR FLIGHTS, ACCOMMODATIONS, TOURS, CAR HIRE AND TRAVEL INSURANCE (U.S. CLS. 100 AND 101).

CLASS 43—HOTEL AND RESTAURANT SERVICES

FOR HOTEL AND ACCOMMODATION SERVICES, NAMELY PROVIDING LINKS TO WEB SITES OF ACCOMMODATION PROVIDERS TO ENABLE USERS TO MAKE INQUIRIES AND RESERVATIONS; PROVIDING AN ON-LINE COMPUTER DATABASE IN THE FIELD OF ACCOMMODATION INFORMATION FOR TRAVELERS; PROVISION OF DATABASES FEATURING TRAVEL INFORMATION FOR TRAVELERS, NAMELY, INTERACTIVE COMPUTER DATABASE SEARCHING SERVICE IN THE FIELD OF ACCOMMODATIONS (U.S. CLS. 100 AND 101).

CLASS 44—MEDICAL, BEAUTY AND AGRICULTURAL SERVICES

FOR MEDICAL ADVISORY SERVICES FOR TRAVELERS; PROVIDING LINKS TO THE WEB SITES OF OTHERS FEATURING HEALTH (U.S. CLS. 100 AND 101).

CLASS 45—PERSONAL SERVICES

FOR PROVIDING LINKS TO WEB SITES OF OTHERS FEATURING FAMILY (U.S. CLS. 100 AND 101).
ODESSA BIBBINS, EXAMINING ATTORNEY

CLASS 36—INSURANCE AND FINANCIAL

FOR FINANCIAL SERVICES, NAMELY, BROKERAGE SERVICES FOR TRANSACTING AND TRADING OF FINANCIAL INSTRUMENTS; PROVIDING FINANCIAL INFORMATION, NAMELY, BIDS, OFFERS, TRADES, AND SIZES; FINANCIAL INSTRUMENT TRADE EXECUTION AND FINANCIAL INSTRUMENT TRADE CONFIRMATION SERVICES FOR OTHERS; PROVIDING AN ELECTRONIC FINANCIAL EXCHANGE FOR TRADING OF FINANCIAL INSTRUMENTS; PROVIDING A SECURITIES TRADING NETWORK VIA AN ELECTRONIC PRIVATE INTRANET NETWORK AND GLOBAL COMPUTER NETWORK FOR THE BENEFIT OF TRADING SECURITIES; FINANCIAL INFORMATION PROVIDED BY ELECTRONIC MEANS RELATING TO MARKET QUOTATIONS AND FINANCIAL INSTRUMENT TRADING INFORMATION, INCLUDING BIDS, OFFERS, TRADE AND SIZES; PROVIDING FINANCIAL CLEARING HOUSES FOR FINANCIAL INSTRUMENTS; PROVIDING FINANCIAL INFORMATION RELATING TO FINANCIAL INSTRUMENTS, BROKERAGE, TRADING, INVESTMENTS, COMPANIES AND FINANCIAL MARKETS THROUGH A GLOBAL COMPUTER NETWORK (U.S. CLS. 100, 101 AND 102).

SCOTT BALDWIN, EXAMINING ATTORNEY

SN 78-439,825. NBS TECHNOLOGIES INC., TORONTO, CANADA, FILED 6-23-2004.

SN 78-422,850. CANTOR FITZGERALD SECURITIES, NEW YORK, NY. FILED 5-21-2004.

CANTOR FITS

THE MARK CONSISTS OF STANDARD CHARACTERS WITHOUT CLAIM TO ANY PARTICULAR FONT, STYLE, SIZE, OR COLOR.

OWNER OF U.S. REG. NOS. 256,884, 2,703,811 AND OTHERS.

CLASS 9—ELECTRICAL AND SCIENTIFIC APPARATUS

FOR COMPUTER SOFTWARE THAT ENABLES TRADING IN FINANCIAL INSTRUMENTS, PROVIDES TRADE EXECUTION AND TRADE CONFIRMATION CAPABILITIES, AND PROVIDES ACCESS TO FINANCIAL INFORMATION AND FINANCIAL MARKET INFORMATION, REAL TIME AND OTHERWISE (U.S. CLS. 21, 23, 26, 36 AND 38).

NBSTECH

THE MARK CONSISTS OF STANDARD CHARACTERS WITHOUT CLAIM TO ANY PARTICULAR FONT, STYLE, SIZE, OR COLOR.

PRIORITY CLAIMED UNDER SEC. 44(D) ON CANADA APPLICATION NO. 1214995, FILED 4-28-2004, REG. NO. TMA662,496, DATED 4-11-2006, EXPIRES 4-11-2021.

CLASS 7—MACHINERY

FOR MACHINERY AND HARDWARE NAMELY EMBOSsing, MILLING, EMBEDDING AND LAMINATING MACHINERY FOR CUSTOMIZING CARDS, NAMELY, FOR EMBOSsing AND ENCODING FINANCIAL CREDIT AND DEBIT CARDS, MAGNETIC CODED CARDS, PERSONAL IDENTIFICATION CARDS, PROMOTIONAL CARDS AND SMART CARDS (U.S. CLS. 13, 19, 21, 23, 31, 34 AND 35).

CLASS 9—ELECTRICAL AND SCIENTIFIC APPARATUS

FOR PRINTERS FOR CUSTOMIZING CARDS, NAMELY, FOR TRANSPOSING CUSTOM GRAPHICS AND PHOTOGRAPHIC IMAGES ONTO FINANCIAL CREDIT AND DEBIT CARDS, MAGNETIC CODED CARDS, PERSONAL IDENTIFICATION CARDS, PROMOTIONAL CARDS AND SMART CARDS; POINT OF SALE TERMINALS FOR PROCESSING DEBIT AND CREDIT CARD TRANSACTION AND RETAIL GIFT CARD AND REWARD PROGRAMS; SECURE IDENTIFICATION AND ACCESS CONTROL HARDWARE AND SOFTWARE; COMPUTER SOFTWARE FOR USE IN CUSTOMIZING FINANCIAL CREDIT AND DEBIT CARDS; MAGNETIC CODED CARDS, PERSONAL IDENTIFICATION CARDS, PROMOTIONAL CARDS AND SMART CARDS; COMPUTER SOFTWARE FOR USE IN PRINTERS FOR CUSTOMIZING FINANCIAL CREDIT AND DEBIT CARDS, MAGNETIC CODED CARDS, PERSONAL IDENTIFICATION CARDS, PROMOTIONAL CARDS AND SMART CARDS; COMPUTER SOFTWARE FOR USE IN DEVELOPING CUSTOMIZED TELECOMMUNICATION GATEWAYS; COMPUTER SOFTWARE FOR USE IN DEBIT AND CREDIT TRANSACTIONS; COMPUTER SOFTWARE FOR USE IN SECURING ELECTRONIC TRANSACTIONS; COMPUTER SOFTWARE FOR USE IN INTEGRATING RETAIL GIFT CARD AND REWARD PROGRAMS AT POINT OF SALE; COMPUTER SOFTWARE FOR USE IN CUSTOMIZING POINT OF SALE TERMINALS; COMPUTER SOFTWARE FOR USE IN DEVELOPING DIAL-IN AND WIRELESS COMMUNICATION APPLICATIONS IN CONJUNCTION WITH FINANCIAL CREDIT AND DEBIT CARDS, MAGNETIC CODED CARDS, PERSONAL IDENTIFICATION CARDS, PROMOTIONAL CARDS, AND SMART CARDS; SOFTWARE FOR USE IN ELECTRONIC CASH REGISTERS (U.S. CLS. 21, 23, 26, 36 AND 38).

CLASS 37—CONSTRUCTION AND REPAIR

FOR PROVIDING MAINTENANCE SERVICES, NAMELY FOR MACHINERY AND HARDWARE FOR EMBOSSING AND ENCODING FINANCIAL CREDIT AND DEBIT CARDS, MAGNETIC CODED CARDS, PERSONAL IDENTIFICATION CARDS, PROMOTIONAL CARDS AND SMART CARDS; PROVIDING MAINTENANCE SERVICES, NAMELY FOR PRINTERS FOR TRANSPOSING CUSTOM GRAPHICS AND PHOTOGRAPHIC IMAGES ONTO FINANCIAL CREDIT AND DEBIT CARDS, MAGNETIC CODED CARDS, PERSONAL IDENTIFICATION CARDS, PROMOTIONAL CARDS AND SMART CARDS; PROVIDING REPAIR SERVICES, NAMELY FOR EQUIPMENT FOR EMBOSSING AND ENCODING FINANCIAL CREDIT AND DEBIT CARDS, MAGNETIC CODED CARDS, PERSONAL IDENTIFICATION CARDS, PROMOTIONAL CARDS AND SMART CARDS; PROVIDING REPAIR SERVICES, NAMELY FOR PRINTERS FOR TRANSPOSING CUSTOM GRAPHICS AND PHOTOGRAPHIC IMAGES ONTO FINANCIAL CREDIT AND DEBIT CARDS, MAGNETIC CODED CARDS, PERSONAL IDENTIFICATION CARDS, PROMOTIONAL CARDS AND SMART CARDS; PROVIDING REPAIR SERVICES, NAMELY FOR POINT OF SALE TERMINALS FOR PROCESSING DEBIT AND CREDIT CARD TRANSACTIONS AND RETAIL GIFT CARD AND REWARD PROGRAMS (U.S. CLS. 100, 103 AND 106).

CLASS 38—COMMUNICATION

FOR TELECOMMUNICATION GATEWAY SERVICES FOR PROCESSING FINANCIAL DEBIT AND CREDIT CARD TRANSACTIONS; ELECTRONIC TRANSMISSION OF DATA AND DOCUMENTS (U.S. CLS. 100, 101 AND 104).

CLASS 40—MATERIAL TREATMENT

FOR CARD PRINTING, NAMELY TRANSPOSING CUSTOM GRAPHICS AND PHOTOGRAPHIC IMAGES ONTO FINANCIAL CREDIT AND DEBIT CARDS, MAGNETIC CODED CARDS, PERSONAL IDENTIFICATION CARDS, PROMOTIONAL CARDS AND SMART CARDS; CREDIT AND DEBIT CARD TRANSACTION PROCESSING SERVICES; CARD CUSTOMIZATION, NAMELY EMBOSSING AND ENCODING FINANCIAL CREDIT AND DEBIT CARDS, MAGNETIC CODED CARDS, PERSONAL IDENTIFICATION CARDS, PROMOTIONAL CARDS AND SMART CARDS (U.S. CLS. 100, 103 AND 106).

CLASS 42—SCIENTIFIC, COMPUTER AND LEGAL SERVICES

FOR COMPUTER SOFTWARE DESIGN, NAMELY, OF COMPUTER SOFTWARE FOR USE IN PRINTING CUSTOM GRAPHICS AND PHOTOGRAPHIC IMAGES ONTO FINANCIAL CREDIT AND DEBIT CARDS, MAGNETIC CODED CARDS, PERSONAL IDENTIFICATION CARDS, PROMOTIONAL CARDS AND SMART CARDS; COMPUTER SOFTWARE DESIGN, NAMELY, OF COMPUTER SOFTWARE FOR USE IN DEVELOPMENT CUSTOMIZED TELECOMMUNICATION GATEWAYS; COMPUTER SOFTWARE DESIGN, NAMELY, OF COMPUTER SOFTWARE FOR USE IN DEBIT AND CREDIT TRANSACTIONS; COMPUTER SOFTWARE DESIGN, NAMELY, OF COMPUTER SOFTWARE FOR USE IN SECURING ELECTRONIC TRANSACTIONS; COMPUTER SOFTWARE DESIGN, NAMELY, OF COMPUTER SOFTWARE FOR USE IN INTEGRATING RETAIL GIFT CARD AND REWARD PROGRAMS AT POINT OF SALE; COMPUTER SOFTWARE DESIGN, NAMELY, OF COMPUTER SOFTWARE FOR USE IN CUSTOMIZING POINT OF SALE TERMINALS; COMPUTER SOFTWARE DESIGN, NAMELY, OF COMPUTER SOFTWARE FOR USE IN CUSTOMIZING FINANCIAL CREDIT AND DEBIT CARDS, MAGNETIC CODED CARDS, PERSONAL IDENTIFICATION CARDS, PROMOTIONAL CARDS AND SMART CARDS (U.S. CLS. 100 AND 101).

DOMINICK J. SALEMI, EXAMINING ATTORNEY

SN 78-458,024. PAREMUS LIMITED, LONDON, UNITED KINGDOM, FILED 7-28-2004.

INFINIFLOW

THE MARK CONSISTS OF STANDARD CHARACTERS WITHOUT CLAIM TO ANY PARTICULAR FONT, STYLE, SIZE, OR COLOR.

PRIORITY CLAIMED UNDER SEC. 44(D) ON ERPN CMNTY TM OFC APPLICATION NO. 003847431, FILED 5-27-2004, REG. NO. 003847431, DATED 9-27-2005, EXPIRES 5-27-2014.

CLASS 9—ELECTRICAL AND SCIENTIFIC APPARATUS

FOR COMPUTER HARDWARE AND PERIPHERALS; COMPUTER PROGRAMS AND SOFTWARE THAT ALLOWS USERS TO OPTIMIZE INFORMATION TECHNOLOGY ACROSS A NETWORK OF DISTRIBUTED RESOURCES BY ENABLING APPLICATIONS RUNNING ON THE NETWORK TO FUNCTION IN A COMMUNAL MANNER AND SHARE THOSE RESOURCES THROUGH SELF-MANAGEMENT, GUARANTEED SERVICE, RESOURCE PROVISIONING AND WORKLOAD MANAGEMENT ACROSS MULTIPLE DOMAINS AND GEOGRAPHIC LOCATIONS IN THE FIELD OF NETWORK AND SYSTEM MANAGEMENT; ELECTRONIC DATABASE IN THE FIELD OF NETWORK AND SYSTEM MANAGEMENT RECORDED ON COMPUTER MEDIA; CALCULATORS; DATA PROCESSING EQUIPMENT, NAMELY, COMPUTER DATA PROCESSING EQUIPMENT CAPABLE OF RUNNING GENERAL PURPOSE MULTI-USER OPERATING SYSTEMS; DESKTOP AND LAPTOP COMPUTERS; COMPUTER SOFTWARE FOR THE DEVELOPMENT OF SYSTEM AND NETWORK MANAGEMENT SYSTEMS; COMPUTER HARDWARE AND SOFTWARE FOR INTERCONNECTING, MANAGING, SECURING, AND OPERATING LOCAL AND WIDE AREA NETWORKS AND TELEPHONY SYSTEMS PRE-RECORDED ON COMPUTER-READABLE MEDIA, NAMELY, HARD DISCS, FLOPPY DISCS, DISKETTES AND COMPACT DISCS; WIRELESS COMPUTER COMMUNICATIONS DEVICES, NAMELY, WIRELESS LAN HARDWARE AND SOFTWARE FOR THE TRANSMISSION OF VOICE, DATA, AND VIDEO; COMPUTER TELECOMMUNICATIONS EQUIPMENT, NAMELY HARDWARE AND SOFTWARE FOR USE IN CONJUNCTION WITH MANAGING AND OPERATING LOCAL AND WIDE AREA NETWORKS; TELEPHONY SYSTEMS, NAMELY GATEWAYS, SWITCHES, PHONES AND OTHER COMMUNICATION DEVICES; CALL PROCESSING SOFTWARE FOR THE TRANSMISSION OF DATA, VIDEO AND VOICE TRAFFIC; STORAGE NETWORKING PRODUCTS, NAMELY ROUTERS, SWITCHES, PORT ADAPTERS, AND SOFTWARE USED IN THE OPERATION AND MANAGEMENT THEREOF VIA A GLOBAL COMPUTER NETWORK OR THE INTERNET (U.S. CLS. 21, 23, 26, 36 AND 38).

CLASS 37—CONSTRUCTION AND REPAIR

FOR INSTALLATION, MAINTENANCE AND REPAIR OF COMPUTER HARDWARE, COMPUTER SYSTEMS AND COMPUTER NETWORKS; UPDATING AND UPGRADING OF COMPUTER HARDWARE, COMPUTER SYSTEMS, COMPUTER NETWORKS AND COMPUTER PERIPHERAL DEVICES; CONNECTION OF COMPUTER APPARATUS AND INSTRUMENTS, NAMELY, THE ASSEMBLY OF THE DESKTOP COMPUTER COMPONENTS AND CONNECTING NECESSARY CABLES TO COMPUTER NETWORK; PROVIDING ONLINE COMPUTER DATABASE FEATURING INFORMATION RELATING TO THE AFORESAID AND CONSULTATION SERVICES THEREOF (U.S. CLS. 100, 103 AND 106).

CLASS 42—SCIENTIFIC, COMPUTER AND LEGAL SERVICES

FOR SCIENTIFIC AND TECHNOLOGICAL RESEARCH AND DEVELOPMENT SERVICES IN ASSOCIATION WITH COMPUTER SOFTWARE THAT ALLOWS USERS TO OPTIMIZE INFORMATION TECHNOLOGY ACROSS A NETWORK OF DISTRIBUTED RESOURCES BY ENABLING APPLICATIONS RUNNING ON THE NETWORK TO FUNCTION IN A COMMUNAL MANNER AND SHARE THOSE RESOURCES THROUGH SELF-MANAGEMENT, GUARANTEED SERVICE, RESOURCE PROVISIONING AND WORKLOAD MANAGEMENT, ACROSS MULTIPLE DOMAINS AND GEOGRAPHIC LOCATIONS; INDUSTRIAL ANALYSIS AND RESEARCH SERVICES IN THE FIELD OF COMPUTING, NETWORKING, TELECOMMUNICATIONS AND THE INSTALLATION AND USE OF COMPUTING, NETWORKING, AND TELECOMMUNICATIONS HARDWARE AND SOFTWARE; DESIGN AND DEVELOPMENT OF COMPUTER HARDWARE AND SOFTWARE; COMPUTER GRAPHIC DESIGN SERVICES; COMPUTER HARDWARE AND SOFTWARE CONSULTING SERVICES; COMPUTER PROGRAMMING; INSTALLATION,

MAINTENANCE AND REPAIR OF COMPUTER SOFTWARE; PROVIDING AN ONLINE COMPUTER DATABASE FEATURING INFORMATION RELATING TO COMPUTER HARDWARE AND SOFTWARE PROVIDED VIA A GLOBAL COMPUTER NETWORK OR THE INTERNET; TECHNICAL SUPPORT AND CONSULTATION SERVICES FOR MONITORING COMPUTER SYSTEMS, DATABASES AND APPLICATIONS; TROUBLESHOOTING COMPUTER HARDWARE AND SOFTWARE PROBLEMS; PROVIDING ONLINE COMPUTER DATABASE FEATURING INFORMATION RELATING TO THE AFORESAID AND CONSULTATION SERVICES THEREOF (U.S. CLS. 100 AND 101).

ANGELA M. MICHELI, EXAMINING ATTORNEY

SN 78-475,008. MERTENS, MARC, MR., LOS ANGELES, CA. FILED 8-27-2004.



THE MARK CONSISTS OF SESO AND DESIGN ALONG WITH THE WORDING MEDIA GROUP.

CLASS 35—ADVERTISING AND BUSINESS

FOR ADVERTISING AND PUBLICITY SERVICES, NAMELY, PROMOTING THE GOODS, SERVICES, BRAND IDENTITY AND COMMERCIAL INFORMATION AND NEWS OF THIRD PARTIES THROUGH PRINT, AUDIO, VIDEO, DIGITAL AND ON-LINE MEDIUM; ADVERTISING AND BUSINESS MANAGEMENT CONSULTANCY; ADVERTISING AND COMMERCIAL INFORMATION SERVICES, VIA THE INTERNET; ADVERTISING SERVICES, NAMELY, CREATING CORPORATE AND BRAND IDENTITY FOR OTHERS; CREATION OF MARKETING TOOLS DESIGNED TO INCREASE A CLIENT COMPANY'S KNOWLEDGE OF CUSTOMER NEEDS, AND ITS COMPETITORS' PRODUCTS AND SERVICES, PRICING, ADVERTISING STRATEGY AND SALES STRATEGY; ON-LINE ADVERTISING ON COMPUTER COMMUNICATION NETWORKS; BUSINESS MARKETING CONSULTING SERVICES; DEVELOPMENT OF MARKETING STRATEGIES AND CONCEPTS; MARKETING CONSULTING; PROMOTING THE PARTIES AND SPECIAL EVENTS OF OTHERS; ARRANGING AND CONDUCTING MARKETING PROMOTIONAL EVENTS FOR OTHERS; PUBLIC RELATIONS (U.S. CLS. 100, 101 AND 102).

FIRST USE 6-1-2000; IN COMMERCE 6-1-2000.

CLASS 42—SCIENTIFIC, COMPUTER AND LEGAL SERVICES

FOR DESIGN, CREATION, HOSTING, MAINTENANCE OF WEBSITES FOR OTHERS; COMPUTER SERVICES, NAMELY, CREATING AND MAINTAINING WEB SITES FOR OTHERS; DESIGN OF HOME PAGES, COMPUTER SOFTWARE AND WEB SITES (U.S. CLS. 100 AND 101).

FIRST USE 6-1-2000; IN COMMERCE 6-1-2000.
KAREN K. BUSH, EXAMINING ATTORNEY

SN 78-484,367. ARITZIA, LP, VANCOUVER, B.C., CANADA,
FILED 9-15-2004.

SN 78-490,863. SLAZENGRS LIMITED, BUCKINGHAM-
SHIRE, UNITED KINGDOM, FILED 9-28-2004.



SLAZENGR

OWNER OF UNITED KINGDOM REG. NO. 2184297,
DATED 5-26-2000, EXPIRES 12-11-2008.
OWNER OF U.S. REG. NOS. 859,637 AND 1,467,418.

PRIORITY CLAIMED UNDER SEC. 44(D) ON CANADA
APPLICATION NO. 1209743, FILED 3-15-2004, REG. NO.
TMA677883, DATED 11-29-2006, EXPIRES 11-29-2021.

CLASS 3—COSMETICS AND CLEANING PREPARATIONS

FOR COSMETICS; FRAGRANCES, NAMELY, PERFUMES, COLOGNE AND EAU DE TOILETTE; SKIN CARE PRODUCTS, NAMELY, BODY, EYE, FACE, HAND, SHAVING AND SKIN CREAM; BATH PRODUCTS, NAMELY, SOAP, SHOWER AND BATH GEL, SKIN, FACIAL AND BODY LOTION, HAIR GEL, AND ESSENTIAL OILS FOR PERSONAL USE. (U.S. CLS. 1, 4, 6, 50, 51 AND 52).

CLASS 14—JEWELRY

FOR JEWELRY. (U.S. CLS. 2, 27, 28 AND 50).

CLASS 18—LEATHER GOODS

FOR BAGS, NAMELY, LEATHER AND IMITATION LEATHER BAGS, TRAVELING BAGS, ATHLETIC BAGS, BEACH BAGS, HANDBAGS, SHOULDER BAGS, AND TOTE BAGS; TRUNKS FOR TRAVELING, KNAPSACKS, PURSES, WALLETS AND LUGGAGE. (U.S. CLS. 1, 2, 3, 22 AND 41).

CLASS 25—CLOTHING

FOR CLOTHING, NAMELY PANTS, TOPS, BLAZERS, BLOUSES, CAPS, COATS, DRESS SHIRTS, DRESSES, GLOVES, HATS, HOSIERY, JACKETS, JEANS, LINGERIE, OVER COATS, OVERALLS, SCARVES, SHIRTS, SHORTS, SKIRTS, SLACKS, SLEEP WEAR, SOCKS, SPORT JACKETS, SPORT SHIRTS, SUITS, SWEATERS, SWEATSHIRTS, SWEAT PANTS, SWIMWEAR, TIES, TIGHTS, TOQUES, T-SHIRTS, UNDERWEAR, VESTS, BELTS, AND WIND RESISTANT JACKETS; FOOTWEAR NAMELY BOOTS, SANDALS, SHOES AND SLIPPERS; HEADBANDS (U.S. CLS. 22 AND 39).

CLASS 26—FANCY GOODS

FOR HAIR ORNAMENTS, NAMELY, HAIR BANDS, HAIR BARRETTES, HAIR CLIPS, HAIR PINS, HAIR RUFFLES, FABRIC BOWS (U.S. CLS. 37, 39, 40, 42 AND 50).

CLASS 35—ADVERTISING AND BUSINESS

FOR RETAIL STORE SERVICES FEATURING WEARING APPAREL AND ACCESSORIES, JEWELRY, FOOTWEAR, EYE WEAR, COSMETICS, FRAGRANCES, SKIN CARE AND HOUSE WARES. (U.S. CLS. 100, 101 AND 102).

SALLY SHIH, EXAMINING ATTORNEY

CLASS 9—ELECTRICAL AND SCIENTIFIC APPARATUS

FOR TELECOMMUNICATION APPARATUS, NAMELY, FACSIMILE MACHINES; TELEPHONES, MOBILE TELEPHONES, CORDLESS TELEPHONES; TELEPHONE ANSWERING APPARATUS; RADIO PAGERS; DVD PLAYERS; DVD RECORDERS; CD RECORDERS; PHOTOGRAPHIC APPARATUS AND INSTRUMENTS, NAMELY, DIGITAL CAMERAS, LENSES FOR CAMERAS, STRAPS FOR CAMERAS AND CASES FOR CAMERAS; CAMERAS; VIDEO CAMERAS; CAMERA LENSES; CAMCORDERS; TELEVISIONS; TELEVISIONS FOR RECEIVING SATELLITE BROADCASTING; SATELLITES AND DECODERS; VIDEO TAPE RECORDERS; VIDEO DISC PLAYERS; COMBINED TELEVISIONS AND VCRs; TELEVISION AERIALS; ANTENNAS; TRANSFORMERS; SURGE PROTECTORS; REMOTE CONTROL APPARATUS FOR AUTHENTICATION AND IDENTIFICATION TO PROVIDE ACCESS CONTROL TO COMPUTERS; REMOTE CONTROL APPARATUS FOR AUTHENTICATION AND IDENTIFICATION TO PROVIDE ACCESS TO A BUILDING OR A ROOM; REMOTE CONTROLS FOR TELEVISIONS, COMPUTERS, DVD RECORDERS AND PLAYERS, CD RECORDERS AND PLAYERS, VIDEO CASSETTES RECORDERS AND PLAYERS, AUDIO CASSETTE RECORDERS AND PLAYERS; RADIO TUNERS; RADIO RECEIVERS; RADIO CASSETTES FOR REPRODUCING SOUNDS; CD RADIO CASSETTES; COMPACT DISC PLAYERS; TAPE RECORDERS; TAPE PLAYERS; RECORD PLAYERS; GRAPHIC EQUALIZERS; HEADPHONES; SPEAKERS, NAMELY, BOOK SHELF SPEAKERS, FLOOR STANDING SPEAKERS, WIRELESS SPEAKERS, SUB-WOOFERS, MULTI MEDIA SPEAKERS AND SPEAKERS FOR COMPUTERS; LOUDSPEAKERS, EAR PHONE SPEAKERS, SPEAKER CABLES; AMPLIFIERS; RADIOS, RADIOS INCORPORATING CLOCKS; KARAOKE MACHINES, JUKE BOXES; COMPUTERS, LAPTOP AND NOTEBOOK COMPUTERS, GAME COMPUTERS; APPARATUS FOR USE WITH COMPUTERS, NAMELY, PRINTERS, COMPUTER SCREENS AND MODEMS; COMPUTER SOFTWARE FOR COMPUTER SYSTEM AND APPLICATION DEVELOPMENT, DEPLOYMENT AND MANAGEMENT; COMPUTER SOFTWARE FOR USE IN DATABASE MANAGEMENT; COMPUTER SOFTWARE FOR USE AS A SPREADSHEET; COMPUTER SOFTWARE FOR USE FOR WORD PROCESSING; COMPUTER SOFTWARE FOR ACCESSING INFORMATION DIRECTORIES; COMPUTER SOFTWARE FOR WIRELESS CONTENT DELIVERY; COMPUTER PROGRAMS FOR DOCUMENT PROCESSING; COMPUTER PROGRAMS FOR USE IN COMPUTER SECURITY; COMPUTER PROGRAMS FOR USE IN THE DEVELOPMENT OF COMPUTER PROGRAMS; COMPUTER PROGRAMS FOR USE IN DEVELOPING, EXECUTING AND MANAGING OTHER COMPUTER PROGRAMS, ON COMPUTERS, COMPUTER NETWORKS AND GLOBAL COMPUTER NETWORKS; COMPUTER PROGRAMS FOR USE IN TRANSFERRING INFORMATION, AND DISTRIBUTING AND VIEWING OTHER COMPUTER PROGRAMS, ON COMPUTERS, COMPUTER NETWORKS AND GLOBAL COMPUTER NETWORKS; MULTIMEDIA SOFT-

WARE RECORDED ON CD-ROM FOR USE IN DESKTOP PUBLISHING, ELECTRONIC PUBLISHING, PRINTING, GRAPHICS AND TYPESETTING; MULTIMEDIA SOFTWARE RECORDED ON CD-ROM FOR USE IN GENERATING AND MANAGING PAGES ON GLOBAL COMPUTER NETWORKS AND OTHER NETWORKS; MULTIMEDIA SOFTWARE RECORDED ON CD-ROM FOR USE IN CONNECTION WITH THE CREATION, EDITING, MANIPULATION AND PRINTING OF TEXT, AUDIO, GRAPHICS, ANIMATED GRAPHICS AND FULL MOTION VIDEOS; CD ROMS, NAMELY, BLANK CD ROMS; MULTIMEDIA SOFTWARE RECORDED ON CD-ROM FOR USE IN PERSONAL COMMUNICATION SERVICES; PRE-RECORDED CD ROMS FEATURING SPORTS OR PROVIDING INSTRUCTION IN SPORTS; COMPUTER GAME PROGRAMS; VIDEO GAMES, NAMELY, VIDEO GAMES SOFTWARE, DISCS AND CARTRIDGES; PRE-RECORDED MAGNETIC TAPES AND PRE-RECORDED MAGNETIC DISCS FEATURING SPORTING AND LEISURE ACTIVITIES, ALL RECORDED WITH COMPUTER PROGRAMS FOR USE IN THE MANAGEMENT OF BUSINESSES, FOR USE IN STOCK CONTROL AND FOR PROVIDING INFORMATION ON SPORTS EVENTS; PRE-RECORDED MAGNETIC DISCS AND PRE-RECORDED MAGNETIC TAPES, ALL FEATURING VIDEO GAMES OR ADAPTED FOR USE WITH TELEVISION RECEIVERS; AUDIO AND VIDEO TAPES AND DISCS, ALL FEATURING SPORTS EVENTS OR INSTRUCTION IN SPORTS; BLANK TAPES FOR RECORDING AUDIO AND VIDEO; BLANK COMPACT DISCS; PRE-RECORDED COMPACT DISCS FEATURING SPORTS EVENTS OR INSTRUCTION IN SPORTS; PRE-RECORDED COMPACT DISCS CONTAINING DIRECTORY INFORMATION IN THE NATURE OF COMMUNICATION, TELEPHONE, PERSONAL, BUSINESS AND ADVERTISING INFORMATION; PHONOGRAPH RECORDS, PRE-RECORDED MAGNETIC CASSETTES AND PRE-RECORDED MAGNETIC DISCS, ALL CONTAINING SPORTING EVENTS OR PROVIDING INFORMATION ON SPORTS; CABINETS FOR LOUDSPEAKERS; PHOTOCOPIERS; CALCULATORS; PRICE COMPUTING SCALES; COUNTING SCALES; POSTAL SCALES; SCALES WITH DIGITAL DISPLAY; TIME CLOCKS; TIMERS; ENCODED ELECTRONIC CHIP CARDS FOR IDENTIFYING PARTICULAR USERS OF COMPUTERS AND MOBILE TELEPHONES; HOLOGRAM APPARATUS; MAGNIFYING GLASSES; PEDOMETERS; PERISCOPES; BATTERIES, BATTERY CHARGERS, BATTERY BOXES; ELECTRIC PLUGS; ELECTRIC IRONS; ELECTRIC HAIR CURLING BRUSHES; ELECTRIC HAIR CURLING IRONS; ELECTRICALLY HEATED HAIR CURLERS; BINOCULARS; MONOCLES; SPECTACLES; SUNGLASSES; SPORTS GOGGLES; SWIMMING GOGGLES; FRAMES AND LENSES FOR SPECTACLES AND SUNGLASSES; CASES FOR SPECTACLES AND SUNGLASSES; CHAINS AND CORDS FOR SPECTACLES AND SUNGLASSES; PROTECTIVE CLOTHING, NAMELY, JACKETS, OVERCOATS, PARKAS, PANTS, SHORTS, TROUSERS, SWEATERS AND SHIRTS; KNEE PADS FOR WORKERS, FACE PROTECTION SHIELDS; PROTECTIVE FACE SHIELDS FOR PROTECTIVE HELMETS, ALL FOR WORKERS; HELMETS FOR MOTORCYCLISTS; PROTECTIVE GLASSES, SUNGLASSES AND GOGGLES; FACE SHIELDS; LIFE BELTS; COMPUTER CARRYING CASES; CASES FOR MOBILE TELEPHONES (U.S. CLS. 21, 23, 26, 36 AND 38).

CLASS 14—JEWELRY

FOR CLOCKS AND WATCHES; SPORTS WATCHES; WATCH STRAPS; MUGS OF PRECIOUS METAL; TANKARDS OF PRECIOUS METAL; TROPHIES, BELT BUCKLES, ALL BEING OF PRECIOUS METAL OR COATED THEREWITH; JEWELLERY AND IMITATION JEWELLERY; STOP WATCHES; ALARM CLOCKS; ASHTRAYS OF PRECIOUS METAL; BADGES OF PRECIOUS METAL; BOXES OF PRECIOUS METAL; BRACELETS; MEDALS, BADGES OF PRECIOUS METAL; CANDLE RINGS OF PRECIOUS METAL; CANDLESTICKS OF PRECIOUS METAL; CASES FOR CLOCK AND WATCH MAKING; CASES FOR WATCHES; CLOCK CASES; CLOCK HANDS; NON-ELECTRIC COFFEE POTS OF PRECIOUS METAL; HOUSEHOLD CONTAINERS OF PRECIOUS METAL, NAMELY, BOWLS; HOUSEHOLD UTENSILS OF PRECIOUS METAL, NAMELY, FORKS, SPOONS AND KNIVES; JEWEL CASES OF PRECIOUS METAL; JEWELLERY; KEY RINGS OF PRECIOUS METAL; RINGS BEING JEWELLERY; SAUCERS OF PRECIOUS METAL; CUFFLINKS, TIE CLIPS, TIE PINS; WATCH BANDS; WRIST WATCHES; ORNAMENTS OF PRECIOUS METAL; TRINKETS, NAMELY, KEY CHAINS MADE OF METAL (U.S. CLS. 2, 27, 28 AND 50).

CLASS 16—PAPER GOODS AND PRINTED MATTER

FOR BOOKS IN THE FIELD OF SPORTS, TUITION AND INSTRUCTION IN SPORTS, GYMNASTICS, ATHLETICS AND BUSINESS MANAGEMENT; PRINTED MATTER, NAMELY, POSTERS, CALENDARS, FLYERS, MAGAZINES FEATURING SPORTS; AND NEWSLETTERS IN THE FIELD OF SPORT; PICTURES, POSTERS, PRINTS; WRITING IMPLEMENTS, NAMELY, PENS, PENCILS AND CRAYONS; PRINTED CARDS, NAMELY, BUSINESS CARDS AND NOTE CARDS; POSTCARDS; BINDERS; GREETINGS CARDS; MECHANICAL PENCILS; PHOTOGRAPHS; PHOTOGRAPH ALBUMS; POSTCARD ALBUMS; AUTOGRAPH ALBUMS; RECEPTION ALBUMS; TOILET TISSUES, TOILET PAPER; NAPKIN PAPER, TISSUE PAPER; TABLE CLOTHS OF PAPER; PLACEMATS OF PAPER; ADDRESS BOOKS, BINDER NOTEBOOKS, LOOSE LEAF BOOKS, NOTEBOOKS, BOOK ENDS, PAINT BRUSHES, CALENDARS, DIARIES, PHOTOGRAPH MOUNTS; INSTRUCTION AND TEACHING SHEETS; PEN STANDS, PENCIL STANDS, PHOTO STANDS; STICKERS; ADHESIVE TAPES FOR DOMESTIC AND STATIONERY USE; MAGAZINES FEATURING SPORTS, GYMNASTICS, ATHLETICS AND TRAVEL; NEWSPAPERS; DECALCOMANIAS, PEN TRAYS, PENCIL TRAYS, MANUALS IN THE FIELD OF SPORTS; STATIONERY; TOWELS OF PAPER; TABLE LINERS OF PAPER; FACE TOWELS OF PAPER; HYGIENIC PAPER, PAPER HANDKERCHIEFS, WRITING PAPER; CATALOGUES IN THE FIELD OF SPORTS, GYMNASTIC AND ATHLETICS APPARATUS; WRAPPING AND PACKING MATERIALS, NAMELY, GIFT WRAP PAPER, GIFT BAGS; PLASTIC BAGS FOR PACKAGING; CHEQUE BOOK HOLDERS; DOCUMENT PORTFOLIOS; PAPER SHOPPING BAGS; PLASTIC SHOPPING BAGS (U.S. CLS. 2, 5, 22, 23, 29, 37, 38 AND 50).

CLASS 18—LEATHER GOODS

FOR LEATHER; LUGGAGE; BUSINESS CARD CASES, CALLING CARD CASES, CREDIT CARD CASES, DOCUMENT CASES, KEY CASES; TRUNKS, TRAVELLING BAGS, TRAVELLING CASES, OVERNIGHT LUGGAGE, TRAVEL BAGS, SHOE BAGS FOR TRAVEL AND GARMENT BAGS FOR TRAVEL; BRIEFCASES; SCHOOL BAGS AND SCHOOL SATCHELS; CARRY ALL BAGS, HAVERSACKS, BACKPACKS, RUCKSACKS, KNAPSACKS, HANDBAGS, SHOULDER BAGS, CLUTCH BAGS, TOTE BAGS, SPORTS BAGS, ATHLETIC BAGS, BEACH BAGS; MESH SHOPPING BAGS; TEXTILE SHOPPING BAGS, BELT BAGS, WASH BAG FOR CARRYING TOILETRIES; HIP SACKS, SHORT BELTS, NAMELY, STRAPS FOR SPORTS BAGS, HAVERSACKS, BACKPACKS, RUCKSACKS AND KNAPSACKS; WALLET, PURSES, POUCHES OF LEATHER, KEY CASES OF LEATHER; UMBRELLAS, GOLF UMBRELLAS, GOLF UMBRELLA SEATS, PARASOLS, CANES AND WALKING STICKS; WHIPS, HARNESSES AND SADDLERY (U.S. CLS. 1, 2, 3, 22 AND 41).

CLASS 24—FABRICS

FOR TEXTILE FABRICS FOR THE MANUFACTURE OF CLOTHING; TEXTILE FABRICS FOR LINGERIE; TEXTILE FABRICS FOR HOME AND COMMERCIAL INTERIORS; TEXTILE LABELS; TEXTILE LININGS FOR GARMENTS; TEXTILE NAPKINS; TEXTILE PLACE-MATS; TEXTILE SIGNAGE PANELS; TEXTILE TABLE CLOTHS; TEXTILE WALL HANGINGS; LINEN AND UPHOLSTERY FABRICS; BED LINEN; BEDSPREADS; BED SHEETS; QUILT COVERS, DUVET COVERS, PILLOW CASES, PILLOW COVERS, QUILTS, DUVETS, THROWS; BATH LINEN, TOWELS, FLANNELS, FACE TOWELS, SHOWER CURTAINS; TABLE LINEN, TABLE CLOTHS NOT OF PAPER; TABLE MATS, NAMELY, PLACEMATS; TABLE LINEN, NAMELY, NAPKINS; TABLE LINEN, NAMELY, COASTERS; KITCHEN TOWELS, TEA TOWELS; CURTAINS, CURTAIN TIE-BACKS, NAMELY, CURTAIN LOOPS OF TEXTILE MATERIAL; CUSHION COVERS; FURNITURE COVERINGS, NAMELY, UPHOLSTERY FABRICS; HANDKERCHIEFS (U.S. CLS. 42 AND 50).

CLASS 25—CLOTHING

FOR CLOTHING, NAMELY, SHORTS, SHIRTS, SPORT SHIRTS, UNDERSHIRTS, SWIMSUITS, PULLOVERS, SWEATERS, JUMPERS, SMOCKS, SALOPETTES, UNDERWEAR, LONG UNDERWEAR, UNDERPANTS, BRASSIERES, GAITERS, GARTERS, STOCKINGS, SUSPENDERS, BRACES, WAIST BANDS, GLOVES, WATER-PROOF CLOTHING, NAMELY, COATS, JACKETS, ANORAKS, PARKAS, PULLOVERS, TROUSERS, SMOCKS, HOODS AND OVERALLS; FLEECE PULL-OVERS, COATS, JACKETS, PARKAS, ANORAKS, OVERCOATS, RAINCOATS, RAIN SUITS, WIND JACKETS, SKIRTS, DRESSES, PANTIES, BRIEFS, TRACKSUITS AND WARM-UP SUITS; SPORTSWEAR, NAMELY, GOAL KEEPING SMOCKS FOR HOCKEY, SWEAT-BANDS; FOOTWEAR; SPORTS SHOES; BOOTS, WALKING BOOTS, FOOTBALL BOOTS, SHOES, CYCLING SHOES; HEADGEAR, NAMELY, HEADBANDS, HATS AND CAPS; WATERPROOF CLOTHING, NAMELY, WATERPROOF JACKETS AND PANTS; THERMAL CLOTHING, NAMELY, THERMAL SOCKS AND THERMAL UNDERWEAR; COATS; SPORTS CLOTHING, NAMELY, SPORTS COATS, SPORTS SHIRTS, SPORTS JACKETS, SPORTS JERSEYS, BREECHES FOR SPORTS, SPORTS OVER UNIFORMS AND SPORTS SHIRTS; JACKETS, ANORAKS, PULLOVERS, TROUSERS, SHIRTS, T-SHIRTS, CAGOULES, SMOCKS, SKI PANTS; GLOVES, BALACLAVAS, SOCKS, UNDERWEAR AND GAITERS; GOLF SPIKES (U.S. CLS. 22 AND 39).

CLASS 28—TOYS AND SPORTING GOODS

FOR GYMNASTIC AND SPORTING ARTICLES AND APPARATUS, NAMELY, WATER POLO BALLS, SQUASH BALLS, SHUTTLECOCKS, GOLF BALLS, TENNIS BALLS, CRICKET BALLS, SPORTS BALLS, ICE HOCKEY PUCKS, DARTS, TENNIS RACKETS, BADMINTON RACKETS, SQUASH RACKETS, GRIP BANDS FOR TENNIS RACKETS, GRIP BANDS FOR BADMINTON RACKETS, GRIP BANDS FOR SQUASH RACKETS, HOCKEY STICKS, LACROSSE STICKS, BASEBALL BATS, SOFTBALL BATS, CRICKET BATS, STRINGS FOR TENNIS RACKETS, STRINGS FOR BADMINTON RACKETS, STRINGS FOR SQUASH RACKETS, GUTS FOR TENNIS RACKETS, GUTS FOR BADMINTON RACKETS, GUT FOR SQUASH RACKETS, GUTS FOR RACKET BALL RACKETS, TENNIS NETS, NETS FOR BALL GAMES, RACKET BALL NETS, TABLES FOR TABLE TENNIS, BALL PITCHING MACHINES, HEAD COVERS FOR TENNIS RACKETS, HEAD COVERS FOR BADMINTON RACKETS, HEAD COVERS FOR SQUASH RACKETS, GOLF CLUBS, COVERS FOR GOLF CLUBS, GOLF GRIPS, GOLF CLUB HEAD COVERS, GOLF BAG COVERS, GOLF BAG PEGS, GOLF BALL MARKERS, GOLF FLAGS, GOLF TEES, GOLF TEE MARKERS, NON-MOTORIZED GOLF CARTS, PUTTING PRACTICE MATS, TAPES FOR WRAPPING TENNIS RACKET HANDLE GRIPS, TAPES FOR WRAPPING SQUASH RACKET HANDLE GRIPS, TAPES FOR WRAPPING BADMINTON RACKET HANDLE GRIPS, ICE SKATES, KITES, KITE REELS, TARGETS, FENCING GAUNTLETS, DISCS FOR SPORTS, BILLIARD CUES, BILLIARD CUE TIPS, SKATEBOARDS, ROLLER SKATES, ICE SKATES, CHEST EXPANDERS, GOLF BAGS, TENNIS

RACKET BAGS, BADMINTON RACKET BAGS, SQUASH RACKET BAGS, RACKET BALL RACKET BAGS, HOCKEY STICK BAGS, FRAMES FOR TENNIS RACKETS, FRAMES FOR BADMINTON RACKETS, FRAMES FOR SQUASH RACKETS, RACKET GRIPS, CRICKET STUMPS, BATTING PADS FOR CRICKET, WICKET KEEPING PADS FOR CRICKET, THIGH GUARDS, HOCKEY BALLS, HOCKEY STICK BAGS, GOALKEEPING GLOVES FOR SOCCER AND HOCKEY, GOALKEEPING LEG GUARDS FOR SOCCER AND HOCKEY, CHEST PROTECTORS AND ABDOMINAL PROTECTORS; BALLS FOR USE IN SPORTS, NAMELY, BASEBALLS, BASKETBALLS, BEACH BALLS, BILLIARD BALLS, BOWLING BALLS, CRICKET BALLS, FIELD HOCKEY BALLS, FOOTBALLS, HAND BALLS, LACROSSE BALLS, NET BALLS, PADDLE BALLS, PLAYGROUND BALLS, PUNCHING BALLS, RACKET BALLS, RUBBER BALLS, RUGBY BALLS, SOCCER BALLS, TABLE TENNIS BALLS AND VOLLEYBALLS; TOYS, NAMELY, PLASTIC CHARACTER TOYS, PLUSH TOYS, PUNCHING TOYS, SOFT SCULPTURE TOYS, SQUEEZE TOYS, STUFFED TOYS, TALKING TOYS AND TOY ACTION FIGURES; BALLOONS; SPORTS BAGS, NAMELY, BAGS FOR SKATEBOARDS, BAGS ESPECIALLY ADAPTED FOR SPORTS EQUIPMENT, BOWLING BAGS, BOXING BAGS, GOLF BAGS, PUNCHING BAGS AND GOLF BALL BAGS; ELECTRONIC GAMES, NAMELY, HANDHELD UNITS FOR PLAYING ELECTRONIC GAMES, HANDHELD GAMES WITH LIQUID CRYSTAL DISPLAYS AND HANDHELD UNITS FOR PLAYING VIDEO GAMES; MODELLED PLASTIC TOY FIGURINES; ARTIFICIAL CHRISTMAS TREES AND CHRISTMAS TREE STANDS; KALEIDOSCOPIES, FACE MASKS FOR HOCKEY, LEG GUARDS FOR ATHLETIC USE; ELBOW PADS FOR ATHLETIC USE (U.S. CLS. 22, 23, 38 AND 50).

TEJBIR SINGH, EXAMINING ATTORNEY

SN 78-497.604. JACKSON INTERNATIONAL TRADING COMPANY K.D. BRÜHL GMBH & CO. KG, A-8010 GRAZ, AUSTRIA, FILED 10-11-2004.



**GOOD
MAN**

NO CLAIM IS MADE TO THE EXCLUSIVE RIGHT TO USE "QUALITY", APART FROM THE MARK AS SHOWN.

CLASS 3—COSMETICS AND CLEANING PREPARATIONS

FOR LAUNDRY SOAP AND DETERGENT, LAUNDRY AND ALL PURPOSE BLEACH, ALL PURPOSE CLEANERS; POLISHING PREPARATIONS, GREASE CUTTERS AND ABRASIVES; PERFUME PRODUCTS AND SOAPS, NAMELY COLOGNE, SKIN LOTIONS, TALCUM POWDER, BODY OILS, BODY LOTIONS, SKIN SOAPS; ESSENTIAL OILS FOR PERFUMERY; HEALTH AND BEAUTY AIDS NAMELY, HAIR SHAMPOOS, HAIR CONDITIONERS, AND HAIR TONICS; SKIN BALMS, SKIN CREAMS; BATH GELS, BATH SALTS, BODY MASKS; PERSONAL HYGIENE PRODUCTS, NAMELY ANTIPERSPIRANTS, DEODORANTS, DENTIFRICES, BREATH FRESHENERS; TOILETRIES NAMELY, BUBBLE BATH; COTTON FOR COSMETIC PURPOSES, CUTICLE REMOVING PREPARATIONS; EMERY BOARDS; NAIL CARE PREPARATIONS, NAIL POLISH; HAIR POMADES, COTTON SWABS FOR COSMETIC PURPOSES AND PRE-MOISTENED COSMETIC WIPES AND COSMETICS (U.S. CLS. 1, 4, 6, 50, 51 AND 52).

CLASS 18—LEATHER GOODS

FOR LEATHER AND ARTIFICIAL LEATHER AND PRODUCTS MADE THEREOF, NAMELY CARRYING BAGS AND LUGGAGE; ANIMAL SKINS AND FURS; SUITCASES, BRIEFCASES AND TRAVEL BAGS, UMBRELLAS, PARASOLS AND NON-MEDICAL WALKING CANES; WHIPS, HARNESSES FOR HORSES, SADDLES AND SADDLE STRAPS AND ACCESSORIES, NAMELY, SADDLE STRAPS (U.S. CLS. 1, 2, 3, 22 AND 41).

CLASS 25—CLOTHING

FOR MEN'S, WOMEN'S AND CHILDREN'S CLOTHING, NAMELY COATS, JACKETS, SHIRTS, SKIRTS, SLACKS; SHOES AND SOCKS; HEADGEAR, NAMELY HATS, CAPS, SCARVES, HEADBANDS (U.S. CLS. 22 AND 39).

CLASS 32—LIGHT BEVERAGES

FOR BEER, MINERAL, WATER, CARBONATED WATERS AND OTHER NON-ALCOHOLIC BEVERAGE, NAMELY SOFT DRINKS, ICE TEAS; FRUIT DRINKS AND FRUIT JUICES; SYRUPS AND POWERS FOR MAKING SOFT DRINKS (U.S. CLS. 45, 46 AND 48).
GEORGIA CARTY, EXAMINING ATTORNEY

SN 78-498,315. URBAN SHOPPING CENTERS, L.P., CHICAGO, IL. FILED 10-12-2004.

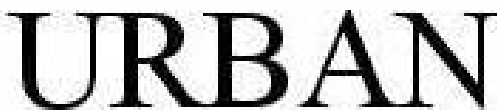

THE MARK CONSISTS OF STANDARD CHARACTERS WITHOUT CLAIM TO ANY PARTICULAR FONT, STYLE, SIZE, OR COLOR.

OWNER OF U.S. REG. NO. 2,717,059.
SEC. 2(F).

CLASS 36—INSURANCE AND FINANCIAL

FOR REAL ESTATE MANAGEMENT, LEASING OF REAL ESTATE, REAL ESTATE BROKERAGE, REAL ESTATE APPRAISAL, REAL ESTATE INVESTMENT, REAL ESTATE PROCUREMENT FOR OTHERS (U.S. CLS. 100, 101 AND 102).

FIRST USE 3-1-1995; IN COMMERCE 3-1-1995.

CLASS 37—CONSTRUCTION AND REPAIR

FOR REAL ESTATE DEVELOPMENT SERVICES (U.S. CLS. 100, 103 AND 106).
FIRST USE 3-1-1995; IN COMMERCE 3-1-1995.
ELLEN PERKINS, EXAMINING ATTORNEY

SN 78-507,187. CARTE BLANCHE GREETINGS LIMITED, CHICHESTER, UNITED KINGDOM, FILED 10-28-2004.



OWNER OF ERPN CMNTY TM OFC REG. NO. 2552172, DATED 1-28-2002, EXPIRES 1-28-2012.

NO CLAIM IS MADE TO THE EXCLUSIVE RIGHT TO USE "GREETINGS LTD.", APART FROM THE MARK AS SHOWN.

CLASS 16—PAPER GOODS AND PRINTED MATTER

FOR NOTEBOOKS, AUTOGRAPH BOOKS, EXERCISE BOOKS, EDUCATIONAL PICTURE BOOKS FOR CHILDREN, CHILDREN'S ACTIVITY BOOKS, COLORING BOOKS, CHILDREN'S BOOKS; STATIONERY; PUBLICATIONS AND PRINTED MATERIALS, NAMELY, BROCHURES RELATING TO GIFTWARE AND SOFT TOYS; SCRAPBOOKS, ADDRESS BOOKS; PHOTO ALBUMS, DIARIES AND SECRET BOOKS; PHOTOGRAPHS, PICTURES AND POSTERS; DRAWING RULERS, UNGRADUATED RULERS; ERASERS, PENS, PENCILS, CRAYONS, PAINTS, PEN AND PENCIL STANDS; PEN AND PENCIL HOLDERS AND CASES; ADHESIVES FOR STATIONERY OR HOUSEHOLD USE; ARTISTS MATERIALS, NAMELY, ARTISTS' BRUSHES, ARTISTS' PENCILS; PAINT BRUSHES; GREETING CARDS; STICKERS, WRAPPING PAPER, BUSINESS CARDS, PAPER AND CARDBOARD BOWS FOR GIFTWRAP; PAPER AND CARDBOARD GIFT RIBBONS; ENVELOPES, PRINTED PAPER SIGNS; STICKERS; DECORATIVE STICKERS FOR CARS; TABLE LINEN OF PAPER; TABLECLOTHS OF PAPER; TABLE NAPKINS OF PAPER; TRASH BAGS; PAPER CLIPS (U.S. CLS. 2, 5, 22, 23, 29, 37, 38 AND 50).

CLASS 21—HOUSEWARES AND GLASS

FOR FIGURINES OF CHINA, CRYSTAL, EARTHENWARE, GLASS, PORCELAIN AND TERRA COTTA; HAIRBRUSHES AND COMBS; HAIR BRUSH AND COMB CASES; CANDLE-HOLDERS; MUGS, BEVERAGE GLASSWARE; CHINA ORNAMENTS, PORCELAIN, GLASSWARE AND EARTHENWARE, NAMELY, MUGS, PLATES, BOWLS, ORNAMENTS AND FIGURINES; CONTAINERS FOR HOUSEHOLD OR KITCHEN USE; CLOTHES PINS (U.S. CLS. 2, 13, 23, 29, 30, 33, 40 AND 50).

MICHAEL SOUDERS, EXAMINING ATTORNEY

SN 78-514,103. NJ PROPERTIES, INC., BOCA RATON, FL.
FILED 11-9-2004.

CALL4HEALTH

THE MARK CONSISTS OF STANDARD CHARACTERS WITHOUT CLAIM TO ANY PARTICULAR FONT, STYLE, SIZE, OR COLOR.

CLASS 35—ADVERTISING AND BUSINESS

FOR MANAGEMENT AND OPERATION OF TELEPHONE CALL CENTERS FOR OTHERS FOR THE MEDICAL AND HEALTH CARE INDUSTRIES, NAMELY, GENERAL HOME HEALTH CARE, HOSPICE, MEDICAL EQUIPMENT COMPANIES, PHARMACIES, PHYSICAL THERAPISTS, NURSING REGISTRIES, HOSPITALS, PHYSICIANS, HEALTH, AND BEAUTY AND SELF-HELP CENTERS; ORDER-TAKING SERVICES FOR OTHERS VIA TELEPHONE CALL CENTERS; APPOINTMENT SCHEDULING VIA TELEPHONE CALL CENTERS; OUTSOURCING IN THE FIELD OF MEDICINE AND HEALTH CARE VIA TELEPHONE CALL CENTERS; RECORDS MANAGEMENT SERVICES FOR OTHERS, NAMELY, DOCUMENT INDEXING OF ELECTRONIC HEALTH RECORDS, ELECTRONIC PROCESSING OF ORDERS, AND ELECTRONIC PROCESSING OF HEALTH CARE INFORMATION; BUSINESS DEVELOPMENT SERVICES, NAMELY DEVELOPING COLLABORATIVE MODELS TO EXPAND ACCESS, QUALITY, SAFETY AND EFFECTIVENESS TO PATIENTS' CALL REQUIREMENTS (U.S. CLS. 100, 101 AND 102).

CLASS 42—SCIENTIFIC, COMPUTER AND LEGAL SERVICES

FOR MAINTENANCE OF COMPUTER SOFTWARE USED FOR CLINICAL DECISION SUPPORT; DEVELOPMENT OF SOFTWARE FOR THE MANAGED CARE PROCESS FROM HEALTHY FITNESS TO DISEASE MANAGEMENT (U.S. CLS. 100 AND 101).
ADA HAN, EXAMINING ATTORNEY

SN 78-517,943. ACTION MEDIA OPERATING, LLC, IRVINE, CA. FILED 11-16-2004.

D FORCE

THE MARK CONSISTS OF STANDARD CHARACTERS WITHOUT CLAIM TO ANY PARTICULAR FONT, STYLE, SIZE, OR COLOR.

CLASS 16—PAPER GOODS AND PRINTED MATTER

FOR PRINTED MATERIALS, NAMELY, LEAFLETS, FLYERS, NEWSLETTERS AND NEWSPAPERS ON THE SUBJECT OF AUTOMOBILE AND MOTORCYCLE RACING (U.S. CLS. 2, 5, 22, 23, 29, 37, 38 AND 50).

CLASS 25—CLOTHING

FOR CLOTHING, NAMELY, T-SHIRTS, POLO SHIRTS, BLOUSES, TOPS, FASHION KNIT SHIRTS, BUTTON-DOWN SHIRTS, LONG-SLEEVE T-SHIRTS, TANK TOPS, CAPS, JACKETS, COATS, VESTS, PONCHOS, SWEATERS, SWEATSHIRTS, CLOTHING TIES, GLOVES, SHORTS, SWIM SHORTS, SWIMSUITS, PANTS, DRESSES, SKIRTS, SWEATPANTS, SWEATBANDS, HEAD BANDS, SUN VISORS, HATS, BELTS, SCARVES, AND FOOTWEAR (U.S. CLS. 22 AND 39).

CLASS 28—TOYS AND SPORTING GOODS

FOR TOYS, NAMELY, MODEL CARS, TOY MODEL CARS, TOY MODEL KIT CARS, PLAY MOTOR CARS, STUFFED TOYS, PLAYING CARDS, CARD GAMES, AND ACTION SKILL GAMES (U.S. CLS. 22, 23, 38 AND 50).

CLASS 36—INSURANCE AND FINANCIAL

FOR FINANCIAL SPONSORSHIP OF AUTOMOBILE AND MOTORCYCLE RACING TEAMS (U.S. CLS. 100, 101 AND 102).

ANDREA K. NADELMAN, EXAMINING ATTORNEY

SN 78-525,382. ROYAL COLLEGE OF SURGEONS IN IRELAND, DUBLIN, IRELAND, FILED 12-1-2004.



PRIORITY CLAIMED UNDER SEC. 44(D) ON ERPNCMNTY TM OFC APPLICATION NO. 3875391, FILED 6-8-2004, REG. NO. 003875391, DATED 3-10-2006, EXPIRES 6-8-2014.

THE STIPPLING IS FOR SHADING PURPOSES ONLY. THE MARK CONSISTS OF THE WORDS CONSILIO MANUQUE AND A CREST DESIGN.

THE FOREIGN WORDING IN THE MARK TRANSLATES INTO ENGLISH AS "BY COUNSEL AND BY THE HAND".

CLASS 41—EDUCATION AND ENTERTAINMENT

FOR ARRANGEMENT, CONDUCTING AND ORGANIZATION OF EXHIBITIONS, AND CONFERENCES IN THE FIELDS OF MEDICINE AND HEALTHCARE; PUBLICATION OF BOOKS AND TEXTS IN THE FIELDS OF MEDICINE AND HEALTHCARE; ELECTRONIC PUBLICATION IN THE FIELD OF EDUCATIONAL MATERIALS FOR THE MEDICAL FIELD; EDUCATIONAL SERVICES, NAMELY, PROVIDING TUTORIALS, SEMINARS, WORKSHOPS, AND COURSES IN THE FIELDS OF MEDICINE AND HEALTHCARE; EDUCATIONAL EXAMINATION SERVICES; INSTRUCTION AND TRAINING SERVICES IN THE FIELDS OF MEDICINE AND HEALTHCARE; ARRANGING AND CONDUCTING OF SEMINARS, WORKSHOPS AND SYMPOSIUMS, IN THE HEALTHCARE FIELD; TEACHING AND PRACTICAL TRAINING IN THE FIELDS OF MEDICINE AND HEALTHCARE; TRAINING AND EDUCATION OF HEALTHCARE PROFESSIONALS NAMELY DOCTORS, SURGEONS, NURSES, PHYSIOTHERAPISTS, DENTISTS, MIDWIVES, PHARMACISTS, AND SCIENTISTS IN THE FIELDS OF MEDICINE, HEALTHCARE AND BUSINESS MANAGEMENT FOR HEALTH CARE PROVIDERS; INSTRUCTION AND TRAINING PROVIDED ON-LINE VIA A GLOBAL COMPUTER NETWORK IN THE FIELDS OF MEDICINE AND HEALTHCARE (U.S. CLS. 100, 101 AND 107).

CLASS 44—MEDICAL, BEAUTY AND AGRICULTURAL SERVICES

FOR PROVIDING MEDICAL INFORMATION VIA A GLOBAL COMPUTER NETWORK; MEDICAL AND HEALTHCARE SERVICES; MEDICAL AND SCIENTIFIC RESEARCH, NAMELY CONDUCTING CLINICAL TRIALS; AND MEDICAL ANALYSIS FOR THE DIAGNOSIS AND TREATMENT OF PERSONS; ADVISORY AND CONSULTANCY SERVICES IN THE FIELDS OF MEDICINE AND HEALTHCARE (U.S. CLS. 100 AND 101).

LINDA POWELL, EXAMINING ATTORNEY

SN 78-553,641. BARBARA BARRY, INC., LOS ANGELES, CA.
FILED 1-25-2005.

OVAL

THE MARK CONSISTS OF STANDARD CHARACTERS WITHOUT CLAIM TO ANY PARTICULAR FONT, STYLE, SIZE, OR COLOR.

CLASS 2—PAINTS

FOR INTERIOR PAINTS; PAINT PRIMERS; PAINT SEALERS; PAINTS (U.S. CLS. 6, 11 AND 16).

CLASS 4—LUBRICANTS AND FUELS

FOR CANDLES AND SCENTED CANDLES (U.S. CLS. 1, 6 AND 15).

CLASS 16—PAPER GOODS AND PRINTED MATTER

FOR ADDRESS BOOKS; APPOINTMENT BOOKS; BABY BOOKS; CALENDAR DESK PADS; CALENDARS; CHRISTMAS CARDS; DATE BOOKS; DESK TOP ORGANIZERS; GIFT WRAPPING PAPER; GREETING CARDS; PEN AND PENCIL TRAYS; PHOTOGRAPH ALBUMS; STATIONERY; DESK ACCESSORIES, NAMELY, BLOTTERS, PENCIL HOLDERS, FILE TRAYS, PAPER WEIGHTS, ART PRINTS, ART PICTURES AND ART ETCHINGS (U.S. CLS. 2, 5, 22, 23, 29, 37, 38 AND 50).

CLASS 18—LEATHER GOODS

FOR ATHLETIC BAGS, ATTACHE CASES, BEACH BAGS, DUFFEL BAGS, HANDBAGS, KEY CASES, LUGGAGE, OVERNIGHT BAGS, TOILETRY CASES SOLD EMPTY, TOTE BAGS, TRAVEL BAGS, WALLET (U.S. CLS. 1, 2, 3, 22 AND 41).

CLASS 19—NON-METALLIC BUILDING MATERIALS

FOR TILES OF CLAY, GLASS, GYPSUM, CERAMIC, STONE AND EARTHENWARE FOR WALL, FLOOR; WOOD TILE FLOORS AND TILES (U.S. CLS. 1, 12, 33 AND 50).

CLASS 20—FURNITURE AND ARTICLES NOT OTHERWISE CLASSIFIED

FOR DECK CHAIRS; FURNITURE; MIRRORS; DRAPERY HARDWARE AND ACCESSORIES, NAMELY, TRAVERSE RODS, POLES, CURTAIN HOOKS, CURTAIN RODS AND FINIALS; NON METAL LACQUER BOXES AND MATTRESSES; ART FRAMES; PICTURE FRAMES; TEA CARTS; TOY CHESTS; OUTDOOR FURNITURE; WINE RACKS; FITTED FABRIC FURNITURE COVERS; PILLOWS; DECORATIVE PILLOWS; DOWN, FEATHER AND POLYESTER PILLOWS (U.S. CLS. 2, 13, 22, 25, 32 AND 50).

CLASS 21—HOUSEWARES AND GLASS

FOR CHINA AND CRYSTAL FIGURINES, ORNAMENTS AND STATUETTES; PLATES, BOWLS, CUPS, SAUCERS AND SERVING PLATTERS, ALL OF CHINA; CRYSTAL STEMWARE; SERVING TRAYS NOT OF PRECIOUS METAL; BEVERAGE GLASSWARE; PORTABLE BEVERAGE DISPENSERS; BEVERAGE DISPENSERS, NAMELY, URNS AND VACUUM FLASKS; GLASS BOXES; DISHES; PLATES; BOWLS; VASES; CANDLE HOLDERS NOT OF PRECIOUS METAL; COASTERS NOT OF PAPER AND NOT BEING TABLE LINEN; HOUSEHOLD UTENSILS, NAMELY, GRATERS, SIEVES, SPATULAS, STRAINERS, TURNERS, POT AND PAN SCRAPERS, ROLLING PINS, WHISKS AND TONGS; TRAYS NOT OF PRECIOUS METAL; CERAMIC AND CRYSTAL BOWLS; VASES AND PLATES; WOOD TRAYS; BAR WARE, NAMELY, COCKTAIL PICKS, COCKTAIL SHAKERS, SELTZER BOTTLES, BEER MUGS, BOTTLE OPENERS, CARAFES, DECANTERS, DRINKING GLASSES, GOBLET, ICE BUCKETS, SHOT GLASSES, AND WINE BUCKETS; COMPACTS SOLD EMPTY; WASTE BASKETS; BATHROOM ACCESSORIES, NAMELY, MANUAL TOOTHBRUSHES, TOOTHBRUSH HOLDERS, SOAP DISHES, CUP HOLDERS, BATH SPONGES, COMBS, COTTON BALL DISPENSERS, GARBAGE CANS, HAND WASH BASINS, PORCELAIN KNOBS, SHAVING BRUSHES, SHAVING BRUSH HOLDERS, SHOWER CADDIES, SOAP DISPENSERS, TOILET BRUSHES AND TOILET BRUSH HOLDERS, TOILET PAPER DISPENSERS, TOWEL BARS, TOWEL HOLDERS, TOWEL RACKS, AND TOWEL RINGS (U.S. CLS. 2, 13, 23, 29, 30, 33, 40 AND 50).

CLASS 24—FABRICS

FOR FABRICS FOR CURTAINS; DRAPERIES; WINDOW TOP TREATMENTS, NAMELY, FABRIC VALANCES, POUFS AND SWAGS; UPHOLSTERY FABRICS AND UNFITTED FURNITURE COVERS; HOUSEHOLD LINENS; KITCHEN LINENS; BATH LINENS; BED LINENS; TOWELS; WASHCLOTHS; SHOWER CURTAINS; BED SHEETS; BATH SHEETS; BED BLANKETS; RECEIVING BLANKETS; BLANKETS FOR OUTDOOR USE; THROWS; COMFORTERS; BEDSPREADS; TEXTILE NAPKINS; DUVETS AND DUVET COVERS; COVERLETS; DUST RUFFLES; QUILTS; TABLECLOTHS NOT OF PAPER; TABLE LINENS AND PLACE MATS NOT OF PAPER; BOX SPRING COVERS; SHAMS; CURTAINS; DRAPERY; PILLOWCASES (U.S. CLS. 42 AND 50).

CLASS 27—FLOOR COVERINGS

FOR RUGS; CARPETS; CARPET TILES; WALL COVERINGS CONSISTING OF VINYL, PLASTIC, LINEN, NON-TEXTILE AND CLOTH; WALLPAPER; FABRIC AND PLASTIC BATH MATS AND BATH RUGS (U.S. CLS. 19, 20, 37, 42 AND 50).

CLASS 30—STAPLE FOODS

FOR COCOA; COFFEE; TEA; CHOCOLATES (U.S. CL. 46).

CLASS 35—ADVERTISING AND BUSINESS

FOR RETAIL STORE SERVICES FEATURING FURNITURE, HOME FURNISHINGS, AND HOME FURNISHING PRODUCTS AND ACCESSORIES (U.S. CLS. 100, 101 AND 102).

AMY HELLA, EXAMINING ATTORNEY

CLASS 9—ELECTRICAL AND SCIENTIFIC APPARATUS

FOR TELECOMMUNICATIONS APPARATUS AND INSTRUMENTS, NAMELY TELEPHONE HANDSETS, TELEPHONE EAR PIECES, HANDS-FREE TELEPHONE SETS AND TELEPHONE HOLDERS; CELLULAR TELEPHONES; MOBILE TELEPHONES; TELEPHONE EQUIPMENT CABINETS; TELEPHONE EQUIPMENT RACKS; TELEPHONE SWITCHING UNITS, SWITCHES AND RELAYS FOR TELEPHONE CONSOLES AND SWITCHBOARDS; AUDIO AMPLIFIERS; TELEPHONE RECEIVERS; TELEPHONES; FAX MACHINES; DISPLAY SCREENS, NAMELY COMPUTER DISPLAY SCREENS AND DISPLAY SCREENS FOR TELEPHONES; ELECTRONIC GAMES PROGRAMS; COMPONENT PARTS FOR TELEPHONE HANDSETS, TELEPHONE EAR PIECES, HANDS-FREE TELEPHONE SETS AND TELEPHONE HOLDERS, CELLULAR TELEPHONES, MOBILE TELEPHONES, TELEPHONE SWITCHING UNITS, SWITCHES AND RELAYS FOR TELEPHONE CONSOLES AND SWITCHBOARDS, AUDIO AMPLIFIERS, TELEPHONE RECEIVERS; BATTERIES AND CHARGERS FOR TELEPHONE HANDSETS, TELEPHONE EAR PIECES, HANDS-FREE TELEPHONE SETS AND TELEPHONE HOLDERS, CELLULAR TELEPHONES, MOBILE TELEPHONES; HEADSETS FOR USE IN RELATION TO HANDS-FREE USE OF TELEPHONES; TELEPHONE EAR PIECES FOR USE IN RELATION TO HANDS-FREE USE OF TELEPHONES; COMPUTER KEYBOARDS AND KEYBOARDS ON OR FOR USE IN CONJUNCTION WITH MOBILE TELEPHONES; DATA PROCESSING APPARATUS, NAMELY DATA MODEMS FOR HIGH SPEED DATA TRANSMISSIONS; MEDIA FOR RECORDING OR REPRODUCTION OF DATA, SOUND, IMAGES OR SIGNALS, NAMELY BLANK AUDIO MAGNETIC TAPES, BLANK VIDEO MAGNETIC TAPES AND BLANK VIDEO DISCS; OPTICAL OR MAGNETIC APPARATUS AND INSTRUMENTS, NAMELY EYEGLASSES, SUNGLASSES AND BINOCULARS; COMPUTERS, COMPUTER TERMINALS; SOFTWARE, NAMELY COMPUTER PROGRAMS IN RECORDED FORM AND FIXED IN ELECTRONIC MEMORY CIRCUITS, ALL FOR USE IN RELATION TO TELECOMMUNICATION DEVICES FOR ELECTRONIC GAMES, FOR THE TRANSMISSION, REPRODUCTION, RECEIVING, ACCESSING, SEARCHING, INDEXING AND RETRIEVING OF GAMES, IMAGES, MUSIC, SOUNDS, TEXT, MOVIES, VIDEO AND ANIMATIONS IN THE FIELD OF GENERAL ENTERTAINMENT, AND DATA, FOR GENERAL DATABASE MANAGEMENT, FOR THE MANAGEMENT AND OPERATION OF WIRELESS COMMUNICATION DEVICES, FOR ENABLING AND SECURING ELECTRONIC TRANSACTIONS, AND FOR THE TRANSMISSION, REPRODUCTION, RECEIVING, ACCESSING, SEARCHING, INDEXING AND RETRIEVING OF GAMES, IMAGES, MUSIC, SOUNDS, TEXT, MOVIES, VIDEO AND ANIMATIONS IN THE FIELD OF GENERAL ENTERTAINMENT, AND DATA FROM COMPUTER OR COMMUNICATION NETWORKS; MEDIA FOR DATA STORAGE, NAMELY BLANK SMART CARDS, BLANK MEMORY CHIPS AND BLANK MAGNETIC CARDS; ELECTRONIC PERSONAL ORGANIZERS; MULTI-MEDIA TERMINALS, NAMELY COMPUTERS AND MOBILE TELEPHONES; DOWNLOADABLE ELECTRONIC PUBLICATIONS, IN THE NATURE OF MAGAZINES AND MANUALS IN THE FIELD OF TELECOMMUNICATIONS; ELECTRONIC PUBLICATIONS, NAMELY, MAGAZINES AND MANUALS RELATING TO TELECOMMUNICATIONS RECORDED ON COMPUTER MEDIA; CINEMATOGRAPHIC AND PHOTOGRAPHIC APPARATUS AND INSTRUMENTS, NAMELY STILL AND VIDEO CAMERAS, VIEWING SCREENS AND VIEWFINDERS, ALL ADAPTED FOR USE IN RELATION TO TELECOMMUNICATIONS DEVICES; PRINTERS (U.S. CLS. 21, 23, 26, 36 AND 38).

SN 78-556,694, SONY ERICSSON MOBILE COMMUNICATIONS AB, LUND, SWEDEN, FILED 1-31-2005.

P910a

THE MARK CONSISTS OF STANDARD CHARACTERS WITHOUT CLAIM TO ANY PARTICULAR FONT, STYLE, SIZE, OR COLOR.

CLASS 38—COMMUNICATION

FOR TELECOMMUNICATIONS AND DATA COMMUNICATIONS SERVICES, NAMELY WIRELESS LOCAL AND LONG DISTANCE TELEPHONE, DATA TRANSMITTAL, E-MAIL AND TEXT MESSAGING, PAGING, ELECTRONIC DATA TRANSMISSION PACKET AND INTERNET PROTOCOL TELEPHONY SERVICES; TELECOMMUNICATIONS CONSULTATION; PROVIDING MULTIPLE USER ACCESS TO THE INTERNET, TO INTRANET AND TO EXTRA NETS; PROVIDING TELECOMMUNICATIONS CONNECTIONS TO THE INTERNET, TO INTRANETS AND EXTRANETS; RENTAL OF TELECOMMUNICATIONS EQUIPMENT; PROVISION OF REMOTE ACCESS TO DATA STORED ELECTRONICALLY IN CENTRAL FILES FOR REMOTE CONSULTATION, NAMELY COMPUTER PROGRAMS IN RECORDED FORM AND FIXED IN ELECTRONIC MEMORY CIRCUITS, ALL FOR USE IN RELATION TO TELECOMMUNICATION DEVICES FOR ELECTRONIC GAMES, FOR THE TRANSMISSION, REPRODUCTION, RECEIVING, ACCESSING, SEARCHING, INDEXING AND RETRIEVING OF GAMES, IMAGES, MUSIC, SOUNDS, TEXT, MOVIES, VIDEO AND ANIMATIONS IN THE FIELD OF GENERAL ENTERTAINMENT, AND DATA, FOR GENERAL DATABASE MANAGEMENT, FOR THE MANAGEMENT AND OPERATION OF WIRELESS COMMUNICATION DEVICES, FOR ENABLING AND SECURING ELECTRONIC TRANSACTIONS, AND FOR THE TRANSMISSION, REPRODUCTION, RECEIVING, ACCESSING, SEARCHING, INDEXING AND RETRIEVING OF GAMES, IMAGES, MUSIC, SOUNDS, TEXT, MOVIES, VIDEO AND ANIMATIONS IN THE FIELD OF GENERAL ENTERTAINMENT, AND DATA FROM COMPUTER OR COMMUNICATION NETWORKS; PROVIDING MULTIPLE-USER ACCESS TO A COMPUTER NETWORK (U.S. CLS. 100, 101 AND 104).

C. DIONNE CLYBURN, EXAMINING ATTORNEY

CLASS 9—ELECTRICAL AND SCIENTIFIC APPARATUS

FOR (BASED ON INTENT TO USE) PRE-RECORDED CD'S AND DVD'S FEATURING TOPICS RELATED TO WEIGHT LOSS, WEIGHT MANAGEMENT, PROPER EATING HABITS, NUTRITION, EXERCISE, DIETARY SUPPLEMENTATION AND INFORMATION RELATED TO A COMPREHENSIVE, HOLISTIC APPROACH TO MENTAL, EMOTIONAL AND PHYSICAL HEALTH AND WELL BEING (U.S. CLS. 21, 23, 26, 36 AND 38).

FIRST USE 1-3-2005; IN COMMERCE 1-3-2005.

CLASS 16—PAPER GOODS AND PRINTED MATTER

FOR (BASED ON USE IN COMMERCE) BOOKS, JOURNALS, BROCHURES AND BOOKLETS FEATURING TOPICS RELATED TO WEIGHT LOSS, WEIGHT MANAGEMENT, PROPER EATING HABITS, NUTRITION, EXERCISE, DIETARY SUPPLEMENTATION AND INFORMATION RELATED TO A COMPREHENSIVE, HOLISTIC APPROACH TO MENTAL, EMOTIONAL AND PHYSICAL HEALTH AND WELL BEING (U.S. CLS. 2, 5, 22, 23, 29, 37, 38 AND 50).

FIRST USE 1-3-2005; IN COMMERCE 1-3-2005.

CLASS 29—MEATS AND PROCESSED FOODS

FOR (BASED ON INTENT TO USE) PACKAGED ENTREES CONSISTING PRIMARILY OF MEAT, POULTRY, LEGUMES OR VEGETABLES (U.S. CL. 46).

FIRST USE 1-3-2005; IN COMMERCE 1-3-2005.

DARRYL SPRUILL, EXAMINING ATTORNEY

SN 78-577,988. FUJINON CORPORATION, SAITAMA, JAPAN, FILED 3-2-2005.

SN 78-570,834. MARKET AMERICA, INC., GREENSBORO, NC. FILED 2-18-2005.



THE COLOR(S) PINK, BLUE, AND GREY IS/ARE CLAIMED AS A FEATURE OF THE MARK.

THE MARK CONSISTS OF THE WORDING TRANSITIONS IN PINK, AND THE LETTERS IT (LOWER CASE) IN BLUE AND SHADES OF BLUE APPEARING IN A REPEATING FASHION BELOW THE WORDING TRANSITIONS, WITH A GREY LINE APPEARING BETWEEN TRANSITIONS AND IT.

CLASS 5—PHARMACEUTICALS

FOR (BASED ON INTENT TO USE) MEAL REPLACEMENT BARS AND SHAKES CONSISTING PRIMARILY OF PROTEIN AND NUTRIENTS; DIETARY SUPPLEMENTS, NAMELY FOR SUPPORT AND MAINTENANCE OF WEIGHT (U.S. CLS. 6, 18, 44, 46, 51 AND 52).

FIRST USE 8-5-2004; IN COMMERCE 8-5-2004.

FUJINON

THE MARK CONSISTS OF STANDARD CHARACTERS WITHOUT CLAIM TO ANY PARTICULAR FONT, STYLE, SIZE, OR COLOR.

PRIORITY CLAIMED UNDER SEC. 44(D) ON JAPAN APPLICATION NO. 2004084685, FILED 9-14-2004, REG. NO. 4882575, DATED 7-22-2005, EXPIRES 7-22-2015.

CLASS 9—ELECTRICAL AND SCIENTIFIC APPARATUS

FOR DIGITAL CAMERAS, CAMERAS, VIDEO CAMCORDERS, LENSES FOR TELEVISION CAMERAS, LENSES FOR CAMERAS, LENSES FOR FACSIMILE MACHINES, LENSES FOR PICTURE PROJECTORS; PROJECTORS, NAMELY, PICTURE PROJECTORS, VIDEO PROJECTORS AND LIQUID CRYSTAL PROJECTORS; OPTICAL APPARATUS AND INSTRUMENTS, NAMELY, BODY-TUBES FOR TELESCOPES, TRIPODS, PERISCOPES, BINOCULARS, REFLECTORS FOR TELESCOPES, PRISMS FOR TELESCOPES, TELESCOPES, LENSES FOR TELESCOPES, MICROSCOPES, MAGNIFYING GLASSES, BODY TUBES FOR MICROSCOPES, METALLURGICAL MICROSCOPES, BIOLOGICAL MI-

CROSCOPES, REFLECTORS FOR MICROSCOPES, PRISMS FOR MICROSCOPES, POLARIZING MICROSCOPES, STEREOSCOPES; INTERFEROMETERS; AND OTHER MEASURING OR TESTING MACHINES AND INSTRUMENTS, NAMELY, ANGLE GAUGES, ANGLE DIVIDING MACHINES, SPHEROMETERS, INCLINOMETERS, INTERFEROMETERS, STRAIGHTNESS TESTING MACHINES AND INSTRUMENTS, PROFILE PROJECTORS, GRADUATION CHECKERS, LENGTH MEASURING GAUGES, COMPARATORS, ENDOSCOPES FOR INDUSTRIAL USE AND THEIR STRUCTURAL PARTS; ACCESSORIES FOR ENDOSCOPES FOR INDUSTRIAL USE, NAMELY, LIGHT EMITTING DIODES TO ILLUMINATE OBSERVATION AREA OF ENDSCOPE, PORTABLE CASES AND VIDEO MONITORS FOR USE THEREWITH; VIDEO FREQUENCY MACHINES AND APPARATUS FOR EDUCATIONAL PURPOSES, NAMELY, VIDEO CAMERAS, VIDEO DISC PLAYERS, VIDEO TAPE RECORDERS AND VIDEO MONITORS; AUDIO FREQUENCY MACHINES AND APPARATUS FOR EDUCATION PURPOSES, NAMELY, LOUD SPEAKERS, MICROPHONES AND TAPE RECORDERS; TELECOMMUNICATION MACHINES AND APPARATUS, NAMELY, CELLULAR PHONE INCORPORATED WITH CAMERAS; EAR PLUGS FOR SLEEPING; OPTICAL PROCESSED GLASS; OZONISERS; ELECTROLYSERS; ELECTROLYTIC CELLS; EGG-CANDLERS; CASH REGISTERS; COIN COUNTING OR SORTING MACHINES; TIME AND DATE STAMPING MACHINES, TIME CLOCKS, VOTING MACHINES, AUTOMATED PAPER MONEY SORTING MACHINES; POSTAGE METERS; VENDING MACHINES; GASOLINE STATION EQUIPMENT, NAMELY, METERED GASOLINE PUMPS; COIN-OPERATED GATES FOR CAR PARKING FACILITIES; LIFE SAVING APPARATUS AND EQUIPMENT, NAMELY, LIFE SAVING RAFTS; FIRE EXTINGUISHERS, FIRE HYDRANTS, FIRE HOSE NOZZLES, SPRINKLER SYSTEMS FOR FIRE PROTECTION, FIRE ALARMS, ALARMS FOR THE DETECTION OF INFLAMMABLE GASES; ANTI-THEFT WARNING APPARATUS, NAMELY, BURGLAR ALARMS; PROTECTIVE HELMETS, RAILWAY SIGNALS; VEHICLE BREAKDOWN WARNING TRIANGLES; LUMINOUS OR MECHANICAL ROAD SIGNS; ARCADE VIDEO GAME MACHINES; ELECTRIC DOOR OPENERS, VEHICLE DRIVE TRAINING SIMULATORS; ELECTRIC WIRES AND CABLES, ELECTRIC FLAT IRONS, ELECTRIC HAIR-CURLERS, ELECTRIC BUZZERS, MAGNETIC CORES, RESISTANCE WIRES, ELECTRODES, FIRE EXTINGUISHERS IN THE NATURE OF FIREBOATS, FIRE ENGINES, CIGAR LIGHTERS FOR AUTOMOBILES, GLOVES FOR PROTECTION AGAINST ACCIDENTS, DUST MASKS, GAS MASKS, WELDING MASKS, FIREPROOF GARMENTS, SPECTACLES, NAMELY, EYEGLASSES AND GOGGLES, CONSUMER VIDEO GAME SOFTWARE; ELECTRONIC INTEGRATED CIRCUITS; PRERECORDED CDS FEATURING GAMES WITH LIQUID CRYSTAL DISPLAYS; SLOT MACHINES; WEIGHT BELTS FOR SCUBA DIVING; PROTECTIVE HELMETS FOR SPORTS; AIR TANKS FOR SCUBA DIVING; REGULATORS FOR USE IN SCUBA DIVING; PRERECORDED CDS FEATURING AUTOMATIC PERFORMANCES OF ELECTRONIC MUSICAL INSTRUMENTS, SLIDE-RULES, EXPOSED CINEMATOGRAPHIC FILMS, SLIDE FILM MOUNTS (U.S. CLS. 21, 23, 26, 36 AND 38).

CLASS 10—MEDICAL APPARATUS

FOR ENDOSCOPES AND OTHER MEDICAL MACHINES AND APPARATUS, NAMELY, ENDOSCOPES, CATHETERS, SURGICAL CLIP, SURGICAL FORCEPS, GASTROSCOPES, KNIVES FOR SURGICAL PURPOSES, LASER FOR MEDICAL PURPOSES, SURGICAL DEVICES, NAMELY, TROCARS; UROLOGICAL APPARATUS AND INSTRUMENTS, NAMELY, UROLOGICAL ENDSCOPE; PACIFIERS FOR BABIES, ICE BAG PILLOWS FOR MEDICAL PURPOSES, TRIANGULAR BANDAGES FOR ANATOMICAL JOINTS, SUPPORTIVE ELASTIC BANDAGES, SURGICAL CATGUTS, FEEDING CUPS FOR MEDICAL PURPOSES, DROPPING PIPETTES

FOR MEDICAL PURPOSES, TEATS, MEDICAL ICE BAGS, MEDICAL ICE BAG HOLDERS, BABY BOTTLES, VACUUM NURSING BOTTLES, FINGER GUARDS FOR MEDICAL PURPOSES, CONTRACEPTIVES, ARTIFICIAL TYMPANIC MEMBRANES, PROSTHETIC AND FILLING MATERIALS, NAMELY, PUTTY FOR USE IN REPLACEMENT OF BONES; ELECTRIC MASSAGE APPARATUS FOR INDUSTRIAL PURPOSES, ELECTRIC MASSAGE APPARATUS FOR HOUSEHOLD USE, GLOVES FOR MEDICAL PURPOSES, URINALS FOR MEDICAL PURPOSES, BED PANS, EAR PICKS (U.S. CLS. 26, 39 AND 44).

CLASS 11—ENVIRONMENTAL CONTROL APPARATUS

FOR ACCESSORIES FOR ENDOCARPS FOR INDUSTRIAL USE, NAMELY, HALOGEN LAMPS, XENON LAMPS AND ELECTRIC LUMINARIES TO ILLUMINATE OBSERVATION AREA OF ENDOCARPS (U.S. CLS. 13, 21, 23, 31 AND 34).

CLASS 37—CONSTRUCTION AND REPAIR

FOR REPAIR OF LENSES FOR TELEVISION CAMERAS, REPAIR OR MAINTENANCE OF CINEMATOGRAPHIC MACHINES AND APPARATUS, REPAIR OR MAINTENANCE OF OPTICAL MACHINES AND INSTRUMENTS, REPAIR OR MAINTENANCE OF PHOTOGRAPHIC MACHINES AND APPARATUS, REPAIR OR MAINTENANCE OF ELECTRONIC MACHINES AND APPARATUS, REPAIR OR MAINTENANCE OF TELECOMMUNICATION MACHINES AND APPARATUS, REPAIR OR MAINTENANCE OF MEASURING AND TESTING MACHINES AND INSTRUMENTS, REPAIR OR MAINTENANCE OF MEDICAL MACHINES AND APPARATUS, BUILDING CONSTRUCTION, CONSTRUCTION CONSULTANCY, REPAIR AND MAINTENANCE OF BUILDING CONSTRUCTION MATERIAL, SHIPBUILDING, REPAIR OR MAINTENANCE OF VESSELS, AIRCRAFT MAINTENANCE OR REPAIR, REPAIR OF BICYCLES, REPAIR OR MAINTENANCE OF AUTOMOBILES, REPAIR OR MAINTENANCE OF RAILWAY ROLLING STOCK, REPAIR OR MAINTENANCE OF TWO WHEELED MOTOR VEHICLES, REPAIR OR MAINTENANCE OF LOADING-UNLOADING MACHINES AND APPARATUS, REPAIR OR MAINTENANCE OF FIRE ALARMS, REPAIR OR MAINTENANCE OF OFFICE MACHINES AND APPARATUS, REPAIR OR MAINTENANCE OF AIR-CONDITIONING APPARATUS FOR INDUSTRIAL PURPOSES, BURNER MAINTENANCE OR REPAIR, REPAIR OR MAINTENANCE OF BOILERS, PUMP REPAIR OR MAINTENANCE, REPAIR OR MAINTENANCE OF FREEZING MACHINES AND APPARATUS REPAIR OR MAINTENANCE OF CONSTRUCTION MACHINES AND APPARATUS, REPAIR OR MAINTENANCE OF CONSUMER ELECTRIC APPLIANCES, REPAIR OR MAINTENANCE OF ELECTRIC LIGHTING APPARATUS, REPAIR OR MAINTENANCE OF POWER DISTRIBUTION OR CONTROL MACHINES AND APPARATUS, REPAIR OR MAINTENANCE OF POWER GENERATORS, REPAIR OR MAINTENANCE OF ELECTRIC MOTORS, REPAIR OR MAINTENANCE OF LABORATORY APPARATUS AND INSTRUMENTS, REPAIR OR MAINTENANCE OF FIREARMS, REPAIR OR MAINTENANCE OF PRINTING OR BOOKBINDING MACHINES AND APPARATUS, REPAIR OR MAINTENANCE OF CHEMICAL PROCESSING MACHINES AND APPARATUS, REPAIR OR MAINTENANCE OF GLASSWARE MANUFACTURING MACHINES AND APPARATUS; REPAIR OR MAINTENANCE OF FISHING MACHINES AND INSTRUMENTS, REPAIR OR MAINTENANCE OF METALWORKING MACHINES AND TOOLS, REPAIR OR MAINTENANCE OF SHOE MAKING MACHINES AND INSTRUMENTS, REPAIR OR MAINTENANCE OF INDUSTRIAL FURNACES, REPAIR OR MAINTENANCE OF MINING MACHINES AND APPARATUS, REPAIR OR MAINTENANCE OF RUBBER-GOODS MANUFACTURING MACHINES AND APPARATUS, REPAIR OR MAINTENANCE OF INTEGRATED CIRCUITS MANUFACTURING MACHINES AND SYSTEMS, REPAIR OR MAINTENANCE OF SEMICONDUCTOR MANUFACTURING MACHINES AND SYSTEMS, REPAIR OR MAINTENANCE OF MACHINES AND APPARATUS FOR PROCESSING FOODS OR BEVERAGES, REPAIR OR MAINTENANCE OF MACHINES AND APPARATUS

FOR LUMBERING, WOODWORKING, OR VENEER OR PLYWOOD MAKING, REPAIR OR MAINTENANCE OF TEXTILE MACHINES AND APPARATUS, REPAIR OR MAINTENANCE OF TOBACCO PROCESSING MACHINES, REPAIR OR MAINTENANCE OF PAINTING MACHINES AND APPARATUS, REPAIR OR MAINTENANCE OF AGRICULTURAL MACHINES AND IMPLEMENTS, REPAIR OR MAINTENANCE OF MACHINES AND APPARATUS FOR PULP-MAKING, PAPER MAKING OR PAPER-WORKING, REPAIR OR MAINTENANCE OF PLASTIC PROCESSING MACHINES AND APPARATUS, REPAIR OR MAINTENANCE OF PACKING OR WRAPPING MACHINES AND APPARATUS, REPAIR OR MAINTENANCE OF SEWING MACHINES, REPAIR OR MAINTENANCE OF STORAGE TANKS, REPAIR OR MAINTENANCE OF GASOLINE STATION EQUIPMENT, REPAIR OR MAINTENANCE OF BICYCLE PARKING APPARATUS, REPAIR OR MAINTENANCE OF INDUSTRIAL DISH WASHING MACHINES, REPAIR OR MAINTENANCE OF COOKING APPARATUS FOR INDUSTRIAL PURPOSES, REPAIR OR MAINTENANCE OF INDUSTRIAL WASHING MACHINES, REPAIR OR MAINTENANCE OF VEHICLE WASHING INSTALLATION, REPAIR OR MAINTENANCE OF VENDING MACHINES, REPAIR OR MAINTENANCE OF POWER-DRIVEN FLOOR CLEANING MACHINES, REPAIR OR MAINTENANCE OF AMUSEMENT MACHINES AND APPARATUS; REPAIR OR MAINTENANCE OF MACHINES AND APPARATUS FOR USE IN BEAUTY SALONS OR BARBERS' SHOPS, REPAIR OR MAINTENANCE OF WATER POLLUTION CONTROL EQUIPMENT, REPAIR OR MAINTENANCE OF WATER PURIFYING APPARATUS, REPAIR OR MAINTENANCE OF WASTE COMPACTING MACHINES AND APPARATUS, REPAIR OR MAINTENANCE OF WASTE CRUSHING MACHINES AND APPARATUS, REPAIR OR MAINTENANCE OF DIVING MACHINES AND APPARATUS, REPAIR OR MAINTENANCE OF NUCLEAR POWER PLANTS, REPAIR OR MAINTENANCE OF CHEMICAL PLANTS, FURNITURE RESTORATION, UMBRELLA REPAIR, REPAIR OR MAINTENANCE OF MUSICAL INSTRUMENTS, SAFE MAINTENANCE OR REPAIR, SHOE REPAIR, CLOCK AND WATCH REPAIR OR MAINTENANCE, SHARPENING OF SCISSORS AND KITCHEN KNIVES, SETUP OR REPAIR OF LOCKS, REPAIR OR MAINTENANCE OF GAS WATER HEATERS, REPAIR OR MAINTENANCE OF NON-ELECTRIC COOKING HEATERS, REPAIR OR MAINTENANCE OF GAS WATER HEATERS, REPAIR OR MAINTENANCE OF NON-ELECTRIC COOKING HEATERS, REPAIR OR MAINTENANCE OF COOKING POTS AND PANS, REPAIR OR MAINTENANCE OF SIGNBOARDS, REPAIR OF BAGS OR POUCHES, REPAIR OR MAINTENANCE OF PERSONAL ORNAMENTS, REPAIR OF TOYS OR DOLLS, REPAIR OF SPORTS EQUIPMENT, REPAIR OF BILLIARD EQUIPMENT, REPAIR OF GAME MACHINES AND APPARATUS, REPAIR OR MAINTENANCE OF BATHTUBS AND THE LIKE, REPAIR OF TOILET STOOL UNITS WITH A WASHING WATER, REPAIR OF FISHING TACKLE, REPAIR OF SPECTACLES, FUR CARE AND REPAIR, LAUNDERING, PRESSING OF CLOTHING, CLOTHING REPAIR, NAMELY, MENDING CLOTHING, FLUFFING OF COTTON BATTING FOR FUTON, REPAIR OF TATAMI MATS, CHIMNEY SWEEPING, CLEANING OF BUILDING EXTERIOR SURFACES, WINDOW CLEANING, CARPET AND RUG CLEANING, FLOOR POLISHING, SEPTIC TANK CLEANING, BATHTUB AND BATH BOILER CLEANING, STREET CLEANING, STORAGE TANK CLEANING; DISINFECTING OF TELEPHONE HAND-SETS, VERMIN EXTERMINATING OTHER THAN FOR AGRICULTURE, FORESTRY OR HORTICULTURE, RENTAL OF CONSTRUCTION MACHINES AND APPARATUS, RENTAL OF FLOOR CLEANING MACHINES, RENTAL OF MOPS, RENTAL OF CAR-WASHING APPARATUS, RENTAL OF ELECTRIC WASHING MACHINES, RENTAL OF LAUNDRY DRYERS, RENTAL OF SPIN DRYERS FOR CLOTHES (U.S. CLS. 100, 103 AND 106).

CLASS 40—MATERIAL TREATMENT

FOR STERILIZATION OF MEDICAL MACHINES AND APPARATUS, RENTAL OF SPACE COOLING APPARATUS FOR HOUSEHOLD PURPOSES, RENTAL OF AIR-CONDITIONING APPARATUS (U.S. CLS. 100, 103 AND 106).

CLASS 41—EDUCATION AND ENTERTAINMENT

FOR RENTAL OF CINEMATOGRAPHIC MACHINES AND APPARATUS; ADMINISTRATION OF LOTTERIES FOR OTHERS; EDUCATIONAL AND INSTRUCTION SERVICES, NAMELY, CONDUCTING CLASSES, SEMINARS, CONFERENCES, WORKSHOPS IN THE FIELD OF ARTS, CRAFTS, SPORTS AND GENERAL KNOWLEDGE; ORGANIZATION AND ARRANGEMENT OF SEMINARS, ANIMAL TRAINING, PLANT EXHIBITIONS AND ANIMAL EXHIBITIONS; REFERENCE LIBRARIES OF LITERATURE AND DOCUMENTARY RECORDS, ART EXHIBITIONS, GARDENS FOR PUBLIC ADMISSION, CAVES FOR PUBLIC ADMISSION, PUBLICATION OF BOOKS, PLANNING ARRANGEMENT OF SHOWING MOVIES, SHOWS, PLAYS OR MUSICAL PERFORMANCES; MOVIE THEATERS, MOTION PICTURE FILM PRODUCTION; MOTION PICTURE FILM DISTRIBUTION, PRESENTATION OF LIVE SHOW PERFORMANCES, DIRECTION OR PRESENTATION OF PLAYS, PRESENTATION OF MUSICAL PERFORMANCE, PRODUCTION OF RADIO OR TELEVISION PROGRAMS, PRODUCTION OF VIDEO TAPE CASSETTES IN THE FIELD OF EDUCATION, CULTURE, ENTERTAINMENT OR SPORTS NOT FOR MOVIES, RADIO OR TELEVISION PROGRAMS AND NOT FOR ADVERTISING AND PUBLICITY; DIRECTION OF MAKING RADIO OR TELEVISION PROGRAMS, OPERATION OF VIDEO EQUIPMENT OR AUDIO EQUIPMENT ETC. FOR PRODUCTION OF RADIO OR TELEVISION PROGRAMS, ENTERTAINMENT IN THE NATURE OF COMPETITIONS IN THE FIELD OF ATHLETICS; ENTERTAINMENT IN THE NATURE OF HORSE RACES, BICYCLE RACES, BOAT RACES AND SPORTS CAR RACES; PROVIDING AUDIO OR VIDEO STUDIOS, PROVIDING SPORTS FACILITIES, PROVIDING AMUSEMENT FACILITIES, PROVIDING FACILITIES FOR MOVIES, SHOWS, PLAYS, MUSIC OR EDUCATIONAL TRAINING, BOOKING OF SEATS FOR SHOWS, RENTAL OF CINEMA FILMS, RENTAL OF MUSICAL INSTRUMENTS, RENTAL OF SPORTS EQUIPMENT, RENTAL OF TELEVISION SETS, RENTAL OF RADIO SETS, BOOK RENTAL, RENTAL OF RECORDS OR SOUND-RECORDED MAGNETIC TAPES; RENTAL OF IMAGE-RECORDED MAGNETIC TAPES, RENTAL OF PHOTOGRAPHIC FILM NEGATIVES, RENTAL OF PHOTOGRAPHIC FILM POSITIVES, RENTAL OF TOYS, RENTAL OF AMUSEMENT MACHINES AND APPARATUS, RENTAL OF GAME MACHINES AND APPARATUS, RENTAL OF PAINTING AND CALLIGRAPHIC WORKS; PHOTOGRAPHY; LANGUAGE INTERPRETATION; TRANSLATION; RENTAL OF CAMERAS (U.S. CLS. 100, 101 AND 107).

CLASS 42—SCIENTIFIC, COMPUTER AND LEGAL SERVICES

FOR RENTAL OF MEASURING APPARATUS, PROVIDING METEOROLOGICAL INFORMATION, ARCHITECTURAL DESIGN, LAND SURVEYING, GEOLOGIC SURVEYS OR RESEARCH, COMPUTER SOFTWARE DESIGN FOR OTHERS; COMPUTER PROGRAMMING FOR OTHERS; MAINTENANCE OF COMPUTER SOFTWARE, TECHNICAL ADVICE RELATING TO PERFORMANCE OF COMPUTER-OPERATED AUTOMOBILES AND OTHER MACHINES THAT REQUIRE HIGH LEVELS OF PERSONAL KNOWLEDGE, SKILL OR EXPERIENCE OF THE OPERATORS TO MEET THE REQUIRED ACCURACY IN OPERATING THEM, TESTING, INSPECTION OR RESEARCH OF PHARMACEUTICALS, COSMETICS OR FOODSTUFF; RESEARCH ON BUILDING CONSTRUCTION OR CITY PLANNING, TESTING OR RESEARCH ON PREVENTION OF POLLUTION, TESTING OR RESEARCH ON ELECTRICITY, TESTING OR RESEARCH ON CIVIL ENGINEERING; TESTING, INSPECTION AND RESEARCH ON AGRICULTURE.

CULTURE, LIVESTOCK BREEDING OR FISHERIES; TESTING AND RESEARCH ON MACHINES, APPARATUS AND INSTRUMENTS; RENTAL OF COMPUTERS; TECHNICAL SUPPORT, NAMELY, PROVIDING BACK-UP COMPUTER PROGRAMS AND FACILITIES; RENTAL OF LABORATORY APPARATUS AND INSTRUMENTS; RENTAL OF DRAWING INSTRUMENTS; RENTAL OF OPTICAL MACHINES AND INSTRUMENTS; PROVIDING INFORMATION ON DONATION OF HUMAN CORPSES FOR MEDICAL RESEARCH; ARRANGING OF DONATION OF HUMAN CORPSES FOR MEDICAL RESEARCH (U.S. CLS. 100 AND 101).

CLASS 44—MEDICAL, BEAUTY AND AGRICULTURAL SERVICES

FOR RENTAL OF MEDICAL MACHINES AND APPARATUS, BEAUTY SALONS, HAIRDRESSING SALONS, PROVIDING BATH HOUSES, GARDEN OR FLOWER BED CARE, GARDEN TREE PLANTING, FERTILIZER SPREADING, WEED KILLING, VERMIN EXTERMINATING FOR AGRICULTURE, HORTICULTURE OR FORESTRY; MASSAGE AND THERAPEUTIC SHIATSU MASSAGE, CHIROPRACTICS, PHYSICAL THERAPY IN THE NATURE OF MOXA CAUTERY (MOXIBUSION), TREATMENT TO JOINT-DISLOCATION, SPRAIN, BONE-FRACTURE OR THE LIKE (JUDO-SEIFUKU), ACUPUNCTURE, PROVIDING MEDICAL INFORMATION, DIETARY AND NUTRITIONAL GUIDANCE, ANIMAL BREEDING, RENTAL OF POTTED PLANTS, FARMING EQUIPMENT RENTAL, RENTAL OF FISHING MACHINES AND INSTRUMENTS, RENTAL OF MACHINES AND APPARATUS FOR USE IN BEAUTY SALONS OR BARBERS' SHOPS, RENTAL OF LAWNMOWERS (U.S. CLS. 100 AND 101).

DAWN HAN, EXAMINING ATTORNEY

SN 78-581,511. QUEST INTERNATIONAL SERVICES B.V., 1411 GP NAARDEN, NETHERLANDS, FILED 3-7-2005.

ACTISCULPT

THE MARK CONSISTS OF STANDARD CHARACTERS WITHOUT CLAIM TO ANY PARTICULAR FONT, STYLE, SIZE, OR COLOR.

OWNER OF ERPNTM CMNTY TM OFC REG. NO. 004272605, DATED 3-1-2006, EXPIRES 3-4-2015.

CLASS 1—CHEMICALS

FOR SYNTHETIC AROMA CHEMICALS FOR USE IN THE MANUFACTURE OF PERFUMERY, FLAVORINGS, COSMETICS, TOILETRIES AND HOUSEHOLD PRODUCTS; CHEMICAL PREPARATIONS FOR USE IN THE MANUFACTURE OF FRAGRANCES, FRAGRANCE INGREDIENTS AND FRAGRANCE COMPOUNDS; CHEMICALS FOR USE IN THE FORMULATION OF FRAGRANCES; CHEMICALS FOR USE IN THE MANUFACTURE OF PERFUMES AND PERFUMED PRODUCTS; CHEMICALS FOR USE IN THE MANUFACTURE OF COSMETIC AND TOILET PREPARATIONS; CHEMICALS FOR USE IN THE MANUFACTURE OF AIR-FRESHENING AND DEODORIZING PREPARATIONS; CHEMICAL FRAGRANCES FOR USE IN THE MANUFACTURE OF ORAL CARE PREPARATIONS; CHEMICAL FRAGRANCES FOR IMPREGNATION IN TEXTILES; CHEMICAL FRAGRANCES FOR USE IN THE MANUFACTURE OF HOUSEHOLD CLEANSERS, DEODORIZERS AND DISINFECTANTS; FRAGRANCES FOR USE IN THE MANUFACTURE OF PERFUMES, COSMETICS, TOILETRIES, HAIR, BODY AND SKINCARE PREPARATIONS, DEODORIZING AND AIR FRESHENING PREPARATIONS, CLEANING AND LAUNDRY PRODUCTS; CHEMICALS FOR USE IN THE MANUFACTURE OF ODOR NEUTRALIZING PREPARATIONS (U.S. CLS. 1, 5, 6, 10, 26 AND 46).

CLASS 3—COSMETICS AND CLEANING PREPARATIONS

FOR ESSENTIAL OILS FOR USE IN THE MANUFACTURE OF PERFUMERY, FLAVORINGS, COSMETICS, TOILETRIES AND HOUSEHOLD PRODUCTS; PERFUMES; ESSENTIAL OILS FOR PERSONAL USE; ETHERAL ESSENCES AND OILS FOR PERSONAL USE; COSMETICS; NON-MEDICATED TOILETRIES; DEODORANTS AND ANTIPERSPIRANTS FOR THE BODY; PERFUMED SOAPS; DEPILATORIES AND DEPILATORY PREPARATIONS AND SUBSTANCES; DENTIFRICES; DYES FOR COSMETIC PURPOSES; MAKE-UP REMOVING PREPARATIONS; CLEANSING PREPARATIONS FOR PERSONAL USE; NAIL CARE PREPARATIONS AND SUBSTANCES; EXFOLIANT PREPARATIONS FOR PERSONAL USE; SHAVING PREPARATIONS; HAIR CARE PREPARATIONS; HAND AND BODY CREAMS AND LOTIONS; DETERGENTS FOR GENERAL HOUSEHOLD USE; LAUNDRY PREPARATIONS NAMELY LAUNDRY SOAP; DETERGENTS FOR COSMETIC PURPOSES; SOAKING PREPARATIONS FOR LAUNDRY USE; STAIN REMOVERS; FRAGRANCES, NAMELY ESSENTIAL OILS FOR USE IN THE MANUFACTURE OF PERFUMES, COSMETICS, TOILETRIES, HAIR, BODY AND SKINCARE PREPARATIONS, DEODORIZING AND AIR FRESHENING PREPARATIONS, CLEANING AND LAUNDRY PRODUCTS (U.S. CLS. 1, 4, 6, 50, 51 AND 52).

AISHA CLARKE, EXAMINING ATTORNEY

SN 78-583,359. MANOR CARE OF AMERICA, INC., TOLEDO, OH. FILED 3-9-2005.



NO CLAIM IS MADE TO THE EXCLUSIVE RIGHT TO USE "WORK INJURY MANAGEMENT", APART FROM THE MARK AS SHOWN.

CLASS 35—ADVERTISING AND BUSINESS

FOR MEDICAL REFERRAL SERVICES (U.S. CLS. 100, 101 AND 102).

CLASS 44—MEDICAL, BEAUTY AND AGRICULTURAL SERVICES

FOR MEDICAL SERVICES; NAMELY, INDUSTRIAL, SPEECH, PHYSICAL AND OCCUPATIONAL ASSESSMENTS AND REHABILITATION FOR THE PURPOSES OF PREVENTION, REHABILITATION AND ASSESSMENT OF INJURIES (U.S. CLS. 100 AND 101).
 GEORGIA CARTY, EXAMINING ATTORNEY

SN 78-596,613. MICROSOFT CORPORATION, REDMOND, WA. FILED 3-28-2005.

VIRTUAL EARTH

SN 78-585,545. MOTOVAN CORPORATION, BOUCHERVILLE, QUEBEC, CANADA, FILED 3-11-2005.



PRIORITY CLAIMED UNDER SEC. 44(D) ON CANADA APPLICATION NO. 1249759, FILED 3-8-2005, REG. NO. TMA6S7,890, DATED 2-2-2006, EXPIRES 2-2-2021.

NO CLAIM IS MADE TO THE EXCLUSIVE RIGHT TO USE "MX", APART FROM THE MARK AS SHOWN.

CLASS 12—VEHICLES

FOR PARTS OF MOTORCYCLES, NAMELY FOOT PEG FORKS, CLUTCH LEVERS AND BRAKE LEVERS; CHAIN ROLLERS FOR BEARINGS; HANDLEBARS; KICKSTANDS; HANDLEBAR GRIPS; SEAT COVERS FOR MOTORCYCLES; BIKE STANDS (U.S. CLS. 19, 21, 23, 31, 35 AND 44).

CLASS 16—PAPER GOODS AND PRINTED MATTER

FOR STICKER KITS COMPRISED PRIMARILY OF STICKERS AND PAPER (U.S. CLS. 2, 5, 22, 23, 29, 37, 38 AND 50).

CLASS 25—CLOTHING

FOR CLOTHING, NAMELY MOTOCROSS GLOVES, MOTOCROSS PANTS, MOTOCROSS JACKETS, MOTOCROSS JERSEYS, MOTOCROSS BOOTS, JACKET, VESTS, T-SHIRTS, CAPS, PANTS, SHORTS (U.S. CLS. 22 AND 39).

CLASS 28—TOYS AND SPORTING GOODS

FOR SPORTING GOODS AND SPORTING EQUIPMENT, NAMELY, MOTOCROSS KNEE GUARDS, MOTOCROSS CHEST GUARD, MOTOCROSS ELBOW GUARDS, MOTOCROSS SHIN GUARDS, NECK ROLL PADS FOR ATHLETIC USE, ANKLE GUARDS AND WRIST GUARDS FOR ATHLETIC USE, KIDNEY BELTS AND SUPPORT BELTS (U.S. CLS. 22, 23, 38 AND 50).
 RAMONA ORTIGA, EXAMINING ATTORNEY

THE MARK CONSISTS OF STANDARD CHARACTERS WITHOUT CLAIM TO ANY PARTICULAR FONT, STYLE, SIZE, OR COLOR.

NO CLAIM IS MADE TO THE EXCLUSIVE RIGHT TO USE "VIRTUAL", APART FROM THE MARK AS SHOWN. SEC. 2(F).

CLASS 35—ADVERTISING AND BUSINESS

FOR PROVIDING ONLINE BUSINESS DIRECTORY INFORMATION VIA WIRELESS NETWORKS AND THE INTERNET FEATURING VARIOUS TYPES OF BUSINESSES (U.S. CLS. 100, 101 AND 102).

FIRST USE 11-1-2005; IN COMMERCE 11-1-2005.

CLASS 42—SCIENTIFIC, COMPUTER AND LEGAL SERVICES

FOR MAPPING SERVICES, NAMELY, CREATING CUSTOM MAPS AND OTHER DISPLAYS OF GEOGRAPHICAL INFORMATION VIA WIRELESS NETWORKS AND THE INTERNET; COMPUTER SERVICES, NAMELY, PROVIDING A SPECIALIZED SEARCH ENGINE FOR OBTAINING GEOGRAPHICAL DATA ON A GLOBAL COMPUTER NETWORK (U.S. CLS. 100 AND 101).

FIRST USE 5-8-2006; IN COMMERCE 5-8-2006.
 CURTIS FRENCH, EXAMINING ATTORNEY

SN 78-599,224. NOKIA CORPORATION, 02150 ESPOO, FINLAND, FILED 3-31-2005.

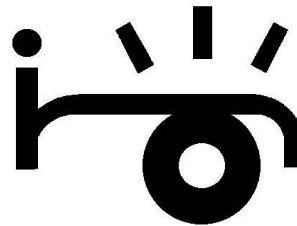

PRIORITY CLAIMED UNDER SEC. 44(D) ON ERPNCMNTY TM OFC APPLICATION NO. 4099818, FILED 11-8-2004, REG. NO. 409918, DATED 5-19-2006, EXPIRES 8-11-2014.

CLASS 9—ELECTRICAL AND SCIENTIFIC APPARATUS

FOR COMPUTER MUSIC SOFTWARE FOR CONNECTING RADIO STATIONS TO COMMUNICATION DEVICES; COMPUTER MUSIC SOFTWARE AND PROGRAMS ENABLING USERS TO LISTEN TO FM RADIO STATIONS THROUGH MOBILE PHONES; COMPUTER MUSIC SOFTWARE AND PROGRAMS ENABLING USERS OF COMMUNICATION DEVICES TO SIMULTANEOUSLY VIEW PROGRAMS, SONG AND ARTIST INFORMATION AND TO PURCHASE DIGITAL CONTENT AND TO PARTICIPATE TO CONTESTS; MOBILE TELEPHONES WITH ADDITIONAL FEATURES SUCH AS INTERNET ACCESS AND RADIO; PORTABLE LISTENING DEVICES, NAMELY, RADIOS AND MP3 PLAYERS (U.S. CLS. 21, 23, 26, 36 AND 38).

CLASS 38—COMMUNICATION

FOR ELECTRONIC TRANSMISSION OF VOICE, VIDEO, MESSAGES, IMAGES AND DATA; PROVIDING ACCESS TO A GLOBAL COMPUTER INFORMATION NETWORK (U.S. CLS. 100, 101 AND 104).

CLASS 41—EDUCATION AND ENTERTAINMENT

FOR PROVIDING ONLINE DATABASES FEATURING PRERECORDED MUSIC TRACKS AND MUSIC, MUSIC PROGRAM LISTS, SONG AND ARTIST INFORMATION, AND COMMENTARY AND ARTICLES ABOUT MUSIC, INFORMATION ABOUT MUSIC, ARRANGING AND CONDUCTING CONTESTS (U.S. CLS. 100, 101 AND 107).
KHANH LE, EXAMINING ATTORNEY

CLASS 9—ELECTRICAL AND SCIENTIFIC APPARATUS

FOR EYEWEAR, NAMELY, EYEGLASSES, SUNGLASSES; PREPAID MAGNETICALLY ENCODED TELEPHONE CALLING CARDS, PRERECORDED AUDIO AND VIDEO DISCS AND TAPES FEATURING MUSICAL, DRAMATIC AND COMEDY PERFORMANCES; APPARATUS FOR RECORDING, TRANSMISSION OR REPRODUCTION OF SOUND OR IMAGES, NAMELY, VIDEO CAMERAS, AUDIO AND VIDEO TAPE AND DISC RECORDERS AND PLAYERS, HARD-DISC-BASED AUDIOVISUAL MEDIA PLAYERS; BLANK MAGNETIC DATA CARRIERS; BLANK OPTICAL RECORDING DISCS; VIDEO AND COMPUTER GAME CARTRIDGES (U.S. CLS. 21, 23, 26, 36 AND 38).

CLASS 14—JEWELRY

FOR PINS, NAMELY, ORNAMENTAL PINS; JEWELRY; WATCHES (U.S. CLS. 2, 27, 28 AND 50).

CLASS 16—PAPER GOODS AND PRINTED MATTER

FOR PAPER AND PAPER ARTICLES, NAMELY, TABLE CLOTHS OF PAPER, POSTERS; PUBLICATIONS, NAMELY, MAGAZINES, NEWSLETTERS, AND BULLETINS IN THE FIELD OF MUSIC, TELEVISION AND FILMED ENTERTAINMENT; COLORING BOOKS, FAN MAGAZINES; TEMPORARY TATTOOS; TRADING CARDS AND PAPER BADGES (U.S. CLS. 2, 5, 22, 23, 29, 37, 38 AND 50).

CLASS 18—LEATHER GOODS

FOR LEATHER AND IMITATION LEATHER GOODS, NAMELY, TOTE BAGS, HAND BAGS, SHOULDER BAGS, APPAREL-CARRYING BAGS, WALLETS, PURSES AND LEATHER KEY CHAINS (U.S. CLS. 1, 2, 3, 22 AND 41).

CLASS 20—FURNITURE AND ARTICLES NOT OTHERWISE CLASSIFIED

FOR NON-METAL AND NON-LEATHER KEY CHAINS, PLASTIC CAKE DECORATIONS (U.S. CLS. 2, 13, 22, 25, 32 AND 50).

CLASS 21—HOUSEWARES AND GLASS

FOR HOUSEHOLD OR KITCHEN CONTAINERS, NOT OF PRECIOUS METAL; KITCHEN AND HOUSEHOLD UTENSILS, NAMELY MIXING SPOONS, SERVING FORKS AND SPATULAS; GLASSWARE AND DISHES, NAMELY SERVING DISHES, PLATES, CUPS, MUGS, SHOT GLASSES (U.S. CLS. 2, 13, 23, 29, 30, 33, 40 AND 50).

CLASS 25—CLOTHING

FOR MEN'S AND WOMEN'S CLOTHING, NAMELY, SHIRTS, SHORTS, JEANS, JACKETS, SKIRTS, SLACKS, BLOUSES, DRESSES, VESTS, COATS, SWEATERS, SCARVES, SWIMSUITS, UNDERWEAR, UNDERPANTS, SLIPS, CAMISOLES, BRAS, NIGHTGOWNS, ROBES, SOCKS, HOSIERY; INFANTS' AND CHILDREN'S CLOTHING, NAMELY T-SHIRTS, SWEATERS, LONG SLEEVED SHIRTS, SHORTS, PANTS, JUMPERS, JUMPSUITS, OVERALLS, ONE-PIECE GARMENT FOR INFANTS AND TODDLERS, PAJAMAS, SOCKS, DRESSES, SKIRTS; MEN'S, WOMEN'S, CHILDREN'S AND INFANT'S FOOTWEAR; MEN'S, WOMEN'S, CHILDREN'S AND INFANT'S HEADGEAR, NAMELY, HATS, CAPS AND VISORS; BELTS (U.S. CLS. 22 AND 39).

CLASS 26—FANCY GOODS

FOR ORNAMENTAL NOVELTY BUTTONS AND PINS (U.S. CLS. 37, 39, 40, 42 AND 50).

SN 78-610,205. PERRY, TYLER, LOS ANGELES, CA. FILED 4-15-2005.

TYLER PERRY

THE MARK CONSISTS OF STANDARD CHARACTERS WITHOUT CLAIM TO ANY PARTICULAR FONT, STYLE, SIZE, OR COLOR.

THE NAME "TYLER PERRY" IDENTIFIES A LIVING INDIVIDUAL WHOSE CONSENT IS OF RECORD.

CLASS 3—COSMETICS AND CLEANING PREPARATIONS

FOR FRAGRANCES, NAMELY, ROOM FRAGRANCES, FRAGRANCES FOR PERSONAL USE; SOAPS; ESSENTIAL OILS FOR PERSONAL USE; COSMETICS; BODY AND HAIR LOTIONS AND OILS; BATH GEL; HAIR CARE PREPARATIONS (U.S. CLS. 1, 4, 6, 50, 51 AND 52).

CLASS 6—METAL GOODS

FOR METAL KEY CHAINS (U.S. CLS. 2, 12, 13, 14, 23, 25 AND 50).

CLASS 28—TOYS AND SPORTING GOODS

FOR GAMES, PLAYTHINGS, AND SPORTING GOODS, NAMELY ACTION FIGURES AND ACCESSORIES THEREFOR; STUFFED TOY ANIMALS; BABY'S MULTIPLE ACTIVITY TOYS; TOY BAKEWARE AND COOKWARE; BALLOONS; TOY BANKS; BATH TOYS; BATH TUB TOYS; INFLATABLE BATH TOYS; RIDE-ON TOYS; INFLATABLE RIDE- ON TOYS, EQUIPMENT SOLD AS A UNIT FOR PLAYING CARD GAMES; TOY CARS; DOLLS; BEANBAG DOLLS; PAPER DOLLS, RAG DOLLS, SOFT SCULPTURE DOLLS, DOLL ACCESSORIES AND PLAYSETS THEREFOR, NAMELY DOLL CASES, DOLL CLOTHING; DOLL HOUSE FURNISHINGS, DOLL COSTUMES; STUFFED TOYS; CHECKER SETS; CHESS SETS; CHILDREN'S PLAY COSMETICS; CHILD'S MULTIPLE ACTIVITY TOYS; TOY CONSTRUCTION BLOCKS; INFANT'S ACTION CRIB TOYS; FLYING DISCS; ELECTRONIC HAND HELD GAME UNITS; ELECTRONIC GAME EQUIPMENT WITH A WATCH FUNCTION; ELECTRONICALLY OPERATED TOY MOTOR VEHICLES; BOARD GAMES AND GAME EQUIPMENT SOLD AS A UNIT FOR PLAYING BOARD GAMES; CARD GAMES; MANIPULATIVE GAMES; PARLOR GAMES; ROLE-PLAYING GAMES; STAND-ALONE VIDEO PARLOR COMPUTER GAME MACHINES; ACTION TYPE TARGET GAMES; COIN OPERATED AND NON COIN OPERATED VIDEO OUTPUT GAME MACHINES; ROCKING HORSES; JIGSAW PUZZLES; KITES; MANIPULATIVE PUZZLES; PAPER FACE MASKS; TOY MODEL TRAIN SETS; TOY MODEL VEHICLES AND RELATED ACCESSORIES SOLD AS A UNIT; ELECTRONICALLY OPERATED TOY MOTOR VEHICLES; ELECTRONIC BATTERY OPERATED TOYS; TOY MAGIC TRICKS, NOISEMAKERS; TOY WHISTLES; PARTY FAVORS IN THE NATURE OF SMALL TOYS; TOY CAP PISTOLS; PLUSH TOYS; SOFT SCULPTURE PLUSH TOYS; MANIPULATIVE PUZZLES, NAMELY, THREE DIMENSIONAL CUBE TYPE PUZZLES; TOY RECORD PLAYER FOR PLAYING TUNES AND CASSETTES AND DISCS THEREFOR; SKATEBOARDS; ICE SKATES; TOY ROLLER SKATES; TOY IN-LINE SKATES AND ACCESSORIES, NAMELY KNEE, WRIST, AND ELBOW PADS; WATER SQUIRTING TOYS; TEDDY BEARS; WIND UP WALKING TOYS; WIND UP TOYS; NON-MOTORIZED NON-ELECTRIC MOBILE SELF-PROPELLED RIDING TOYS; TOY TRUCKS; TWIRLING BATONS; TOY ZIP GUNS; GYMNAS TIC APPARATUS; BALLS, NAMELY PLAYGROUND BALLS, SOCCER BALLS, SPORTBALLS, BASEBALLS, BASKETBALLS, AND FOAM BALLS; BASEBALL GLOVES; SWIMMING AIDS, NAMELY, SWIMMING FLOATS FOR RECREATIONAL USE; HEAD COVERS FOR GOLF CLUBS; GOLF BALLS; GOLF CLUBS; INFLATABLE SWIMMING POOLS FOR RECREATIONAL USE; KICKBOARD FLOATATION DEVICES FOR RECREATIONAL USE; GYMNAS TIC PARALLEL BARS; SKIS; SNOW SKIS; SNOWBOARDS; SKIPPING ROPES; JUMP ROPES; SNOW SLEDS FOR RECREATIONAL USE; SURF FINS; SURFBOARDS; SWIM BOARDS FOR RECREATIONAL USE; BODYBOARDS; SWIM FINS; INFLATABLE AND BUOYANT BATH TOYS; SWIMMING AND RIDE ON TOYS; MUSICAL TOYS; LATEX SQUEEZE TOYS; EXERCISE EQUIPMENT, NAMELY STATIONARY BIKES, TREADMILLS, STAIR STEPPING MACHINES; EXERCISE EQUIPMENT, NAMELY, WEIGHT LIFTING MACHINES, AND FREE WEIGHTS; AND NON-ILLUMINATING CHRISTMAS TREE ORNAMENTS; PLAYING CARDS (U.S. CLS. 22, 23, 38 AND 50).

CLASS 38—COMMUNICATION

FOR TRANSMISSION OF SOUND AND PICTURE SIGNALS (U.S. CLS. 100, 101 AND 104).

CLASS 40—MATERIAL TREATMENT

FOR REPRODUCTION OF SOUND AND IMAGES, NAMELY, PHOTOGRAPHIC REPRODUCTION, TAPE AND DISC DUPLICATING SERVICES (U.S. CLS. 100, 103 AND 106).

CLASS 41—EDUCATION AND ENTERTAINMENT

FOR ENTERTAINMENT SERVICES, NAMELY, ARRANGING AND CONDUCTING LIVE CONCERTS AND PRODUCING TELEVISION PROGRAM AND MOTION PICTURE FILMS, ALL FEATURING MUSICAL, DRAMATIC AND COMEDY PERFORMANCES; ENTERTAINMENT SERVICES, NAMELY, TELEVISION AND MOTION PICTURE FILM PRODUCTION SERVICES (U.S. CLS. 100, 101 AND 107).

SANJEEV VOHRA, EXAMINING ATTORNEY

SN 78-614,075. BREAD STORY BY JUN PTE. LTD., SINGAPORE, SINGAPORE, FILED 4-21-2005.



OWNER OF HONG KONG REG. NO. 300132434, DATED 12-23-2003, EXPIRES 12-23-2013.

NO CLAIM IS MADE TO THE EXCLUSIVE RIGHT TO USE "ALL TIME BEST SELLER", APART FROM THE MARK AS SHOWN.

THE NAME SHOWN IN THE MARK IDENTIFIES JUN WHOSE CONSENT TO REGISTER IS SUBMITTED.

THE WORDING IS STYLIZED AND THERE IS A BLOCK AROUND THE WORDING "ALL TIME BEST SELLER".

CLASS 30—STAPLE FOODS

FOR FLOUR PREPARATIONS MADE FROM CEREALS AND RICE, NAMELY, PROCESSED CEREALS; BREAD; BAKERY PRODUCTS, NAMELY, BISCUITS, COOKIES, CAKES, PASTRIES, HAMBURGER SANDWICHES; CHOCOLATE-BASED FILLINGS FOR CAKES AND PIES; MEAT PIES; PACKAGED MEALS CONSISTING PRIMARILY OF PASTA OR RICE; BAKERY DESERTS AND DESSERT PUDDINGS; COFFEE; TEA; COCOA; CHOCOLATE; CHOCOLATE PRODUCTS, NAMELY, CANDIES, SYRUP, MOUSSE, POWDER AND BARS; COFFEE SUBSTITUTES; CONFECTIONERY CHIPS FOR BAKING; CANDY; WATER ICES; ICE CREAM AND FROZEN CONFECTIONS; HONEY; SAUCES AND SYRUPS AND TOPPINGS IN THE NATURE OF SAUCES; SUGAR AND NATURAL SWEETENERS; SALT; MUSTARD; VINEGAR; SPICES; FLAVORINGS FOR BEVERAGES AND SEASONING; BREAD AND PASTRY MIXES; AROMATIC PREPARATIONS FOR CAKES, NAMELY, ALLSPICE, CINNAMON, VANILLA, MINT; EDIBLE CAKE DECORATIONS; CAKE MIXES FOR MAKING CAKES; DANISH PASTRIES AND CROISSANTS WITH FLAVORED FILLINGS; SPREADS FOR BREAD CONTAINING CHOCOLATE (U.S. CL. 46).

CLASS 43—HOTEL AND RESTAURANT SERVICES

FOR CAFÉ SERVICES; CAFETERIA SERVICES; RESTAURANT SERVICES; TAKE-OUT RESTAURANTS; SNACK BAR SERVICES; BISTRO SERVICES; CATERING SERVICES; RESTAURANT CHAINS; SELF-SERVICE RESTAURANTS; FOOD PREPARATION; CONSULTANCY SERVICES IN RELATION TO FOOD AND FOOD PREPARATION; ADVISORY SERVICES RELATING TO CATERING; BANQUETING SERVICES; CONSULTANCY SERVICES RELATING TO BAKING TECHNIQUES (U.S. CLS. 100 AND 101).

DAHLIA GEORGE, EXAMINING ATTORNEY

SN 78-635,214. PAPAYA LIMITED, LONDON, UNITED KINGDOM, FILED 5-23-2005.

AROUND

THE MARK CONSISTS OF STANDARD CHARACTERS WITHOUT CLAIM TO ANY PARTICULAR FONT, STYLE, SIZE, OR COLOR.

PRIORITY CLAIMED UNDER SEC. 44(D) ON ERP N CMNTY TM OFC APPLICATION NO. 4395521, FILED 5-13-2005, REG. NO. 4395521, DATED 9-1-2006, EXPIRES 5-13-2015.

CLASS 16—PAPER GOODS AND PRINTED MATTER

FOR PRINTED PUBLICATIONS, NAMELY PERIODICALS, MAGAZINES, BOOKS, INSTRUCTIONAL AND TEACHING MATERIAL, ALL IN THE FIELDS OF NEWS, CURRENT EVENTS, SPORTS, MUSIC, ENTERTAINMENT, EDUCATION, ANIMALS, THE ARTS, HISTORY, SCIENCE, COOKERY, TRAVEL, LIFESTYLES AND RELIGION; PHOTOGRAPHS; POSTERS; POSTCARDS; GREETING CARDS; CALENDARS; DIARIES; STICKERS; DECALS; STATIONERY (U.S. CLS. 2, 5, 22, 23, 29, 37, 38 AND 50).

CLASS 38—COMMUNICATION

FOR BROADCASTING AND TRANSMISSION OF PROGRAMS IN THE FIELDS OF NEWS, CURRENT EVENTS, SPORTS, MUSIC, ENTERTAINMENT, EDUCATION, ANIMALS, THE ARTS, HISTORY, SCIENCE, COOKERY, TRAVEL, LIFESTYLES AND RELIGION, VIA A GLOBAL COMPUTER NETWORK, A MOBILE WIRELESS TELEPHONE NETWORK, BY STREAMING OF VIDEO AND AUDIO SIGNALS, OR BY TEXT OR MULTIMEDIA MESSAGING SERVICE; TELEVISION AND RADIO BROADCASTING IN THE FIELDS OF NEWS, CURRENT EVENTS, SPORTS, MUSIC, ENTERTAINMENT, EDUCATION, ANIMALS, THE ARTS, HISTORY, SCIENCE, COOKERY, TRAVEL, LIFESTYLES AND RELIGION; TRANSMISSION AND DELIVERY OF INFORMATION BY ELECTRONIC COMMUNICATIONS NETWORK, MOBILE COMMUNICATION NETWORK, TELEPHONE NETWORK, AND BY COMPUTER COMMUNICATIONS NETWORK, IN THE FIELDS OF NETWORK MULTIMEDIA NEWS, CURRENT EVENTS, SPORTS, MUSIC ENTERTAINMENT, EDUCATION, ANIMALS, THE ARTS, HISTORY, SCIENCE, COOKERY, TRAVEL, LIFESTYLES AND RELIGION; PROVIDING INFORMATION IN THE FIELD OF TELEVISION AND RADIO BROADCASTING, TELECOMMUNICATION ACCESS SERVICES (U.S. CLS. 100, 101 AND 104).

CLASS 41—EDUCATION AND ENTERTAINMENT

FOR PROVIDING INFORMATION IN THE FIELD OF CURRENT EVENT NEWS, MUSIC, ENTERTAINMENT, EDUCATION; TELEVISION PRODUCTION IN THE FIELDS OF NEWS, CURRENT EVENTS, SPORTS, MUSIC, ENTERTAINMENT, EDUCATION, ANIMALS, THE ARTS, HISTORY, SCIENCE, COOKERY, TRAVEL, LIFESTYLES AND RELIGION; PUBLICATION OF PERIODICALS, MAGAZINES AND BOOKS AND ONLINE PUBLICATION OF ELECTRONIC MAGAZINES AND BOOKS IN THE FIELDS OF NEWS, CURRENT EVENTS, SPORTS, MUSIC, ENTERTAINMENT, EDUCATION, ANIMALS, THE ARTS, HISTORY, SCIENCE, COOKERY, TRAVEL, LIFESTYLES AND RELIGION; PUBLICATION OF PERIODICALS, MAGAZINES, AND BOOKS IN THE FIELDS OF NEWS, CURRENT EVENTS, SPORTS, MUSIC, ENTERTAINMENT, EDUCATION, ANIMALS, THE ARTS, HISTORY, SCIENCE, COOKERY, TRAVEL, LIFESTYLES AND RELIGION; ENTERTAINMENT, NAMELY A CONTINUING NEWS, CURRENT EVENTS, SPORTS, MUSIC, ENTERTAINMENT, EDUCATION, ANIMALS, ARTS, HISTORY, SCIENCE, COOKING, TRAVEL, LIFESTYLE, AND RELIGION SHOW BROADCAST OVER TELEVISION, SATELLITE, AUDIO, AND VIDEO MEDIA (U.S. CLS. 100, 101 AND 107).

GINA HAYES, EXAMINING ATTORNEY

SN 78-636,156. DATA SECURITY FINANCIAL PARTNERS, LLC, BENSALEM, PA. FILED 5-24-2005.

SHREDSTATION

THE MARK CONSISTS OF STANDARD CHARACTERS WITHOUT CLAIM TO ANY PARTICULAR FONT, STYLE, SIZE, OR COLOR.

CLASS 6—METAL GOODS

FOR METAL BOXES FOR DEPOSITING ITEMS TO BE DESTROYED (U.S. CLS. 2, 12, 13, 14, 23, 25 AND 50).

CLASS 37—CONSTRUCTION AND REPAIR

FOR MAINTAINING AND EMPTYING DEPOSITORY BOXES HOLDING ITEMS TO BE DESTROYED (U.S. CLS. 100, 103 AND 106).

ROBERT STRUCK, EXAMINING ATTORNEY

SN 78-639,385. OSIECKI, LORI LYNN, MESA, AZ. FILED 5-27-2005.



NO CLAIM IS MADE TO THE EXCLUSIVE RIGHT TO USE "SNACKS", APART FROM THE MARK AS SHOWN.

THE STIPLING IS A FEATURE OF THE MARK.

THE COLOR(S) RED, BLACK, BLUE, BROWN, PINK AND ORANGE IS/ARE CLAIMED AS A FEATURE OF THE MARK.

THE COLORS INCLUDE A RED AND BLACK CHECKERBOARD, RED LETTERING AND BLUE BACKGROUND, BROWN, BLACK AND YELLOW HAIR AND PINK CHEEK SPOTS, RED AND ORANGE FOOD PRODUCTS AND AN ORANGE BOWL.

CLASS 16—PAPER GOODS AND PRINTED MATTER

FOR CALENDARS; CHILDREN'S BOOKS; SHEET MUSIC; PHOTO AND SCRAPBOOK ALBUMS, GIFT WRAPPING PAPER, GREETING CARDS, STATIONERY, CRAFT PAPER; ARTS AND CRAFTS PAINT KITS, MARKERS, CRAYONS, PENS, PENCILS, STICKERS, STAMP PADS, RUBBER STAMPS, PENCIL BOXES; PRINTED TEACHING MATERIALS ARE IN THE NATURE OF MANUALS AND VISUAL AIDS IN THE FIELD OF CHILD DEVELOPMENT; PAPER TAGS AND LABELS FOR PRODUCTS (U.S. CLS. 2, 5, 22, 23, 29, 37, 38 AND 50).

CLASS 21—HOUSEWARES AND GLASS

FOR HOUSEHOLD OR KITCHEN UTENSILS AND CONTAINERS NOT OF PRECIOUS METAL OR COATED THEREWITH; COMBS AND BATH SPONGES; BRUSHES, BRUSHES NAMELY, PASTRY AND TOOTH BRUSHES, HAIR BRUSHES AND CLOTHES BRUSHES; BRUSH-MAKING MATERIALS; ARTICLES FOR CLEANING PURPOSES, NAMELY, STEEL-WOOL; UNWORKED OR SEMI-WORKED GLASS NOT FOR BUILDING; BEVERAGE GLASSWARE, PORCELAIN AND EARTHENWARE DISHES AND PLATES (U.S. CLS. 2, 13, 23, 29, 30, 33, 40 AND 50).

CLASS 24—FABRICS

FOR TEXTILES AND TEXTILE GOODS, THE TEXTILES, NAMELY, BEDDING AND TABLE COVERS (U.S. CLS. 42 AND 50).

CLASS 25—CLOTHING

FOR CHILDREN'S CLOTHING, NAMELY, HATS, TOPS, T-SHIRTS, SHORTS, BIBS, NAMELY, CLOTH BIBS, SKI BIBS AND BIB OVERALLS, APRONS, UNDERWEAR, DRESSES, SHIRTS, SOCKS, BATHING SUITS, SLEEPWEAR, JUMPERS; OUTERWEAR, NAMELY, JACKETS, COATS AND SWEATERS; AND SHOES, NAMELY, SNOW BOOTS AND FLIP-FLOP SANDALS (U.S. CLS. 22 AND 39).

CLASS 28—TOYS AND SPORTING GOODS

FOR GAMES, PLAYTHINGS AND EDUCATIONAL TOYS ALL FOR CHILDREN, NAMELY, BOARD GAMES; CRIB MOBILES; BABY MULTIPLE ACTIVITY TOYS; CARD GAMES; STUFFED TOY ANIMALS; MAGNETIC DART BOARDS; CHILDREN'S TOY GLOBES; COMPUTER GAMES, NAMELY TOY BATTERY OR ELECTRIC POWERED COMPUTER GAMES WITH LCD SCREENS THAT FEATURE ANIMATION AND SOUND EFFECTS; CUBE, MANIPULATIVE AND JIGSAW PUZZLES; BATH TOYS; WATER WING SWIM AIDS FOR RECREATIONAL USE; KICK BOARD FLOTATION DEVICES FOR RECREATIONAL USE; AND INFLATABLE FLOTATION DEVICES FOR RECREATIONAL USE, NAMELY, TUBES AND SIMILAR-SHAPED OBJECTS (U.S. CLS. 22, 23, 38 AND 50).

CLASS 30—STAPLE FOODS

FOR COFFEE, TEA, COCOA, SUGAR, RICE, TAPIOCA, SAGO, ARTIFICIAL COFFEE; FLOUR AND PREPARATIONS MADE FROM CEREALS, BREAD, PASTRY, NAMELY, CAKES, BREADS, BISCUITS, RICE CAKES, RUSKS AND PROCESSED CEREALS AND CONFECTIONERY CHIPS FOR BAKING, FRUIT ICES; HONEY, TREACLE; YEAST, BAKING POWDER; SALT, MUSTARD; VINEGAR, SAUCES, CONDIMENTS, NAMELY PEPPER SAUCE; SPICES; ICE (U.S. CL. 46).

CLASS 31—NATURAL AGRICULTURAL PRODUCTS

FOR AGRICULTURAL, HORTICULTURAL AND FORESTRY PRODUCTS, NAMELY, LIVE PLANTS, FLOWERS AND UNPROCESSED GRAINS; LIVE ANIMALS; FRESH FRUITS AND VEGETABLES; PLANT SEEDS, FLOWER AND GRASS SEEDS; FOODSTUFFS FOR ANIMALS; MALT FOR BREWING AND DISTILLING (U.S. CLS. 1 AND 46).

CLASS 41—EDUCATION AND ENTERTAINMENT

FOR ENTERTAINMENT SERVICES IN THE NATURE OF ON-GOING TELEVISION AND CABLE PROGRAMS FOR CHILDREN (U.S. CLS. 100, 101 AND 107).

NAKWAMA ANKRAH, EXAMINING ATTORNEY

SN 78-644,062. STELOR PRODUCTIONS, LLC, DARNESTOWN, MD. FILED 6-6-2005.

JINGLES THE JUKEBOX

THE MARK CONSISTS OF STANDARD CHARACTERS WITHOUT CLAIM TO ANY PARTICULAR FONT, STYLE, SIZE, OR COLOR.

CLASS 9—ELECTRICAL AND SCIENTIFIC APPARATUS

FOR AUDIO AND VIDEO RECORDINGS, NAMELY, AUDIO AND VIDEO RECORDINGS FEATURING MUSIC AND ANIMATION; DOWNLOADABLE VIDEOS OF TELEVISION PROGRAMS FEATURING MUSIC AND ANIMATION; PRERECORDED DVDS, VIDEO TAPES, AND CD-ROMS CONTAINING TELEVISION PROGRAMS FEATURING MUSIC AND ANIMATION; VIDEO GAMES, NAMELY, VIDEO GAME DISCS, TAPE CASSETTES, SOFTWARE AND CARTRIDGES; VIDEO GAME SOFTWARE, NAMELY, VIDEO GAME SOFTWARE FEATURING MUSIC AND ANIMATION; CELLULAR TELEPHONES; COMPUTERS; COMPUTER PERIPHERALS. (U.S. CLS. 21, 23, 26, 36 AND 38).

CLASS 16—PAPER GOODS AND PRINTED MATTER

FOR PRINTED MATTER, NAMELY, STICKERS; DECALCOMANIAS; PAPER PARTY DECORATIONS; PRINTED INSTRUCTIONAL AND TEACHING MATERIAL FOR USE IN TEACHING MATH, SPELLING, GEOGRAPHY AND READING; TRADING CARDS; CHILDREN'S MAGAZINES; CHILDREN'S BOOKS; CHILDREN'S NEWSPAPERS; CHILDREN'S NEWSLETTERS; CHILDREN'S ACTIVITY BOOKS; COLORING BOOKS; STATIONERY; GIFT WRAPPING PAPER; PAPER TABLE CLOTHS AND PAPER NAPKINS; PAPER PARTY HATS; PAPER BANNERS, CALENDARS, GREETING CARDS, PAPER PARTY BAGS; PAMPHLETS IN THE FIELDS OF MATH, SPELLING, GEOGRAPHY AND READING (U.S. CLS. 2, 5, 22, 23, 29, 37, 38 AND 50).

CLASS 25—CLOTHING

FOR CLOTHING, NAMELY, SHORTS; SHIRTS; T-SHIRTS; BLOUSES; JACKETS; PANTS; SOCKS; UNDERWEAR; PAJAMAS; NIGHTGOWNS; DRESSES; SKIRTS; TIES; BELTS; BATHING SUITS AND HATS; HALLOWEEN AND MASQUERADE COSTUMES. (U.S. CLS. 22 AND 39).

CLASS 28—TOYS AND SPORTING GOODS

FOR TOYS, NAMELY, PLUSH TOYS; DOLLS; GAMES AND PLAYTHINGS, NAMELY, BOARD GAMES; CARD GAMES; SCIENCE GAMES FEATURING EXPERIMENTS TO BE PERFORMED BY CHILDREN; ELECTRONIC GAMES, NAMELY, ELECTRONIC VIDEO GAMES; ARCADE-TYPE ELECTRONIC VIDEO GAMES AND ELECTRONIC ACTION GAMES; HAND-HELD UNITS FOR PLAYING ELECTRONIC GAMES FEATURING LCD AND VIDEO DISPLAY SCREENS; ELECTRONIC TOYS, NAMELY, ELECTRONIC TOY ACTION FIGURES AND ACCESSORIES FOR USE IN CONNECTION THEREWITH; MOTORIZED TOY VEHICLES. (U.S. CLS. 22, 23, 38 AND 50).

CLASS 38—COMMUNICATION

FOR TELECOMMUNICATIONS SERVICES, NAMELY, ELECTRONIC TRANSMISSION OF DATA, IMAGES AND DOCUMENTS VIA COMPUTER TERMINALS; ELECTRONIC MAIL SERVICES; AND FACSIMILE TRANSMISSION (U.S. CLS. 100, 101 AND 104).

CLASS 41—EDUCATION AND ENTERTAINMENT

FOR EDUCATIONAL SERVICES, NAMELY, DEVELOPING EDUCATIONAL AUDIO AND VISUAL PROGRAMS FOR CHILDREN, NAMELY, TELEVISION PROGRAMS, RADIO PROGRAMS, LIVE SHOWS AND CULTURAL EVENTS AND PROGRAMS AND ON-LINE EDUCATIONAL PROGRAMS, AND MATERIALS DISTRIBUTED IN CONNECTION THEREWITH, NAMELY, EDUCATIONAL PAMPHLETS, MANUALS, LYRIC BOOKS, ON-LINE ELECTRONIC NON-DOWNLOADABLE PUBLICATIONS AND INSTRUCTION MATERIALS; ENTERTAINMENT SERVICES, NAMELY, DEVELOPING AUDIO AND VISUAL PROGRAMS FOR CHILDREN, NAMELY, TELEVISION PROGRAMS, RADIO PROGRAMS, LIVE SHOWS AND CULTURAL EVENTS AND PROGRAMS AND ON-LINE ENTERTAINMENT PROGRAMS CONSISTING OF ONLINE INTERACTIVE GAMES AND KARAOKE PROGRAMS FOR CHILDREN, AND MATERIALS DISTRIBUTED IN CONNECTION THEREWITH, NAMELY, EDUCATIONAL PAMPHLETS, MANUALS, LYRIC BOOKS, ON-LINE ELECTRONIC NON-DOWNLOADABLE PUBLICATIONS AND INSTRUCTION MATERIALS; ENTERTAINMENT IN THE NATURE OF AN ANIMATED TELEVISION SERIES (U.S. CLS. 100, 101 AND 107).

YONG KIM, EXAMINING ATTORNEY

SN 78-652,036. SIMPLE MAN PRODUCTS, LLC, WILSON, NC. FILED 6-16-2005.

COOTER CAY

THE MARK CONSISTS OF STANDARD CHARACTERS WITHOUT CLAIM TO ANY PARTICULAR FONT, STYLE, SIZE, OR COLOR.

THE NAME COOTER CAY DOES NOT IDENTIFY A LIVING INDIVIDUAL.

CLASS 16—PAPER GOODS AND PRINTED MATTER

FOR PRINTED MATERIALS, NAMELY, STICKERS AND ADHESIVE LABELS (U.S. CLS. 2, 5, 22, 23, 29, 37, 38 AND 50).

FIRST USE 5-31-2004; IN COMMERCE 5-31-2004.

CLASS 25—CLOTHING

FOR CLOTHING, NAMELY, HEADWEAR AND SHIRTS (U.S. CLS. 22 AND 39).

FIRST USE 5-31-2004; IN COMMERCE 5-31-2004.

ANTHONY RINKER, EXAMINING ATTORNEY

SN 78-665,738. RUSSULA S.A., LA CORUÑA, SPAIN, FILED 7-7-2005.

RUSSULA

THE MARK CONSISTS OF STANDARD CHARACTERS WITHOUT CLAIM TO ANY PARTICULAR FONT, STYLE, SIZE, OR COLOR.

CLASS 37—CONSTRUCTION AND REPAIR

FOR TECHNOLOGICAL SERVICES, NAMELY, INSTALLATION OF ELECTRONIC AND MECHANICAL COMPONENTS AND SYSTEMS IN THE FIELD OF METALS MANUFACTURING AND RELATED INDUSTRIES; INSTALLATION OF COMPUTER SYSTEMS (U.S. CLS. 100, 103 AND 106).

CLASS 42—SCIENTIFIC, COMPUTER AND LEGAL SERVICES

FOR SCIENTIFIC AND TECHNOLOGICAL SERVICES, NAMELY, PROVIDING DESIGN SERVICES FOR OTHERS IN THE FIELD OF ENGINEERING AND METALS MANUFACTURING AND RELATED INDUSTRIES AND SCIENTIFIC RESEARCH RELATED THERETO; INDUSTRIAL RESEARCH AND ANALYSIS, NAMELY, ENGINEERING ANALYSIS OF ELECTRONIC AND MECHANICAL CONTROL SYSTEMS FOR THE METALS MANUFACTURING INDUSTRY TO IMPROVE PRODUCTIVITY AND EFFICIENCY; DESIGN AND DEVELOPMENT OF COMPUTERS AND SOFTWARE FOR OTHERS; AND ENGINEERING CONSULTATION SERVICES (U.S. CLS. 100 AND 101).

ANDREA SAUNDERS, EXAMINING ATTORNEY

SN 78-670,769. CANONICAL LIMITED, DOUGLAS, ISLE OF MAN, FILED 7-14-2005.

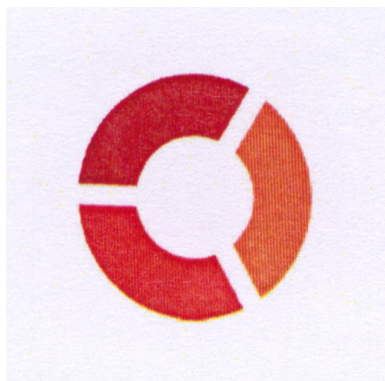

OWNER OF ERP N CMNTY TM OFC REG. NO. 004541652, DATED 5-18-2006, EXPIRES 7-8-2015.

THE COLOR(S) RED, ORANGE AND TERRA COTTA IS/ARE CLAIMED AS A FEATURE OF THE MARK.

THE MARK CONSISTS OF RED AT THE TOP, ORANGE ON THE SIDE AND TERRA COTTA AT THE BOTTOM.

CLASS 9—ELECTRICAL AND SCIENTIFIC APPARATUS

FOR COMPUTER OPERATING SYSTEMS SOFTWARE, EMAIL SOFTWARE, WEB BROWSER SOFTWARE, WORD PROCESSOR SOFTWARE, SPREADSHEET SOFTWARE, PRESENTATION SOFTWARE, GRAPHIC SOFTWARE, SOFTWARE ENABLING AND CONTROLLING ACCESS TO THE INTERNET, FIREWALL SOFTWARE AND SPAM FILTER SOFTWARE; DOWNLOADABLE PUBLICATIONS IN THE NATURE OF MANUALS AND GUIDES RELATING TO COMPUTERS AND COMPUTER PROGRAMS; DIGITAL MUSIC DOWNLOADABLE FROM THE INTERNET (U.S. CLS. 21, 23, 26, 36 AND 38).

CLASS 35—ADVERTISING AND BUSINESS

FOR ADVERTISING SERVICES, RENTAL OF ADVERTISING SPACE ON WEBSITES; AUCTIONING SERVICES; DATA PROCESSING SERVICES; EMPLOYMENT RECRUITING SERVICES; CONSULTANCY SERVICES RELATING TO BUSINESS MANAGEMENT AND ORGANIZATION (U.S. CLS. 100, 101 AND 102).

CLASS 42—SCIENTIFIC, COMPUTER AND LEGAL SERVICES

FOR PROVIDING INFORMATION IN THE FIELD OF THE DESIGN AND IMPLEMENTATION OF COMPUTER SOFTWARE (U.S. CLS. 100 AND 101).

MICHELLE DUBOIS, EXAMINING ATTORNEY

SN 78-672,796. THE CONSULTING COMPANY, DEWITT, IA, FILED 7-18-2005.

AGRI-DNA

THE MARK CONSISTS OF STANDARD CHARACTERS WITHOUT CLAIM TO ANY PARTICULAR FONT, STYLE, SIZE, OR COLOR.

CLASS 9—ELECTRICAL AND SCIENTIFIC APPARATUS

FOR ELECTRONIC REFERENCE DATABASE IN THE FIELD OF AGRICULTURE RECORDED ON COMPUTER MEDIA (U.S. CLS. 21, 23, 26, 36 AND 38).

CLASS 44—MEDICAL, BEAUTY AND AGRICULTURAL SERVICES

FOR PROVIDING REFERENCE DATABASE IN THE FIELD OF AGRICULTURAL ADVICE (U.S. CLS. 100 AND 101).

GINA FINK, EXAMINING ATTORNEY

SN 78-675,734. ALLEN-VANGUARD CORPORATION, OTTAWA, CANADA, FILED 7-21-2005.

ALLEN-VANGUARD

THE MARK CONSISTS OF STANDARD CHARACTERS WITHOUT CLAIM TO ANY PARTICULAR FONT, STYLE, SIZE, OR COLOR.

PRIORITY CLAIMED UNDER SEC. 44(D) ON CANADA APPLICATION NO. 1244492, FILED 1-21-2005, REG. NO. TMA665798, DATED 6-7-2006, EXPIRES 6-7-2021.

CLASS 1—CHEMICALS

FOR CHEMICALS USED IN INDUSTRY; RELEASING FLUID CHEMICALS USED IN CONTRABAND AND COUNTER-TERRORIST SEARCHING; CHEMICAL, BIOLOGICAL AND RADIOLOGICAL DECONTAMINATING CHEMICALS AND FOAM USED FOR BOMB DISPOSAL (U.S. CLS. 1, 5, 6, 10, 26 AND 46).

CLASS 5—PHARMACEUTICALS

FOR DISINFECTANTS USED TO DISINFECT INDIVIDUALS EXPOSED TO NUCLEAR, BIOLOGICAL OR CHEMICAL CONTAMINATION; SKIN DECONTAMINATING LOTION USED AS DISINFECTANTS FOR INDIVIDUALS EXPOSED TO NUCLEAR, BIOLOGICAL OR CHEMICAL CONTAMINATION (U.S. CLS. 6, 18, 44, 46, 51 AND 52).

CLASS 6—METAL GOODS

FOR NON-ELECTRIC CABLES AND WIRES OF COMMON METAL; SMALL ITEMS OF METAL HARDWARE, NAMELY, NAILS, ADJUSTING SCREWS, EYELETS, METAL HOOKS, METAL SAFETY CHAINS, METAL CONNECTIVE HINGES, METAL FASTENING COLLARS, METAL CABLES AND WIRE SNOT FOR ELECTRICAL PURPOSES, METAL CABLE ROLLERS AND REELS, METAL CABLE UNWINDING DRUMS, METAL CABLE HOLDERS, METAL LUBRICATOR NIPPLES, METAL RIVETS AND PINS, METAL THREADED RODS, METAL PLUGS AND PLUG-IN COUPLINGS, NON-ELECTRIC METAL WIRE CLAMPS, AND WASHERS; KITS FOR THE DETECTION AND DIFFUSION OF EXPLOSIVE DEVICES, AND SINGLE LINE KITS FOR MINE/MUNITIONS CLEARANCE AND HIGH RISK SEARCHES, COMPRISING HOOK AND LINE COMPONENTS, NAMELY, SNATCH BLOCKS, REELS, PULLING HANDLES, EYE RINGS, SEIZERS USED TO HOLD, FASTEN OR BIND OBJECTS, ANCHORS, PITONS, FISH HOOKS, SPRING GRIPS, JAW GRIPS, SUCTION PAD ANCHORS, SELF-ADHESIVE ANCHORS, GROUND ANCHORS, CORKSCREW STAKES, EXTENSION RODS, PULLEYS, GROUND PEGS, HOOKS, RINGS, BELT SLINGS, WIRE SLINGS, SLEDGES, PITONS, KARABINERS, WEDGES, BLOCKS, MAIN LINES; HEAVY DUTY HOOK AND LINE KITS FOR MOVING VEHICLES AND HEAVY IMPROVISED EXPLOSIVE DEVICES, WITH REELS, LINES, WEBBING SLINGS, ROUND SLINGS, GROUND ANCHORS, SHACKLES, SNATCH BLOCKS, HOOKS; METAL GOODS, NAMELY ANCHORS, PITON SAND WIRE SLINGS AND HOOKS; ALL OF THE FOREGOING PRIMARILY OF METAL; METAL GUARD BARRIER ARMS AND BARS FOR LAND VEHICLE AND MOBILE VEHICLE CONTAINMENT ON ROADS (U.S. CLS. 2, 12, 13, 14, 23, 25 AND 50).

CLASS 7—MACHINERY

FOR MACHINES AND MACHINE TOOLS; NAMELY, POWER DRILLS; MOTORS AND ENGINES EXCEPT FOR LAND VEHICLES; POWER-OPERATED REELING MACHINES FOR USE IN SECURITY AND SURVEILLANCE AND IN THE DETECTION AND DIFFUSION OF EXPLOSIVE DEVICES; TACTICAL ROBOTS FOR USE IN LAW ENFORCEMENT AND MILITARY APPLICATIONS, SURVEILLANCE, BOMB DISPOSAL, HAZARDOUS MATERIAL ACCIDENT CLEAN-UP AND HOSTAGE TAKING SITUATIONS, RECONNAISSANCE AND WEAPON DELIVERY IN RAPID DEPLOYMENT SCENARIOS WITHIN AREAS OF RESTRICTED PHYSICAL AREAS AND STRUCTURAL PARTS AND ACCESSORIES THEREFOR, NAMELY, BATTERY PACKS AND CHARGERS SOLD AS A UNIT; POWER OPERATED SEARCH TOOL KITS COMPRISED OF POWER OPERATED CORDLESS DRILLS WITH CORDLESS DRILL CHARGERS AND DRILL BITS, CENTRE PUNCHES; HYDRAULIC RAMS, PNEUMATIC RAMS; EQUIPMENT AND SYSTEMS FOR CONTAINMENT AND MITIGATION OF WEAPONS OF MASS DESTRUCTION AND CHEMICAL, BIOLOGICAL, RADIOLOGICAL AND NUCLEAR EXPLOSIVE DEVICES AND MATERIALS NAMELY, FOAM INJECTION MACHINES, CONTROLLERS, PUMPS, AERATING NOZZLES AND REUSABLE ENCLOSURES MADE OF BALLISTIC MATERIAL FOR CONTAINING THE EFFECT OF EXPLOSIVE DEVICES AND FOR DECONTAMINATING CHEMICAL AND BIOLOGICAL AGENTS SOLD AS A UNIT; FOAM APPLICATION EQUIPMENT NAMELY, PORTABLE SELF CONTAINING DECONTAMINATING FOAM APPLICATION EQUIPMENT UNITS DESIGNED FOR PERFORMING EMERGENCY SPOT DECONTAMINATION OF CHEMICAL AND BIOLOGICAL AGENTS ON HARDWARE, STRUCTURAL SURFACES, TERRAIN AND DRUG LABELS (U.S. CLS. 13, 19, 21, 23, 31, 34 AND 35).

CLASS 8—HAND TOOLS

FOR HAND OPERATED TOOLS AND IMPLEMENTS, NAMELY, HAMMERS, SHEARS, STRAP ROLLERS, DRILLS, HAND JACKS, AUGERS, AWLS, CLAMPS, FILES, PINCERS, PLANERS, PUNCHES, WRENCHES, SAWS, SCREWDRIVERS, TONGS, NIPPERS, WIRE STRIPPERS, VICES, PRUNERS, CHISELS, DRILL FILES, KNIVES, PLIERS; SECURITY, SURVEILLANCE AND SEARCH TOOL KITS, COMPRISED OF RETRACTABLE KNIVES, STEEL MEASURING TAPE, LINOLEUM KNIVES, SCISSORS, PAD SAWS, HACKSAWS, TACK EXTRACTORS, CLAW HAMMERS, CLUB HAMMERS, COLD CHISELS, WRECKING BARS, WIRE CUTTERS; BOLT CUTTERS, SCREWDRIVER SETS, WRENCHES, PLIERS, VICES, CLAMPS, CRIMPING IRONS, CABLE STRIPPERS, SEIZERS USED TO HOLD, FASTEN OR BIND OBJECTS, TWEEZERS, SOCKETS SETS AND BITS, HEXAGON WRENCHES, COMBINATION WRENCHES, RATCHET WRENCH SETS, TELESCOPIC SEARCH MIRRORS, HAND OPERATED SURVEILLANCE APPARATUS AND INSTRUMENTS, NAMELY, DOOR RAMS, MANUAL DOOR RAMS, LOCK BREAKERS, DOOR RIPPERS, FLOOR AND CAR ENTRY TOOLS; HAND OPERATED TOOLS USED FOR THE DETECTION AND DIFFUSION OF EXPLOSIVE DEVICES, NAMELY, SCREWDRIVERS, ADJUSTABLE WRENCHES, WRENCH SETS, VICE GRIP WRENCHES, PLIERS, SEIZERS, TWEEZERS, WIRE CUTTERS, TIN SNIPS, KNIVES, BLADE DISPENSERS, FLEXI SAWS, MINI SAWS, SCISSORS, HOOKS, WRECKING BARS, CLAW HAMMERS, TACK LIFTERS, NON-MAGNETIC TOOLS FOR EXPLOSIVE ORDNANCE DISPOSAL, NAMELY TWEEZERS, PROBES, KNIVES, SCISSORS, HACKSAWS, BLADES, SCRAPERS, WIRE BRUSHES, SCREWDRIVERS, PLIERS, WIRE CUTTERS, WRENCHES, HAMMERS, CHISELS, BARS, SAWS, WIRE STRIPPERS, AND KITS COMPRISING THE FOREGOING; HAND OPERATED EXCAVATION TOOLS FOR EXPLOSIVE ORDNANCE DISPOSAL, NAMELY, SHOVELS, PICKS, PRY BARS, SLEDGEHAMMERS, CLUB HAMMERS, CHISELS, SCRAPERS, WRENCH SETS, NON MAGNETIC SHOVELS USED ON UNEXPLODED ORDNANCE, TRIPODS DESIGNED FOR LIFTING HEAVY OBJECTS DURING EXPLOSIVE ORDNANCE DISPOSAL OPERATIONS, HAND OPERATED LIGHTWEIGHT TRIPODS DESIGNED FOR LIFTING SMALLER OBJECTS DURING IMPROVISED EXPLOSIVE ORDNANCE DISPOSAL OPERATIONS; VEHICLE ACCESS HAND-OPERATED TOOLS, NAMELY, REMOTE WINDOW BREAKERS, VEHICLE DOOR HANDLE LIFTERS, VEHICLE KEY/HANDLE CLAMPS, VEHICLE DOOR BUTTON PUSHERS, VEHICLE DOOR TRIM/PANEL REMOVING TOOLS (U.S. CLS. 23, 28 AND 44).

CLASS 9—ELECTRICAL AND SCIENTIFIC APPARATUS

FOR SCIENTIFIC, SURVEYING, PHOTOGRAPHIC, CINEMATOGRAPHIC, OPTICAL, MEASURING, SIGNALING, LIFE-SAVING APPARATUS AND INSTRUMENTS, NAMELY, SECURITY AND SURVEILLANCE INSTRUMENTS FOR USE IN THE FIELDS OF SECURITY, CONTRABAND AND COUNTER-TERRORIST SEARCHING, NAMELY HAND HELD METAL DETECTORS, GENERAL PURPOSE METAL DETECTORS, HIGH SENSITIVITY METAL DETECTORS, DUAL PURPOSE METAL DETECTORS AND WALK THROUGH METAL DETECTORS, PORTABLE EXPLOSIVES DETECTORS, CONTRABAND DETECTORS, NAMELY, HAND HELD ELECTRONIC CONTRABAND DETECTORS THAT INDICATE THE PRESENCE OF HIDDEN MATERIALS BY SIGNALING UNEXPECTED CHANGES IN THE DENSITY OR THICKNESS OF A SURFACE THROUGH THE RELEASE OF GAMMA RAYS; OPTICAL APPARATUS AND INSTRUMENTS FOR USE IN THE FIELDS OF SECURITY AND CONTRABAND AND COUNTER-TERRORIST SEARCHING, AND IN FORENSIC POST BLAST EXAMINATIONS, NAMELY, LIGHT PROBES, FLEXIBLE AND RIGID ENDOSCOPES, TELESCOPIC ARMS FOR ENDOSCOPES, CABLE DRUMS, REMOVABLE CLAWS BEING PARTS OF FLEXIBLE AND RIGID ENDOSCOPES AND TELESCOPIC ARMS, ELECTRONIC MICROSCOPES; PHOTOGRAPHIC AND CINEMATOGRAPHIC APPARATUS AND INSTRUMENTS NAMELY, DIGITAL AND VIDEO CAMERAS, USED WITH UNDER VEHICLE TROLLEYS, CAMERAS WITH INFRARED SENSORS, FIBER OPTIC SCOPES

FOR VISUAL INSPECTION BEHIND OR INSIDE CLOSED AREAS, ILLUMINATED MAGNIFIERS; X-RAY KITS COMPRISED OF PORTABLE X-RAY MACHINES FOR NON-MEDICAL USE, NOTEBOOK PERSONAL COMPUTER, BATTERY, AND CASES THEREFOR; ZOOM CAMERAS, INFRARED CAMERAS FOR DAY AND NIGHT OPERATIONS; FERROUS ORDNANCE LOCATORS, NAMELY, PORTABLE DETECTORS FOR LOCATING FERROUS OBJECTS UNDER GROUND OR WATER AND SUITABLE FOR THE ACCURATE LOCATION OF BOMBS, PIPES AND WRECKAGE; COMPUTER MONITORS, COMPUTER HARDWARE, COMPUTER SOFTWARE, NAMELY, APPLICATION SOFTWARE FOR USE IN ASSOCIATION WITH LOCATING FERROUS OBJECTS UNDER GROUND AND WATER AND FOR THE ACCURATE LOCATION OF BOMBS, PIPES AND WRECKAGE; APPARATUS FOR THE DETECTION AND DIFFUSION OF EXPLOSIVE DEVICES, USED IN IMPROVED EXPLOSIVE DEVICE DISPOSAL, NAMELY, ELECTRONIC BOMB DETECTORS AND DIFFUSERS, ELECTRONIC COUNTER MEASURES EQUIPMENT, NAMELY, PORTABLE COMMUNICATIONS JAMMERS, MODULAR JAMMERS, NAMELY, ELECTRONIC APPARATUS THAT INHIBIT RADIO CONTROLLED IMPROVED EXPLOSIVE DEVICE SIGNALS THAT MAY BE USED TO DETONATE EXPLOSIVE DEVICES, ELECTRONIC STETHOSCOPES FOR THE DETECTION OF MECHANICAL RUN BACK TIMERS AND ELECTRONIC TIMING SYSTEMS IN IMPROVED EXPLOSIVE DEVICES, NON-LINEAR JUNCTION DETECTORS, NAMELY ELECTRONIC APPARATUS AND INSTRUMENTS FOR DETECTING ELECTRONIC CIRCUITS FOUND IN EXPLOSIVE DEVICES AND RADIO TRANSMITTERS, ELECTRONIC CABLE DETECTORS USED TO LOCATE UNDERGROUND COMMAND WIRE CABLES, ELECTRONIC LETTER BOMB DETECTORS, X-RAY PARCEL BOMB DETECTORS, PORTABLE X-RAY GENERATORS, PORTABLE X-RAY COMPUTERS USED TO EXAMINE SUSPECT PACKAGES THAT MAY CONTAIN IMPROVED EXPLOSIVE DEVICES OR OTHER INACCESSIBLE AREAS WHERE CONTRABAND MAY BE HIDDEN; LAND MINE CLEARING APPARATUS AND EQUIPMENT, NAMELY LAND MINE DETECTORS, NAMELY NON MAGNETIC LAND MINE PRODDERS, REPLICA LAND MINE TRAINING AIDS; ELECTRONIC DISRUPTORS, NAMELY RECOILLESS DISPOSABLE DISRUPTORS USED TO DISRUPT EXPLOSIVE DEVICES, NAMELY, WATER JET DISRUPTORS USED TO DISRUPT THIN WALLED EXPLOSIVE DEVICES, DISPOSABLE CAR TRUNK DISRUPTORS USED TO DISRUPT EXPLOSIVE DEVICES IN VEHICLES; PERSONAL PROTECTIVE EQUIPMENT FOR THE PROTECTION OF INDIVIDUALS FROM CHEMICAL AND BIOLOGICAL WARFARE AGENTS NAMELY, PROTECTIVE SUITS, PROTECTIVE GLOVES AND PROTECTIVE OVER BOOTS, GAS MASKS, ELECTRO-VOICE AMPLIFIERS FOR GAS MASKS, CANISTERS DESIGNED TO HELP PROVIDE RESPIRATORY PROTECTION AGAINST AIRBORNE CONTAMINANTS, NEXT TO SKIN PROTECTIVE EQUIPMENT, NAMELY, WET SUITS, DRY SUITS, LIGHT WEIGHT PROTECTIVE SUITS, CHEMICAL PROTECTIVE UNDERGARMENTS; PROTECTIVE CLOTHING USED IN IMPROVED EXPLOSIVE DEVICE DISPOSAL, NAMELY BOMB SUITS, LIQUID COOLING UNDER SUITS; SEARCH SUITS, NAMELY, BODY ARMOUR SUITS DESIGNED FOR USE WHEN SEARCHING FOR IMPROVED EXPLOSIVE DEVICES; WIRELESS RADIO SYSTEMS FOR USE WITH BOMB SUITS; DEMINING BALLISTIC PROTECTION, NAMELY LAND MINE CLEARANCE VESTS AND HELMETS WITH VISORS; SAFETY EQUIPMENT, NAMELY, FOREARM PROTECTION FOR USE IN ASSOCIATION WITH MANUAL DOOR RAMS OR DOOR RIPPERS; SURVEILLANCE SCOPES, HAND HELD THERMAL IMAGERS, SPOTTING SCOPES, NAMELY LIGHTWEIGHT TELESCOPES, INFRARED TELESCOPIC CAMERAS, SURVEILLANCE PROBES, NAMELY UNDER DOOR REMOTE VIEWING TOOLS, MICRO-THROUGH-WALL VIEWING TOOLS, AUDIO PROBES, PEEPHOLE VIEWERS, REVERSE PEEPHOLE SCOPES, MIRRORS, TELESCOPIC MIRRORS, TELESCOPIC SEARCH MIRRORS, CONVEX MIRRORS, PLAIN MIRRORS, RECTANGULAR MIRRORS, MIRROR SLEEVES, CLIP ON MIRRORS, TELESCOPIC ARMS FOR SEARCH MIRRORS, POCKET SEARCH MIRRORS, UNDER VEHICLE SEARCH MIRRORS, SEARCH MIRRORS WITH NON-ROTATIONAL ALUMINUM POLES, PADDED FOREARM RESTS AND FOAM GRIPS, FOREARM STRAPS

FOR USE WITH TELESCOPIC ARMS FOR SEARCH MIRRORS, BATTERY HANDLES; PORTABLE COMMAND AND CONTROL CONSOLES, NAMELY, COMPUTER HARDWARE AND SOFTWARE FOR THE OPERATION OF ROBOTS AND RF WIRELESS CONTROL SYSTEMS, COMPRISED OF RF TRANSMITTERS AND RECEIVERS, INTEGRATED SPREAD SPECTRUM RF CONTROL SYSTEMS, NAMELY ELECTRONIC VIDEO APPARATUS THAT GIVE CONTROL AND FLICKER FREE VIDEO OVER LONG DISTANCES IN BUILT UP AREAS AND INSIDE BUILDINGS, SLIP RING DRUM CABLES, ZOOM CAMERAS, INFRARED CAMERAS FOR DAY AND NIGHT OPERATIONS, LASERS, SHOCK TUBE INITIATORS, EXTENSION BOOMS, DISRUPT OR MOUNTS; SECURITY SEALS, NAMELY GENERAL PURPOSE FOR USE AS AN ADHESIVE ON POROUS AND NON-POROUS SURFACES TO MONITOR THE SECURE STATUS OF WINDOWS AND DOOR AND OTHER ENTRIES, SEALS FOR EXTERIOR MANHOLES AND DRAIN COVERS FOR BLOCKING ENTRY AS A SECURITY MEASURE, ELECTRONIC SEALS FOR TAMPER INDICATION; BLAST PROTECTION ARMOR FOR VEHICLES; BLAST PROTECTION SEATS FOR USE IN MILITARY AND SECURITY/POLICE VEHICLES; RECHARGERS FOR FLASHLIGHTS, BATTERY PACKS, BATTERY CHARGERS, BATTERY HANDLES; BALLISTIC TESTING EQUIPMENT, NAMELY, MULTI-BARREL FIRING RECEIVER FOR FIRING AMMUNITION, HYDRAULIC TARGET RETENTION TEST FRAMES, ADJUSTABLE TORSO MOULDS FOR ARMOR AND BODY ARMOR, AMMUNITIONS AND WEAPONS; INSTRUMENTS FOR THE MEASUREMENT OF BALLISTIC VELOCITY AND RATE OF FIRE; COMPUTER SOFTWARE NAMELY, APPLICATION SOFTWARE FOR BALLISTICS TESTING; BOMB SUPPRESSION BLANKETS, SECURITY MIRRORS ON POLES WITH A LIGHT FIXTURE (U.S. CLS. 21, 23, 26, 36 AND 38).

CLASS 11—ENVIRONMENTAL CONTROL APPARATUS

FOR APPARATUS FOR LIGHTING, NAMELY FLUORESCENT LAMPS, SPARE LAMPS, FLASHLIGHTS, FLASHLIGHTS AND RECHARGES SOLD AS A UNIT, SEARCHLIGHTS, PORTABLE FLOODLIGHTS, POCKET ULTRAVIOLET LAMPS NOT FOR MEDICAL PURPOSES AND SPOTLIGHTS, FLASHLIGHTS INCORPORATING A MIRROR (U.S. CLS. 13, 21, 23, 31 AND 34).

CLASS 12—VEHICLES

FOR RESPONSE VEHICLES, NAMELY, LAND VEHICLES EQUIPPED WITH EXPLOSIVE ORDNANCE AND IMPROVED EXPLOSIVE DEVICE DISPOSAL EQUIPMENT; EMERGENCY RESPONSE TRAILERS CONTAINING BLAST SUPPRESSANT FOAM APPLICATION EQUIPMENT (U.S. CLS. 19, 21, 23, 31, 35 AND 44).

CLASS 13—FIREARMS

FOR FIREARMS; AMMUNITION AND PROJECTILES; EXPLOSIVES; APPARATUS AND INSTRUMENTS USED IN EXPLOSIVE ORDNANCE DISPOSAL, NAMELY, SMALL SHAPED AND LARGE SHAPED COPPER CONE CHARGES, SMALL SHAPED MAGNESIUM CONE CHARGES, SMALL SHAPED LIQUESCENT CONE CHARGES, LARGE SELF FORGING FRAGMENT CONES; DE-ARMERS DESIGNED TO PROJECT A VARIETY OF STEEL SLUGS AT HIGH VELOCITY INTO THE FUZES OR PISTOLS OF AIR DROPPED BOMBS; EXPLOSIVE WALL BREACHING EQUIPMENT COMPRISED OF A PLASTIC SHELL AND EXPLOSIVE DEVICES; SHOTGUNS, INTEGRATED WEAPONS CARRIERS; NON-ELECTRIC-EXPLOSIVE-DELIVERY TOOL KITS SPECIFICALLY DESIGNED TO BREAK THROUGH WINDOWS, NAMELY, DUAL INITIATORS USED AS DETONATORS, INITIATOR POLE MOUNTS, INITIATOR REEL MOUNTS, INDEXING JOINTS, POLE EXTENSIONS, HITCH PINS, POLE SIDE GRIP HANDLES, POLE TRANSITIONS, CHARGE PLATES; SHOCK TUBE STORAGE REELS; FORCED-ENTRY TOOLS, NAMELY, SAFETY INITIATORS AS DETONATORS USED FOR EXPLOSIVE FIRING (U.S. CLS. 2 AND 9).

CLASS 16—PAPER GOODS AND PRINTED MATTER

FOR PRINTED MATTER AND INSTRUCTIONAL AND TEACHING MATERIAL, NAMELY BOOKS AND MANUALS IN THE FIELDS OF EQUIPMENT TRAINING, NAMELY NUCLEAR, BIOLOGICAL AND CHEMICAL CLEAN-UP, EXPLOSIVE ORDNANCE DETECTION AND DISPOSAL, SECURITY SURVEILLANCE AND SEARCH, SECURITY CONTRABAND AND COUNTER-TERRORIST SEARCHING, IMPROVISED EXPLOSIVE DEVICE DISPOSAL; ADHESIVES FOR STATIONERY OR HOUSEHOLD PURPOSES; PRINTED MATERIALS, NAMELY INSTRUCTION MANUALS DETAILING THE USE OF TACTICAL HOOK AND LINE TECHNIQUES IN EXPLOSIVE ORDNANCE DISPOSAL OPERATIONS; OWNER MANUALS AND DOCUMENTATION IN THE NATURE OF TRAINING MANUALS RELATING TO TACTICAL ROBOTS, COMPUTER HARDWARE AND SOFTWARE FOR THE OPERATION OF SAID ROBOT SAND RF WIRELESS CONTROL SYSTEMS; PRINTED SECURITY SEALS USED TO SEAL PARCELS (U.S. CLS. 2, 5, 22, 23, 29, 37, 38 AND 50).

CLASS 20—FURNITURE AND ARTICLES NOT OTHERWISE CLASSIFIED

FOR NON-METAL DOOR WEDGES, NON-METAL FASTENING ANCHORS FOR GRIPPING TO FLAT SURFACES AND FOR HOOKS AND LINES AND ATTACHING SNATCH BLOCKS AND OTHER LINKS; DOORSTOP OF PLASTIC; NON-METAL CLAMPS; NON-METAL GROUND PEGS; NONMETAL PULLEYS; HAND-OPERATED NON-METAL REELS FOR STORING AND DEPLOYING LINES; NON-METAL SECURITY AND SURVEILLANCE TOOL KITS COMPRISED OF ANCHORS, CLAMPS, GROUND PEGS, HAND-OPERATED REELS, AND METAL SNATCH BLOCKS, REELS, GRIPS, SEIZERS, CORDS, STRINGS AND LINES, ANCHORS, PITONS AND WIRE SLINGS, HOOKS AND ROPE; NON-METAL EXPLOSIVE DEVICE DETECTION AND DIFFUSION TOOL KITS COMPRISED OF ANCHORS, CLAMPS, GROUND PEGS, HAND-OPERATED REELS, AND METAL SNATCH BLOCKS, REELS, GRIPS, SEIZERS, CORDS, STRINGS AND LINES, ANCHORS, PITONS, WIRE SLINGS, HOOKS AND ROPE; BOMB BLAST INHIBITORS, NAMELY, NON-METAL BOMB BLAST SUPPRESSION BINS, NON-METAL LIGHT-WEIGHT CONTAINERS FOR THE ISOLATION AND TRANSPORT, CONTAINMENT, MITIGATION AND DESTRUCTION OF SUSPECT PACKAGES (U.S. CLS. 2, 13, 22, 25, 32 AND 50).

CLASS 22—CORDAGE AND FIBERS

FOR ROPES, STRINGS, SACKS AND BAGS FOR THE TRANSPORTATION OR STORAGE OF MATERIALS IN BULK; RAW FIBROUS TEXTILE MATERIALS; ROPES, NON-METAL LINES AND CABLE STRAPS, TEXTILE CORDS, NON-METAL SLINGS FOR HOISTING AND HANDLING LOADS; SECURITY AND SURVEILLANCE KITS COMPRISING OF NON-METAL GOODS, NAMELY, ROPES, NON-METAL STRAPS AND LINES, SLINGS, TEXTILE CORDS AND SNATCH BLOCKS, REELS, GRIPS, SEIZERS, CORDS, STRINGS AND LINES; DETECTION AND DIFFUSION OF EXPLOSIVE DEVICES KITS COMPRISING OF NON-METAL GOODS, NAMELY, ROPES, NON-METAL SNAPS AND LINES, SLINGS, TEXTILE CORDS, AND METAL SNATCH BLOCKS, REELS, GRIPS, SEIZERS, CORDS, STRINGS AND LINES, ANCHORS, PITONS AND WIRE SLINGS, HOOKS, ROPE; NYLON CORD; LETTER BOMB CONTAINMENT BAGS, STRINGS AND LINES THERETO, SHOCK CORDS, ALL-PURPOSE STRAPS AND LINES THERETO (U.S. CLS. 1, 2, 7, 19, 22, 42 AND 50).

CLASS 35—ADVERTISING AND BUSINESS

FOR ADVERTISING; BUSINESS MANAGEMENT; BUSINESS ADMINISTRATION; MAIL ORDER CATALOG, ELECTRONIC CATALOG, MAIL ORDER, ONLINE ORDERING SERVICES FEATURING SECURITY APPARATUS AND HARDWARE (U.S. CLS. 100, 101 AND 102).

CLASS 41—EDUCATION AND ENTERTAINMENT

FOR EDUCATION SERVICES NAMELY, PROVIDING CLASSES, SEMINARS, WORKSHOPS IN THE FIELDS OF EQUIPMENT TRAINING, NAMELY, NUCLEAR, BIOLOGICAL AND CHEMICAL CLEAN-UP, EXPLOSIVE ORDNANCE DETECTION AND DISPOSAL, SECURITY SURVEILLANCE AND SEARCH, SECURITY CONTRABAND AND COUNTER-TERRORIST SEARCHING, IMPROVISED EXPLOSIVE DEVICE DISPOSAL; PROVIDING OF EDUCATION TRAINING IN THE FIELDS OF EQUIPMENT TRAINING, NAMELY, NUCLEAR, BIOLOGICAL AND CHEMICAL CLEAN-UP, EXPLOSIVE ORDNANCE DETECTION AND DISPOSAL, SECURITY SURVEILLANCE AND SEARCH, SECURITY CONTRABAND AND COUNTER-TERRORIST SEARCHING, IMPROVISED EXPLOSIVE DEVICE DISPOSAL; EDUCATION AND TRAINING SERVICES NAMELY, EDUCATIONAL TRAINING SERVICES IN RESPECT OF THE OPERATION, INSTALLATION, MAINTENANCE, AND REPAIR OF APPARATUS AND INSTRUMENTS USED IN THE FIELDS OF SECRET AND IN CONTRABAND AND COUNTER-TERRORIST SEARCHING; EDUCATIONAL TRAINING SERVICES, NAMELY TRAINING FOR PROCEDURES FOR DEALING WITH CHEMICAL, BIOLOGICAL, NUCLEAR AND RADIOLOGICAL INCIDENTS, COUNTER TERRORIST AND CONTRABAND SEARCH TRAINING, BOMB AWARENESS AND COUNTER MEASURE TRAINING, THREAT ANALYSIS AND PLANNING TRAINING, IMPROVISED EXPLOSIVE DEVICE DISPOSAL TRAINING (U.S. CLS. 100, 101 AND 107).

CLASS 42—SCIENTIFIC, COMPUTER AND LEGAL SERVICES

FOR SCIENTIFIC RESEARCH AND TECHNOLOGICAL CONSULTATION IN THE TECHNOLOGY FIELD OF BALLISTIC TESTING SERVICES, NAMELY TESTING AND EVALUATION OF WEAPON, AMMUNITION AND ARMOR; DESIGN, DEVELOPMENT AND TESTING FOR OTHERS OF APPARATUS AND INSTRUMENTS USED IN THE FIELD OF SECURITY AND IN CONTRABAND ENCOUNTER SEARCHING, APPARATUS AND INSTRUMENTS USED IN EXPLOSIVE ORDNANCE DISPOSAL, APPARATUS AND INSTRUMENTS USED IN IMPROVISED EXPLOSIVE DEVICE DISPOSAL, PERSONAL PROTECTIVE EQUIPMENT FOR THE PROTECTION OF INDIVIDUALS FROM CHEMICAL AND BIOLOGICAL WARFARE AGENTS, SURVEILLANCE APPARATUS AND INSTRUMENTS, VEHICLE BARRIER SYSTEMS, TACTICAL ROBOTS FOR USE IN LAW ENFORCEMENT AND MILITARY APPLICATIONS, SURVEILLANCE, BOMB DISPOSAL, HAZARDOUS MATERIAL ACCIDENT CLEAN-UP AND HOSTAGE TAKING SITUATIONS, EQUIPMENT AND SYSTEMS FOR CONTAINMENT AND MITIGATION OF WEAPONS OF MASS DESTRUCTION AND CHEMICAL, BIOLOGICAL, RADIOLOGICAL AND NUCLEAR EXPLOSIVE DEVICES AND MATERIALS, CHEMICAL BIOLOGICAL AND RADIOLOGICAL DECONTAMINATION SYSTEMS AND EQUIPMENT, BALLISTIC TESTING EQUIPMENT, BLAST PROTECTION ARMOR FOR VEHICLES AND BLAST PROTECTION SEATS; TECHNOLOGY CONSULTING SERVICES IN THE FIELDS OF THE TECHNICAL PROCEDURES FOR DEALING WITH CHEMICAL, BIOLOGICAL, NUCLEAR AND RADIOLOGICAL INCIDENTS, COUNTER-TERRORIST TRAINING AND TACTICS, CONTRABAND SEARCH AND DETECTION TRAINING AND TACTICS, BOMB COUNTERMEASURES TACTICS, THREAT ANALYSIS SECURITY CONSULTING; IMPACT TESTING SERVICES NAMELY, TESTING OF DATA RECORDERS AND HIGH G SHOCK TESTING OF AIR, LAND AND SEA VEHICLE; DEVELOPMENT OF TOOLS AND EQUIPMENT FOR USE IN THE MAINTENANCE, REPAIR AND OVERHAUL OF AIRCRAFT, TECHNOLOGICAL CONSULTANCY, ADVISORY AND INFORMATION SERVICES RELATING TO THE ABOVE SERVICES (U.S. CLS. 100 AND 101).

WILLIAM VERHOSEK, EXAMINING ATTORNEY

SN 78-675,739. ALLEN-VANGUARD CORPORATION, OTTAWA, CANADA, FILED 7-21-2005.



PRIORITY CLAIMED UNDER SEC. 44(D) ON CANADA APPLICATION NO. 1244493, FILED 1-21-2005, REG. NO. TMA663383, DATED 4-26-2006, EXPIRES 4-26-2021.

THE COLOR(S) RED, BLACK, WHITE AND GRAY IS/ARE CLAIMED AS A FEATURE OF THE MARK.

THE COLOR RED APPEARS IN THE STYLIZED LETTERS AV; THE COLOR BLACK APPEARS IN THE INNER OVAL BACKGROUND; THE COLOR WHITE APPEARS IN THE WORDING ALLEN VANGUARD, AS HIGHLIGHTED ARCS IN THE INNER OVAL BACKGROUND AND THE OUTSIDE OVAL BORDER; THE COLOR GRAY APPEARS AS SHADING AROUND THE OVAL BORDER AND ON THE ENDS OF THE HIGHLIGHTED ARCS INSIDE THE INNER OVAL

CLASS 1—CHEMICALS

FOR CHEMICALS USED IN INDUSTRY; RELEASING FLUID CHEMICALS USED IN CONTRABAND AND COUNTER TERRORIST SEARCHING; CHEMICAL, BIOLOGICAL AND RADIOLOGICAL DECONTAMINATING CHEMICALS AND FOAM USED FOR BOMB DISPOSAL (U.S. CLS. 1, 5, 6, 10, 26 AND 46).

CLASS 5—PHARMACEUTICALS

FOR DISINFECTANTS USED TO DISINFECT INDIVIDUALS EXPOSED TO NUCLEAR, BIOLOGICAL OR CHEMICAL CONTAMINATION; SKIN DECONTAMINATING LOTION USED AS DISINFECTANTS FOR INDIVIDUALS EXPOSED TO NUCLEAR, BIOLOGICAL OR CHEMICAL CONTAMINATION (U.S. CLS. 6, 18, 44, 46, 51 AND 52).

CLASS 6—METAL GOODS

FOR NON-ELECTRIC CABLES AND WIRES OF COMMON METAL; SMALL ITEMS OF METAL HARDWARE, NAMELY, NAILS, ADJUSTING SCREWS, EYELETS, METAL HOOKS, METAL SAFETY CHAINS, METAL CONNECTIVE HINGES, METAL FASTENING COLLARS, METAL CABLES AND WIRE SNOT FOR ELECTRICAL PURPOSES, METAL CABLE ROLLERS AND REELS, METAL CABLE UNWINDING DRUMS, METAL CABLE HOLDERS, METAL LUBRICATOR NIPPLES, METAL RIVETS AND PINS, METAL THREADED RODS, METAL PLUGS AND PLUG-IN COUPLINGS, NON-ELECTRIC METAL WIRE CLAMPS, AND WASHERS; KITS FOR THE DETECTION AND DIFFUSION OF EXPLOSIVE DEVICES, AND SINGLE LINE KITS FOR MINE/MUNITIONS CLEARANCE AND HIGH RISK SEARCHES, COMPRISING HOOK AND LINE COMPONENTS, NAMELY, SNATCH BLOCKS, REELS, PULLING HANDLES, EYE RINGS, SEIZERS USED TO HOLD, FASTEN OR BIND OBJECTS, ANCHORS, PITONS, FISH HOOKS, SPRING GRIPS, JAW GRIPS, SUCTION PAD ANCHORS, SELF-ADHESIVE ANCHORS, GROUND ANCHORS, CORKSCREW STAKES, EXTENSION RODS, PULLEYS, GROUND PEGS, HOOKS, RINGS, BELT SLINGS, WIRE SLINGS, SLEDGES, PITONS, KARABINERS, WEDGES, BLOCKS, MAINLINES; HEAVY DUTY HOOK AND LINE KITS FOR MOVING VEHICLES AND HEAVY IMPROVISED EXPLOSIVE DEVICES, WITH REELS, LINES, WEBBING SLINGS, ROUND SLINGS, GROUND ANCHORS, SHACKLES, SNATCH BLOCKS, HOOKS; METAL GOODS, NAMELY ANCHORS, PITON SAND WIRE SLINGS AND HOOKS; ALL OF THE FOREGOING PRIMARILY OF METAL; METAL GUARD BARRIER ARMS AND BARS FOR LAND VEHICLE AND MOBILE VEHICLE CONTAINMENT ON ROADS (U.S. CLS. 2, 12, 13, 14, 23, 25 AND 50).

CLASS 7—MACHINERY

FOR MACHINES AND MACHINE TOOLS, NAMELY, POWER DRILLS, MOTORS AND ENGINES EXCEPT FOR LAND VEHICLES; POWER-OPERATED REELING MACHINES FOR USE IN SECURITY AND SURVEILLANCE AND IN THE DETECTION AND DIFFUSION OF EXPLOSIVE DEVICES; TACTICAL ROBOTS FOR USE IN LAW ENFORCEMENT AND MILITARY APPLICATIONS, SURVEILLANCE, BOMB DISPOSAL, HAZARDOUS MATERIAL ACCIDENT CLEAN-UP AND HOSTAGE TAKING SITUATIONS, RECONNAISSANCE AND WEAPON DELIVERY IN RAPID DEPLOYMENT SCENARIOS WITHIN AREAS OF RESTRICTED PHYSICAL AREAS AND STRUCTURAL PARTS AND ACCESSORIES THEREFOR, NAMELY, BATTERY PACKS AND CHARGERS SOLD AS A UNIT; POWER OPERATED SEARCH TOOL KITS COMPRISED OF POWER OPERATED CORDLESS DRILLS WITH CORDLESS DRILL CHARGERS AND DRILL BITS, CENTER PUNCHES; HYDRAULIC RAMS, PNEUMATIC RAMS; EQUIPMENT AND SYSTEMS FOR CONTAINMENT AND MITIGATION OF WEAPONS OF MASS DESTRUCTION AND CHEMICAL, BIOLOGICAL, RADIOLOGICAL AND NUCLEAR EXPLOSIVE DEVICES AND MATERIALS NAMELY, FOAM INJECTION MACHINES, CONTROLLERS, PUMPS, AERATING NOZZLES AND REUSABLE ENCLOSURES MADE OF BALLISTIC MATERIAL FOR CONTAINING THE EFFECT OF EXPLOSIVE DEVICES AND FOR DECONTAMINATING CHEMICAL AND BIOLOGICAL AGENTS SOLD AS A UNIT; FOAM APPLICATION EQUIPMENT, NAMELY, PORTABLE SELF CONTAINING DECONTAMINATING FOAM APPLICATION EQUIPMENT UNITS DESIGNED FOR PERFORMING EMERGENCY SPOT DECONTAMINATION OF CHEMICAL AND BIOLOGICAL AGENTS ON HARDWARE, STRUCTURAL SURFACES, TERRAIN AND DRUG LABELS (U.S. CLS. 13, 19, 21, 23, 31, 34 AND 35).

CLASS 8—HAND TOOLS

FOR HAND OPERATED TOOLS AND IMPLEMENTS, NAMELY, HAMMERS, SHEARS, STRAP ROLLERS, DRILLS, HAND JACKS, AUGERS, AWLS, CLAMPS, FILES, PINNERS, PLANERS, PUNCHES, WRENCHES, SAWS, SCREWDRIVERS, TONGS, NIPPERS, WIRE STRIPPERS, VICES, PRUNERS, CHISELS, DRILL FILES, KNIVES, PLIERS; SECURITY, SURVEILLANCE AND SEARCH TOOL KITS, COMPRISED OF RETRACTABLE KNIVES, STEEL MEASURING TAPE, LINOLEUM KNIVES, SCISSORS, PAD SAWS, HACKSAWS, TACK EXTRACTORS, CLAW HAMMERS, CLUB HAMMERS, COLD CHISELS, WRECKING BARS, WIRE CUTTERS; BOLT CUTTERS, SCREWDRIVER SETS, WRENCHES, PLIERS, VICES, CLAMPS, CRIMPING IRONS, CABLE STRIPPERS, SEIZERS USED TO HOLD, FASTEN OR BIND OBJECTS, TWEEZERS, SOCKETS SETS AND BITS, HEXAGON WRENCHES, COMBINATION WRENCHES, RATCHET WRENCH SETS, TELESCOPIC SEARCH MIRRORS, HAND OPERATED SURVEILLANCE APPARATUS AND INSTRUMENTS, NAMELY, DOOR RAMS, MANUAL DOOR RAMS, LOCK BREAKERS, DOOR RIPPERS, FLOOR AND CAR ENTRY TOOLS; HAND OPERATED TOOLS USED FOR THE DETECTION AND DIFFUSION OF EXPLOSIVE DEVICES, NAMELY, SCREWDRIVERS, ADJUSTABLE WRENCHES, WRENCH SETS, VICE GRIP WRENCHES, PLIERS, SEIZERS, TWEEZERS, WIRE CUTTERS, TIN SNIPS, KNIVES, BLADE DISPENSERS, FLEXI SAWS, MINI SAWS, SCISSORS, HOOKS, WRECKING BARS, CLAW HAMMERS, TACK LIFTERS, NON-MAGNETIC TOOLS FOR EXPLOSIVE ORDNANCE DISPOSAL, NAMELY TWEEZERS, PROBES, KNIVES, SCISSORS, HACKSAWS, BLADES, SCRAPERS, WIRE BRUSHES, SCREWDRIVERS, PLIERS, WIRE CUTTERS, WRENCHES, HAMMERS, CHISELS, BARS, SAWS, WIRE STRIPPERS, AND KITS COMPRISING THE FOREGOING; HAND OPERATED EXCAVATION TOOLS FOR EXPLOSIVE ORDNANCE DISPOSAL, NAMELY, SHOVELS, PICKS, PRY BARS, SLEDGEHAMMERS, CLUB HAMMERS, CHISELS, SCRAPERS, WRENCH SETS, NON MAGNETIC SHOVELS USED ON UNEXPLODED ORDNANCE, TRIPODS DESIGNED FOR LIFTING HEAVY OBJECTS DURING EXPLOSIVE ORDNANCE DISPOSAL OPERATIONS, HAND OPERATED LIGHTWEIGHT TRIPODS DESIGNED FOR LIFTING SMALLER OBJECTS DURING IMPROVISED EXPLOSIVE ORDNANCE DISPOSAL OPERATIONS; VEHICLE ACCESS HAND-OPERATED TOOLS, NAMELY, REMOTE WINDOW BREAKERS, VEHICLE DOOR HANDLE LIFTERS, VEHICLE KEY/HANDLE CLAMPS, VEHICLE DOOR BUTTON PUSHERS, VEHICLE DOOR TRIM/PANEL REMOVING TOOLS (U.S. CLS. 23, 28 AND 44).

CLASS 9—ELECTRICAL AND SCIENTIFIC APPARATUS

FOR SCIENTIFIC, SURVEYING, PHOTOGRAPHIC, CINEMATOGRAPHIC, OPTICAL, MEASURING, SIGNALING, LIFE-SAVING APPARATUS AND INSTRUMENTS, NAMELY, SECURITY AND SURVEILLANCE INSTRUMENTS FOR USE IN THE FIELDS OF SECURITY, CONTRABAND AND COUNTER-TERRORIST SEARCHING, NAMELY HAND HELD METAL DETECTORS, GENERAL PURPOSE METAL DETECTORS, HIGH SENSITIVITY METAL DETECTORS, DUAL PURPOSE METAL DETECTORS AND WALK THROUGH METAL DETECTORS, PORTABLE EXPLOSIVES DETECTORS, CONTRABAND DETECTORS, NAMELY, HAND HELD ELECTRONIC CONTRABAND DETECTORS THAT INDICATE THE PRESENCE OF HIDDEN MATERIALS BY SIGNALING UNEXPECTED CHANGES IN THE DENSITY OR THICKNESS OF A SURFACE THROUGH THE RELEASE OF GAMMA RAYS; OPTICAL APPARATUS AND INSTRUMENTS FOR USE IN THE FIELDS OF SECURITY AND CONTRABAND AND COUNTER-TERRORIST SEARCHING, AND IN FORENSIC POST BLAST EXAMINATIONS, NAMELY, LIGHT PROBES, FLEXIBLE AND RIGID ENDOSCOPES, TELESCOPIC ARMS FOR ENDOSCOPES, CABLE DRUMS, REMOVABLE CLAWS BEING PARTS OF FLEXIBLE AND RIGID ENDOSCOPES AND TELESCOPIC ARMS, ELECTRONIC MICROSCOPES; PHOTOGRAPHIC AND CINEMATOGRAPHIC APPARATUS AND INSTRUMENTS NAMELY, DIGITAL AND VIDEO CAMERAS, USED WITH UNDER VEHICLE TROLLEYS, CAMERAS WITH INFRARED SENSORS, FIBER OPTIC SCOPES

FOR VISUAL INSPECTION BEHIND OR INSIDE CLOSED AREAS, ILLUMINATED MAGNIFIERS; X-RAY KITS COMPRISED OF PORTABLE X-RAY MACHINES FOR NON-MEDICAL USE, NOTEBOOK PERSONAL COMPUTER, BATTERY, AND CASES THEREFOR; ZOOM CAMERAS, INFRARED CAMERAS FOR DAY AND NIGHT OPERATIONS; FERROUS ORDNANCE LOCATORS, NAMELY, PORTABLE DETECTORS FOR LOCATING FERROUS OBJECTS UNDER GROUND OR WATER AND SUITABLE FOR THE ACCURATE LOCATION OF BOMBS, PIPES AND WRECKAGE; COMPUTER MONITORS, COMPUTER HARDWARE, COMPUTER SOFTWARE, NAMELY, APPLICATION SOFTWARE FOR USE IN ASSOCIATION WITH LOCATING FERROUS OBJECTS UNDER GROUND AND WATER AND FOR THE ACCURATE LOCATION OF BOMBS, PIPES AND WRECKAGE; APPARATUS FOR THE DETECTION AND DIFFUSION OF EXPLOSIVE DEVICES, USED IN IMPROVISED EXPLOSIVE DEVICE DISPOSAL, NAMELY, ELECTRONIC BOMB DETECTORS AND DIFFUSERS, ELECTRONIC COUNTER MEASURES EQUIPMENT, NAMELY, PORTABLE COMMUNICATIONS JAMMERS, MODULAR JAMMERS, NAMELY, ELECTRONIC APPARATUS THAT INHIBIT RADIO CONTROLLED IMPROVISED EXPLOSIVE DEVICE SIGNALS THAT MAY BE USED TO DETONATE EXPLOSIVE DEVICES, ELECTRONIC STETHOSCOPES FOR THE DETECTION OF MECHANICAL RUN BACK TIMERS AND ELECTRONIC TIMING SYSTEMS IN IMPROVISED EXPLOSIVE DEVICES, NON-LINEAR JUNCTION DETECTORS, NAMELY ELECTRONIC APPARATUS AND INSTRUMENTS FOR DETECTING ELECTRONIC CIRCUITS FOUND IN EXPLOSIVE DEVICES AND RADIO TRANSMITTERS, ELECTRONIC CABLE DETECTORS USED TO LOCATE UNDERGROUND COMMAND WIRE CABLES, ELECTRONIC LETTER BOMB DETECTORS, X-RAY PARCEL BOMB DETECTORS, PORTABLE X-RAY GENERATORS, PORTABLE X-RAY COMPUTERS USED TO EXAMINE SUSPECT PACKAGES THAT MAY CONTAIN IMPROVISED EXPLOSIVE DEVICES OR OTHER INACCESSIBLE AREAS WHERE CONTRABAND MAY BE HIDDEN; LAND MINE CLEARING APPARATUS AND EQUIPMENT, NAMELY LAND MINE DETECTORS, NAMELY NON MAGNETIC LAND MINE PRODDERS, REPLICA LAND MINE TRAINING AIDS; ELECTRONIC DISRUPTORS, NAMELY RECOILLESS DISPOSABLE DISRUPTORS USED TO DISRUPT EXPLOSIVE DEVICES, NAMELY, WATER JET DISRUPTORS USED TO DISRUPT THIN WALLED EXPLOSIVE DEVICES, DISPOSABLE CAR TRUNK DISRUPTORS USED TO DISRUPT EXPLOSIVE DEVICES IN VEHICLES; PERSONAL PROTECTIVE EQUIPMENT FOR THE PROTECTION OF INDIVIDUALS FROM CHEMICAL AND BIOLOGICAL WARFARE AGENTS, NAMELY, PROTECTIVE SUITS, PROTECTIVE GLOVES AND PROTECTIVE OVER BOOTS, GAS MASKS, ELECTRO-VOICE AMPLIFIERS FOR GAS MASKS, CANISTERS DESIGNED TO HELP PROVIDE RESPIRATORY PROTECTION AGAINST AIRBORNE CONTAMINANTS, NEXT TO SKIN PROTECTIVE EQUIPMENT, NAMELY, WET SUITS, DRY SUITS, LIGHT WEIGHT PROTECTIVE SUITS, CHEMICAL PROTECTIVE UNDERGARMENTS; PROTECTIVE CLOTHING USED IN IMPROVISED EXPLOSIVE DEVICE DISPOSAL, NAMELY BOMB SUITS, LIQUID COOLING UNDERSUITS; SEARCH SUITS, NAMELY, BODY ARMOR SUITS DESIGNED FOR USE WHEN SEARCHING FOR IMPROVISED EXPLOSIVE DEVICES; WIRELESS RADIO SYSTEMS FOR USE WITH BOMB SUITS; DEMINING BALLISTIC PROTECTION, NAMELY LAND MINE CLEARANCE VESTS AND HELMETS WITH VISORS; SAFETY EQUIPMENT, NAMELY, FOREARM PROTECTION FOR USE IN ASSOCIATION WITH MANUAL DOOR RAMS OR DOOR RIPPERS; SURVEILLANCE SCOPES, HAND HELD THERMAL IMAGERS, SPOTTING SCOPES, NAMELY LIGHTWEIGHT TELESCOPES, INFRARED TELESCOPIC CAMERAS, SURVEILLANCE PROBES, NAMELY UNDER DOOR REMOTE VIEWING TOOLS, MICRO-THROUGH-WALL VIEWING TOOLS, AUDIO PROBES, PEEPHOLE VIEWERS, REVERSE PEEPHOLE SCOPES, MIRRORS, TELESCOPIC MIRRORS, TELESCOPIC SEARCH MIRRORS, CONVEX MIRRORS, PLAIN MIRRORS, RECTANGULAR MIRRORS, MIRROR SLEEVES, CLIP ON MIRRORS, TELESCOPIC ARMS FOR SEARCH MIRRORS, POCKET SEARCH MIRRORS, UNDER VEHICLE SEARCH MIRRORS, SEARCH MIRRORS WITH NON-ROTATIONAL ALUMINUM POLES, PADDED FOREARM RESTS AND FOAM GRIPS, FOREARM STRAPS

FOR USE WITH TELESCOPIC ARMS FOR SEARCH MIRRORS, BATTERY HANDLES; PORTABLE COMMAND AND CONTROL CONSOLES, NAMELY, COMPUTER HARDWARE AND SOFTWARE FOR THE OPERATION OF ROBOT SAND RF WIRELESS CONTROL SYSTEMS, COMPRISED OF RF TRANSMITTERS AND RECEIVERS, INTEGRATED SPREAD SPECTRUM RF CONTROL SYSTEMS, NAMELY ELECTRONIC VIDEO APPARATUS THAT GIVE CONTROL AND FLICKER FREE VIDEO OVER LONG DISTANCES IN BUILT UP AREAS AND INSIDE BUILDINGS, SLIP RING DRUM CABLES, ZOOM CAMERAS, INFRARED CAMERAS FOR DAY AND NIGHT OPERATIONS, LASERS, SHOCK TUBE INITIATORS, EXTENSION BOOMS, DISRUPT OR MOUNTS; SECURITY SEALS, NAMELY GENERAL PURPOSE FOR USE AS AN ADHESIVE ON POROUS AND NON-POROUS SURFACES TO MONITOR THE SECURE STATUS OF WINDOWS AND DOOR AND OTHER ENTRIES, SEALS FOR EXTERIOR MANHOLES AND DRAIN COVERS FOR BLOCKING ENTRY AS A SECURITY MEASURE, ELECTRONIC SEALS FOR TAMPER INDICATION; BLAST PROTECTION ARMOR FOR VEHICLES; BLAST PROTECTION SEATS FOR USE IN MILITARY AND SECURITY/POLICE VEHICLES; RECHARGERS FOR FLASHLIGHTS, BATTERY PACKS, BATTERY CHARGERS, BATTERY HANDLES; BALLISTIC TESTING EQUIPMENT, NAMELY, MULTI-BARREL FIRING RECEIVER FOR FIRING AMMUNITION, HYDRAULIC TARGET RETENTION TEST FRAMES, ADJUSTABLE TORSO MOULDS FOR AMOUR AND BODY ARMOR, AMMUNITIONS AND WEAPONS; INSTRUMENTS FOR THE MEASUREMENT OF BALLISTIC VELOCITY AND RATE OF FIRE; COMPUTER SOFTWARE NAMELY, APPLICATION SOFTWARE FOR BALLISTICS TESTING; BOMB SUPPRESSION BLANKETS, SECURITY MIRRORS ON POLES WITH A LIGHT FIXTURE (U.S. CLS. 21, 23, 26, 36 AND 38).

CLASS 11—ENVIRONMENTAL CONTROL APPARATUS

FOR APPARATUS FOR LIGHTING, NAMELY FLUORESCENT LAMPS, SPARE LAMPS, FLASHLIGHTS, FLASHLIGHTS AND RECHARGES SOLD AS A UNIT, SEARCHLIGHTS, PORTABLE FLOODLIGHTS, POCKET ULTRAVIOLET LAMPS NOT FOR MEDICAL PURPOSES AND SPOTLIGHTS, FLASHLIGHTS INCORPORATING A MIRROR (U.S. CLS. 13, 21, 23, 31 AND 34).

CLASS 12—VEHICLES

FOR RESPONSE VEHICLES, NAMELY, LAND VEHICLES EQUIPPED WITH EXPLOSIVE ORDNANCE AND IMPROVISED EXPLOSIVE DEVICE DISPOSAL EQUIPMENT; EMERGENCY RESPONSE TRAILERS CONTAINING BLAST SUPPRESSANT FOAM APPLICATION EQUIPMENT (U.S. CLS. 19, 21, 23, 31, 35 AND 44).

CLASS 13—FIREARMS

FOR FIREARMS; AMMUNITION AND PROJECTILES; EXPLOSIVES; APPARATUS AND INSTRUMENTS USED IN EXPLOSIVE ORDNANCE DISPOSAL, NAMELY, SMALL SHAPED AND LARGE SHAPED COPPER CONE CHARGES, SMALL SHAPED MAGNESIUM CONE CHARGES, SMALL SHAPED LIQUESCENT CONE CHARGES, LARGE SELF FORGING FRAGMENT CONES; DE-FOREORDAINED TO PROJECT A VARIETY OF STEEL SLUGS AT HIGH VELOCITY INTO THE FUZES OR PISTOLS OF AIR DROPPED BOMBS; EXPLOSIVE WALL BREACHING EQUIPMENT COMPRISED SOFA PLASTIC SHELL AND EXPLOSIVE DEVICES; SHOTGUNS, INTEGRATED WEAPONS CARRIERS; NON-ELECTRIC-EXPLOSIVE-DELIVERY TOOL KITS SPECIFICALLY DESIGNED TO BREAK THROUGH WINDOWS, NAMELY, DUAL INITIATORS USED AS DETONATORS, INITIATOR POLE MOUNTS, INITIATOR REEL MOUNTS, INDEXING JOINTS, POLE EXTENSIONS, HITCH PINS, POLE SIDE GRIP HANDLES, POLE TRANSITIONS, CHARGE PLATES, SHOCK TUBE STORAGE REELS; FORCED-ENTRY TOOLS, NAMELY, SAFETY INITIATORS AS DETONATORS USED FOR EXPLOSIVE FIRING (U.S. CLS. 2 AND 9).

CLASS 16—PAPER GOODS AND PRINTED MATTER

FOR PRINTED MATTER AND INSTRUCTIONAL AND TEACHING MATERIAL, NAMELY BOOKS AND MANUALS IN THE FIELDS OF EQUIPMENT TRAINING, NAMELY NUCLEAR, BIOLOGICAL AND CHEMICAL CLEAN-UP, EXPLOSIVE ORDNANCE DETECTION AND DISPOSAL, SECURITY SURVEILLANCE AND SEARCH, SECURITY CONTRABAND AND COUNTER-TERRORIST SEARCHING, IMPROVISED EXPLOSIVE DEVICE DISPOSAL; ADHESIVES FOR STATIONERY OR HOUSEHOLD PURPOSES; PRINTED MATERIALS, NAMELY INSTRUCTION MANUALS DETAILING THE USE OF TACTICAL HOOK AND LINE TECHNIQUES IN EXPLOSIVE ORDNANCE DISPOSAL OPERATIONS; OWNER MANUALS AND DOCUMENTATION IN THE NATURE OF TRAINING MANUALS RELATING TO TACTICAL ROBOTS, COMPUTER HARDWARE AND SOFTWARE FOR THE OPERATION OF SAID ROBOT SAND RF WIRELESS CONTROL SYSTEMS; PRINTED SECURITY SEALS USED TO SEAL PARCELS (U.S. CLS. 2, 5, 22, 23, 29, 37, 38 AND 50).

CLASS 20—FURNITURE AND ARTICLES NOT OTHERWISE CLASSIFIED

FOR NON-METAL DOOR WEDGES, NON-METAL FASTENING ANCHORS FOR GRIPPING TO FLAT SURFACES AND FOR HOOKS AND LINES AND ATTACHING SNATCH BLOCKS AND OTHER LINKS; DOOR STOP OF PLASTIC; NON-METAL CLAMPS; NON-METAL GROUND PEGS; NONMETAL PULLEYS; HAND-OPERATED NON-METAL REELS FOR STORING AND DEPLOYING LINES; NON-METAL SECURITY AND SURVEILLANCE TOOL KITS COMPRISED OF ANCHORS, CLAMPS, GROUND PEGS, HAND-OPERATED REELS, AND METAL SNATCH BLOCKS, REELS, GRIPS, SEIZERS, CORDS, STRINGS AND LINES, ANCHORS, PITONS AND WIRE SLINGS, HOOKS AND ROPE; NON-METAL EXPLOSIVE DEVICE DETECTION AND DIFFUSION TOOL KITS COMPRISED OF ANCHORS, CLAMPS, GROUND PEGS, HAND-OPERATED REELS, AND METAL SNATCH BLOCKS, REELS, GRIPS, SEIZERS, CORDS, STRINGS AND LINES, ANCHORS, PITONS, WIRE SLINGS, HOOKS AND ROPE; BOMB BLAST INHIBITORS, NAMELY, NON-METAL BOMB BLAST SUPPRESSION BINS, NON-METAL LIGHT-WEIGHT CONTAINERS FOR THE ISOLATION AND TRANSPORT, CONTAINMENT, MITIGATION AND DESTRUCTION OF SUSPECT PACKAGES (U.S. CLS. 2, 13, 22, 25, 32 AND 50).

CLASS 22—CORDAGE AND FIBERS

FOR ROPES, STRINGS; SACKS AND BAGS FOR THE TRANSPORTATION OR STORAGE OF MATERIALS IN BULK; RAW FIBROUS TEXTILE MATERIALS; ROPES, NON-METAL LINES AND CABLE STRAPS, TEXTILE CORDS, NON-METAL SLINGS FOR HOISTING AND HANDLING LOADS; SECURITY AND SURVEILLANCE KITS COMPRISING OF NON-METAL GOODS, NAMELY, ROPES, NON-METAL STRAPS AND LINES, SLINGS, TEXTILE CORDS AND SNATCH BLOCKS, REELS, GRIPS, SEIZERS, CORDS, STRINGS AND LINES; DETECTION AND DIFFUSION OF EXPLOSIVE DEVICES KITS COMPRISING OF NON-METAL GOODS, NAMELY, ROPES, NON-METAL SNAPS AND LINES, SLINGS, TEXTILE CORDS, AND METAL SNATCH BLOCKS, REELS, GRIPS, SEIZERS, CORDS, STRINGS AND LINES, ANCHORS, PITONS AND WIRE SLINGS, HOOKS, ROPE; NYLON CORD; LETTER BOMB CONTAINMENT BAGS, STRINGS AND LINES THERETO, SHOCK CORDS, ALL-PURPOSE STRAPS AND LINES THERETO (U.S. CLS. 1, 2, 7, 19, 22, 42 AND 50).

CLASS 35—ADVERTISING AND BUSINESS

FOR ADVERTISING; BUSINESS MANAGEMENT; BUSINESS ADMINISTRATION; MAIL ORDER CATALOG, ELECTRONIC CATALOG, MAIL ORDER, ON-LINE ORDERING SERVICES FEATURING SECURITY APPARATUS AND HARDWARE (U.S. CLS. 100, 101 AND 102).

CLASS 41—EDUCATION AND ENTERTAINMENT

FOR EDUCATION SERVICES NAMELY, PROVIDING CLASSES, SEMINARS, WORKSHOPS IN THE FIELDS OF EQUIPMENT TRAINING, NAMELY, NUCLEAR, BIOLOGICAL AND CHEMICAL CLEAN-UP, EXPLOSIVE ORDNANCE DETECTION AND DISPOSAL, SECURITY SURVEILLANCE AND SEARCH, SECURITY CONTRABAND AND COUNTER-TERRORIST SEARCHING, IMPROVISED EXPLOSIVE DEVICE DISPOSAL; PROVIDING OF EDUCATION TRAINING IN THE FIELDS OF EQUIPMENT TRAINING, IN THE FIELDS OF EQUIPMENT TRAINING, NAMELY, NUCLEAR, BIOLOGICAL AND CHEMICAL CLEAN-UP, EXPLOSIVE ORDNANCE DETECTION AND DISPOSAL, SECURITY SURVEILLANCE AND SEARCH, SECURITY CONTRABAND AND COUNTER-TERRORIST SEARCHING, IMPROVISED EXPLOSIVE DEVICE DISPOSAL; EDUCATION AND TRAINING SERVICES NAMELY, EDUCATIONAL TRAINING SERVICES IN RESPECT OF THE OPERATION, INSTALLATION, MAINTENANCE, AND REPAIR OF APPARATUS AND INSTRUMENTS USED IN THE FIELDS OF SECRET AND IN CONTRABAND AND COUNTER-TERRORIST SEARCHING; EDUCATIONAL TRAINING SERVICES, NAMELY TRAINING FOR PROCEDURES FOR DEALING WITH CHEMICAL, BIOLOGICAL, NUCLEAR AND RADIOLOGICAL INCIDENTS, COUNTER TERRORIST AND CONTRABAND SEARCH TRAINING, BOMB AWARENESS AND COUNTER MEASURE TRAINING, THREAT ANALYSIS AND PLANNING TRAINING, IMPROVISED EXPLOSIVE DEVICE DISPOSAL TRAINING (U.S. CLS. 100, 101 AND 107).

CLASS 42—SCIENTIFIC, COMPUTER AND LEGAL SERVICES

FOR SCIENTIFIC RESEARCH AND TECHNOLOGICAL CONSULTATION IN THE TECHNOLOGY FIELD OF BALLISTIC TESTING SERVICES, NAMELY TESTING AND EVALUATION OF WEAPON, AMMUNITION AND ARMOR; DESIGN, DEVELOPMENT AND TESTING FOR OTHERS OF APPARATUS AND INSTRUMENTS USED IN THE FIELD OF SECURITY AND IN CONTRABAND AND COUNTERTERRORIST SEARCHING, APPARATUS AND INSTRUMENTS USED IN EXPLOSIVE ORDNANCE DISPOSAL, APPARATUS AND INSTRUMENTS USED IN IMPROVISED EXPLOSIVE DEVICE DISPOSAL, PERSONAL PROTECTIVE EQUIPMENT FOR THE PROTECTION OF INDIVIDUALS FROM CHEMICAL AND BIOLOGICAL WARFARE AGENTS, SURVEILLANCE APPARATUS AND INSTRUMENTS, VEHICLE BARRIER SYSTEMS, TACTICAL ROBOTS FOR USE IN LAW ENFORCEMENT AND MILITARY APPLICATIONS, SURVEILLANCE, BOMB DISPOSAL, HAZARDOUS MATERIAL ACCIDENT CLEAN-UP AND HOSTAGE TAKING SITUATIONS, EQUIPMENT AND SYSTEMS FOR CONTAINMENT AND MITIGATION OF WEAPONS OF MASS DESTRUCTION AND CHEMICAL, BIOLOGICAL, RADIOLOGICAL AND NUCLEAR EXPLOSIVE DEVICES AND MATERIALS, CHEMICAL BIOLOGICAL AND RADIOLOGICAL DECONTAMINATION SYSTEMS AND EQUIPMENT, BALLISTIC TESTING EQUIPMENT, BLAST PROTECTION ARMOR FOR VEHICLES AND BLAST PROTECTION SEATS; TECHNOLOGY AND OPERATIONAL CONSULTING SERVICES IN THE FIELDS OF THE TECHNICAL PROCEDURES FOR DEALING WITH CHEMICAL, BIOLOGICAL, NUCLEAR AND RADIOLOGICAL INCIDENTS, COUNTER-TERRORIST TRAINING AND TACTICS, CONTRABAND SEARCH AND DETECTION TRAINING AND TACTICS, BOMB COUNTER-MEASURES TACTICS, THREAT ANALYSIS SECURITY CONSULTING; IMPACT TESTING SERVICES NAMELY, TESTING OF DATA RECORDERS AND HIGH G SHOCK TESTING OF AIR, LAND AND SEA VEHICLE; DEVELOPMENT OF TOOLS AND EQUIPMENT FOR USE IN THE MAINTENANCE, REPAIR AND OVERHAUL OF AIRCRAFT, TECHNOLOGICAL CONSULTANCY, ADVISORY AND INFORMATION SERVICES RELATING TO THE ABOVE SERVICES (U.S. CLS. 100 AND 101).

WILLIAM VERHOSEK, EXAMINING ATTORNEY

SN 78-676,038. SOLVOYO CO, BOSTON, MA. FILED 7-22-2005.

SOLVOYO

THE MARK CONSISTS OF STANDARD CHARACTERS WITHOUT CLAIM TO ANY PARTICULAR FONT, STYLE, SIZE, OR COLOR.

CLASS 9—ELECTRICAL AND SCIENTIFIC APPARATUS

FOR COMPUTER SOFTWARE FOR USE IN BUSINESS APPLICATIONS FOR SUPPLY CHAIN PLANNING AND MANAGEMENT, SALES AND OPERATION PLANNING, INVENTORY AND NETWORK OPTIMIZATION, STRATEGIC PLANNING, FORECASTING AND DEMAND MANAGEMENT, TRANSPORTATION OPTIMIZATION, PRODUCTION AND DISTRIBUTION ANALYSIS, OPERATIONAL PERFORMANCE REPORTING; COMPUTER SOFTWARE FOR PLANNING AND ANALYSIS OF DECISION MAKING PROCESSES DURING ALL STAGES OF SUPPLY CHAIN MANAGEMENT AND ADVANCED PLANNING SYSTEMS (U.S. CLS. 21, 23, 26, 36 AND 38).

FIRST USE 2-1-2005; IN COMMERCE 5-15-2005.

CLASS 42—SCIENTIFIC, COMPUTER AND LEGAL SERVICES

FOR APPLICATION SERVICE PROVIDER (ASP) FEATURING SOFTWARE IN THE FIELD OF SUPPLY CHAIN PLANNING AND MANAGEMENT, SALES AND OPERATION PLANNING, INVENTORY AND NETWORK OPTIMIZATION, STRATEGIC PLANNING, FORECASTING AND DEMAND MANAGEMENT, TRANSPORTATION OPTIMIZATION, PRODUCTION AND DISTRIBUTION ANALYSIS, OPERATIONAL PERFORMANCE REPORTING; TECHNICAL SUPPORT, NAMELY, TROUBLESHOOTING OF COMPUTER SOFTWARE PROBLEMS RELATED DIRECTLY TO THE SOFTWARE PROVIDED THROUGH THE APPLICATION SERVICE (U.S. CLS. 100 AND 101).

FIRST USE 2-1-2005; IN COMMERCE 5-15-2005.

DAVID TAYLOR, EXAMINING ATTORNEY

SN 78-677,445. RELIANCE RELOCATION SERVICES, INC., CHICAGO, IL. FILED 7-25-2005.



OWNER OF U.S. REG. NO. 2,273,976.

THE MARK CONSISTS OF A DESIGN OF TWO ADJACENT ROOFTOPS.

CLASS 35—ADVERTISING AND BUSINESS

FOR BUSINESS, EMPLOYEE AND PERSONNEL RELOCATION SERVICES FOR INDIVIDUAL AND/OR GROUP TRANSFERS, INTERNATIONAL AND DOMESTIC, NAMELY PROVIDING INFORMATION AND COUNSELING ON FINDING A NEW HOME, PROVIDING PRE-DECISION DESTINATION INFORMATION, PROVIDING INFORMATION AND COUNSELING FOR FAMILY MEMBERS' JOB SEARCH, PROVIDING DESTINATION AREA INFORMATION, COUNSELING, AND/OR TOURS TO RELOCATING PEOPLE IN ORDER TO FIND A NEW HOME TO BUY OR RENT; PROVIDING MORTGAGE LENDER REFERRAL; PROVIDING REFERRALS FOR SELECTING REAL ESTATE AGENTS; MARKETING CONSULTING IN THE FIELD OF RE-SALE OF BUSINESS-OWNED HOME PURCHASES FROM TRANSFERRED EMPLOYEES; PROVIDING COUNSELING, SUPERVISION AND MANAGEMENT OF A REAL ESTATE AGENT'S MARKETING OF THE RELOCATING PERSON'S HOME (U.S. CLS. 100, 101 AND 102).

FIRST USE 3-15-1998; IN COMMERCE 3-15-1998.

CLASS 36—INSURANCE AND FINANCIAL

FOR REAL ESTATE AGENCY SERVICES, REAL ESTATE RELOCATION SERVICES, SPECIFICALLY, ASSISTING PERSONS MOVING FROM ONE COMMUNITY TO ANOTHER TO DISPOSE OF FORMER RESIDENCES AND TO OBTAIN NEW RESIDENCES; PROVIDING COUNSELING AND INFORMATION IN THE PRICING AND SHOWING OF A HOME FOR SALE; HOME APPRAISAL SERVICES; HOME MORTGAGE ASSISTANCE FOR TRANSFEREES, NAMELY, EXPEDITED APPLICATION AND QUALIFICATION PROGRAM FOR TRANSFEREES, AND OPTIONAL BILLINGS THEREFOR TO THE TRANSFEREE'S EMPLOYER (U.S. CLS. 100, 101 AND 102).

FIRST USE 3-15-1998; IN COMMERCE 3-15-1998.

CLASS 42—SCIENTIFIC, COMPUTER AND LEGAL SERVICES

FOR AMENDED VALUE REAL ESTATE CLOSING SERVICES IN THE FIELD OF HOMES OF RELOCATING BUSINESS EMPLOYEES (U.S. CLS. 100 AND 101).

FIRST USE 3-15-1998; IN COMMERCE 3-15-1998.
HOWARD B. LEVINE, EXAMINING ATTORNEY

CLASS 9—ELECTRICAL AND SCIENTIFIC APPARATUS

FOR ENCRYPTION APPARATUS, DEVICES AND EQUIPMENT, NAMELY, COMPUTER SOFTWARE FOR DATA ENCRYPTION; ELECTRONIC DATA ENCRYPTION APPARATUS, COMPUTER SOFTWARE FOR SECURE TRANSMISSION OF DATA OVER THE INTERNET; COMPUTER SOFTWARE FOR PROVIDING SECURE ACCESS CONTROL TO COMPUTER NETWORKS AND WEBSITES; ELECTRONIC SECURITY APPARATUS, NAMELY, COMPUTER SOFTWARE FOR ENSURING THE SECURITY OF ELECTRONIC MAIL; COMPUTER SOFTWARE FOR VERIFYING USER IDENTITY IN ON-LINE TRANSACTIONS; COMPUTER SOFTWARE FOR NETWORK AND DATA SECURITY, NAMELY, SOFTWARE FOR USE IN PREVENTING NETWORK INTRUSION; ELECTRICAL TRANSFORMERS FOR TELECOMMUNICATION APPARATUS (U.S. CLS. 21, 23, 26, 36 AND 38).

CLASS 37—CONSTRUCTION AND REPAIR

FOR MAINTENANCE OF COMPUTERS, COMPUTER HARDWARE AND COMPUTER NETWORKS IN THE FIELDS OF SECURITY, ACCESS, AUTHORIZATION, AUTHENTICATION, ENCRYPTION AND IDENTIFICATION (U.S. CLS. 100, 103 AND 106).

CLASS 38—COMMUNICATION

FOR PROVISION OF SECURE TELECOMMUNICATION SERVICES, NAMELY, ELECTRONIC DATA TRANSMISSION IN THE NATURE OF WEB AND E-COMMERCE TRANSMISSIONS OVER THE PUBLIC INTERNET; PROVISION OF SECURE ELECTRONIC DATA TRANSMISSION SERVICES, SECURE TRANSFER OF INFORMATION AND DATA IN ENCRYPTED FORM BY TELECOMMUNICATION; ELECTRONIC MAIL SERVICES; ADVISORY, INFORMATION AND CONSULTANCY SERVICES RELATING TO ALL OF THE AFORESAID SERVICES (U.S. CLS. 100, 101 AND 104).

SN 78-677,687. PALM TREE TECHNOLOGY, INC., REDDING, CT. FILED 7-25-2005.

ID INSURE

THE MARK CONSISTS OF STANDARD CHARACTERS WITHOUT CLAIM TO ANY PARTICULAR FONT, STYLE, SIZE, OR COLOR.

PRIORITY CLAIMED UNDER SEC. 44(D) ON ERP CMNTY TM OFC APPLICATION NO. 004455952, FILED 6-21-2005, REG. NO. 004455952, DATED 7-25-2006, EXPIRES 6-21-2015.

NO CLAIM IS MADE TO THE EXCLUSIVE RIGHT TO USE "ID", APART FROM THE MARK AS SHOWN.

CLASS 42—SCIENTIFIC, COMPUTER AND LEGAL SERVICES

FOR DATA SECURITY SERVICES AND AUTHENTICATION SERVICES, NAMELY, DATA ENCRYPTION SERVICES, COMPUTER SECURITY SERVICES, NAMELY, RESTRICTING ACCESS TO AND BY COMPUTER NETWORKS TO AND OF UNDESIRED WEBSITES OR SECURE WEBSITE AREAS; DESIGN, IMPLEMENTATION, TESTING, ANALYSIS AND CONSULTING SERVICES IN THE FIELDS OF SECURITY, ACCESS, AUTHORIZATION, AUTHENTICATION, ENCRYPTION AND IDENTIFICATION SYSTEMS FOR COMPUTERS, COMPUTER HARDWARE, COMPUTER SOFTWARE AND COMPUTER NETWORKS; ADVISORY, INFORMATION AND CONSULTANCY SERVICES RELATING TO THE AFORESAID SERVICES; MAINTENANCE OF COMPUTER SOFTWARE IN THE FIELDS OF SECURITY, ACCESS, AUTHORIZATION, AUTHENTICATION, ENCRYPTION AND IDENTIFICATION (U.S. CLS. 100 AND 101).

RENEE MCCRAY, EXAMINING ATTORNEY

SN 78-684,423. MARK OFFICER, BROADBEACH QLD, AUSTRALIA, FILED 8-3-2005.

SN 78-687,494. DANIEL, LESSARD, SAINTE-JULIE, CANADA, FILED 8-8-2005.



PRIORITY CLAIMED UNDER SEC. 44(D) ON AUSTRALIA APPLICATION NO. 1066193, FILED 7-25-2005, REG. NO. 1066193, DATED 7-25-2005, EXPIRES 7-25-2015.

THE MARK CONSISTS OF A RECTANGLE CONTAINING THE WORDING PERFECTSTROKE, WITH A DESIGN ELEMENT UNDERNEATH COMPRISED OF A HORIZONTAL LINE WITH TWO VERTICAL BARS AT THE LEFT AND RIGHT END OF SAME, AND A REPRESENTATION OF A GOLF BALL AND GOLF CLUB FACE IN THE CENTER OF SAID HORIZONTAL LINE.

CLASS 16—PAPER GOODS AND PRINTED MATTER

FOR PAPER, CARDBOARD AND GOODS MADE FROM THESE MATERIALS AND OTHER PRINTED MATTER, NAMELY POSTERS AND BROCHURES FEATURING GOLF INSTRUCTIONAL INFORMATION AND PRINTED VISUALS IN THE NATURE OF PROMOTIONAL MATERIALS; PLASTIC MATERIALS FOR PACKAGING, NAMELY BUBBLE PACKS (U.S. CLS. 2, 5, 22, 23, 29, 37, 38 AND 50).

CLASS 28—TOYS AND SPORTING GOODS

FOR PUTTING AIDS FOR GOLF, NAMELY PUTTING STROKE AND STROKE ALIGNMENT TRAINING AIDS AND TRAINING AIDS FOR DEVELOPING CORRECT PATH, PLANE AND CLUBFACE CONTROL; GOLF EQUIPMENT, NAMELY GOLF CLUBS, GOLF CLUB GRIPS, GOLF BALLS, HAND PROPELLED GOLF BAG CARTS; GOLF PRACTICE DEVICES, NAMELY PUTTING STROKE AND SWING PATH TRAINING AIDS AND GOLF TRAINING AIDS, NAMELY PUTTING STROKE PRACTICE AIDS (U.S. CLS. 22, 23, 38 AND 50).

CLASS 35—ADVERTISING AND BUSINESS

FOR RETAIL STORE SERVICES AND ONLINE RETAIL AND WHOLESALE STORE SERVICES FEATURING PUTTING AIDS FOR GOLF, SPORTING ARTICLES FOR GOLF, GOLF EQUIPMENT, FEATURING INCLUDING GOLF CLUBS, GOLF CLUB GRIPS, GOLF BALLS, HAND PROPELLED GOLF BAG CARTS, GOLF PRACTICE DEVICES AND GOLF TRAINING AIDS; ONLINE ADVERTISING AND PROMOTION SERVICES FOR THE PROMOTION OF GOODS, FEATURING PUTTING AIDS FOR GOLF, SPORTING ARTICLES FOR GOLF, GOLF EQUIPMENT, FEATURING GOLF CLUBS, GOLF CLUB GRIPS, GOLF BALLS, HAND PROPELLED GOLF BAG CARTS, GOLF PRACTICE DEVICES AND GOLF TRAINING AIDS (U.S. CLS. 100, 101 AND 102).

CLASS 41—EDUCATION AND ENTERTAINMENT

FOR EDUCATIONAL, ENTERTAINMENT AND RECREATIONAL SERVICES FEATURING COURSES OF GOLF INSTRUCTION AND GOLF TRAINING LESSONS (U.S. CLS. 100, 101 AND 107).

ODESSA BIBBINS, EXAMINING ATTORNEY

WORLD SERIES OF HOCKEY

THE MARK CONSISTS OF STANDARD CHARACTERS WITHOUT CLAIM TO ANY PARTICULAR FONT, STYLE, SIZE, OR COLOR.

NO CLAIM IS MADE TO THE EXCLUSIVE RIGHT TO USE "HOCKEY", APART FROM THE MARK AS SHOWN.

CLASS 25—CLOTHING

FOR CLOTHING AND ACCESSORIES, NAMELY, BLOUSES, COATS, DRESSES, JACKETS, JEANS, JUMPSUITS, LINGERIE, OVERALLS, PANTS, POLO SHIRTS, RAINCOATS, SHIRTS, SHORTS, SKIRTS, SWEATERS, SWEATPANTS, SWEATSHIRTS, SWIMSUITS, PONCHOS, RAINWEAR, COVERALLS, T-SHIRTS, TOPS, JERSEYS, HOCKEY JERSEYS, PULLOVERS, TROUSERS, VESTS, TANK TOPS, JOGGING SUITS, WARM-UP SUITS, SHORT SETS, DIAPER SETS COMPRISING A TANK TOP AND A TEXTILE DIAPER COVER, DRESS AND PANT SETS, PANT SETS COMPRISING A SHIRT AND A PANT, SWEATER SETS COMPRISING A SWEATER AND A HAT, SUNSUITS, INFANT SLEEPERS, SNOWSUITS, LOUNGEWEAR, UNDERWEAR, HOUSECOATS, BATH ROBES, BATH WRAPS, UNDERSHIRTS, CLOTH BIBS, SLEEPWEAR, PAJAMAS, NIGHTGOWNS, NIGHTSHIRTS, BOXER SHORTS, LAYETTE SETS COMPRISING ROMPERS, CLOTH BIBS AND HATS, SOCKS, HOSIERY, WRISTBANDS, MITTS, GLOVES, SCARVES, BELTS, SUSPENDERS, TIES, MASQUERADE COSTUMES COMPRISED OF BODY SUITS AND FACE MASKS; FOOTWEAR NAMELY ATHLETIC SHOES, SNOW BOOTS, BOOTS, SHOES; HEADGEAR NAMELY HATS, CAPS, VISORS, HEADBANDS (U.S. CLS. 22 AND 39).

CLASS 41—EDUCATION AND ENTERTAINMENT

FOR ENTERTAINMENT IN THE NATURE OF ARRANGING AND CONDUCTING ICE HOCKEY CONTESTS BETWEEN HOCKEY CLUBS OF DIFFERENT CITIES, REGIONS, NATIONS OR ETHNIC ORIGINS, WITH THE GOAL OF HOLDING HOCKEY CHAMPIONSHIPS; PROVIDING ON-LINE MAGAZINES AND NEWSLETTERS IN THE FIELD OF ICE HOCKEY; DEVELOPMENT AND DIFFUSION OF INFORMATIONAL AND EDUCATIONAL MATERIAL, NAMELY, PROVIDING EDUCATIONAL INFORMATION IN THE FIELD OF ICE HOCKEY (U.S. CLS. 100, 101 AND 107).

SOPHIA S. KIM, EXAMINING ATTORNEY

SN 78-703,214. NEW YORK COLLEGE OF HEALTH PROFESSIONS, SYOSSET, NY. FILED 8-30-2005.

SN 78-707,155. TBC WORLDWIDE, INC., SAN MATEO, CA. FILED 9-6-2005.



**New York
COLLEGE**
OF HEALTH PROFESSIONS

NO CLAIM IS MADE TO THE EXCLUSIVE RIGHT TO USE "NEW YORK COLLEGE OF HEALTH PROFESSIONS", "EST 1981" OR THE REPRESENTATION OF THE CADUCEUS SYMBOL, APART FROM THE MARK AS SHOWN.

THE MARK CONSISTS OF SEAL WITH LAUREL LEAVES, A CADUCEUS AND THE YIN-YANG SYMBOL INSIDE IT.

CLASS 9—ELECTRICAL AND SCIENTIFIC APPARATUS

FOR VIDEO TAPES, DVDS AND CD TEACHING MATERIALS ON THE TOPICS OF HEALTH, SELF-IMPROVEMENT AND WELLNESS. (U.S. CLS. 21, 23, 26, 36 AND 38).

CLASS 16—PAPER GOODS AND PRINTED MATTER

FOR PRINTED MATTER, NAMELY, BOOKS, NEWSPAPERS, NEWSLETTERS, BOOKLETS, PRINTED INSTRUCTIONAL AND TEACHING MATERIALS, PRINTED LONG DISTANCE LEARNING MATERIALS, PRINTED TESTS, PRINTED ASSESSMENT FORMS, PRINTED TEACHING AIDS AND WORKBOOKS, ALL OF THE ABOVE ON THE TOPICS OF HEALTH, HEALTH PROFESSIONS, SELF-IMPROVEMENT, MEDICINE, PSYCHOLOGY, EXERCISE AND WELLNESS (U.S. CLS. 2, 5, 22, 23, 29, 37, 38 AND 50).

CLASS 41—EDUCATION AND ENTERTAINMENT

FOR EDUCATION AT THE COLLEGE LEVEL AND THE EXAMINATION AND ISSUING OF DIPLOMAS AND CERTIFICATES IN CONNECTION THEREWITH; PROVIDING ON-LINE EDUCATIONAL PUBLICATIONS, NAMELY, BOOKS, NEWSLETTERS, BOOKLETS, INSTRUCTIONAL AND TEACHING MATERIALS, LONG DISTANCE LEARNING MATERIALS, TESTS, ASSESSMENT FORMS, TEACHING AIDS AND WORKBOOKS IN THE FIELDS OF HEALTH, SELF-IMPROVEMENT, HEALTH PROFESSIONS AND WELLNESS; PROVIDING EDUCATIONAL AND INFORMATIONAL SEMINARS ON THE TOPICS OF HEALTH, SELF-IMPROVEMENT, HEALTH PROFESSIONS AND WELLNESS; PUBLISHING OF BOOKS, REVIEWS AND JOURNALS ON THE TOPICS OF HEALTH, SELF-IMPROVEMENT, HEALTH PROFESSIONS AND WELLNESS; PROVIDING INDIVIDUAL AND GROUP CAREER COUNSELING RELATING TO HEALTH PROFESSIONS; INDIVIDUAL AND GROUP COUNSELING RELATING TO HEALTH PROFESSIONS, SELF-IMPROVEMENT AND WELLNESS; PROVIDING FACILITIES FOR EDUCATIONAL CONVENTIONS; PROVIDING INSTRUCTION IN THE FIELDS OF HEALTH, HEALTH PROFESSIONS, PSYCHOLOGY, EXERCISE, MEDICINE, SELF-IMPROVEMENT AND WELLNESS (U.S. CLS. 100, 101 AND 107).

JAMES GRIFFIN, EXAMINING ATTORNEY

THE BALANCE COMPANY

THE MARK CONSISTS OF STANDARD CHARACTERS WITHOUT CLAIM TO ANY PARTICULAR FONT, STYLE, SIZE, OR COLOR.

NO CLAIM IS MADE TO THE EXCLUSIVE RIGHT TO USE "COMPANY", APART FROM THE MARK AS SHOWN.

CLASS 5—PHARMACEUTICALS

FOR FOOD SUPPLEMENTS; HERBAL SUPPLEMENTS; NUTRITIONAL SUPPLEMENTS; VITAMIN AND MINERAL SUPPLEMENTS; DIETARY SUPPLEMENTS; HERBAL EXTRACTS FOR MEDICINAL PURPOSES; LOZENGES, NAMELY, DIETARY SUPPLEMENT LOZENGES COMPRISED OF JUICES, HERBS AND EXTRACTS; DIETARY SUPPLEMENT DRINKS; NUTRITIONALLY FORTIFIED BEVERAGES; DIETARY SUPPLEMENT DRINKS COMPRISED OF JUICES, HERBS, VITAMINS, MINERALS, FRUIT EXTRACTS, AND OTHER PHYTONUTRIENTS (U.S. CLS. 6, 18, 44, 46, 51 AND 52).

FIRST USE 4-17-2006; IN COMMERCE 4-17-2006.

CLASS 9—ELECTRICAL AND SCIENTIFIC APPARATUS

FOR CD-ROMS FEATURING INFORMATION IN THE FIELDS OF HOLISTIC HEALING, HEALTH, WELLNESS, MIND/BODY HEALTH, NUTRITION, MEDITATION, YOGA, ALTERNATIVE MEDICINE, AND HERBAL REMEDIES; DVD-ROMS FEATURING INFORMATION IN THE FIELDS OF HOLISTIC HEALING, HEALTH, WELLNESS, MIND/BODY HEALTH, NUTRITION, MEDITATION, YOGA, ALTERNATIVE MEDICINE, AND HERBAL REMEDIES (U.S. CLS. 21, 23, 26, 36 AND 38).

FIRST USE 6-30-2006; IN COMMERCE 6-30-2006.

CLASS 41—EDUCATION AND ENTERTAINMENT

FOR PROVIDING ELECTRONIC NEWSLETTERS FEATURING NEWS AND INFORMATION IN THE FIELDS OF HOLISTIC HEALING, HEALTH, WELLNESS, MIND/BODY HEALTH, NUTRITION, MEDITATION, YOGA, ALTERNATIVE MEDICINE, AND HERBAL REMEDIES, VIA E-MAIL (U.S. CLS. 100, 101 AND 107).

FIRST USE 6-29-2006; IN COMMERCE 6-29-2006.

RUDY R. SINGLETON, EXAMINING ATTORNEY

SN 78-707,242. JPMORGAN CHASE & CO., NEW YORK, NY. FILED 9-6-2005.

CHASE 

OWNER OF U.S. REG. NOS. 717,319, 1,521,765 AND OTHERS.

THE MARK CONSISTS OF THE WORD "CHASE" AND A UNIQUE OCTAGON DESIGN.

CLASS 16—PAPER GOODS AND PRINTED MATTER

FOR PRINTED MATTER IN THE NATURE OF PUBLICATIONS, NAMELY, MONTHLY AND PERIODIC NEWSLETTERS IN THE FIELDS OF BANKING AND FINANCIAL SERVICES (U.S. CLS. 2, 5, 22, 23, 29, 37, 38 AND 50).

FIRST USE 3-1-2005; IN COMMERCE 3-1-2005.

CLASS 36—INSURANCE AND FINANCIAL

FOR BANKING AND FINANCIAL SERVICES, NAMELY, RETAIL BANKING SERVICES INCLUDING DEPOSIT ACCOUNTS, HOME MORTGAGE LENDING AND SERVICING, CREDIT CARD SERVICES, AUTO LENDING AND BANKING, EDUCATION FINANCE, NAMELY, STUDENT LOAN SERVICES AND PROVIDING AND SERVICING LOANS FOR THE PURPOSE OF FINANCING EDUCATIONAL EXPENSES, INSURANCE AGENCY SERVICES, INVESTMENT ADVICE, STOCK BROKERAGE SERVICES, AND FINANCIAL BANKING SERVICES TO SMALL BUSINESSES; FINANCIAL BANKING SUPPORT IN THE FORM OF LOANS FOR COMMUNITY DEVELOPMENT; AND ELECTRONIC COMMERCE PAYMENT SERVICES, NAMELY, ESTABLISHING FUNDED ACCOUNTS USED TO PURCHASE GOODS AND SERVICES ON THE INTERNET (U.S. CLS. 100, 101 AND 102).

FIRST USE 3-1-2005; IN COMMERCE 3-1-2005.
NICHOLAS ALTREE, EXAMINING ATTORNEY

CLASS 37—CONSTRUCTION AND REPAIR

FOR CONSTRUCTION OF ENERGY EFFICIENT ENERGY PLANTS AND PLANTS THAT CONVERT ONE FORM OF ENERGY TO ANOTHER (U.S. CLS. 100, 103 AND 106).

CLASS 42—SCIENTIFIC, COMPUTER AND LEGAL SERVICES

FOR ENGINEERING SERVICES FOR THE DESIGN OF ENERGY PLANTS (U.S. CLS. 100 AND 101).

INGRID C. EULIN, EXAMINING ATTORNEY

SN 78-719,446. SIENNA TECHNOLOGIES, INC., WOODINVILLE, WA. FILED 9-23-2005.

SN 78-712,180. AMERESCO CANADA INC., NORTH YORK, ONTARIO, CANADA, FILED 9-13-2005.

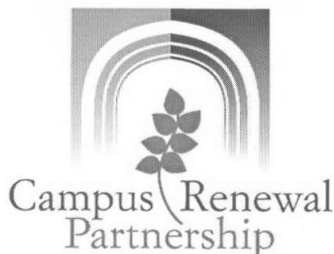

PRIORITY CLAIMED UNDER SEC. 44(D) ON CANADA APPLICATION NO. 1250627, FILED 3-15-2005, REG. NO. TMA659497, DATED 2-21-2006, EXPIRES 2-21-2021.

NO CLAIM IS MADE TO THE EXCLUSIVE RIGHT TO USE "RENEWAL PARTNERSHIP", APART FROM THE MARK AS SHOWN.

CLASS 35—ADVERTISING AND BUSINESS

FOR PROCUREMENT, NAMELY, PROCUREMENT OF ENERGY FOR OTHERS; BUSINESS MANAGEMENT AND OPERATIONAL MANAGEMENT IN THE FIELD OF OPERATING POWER AND ENERGY FACILITIES (U.S. CLS. 100, 101 AND 102).

CLASS 36—INSURANCE AND FINANCIAL

FOR FINANCING SERVICES IN THE FORM OF FINANCING ENERGY PLANTS AND PLANTS THAT CONVERT ONE FORM OF ENERGY TO ANOTHER FORM OF ENERGY; CONSULTING IN THE FIELD OF RISK MANAGEMENT AS IT RELATED TO ENERGY PROCUREMENT, COLLECTING, ANALYZING AND REPORT ENERGY CONSUMPTION OF OTHERS (U.S. CLS. 100, 101 AND 102).



NO CLAIM IS MADE TO THE EXCLUSIVE RIGHT TO USE "TECHNOLOGIES INC.", APART FROM THE MARK AS SHOWN.

CLASS 1—CHEMICALS

FOR CATALYSIS FOR CHEMICAL, BIOCHEMICAL OR OXIDATION PROCESSES, NAMELY, CATALYSTS FOR USE IN NITROUS OXIDE DECOMPOSITION, SULFUR ELIMINATION, REDUCTION OF FOSSIL FUELS IN ENVIRONMENTAL APPLICATIONS, AND HYDRAZINE AND HYDROXYL AMMONIUM NITRATE DECOMPOSITION FOR USE IN SPACE PROPULSION (U.S. CLS. 1, 5, 6, 10, 26 AND 46).

FIRST USE 5-12-2004; IN COMMERCE 5-12-2004.

CLASS 9—ELECTRICAL AND SCIENTIFIC APPARATUS

FOR ALUMINUM NITRIDE AND ALUMINUM NITRIDE LOSSY DIELECTRIC COMPONENTS FOR ELECTRONIC AND MICROWAVE APPLICATIONS, NAMELY, SUBSTRATES OF ELECTRONIC CIRCUIT BOARDS, INSULATORS, HEAT SINKS, AND SUBCOMPONENTS OF MICROWAVE POWER TUBES, NAMELY, LOSS BUTTONS, COLLECTOR RODS, SEVERES, OUTPUT WINDOWS, NAMELY, LENSES, TERMINATIONS, AND WEDGES (U.S. CLS. 21, 23, 26, 36 AND 38).

FIRST USE 5-12-2004; IN COMMERCE 5-12-2004.
ANTHONY RINKER, EXAMINING ATTORNEY

SN 78-722,473. WG WINES CONSULTING INC., COCHRANE, ALBERTA, CANADA, FILED 9-28-2005.

WINE GIRL

THE MARK CONSISTS OF STANDARD CHARACTERS WITHOUT CLAIM TO ANY PARTICULAR FONT, STYLE, SIZE, OR COLOR.

PRIORITY CLAIMED UNDER SEC. 44(D) ON CANADA APPLICATION NO. 12266874, FILED 8-2-2005, REG. NO. TMA690258, DATED 6-19-2007, EXPIRES 6-19-2022.

NO CLAIM IS MADE TO THE EXCLUSIVE RIGHT TO USE "WINE", APART FROM THE MARK AS SHOWN.

CLASS 16—PAPER GOODS AND PRINTED MATTER

FOR PENS; BOOKS IN THE FIELD OF WINE EDUCATION (U.S. CLS. 2, 5, 22, 23, 29, 37, 38 AND 50).

CLASS 41—EDUCATION AND ENTERTAINMENT

FOR WINE EDUCATION SERVICES, NAMELY PROVIDING SEMINARS, WORKSHOPS, AND LECTURES IN THE FIELD OF WINE (U.S. CLS. 100, 101 AND 107).

SUNG IN, EXAMINING ATTORNEY

SN 78-729,318. FUJITSU LIMITED, KAWASAKI-SHI, KANAGAWA, 211-8588, JAPAN, FILED 10-7-2005.

PushToCommunication

THE MARK CONSISTS OF STANDARD CHARACTERS WITHOUT CLAIM TO ANY PARTICULAR FONT, STYLE, SIZE, OR COLOR.

PRIORITY CLAIMED UNDER SEC. 44(D) ON JAPAN APPLICATION NO. 2005-060331, FILED 7-1-2005, REG. NO. 4925715, DATED 2-3-2006, EXPIRES 2-3-2016.

PRIORITY CLAIMED UNDER SEC. 44(D) ON JAPAN APPLICATION NO. 2005-060330, FILED 7-1-2005, REG. NO. 4925714, DATED 2-3-2006, EXPIRES 2-3-2016.

PRIORITY CLAIMED UNDER SEC. 44(D) ON JAPAN APPLICATION NO. 2005-060329, FILED 7-1-2005, REG. NO. 4925713, DATED 2-3-2006, EXPIRES 2-3-2016.

PRIORITY CLAIMED UNDER SEC. 44(D) ON JAPAN APPLICATION NO. 2005-060328, FILED 7-1-2005, REG. NO. 4927356, DATED 2-10-2006, EXPIRES 2-10-2016.

CLASS 9—ELECTRICAL AND SCIENTIFIC APPARATUS

FOR COMPUTERS, COMMUNICATION SERVERS, INTERNET PHONES, PERSONAL DIGITAL ASSISTANTS (PDA), MOBILE PHONES AND MOBILE COMPUTERS AND COMPUTER SOFTWARE WHICH CONNECTS THE CALLER REGARDLESS OF THE LOCATION OF THE RECIPIENT BASED ON AN UBIQUITOUS NETWORKING SYSTEM (U.S. CLS. 21, 23, 26, 36 AND 38).

CLASS 35—ADVERTISING AND BUSINESS

FOR ADVISORY SERVICES FOR BUSINESS MANAGEMENT; DATA PROCESSING SERVICES USING COMPUTERS; OPERATION AND ADMINISTRATION OF TELECOMMUNICATION SYSTEMS AND NETWORKS FOR OTHERS (U.S. CLS. 100, 101 AND 102).

CLASS 38—COMMUNICATION

FOR COMMUNICATIONS BY COMPUTER TERMINALS; COMPUTER AIDED TRANSMISSION OF MESSAGES AND IMAGES; RENTAL OF TELECOMMUNICATION EQUIPMENT; AND PROVIDING TELECOMMUNICATIONS CONNECTIONS TO A GLOBAL COMPUTER NETWORK; TELECOMMUNICATIONS ACCESS SERVICES (U.S. CLS. 100, 101 AND 104).

CLASS 42—SCIENTIFIC, COMPUTER AND LEGAL SERVICES

FOR COMPUTER PROGRAMMING FOR OTHERS; COMPUTER SOFTWARE DESIGN; INSTALLATION AND SETUP OF COMPUTER SOFTWARE; MAINTENANCE AND UPDATING OF COMPUTER SOFTWARE; REMOTE CONTROLLING AND SUPERVISING OF COMPUTER SYSTEMS AND NETWORKS; COMPUTER SYSTEMS ANALYSIS; CONSULTING IN THE FIELD OF COMPUTER HARDWARE AND SOFTWARE; PROVIDING INFORMATION REGARDING DESIGN, DEVELOPMENT AND MAINTENANCE OF COMPUTER SOFTWARE; RENTAL AND LEASING OF COMPUTERS, SERVERS AND COMPUTER SOFTWARE; AND RESEARCH AND DEVELOPMENT FOR OTHERS IN THE FIELD OF COMPUTER HARDWARE AND SOFTWARE, COMMUNICATION SYSTEMS AND SEMICONDUCTOR DEVICES (U.S. CLS. 100 AND 101).

JANICE L. MCMORROW, EXAMINING ATTORNEY

SN 78-731,416. PATRIOT EQUITIES, L.P., WAYNE, PA. FILED 10-12-2005.

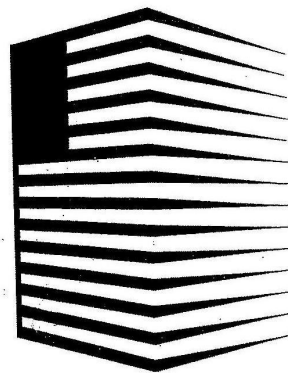

THE MARK CONSISTS OF A STYLIZED VERSION OF THE AMERICAN FLAG IN THE SHAPE OF A BUILDING.

CLASS 35—ADVERTISING AND BUSINESS

FOR BUSINESS SERVICES, NAMELY, FACILITIES MANAGEMENT OF COMMERCIAL REAL ESTATE; REAL ESTATE SALES MANAGEMENT (U.S. CLS. 100, 101 AND 102).

FIRST USE 9-1-2005; IN COMMERCE 9-1-2005.

CLASS 36—INSURANCE AND FINANCIAL

FOR REAL ESTATE SERVICES, NAMELY, ACQUISITION OF COMMERCIAL REAL ESTATE FOR OTHERS AND REAL ESTATE MANAGEMENT (U.S. CLS. 100, 101 AND 102).

FIRST USE 9-1-2005; IN COMMERCE 9-1-2005.

CLASS 37—CONSTRUCTION AND REPAIR

FOR REAL ESTATE DEVELOPMENT (U.S. CLS. 100, 103 AND 106).
FIRST USE 9-1-2005; IN COMMERCE 9-1-2005.
SANDRA MANIOS, EXAMINING ATTORNEY

SN 78-732,327. CANADIAN NATIONAL RAILWAY COMPANY, MONTREAL, QUEBEC, CANADA, FILED 10-13-2005.

CN WORLDWIDE

THE MARK CONSISTS OF STANDARD CHARACTERS WITHOUT CLAIM TO ANY PARTICULAR FONT, STYLE, SIZE, OR COLOR.

PRIORITY CLAIMED UNDER SEC. 44(D) ON CANADA APPLICATION NO. 1,274,877, FILED 10-6-2005, REG. NO. TMA680,241, DATED 1-24-2007, EXPIRES 1-24-2022.

OWNER OF U.S. REG. NOS. 1,939,594, 3,053,777 AND OTHERS.

NO CLAIM IS MADE TO THE EXCLUSIVE RIGHT TO USE "WORLDWIDE", APART FROM THE MARK AS SHOWN.

CLASS 35—ADVERTISING AND BUSINESS

FOR CUSTOMS CLEARANCE SERVICES (U.S. CLS. 100, 101 AND 102).

CLASS 39—TRANSPORTATION AND STORAGE

FOR TRANSPORTATION OF GOODS BY RAIL, ROAD AND BOAT; RAIL AND ROAD TRANSLOADING SERVICES, NAMELY, FREIGHT LOADING FROM AND TO RAIL CARS AND FROM RAIL CARS TO TRACTOR TRAILORS AND VICE VERSA; FREIGHT FORWARDING; WAREHOUSING SERVICES, NAMELY, WAREHOUSE STORAGE, RENTAL OF WAREHOUSE SPACE (U.S. CLS. 100 AND 105).

BRIDGETT SMITH, EXAMINING ATTORNEY

SN 78-735,178. MTT MEDIAWORKS, SANTA MONICA, CA. FILED 10-18-2005.

GOLFCHIX

THE MARK CONSISTS OF STANDARD CHARACTERS WITHOUT CLAIM TO ANY PARTICULAR FONT, STYLE, SIZE, OR COLOR.

CLASS 35—ADVERTISING AND BUSINESS

FOR ON-LINE RETAIL SERVICES FEATURING SPORTING GOODS, CLOTHING AND ACCESSORIES AND MULTIMEDIA PRODUCTS; PUBLIC RELATIONS, NAMELY, SPORTS MARKETING; PROMOTION OF SPORTS COMPETITIONS AND EVENTS OF OTHERS; ARRANGING FOR SPONSORS TO AFFILIATE THEIR GOODS AND SERVICES WITH A WIDE VARIETY OF SPORTING COMPETITIONS AND EVENTS (U.S. CLS. 100, 101 AND 102).

FIRST USE 3-0-2000; IN COMMERCE 3-0-2000.

CLASS 38—COMMUNICATION

FOR BROADCASTING PROGRAMS BY ENCODING, TRANSMITTING AND RECEIVING OF PICTURES, VIDEO, TEXT AND/OR AUDIO OVER LOCAL AND GLOBAL NETWORKS, NAMELY RADIO, WEBCASTING AND TELEVISION BROADCASTING (U.S. CLS. 100, 101 AND 104).

FIRST USE 3-0-2000; IN COMMERCE 3-0-2000.

CLASS 39—TRANSPORTATION AND STORAGE

FOR PROVIDING ON-LINE INFORMATION RELATING TO TRAVEL AND ADVENTURE TOURS VIA A GLOBAL COMPUTER INFORMATION NETWORK (U.S. CLS. 100 AND 105).

FIRST USE 3-0-2000; IN COMMERCE 3-0-2000.

CLASS 41—EDUCATION AND ENTERTAINMENT

FOR PROVIDING ON-LINE INFORMATION RELATING TO SPORTS AND FITNESS, VIA A GLOBAL COMPUTER INFORMATION NETWORK; PRODUCTION OF VIDEO PROGRAMS FOR TRANSMISSION OVER TELEVISION AND GLOBAL COMPUTER NETWORKS; ARRANGING AND CONDUCTING ATHLETIC COMPETITIONS; ORGANIZING ATHLETIC EVENTS AND EXHIBITIONS OF OTHERS (U.S. CLS. 100, 101 AND 107).

FIRST USE 3-0-2000; IN COMMERCE 3-0-2000.

JANICE L. MCMORROW, EXAMINING ATTORNEY

SN 78-738,314. DREAMSPRING PTY LIMITED, BURLEIGH WATERS, AUSTRALIA, FILED 10-21-2005.

DREAMSPRING

THE MARK CONSISTS OF STANDARD CHARACTERS WITHOUT CLAIM TO ANY PARTICULAR FONT, STYLE, SIZE, OR COLOR.

PRIORITY CLAIMED UNDER SEC. 44(D) ON AUSTRALIA APPLICATION NO. 1068619, FILED 8-8-2005, REG. NO. 1068619, DATED 8-8-2005, EXPIRES 8-8-2015.

CLASS 9—ELECTRICAL AND SCIENTIFIC APPARATUS

FOR COMPUTER SOFTWARE, NAMELY CONTACT MANAGEMENT SOFTWARE, ACTIVITY CREATION SOFTWARE, NAMELY PERSONAL INFORMATION MANAGEMENT SOFTWARE AND MESSAGING SOFTWARE FOR MOBILE COMPUTERS AND COMMUNICATORS, NAMELY PERSONAL DIGITAL ASSISTANTS AND SMART PHONES; PRERECORDED COMPACT DISCS, CD-ROMS, DIGITAL VIDEO DISKS, OPTICAL AND MAGNETIC DATA CARRIERS AND MAGNETIC DISKS ALL FEATURING PERSONAL DATABASE MANAGEMENT SOFTWARE AND ELECTRONIC DOCUMENTATION FOR SAID SOFTWARE; DIGITAL MEDIA CARRIERS, NAMELY MEMORY CARDS FEATURING PERSONAL DATABASE MANAGEMENT SOFTWARE AND ELECTRONIC DOCUMENTATION FOR SAID SOFTWARE; PRERECORDED MAGNETIC DATA CARRIERS FEATURING PERSONAL DATABASE MANAGEMENT SOFTWARE AND ELECTRONIC DOCUMENTATION FOR SAID SOFTWARE (U.S. CLS. 21, 23, 26, 36 AND 38).

FIRST USE 12-21-2001; IN COMMERCE 4-16-2002.

CLASS 16—PAPER GOODS AND PRINTED MATTER

FOR PRINTED INSTRUCTIONAL AND TEACHING MATERIAL IN THE FIELD OF COMPUTERS AND COMPUTER SOFTWARE; BOOKS IN THE FIELD OF COMPUTERS, TELECOMMUNICATIONS TECHNOLOGY; COMPUTER HARDWARE AND SOFTWARE MANUALS FOR PERSONAL INFORMATION MANAGEMENT, SOLD WITH SOFTWARE AND DEVICES AS A UNIT (U.S. CLS. 2, 5, 22, 23, 29, 37, 38 AND 50).

FIRST USE 12-21-2001; IN COMMERCE 4-16-2002.

CLASS 42—SCIENTIFIC, COMPUTER AND LEGAL SERVICES

FOR TECHNICAL SUPPORT SERVICES IN THE FIELD OF THE USE AND INSTALLATION OF COMPUTER SOFTWARE, COMPUTER PROGRAMS, COMPUTERS, AND COMPUTER SYSTEMS, NAMELY ASSISTANCE IN INSTALLING, USING, AND CONFIGURING COMPUTER SOFTWARE, TROUBLESHOOTING OF COMPUTER SOFTWARE AND HARDWARE PROBLEMS; COMPUTER PROGRAMMING SERVICES FOR OTHERS (U.S. CLS. 100 AND 101).

FIRST USE 12-21-2001; IN COMMERCE 4-16-2002.
SEAN CROWLEY, EXAMINING ATTORNEY

SN 78-739,763. MASERATI S.P.A., MODENA, ITALY, FILED 10-25-2005.



PRIORITY CLAIMED UNDER SEC. 44(D) ON ERP CMNTY TM OFC APPLICATION NO. 4600854, FILED 8-23-2005, REG. NO. 4600854, DATED 7-5-2006, EXPIRES 8-23-2015.
OWNER OF U.S. REG. NOS. 2,059,563, 2,689,763 AND OTHERS.

NO CLAIM IS MADE TO THE EXCLUSIVE RIGHT TO USE "CLASSICHE", APART FROM THE MARK AS SHOWN.

THE MARK CONSISTS OF AN OVAL CHECKERBOARD SURROUNDING A BLACK OVAL. ACROSS THE OVAL IS A PARALLELOGRAM CONTAINING THE WORD "CLASSICHE" IN STYLIZED LETTERS, AND ABOVE THE PARALLELOGRAM IS THE WORD "MASERATI" WITH A TRIDENT DEVICE.

CLASS 12—VEHICLES

FOR MOTOR CARS, AUTOMOBILES, SPORT CARS AND CONVERTIBLE CARS, AND STRUCTURAL PARTS THEREFOR; ACCESSORIES FOR MOTOR CARS, AUTOMOBILES, SPORTS CARS AND CONVERTIBLE CARS, NAMELY, AIRBAGS, AIRBAG SWITCH-OFF KITS, VEHICLE ROLL BARS, TRACTION CONTROL SYSTEMS, AUTOMOBILE SEAT COVERS, OPENABLE ROOFS, REMOVABLE ROOFS, CONVERTIBLE AUTOMOBILE TOPS, ABS ANTI-BLOCKING BRAKING SYSTEMS, SPOILERS, 4-POINT SAFETY BELTS, SUN VISORS, ASHTRAYS, GLASS HOLDERS, DASHBOARD DRAWERS, DASHBOARD HATCHES, GLOVE COMPARTMENTS, GLOVE BOXES, BAGGAGE COMPARTMENT COVERS, GEAR LEVER COVERINGS; LAND VEHICLE PARTS, NAMELY, ENGINES, TRANSMISSIONS, BRAKES, AND BODIES FOR MOTORCARS; MOTORBIKES AND BICYCLES (U.S. CLS. 19, 21, 23, 31, 35 AND 44).

CLASS 16—PAPER GOODS AND PRINTED MATTER

FOR WRITING INSTRUMENTS, DRAWING INSTRUMENTS, MARKER PENS, PENS, FOUNTAIN PENS, ROLLER BALL PENS, FELT PENS, PENCILS, WRITING INK AND PEN INK REFILLS, PEN INK CARTRIDGES, INK CARTRIDGES FOR BALL POINT PENS AND FELT TIPPED PENS AND FOR BALL POINT FELT PENS, PENCIL LEADS, PENCIL LEAD REFILLS, CASES AND BOXES FOR WRITING INSTRUMENTS, NIBS AND TIPS FOR WRITING INSTRUMENTS, ADHESIVE LABELS, STICKERS, FLAGS MADE FROM PAPERS, CALENDARS; CATALOGUES AND BROCHURES FEATURING HIGH-PERFORMANCE CARS AND AUTOMOBILES, THE HISTORY OF AUTOMOBILE MANUFACTURERS AND CLUB ACTIVITIES; BOOKLETS FEATURING HIGH-PERFORMANCE CARS AND AUTOMOBILES AND THE HISTORY OF AUTOMOBILE MANUFACTURERS AND CLUB ACTIVITIES RELATING TO THE AUTOMOTIVE FIELD AND FEATURING THE CAR DEALER ORGANIZATION; PENHOLDERS NOT IN PRECIOUS METAL, PAPER CUTTERS, DOCUMENT FOLDERS FOR CARDS AND DOCUMENTS, COIN ALBUMS, STAMP ALBUMS; NEWSPAPERS AND PERIODICALS AND BOOKS ON THE SUBJECT OF HIGH PERFORMANCE CARS, AND AUTOMOBILES, CAR RACES, COMPETITIONS AND THE HISTORY OF APPLICANT; PHOTOGRAPHIC PRINTS, POSTERS, TICKET HOLDERS, POSTCARDS, STATIONERY, ERASERS, DRAWING SQUARES, T-SQUARES, DRAFTING SQUARES DRAWING RULERS, DRAFTING RULERS, UNGRADUATED RULERS, CARDBOARD BOXES, AGENDAS, NOTE PAPERS, PHOTO ALBUMS, GREETING CARDS, WRAPPING PAPERS, PENCIL SHARPENERS, SMALL BLACKBOARDS, NOTE PADS, RUBBER STAMPS, INK STAMPS, SEALING STAMPS, MARKING STAMPS, STATIONERY ITEMS FOR SCHOOL, NAMELY SCHOOL WRITING BOOKS (U.S. CLS. 2, 5, 22, 23, 29, 37, 38 AND 50).

CLASS 37—CONSTRUCTION AND REPAIR

FOR INSTALLATION, REPAIR AND MAINTENANCE OF MOTOR CARS, AUTOMOBILES AND SPORTS CARS (U.S. CLS. 100, 103 AND 106).

CLASS 41—EDUCATION AND ENTERTAINMENT

FOR ORGANIZING AUTOMOBILE RACING EXHIBITIONS FOR SPORTING PURPOSES; ENTERTAINMENT IN THE NATURE OF AUTOMOBILES RACES, ORGANIZING WORKSHOPS AND CONGRESSES IN THE FIELD OF AUTOMOBILES, PROVIDING INFORMATION IN THE FIELD OF SPORTS, RECREATION AND AMUSEMENTS, NAMELY AUTOMOBILE RACES AND EXHIBITIONS AND LOCATIONS OF THEME PARKS FEATURING AUTOMOBILE RACES AND EXHIBITIONS, SPORT TRAINING SERVICES IN THE NATURE OF DRIVING AUTOMOBILES AND SPORT AUTOMOBILES, ORGANIZING AND OPERATING CLUBS OF ENTHUSIASTS OF AUTOMOBILES AND RACING TEAMS AND FURNISHING INFORMATION ABOUT AUTOMOBILE RACING AND RACING TEAMS TO CLUB MEMBERS (U.S. CLS. 100, 101 AND 107).

MONIQUE MILLER, EXAMINING ATTORNEY

SN 78-750,026. OMRON CORPORATION, KYOTO-CITY, JAPAN, FILED 11-9-2005.



PRIORITY CLAIMED UNDER SEC. 44(D) ON JAPAN APPLICATION NO. 2005-097870, FILED 10-15-2005, REG. NO. 4979427, DATED 8-18-2006, EXPIRES 8-18-2016.

PRIORITY CLAIMED UNDER SEC. 44(D) ON JAPAN APPLICATION NO. 2006-059529, FILED 10-19-2005, REG. NO. 4993199, DATED 10-6-2006, EXPIRES 10-6-2016.

THE MARK CONSISTS OF A STYLIZED CLOCK WITH A LARGE, PROTRUDING ARROW AS THE MINUTE HAND.

CLASS 9—ELECTRICAL AND SCIENTIFIC APPARATUS

FOR COMPUTER SOFTWARE FOR ANALYZING AND IMPROVING THE PRODUCTION PROCESS IN THE MANUFACTURING INDUSTRIES; COMPUTER HARDWARE USED FOR ANALYZING AND IMPROVING THE PRODUCTION PROCESS IN THE MANUFACTURING INDUSTRIES (U.S. CLS. 21, 23, 26, 36 AND 38).

CLASS 42—SCIENTIFIC, COMPUTER AND LEGAL SERVICES

FOR COMPUTER PROGRAMMING FOR OTHERS; COMPUTER SOFTWARE DESIGN FOR OTHERS; COMPUTER SYSTEMS ANALYSIS; DESIGN AND DEVELOPMENT OF COMPUTERS, COMPUTER SOFTWARE AND COMPUTER HARDWARE SYSTEMS FOR OTHERS; COMPUTER SOFTWARE AND COMPUTER PROGRAM CONSULTATION; DATA CONVERSION OF COMPUTER PROGRAM DATA OR INFORMATION; MECHANICAL RESEARCH; UPDATING OF COMPUTER SOFTWARE FOR OTHERS; QUALITY CONTROL FOR OTHERS (U.S. CLS. 100 AND 101).

RONALD MCMORROW, EXAMINING ATTORNEY

SN 78-751,358. LUCASFILM LTD., SAN FRANCISCO, CA. FILED 11-10-2005.

OWNER OF U.S. REG. NOS. 1,341,020, 2,805,231 AND OTHERS.

CLASS 9—ELECTRICAL AND SCIENTIFIC APPARATUS

FOR PRE-RECORDED AUDIO TAPES, VIDEO TAPES, AUDIO CASSETTES, VIDEO CASSETTES, CD-ROMS, DVDS, COMPACT DISCS, AND VIDEO DISCS, FEATURING ENTERTAINMENT RELATED TO FILMS, GAMES, ANIMATION AND MUSIC; COMPUTER GAME SOFTWARE; COMPUTER GAME SOFTWARE AND MANUALS SOLD AS A UNIT; COMPUTER VIDEO GAME SOFTWARE; COMPUTER VIDEO GAME SOFTWARE AND MANUALS SOLD AS A UNIT; INTERACTIVE VIDEO GAME PROGRAMS; INTERACTIVE COMPUTER GAME PROGRAMS, DOWNLOADABLE COMPUTER GAME SOFTWARE, DOWNLOADABLE INTERACTIVE ENTERTAINMENT SOFTWARE FOR PLAYING COMPUTER GAMES, DOWNLOADABLE INTERACTIVE ENTERTAINMENT SOFTWARE FOR PLAYING VIDEO GAMES; SPORTS HELMETS, HANDHELD JOY STICKS WITH EMBEDDED SOFTWARE FOR PLAYING VIDEO GAMES; INTERACTIVE VIDEO GAME REMOTE CONTROLS (U.S. CLS. 21, 23, 26, 36 AND 38).

CLASS 16—PAPER GOODS AND PRINTED MATTER

FOR CHILDREN'S ACTIVITY BOOKS; ADDRESS BOOKS; NOVELS FOR ADULTS; ART BOOKS; ARTIST'S MATERIALS, NAMELY, PENS AND PENCILS; BANK CHECKS; BOOK COVERS; BOOK MARKS; BOOK PLATES; BOOKS CONTAINING PUZZLES AND GAMES; BOOKS CONTAINING SCREENPLAYS; BOOKS FEATURING PHOTOGRAPHS; BOOKS FOR ROLE-PLAYING; BOOKS ON MOVIE-MAKING; CALENDARS; CARDBOARD FIGURES; CHECKBOOK HOLDERS AND COVERS; CHILDREN'S BOOKS; CHILDREN'S BOOKS COMBINED WITH TOYS AND SOLD AS A UNIT; CHILDREN'S READ-ALONG BOOKS AND PRE-RECORDED TAPES SOLD AS A UNIT; CHILDREN'S STORY BOOKS; COFFEE TABLE BOOKS; COLORING BOOKS; COMIC BOOKS; COMIC MAGAZINES; COOKBOOKS; DIARIES; ERASERS; PAPER GIFT BAGS; GIFT BOOKS; PAPER GIFT TAGS; PAPER GIFT WRAP; GRAPHIC NOVELS; GREETING CARDS; PRINTED INSTRUCTIONAL MANUALS AND STRATEGY GUIDES IN THE FIELD OF COMPUTER GAMES; PRINTED INVITATIONS; IRON-ON TRANSFERS; JUVENILE BOOKS; MAGAZINES IN THE FIELD OF ENTERTAINMENT; MARKERS; NON-ELECTRONIC PERSONAL PLANNERS AND ORGANIZERS; NOTEBOOKS; NOVELS FOR JUVENILES; PAPER CAKE DECORATIONS; PAPER DECORATIONS IN THE NATURE OF DOORKNOB HANGERS; PAPER NAPKINS; PAPER PARTY BAGS; PAPER PARTY DECORATIONS; PAPER PARTY HATS; PAPER TABLE CLOTHS; PENCIL CASES; PENCIL SHARPENERS; PENCILS; PENS; PERSONAL ORGANIZERS; POSTCARDS; POSTERS; PUZZLE BOOKS; READ-ALONG BOOKS; READ-ALONG CHILDREN'S BOOKS; REFERENCE BOOKS IN THE FIELD OF ENTERTAINMENT; REFERENCE BOOKS IN THE FIELD OF ACTION/ADVENTURE MYSTERIES; SCHOOL SUPPLY KITS CONTAINING VARIOUS COMBINATIONS OF SELECTED SCHOOL SUPPLIES, NAMELY, WRITING INSTRUMENTS, PENS, PENCILS, MECHANICAL PENCILS, ERASERS, MARKERS, CRAYONS, HIGHLIGHTERS, FOLDERS, NOTEBOOKS, PAPER, GRADUATED RULERS, PROTRACTORS, PAPER CLIPS, PENCIL SHARPENERS, WRITING GRIPS, GLUE AND BOOK MARKS; SCRAPBOOK ALBUMS; SCRAPBOOKS; SCRIPT BOOKS; SERIES OF FICTION BOOKS; SHEET MUSIC; STATIONERY TYPE PORTFOLIOS; STICKER ALBUMS; STICKER BOOKS; STICKERS; STORY BOOKS; TEMPORARY TATTOOS; TRADING CARDS; BUSINESS CARDS; ART PRINTS; ANIMATION CELLS; COLLECTIBLE CARDS; LITHOGRAPHIC PRINTS; ORIGINAL WORKS OF ART CREATED FROM PAPER; PHOTOGRAPHIC PRINTS; PRINTED ART REPRODUCTIONS; REPLICAS OF PROPS IN THE NATURE OF PAPER CUT OUTS IN THE FORM OF POSTERS FEATURING PRINTED REPLICAS OF CHARACTERS FROM MOVIES (U.S. CLS. 2, 5, 22, 23, 29, 37, 38 AND 50).

CLASS 25—CLOTHING

FOR CLOTHING, NAMELY, T-SHIRTS, SWEAT-SHIRTS, JACKETS, SCARVES, BANDANAS AND HEADWEAR (U.S. CLS. 22 AND 39).

CLASS 28—TOYS AND SPORTING GOODS

FOR ACCESSORIES FOR USE WITH TOY ACTION FIGURES; ACTION TYPE TARGET GAMES; AMUSEMENT PARK RIDES; BALLOONS; BATH TOYS; BOARD GAMES; CARD GAMES; CASES FOR ACTION FIGURES; CASES FOR PLAY ACCESSORIES FOR ACTION FIGURE; MODEL VEHICLES AND MODEL SPACE CRAFT; CHRISTMAS TREE ORNAMENTS; CONNECTING LINKS FOR TOY BUILDING BLOCKS; CONSTRUCTION TOYS; COSTUME MASKS; DOLL COSTUME MASKS; DOLLS; HAND HELD UNITS FOR PLAYING ELECTRONIC GAMES; HI BOUNCE BALLS; INFLATABLE SWIMMING POOLS; IN-LINE SKATES; JIGSAW PUZZLES; PAPER FACE MASKS; PARLOR GAMES; COIN OPERATED AND NON-COIN OPERATED PINBALL MACHINES; PLAY SETS FOR TOY MODEL VEHICLES; TOY MODEL SPACE CRAFT; PLUSH TOYS; PROTECTIVE PADS AND PADDING FOR SKATEBOARDING; ROLE-PLAYING TOYS; ROLLER SKATES; TOY MODEL SPACE CRAFTS AND RELATED ACCESSORIES SOLD AS UNITS; STAND ALONE VIDEO GAME MACHINES; SWIMMING AIDS, NAMELY, SWIM FLOATS FOR RECREATIONAL USE; THREE-DIMENSIONAL PUZZLES; TOY ACTION FIGURES; TOY BUILDING BLOCKS; TOY CANDY DISPENSERS; TOY CANDY HOLDERS; TOY COIN BANKS; TOY MODEL HOBBY CRAFT KITS; TOY MODEL ROCKETS AND ACCESSORIES THEREFORE SOLD AS A UNIT; TOY MODEL VEHICLES AND RELATED ACCESSORIES SOLD AS A UNIT; TOY MODELING DOUGH KITS AND ACCESSORIES FOR USE THEREWITH SOLD AS UNITS; TOY PEDAL CARS; TOY REMOTE CONTROL VEHICLES; TOY SCOOTERS; TOY SNOW GLOBES; TOY VEHICLES; TOY WEAPONS; TOY MODEL VEHICLES AND ACCESSORIES THEREFORE SOLD AS A UNIT; WATER SQUIRTING TOYS; WIND-UP TOYS; YO-YOS; COLLECTIBLE CARD GAMES; COLLECTIBLE MINIATURE BOARD GAMES, AND TOY HELMETS (U.S. CLS. 22, 23, 38 AND 50).

CLASS 41—EDUCATION AND ENTERTAINMENT

FOR ENTERTAINMENT SERVICES IN THE FIELD OF FILM AND TELEVISION, NAMELY, THE CREATION, PRODUCTION AND DISTRIBUTION OF MOTION PICTURE FILMS, ANIMATED MOVIES, VIDEOS, ANIMATED VIDEOS, TELEVISION PROGRAMS AND COMPUTER GENERATED IMAGES FOR MOTION PICTURE FILMS, ANIMATED MOVIES, VIDEOS, ANIMATED VIDEOS, TELEVISION PROGRAMS; ANIMATION PRODUCTION SERVICES; PROVIDING TELEVISION AND MOTION PICTURE AUDIO AND VISUAL SPECIAL EFFECTS ANIMATION SERVICES FOR FILM, VIDEO AND TELEVISION; PROVIDING NEWS IN THE FIELD OF ENTERTAINMENT; ENTERTAINMENT SERVICES, NAMELY, PRE-PRODUCTION, AND POST-PRODUCTION FOR MOTION PICTURES, VIDEOS, ANIMATION AND TELEVISION PROGRAMS; ENTERTAINMENT SERVICES PROVIDED ON-LINE BY MEANS OF GLOBAL AND LOCAL AREA NETWORKS, NAMELY, PROVIDING INFORMATION REGARDING INTERACTIVE COMPUTER GAME SOFTWARE, INTERACTIVE VIDEO GAME SOFTWARE AND INTERACTIVE COMPUTER GAMES AND INTERACTIVE VIDEO GAMES, ALL ON-LINE BY MEANS OF GLOBAL AND LOCAL AREA NETWORKS; PROVIDING NEWS IN THE FIELD OF ENTERTAINMENT RELATING TO INTERACTIVE COMPUTER GAME SOFTWARE AND INTERACTIVE VIDEO GAME SOFTWARE OVER AN ELECTRONIC NETWORK; PROVIDING NEWS PROGRAMMING IN THE FIELD OF ENTERTAINMENT RELATING TO SCIENCE FICTION OVER AN ELECTRONIC NETWORK; FAN CLUB SERVICES; AND PROVIDING INTERACTIVE COMPUTER GAME SOFTWARE OVER AN ELECTRONIC NETWORK THAT MAY BE ACCESSED NETWORK-WIDE BY NETWORK USERS; AND PROVIDING ONLINE COMPUTER GAMES (U.S. CLS. 100, 101 AND 107).

TEJBIR SINGH, EXAMINING ATTORNEY

SN 78-753,594. AIRWAVE WIRELESS, INC., SAN MATEO, CA. FILED 11-14-2005.

FOR WIRELESS THAT WORKS

THE MARK CONSISTS OF STANDARD CHARACTERS WITHOUT CLAIM TO ANY PARTICULAR FONT, STYLE, SIZE, OR COLOR.

CLASS 9—ELECTRICAL AND SCIENTIFIC APPARATUS

FOR DOWNLOADABLE COMPUTER SOFTWARE USED TO MONITOR, ANALYZE, CONFIGURE, OPTIMIZE, TROUBLESHOOT AND MANAGE THE TRANSMISSION AND SECURITY OF COMMUNICATIONS BETWEEN AND WITHIN WIRELESS AND WIRED LOCAL AREA NETWORKS, WIDE AREA NETWORKS, AND OTHER COMPUTER NETWORKS; DOWNLOADABLE COMPUTER SOFTWARE FOR THE GRAPHICAL DEPICTION AND MONITORING OF RADIO FREQUENCY (RF) COVERAGE ON WIRELESS LOCAL AREA NETWORKS, FOR THE OPTIMIZATION OF RF COVERAGE ON WIRELESS LOCAL AREA NETWORKS, AND FOR THE IDENTIFICATION AND LOCATION OF USERS, WIRELESS ACCESS POINTS AND UNAUTHORIZED ROGUE ACCESS POINTS ON WIRELESS LOCAL AREA NETWORKS; DOWNLOADABLE COMPUTER SOFTWARE FOR THE SCANNING OF WIRELESS AND WIRED LOCAL AREA NETWORKS AND WIDE AREA NETWORKS IN ORDER TO IDENTIFY DEVICES ON THOSE NETWORKS AND TO DETECT AND LOCATE UNAUTHORIZED ROGUE WIRELESS ACCESS POINTS; DOWNLOADABLE COMPUTER SOFTWARE FOR THE CREATION, GRAPHICAL DEPICTION AND AUTOMATIC UPDATING OF A WIRELESS NETWORK SITE PLAN AND FOR THE PROVISIONING OF WIRELESS ACCESS POINTS ACROSS THAT SITE PLAN. (U.S. CLS. 21, 23, 26, 36 AND 38).

FIRST USE 10-1-2005; IN COMMERCE 10-1-2005.

CLASS 42—SCIENTIFIC, COMPUTER AND LEGAL SERVICES

FOR DESIGN AND DEVELOPMENT OF COMPUTER SOFTWARE FOR MONITORING, ANALYZING, CONFIGURING, OPTIMIZING, TROUBLESHOOTING AND MANAGING WIRED AND WIRELESS LOCAL AND WIDE AREA NETWORKS; CONFIGURATION AND CUSTOMIZATION OF WIRELESS AND WIDE AREA COMPUTER NETWORKS AND NETWORK DEVICES, NAMELY, DESIGN AND DEVELOPMENT OF COMPUTER NETWORKS AND NETWORK DEVICES, NAMELY, COMPUTER HARDWARE. (U.S. CLS. 100 AND 101).

FIRST USE 10-1-2005; IN COMMERCE 10-1-2005.
SARA THOMAS, EXAMINING ATTORNEY

SN 78-753,638. THE ACCESS FUND, BOULDER, CO. FILED 11-14-2005.



OWNER OF U.S. REG. NO. 1,977,882.
NO CLAIM IS MADE TO THE EXCLUSIVE RIGHT TO USE "FUND" AS TO CLASS 36, APART FROM THE MARK AS SHOWN.

CLASS 9—ELECTRICAL AND SCIENTIFIC APPARATUS

FOR DOWNLOADABLE ELECTRONIC PUBLICATIONS AND INFORMATIONAL MATERIALS FROM THE INTERNET IN THE NATURE OF NAMELY PRESS RELEASES, GUIDES, MANUALS, HANDBOOKS, AND OTHER MATERIALS RELATING TO PUBLIC POLICY, EDUCATION, STEWARDSHIP, CONSERVATION, GRASS ROOTS ACTIVISM, LAND ACQUISITION, AND CLIMBING COMMUNITY SUPPORT (U.S. CLS. 21, 23, 26, 36 AND 38).

FIRST USE 2-1-2002; IN COMMERCE 2-1-2002.

CLASS 16—PAPER GOODS AND PRINTED MATTER

FOR PRINTED MATERIALS, NAMELY EDUCATIONAL BROCHURES, INSTRUCTIONAL AND PRINTED VISUAL PROMOTIONAL MATERIALS, PAPER LABELS, STICKERS, POSTCARDS, AND PAPER TAGS IN THE FIELDS OF CLIMBING, BOULDERING, CONSERVING AND MAINTAINING NATURAL RESOURCES, STEWARDSHIP, AND VOLUNTEERISM (U.S. CLS. 2, 5, 22, 23, 29, 37, 38 AND 50).

FIRST USE 2-1-2002; IN COMMERCE 2-1-2002.

CLASS 36—INSURANCE AND FINANCIAL

FOR PROVIDING GRANTS TO LOCAL CLIMBING ORGANIZATIONS, SPONSORSHIP OF CLIMBING THROUGHOUT THE NATION, AND REAL ESTATE ACQUISITION SERVICES (U.S. CLS. 100, 101 AND 102).

FIRST USE 2-1-2002; IN COMMERCE 2-1-2002.

CLASS 41—EDUCATION AND ENTERTAINMENT

FOR RECREATIONAL SERVICES, NAMELY PROVIDING AND ENCOURAGING THE CONTINUED PROVISION OF OPPORTUNITIES FOR OUTDOOR RECREATION, NAMELY PRESERVING ACCESS TO CLIMBING AREAS AND PROVIDING RECREATIONAL PARK SERVICES; DEVELOPING AND DISSEMINATING EDUCATIONAL MATERIALS REGARDING CLIMBING AND LOW IMPACT USES AND CONSERVATION OF CLIMBING RESOURCES, PUBLIC POLICY ANALYSIS, AND DEVELOPMENT (U.S. CLS. 100, 101 AND 107).

FIRST USE 2-1-2002; IN COMMERCE 2-1-2002.
DOMINIC FATHY, EXAMINING ATTORNEY

SN 78-756,033. TERUMO MEDICAL CORPORATION, SOMERSET, NJ. FILED 11-17-2005.



NO CLAIM IS MADE TO THE EXCLUSIVE RIGHT TO USE "TOTAL SYSTEM", APART FROM THE MARK AS SHOWN.

CLASS 6—METAL GOODS

FOR WELDING MATERIAL, NAMELY, WELDING WAFERS MADE PRIMARILY OF COPPER AND WELDING WAFERS MADE PRIMARILY OF STAINLESS STEEL, ALL USED TO SEAL SECTIONS OF MEDICAL GRADE THERMOPLASTIC TUBING (U.S. CLS. 2, 12, 13, 14, 23, 25 AND 50).

CLASS 9—ELECTRICAL AND SCIENTIFIC APPARATUS

FOR COMPUTER SOFTWARE FOR THE MONITORING, RECORDING, OUTPUTTING, AND MANAGING OF DATA AND INFORMATION; ELECTRONIC DEVICES FOR USE IN THE FIELD OF WELDING FOR MANAGING DATA, NAMELY MONITORING, RECORDING, AND OUTPUTTING DATA ON WELDING EQUIPMENT USED TO CONNECT SECTIONS OF MEDICAL GRADE THERMOPLASTIC TUBING (U.S. CLS. 21, 23, 26, 36 AND 38).

RAY THOMAS, EXAMINING ATTORNEY

SN 78-756,040. TERUMO MEDICAL CORPORATION, SOMERSET, NJ. FILED 11-17-2005.



CLASS 6—METAL GOODS

FOR WELDING MATERIAL, NAMELY WELDING WAFERS MADE PRIMARILY OF COPPER AND STAINLESS STEEL USED TO SEAL SECTIONS OF MEDICAL GRADE THERMOPLASTIC TUBING (U.S. CLS. 2, 12, 13, 14, 23, 25 AND 50).

CLASS 9—ELECTRICAL AND SCIENTIFIC APPARATUS

FOR COMPUTER SOFTWARE FOR THE MONITORING, RECORDING, OUTPUTTING, AND MANAGING OF DATA AND INFORMATION; ELECTRONIC DEVICES FOR USE IN THE FIELD OF WELDING FOR MANAGING DATA, NAMELY MONITORING, RECORDING, AND OUTPUTTING DATA ON WELDING EQUIPMENT USED TO CONNECT SECTIONS OF MEDICAL GRADE THERMOPLASTIC TUBING (U.S. CLS. 21, 23, 26, 36 AND 38).

RAY THOMAS, EXAMINING ATTORNEY

SN 78-759,193. B9 ENERGY LIMITED, LARNE, NORTHERN IRELAND, FILED 11-22-2005.

B9 ENERGY

THE MARK CONSISTS OF STANDARD CHARACTERS WITHOUT CLAIM TO ANY PARTICULAR FONT, STYLE, SIZE, OR COLOR.

NO CLAIM IS MADE TO THE EXCLUSIVE RIGHT TO USE "ENERGY", APART FROM THE MARK AS SHOWN.

CLASS 35—ADVERTISING AND BUSINESS

FOR OPERATION AND MANAGEMENT OF WIND FARMS FOR OTHERS; OPERATION AND MANAGEMENT OF FUEL, POWER AND ENERGY INSTALLATIONS FOR OTHERS (U.S. CLS. 100, 101 AND 102).

CLASS 37—CONSTRUCTION AND REPAIR

FOR REAL ESTATE SERVICES, NAMELY, SITE PLANNING OF WIND FARMS; CONSTRUCTING AND ERECTING WIND FARMS; MAINTENANCE OF WIND FARMS; REAL ESTATE SERVICES, NAMELY, SITE PLANNING OF FUEL, POWER AND ENERGY INSTALLATIONS; MAINTENANCE OF FUEL, POWER AND ENERGY INSTALLATIONS (U.S. CLS. 100, 103 AND 106).
WENDY JUN, EXAMINING ATTORNEY

SN 78-759,964. DELTA ENVIRONMENTAL CONSULTANTS, INC., SHOREVIEW, MN. FILED 11-23-2005.



OWNER OF U.S. REG. NOS. 1,517,468, 1,594,715 AND OTHERS.

CLASS 36—INSURANCE AND FINANCIAL

FOR ENVIRONMENTAL RISK MANAGEMENT CONSULTING, NAMELY, AUDITING OF OCCUPATIONAL HEALTH AND SAFETY PROGRAMS AND OVERSIGHT MANAGEMENT OF HAZARDOUS AND NON-HAZARDOUS WASTES (U.S. CLS. 100, 101 AND 102).

CLASS 40—MATERIAL TREATMENT

FOR ENVIRONMENTAL REMEDIATION CONSULTING SERVICES IN THE FIELD OF SOIL, AIR, WASTE AND WATER TREATMENT (U.S. CLS. 100, 103 AND 106).

CLASS 42—SCIENTIFIC, COMPUTER AND LEGAL SERVICES

FOR ENVIRONMENTAL CONSULTING SERVICES, NAMELY, TECHNICAL CONSULTATION IN THE FIELD OF ENVIRONMENTAL ENGINEERING, OCCUPATIONAL HEALTH AND SAFETY, DEVELOPMENT OF HEALTH AND SAFETY TRAINING PROGRAMS FOR OTHERS, ENVIRONMENTAL EVALUATION AND DUE DILIGENCE REVIEW FOR THE PRESENCE OF HAZARDOUS MATERIAL PRIOR TO PURCHASE AND SALE OF REAL ESTATE; DESIGN OF PETROLEUM HANDLING FACILITIES, AQUIFER RESTORATION SYSTEMS AND MINE DEWATERING SYSTEMS; ENVIRONMENTAL REGULATION COMPLIANCE CONSULTING, NAMELY, REVIEWING STANDARDS AND PRACTICES TO ASSURE COMPLIANCE WITH ENVIRONMENTAL AND OSHA LAWS AND REGULATIONS (U.S. CLS. 100 AND 101).

WILLIAM VERHOSEK, EXAMINING ATTORNEY

SN 78-762,959. GOLDMAN, ROBERT L, BEVERLY HILLS, CA. FILED 11-29-2005.

ELISE

THE MARK CONSISTS OF STANDARD CHARACTERS WITHOUT CLAIM TO ANY PARTICULAR FONT, STYLE, SIZE, OR COLOR.

CLASS 18—LEATHER GOODS

FOR HANDBAGS (U.S. CLS. 1, 2, 3, 22 AND 41).

CLASS 25—CLOTHING

FOR BELTS ; DRESSES; EVENING DRESSES; FOOTWEAR; FOOTWEAR FOR WOMEN; LEATHER BELTS ; PANTS; SHIRTS; SHORTS; SKIRTS; SOCKS; SWEAT PANTS; T-SHIRTS; TOP COATS; TOPS (U.S. CLS. 22 AND 39).

JANICE L. MCMORROW, EXAMINING ATTORNEY

SN 78-763,268. HEALTH MANAGEMENT RESOURCES CORPORATION, BOSTON, MA. FILED 11-30-2005.

HMR

THE MARK CONSISTS OF STANDARD CHARACTERS WITHOUT CLAIM TO ANY PARTICULAR FONT, STYLE, SIZE, OR COLOR.

OWNER OF U.S. REG. NO. 1,436,157.
SEC. 2(F).

CLASS 5—PHARMACEUTICALS

FOR MEAL REPLACEMENT SHAKES (U.S. CLS. 6, 18, 44, 46, 51 AND 52).
FIRST USE 6-0-1983; IN COMMERCE 6-0-1983.

CLASS 16—PAPER GOODS AND PRINTED MATTER

FOR PRINTED MATTER, NAMELY, NEWSLETTERS IN THE FIELDS OF WEIGHT MANAGEMENT, OBESITY MANAGEMENT, WEIGHT REDUCTION, DIET, NUTRITION, HEALTH AND EXERCISE (U.S. CLS. 2, 5, 22, 23, 29, 37, 38 AND 50).

FIRST USE 6-0-1983; IN COMMERCE 6-0-1983.

CLASS 29—MEATS AND PROCESSED FOODS

FOR MEAL REPLACEMENT ENTREES, NAMELY, PACKAGED VEGETABLE, BEEF AND CHICKEN ENTREES (U.S. CL. 46).

FIRST USE 6-0-1983; IN COMMERCE 6-0-1983.

CLASS 41—EDUCATION AND ENTERTAINMENT

FOR EDUCATION SERVICES, NAMELY, MENTORING AND TRAINING IN THE FIELD OF WEIGHT MANAGEMENT, OBESITY MANAGEMENT, DIET, NUTRITION, HEALTH AND EXERCISE (U.S. CLS. 100, 101 AND 107).

FIRST USE 6-0-1983; IN COMMERCE 6-0-1983.

CLASS 44—MEDICAL, BEAUTY AND AGRICULTURAL SERVICES

FOR PROVIDING MEDICAL INFORMATION, CONSULTANCY AND ADVISORY SERVICES, NAMELY, DESIGNING AND IMPLEMENTING OF PROGRAMS AND ADVICE AND PROVIDING INFORMATION FOR OTHERS IN THE FIELD OF WEIGHT MANAGEMENT, OBESITY MANAGEMENT, DIET, HEALTH AND NUTRITION, HEALTH CARE; WEIGHT REDUCTION DIET PLANNING AND SUPERVISION (U.S. CLS. 100 AND 101).

FIRST USE 6-0-1983; IN COMMERCE 6-0-1983.

JILL PRATER, EXAMINING ATTORNEY

SN 78-764,054. 13TH GENERATION MEDIA, INC., BERKELEY, CA. FILED 11-30-2005.

BookFinder.com

THE MARK CONSISTS OF STANDARD CHARACTERS WITHOUT CLAIM TO ANY PARTICULAR FONT, STYLE, SIZE, OR COLOR.

SEC. 2(F).

CLASS 35—ADVERTISING AND BUSINESS

FOR PROMOTING THE GOODS AND SERVICES OF OTHERS BY PROVIDING HYPERTEXT LINKS TO THE WEB SITES OF OTHERS; COMPARISON SHOPPING SERVICES; PROVIDING INFORMATION ABOUT THE GOODS AND SERVICES OF OTHERS VIA THE GLOBAL COMPUTER NETWORK (U.S. CLS. 100, 101 AND 102).

FIRST USE 12-31-1998; IN COMMERCE 12-31-1998.

CLASS 42—SCIENTIFIC, COMPUTER AND LEGAL SERVICES

FOR PROVIDING A SEARCH ENGINE ON THE INTERNET FOR OBTAINING INFORMATION ON CONSUMER PRODUCTS AND MERCHANTS (U.S. CLS. 100 AND 101).

FIRST USE 12-31-1998; IN COMMERCE 12-31-1998.

SEAN CROWLEY, EXAMINING ATTORNEY

SN 78-764,280. ROSS OPERATING VALVE COMPANY, DBA ROSS CONTROLS, TROY, MI. FILED 12-1-2005.

ROSS CONTROLS

THE MARK CONSISTS OF STANDARD CHARACTERS WITHOUT CLAIM TO ANY PARTICULAR FONT, STYLE, SIZE, OR COLOR.

OWNER OF U.S. REG. NO. 2,025,126.

NO CLAIM IS MADE TO THE EXCLUSIVE RIGHT TO USE "CONTROLS", APART FROM THE MARK AS SHOWN.

CLASS 9—ELECTRICAL AND SCIENTIFIC APPARATUS

FOR PNEUMATIC CONTROL SYSTEMS FOR REGULATING THE PRESSURE AND FLOW OF COMPRESSED AIR IN INDUSTRIAL APPLICATIONS COMPRISED OF PNEUMATIC CONTROL VALVES, MANIFOLDS, COUPLINGS, CONDUITS, CYLINDERS, FILTERS, LUBRICATORS, REGULATORS, MUFFLERS AND PRESSURE GAUGES (U.S. CLS. 21, 23, 26, 36 AND 38).

FIRST USE 1-0-1995; IN COMMERCE 1-0-1995.

CLASS 42—SCIENTIFIC, COMPUTER AND LEGAL SERVICES

FOR ENGINEERING SERVICES RELATING TO THE SPECIFYING OF, THE SELECTION OF, THE REPORTING ON, AND THE DESIGN, ENGINEERING, PRODUCTION, AND INSTALLATION SUPERVISION OF THE PNEUMATIC SYSTEMS AND COMPONENTS DESCRIBED ABOVE (U.S. CLS. 100 AND 101).

FIRST USE 1-0-1995; IN COMMERCE 1-0-1995.

TEJBIR SINGH, EXAMINING ATTORNEY

SN 78-764,530. GARAGE TOWN USA, LLC, COEUR D'ALENE, ID. FILED 12-1-2005.



NO CLAIM IS MADE TO THE EXCLUSIVE RIGHT TO USE "USA", APART FROM THE MARK AS SHOWN.

CLASS 25—CLOTHING

FOR CLOTHING, NAMELY SHIRTS AND JACKETS (U.S. CLS. 22 AND 39).

FIRST USE 1-30-2005; IN COMMERCE 1-30-2005.

CLASS 36—INSURANCE AND FINANCIAL

FOR CONDOMINIUM CORPORATION MANAGEMENT AND CONDOMINIUM PROPERTY MANAGEMENT; REAL ESTATE MANAGEMENT SERVICES, NAMELY MANAGEMENT OF CONDOMINIUM STORAGE UNITS; CONDOMINIUM UNITS FOR STORAGE (U.S. CLS. 100, 101 AND 102).

FIRST USE 12-31-2004; IN COMMERCE 12-31-2004.
AISHA CLARKE, EXAMINING ATTORNEY

SN 78-769,014. BRAUN GMBH, KRONBERG IM TAUNUS, FED REP GERMANY, FILED 12-8-2005.

AromaPure

THE MARK CONSISTS OF STANDARD CHARACTERS WITHOUT CLAIM TO ANY PARTICULAR FONT, STYLE, SIZE, OR COLOR.

OWNER OF U.S. REG. NOS. 1,558,918, 1,592,747 AND 2,841,536.

CLASS 11—ENVIRONMENTAL CONTROL APPARATUS

FOR ELECTRIC APPLIANCES FOR PREPARING BREWED BEVERAGES, NAMELY, COFFEE MAKERS, CAPPUCCINO AND ESPRESSO MACHINES; STRUCTURAL PARTS OF THE AFORESAID APPLIANCES; COFFEE FILTERS NOT MADE OF PAPER FOR USE WITH ELECTRIC COFFEE MAKERS (U.S. CLS. 13, 21, 23, 31 AND 34).

CLASS 21—HOUSEWARES AND GLASS

FOR CONTAINERS FOR HOUSEHOLD USE NOT OF PRECIOUS METAL OR CLAD IN METAL, NAMELY, GLASS CARAFES (U.S. CLS. 2, 13, 23, 29, 30, 33, 40 AND 50).

LYDIA BELZER, EXAMINING ATTORNEY

SN 78-769,016. BRAUN GMBH, KRONBERG IM TAUNUS, FED REP GERMANY, FILED 12-8-2005.

PurAroma

THE MARK CONSISTS OF STANDARD CHARACTERS WITHOUT CLAIM TO ANY PARTICULAR FONT, STYLE, SIZE, OR COLOR.

PRIORITY CLAIMED UNDER SEC. 44(D) ON ERPN CMNTY TM OFC APPLICATION NO. 004477709, FILED 6-8-2005.

OWNER OF U.S. REG. NOS. 1,558,918, 1,592,747 AND 2,841,536.

CLASS 11—ENVIRONMENTAL CONTROL APPARATUS

FOR ELECTRIC APPLIANCES FOR PREPARING BREWED BEVERAGES, NAMELY, COFFEE MAKERS, CAPPUCCINO AND ESPRESSO MACHINES; STRUCTURAL PARTS OF THE AFORESAID APPLIANCES; COFFEE FILTERS NOT MADE OF PAPER FOR USE WITH ELECTRIC COFFEE MAKERS (U.S. CLS. 13, 21, 23, 31 AND 34).

CLASS 21—HOUSEWARES AND GLASS

FOR CONTAINERS FOR HOUSEHOLD USE NOT OF PRECIOUS METAL OR CLAD IN METAL, NAMELY, GLASS CARAFES (U.S. CLS. 2, 13, 23, 29, 30, 33, 40 AND 50).

LYDIA BELZER, EXAMINING ATTORNEY

SN 78-771,412. THE JANE GOODALL INSTITUTE FOR WILDLIFE RESEARCH, EDUCATION AND CONSERVATION, ARLINGTON, VA. FILED 12-12-2005.

MR. H

THE MARK CONSISTS OF STANDARD CHARACTERS WITHOUT CLAIM TO ANY PARTICULAR FONT, STYLE, SIZE, OR COLOR.

THE NAME MR. H DOES NOT IDENTIFY A LIVING INDIVIDUAL.

CLASS 16—PAPER GOODS AND PRINTED MATTER

FOR SERIES OF CHILDREN'S BOOKS; NON-FICTION BOOKS IN THE FIELDS OF COMMUNITY SERVICE, CIVIC AFFAIRS, LOCAL CULTURE, INTERCULTURAL HUMAN RELATIONS, NATURE, THE ENVIRONMENT, ANIMALS AND INTERSPECIES COMMUNICATIONS; NEWSPAPERS, NEWSLETTERS AND MAGAZINES IN THE FIELDS OF COMMUNITY SERVICE, CIVIC AFFAIRS, LOCAL CULTURE, INTERCULTURAL HUMAN RELATIONS, NATURE, THE ENVIRONMENT, ANIMALS AND INTERSPECIES COMMUNICATIONS; PRINTED INSTRUCTIONAL AND TEACHING MATERIALS IN THE FIELDS OF COMMUNITY SERVICE, CIVIC AFFAIRS, LOCAL CULTURE, INTERCULTURAL HUMAN RELATIONS, NATURE, THE ENVIRONMENT, ANIMALS AND INTERSPECIES COMMUNICATIONS; EDUCATIONAL BROCHURES IN THE FIELD OF COMMUNITY SERVICE, CIVIC AFFAIRS, LOCAL CULTURE, INTERCULTURAL HUMAN RELATIONS, NATURE, THE ENVIRONMENT, ANIMALS AND INTERSPECIES COMMUNICATIONS; TEACHING GUIDES IN THE FIELDS OF COMMUNITY SERVICE, CIVIC AFFAIRS, LOCAL CULTURE, INTERCULTURAL HUMAN RELATIONS, NATURE, THE ENVIRONMENT, ANIMALS AND INTERSPECIES COMMUNICATIONS; TRAVEL GUIDES; POSTERS; COLORING BOOKS; AND FLIP BOOKS. (U.S. CLS. 2, 5, 22, 23, 29, 37, 38 AND 50).

CLASS 25—CLOTHING

FOR CLOTHING, NAMELY, T-SHIRTS, GOLF SHIRTS, JACKETS, HATS, AND CAPS (U.S. CLS. 22 AND 39).

LINDA POWELL, EXAMINING ATTORNEY

SN 78-773,118. HOULIHAN, LOKEY, HOWARD & ZUKIN, INC., LOS ANGELES, CA. FILED 12-14-2005.

**INSOURCE TRANSACTION
SUPPORT & ADVISORY SERVICES**

THE MARK CONSISTS OF STANDARD CHARACTERS WITHOUT CLAIM TO ANY PARTICULAR FONT, STYLE, SIZE, OR COLOR.

NO CLAIM IS MADE TO THE EXCLUSIVE RIGHT TO USE "TRANSACTION SUPPORT AND ADVISORY SERVICES", APART FROM THE MARK AS SHOWN.

CLASS 35—ADVERTISING AND BUSINESS

FOR TAX ADVISORY SERVICES FEATURING TAX EVALUATION AND ANALYSIS; BUSINESS CONSULTATION SERVICES FEATURING PREPARATION OF BUSINESS PLANS AND STRATEGIES; ACQUISITION AND MERGER CONSULTATION FEATURING ANALYSIS AND STRUCTURING OF POTENTIAL MERGERS AND ACQUISITIONS (U.S. CLS. 100, 101 AND 102).

CLASS 36—INSURANCE AND FINANCIAL

FOR INVESTMENT OF FUNDS FOR OTHERS; ADVISE RELATING TO INVESTMENTS IN THE NATURE OF ANALYSIS OF INVESTMENT RETURNS; FINANCIAL VALUATION OF BUSINESSES; FINANCIAL DUE DILIGENCE FOR MERGERS AND ACQUISITIONS (U.S. CLS. 100, 101 AND 102).

ALLISON HOLTZ, EXAMINING ATTORNEY

SN 78-773,150. AMSOIL INC., SUPERIOR, WI. FILED 12-14-2005.

AMSOIL

THE MARK CONSISTS OF STANDARD CHARACTERS WITHOUT CLAIM TO ANY PARTICULAR FONT, STYLE, SIZE, OR COLOR.

OWNER OF U.S. REG. NO. 1,474,708.

CLASS 1—CHEMICALS

FOR CHEMICAL ADDITIVES FOR LUBRICANTS AND FUELS; ANTI-FREEZE; TRANSMISSION FLUID (U.S. CLS. 1, 5, 6, 10, 26 AND 46).

FIRST USE 5-0-1978; IN COMMERCE 5-0-1978.

CLASS 2—PAINTS

FOR RUST PREVENTATIVES IN THE NATURE OF A COATING; COATINGS IN THE NATURE OF PROTECTANTS FOR VINYL, LEATHER, PLASTIC AND RUBBER (U.S. CLS. 6, 11 AND 16).

FIRST USE 9-0-1978; IN COMMERCE 9-0-1978.

CLASS 3—COSMETICS AND CLEANING PREPARATIONS

FOR ALL PURPOSE CLEANERS; HAND CLEANERS; AUTOMOTIVE CLEANING PREPARATIONS; AUTOMOBILE POLISH; AUTOMOBILE WAX; METAL POLISH (U.S. CLS. 1, 4, 6, 50, 51 AND 52).

FIRST USE 6-0-1976; IN COMMERCE 6-0-1976.

CLASS 4—LUBRICANTS AND FUELS

FOR LUBRICANTS, OILS AND GREASES FOR AUTOMOTIVE, INDUSTRIAL AND COMMERCIAL USE (U.S. CLS. 1, 6 AND 15).

FIRST USE 6-0-1976; IN COMMERCE 6-0-1976.

CLASS 7—MACHINERY

FOR OIL, FUEL AND AIR FILTERS FOR MOTORS AND ENGINES; OIL FILTER ADAPTERS AND MOUNTING BRACKETS, SOLD AS A UNIT; VEHICLE ENGINE PARTS, NAMELY, ENGINE PRE-OILERS WHICH OPERATE AS AN ENGINE OIL RESERVOIR TO LUBRICATE ENGINE SURFACES PRIOR TO IGNITION (U.S. CLS. 13, 19, 21, 23, 31, 34 AND 35).

FIRST USE 12-0-1976; IN COMMERCE 12-0-1976.

MARY CRAWFORD, EXAMINING ATTORNEY

SN 78-773,541. SCIENTIFIC GAMES HOLDINGS LIMITED, BALLSBRIDGE, DUBLIN, IRELAND, FILED 12-14-2005.

ROLL-A-BET

THE MARK CONSISTS OF STANDARD CHARACTERS WITHOUT CLAIM TO ANY PARTICULAR FONT, STYLE, SIZE, OR COLOR.

PRIORITY CLAIMED UNDER SEC. 44(D) ON ERPNTY TM OFC APPLICATION NO. 4493896, FILED 6-15-2005, REG. NO. 4493896, DATED 4-12-2007, EXPIRES 6-15-2015.

CLASS 9—ELECTRICAL AND SCIENTIFIC APPARATUS

FOR COMPUTER HARDWARE AND SOFTWARE FOR USE IN CONNECTION WITH ONLINE GAMING (U.S. CLS. 21, 23, 26, 36 AND 38).

CLASS 41—EDUCATION AND ENTERTAINMENT

FOR OPERATION OF BETTING OFFICES, AMUSEMENT ARCADES AND CASINOS AND OF BETTING OUTLETS, GAMES OF CHANCE, ONLINE GAMING (U.S. CLS. 100, 101 AND 107).

DOMINICK J. SALEMI, EXAMINING ATTORNEY

SN 78-774,088. PAUL DAVIES LONDON LIMITED, LONDON, ENGLAND, FILED 12-15-2005.

pd
l o n d o n

CLASS 43—HOTEL AND RESTAURANT SERVICES

FOR RESTAURANT SERVICES (U.S. CLS. 100 AND 101).
FIRST USE 1-30-1978; IN COMMERCE 1-30-1978.
LEE-ANNE BERNS, EXAMINING ATTORNEY

SN 78-776,693. TOPLINGO, INC., IRVINE, CA. FILED 12-19-2005.

DOTCOMGOOD

PRIORITY CLAIMED UNDER SEC. 44(D) ON UNITED KINGDOM APPLICATION NO. 2394990, FILED 6-23-2005, REG. NO. 2394990, DATED 6-23-2005, EXPIRES 6-23-2015.

NO CLAIM IS MADE TO THE EXCLUSIVE RIGHT TO USE "LONDON", APART FROM THE MARK AS SHOWN.

CLASS 37—CONSTRUCTION AND REPAIR

FOR INSTALLATION OF HOUSEHOLD ELECTRICAL GOODS; INSTALLATION OF HOME FURNISHINGS; CONSTRUCTION PLANNING, PLANNING AND LAYING OUT RESIDENTIAL AND COMMERCIAL PROPERTIES (U.S. CLS. 100, 103 AND 106).

CLASS 42—SCIENTIFIC, COMPUTER AND LEGAL SERVICES

FOR DESIGN SERVICES IN THE FIELDS OF GRAPHIC ARTS, CONSTRUCTION OF BUILDINGS, INTERIORS OF BUILDINGS, EXTERIOR OF BUILDINGS, OUT DOOR RECREATION AREAS, SCULPTURAL, DECORATIVE AND FUNCTIONAL ARRANGEMENTS OF OUTDOOR AREAS, ADVISORY INFORMATION AND CONSULTANCY SERVICES RELATING TO ALL THE AFORESAID SERVICES; ARCHITECTURAL DESIGN SERVICES; LAND AND BUILDING SURVEYING (U.S. CLS. 100 AND 101).

DAVID TAYLOR, EXAMINING ATTORNEY

THE MARK CONSISTS OF STANDARD CHARACTERS WITHOUT CLAIM TO ANY PARTICULAR FONT, STYLE, SIZE, OR COLOR.

CLASS 35—ADVERTISING AND BUSINESS

FOR BUSINESS CONSULTATION SERVICES RELATING TO CONCEIVING, PLANNING AND EXECUTING WEBSITE DEVELOPMENT, WEB APPLICATION DEVELOPMENT, INTERNET MARKETING AND E-COMMERCE (U.S. CLS. 100, 101 AND 102).

FIRST USE 5-31-2005; IN COMMERCE 5-31-2005.

CLASS 42—SCIENTIFIC, COMPUTER AND LEGAL SERVICES

FOR DESIGNING, DEVELOPING, AND MAINTAINING COMPUTER SOFTWARE PROGRAMS IN THE FIELD OF INFORMATION MANAGEMENT; AND DESIGNING COMPUTER SOFTWARE FOR OTHERS TO ENABLE THE OPERATION, MAINTAINING AND MANAGING OF WEB SITES (U.S. CLS. 100 AND 101).

FIRST USE 5-31-2005; IN COMMERCE 5-31-2005.
REBECCA EISINGER, EXAMINING ATTORNEY

SN 78-776,193. LA BONNE BOUCHEE DE SAINT LOUIS, INC., SAINT LOUIS, MO. FILED 12-19-2005.

LA BONNE BOUCHÉE

THE MARK CONSISTS OF STANDARD CHARACTERS WITHOUT CLAIM TO ANY PARTICULAR FONT, STYLE, SIZE, OR COLOR.

THE ENGLISH TRANSLATION FOR "LA BONNE BOUCHEE" IS "THE GOOD MOUTHFUL".

CLASS 35—ADVERTISING AND BUSINESS

FOR RETAIL BAKERY SERVICES (U.S. CLS. 100, 101 AND 102).

FIRST USE 1-30-1978; IN COMMERCE 1-30-1978.

SN 78-777,404. NEW RIVER PHARMACEUTICALS INC., RADFORD, VA. FILED 12-20-2005.

CARRIERWAVE

THE MARK CONSISTS OF STANDARD CHARACTERS WITHOUT CLAIM TO ANY PARTICULAR FONT, STYLE, SIZE, OR COLOR.

CLASS 5—PHARMACEUTICALS

FOR ADJUVANTS FOR USE WITH A FULL LINE OF PHARMACEUTICALS AND NUTRACEUTICALS FOR THE TREATMENT OF A WIDE VARIETY OF CONDITIONS AND ILLNESSES; A FULL LINE OF PHARMACEUTICALS AND NUTRACEUTICALS HAVING AN ATTACHED ADJUVANT FOR THE TREATMENT OF VARIOUS NEUROLOGICAL CONDITIONS, INCLUDING DISORDERS OF THE CENTRAL NERVOUS SYSTEM, DISORDERS OF THE ENDOCRINE SYSTEM, AND FOR THE TREATMENT OF PAIN; A FULL LINE OF PHARMACEUTICALS AND NUTRACEUTICALS FORMULATED WITH OR ATTACHED TO AN ADJUVANT FOR THE TREATMENT OF VARIOUS NEUROLOGICAL CONDITIONS, INCLUDING DISORDERS OF THE CENTRAL NERVOUS SYSTEM, DISORDERS OF THE ENDOCRINE SYSTEM, AND FOR THE TREATMENT OF PAIN (U.S. CLS. 6, 18, 44, 46, 51 AND 52).

SN 78-777,698. GENCOM TECHNOLOGY LIMITED, NORTH HARBOUR, AUCKLAND, NEW ZEALAND, FILED 12-20-2005.

GENCOM TECHNOLOGY**CLASS 35—ADVERTISING AND BUSINESS**

FOR LICENSING OF TECHNOLOGY USED IN THE DEVELOPMENT AND MANUFACTURE OF PHARMACEUTICALS (U.S. CLS. 100, 101 AND 102).
COLLEEN KEARNEY, EXAMINING ATTORNEY

THE MARK CONSISTS OF STANDARD CHARACTERS WITHOUT CLAIM TO ANY PARTICULAR FONT, STYLE, SIZE, OR COLOR.

NO CLAIM IS MADE TO THE EXCLUSIVE RIGHT TO USE "TECHNOLOGY", APART FROM THE MARK AS SHOWN.

SN 78-777,617. SIVERS, DEREK, PORTLAND, OR. FILED 12-20-2005.

CD BABY

THE MARK CONSISTS OF STANDARD CHARACTERS WITHOUT CLAIM TO ANY PARTICULAR FONT, STYLE, SIZE, OR COLOR.

OWNER OF U.S. REG. NO. 2,325,487.
NO CLAIM IS MADE TO THE EXCLUSIVE RIGHT TO USE "CD", APART FROM THE MARK AS SHOWN.

CLASS 35—ADVERTISING AND BUSINESS

FOR ONLINE RETAIL STORE SERVICES FEATURING DOWNLOADABLE PRERECORDED MUSIC AND VIDEO ITEMS, AND AUDIOVISUAL ITEMS SUCH AS DVDS, COMPACT DISCS, CASSETTES, POSTERS AND T-SHIRTS; WHOLESALE DISTRIBUTORSHIP FEATURING DOWNLOADABLE DIGITAL MUSIC AND VIDEO RECORDINGS TO RETAILERS OF DIGITAL MUSIC AND VIDEO (U.S. CLS. 100, 101 AND 102).

CLASS 42—SCIENTIFIC, COMPUTER AND LEGAL SERVICES

FOR DIGITAL FORMATTING OF MUSIC AND IMAGES, NAMELY, PROCESSING OF DIGITAL MUSIC AND VIDEO IMAGES INTO DOWNLOADABLE PRODUCTS (U.S. CLS. 100 AND 101).
CAROL SPILS, EXAMINING ATTORNEY

CLASS 35—ADVERTISING AND BUSINESS

FOR PROCUREMENT, NAMELY PURCHASING FOR OTHERS OF TELECOMMUNICATIONS EQUIPMENT AND SYSTEMS, BROADCAST AND MULTIMEDIA EQUIPMENT AND SYSTEMS, AND EQUIPMENT FOR TESTING AND MEASURING BROADCAST EQUIPMENT, FOR USE IN ELECTRONIC NEWS GATHERING, MOBILE AND FIXED TELEVISION BROADCASTING, RADIO BROADCASTING, VIDEO BROADCASTING OVER TELEVISION NETWORKS, AND MULTIMEDIA PRESENTATION CENTERS; SUPPLY, NAMELY, DISTRIBUTORSHIP SERVICES FEATURING TELECOMMUNICATIONS EQUIPMENT AND SYSTEMS, BROADCAST AND MULTIMEDIA EQUIPMENT AND SYSTEMS, AND EQUIPMENT FOR TESTING AND MEASURING BROADCAST EQUIPMENT, FOR USE IN ELECTRONIC NEWS GATHERING, MOBILE AND FIXED TELEVISION BROADCASTING, RADIO BROADCASTING, VIDEO BROADCASTING OVER TELEVISION NETWORKS, AND MULTIMEDIA PRESENTATION CENTERS; PROVISION, NAMELY PURCHASING FOR OTHERS OF, TELEVISION TRANSMISSION SYSTEMS; DISTRIBUTORSHIP SERVICES FEATURING TELEVISION TRANSMISSION SYSTEMS; LEASE AND RENTAL OF ELECTRONIC ADVERTISEMENT DISPLAY UNITS WITH MULTI-NETWORKING CAPABILITIES AND REMOTE CONNECTIVITY (U.S. CLS. 100, 101 AND 102).

CLASS 37—CONSTRUCTION AND REPAIR

FOR BUILDING, WIRING, INSTALLING, MAINTAINING, AND REPAIR OF BROADCASTING FACILITIES, NAMELY, PERMANENT AND TEMPORARY TELEVISION STUDIOS, TELEVISION STATIONS, HEADENDS FOR CABLE AND SATELLITE, DIGITAL OUTSIDE BROADCAST VEHICLES, THEATERS, MULTIMEDIA PRESENTATION CENTERS, CORPORATE BOARDROOMS, SATELLITE UPLINKS, AND DIGITAL SATELLITE NEWS GATHERING VANS; CUSTOM FITTING SERVICES, NAMELY, CONSTRUCTION OF BUILT-IN FURNITURE AND CONSOLES FOR BROADCASTING FACILITIES, NAMELY, PERMANENT AND TEMPORARY TELEVISION STUDIOS, TELEVISION STATIONS, HEADENDS FOR CABLE AND SATELLITE, DIGITAL OUTSIDE BROADCAST VEHICLES, THEATERS, MULTIMEDIA PRESENTATION CENTERS, CORPORATE BOARDROOMS, SATELLITE UPLINKS, AND DIGITAL SATELLITE NEWS GATHERING VANS; INSTALLATION OF TELEVISION TRANSMISSION SYSTEMS FOR OTHERS; SYSTEM INTEGRATION, NAMELY, WIRING AND INSTALLATION OF BROADCASTING, AUDIOVISUAL, AND TELECOMMUNICATIONS HARDWARE TO FUNCTION AS A COORDINATED SYSTEM, FOR USE IN BROADCASTING FACILITIES (U.S. CLS. 100, 103 AND 106).

CLASS 38—COMMUNICATION

FOR LEASE AND RENTAL OF TELECOMMUNICATIONS EQUIPMENT AND SYSTEMS, AND BROADCAST EQUIPMENT AND SYSTEMS, FOR USE IN ELECTRONIC NEWS GATHERING, MOBILE AND FIXED TELEVISION BROADCASTING, RADIO BROADCASTING, VIDEO BROADCASTING OVER TELEVISION NETWORKS, AND MULTIMEDIA PRESENTATION CENTERS (U.S. CLS. 100, 101 AND 104).

CLASS 41—EDUCATION AND ENTERTAINMENT

FOR PROVISION OF TRAINING FOR OTHERS IN THE USE OF BROADCASTING AND MULTIMEDIA EQUIPMENT; LEASE AND RENTAL OF MULTIMEDIA EQUIPMENT AND SYSTEMS, NAMELY, VIDEO MONITORS, HEAD-MOUNTED VIDEO DISPLAYS, LCD AND PLASMA LARGE-SCREEN DISPLAYS, PROJECTION SCREENS, REAR PROJECTORS, PROFESSIONAL VIDEO TAPE RECORDERS, PROFESSIONAL DIGITAL DISC RECORDERS, PROFESSIONAL FILM AND VIDEO CAMERAS, FOR USE IN ELECTRONIC NEWS GATHERING, MOBILE AND FIXED TELEVISION BROADCASTING, RADIO BROADCASTING, VIDEO BROADCASTING OVER TELEVISION NETWORKS, AND MULTIMEDIA PRESENTATION CENTERS (U.S. CLS. 100, 101 AND 107).

CLASS 42—SCIENTIFIC, COMPUTER AND LEGAL SERVICES

FOR ENGINEERING, DESIGN, DRAWING SERVICES CONSISTING OF DRAFTING, AND DOCUMENTATION SERVICES FOR OTHERS IN THE FIELD OF BROADCASTING FACILITIES, NAMELY, PERMANENT AND TEMPORARY TELEVISION STUDIOS, TELEVISION STATIONS, HEADENDS FOR CABLE AND SATELLITE, DIGITAL OUTSIDE BROADCAST VEHICLES, THEATERS, MULTIMEDIA PRESENTATION CENTERS, CORPORATE BOARDROOMS, SATELLITE UPLINKS, AND DIGITAL SATELLITE NEWS GATHERING VANS; TECHNOLOGY CONSULTATION FOR OTHERS IN THE FIELD OF BROADCASTING FACILITIES, NAMELY, PERMANENT AND TEMPORARY TELEVISION STUDIOS, TELEVISION STATIONS, HEADENDS FOR CABLE AND SATELLITE, DIGITAL OUTSIDE BROADCAST VEHICLES, THEATERS, MULTIMEDIA PRESENTATION CENTERS, CORPORATE BOARDROOMS, SATELLITE UPLINKS, AND DIGITAL SATELLITE NEWS GATHERING VANS; LEASE AND RENTAL OF EQUIPMENT FOR TESTING AND MEASURING BROADCAST EQUIPMENT, FOR USE IN ELECTRONIC NEWS GATHERING, MOBILE AND FIXED TELEVISION BROADCASTING, RADIO BROADCASTING, VIDEO BROADCASTING OVER TELEVISION NETWORKS, AND MULTIMEDIA PRESENTATION CENTERS (U.S. CLS. 100 AND 101).

RUDY R. SINGLETON, EXAMINING ATTORNEY

SN 78-777,707. GENCOM TECHNOLOGY LIMITED, NORTH HARBOUR, AUCKLAND, NEW ZEALAND, FILED 12-20-2005.

GENCOM

THE MARK CONSISTS OF STANDARD CHARACTERS WITHOUT CLAIM TO ANY PARTICULAR FONT, STYLE, SIZE, OR COLOR.

CLASS 35—ADVERTISING AND BUSINESS

FOR PROCUREMENT, NAMELY PURCHASING FOR OTHERS OF TELECOMMUNICATIONS EQUIPMENT AND SYSTEMS, BROADCAST AND MULTIMEDIA EQUIPMENT AND SYSTEMS, AND EQUIPMENT FOR TESTING AND MEASURING BROADCAST EQUIPMENT, FOR USE IN ELECTRONIC NEWS GATHERING, MOBILE AND FIXED TELEVISION BROADCASTING, RADIO BROADCASTING, VIDEO BROADCASTING OVER TELEVISION NETWORKS, AND MULTIMEDIA PRESENTATION CENTERS; SUPPLY, NAMELY, DISTRIBUTORSHIP SERVICES FEATURING TELECOMMUNICATIONS EQUIPMENT AND SYSTEMS, BROADCAST AND MULTIMEDIA EQUIPMENT AND SYSTEMS, AND EQUIPMENT FOR TESTING AND MEASURING BROADCAST EQUIPMENT, FOR USE IN ELECTRONIC NEWS GATHERING, MOBILE AND FIXED TELEVISION BROADCASTING, RADIO BROADCASTING, VIDEO BROADCASTING OVER TELEVISION NETWORKS, AND MULTIMEDIA PRESENTATION CENTERS; PROVISION, NAMELY PURCHASING FOR OTHERS OF, TELEVISION TRANSMISSION SYSTEMS; DISTRIBUTORSHIP SERVICES FEATURING TELEVISION TRANSMISSION SYSTEMS; LEASE AND RENTAL OF ELECTRONIC ADVERTISEMENT DISPLAY UNITS WITH MULTI-NETWORKING CAPABILITIES AND REMOTE CONNECTIVITY (U.S. CLS. 100, 101 AND 102).

CLASS 37—CONSTRUCTION AND REPAIR

FOR BUILDING, WIRING, INSTALLING, MAINTAINING, AND REPAIR OF BROADCASTING FACILITIES, NAMELY, PERMANENT AND TEMPORARY TELEVISION STUDIOS, TELEVISION STATIONS, HEADENDS FOR CABLE AND SATELLITE, DIGITAL OUTSIDE BROADCAST VEHICLES, THEATERS, MULTIMEDIA PRESENTATION CENTERS, CORPORATE BOARDROOMS, SATELLITE UPLINKS, AND DIGITAL SATELLITE NEWS GATHERING VANS; CUSTOM FITTING SERVICES, NAMELY, CONSTRUCTION OF BUILT-IN FURNITURE AND CONSOLES FOR BROADCASTING FACILITIES, NAMELY, PERMANENT AND TEMPORARY TELEVISION STUDIOS, TELEVISION STATIONS, HEADENDS FOR CABLE AND SATELLITE, DIGITAL OUTSIDE BROADCAST VEHICLES, THEATERS, MULTIMEDIA PRESENTATION CENTERS, CORPORATE BOARDROOMS, SATELLITE UPLINKS, AND DIGITAL SATELLITE NEWS GATHERING VANS; INSTALLATION OF TELEVISION TRANSMISSION SYSTEMS FOR OTHERS; SYSTEM INTEGRATION, NAMELY, WIRING AND INSTALLATION OF BROADCASTING, AUDIOVISUAL, AND TELECOMMUNICATIONS HARDWARE TO FUNCTION AS A COORDINATED SYSTEM, FOR USE IN BROADCASTING FACILITIES (U.S. CLS. 100, 103 AND 106).

CLASS 38—COMMUNICATION

FOR LEASE AND RENTAL OF TELECOMMUNICATIONS EQUIPMENT AND SYSTEMS, AND BROADCAST EQUIPMENT AND SYSTEMS, FOR USE IN ELECTRONIC NEWS GATHERING, MOBILE AND FIXED TELEVISION BROADCASTING, RADIO BROADCASTING, VIDEO BROADCASTING OVER TELEVISION NETWORKS, AND MULTIMEDIA PRESENTATION CENTERS (U.S. CLS. 100, 101 AND 104).

CLASS 41—EDUCATION AND ENTERTAINMENT

FOR PROVISION OF TRAINING FOR OTHERS IN THE USE OF BROADCASTING AND MULTIMEDIA EQUIPMENT; LEASE AND RENTAL OF MULTIMEDIA EQUIPMENT AND SYSTEMS, NAMELY, VIDEO MONITORS, HEAD-MOUNTED VIDEO DISPLAYS, LCD AND PLASMA LARGE-SCREEN DISPLAYS, PROJECTION SCREENS, REAR PROJECTORS, PROFESSIONAL VIDEO TAPE RECORDERS, PROFESSIONAL DIGITAL DISC RECORDERS, PROFESSIONAL FILM AND VIDEO CAMERAS, FOR USE IN ELECTRONIC NEWS GATHERING, MOBILE AND FIXED TELEVISION BROADCASTING, RADIO BROADCASTING, VIDEO BROADCASTING OVER TELEVISION NETWORKS, AND MULTIMEDIA PRESENTATION CENTERS (U.S. CLS. 100, 101 AND 107).

CLASS 42—SCIENTIFIC, COMPUTER AND LEGAL SERVICES

FOR ENGINEERING, DESIGN, DRAWING SERVICES CONSISTING OF DRAFTING, AND DOCUMENTATION SERVICES FOR OTHERS IN THE FIELD OF BROADCASTING FACILITIES, NAMELY, PERMANENT AND TEMPORARY TELEVISION STUDIOS, TELEVISION STATIONS, HEADENDS FOR CABLE AND SATELLITE, DIGITAL OUTSIDE BROADCAST VEHICLES, THEATERS, MULTIMEDIA PRESENTATION CENTERS, CORPORATE BOARDROOMS, SATELLITE UPLINKS, AND DIGITAL SATELLITE NEWS GATHERING VANS; TECHNOLOGY CONSULTATION FOR OTHERS IN THE FIELD OF BROADCASTING FACILITIES, NAMELY, PERMANENT AND TEMPORARY TELEVISION STUDIOS, TELEVISION STATIONS, HEADENDS FOR CABLE AND SATELLITE, DIGITAL OUTSIDE BROADCAST VEHICLES, THEATERS, MULTIMEDIA PRESENTATION CENTERS, CORPORATE BOARDROOMS, SATELLITE UPLINKS, AND DIGITAL SATELLITE NEWS GATHERING VANS; LEASE AND RENTAL OF EQUIPMENT FOR TESTING AND MEASURING BROADCAST EQUIPMENT, FOR USE IN ELECTRONIC NEWS GATHERING, MOBILE AND FIXED TELEVISION BROADCASTING, RADIO BROADCASTING, VIDEO BROADCASTING OVER TELEVISION NETWORKS, AND MULTIMEDIA PRESENTATION CENTERS (U.S. CLS. 100 AND 101).

RUDY R. SINGLETON, EXAMINING ATTORNEY

SN 78-779,108. MDY ADVANCED TECHNOLOGIES, INC., FAIR LAWN, NJ. FILED 12-22-2005.

MANAGE. FIND. COMPLY.

THE MARK CONSISTS OF STANDARD CHARACTERS WITHOUT CLAIM TO ANY PARTICULAR FONT, STYLE, SIZE, OR COLOR.

CLASS 9—ELECTRICAL AND SCIENTIFIC APPARATUS

FOR (BASED ON INTENT TO USE) ELECTRONIC RECORDS MANAGEMENT SOFTWARE; COMPUTER SOFTWARE THAT ENABLES USERS TO TRACK, SEARCH AND REQUEST ALL FORMS OF ELECTRONIC AND NON-ELECTRONIC FILES (U.S. CLS. 21, 23, 26, 36 AND 38).

CLASS 35—ADVERTISING AND BUSINESS

FOR (BASED ON USE IN COMMERCE) RECORDS MANAGEMENT SERVICES, NAMELY, CONSULTING SERVICES WITH RESPECT TO IMPLEMENTATION OF BEST PRACTICES IN RECORDS MANAGEMENT (U.S. CLS. 100, 101 AND 102).

FIRST USE 8-11-2005; IN COMMERCE 8-11-2005.
PETER CHENG, EXAMINING ATTORNEY

SN 78-779,593. THE GOVERNING COUNCIL OF THE UNIVERSITY OF TORONTO, TORONTO, ONTARIO, CANADA, FILED 12-22-2005.

DESIGNWORKS

THE MARK CONSISTS OF STANDARD CHARACTERS WITHOUT CLAIM TO ANY PARTICULAR FONT, STYLE, SIZE, OR COLOR.

CLASS 16—PAPER GOODS AND PRINTED MATTER

FOR PRINTED MATERIALS IN RELATION TO THE PRESENTATION OF BUSINESS WORKSHOPS AND SEMINARS, NAMELY, COURSE MATERIALS, HANDBOOKS, REFERENCE GUIDES, JOURNALS, TEACHING MANUALS (U.S. CLS. 2, 5, 22, 23, 29, 37, 38 AND 50).

CLASS 41—EDUCATION AND ENTERTAINMENT

FOR EDUCATIONAL SERVICES, NAMELY THE PRESENTATION OF WORKSHOPS, LECTURES, SEMINARS AND CLASSES, BOTH IN PERSON AND BY ELECTRONIC MEANS, IN THE FIELD OF BUSINESS (U.S. CLS. 100, 101 AND 107).

ROBIN CHOSID, EXAMINING ATTORNEY

SN 78-780,047. LEOPOLD'S ICE CREAM, INC., SAVANNAH, GA. FILED 12-23-2005.



THE NAME(S), PORTRAIT(S), AND/OR SIGNATURE(S) SHOWN IN THE MARK DOES NOT IDENTIFY A PARTICULAR LIVING INDIVIDUAL.

THE COLOR(S) DARK RED IS/ARE CLAIMED AS A FEATURE OF THE MARK.

THE MARK CONSISTS OF THE COLOR DARK RED IN THE LETTERS LEOPOLD'S.

CLASS 30—STAPLE FOODS

FOR ICE CREAM, ICE CREAM TOPPINGS, NAMELY CHOCOLATE TOPPING, SYRUP TOPPING, MARSHMALLOW TOPPING (U.S. CL. 46).

FIRST USE 8-18-2004; IN COMMERCE 11-1-2004.

CLASS 43—HOTEL AND RESTAURANT SERVICES

FOR RESTAURANT SERVICES, NAMELY THE PREPARATION AND SERVICE OF VARIOUS ITEMS, INCLUDING ICE CREAM, FLOATS, AND SANDWICHES FOR ON AND OFF PREMISE CONSUMPTION (U.S. CLS. 100 AND 101).

FIRST USE 8-18-2004; IN COMMERCE 11-1-2005.
CAROLYN GRAY, EXAMINING ATTORNEY

SN 78-781,037. FERRARI EXPRESS, LAWRENCE, NY. FILED 12-27-2005.

FERRARI EXPRESS

THE MARK CONSISTS OF STANDARD CHARACTERS WITHOUT CLAIM TO ANY PARTICULAR FONT, STYLE, SIZE, OR COLOR.

NO CLAIM IS MADE TO THE EXCLUSIVE RIGHT TO USE "EXPRESS", APART FROM THE MARK AS SHOWN.

SEC. 2(F).

CLASS 35—ADVERTISING AND BUSINESS

FOR CUSTOMS CLEARANCE SERVICES IN RELATION TO THE PREPARATION OF APPROPRIATE PAPER WORK AND TRANSPORTATION DOCUMENTATION FOR OTHERS IN THE FIELD OF JEWELRY, GEMS, PRECIOUS METALS, FASHION ACCESSORIES AND WATCHES; LOGISTICS SERVICES, NAMELY, ARRANGING THE COLLECTION, PICK-UP, STORAGE, TRANSPORTATION, SECURITY PACKING, AND DISTRIBUTION OF GOODS FOR OTHERS BY AIR, RAIL, SHIP AND/OR TRUCK IN THE FIELD OF JEWELRY, GEMS, PRECIOUS METALS, FASHION ACCESSORIES AND WATCHES (U.S. CLS. 100, 101 AND 102).

FIRST USE 7-10-1990; IN COMMERCE 7-10-1990.

CLASS 36—INSURANCE AND FINANCIAL

FOR CUSTOMS BROKERAGE SERVICES IN THE FIELD OF JEWELRY, GEMS, PRECIOUS METALS, FASHION ACCESSORIES AND WATCHES (U.S. CLS. 100, 101 AND 102).

FIRST USE 7-10-1990; IN COMMERCE 7-10-1990.

CLASS 39—TRANSPORTATION AND STORAGE

FOR TRANSPORTATION SERVICES, NAMELY, FREIGHT FORWARDING OF CARGO BY AIR, RAIL, SHIP AND/OR TRUCK IN THE FIELD OF JEWELRY, GEMS, PRECIOUS METALS, FASHION ACCESSORIES AND WATCHES; SHIPPING OF GOODS BY AIR, RAIL, SHIP AND/OR TRUCK IN THE FIELD OF JEWELRY, GEMS, PRECIOUS METALS, FASHION ACCESSORIES AND WATCHES; TRANSPORT OF GOODS BY ARMORED AND NON-ARMORED VEHICLES IN THE FIELD OF JEWELRY, GEMS, PRECIOUS METALS, FASHION ACCESSORIES AND WATCHES; WAREHOUSE STORAGE IN THE FIELD OF JEWELRY, GEMS, PRECIOUS METALS, FASHION ACCESSORIES AND WATCHES; RENTAL OF WAREHOUSE SPACE IN THE FIELD OF JEWELRY, GEMS, PRECIOUS METALS, FASHION ACCESSORIES AND WATCHES; SECURITY PACKING FOR HIGH VALUE GOODS FOR TRANSPORTATION IN THE FIELD OF JEWELRY, GEMS, PRECIOUS METALS, FASHION ACCESSORIES AND WATCHES; DISTRIBUTION SERVICES, NAMELY DELIVERY OF GOODS FOR OTHERS IN THE FIELD OF JEWELRY, GEMS, PRECIOUS METALS, FASHION ACCESSORIES AND WATCHES (U.S. CLS. 100 AND 105).

FIRST USE 7-10-1990; IN COMMERCE 7-10-1990.

BARBARA RUTLAND, EXAMINING ATTORNEY

SN 78-781,519. CHELSEA FOOTBALL CLUB LIMITED, LONDON, UNITED KINGDOM, FILED 12-28-2005.



PRIORITY CLAIMED UNDER SEC. 44(D) ON UNITED KINGDOM APPLICATION NO. 2407465, FILED 11-24-2005, REG. NO. 2407465, DATED 6-9-2006, EXPIRES 11-24-2015.

THE NAME AND SIGNATURE SHOWN IN THE MARK IDENTIFIES JOSE MOURINHO, WHOSE CONSENT IS OF RECORD.

THE MARK CONSISTS OF A SIGNATURE OF THE NAME "JOSE MOURINHO".

CLASS 3—COSMETICS AND CLEANING PREPARATIONS

FOR AFTER-SHAVE LOTIONS; EAU DE COLOGNE; NON-MEDICATED TOILETRIES; BLEACHING PREPARATIONS AND OTHER SUBSTANCES FOR LAUNDRY USE, NAMELY LAUNDRY DETERGENT, FABRIC SOFTENERS FOR LAUNDRY USE, LAUNDRY PRE-SOAK, LAUNDRY SIZING, LAUNDRY STARCH, LAUNDRY BLUEING, AND ESSENTIAL OILS AS PERFUME FOR LAUNDRY PURPOSES; CLEANING PREPARATIONS FOR HOUSEHOLD PURPOSES; POLISHING PREPARATIONS; LIQUID AND POWDER SCOURING PREPARATIONS; GENERAL PURPOSE ABRASIVE LIQUIDS AND POWDERS; PERFUMERY; HAIR CARE PREPARATIONS; SUNTANNING PREPARATIONS; DENTIFRICES; TOOTHPASTE; BOOT CREAM; BOOT POLISH; DEPILOTORIES; SOAPS; ANTIPERSPIRANTS; ESSENTIAL OILS, FLOWER PERFUMES IN THE FORM OF OIL AND SCENTED WATERS; BATH SALTS; NON-MEDICATED BATH PREPARATIONS; COSMETICS KITS COMPRISED OF COSMETICS; COSMETICS; NON-MEDICATED SKIN CARE PREPARATIONS, NON-MEDICATED SKIN CREAMS; PERSONAL DEODORANTS; DEODORANT SOAPS FOR BODY AND FEET; COSMETIC DYES, NAMELY HAIR DYES; EYEBROW COLORS; EYEBROW PENCILS; FABRIC SOFTENERS; FLOWER PERFUMES; HAIR SPRAYS; INCENSE; PERFUMERY MADE FROM IONONE; JEWELLERS' ROUGE; LIPSTICKS; MAKE-UP PREPARATIONS; NON-MEDICATED MOUTH WASHES; NAIL POLISH; NAIL CARE PREPARATIONS; COSMETIC PENCILS; POTPOURRIS; HAIR SHAMPOOS; SHAVING PREPARATIONS; TALCUM POWDERS; DECORATIVE TRANSFERS FOR COSMETIC PURPOSES; WINDSCREEN CLEANING LIQUIDS (U.S. CLS. 1, 4, 6, 50, 51 AND 52).

CLASS 9—ELECTRICAL AND SCIENTIFIC APPARATUS

FOR BLANK SMART CARDS; PRE-PAID TELEPHONE CARDS, MAGNETICALLY ENCODED; ENCRYPTED TELEPHONE CARDS; ENCODED TELEPHONE CARDS; CAMERAS AND PARTS AND FITTINGS THEREFOR; EXPOSED CAMERA FILM; SOUND RECORDING AND SOUND REPRODUCING APPARATUS AND INSTRUMENTS; MUSICAL SOUND RECORDINGS; MUSICAL VIDEO RECORDINGS; BLANK AUDIO AND VIDEO CASSETTES, CARTRIDGES, TAPES, CDS, DVDS; BLANK CD-ROMS FOR SOUND OR VIDEO RECORDINGS; PRE-RECORDED CD-ROMS FEATURING SOCCER AND INFORMATION RELATING TO SOCCER; PRE-RECORDED AUDIO AND VIDEO CASSETTES, CARTRIDGES, TAPES, CDS, DVDS; CD-ROMS, FEATURING SOCCER AND INFORMATION RELATING TO SOCCER; GRAMOPHONE RECORDS; BLANK MAGNETIC TAPES FOR RECORDING OR REPRODUCING SOUND OR VISION; TELEVISIONS; RADIOS; CD RECORDERS AND PLAYERS; DVD RECORDERS AND PLAYERS; VIDEO CASSETTES RECORDERS AND PLAYERS; PHOTOGRAPHIC SLIDE TRANSPARENCIES; EXPOSED CINEMATOGRAPHIC FILMS PREPARED FOR EXHIBITION PURPOSES; CALCULATING MACHINES, NAMELY CALCULATORS; COMPUTER GAME PROGRAMS; BLANK MAGNETIC COMPUTER TAPES AND DISCS; TELEPHONES, MOBILE TELEPHONES; TELEPHONE ANSWERING APPARATUS, TELEPHONE RECORDERS, TELEPHONES INCORPORATING FACSIMILE MACHINES; MAGNETS; COMPUTER GAME TAPES, CASSETTES, DISCS; COMPUTER GAME SOFTWARE; DOWNLOADABLE ELECTRONIC PUBLICATIONS IN THE NATURE OF BOOKLETS, MAGAZINES, NEWSLETTERS IN THE FIELD OF SOCCER; VIDEO DISCS AND TAPES WITH RECORDED ANIMATED CARTOONS; BATTERIES; COMPUTERS; PRINTERS; COMPUTER PERIPHERALS; SPECTACLES, SPECTACLE CASES; SUNGLASSES, SUNGLASSES CASES; BAROMETERS (U.S. CLS. 21, 23, 26, 36 AND 38).

CLASS 14—JEWELRY

FOR JEWELRY; EARRINGS; NECKLACES; BRACELETS; BROOCHES; WATCHES; WATCH STRAPS; STOPWATCHES; CLOCKS; TIMEPIECES; CHRONOMETERS; KEY RINGS OF PRECIOUS METAL; SMALL ORNAMENTS OF PRECIOUS METAL, FOR WEAR; WATCH FOBs; CUFFLINKS; TIE CLIPS; TIE PINS; CANDLE STICKS AND NON-ELECTRIC CANDELABRAS OF PRECIOUS METAL; JEWELLERY CASES OF PRECIOUS METAL; JEWEL CHAINS OF PRECIOUS METAL; COLLECTIBLE COINS; FIGURINES OF PRECIOUS METAL; NAPKIN RINGS AND NAPKIN HOLDERS OF PRECIOUS METAL; ORNAMENTS OF PRECIOUS METAL AND ORNAMENTAL PINS; TANKARDS OF PRECIOUS METAL AND SILVER ORNAMENTS; VASES OF PRECIOUS METAL; CIGAR AND CIGARETTE HOLDERS OF PRECIOUS METAL; HAT AND SHOE ORNAMENTS OF PRECIOUS METAL; JEWELLERY CHARMS, KEYS, KEY RINGS, NAPKIN HOLDERS, NAPKIN RINGS, NUTCRACKERS, ALL THE AFORESAID GOODS BEING MADE WHOLLY OR PRINCIPALLY OF PRECIOUS METAL AND THEIR ALLOYS OR COATED THEREWITH (U.S. CLS. 2, 27, 28 AND 50).

CLASS 18—LEATHER GOODS

FOR ARTICLES MADE OF LEATHER AND/OR IMITATION LEATHER, NAMELY CASES, BAGS, SUITCASES, WALLETS, BRIEFCASES, POUCHES, ENVELOPES, PURSES AND SADDLERY; SUITCASES, LUGGAGE BAGS; BACK PACKS, RUCKSACKS; HAVERSACKS; KNAPSACKS; LEATHER SHOPPING BAGS; TEXTILE SHOPPING BAGS; DUFFEL BAGS; TRAVEL BAGS FOR BOOTS AND SHOES; PURSES; WALLETS, WALLETS INCORPORATING CHECK BOOK COVERS; HANDBAGS; SHOULDER BAGS; CREDIT CARD HOLDERS; KEY CASES, CREDIT CARD CASES, ATTACHE CASES, BRIEFCASES; BAGS AND HOLDALLS FOR SPORTS CLOTHING; SATCHELS; SCHOOL BAGS; TRUNKS AND TRAVELLING BAGS; CARRY-ALL BAGS; UMBRELLAS; WALKING STICKS; VALISES (U.S. CLS. 1, 2, 3, 22 AND 41).

CLASS 25—CLOTHING

FOR ARTICLES OF OUTERCLOTHING, NAMELY SUITS; T-SHIRTS; SHIRTS; SWEATERS; CARDIGANS; JACKETS; COATS; SHAWLS; TROUSERS; PANTS; SHORTS; DUNGAREES; LEGGINGS; SKIRTS; DRESSES; WATERPROOF CLOTHING, NAMELY WATERPROOF JACKETS, PANTS, RAIN BOOTS; GALOSHES; OVERALLS; COLLARS; COLLAR PROTECTORS; TIES; CRAVATS; SCARVES; GLOVES; MITTENS; BELTS; BRACES; PAJAMAS; NIGHTSHIRTS; NIGHTGOWNS; DRESSING GOWNS; BATHROBES; BATHING SUITS, BATHING TRUNKS; BATHING CAPS; APRONS; BABY BOOTS; CLOTH DIAPERS; CLOTH BIBS; ROMPER SUITS; BABY PANTS AND SLEEP SUITS; ARTICLES OF SPORTS CLOTHING, NAMELY SPORTS JERSEYS AND BREECHES, ATHLETIC UNIFORMS AND ATHLETIC FOOTWEAR; TRACK SUITS; HEADBANDS; WRIST BANDS; UNDERGARMENTS; UNDERWEAR; SINGLETs; VESTS; UNDERPANTS; BRIEFS; BOXER SHORTS; LINGERIE; HOSIERY; FOOTWEAR BEING ARTICLES OF CLOTHING; SOCKS; GARTERS; BOOTS; SHOES; SANDALS; SLIPPERS; FOOTBALL BOOTS; FOOTBALL SHOES; TRAINING SHOES; ARTICLES OF HEADGEAR, NAMELY CAPS, HATS, BERETS, HOODS, EAR MUFFS, AND VISORS (U.S. CLS. 22 AND 39).

GISELLE AGOSTO, EXAMINING ATTORNEY

SN 78-781,927. BAYERISCHE MOTOREN WERKE AKTIENGESELLSCHAFT, MUNICH, FED REP GERMANY, FILED 12-28-2005.

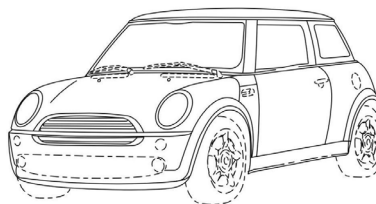

THE MARK CONSISTS OF THE CONFIGURATION OF AN AUTOMOBILE. THE MARK IS THREE-DIMENSIONAL. BROKEN LINES INDICATE MATTER NOT CLAIMED AS PART OF THE MARK.

SEC. 2(F).

CLASS 12—VEHICLES

FOR AUTOMOBILES AND STRUCTURAL PARTS THEREFOR (U.S. CLS. 19, 21, 23, 31, 35 AND 44). FIRST USE 5-0-2001; IN COMMERCE 12-20-2001.

CLASS 28—TOYS AND SPORTING GOODS

FOR MODEL CARS; RADIO CONTROLLED MODEL VEHICLES (U.S. CLS. 22, 23, 38 AND 50). FIRST USE 5-0-2001; IN COMMERCE 12-20-2001. KRISTINA MORRIS, EXAMINING ATTORNEY

SN 78-782,007. REDCARPET CREATIONS, INC., ALEXANDRIA, VA. FILED 12-28-2005.

**CLASS 9—ELECTRICAL AND SCIENTIFIC APPARATUS**

FOR MULTI-MEDIA MARKETING MATERIALS, NAMELY, CD-ROMS AND DVDS IN THE FIELD OF MARKETING PROGRAMS, GOODS AND SERVICES LAUNCHES, CAMPAIGNS, REAL ESTATE AND FUNDRAISING PROJECTS OF COMPANIES, ASSOCIATIONS, NONPROFITS, AND OTHER ENTITIES (U.S. CLS. 21, 23, 26, 36 AND 38).

FIRST USE 4-21-2004; IN COMMERCE 4-21-2004.

CLASS 16—PAPER GOODS AND PRINTED MATTER

FOR PRINTED MATERIALS, NAMELY, BROCHURES, PORTFOLIOS, MAGAZINES, NEWS PUBLICATIONS IN THE NATURE OF NEWSPAPERS, ANNUAL REPORTS, BROCHURES, PAPER SIGNS, PHOTOGRAPHS, PRESS RELEASES, PRESS KITS, INSTRUCTIONAL LITERATURE, NEWSLETTERS, CHECKLISTS ALL IN THE FIELD OF FUND-RAISING CAMPAIGNS, PUBLIC RELATIONS, MEDIA ADVISORIES, MARKETING PROGRAMS, GOODS AND SERVICES LAUNCHES, CAMPAIGNS, REAL ESTATE AND ADVERTISING PROJECTS OF COMPANIES, ASSOCIATIONS, NONPROFITS, AND OTHER ENTITIES (U.S. CLS. 2, 5, 22, 23, 29, 37, 38 AND 50).

FIRST USE 4-21-2004; IN COMMERCE 4-21-2004.

CLASS 35—ADVERTISING AND BUSINESS

FOR ADVERTISING AND MARKETING, BUSINESS MARKETING CONSULTING, AND BUSINESS MARKETING MANAGEMENT SERVICES, NAMELY MARKETING INFRASTRUCTURE DEVELOPMENT, MARKETING PLAN AND BUDGET DEVELOPMENT; BUSINESS DEVELOPMENT SERVICES, NAMELY, PROVIDING START-UP AND SUPPORT FOR THE BUSINESS OF OTHERS; PROMOTING THE SALE OF GOODS AND SERVICES OF OTHERS THROUGH THE DISTRIBUTION OF PRINTED MATERIALS AND ELECTRONIC MATERIALS IN THE NATURE OF PROVIDING HYPER TEXT LINKS TO THE WEBSITE OF OTHERS; BUSINESS MARKETING CONSULTING SERVICES IN THE NATURE OF DEVELOPING STANDARD FORMATS AND TEMPLATES FOR PROPOSALS CREATED BY OTHERS IN ALL INDUSTRY MARKETS, DEVELOPMENT OF PROCEDURES FOR PROPOSAL PREPARATION, AND ASSEMBLING PROJECT TEAM RESUMES AND PROFILES; DIRECT MARKETING SERVICES, NAMELY, MARKETING TO GENERATE NEW BUSINESS LEADS FOR OTHERS; APPOINTMENT SCHEDULING SERVICES; ADVERTISING AND MARKETING SERVICES FEATURING BUSINESS PROPOSAL WRITING, MARKETING AND PROPOSAL PRESENTATION STRATEGY AND PREPARATION SERVICES; ADVERTISING SERVICES; PUBLIC RELATIONS; AND MEDIA BUYING IN THE NATURE OF PREPARING AND PLACING OF ADVERTISEMENTS; ADVERTISING SERVICES, NAMELY, CREATING CORPORATE LOGOS AND BRAND IDENTITY FOR OTHERS; CREATING AND UPDATING ADVERTISING MATERIALS FOR FUNDRAISING CAMPAIGNS; ARRANGING AND CONDUCTING OF SILENT AUCTION SALES; PRODUCT MERCHANDISING; ARRANGING AND CONDUCTING TRADE SHOW EXHIBITIONS FOR ALL INDUSTRY MARKETS, ALL IN SUPPORT OF THE MARKETING PROGRAMS, GOODS AND SERVICES LAUNCHES, CAMPAIGNS, AND PROJECTS OF COMPANIES, ASSOCIATIONS, NONPROFITS, AND OTHER ENTITIES; ARRANGING FOR CATERING AND EQUIPMENT, ENTERTAINMENT, EMCEES, KEYNOTE SPEAKERS, AND AUDIO VISUAL EQUIPMENT (U.S. CLS. 100, 101 AND 102).

FIRST USE 4-21-2004; IN COMMERCE 4-21-2004.

CLASS 36—INSURANCE AND FINANCIAL

FOR NONPROFIT CHARITABLE FUND-RAISING SERVICES FOR THE MARKETING PROGRAMS, CAMPAIGNS, AND PROJECTS OF FOUNDATIONS, ASSOCIATIONS, AND OTHER ENTITIES CLASSIFIED AS NONPROFIT ORGANIZATIONS (U.S. CLS. 100, 101 AND 102).

FIRST USE 4-21-2004; IN COMMERCE 4-21-2004.

CLASS 40—MATERIAL TREATMENT

FOR CUSTOMIZED PRINTING OF COMPANY NAMES AND LOGOS FOR PROMOTIONAL AND ADVERTISING PURPOSES ON THE GOODS OF OTHERS; PHOTOGRAPHIC RETOUCHING SERVICES IN THE NATURE OF IMAGE AND COLOR CORRECTION, ALL IN SUPPORT OF THE MARKETING PROGRAMS, GOODS AND SERVICES LAUNCHES, CAMPAIGNS, AND PROJECTS OF COMPANIES, ASSOCIATIONS, NONPROFITS, AND OTHER ENTITIES (U.S. CLS. 100, 103 AND 106).

FIRST USE 4-21-2004; IN COMMERCE 4-21-2004.

CLASS 41—EDUCATION AND ENTERTAINMENT

FOR SPECIAL EVENT PLANNING, ORGANIZING OF CONFERENCES AND MEETINGS FEATURING THEME AND DECOR DEVELOPMENT, VENUE LOCATING; SPECIAL EVENT PLANNING FOR THE MARKETING PROGRAMS, CAMPAIGNS, AND PROJECTS OF FOUNDATIONS, ASSOCIATIONS, AND OTHER ENTITIES CLASSIFIED AS NONPROFIT ORGANIZATIONS; EDUCATIONAL SERVICES, NAMELY, PROVIDING INCENTIVES TO ORGANIZATIONS TO DEMONSTRATE EXCELLENCE IN THE FIELD OF THEIR MEMBERSHIP BUSINESS PRACTICES THROUGH THE ISSUANCE OF PEER, PROJECT AND INDUSTRY AWARDS; PHOTOGRAPHY SERVICES (U.S. CLS. 100, 101 AND 107).

FIRST USE 4-21-2004; IN COMMERCE 4-21-2004.

CLASS 42—SCIENTIFIC, COMPUTER AND LEGAL SERVICES

FOR GRAPHIC ART DESIGN AND COMPUTER SERVICES, NAMELY, CREATING AND MAINTAINING WEBSITES FOR OTHERS AND HOSTING THE WEBSITE OF OTHERS ON A COMPUTER SERVER FOR A GLOBAL COMPUTER NETWORK; COMPUTER CORPORATE INTERNET DESIGN; COMPUTER PROGRAMMING FOR OTHERS; GRAPHIC ART DESIGN SERVICES FOR PRINTED FUND-RAISING CAMPAIGN MATERIALS FEATURING CASE STATEMENTS, QUALIFICATIONS, PROPOSALS, PRESENTATIONS, PRESS RELEASES, MEDIA ADVISORIES, AND LISTS; DESIGN AND DEVELOPMENT OF MULTIMEDIA PRODUCTS IN THE NATURE OF CD-ROMS AND DVDS FOR FUNDRAISING CAMPAIGNS, ALL IN SUPPORT OF THE MARKETING PROGRAMS, GOODS AND SERVICES LAUNCHES, CAMPAIGNS, AND PROJECTS OF COMPANIES, ASSOCIATIONS, NONPROFITS, AND OTHER ENTITIES (U.S. CLS. 100 AND 101).

FIRST USE 4-21-2004; IN COMMERCE 4-21-2004.

TARAH HARDY, EXAMINING ATTORNEY

SN 78-782,177. EXOSECT LIMITED, SOUTHAMPTON, HAMPSHIRE, UNITED KINGDOM, FILED 12-29-2005.

EXOSECT

THE MARK CONSISTS OF STANDARD CHARACTERS WITHOUT CLAIM TO ANY PARTICULAR FONT, STYLE, SIZE, OR COLOR.

PRIORITY CLAIMED UNDER SEC. 44(D) ON ERP CMNTY TM OFC APPLICATION NO. 4667796, FILED 10-24-2005, REG. NO. 004667796, DATED 9-28-2006, EXPIRES 10-24-2015.

CLASS 5—PHARMACEUTICALS

FOR INSECTICIDES; INSECT REPELLENTS; INSECT ATTRACTANTS; INSECT MATING DISRUPTANTS; PESTICIDES; PARASITICIDES FOR AGRICULTURAL, HORTICULTURAL AND APICULTURAL USE; PREPARATIONS FOR THE CONTROL OF PESTS, INSECTS, PARASITES, AND OF VIRAL OR BACTERIAL INJECTIONS FOR AGRICULTURAL, HORTICULTURAL AND APICULTURAL USE; PHEROMONES FOR DOMESTIC, AGRICULTURAL, HORTICULTURAL AND APICULTURAL USE WITH INSECT TRAPS AND LURES AND PHEROMONE-BASED ATTRACTANTS; FLY CATCHING ADHESIVES; FLY CATCHING PAPER; FLY DESTROYING PREPARATIONS. (U.S. CLS. 6, 18, 44, 46, 51 AND 52).

CLASS 20—FURNITURE AND ARTICLES NOT OTHERWISE CLASSIFIED

FOR PARTS AND FITTINGS FOR BEEHIVES, ALL FOR USE IN THE PROTECTION OF BEES FROM PARASITES, PESTS AND VIRAL INFECTIONS; DEVICES FOR BEEHIVES TO FACILITATE THE APPLICATION AND DELIVERY OF PREPARATIONS AND SUBSTANCES FOR THE CONTROL OF PESTS, INSECTS, PARASITES, AND OF VIRAL OR BACTERIAL INFECTIONS (U.S. CLS. 2, 13, 22, 25, 32 AND 50).

CLASS 21—HOUSEWARES AND GLASS

FOR INSECT TRAPS; FLY CATCHERS; FLY SWATERS; NON-ELECTRIC, NON-SPRAYING, NON-POWERED AND NON-AUTOMATED DEVICES IN THE NATURE OF DISPENSERS FOR DISPENSING INSECTICIDES, INSECT REPELLENTS, INSECT ATTRACTANTS, INSECT MATING DISRUPTANTS, PESTICIDES, PARASITICIDES, PREPARATIONS AND SUBSTANCES FOR THE CONTROL OF PESTS, INSECTS, PARASITES, AND OF VIRAL OR BACTERIAL INFECTIONS, OR FOR DISPENSING PHEROMONES; PARTS AND FITTINGS FOR ALL THE AFORESAID GOODS. (U.S. CLS. 2, 13, 23, 29, 30, 33, 40 AND 50).

JUDITH HELFMAN, EXAMINING ATTORNEY

SN 78-782,284. HEMOFARM KONCERN A.D. PHARMACEUTICAL-CHEMICAL INDUSTRY VRAC, SERBIA AND MONTENEGRO, YUGOSLAVIA, FILED 12-29-2005.

HEMOFARM

THE MARK CONSISTS OF STANDARD CHARACTERS WITHOUT CLAIM TO ANY PARTICULAR FONT, STYLE, SIZE, OR COLOR.

CLASS 5—PHARMACEUTICALS

FOR HOUSE MARK FOR A FULL LINE OF PHARMACEUTICAL AND VETERINARY PREPARATIONS; SANITARY PREPARATIONS FOR MEDICAL USE; DISINFECTANTS FOR HYGIENIC PURPOSES; DISINFECTANTS FOR MEDICAL INSTRUMENTS; DISINFECTANTS FOR SANITARY PURPOSES; DISINFECTING HAND WASH; ALL PURPOSE DISINFECTANTS; PESTICIDES, FUNGICIDES AND HERBICIDES FOR DOMESTIC, AGRICULTURAL AND MEDICAL USE (U.S. CLS. 6, 18, 44, 46, 51 AND 52).

CLASS 35—ADVERTISING AND BUSINESS

FOR ADVERTISING AND ADVERTISEMENT SERVICES; BUSINESS MANAGEMENT; BUSINESS ADMINISTRATION; PROVIDING OFFICE FUNCTIONS (U.S. CLS. 100, 101 AND 102).

JOHN DWYER, EXAMINING ATTORNEY

SN 78-782,286. HEMOFARM KONCERN A.D. PHARMACEUTICAL-CHEMICAL INDUSTRY VRAC, SERBIA AND MONTENEGRO, YUGOSLAVIA, FILED 12-29-2005.

HEMOPHARM

THE MARK CONSISTS OF STANDARD CHARACTERS WITHOUT CLAIM TO ANY PARTICULAR FONT, STYLE, SIZE, OR COLOR.

CLASS 5—PHARMACEUTICALS

FOR HOUSE MARK FOR A FULL LINE OF PHARMACEUTICAL AND VETERINARY PREPARATIONS; SANITARY PREPARATIONS FOR MEDICAL USE; DISINFECTANTS FOR HYGIENIC PURPOSES; DISINFECTANTS FOR MEDICAL INSTRUMENTS; DISINFECTANTS FOR SANITARY PURPOSES; DISINFECTING HAND WASH; ALL PURPOSE DISINFECTANTS; PESTICIDES, FUNGICIDES AND HERBICIDES FOR DOMESTIC, AGRICULTURAL AND MEDICAL USE (U.S. CLS. 6, 18, 44, 46, 51 AND 52).

CLASS 35—ADVERTISING AND BUSINESS

FOR ADVERTISING AND ADVERTISEMENT SERVICES; BUSINESS MANAGEMENT; BUSINESS ADMINISTRATION; PROVIDING OFFICE FUNCTIONS (U.S. CLS. 100, 101 AND 102).

JOHN DWYER, EXAMINING ATTORNEY

SN 78-782,288. HEMOFARM KONCERN A.D. PHARMACEUTICAL-CHEMICAL INDUSTRY VRAC, SERBIA AND MONTENEGRO, YUGOSLAVIA, FILED 12-29-2005.



NO CLAIM IS MADE TO THE EXCLUSIVE RIGHT TO USE "USA CORPORATION", APART FROM THE MARK AS SHOWN.

CLASS 5—PHARMACEUTICALS

FOR HOUSE MARK FOR A FULL LINE OF PHARMACEUTICAL AND VETERINARY PREPARATIONS; SANITARY PREPARATIONS FOR MEDICAL USE; DISINFECTANTS FOR HYGIENIC PURPOSES; DISINFECTANTS FOR MEDICAL INSTRUMENTS; DISINFECTANTS FOR SANITARY PURPOSES; DISINFECTING HAND WASH; ALL PURPOSE DISINFECTANTS; PESTICIDES, FUNGICIDES AND HERBICIDES FOR DOMESTIC, AGRICULTURAL AND MEDICAL USE (U.S. CLS. 6, 18, 44, 46, 51 AND 52).

CLASS 35—ADVERTISING AND BUSINESS

FOR ADVERTISING AND ADVERTISEMENT SERVICES; BUSINESS MANAGEMENT; BUSINESS ADMINISTRATION; PROVIDING OFFICE FUNCTIONS (U.S. CLS. 100, 101 AND 102).

JOHN DWYER, EXAMINING ATTORNEY

SN 78-783,684. SYLER, RENE, CHAPPAQUA, NY. AND LIPMAN, LINDA, NEW YORK, NY. FILED 1-2-2006.

CLASS 41—EDUCATION AND ENTERTAINMENT

FOR EDUCATIONAL SERVICES, NAMELY, ARRANGING AND CONDUCTING CONFERENCES, SEMINARS AND WORKSHOPS FEATURING TOPICS OF INTEREST TO WOMEN; ENTERTAINMENT SERVICES, NAMELY, PRODUCTION OF RADIO AND TELEVISION PROGRAMMING AND VIDEOTAPES (U.S. CLS. 100, 101 AND 107).

SHARON MEIER, EXAMINING ATTORNEY

THE GOOD ENOUGH MOTHER

SN 78-783,687. SYLER, RENE, CHAPPAQUA, NY. AND LIPMAN, LINDA, NEW YORK, NY. FILED 1-2-2006.

THE MARK CONSISTS OF STANDARD CHARACTERS WITHOUT CLAIM TO ANY PARTICULAR FONT, STYLE, SIZE, OR COLOR.

GEM

CLASS 16—PAPER GOODS AND PRINTED MATTER

FOR ALBUMS, NAMELY, PHOTOGRAPH AND SCRAPBOOK ALBUMS; BOOKMARKERS, BROCHURES AND PAMPHLETS FEATURING TOPICS OF INTEREST TO WOMEN, BUMPER STICKERS, CALENDARS, COASTERS MADE OF PAPER, COOKBOOKS, DAY PLANNERS, DECALS AND STICKERS, GREETING CARDS, HAT BOXES OF CARDBOARD, MAGAZINES FEATURING TOPICS OF INTEREST TO WOMEN, NEWSLETTERS FEATURING TOPICS OF INTEREST TO WOMEN, NAPKINS MADE OF PAPER, NOTEBOOKS, PAPER PARTY FAVORS, PENS AND PENCILS, PEN AND PENCIL HOLDERS, POSTCARDS, POSTERS, SERIES OF BOOKS FEATURING TOPICS OF INTEREST TO WOMEN, STATIONERY, SYNDICATED COLUMN FEATURING TOPICS OF INTEREST TO WOMEN, TABLE LINENS OF PAPER, WRITING PADS (U.S. CLS. 2, 5, 22, 23, 29, 37, 38 AND 50).

THE MARK CONSISTS OF STANDARD CHARACTERS WITHOUT CLAIM TO ANY PARTICULAR FONT, STYLE, SIZE, OR COLOR.

CLASS 16—PAPER GOODS AND PRINTED MATTER

FOR BROCHURES AND PAMPHLETS FEATURING TOPICS OF INTEREST TO WOMEN, MAGAZINES FEATURING TOPICS OF INTEREST TO WOMEN, NEWSLETTERS FEATURING TOPICS OF INTEREST TO WOMEN, SERIES OF BOOKS FEATURING TOPICS OF INTEREST TO WOMEN, SYNDICATED COLUMN FEATURING TOPICS OF INTEREST TO WOMEN (U.S. CLS. 2, 5, 22, 23, 29, 37, 38 AND 50).

CLASS 25—CLOTHING

FOR WEARING APPAREL FOR WOMEN AND CHILDREN, NAMELY, BLOUSES, CAMISOLES, DRESSES, HOSIERY, JEANS, LINGERIE, LOUNGEWEAR, PANTS, SHIRTS, SHORTS, SKIRTS, SLEEPWEAR, SUITS, SWEATERS, SWEAT SHIRTS AND PANTS, TANKTOPS, T-SHIRTS AND UNDERWEAR; CLOTHING FOR BABIES, NAMELY, CLOTH BIBS, ONE-PIECE CLOTHING, SLEEPERS, PANTS, DRESSES, UNDERWEAR AND SOCKS, SKIRTS, SWEATERS, SHIRTS, PAJAMAS, COATS AND JACKETS, SHOES, BOOTIES AND SLIPPERS; ACCESSORIES, NAMELY, BELTS, GLOVES, SCARVES; FOOTWEAR; HEADWEAR, NAMELY, CAPS, HATS, VISORS; OUTERWEAR, NAMELY, COATS, JACKETS, RAINWEAR, SHAWLS, VESTS (U.S. CLS. 22 AND 39).

CLASS 25—CLOTHING

FOR WEARING APPAREL FOR WOMEN AND CHILDREN, NAMELY, BLOUSES, CAMISOLES, DRESSES, HOSIERY, JEANS, LINGERIE, LOUNGEWEAR, PANTS, SHIRTS, SHORTS, SKIRTS, SLEEPWEAR, SUITS, SWEATERS, SWEAT SHIRTS AND PANTS, TANK TOPS, T-SHIRTS AND UNDERWEAR; CLOTHING FOR BABIES, NAMELY, CLOTH BIBS, ONE-PIECE CLOTHING, SLEEPERS, PANTS, DRESSES, UNDERWEAR AND SOCKS, SKIRTS, SWEATERS, SHIRTS, PAJAMAS, COATS AND JACKETS, SHOES, BOOTIES AND SLIPPERS; ACCESSORIES, NAMELY, BELTS, GLOVES, SCARVES; FOOTWEAR; HEADWEAR, NAMELY, CAPS, HATS, VISORS; OUTERWEAR, NAMELY, COATS, JACKETS, RAINWEAR, SHAWLS, VESTS (U.S. CLS. 22 AND 39).

CLASS 35—ADVERTISING AND BUSINESS

FOR DEMONSTRATION OF GOODS BY ELECTRONIC MEANS AND FOR THE BENEFIT OF TEleshopping AND HOMESHOPPING SERVICES; DIRECT MAIL ADVERTISING, ORGANIZING EXHIBITIONS FOR WOMEN, NAMELY, ORGANIZING EXHIBITIONS FOR; MAIL ORDER, RETAIL STORE AND ON-LINE RETAIL SERVICES FEATURING ACCESSORIES, BOOKS, CLOTHING, COSMETICS, GIFT ITEMS AND PAPER GOODS; RADIO AND TELEVISION ADVERTISING SERVICES; PRODUCTION OF RADIO AND TELEVISION COMMERCIALS; DEMOGRAPHIC CONSULTATION SERVICES AND MARKET RESEARCH, NAMELY, PROVIDING INFORMATION TO OTHERS ABOUT TOPICS OF INTEREST TO WOMEN; PROMOTING THE GOODS AND SERVICES OF OTHERS VIA A COMPUTERIZED, ONLINE GLOBAL COMMUNICATIONS NETWORK; DISSEMINATING ADVERTISEMENT MATERIAL FOR OTHERS VIA AN ONLINE GLOBAL NETWORK (U.S. CLS. 100, 101 AND 102).

CLASS 35—ADVERTISING AND BUSINESS

FOR ORGANIZING EXHIBITIONS FOR WOMEN FOR COMMERCIAL PURPOSES, NAMELY, FASHION SHOWS; ARRANGING AND CONDUCTING OF FAIRS AND EXHIBITIONS FOR WOMEN FOR BUSINESS AND ADVERTISING PURPOSES; MAIL ORDER, RETAIL STORE AND ON-LINE RETAIL SERVICES FEATURING BOOKS FEATURING TOPICS OF INTEREST TO WOMEN, CLOTHING, AND COSMETICS (U.S. CLS. 100, 101 AND 102).

CLASS 41—EDUCATION AND ENTERTAINMENT

FOR EDUCATIONAL SERVICES, NAMELY, ARRANGING AND CONDUCTING CONFERENCES, SEMINARS AND WORKSHOPS FEATURING TOPICS OF INTEREST TO WOMEN (U.S. CLS. 100, 101 AND 107).

SHARON MEIER, EXAMINING ATTORNEY

SN 78-784,625. IN CHRIST NEW HOPE MINISTRY, INC., HENRIETTA, NY. FILED 1-4-2006.

SN 78-786,048. FRIEDMAN, THOMAS L., WASHINGTON, DC. FILED 1-5-2006.

IN CHRIST NEW HOPE MINISTRY

THE MARK CONSISTS OF STANDARD CHARACTERS WITHOUT CLAIM TO ANY PARTICULAR FONT, STYLE, SIZE, OR COLOR.

NO CLAIM IS MADE TO THE EXCLUSIVE RIGHT TO USE "MINISTRY" AND "CHRIST", APART FROM THE MARK AS SHOWN.

CLASS 43—HOTEL AND RESTAURANT SERVICES

FOR CHRISTIAN BASED SOCIAL PROGRAMS, NAMELY, PROVIDING COMMUNITY CENTERS FOR SOCIAL GATHERINGS AND MEETINGS (U.S. CLS. 100 AND 101).

FIRST USE 4-12-1988; IN COMMERCE 4-12-1998.

CLASS 44—MEDICAL, BEAUTY AND AGRICULTURAL SERVICES

FOR EVANGELISTIC AND MINISTERIAL SERVICES, NAMELY, RELIGIOUS CEREMONIAL SERVICES (U.S. CLS. 100 AND 101).

FIRST USE 4-12-1998; IN COMMERCE 4-12-1998.
BRENDAN MCCAULEY, EXAMINING ATTORNEY

SN 78-785,698. HBO TCF HOLDING COMPANY INC., NEW YORK, NY. FILED 1-5-2006.



NO CLAIM IS MADE TO THE EXCLUSIVE RIGHT TO USE "THE COMEDY FESTIVAL", APART FROM THE MARK AS SHOWN.

CLASS 25—CLOTHING

FOR CLOTHING, NAMELY SHIRTS AND T-SHIRTS (U.S. CLS. 22 AND 39).

FIRST USE 11-0-2005; IN COMMERCE 11-0-2005.

CLASS 41—EDUCATION AND ENTERTAINMENT

FOR ENTERTAINMENT IN THE NATURE OF LIVE COMEDY PERFORMANCES (U.S. CLS. 100, 101 AND 107).

FIRST USE 11-0-2005; IN COMMERCE 11-0-2005.
CHRISTOPHER BUONGIORNO, EXAMINING ATTORNEY

**GREEN IS THE NEW RED,
WHITE AND BLUE**

THE MARK CONSISTS OF STANDARD CHARACTERS WITHOUT CLAIM TO ANY PARTICULAR FONT, STYLE, SIZE, OR COLOR.

CLASS 9—ELECTRICAL AND SCIENTIFIC APPARATUS

FOR EDUCATIONAL SOFTWARE FEATURING INSTRUCTION ON ENVIRONMENTAL, POLITICAL, ECONOMIC AND GLOBAL ISSUES FOR USE IN PROMOTING PUBLIC AWARENESS; SUNGLASSES; AND DOWNLOADABLE ELECTRONIC PUBLICATIONS IN THE NATURE OF NEWSPAPERS, BOOKS, MAGAZINES, NEWSLETTERS, PAMPHLETS, WHITE PAPERS, WRITTEN ARTICLES AND HANDOUTS CONCERNING ENVIRONMENTAL, POLITICAL, ECONOMIC AND GLOBAL ISSUES (U.S. CLS. 21, 23, 26, 36 AND 38).

CLASS 16—PAPER GOODS AND PRINTED MATTER

FOR PRINTED MATTER, NAMELY, BOOKS, MAGAZINES, NEWSLETTERS, PAMPHLETS, WHITE PAPERS, WRITTEN ARTICLES AND HANDOUTS CONCERNING ENVIRONMENTAL, POLITICAL, ECONOMIC AND GLOBAL ISSUES; NEWSPAPERS; PHOTOGRAPHS; STATIONERY; PRINTED INSTRUCTIONAL AND TEACHING MATERIAL IN THE FIELD OF PROMOTING PUBLIC AWARENESS OF ENVIRONMENTAL, POLITICAL, ECONOMIC AND GLOBAL ISSUES (U.S. CLS. 2, 5, 22, 23, 29, 37, 38 AND 50).

CLASS 20—FURNITURE AND ARTICLES NOT OTHERWISE CLASSIFIED

FOR MIRRORS; PICTURE FRAMES; DRAWER PULLS OF WOOD, CORK, REED, CANE, WICKER, SHELL, AMBER, MOTHER-OF-PEARL AND SUBSTITUTES FOR ALL THESE MATERIALS, OR OF PLASTICS; BOOK STANDS AND BOOKSHELVES; JEWELRY BOXES NOT OF METAL (U.S. CLS. 2, 13, 22, 25, 32 AND 50).

CLASS 21—HOUSEWARES AND GLASS

FOR CONTAINERS FOR HOUSEHOLD OR KITCHEN USE; ARTICLES FOR CLEANING PURPOSES, NAMELY CLEANING CLOTHS; FIGURES OF GLASSWARE, BEVERAGE GLASSWARE, FIGURES OF PORCELAIN, PORCELAIN MUGS, FIGURES OF EARTHENWARE, AND EARTHENWARE MUGS (U.S. CLS. 2, 13, 23, 29, 30, 33, 40 AND 50).

CLASS 25—CLOTHING

FOR CLOTHING, NAMELY, T-SHIRTS, SHIRTS, BLOUSES, CAMISOLES, JACKETS, COATS, SWEATERS, SWEATSHIRTS, JOGGING OUTFITS, DRESSES, SKIRTS, SHORTS, PANTS, SCARVES, SHAWLS, GLOVES, BELTS, TIES, SOCKS, UNDERGARMENTS, SLEEPING GARMENTS, BATHING SUITS, BEACH WEAR AND WRISTBANDS; FOOTWEAR; AND HEADWEAR (U.S. CLS. 22 AND 39).

CLASS 26—FANCY GOODS

FOR NOVELTY BUTTONS (U.S. CLS. 37, 39, 40, 42 AND 50).

CLASS 28—TOYS AND SPORTING GOODS

FOR PLAYING CARDS (U.S. CLS. 22, 23, 38 AND 50).

SN 78-786,151. TIME WARNER INC., NEW YORK, NY.
FILED 1-6-2006.**CLASS 30—STAPLE FOODS**

FOR COFFEE, PREPARED COFFEE AND COFFEE-BASED BEVERAGES; TEA, PREPARED TEA AND TEA-BASED BEVERAGES; BAKERY PRODUCTS (U.S. CL. 46).

TIME WARNER CABLE**CLASS 35—ADVERTISING AND BUSINESS**

FOR ASSOCIATION SERVICES, NAMELY, PROMOTING THE INTEREST OF ORGANIZATIONS PROMOTING PUBLIC AWARENESS OF ENVIRONMENTAL, POLITICAL, ECONOMIC AND GLOBAL ISSUES; BUSINESS CONSULTATION AND INFORMATION SERVICES; POLITICAL ACTION COMMITTEE SERVICES, NAMELY, PROMOTING THE INTERESTS OF INDIVIDUALS AND ORGANIZATIONS CONCERNED ABOUT THE ENVIRONMENT IN THE FIELD OF POLITICS; POLITICAL CONSULTATION; DEVELOPING AND COORDINATING VOLUNTEER PROJECTS FOR NONPROFIT ORGANIZATIONS; PROMOTING PUBLIC AWARENESS OF ENVIRONMENTAL, POLITICAL, ECONOMIC AND GLOBAL ISSUES (U.S. CLS. 100, 101 AND 102).

THE MARK CONSISTS OF STANDARD CHARACTERS WITHOUT CLAIM TO ANY PARTICULAR FONT, STYLE, SIZE, OR COLOR.

OWNER OF U.S. REG. NOS. 1,931,702, 2,775,146 AND OTHERS.

NO CLAIM IS MADE TO THE EXCLUSIVE RIGHT TO USE "CABLE", APART FROM THE MARK AS SHOWN.

CLASS 41—EDUCATION AND ENTERTAINMENT

FOR EDUCATIONAL SERVICES, NAMELY, ARRANGING AND CONDUCTING EDUCATIONAL CONFERENCES; TRAINING IN THE FIELD OF PROTECTING THE ENVIRONMENT; ENTERTAINMENT IN THE NATURE OF PERSONAL APPEARANCES BY AN AUTHOR, PERSONAL APPEARANCES BY A JOURNALIST, PERSONAL APPEARANCES BY A CELEBRITY AND LIVE APPEARANCES BY A MUSICAL BAND; CULTURAL ACTIVITIES, NAMELY, PERSONAL APPEARANCES BY AN AUTHOR, PERSONAL APPEARANCES BY A JOURNALIST; PUBLICATION OF ELECTRONIC NEWSPAPERS, BOOKS, MAGAZINES, NEWSLETTERS, PAMPHLETS, WHITE PAPERS, WRITTEN ARTICLES AND HANDOUTS ACCESSIBLE VIA A GLOBAL COMPUTER NETWORK (U.S. CLS. 100, 101 AND 107).

CLASS 38—COMMUNICATION

FOR CABLE MODEM SERVICES, NAMELY, PROVIDING MULTIPLE USER-DIAL-UP AND DEDICATED ACCESS TO THE INTERNET VIA MODEMS; HIGH SPEED INTERNET SERVICE PROVIDER SERVICES; WIRELESS COMMUNICATION SERVICES, NAMELY WIRELESS NETWORKS FOR MULTIPLE COMPUTERS IN THE SAME HOME; CABLE, MOBILE AND INTERNET TELEPHONY SERVICES; DIGITAL PHONE SERVICES; INTERACTIVE TELEVISION BROADCASTING SERVICES; TELEVISION ON DEMAND TRANSMISSION SERVICES; CABLE TELEVISION BROADCASTING SERVICES; CABLE TELEVISION BROADCAST AND TELECOMMUNICATIONS SERVICES PROVIDED VIA A CABLE PLATFORM, NAMELY ANALOG AND DIGITAL VIDEO; PAY-PER-VIEW AND PAY TELEVISION SUBSCRIPTION BROADCASTING SERVICES (U.S. CLS. 100, 101 AND 104).

FIRST USE 12-1-1996; IN COMMERCE 12-1-1996.

CLASS 41—EDUCATION AND ENTERTAINMENT

FOR VIDEO RECORDING SERVICES; PRODUCTION OF TELEVISION PROGRAMMING; TELEVISION PROGRAMMING SERVICES (U.S. CLS. 100, 101 AND 107).

FIRST USE 5-0-1990; IN COMMERCE 5-0-1990.

CLASS 42—SCIENTIFIC, COMPUTER AND LEGAL SERVICES

FOR ENVIRONMENTAL SERVICES, NAMELY, TECHNICAL CONSULTATION IN THE FIELD OF ENVIRONMENTAL SCIENCE, ENGINEERING SERVICES, DESIGN FOR OTHERS IN THE FIELD OF ENVIRONMENTAL ENGINEERING, DESIGNING AND TESTING OF NEW ENVIRONMENTALLY FRIENDLY PRODUCTS FOR OTHERS AND CONSULTING IN THE FIELD OF ENVIRONMENTAL PROTECTION (U.S. CLS. 100 AND 101).

CLASS 45—PERSONAL SERVICES

FOR HOME AND BUSINESS SECURITY SYSTEMS, NAMELY CONTROL OF BUILDING ACCESS AND MONITORING OF SECURITY SYSTEMS (U.S. CLS. 100 AND 101).

FIRST USE 1-1-1997; IN COMMERCE 1-1-1997.
JENNIFER KRISP, EXAMINING ATTORNEY**CLASS 43—HOTEL AND RESTAURANT SERVICES**

FOR PROVIDING OF FOOD AND DRINK FOR PATIENTS AND GUESTS (U.S. CLS. 100 AND 101).

SN 78-786,339. CALGON CORPORATION, NAPERVILLE, IL.
FILED 1-6-2006.**CALGON****CLASS 44—MEDICAL, BEAUTY AND AGRICULTURAL SERVICES**FOR AGRICULTURAL ADVICE; HORTICULTURE ADVICE; FORESTRY ADVICE (U.S. CLS. 100 AND 101).
CHRISIE B. KING, EXAMINING ATTORNEY

THE MARK CONSISTS OF STANDARD CHARACTERS WITHOUT CLAIM TO ANY PARTICULAR FONT, STYLE, SIZE, OR COLOR.

OWNER OF U.S. REG. NOS. 306,582, 868,474 AND 1,949,067.

CLASS 1—CHEMICALS

FOR DESCALING PREPARATIONS FOR INDUSTRIAL PURPOSES; WATER SOFTENING CHEMICALS (U.S. CLS. 1, 5, 6, 10, 26 AND 46).

CLASS 3—COSMETICS AND CLEANING PREPARATIONS

FOR LAUNDRY PREPARATIONS, NAMELY, LAUNDRY BLEACH, LAUNDRY DETERGENT, LAUNDRY SOAP, FABRIC SOFTENERS FOR LAUNDRY USE; STAIN REMOVERS; DECALCIFYING AND DESCALING PREPARATIONS FOR CLEANING HOUSEHOLD PRODUCTS (U.S. CLS. 1, 4, 6, 50, 51 AND 52).

CLASS 11—ENVIRONMENTAL CONTROL APPARATUS

FOR FILTERING UNITS FOR WATER DECALCIFYING AND DESCALING FOR DOMESTIC USE; WATER FILTERS; WATER SOFTENING UNITS; FILTERS MADE OF FIBER FOR WATER PURIFICATION AND WATER SOFTENING FOR HOUSEHOLD USE; WATER TREATMENT EQUIPMENT, NAMELY CARTRIDGE FILTRATION UNITS (U.S. CLS. 13, 21, 23, 31 AND 34).
ROBERT STRUCK, EXAMINING ATTORNEY

SN 78-786,367. CALGON CORPORATION, NAPERVILLE, IL.
FILED 1-6-2006.

CALGON PROTECTION

THE MARK CONSISTS OF STANDARD CHARACTERS WITHOUT CLAIM TO ANY PARTICULAR FONT, STYLE, SIZE, OR COLOR.

OWNER OF U.S. REG. NOS. 306,582, 868,474 AND 1,949,067.

NO CLAIM IS MADE TO THE EXCLUSIVE RIGHT TO USE "PROTECTION", APART FROM THE MARK AS SHOWN.

CLASS 1—CHEMICALS

FOR DESCALING PREPARATIONS FOR INDUSTRIAL PURPOSES; WATER SOFTENING CHEMICALS (U.S. CLS. 1, 5, 6, 10, 26 AND 46).

CLASS 3—COSMETICS AND CLEANING PREPARATIONS

FOR LAUNDRY PREPARATIONS, NAMELY, LAUNDRY BLEACH, LAUNDRY DETERGENT, LAUNDRY SOAP, FABRIC SOFTENERS FOR LAUNDRY USE; STAIN REMOVERS; DECALCIFYING AND DESCALING PREPARATIONS FOR CLEANING HOUSEHOLD PRODUCTS (U.S. CLS. 1, 4, 6, 50, 51 AND 52).
ROBERT STRUCK, EXAMINING ATTORNEY

SN 78-786,379. JOSÉ ANDRÉS CORPORATION, WASHINGTON, DC. FILED 1-6-2006.

JOSÉ ANDRÉS

THE MARK CONSISTS OF STANDARD CHARACTERS WITHOUT CLAIM TO ANY PARTICULAR FONT, STYLE, SIZE, OR COLOR.

THE NAME(S), PORTRAIT(S), AND/OR SIGNATURE(S) SHOWN IN THE MARK IDENTIFIES JOSÉ ANDRÉS, WHOSE CONSENT(S) TO REGISTER IS SUBMITTED.

CLASS 8—HAND TOOLS

FOR KNIVES, NAMELY, CHEF KNIVES, CARVING KNIVES, HOUSEHOLD KNIVES, PARING KNIVES, TABLE KNIVES, VEGETABLE KNIVES, THIN BLADED KITCHEN KNIVES (U.S. CLS. 23, 28 AND 44).

CLASS 16—PAPER GOODS AND PRINTED MATTER

FOR PAPER, CARDBOARD GOODS MADE FROM THESE MATERIALS, NAMELY, NAPKINS, GREETING CARDS, STATIONERY, INVITATIONS, NOTE CARDS, NOTE PADS, PLACE CARDS, POSTCARDS; NEWSLETTERS IN THE FIELDS OF COOKING AND ENTERTAINMENT; AND MAILING LABELS; PRINTED MATTER, NAMELY, BOOKS IN THE FIELDS OF COOKING AND ENTERTAINMENT; CALENDARS, NOTECARDS AND RECIPE JOURNALS (U.S. CLS. 2, 5, 22, 23, 29, 37, 38 AND 50).

CLASS 21—HOUSEWARES AND GLASS

FOR HOUSEHOLD OR KITCHEN UTENSILS AND CONTAINERS NOT OF PRECIOUS METAL OR COATED THEREWITH, NAMELY, KNIFE BLOCKS, KITCHEN SERVING TONGS, SPATULAS, TURNERS, WHISKS, POTATO MASHERS, GARLIC PRESSES, LADLES, GRATERS, SPLATTER SCREENS, STRAINERS, BOWLS, CANISTER SETS, COLANDERS, STORAGE CONTAINERS FOR FOOD AND BEVERAGES, CORKSCREWS, COOKIE SHEETS, AND POTS AND PANS; BEVERAGE GLASSWARE AND STEMWARE; PORCELAIN AND EARTHENWARE NOT INCLUDED IN OTHER CLASSES, NAMELY, DINNERWARE, PLATES, SAUCERS, SERVING DISHES, COFFEE CUPS, AND CHARGER PLATES (U.S. CLS. 2, 13, 23, 29, 30, 33, 40 AND 50).

CLASS 25—CLOTHING

FOR CLOTHING, NAMELY, T-SHIRTS, APRONS, SWEATSHIRTS, SHIRTS, JACKETS; FOOTWEAR, AND HEADWEAR (U.S. CLS. 22 AND 39).

CLASS 29—MEATS AND PROCESSED FOODS

FOR MEAT, FISH, POULTRY AND GAME; MEAT EXTRACTS; PRESERVED, DRIED AND COOKED FRUITS AND VEGETABLES; JELLIES, JAMS, FRUIT SAUCES; EGGS, MILK AND MILK PRODUCTS EXCLUDING ICE CREAM, ICE MILK AND FROZEN YOGURT; EDIBLE OILS AND FATS AND OTHER FOOD PRODUCTS, NAMELY, OLIVE OIL AND SOUP MIXES (U.S. CL. 46).

CLASS 30—STAPLE FOODS

FOR COFFEE, TEA, COCOA, SUGAR, RICE, TAPIOCA, SAGO, ARTIFICIAL COFFEE; FLOUR AND PREPARATIONS MADE FROM CEREALS, NAMELY, SNACKS, READY TO EAT CEREALS, BREAKFAST FOOD, SNACK FOR OR INGREDIENT FOR MAKING OTHER FOODS, BREAD, PASTRY AND CONFECTIONERY CHIPS; ICES; HONEY, TREACLE; YEAST, BAKING-POWDER; SALT, MUSTARD; VINEGAR; CONDIMENTS, NAMELY, SAUCES AND SPICES; ICE AND OTHER FOOD PRODUCTS, NAMELY, SALAD DRESSINGS, CANDY, BAKERY GOODS, SNACKS, COOKIES, CRACKERS, PASTA, PANCAKE MIXES, CAKE MIXES, MIXES IN THE NATURE OF CONCENTRATES, SYRUPS OR POWDERS USED IN THE PREPARATION OF TEA BASED BEVERAGES; SYRUPS USED IN THE PREPARATION OF FOODS; VINEGARS, ICE CREAM, ICE MILK AND FROZEN YOGURT (U.S. CL. 46).

CLASS 41—EDUCATION AND ENTERTAINMENT

FOR EDUCATIONAL SERVICES, NAMELY, DEVELOPING, ARRANGING, AND CONDUCTING EDUCATIONAL CONFERENCES AND PROGRAMS IN THE FIELDS OF COOKING AND ENTERTAINMENT; ENTERTAINMENT SERVICES IN THE NATURE OF AN ON-GOING TELEVISION PROGRAM IN THE FIELDS OF COOKING AND ENTERTAINMENT (U.S. CLS. 100, 101 AND 107).

CLASS 43—HOTEL AND RESTAURANT SERVICES

FOR SERVICES FOR PROVIDING FOOD AND DRINK (U.S. CLS. 100 AND 101).
ZACHARY BELLO, EXAMINING ATTORNEY

SN 78-788,716. KATHARINE HAMNETT HOLDINGS LIMITED, ST. HELIER, JERSEY, FILED 1-10-2006.

KATHARINE HAMNETT

THE MARK CONSISTS OF STANDARD CHARACTERS WITHOUT CLAIM TO ANY PARTICULAR FONT, STYLE, SIZE, OR COLOR.

OWNER OF U.S. REG. NO. 1,401,295.

THE NAME "KATHARINE HAMNETT" IDENTIFIES A LIVING INDIVIDUAL WHOSE CONSENT IS OF RECORD.

CLASS 9—ELECTRICAL AND SCIENTIFIC APPARATUS

FOR SPECTACLES AND THEIR PARTS AND ACCESSORIES, NAMELY, SPECTACLE FRAMES, BOWS AND CASES, LENSES AND LENS MOUNTS; PINCE-NEZ, GLASSES, EYE-GLASSES, EYE-PIECES, EYE-SHADES, SUNGLASSES, GOGGLES FOR SPORTS, SWIMMING GOGGLES, CONTACT LENSES; CORDS AND CHAINS FOR SPECTACLES AND EYEGLASSES (U.S. CLS. 21, 23, 26, 36 AND 38).

CLASS 14—JEWELRY

FOR JEWELRY; WATCHES, CLOCKS, HOROLOGICAL AND CHRONOMETRIC INSTRUMENTS (U.S. CLS. 2, 27, 28 AND 50).

CLASS 25—CLOTHING

FOR CLOTHING, NAMELY, LINGERIE AND NECKWEAR; BELTS; FOOTWEAR, HATS AND CAPS (U.S. CLS. 22 AND 39).

CIMMERIAN COLEMAN, EXAMINING ATTORNEY

SN 78-788,750. O.C. TANNER COMPANY, SALT LAKE CITY, UT. FILED 1-10-2006.

CARROT CULTURE

THE MARK CONSISTS OF STANDARD CHARACTERS WITHOUT CLAIM TO ANY PARTICULAR FONT, STYLE, SIZE, OR COLOR.

CLASS 9—ELECTRICAL AND SCIENTIFIC APPARATUS

FOR VIDEO DISCS AND VIDEO TAPES IN THE FIELD OF RECOGNITION AND INCENTIVE AWARD PRESENTATION TRAINING INCLUDING THE FORMAL AND INFORMAL USE OF RECOGNITION TECHNIQUES AND HELP IN IMPROVING THE EFFECTIVENESS OF AWARD PRESENTATIONS, SOLD EXCLUSIVELY THROUGH PROPRIETARY SEMINARS, WORKSHOPS, OR CLASSES (U.S. CLS. 21, 23, 26, 36 AND 38).
FIRST USE 10-31-2005; IN COMMERCE 10-31-2005.

CLASS 16—PAPER GOODS AND PRINTED MATTER

FOR PRINTED TRAINING MATERIALS, CERTIFICATES, CARDS, AND OTHER COMMUNICATION MATERIALS NAMELY MANUALS FOR USE WITH RECOGNITION AND INCENTIVE AWARD PROGRAMS, NAMELY EMPLOYEE ACHIEVEMENT, PRODUCTIVITY, PERFORMANCE, SALES, SERVICE, CUSTOMER SATISFACTION, QUALITY, SAFETY, RETIREMENT, EVENT, AND OTHER RECOGNITION AND INCENTIVE AWARD PROGRAMS; PRINTED TRAINING MATERIALS IN THE FIELD OF RECOGNITION AND INCENTIVE AWARD PRESENTATION TRAINING INCLUDING THE FORMAL AND INFORMAL USE OF RECOGNITION TECHNIQUES AND HELP IN IMPROVING THE EFFECTIVENESS OF AWARD PRESENTATIONS; CUSTOM DESIGNED AND PRINTED TRAINING MATERIALS IN THE FIELD OF RECOGNITION AND INCENTIVE AWARD PRESENTATION TRAINING WHICH INCORPORATE THE PURCHASER'S LOGOS OR SYMBOLS, WHEREIN THESE PRINTED MATERIALS ARE SOLD EXCLUSIVELY THROUGH PROPRIETARY SEMINARS, WORKSHOPS, OR CLASSES (U.S. CLS. 2, 5, 22, 23, 29, 37, 38 AND 50).
FIRST USE 10-31-2005; IN COMMERCE 10-31-2005.

CLASS 41—EDUCATION AND ENTERTAINMENT

FOR EDUCATIONAL SERVICES, NAMELY, CONDUCTING CLASSES, SEMINARS, WORKSHOPS AND ON-LINE CLASSES AND WORKSHOPS IN THE FIELD OF RECOGNITION AND INCENTIVE AWARD PRESENTATION TRAINING INCLUDING THE FORMAL AND INFORMAL USE OF RECOGNITION TECHNIQUES AND HELP IN IMPROVING THE EFFECTIVENESS OF AWARD PRESENTATIONS; PROVIDING NEWSLETTERS IN THE FIELD OF RECOGNITION AND INCENTIVE AWARD PROGRAMS VIA E-MAIL (U.S. CLS. 100, 101 AND 107).

FIRST USE 7-13-2005; IN COMMERCE 7-13-2005.
KELLY CHOE, EXAMINING ATTORNEY

SN 78-788,799. O.C. TANNER COMPANY, SALT LAKE CITY, UT. FILED 1-10-2006.

SN 78-791,712. DOERAYME, INC., COLUMBUS, OH. FILED 1-13-2006.



THE COLOR(S) ORANGE AND GREEN IS/ARE CLAIMED AS A FEATURE OF THE MARK.

THE MARK CONSISTS OF A STYLIZED CARROT IMAGE WITH A GREEN TOP AND AN ORANGE BODY.

CLASS 9—ELECTRICAL AND SCIENTIFIC APPARATUS

FOR VIDEO DISCS AND VIDEO TAPES IN THE FIELD OF RECOGNITION AND INCENTIVE AWARD PRESENTATION TRAINING INCLUDING THE FORMAL AND INFORMAL USE OF RECOGNITION TECHNIQUES AND HELP IN IMPROVING THE EFFECTIVENESS OF AWARD PRESENTATIONS, SOLD EXCLUSIVELY THROUGH PROPRIETARY SEMINARS, WORKSHOPS, OR CLASSES (U.S. CLS. 21, 23, 26, 36 AND 38).

FIRST USE 10-31-2005; IN COMMERCE 10-31-2005.

CLASS 16—PAPER GOODS AND PRINTED MATTER

FOR PRINTED TRAINING MATERIALS, CERTIFICATES, CARDS, AND OTHER COMMUNICATION MATERIALS NAMELY MANUALS FOR USE WITH RECOGNITION AND INCENTIVE AWARD PROGRAMS, NAMELY EMPLOYEE ACHIEVEMENT, PRODUCTIVITY, PERFORMANCE, SALES, SERVICE, CUSTOMER SATISFACTION, QUALITY, SAFETY, RETIREMENT, EVENT, AND OTHER RECOGNITION AND INCENTIVE AWARD PROGRAMS; PRINTED TRAINING MATERIALS IN THE FIELD OF RECOGNITION AND INCENTIVE AWARD PRESENTATION TRAINING INCLUDING THE FORMAL AND INFORMAL USE OF RECOGNITION TECHNIQUES AND HELP IN IMPROVING THE EFFECTIVENESS OF AWARD PRESENTATIONS; CUSTOM DESIGNED AND PRINTED TRAINING MATERIALS IN THE FIELD OF RECOGNITION AND INCENTIVE AWARD PRESENTATION TRAINING WHICH INCORPORATE THE PURCHASER'S LOGOS OR SYMBOLS, WHEREIN THESE PRINTED MATERIALS ARE SOLD EXCLUSIVELY THROUGH PROPRIETARY SEMINARS, WORKSHOPS, OR CLASSES (U.S. CLS. 2, 5, 22, 23, 29, 37, 38 AND 50).

FIRST USE 10-31-2005; IN COMMERCE 10-31-2005.

CLASS 41—EDUCATION AND ENTERTAINMENT

FOR EDUCATIONAL SERVICES, NAMELY, CONDUCTING CLASSES, SEMINARS, WORKSHOPS AND ON-LINE CLASSES AND WORKSHOPS IN THE FIELD OF RECOGNITION AND INCENTIVE AWARD PRESENTATION TRAINING INCLUDING THE FORMAL AND INFORMAL USE OF RECOGNITION TECHNIQUES AND HELP IN IMPROVING THE EFFECTIVENESS OF AWARD PRESENTATIONS; PROVIDING NEWSLETTERS IN THE FIELD OF RECOGNITION AND INCENTIVE AWARD PROGRAMS VIA E-MAIL (U.S. CLS. 100, 101 AND 107).

FIRST USE 7-13-2005; IN COMMERCE 7-13-2005.
KELLY CHOE, EXAMINING ATTORNEY

doe·ray·me

CLASS 11—ENVIRONMENTAL CONTROL APPARATUS

FOR LIGHTING APPARATUS, NAMELY, LAMPS, ELECTRIC NIGHT LIGHTS (U.S. CLS. 13, 21, 23, 31 AND 34).

CLASS 16—PAPER GOODS AND PRINTED MATTER

FOR PAPER AND CARDBOARD; GOODS MADE FROM PAPER AND CARDBOARD, NAMELY, KEEP SAKE BOXES, FLASH CARDS, HANG TAGS, PHOTO ALBUMS (U.S. CLS. 2, 5, 22, 23, 29, 37, 38 AND 50).

CLASS 18—LEATHER GOODS

FOR BAGS, NAMELY, DIAPER BAGS, INFANT CARRIERS WORN ON THE BODY, PET CLOTHING BAGS, PET ACCESSORIES BAGS, ORGANIZERS, CARRY-ALL BAGS, COSMETIC BAGS SOLD EMPTY, TRAVEL BAGS, COOLER BAGS, BACKPACKS (U.S. CLS. 1, 2, 3, 22 AND 41).

CLASS 24—FABRICS

FOR TEXTILES, NAMELY, BED SHEETS AND BLANKETS FOR INFANT AND TODDLER BEDS, CRIB BUMPERS, FITTED CRIB SHEETS, COMFORTERS, DUST RUFFLES, DIAPER CHANGING PAD COVERS, BURP CLOTHS, DIAPER CHANGING MATS, DIAPER STACKERS, DUVETS, DUVET COVERS, RECEIVING BLANKETS, PET BLANKETS, VALANCES (U.S. CLS. 22 AND 50).

CLASS 25—CLOTHING

FOR CLOTHING, NAMELY, SWADDLING CLOTHES, LAYETTES, CLOTH BIBS; HEADWEAR; FOOTWEAR (U.S. CLS. 22 AND 39).

CLASS 28—TOYS AND SPORTING GOODS

FOR GAMES AND PLAYTHINGS, NAMELY, MOBILES, PLUSH TOYS AND DOLLS (U.S. CLS. 22, 23, 38 AND 50).

TIMOTHY FINNEGAN, EXAMINING ATTORNEY

SN 78-791,921. VILLA FURNITURE MANUFACTURING COMPANY, CERRITOS, CA. FILED 1-14-2006.

VILLA

THE MARK CONSISTS OF STANDARD CHARACTERS WITHOUT CLAIM TO ANY PARTICULAR FONT, STYLE, SIZE, OR COLOR.

CLASS 12—VEHICLES

FOR VEHICLE SEATS, NAMELY, SEATS FOR RECREATIONAL VEHICLES, TRAILERS AND YACHTS; VEHICLE PASSENGER SEATS AND VEHICLE DRIVER SEATS; ACCESSORIES FOR RECREATIONAL VEHICLES, TRAILERS AND YACHTS, NAMELY, STRUCTURAL FURNITURE, NAMELY, DINETTES, TABLES, SOFAS, SLEEPER SOFAS, RECLINERS, LOUNGES, J-LOUNGES, CHAIRS, SEATS, AND FURNITURE ENSEMBLES (U.S. CLS. 19, 21, 23, 31, 35 AND 44).

FIRST USE 12-31-1955; IN COMMERCE 12-31-1955.

CLASS 20—FURNITURE AND ARTICLES NOT OTHERWISE CLASSIFIED

FOR NON-STRUCTURAL FURNITURE FOR RECREATIONAL VEHICLES, TRAILER AND YACHTS; NON-STRUCTURAL FURNITURE AND ACCESSORIES, NAMELY, DINETTES, TABLES, SOFAS, SLEEPER SOFAS, RECLINERS, LOUNGES, J-LOUNGES, CHAIRS, AND FURNITURE ENSEMBLES FOR RECREATIONAL VEHICLES, TRAILERS AND YACHTS (U.S. CLS. 2, 13, 22, 25, 32 AND 50).

FIRST USE 12-31-1955; IN COMMERCE 12-31-1955.
JENNIFER VASQUEZ, EXAMINING ATTORNEY

SN 78-791,929. VILLA FURNITURE MANUFACTURING COMPANY, CERRITOS, CA. FILED 1-14-2006.

VILLA INTERNATIONAL

THE MARK CONSISTS OF STANDARD CHARACTERS WITHOUT CLAIM TO ANY PARTICULAR FONT, STYLE, SIZE, OR COLOR.

NO CLAIM IS MADE TO THE EXCLUSIVE RIGHT TO USE "INTERNATIONAL", APART FROM THE MARK AS SHOWN.

CLASS 12—VEHICLES

FOR VEHICLE SEATS, NAMELY, SEATS FOR RECREATIONAL VEHICLES, TRAILERS AND YACHTS; VEHICLE PASSENGER SEATS AND VEHICLE DRIVER SEATS; ACCESSORIES FOR RECREATIONAL VEHICLES, TRAILERS AND YACHTS, NAMELY, STRUCTURAL FURNITURE, NAMELY, DINETTES, TABLES, SOFAS, SLEEPER SOFAS, RECLINERS, LOUNGES, J-LOUNGES, CHAIRS, SEATS, AND FURNITURE ENSEMBLES (U.S. CLS. 19, 21, 23, 31, 35 AND 44).

FIRST USE 0-0-1955; IN COMMERCE 0-0-1955.

CLASS 20—FURNITURE AND ARTICLES NOT OTHERWISE CLASSIFIED

FOR NON-STRUCTURAL FURNITURE FOR RECREATIONAL VEHICLES, TRAILER AND YACHTS; NON-STRUCTURAL FURNITURE AND ACCESSORIES, NAMELY, DINETTES, TABLES, SOFAS, SLEEPER SOFAS, RECLINERS, LOUNGES, J-LOUNGES, CHAIRS, AND FURNITURE ENSEMBLES FOR RECREATIONAL VEHICLES, TRAILERS AND YACHTS (U.S. CLS. 2, 13, 22, 25, 32 AND 50).

FIRST USE 0-0-1955; IN COMMERCE 0-0-1955.
JENNIFER VASQUEZ, EXAMINING ATTORNEY

SN 78-792,575. CHRISTOPHER CASAMASSA, POMONA, CA. FILED 1-16-2006.

**LOU CASAMASSA'S RED DRAGON
KARATE**

THE MARK CONSISTS OF STANDARD CHARACTERS WITHOUT CLAIM TO ANY PARTICULAR FONT, STYLE, SIZE, OR COLOR.

NO CLAIM IS MADE TO THE EXCLUSIVE RIGHT TO USE "KARATE", APART FROM THE MARK AS SHOWN.

THE NAME(S), PORTRAIT(S), AND/OR SIGNATURE(S) SHOWN IN THE MARK IDENTIFIES A LIVING INDIVIDUAL, WHOSE CONSENT(S) TO REGISTER IS SUBMITTED.

CLASS 25—CLOTHING

FOR CLOTHING, NAMELY SWEAT BANDS, HEADGEAR, NAMELY HATS, AND CAPS, JACKETS, KARATE SUITS, SWEAT PANTS, SWEAT SHIRTS, WARM-UP SUITS, JOGGING CLOTHES, T-SHIRTS, AND FOOTWEAR (U.S. CLS. 22 AND 39).

FIRST USE 2-1-1973; IN COMMERCE 2-1-1973.

CLASS 41—EDUCATION AND ENTERTAINMENT

FOR MARTIAL ARTS INSTRUCTION; OPERATING OF MARTIAL ARTS' SCHOOLS (U.S. CLS. 100, 101 AND 107).

FIRST USE 2-1-1973; IN COMMERCE 2-1-1973.
ANDREA K. NADELMAN, EXAMINING ATTORNEY

SN 78-792,740. ADMINISTRADORA DE MARCAS RD, S. DE R.L. DE C.V., CH-6301 ZUG, SWITZERLAND, FILED 1-17-2006.

RELOAD TELCEL

THE MARK CONSISTS OF STANDARD CHARACTERS WITHOUT CLAIM TO ANY PARTICULAR FONT, STYLE, SIZE, OR COLOR.

OWNER OF U.S. REG. NO. 1,474,007.

CLASS 9—ELECTRICAL AND SCIENTIFIC APPARATUS

FOR TELECOMMUNICATION PRODUCTS, NAMELY TELEPHONES, CELLULAR TELEPHONES AND TELEPHONE ANSWERING MACHINES; APPARATUS FOR RECORDING, TRANSMISSION, REPRODUCTION OF SOUND OR IMAGES, NAMELY, PHONOGRAPH RECORD, CD AND DVD PLAYERS, AUDIO AND VIDEO TAPE RECORDERS; BLANK AUDIO AND VIDEO TAPES AND CDS; STEREO RECEIVERS, AMPLIFIERS, AND TUNERS; BLANK MAGNETIC DATA CARRIERS, DATA PROCESSORS AND COMPUTERS; COMPUTER HARDWARE, NAMELY, MEMORY CARDS, MODEMS, COMPUTER INTERFACE BOARDS, BLANK MAGNETIC COMPUTER TAPES, FAX MACHINES, FIBER OPTIC CABLES, COMPUTER AND ELECTRIC CABLES, OPTICAL CHARACTER RECOGNITION APPARATUS, BLANK OPTICAL DISCS, OPTICAL SCANNERS, MAGNETIC CODED CARDS FOR PREPAID TELECOMMUNICATIONS SERVICES; SATELLITES, BLANK DIGITAL OPTICAL DISKS, COMPUTER KEYBOARDS, PROCESS COMPUTERS, COMPUTERS FOR DATA AND WORD PROCESSING, COMPUTER TERMINALS, COMPUTER PRINTERS, COMPUTER MONITORS, INTEGRATED CIRCUITS AND COMPONENTS, NAMELY COMPUTER CHIPS; ELECTRONIC CIRCUIT BOARDS, ELECTRONIC NOTICE BOARDS, INTEGRATED CIRCUIT CARDS (U.S. CLS. 21, 23, 26, 36 AND 38).

CLASS 38—COMMUNICATION

FOR TELECOMMUNICATION SERVICES, NAMELY, PERSONAL COMMUNICATION SERVICES; TELE-MATIC SERVICES, NAMELY, TELECOMMUNICATION SERVICES, NAMELY PROVISION OF MOBILE TELECOMMUNICATIONS SERVICES NAMELY, VOICE AND DATA TRANSMISSIONS, ACCESSIBLE BY ACCESS CODE OR TERMINALS, TELEPHONE, TELEVISION, RADIO AND TELEPRINTER; ELECTRONIC TRANSMISSION OF MESSAGES AND CODED IMAGES; ELECTRONIC TRANSMISSION OF MESSAGE AND DATA; WIRELESS DIGITAL MESSAGING SERVICES, ELECTRONIC STORE-AND-FORWARD MESSAGING, ELECTRONIC TRANSMISSION OF DATA AND DOCUMENTS VIA COMPUTER TERMINALS, COMPUTER TELECOMMUNICATIONS, NAMELY PROVIDING MULTIPLE USER ACCESS TO THE INTERNET, FACSIMILE TRANSMISSION, ELECTRONIC MAIL SERVICES, TELEPHONE COMMUNICATION SERVICES (U.S. CLS. 100, 101 AND 104).

MICHAEL KEATING, EXAMINING ATTORNEY

CLASS 9—ELECTRICAL AND SCIENTIFIC APPARATUS

FOR TELECOMMUNICATION PRODUCTS, NAMELY TELEPHONES, CELLULAR TELEPHONES AND TELEPHONE ANSWERING MACHINES; APPARATUS FOR RECORDING, TRANSMISSION, REPRODUCTION OF SOUND OR IMAGES, NAMELY, PHONOGRAPH RECORD, CD AND DVD PLAYERS, AUDIO AND VIDEO TAPE RECORDERS; BLANK AUDIO AND VIDEO TAPES AND CDS; STEREO RECEIVERS, AMPLIFIERS, AND TUNERS; BLANK MAGNETIC DATA CARRIERS, DATA PROCESSORS AND COMPUTERS; COMPUTER HARDWARE, NAMELY, MEMORY CARDS, MODEMS, COMPUTER INTERFACE BOARDS, BLANK MAGNETIC COMPUTER TAPES, FAX MACHINES, FIBER OPTIC CABLES, COMPUTER AND ELECTRIC CABLES, OPTICAL CHARACTER RECOGNITION APPARATUS, BLANK OPTICAL DISCS, OPTICAL SCANNERS, MAGNETIC CODED CARDS FOR PREPAID TELECOMMUNICATIONS SERVICES; SATELLITES, BLANK DIGITAL OPTICAL DISKS, COMPUTER KEYBOARDS, PROCESS COMPUTERS, COMPUTERS FOR DATA AND WORD PROCESSING, COMPUTER TERMINALS, COMPUTER PRINTERS, COMPUTER MONITORS, INTEGRATED CIRCUITS AND COMPONENTS, NAMELY COMPUTER CHIPS; ELECTRONIC CIRCUIT BOARDS, ELECTRONIC NOTICE BOARDS, INTEGRATED CIRCUIT CARDS (U.S. CLS. 21, 23, 26, 36 AND 38).

CLASS 38—COMMUNICATION

FOR TELECOMMUNICATION SERVICES, NAMELY, PERSONAL COMMUNICATION SERVICES; TELE-MATIC SERVICES, NAMELY, TELECOMMUNICATION SERVICES, NAMELY PROVISION OF MOBILE TELECOMMUNICATIONS SERVICES NAMELY, VOICE AND DATA TRANSMISSIONS, ACCESSIBLE BY ACCESS CODE OR TERMINALS, TELEPHONE, TELEVISION, RADIO AND TELEPRINTER; ELECTRONIC TRANSMISSION OF MESSAGES AND CODED IMAGES; ELECTRONIC TRANSMISSION OF MESSAGE AND DATA; WIRELESS DIGITAL MESSAGING SERVICES, ELECTRONIC STORE-AND-FORWARD MESSAGING, ELECTRONIC TRANSMISSION OF DATA AND DOCUMENTS VIA COMPUTER TERMINALS, COMPUTER TELECOMMUNICATIONS, NAMELY PROVIDING MULTIPLE USER ACCESS TO THE INTERNET, FACSIMILE TRANSMISSION, ELECTRONIC MAIL SERVICES, TELEPHONE COMMUNICATION SERVICES (U.S. CLS. 100, 101 AND 104).

MICHAEL KEATING, EXAMINING ATTORNEY

SN 78-793,064. ADMINISTRADORA DE MARCAS RD. S. DE R.L. DE C.V., CH-6301 ZUG, SWITZERLAND, FILED 1-17-2006.

SN 78-796,262. THOMSON, BOULOGNE-BILLANCOURT, FRANCE, FILED 1-20-2006.

TELCEL TV

IMAGE AND BEYOND

THE MARK CONSISTS OF STANDARD CHARACTERS WITHOUT CLAIM TO ANY PARTICULAR FONT, STYLE, SIZE, OR COLOR.

OWNER OF U.S. REG. NO. 1,474,007.

NO CLAIM IS MADE TO THE EXCLUSIVE RIGHT TO USE "TV", APART FROM THE MARK AS SHOWN.

THE MARK CONSISTS OF STANDARD CHARACTERS WITHOUT CLAIM TO ANY PARTICULAR FONT, STYLE, SIZE, OR COLOR.

PRIORITY CLAIMED UNDER SEC. 44(D) ON FRANCE APPLICATION NO. 053373695, FILED 8-2-2005, REG. NO. 053373695, DATED 8-2-2005, EXPIRES 8-2-2015.

CLASS 9—ELECTRICAL AND SCIENTIFIC APPARATUS

FOR APPARATUS FOR RECORDING, EMISSION, TRANSMISSION, GENERATION, REPRODUCTION, TRANSFORMATION OF DATA, SOUND OR IMAGES; APPARATUS FOR COLLECTION AND PROCESSING OF SOUND OR IMAGES; MAGNETIC DATA CARRIERS; PHOTOGRAPHIC APPARATUS; DEVICES FOR THE ASSEMBLY OF CINEMATOGRAPHIC FILMS; DECODERS, ENCODERS; TELEVISION SCREENS, MULTIMEDIA SCREENS; APPARATUS FOR RECORDING OR REPRODUCTION OF TELEVISION SIGNALS ON DISCS; CAMERAS, VIDEO CAMERAS, TELEVISION AND CINEMA CAMERAS; VIDEO RECORDERS AND VIDEO CASSETTE RECORDERS; PLAYERS AND RECORDERS OF CASSETTES, COMPACT DISCS, AND DIGITAL AUDIO AND VIDEO DISCS; VIDEOGRAMS, NAMELY, BLANK CASSETTES, DISCS AND VIDEODISKS, AND PRE-RECORDED CASSETTES IN THE FIELDS OF MUSIC, VIDEO GAMES, AND MOVIES, PRE-RECORDED DISCS AND VIDEODISCS IN THE FIELDS OF MUSIC, VIDEO GAMES, AND MOVIES; ACOUSTIC DISKS, NAMELY, BLANK AND PRE-RECORDED COMPACT DISCS IN THE FIELD OF MUSIC; REMOTE CONTROLS FOR USE WITH AUDIO AND VIDEO CASSETTE PLAYERS AND RECORDERS, COMPACT DISC PLAYERS AND RECORDERS, DIGITAL AUDIO AND VIDEO DISC PLAYERS AND RECORDERS, AND HIGH FIDELITY STEREO SYSTEMS; HIGH FIDELITY SYSTEMS COMPRISED OF STEREO TUNERS, STEREO RECEIVERS, STEREO SPEAKERS, COMPACT DISC PLAYERS AND RECORDERS, AUDIO AND VIDEOTAPE CASSETTE PLAYERS AND RECORDERS, DIGITAL VIDEO DISK PLAYERS AND RECORDERS, RADIOS, VIDEO TRANSMITTERS, AND ACOUSTIC AMPLIFIERS; COMBINATION RADIOS AND CASSETTE RECORDERS; ACOUSTIC SPEAKERS; AMPLIFIERS; TAPE RECORDERS; PERSONAL STEREO; HEADPHONES AND CORDLESS HEADPHONES; TELEPHONES AND CORDLESS TELEPHONES; TELEPHONE ANSWERING MACHINES; DICTAPHONES; RADIOELECTRIC ANTENNAE, NAMELY, TELEVISION AERIAL ANTENNAS AND SATELLITE DISHES; VIDEO TRANSMITTERS; MIXERS; VIDEO SERVERS; SOFTWARE ALLOWING TO ENCODE AND TO DECODE AUDIO AND VIDEO DATA; ELECTRIC WIRES AND CABLES AND IN PARTICULAR COAXIAL CABLES; SCREENS FOR PHOTOGRAPHIC OR CINEMATOGRAPHIC PROJECTION (U.S. CLS. 21, 23, 26, 36 AND 38).

CLASS 35—ADVERTISING AND BUSINESS

FOR ADVERTISING AND BUSINESS SERVICES IN THE FIELDS OF MEDIA AND ENTERTAINMENT, NAMELY, BUSINESS MANAGEMENT AND CONSULTATION, INTERACTIVE ADVERTISING; DOCUMENT REPRODUCTION SERVICES (U.S. CLS. 100, 101 AND 102).

CLASS 38—COMMUNICATION

FOR COMMUNICATIONS SERVICES IN THE FIELDS OF MEDIA AND ENTERTAINMENT, NAMELY, TRANSMISSION OF SOUNDS, PICTURES, AND DATA VIA SATELLITE, CABLE, AND AERIAL; TRANSMISSION OF INFORMATION VIA ELECTRONIC COMMUNICATIONS NETWORKS (U.S. CLS. 100, 101 AND 104).

CLASS 41—EDUCATION AND ENTERTAINMENT

FOR ENTERTAINMENT SERVICES IN THE FIELD OF THE MEDIA, NAMELY, MOTION PICTURE FILM PRODUCTION; PRODUCTION AND ASSEMBLY OF TELEVISUAL PROGRAMS, NAMELY, FILM AND VIDEO EDITING, AND CINEMATOGRAPHIC ADAPTATION AND EDITING; RENTAL OF AUDIOVISUAL APPARATUS, NAMELY, VIDEOCASSETTE RECORDERS, DVD PLAYERS, MOVIE PROJECTORS, AND ACCESSORIES FOR THOSE GOODS; SOUND RECORDING STUDIO SERVICES, CINEMA STUDIOS (U.S. CLS. 100, 101 AND 107).

GIANCARLO CASTRO, EXAMINING ATTORNEY

SN 78-800,761. DONALD L. ROGERS, TUCSON, AZ. FILED 1-27-2006.

BANDALERO RANCH

THE MARK CONSISTS OF STANDARD CHARACTERS WITHOUT CLAIM TO ANY PARTICULAR FONT, STYLE, SIZE, OR COLOR.

NO CLAIM IS MADE TO THE EXCLUSIVE RIGHT TO USE "RANCH", APART FROM THE MARK AS SHOWN.

CLASS 18—LEATHER GOODS

FOR PADS FOR HORSE SADDLES; RIDING SADDLES; SADDLE BELTS; SADDLE COVERS; SADDLE RACKS; SADDLES; HORSE BRIDLES, BITS (HARNESS); BITS FOR ANIMALS; HORSE BLANKETS; BLINDERS FOR HORSES; BLINKERS FOR HORSES; GAITERS, NAMELY JUMPING BOOTS FOR HORSES; HORSE COLLARS; HORSE FLANKS AND SHANKS, NAMELY HORSE PROTECTIVE PADDING, BRACES AND LEG BOOTS FOR THE FLANKS AND LEGS; HORSE HALTERS (U.S. CLS. 1, 2, 3, 22 AND 41).

CLASS 21—HOUSEWARES AND GLASS

FOR HORSE BRUSHES; MANE BRUSHES; HORSE COMBS (U.S. CLS. 2, 13, 23, 29, 30, 33, 40 AND 50).

CLASS 25—CLOTHING

FOR CLOTHING, NAMELY T-SHIRTS, SHIRTS, JACKETS, HATS, BOOTS (U.S. CLS. 22 AND 39).

CLASS 41—EDUCATION AND ENTERTAINMENT

FOR HORSE SHOWS; RECREATIONAL SERVICES IN THE NATURE OF HORSEBACK RIDING FACILITIES; PROVIDING HORSEBACK RIDING LESSONS AND CLASSES; HORSEBACK RIDING CAMPS; HORSE TRAINING (U.S. CLS. 100, 101 AND 107).

CLASS 43—HOTEL AND RESTAURANT SERVICES

FOR STABLE SERVICES, NAMELY BOARDING FOR ANIMALS (U.S. CLS. 100 AND 101).

CLASS 44—MEDICAL, BEAUTY AND AGRICULTURAL SERVICES

FOR HORSE BREEDING AND STUD SERVICES; HORSE FARMS; FARRIER SERVICES, NAMELY SHOEING HORSES AND MAINTAINING HORSES' HOOVES; EQUINE PHYSICAL REHABILITATION SERVICES (U.S. CLS. 100 AND 101).

REBECCA SMITH, EXAMINING ATTORNEY

SN 78-801,225. PHILLIPS SCREW COMPANY, WAKEFIELD, MA. FILED S.R. 1-27-2006; AM. P.R. 1-27-2006.

DECKMATE PLUS

THE MARK CONSISTS OF STANDARD CHARACTERS WITHOUT CLAIM TO ANY PARTICULAR FONT, STYLE, SIZE, OR COLOR.

OWNER OF U.S. REG. NOS. 2,114,819 AND 2,222,327.

CLASS 6—METAL GOODS

FOR METAL FASTENERS, NAMELY, SCREWS, BOLTS, STUDS, RIVETS, AND METAL THREADED FASTENERS, NONE OF WHICH ARE MADE SPECIFICALLY FOR USE IN DECKING (U.S. CLS. 2, 12, 13, 14, 23, 25 AND 50).

CLASS 7—MACHINERY

FOR METAL TOOLS, NAMELY, BITS FOR POWER TOOLS AND POWER DRIVERS FOR DRIVING BOLTS, SCREWS, RIVETS AND OTHER FASTENERS HAVING RECESSED HEADS, NONE OF WHICH ARE MADE SPECIFICALLY FOR USE IN CONSTRUCTING DECKING (U.S. CLS. 13, 19, 21, 23, 31, 34 AND 35).

CLASS 8—HAND TOOLS

FOR METAL HAND TOOLS, NAMELY, BITS AND DRIVERS FOR DRIVING BOLTS, SCREWS, RIVETS AND OTHER FASTENERS HAVING RECESSED HEADS, NONE OF WHICH ARE MADE SPECIFICALLY FOR USE IN CONSTRUCTING DECKING (U.S. CLS. 23, 28 AND 44).

FRED CARL, EXAMINING ATTORNEY

SN 78-801,237. PHILLIPS SCREW COMPANY, WAKEFIELD, MA. FILED 1-27-2006.

DECKMATE II

THE MARK CONSISTS OF STANDARD CHARACTERS WITHOUT CLAIM TO ANY PARTICULAR FONT, STYLE, SIZE, OR COLOR.

OWNER OF U.S. REG. NOS. 2,114,819 AND 2,222,327.

CLASS 6—METAL GOODS

FOR METAL FASTENERS, NAMELY, SCREWS, BOLTS, STUDS, RIVETS, AND METAL THREADED FASTENERS, NONE OF WHICH ARE MADE SPECIFICALLY FOR USE IN DECKING (U.S. CLS. 2, 12, 13, 14, 23, 25 AND 50).

CLASS 7—MACHINERY

FOR METAL TOOLS, NAMELY, BITS FOR POWER TOOLS AND POWER DRIVERS FOR DRIVING BOLTS, SCREWS, RIVETS AND OTHER FASTENERS HAVING RECESSED HEADS, NONE OF WHICH ARE MADE SPECIFICALLY FOR USE IN CONSTRUCTING DECKING (U.S. CLS. 13, 19, 21, 23, 31, 34 AND 35).

CLASS 8—HAND TOOLS

FOR METAL HAND TOOLS, NAMELY, BITS AND DRIVERS FOR DRIVING BOLTS, SCREWS, RIVETS AND OTHER FASTENERS HAVING RECESSED HEADS, NONE OF WHICH ARE MADE SPECIFICALLY FOR USE IN CONSTRUCTING DECKING (U.S. CLS. 23, 28 AND 44).

FRED CARL, EXAMINING ATTORNEY

SN 78-801,495. VMIX MEDIA INC., SAN DIEGO, CA. FILED 1-27-2006.

VMIX

THE MARK CONSISTS OF STANDARD CHARACTERS WITHOUT CLAIM TO ANY PARTICULAR FONT, STYLE, SIZE, OR COLOR.

CLASS 35—ADVERTISING AND BUSINESS

FOR PROMOTION USING AUDIOVISUAL MEDIA VIA GLOBAL COMPUTER NETWORK (U.S. CLS. 100, 101 AND 102).

FIRST USE 10-0-2005; IN COMMERCE 10-0-2005.

CLASS 38—COMMUNICATION

FOR ELECTRONIC TRANSMISSION OF ENTERTAINMENT CONTENT, NAMELY MUSIC, FILM, PICTURES, VIDEO AND AUDIOVISUAL ENTERTAINMENT VIA GLOBAL COMPUTER NETWORK (U.S. CLS. 100, 101 AND 104).

FIRST USE 10-0-2005; IN COMMERCE 10-0-2005.

CLASS 41—EDUCATION AND ENTERTAINMENT

FOR ENTERTAINMENT SERVICES, NAMELY, PROVIDING A WEBSITE FEATURING VARIOUS SUBJECTS SUBMITTED BY OTHERS, SPECIFICALLY PHOTOGRAPHIC, AUDIO, VIDEO AND AUDIOVISUAL PRESENTATIONS, INCLUDING MUSICAL PERFORMANCES, MUSICAL VIDEOS, RELATED FILM CLIPS, PHOTOGRAPHS AND OTHER MULTIMEDIA MATERIALS, VIA GLOBAL COMPUTER NETWORK (U.S. CLS. 100, 101 AND 107).

FIRST USE 10-0-2005; IN COMMERCE 10-0-2005.

MICHAEL LEWIS, EXAMINING ATTORNEY

SN 78-801,503. VMIX MEDIA INC., SAN DIEGO, CA. FILED 1-27-2006.



THE MARK CONSISTS OF A STYLIZED DESIGN WITH A FULLY SHADED INNER CIRCLE SURROUNDED BY AN OUTER RING FROM WHICH TWO "WINGS" EXTEND OUTWARD, WITH THE WORD "VMIX" LOCATED DIRECTLY BELOW THE DESIGN ELEMENT.

CLASS 35—ADVERTISING AND BUSINESS

FOR PROMOTION USING AUDIOVISUAL MEDIA VIA GLOBAL COMPUTER NETWORK (U.S. CLS. 100, 101 AND 102).

FIRST USE 10-0-2005; IN COMMERCE 10-0-2005.

CLASS 38—COMMUNICATION

FOR ELECTRONIC TRANSMISSION OF ENTERTAINMENT CONTENT, NAMELY MUSIC, FILM, PICTURES, VIDEO AND AUDIOVISUAL ENTERTAINMENT VIA GLOBAL COMPUTER NETWORK (U.S. CLS. 100, 101 AND 104).

FIRST USE 10-0-2005; IN COMMERCE 10-0-2005.

CLASS 41—EDUCATION AND ENTERTAINMENT

FOR ENTERTAINMENT SERVICES, NAMELY, PROVIDING A WEBSITE FEATURING VARIOUS SUBJECTS SUBMITTED BY OTHERS, SPECIFICALLY PHOTOGRAPHIC, AUDIO, VIDEO AND AUDIOVISUAL PRESENTATIONS, INCLUDING MUSICAL PERFORMANCES, MUSICAL VIDEOS, RELATED FILM CLIPS, PHOTOGRAPHS AND OTHER MULTIMEDIA MATERIALS, VIA GLOBAL COMPUTER NETWORK (U.S. CLS. 100, 101 AND 107).

FIRST USE 10-0-2005; IN COMMERCE 10-0-2005.
MICHAEL LEWIS, EXAMINING ATTORNEY

SN 78-802,225. ADVINUS THERAPEUTICS PRIVATE LTD., BANGALORE 560 058, KARNATAKA STATE, INDIA, FILED 1-30-2006.

ADVINUS

THE MARK CONSISTS OF STANDARD CHARACTERS WITHOUT CLAIM TO ANY PARTICULAR FONT, STYLE, SIZE, OR COLOR.

CLASS 1—CHEMICALS

FOR CHEMICALS, BIOLOGICALS AND BIO-CHEMICALS FOR USE IN THE MANUFACTURE OF ALL OF THE FOLLOWING: DRUGS, AGRO-CHEMICALS, DRUGS TO BE ADMINISTERED BY INHALATION, GASTROINTESTINAL DRUGS, ORAL CAVITY DRUGS, DRUGS ADMINISTERED ORALLY, INTRAVENOUSLY, INTRAMUSCULARLY, SUBCUTANEOUSLY AND TOPICALLY, RADIO-THERAPEUTIC DRUGS, AND THERAPEUTIC DRUGS FOR USE IN THE FIELDS OF GENOMICS, PROTEOMICS, CHEMICAL SCIENCES, PHARMACOLOGY, BIOLOGY, BIO-TECHNOLOGY, BIO-SCIENCE, AND STRUCTURAL BIOLOGY (U.S. CLS. 1, 5, 6, 10, 26 AND 46).

CLASS 42—SCIENTIFIC, COMPUTER AND LEGAL SERVICES

FOR CONTRACT SCIENTIFIC AND TECHNICAL RESEARCH FOR PHARMACEUTICALS, BIOTECH PRODUCTS AND CHEMICALS; PHARMACEUTICAL DRUG DISCOVERY, DEVELOPMENT AND RESEARCH IN THE FIELDS OF PHARMACEUTICALS, BIOTECH PRODUCTS, CHEMICALS AND AGRO-CHEMICALS; CLINICAL TRIALS FOR DRUGS; SERVICES FOR ENSURING THE SAFETY AND EFFICACY OF DRUGS; RESEARCH SERVICES IN THE AREAS OF GENOMICS, PROTEOMICS, CHEMISTRY, PHARMACOLOGY, BIOLOGY, MEDICINAL CHEMISTRY, ORGANIC AND INORGANIC CHEMISTRY, SYNTHETIC CHEMISTRY, ANALOGUE CHEMISTRY, AND COMPUTATIONAL CHEMISTRY; SERVICES TO GENERATE INFORMATION ON THE GENOMICS AND PROTEOMICS OF LIVING ORGANISMS INCLUDING HUMAN BEINGS BASED ON EXISTING BIOLOGICAL DATA BY USING INFORMATION TECHNOLOGY TOOLS AND TECHNIQUES (U.S. CLS. 100 AND 101).

SANDRA MANIOS, EXAMINING ATTORNEY

SN 78-802,261. GOOGLE INC., MOUNTAIN VIEW, CA. FILED 1-30-2006.

YouTube

THE MARK CONSISTS OF STANDARD CHARACTERS WITHOUT CLAIM TO ANY PARTICULAR FONT, STYLE, SIZE, OR COLOR.

CLASS 9—ELECTRICAL AND SCIENTIFIC APPARATUS

FOR (BASED ON INTENT TO USE) SOFTWARE TO ENABLE UPLOADING, POSTING, SHOWING, DISPLAYING, TAGGING, BLOGGING, SHARING OR OTHERWISE PROVIDING ELECTRONIC MEDIA OR INFORMATION OVER THE INTERNET OR OTHER COMMUNICATIONS NETWORK (U.S. CLS. 21, 23, 26, 36 AND 38).

CLASS 35—ADVERTISING AND BUSINESS

FOR ADVERTISING AND ADVERTISEMENT, PROMOTION AND MARKETING SERVICES FOR PROVIDING ELECTRONIC MEDIA OR INFORMATION OVER THE INTERNET OR OTHER COMMUNICATIONS NETWORK (U.S. CLS. 100, 101 AND 102).

FIRST USE 3-1-2005; IN COMMERCE 3-1-2005.

CLASS 38—COMMUNICATION

FOR AUDIO AND VIDEO BROADCASTING SERVICES OVER THE INTERNET OR OTHER COMMUNICATIONS NETWORK, NAMELY, UPLOADING, POSTING, SHOWING, DISPLAYING, TAGGING AND ELECTRONICALLY TRANSMITTING INFORMATION, AUDIO, AND VIDEO CLIPS; PROVIDING ACCESS TO INFORMATION, AUDIO, AND VIDEO VIA WEBSITES, ONLINE FORUMS, CHAT ROOMS, LISTSERVS AND BLOGS OVER THE INTERNET; PROVIDING ON-LINE CHAT ROOMS AND ELECTRONIC BULLETIN BOARDS FOR TRANSMISSION OF MESSAGES AMONG USERS IN THE FIELD OF GENERAL INTEREST (U.S. CLS. 100, 101 AND 104).

FIRST USE 4-24-2005; IN COMMERCE 4-24-2005.

CLASS 41—EDUCATION AND ENTERTAINMENT

FOR EDUCATION AND ENTERTAINMENT SERVICES, NAMELY, PROVIDING A WEBSITE FEATURING AUDIO CLIPS, VIDEO CLIPS, MUSICAL PERFORMANCES, MUSICAL VIDEOS, FILM CLIPS, PHOTOGRAPHS, OTHER MULTIMEDIA MATERIALS, AND INFORMATION IN THE FIELD OF AUDIO CLIPS, VIDEO CLIPS, MUSICAL PERFORMANCES, MUSICAL VIDEOS, FILM CLIPS, PHOTOGRAPHS, AND OTHER MULTIMEDIA MATERIALS; BLOGS FEATURING INFORMATION IN THE FIELD OF AUDIO CLIPS, VIDEO CLIPS, MUSICAL PERFORMANCES, MUSICAL VIDEOS, FILM CLIPS, PHOTOGRAPHS, AND OTHER MULTIMEDIA MATERIALS (U.S. CLS. 100, 101 AND 107).

FIRST USE 4-24-2005; IN COMMERCE 4-24-2005.

CLASS 42—SCIENTIFIC, COMPUTER AND LEGAL SERVICES

FOR APPLICATION SERVICE PROVIDER (ASP) FEATURING SOFTWARE TO ENABLE UPLOADING, POSTING, SHOWING, DISPLAYING, TAGGING, BLOGGING, SHARING OR OTHERWISE PROVIDING ELECTRONIC MEDIA OR INFORMATION OVER THE INTERNET OR OTHER COMMUNICATIONS NETWORK (U.S. CLS. 100 AND 101).

FIRST USE 4-24-2005; IN COMMERCE 4-24-2005.
SOPHIA S. KIM, EXAMINING ATTORNEY

SN 78-802,278. GOOGLE INC., MOUNTAIN VIEW, CA.
FILED 1-30-2006.



"THE COLOR(S) BLACK, RED AND WHITE IS/ARE CLAIMED AS A FEATURE OF THE MARK."

"THE MARK CONSISTS OF THE WORD "YOU" IN BLACK, AND THE WORD "TUBE" IN WHITE ON A RED VIEWING MONITOR."

CLASS 9—ELECTRICAL AND SCIENTIFIC APPARATUS

FOR (BASED ON INTENT TO USE) SOFTWARE TO ENABLE UPLOADING, POSTING, SHOWING, DISPLAYING, TAGGING, BLOGGING, SHARING OR OTHERWISE PROVIDING ELECTRONIC MEDIA OR INFORMATION OVER THE INTERNET OR OTHER COMMUNICATIONS NETWORK (U.S. CLS. 21, 23, 26, 36 AND 38).

CLASS 35—ADVERTISING AND BUSINESS

FOR ADVERTISING AND ADVERTISEMENT, PROMOTION AND MARKETING SERVICES FOR PROVIDING ELECTRONIC MEDIA OR INFORMATION OVER THE INTERNET OR OTHER COMMUNICATIONS NETWORK (U.S. CLS. 100, 101 AND 102).

FIRST USE 3-1-2005; IN COMMERCE 3-1-2005.

CLASS 38—COMMUNICATION

FOR AUDIO AND VIDEO BROADCASTING SERVICES OVER THE INTERNET OR OTHER COMMUNICATIONS NETWORK, NAMELY, UPLOADING, POSTING, SHOWING, DISPLAYING, TAGGING AND ELECTRONICALLY TRANSMITTING INFORMATION, AUDIO, AND VIDEO CLIPS; PROVIDING ACCESS TO INFORMATION, AUDIO, AND VIDEO VIA WEBSITES, ONLINE FORUMS, CHAT ROOMS, LISTSERVS AND BLOGS OVER THE INTERNET; PROVIDING ON-LINE CHAT ROOMS AND ELECTRONIC BULLETIN BOARDS FOR TRANSMISSION OF MESSAGES AMONG USERS IN THE FIELD OF GENERAL INTEREST (U.S. CLS. 100, 101 AND 104).

FIRST USE 4-24-2005; IN COMMERCE 4-24-2005.

CLASS 41—EDUCATION AND ENTERTAINMENT

FOR EDUCATION AND ENTERTAINMENT SERVICES, NAMELY, PROVIDING A WEBSITE FEATURING AUDIO CLIPS, VIDEO CLIPS, MUSICAL PERFORMANCES, MUSICAL VIDEOS, FILM CLIPS, PHOTOGRAPHS, OTHER MULTIMEDIA MATERIALS, AND INFORMATION IN THE FIELD OF AUDIO CLIPS, VIDEO CLIPS, MUSICAL PERFORMANCES, MUSICAL VIDEOS, FILM CLIPS, PHOTOGRAPHS, AND OTHER MULTIMEDIA MATERIALS; BLOGS FEATURING INFORMATION IN THE FIELD OF AUDIO CLIPS, VIDEO CLIPS, MUSICAL PERFORMANCES, MUSICAL VIDEOS, FILM CLIPS, PHOTOGRAPHS, AND OTHER MULTIMEDIA MATERIALS (U.S. CLS. 100, 101 AND 107).

FIRST USE 4-24-2005; IN COMMERCE 4-24-2005.

CLASS 42—SCIENTIFIC, COMPUTER AND LEGAL SERVICES

FOR APPLICATION SERVICE PROVIDER (ASP) FEATURING SOFTWARE TO ENABLE UPLOADING, POSTING, SHOWING, DISPLAYING, TAGGING, BLOGGING, SHARING OR OTHERWISE PROVIDING ELECTRONIC MEDIA OR INFORMATION OVER THE INTERNET OR OTHER COMMUNICATIONS NETWORK (U.S. CLS. 100 AND 101).

FIRST USE 4-24-2005; IN COMMERCE 4-24-2005.
SOPHIA S. KIM, EXAMINING ATTORNEY

SN 78-802,315. GOOGLE INC., MOUNTAIN VIEW, CA.
FILED 1-30-2006.

BROADCAST YOURSELF

THE MARK CONSISTS OF STANDARD CHARACTERS WITHOUT CLAIM TO ANY PARTICULAR FONT, STYLE, SIZE, OR COLOR.

CLASS 9—ELECTRICAL AND SCIENTIFIC APPARATUS

FOR SOFTWARE TO ENABLE UPLOADING, POSTING, SHOWING, DISPLAYING, TAGGING, BLOGGING, SHARING OR OTHERWISE PROVIDING ELECTRONIC MEDIA OR INFORMATION OVER THE INTERNET OR OTHER COMMUNICATIONS NETWORK (U.S. CLS. 21, 23, 26, 36 AND 38).

CLASS 35—ADVERTISING AND BUSINESS

FOR ADVERTISING AND ADVERTISEMENT, PROMOTION AND MARKETING SERVICES FOR PROVIDING ELECTRONIC MEDIA OR INFORMATION OVER THE INTERNET OR OTHER COMMUNICATIONS NETWORK (U.S. CLS. 100, 101 AND 102).

CLASS 38—COMMUNICATION

FOR AUDIO AND VIDEO BROADCASTING SERVICES OVER THE INTERNET OR OTHER COMMUNICATIONS NETWORK, NAMELY, UPLOADING, POSTING, SHOWING, DISPLAYING, TAGGING AND ELECTRONICALLY TRANSMITTING INFORMATION, AUDIO, AND VIDEO CLIPS; PROVIDING ACCESS TO INFORMATION, AUDIO, AND VIDEO VIA WEBSITES, ONLINE FORUMS, CHAT ROOMS, LISTSERVS AND BLOGS OVER THE INTERNET; PROVIDING ON-LINE CHAT ROOMS AND ELECTRONIC BULLETIN BOARDS FOR TRANSMISSION OF MESSAGES AMONG USERS IN THE FIELD OF GENERAL INTEREST (U.S. CLS. 100, 101 AND 104).

CLASS 41—EDUCATION AND ENTERTAINMENT

FOR EDUCATION AND ENTERTAINMENT SERVICES, NAMELY, PROVIDING A WEBSITE FEATURING AUDIO CLIPS, VIDEO CLIPS, MUSICAL PERFORMANCES, MUSICAL VIDEOS, FILM CLIPS, PHOTOGRAPHS, OTHER MULTIMEDIA MATERIALS, AND INFORMATION IN THE FIELD OF AUDIO CLIPS, VIDEO CLIPS, MUSICAL PERFORMANCES, MUSICAL VIDEOS, FILM CLIPS, PHOTOGRAPHS, AND OTHER MULTIMEDIA MATERIALS; BLOGS FEATURING INFORMATION IN THE FIELD OF AUDIO CLIPS, VIDEO CLIPS, MUSICAL PERFORMANCES, MUSICAL VIDEOS, FILM CLIPS, PHOTOGRAPHS, AND OTHER MULTIMEDIA MATERIALS (U.S. CLS. 100, 101 AND 107).

CLASS 42—SCIENTIFIC, COMPUTER AND LEGAL SERVICES

FOR APPLICATION SERVICE PROVIDER (ASP) FEATURING SOFTWARE TO ENABLE UPLOADING, POSTING, SHOWING, DISPLAYING, TAGGING, BLOGGING, SHARING OR OTHERWISE PROVIDING ELECTRONIC MEDIA OR INFORMATION OVER THE INTERNET OR OTHER COMMUNICATIONS NETWORK (U.S. CLS. 100 AND 101).

SOPHIA S. KIM, EXAMINING ATTORNEY

SN 78-802,372. MEDIA CONSULTING CORPORATION LIMITED, LONDON, UNITED KINGDOM, FILED 1-30-2006.



NO CLAIM IS MADE TO THE EXCLUSIVE RIGHT TO USE "FINANCE", APART FROM THE MARK AS SHOWN. THE COLOR(S) BLUE AND GREY IS/ARE CLAIMED AS A FEATURE OF THE MARK.

THE MARK CONSISTS OF THE WORD "FINANCE" IN BLUE; THE RIGHT HALF OF THE LETTER "O" AND THE BOTTOM HALF OF THE LETTERS "NLY" ARE BLUE; THE LEFT HALF OF "O" AND THE TOP HALF OF "NLY" ARE GRAY; THE CIRCLES ARE SHADES OF GRAY, THE LIGHTEST ON THE LEFT AND THE DARKEST ON THE RIGHT.

CLASS 9—ELECTRICAL AND SCIENTIFIC APPARATUS

FOR COMPUTER SOFTWARE, SOFTWARE PACKAGES, AND COMPUTER PROGRAMS FOR CREATING SEARCHABLE DATABASES OF INFORMATION AND DATA, SCHEDULING AND MANAGEMENT, MANAGING PAYROLL AND ATTENDANCE, AND CREATING EMPLOYMENT VACANCY AND TRAINING ADVERTISEMENTS, FOR USE IN THE FIELD OF HUMAN RESOURCES AND STAFF RECRUITMENT, PLACEMENT AND TRAINING; SEARCH ENGINE SOFTWARE; MAGNETIC RECORDING MEDIA, NAMELY, BLANK MAGNETIC COMPUTER TAPES AND BLANK MAGNETIC TAPES FOR TAPE RECORDERS AND VIDEO RECORDERS; COMPACT DISCS, INTERACTIVE COMPACT DISCS, OPTICAL COMPACT DISCS, AND CD-ROMS FEATURING DATA RELATING TO BUSINESS MANAGEMENT, OFFICE FUNCTIONS, PERSONNEL RECRUITMENT, ADVERTISING AND INTERVIEWING SERVICES FOR RECRUITMENT; DATA PROCESSORS FOR USE IN THE FIELD OF HUMAN RESOURCES AND STAFF RECRUITMENT, PLACEMENT AND TRAINING; COMPUTERS AND COMPUTER PERIPHERALS; COMPUTER SOFTWARE FOR CREATING SEARCHABLE DATABASES OF INFORMATION AND DATA, SCHEDULING AND MANAGEMENT, MANAGING PAYROLL AND ATTENDANCE, AND CREATING EMPLOYMENT VACANCY AND TRAINING ADVERTISEMENTS, FOR USE IN RECRUITMENT, TRAVEL, INSURANCE, AND FINANCIAL SERVICES (U.S. CLS. 21, 23, 26, 36 AND 38).

CLASS 35—ADVERTISING AND BUSINESS

FOR ADVERTISING; BUSINESS MANAGEMENT; BUSINESS ADMINISTRATION; OFFICE FUNCTIONS; PERSONNEL RECRUITMENT ADVERTISING; INTERVIEWING SERVICES FOR RECRUITMENT; PROVIDING INFORMATION, ADVICE, CONSULTANCY AND ADMINISTRATION IN RELATION TO ADVERTISING, BUSINESS MANAGEMENT, BUSINESS ADMINISTRATION, OFFICE FUNCTIONS, PERSONNEL RECRUITMENT, ADVERTISING AND INTERVIEWING SERVICES FOR RECRUITMENT; BUSINESS CONSULTING AND MANAGEMENT SERVICES IN THE FIELD OF TRAVEL, TRAVEL PLANNING AND THE OPERATION OF TRAVEL-RELATED BUSINESSES; THE BRINGING TOGETHER, FOR THE BENEFIT OF OTHERS, A VARIETY OF GOODS AND SERVICES, ENABLING CUSTOMERS TO CONVENIENTLY VIEW AND PURCHASE THOSE GOODS AND SERVICES FROM AN INTERNET WEBSITE SPECIALIZING IN PROVIDING TRAVEL, RELATED GOODS AND SERVICES, RECRUITMENT SERVICES, TRAVEL SERVICES, INSURANCE SERVICES, FINANCIAL SERVICES; PROVIDING AND RENTAL OF ADVERTISING SPACE ON THE INTERNET; COMMUNICATION OF JOB VACANCIES AND EMPLOYMENT AGENCY SERVICES VIA THE INTERNET; PROVIDING ELECTRONIC COMMUNICATIONS LINKS USED FOR TRANSMISSION OF DATA IN THE FIELDS OF BUSINESS MANAGEMENT, OFFICE FUNCTIONS, PERSONNEL RECRUITMENT, ADVERTISING AND INTERVIEWING SERVICES FOR RECRUITMENT (U.S. CLS. 100, 101 AND 102).

CLASS 36—INSURANCE AND FINANCIAL

FOR INSURANCE SERVICES, NAMELY, INSURANCE BROKERAGE, INSURANCE UNDERWRITING IN THE FIELDS OF LIFE, HEALTH, DISABILITY AND UNEMPLOYMENT, INSURANCE AGENCIES, INSURANCE ADMINISTRATION; FINANCIAL SERVICES, NAMELY, MONEY LENDING, FINANCIAL FORECASTING, FINANCIAL PLANNING, INVESTMENT FUND TRANSFER AND TRANSACTION SERVICES; MONETARY AFFAIRS, NAMELY, MONETARY EXCHANGE; REAL ESTATE AFFAIRS, NAMELY, APPRAISAL OF REAL ESTATE, ASSESSMENT AND MANAGEMENT OF REAL ESTATE, REAL ESTATE BROKERAGE; INSURANCE, MORTGAGE, INVESTMENT, SAVINGS AND PENSION SERVICES IN THE NATURE OF INSURANCE BROKERAGE, INVESTMENT BROKERAGE, ADMINISTRATION OF EMPLOYMENT PENSION PLANS, SAVINGS BANK SERVICES; PROVISION OF PAYMENT PROTECTION IN THE NATURE OF AN INSURANCE PLAN TO INSURE AGAINST LOAN REPAYMENT OBLIGATION DEFAULT IN SPECIFIED CIRCUMSTANCES; CREDIT SERVICES, NAMELY, CREDIT AGENCIES, CREDIT REPORTING AGENCIES; CREDIT CARD SERVICES; FINANCIAL INFORMATION SERVICES; INFORMATION, ADVISORY AND CONSULTANCY SERVICES IN THE FIELDS OF INSURANCE SERVICES, NAMELY, INSURANCE BROKERAGE, INSURANCE UNDERWRITING IN THE FIELDS OF LIFE, HEALTH, DISABILITY AND UNEMPLOYMENT, INSURANCE AGENCIES, INSURANCE ADMINISTRATION, FINANCIAL SERVICES, MONEY LENDING, FINANCIAL FORECASTING, FINANCIAL PLANNING, INVESTMENT FUND TRANSFER AND TRANSACTION SERVICES; MONETARY AFFAIRS, NAMELY, MONETARY EXCHANGE; REAL ESTATE AFFAIRS, NAMELY, APPRAISAL OF REAL ESTATE, ASSESSMENT AND MANAGEMENT OF REAL ESTATE, REAL ESTATE BROKERAGE INSURANCE; MORTGAGE, INVESTMENT, SAVINGS AND PENSION SERVICES IN THE NATURE OF INSURANCE BROKERAGE, INVESTMENT BROKERAGE, ADMINISTRATION OF EMPLOYMENT PENSION PLANS, SAVINGS BANK SERVICES, PROVISION OF PAYMENT PROTECTION IN THE NATURE OF AN INSURANCE PLAN TO INSURE AGAINST LOAN REPAYMENT OBLIGATION DEFAULT IN SPECIFIED CIRCUMSTANCES; CREDIT SERVICES, NAMELY, CREDIT AGENCIES, CREDIT REPORTING AGENCIES, AND CREDIT CARD SERVICES (U.S. CLS. 100, 101 AND 102).

CLASS 38—COMMUNICATION

FOR TELECOMMUNICATIONS SERVICES, NAMELY, DATA TRANSMISSION AND RECEPTION SERVICES VIA TELECOMMUNICATION MEANS; PROVIDING ELECTRONIC TELECOMMUNICATION CONNECTIONS; PROVIDING TELECOMMUNICATIONS CONNECTIONS TO A GLOBAL COMPUTER NETWORK; COMMUNICATION SERVICES BETWEEN COMPUTERS, NAMELY, COMMUNICATION BETWEEN COMPUTER TERMINALS; TRANSMISSION OF MESSAGES, DATA AND INFORMATION STORED IN A DATABASE; TRANSMISSION OF DATA, IMAGES AND TEXTS VIA DATA PROCESSING EQUIPMENT AND COMPUTER TERMINALS; ELECTRONIC MAIL SERVICES; DISSEMINATION OF TEXTS AND IMAGES BY MEANS OF TELECOMMUNICATIONS NETWORKS; INFORMATION STORAGE SERVICES; ELECTRONIC DATA TRANSMISSION AND INFORMATION TRANSMISSIONS VIA ELECTRONIC COMMUNICATIONS NETWORKS; ELECTRONIC MESSAGE-SENDING SERVICES (U.S. CLS. 100, 101 AND 104).

ALICE SUE CARRUTHERS, EXAMINING ATTORNEY

SN 78-803,629, TASTEBUD ENTERTAINMENT, INC., NEWPORT COAST, CA. FILED 1-31-2006.

TASTEBUD ENTERTAINMENT

THE MARK CONSISTS OF STANDARD CHARACTERS WITHOUT CLAIM TO ANY PARTICULAR FONT, STYLE, SIZE, OR COLOR.

NO CLAIM IS MADE TO THE EXCLUSIVE RIGHT TO USE "ENTERTAINMENT", APART FROM THE MARK AS SHOWN.

CLASS 16—PAPER GOODS AND PRINTED MATTER

FOR INSTRUCTIONAL AND TEACHING MATERIALS IN THE FIELDS OF COOKING, HOME AND LIFESTYLE, AND CULINARY ARTS; BOOKS IN THE FIELDS OF COOKING, HOME AND LIFESTYLE, AND CULINARY ARTS; RECIPE BOOKS AND PAMPHLETS IN THE FIELD OF COOKING; AND STATIONERY (U.S. CLS. 2, 5, 22, 23, 29, 37, 38 AND 50).

FIRST USE 12-2-2001; IN COMMERCE 3-1-2007.

CLASS 41—EDUCATION AND ENTERTAINMENT

FOR ENTERTAINMENT SERVICES, NAMELY, LIVE AND PRE-RECORDED TELEVISION AND RADIO SHOW PERFORMANCES, AND LIVE PERFORMANCES FEATURING FOOD PRODUCTS, COOKING, CULINARY ARTS, AND ENTERTAINMENT RELATED THERETO; PUBLICATION OF RECIPES, AND INSTRUCTIONAL MATERIALS IN THE FIELDS OF COOKING, CULINARY ARTS, AND ENTERTAINMENT (U.S. CLS. 100, 101 AND 107).

FIRST USE 12-1-2001; IN COMMERCE 3-1-2007.

JOHN E. MICHOS, EXAMINING ATTORNEY

SN 78-804,128, BIOMET CEMENTING TECHNOLOGIES AB, SJÖBO, SWEDEN, FILED 2-1-2006.

OPTIPAC

THE MARK CONSISTS OF STANDARD CHARACTERS WITHOUT CLAIM TO ANY PARTICULAR FONT, STYLE, SIZE, OR COLOR.

CLASS 5—PHARMACEUTICALS

FOR ALL PURPOSE DISINFECTANTS; PREPARATIONS FOR DESTROYING VERMIN; FUNGICIDES, HERBICIDES; BONE CEMENT FOR MEDICAL PURPOSES (U.S. CLS. 6, 18, 44, 46, 51 AND 52).

CLASS 10—MEDICAL APPARATUS

FOR ARTIFICIAL LIMBS AND PROSTHESES FOR THE KNEES, HIPS, ANKLES AND SHOULDERS ORTHOPEDIC IMPLANTS; ARTIFICIAL BONE IMPLANTS; BONE CEMENTATION SYSTEMS, NAMELY APPARATUS AND INSTRUMENTS FOR MIXING, COLLECTION AND/OR DELIVERY OF BONE CEMENT AS WELL AS ARTIFICIAL IMPLANTS FOR FIXATION BY MEANS OF BONE CEMENT (U.S. CLS. 26, 39 AND 44).

RONALD MCMORROW, EXAMINING ATTORNEY

SN 78-805,473. NIAMA CAPITAL GMBH, STUTTGART, FED REP GERMANY, FILED 2-2-2006.

SN 78-814,801. FLEETGUARD, INC., COLUMBUS, IN. FILED 2-14-2006.

NIAMA

THE MARK CONSISTS OF STANDARD CHARACTERS WITHOUT CLAIM TO ANY PARTICULAR FONT, STYLE, SIZE, OR COLOR.

PRIORITY CLAIMED UNDER SEC. 44(D) ON ERPN CMNTY TM OFC APPLICATION NO. 004604914, FILED 8-25-2005, REG. NO. 004604914, DATED 8-30-2006, EXPIRES 8-25-2015.

CLASS 9—ELECTRICAL AND SCIENTIFIC APPARATUS

FOR PRE-RECORDED CDS, LASER DISCS, DVDS AND MAGNETIC DATA CARRIERS FEATURING MUSIC, MOVIES AND GAMES; VISUAL RECORDINGS AND AUDIO VISUAL RECORDINGS FEATURING MUSIC, MOVIES AND GAMES; MUSICAL VIDEO RECORDINGS; MICROPHONES; AMPLIFIERS (U.S. CLS. 21, 23, 26, 36 AND 38).

CLASS 16—PAPER GOODS AND PRINTED MATTER

FOR PRINTED MATTER, NAMELY, INSTRUCTION MANUALS FOR MUSICAL INSTRUMENTS, MUSIC SHEETS, MUSIC BOOKS, BOOKLETS IN THE FIELD OF MUSIC HISTORY AND MUSICIANS (U.S. CLS. 2, 5, 22, 23, 29, 37, 38 AND 50).

CLASS 35—ADVERTISING AND BUSINESS

FOR ADVERTISING AGENCY SERVICES, BUSINESS MANAGEMENT SERVICES, BUSINESS ADMINISTRATION SERVICES, OFFICE MANAGEMENT AND ADMINISTRATION SERVICES; ON-LINE RETAIL STORE SERVICES FEATURING COMPACT DISCS, MICROPHONES, AMPLIFIERS, CARRIERS FOR IMAGES AND SOUND, OPTICAL CARRIERS FOR IMAGES AND SOUND, MAGNETIC CARRIERS FOR IMAGES AND SOUND, INSTRUCTIONS FOR MUSICAL INSTRUMENTS, MUSIC SHEETS AND MUSIC BOOKS (U.S. CLS. 100, 101 AND 102).

CLASS 38—COMMUNICATION

FOR TELECOMMUNICATIONS SERVICES, NAMELY, BROADCAST OF CABLE TELEVISION, SATELLITE TELEVISION, AUDIO, VIDEO AND RADIO PROGRAMS AND SERVICES, TELEVISION BROADCASTING SERVICES, RADIO BROADCASTING SERVICES (U.S. CLS. 100, 101 AND 104).

CLASS 41—EDUCATION AND ENTERTAINMENT

FOR EDUCATION SERVICES, NAMELY, PROVIDING CLASSES AND TRAINING IN THE FIELD OF MUSIC, MOVIES, GAMES AND ART; PROVIDING ENTERTAINMENT, SPORTING AND CULTURAL ACTIVITIES IN THE FIELD OF MUSIC, MOVIES, GAMES AND ART; ORGANIZATION OF LIVE MUSIC CONCERTS; ENTERTAINMENT, NAMELY, PRODUCTION OF A CONTINUING MUSIC SHOW PROVIDED OVER TELEVISION, SATELLITE, AUDIO OR VIDEO MEDIA (U.S. CLS. 100, 101 AND 107).

JAMES STEIN, EXAMINING ATTORNEY

FLEETGUARD

THE MARK CONSISTS OF STANDARD CHARACTERS WITHOUT CLAIM TO ANY PARTICULAR FONT, STYLE, SIZE, OR COLOR.

CLASS 1—CHEMICALS

FOR COOLANTS FOR VEHICLE ENGINES (U.S. CLS. 1, 5, 6, 10, 26 AND 46).

CLASS 7—MACHINERY

FOR OIL FILTERS; OIL, GASOLINE, DIESEL FUEL AND AIR FILTERS FOR MOTORS AND ENGINES; FUEL FILTERS AND STRUCTURAL PARTS THEREOF; AIR AND OIL FILTERS AND STRUCTURAL PARTS THEREOF; AIR AND OIL FILTERS FOR MECHANICAL PURPOSES; HYDRAULIC FLUID FILTERS FOR MECHANICAL PURPOSES; OIL, GASOLINE, AIR AND FUEL FILTERS FOR MOTORS AND ENGINES OF LAND AND MARINE VEHICLES; CANISTERS AND HOUSING FOR ALL THE FOREGOING FILTERS, HEAVY DUTY STARTERS; HEAVY-DUTY STARTERS FOR ENGINES AND MOTORS (U.S. CLS. 13, 19, 21, 23, 31, 34 AND 35).

CLASS 11—ENVIRONMENTAL CONTROL APPARATUS

FOR AIR FILTERS FOR THE REDUCTION OF EMISSIONS FROM INDUSTRIAL INSTALLATIONS; BATTERY WARMING BLANKETS, HEATERS FOR WARMING COOLANT; HEATERS FOR WARMING OIL; HEATERS FOR WARMING DIESEL FUEL (U.S. CLS. 13, 21, 23, 31 AND 34).

CAROLYN GRAY, EXAMINING ATTORNEY

SN 78-814,818. FLEETGUARD, INC., COLUMBUS, IN. FILED 2-14-2006.



THE COLOR(S) RED AND BLACK IS/ARE CLAIMED AS A FEATURE OF THE MARK.

THE COLOR RED APPEARS IN THE DESIGN OF A SQUARE AND THE LETTERS FLEETGUARD APPEAR IN BLACK.

THE MARK CONSISTS OF THE DEVICE OF A SQUARE AND THE LITERAL ELEMENT FLEETGUARD.

CLASS 1—CHEMICALS

FOR COOLANTS FOR VEHICLE ENGINES (U.S. CLS. 1, 5, 6, 10, 26 AND 46).

CLASS 7—MACHINERY

FOR OIL FILTERS; OIL, GASOLINE, DIESEL FUEL AND AIR FILTERS FOR MOTORS AND ENGINES; FUEL FILTERS AND STRUCTURAL PARTS THEREOF; AIR AND OIL FILTERS AND STRUCTURAL PARTS THEREOF; AIR AND OIL FILTERS FOR MECHANICAL PURPOSES; HYDRAULIC FLUID FILTERS FOR MECHANICAL PURPOSES; OIL, GASOLINE, AIR AND FUEL FILTERS FOR MOTORS AND ENGINES OF LAND AND MARINE VEHICLES; CANISTERS AND HOUSING FOR ALL THE FOREGOING FILTERS, HEAVY DUTY STARTERS; HEAVY DUTY STARTERS FOR ENGINES AND MOTORS (U.S. CLS. 13, 19, 21, 23, 31, 34 AND 35).

CLASS 11—ENVIRONMENTAL CONTROL APPARATUS

FOR AIR FILTERS FOR THE REDUCTION OF EMISSIONS IN INDUSTRIAL INSTALLATIONS; BATTERY WARMING BLANKETS; HEATERS FOR WARMING COOLANTS; HEATERS FOR WARMING OIL; HEATERS FOR WARMING DIESEL FUEL (U.S. CLS. 13, 21, 23, 31 AND 34).

CAROLYN GRAY, EXAMINING ATTORNEY

SN 78-816,784. NATIONAL ASSOCIATION FOR THE SPECIALTY FOOD TRADE, INC., NEW YORK, NY. FILED 2-16-2006.

FOOD ADVENTURIST

THE MARK CONSISTS OF STANDARD CHARACTERS WITHOUT CLAIM TO ANY PARTICULAR FONT, STYLE, SIZE, OR COLOR.

NO CLAIM IS MADE TO THE EXCLUSIVE RIGHT TO USE "FOOD", APART FROM THE MARK AS SHOWN.

CLASS 14—JEWELRY

FOR ALARM CLOCKS, ASHTRAYS MADE OF PRECIOUS METAL, BELT BUCKLES OF PRECIOUS METAL, BRACELETS, CANDLESTICKS, CANDLE HOLDERS AND CANDLE RINGS OF PRECIOUS METAL, CHARMS, CHOKERS, CLOCKS, COSTUME JEWELRY, EARRINGS, KEYRINGS OF PRECIOUS METAL, JEWELRY BOXES OF PRECIOUS METAL, LAPEL PINS, NECKLACES, WATCHES, RINGS, SAUCERS AND SALT SHAKERS OR PRECIOUS METAL, TIE PINS (U.S. CLS. 2, 27, 28 AND 50).

CLASS 16—PAPER GOODS AND PRINTED MATTER

FOR ADDRESS BOOKS, PHOTOGRAPH ALBUMS, ALMANACS, APPOINTMENT BOOKS, PENS, PENCILS, BLANK NOTE CARDS, BLANK WRITING JOURNALS, BOOKMARKS, CALENDARS, COOK BOOKS, DESK SETS, EDUCATIONAL BOOKS AND PUBLICATIONS CONTAINING INFORMATION ON GOURMET FOOD, GIFT CARDS, MAGAZINES FEATURING INFORMATION ON GOURMET FOOD AND COMPANIES IN THE GOURMET FOOD INDUSTRY, NOTE CARDS, PLACE CARDS, POSTCARDS, POSTERS, RECIPE BOOKS, RECIPE CARDS, PAPER TABLE CLOTHS AND NAPKINS, WRITING PAPER (U.S. CLS. 2, 5, 22, 23, 29, 37, 38 AND 50).

CLASS 21—HOUSEWARES AND GLASS

FOR BAKEWARE, BAKING DISHES, BEVERAGE GLASSWARE, BEER MUGS, BEVERAGE STIRRERS, BOWLS, CAKE PANS, CANDLESTICKS, CANDLE RINGS AND CANDLE HOLDERS NOT OF PRECIOUS METAL, CARAFES, CERAMIC FIGURINES, CHAMPAGNE BUCKETS, CUPS, MUGS, COOKING UTENSILS, NAMELY, WHISKS, SPATULAS, STIRRERS, GRATERS, SIEVES, AND SKIMMERS, COOKWARE, NAMELY, POTS, PANS, AND CASSEROLE DISHES, COOLERS FOR WINE, DISHES AND PLATES, DRINKING GLASSES, ICE BUCKETS, OVENWARE, PAPER CUPS, PAPER PLATES, RECIPE BOXES, AND SERVING PLATTERS (U.S. CLS. 2, 13, 23, 29, 30, 33, 40 AND 50).

CLASS 25—CLOTHING

FOR CLOTHING, NAMELY, APRONS, CAPS, HATS, BELTS, CHEF'S HATS, GLOVES, SHIRTS, JACKETS, NECKTIES, SCARVES, T-SHIRTS, CHEF'S UNIFORMS (U.S. CLS. 22 AND 39).

CLASS 28—TOYS AND SPORTING GOODS

FOR ARCADE GAMES, BALLOONS, JIGSAW PUZZLES, PLAYFIGURES, BALLS FOR GAMES, PLAYING CARDS, PUZZLES, TOY VEHICLES, BOARD GAMES, TRADING CARD GAMES (U.S. CLS. 22, 23, 38 AND 50).

CLASS 29—MEATS AND PROCESSED FOODS

FOR MEATS AND PROCESSED FOODS, NAMELY, CANNED FRUIT, DRIED FRUIT, BEEF, CANDIED FRUIT, CANDIED NUTS, CANNED VEGETABLES, CAVIAR, CHEESE, CHICKEN, CREAM, CUT FRESH FRUIT, CUR FRESH VEGETABLES, DAIRY PRODUCTS, DAIRY BASED BEVERAGES, EGGS, FISH, GARDEN SALADS, MEAT, HAM, LOBSTER, MILK, OLIVE OIL, PORK, POULTRY, PROCESSED MEATS, SAUSAGES, SEAFOOD, SOUP MIXES, SHELLED NUTS, YOGURT (U.S. CL. 46).

CLASS 30—STAPLE FOODS

FOR BAGELS, BAKERY GOODS, BISCUITS, BREAD, CAKES, PASTRIES, CANDY, CHOCOLATE, COCOA, COFFEE, PASTA, FRUIT JELLIES, GRAVIES, ICE CREAM, MARINADES, SEASONINGS, SANDWICHES, TEA (U.S. CL. 46).

CLASS 31—NATURAL AGRICULTURAL PRODUCTS

FOR FRESH FRUIT AND VEGETABLES, RAW NUTS (U.S. CLS. 1 AND 46).

CLASS 32—LIGHT BEVERAGES

FOR BEVERAGES, NAMELY, ALE, BEER, WATER, FLAVORED WATER, AERATED WATER, FRUIT DRINKS, ENERGY DRINKS, JUICE BEVERAGES, SOFT DRINKS (U.S. CLS. 45, 46 AND 48).

CLASS 33—WINES AND SPIRITS

FOR WINE, AND ALCOHOLIC BEVERAGES, NAMELY, DISTILLED SPIRITS, DISTILLED LIQUORS, AND CORDIALS (U.S. CLS. 47 AND 49).

CLASS 35—ADVERTISING AND BUSINESS

FOR ARRANGING AND CONDUCTING CONSUMER AND TRADE SHOWS IN THE FIELD OF GOURMET FOOD (U.S. CLS. 100, 101 AND 102).

CLASS 41—EDUCATION AND ENTERTAINMENT

FOR ARRANGING AND CONDUCTING EDUCATIONAL SEMINARS, EXHIBITIONS AND CONFERENCES ON GOURMET FOOD, DEVELOPING AND DISSEMINATING EDUCATION MATERIALS ON GOURMET FOOD, ENTERTAINMENT SERVICES, NAMELY, PROVIDING TELEVISION PROGRAMS IN THE FIELD OF GOURMET FOOD; PROVIDING ONLINE EDUCATIONAL RESOURCES IN THE FIELD OF GOURMET FOOD, ONLINE MAGAZINES IN THE FIELD OF GOURMET FOOD (U.S. CLS. 100, 101 AND 107).

JOHN E. MICHOS, EXAMINING ATTORNEY

SN 78-816,954. FAKEDLIC HOLDINGS CO., LTD., TOKYO, JAPAN, FILED 2-16-2006.

m o u s s y

OWNER OF JAPAN REG. NO. 4533855, DATED 1-11-2002, EXPIRES 1-11-2012.

CLASS 9—ELECTRICAL AND SCIENTIFIC APPARATUS

FOR SPECTACLES, NAMELY, ANTI-GLARE GLASSES AND SUNGLASSES (U.S. CLS. 21, 23, 26, 36 AND 38).

CLASS 14—JEWELRY

FOR PERSONAL ORNAMENTS, NAMELY, ANKLE BRACELETS, BRACELETS OF PRECIOUS METAL, CHOKERS, CLOCKS, DIAMONDS, NECKLACES, PLATINUM AND ITS ALLOYS, PRECIOUS METALS, SILVER AND ITS ALLOYS, SMALL CLOCKS, TIARAS, TIE PINS, PERSONAL ORNAMENTS OF PRECIOUS METAL, WATCHES, KEY RINGS OF PRECIOUS METAL (U.S. CLS. 2, 27, 28 AND 50).

CLASS 18—LEATHER GOODS

FOR LEATHER; ALL PURPOSE SPORTS BAGS; ALL-PURPOSE CARRYING BAGS; BOSTON BAGS; CARRY-ON BAGS; DUFFEL BAGS FOR TRAVEL; KEY BAGS; LEATHER AND IMITATION LEATHER BAGS; MESH SHOPPING BAGS; MESSENGER BAGS; SHOPPING BAGS WITH WHEELS ATTACHED; SHOULDER BAGS; SPORTS BAGS; SUIT BAGS; TOTE BAGS; WAIST BAGS; FELT POUCHES; POUCHES OF LEATHER, UMBRELLAS AND THEIR PARTS; VANITY CASES SOLD EMPTY (U.S. CLS. 1, 2, 3, 22 AND 41).

CLASS 25—CLOTHING

FOR CLOTHING, NAMELY, BANDANAS, BATH-ROBES, BELTS, BELTS MADE OF LEATHER, BIKINIS, BLOUSES, BLOUSONS, BOOTS, BOTTOMS, BRASIERES, CAMISOLES, CAPS, COATS, CORSETS, COVERALLS, DENIM JACKETS, DENIM PANTS, DOWN JACKETS, DRESS SHIRTS, DRESS SUITS, DRESSES, EAR MUFFS, FITTED SWIMMING COSTUMES WITH BRA CUPS, FLIGHT SUITS, FOOTWEAR, FUR COATS AND JACKETS, FUR HATS, FUR MUFFS, FUR STOLE, GOLF CAPS, GOLF SHIRTS, GOLF SHOES, HALTER TOPS, HATS, HEADWEAR, HEELS, HOODS, JACKETS, JEANS, JERSEYS, KNIT SHIRTS, KNITTED CAPS, KNITTED UNDERWEAR, LADIES' UNDERWEAR, LEATHER COATS, LEATHER JACKETS, LEATHER PANTS, LEATHER SHOES, LEG WARMERS, LINGERIE, LOUNGEWEAR, MANTLES, MINISKIRTS, MULES, NECK BANDS, NECKERCHIEFS, NECKTIES, NEGLIGES, NIGHTWEAR, OVERALLS, PARKAS, POLO SHIRTS, PONCHOS, PUMPS, RAIN BOOTS, ROBES, SANDALS, SHAWLS, SHIRTS, SHOES, SHORTS, SHORT-SLEEVED OR LONG-SLEEVED T-SHIRTS, SHORT-SLEEVED SHIRTS, SHOULDER PADS FOR CLOTHING, SKIRTS, SOCKS, STOCKINGS, STOLE, SUITS, SUSPENDERS, SWEAT PANTS, SWEAT SHIRTS, SWEATERS, TANK TOPS, TIES, TOPS, TUXEDOS, T-SHIRTS, UNDERCLOTHES, VESTS, V-NECK SWEATERS, WRAPS, AND WRIST BANDS (U.S. CLS. 22 AND 39).

ZACHARY BELLO, EXAMINING ATTORNEY

SN 78-819,951. GRANTIUM INC., OTTAWA, ONTARIO, CANADA, FILED 2-21-2006.

GRANTIUM

THE MARK CONSISTS OF STANDARD CHARACTERS WITHOUT CLAIM TO ANY PARTICULAR FONT, STYLE, SIZE, OR COLOR.

PRIORITY CLAIMED UNDER SEC. 44(D) ON CANADA APPLICATION NO. 1288440, FILED 2-2-2006, REG. NO. TMA678951, DATED 1-8-2007, EXPIRES 1-8-2022.

CLASS 9—ELECTRICAL AND SCIENTIFIC APPARATUS

FOR COMPUTER SOFTWARE FOR GRANTS MANAGEMENT, NAMELY, FOR USE BY FEDERAL, STATE AND MUNICIPAL GOVERNMENTS IN SUPPORT OF THEIR RESPECTIVE GRANTS PROGRAMS FOR THE MANAGEMENT OF THE APPLICATION, PROCESSING AND MONITORING PROCESSES; TRAINING AND COURSE MATERIALS, NAMELY, DOWNLOADABLE WORKBOOKS IN ELECTRONIC FORM RELATING TO THE IMPLEMENTATION, INTEGRATION, OPERATION, CUSTOMIZATION AND ADMINISTRATION OF GRANTS MANAGEMENT SOFTWARE (U.S. CLS. 21, 23, 26, 36 AND 38).

CLASS 16—PAPER GOODS AND PRINTED MATTER

FOR TRAINING AND COURSE MATERIALS, NAMELY, WORKBOOKS IN PRINTED FORM RELATING TO THE IMPLEMENTATION, INTEGRATION, OPERATION, CUSTOMIZATION AND ADMINISTRATION OF GRANTS MANAGEMENT SOFTWARE (U.S. CLS. 2, 5, 22, 23, 29, 37, 38 AND 50).

CLASS 41—EDUCATION AND ENTERTAINMENT

FOR TRAINING SERVICES RELATING TO THE IMPLEMENTATION, INTEGRATION, OPERATION, CUSTOMIZATION AND ADMINISTRATION OF GRANTS MANAGEMENT SOFTWARE (U.S. CLS. 100, 101 AND 107).

CLASS 42—SCIENTIFIC, COMPUTER AND LEGAL SERVICES

FOR CONSULTING SUPPORT SERVICES IN ALL ASPECTS OF GRANTS AND CONTRIBUTIONS AUTOMATION TECHNOLOGY AND PROCESS, NAMELY TO BE PROVIDED TO FEDERAL, STATE AND MUNICIPAL GOVERNMENTS IN SUPPORT OF THE INSTALLATION AND IMPLEMENTATION OF GRANTS MANAGEMENT SOFTWARE TO BE USED FOR THE SUPPORT OF THE RESPECTIVE GRANTS PROGRAMS FOR THE MANAGEMENT OF THE APPLICATION, PROCESSING AND MONITORING PROCESSES; INSTALLATION AND IMPLEMENTATION OF GRANTS MANAGEMENT SOFTWARE (U.S. CLS. 100 AND 101).

MATTHEW MCDOWELL, EXAMINING ATTORNEY

SN 78-820,966. PHOENIX MANUFACTURING, INC., PHOENIX, AZ. FILED 2-22-2006.



NO CLAIM IS MADE TO THE EXCLUSIVE RIGHT TO USE "PHOENIX MANUFACTURING, INC.", APART FROM THE MARK AS SHOWN.

THE COLOR(S) BLUE, WHITE, AND BLACK IS/ARE CLAIMED AS A FEATURE OF THE MARK.

THE MARK CONSISTS OF THE LETTERS "PMI" IN BLUE WITH A WHITE BIRD FIGURE (THE UPPER PORTION OF A PHOENIX) IN THE CENTER OF THE LETTER "P" AND WHITE RAYS CROSSING THROUGH THE LETTERS "PMI" AND, BENEATH THAT, THE WORD "PHOENIX MANUFACTURING, INC." IN BLACK.

CLASS 11—ENVIRONMENTAL CONTROL APPARATUS

FOR EVAPORATIVE AIR COOLERS (U.S. CLS. 13, 21, 23, 31 AND 34).
FIRST USE 5-0-1997; IN COMMERCE 5-0-1997.

CLASS 40—MATERIAL TREATMENT

FOR MANUFACTURING FOR OTHERS IN THE FIELD OF EVAPORATIVE COOLING UNITS. (U.S. CLS. 100, 103 AND 106).

FIRST USE 5-0-1997; IN COMMERCE 5-0-1997.
SALLY SHIH, EXAMINING ATTORNEY

SN 78-821,909. SOCIÉTÉ DES SCIENCES VASCULAIRES DU QUÉBEC, MONTREAL, CANADA, FILED 2-23-2006.



OWNER OF CANADA REG. NO. TMA693506, DATED 8-6-2007, EXPIRES 8-6-2022.

NO CLAIM IS MADE TO THE EXCLUSIVE RIGHT TO USE "QUEBEC SOCIETY OF VASCULAR SCIENCES", APART FROM THE MARK AS SHOWN.

CLASS 9—ELECTRICAL AND SCIENTIFIC APPARATUS

FOR EDUCATIONAL AND INFORMATIONAL CD-ROMS IN THE FIELD OF VASCULAR SCIENCES (U.S. CLS. 21, 23, 26, 36 AND 38).

CLASS 35—ADVERTISING AND BUSINESS

FOR PROMOTING PUBLIC AWARENESS OF A MULTIDISCIPLINARY APPROACH TO PREVENTION, CARE, TEACHING AND RESEARCH IN THE FIELD OF VASCULAR DISEASE; AND PROMOTING PUBLIC AWARENESS OF VASCULAR SCIENCE (U.S. CLS. 100, 101 AND 102).

CLASS 36—INSURANCE AND FINANCIAL

FOR CHARITABLE FUND RAISING IN THE FIELD OF VASCULAR DISEASE; FINANCIAL MANAGEMENT OF MONETARY DONATIONS, SECURITIES AND OTHER FIXED FINANCIAL ASSETS TO RAISE FUNDS FOR CHARITABLE PURPOSES IN THE FIELD OF VASCULAR SCIENCE (U.S. CLS. 100, 101 AND 102).

CLASS 41—EDUCATION AND ENTERTAINMENT

FOR PROVIDING CONTINUING HEALTH AND MEDICAL EDUCATION COURSES IN THE FIELD OF VASCULAR SCIENCE; PROVIDING ONLINE EDUCATIONAL VIDEO CONFERENCES IN THE FIELD OF VASCULAR SCIENCE; AND PROVIDING EDUCATIONAL SYMPOSIUMS IN THE FIELD OF VASCULAR SCIENCE (U.S. CLS. 100, 101 AND 107).

CLASS 44—MEDICAL, BEAUTY AND AGRICULTURAL SERVICES

FOR PROVIDING MEDICAL AND HEALTH INFORMATION IN THE FIELD OF VASCULAR SCIENCE VIA A WEB SITE ON A GLOBAL COMPUTER NETWORK. (U.S. CLS. 100 AND 101).

PATRICIA EVANKO, EXAMINING ATTORNEY

SN 78-822,317. TEST RITE PRODUCTS CORPORATION, ONTARIO, CA. FILED 2-23-2006.

SAF-T-FRYER

THE MARK CONSISTS OF STANDARD CHARACTERS WITHOUT CLAIM TO ANY PARTICULAR FONT, STYLE, SIZE, OR COLOR.

CLASS 11—ENVIRONMENTAL CONTROL APPARATUS

FOR GAS DEEP FAT TURKEY FRYERS AND FRYER STANDS; ELECTRIC FISH COOKERS; ELECTRIC BROILERS; ELECTRIC FOOD STEAMERS; ELECTRIC TOASTER OVENS; BARBEQUE GRILLS; ELECTRIC DEEP FRYERS (U.S. CLS. 13, 21, 23, 31 AND 34).

CLASS 21—HOUSEWARES AND GLASS

FOR COOKING EQUIPMENT, NAMELY, COOKING STANDS, POTS AND PANS; COOKING UTENSILS, NAMELY, SPATULAS, FLIPPERS, TURNERS, TONGS, SKIMMERS, SKEWERS, SERVING FORKS, SERVING SPOONS; SERVING LADLES, SLOTTED SPOONS, BASTING BRUSHES; COOKING, FRYING AND BARBEQUE ACCESSORIES, NAMELY SALT AND PEPPER SHAKERS, FUNNELS, PLATTERS, WIRE SERVING BASKETS, CARVING BOARDS, KNIVES, PORTABLE PLASTIC CONTAINERS FOR STORING FOOD; COOKWARE FOR CAMPING, NAMELY POTS AND PANS, GRILL CLEANING UTENSILS, NAMELY GRILL CLEANING SPONGES, BRUSHES AND SCRAPERS (U.S. CLS. 2, 13, 23, 29, 30, 33, 40 AND 50).

CLASS 24—FABRICS

FOR GLOVES, MITTS, SILICONE POT HOLDERS, AND POT HOLDERS FOR USE IN COOKING (U.S. CLS. 42 AND 50).

CLASS 25—CLOTHING

FOR APRONS (U.S. CLS. 22 AND 39).
CAROLYN CATALDO, EXAMINING ATTORNEY

SN 78-822,582. UNIVERSITY ATHLETIC ASSOCIATION, INC., GAINESVILLE, FL. FILED 2-24-2006.

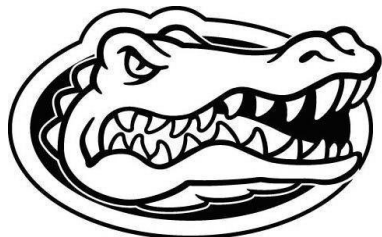

OWNER OF U.S. REG. NOS. 1,970,217 AND 1,975,079.
SEC. 2(F).

CLASS 14—JEWELRY

FOR LAPEL PINS, WATCHES, PRECIOUS METAL MONEY CLIPS, PENDANTS, EARRINGS, TIE TACKS, RINGS, BRACELETS, BRACELET CHARMS, PRECIOUS METAL KEY CHAINS (U.S. CLS. 2, 27, 28 AND 50).
FIRST USE 1-1-1995; IN COMMERCE 1-1-1995.

CLASS 16—PAPER GOODS AND PRINTED MATTER

FOR NOTEBOOKS, PAPER TABLECLOTHS, PAPER GIFT BAGS, TEMPORARY TATTOOS, GIFT WRAP PAPER, CALENDARS, MEMO PADS, PENCILS, PENS, GREETING CARDS, ADDRESS LABELS, STATIONERY, PRINTED PARTY INVITATIONS, PHOTO ALBUMS, SELF-STICK NOTES, NAMELY, ADHESIVE NOTEPADS, TISSUE PAPER FOR WRAPPING PRESENTS (U.S. CLS. 2, 5, 22, 23, 29, 37, 38 AND 50).
FIRST USE 1-1-1995; IN COMMERCE 1-1-1995.

CLASS 21—HOUSEWARES AND GLASS

FOR BOWLS, CERAMIC MUGS, TRAVEL MUGS, PLASTIC MUGS, PILSNER DRINKING GLASSES, DRINKING STEMS, CANDY JARS, GLASS STORAGE JARS, PAPER PLATES, PLASTIC CUPS, PAPER CUPS, BOTTLE OPENERS, CRYSTAL DECANTERS, DRINKING GLASSES (U.S. CLS. 2, 13, 23, 29, 30, 33, 40 AND 50).
FIRST USE 1-1-1995; IN COMMERCE 1-1-1995.

CLASS 28—TOYS AND SPORTING GOODS

FOR PAPER STREAMERS, NAMELY, PARTY STREAMERS MADE OF PAPER, BASKETBALLS, FOOTBALLS, GOLF BALLS, DIVOT REPAIR TOOLS, VOLLEYBALLS, BASEBALLS, SOCCER BALLS, BASKETBALL HOOP BACKBOARDS, STUFFED TOY ANIMALS, CHECKER GAMES, DART GAMES, PLAYING CARDS, PUZZLES, SNOW GLOBES, CHRISTMAS TREE ORNAMENTS (U.S. CLS. 22, 23, 38 AND 50).
FIRST USE 1-1-1995; IN COMMERCE 1-1-1995.
SONYA STEPHENS, EXAMINING ATTORNEY

SN 78-823,170. KING COUNTY BAR FOUNDATION, SEATTLE, WA. FILED 2-24-2006.

**King County Bar
Foundation**



For the Public Good

NO CLAIM IS MADE TO THE EXCLUSIVE RIGHT TO USE "KING COUNTY BAR FOUNDATION", APART FROM THE MARK AS SHOWN.

THE MARK CONSISTS OF WORDS AND A PAIR OF OVERLAPPING CUPPED HANDS WITH A FLAME COMING OUT OF THE HANDS.

CLASS 36—INSURANCE AND FINANCIAL

FOR CHARITABLE SERVICES, NAMELY, CHARITABLE FUND RAISING FOR LEGAL SERVICES FOR THE UNDERSERVED PUBLIC (U.S. CLS. 100, 101 AND 102).
FIRST USE 6-0-1998; IN COMMERCE 6-0-1998.

CLASS 42—SCIENTIFIC, COMPUTER AND LEGAL SERVICES

FOR PROVIDING LEGAL SERVICES FOR THE UNDERSERVED PUBLIC (U.S. CLS. 100 AND 101).
FIRST USE 6-0-1998; IN COMMERCE 6-0-1998.
MICHAEL WEBSTER, EXAMINING ATTORNEY

SN 78-824,591. ASSESSMENT TECHNOLOGIES INSTITUTE, L.L.C., USING THE MARK THROUGH ITS OPERATING DIVISION, COLLEGE ASSESSMENT INSTITUTE, STILLWELL, KS. FILED 2-27-2006.



NO CLAIM IS MADE TO THE EXCLUSIVE RIGHT TO USE "COLLEGE ASSESSMENT INSTITUTE", APART FROM THE MARK AS SHOWN.

CLASS 35—ADVERTISING AND BUSINESS

FOR MANAGEMENT OF EDUCATIONAL DATA (U.S. CLS. 100, 101 AND 102).

CLASS 41—EDUCATION AND ENTERTAINMENT

FOR ASSESSMENT OF EDUCATIONAL DATA, NAMELY, DEFINING RESULTS AND TRENDS AND PROVIDING DIAGNOSTICS FOR CURRICULA; ASSESSMENT OF DATA IN THE FIELD OF GENERAL POST-SECONDARY EDUCATION KNOWLEDGE AND CORE ACADEMIC SKILLS FOR OTHERS; ANALYZING EDUCATION TEST SCORES AND DATA FOR OTHERS. CUSTOMIZATION OF EDUCATIONAL ASSESSMENT TOOLS, NAMELY, COMPUTERIZED TESTING SERVICES, REPORTING AND RESULTS GENERATION FOR COLLEGES OR GROUPS OF COLLEGES (U.S. CLS. 100, 101 AND 107).

LINDA E. BLOHM, EXAMINING ATTORNEY

SN 78-825,288. FLYSPY, INC., MINNEAPOLIS, MN. FILED 2-28-2006.

FLYSPY

THE MARK CONSISTS OF STANDARD CHARACTERS WITHOUT CLAIM TO ANY PARTICULAR FONT, STYLE, SIZE, OR COLOR.

CLASS 35—ADVERTISING AND BUSINESS

FOR PROVIDING, VIA GLOBAL COMPUTER NETWORK, COMPARATIVE HOTEL PRICE INFORMATION IN A GRAPH SHOWING HOTEL FARES AS THEY VARY BASED ON DATES OF DEPARTURE, WITH IDENTIFICATION OF LOWEST PRICE OPTIONS ACROSS MULTIPLE HOTELS AND PROVIDING LINKS TO OTHERS' ONLINE RESERVATION SERVICES; PROVIDING AN ONLINE COMPUTER DATABASE IN THE FIELD OF HOTEL ROOM RATE INFORMATION; PROVIDING, VIA GLOBAL COMPUTER NETWORK, COMPARATIVE VEHICLE RENTAL PRICE INFORMATION IN A GRAPH SHOWING VEHICLE RENTAL FARES AS THEY VARY BASED ON DATES OF RENTAL, WITH IDENTIFICATION OF LOWEST RENTAL OPTIONS ACROSS MULTIPLE CARRIERS AND PROVIDING LINKS TO OTHERS' ONLINE RESERVATION SERVICES; PROVIDING, VIA GLOBAL COMPUTER NETWORK, COMPARATIVE FLIGHT PRICE INFORMATION IN A GRAPH SHOWING FLIGHT FARES AS THEY VARY BASED ON DATES OF DEPARTURE, WITH IDENTIFICATION OF LOWEST FARE OPTIONS ACROSS MULTIPLE CARRIERS AND PROVIDING LINKS TO OTHERS' ONLINE RESERVATION SERVICES (U.S. CLS. 100, 101 AND 102).

CLASS 39—TRANSPORTATION AND STORAGE

FOR PROVIDING INFORMATION IN THE FIELD OF TRAVEL VIA COMPUTER NETWORKS, GLOBAL INFORMATION NETWORKS AND WIRELESS NETWORKS; PROVIDING AN ONLINE COMPUTER DATABASE IN THE FIELD OF AIR CARRIERS' FLIGHT INFORMATION AND VEHICLE RENTERS' RENTAL INFORMATION (U.S. CLS. 100 AND 105).

AMY BROZENIC, EXAMINING ATTORNEY

SN 78-827,510. ZELCO INDUSTRIES, INC., MOUNT VERNON, NY. FILED 3-2-2006.

THINK FAST

THE MARK CONSISTS OF STANDARD CHARACTERS WITHOUT CLAIM TO ANY PARTICULAR FONT, STYLE, SIZE, OR COLOR.

CLASS 11—ENVIRONMENTAL CONTROL APPARATUS

FOR BOOK LIGHTS (U.S. CLS. 13, 21, 23, 31 AND 34).

CLASS 16—PAPER GOODS AND PRINTED MATTER

FOR PLASTIC PAPER CLIPS FOR LOCATING PAGES IN BOOKS AND STICKERS THEREFOR, METAL PAPER CLIPS FOR LOCATING PAGES IN BOOKS AND STICKERS THEREFOR (U.S. CLS. 2, 5, 22, 23, 29, 37, 38 AND 50).

CLASS 20—FURNITURE AND ARTICLES NOT OTHERWISE CLASSIFIED

FOR BOOK STANDS (U.S. CLS. 2, 13, 22, 25, 32 AND 50).

WILLIAM VERHOSEK, EXAMINING ATTORNEY

SN 78-828,155. HEALTH INTERNATIONAL CORPORATION,
ST. PETERSBURG, FL. FILED 3-3-2006.

YOU CAN DO IT!

THE MARK CONSISTS OF STANDARD CHARACTERS
WITHOUT CLAIM TO ANY PARTICULAR FONT, STYLE,
SIZE, OR COLOR.

CLASS 35—ADVERTISING AND BUSINESS

FOR ADVERTISING, MARKETING AND PROMO-
TION SERVICES (U.S. CLS. 100, 101 AND 102).
FIRST USE 0-0-1993; IN COMMERCE 0-0-1993.

CLASS 41—EDUCATION AND ENTERTAIN- MENT

FOR ENTERTAINMENT IN THE NATURE OF LIVE
PERFORMANCES AND TELEVISED PERFORMANCES
AND APPEARANCES FEATURING PHYSICAL FIT-
NESS, EXERCISE, AND BODYBUILDING INSTRU-
CTION AND TRAINING; EDUCATIONAL SERVICES,
NAMELY PROVIDING INSTRUCTION AND TRAINING
IN THE FIELD OF PHYSICAL FITNESS, EXERCISE
AND BODYBUILDING INSTRUCTION AND TRAINING
(U.S. CLS. 100, 101 AND 107).

FIRST USE 0-0-1993; IN COMMERCE 0-0-1993.
MAUREEN DALL, EXAMINING ATTORNEY

SN 78-828,553. AVAMERE HOME HEALTH CARE, LLC,
WILSONVILLE, OR. FILED 3-3-2006.

AS INDIVIDUAL AS YOU ARE

THE MARK CONSISTS OF STANDARD CHARACTERS
WITHOUT CLAIM TO ANY PARTICULAR FONT, STYLE,
SIZE, OR COLOR.

CLASS 44—MEDICAL, BEAUTY AND AGRI- CULTURAL SERVICES

FOR DIETARY AND NUTRITIONAL GUIDANCE;
FOOD NUTRITION CONSULTATION; HEALTH CARE;
HOME HEALTH CARE SERVICES; HOME NURSING
AID SERVICES; MEDICAL COUNSELING; MEDICAL
EVALUATION SERVICES, NAMELY, FUNCTIONAL AS-
SESSMENT PROGRAM FOR PATIENTS RECEIVING
MEDICAL REHABILITATION SERVICES FOR PUR-
POSES OF GUIDING TREATMENT AND ASSESSING
PROGRAM EFFECTIVENESS; NURSING CARE; NUTRI-
TION COUNSELING; OCCUPATIONAL THERAPY SER-
VICES; PHYSICAL REHABILITATION; PHYSICAL
THERAPY; PREPARATION AND DISPENSING OF MED-
ICATIONS; SPEECH AND HEARING THERAPY (U.S.
CLS. 100 AND 101).

FIRST USE 1-3-2005; IN COMMERCE 1-3-2005.

CLASS 45—PERSONAL SERVICES

FOR PERSONAL CARE ASSISTANCE OF ACTIVITIES
OF DAILY LIVING, SUCH AS BATHING, GROOMING
AND PERSONAL MOBILITY FOR MENTALLY OR
PHYSICALLY CHALLENGED PEOPLE; PERSONAL
SHOPPING FOR OTHERS; RUNNING ERRANDS FOR
OTHERS; GRIEF COUNSELING; PROVIDING PERSONAL
SUPPORT SERVICES FOR FAMILIES OF PAT-
IENTS WITH LIFE THREATENING DISORDERS,
NAMELY, COMPANIONSHIP, COUNSELING AND
EMOTIONAL SUPPORT (U.S. CLS. 100 AND 101).

FIRST USE 1-3-2005; IN COMMERCE 1-3-2005.
JULIE WATSON, EXAMINING ATTORNEY

SN 78-829,088. LUCID ADVISORS, INC., SEATTLE, WA.
FILED 3-3-2006.

PURE ADVICE

THE MARK CONSISTS OF STANDARD CHARACTERS
WITHOUT CLAIM TO ANY PARTICULAR FONT, STYLE,
SIZE, OR COLOR.

OWNER OF U.S. REG. NO. 3,185,782.
NO CLAIM IS MADE TO THE EXCLUSIVE RIGHT TO
USE "ADVICE", APART FROM THE MARK AS SHOWN.

CLASS 36—INSURANCE AND FINANCIAL

FOR FINANCIAL SERVICES, NAMELY RETIREMENT
PLAN MANAGEMENT CONSULTING; INVESTMENT
MANAGEMENT CONSULTING; REVIEW, ANALYSIS
AND ADVICE REGARDING RETIREMENT PLAN AND
INVESTMENT EXPENSES; FINANCIAL PLANNING
AND CONSULTING. (U.S. CLS. 100, 101 AND 102).

FIRST USE 5-13-2003; IN COMMERCE 5-13-2003.

CLASS 41—EDUCATION AND ENTERTAIN- MENT

FOR EMPLOYEE EDUCATION, NAMELY, WORK-
SHOPS AND SEMINARS IN THE FIELDS OF RETIRE-
MENT PLAN MANAGEMENT AND INVESTMENT
MANAGEMENT; EDUCATION, NAMELY, WORKSHOPS
AND SEMINARS IN THE FIELDS OF RETIREMENT
PLAN FIDUCIARY OBLIGATIONS, INVESTMENT PRO-
CESSES, AND INVESTMENT EXPENSES (U.S. CLS. 100,
101 AND 107).

FIRST USE 5-13-2003; IN COMMERCE 5-13-2003.
SUSAN STIGLITZ, EXAMINING ATTORNEY

SN 78-830,546. BIOVIGILANT SYSTEMS, INC., TUCSON, AZ.
FILED 3-6-2006.

BIOVIGILANT

THE MARK CONSISTS OF STANDARD CHARACTERS
WITHOUT CLAIM TO ANY PARTICULAR FONT, STYLE,
SIZE, OR COLOR.

CLASS 9—ELECTRICAL AND SCIENTIFIC APPARATUS

FOR ELECTRICAL AND OPTICAL INSTRUMENTS FOR MONITORING AND TESTING AIR AND WATER FOR AGRICULTURE, CONSUMER, GOVERNMENTAL, MILITARY, HOMELAND SECURITY, RETAIL, TRANSPORTATION, ENTERTAINMENT, FOOD, LODGING, EDUCATION AND HEALTHCARE INDUSTRIES, FOR LABORATORY APPLICATIONS, AND FOR MANUFACTURING APPLICATIONS, NAMELY, PHARMACEUTICAL AND MEDICAL DEVICE MANUFACTURING, FOOD PROCESSING MANUFACTURING, SEMICONDUCTOR MANUFACTURING AND OPTICAL MANUFACTURING (U.S. CLS. 21, 23, 26, 36 AND 38).

CLASS 37—CONSTRUCTION AND REPAIR

FOR CONSULTING SERVICES IN THE INSTALLATION OF AIR AND/OR WATER TESTING, ANALYSIS AND MONITORING SYSTEMS; INSTALLATION AND MAINTENANCE OF AIR AND/OR WATER TESTING, ANALYSIS AND MONITORING EQUIPMENT (U.S. CLS. 100, 103 AND 106).

CLASS 41—EDUCATION AND ENTERTAINMENT

FOR PUBLISHING WHITE PAPERS IN THE FIELD OF AIR AND/OR WATER TESTING, ANALYSIS AND MONITORING SYSTEMS (U.S. CLS. 100, 101 AND 107).

CLASS 42—SCIENTIFIC, COMPUTER AND LEGAL SERVICES

FOR CONSULTING SERVICES IN THE DESIGN AND TECHNICAL MONITORING OF AIR AND/OR WATER TESTING, ANALYSIS AND MONITORING SYSTEMS; AND AIR AND WATER TESTING, ANALYSIS AND TECHNICAL MONITORING SERVICES (U.S. CLS. 100 AND 101).

NORA BUCHANAN WILL, EXAMINING ATTORNEY

SN 78-831,578. AB HOLDINGS, LLC, BOISE, ID. FILED 3-7-2006.

AB

THE MARK CONSISTS OF STANDARD CHARACTERS WITHOUT CLAIM TO ANY PARTICULAR FONT, STYLE, SIZE, OR COLOR.

OWNER OF U.S. REG. NO. 2,532,838.

CLASS 35—ADVERTISING AND BUSINESS

FOR ON-LINE ORDERING SERVICES FEATURING HIGH QUALITY BEEF AND BEEF RELATED PRODUCTS, NAMELY BEEF CARCASSES, CUT PORTIONS OF BEEF BOTH PACKAGED AND NON-PACKAGED AND GROUND BEEF (U.S. CLS. 100, 101 AND 102).

FIRST USE 11-30-2005; IN COMMERCE 11-30-2005.

CLASS 44—MEDICAL, BEAUTY AND AGRICULTURAL SERVICES

FOR RANCHING AND FEEDING OF CATTLE (U.S. CLS. 100 AND 101).

FIRST USE 12-4-1978; IN COMMERCE 12-4-1978.
HOWARD FRIEDMAN, EXAMINING ATTORNEY

SN 78-834,230. PROETHIC PHARMACEUTICALS, INC., MONTGOMERY, AL. FILED 3-10-2006.

IMPACT

THE MARK CONSISTS OF STANDARD CHARACTERS WITHOUT CLAIM TO ANY PARTICULAR FONT, STYLE, SIZE, OR COLOR.

CLASS 16—PAPER GOODS AND PRINTED MATTER

FOR PRINTED REPORTS FEATURING CLINICAL TRIAL RESULTS INVOLVING MIGRAINE HEADACHE TREATMENTS (U.S. CLS. 2, 5, 22, 23, 29, 37, 38 AND 50).

CLASS 42—SCIENTIFIC, COMPUTER AND LEGAL SERVICES

FOR PROVIDING ON-LINE COMPUTER DATABASES IN THE FIELD OF CLINICAL TRIAL RESULTS INVOLVING MIGRAINE HEADACHE TREATMENTS TO PHYSICIANS AND PATIENTS; PROVIDING ON-LINE COMPUTER DATABASES TO MIGRAINE HEADACHE SUFFERERS FEATURING RESULTS OF CLINICAL TRIALS IN THE FIELD OF MIGRAINE HEADACHES; PROVIDING HEALTH INFORMATION, NAMELY PROVIDING CLINICAL TRIAL RESULTS INVOLVING MIGRAINE HEADACHE TREATMENTS TO PHYSICIANS AND PATIENTS (U.S. CLS. 100 AND 101).

CLASS 44—MEDICAL, BEAUTY AND AGRICULTURAL SERVICES

FOR PROVIDING HEALTH INFORMATION, NAMELY, PROVIDING INFORMATION TO PATIENTS SUFFERING FROM MIGRAINE HEADACHES (U.S. CLS. 100 AND 101).

ALYSSA PALADINO, EXAMINING ATTORNEY

SN 78-838,123. DATATRAX TECHNOLOGIES INC., TORONTO, CANADA, FILED 3-15-2006.

DataTrax

PRIORITY CLAIMED UNDER SEC. 44(D) ON CANADA APPLICATION NO. 1272053, FILED 9-15-2005, REG. NO. TMA691053, DATED 6-28-2007, EXPIRES 6-28-2022.

CLASS 35—ADVERTISING AND BUSINESS

FOR (BASED ON USE IN COMMERCE) LICENSING COMPUTER SOFTWARE FOR USE BY OTHERS AT POINT OF SALE TERMINALS FOR ISSUING AND TRACKING ATTRACTION, EVENT AND TOUR TICKETS; OPERATING AND HOSTING REPORT SEVERs FOR USERS OF COMPUTER SOFTWARE, AND COMPILING DAILY, WEEKLY, AND MONTHLY REPORTS FOR TERMINAL COMPUTER SOFTWARE USERS; (BASED ON INTENT TO USE) LICENSING OF COMPUTER SOFTWARE FOR USE BY OTHERS AT POINT OF SALE TERMINALS TO TRACK AND RECORD SALES AND RECEIPTS AND RETAIL OUTLETS; LICENSING COMPUTER SOFTWARE FOR USE BY SALES PROFESSIONALS ON HAND-HELD TERMINALS TO PROVIDE CUSTOMER ACCOUNT INFORMATION, PRODUCT INVENTORY CONTROLS, AND ORDER CONFIRMATIONS; LICENSING OF COMPUTER SOFTWARE FOR USE BY CONTRACTORS AT POINT OF SALE TERMINALS FOR QUOTING, INVOICING AND PROVIDING A FIELD ACCOUNTING SYSTEM; LICENSING OF COMPUTER SOFTWARE FOR USE BY OTHERS AT POINT OF SALE TERMINALS TO PROCESS CREDIT AND DEBIT CARD TRANSACTIONS; PREPARING FINANCIAL REPORTS FOR OTHERS (U.S. CLS. 100, 101 AND 102).

CLASS 36—INSURANCE AND FINANCIAL

FOR (BASED ON INTENT TO USE) FINANCIAL MANAGEMENT SERVICES; ACCOUNTS PAYABLE AND COMMISSIONS DEBITING SERVICES (U.S. CLS. 100, 101 AND 102).

CLASS 42—SCIENTIFIC, COMPUTER AND LEGAL SERVICES

FOR (BASED ON USE IN COMMERCE) OPERATING AND HOSTING WEB SITES ON A COMPUTER SERVER FOR USERS OF COMPUTER SOFTWARE FOR THE PURPOSE OF MANAGING THEIR PRODUCTS, AGENTS, REPORTS AND INVENTORY (U.S. CLS. 100 AND 101).

FIRST USE 5-1-2001; IN COMMERCE 5-1-2005.
ARETHA SOMERVILLE, EXAMINING ATTORNEY

SN 78-838,144. MOMAR, INC., ATLANTA, GA. FILED 3-15-2006.

MOCHEM

THE MARK CONSISTS OF STANDARD CHARACTERS WITHOUT CLAIM TO ANY PARTICULAR FONT, STYLE, SIZE, OR COLOR.

CLASS 1—CHEMICALS

FOR SOIL ADDITIVES AND SOIL STERILANTS; SNOW AND DE-ICING PREPARATIONS FOR CONCRETE SURFACES; ALL PURPOSE DEGREASERS USED IN MANUFACTURING PROCESSES FOR METAL PARTS AND ELECTRICAL COMPONENTS (U.S. CLS. 1, 5, 6, 10, 26 AND 46).

FIRST USE 0-0-1996; IN COMMERCE 0-0-1996.

CLASS 2—PAINTS

FOR FLOOR COATINGS, NAMELY VARNISHES FOR WOOD FLOORS (U.S. CLS. 6, 11 AND 16).

FIRST USE 0-0-1996; IN COMMERCE 0-0-1996.

CLASS 3—COSMETICS AND CLEANING PREPARATIONS

FOR CLEANING PREPARATIONS FOR USE ON COILS, FILTERS, ELECTRICAL EQUIPMENT, BATHROOMS, GLASS, FLOORS, OVENS, STOVES, CIRCUIT BOARDS, ENGINES; ALL PURPOSE CLEANING PREPARATIONS; ALL PURPOSE DEGREASERS NOT USED IN MANUFACTURING PROCESSES FOR OVENS, STOVES, FLOORS, ENGINES, EQUIPMENT PARTS, AND BATHROOMS AND GLASS; HAND AND BODY CLEANSER; FLOOR STRIPPERS, FLOOR WAX REMOVER, FLOOR WAXES, FLOOR FINISHING PREPARATIONS; CARPET CLEANING PREPARATIONS; DISH DETERGENTS; CLEANING COMPOUNDS FOR PRESSURE WASHERS AND STEAM CLEANERS; LAUNDRY DETERGENTS; PAINT REMOVERS; RUST REMOVING PREPARATIONS; FURNITURE POLISH; DISPOSABLE WIPES IMPREGNATED WITH CHEMICALS OR COMPOUNDS FOR PERSONAL HYGIENE; DRAIN OPENERS; TAR AND GREASE SOLVENTS; DESCALERS PREPARATIONS FOR ALUMINUM, STAINLESS STEEL AND COPPER HOUSEHOLD GOODS; DRYING AGENTS FOR DISHES, GLASSWARE AND UTENSILS (U.S. CLS. 1, 4, 6, 50, 51 AND 52).

FIRST USE 0-0-1996; IN COMMERCE 0-0-1996.

CLASS 5—PHARMACEUTICALS

FOR VIRUCIDES, GERMICIDES AND FUNGICIDES; ANTI-BACTERIAL ALCOHOL SKIN SANITIZER GEL; INSECTICIDES; WEED AND GRASS KILLERS FOR COMMERCIAL AND DOMESTIC USE; AIR DEODORIZER; CARPET DEODORIZER; ALL PURPOSE SANITIZERS AND DISINFECTANTS (U.S. CLS. 6, 18, 44, 46, 51 AND 52).

FIRST USE 0-0-1996; IN COMMERCE 0-0-1996.
THEODORE MCBRIDE, EXAMINING ATTORNEY

SN 78-839,931. 2932105 CANADA INC., MARKHAM, ONTARIO, CANADA, FILED 3-17-2006.

PROMONOW

THE MARK CONSISTS OF STANDARD CHARACTERS WITHOUT CLAIM TO ANY PARTICULAR FONT, STYLE, SIZE, OR COLOR.

CLASS 35—ADVERTISING AND BUSINESS

FOR MAIL ORDER SERVICES FEATURING PROMOTIONAL ITEMS, NAMELY, KITCHEN SETS, BAR SETS, CARVING SETS, PEPPER MILLS, SALT AND PEPPER MILLS, TEA MAKER, STAINLESS STEEL TABLEWARE SET, COMPACT THREE PIECE CUTLERY SET, BISTRO SPOON SETS, GARDEN TOOL BAGS, COASTER SETS, CHEESE SETS, WINE BOTTLE CASES, WINE CASE SETS, WINE OPENERS, WINE STOPPERS, BARBEQUE SETS; GAMES, NAMELY, SUDOKU, BOARD GAMES, POKER; BOOK LIGHTS; FITNESS ACCESSORIES, NAMELY, PEDOMETERS, STOP WATCHES, STOP WATCHES WITH LAP COUNTER; CLOTHING, NAMELY, SCARVES; HEADGEAR, NAMELY, HATS; SHOE POLISH KITS; TRAVEL KITS; MANICURE KITS; BINOCULARS; PILL DISPENSER CASES; COMPASSES; MAGNIFIERS; FLASHLIGHTS; COMPASS KEY CHAINS; COMPASS CARABINERS; POCKET WATCH CARABINERS; LANTERNS; SUNGLASSES; DRINKWARE, NAMELY, MUGS, TUMBLERS, INSULATED MUGS, MARTINI GLASSES, WATER BOTTLES, WATER BOTTLES WITH METAL CAPS, POLYCARB WATER BOTTLES, FLASKS; GOLF ACCESSORIES, NAMELY, GOLF DIVOT WITH MAGNET GOLF MARKER, INDOOR PUTTER SET, GOLF TOWEL, PUTTERS, MONOCULARS, GOLF CARABINER CLIPS, GOLF COUNTERS, TOOL SETS, KNIFES, DIVOT TOOLS, PENS WITH GOLF

CLIP; SUNGLASSES; TOYS, NAMELY, STUFFED ANIMALS, HOLIDAY ORNAMENTS; RADIOS; GIFT SETS, NAMELY, FLASK AND TUMBLER SETS, TUMBLER AND MULTI-TOOL SETS, WATER BOTTLE AND TUMBLER SET, TUMBLER AND BISTRO SPOON SETS, WINE STOPPER AND WINE OPENER SETS, POCKET WATCH AND WINE OPENER SETS, WATCH AND KNIFE SETS, WATCH AND MULTI-TOOLS SETS, FLASHLIGHT AND COMPASS SETS, WATCH WITH BUSINESS CARD HOLDER SETS, WATCH WITH PEN SETS, STOP WATCH WITH RADIO SETS; BAGS, NAMELY, DUFFEL BAGS, CARRY-ON TOTE BAGS, BOARDING BAGS, TRAVEL KITS, ROLLER BACKPACK SETS, 4-IN-1 BAGS, TRAVEL DUFFEL BAGS ON WHEELS, DUAL COMPARTMENT ALL PURPOSE BAGS, SHOE BAGS, DAYPACKS, COMPUTER BACKPACKS, SLING PACKS, HYDRA BACKPACKS, EXPANDABLE WHEELED BACKPACKS, PICNIC COOLER BACKPACKS, COOLER BAGS, GYM BAGS, SPORT BAGS, MESSENGER BAGS, DOCUMENT BAGS, BRIEFCASES, TRAVEL ORGANIZERS; CD ORGANIZERS; FLEECE BLANKETS; UMBRELLAS; PICNIC SETS; TOOLS, NAMELY, TOOL KITS, SCREWDRIVER SETS, FLASHLIGHT TOOL KITS, KEY RING TOOL KITS, POCKET LEVELS, ALUMINUM LEVELS, LEVEL KEY CHAIN, MULTI-TOOLS; KNIVES, NAMELY, POCKET KNIVES; MEASURING TAPES; AUTOMOTIVE ACCESSORIES, NAMELY, SUNGLASS CLIPS, TIRE GAUGES, DIGITAL TIRE GAUGES, KEY CHAIN GAUGES, CAR EMERGENCY KITS; AUTO ESCAPE TOOLS; AIR COMPRESSORS; WATCHES, WATCH ACCESSORIES, NAMELY, WATCH BANDS, WATCH CASES; CLOCKS; WORLD TIMERS; COMPUTER ACCESSORIES, NAMELY, USB MP3 PLAYER SPEAKERS, USB 4-PORT HUBS, USB 4-PORT MOUSE PADS, KEYBOARD AND MOUSE SETS, MEMORY STICKS, NETWORK CABLES; LASER POINTERS; PORTFOLIOS, NAMELY, BRIEFCASES, WALLETS, PASSPORT HOLDERS; DESK ACCESSORIES, NAMELY, TELEPHONE CORD DETANGLERS, DESK CADDY, NOTE HOLDERS, MEMO AND PEN HOLDERS, BUSINESS CARD HOLDER AND LANYARDS, BUSINESS CARD HOLDERS WITH CALCULATORS, PHOTO FRAMES, DESK GLOBES, CALCULATORS, PENS AND PEN SETS; BOOKLIGHTS; CANDLES (U.S. CLS. 100, 101 AND 102).

CLASS 40—MATERIAL TREATMENT

FOR MANUFACTURE OF PROMOTIONAL PRODUCTS TO ORDER AND/OR SPECIFICATION OF OTHERS, NAMELY, KITCHEN SETS, BAR SETS, CARVING SETS, PEPPER MILLS, SALT AND PEPPER MILLS, TEA MAKER, STAINLESS STEEL TABLEWARE SET, COMPACT THREE PIECE CUTLERY SET, BISTRO SPOON SETS, GARDEN TOOL BAGS, COASTER SETS, CHEESE SETS, WINE BOTTLE CASES, WINE CASE SETS, WINE OPENERS, WINE STOPPERS, BARBEQUE SETS; GAMES, NAMELY, SUDOKU, BOARD GAMES, POKER; BOOK LIGHTS; FITNESS ACCESSORIES, NAMELY, Pedometers, STOP WATCHES, STOP WATCHES WITH LAP COUNTER; CLOTHING, NAMELY, SCARVES; HEADGEAR, NAMELY, HATS; SHOE POLISH KITS; TRAVEL KITS; MANICURE KITS; BINOCULARS; PILL DISPENSER CASES; COMPASSES; MAGNIFIERS; FLASHLIGHTS; COMPASS KEY CHAINS; COMPASS CARABINERS; POCKET WATCH CARABINERS; LANTERNS; SUNGLASSES; DRINKWARE, NAMELY, MUGS, TUMBLERS, INSULATED MUGS, MARTINI GLASSES, WATER BOTTLES, WATER BOTTLES WITH METAL CAPS, POLYCARB WATER BOTTLES, FLASKS; GOLF ACCESSORIES, NAMELY, GOLF DIVOT WITH MAGNET GOLF MARKER, INDOOR PUTTER SET, GOLF TOWEL, PUTTERS, MONOCULARS, GOLF CARABINER CLIPS, GOLF COUNTERS, TOOL SETS, KNIVES, DIVOT TOOLS, PENS WITH GOLF CLIP; SUNGLASSES; TOYS, NAMELY, STUFFED ANIMALS, HOLIDAY ORNAMENTS; RADIOS; GIFT SETS, NAMELY, FLASK AND TUMBLER SETS, TUMBLER AND MULTI-TOOL SETS, WATER BOTTLE AND TUMBLER SET, TUMBLER AND BISTRO SPOON SETS, WINE STOPPER AND WINE OPENER SETS, POCKET WATCH AND WINE OPENER SETS, WATCH AND KNIFE SETS, WATCH AND MULTI-TOOLS SETS, FLASHLIGHT AND COMPASS SETS, WATCH WITH BUSINESS CARD HOLDER SETS, WATCH WITH PEN SETS, STOP WATCH WITH RADIO SETS; BAGS, NAMELY, DUFFEL BAGS, CARRY-ON TOTE BAGS, BOARDING BAGS, TRAVEL KITS, ROLLER BACKPACK SETS, 4-IN-1 BAGS, TRAVEL DUFFEL BAGS ON WHEELS, DUAL COMPART-

MENT ALL PURPOSE BAGS, SHOE BAGS, DAYPACKS, COMPUTER BACKPACKS, SLING PACKS, HYDRA BACKPACKS, EXPANDABLE WHEELED BACKPACKS, PICNIC COOLER BACKPACKS, COOLER BAGS, GYM BAGS, SPORT BAGS, MESSENGER BAGS, DOCUMENT BAGS, BRIEFCASES, TRAVEL ORGANIZERS; CD ORGANIZERS; FLEECE BLANKETS; UMBRELLAS; PICNIC SETS; TOOLS, NAMELY, TOOL KITS, SCREWDRIVER SETS, FLASHLIGHT TOOL KITS, KEY RING TOOL KITS, POCKET LEVELS, ALUMINUM LEVELS, LEVEL KEY CHAIN, MULTI-TOOLS; KNIVES, NAMELY, POCKET KNIVES; MEASURING TAPES; AUTOMOTIVE ACCESSORIES, NAMELY, SUNGLASS CLIPS, TIRE GAUGES, DIGITAL TIRE GAUGES, KEY CHAIN GAUGES, CAR EMERGENCY KITS; AUTO ESCAPE TOOLS; AIR COMPRESSORS; WATCHES, WATCH ACCESSORIES, NAMELY, WATCH BANDS, WATCH CASES; CLOCKS; WORLD TIMERS; COMPUTER ACCESSORIES, NAMELY, USB MP3 PLAYER SPEAKERS, USB 4-PORT HUBS, USB 4-PORT MOUSE PADS, KEYBOARD AND MOUSE SETS, MEMORY STICKS, NETWORK CABLES; LASER POINTERS; PORTFOLIOS, NAMELY, BRIEFCASES, WALLETS, PASSPORT HOLDERS; DESK ACCESSORIES, NAMELY, TELEPHONE CORD DETANGLERS, DESK CADDY, NOTE HOLDERS, MEMO AND PEN HOLDERS, BUSINESS CARD HOLDER AND LANYARDS, BUSINESS CARD HOLDERS WITH CALCULATORS, PHOTO FRAMES, DESK GLOBES, CALCULATORS, PENS AND PEN SETS; BOOKLIGHTS; CANDLES (U.S. CLS. 100, 103 AND 106).
KELLY CHOE, EXAMINING ATTORNEY

SN 78-845,558. SIEB & MEYER AG, LUNEBURG, FED REP GERMANY, FILED 3-24-2006.

SIEB & MEYER 

THE MARK CONSISTS OF THE WORDS SIEB & MEYER TO THE LEFT OF THE STYLIZED LETTERS "SM".

CLASS 7—MACHINERY

FOR APPARATUS FOR THE CONTROL AND REGULATION OF MACHINES OR MOTORS, NAMELY, SERVO MOTORS, STEPPER MOTORS; ELECTRIC MOTORS FOR MACHINES (U.S. CLS. 13, 19, 21, 23, 31, 34 AND 35).
FIRST USE 12-31-1996; IN COMMERCE 12-31-1996.

CLASS 9—ELECTRICAL AND SCIENTIFIC APPARATUS

FOR ELECTRICAL AND ELECTRONIC APPARATUS AND SYSTEMS FOR THE CONTROL AND REGULATION OF INDUSTRIAL OPERATIONS, NAMELY, ELECTRICAL POWER SUPPLIES, ELECTRONIC CONTROLLERS, MEASURING DEVICES, NAMELY, FOR CURRENT, FREQUENCY, TENSION, POWER, TORQUE, TEMPERATURE, TIME, ROTATION, SPEED, LOCATION, FORCE, PRESSURE, WEATHER, SERVO AMPLIFIERS, FREQUENCY CONVERTERS, CONTROLLER INTEGRATED CIRCUIT BOARDS, FIELDBUS ELECTRICAL CONTROLLERS, INDUSTRIAL COMPUTERS IN PARTICULAR WITH INTEGRATED CONTROL SOFTWARE PACKAGES, IN PARTICULAR FOR THE CONTROL OF TORQUE; APPARATUS AND INSTRUMENTS FOR THE REGULATION AND CONTROL OF THE MOTION AND POSITION OF MACHINES AND THEIR PARTS, NAMELY, ELECTRICAL POWER SUPPLIES, ELECTRONIC CONTROLLERS, MEASURING DEVICES, NAMELY, FOR CURRENT, FREQUENCY, TENSION, POWER, TORQUE, TEMPERATURE, TIME, ROTATION, SPEED, LOCATION, FORCE, PRESSURE, WEATHER, SERVO AMPLIFIERS, FREQUENCY CONVERTERS, INDUSTRIAL COMPUTERS; ELECTRONIC AND ELECTRICAL APPARATUS AND INSTRUMENTS FOR USE IN GENERATING OR DISTRIBUTING ENERGY OF HIGH FREQUENT CURRENT AND/OR TENSION, NAMELY, ELECTRICAL POWER SUPPLIES, ELECTRONIC CONTROLLERS, MEASURING DEVICES, NAMELY, FOR CURRENT, FREQUENCY, TENSION, POWER, TORQUE, TEMPERATURE, TIME, ROTATION, SPEED, LOCATION, FORCE, PRESSURE, WEATHER, SERVO AMPLIFIERS, FREQUENCY CONVERTERS, INDUSTRIAL COMPUTERS; ELECTRICAL AND ELECTRONIC CONTROL AND REGULATING MECHANISMS AND FEEDBACK AMPLIFIERS FOR MACHINES, ENGINES OR MOTORS, NAMELY, ELECTRONIC CLOSED-LOOP AND OPEN-LOOP CONTROLLERS, PID-CONTROLLERS, ADAPTIVE CONTROLLERS; COMPUTER SOFTWARE FOR SPREADSHEETS, DATABASE MANAGEMENT, CNC (COMPUTER NUMERICAL CONTROL) FOR ELECTRONIC CIRCUIT BOARD PRODUCTION AND MACHINE TOOLS, EACH IN THE FIELDS OF CONTROL AND REGULATION OF MACHINES OR MOTORS, OF THE SUPPLY OF ELECTRIC AND ELECTRONIC COMPONENTS WITH ELECTRICAL ENERGY, AND OF GENERATING OR DISTRIBUTING ENERGY OF HIGH FREQUENT CURRENT AND/OR TENSION; COMPUTER SOFTWARE FOR DIAGNOSING FUNCTION OR DISFUNCTION OF MACHINES, ENGINES, OR MOTORS; COMPUTERS AND COMPUTER PERIPHERALS, NAMELY, BUS SYSTEMS, DATA INTERFACES, DATA LOGGERS AND INTERFACE BOARDS FOR COMPUTERS (U.S. CLS. 21, 23, 26, 36 AND 38).

FIRST USE 12-31-1996; IN COMMERCE 12-31-1996.

CLASS 37—CONSTRUCTION AND REPAIR

FOR REPAIRING, MAINTENANCE AND SERVICING OF ELECTRIC AND ELECTRONIC EQUIPMENT, MACHINES, MOTORS AND THEIR COMPONENTS, NAMELY APPARATUS FOR THE CONTROL AND REGULATION OF MACHINES OR MOTORS, ELECTRIC MOTORS FOR MACHINES, APPARATUS AND INSTRUMENTS FOR THE REGULATION AND CONTROL OF THE MOTION AND POSITION OF MACHINES AND THEIR PARTS, APPARATUS FOR THE SUPPLY OF ELECTRIC AND ELECTRONIC COMPONENTS WITH ELECTRICAL ENERGY, ELECTRONIC AND ELECTRICAL APPARATUS AND INSTRUMENTS, FOR USE IN GENERATING OR DISTRIBUTING ENERGY OF HIGH FREQUENT CURRENT AND/OR TENSION (U.S. CLS. 100, 103 AND 106).

FIRST USE 12-31-1996; IN COMMERCE 12-31-1996.
HEATHER THOMPSON, EXAMINING ATTORNEY

SN 78-849,680. GREATER WASHINGTON BOARD OF TRADE, WASHINGTON, DC. FILED 3-30-2006.



GREATER WASHINGTON
Board of Trade

OWNER OF U.S. REG. NO. 2,212,297.

NO CLAIM IS MADE TO THE EXCLUSIVE RIGHT TO USE "BOARD OF TRADE", APART FROM THE MARK AS SHOWN.

SEC. 2(F) AS TO "WASHINGTON".

CLASS 35—ADVERTISING AND BUSINESS

FOR PROMOTING THE ECONOMIC GROWTH AND BUSINESS DEVELOPMENT IN THE WASHINGTON, DC REGION THROUGH BUSINESS, TRADE, NETWORKING AND ORGANIZING AND CONDUCTING COMMUNITY SERVICE PROJECTS; AND ADVOCACY SERVICES REGARDING THE ISSUES IMPORTANT TO BUSINESSES AND COMMUNITY ORGANIZATIONS IN THE WASHINGTON, DC REGION (U.S. CLS. 100, 101 AND 102).

FIRST USE 1-0-2003; IN COMMERCE 1-0-2003.

CLASS 36—INSURANCE AND FINANCIAL

FOR PROMOTING THE ECONOMIC GROWTH AND BUSINESS DEVELOPMENT IN THE WASHINGTON, DC REGION THROUGH FUNDRAISING FOR COMMUNITY BUILDING PROJECTS AND TRANSPORTATION INFRASTRUCTURE DEVELOPMENT (U.S. CLS. 100, 101 AND 102).

FIRST USE 1-0-2003; IN COMMERCE 1-0-2003.

CLASS 41—EDUCATION AND ENTERTAINMENT

FOR EDUCATIONAL SERVICES, NAMELY, ARRANGING AND CONDUCTING SEMINARS AND CONFERENCES IN THE FIELDS OF BUSINESS, TRADE, AND COMMUNITY DEVELOPMENT; ORGANIZING COMMUNITY SPORTING AND CULTURAL EVENTS (U.S. CLS. 100, 101 AND 107).

FIRST USE 1-0-2003; IN COMMERCE 1-0-2003.

BONNIE LUKEN, EXAMINING ATTORNEY

SN 78-852,441. SIEPER, ACHIM, FRONDENBERG, FED REP GERMANY, FILED 4-3-2006.

Regioforcing

THE MARK CONSISTS OF STANDARD CHARACTERS WITHOUT CLAIM TO ANY PARTICULAR FONT, STYLE, SIZE, OR COLOR.

PRIORITY CLAIMED UNDER SEC. 44(D) ON ERPNCMNTY TM OFC APPLICATION NO. 004868303, FILED 1-24-2006, REG. NO. 004868303, DATED 3-7-2007, EXPIRES 1-24-2016.

CLASS 16—PAPER GOODS AND PRINTED MATTER

FOR PRINTED MATTER, NAMELY BOOKS, NEWSPAPERS, JOURNALS, AND MAGAZINES, ALL IN THE FIELD OF HEALTH AND DENTAL MEDICINE (U.S. CLS. 2, 5, 22, 23, 29, 37, 38 AND 50).

CLASS 35—ADVERTISING AND BUSINESS

FOR ADVERTISING SERVICES; CONSUMER CREDIT CONSULTANCY; BUSINESS MANAGEMENT CONSULTANCY; PERSONAL MANAGEMENT CONSULTANCY; BUSINESS ORGANIZATIONAL AND OPERATION CONSULTANCY; CONDUCTING BUSINESS MARKETING AND BUSINESS MARKETING RESEARCH IN THE FIELD OF DIGITAL NETWORKS; TELEMARKETING; SALES PROMOTION SERVICES FOR OTHERS; BUSINESS PLANNING, NAMELY COMPILATION OF GOODS FOR OTHERS FOR PRESENTATION AND COMMERCIAL PURPOSES (U.S. CLS. 100, 101 AND 102).

CLASS 41—EDUCATION AND ENTERTAINMENT

FOR PUBLICATION OF BOOKS AND JOURNALS; SERVICES OF A PUBLISHING HOUSE, NAMELY PUBLICATION OF TEXTS AND BOOKS; EDITING OF JOURNALS AND BOOKS IN ELECTRONIC FORM, ALSO VIA THE INTERNET; BOOK RENTAL; EDUCATIONAL SERVICES, NAMELY, TEACHING CORRESPONDENCE AND DISTANT LEARNING COURSES; ORGANIZING AND CONDUCTING CONGRESSES, SEMINARS, WORKSHOPS, TRAINING COURSES AND SYMPOSIA; ORGANIZING COMMUNITY SPORTING AND CULTURAL EVENTS; ORGANIZING AND CONDUCTING CULTURAL AND/OR SPORTING EVENTS, NAMELY, ART EXHIBITIONS, THEATER EVENTS, MUSIC EVENTS, FAMILY SPORTS, BASKETBALL, SOCCER, TENNIS, GOLF, BASEBALL, FOOTBALL, SKATING, SKIING; PERSONAL COACHING SERVICES IN THE FIELD OF HEALTH CARE; VOCATIONAL GUIDANCE CONSULTANCY (U.S. CLS. 100, 101 AND 107).

CLASS 44—MEDICAL, BEAUTY AND AGRICULTURAL SERVICES

FOR PHYSICIAN, DENTAL, ALTERNATIVE MEDICINE PRACTITIONER, AND PSYCHOLOGIST SERVICES; BEAUTY SALONS; NUTRITIONAL FOOD CONSULTANCY; HEALTH CONSULTANCY; PLASTIC AND AESTHETIC SURGERY; PHYSICAL THERAPY AND MEDICAL CARE; RENTAL OF MEDICAL EQUIPMENT (U.S. CLS. 100 AND 101).

ODESSA BIBBINS, EXAMINING ATTORNEY

SN 78-853,043. FLORENCE, DAVID W., HUDSON, WI. FILED 4-3-2006.

DR. TRUCKER

THE MARK CONSISTS OF STANDARD CHARACTERS WITHOUT CLAIM TO ANY PARTICULAR FONT, STYLE, SIZE, OR COLOR.

THE NAME "DR. TRUCKER" IDENTIFIES THE NICKNAME OF A LIVING INDIVIDUAL WHOSE CONSENT IS OF RECORD.

CLASS 5—PHARMACEUTICALS

FOR DIETARY SUPPLEMENTS (U.S. CLS. 6, 18, 44, 46, 51 AND 52).

CLASS 25—CLOTHING

FOR CLOTHING, NAMELY SHIRTS, T-SHIRTS, SWEATSHIRTS, CAPS, AND JACKETS (U.S. CLS. 22 AND 39).

CLASS 29—MEATS AND PROCESSED FOODS

FOR POTATO CHIPS, FRUIT-BASED ORGANIC FOOD BARS; CANDIED FRUIT SNACKS, DEHYDRATED FRUIT SNACKS; ROASTED NUTS; YOGURT (U.S. CL. 46).

CLASS 30—STAPLE FOODS

FOR STAPLE FOODS, NAMELY, WHEAT-BASED SNACK FOODS, BAGELS, BREAD, BREAD STICKS, BREAKFAST CEREALS, CORN CHIPS, CHOCOLATE, COFFEE, COOKIES, CRACKERS; PREPACKAGED ENTREES CONSISTING PRIMARILY OF PASTA OR RICE; MEAT PIES, MILKSHAKES, MUFFINS, NOODLES, PACKAGE COMBINATIONS CONSISTING PRIMARILY OF BREAD AND CRACKERS; PASTIES, PIES, POT PIES, PRETZELS, RICE-BASED SNACK FOODS, PASTA SALAD, MEAT SANDWICHES, GRANOLA-BASED SNACK FOODS AND BARS, CEREAL-BASED SNACK FOODS AND BARS, WHEAT-BASED SNACK FOODS AND BARS (U.S. CL. 46).

CLASS 44—MEDICAL, BEAUTY AND AGRICULTURAL SERVICES

FOR MEDICAL SERVICES; HEALTH CARE SERVICES, NAMELY, MEDICAL SERVICES, HEALTHCARE WELLNESS PROGRAMS, HEALTHCARE DIAGNOSIS PROGRAMS, HEALTHCARE TREATMENT PROGRAMS, HEALTHCARE PREVENTION PROGRAMS, MANAGED HEALTHCARE SERVICES, OCCUPATIONAL THERAPY, PHYSICAL THERAPY, MEDICAL CLINIC SERVICES, URGENT MEDICAL CARE SERVICES; EXPRESS MEDICAL CLINIC SERVICES, HEALTH CARE MONITORING IN THE NATURE OF REMOTE MONITORING OF DATA INDICATIVE OF HEALTH OR CONDITION OF AN INDIVIDUAL OR GROUP OF INDIVIDUALS (U.S. CLS. 100 AND 101).

MEGAN WHITNEY, EXAMINING ATTORNEY

SN 78-853,445. Q-MED AB, UPPSALA, SWEDEN, FILED 4-4-2006.

SOLESTA

THE MARK CONSISTS OF STANDARD CHARACTERS WITHOUT CLAIM TO ANY PARTICULAR FONT, STYLE, SIZE, OR COLOR.

PRIORITY CLAIMED UNDER SEC. 44(D) ON ERPNCMNTY TM OFC APPLICATION NO. 004687695, FILED 10-28-2005, REG. NO. 004687695, DATED 3-12-2007, EXPIRES 10-28-2015.

CLASS 5—PHARMACEUTICALS

FOR TOPICAL GEL FOR MEDICAL TREATMENT OF ANAL INCONTINENCE (U.S. CLS. 6, 18, 44, 46, 51 AND 52).

CLASS 10—MEDICAL APPARATUS

FOR INJECTABLE IMPLANTS CONSISTING OF ARTIFICIAL MATERIALS TO TREAT ANAL INCONTINENCE, SOLD IN A KIT COMPRISED OF SYRINGES FILLED WITH A HYALURONIC GEL AND AN INJECTOR (U.S. CLS. 26, 39 AND 44).

IRA J. GOODSAY, EXAMINING ATTORNEY

SN 78-856,457. GLOBAL 360, INC., DALLAS, TX. FILED 4-7-2006.



THE COLOR(S) BLUE IS/ARE CLAIMED AS A FEATURE OF THE MARK.
THE MARK CONSISTS OF A GLOBE DESIGN

CLASS 9—ELECTRICAL AND SCIENTIFIC APPARATUS

FOR BUSINESS PROCESS MANAGEMENT SOFTWARE, AND OPTIMIZING AND AUTOMATION SOFTWARE FOR THE CAPTURE, INDEXING, STORAGE, PROCESSING, MANAGEMENT AND RETRIEVAL OF DOCUMENTS IN THE FIELD OF GENERAL USE (U.S. CLS. 21, 23, 26, 36 AND 38).
FIRST USE 1-3-2005; IN COMMERCE 1-3-2005.

CLASS 16—PAPER GOODS AND PRINTED MATTER

FOR PRINTED MATTER, NAMELY, TRAINING MANUALS, USER MANUALS, USER GUIDES, BROCHURES, LEAFLETS AND DATA SHEETS ON THE SUBJECT OF, AND FOR USE WITH, SOFTWARE FOR THE CAPTURE, INDEXING, STORAGE AND RETRIEVAL OF DOCUMENTS AND RELATED INFORMATION AND SOFTWARE FOR USE IN PROCESSING OR MANAGING BUSINESS INFORMATION AND DOCUMENTS (U.S. CLS. 2, 5, 22, 23, 29, 37, 38 AND 50).
FIRST USE 1-3-2005; IN COMMERCE 1-3-2005.

CLASS 41—EDUCATION AND ENTERTAINMENT

FOR EDUCATIONAL SERVICES, NAMELY, PROVIDING CONFERENCES, CLASSES, SEMINARS AND WORKSHOPS IN THE FIELD OF USE AND OPERATION OF SOFTWARE, AND THE TRANSFER AND PHYSICAL CONVERSION OF DATA AND DOCUMENTS FROM ONE MEDIA TO ANOTHER (U.S. CLS. 100, 101 AND 107).
FIRST USE 1-3-2005; IN COMMERCE 1-3-2005.
SANJEEV VOHRA, EXAMINING ATTORNEY

SN 78-859,173. NOVAVAX, INC., MALVERN, PA. FILED 4-11-2006.

NOVAVAX

THE MARK CONSISTS OF STANDARD CHARACTERS WITHOUT CLAIM TO ANY PARTICULAR FONT, STYLE, SIZE, OR COLOR.

CLASS 5—PHARMACEUTICALS

FOR FULL LINE OF PHARMACEUTICAL PREPARATIONS VACCINES AND BIOLOGICS PREPARATIONS FOR MEDICAL PURPOSES (U.S. CLS. 6, 18, 44, 46, 51 AND 52).

CLASS 42—SCIENTIFIC, COMPUTER AND LEGAL SERVICES

FOR PHARMACEUTICAL, BIOLOGIC AND VACCINE RESEARCH AND DEVELOPMENT SERVICES; CONSULTING SERVICES IN THE FIELD OF PHARMACEUTICAL PREPARATIONS, BIOLOGICS AND VACCINES (U.S. CLS. 100 AND 101).
FRANK LATTUCA, EXAMINING ATTORNEY

SN 78-863,944. BURTON COMPUTER RESOURCES, INC., LAUREL, MS. FILED 4-18-2006.

Now you have a friend in the computer business.

THE MARK CONSISTS OF STANDARD CHARACTERS WITHOUT CLAIM TO ANY PARTICULAR FONT, STYLE, SIZE, OR COLOR.

CLASS 37—CONSTRUCTION AND REPAIR

FOR COMPUTER INSTALLATION AND REPAIR; INSTALLATION OF COMPUTER NETWORKS; INSTALLATION OF COMPUTER SYSTEMS; MAINTENANCE AND REPAIR OF COMPUTER HARDWARE; MAINTENANCE AND REPAIR OF COMPUTER NETWORKS; MAINTENANCE OF COMPUTER HARDWARE; REPAIR OF DAMAGED COMPUTERS; REPAIR OR MAINTENANCE OF COMPUTERS; UPDATING OF COMPUTER HARDWARE; UPGRADING OF COMPUTER HARDWARE (U.S. CLS. 100, 103 AND 106).
FIRST USE 10-1-2005; IN COMMERCE 10-1-2005.

CLASS 42—SCIENTIFIC, COMPUTER AND LEGAL SERVICES

FOR APPLICATION SERVICE PROVIDER (ASP), NAMELY, HOSTING COMPUTER SOFTWARE APPLICATIONS OF OTHERS; COMPUTER CONSULTATION; COMPUTER CONSULTATION IN THE FIELD OF COMPUTER SECURITY; COMPUTER DIAGNOSTIC SERVICES; COMPUTER DISASTER RECOVERY PLANNING; COMPUTER NETWORK DESIGN FOR OTHERS; COMPUTER PROGRAMMING FOR OTHERS; COMPUTER SECURITY SERVICE, NAMELY, RESTRICTING ACCESS TO AND BY COMPUTER NETWORKS TO AND OF UNDESIRE WEB SITES, MEDIA AND INDIVIDUALS AND FACILITIES; COMPUTER SERVICE, NAMELY, ACTING AS AN APPLICATION SERVICE PROVIDER IN THE FIELD OF KNOWLEDGE MANAGEMENT TO HOST COMPUTER APPLICATION SOFTWARE FOR SEARCHING AND RETRIEVING INFORMATION FROM DATABASES AND COMPUTER NETWORKS;; COMPUTER SERVICES, NAMELY, CREATING AND MAINTAINING WEB SITES FOR OTHERS; COMPUTER SERVICES, NAMELY, DESIGNING AND IMPLEMENTING WEB SITES FOR OTHERS; COMPUTER SERVICES, NAMELY, MANAGING WEB SITES FOR OTHERS; COMPUTER SOFTWARE DESIGN FOR OTHERS; COMPUTER SOFTWARE DESIGN, COMPUTER PROGRAMMING, OR MAINTENANCE OF COMPUTER SOFTWARE; COMPUTER SOFTWARE DEVELOPMENT; COMPUTER SYSTEMS ANALYSIS; CUSTOMIZATION OF COMPUTER HARDWARE AND SOFTWARE; DESIGN OF COMPUTER HARDWARE, INTEGRATED CIRCUITS, COMMUNICATIONS HARDWARE AND SOFTWARE AND COMPUTER NETWORKS FOR OTHERS; HOSTING THE WEB SITES OF OTHERS ON A COMPUTER SERVER FOR A GLOBAL COMPUTER NETWORK; LEASING OF COMPUTERS; MAINTENANCE OF COMPUTER SOFTWARE; MONITORING THE COMPUTER SYSTEMS OF OTHERS FOR TECHNICAL PURPOSES AND PROVIDING BACK-UP COMPUTER PROGRAMS AND FACILITIES; PROVIDING INFORMATION AT THE SPECIFIC REQUEST OF END-USERS BY MEANS OF TELEPHONE OR GLOBAL COMPUTER NETWORKS ; RENTAL OF COMPUTERS; RENTAL OF COMPUTERS AND SOFTWARE; REPAIR OF COMPUTER SOFTWARE; REPAIR OF DAMAGED COMPUTER PROGRAMS; TECHNICAL SUPPORT SERVICES, NAMELY, TROUBLESHOOTING OF COMPUTER HARDWARE AND SOFTWARE PROBLEMS; TECHNICAL SUPPORT, NAMELY, PROVIDING BACK-UP COMPUTER PROGRAMS AND FACILITIES; UP-DATING OF COMPUTER SOFTWARE (U.S. CLS. 100 AND 101).

FIRST USE 10-1-2005; IN COMMERCE 10-1-2005.
ANNE FARRELL, EXAMINING ATTORNEY

CLASS 16—PAPER GOODS AND PRINTED MATTER

FOR BROCHURES ABOUT HAEMOPHILIA TREATMENT; GOODS MADE FROM PAPER AND CARDBOARD, NAMELY, PAMPHLETS IN THE FIELD OF HAEMOPHILIA TREATMENT, PHOTOGRAPHS, STATIONERY, ARTIST MATERIAL, NAMELY DRAWINGS, PRINTED INSTRUCTIONAL AND TEACHING MATERIAL IN THE FIELD OF HAEMOPHILIA (U.S. CLS. 2, 5, 22, 23, 29, 37, 38 AND 50).

CLASS 41—EDUCATION AND ENTERTAINMENT

FOR EDUCATION SERVICES, NAMELY, CONDUCTING INFORMATION COURSES IN THE FIELD OF DIFFERENT SIDE-EFFECTS CAUSED BY HAEMOPHILIA; PROVIDING OF TRAINING TO HAEMOPHILIA EFFECTED PEOPLE; ORGANIZING ENTERTAINMENT, NAMELY SPORTING AND CULTURAL ACTIVITIES FOR HAEMOPHILIA EFFECTED AND THEIR RELATIVES (U.S. CLS. 100, 101 AND 107).

CLASS 42—SCIENTIFIC, COMPUTER AND LEGAL SERVICES

FOR SCIENTIFIC RESEARCH SERVICES ABOUT PEOPLE AFFECTED BY HAEMOPHILIA DISEASES; DESIGN AND DEVELOPMENT OF COMPUTER SOFTWARE (U.S. CLS. 100 AND 101).

CLASS 44—MEDICAL, BEAUTY AND AGRICULTURAL SERVICES

FOR MEDICAL AND CONSULTANCY SERVICES ALL ABOUT PEOPLE AFFECTED BY HAEMOPHILIA DISEASES (U.S. CLS. 100 AND 101).

DOMINIC FATHY, EXAMINING ATTORNEY

SN 78-869,694. MEIJER, INC., GRAND RAPIDS, MI. FILED 4-26-2006.

Grand Gourmet

THE MARK CONSISTS OF STANDARD CHARACTERS WITHOUT CLAIM TO ANY PARTICULAR FONT, STYLE, SIZE, OR COLOR.

NO CLAIM IS MADE TO THE EXCLUSIVE RIGHT TO USE "GOURMET", APART FROM THE MARK AS SHOWN.

CLASS 9—ELECTRICAL AND SCIENTIFIC APPARATUS

FOR THERMOMETERS NOT FOR MEDICAL USE (U.S. CLS. 21, 23, 26, 36 AND 38).

FIRST USE 10-24-2004; IN COMMERCE 10-24-2004.

CLASS 11—ENVIRONMENTAL CONTROL APPARATUS

FOR OUTDOOR PATIO AND GARDEN HEATERS, NAMELY, FIRE PITS AND FIRE RINGS; LIGHTERS, PRIMARILY FOR LIGHTING GRILLS, FIREPLACES AND CANDLES; BARBECUE GRILLS, GAS GRILLS, CHARCOAL GRILLS, FOLDING, PORTABLE, CHARCOAL AND PROPANE GAS FIRED BARBECUES, STOVES AND GRILLS; GAS DEEP FAT FRYERS, NAMELY, GAS TURKEY FRYERS (U.S. CLS. 13, 21, 23, 31 AND 34).

FIRST USE 4-0-2000; IN COMMERCE 4-0-2000.

SN 78-864,620. NOVO NORDISK HAEMOPHILIA FOUNDATION (NOVO NORDISK HAEMOPHILIE STIFTUNG), CH-8050 ZURICH, SWITZERLAND, FILED 4-19-2006.

**NOVO NORDISK
HAEMOPHILIA
FOUNDATION**

NO CLAIM IS MADE TO THE EXCLUSIVE RIGHT TO USE "HAEMOPHILIA FOUNDATION", APART FROM THE MARK AS SHOWN.

THE COLOR(S) NAVY BLUE AND TURQUOISE IS/ARE CLAIMED AS A FEATURE OF THE MARK.

"THE MARK CONSISTS OF THE WORDS NOVO NORDISK AND FOUNDATION APPEAR IN THE COLOR NAVY BLUE; THE WORD HAEMOPHILIA APPEARS IN THE COLOR TURQUOISE."

"THE FOREIGN WORDING IN THE MARK TRANSLATES INTO ENGLISH AS NEW NORDIC."

CLASS 21—HOUSEWARES AND GLASS

FOR COOKING UTENSILS, NAMELY, GRILL COVERS; HOUSEHOLD UTENSILS, NAMELY, SKIMMERS AND SEASONING INJECTORS; COOKWARE, NAMELY, NON-ELECTRIC PROPANE COOKING STEAMERS (U.S. CLS. 2, 13, 23, 29, 30, 33, 40 AND 50).

FIRST USE 4-0-2000; IN COMMERCE 4-0-2000.

CLASS 24—FABRICS

FOR BARBECUE MITTS, NAMELY, OUTDOOR COOKING GLOVES (U.S. CLS. 42 AND 50).

FIRST USE 4-0-2000; IN COMMERCE 4-0-2000.
RONALD AIKENS, EXAMINING ATTORNEY

SN 78-870,856. MARISOL INTERNATIONAL LLC, SPRINGFIELD, MO. FILED 4-27-2006.

MARISOL INTERNATIONAL

THE MARK CONSISTS OF STANDARD CHARACTERS WITHOUT CLAIM TO ANY PARTICULAR FONT, STYLE, SIZE, OR COLOR.

NO CLAIM IS MADE TO THE EXCLUSIVE RIGHT TO USE "INTERNATIONAL", APART FROM THE MARK AS SHOWN.

CLASS 35—ADVERTISING AND BUSINESS

FOR TRANSPORTATION LOGISTICS SERVICES, NAMELY, ARRANGING THE TRANSPORTATION OF GOODS FOR OTHERS; TRANSPORTATION LOGISTICS SERVICES, NAMELY, PLANNING AND SCHEDULING SHIPMENTS FOR USERS OF TRANSPORTATION SERVICES; CUSTOMS CLEARANCE SERVICES; AND EXPORT AND IMPORT AGENCIES (U.S. CLS. 100, 101 AND 102).

FIRST USE 7-15-2002; IN COMMERCE 7-15-2002.

CLASS 36—INSURANCE AND FINANCIAL

FOR CUSTOMS BROKERAGE (U.S. CLS. 100, 101 AND 102).

FIRST USE 7-15-2002; IN COMMERCE 7-15-2002.

CLASS 39—TRANSPORTATION AND STORAGE

FOR SUPPLY CHAIN, LOGISTICS, AND REVERSE LOGISTICS SERVICES, NAMELY, STORAGE, TRANSPORTATION, AND DELIVERY OF DOCUMENTS, PACKAGES, RAW MATERIALS, AND OTHER FREIGHT FOR OTHERS BY AIR, RAIL, SHIP, OR TRUCK; FREIGHT FORWARDING; GLOBAL TRANSPORTATION OF FREIGHT FOR OTHERS BY ALL AVAILABLE MEANS; CARGO HANDLING; AND TRANSPORTATION RESELLER SERVICES, NAMELY, PROVIDING FREIGHT TRANSPORTATION BY MEANS OF TRUCK, TRAIN, AIR, AND SHIP (U.S. CLS. 100 AND 105).

FIRST USE 7-15-2002; IN COMMERCE 7-15-2002.
EUGENIA MARTIN, EXAMINING ATTORNEY

SN 78-873,301. COLONIAL MIRROR & GLASS CORPORATION, BROOKLYN, NY. FILED 5-1-2006.

SAFETYSTEEL

THE MARK CONSISTS OF STANDARD CHARACTERS WITHOUT CLAIM TO ANY PARTICULAR FONT, STYLE, SIZE, OR COLOR.

CLASS 19—NON-METALLIC BUILDING MATERIALS

FOR LAMINATED FLAT GLASS FOR BUILDING (U.S. CLS. 1, 12, 33 AND 50).

FIRST USE 12-0-2004; IN COMMERCE 12-0-2004.

CLASS 21—HOUSEWARES AND GLASS

FOR LAMINATED FLAT GLASS NOT FOR USE IN BUILDING (U.S. CLS. 2, 13, 23, 29, 30, 33, 40 AND 50).

FIRST USE 12-0-2004; IN COMMERCE 12-0-2004.
MICHAEL LEWIS, EXAMINING ATTORNEY

SN 78-873,599. LOUISVILLE BEDDING COMPANY, LOUISVILLE, KY. FILED 5-1-2006.

SMART FIBRE

THE MARK CONSISTS OF STANDARD CHARACTERS WITHOUT CLAIM TO ANY PARTICULAR FONT, STYLE, SIZE, OR COLOR.

CLASS 20—FURNITURE AND ARTICLES NOT OTHERWISE CLASSIFIED

FOR PILLOWS, MATTRESS TOPPERS (U.S. CLS. 2, 13, 22, 25, 32 AND 50).

CLASS 24—FABRICS

FOR MATTRESS PADS, COMFORTERS, DUVETS, DUVET COVERS (U.S. CLS. 42 AND 50).

PAULA MAHONEY, EXAMINING ATTORNEY

SN 78-875,138. IVOCLAR VIVADENT, INC., AMHERST, NY. FILED 5-3-2006.

CALLISTO

THE MARK CONSISTS OF STANDARD CHARACTERS WITHOUT CLAIM TO ANY PARTICULAR FONT, STYLE, SIZE, OR COLOR.

CLASS 5—PHARMACEUTICALS

FOR DENTAL MATERIALS, NAMELY, DENTAL ALLOYS, DENTAL FILLING MATERIALS, DENTAL ADHESIVES, DENTAL COMPOSITES; DENTAL CERAMIC STRATUM; DENTAL CAVITY LINING MATERIALS, NAMELY, CERAMICS AND CEMENTS; PRECIOUS METAL ALLOYS AND NON-PRECIOUS METAL ALLOYS FOR DENTAL TECHNOLOGY; PRECIOUS METALS AND NON-PRECIOUS METALS FOR DENTAL TECHNOLOGY; DENTAL CERAMICS; DENTAL INVESTMENT MATERIALS, NAMELY, GYPSUM AND PHOSPHATE BONDED QUARTZ; OPAQUE DENTAL CERAMICS, OPAQUE DENTAL RESINS; PREFABRICATED PARTS FOR DENTAL CROWNS AND DENTAL BRIDGES; INGOTS MADE OF RESIN, METAL OR CERAMIC FOR FABRICATION OF DENTAL RESTORATIONS BY MOULDING OR MILLING PROCESSES (U.S. CLS. 6, 18, 44, 46, 51 AND 52).

CLASS 6—METAL GOODS

FOR METAL BARS FOR FURTHER MANUFACTURE, METAL CASTINGS (U.S. CLS. 2, 12, 13, 14, 23, 25 AND 50).

FRED CARL, EXAMINING ATTORNEY

SN 78-875,521. CANAROPA (1954) INC., LACHINE, CANADA, FILED 5-3-2006.



PRIORITY CLAIMED UNDER SEC. 44(D) ON CANADA APPLICATION NO. 1285833, FILED 1-12-2006, REG. NO. TMA67215, DATED 11-17-2006, EXPIRES 11-17-2022.

THE MARK CONSISTS OF THE WORDS AND NUMBERS: D8 DIVISION 8 IN STYLIZED FORM.

CLASS 6—METAL GOODS

FOR METAL HARDWARE FOR DOORS, NAMELY, LOCKS, HINGES, DOOR LOCKS, DOOR LATCHES AND EXIT DEVICES CONSISTING OF TOUCH BARS AND CROSS BARS FOR OPENING DOORS AND ASSOCIATED STRUCTURAL HARDWARE FOR THE FOREGOING, NAMELY, ARCHITECTURAL HARDWARE FOR DOOR FRAMES AND FLOOR IN DOOR SWING PATH, NAMELY DOOR STOPPERS, HOOKS AND CATCHES (U.S. CLS. 2, 12, 13, 14, 23, 25 AND 50).

CLASS 7—MACHINERY

FOR HYDRAULIC OR PNEUMATIC DOOR CLOSERS (U.S. CLS. 13, 19, 21, 23, 31, 34 AND 35).

CLASS 9—ELECTRICAL AND SCIENTIFIC APPARATUS

FOR ELECTRONIC CARD ACCESS DOOR LOCKS (U.S. CLS. 21, 23, 26, 36 AND 38).

LAURIE KAUFMAN, EXAMINING ATTORNEY

SN 78-876,673. LIFE LANGUAGES INSTITUTE, INC., DALLAS, TX. FILED 5-4-2006.

KLLP

THE MARK CONSISTS OF STANDARD CHARACTERS WITHOUT CLAIM TO ANY PARTICULAR FONT, STYLE, SIZE, OR COLOR.

CLASS 16—PAPER GOODS AND PRINTED MATTER

FOR PRINTED INSTRUCTIONAL, EDUCATIONAL, AND TEACHING MATERIALS IN THE FIELD OF INTERPERSONAL AND ORGANIZATIONAL COMMUNICATION METHODS AND CROSSED COMMUNICATION; AND THE VARIOUS STYLES AND SKILLS OF EFFECTIVE COMMUNICATION (U.S. CLS. 2, 5, 22, 23, 29, 37, 38 AND 50).

FIRST USE 3-1-1986; IN COMMERCE 3-1-1986.

CLASS 41—EDUCATION AND ENTERTAINMENT

FOR EDUCATIONAL SERVICES, NAMELY, CONDUCTING SEMINARS, TRAINING, AND STANDARDIZED TEST ADMINISTRATION IN THE FIELD OF RELATIONSHIPS, COMMUNICATION, RECONCILIATION, DIVERSITY, HARASSMENT, VIOLENCE, DISCONNECTEDNESS, CONNECTEDNESS, TEAM BUILDING, EFFECTIVENESS, PURPOSE, PASSION, CHARACTER, AND DESTINY; AND THE DISTRIBUTION OF COURSE MATERIALS IN CONNECTION THEREWITH (U.S. CLS. 100, 101 AND 107).

FIRST USE 3-1-1986; IN COMMERCE 3-1-1986.

CLASS 42—SCIENTIFIC, COMPUTER AND LEGAL SERVICES

FOR PROVIDING ONLINE NON-DOWNLOADABLE SOFTWARE FOR PROFILING AND TEST ADMINISTRATION, ASSESSMENT, ANALYSIS AND EXPLANATION OF THE VARIOUS STYLES, METHODS AND SKILLS OF COMMUNICATION AND CROSSED COMMUNICATION (U.S. CLS. 100 AND 101).

FIRST USE 8-1-1999; IN COMMERCE 8-1-1999.

MICHAEL LEWIS, EXAMINING ATTORNEY

SN 78-878,423. EXPEDIA, INC., BELLEVUE, WA. FILED 5-7-2006.

CLICK WITH CONFIDENCE

THE MARK CONSISTS OF STANDARD CHARACTERS WITHOUT CLAIM TO ANY PARTICULAR FONT, STYLE, SIZE, OR COLOR.

CLASS 35—ADVERTISING AND BUSINESS

FOR BUSINESS CONSULTING AND MANAGEMENT SERVICES IN THE FIELD OF TRAVEL, TRAVEL PLANNING AND THE OPERATION OF TRAVEL-RELATED BUSINESSES, RETAIL STORE SERVICES FEATURING TRAVEL-RELATED GOODS AND SERVICES (U.S. CLS. 100, 101 AND 102).

CLASS 39—TRANSPORTATION AND STORAGE

FOR TRAVEL AGENCY SERVICES, NAMELY, MAKING RESERVATIONS AND BOOKINGS FOR TRANSPORTATION AND PROVIDING INFORMATION CONCERNING TRAVEL AND PROVIDING TRAVEL AND INFORMATION OVER COMPUTER NETWORKS AND GLOBAL COMMUNICATION NETWORKS; PROVIDING TRAVEL NEWS VIA THE INTERNET (U.S. CLS. 100 AND 105).

CLASS 41—EDUCATION AND ENTERTAINMENT

FOR PROVIDING ENTERTAINMENT NEWS VIA THE INTERNET; PROVIDING ONLINE NON-DOWNLOADABLE TRAVEL GUIDE BOOKS, MAPS, CITY DIRECTORIES, AND LISTINGS OF LOCAL EVENTS AND ATTRACTIONS (U.S. CLS. 100, 101 AND 107).

CLASS 43—HOTEL AND RESTAURANT SERVICES

FOR TRAVEL AGENCY SERVICES, NAMELY, MAKING RESERVATIONS AND BOOKINGS FOR TEMPORARY ACCOMMODATIONS; PROVIDING ACCOMMODATION INFORMATION SERVICES (U.S. CLS. 100 AND 101).
CAROLYN GRAY, EXAMINING ATTORNEY

CLASS 44—MEDICAL, BEAUTY AND AGRICULTURAL SERVICES

FOR MEDICAL SERVICES; HYGENIC AND BEAUTY CARE FOR HUMAN BEINGS, NAMELY FITTING OF ARTIFICIAL LIMBS AND OF CONTROLLING APPARATUS FOR LIMBS TO PATIENTS INDIVIDUAL NEEDS (U.S. CLS. 100 AND 101).
GRETTA YAO, EXAMINING ATTORNEY

SN 78-879,076. FAIRWAY IMPORT EXPORT, INC., RANCHO DOMINGUEZ, CA. FILED 5-8-2006.

LIFT

SN 78-878,696. OTTO BOCK HEALTHCARE GMBH, 37115 DUDERSTADT, FED REP GERMANY, FILED 5-8-2006.

THE MARK CONSISTS OF STANDARD CHARACTERS WITHOUT CLAIM TO ANY PARTICULAR FONT, STYLE, SIZE, OR COLOR.
OWNER OF U.S. REG. NO. 3,042,245.

BIONICMOBILITY

THE MARK CONSISTS OF STANDARD CHARACTERS WITHOUT CLAIM TO ANY PARTICULAR FONT, STYLE, SIZE, OR COLOR.

PRIORITY CLAIMED UNDER SEC. 44(D) ON FED REP GERMANY APPLICATION NO. 30601393.2/1, FILED 1-12-2006, REG. NO. 30601393, DATED 6-16-2006, EXPIRES 6-16-2016.

CLASS 9—ELECTRICAL AND SCIENTIFIC APPARATUS

FOR COMPUTER HARDWARE AND SOFTWARE PROGRAMS FOR MEASURING, ESTABLISHING AND ANALYZING MUSCLE ACTIVITY (U.S. CLS. 21, 23, 26, 36 AND 38).

CLASS 10—MEDICAL APPARATUS

FOR MEASURING, SIGNALLING AND CONTROLLING APPARATUS AND INSTRUMENTS, NAMELY ELECTRICAL CONTROLLERS FOR ARTIFICIAL LIMBS THAT SENSE PRESSURE AND BODY POTENTIAL AND MEASURE UNITS OF PRESSURE, BODY POTENTIAL AND POSITIONING FOR PARALYZED LIMBS AND ARTIFICIAL LIMBS WHILE BEING WORN, APPARATUS FOR MEASURING, CLASSIFYING AND ANALYZING MUSCLE ACTIVITIES IN THE NATURE OF PRESSURE, DILATION, POTENTIAL AND CURRENT MEASURING DEVICES FOR PARALYZED LIMBS AND ARTIFICIAL LIMBS WHILE BEING WORN; SURGICAL IMPLANTS MADE OF ARTIFICIAL MATERIALS (U.S. CLS. 26, 39 AND 44).

CLASS 14—JEWELRY

FOR ALARM CLOCKS, ANKLE BRACELETS, ASHTRAYS OF PRECIOUS METAL, BRACELETS, CLOCKS, COSTUME JEWELRY, CUFPLINKS, EARRINGS, JEWELRY, MONEY CLIPS OF PRECIOUS METAL, PENDANTS, WATCHES, AND WATCH CHAINS (U.S. CLS. 2, 27, 28 AND 50).
FIRST USE 5-1-2003; IN COMMERCE 6-1-2004.

CLASS 25—CLOTHING

FOR T-SHIRTS, POLO SHIRTS, SWEAT SHIRTS, SOCKS, RAIN COATS, RAIN JACKETS, RAIN PANTS, THERMAL COATS, THERMAL PANTS, THERMAL UNDERWEAR, HOODED JACKETS, HOODED SWEATSHIRTS, GLOVES, THERMAL HATS, SHOES AND BOOTS, BANDANAS, BELTS, CAPS, HATS, HEAD WEAR, JACKETS, FLANNEL SHIRTS, SPORTS SHIRTS, SOCKS, SUN VISORS, SUSPENDERS, SWEATERS, TANK TOPS, ALL TO BE SOLD AT DO IT YOURSELF STORES, CONSTRUCTION EQUIPMENT AND SUPPLY STORES, INDUSTRIAL WORK WEAR STORES AND INDUSTRIAL WORK WEAR DEPARTMENTS (U.S. CLS. 22 AND 39).
FIRST USE 8-1-2002; IN COMMERCE 6-1-2004.

CLASS 26—FANCY GOODS

FOR BELT BUCKLES NOT OF PRECIOUS METAL, BELT CLASPS, BARRETTES, BUTTONS FOR CLOTHING, CLOTH PATCHES FOR CLOTHING, CLOTHING BUCKLES, EMBROIDERED EMBLEMS, EMBROIDERED PATCHES FOR CLOTHING, EMBROIDERY FOR GARMENTS, FABRIC APPLIQUES, HAIR BANDS, HAIR BOWS, HAIR CLIPS, HAIR ORNAMENTS, HAIR SCRUNCHIES, HAT ORNAMENTS NOT OF PRECIOUS METAL, AND NOVELTY BUTTONS (U.S. CLS. 37, 39, 40, 42 AND 50).
FIRST USE 5-1-2003; IN COMMERCE 6-1-2004.
KIMBERLY FRYE, EXAMINING ATTORNEY

SN 78-880,614. WEAVER, MICHELLE, MOBILE, AL. AND STEWART, TRACI, SEMMES, AL. FILED 5-10-2006.

G.I.R.A.F.F.E. God is righteous and forever faithful everyday

THE MARK CONSISTS OF STANDARD CHARACTERS WITHOUT CLAIM TO ANY PARTICULAR FONT, STYLE, SIZE, OR COLOR.

NO CLAIM IS MADE TO THE EXCLUSIVE RIGHT TO USE "GIRAFFE", APART FROM THE MARK AS SHOWN.

CLASS 14—JEWELRY

FOR JEWELRY, NAMELY, NECKLACES, EARRINGS, RINGS, BRACELETS, ANKLETS, AND WATCHES (U.S. CLS. 2, 27, 28 AND 50).

CLASS 16—PAPER GOODS AND PRINTED MATTER

FOR GREETING CARDS, STATIONERY, ADDRESS BOOKS, BLANK WRITING JOURNALS, DAY PLANNERS, PENS, PENCILS, BOOKMARKS (U.S. CLS. 2, 5, 22, 23, 29, 37, 38 AND 50).

CLASS 25—CLOTHING

FOR T-SHIRTS, HATS, CAPS, BODYSUITS FOR BABIES, SWEATSHIRTS, SWEATPANTS, AND PAJAMAS (U.S. CLS. 22 AND 39).

CLASS 28—TOYS AND SPORTING GOODS

FOR TOYS, NAMELY, STUFFED ANIMALS IN THE NATURE OF GIRAFFES, WOODEN ANIMALS IN THE NATURE OF GIRAFFES, AND PLASTIC ANIMALS IN THE NATURE OF GIRAFFES (U.S. CLS. 22, 23, 38 AND 50).

TRACY WHITTAKER-BROWN, EXAMINING ATTORNEY

SN 78-881,258. INNOVATIVE LATIN GROUP LLC, NEW YORK, NY. FILED 5-11-2006.

PA' MI GENTE

THE MARK CONSISTS OF STANDARD CHARACTERS WITHOUT CLAIM TO ANY PARTICULAR FONT, STYLE, SIZE, OR COLOR.

THE FOREIGN WORDING IN THE MARK TRANSLATES INTO ENGLISH AS FOR MY PEOPLE.

CLASS 3—COSMETICS AND CLEANING PREPARATIONS

FOR PERFUME, EAU DE PERFUME, PERFUME OILS, BODY SPRAY USED AS A PERSONAL DEODORANT AND AS FRAGRANCE, FRAGRANCE EMITTING WICKS FOR ROOM FRAGRANCE, FRAGRANCE FOR AUTOMOBILES, COSMETICS, FACIAL MAKE-UP, MAKE-UP KITS COMPRISING COSMETICS, LIPSTICKS, LIP GLOSS, LIPSTICK CASES, SHAMPOOS, BATH SOAPS (U.S. CLS. 1, 4, 6, 50, 51 AND 52).

CLASS 9—ELECTRICAL AND SCIENTIFIC APPARATUS

FOR SUNGLASSES, CASES FOR SPECTACLES AND SUNGLASSES, CARRYING CASES FOR DIGITAL MUSIC PLAYERS, CELLULAR PHONES, PAGERS, PERSONAL DIGITAL ASSISTANTS, DIGITAL CAMERAS, DIGITAL VIDEO AND VIDEO TAPE RECORDERS AND HANDHELD PERSONAL COMPUTERS (U.S. CLS. 21, 23, 26, 36 AND 38).

CLASS 14—JEWELRY

FOR COSTUME JEWELRY, JEWELRY CHAINS, NECK CHAINS, BRACELETS, JEWELRY RINGS, AND WATCHES (U.S. CLS. 2, 27, 28 AND 50).

CLASS 16—PAPER GOODS AND PRINTED MATTER

FOR STICKERS, BUMPER STICKERS, STATIONERY WRITING PAPER AND ENVELOPES, BINDERS, SCHOOL WRITING BOOKS, PENS, PENCILS, PEN AND PENCIL CASES, FOLDERS, SPIRAL NOTEBOOKS, ADDRESS BOOKS, BLANK JOURNAL BOOKS (U.S. CLS. 2, 5, 22, 23, 29, 37, 38 AND 50).

CLASS 18—LEATHER GOODS

FOR HANDBAGS, BACKPACKS AND WALLETS (U.S. CLS. 1, 2, 3, 22 AND 41).

CLASS 28—TOYS AND SPORTING GOODS

FOR BATTERY OPERATED ACTION TOYS, BENDABLE TOYS, CASES FOR TOY STRUCTURES, CHILDREN'S MULTIPLE ACTIVITY TOYS, DOG TOYS, ELECTRIC ACTION TOYS, MUSICAL TOYS, PLUSH TOYS, SQUEEZE TOYS, STUFFED TOY ANIMALS, STUFFED TOYS, TALKING TOYS, TOY ANIMALS (U.S. CLS. 22, 23, 38 AND 50).

STEVEN PEREZ, EXAMINING ATTORNEY

SN 78-885,456. SWIFT SOFTWARE, INC., FREDERICK, MD. FILED 5-17-2006.

JOBTRAQ

THE MARK CONSISTS OF STANDARD CHARACTERS WITHOUT CLAIM TO ANY PARTICULAR FONT, STYLE, SIZE, OR COLOR.

CLASS 9—ELECTRICAL AND SCIENTIFIC APPARATUS

FOR COMPUTER SOFTWARE FOR AUTOMATING BUSINESS PROCESSES, TASKS, WORKFLOW, AND ELECTRONIC RESOURCES IN THE FIELDS OF BUSINESS PROCESS MANAGEMENT, TASK MANAGEMENT, AND COLLABORATIVE PROJECT MANAGEMENT (U.S. CLS. 21, 23, 26, 36 AND 38).
FIRST USE 3-0-2003; IN COMMERCE 3-0-2003.

CLASS 42—SCIENTIFIC, COMPUTER AND LEGAL SERVICES

FOR TECHNICAL SUPPORT SERVICES, NAMELY, TROUBLESHOOTING COMPUTER SOFTWARE PROBLEMS (U.S. CLS. 100 AND 101).
FIRST USE 3-0-2003; IN COMMERCE 3-0-2003.
JASON LOTT, EXAMINING ATTORNEY

SN 78-885,480. THE NASDAQ STOCK MARKET, INC., NEW YORK, NY. FILED 5-17-2006.

NASDAQ GLOBAL SELECT MARKET

THE MARK CONSISTS OF STANDARD CHARACTERS WITHOUT CLAIM TO ANY PARTICULAR FONT, STYLE, SIZE, OR COLOR.

OWNER OF U.S. REG. NOS. 2,156,075, 2,932,509 AND OTHERS.

NO CLAIM IS MADE TO THE EXCLUSIVE RIGHT TO USE "GLOBAL SELECT MARKET", APART FROM THE MARK AS SHOWN.

CLASS 36—INSURANCE AND FINANCIAL

FOR FINANCIAL SERVICES, NAMELY, CONDUCTING A SECURITIES EXCHANGE; AND PROVIDING FINANCIAL INFORMATION IN THE NATURE OF MARKET QUOTATIONS AND ORDERS (U.S. CLS. 100, 101 AND 102).

CLASS 38—COMMUNICATION

FOR ELECTRONIC TRANSMISSION OF FINANCIAL INSTRUMENTS MARKET INFORMATION (U.S. CLS. 100, 101 AND 104).

KELLY BOULTON, EXAMINING ATTORNEY

SN 78-885,729. ATRONIC INTERNATIONAL GMBH, LÜBBECKE, FED REP GERMANY, FILED 5-17-2006.

Wild Fangs

THE MARK CONSISTS OF STANDARD CHARACTERS WITHOUT CLAIM TO ANY PARTICULAR FONT, STYLE, SIZE, OR COLOR.

PRIORITY CLAIMED UNDER SEC. 44(D) ON ERPN CMNTY TM OFC APPLICATION NO. 005064001, FILED 5-9-2006, REG. NO. 005064001, DATED 5-4-2007, EXPIRES 5-9-2016.

CLASS 9—ELECTRICAL AND SCIENTIFIC APPARATUS

FOR ELECTRIC AND ELECTRONIC, COIN AND TOKEN-OPERATED GAMING MACHINES, NAMELY, SLOT MACHINES WITH OR WITHOUT VIDEO OUTPUT AND VIDEO LOTTERY TERMINALS; MULTI-USER AND NETWORKED GAMING MACHINES WITH OR WITHOUT VIDEO OUTPUT OR VIDEO LOTTERY TERMINALS, COMPUTER PROGRAMS FOR OPERATING ELECTRIC AND ELECTRONIC MACHINES FOR GAMING AND/OR AMUSEMENT PURPOSES; ACCOUNTING APPARATUS FOR COIN AND TOKEN OPERATED MACHINES FOR GAMING AND AMUSEMENT PURPOSES, AND PARTS FOR THE AFORESAID GOODS (U.S. CLS. 21, 23, 26, 36 AND 38).

CLASS 41—EDUCATION AND ENTERTAINMENT

FOR ENTERTAINMENT IN THE NATURE OF CASINO SERVICES FEATURING A PROGRESSIVE GAMING MACHINE JACKPOT INVOLVING ONE OR MORE GAMING MACHINES, NAMELY A JACKPOT OR PRIZE WITH A FIXED MINIMUM VALUE WHICH INCREASES UNTIL THE JACKPOT IS WON (U.S. CLS. 100, 101 AND 107).

KYLE PEETE, EXAMINING ATTORNEY

SN 78-886,495. STORED VALUE MARKETING, DES PLAINES, IL. FILED 5-18-2006.

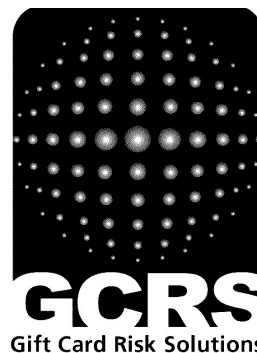

NO CLAIM IS MADE TO THE EXCLUSIVE RIGHT TO USE "GIFT CARD RISK SOLUTIONS", APART FROM THE MARK AS SHOWN.

THE MARK CONSISTS OF THE SHAPE OF A BALL MADE UP OF SMALL CIRCLES AND THE LETTERS GCRS UNDERNEATH THE BALL SHAPE AND THE WORDS GIFT CARD RISK SOLUTIONS UNDER THE LETTERS GCRS.

CLASS 9—ELECTRICAL AND SCIENTIFIC APPARATUS

FOR BLANK INTEGRATED CIRCUIT CARDS ; BLANK SMART CARDS; ELECTRONIC AND MAGNETIC ID CARDS FOR USE IN CONNECTION WITH PAYMENT FOR SERVICES; MAGNETIC CARDS; MAGNETICALLY ENCODED DEBIT CARDS (U.S. CLS. 21, 23, 26, 36 AND 38).

CLASS 16—PAPER GOODS AND PRINTED MATTER

FOR CARDS NOT MAGNETICALLY CODED FOR USE IN BUSINESS TRANSACTIONS ; DEBIT CARDS WITHOUT MAGNETIC CODING (U.S. CLS. 2, 5, 22, 23, 29, 37, 38 AND 50).

CLASS 35—ADVERTISING AND BUSINESS

FOR ADVERTISING AND PROMOTION SERVICES AND RELATED CONSULTING; ADVERTISING SERVICES, NAMELY, PROMOTING THE GIFT CARDS OF OTHERS (U.S. CLS. 100, 101 AND 102).

JOHN DWYER, EXAMINING ATTORNEY

SN 78-887,246. HSBC FINANCE CORPORATION, PROSPECT HEIGHTS, IL. FILED 5-18-2006.

SN 78-889,033. CHEETHAM, EDWARD J., NASHVILLE, TN. FILED 5-22-2006.

SNAPSHOT

THE MARK CONSISTS OF STANDARD CHARACTERS WITHOUT CLAIM TO ANY PARTICULAR FONT, STYLE, SIZE, OR COLOR.

CLASS 9—ELECTRICAL AND SCIENTIFIC APPARATUS

FOR MAGNETICALLY ENCODED CARDS AND CARDS CONTAINING AN INTEGRATED CIRCUIT CHIP CONTAINING SOFTWARE USED FOR THE PURPOSE OF CONDUCTING FINANCIAL TRANSACTIONS (U.S. CLS. 21, 23, 26, 36 AND 38).

CLASS 36—INSURANCE AND FINANCIAL

FOR FINANCIAL SERVICES, NAMELY, CREDIT CARD SERVICES, CHARGE CARD SERVICES, DEBIT CARD SERVICES AND PRE-PAID CARD SERVICES OFFERED THROUGH CARDS WITH STORED VALUE (U.S. CLS. 100, 101 AND 102).

ANNE MADDEN, EXAMINING ATTORNEY

SN 78-888,209. BOWSER, JOHN, LAGUNA BEACH, CA. FILED 5-19-2006.

FREEDOM FLEX

THE MARK CONSISTS OF STANDARD CHARACTERS WITHOUT CLAIM TO ANY PARTICULAR FONT, STYLE, SIZE, OR COLOR.

CLASS 10—MEDICAL APPARATUS

FOR PHYSICAL REHABILITATION, PHYSICAL THERAPY AND SPORTS MEDICINE EQUIPMENT ALL DESIGNED SPECIFICALLY FOR MEDICAL USE, NAMELY, SHOULDER STRETCHER USING A CABLE (U.S. CLS. 26, 39 AND 44).

FIRST USE 10-31-2005; IN COMMERCE 10-31-2005.

CLASS 28—TOYS AND SPORTING GOODS

FOR EXERCISE EQUIPMENT, NAMELY, SHOULDER STRETCHER USING A CABLE (U.S. CLS. 22, 23, 38 AND 50).

FIRST USE 10-31-2005; IN COMMERCE 10-31-2005.
DORITT L. CARROLL, EXAMINING ATTORNEY

Faith Out Loud

THE MARK CONSISTS OF STANDARD CHARACTERS WITHOUT CLAIM TO ANY PARTICULAR FONT, STYLE, SIZE, OR COLOR.

CLASS 35—ADVERTISING AND BUSINESS

FOR MANAGEMENT OF PERFORMING ARTISTS; PERSONAL MANAGEMENT SERVICES FOR MUSICAL PERFORMERS (U.S. CLS. 100, 101 AND 102).

FIRST USE 4-1-1999; IN COMMERCE 6-1-1999.

CLASS 41—EDUCATION AND ENTERTAINMENT

FOR ENTERTAINMENT NAMELY, LIVE PERFORMANCES BY A MUSICAL BAND; PRESENTATION OF MUSICAL PERFORMANCE (U.S. CLS. 100, 101 AND 107).

FIRST USE 4-1-1999; IN COMMERCE 6-1-1999.

KATHERINE CHANG, EXAMINING ATTORNEY

SN 78-891,333. AMERICAN SPECIALTY HEALTH, INC., SAN DIEGO, CA. FILED 5-24-2006.

HEALTHYROADS

THE MARK CONSISTS OF STANDARD CHARACTERS WITHOUT CLAIM TO ANY PARTICULAR FONT, STYLE, SIZE, OR COLOR.

OWNER OF U.S. REG. NO. 2,726,245.

CLASS 9—ELECTRICAL AND SCIENTIFIC APPARATUS

FOR PRERECORDED VIDEO CASSETTES, MUSICAL TAPES, COMPACT DISCS, DVDS, AUDIO CASSETTES, AND CD-ROMS, ALL IN THE FIELD OF HEALTH, WELLNESS, FITNESS AND EXERCISE (U.S. CLS. 21, 23, 26, 36 AND 38).

FIRST USE 10-10-1999; IN COMMERCE 10-10-1999.

CLASS 16—PAPER GOODS AND PRINTED MATTER

FOR BOOKS REGARDING HEALTH, WELLNESS, FITNESS AND EXERCISE (U.S. CLS. 2, 5, 22, 23, 29, 37, 38 AND 50).

FIRST USE 10-10-1999; IN COMMERCE 10-10-1999.

CLASS 35—ADVERTISING AND BUSINESS

FOR MAIL ORDER CATALOG SERVICES AND ON-LINE RETAIL STORE SERVICES FEATURING DIETARY SUPPLEMENTS, NAMELY, VITAMINS, MINERALS, HERBAL REMEDIES, NATURAL THERAPIES; MAIL ORDER CATALOG SERVICES AND ON-LINE RETAIL STORE SERVICES FEATURING DIET AND SPORTS NUTRITION FOOD, NAMELY, BARS, DRINKS AND POWDERS; MAIL ORDER CATALOG SERVICES AND ON-LINE RETAIL STORE SERVICES FEATURING YOGA AND FITNESS EQUIPMENT, VIDEOS AND BOOKS; MAIL ORDER CATALOG SERVICES AND ON-LINE RETAIL STORE SERVICES FEATURING PERSONAL BODY CARE EQUIPMENT; MAIL ORDER CATALOG SERVICES AND ON-LINE RETAIL STORE SERVICES FEATURING HOMEOPATHIC REMEDIES; MAIL ORDER CATALOG SERVICES AND ON-LINE RETAIL STORE SERVICES FEATURING PRE-RECORDED VIDEO CASSETTES, MUSICAL TAPES, COMPACT DISKS, DVDS, AUDIO CASSETTES AND CD-ROMS REGARDING HEALTH, WELLNESS, FITNESS AND EXERCISE; MAIL ORDER CATALOG SERVICES AND ON-LINE RETAIL STORE SERVICES FEATURING BOOKS ON HEALTH, WELLNESS, FITNESS AND EXERCISE; DIRECTORY SERVICES, NAMELY PROVIDING AN ONLINE BUSINESS DIRECTORY FEATURING HEALTHCARE PROVIDERS (U.S. CLS. 100, 101 AND 102).

FIRST USE 10-10-1999; IN COMMERCE 10-10-1999.

CLASS 41—EDUCATION AND ENTERTAINMENT

FOR EDUCATION SERVICES, NAMELY, PROVIDING TELEPHONIC AND ON-LINE PERSONAL COACHING IN THE FIELD OF WEIGHT MANAGEMENT, TOBACCO CESSATION, HEALTHY LIVING, WELLNESS, CHILDHOOD OBESITY, AND IMPROVING LIFESTYLE HABITS IN PREPARATION FOR BARIATRIC SURGERY; PROVIDING AN ONLINE NEWSLETTER IN THE FIELD OF HEALTH, WELLNESS, AND FITNESS; INCENTIVE AND REWARD PROGRAM DESIGNED TO REWARD PROGRAM PARTICIPANTS WHO EXERCISE, MAKE HEALTHY EATING CHOICES, AND ENGAGE IN WEIGHT LOSS AND OTHER HEALTH-PROMOTING ACTIVITIES (U.S. CLS. 100, 101 AND 107).

FIRST USE 1-1-2003; IN COMMERCE 1-1-2003.

CLASS 44—MEDICAL, BEAUTY AND AGRICULTURAL SERVICES

FOR HEALTH RISK ASSESSMENT SERVICES, NAMELY PROVIDING QUESTIONNAIRES REGARDING HEALTH AND MEDICAL INFORMATION FOR COMPLETION BY CLIENT, PROVIDING A PRINTED REPORT OF RESULTS AND EXPLANATION OF RESULTS, AND PROVIDING ONLINE INFORMATION, RESOURCES, AND SUPPORT TO ALLOW INDIVIDUALS TO MANAGE THEIR HEALTH RISKS (U.S. CLS. 100 AND 101).

FIRST USE 1-1-2005; IN COMMERCE 1-1-2005.

JASON BLAIR, EXAMINING ATTORNEY

SN 78-891,356. LOVEHONEY LIMITED, BATH, UNITED KINGDOM, FILED 5-24-2006.

LOVEHONEY

THE MARK CONSISTS OF STANDARD CHARACTERS WITHOUT CLAIM TO ANY PARTICULAR FONT, STYLE, SIZE, OR COLOR.

OWNER OF ERPN CMNTY TM OFC REG. NO. E3400298, DATED 1-17-2005, EXPIRES 1-14-2015.

CLASS 3—COSMETICS AND CLEANING PREPARATIONS

FOR SOAPS; PERFUMES, ESSENTIAL OILS, COSMETICS, HAIR LOTIONS, BODY LOTIONS, MASSAGE OILS, MASSAGE LOTIONS, SHOWER GELS, MASSAGE CREAMS, BUBBLE BATHS, BODY POWDERS, BODY PAINTS, LIP BALMS, DEPILATORY PREPARATIONS (U.S. CLS. 1, 4, 6, 50, 51 AND 52).

CLASS 5—PHARMACEUTICALS

FOR LUBRICANT SUBSTANCES FOR USE ON THE PENIS, ANUS OR VAGINA, NAMELY, GELS AND WATER-BASED, SILICONE-BASED AND OIL-BASED LUBRICANTS; HERBAL PREPARATIONS FOR AROUSING OR ENHANCING SEXUAL DESIRE OR IMPROVING SEXUAL PERFORMANCE (U.S. CLS. 6, 18, 44, 46, 51 AND 52).

CLASS 10—MEDICAL APPARATUS

FOR MASSAGE DEVICES, NAMELY APPARATUSES FOR VIBRATING OR STIMULATING THE BODY; REPRODUCTIONS OF PARTS OF THE MALE AND FEMALE ANATOMY IN THE NATURE OF ARTIFICIAL PENISES AND ARTIFICIAL VAGINAS; SYNTHETIC REPRODUCTIONS OF PENISES AND VAGINAS, NAMELY, ARTIFICIAL PENISES AND VAGINAS; DEVICES FOR AIDING COPULATION, MASTURBATION AND SEXUAL AROUSAL IN THE NATURE OF ADULT SEXUAL AIDS, NAMELY, PENIS RINGS, NIPPLE CLAMPS, VIBRATORS, DILDOS, DONGS, BUTT PLUGS, PENIS SLEEVES, PENIS EXTENSIONS, HARNESSES, MASTURBATORS, SEX CHAIRS, SEX SWINGS, BODY PROSTHESES, LOVE DOLLS, VAGINAL EXERCISERS, BENWA BALLS; CONDOMS (U.S. CLS. 26, 39 AND 44).

CLASS 25—CLOTHING

FOR CLOTHING, NAMELY, EROTIC LINGERIE; FANTASY CLOTHING OF LEATHER OR LATEX, NAMELY, BLINDFOLDS AND GAGS, BODY SUITS, BELTS, UNIFORMS AND HOODS (U.S. CLS. 22 AND 39).

CLASS 28—TOYS AND SPORTING GOODS

FOR FANTASY CLOTHING OF LEATHER OR LATEX, NAMELY, MASKS; GAMES AND PLAYTHINGS, NAMELY, ADULT-THEMED BOARD GAMES, CARD GAMES, ROLE-PLAYING GAMES AND ACCESSORIES THEREFORE (U.S. CLS. 22, 23, 38 AND 50).

CLASS 35—ADVERTISING AND BUSINESS

FOR RETAIL STORE SERVICES, MAIL ORDER SERVICES, CATALOGUE SERVICES AND ONLINE RETAIL STORE SERVICES PROVIDED THROUGH AN INTERNET WEBSITE FEATURING BOOKS, AUDIO-VISUAL WORKS, CLOTHING, SCENTS, NOVELTY ITEMS, GIFTS, DEVICES PROVIDING EROTIC MASSAGE AND STIMULATION AND OTHER PRODUCTS CONCERNING HUMAN SEXUALITY OR THAT ARE PRIMARILY EROTIC, SENSUAL OR SEXUAL IN NATURE (U.S. CLS. 100, 101 AND 102).

BRENDAN MCCAULEY, EXAMINING ATTORNEY

SN 78-894,372. HUMAN DEVELOPMENT REPORT, INC.,
SHIBUYA-KU, TOKYO, JAPAN, FILED 5-26-2006.

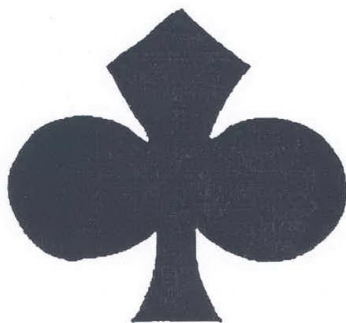

OWNER OF JAPAN REG. NO. 4907170, DATED 11-11-2005,
EXPIRES 11-11-2015.

THE MARK CONSISTS OF THE SHAPE OF A CLOVER.

CLASS 18—LEATHER GOODS

FOR TRAVELING BAGS OF LEATHER AND IMITATION LEATHER, ALL PURPOSE SPORTS BAGS, ATHLETIC BAGS, GARMENT BAGS FOR TRAVEL, VALISES, BRIEFCASES, POUCHES OF LEATHER AND IMITATION LEATHER, DRAWSTRING POUCHES, FELT POUCHES, BACKPACKS, HANDBAGS, SHOULDER BAGS, SHOPPING BAGS OF LEATHER AND IMITATION LEATHER, VANITY BAGS SOLD EMPTY, TOTE BAGS, BEACH BAGS, SCHOOL SATCHELS, PURSES, WALLETS, BUSINESS CARD CASES, CREDIT CARD CASES; CLOTHING FOR PETS; UMBRELLAS, PARASOLS (U.S. CLS. 1, 2, 3, 22 AND 41).

CLASS 25—CLOTHING

FOR SHIRTS, TEE-SHIRTS, POLO SHIRTS, BLOUSES, TANK TOPS, CAMISOLES, SWEATSHIRTS, PULL-OVERS, VESTS, SWEATERS, CARDIGANS, JACKETS, DRESSES, PARKAS, COATS, PANTS, SWEATPANTS, OVERALLS, ROMPERS, CREEPERS, TROUSERS, SHORTS, SKIRTS, UNDERWEAR, PAJAMAS, SOCKS, CLOTH BIBS, APRONS, MUFFLERS, BANDANAS, GLOVES; HATS, CAPS, SUN VISORS; BELTS; SNEAKERS, SANDALS, PUMPS, SLIPPERS (U.S. CLS. 22 AND 39).

RONALD AIKENS, EXAMINING ATTORNEY

SN 78-895,825. KAPRO INDUSTRIES LIMITED, KIBBUTZ
KADARIM, ISRAEL, FILED 5-30-2006.



THE COLOR(S) RED, BLACK AND WHITE IS/ARE CLAIMED AS A FEATURE OF THE MARK.

THE MARK CONSISTS OF A BLACK RECTANGLE, WITH A WHITE CAPITAL "K", AND A RED TRIANGLE IN THE LEFT CENTER PORTION OF THE MARK.

CLASS 8—HAND TOOLS

FOR HAND TOOLS, NAMELY, SQUARES, COMBINATION SQUARES, AND CHALK LINES (U.S. CLS. 23, 28 AND 44).

CLASS 9—ELECTRICAL AND SCIENTIFIC APPARATUS

FOR MEASURING, LAYOUT AND MARKING TOOLS FOR THE BUILDING, DO-IT-YOURSELF, HARDWARE AND ENGINEERING INDUSTRIES, NAMELY, CAST LEVELS, BOX LEVELS, I-BEAM LEVELS, PLASTIC TORPEDO LEVELS, TOOL-BOX LEVELS, GRADIENT LEVELS, ELECTRONIC LEVELS, DIGITAL LEVELS, LASER LEVELS, SELF-LEVELING LASER LEVELS, ROTATING LASER LEVELS, SCREED LEVELS, DIGITAL ANGLE LEVELS, LASER LEVEL DETECTORS, INCLINOMETERS, MEASURING TAPES, LONG-REEL TAPES, OPEN-REEL TAPES, MEASURING WHEELS, FOLDING RULERS, TAPE RULERS, TELESCOPIC RULERS, GRADUATED METAL, WOOD AND PLASTIC RULERS, ELECTRONIC DISTANCE MEASURERS, DIGITAL DISTANCE MEASURERS, PROTRACTORS, DIGITAL AND ELECTRONIC ANGLE MEASURERS, MARKING GAUGES, PLUMB BOBS, BEVELS, SLIDING-T BEVELS, LASER LINE GENERATORS, LASER MEASURER ACCESSORIES, NAMELY, SAFETY GLASSES, LASER TARGETS, TRIPODS, LASER MOUNTING POLES, LASER LEVELING DISCS AND LASER PRISMS, WATER HOSE LEVELS; AND PARTS FOR ALL OF THE FOREGOING (U.S. CLS. 21, 23, 26, 36 AND 38).

CLASS 16—PAPER GOODS AND PRINTED MATTER

FOR CHALK, CRAYONS, MARKERS, STRAIGHT-EDGES, CARPENTER PENCILS AND PENCIL SHARPENERS (U.S. CLS. 2, 5, 22, 23, 29, 37, 38 AND 50).

SHANNON TWOHIG, EXAMINING ATTORNEY

SN 78-895,856. QUADREM INTERNATIONAL, LTD.,
HAMILTON, BERMUDA, FILED 5-30-2006.

QUICKPAY

THE MARK CONSISTS OF STANDARD CHARACTERS WITHOUT CLAIM TO ANY PARTICULAR FONT, STYLE, SIZE, OR COLOR.

CLASS 35—ADVERTISING AND BUSINESS

FOR ACCOUNTS RECEIVABLE SERVICES, NAMELY, PROVIDING ELECTRONIC VIEWING OF RECEIVABLES FOR SUPPLIERS IN THE FIELDS OF EXTRACTION INDUSTRIES, CONSUMER PACKAGED GOODS, AND OTHER BUSINESS-TO-BUSINESS TRANSACTIONS. (U.S. CLS. 100, 101 AND 102).

FIRST USE 2-1-2005; IN COMMERCE 2-1-2005.

CLASS 36—INSURANCE AND FINANCIAL

FOR ACCOUNTS RECEIVABLE FINANCING, NAMELY, PROVIDING DISPOSITION OF RECEIVABLES FOR SUPPLIERS IN THE FIELDS OF EXTRACTION INDUSTRIES, CONSUMER PACKAGED GOODS, AND OTHER BUSINESS-TO-BUSINESS TRANSACTIONS. (U.S. CLS. 100, 101 AND 102).

FIRST USE 2-1-2005; IN COMMERCE 2-1-2005.

LINDA ORNDORFF, EXAMINING ATTORNEY

SN 78-896,360. VAULT BRANDS, INC., BEAVERTON, OR.
FILED 5-30-2006.

Vault

THE MARK CONSISTS OF STANDARD CHARACTERS WITHOUT CLAIM TO ANY PARTICULAR FONT, STYLE, SIZE, OR COLOR.

CLASS 6—METAL GOODS

FOR STORAGE AND ORGANIZATION UNITS MAINLY COMPRISED OF METAL SHELVES, CABINETS, DRAWERS, TOOL CHESTS AND WORKBENCHES; METAL WORKING SURFACES THAT FUNCTION AS A TABLE TOP ON CABINETS AND TOOL CHESTS; METAL STORAGE AND ORGANIZATION PRODUCTS AND PARTS THAT ATTACH TO WALL PANELS, NAMELY, METAL SHELF BRACKETS, RACKS, AND HOOKS AND RODS (U.S. CLS. 2, 12, 13, 14, 23, 25 AND 50).
FIRST USE 9-28-2005; IN COMMERCE 9-28-2005.

CLASS 20—FURNITURE AND ARTICLES NOT OTHERWISE CLASSIFIED

FOR STORAGE AND ORGANIZATION UNITS COMPRISED OF SHELVES, CABINETS, DRAWERS, TOOL CHESTS AND WORKBENCHES; WORKING SURFACES THAT FUNCTION AS A TABLE TOP ON CABINETS AND TOOL CHESTS; STORAGE AND ORGANIZATION PRODUCTS AND PARTS THAT ATTACH TO WALL PANELS, NAMELY, NON-METAL SHELF BRACKETS, RACKS, AND HOOKS AND RODS (U.S. CLS. 2, 13, 22, 25, 32 AND 50).
FIRST USE 9-28-2005; IN COMMERCE 9-28-2005.
KATHRYN COWARD, EXAMINING ATTORNEY

SN 78-898,905. AMERICAN SOCIETY OF ANESTHESIOLOGISTS, INC., WASHINGTON, DC. FILED 6-2-2006.

Relative Value Guide

THE MARK CONSISTS OF STANDARD CHARACTERS WITHOUT CLAIM TO ANY PARTICULAR FONT, STYLE, SIZE, OR COLOR.
NO CLAIM IS MADE TO THE EXCLUSIVE RIGHT TO USE "GUIDE", APART FROM THE MARK AS SHOWN. SEC. 2(F).

CLASS 9—ELECTRICAL AND SCIENTIFIC APPARATUS

FOR PRE-RECORDED CDS FEATURING MEDICAL CODES, MODIFIERS, ASSOCIATED VALUES AND INSTRUCTIONS USED FOR BILLING PURPOSES (U.S. CLS. 21, 23, 26, 36 AND 38).
FIRST USE 0-0-1996; IN COMMERCE 0-0-1996.

CLASS 16—PAPER GOODS AND PRINTED MATTER

FOR ANNUAL PUBLICATION, NAMELY PAMPHLETS FEATURING MEDICAL CODES, MODIFIERS, ASSOCIATED VALUES AND INSTRUCTIONS USED FOR BILLING PURPOSES (U.S. CLS. 2, 5, 22, 23, 29, 37, 38 AND 50).
FIRST USE 0-0-1963; IN COMMERCE 0-0-1963.
AMY HELLA, EXAMINING ATTORNEY

SN 78-899,600. SILVER STAR A.G., LTD., THOUSAND OAKS, CA. FILED 6-2-2006.

FIND GORGEOUS

THE MARK CONSISTS OF STANDARD CHARACTERS WITHOUT CLAIM TO ANY PARTICULAR FONT, STYLE, SIZE, OR COLOR.

CLASS 35—ADVERTISING AND BUSINESS

FOR AUTOMOBILE DEALERSHIPS; RETAIL AUTOMOBILE PARTS STORE (U.S. CLS. 100, 101 AND 102).
FIRST USE 3-24-2006; IN COMMERCE 3-24-2006.

CLASS 37—CONSTRUCTION AND REPAIR

FOR AUTOMOBILE REPAIR AND MAINTENANCE SERVICES (U.S. CLS. 100, 103 AND 106).
FIRST USE 3-24-2006; IN COMMERCE 3-24-2006.
BARBARA A. GOLD, EXAMINING ATTORNEY

SN 78-900,413. THRESHOLD ENTERPRISES LTD., SCOTTS VALLEY, CA. FILED 6-5-2006.

SYSTEMICARE

THE MARK CONSISTS OF STANDARD CHARACTERS WITHOUT CLAIM TO ANY PARTICULAR FONT, STYLE, SIZE, OR COLOR.

CLASS 3—COSMETICS AND CLEANING PREPARATIONS

FOR COSMETICS (U.S. CLS. 1, 4, 6, 50, 51 AND 52).

CLASS 5—PHARMACEUTICALS

FOR DIETARY SUPPLEMENTS, NUTRITIONAL SUPPLEMENTS, FOOD SUPPLEMENTS, HERBAL SUPPLEMENTS, AND A FULL LINE OF HOMEOPATHIC PHARMACEUTICAL PREPARATIONS, NAMELY TABLETS, CAPSULES AND LIQUIDS (U.S. CLS. 6, 18, 44, 46, 51 AND 52).
DEIRDRE ROBERTSON, EXAMINING ATTORNEY

SN 78-901,320. TOTAL COMPLIANCE NETWORK, INC.,
CORAL SPRINGS, FL. FILED 6-6-2006.

TOTAL COMPLIANCE NETWORK

THE MARK CONSISTS OF STANDARD CHARACTERS WITHOUT CLAIM TO ANY PARTICULAR FONT, STYLE, SIZE, OR COLOR.

NO CLAIM IS MADE TO THE EXCLUSIVE RIGHT TO USE "NETWORK", APART FROM THE MARK AS SHOWN. SEC. 2(F).

CLASS 35—ADVERTISING AND BUSINESS

FOR ADMINISTRATION OF EMPLOYEE DRUG TESTING PROGRAMS; DEVELOPING, IMPLEMENTING, AND ADMINISTERING DRUG POLICY CONFORMANCE PROGRAMS FOR OTHERS; BUSINESS CONSULTATION SERVICES IN THE FIELD OF DRUG POLICY CONFORMANCE (U.S. CLS. 100, 101 AND 102).
FIRST USE 12-7-1992; IN COMMERCE 12-7-1992.

CLASS 42—SCIENTIFIC, COMPUTER AND LEGAL SERVICES

FOR REVIEWING STANDARDS AND PRACTICES OF OTHERS TO ENSURE CONFORMANCE WITH DRUG POLICIES, LAWS AND REGULATIONS (U.S. CLS. 100 AND 101).

FIRST USE 12-7-1992; IN COMMERCE 12-7-1992.

CLASS 44—MEDICAL, BEAUTY AND AGRICULTURAL SERVICES

FOR EMPLOYEE DRUG TESTING (U.S. CLS. 100 AND 101).

FIRST USE 12-7-1992; IN COMMERCE 12-7-1992.
JAMES STEIN, EXAMINING ATTORNEY

SN 78-901,568. DELTATHREE, INC., NEW YORK, NY.
FILED 6-6-2006.



THE COLOR(S) BLUE, ORANGE AND BLACK IS/ARE CLAIMED AS A FEATURE OF THE MARK.

THE LETTERS "JO" ARE BLUE AND THE LETTERS "IP" ARE ORANGE. THE SPACE WITHIN THE LETTER "O" IS ORANGE AND THE SPACE WITHIN THE LETTER "P" IS BLUE. THE WORDS "JUST TALK" ARE DISPLAYED IN ITALICS, IN BLACK BENEATH THE STYLIZED WORD "JOIP".

CLASS 9—ELECTRICAL AND SCIENTIFIC APPARATUS

FOR TELECOMMUNICATIONS DEVICES, NAMELY, PORTABLE AND HANDHELD ELECTRONIC DEVICES FOR WIRELESS AND WIRED COMMUNICATIONS, NAMELY, TELEPHONES, HANDSETS, HEADSETS, SPEAKERS, MICROPHONES, EARPHONES; REMOTE CONTROL UNITS FOR ELECTRONIC HOME AUDIO AND VIDEO DEVICES; SET TOP BOXES; PORTABLE AND HANDHELD DIGITAL ELECTRONIC DEVICES FOR RECORDING, ORGANIZING, TRANSMITTING, MANIPULATING, AND REVIEWING TEXT, DATA, AND AUDIO FILES; DOWNLOADABLE SOFTWARE FOR USE IN VOIP COMMUNICATIONS SERVICES (U.S. CLS. 21, 23, 26, 36 AND 38).

CLASS 35—ADVERTISING AND BUSINESS

FOR ONLINE ADVERTISING SERVICES; ADVERTISING SERVICES INVOLVING COUPONS, REBATES AND DISCOUNTS (U.S. CLS. 100, 101 AND 102).

CLASS 38—COMMUNICATION

FOR ELECTRONIC, ELECTRIC, AND DIGITAL TRANSMISSION OF VOICE, DATA, IMAGES, SIGNALS, AND MESSAGES; PROVIDING BROADBAND COMMUNICATIONS; PROVIDING VOICE OVER INTERNET PROTOCOL PEER-TO-PEER COMMUNICATIONS; INSTANT MESSAGING SERVICES; SHORT MESSAGING SERVICES AND TEXT MESSAGING SERVICES (U.S. CLS. 100, 101 AND 104).

CLASS 42—SCIENTIFIC, COMPUTER AND LEGAL SERVICES

FOR COMPUTER SERVICES AND SOFTWARE DEVELOPMENT FOR OTHERS, NAMELY, DESIGN OF COMPUTER SOFTWARE AND HARDWARE FOR USE IN TELECOMMUNICATIONS AND VOICE OVER INTERNET PROTOCOL (VOIP) APPLICATIONS, DATA TRANSMISSION AND INSTANT MESSAGING SERVICES; INSTALLATION AND MAINTENANCE OF COMPUTER SOFTWARE; PROVIDING TEMPORARY USE OF ONLINE, NON-DOWNLOADABLE COMPUTER SOFTWARE THAT ALLOWS SUBSCRIBERS TO UTILIZE VOIP COMMUNICATION SERVICES (U.S. CLS. 100 AND 101).

JANICE L. MCMORROW, EXAMINING ATTORNEY

SN 78-902,540. CARR, KEVIN F., STANTON, CA. FILED 6-7-2006.

internetusers

THE MARK CONSISTS OF STANDARD CHARACTERS WITHOUT CLAIM TO ANY PARTICULAR FONT, STYLE, SIZE, OR COLOR.
SEC. 2(F).

CLASS 41—EDUCATION AND ENTERTAINMENT

FOR PROVIDING INFORMATION IN THE FIELDS OF NEWS, CURRENT EVENTS AND ENTERTAINMENT, VIA A WEBSITE ON A GLOBAL COMPUTER NETWORK; PROVIDING INFORMATION IN THE FIELDS OF NEWS, CURRENT EVENTS AND ENTERTAINMENT, VIA THE INTERNET (U.S. CLS. 100, 101 AND 107).

FIRST USE 12-15-1997; IN COMMERCE 12-15-1997.

CLASS 42—SCIENTIFIC, COMPUTER AND LEGAL SERVICES

FOR PROVIDING INFORMATION ABOUT THE WEATHER AND WEATHER FORECASTS VIA THE INTERNET AND VIA A WEBSITE ON A GLOBAL COMPUTER NETWORK; COMPUTER SERVICES, NAMELY, PROVIDING SEARCH ENGINES FOR OBTAINING DATA ON A GLOBAL COMPUTER NETWORK (U.S. CLS. 100 AND 101).

FIRST USE 12-15-1997; IN COMMERCE 12-15-1997.
BARBARA A. GOLD, EXAMINING ATTORNEY

SN 78-903,677. SILVER STAR A.G., LTD., THOUSAND OAKS, CA. FILED 6-8-2006.

ARE YOU HAVING FUN YET?

THE MARK CONSISTS OF STANDARD CHARACTERS WITHOUT CLAIM TO ANY PARTICULAR FONT, STYLE, SIZE, OR COLOR.

CLASS 35—ADVERTISING AND BUSINESS

FOR AUTOMOBILE DEALERSHIPS; RETAIL AUTOMOBILE PARTS STORES (U.S. CLS. 100, 101 AND 102).
FIRST USE 4-23-2006; IN COMMERCE 4-23-2006.

CLASS 37—CONSTRUCTION AND REPAIR

FOR AUTOMOBILE REPAIR AND MAINTENANCE SERVICES (U.S. CLS. 100, 103 AND 106).
FIRST USE 4-23-2006; IN COMMERCE 4-23-2006.
BARBARA A. GOLD, EXAMINING ATTORNEY

SN 78-903,749. ARB, INC., LAKE FOREST, CA. FILED 6-8-2006.

ARB

THE MARK CONSISTS OF STANDARD CHARACTERS WITHOUT CLAIM TO ANY PARTICULAR FONT, STYLE, SIZE, OR COLOR.

CLASS 37—CONSTRUCTION AND REPAIR

FOR PROVIDING CONSTRUCTION, CONSTRUCTION MANAGEMENT, MAINTENANCE, REPLACEMENT, REPAIR AND INSTALLATION SERVICES ON A CUSTOM BASIS FOR BUILDINGS, PLANTS, STRUCTURES, STORAGE, OPERATING AND PROCESSING FACILITIES, NAMELY, WATER AND WASTEWATER TREATMENT PLANTS, POWER PLANTS, COMPRESSOR STATIONS, REFINERIES, PIPELINE AND RELATED FACILITIES, MANUFACTURING PLANTS, PARKING STRUCTURES, CONCRETE STRUCTURES, AND STEEL STRUCTURES IN THE POWER AND ENERGY, PETROCHEMICAL, REFINING, OIL AND GAS, MINING, COMMERCIAL DEVELOPMENT, UTILITIES, POWER GENERATION, EMISSION REDUCTION, WATER/WASTEWATER TREATMENT, FOOD AND BEVERAGE PROCESSING, LIQUID AND BULK MATERIALS, AND MANUFACTURING INDUSTRIES; PROVIDING CUSTOM FABRICATION SERVICES FOR BUILDINGS, PLANTS, STRUCTURES, STORAGE, OPERATING AND PROCESSING FACILITIES, NAMELY, WATER AND WASTEWATER TREATMENT PLANTS, POWER PLANTS, COMPRESSOR STATIONS, REFINERIES, PIPELINE AND RELATED FACILITIES, MANUFACTURING PLANTS, PARKING STRUCTURES, CONCRETE STRUCTURES, AND STEEL STRUCTURES IN THE POWER AND ENERGY, PETROCHEMICAL, REFINING, OIL AND GAS, MINING, COMMERCIAL DEVELOPMENT, UTILITIES, POWER GENERATION, EMISSION REDUCTION, WATER/WASTEWATER TREATMENT, FOOD AND BEVERAGE PROCESSING, LIQUID AND BULK MATERIALS, AND MANUFACTURING INDUSTRIES (U.S. CLS. 100, 103 AND 106).

FIRST USE 12-31-1946; IN COMMERCE 12-31-1946.

CLASS 42—SCIENTIFIC, COMPUTER AND LEGAL SERVICES

FOR ENGINEERING SERVICES ON A CUSTOM BASIS FOR BUILDINGS, PLANTS, STRUCTURES, STORAGE, OPERATING AND PROCESSING FACILITIES, NAMELY, WATER AND WASTEWATER TREATMENT PLANTS, POWER PLANTS, COMPRESSOR STATIONS, REFINERIES, PIPELINE AND RELATED FACILITIES, MANUFACTURING PLANTS, PARKING STRUCTURES, CONCRETE STRUCTURES, AND STEEL STRUCTURES IN THE POWER AND ENERGY, PETROCHEMICAL, REFINING, OIL AND GAS, MINING, COMMERCIAL DEVELOPMENT, UTILITIES, POWER GENERATION, EMISSION REDUCTION, WATER/WASTEWATER TREATMENT, FOOD AND BEVERAGE PROCESSING, LIQUID AND BULK MATERIALS, AND MANUFACTURING INDUSTRIES (U.S. CLS. 100 AND 101).

FIRST USE 12-31-1946; IN COMMERCE 12-31-1946.
AMY ALFIERI, EXAMINING ATTORNEY

SN 78-903,780. GEN10 TECHNOLOGY, INC., DALLAS, TX. FILED 6-8-2006.

CARMA

THE MARK CONSISTS OF STANDARD CHARACTERS WITHOUT CLAIM TO ANY PARTICULAR FONT, STYLE, SIZE, OR COLOR.

CLASS 9—ELECTRICAL AND SCIENTIFIC APPARATUS

FOR COMPUTER E-COMMERCE SOFTWARE TO ALLOW USERS TO PERFORM ELECTRONIC BUSINESS TRANSACTIONS VIA A GLOBAL COMPUTER NETWORK; COMPUTER NETWORK SWITCHES AND ROUTERS; COMPUTER PROGRAMS FOR SEARCHING THE CONTENTS OF COMPUTERS AND COMPUTER NETWORKS BY REMOTE CONTROL; COMPUTER PROGRAMS FOR THE ENABLING OF ACCESS OR ENTRANCE CONTROL; COMPUTER SOFTWARE FOR ACCESSING INFORMATION DIRECTORIES THAT MAY BE DOWNLOADED FROM THE GLOBAL COMPUTER NETWORK; COMPUTER SOFTWARE FOR CONTROLLING AND MANAGING ACCESS SERVER APPLICATIONS; COMPUTER SOFTWARE FOR CREATING SEARCHABLE DATABASES OF INFORMATION AND DATA; COMPUTER SOFTWARE FOR ORGANIZING AND VIEWING DIGITAL IMAGES AND PHOTOGRAPHS; COMPUTER SOFTWARE FOR THE COLLECTION, EDITING, ORGANIZING, MODIFYING, BOOK MARKING, TRANSMISSION, STORAGE AND SHARING OF DATA AND INFORMATION; COMPUTER SOFTWARE TO AUTOMATE DATA WAREHOUSING; COMPUTER SOFTWARE FOR USE IN THE ENCRYPTION AND DECRYPTION OF DIGITAL FILES, INCLUDING AUDIO, VIDEO, TEXT, BINARY, STILL IMAGES, GRAPHICS AND MULTIMEDIA FILES; COMPUTER SOFTWARE FOR USE IN THE SAFEGUARDING OF DIGITAL FILES, INCLUDING AUDIO, VIDEO, TEXT, BINARY, STILL IMAGES, GRAPHICS AND MULTIMEDIA FILES; COMPUTER SOFTWARE THAT PROVIDES REAL-TIME, INTEGRATED BUSINESS MANAGEMENT INTELLIGENCE BY COMBINING INFORMATION FROM VARIOUS DATABASES AND PRESENTING IT IN AN EASY-TO-UNDERSTAND USER INTERFACE; COMPUTER SOFTWARE TO AUTOMATE DATA WAREHOUSING; ENTERPRISE SOFTWARE IN THE NATURE OF A DATABASE FOR NON-TRANSACTIONAL DATA AND A SEARCH ENGINE FOR DATABASE CONTENT; GATEWAY ROUTERS IN THE NATURE OF COMPUTER CONTROL HARDWARE; LAN (LOCAL AREA NETWORK) ACCESS POINTS FOR CONNECTING NETWORK COMPUTER USERS; MOBILE DATA RECEIVERS; NETWORK ACCESS SERVER HARDWARE; WIDE AREA NETWORKS (WAN), NAMELY WAN HARDWARE AND WAN OPERATING SOFTWARE (U.S. CLS. 21, 23, 26, 36 AND 38).

CLASS 42—SCIENTIFIC, COMPUTER AND LEGAL SERVICES

FOR COMPUTER SECURITY SERVICE, NAMELY, RESTRICTING ACCESS TO AND BY COMPUTER NETWORKS TO AND OF UNDESIRED WEB SITES, MEDIA AND INDIVIDUALS AND FACILITIES; COMPUTER SERVICE, NAMELY, ACTING AS AN APPLICATION SERVICE PROVIDER IN THE FIELD OF KNOWLEDGE MANAGEMENT TO HOST COMPUTER APPLICATION SOFTWARE FOR CREATING SEARCHABLE DATABASES OF INFORMATION AND DATA; COMPUTER SERVICE, NAMELY, ACTING AS AN APPLICATION SERVICE PROVIDER IN THE FIELD OF KNOWLEDGE MANAGEMENT TO HOST COMPUTER APPLICATION SOFTWARE FOR SEARCHING AND RETRIEVING INFORMATION FROM DATABASES AND COMPUTER NETWORKS; COMPUTER SERVICE, NAMELY, ACTING AS AN APPLICATION SERVICE PROVIDER IN THE FIELD OF KNOWLEDGE MANAGEMENT TO HOST COMPUTER APPLICATION SOFTWARE FOR THE COLLECTION, EDITING, ORGANIZING, MODIFYING, BOOK MARKING, TRANSMISSION, STORAGE AND SHARING OF DATA AND INFORMATION; COMPUTER SERVICES, NAMELY MONITORING, TESTING, ANALYZING, AND REPORTING ON THE INTERNET TRAFFIC CONTROL AND CONTENT CONTROL OF THE WEBSITES OF OTHERS; COMPUTER VIRUS PROTECTION SERVICES; DATA ENCRYPTION SERVICES; PROVIDING INFORMATION RELATING TO LEGAL AFFAIRS; REVIEWING STANDARDS AND PRACTICES TO ASSURE COMPLIANCE WITH CORPORATE ETHIC LAWS AND REGULATIONS (U.S. CLS. 100 AND 101).
MEGAN WHITNEY, EXAMINING ATTORNEY

SN 78-904,157. LIVING NATURE LIMITED, KERIKERI, NEW ZEALAND, FILED 6-8-2006.

LIVING NATURE

THE MARK CONSISTS OF STANDARD CHARACTERS WITHOUT CLAIM TO ANY PARTICULAR FONT, STYLE, SIZE, OR COLOR.

CLASS 3—COSMETICS AND CLEANING PREPARATIONS

FOR SOAPS FOR BODY CARE, PERFUMERY, ESSENTIAL OILS, COSMETICS, HAIR LOTIONS, DENTIFRICES, NON-MEDICATED TOILETRIES, AND NON-MEDICATED SKIN CARE PREPARATIONS (U.S. CLS. 1, 4, 6, 50, 51 AND 52).

CLASS 35—ADVERTISING AND BUSINESS

FOR WHOLESALE AND RETAIL STORES FEATURING SOAPS, PERFUMERY, ESSENTIAL OILS, COSMETICS, HAIR LOTIONS, DENTIFRICES, TOILETRIES, AND SKIN CARE PREPARATIONS (U.S. CLS. 100, 101 AND 102).

CURTIS FRENCH, EXAMINING ATTORNEY

SN 78-906,879. ARB, INC., LAKE FOREST, CA. FILED 6-13-2006.

CLASS 37—CONSTRUCTION AND REPAIR

FOR PROVIDING CUSTOM FABRICATION SERVICES FOR BUILDINGS, PLANTS, STRUCTURES, STORAGE, OPERATING AND PROCESSING FACILITIES, NAMELY, WATER AND WASTEWATER TREATMENT PLANTS, POWER PLANTS, COMPRESSOR STATIONS, REFINERIES, PIPELINE AND RELATED FACILITIES, MANUFACTURING PLANTS, PARKING STRUCTURES, CONCRETE STRUCTURES, AND STEEL STRUCTURES IN THE POWER AND ENERGY, PETROCHEMICAL, REFINING, OIL AND GAS, MINING, COMMERCIAL DEVELOPMENT, UTILITIES, POWER GENERATION, EMISSION REDUCTION, WATER/WASTEWATER TREATMENT, FOOD AND BEVERAGE PROCESSING, LIQUID AND BULK MATERIALS, AND MANUFACTURING INDUSTRIES (U.S. CLS. 100, 103 AND 106).
FIRST USE 11-30-1997; IN COMMERCE 11-30-1997.

CLASS 42—SCIENTIFIC, COMPUTER AND LEGAL SERVICES

FOR ENGINEERING SERVICES ON A CUSTOM BASIS FOR BUILDINGS, PLANTS, STRUCTURES, STORAGE, OPERATING AND PROCESSING FACILITIES, NAMELY, WATER AND WASTEWATER TREATMENT PLANTS, POWER PLANTS, COMPRESSOR STATIONS, REFINERIES, PIPELINE AND RELATED FACILITIES, MANUFACTURING PLANTS, PARKING STRUCTURES, CONCRETE STRUCTURES, AND STEEL STRUCTURES IN THE POWER AND ENERGY, PETROCHEMICAL, REFINING, OIL AND GAS, MINING, COMMERCIAL DEVELOPMENT, UTILITIES, POWER GENERATION, EMISSION REDUCTION, WATER/WASTEWATER TREATMENT, FOOD AND BEVERAGE PROCESSING, LIQUID AND BULK MATERIALS, AND MANUFACTURING INDUSTRIES (U.S. CLS. 100 AND 101).

FIRST USE 11-30-1997; IN COMMERCE 11-30-1997.
AMY ALFIERI, EXAMINING ATTORNEY

CLASS 37—CONSTRUCTION AND REPAIR

FOR INSTALLATION AND REPAIR SERVICES FOR ELECTRONIC DEVICES AND EQUIPMENT, REMOTE CONTROLS, AND ELECTRONIC INTEGRATED CONTROL SYSTEMS RELATING TO AUDIO AND VIDEO ENTERTAINMENT SYSTEMS, HIGH-DEFINITION TELEVISIONS AND DISPLAYS, HOME THEATER SYSTEMS, FIRE ALARM SYSTEMS AND FIREPLACES, SAFETY PERIMETER AND INTERIOR BURGLAR DETECTION AND ALARM SYSTEMS, ACCESS CONTROL AND ALARM MONITORING SYSTEMS, PERSONAL SECURITY MONITORING AND DISPLAYS, COMPUTER NETWORKING HARDWARE, DATA PROCESSORS, TELEPHONY APPARATUS, COMMUNICATIONS SYSTEMS, INTERCOM SYSTEMS, RESIDENTIAL AND COMMERCIAL LIGHTING, MOTORIZATION UNITS, HVAC SYSTEMS, CLIMATE CONTROL UNITS, ACOUSTICAL TREATMENT AND SOUND ISOLATION SYSTEMS (U.S. CLS. 100, 103 AND 106).

FIRST USE 5-10-2001; IN COMMERCE 8-1-2001.

CLASS 42—SCIENTIFIC, COMPUTER AND LEGAL SERVICES

FOR DESIGN, LAYOUT AND SCHEMATICS DEVELOPMENT FOR INSTALLATION, TECHNICAL PROJECT MANAGEMENT AND PROGRAMMING, AND CONSULTING THERETO FOR ELECTRONIC DEVICES AND EQUIPMENT, REMOTE CONTROLS, AND ELECTRONIC INTEGRATED CONTROL SYSTEMS RELATING TO AUDIO AND VIDEO ENTERTAINMENT SYSTEMS, HIGH-DEFINITION TELEVISIONS AND DISPLAYS, HOME THEATER SYSTEMS, FIRE ALARM SYSTEMS AND FIREPLACES, SAFETY PERIMETER AND INTERIOR BURGLAR DETECTION AND ALARM SYSTEMS, ACCESS CONTROL AND ALARM MONITORING SYSTEMS, PERSONAL SECURITY MONITORING AND DISPLAYS, COMPUTER NETWORKING HARDWARE, DATA PROCESSORS, TELEPHONY APPARATUS, COMMUNICATIONS SYSTEMS, INTERCOM SYSTEMS, RESIDENTIAL AND COMMERCIAL LIGHTING, MOTORIZATION UNITS, HVAC SYSTEMS, CLIMATE CONTROL UNITS, ACOUSTICAL TREATMENT AND SOUND ISOLATION SYSTEMS; CALIBRATION OF ELECTRONIC DEVICES AND EQUIPMENT, NAMELY, REMOTE CONTROLS, AND ELECTRONIC INTEGRATED CONTROL SYSTEMS RELATING TO AUDIO AND VIDEO ENTERTAINMENT SYSTEMS, HIGH-DEFINITION TELEVISIONS AND DISPLAYS, HOME THEATER SYSTEMS, FIRE ALARM SYSTEMS AND FIREPLACES, SAFETY PERIMETER AND INTERIOR BURGLAR DETECTION AND ALARM SYSTEMS, ACCESS CONTROL AND ALARM MONITORING SYSTEMS, PERSONAL SECURITY MONITORING AND DISPLAYS, COMPUTER NETWORKING HARDWARE, DATA PROCESSORS, TELEPHONY APPARATUS, COMMUNICATIONS SYSTEMS, INTERCOM SYSTEMS, RESIDENTIAL AND COMMERCIAL LIGHTING, MOTORIZATION UNITS, HVAC SYSTEMS, CLIMATE CONTROL UNITS, ACOUSTICAL TREATMENT AND SOUND ISOLATION SYSTEMS (U.S. CLS. 100 AND 101).

FIRST USE 5-10-2001; IN COMMERCE 8-1-2001.
WILLIAM VERHOSEK, EXAMINING ATTORNEY

SN 78-907,465. LIFESPACES, INC., CHARLESTON, SC. FILED 6-13-2006.

LIFESPACES

THE MARK CONSISTS OF STANDARD CHARACTERS WITHOUT CLAIM TO ANY PARTICULAR FONT, STYLE, SIZE, OR COLOR.

OWNER OF U.S. REG. NOS. 2,660,529 AND 2,664,322.

CLASS 9—ELECTRICAL AND SCIENTIFIC APPARATUS

FOR ELECTRONIC DEVICES AND EQUIPMENT, NAMELY, REMOTE CONTROLS AND ELECTRONIC INTEGRATED CONTROL SYSTEMS COMPRISING WIRED AND WIRELESS CONTROLLERS AND TRANSCIEVERS RELATING TO THE INTEGRATION AND CONTROL OF AUDIO AND VIDEO ENTERTAINMENT SYSTEMS, HIGH-DEFINITION TELEVISIONS AND DISPLAYS, HOME THEATER SYSTEMS, FIRE ALARM SYSTEMS AND FIREPLACES, SAFETY PERIMETER AND INTERIOR BURGLAR DETECTION AND ALARM SYSTEMS, ACCESS CONTROL AND ALARM MONITORING SYSTEMS, PERSONAL SECURITY MONITORING AND DISPLAYS, COMPUTER NETWORKING HARDWARE, DATA PROCESSORS, TELEPHONY APPARATUS, COMMUNICATIONS SYSTEMS, INTERCOM SYSTEMS, RESIDENTIAL AND COMMERCIAL LIGHTING, MOTORIZATION UNITS, HVAC SYSTEMS, CLIMATE CONTROL UNITS, ACOUSTICAL TREATMENT AND SOUND ISOLATION SYSTEMS (U.S. CLS. 21, 23, 26, 36 AND 38).

FIRST USE 5-10-2001; IN COMMERCE 8-1-2001.

SN 78-907,477. LIFESPACES, INC., CHARLESTON, SC. FILED 6-13-2006.

ELIFESPACES

THE MARK CONSISTS OF STANDARD CHARACTERS WITHOUT CLAIM TO ANY PARTICULAR FONT, STYLE, SIZE, OR COLOR.

OWNER OF U.S. REG. NOS. 2,660,529 AND 2,664,322.

CLASS 9—ELECTRICAL AND SCIENTIFIC APPARATUS

FOR ELECTRONIC DEVICES AND EQUIPMENT, NAMELY, REMOTE CONTROLS AND ELECTRONIC INTEGRATED CONTROL SYSTEMS COMPRISING WIRED AND WIRELESS CONTROLLERS AND TRANSCIVERS RELATING TO THE INTEGRATION AND CONTROL OF AUDIO AND VIDEO ENTERTAINMENT SYSTEMS, HIGH-DEFINITION TELEVISIONS AND DISPLAYS, HOME THEATER SYSTEMS, FIRE ALARM SYSTEMS AND FIREPLACES, SAFETY PERIMETER AND INTERIOR BURGLAR DETECTION AND ALARM SYSTEMS, ACCESS CONTROL AND ALARM MONITORING SYSTEMS, PERSONAL SECURITY MONITORING AND DISPLAYS, COMPUTER NETWORKING HARDWARE, DATA PROCESSORS, TELEPHONY APPARATUS, COMMUNICATIONS SYSTEMS, INTERCOM SYSTEMS, RESIDENTIAL AND COMMERCIAL LIGHTING, MOTORIZATION UNITS, HVAC SYSTEMS, CLIMATE CONTROL UNITS, ACOUSTICAL TREATMENT AND SOUND ISOLATION SYSTEMS (U.S. CLS. 21, 23, 26, 36 AND 38).

FIRST USE 5-10-2001; IN COMMERCE 8-1-2001.

THEATER SYSTEMS, FIRE ALARM SYSTEMS AND FIREPLACES, SAFETY PERIMETER AND INTERIOR BURGLAR DETECTION AND ALARM SYSTEMS, ACCESS CONTROL AND ALARM MONITORING SYSTEMS, PERSONAL SECURITY MONITORING AND DISPLAYS, COMPUTER NETWORKING HARDWARE, DATA PROCESSORS, TELEPHONY APPARATUS, COMMUNICATIONS SYSTEMS, INTERCOM SYSTEMS, RESIDENTIAL AND COMMERCIAL LIGHTING, MOTORIZATION UNITS, HVAC SYSTEMS, CLIMATE CONTROL UNITS, ACOUSTICAL TREATMENT AND SOUND ISOLATION SYSTEMS (U.S. CLS. 100 AND 101).
FIRST USE 5-10-2001; IN COMMERCE 8-1-2001.
WILLIAM VERHOSEK, EXAMINING ATTORNEY

SN 78-908,921. STERLING TEK, INC., LAS CRUCES, NM.
FILED 6-15-2006.

CLASS 37—CONSTRUCTION AND REPAIR

FOR INSTALLATION AND REPAIR SERVICES FOR ELECTRONIC DEVICES AND EQUIPMENT, REMOTE CONTROLS, AND ELECTRONIC INTEGRATED CONTROL SYSTEMS RELATING TO AUDIO AND VIDEO ENTERTAINMENT SYSTEMS, HIGH-DEFINITION TELEVISIONS AND DISPLAYS, HOME THEATER SYSTEMS, FIRE ALARM SYSTEMS AND FIREPLACES, SAFETY PERIMETER AND INTERIOR BURGLAR DETECTION AND ALARM SYSTEMS, ACCESS CONTROL AND ALARM MONITORING SYSTEMS, PERSONAL SECURITY MONITORING AND DISPLAYS, COMPUTER NETWORKING HARDWARE, DATA PROCESSORS, TELEPHONY APPARATUS, COMMUNICATIONS SYSTEMS, INTERCOM SYSTEMS, RESIDENTIAL AND COMMERCIAL LIGHTING, MOTORIZATION UNITS, HVAC SYSTEMS, CLIMATE CONTROL UNITS, ACOUSTICAL TREATMENT AND SOUND ISOLATION SYSTEMS (U.S. CLS. 100, 103 AND 106).

FIRST USE 5-10-2001; IN COMMERCE 8-1-2001.

THE MARK CONSISTS OF STANDARD CHARACTERS WITHOUT CLAIM TO ANY PARTICULAR FONT, STYLE, SIZE, OR COLOR.

CLASS 7—MACHINERY

FOR AIR NAILERS, AIR DRILLS, POWER DRILLS, POWER NAILERS, POWER SAWS, POWER SCREWDRIVERS (U.S. CLS. 13, 19, 21, 23, 31, 34 AND 35).

CLASS 9—ELECTRICAL AND SCIENTIFIC APPARATUS

FOR DIGITAL CAMERA BATTERIES, RECHARGEABLE NIMH BATTERIES, RECHARGEABLE LI-ION BATTERIES, MOTORCYCLE HELMETS, RECHARGEABLE BATTERIES FOR ELECTRONIC DEVICES, BAGS FOR PHOTOGRAPHIC EQUIPMENT, TRIPODS FOR CAMERAS, CELL PHONE COVERS, BATTERY CHARGERS, PHONE BATTERIES (U.S. CLS. 21, 23, 26, 36 AND 38).

JOHN WILKE, EXAMINING ATTORNEY

CLASS 42—SCIENTIFIC, COMPUTER AND LEGAL SERVICES

FOR DESIGN, LAYOUT AND SCHEMATICS DEVELOPMENT FOR INSTALLATION, TECHNICAL PROJECT MANAGEMENT AND PROGRAMMING, AND CONSULTING THERETO FOR ELECTRONIC DEVICES AND EQUIPMENT, REMOTE CONTROLS, AND ELECTRONIC INTEGRATED CONTROL SYSTEMS RELATING TO AUDIO AND VIDEO ENTERTAINMENT SYSTEMS, HIGH-DEFINITION TELEVISIONS AND DISPLAYS, HOME THEATER SYSTEMS, FIRE ALARM SYSTEMS AND FIREPLACES, SAFETY PERIMETER AND INTERIOR BURGLAR DETECTION AND ALARM SYSTEMS, ACCESS CONTROL AND ALARM MONITORING SYSTEMS, PERSONAL SECURITY MONITORING AND DISPLAYS, COMPUTER NETWORKING HARDWARE, DATA PROCESSORS, TELEPHONY APPARATUS, COMMUNICATIONS SYSTEMS, INTERCOM SYSTEMS, RESIDENTIAL AND COMMERCIAL LIGHTING, MOTORIZATION UNITS, HVAC SYSTEMS, CLIMATE CONTROL UNITS, ACOUSTICAL TREATMENT AND SOUND ISOLATION SYSTEMS; CALIBRATION OF ELECTRONIC DEVICES AND EQUIPMENT, NAMELY, REMOTE CONTROLS, AND ELECTRONIC INTEGRATED CONTROL SYSTEMS RELATING TO AUDIO AND VIDEO ENTERTAINMENT SYSTEMS, HIGH-DEFINITION TELEVISIONS AND DISPLAYS, HOME

SN 78-909,164. ADVANCE MERCHANDISING COMPANY, INC., ROANOKE, VA. FILED 6-15-2006.

The logo for 'STRIKE FORCE' features the word 'STRIKE' in a bold, italicized, sans-serif font above the word 'FORCE'. The letter 'O' in 'FORCE' is replaced by a stylized graphic of a bullet or a target symbol.

CLASS 6—METAL GOODS

FOR METAL CONTAINERS FOR COMPRESSED GAS OR LIQUID AIR (U.S. CLS. 2, 12, 13, 14, 23, 25 AND 50).

CLASS 7—MACHINERY

FOR AIR COMPRESSORS, AIR-OPERATED POWER TOOLS, NAMELY IMPACT WRENCHES AND SPRAY GUNS AND PART AND ACCESSORIES, THEREFOR, PRIMARILY CONSISTING OF SPANNER WRENCHES, HEX WRENCHES, DIE GRINDERS, RATCHETS, CHISELS, SPRINGS, COLLETS, SOCKETS, CONNECTORS, NEEDLES, BITS AND GRINDING STONES (U.S. CLS. 13, 19, 21, 23, 31, 34 AND 35).

CLASS 9—ELECTRICAL AND SCIENTIFIC APPARATUS

FOR AIR TANK REGULATORS (U.S. CLS. 21, 23, 26, 36 AND 38).

CLASS 17—RUBBER GOODS

FOR AIR HOSES (U.S. CLS. 1, 5, 12, 13, 35 AND 50).
KAREN SEVERSON, EXAMINING ATTORNEY

SN 78-911,126. W. T. LYNCH FOODS LIMITED, TORONTO, ONTARIO, CANADA, FILED 6-19-2006.

HEALTH STYLE

THE MARK CONSISTS OF STANDARD CHARACTERS WITHOUT CLAIM TO ANY PARTICULAR FONT, STYLE, SIZE, OR COLOR.

PRIORITY CLAIMED UNDER SEC. 44(D) ON CANADA APPLICATION NO. 1283877, FILED 12-20-2005, REG. NO. TMA689790, DATED 6-14-2007, EXPIRES 6-14-2022.

CLASS 29—MEATS AND PROCESSED FOODS

FOR JAMS; JELLY POWDERS; SOUP MIXES; FRUIT SPREADS; FRUIT-BASED PIE FILLINGS (U.S. CL. 46).

CLASS 30—STAPLE FOODS

FOR SALAD DRESSINGS; TABLE PANCAKE SYRUPS; SUNDAE DESSERT TOPPINGS, NAMELY, CHOCOLATE SYRUP AND CARAMEL TOPPING SYRUP; DESSERT POWDERS, NAMELY, INSTANT PUDDING MIXES AND DESSERT MOUSSE POWDERS; HOT CHOCOLATE MIX POWDERS AND LIQUIDS; GRAVY MIXES; DRINK CRYSTALS, NAMELY, ICED TEA CRYSTALS AND LIQUID ICED TEA CONCENTRATE (U.S. CL. 46).

SN 78-910,364. SALESFORCE.COM, INC., SAN FRANCISCO, CA. FILED 6-16-2006.

PARTNERFORCE

THE MARK CONSISTS OF STANDARD CHARACTERS WITHOUT CLAIM TO ANY PARTICULAR FONT, STYLE, SIZE, OR COLOR.

CLASS 35—ADVERTISING AND BUSINESS

FOR MANAGEMENT SERVICES FOR BUSINESS AND BUSINESS PARTNERS, NAMELY, PROVIDING CUSTOMER, CLIENT AND BUSINESS PARTNER RELATIONSHIP AND SALES SUPPORT MANAGEMENT SERVICES; MANAGEMENT CONSULTING SERVICES RELATING TO CUSTOMER, CLIENT AND BUSINESS PARTNER RELATIONSHIP AND SALES SUPPORT MANAGEMENT, AND MARKETING AUTOMATION; PROVIDING A WEBSITE WITH GENERAL INFORMATION OF INTEREST TO THE FIELDS OF ADVERTISING, MARKETING, BUSINESS SERVICES AND BUSINESS PARTNER MANAGEMENT SERVICES (U.S. CLS. 100, 101 AND 102).

CLASS 42—SCIENTIFIC, COMPUTER AND LEGAL SERVICES

FOR APPLICATION SERVICE PROVIDER (ASP) FEATURING COMPUTER SOFTWARE APPLICATION DEVELOPMENT TOOLS; PROVIDING TEMPORARY USE OF ON-LINE NON-DOWNLOADABLE SOFTWARE TO STORE, MANAGE, TRACK, ANALYZE AND REPORT DATA IN THE FIELD OF MARKETING, PROMOTION, SALES, CUSTOMER AND CLIENT RELATIONSHIP AND SUPPORT MANAGEMENT, AND EMPLOYEE EFFICIENCY; PROVIDING TEMPORARY USE OF ON-LINE NON-DOWNLOADABLE SOFTWARE TO FACILITATE COMMUNICATING AMONG PEER PROFESSIONALS IN THE ADVERTISING, MARKETING, BUSINESS SERVICES, AND BUSINESS PARTNER MANAGEMENT SERVICES FIELDS (U.S. CLS. 100 AND 101).
GEORGIA CARTY, EXAMINING ATTORNEY

CLASS 32—LIGHT BEVERAGES

FOR SYRUPS FOR MAKING NON-ALCOHOLIC FRUIT DRINKS (U.S. CLS. 45, 46 AND 48).
JACLYN KIDWELL, EXAMINING ATTORNEY

SN 78-911,172. SOAVE ENTEPRISES L.L.C., DETROIT, MI. FILED 6-19-2006.

FERROUS

THE MARK CONSISTS OF STANDARD CHARACTERS WITHOUT CLAIM TO ANY PARTICULAR FONT, STYLE, SIZE, OR COLOR.

SEC. 2(F).

CLASS 35—ADVERTISING AND BUSINESS

FOR SCRAP METAL PRICE QUOTATIONS; BUSINESS MANAGEMENT AND BUSINESS MANAGEMENT CONSULTING SERVICES, NAMELY, MANAGEMENT OF SCRAP METAL PROGRAMS FOR OTHERS (U.S. CLS. 100, 101 AND 102).
FIRST USE 12-31-1986; IN COMMERCE 12-31-1986.

CLASS 36—INSURANCE AND FINANCIAL

FOR BROKERAGE OF SCRAP METAL (U.S. CLS. 100, 101 AND 102).
FIRST USE 12-31-1986; IN COMMERCE 12-31-1986.

CLASS 39—TRANSPORTATION AND STORAGE

FOR TRANSPORTATION OF SCRAP METAL BY WATER, RAIL OR TRUCK; STORAGE OF SCRAP METAL FOR OTHERS (U.S. CLS. 100 AND 105).

FIRST USE 12-31-1986; IN COMMERCE 12-31-1986.

CLASS 40—MATERIAL TREATMENT

FOR RECYCLING OF SCRAP METAL; RENTAL OF EQUIPMENT FOR RECYCLING SCRAP METAL (U.S. CLS. 100, 103 AND 106).

FIRST USE 12-31-1996; IN COMMERCE 12-31-1996.

SOPHIA S. KIM, EXAMINING ATTORNEY

SN 78-913,908. NOVA, VICTOR. H., SANTA ANA, CA. AND FLORES, EDUARDO, SANTA ANA, CA. AND URRUTIA, LUIS, SANTA ANA, CA. AND URRUTIA, AGUSTIN, SANTA ANA, CA. AND URRUTIA, FLAVIO, SANTA ANA, CA. AND URRUTIA, HECTOR, SANTA ANA, CA. FILED 6-21-2006.



THE COLOR(S) BROWN, YELLOW, AND WHITE IS/ARE CLAIMED AS A FEATURE OF THE MARK.

THE MARK CONSISTS OF THE WORDING "GRUPO AMENAZA" WHICH IS IN THE COLORS BROWN, YELLOW, AND WHITE, RAISED ABOVE BROWN "SHADOWS".

THE FOREIGN WORDING IN THE MARK TRANSLATES INTO ENGLISH AS GROUP THREAT.

SN 78-911,318. JASPER, JOHN P., NIAN TIC, CT. FILED 6-19-2006.

ISOTOPIC PEDIGREE

THE MARK CONSISTS OF STANDARD CHARACTERS WITHOUT CLAIM TO ANY PARTICULAR FONT, STYLE, SIZE, OR COLOR.

NO CLAIM IS MADE TO THE EXCLUSIVE RIGHT TO USE "ISOTOPIC", APART FROM THE MARK AS SHOWN.

CLASS 9—ELECTRICAL AND SCIENTIFIC APPARATUS

FOR APPARATUS FOR MEASURING, SIGNALING, RECORDING, PROCESSING, TRANSMITTING, REPRODUCING AND/OR OR DISPLAYING ISOTOPIC INFORMATION REGARDING A CHEMICAL PRODUCT, A SYNTHESIS PROCESS AND/OR STARTING MATERIALS AND INTERMEDIATES OF THE SYNTHESIS PROCESS BY WHICH IT IS MADE, NAMELY, ISOTOPE-RATIO MASS SPECTROMETERS, ELEMENTAL-ANALYZERS, CHROMATOGRAPHY MASS SPECTROMETERS (IRMGCMS), ISOTOPE-RATIO-MONITORING LIQUID CHROMATOGRAPHY MASS SPECTROMETERS (IRMLCMS), ACCELERATOR MASS SPECTROMETERS (AMS) AND BETA-DECAY COUNTING DEVICES, AND COMPUTERIZED DATA SYSTEMS COMPRISING COMPUTERS AND VIDEO DISPLAY MONITORS (U.S. CLS. 21, 23, 26, 36 AND 38).

CLASS 42—SCIENTIFIC, COMPUTER AND LEGAL SERVICES

FOR SCIENTIFIC AND TECHNOLOGICAL RESEARCH AND DESIGN SERVICES IN THE FIELD OF ISOTOPIC ANALYSIS OF CHEMICAL PRODUCTS, THE MANUFACTURING PROCESSES AND/OR THE STARTING MATERIALS AND INTERMEDIATES OF THE MANUFACTURING PROCESSES; INDUSTRIAL ANALYSIS AND RESEARCH SERVICES IN THE FIELD OF ISOTOPIC ANALYSIS OF CHEMICAL PRODUCTS, THE MANUFACTURING PROCESSES AND/OR STARTING MATERIALS AND INTERMEDIATES OF THE MANUFACTURING PROCESSES (U.S. CLS. 100 AND 101).

KAREN BRACEY, EXAMINING ATTORNEY

CLASS 9—ELECTRICAL AND SCIENTIFIC APPARATUS

FOR PRE-RECORDED CDS FEATURING REGIONAL MUSIC (U.S. CLS. 21, 23, 26, 36 AND 38).

FIRST USE 6-21-2006; IN COMMERCE 6-21-2006.

CLASS 41—EDUCATION AND ENTERTAINMENT

FOR ENTERTAINMENT, NAMELY LIVE PERFORMANCES BY A MUSICAL GROUP FEATURING REGIONAL MUSIC (U.S. CLS. 100, 101 AND 107).

FIRST USE 6-21-2006; IN COMMERCE 6-21-2006.

DAWN HAN, EXAMINING ATTORNEY

SN 78-914,479. DERIC WHATLEY, TUSCALOOSA, AL. FILED 6-22-2006.

FIRETREE RECORDS

THE MARK CONSISTS OF STANDARD CHARACTERS WITHOUT CLAIM TO ANY PARTICULAR FONT, STYLE, SIZE, OR COLOR.

NO CLAIM IS MADE TO THE EXCLUSIVE RIGHT TO USE "RECORDS", APART FROM THE MARK AS SHOWN.

CLASS 9—ELECTRICAL AND SCIENTIFIC APPARATUS

FOR MUSICAL SOUND RECORDINGS AND AUDIO-VISUAL RECORDINGS, NAMELY: COMPACT DISCS, AUDIO DISCS, RECORDS, CD-ROMS, VIDEO TAPES, VIDEO CASSETTES, VIDEO DISCS, DVDS, DATS, AND LASER DISCS, ALL FEATURING MUSIC; DOWNLOADABLE MUSICAL SOUND RECORDINGS; DOWNLOADABLE VIDEO RECORDINGS FEATURING MUSIC; DOWNLOADABLE ELECTRONIC PUBLICATIONS IN THE NATURE OF BOOKS, ALL IN THE FIELD OF MUSIC RECORDED ON CD-ROMS; COMPACT DISC CASES; FITTED CASES FOR STORAGE AND TRANSPORTATION, NAMELY, CASES FOR COMPACT DISCS, AUDIO CASSETTES, VIDEO CASSETTES, CD-ROMS (U.S. CLS. 21, 23, 26, 36 AND 38).

CLASS 41—EDUCATION AND ENTERTAINMENT

FOR ENTERTAINMENT SERVICES, NAMELY: AUDIO RECORDING AND PRODUCTION; MUSIC PRODUCTION SERVICES; RECORD PRODUCTION; VIDEO-TAPE PRODUCTION; SOUND RECORDING STUDIOS; PROVIDING A WEBSITE OVER A GLOBAL COMPUTER NETWORK FEATURING MUSICAL PERFORMANCES, MUSICAL VIDEOS, RELATED FILM CLIPS, PHOTOGRAPHS, AND OTHER MULTIMEDIA MATERIAL, AND COMMENTARY AND ARTICLES ABOUT MUSIC; PROVIDING INFORMATION, AND PROVIDING INFORMATION OVER A GLOBAL COMPUTER NETWORK, IN THE FIELD OF MUSIC AND MUSICAL ARTISTS, SOUND RECORDINGS, AND POPULAR CULTURE AND EVENTS; PRODUCTION AND DISTRIBUTION OF ON-LINE MUSICAL ENTERTAINMENT PROGRAMS FEATURING SOUND AND VIDEO RECORDINGS (U.S. CLS. 100, 101 AND 107).
STEVEN R. FINE, EXAMINING ATTORNEY

SN 78-914,836. CHECKERBOARD, LTD., WEST BOYLSTON, MA. FILED 6-22-2006.



CHECKERBOARD

CLASS 16—PAPER GOODS AND PRINTED MATTER

FOR PRINTED INVITATIONS; STATIONERY; PRINTED WEDDING, HOLIDAY, BIRTH, BAR OR BAT MITZVAH ANNOUNCEMENT CARDS; PRINTED PARTY INVITATIONS; AND PHOTOGRAPH ALBUMS (U.S. CLS. 2, 5, 22, 23, 29, 37, 38 AND 50).
FIRST USE 12-1-1995; IN COMMERCE 12-1-1995.

CLASS 40—MATERIAL TREATMENT

FOR DESIGN PRINTING FOR OTHERS IN THE FIELD OF STATIONERY AND INVITATION PRINTING, AND CUSTOMIZED AND PERSONALIZED PRINTED MATERIALS PRINTING (U.S. CLS. 100, 103 AND 106).
FIRST USE 12-1-1995; IN COMMERCE 12-1-1995.
VERNA BETH RIRIE, EXAMINING ATTORNEY

SN 78-915,267. MASSACHUSETTS AUDIO VISUAL EQUIPMENT CORPORATION, BURLINGTON, MA. FILED 6-23-2006.

MASS AV

THE MARK CONSISTS OF STANDARD CHARACTERS WITHOUT CLAIM TO ANY PARTICULAR FONT, STYLE, SIZE, OR COLOR.

CLASS 35—ADVERTISING AND BUSINESS

FOR PREPARING AUDIO VISUAL DISPLAYS FOR MEETINGS, CONFERENCES AND TRADE SHOW EXHIBITS FOR CORPORATE, EDUCATIONAL, NON-PROFIT, SPORTS ENTERTAINMENT, AND CONSUMER PRODUCTS AND SERVICES INDUSTRIES; PROVIDING TECHNICIANS, OPERATORS AND SUPPORT PERSONNEL ON A TEMPORARY BASIS, FOR AUDIO VISUAL PRESENTATIONS AND PRODUCTION, TELECOMMUNICATIONS AND MEETING OR TRADE SHOW PRESENTATIONS; TECHNICAL CONSULTING SERVICES IN THE FIELD OF MEETING, CONFERENCE OR TRADE SHOW PRESENTATIONS; TECHNICAL CONSULTING SERVICES IN THE FIELD OF AUDIO VISUAL PRESENTATIONS FOR COMMERCIAL PURPOSES (U.S. CLS. 100, 101 AND 102).
FIRST USE 12-31-1988; IN COMMERCE 12-31-1988.

CLASS 38—COMMUNICATION

FOR RENTAL OF TELECOMMUNICATIONS EQUIPMENT (U.S. CLS. 100, 101 AND 104).
FIRST USE 12-31-1988; IN COMMERCE 12-31-1988.

CLASS 41—EDUCATION AND ENTERTAINMENT

FOR RENTAL OF AUDIO VISUAL AND MEETING AND EXHIBIT PRESENTATION EQUIPMENT; AUDIO AND VIDEO RECORDING AND PRODUCTION SERVICES; STAGING SERVICES NAMELY, PROVIDING AUDIO, VIDEO AND LIGHTING PRODUCTION, CONFIGURATION, RIGGING, AND PROJECTION SERVICES FOR LIVE EVENTS (U.S. CLS. 100, 101 AND 107).
FIRST USE 12-31-1998; IN COMMERCE 12-31-1998.
YAT SYE, LEE, EXAMINING ATTORNEY

SN 78-917,602. BANDAG, INCORPORATED, MUSCATINE, IA. FILED 6-27-2006.

NO DETOURS

THE MARK CONSISTS OF STANDARD CHARACTERS WITHOUT CLAIM TO ANY PARTICULAR FONT, STYLE, SIZE, OR COLOR.

CLASS 12—VEHICLES

FOR TIRE TREAD FOR RETREAD TIRES (U.S. CLS. 19, 21, 23, 31, 35 AND 44).
FIRST USE 2-1-2003; IN COMMERCE 2-1-2003.

CLASS 37—CONSTRUCTION AND REPAIR

FOR TIRE RETREADING AND TIRE REPAIR SERVICES (U.S. CLS. 100, 103 AND 106).
FIRST USE 2-1-2003; IN COMMERCE 2-1-2003.

CLASS 42—SCIENTIFIC, COMPUTER AND LEGAL SERVICES

FOR INSPECTION OF TIRES AND TRAILERS (U.S. CLS. 100 AND 101).
FIRST USE 2-1-2003; IN COMMERCE 2-1-2003.
NICHOLAS ALTREE, EXAMINING ATTORNEY

SN 78-917,737. BUCHMAN, DAMIAN, BROOKFIELD, WI. FILED 6-27-2006.

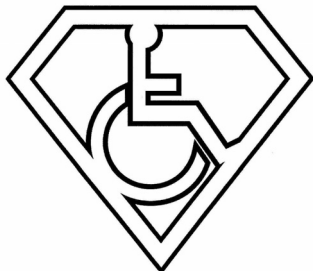

Super Gimp

CLASS 16—PAPER GOODS AND PRINTED MATTER

FOR PAPER GOODS FOR THE PURPOSE OF INSPIRING ATHLETES, NAMELY, BUMPER STICKERS, POSTERS, BUSINESS CARDS, FOLDERS, STATIONERY, LETTERHEAD, BOUND NOTEBOOKS, BOUND NOTEPADS, WINDOW DECALS, AND WHEELCHAIR DECALS (U.S. CLS. 2, 5, 22, 23, 29, 37, 38 AND 50).

CLASS 25—CLOTHING

FOR CLOTHING APPAREL FOR THE PURPOSE OF INSPIRING ATHLETES, NAMELY, SWEATSHIRTS, HOODED SWEATSHIRTS, WINTER HATS, CAPS, BASEBALL STYLE CAPS, T-SHIRTS, LONG SLEEVE T-SHIRTS, TANK TOPS, HEADBANDS, SWEATBANDS, ARM BANDS, WRIST BANDS, SOCKS, UNDERWEAR, SHOES, SANDALS, SWEATPANTS, ATHLETIC UNIFORMS, JERSEYS, JACKETS, GLOVES, SHORTS, AND TRUNKS (U.S. CLS. 22 AND 39).

DAVID TOOLEY, EXAMINING ATTORNEY

SN 78-918,151. DALAL, RONAK R., HOUSTON, TX. AND BROWNELL, MISHAEL D. III, HOUSTON, TX. FILED 6-27-2006.

G2G Entertainment

THE MARK CONSISTS OF STANDARD CHARACTERS WITHOUT CLAIM TO ANY PARTICULAR FONT, STYLE, SIZE, OR COLOR.

NO CLAIM IS MADE TO THE EXCLUSIVE RIGHT TO USE "ENTERTAINMENT", APART FROM THE MARK AS SHOWN.

CLASS 9—ELECTRICAL AND SCIENTIFIC APPARATUS

FOR MUSICAL SOUND RECORDINGS, NAMELY, COMPACT DISCS, AUDIO TAPES AND PRE-RECORDED VIDEOS FEATURING MUSIC AND ENTERTAINMENT (U.S. CLS. 21, 23, 26, 36 AND 38).

CLASS 41—EDUCATION AND ENTERTAINMENT

FOR MUSIC ENTERTAINMENT SERVICES, NAMELY, AUDIO RECORDING AND PRODUCTION; MUSIC PRODUCTION SERVICES; RECORD PRODUCTION; SOUND RECORDING STUDIOS; PRODUCTION OF PRE-RECORDED MUSICAL AND SOUND RECORDINGS (U.S. CLS. 100, 101 AND 107).

SUSAN LESLIE DUBOIS, EXAMINING ATTORNEY

SN 78-918,710. PIERCE, MICHAEL, CANTON, MA. FILED 6-28-2006.

MY LITTLE PINK BOOK

THE MARK CONSISTS OF STANDARD CHARACTERS WITHOUT CLAIM TO ANY PARTICULAR FONT, STYLE, SIZE, OR COLOR.

CLASS 16—PAPER GOODS AND PRINTED MATTER

FOR ADDRESS BOOKS, APPOINTMENT BOOKS, BOOKMARKS, CALENDARS, DAILY PLANNERS, DESK SETS, DIARIES, FABRIC AND PAPER GIFT BAGS, FOLDERS, GIFT CARDS GIFT WRAPPING PAPER, LETTERHEAD, POSTCARDS, POSTERS, SCORE-CARDS, SCORE-BOOKS, SCORE PADS AND SCORE SHEETS TO BE USED WITH GAMES, SCRAP BOOKS, SKETCH BOOKS, SPIRAL AND WIRE BOUND NOTEBOOKS, STAMP PAD INKS, STAMP PADS, STATIONERY BOXES, STICKERS, TRADING CARDS, WRITING JOURNALS, WRITING PAPER AND ENVELOPES AND WRITING UTENSILS (U.S. CLS. 2, 5, 22, 23, 29, 37, 38 AND 50).

CLASS 25—CLOTHING

FOR CLOTHING, NAMELY, SHORTS, PANTS, SWEATPANTS, SWEATSHIRTS, SHIRTS, BASEBALL CAPS, SLIPPERS, BATHING SUITS, BATHROBES, FOOTWEAR, BEACHWEAR, BIKINIS, BLOUSES, LINGERIE, CARDIGANS, CLOGS, DRESSES, TOPS, EAR WARMERS, FABRIC BELTS, PULLOVERS, GLOVES, HATS, HEADBANDS, HEADWEAR, SHIRTS WITH HOODS, JACKETS, JEANS, JOGGING OUTFITS, LEOTARDS, NIGHTSHIRTS, PAJAMAS, RAINWEAR, SCARVES, SKIRTS, SOCKS, SWEATERS, TANK TOPS, TIGHTS, T-SHIRTS, UNDERWEAR, VESTS, AND VISCORS (U.S. CLS. 22 AND 39).

CLASS 28—TOYS AND SPORTING GOODS

FOR BOARD GAMES, JIGSAW PUZZLES AND PLAYING CARDS (U.S. CLS. 22, 23, 38 AND 50).

RONALD AIKENS, EXAMINING ATTORNEY

SN 78-919,828. APHELION, LLC, WARWICK, RI. FILED 6-29-2006.

APHELION

THE MARK CONSISTS OF STANDARD CHARACTERS WITHOUT CLAIM TO ANY PARTICULAR FONT, STYLE, SIZE, OR COLOR.

CLASS 16—PAPER GOODS AND PRINTED MATTER

FOR PRINTED WORKBOOKS AND ADVISOR'S GUIDES ON THE USE AND INTERPRETATION OF QUESTIONNAIRE BASED ASSESSMENT ON THE EVALUATION, TRANSITION AND DECISION MAKING FOR NEXT PHASE OF LIFE AND PRE AND POST RETIREMENT (U.S. CLS. 2, 5, 22, 23, 29, 37, 38 AND 50).

CLASS 35—ADVERTISING AND BUSINESS

FOR PROVIDING MARKETING INFORMATION AND REPORTS ON DEMOGRAPHIC TRENDS AND LIFESTYLES FOR NEXT PHASE OF LIFE, RETIREES AND PRE-RETIREES (U.S. CLS. 100, 101 AND 102).

CLASS 41—EDUCATION AND ENTERTAINMENT

FOR EDUCATIONAL SERVICES NAMELY CONDUCTING TRAINING AND WORKSHOPS FOR RETIREES AND PRE-RETIREES TO ASSIST IN SELF-EVALUATION, ASSESSMENT, AND DECISION MAKING FOR NON-FINANCIAL ASPECTS OF NEXT PHASE OF LIFE AND PRE AND POST RETIREMENT PLANNING; EDUCATIONAL SERVICES, NAMELY, CONDUCTING TRAINING AND WORKSHOPS ON THE USE AND INTERPRETATION OF QUESTIONNAIRE BASED ASSESSMENT ON THE EVALUATION, TRANSITION AND DECISION MAKING FOR NEXT PHASE OF LIFE AND PRE AND POST RETIREMENT (U.S. CLS. 100, 101 AND 107).

CLASS 45—PERSONAL SERVICES

FOR PERSONAL COUNSELING SERVICES, NAMELY ASSISTING OTHERS IN DECIDING PERSONAL ISSUES THAT ARISE IN THE TRANSITION TO NEXT PHASE OF LIFE OR FROM WORK TO RETIREMENT, SUCH AS, RESIDENTIAL LOCATION, HOBBIES, ALTERNATIVE WORK, LIFESTYLE AND QUALITY OF LIFE AND ADMINISTERING AND EVALUATION AND ASSESSMENT OF A QUESTIONNAIRE IN RELATION THERE-TO (U.S. CLS. 100 AND 101).

DAWN FELDMAN, EXAMINING ATTORNEY

SN 78-919,833. APHELION, LLC, WARWICK, RI. FILED 6-29-2006.

NEXT DANCE

THE MARK CONSISTS OF STANDARD CHARACTERS WITHOUT CLAIM TO ANY PARTICULAR FONT, STYLE, SIZE, OR COLOR.

CLASS 16—PAPER GOODS AND PRINTED MATTER

FOR PRINTED WORKBOOKS AND ADVISOR'S GUIDES ON THE USE AND INTERPRETATION OF QUESTIONNAIRE BASED ASSESSMENT ON THE EVALUATION, TRANSITION AND DECISION MAKING FOR NEXT PHASE OF LIFE AND PRE AND POST RETIREMENT (U.S. CLS. 2, 5, 22, 23, 29, 37, 38 AND 50).

CLASS 35—ADVERTISING AND BUSINESS

FOR PROVIDING MARKETING INFORMATION AND REPORTS ON DEMOGRAPHIC TRENDS AND LIFESTYLES FOR NEXT PHASE OF LIFE, RETIREES AND PRE-RETIREES (U.S. CLS. 100, 101 AND 102).

CLASS 41—EDUCATION AND ENTERTAINMENT

FOR EDUCATIONAL SERVICES NAMELY CONDUCTING TRAINING AND WORKSHOPS FOR RETIREES AND PRE-RETIREES TO ASSIST IN SELF-EVALUATION, ASSESSMENT, AND DECISION MAKING FOR NON-FINANCIAL ASPECTS OF NEXT PHASE OF LIFE AND PRE AND POST RETIREMENT PLANNING; EDUCATIONAL SERVICES, NAMELY, CONDUCTING TRAINING AND WORKSHOPS ON THE USE AND INTERPRETATION OF QUESTIONNAIRE BASED ASSESSMENT ON THE EVALUATION, TRANSITION AND DECISION MAKING FOR NEXT PHASE OF LIFE AND PRE AND POST RETIREMENT; NEXT PHASE OF LIFE AND PRE AND POST RETIREMENT COACHING SERVICES (U.S. CLS. 100, 101 AND 107).

CLASS 45—PERSONAL SERVICES

FOR PERSONAL COUNSELING SERVICES, NAMELY ASSISTING OTHERS IN DECIDING PERSONAL ISSUES THAT ARISE IN THE TRANSITION TO NEXT PHASE OF LIFE OR FROM WORK TO RETIREMENT, SUCH AS, RESIDENTIAL LOCATION, HOBBIES, ALTERNATIVE WORK, LIFESTYLE AND QUALITY OF LIFE AND ADMINISTERING AND EVALUATION AND ASSESSMENT OF A QUESTIONNAIRE IN RELATION THERE-TO (U.S. CLS. 100 AND 101).

DAWN FELDMAN, EXAMINING ATTORNEY

SN 78-922,344. GALDERMA S.A., CH - 1000 LAUSANNE 30, SWITZERLAND, FILED 7-5-2006.

CETAPHIL DAILYADVANCE ULTRA HYDRATING LOTION

THE MARK CONSISTS OF STANDARD CHARACTERS WITHOUT CLAIM TO ANY PARTICULAR FONT, STYLE, SIZE, OR COLOR.

NO CLAIM IS MADE TO THE EXCLUSIVE RIGHT TO USE "ULTRA HYDRATING LOTION", APART FROM THE MARK AS SHOWN.

CLASS 3—COSMETICS AND CLEANING PREPARATIONS

FOR COSMETICS AND SKIN CARE PREPARATIONS, NAMELY, FACE, HAND AND BODY SOAPS, CLEANSERS AND MOISTURIZERS; HAIR SHAMPOOS AND CONDITIONERS (U.S. CLS. 1, 4, 6, 50, 51 AND 52).

CLASS 5—PHARMACEUTICALS

FOR PHARMACEUTICAL PREPARATIONS FOR USE IN THE TREATMENT OF DERMATOSIS AND FOR USE AS SKIN AND SCALP EMOLLIENTS; DERMATOLOGICAL PHARMACEUTICAL PREPARATIONS FOR USE IN THE MANUFACTURE OF ADDITIONAL MEDICAMENTS (U.S. CLS. 6, 18, 44, 46, 51 AND 52).

RICHARD WHITE, EXAMINING ATTORNEY

SN 78-923,166. CRISTA MINISTRIES, SEATTLE, WA. FILED 7-6-2006.

SPIRIT EDGE

THE MARK CONSISTS OF STANDARD CHARACTERS WITHOUT CLAIM TO ANY PARTICULAR FONT, STYLE, SIZE, OR COLOR.

OWNER OF U.S. REG. NO. 3,100,794.

CLASS 38—COMMUNICATION

FOR STREAMING OF AUDIO MATERIAL ON THE INTERNET; TRANSMITTING CHRISTIAN ORIENTED MUSIC OVER A GLOBAL COMPUTER NETWORK (U.S. CLS. 100, 101 AND 104).

FIRST USE 4-1-2006; IN COMMERCE 4-1-2006.

CLASS 41—EDUCATION AND ENTERTAINMENT

FOR ENTERTAINMENT SERVICES IN THE NATURE OF PROVIDING PRE-RECORDED CHRISTIAN MUSIC DELIVERED VIA A GLOBAL COMPUTER NETWORK; PROVIDING MUSIC PROGRAMS DELIVERED VIA A GLOBAL COMPUTER NETWORK (U.S. CLS. 100, 101 AND 107).

FIRST USE 4-1-2006; IN COMMERCE 4-1-2006.
MARK PILARO, EXAMINING ATTORNEY

SN 78-923,457. OMICRON ELECTRONICS GMBH, KLAUS, AUSTRIA, FILED 7-6-2006.

IEDSCOUT

THE MARK CONSISTS OF STANDARD CHARACTERS WITHOUT CLAIM TO ANY PARTICULAR FONT, STYLE, SIZE, OR COLOR.

PRIORITY CLAIMED UNDER SEC. 44(D) ON ERPNTY TM OFC APPLICATION NO. 005100821, FILED 5-10-2006, REG. NO. 005100821, DATED 6-7-2007, EXPIRES 5-10-2016.

CLASS 9—ELECTRICAL AND SCIENTIFIC APPARATUS

FOR MEASUREMENT, TESTING AND ANALYSIS SOFTWARE FOR TESTING, ANALYZING, MONITORING, DEVELOPING AND IMPLEMENTING ELECTRONIC DEVICES FOR POWER SUPPLY SYSTEMS; ELECTRONIC MEASUREMENT, TESTING AND ANALYSIS EQUIPMENT FOR TESTING, ANALYZING, MONITORING, DEVELOPING AND IMPLEMENTING ELECTRONIC DEVICES FOR POWER SUPPLY SYSTEMS (U.S. CLS. 21, 23, 26, 36 AND 38).

CLASS 37—CONSTRUCTION AND REPAIR

FOR REPAIR, INSTALLATION AND IMPLEMENTATION OF ELECTRONIC DEVICES FOR POWER SUPPLY SYSTEMS (U.S. CLS. 100, 103 AND 106).

CLASS 42—SCIENTIFIC, COMPUTER AND LEGAL SERVICES

FOR DESIGNING AND DEVELOPING ELECTRONIC MEASUREMENT, TESTING AND ANALYSIS EQUIPMENT USED FOR TESTING, ANALYZING, MONITORING, DEVELOPING AND IMPLEMENTING ELECTRONIC DEVICES FOR POWER SUPPLY SYSTEMS; DESIGNING AND DEVELOPING MEASUREMENT, TESTING AND ANALYSIS SOFTWARE FOR TESTING, ANALYZING, MONITORING, DEVELOPING AND IMPLEMENTING ELECTRONIC DEVICES FOR POWER SUPPLY SYSTEMS (U.S. CLS. 100 AND 101).

KELLY BOULTON, EXAMINING ATTORNEY

SN 78-924,530. NA-CHURS PLANT FOOD COMPANY, MARION, OH. FILED 7-7-2006.

NAS TECHNOLOGIES

THE MARK CONSISTS OF STANDARD CHARACTERS WITHOUT CLAIM TO ANY PARTICULAR FONT, STYLE, SIZE, OR COLOR.

NO CLAIM IS MADE TO THE EXCLUSIVE RIGHT TO USE "TECHNOLOGIES", APART FROM THE MARK AS SHOWN.

CLASS 35—ADVERTISING AND BUSINESS

FOR ADVERTISING AND PROMOTION SERVICES AND RELATED CONSULTING; ADVERTISING GOODS AND SERVICES OF OTHERS; MARKETING GOODS AND SERVICES OF OTHERS (U.S. CLS. 100, 101 AND 102).

CLASS 37—CONSTRUCTION AND REPAIR

FOR MAINTAINING AND REPAIRING FARMING AND AGRICULTURAL EQUIPMENT OF OTHERS (U.S. CLS. 100, 103 AND 106).

CLASS 42—SCIENTIFIC, COMPUTER AND LEGAL SERVICES

FOR TECHNICAL SUPPORT, NAMELY, TROUBLESHOOTING FARMING AND AGRICULTURAL EQUIPMENT FOR OTHERS, SOIL SAMPLING AND TESTING (U.S. CLS. 100 AND 101).

CLASS 44—MEDICAL, BEAUTY AND AGRICULTURAL SERVICES

FOR AGRICULTURAL AND AGRONOMY SERVICES FOR OTHERS, NAMELY, CROP AND LAND MEASUREMENT, CROP, LAND, WATER AND SOIL MAPPING, CROP MANAGEMENT, CROP NUTRIENT MANAGEMENT, AGRICULTURAL CHEMICAL MANAGEMENT AND CROP PLANNING; CONSULTING SERVICES IN THE FIELDS OF AGRICULTURE AND AGRONOMY (U.S. CLS. 100 AND 101).

ELLEN PERKINS, EXAMINING ATTORNEY

SN 78-925,153. CABELL PUBLISHING, INC., BEAUMONT, TX. FILED 7-8-2006.

Cabell's

THE MARK CONSISTS OF STANDARD CHARACTERS WITHOUT CLAIM TO ANY PARTICULAR FONT, STYLE, SIZE, OR COLOR.
SEC. 2(F).

CLASS 16—PAPER GOODS AND PRINTED MATTER

FOR BOOKS, JOURNALS, AND OTHER PUBLICATIONS, NAMELY, PAMPHLETS, BROCHURES, NEWSLETTERS, DIRECTORIES, SUBMISSION REQUIREMENTS, CATALOGUES, AND MAGAZINES, IN THE FIELD OF SCHOLASTIC, PROFESSIONAL, AND ACADEMIC RESEARCH (U.S. CLS. 2, 5, 22, 23, 29, 37, 38 AND 50).
FIRST USE 1-1-1978; IN COMMERCE 6-1-1978.

CLASS 35—ADVERTISING AND BUSINESS

FOR SERVICES FOR ACADEMIC INSTITUTIONS, TEACHERS, PROFESSORS AND GRADUATE STUDENTS, NAMELY, PROVIDING AN ON-LINE DIRECTORY OF WEBSITES AND ON-LINE DIRECTORY OF SCHOLARLY JOURNALS SUBMISSION REQUIREMENTS LINKING ACADEMIC INSTITUTIONS, PROFESSORS, TEACHERS AND GRADUATE STUDENTS WITH ACADEMIC RESEARCH AND PAPERS TO ACADEMIC JOURNALS SEEKING SCHOLARLY SUBMISSIONS FROM ACADEMIC INSTITUTIONS, PROFESSORS, TEACHERS AND GRADUATE STUDENTS (U.S. CLS. 100, 101 AND 102).
FIRST USE 1-1-1978; IN COMMERCE 1-1-1978.

CLASS 41—EDUCATION AND ENTERTAINMENT

FOR PROVIDING SPECIALIZED SERVICES, NAMELY, PROVIDING INFORMATION REGARDING SUBMISSION REQUIREMENTS FOR ACADEMIC PUBLICATIONS AND OTHER INSTITUTIONAL LITERATURE TO PROSPECTIVE SCHOLARS SEEKING TO SUBMIT SCHOLARLY WORK, VIA ELECTRONIC AND PRINT MEDIA (U.S. CLS. 100, 101 AND 107).
FIRST USE 1-1-1978; IN COMMERCE 6-1-1978.
JEFF DEFORD, EXAMINING ATTORNEY

SN 78-926,004. ANGIELAND, LLC, STURGIS, SD. FILED 7-10-2006.

ANGIELAND

THE MARK CONSISTS OF STANDARD CHARACTERS WITHOUT CLAIM TO ANY PARTICULAR FONT, STYLE, SIZE, OR COLOR.
SEC. 2(F).

CLASS 16—PAPER GOODS AND PRINTED MATTER

FOR POSTERS, CALENDARS AND SIGNATURE NOTE CARDS TO BE AUTOGRAPHED (U.S. CLS. 2, 5, 22, 23, 29, 37, 38 AND 50).
FIRST USE 8-0-2001; IN COMMERCE 8-0-2001.

CLASS 25—CLOTHING

FOR SHIRTS, SHORTS AND UNDERWEAR (U.S. CLS. 22 AND 39).
FIRST USE 8-0-2001; IN COMMERCE 8-0-2001.
CAROL SPILS, EXAMINING ATTORNEY

SN 78-926,095. CHRISTINE ALEXANDER, INC., FEDERAL WAY, WA. FILED 7-10-2006.

CHRISTINE ALEXANDER

THE MARK CONSISTS OF STANDARD CHARACTERS WITHOUT CLAIM TO ANY PARTICULAR FONT, STYLE, SIZE, OR COLOR.
OWNER OF U.S. REG. NO. 3,005,033.
"THE NAME(S), PORTRAIT(S), AND/OR SIGNATURE(S) SHOWN IN THE MARK DOES NOT IDENTIFY A PARTICULAR LIVING INDIVIDUAL."

CLASS 14—JEWELRY

FOR COSTUME JEWELRY (U.S. CLS. 2, 27, 28 AND 50).

CLASS 18—LEATHER GOODS

FOR PURSES AND HANDBAGS (U.S. CLS. 1, 2, 3, 22 AND 41).

CLASS 25—CLOTHING

FOR CLOTHING AND SPORTWEAR, NAMELY, BELTS, T-SHIRTS, SHIRTS, SWEATERS, JACKETS, BLOUSES, HATS, CAPS, DRESSES, DICKIES, SOCKS, VESTS, APRONS, SHORTS, TANK TOPS, JEANS, SLACKS, PANTS, COATS, SWIMWEAR, SUITS AND FOOTWEAR (U.S. CLS. 22 AND 39).
GIANCARLO CASTRO, EXAMINING ATTORNEY

SN 78-928,235. TOWXCHANGE, INC., CHATTANOOGA, TN. FILED 7-12-2006.

towPartners

THE MARK CONSISTS OF STANDARD CHARACTERS WITHOUT CLAIM TO ANY PARTICULAR FONT, STYLE, SIZE, OR COLOR.
SEC. 2(F).

CLASS 9—ELECTRICAL AND SCIENTIFIC APPARATUS

FOR DOWNLOADABLE ELECTRONIC PUBLICATIONS IN THE NATURE OF GUIDES, ARTICLES, BULLETINS, NEWSLETTERS, INVENTORY TRACKING SHEETS, AND CLASSIFIED DIRECTORIES, IN THE FIELDS OF TOWING, VEHICLE RECOVERY, AND ROAD SERVICES (U.S. CLS. 21, 23, 26, 36 AND 38).

FIRST USE 2-15-2003; IN COMMERCE 8-15-2003.

CLASS 16—PAPER GOODS AND PRINTED MATTER

FOR PRINTED PERIODICALS IN THE FIELDS OF TOWING, VEHICLE RECOVERY, AND ROAD SERVICES (U.S. CLS. 2, 5, 22, 23, 29, 37, 38 AND 50).

FIRST USE 2-15-2003; IN COMMERCE 8-15-2003.

CLASS 35—ADVERTISING AND BUSINESS

FOR ASSOCIATION SERVICES, NAMELY, PROMOTING THE INTERESTS OF INDIVIDUALS, COMPANIES, AND ORGANIZATIONS IN THE FIELDS OF TOWING, VEHICLE RECOVERY, AND ROAD SERVICES; ADMINISTRATION OF A PROGRAM FOR ENABLING PARTICIPANTS TO OBTAIN DISCOUNTS ON GOODS AND SERVICES AND RECEIVE IMPROVED SERVICES (U.S. CLS. 100, 101 AND 102).

FIRST USE 2-15-2003; IN COMMERCE 8-15-2003.

SALLY SHIH, EXAMINING ATTORNEY

SN 78-928,781. ORME, DEBORAH L., EAST SUSSEX, UNITED KINGDOM, FILED 7-13-2006.



OWNER OF ERPN CMNTY TM OFC REG. NO. 4379715, DATED 2-23-2006, EXPIRES 2-23-2016.

NO CLAIM IS MADE TO THE EXCLUSIVE RIGHT TO USE "PET", APART FROM THE MARK AS SHOWN.

CLASS 6—METAL GOODS

FOR METAL FITTINGS FOR PET COFFINS; METAL BOXES AND CONTAINERS; METAL GRAVE MARKERS; METAL MEMORIAL ITEMS, NAMELY METAL MEMORIAL PLAQUES, METAL MEMORIAL MARKERS; PARTS AND FITTINGS FOR THE AFORESAID GOODS (U.S. CLS. 2, 12, 13, 14, 23, 25 AND 50).

CLASS 16—PAPER GOODS AND PRINTED MATTER

FOR PRINTED MATTER AND PRINTED PUBLICATIONS, NAMELY BOOKS, BROCHURES, BOOKLETS, MAGAZINES, LEAFLETS, PAMPHLETS IN THE FIELD OF PET FUNERALS, PET MEMORIALS, GRIEF AND BEREAVEMENT; STATIONERY AND SYMPATHY CARDS (U.S. CLS. 2, 5, 22, 23, 29, 37, 38 AND 50).

CLASS 20—FURNITURE AND ARTICLES NOT OTHERWISE CLASSIFIED

FOR PET COFFINS AND METAL PET COFFINS; PET COFFIN FITTINGS NOT OF METAL; FUNERARY URNS; BOXES AND CONTAINERS FOR CONTAINING ASHES; MEMORIAL ITEMS, NAMELY PLASTIC MEMORIAL PLAQUES, PLASTIC MEMORIAL MARKERS; PLASTIC GRAVE MARKERS; PARTS AND FITTINGS FOR THE AFORESAID GOODS (U.S. CLS. 2, 13, 22, 25, 32 AND 50).

CLASS 45—PERSONAL SERVICES

FOR FUNERAL SERVICES; UNDERTAKING SERVICES; CREMATION SERVICES; BEREAVEMENT COUNSELING SERVICES FOR THE OWNERS OF DECEASED PETS; INFORMATION, ADVICE AND CONSULTANCY REGARDING THE AFORESAID SERVICES (U.S. CLS. 100 AND 101).

ANDREA SAUNDERS, EXAMINING ATTORNEY

SN 78-928,989. RHEUMINATIONS, INC., NEW YORK, NY, FILED 7-13-2006.

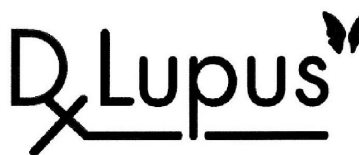

THE MARK CONSISTS OF THE WORD DXLUPUS AND THE STYLIZED IMAGE OF A BUTTERFLY.

CLASS 9—ELECTRICAL AND SCIENTIFIC APPARATUS

FOR DOWNLOADABLE ELECTRONIC PUBLICATIONS IN THE NATURE OF BROCHURES, ARTICLES, TRANSCRIPTS, AUDIO PROGRAMS AND VIDEO PROGRAMS ABOUT LUPUS (U.S. CLS. 21, 23, 26, 36 AND 38).

FIRST USE 11-11-2005; IN COMMERCE 11-11-2005.

CLASS 16—PAPER GOODS AND PRINTED MATTER

FOR PRINTED EDUCATIONAL AND INFORMATIONAL MATERIALS IN THE FIELD OF LUPUS, NAMELY, BROCHURES, ARTICLES AND OTHER PRINTED MATERIALS (U.S. CLS. 2, 5, 22, 23, 29, 37, 38 AND 50).

FIRST USE 10-26-2002; IN COMMERCE 10-26-2002.

CLASS 38—COMMUNICATION

FOR BROADCASTING PRE-RECORDED VIDEOS REGARDING HEALTH CARE OVER THE INTERNET (U.S. CLS. 100, 101 AND 104).

FIRST USE 11-11-2005; IN COMMERCE 11-11-2005.

CLASS 41—EDUCATION AND ENTERTAINMENT

FOR PUBLISHING OF JOURNALS, BOOKS, HANDBOOKS AND TRANSCRIPTS IN THE FIELD OF LUPUS; PROVIDING ONLINE PUBLICATIONS IN THE NATURE OF ARTICLES AND TRANSCRIPTS IN THE FIELD OF LUPUS (U.S. CLS. 100, 101 AND 107).

FIRST USE 11-11-2005; IN COMMERCE 11-11-2005.

CLASS 44—MEDICAL, BEAUTY AND AGRICULTURAL SERVICES

FOR PROVIDING MEDICAL AND HEALTHCARE INFORMATION PERTAINING TO THE DISEASE COMMONLY KNOWN AS LUPUS VIA THE INTERNET (U.S. CLS. 100 AND 101).

FIRST USE 11-11-2005; IN COMMERCE 11-11-2005.

BRENDAN REGAN, EXAMINING ATTORNEY

SN 78-929,233. HIMO, INC., SEOUL, REPUBLIC OF KOREA,
FILED 7-13-2006.

**CLASS 42—SCIENTIFIC, COMPUTER AND
LEGAL SERVICES**

FOR LICENSING OF INTELLECTUAL PROPERTY
(U.S. CLS. 100 AND 101).
ALEX KEAM, EXAMINING ATTORNEY

NEXART

THE MARK CONSISTS OF STANDARD CHARACTERS
WITHOUT CLAIM TO ANY PARTICULAR FONT, STYLE,
SIZE, OR COLOR.

CLASS 17—RUBBER GOODS

FOR VULCANIZED FIBER NOT FOR USE IN TEXTILE; ARAMID FIBER FOR USE IN THE MANUFACTURE OF WIGGERY, IN THE FORM OF WIGS, TOUPEES, FALSE HAIR, AND NOT FOR USE IN TEXTILES; ARTIFICIAL WOOL FOR USE IN THE MANUFACTURE OF WIGGERY, IN THE FORM OF WIGS, TOUPEES, FALSE HAIR, AND NOT FOR USE IN TEXTILES; PLASTIC FIBER FOR USE IN THE MANUFACTURE OF WIGGERY, IN THE FORM OF WIGS, TOUPEES, FALSE HAIR, AND NOT FOR USE IN TEXTILES; THREADS OF RUBBER NOT FOR USE IN TEXTILE; COVERED RUBBER THREAD AND YARN NOT FOR USE IN TEXTILE; SEMI-SYNTHETIC FIBER FOR USE IN THE MANUFACTURE OF WIGGERY, IN FORM OF WIGS, NOT FOR USE IN TEXTILE (U.S. CLS. 1, 5, 12, 13, 35 AND 50).

CLASS 23—YARNS AND THREADS

FOR REGENERATED FIBER FOR USE IN THE MANUFACTURE OF WIGGERY, IN THE FORM OF WIGS, TOUPEES, FALSE HAIR, AND NOT FOR USE IN TEXTILES; SEMI-SYNTHETIC FIBER THREAD AND YARN FOR USE IN THE MANUFACTURE OF WIGGERY, IN THE FORM OF WIGS, TOUPEES, FALSE HAIR, AND NOT FOR USE IN TEXTILES; ELASTIC YARN FOR USE IN THE MANUFACTURE OF WIGGERY, IN THE FORM OF WIGS, TOUPEES, FALSE HAIR, AND NOT FOR USE IN TEXTILES; THREAD OF PLASTIC MATERIALS FOR USE IN THE MANUFACTURE OF WIGGERY, IN THE FORM OF WIGS, TOUPEES, FALSE HAIR, AND NOT FOR USE IN TEXTILES; SYNTHETIC FIBER THREAD AND YARN IN THE MANUFACTURE OF WIGGERY, IN THE FORM OF WIGS, TOUPEES, FALSE HAIR, AND NOT FOR USE IN TEXTILES (U.S. CL. 43).

BENJAMIN OKEKE, EXAMINING ATTORNEY

SN 78-930,901. KULA MEDIA GROUP, SAN MARCOS, TX.
FILED 7-17-2006.

TIMESLICE

THE MARK CONSISTS OF STANDARD CHARACTERS
WITHOUT CLAIM TO ANY PARTICULAR FONT, STYLE,
SIZE, OR COLOR.

**CLASS 9—ELECTRICAL AND SCIENTIFIC
APPARATUS**

FOR SOFTWARE AND HARDWARE USED TO COMPRESS, TRANSMIT, AND DECOMPRESS AUDIO AND VIDEO CONTENT (U.S. CLS. 21, 23, 26, 36 AND 38).

SN 78-931,205. SALOMON, DAVID, BEVERLY HILLS, CA.
FILED 7-17-2006.

NOVATRON

THE MARK CONSISTS OF STANDARD CHARACTERS
WITHOUT CLAIM TO ANY PARTICULAR FONT, STYLE,
SIZE, OR COLOR.

**CLASS 9—ELECTRICAL AND SCIENTIFIC
APPARATUS**

FOR COMPUTER SOFTWARE FOR FINANCIAL MANAGEMENT, NAMELY, ELECTRONIC SPREADSHEET AND ORDER MANAGEMENT OF FINANCIAL INSTRUMENTS AND FOREIGN EXCHANGE; COMPUTER SOFTWARE FOR FINANCIAL ANALYSIS AND FINANCIAL CONSULTING, NAMELY, SOFTWARE FOR TRANSACTION REPORTING, FINANCIAL MODELING AND FINANCIAL ANALYSIS; COMPUTER SOFTWARE FOR FINANCIAL INSTRUMENT AND FOREIGN EXCHANGE TRADING, NAMELY, A GRAPHICAL USER INTERFACE FOR CONDUCTING FINANCIAL INSTRUMENT AND FOREIGN EXCHANGE TRADING OVER ELECTRONIC COMMUNICATIONS NETWORKS; COMPUTER SOFTWARE FOR PORTFOLIO MANAGEMENT AND RISK MANAGEMENT, NAMELY, SOFTWARE FOR AGGREGATION, COMPARISON AND RANKING OF FOREIGN EXCHANGE PRICES AND OTHER FINANCIAL INSTRUMENT ASPECTS AS WELL AS TRANSACTION COORDINATION AND ARCHIVING (U.S. CLS. 21, 23, 26, 36 AND 38).

CLASS 36—INSURANCE AND FINANCIAL

FOR FINANCIAL SERVICES, NAMELY, AUTOMATED TRADE EXECUTION AND SETTLEMENT SERVICES IN THE FIELD OF FOREIGN EXCHANGE; FOREIGN EXCHANGE RATE CALCULATION SERVICES; PROVIDING FINANCIAL INFORMATION IN THE FIELD OF FOREIGN EXCHANGE; INVESTMENT ADVICE, NAMELY, MANAGING, TRACKING AND REPORTING FOREIGN EXCHANGE PURCHASE AND SALE TRANSACTIONS; ANALYSIS OF FOREIGN EXCHANGE TRANSACTIONS AND VALUES; PROVIDING ONLINE DATABASES IN THE FIELD OF FOREIGN EXCHANGE ACCOUNT INFORMATION; FINANCIAL RESEARCH IN THE FIELD OF FOREIGN CURRENCY EXCHANGE; FINANCIAL CONSULTATION SERVICES, NAMELY, PROVIDING FOREIGN EXCHANGE FINANCIAL INFORMATION; COMPUTERIZED ONLINE TRADING SERVICES IN THE FIELD OF FOREIGN EXCHANGE (U.S. CLS. 100, 101 AND 102).

CHRISTOPHER OTT, EXAMINING ATTORNEY

SN 78-931,222. SALOMON, DAVID, BEVERLY HILLS, CA. FILED 7-17-2006.

GOSI

THE MARK CONSISTS OF STANDARD CHARACTERS WITHOUT CLAIM TO ANY PARTICULAR FONT, STYLE, SIZE, OR COLOR.

CLASS 9—ELECTRICAL AND SCIENTIFIC APPARATUS

FOR COMPUTER SOFTWARE FOR FINANCIAL MANAGEMENT, NAMELY, ELECTRONIC SPREADSHEET AND ORDER MANAGEMENT OF FINANCIAL INSTRUMENTS AND FOREIGN EXCHANGE; COMPUTER SOFTWARE FOR FINANCIAL ANALYSIS AND FINANCIAL CONSULTING, NAMELY, SOFTWARE FOR TRANSACTION REPORTING, FINANCIAL MODELING AND FINANCIAL ANALYSIS; COMPUTER SOFTWARE FOR FINANCIAL INSTRUMENT AND FOREIGN EXCHANGE TRADING, NAMELY, A GRAPHICAL USER INTERFACE FOR CONDUCTING FINANCIAL INSTRUMENT AND FOREIGN EXCHANGE TRADING OVER ELECTRONIC COMMUNICATIONS NETWORKS; COMPUTER SOFTWARE FOR PORTFOLIO MANAGEMENT AND RISK MANAGEMENT, NAMELY, SOFTWARE FOR AGGREGATION, COMPARISON AND RANKING OF FOREIGN EXCHANGE PRICES AND OTHER FINANCIAL INSTRUMENT ASPECTS AS WELL AS TRANSACTION COORDINATION AND ARCHIVING (U.S. CLS. 21, 23, 26, 36 AND 38).

CLASS 36—INSURANCE AND FINANCIAL

FOR FINANCIAL SERVICES, NAMELY, AUTOMATED TRADE EXECUTION AND SETTLEMENT SERVICES IN THE FIELD OF FOREIGN EXCHANGE; FOREIGN EXCHANGE RATE CALCULATION SERVICES; PROVIDING FINANCIAL INFORMATION IN THE FIELD OF FOREIGN EXCHANGE; INVESTMENT ADVICE, NAMELY, MANAGING, TRACKING AND REPORTING FOREIGN EXCHANGE PURCHASE AND SALE TRANSACTIONS; ANALYSIS OF FOREIGN EXCHANGE TRANSACTIONS AND VALUES; PROVIDING ONLINE DATABASES IN THE FIELD OF FOREIGN EXCHANGE ACCOUNT INFORMATION; FINANCIAL RESEARCH IN THE FIELD OF FOREIGN CURRENCY EXCHANGE; FINANCIAL CONSULTATION SERVICES, NAMELY, PROVIDING FOREIGN EXCHANGE FINANCIAL INFORMATION; COMPUTERIZED ONLINE TRADING SERVICES IN THE FIELD OF FOREIGN EXCHANGE (U.S. CLS. 100, 101 AND 102).
CHRISTOPHER OTT, EXAMINING ATTORNEY

SN 78-931,326. KEENAN HOLDINGS, INC., RANCHO CORDOVA, CA. FILED 7-17-2006.

Click, Buy & Save

THE MARK CONSISTS OF STANDARD CHARACTERS WITHOUT CLAIM TO ANY PARTICULAR FONT, STYLE, SIZE, OR COLOR.
NO CLAIM IS MADE TO THE EXCLUSIVE RIGHT TO USE "CLICK", APART FROM THE MARK AS SHOWN.

CLASS 35—ADVERTISING AND BUSINESS

FOR THROUGH THE USE OF ELECTRONIC TRANSMISSION AND THE GLOBAL INFORMATION NETWORK, PROVIDING INSURANCE BROKERS WITH INFORMATION CONCERNING PROSPECTIVE CUSTOMERS WHO HAVE RECEIVED PROPERTY AND CASUALTY INSURANCE QUOTES; REFERRALS IN THE FIELD OF INSURANCE. (U.S. CLS. 100, 101 AND 102).
FIRST USE 6-20-2006; IN COMMERCE 6-20-2006.

CLASS 36—INSURANCE AND FINANCIAL

FOR QUOTING, UNDERWRITING, AND WRITING OF INSURANCE, NAMELY, PROPERTY AND CASUALTY; PROVIDING SERVICES, NAMELY, CLAIMS ADMINISTRATION, CLAIMS ADJUSTMENT, BROKERAGE, INSURANCE POLICY MANAGEMENT; CONSULTATION AND RESEARCH IN THE FIELD OF INSURANCE. (U.S. CLS. 100, 101 AND 102).
FIRST USE 6-20-2006; IN COMMERCE 6-20-2006.
JOHN DALIER, EXAMINING ATTORNEY

SN 78-931,519. TRADEMARK MANAGEMENT COMPANY, MERIDIAN, ID. FILED 7-18-2006.

SERV

THE MARK CONSISTS OF STANDARD CHARACTERS WITHOUT CLAIM TO ANY PARTICULAR FONT, STYLE, SIZE, OR COLOR.
OWNER OF U.S. REG. NO. 2,402,293.

CLASS 29—MEATS AND PROCESSED FOODS

FOR JELLIES AS BREAD SPREADS (U.S. CL. 46).
FIRST USE 6-30-1988; IN COMMERCE 6-30-1988.

CLASS 30—STAPLE FOODS

FOR SALAD DRESSINGS; HONEY; TABLE SYRUP; MUSTARD; RELISH; KETCHUP; TARTAR SAUCE; SWEET AND SOUR SAUCE; BARBÈQUE SAUCE; TACO SAUCE; FRUIT JELLIES (U.S. CL. 46).
FIRST USE 6-30-1988; IN COMMERCE 6-30-1988.
FRANK LATTUCA, EXAMINING ATTORNEY

SN 78-932,100. BROADCOM CORPORATION, IRVINE, CA. FILED 7-18-2006.

POWER OF N

THE MARK CONSISTS OF STANDARD CHARACTERS WITHOUT CLAIM TO ANY PARTICULAR FONT, STYLE, SIZE, OR COLOR.

CLASS 9—ELECTRICAL AND SCIENTIFIC APPARATUS

FOR COMPUTER HARDWARE; INTEGRATED CIRCUITS; COMPUTER CHIPSETS; INTEGRATED CIRCUIT CHIPSETS; COMPUTER HARDWARE, INTEGRATED CIRCUITS, COMPUTER CHIPSETS, AND INTEGRATED CIRCUIT CHIPSETS FOR COMMUNICATION, WIRELESS COMMUNICATION AND CONNECTIVITY; FIRMWARE FOR USING AND CONTROLLING WIRELESS BROADBAND COMMUNICATION TECHNOLOGY AND TO ENABLE COMMUNICATION AND WIRELESS COMMUNICATION; COMPUTER SOFTWARE FOR COMMUNICATION, WIRELESS COMMUNICATION, AND CONNECTIVITY, AND FOR CONTROLLING AND USING INTEGRATED CIRCUITS; COMPUTER SOFTWARE EMBEDDED OR CONTAINED IN COMPUTER HARDWARE FOR COMMUNICATION, WIRELESS COMMUNICATION, AND CONNECTIVITY, AND FOR CONTROLLING AND USING INTEGRATED CIRCUITS; AND MANUALS SOLD AS A UNIT WITH THE FOREGOING AND DOWNLOADABLE FROM A GLOBAL COMPUTER NETWORK (U.S. CLS. 21, 23, 26, 36 AND 38).

CLASS 42—SCIENTIFIC, COMPUTER AND LEGAL SERVICES

FOR DESIGN OF COMPUTER HARDWARE, INTEGRATED CIRCUITS, CHIPSETS, FIRMWARE, COMPUTER SOFTWARE AND COMPUTER SOFTWARE EMBEDDED OR CONTAINED IN COMPUTER HARDWARE FOR OTHERS (U.S. CLS. 100 AND 101).
ALICE BENMAMAN, EXAMINING ATTORNEY

SN 78-933,701. HARRAH'S LICENSE COMPANY, LLC, LAS VEGAS, NV. FILED 7-20-2006.

SN 78-934,357. GLOBAL TECHNOLOGY SOLUTIONS, INC., LAS VEGAS, NV. FILED 7-20-2006.

MIS DIVISION

THE MARK CONSISTS OF STANDARD CHARACTERS WITHOUT CLAIM TO ANY PARTICULAR FONT, STYLE, SIZE, OR COLOR.

NO CLAIM IS MADE TO THE EXCLUSIVE RIGHT TO USE MIS, APART FROM THE MARK AS SHOWN.

CLASS 35—ADVERTISING AND BUSINESS

FOR HUMAN CAPITAL MANAGEMENT OUTSOURCING SERVICES; OUTSOURCING IN THE FIELD OF PROFESSIONAL SERVICES (U.S. CLS. 100, 101 AND 102).

CLASS 42—SCIENTIFIC, COMPUTER AND LEGAL SERVICES

FOR COMPUTER COLOCATION SERVICES, NAMELY, PROVIDING FACILITIES FOR THE LOCATION OF COMPUTER SERVERS WITH THE EQUIPMENT OF OTHERS; COMPUTER SERVICES, NAMELY, REMOTE AND ON-SITE MANAGEMENT OF ELECTRONIC MESSAGING SYSTEMS AND APPLICATIONS FOR OTHERS; DESIGN AND DEVELOPMENT OF ONLINE COMPUTER SOFTWARE SYSTEMS (U.S. CLS. 100 AND 101).

LAURIE KAUFMAN, EXAMINING ATTORNEY

SN 78-934,528. ASHOKA: INNOVATORS FOR THE PUBLIC, ARLINGTON, VA. FILED 7-21-2006.

In a Word, Legendary.

THE MARK CONSISTS OF STANDARD CHARACTERS WITHOUT CLAIM TO ANY PARTICULAR FONT, STYLE, SIZE, OR COLOR.

CLASS 41—EDUCATION AND ENTERTAINMENT

FOR CASINO AND GAMING SERVICES; ENTERTAINMENT IN THE NATURE OF LIVE MUSICAL, VARIETY AND COMEDY SHOWS (U.S. CLS. 100, 101 AND 107).

CLASS 43—HOTEL AND RESTAURANT SERVICES

FOR HOTELS, RESTAURANTS, AND COCKTAIL LOUNGE SERVICES; ARENA SERVICES, NAMELY PROVIDING FACILITIES FOR SPORTS, CONCERTS, CONVENTIONS AND EXHIBITIONS (U.S. CLS. 100 AND 101).

TIMOTHY FINNEGAN, EXAMINING ATTORNEY

CITIZEN BASE INITIATIVE

THE MARK CONSISTS OF STANDARD CHARACTERS WITHOUT CLAIM TO ANY PARTICULAR FONT, STYLE, SIZE, OR COLOR.

NO CLAIM IS MADE TO THE EXCLUSIVE RIGHT TO USE "INITIATIVE", APART FROM THE MARK AS SHOWN.

CLASS 35—ADVERTISING AND BUSINESS

FOR CONSULTING, NAMELY BUSINESS CONSULTING IN THE FIELDS OF ECONOMIC AND SOCIAL ISSUES; ADMINISTRATIVE COORDINATION OF ORGANIZATIONS PROVIDING HUMANITARIAN ACTIVITIES; AND ASSOCIATION SERVICES, NAMELY, PROMOTION THE INTERESTS OF SOCIAL ENTREPRENEURS (U.S. CLS. 100, 101 AND 102).

FIRST USE 1-31-1996; IN COMMERCE 1-31-1996.

CLASS 36—INSURANCE AND FINANCIAL

FOR CHARITABLE FUNDRAISING AND PHILANTHROPIC SERVICES (U.S. CLS. 100, 101 AND 102).

FIRST USE 1-31-1996; IN COMMERCE 1-31-1996.
LA TONIA FISHER, EXAMINING ATTORNEY

SN 78-934,537. JONES DAIRY FARM, FORT ATKINSON, WI. FILED 7-21-2006.



OWNER OF U.S. REG. NOS. 60,458, 1,406,008 AND OTHERS.

NO CLAIM IS MADE TO THE EXCLUSIVE RIGHT TO USE "SINCE 1889", APART FROM THE MARK AS SHOWN. SEC. 2(F) AS TO "DAIRY FARM".

CLASS 29—MEATS AND PROCESSED FOODS

FOR SAUSAGE, SAUSAGE MEAT, HAM, BACON, CANADIAN BACON AND SCRAPPLE (U.S. CL. 46). FIRST USE 12-31-1995; IN COMMERCE 12-31-1995.

CLASS 35—ADVERTISING AND BUSINESS

FOR RETAIL STORE SERVICES FEATURING MEATS AND MEAT PRODUCTS (U.S. CLS. 100, 101 AND 102). FIRST USE 12-31-1995; IN COMMERCE 12-31-1995. TASNEEM HUSSAIN, EXAMINING ATTORNEY

SN 78-935,171. THE MOUNT SINAI HOSPITAL, NEW YORK, NY. FILED 7-21-2006.



THE MARK CONSISTS OF A STYLIZED HS WITH AN OSCILATING LINE CONNECTING THE TWO LETTERS.

CLASS 9—ELECTRICAL AND SCIENTIFIC APPARATUS

FOR ENCODED SMART CARDS CONTAINING A PORTABLE SUMMARY OF A PATIENT'S PERSONAL INFORMATION AND MEDICAL HISTORY THAT ENABLES ACCESS TO THE INFORMATION BY MEMBER INSTITUTIONS IN THE NETWORK (U.S. CLS. 21, 23, 26, 36 AND 38). FIRST USE 7-14-2006; IN COMMERCE 7-14-2006.

CLASS 44—MEDICAL, BEAUTY AND AGRICULTURAL SERVICES

FOR HEALTH CARE SERVICES FEATURING A HEALTH CARD PROGRAM THAT PROVIDES PROVIDERS AND PATIENTS WITH ACCESS TO PERSONAL MEDICAL INFORMATION (U.S. CLS. 100 AND 101). FIRST USE 7-14-2006; IN COMMERCE 7-14-2006. JOHN GARTNER, EXAMINING ATTORNEY

SN 78-935,183. THE MOUNT SINAI HOSPITAL, NEW YORK, NY. FILED 7-21-2006.

HEALTHSMART NETWORK

THE MARK CONSISTS OF STANDARD CHARACTERS WITHOUT CLAIM TO ANY PARTICULAR FONT, STYLE, SIZE, OR COLOR. NO CLAIM IS MADE TO THE EXCLUSIVE RIGHT TO USE "NETWORK", APART FROM THE MARK AS SHOWN.

CLASS 9—ELECTRICAL AND SCIENTIFIC APPARATUS

FOR ENCODED SMART CARDS CONTAINING A PORTABLE SUMMARY OF A PATIENT'S PERSONAL INFORMATION AND MEDICAL HISTORY THAT ENABLES ACCESS TO THE INFORMATION BY MEMBER INSTITUTIONS IN THE NETWORK (U.S. CLS. 21, 23, 26, 36 AND 38). FIRST USE 7-14-2006; IN COMMERCE 7-14-2006.

CLASS 44—MEDICAL, BEAUTY AND AGRICULTURAL SERVICES

FOR HEALTH CARE SERVICES FEATURING A HEALTH CARD PROGRAM THAT PROVIDES PROVIDERS AND PATIENTS WITH ACCESS TO PERSONAL MEDICAL INFORMATION (U.S. CLS. 100 AND 101). FIRST USE 7-14-2006; IN COMMERCE 7-14-2006. JOHN GARTNER, EXAMINING ATTORNEY

SN 78-935,628. TOMOTHERAPY INCORPORATED, MADISON, WI. FILED 7-24-2006.

CTRUE

THE MARK CONSISTS OF STANDARD CHARACTERS WITHOUT CLAIM TO ANY PARTICULAR FONT, STYLE, SIZE, OR COLOR.

CLASS 9—ELECTRICAL AND SCIENTIFIC APPARATUS

FOR COMPUTER SOFTWARE FOR PLANNING, DELIVERY, ANALYSIS AND CONTROL OF PATIENT MEDICAL RADIATION TREATMENTS FOR THE PURPOSE OF QUALITY ASSURANCE, IMAGING, TREATMENT AND THERAPY (U.S. CLS. 21, 23, 26, 36 AND 38).

CLASS 10—MEDICAL APPARATUS

FOR MEDICAL APPARATUS AND EQUIPMENT TO DELIVER RADIATION TO PATIENTS FOR IMAGING, TREATMENT AND THERAPY AND FOR MONITORING QUALITY ASSURANCE (U.S. CLS. 26, 39 AND 44).
PAUL CROWLEY, EXAMINING ATTORNEY

SN 78-936,829. CHESHIRE MOULDINGS & WOODTURNINGS LTD., CHESHIRE, UNITED KINGDOM, FILED 7-25-2006.



SN 78-936,564. DANIEL, REGINALD G, LARGO, MD. FILED 7-25-2006.

Living Your Life Backward

CLASS 6—METAL GOODS

FOR BUILDING MATERIALS AND BUILDING ELEMENTS OF METAL, NAMELY, METALLIC PARTS AND FITTINGS FOR STAIRCASES, STAIRCASES MADE OF METAL, SPINDLES, NEWELS, NEWEL CAPS, HAND RAILS, BASE RAILS, NEWEL POSTS, HAND RAIL FITTINGS MADE OF METAL, METAL BALUSTRADES, REPLACEMENT PARTS AND FITTINGS FOR THE AFORESAID GOODS (U.S. CLS. 2, 12, 13, 14, 23, 25 AND 50).

CLASS 19—NON-METALLIC BUILDING MATERIALS

FOR NON-METAL BUILDING MATERIALS, NAMELY, WOOD STAIRCASES FOR INDOOR DOMESTIC USE, HAND RAIL FITTINGS, BEADING, NEWELS, NEWEL CAPS, SURFACES FOR STAIRCASES, DOWELS AND DOWELLING, SPINDLES, COVER BEADS, DOOR BEADS, ARCHITRAVES, DADO RAILS, DECKING, WALL MOUNTED HAND RAIL SYSTEMS, SAWN TIMBER, DECKING BOARDING, DECKING BALUSTERS, TIMBER MOULDINGS, HAND RAIL FITTINGS MADE OF WOOD, MOULDINGS, MOULDINGS MADE OF PLASTIC, MOULDINGS MADE OF WOOD, SKIRTING BOARDS, BALUSTRADES, REPLACEMENT PARTS AND FITTINGS FOR ALL THE AFORESAID (U.S. CLS. 1, 12, 33 AND 50).

CLASS 20—FURNITURE AND ARTICLES NOT OTHERWISE CLASSIFIED

FOR PICTURE FRAMES; REPLACEMENT PARTS AND FITTINGS FOR THE AFORESAID (U.S. CLS. 2, 13, 22, 25, 32 AND 50).
ELLEN BURNS, EXAMINING ATTORNEY

THE MARK CONSISTS OF STANDARD CHARACTERS WITHOUT CLAIM TO ANY PARTICULAR FONT, STYLE, SIZE, OR COLOR.

CLASS 9—ELECTRICAL AND SCIENTIFIC APPARATUS

FOR GAME SOFTWARE; VIDEO GAME CARTRIDGES; VIDEO GAME DISCS; VIDEO GAME INTERACTIVE CONTROL FLOOR PADS OR MATS (U.S. CLS. 21, 23, 26, 36 AND 38).

SN 78-937,404. COLLEY, GERALD A., HIALEAH, FL. FILED 7-25-2006.

CLASS 41—EDUCATION AND ENTERTAINMENT

FOR BOOK AND REVIEW PUBLISHING; PUBLICATION OF BOOKS; PUBLICATION OF BOOKS, MAGAZINES, ALMANACS AND JOURNALS; PUBLICATION OF BOOKS, OF MAGAZINES, OF JOURNALS, OF NEWSPAPERS, OF PERIODICALS, OF CATALOGS, OF BROCHURES; PUBLICATION OF TEXT BOOKS; PUBLICATION OF TEXTS, BOOKS, MAGAZINES AND OTHER PRINTED MATTER; PUBLISHING OF BOOKS, MAGAZINES (U.S. CLS. 100, 101 AND 107).
BRIAN NEVILLE, EXAMINING ATTORNEY

MIROGLYPHICS LLC

THE MARK CONSISTS OF STANDARD CHARACTERS WITHOUT CLAIM TO ANY PARTICULAR FONT, STYLE, SIZE, OR COLOR.
NO CLAIM IS MADE TO THE EXCLUSIVE RIGHT TO USE "LLC", APART FROM THE MARK AS SHOWN.

CLASS 16—PAPER GOODS AND PRINTED MATTER

FOR BOOKS IN THE FIELD OF ISSUES FEATURING AFRO-AMERICAN, HISPANICS, ASIAN, MINORITY, JUVENILE, BUSINESS, URBAN CULTURE, NEW AGE, FITNESS, AND SPORTS; COMIC BOOKS; MAGAZINES FEATURING AFRO-AMERICAN, HISPANICS, ASIAN, MINORITY, JUVENILE, BUSINESS, URBAN CULTURE, NEW AGE, FITNESS, AND SPORTS; PRINTED PERIODICALS IN THE FIELD OF AFRO-AMERICAN, HISPANICS, ASIAN, MINORITY, JUVENILE, BUSINESS, URBAN CULTURE, NEW AGE, FITNESS, AND SPORTS (U.S. CLS. 2, 5, 22, 23, 29, 37, 38 AND 50).

FIRST USE 5-21-2006; IN COMMERCE 5-21-2006.

CLASS 40—MATERIAL TREATMENT

FOR DIGITAL ON-DEMAND PRINTING SERVICES OF BOOKS AND OTHER DOCUMENTS (U.S. CLS. 100, 103 AND 106).

FIRST USE 5-21-2006; IN COMMERCE 5-21-2006.

CLASS 41—EDUCATION AND ENTERTAINMENT

FOR CUSTOM WRITING SERVICES; ENTERTAINMENT IN THE NATURE OF ON-GOING TELEVISION PROGRAMS IN THE FIELD OF ANIMATION, CARTOONS; PUBLISHING OF BOOKS, MAGAZINES (U.S. CLS. 100, 101 AND 107).

FIRST USE 5-21-2006; IN COMMERCE 5-21-2006.

TINA L. SNAPP, EXAMINING ATTORNEY

SN 78-937,533. DELORME PUBLISHING COMPANY, INC., YARMOUTH, ME. FILED 7-26-2006.

EARTHA COMMUNITY ATLAS

THE MARK CONSISTS OF STANDARD CHARACTERS WITHOUT CLAIM TO ANY PARTICULAR FONT, STYLE, SIZE, OR COLOR.

OWNER OF U.S. REG. NOS. 2,300,979, 2,591,208 AND OTHERS.

NO CLAIM IS MADE TO THE EXCLUSIVE RIGHT TO USE "COMMUNITY ATLAS", APART FROM THE MARK AS SHOWN.

CLASS 42—SCIENTIFIC, COMPUTER AND LEGAL SERVICES

FOR PROVIDING AN ONLINE CARTOGRAPHY AND MAPPING SERVICE (U.S. CLS. 100 AND 101).

FIRST USE 3-31-2006; IN COMMERCE 3-31-2006.

CLASS 45—PERSONAL SERVICES

FOR PROVIDING INFORMATION RELATING TO DIVERSE HUMAN CULTURES, BELIEFS, AND LIFESTYLES BASED ON CARTOGRAPHY AND MAPPING DATA, VIA A GLOBAL COMPUTER NETWORK (U.S. CLS. 100 AND 101).

FIRST USE 3-31-2006; IN COMMERCE 3-31-2006.

RONALD AIKENS, EXAMINING ATTORNEY

SN 78-938,673. FUNDAÇÃO JOÃO PAULO II, CACHOEIRA PAULISTA, BRAZIL, FILED 7-27-2006.

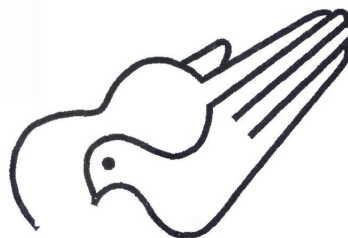

Canção Nova

THE FOREIGN WORDING IN THE MARK TRANSLATES INTO ENGLISH AS NEW SONG.

CLASS 38—COMMUNICATION

FOR BROADCASTING OF RADIO AND TELEVISION PROGRAMS FEATURING EDUCATIONAL AND CULTURAL MESSAGES, NEWS AND RECREATION INFORMATION (U.S. CLS. 100, 101 AND 104).

CLASS 41—EDUCATION AND ENTERTAINMENT

FOR PROVIDING EDUCATIONAL AND CULTURAL ACTIVITIES, NAMELY, LECTURES AND SEMINARS IN THE FIELDS OF CIVIC, MORAL, CULTURAL AND RELIGIOUS FORMATION OF COMMUNITIES, RENDERED VIA TELEVISION, RADIO, PRINT MEDIA, AND LIVE IN PERSON; PRODUCTION OF BROADCAST WORTHY RADIO AND TELEVISION PROGRAMS AND OTHER MEDIA NAMELY, DVD AND VIDEO CASSETTES, ALL FEATURING EDUCATIONAL AND CULTURAL MESSAGES, NEWS AND RECREATION INFORMATION (U.S. CLS. 100, 101 AND 107).

RICHARD WHITE, EXAMINING ATTORNEY

SN 78-938,692. FUNDAÇÃO JOÃO PAULO II, CACHOEIRA PAULISTA, BRAZIL, FILED 7-27-2006.



Padre Jonas Abib

THE NAME JONAS ABIB DOES NOT IDENTIFY A LIVING INDIVIDUAL.

THE FOREIGN WORDING IN THE MARK TRANSLATES INTO ENGLISH AS FATHER JONAS ABIB.

CLASS 38—COMMUNICATION

FOR BROADCASTING OF RADIO AND TELEVISION PROGRAMS FEATURING EDUCATIONAL AND CULTURAL MESSAGES, NEWS AND RECREATION INFORMATION (U.S. CLS. 100, 101 AND 104).

CLASS 41—EDUCATION AND ENTERTAINMENT

FOR PROVIDING EDUCATIONAL AND CULTURAL ACTIVITIES, NAMELY, LECTURES AND SEMINARS IN THE FIELDS OF CIVIC, MORAL, CULTURAL AND RELIGIOUS FORMATION OF COMMUNITIES, RENDERED VIA TELEVISION, RADIO, PRINT MEDIA, AND LIVE IN PERSON; PRODUCTION OF BROADCAST WORTHY RADIO AND TELEVISION PROGRAMS AND OTHER MEDIA NAMELY, DVDS AND VIDEO CASSETTES, ALL FEATURING EDUCATIONAL AND CULTURAL MESSAGES, NEWS AND RECREATION INFORMATION (U.S. CLS. 100, 101 AND 107).

RICHARD WHITE, EXAMINING ATTORNEY

SN 78-940,559. KONZ, KAREN, HONOLULU, HI. FILED 7-29-2006.

PETS OK

THE MARK CONSISTS OF STANDARD CHARACTERS WITHOUT CLAIM TO ANY PARTICULAR FONT, STYLE, SIZE, OR COLOR.

SEC. 2(F).

CLASS 35—ADVERTISING AND BUSINESS

FOR MATCHING CONSUMERS WITH REAL ESTATE PROFESSIONALS IN THE FIELD OF REAL ESTATE SERVICES FEATURING PET FRIENDLY HOMES VIA COMPUTER NETWORK; PROVIDING REAL ESTATE LEADS FOR PROSPECTIVE PURCHASERS FEATURING PET FRIENDLY HOMES; PROVIDING INFORMATION ON RETAIL PET STORES AND RETAIL PET SUPPLY STORES VIA LINKS TO THE WEBSITES OF OTHERS (U.S. CLS. 100, 101 AND 102).

FIRST USE 7-5-2001; IN COMMERCE 9-1-2001.

CLASS 36—INSURANCE AND FINANCIAL

FOR REAL ESTATE LISTINGS AND REAL ESTATE INFORMATION ALL FEATURING PET FRIENDLY RENTAL HOMES (U.S. CLS. 100, 101 AND 102).

FIRST USE 7-5-2001; IN COMMERCE 9-1-2001.

TANYA AMOS, EXAMINING ATTORNEY

SN 78-940,835. TOMOTHERAPY INCORPORATED, MADISON, WI. FILED 7-31-2006.

RESHAPING RADIATION THERAPY

THE MARK CONSISTS OF STANDARD CHARACTERS WITHOUT CLAIM TO ANY PARTICULAR FONT, STYLE, SIZE, OR COLOR.

NO CLAIM IS MADE TO THE EXCLUSIVE RIGHT TO USE "RADIATION THERAPY", APART FROM THE MARK AS SHOWN.

CLASS 9—ELECTRICAL AND SCIENTIFIC APPARATUS

FOR COMPUTER SOFTWARE FOR PLANNING, DELIVERY, ANALYSIS AND CONTROL OF PATIENT MEDICAL RADIATION TREATMENTS FOR THE PURPOSE OF QUALITY ASSURANCE, IMAGING, TREATMENT AND THERAPY (U.S. CLS. 21, 23, 26, 36 AND 38).

CLASS 10—MEDICAL APPARATUS

FOR MEDICAL APPARATUS AND EQUIPMENT TO DELIVER RADIATION TO PATIENTS FOR IMAGING, TREATMENT AND THERAPY AND FOR MONITORING QUALITY ASSURANCE (U.S. CLS. 26, 39 AND 44).

PAUL CROWLEY, EXAMINING ATTORNEY

SN 78-941,554. MISSION BOOT CAMP, LLC, ATLANTA, GA. FILED 7-31-2006.

TRAIN STRONG

THE MARK CONSISTS OF STANDARD CHARACTERS WITHOUT CLAIM TO ANY PARTICULAR FONT, STYLE, SIZE, OR COLOR.

NO CLAIM IS MADE TO THE EXCLUSIVE RIGHT TO USE "TRAIN", APART FROM THE MARK AS SHOWN.

CLASS 25—CLOTHING

FOR CLOTHING, NAMELY T-SHIRTS, SWEAT-SHIRTS, SHORTS, JACKETS AND HATS (U.S. CLS. 22 AND 39).

CLASS 41—EDUCATION AND ENTERTAINMENT

FOR EDUCATION SERVICES, NAMELY, CONDUCTING CLASSES, SEMINARS, WORKSHOPS IN THE FIELD OF PHYSICAL TRAINING AND DISTRIBUTION OF WRITTEN MATERIAL IN CONNECTION THEREWITH; PERSONAL TRAINING SERVICES, NAMELY STRENGTH AND CONDITIONING TRAINING (U.S. CLS. 100, 101 AND 107).

DAWN HAN, EXAMINING ATTORNEY

SN 78-941,612. THE HARTZ MOUNTAIN CORPORATION, SECAUCUS, NJ. FILED 7-31-2006.

HARTZ CLEAN EARTH

THE MARK CONSISTS OF STANDARD CHARACTERS WITHOUT CLAIM TO ANY PARTICULAR FONT, STYLE, SIZE, OR COLOR.

NO CLAIM IS MADE TO THE EXCLUSIVE RIGHT TO USE "CLEAN", APART FROM THE MARK AS SHOWN.

CLASS 3—COSMETICS AND CLEANING PREPARATIONS

FOR STAIN AND ODOR REMOVER; DANDER REMOVER (U.S. CLS. 1, 4, 6, 50, 51 AND 52).

CLASS 5—PHARMACEUTICALS

FOR BITTER TASTING PET TRAINING AID IN THE FORM OF A SPRAY TO PREVENT PETS FROM LICKING, CHEWING AND BITING ON OBJECTS (U.S. CLS. 6, 18, 44, 46, 51 AND 52).

SN 78-943,517. LEARN.COM, INC., SUNRISE, FL. FILED 8-2-2006.

CLASS 16—PAPER GOODS AND PRINTED MATTER

FOR PLASTIC BAGS FOR DISPOSING OF PET WASTE; DISPOSABLE TRAINING PADS FOR THE TRAINING OF DOGS AND PUPPIES (U.S. CLS. 2, 5, 22, 23, 29, 37, 38 AND 50).

CLASS 18—LEATHER GOODS

FOR PADS MADE OF FABRIC FOR USE WITH ANIMAL TRAINING (U.S. CLS. 1, 2, 3, 22 AND 41).
DEZMONA MIZELLE, EXAMINING ATTORNEY

VersionCenter

THE MARK CONSISTS OF STANDARD CHARACTERS WITHOUT CLAIM TO ANY PARTICULAR FONT, STYLE, SIZE, OR COLOR.

CLASS 9—ELECTRICAL AND SCIENTIFIC APPARATUS

FOR COMPUTER SOFTWARE FOR DOCUMENT MANAGEMENT, NAMELY, TRACKING, EDITING AND SHARING DOCUMENT VERSIONS (U.S. CLS. 21, 23, 26, 36 AND 38).

SN 78-943,406. JOHNS MANVILLE, DENVER, CO. FILED 8-2-2006.

CLASS 42—SCIENTIFIC, COMPUTER AND LEGAL SERVICES

FOR COMPUTER SERVICES, NAMELY, DESIGNING, CREATING, MAINTAINING, HOSTING AND IMPLEMENTING WEBSITES FOR THE PURPOSE OF TRACKING, EDITING AND SHARING DOCUMENT VERSIONS WITH CLIENTS FOR OTHERS (U.S. CLS. 100 AND 101).
JOHN DALIER, EXAMINING ATTORNEY

Johns Manville

SN 78-943,672. TELSCO INDUSTRIES, INC., GARLAND, TX. FILED 8-2-2006.

THE MARK CONSISTS OF STANDARD CHARACTERS WITHOUT CLAIM TO ANY PARTICULAR FONT, STYLE, SIZE, OR COLOR.

OWNER OF U.S. REG. NO. 2,390,161.

CLASS 1—CHEMICALS

FOR FILTRATION MEDIA, NAMELY CHEMICAL ADDITIVES FOR INCORPORATION INTO HVAC PRODUCTS AND SYSTEMS AND BORO SILICA MICROGLASS FILTRATION FIBERS (U.S. CLS. 1, 5, 6, 10, 26 AND 46).

FIRST USE 5-0-1997; IN COMMERCE 5-0-1997.

CLASS 17—RUBBER GOODS

FOR FIBER GLASS INSULATION PRODUCTS, NAMELY GLASS FIBER INSULATION FOR USE IN CONSTRUCTION (U.S. CLS. 1, 5, 12, 13, 35 AND 50).

FIRST USE 5-0-1997; IN COMMERCE 5-0-1997.

CLASS 19—NON-METALLIC BUILDING MATERIALS

FOR NON-METAL ROOFING PRODUCTS, NAMELY ROOFING MEMBRANES AND BITUMINOUS ROOF COATINGS (U.S. CLS. 1, 12, 33 AND 50).

FIRST USE 5-0-1997; IN COMMERCE 5-0-1997.
KAPIL BHANOT, EXAMINING ATTORNEY



THE MARK CONSISTS OF THE CHARACTERS "W" AND "M" OVER A STAR WITH SIX ROUNDED POINTS, WITH THE WORD "WEATHERMATIC" TO THE RIGHT OF THE STAR, AND ALL WHICH OVERLAYS AN ELLIPSE THAT IS ORIENTED SLIGHTLY CLOCKWISE TO VERTICAL.

CLASS 9—ELECTRICAL AND SCIENTIFIC APPARATUS

FOR ELECTRONIC AUTOMATIC TIME CONTROLLERS, MONITORS AND MODULES FOR LAWN AND TURF IRRIGATION SYSTEMS (U.S. CLS. 21, 23, 26, 36 AND 38).

FIRST USE 11-1-2004; IN COMMERCE 11-1-2004.

CLASS 11—ENVIRONMENTAL CONTROL APPARATUS

FOR IRRIGATION VALVES, SPRINKLERS, SPRAY-HEADS, ROTORS AND NOZZLES FOR LAWN AND TURF IRRIGATION SYSTEMS (U.S. CLS. 13, 21, 23, 31 AND 34).

FIRST USE 11-1-2004; IN COMMERCE 11-1-2004.
SCOTT SISUN, EXAMINING ATTORNEY

SN 78-944,331. FREIGHTQUOTE.COM, INC., LENEXA, KS.
FILED 8-3-2006.

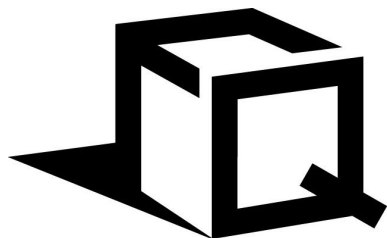

THE MARK CONSISTS OF THE LETTERS FQ IN THE FORM OF A BOX.

CLASS 35—ADVERTISING AND BUSINESS

FOR INFORMATION MANAGEMENT SERVICES, NAMELY, SHIPMENT PROCESSING, PREPARING SHIPPING DOCUMENTS AND INVOICES, TRACKING DOCUMENTS, PACKAGES AND FREIGHT OVER COMPUTER NETWORKS, INTRANETS AND INTERNETS; LOGISTICS MANAGEMENT IN THE FIELD OF TRANSPORTED GOODS; PROVIDING ELECTRONIC TRACKING OF FREIGHT INFORMATION TO OTHERS; TRANSPORTATION LOGISTICS SERVICES, NAMELY, ARRANGING THE TRANSPORTATION OF GOODS FOR OTHERS; TRANSPORTATION LOGISTICS SERVICES, NAMELY, PLANNING AND SCHEDULING SHIPMENTS FOR USERS OF TRANSPORTATION SERVICES (U.S. CLS. 100, 101 AND 102).

FIRST USE 10-31-2000; IN COMMERCE 10-31-2000.

CLASS 39—TRANSPORTATION AND STORAGE

FOR FREIGHT BROKERAGE SERVICES (U.S. CLS. 100 AND 105).

FIRST USE 10-31-2000; IN COMMERCE 10-31-2000.
CHRISTOPHER BUONGIORNO, EXAMINING ATTORNEY

SN 78-944,565. BLACK ROSE, INC., ARLINGTON, VA.
FILED 8-3-2006.

Black Rose

THE MARK CONSISTS OF STANDARD CHARACTERS WITHOUT CLAIM TO ANY PARTICULAR FONT, STYLE, SIZE, OR COLOR.

CLASS 16—PAPER GOODS AND PRINTED MATTER

FOR NEWSLETTERS IN THE FIELD OF THE MANY DIFFERENT EXPRESSIONS OF POWER IN LOVE AND PLAY (U.S. CLS. 2, 5, 22, 23, 29, 37, 38 AND 50).

FIRST USE 12-1-1988; IN COMMERCE 12-1-1988.

CLASS 41—EDUCATION AND ENTERTAINMENT

FOR EDUCATIONAL SERVICES, NAMELY, CONDUCTING CLASSES, WORKSHOPS, AND AN ANNUAL CONFERENCE IN THE FIELD OF THE MANY DIFFERENT EXPRESSIONS OF POWER IN LOVE AND PLAY AND DISTRIBUTION OF COURSE MATERIAL IN CONNECTION THEREWITH; ENTERTAINMENT SERVICES, NAMELY, CONDUCTING PARTIES FOR THE PURPOSE OF DATING AND SOCIAL INTRODUCTION FOR ADULTS; PROVIDING NEWSLETTERS IN THE FIELD OF THE MANY DIFFERENT EXPRESSIONS OF POWER IN LOVE AND PLAY VIA E-MAIL (U.S. CLS. 100, 101 AND 107).

FIRST USE 12-1-1988; IN COMMERCE 12-1-1988.
HEATHER SAPP, EXAMINING ATTORNEY

SN 78-944,912. UNIVERSITY OF VERMONT, BURLINGTON, VT. FILED 8-4-2006.

VTrim

THE MARK CONSISTS OF STANDARD CHARACTERS WITHOUT CLAIM TO ANY PARTICULAR FONT, STYLE, SIZE, OR COLOR.

CLASS 41—EDUCATION AND ENTERTAINMENT

FOR DISSEMINATION OF EDUCATIONAL MATERIALS OF OTHERS IN THE FIELD OF HEALTH AND NUTRITION; EDUCATION IN THE FIELDS OF HEALTH AND NUTRITION RENDERED THROUGH CORRESPONDENCE COURSES; EDUCATIONAL SERVICES, NAMELY, CONDUCTING PROGRAMS IN THE FIELD OF HEALTH AND NUTRITION (U.S. CLS. 100, 101 AND 107).

FIRST USE 9-14-2004; IN COMMERCE 10-14-2005.

CLASS 44—MEDICAL, BEAUTY AND AGRICULTURAL SERVICES

FOR WEIGHT REDUCTION DIET PLANNING CONSULTATION; WEIGHT REDUCTION DIET PLANNING INFORMATION; HEALTH AND NUTRITION SERVICES, NAMELY, WEIGHT REDUCTION DIET PLANNING AND SUPERVISION (U.S. CLS. 100 AND 101).

FIRST USE 9-14-2004; IN COMMERCE 10-14-2005.
MAUREEN DALL, EXAMINING ATTORNEY

SN 78-945,217. COMMONWEALTH EQUITY SERVICES, LLP, WALTHAM, MA. FILED 8-4-2006.

WEALTHMANAGER360

THE MARK CONSISTS OF STANDARD CHARACTERS WITHOUT CLAIM TO ANY PARTICULAR FONT, STYLE, SIZE, OR COLOR.

CLASS 36—INSURANCE AND FINANCIAL

FOR PROVIDING A LIMITED-ACCESS ON-LINE DATABASE IN THE FIELD OF FINANCE FOR USE BY FINANCIAL ACCOUNT REPRESENTATIVES, ACCOUNTANTS, LAWYERS, AND OTHER AUTHORIZED PERSONS WITH A FIDUCIARY DUTY TO A COMMON CLIENT AND FROM WHICH, TO WHICH, AND THROUGH WHICH SUCH AUTHORIZED PERSONS CAN DOWNLOAD, UPLOAD VIEW AND/OR ANNOTATE DOCUMENTS RELATED TO A COMMON CLIENT'S ASSET HOLDINGS, LIABILITIES, FINANCIAL POSITIONS, MONETARY AND SECURITIES ACCOUNTS, ESTATE PLANS, INSURANCE POLICIES, TAX-RELATED DOCUMENTS, FINANCIAL PLANS AND TRUST DOCUMENTS (U.S. CLS. 100, 101 AND 102).

CLASS 42—SCIENTIFIC, COMPUTER AND LEGAL SERVICES

FOR PROVIDING, ON A LIMITED AND SECURE BASIS TO AUTHORIZED THIRD PARTIES, TEMPORARY USE OF NON-DOWNLOADABLE COMPUTER SOFTWARE FOR UPLOADING, DOWNLOADING, VIEWING AND/OR ANNOTATING DOCUMENTS RELATING TO A COMMON CLIENT'S FINANCIAL POSITIONS, MONETARY AND SECURITY ACCOUNTS, ESTATE PLANS, ASSET HOLDINGS, INSURANCE POLICIES, TAX RELATED DOCUMENTS, FINANCIAL PLANS AND TRUST DOCUMENTS (U.S. CLS. 100 AND 101).

CIMMERIAN COLEMAN, EXAMINING ATTORNEY

SN 78-945,267. ELVIS PRESLEY ENTERPRISES, INC., MEMPHIS, TN. FILED 8-4-2006.

THE WHITE HOUSE OF ROCK & ROLL

THE MARK CONSISTS OF STANDARD CHARACTERS WITHOUT CLAIM TO ANY PARTICULAR FONT, STYLE, SIZE, OR COLOR.

CLASS 16—PAPER GOODS AND PRINTED MATTER

FOR ADDRESS BOOKS, GREETING CARDS, POSTCARDS, ART PRINTS, GRAPHIC AND PRINTED ART REPRODUCTIONS, POSTERS, WRITING INSTRUMENTS, BUMPER STICKERS, CALENDARS, COMMEMORATIVE STAMP SHEETS THAT ARE NOT ISSUED BY THE US POSTAL OFFICE, PHOTOGRAPHIC PRINTS, STATIONERY, STICKERS, AND TEMPORARY TATTOOS (U.S. CLS. 2, 5, 22, 23, 29, 37, 38 AND 50).

CLASS 21—HOUSEWARES AND GLASS

FOR BEVERAGEWARE, NAMELY, DRINKING GLASSES, COFFEE MUGS, CERAMIC MUGS, GLASS MUGS, CARAFES, TUMBLERS, MARTINI GLASSES, GOBLETS, AND SHOT GLASSES; COMMEMORATIVE PLATES; AND COOKIE JARS (U.S. CLS. 2, 13, 23, 29, 30, 33, 40 AND 50).

CLASS 25—CLOTHING

FOR T-SHIRTS, SHIRTS, SWEATSHIRTS, SHORTS, HATS AND CAPS (U.S. CLS. 22 AND 39).

CLASS 33—WINES AND SPIRITS

FOR WINE (U.S. CLS. 47 AND 49).
CHARLOTTE CORWIN, EXAMINING ATTORNEY

SN 78-945,538. SINCLAIRE, MAHARA, VANCOUVER, BRITISH COLUMBIA, CANADA, FILED 8-4-2006.



NO CLAIM IS MADE TO THE EXCLUSIVE RIGHT TO USE "BOOMER", APART FROM THE MARK AS SHOWN.

THE COLOR(S) BLACK, RED AND WHITE IS/ARE CLAIMED AS A FEATURE OF THE MARK.

THE MARK CONSISTS OF THE COLOR BLACK APPEARS IN THE WORDING THE LAUGHING BOOMER AND THE COLORS RED, BLACK AND WHITE APPEAR IN THE LAUGHING MOUTH DESIGN ELEMENT.

CLASS 9—ELECTRICAL AND SCIENTIFIC APPARATUS

FOR ELECTRONIC MEDIA, NAMELY, AUDIO/VIDEO DISCS AND TAPES, DIGITAL RECORDING DISCS AND TAPES, SERIES OF PRE-RECORDED COMPACT SOUND RECORDING DISCS, VIDEO DISCS AND VIDEOTAPES FEATURING INSTRUCTION, MUSIC, SOUND EFFECTS AND SPEECHES IN THE FIELD OF BUSINESS, FINANCE, FITNESS, HEALTH, INVESTMENT, LIFESTYLE, NEWS IN THE NATURE OF CURRENT EVENTS, NUTRITION, REAL ESTATE, RETIREMENT AND TRAVEL FOR THE BABY BOOMER GENERATION (U.S. CLS. 21, 23, 26, 36 AND 38).

CLASS 16—PAPER GOODS AND PRINTED MATTER

FOR PRINTED MATTER, NAMELY, A SERIES OF WRITTEN ARTICLES FOR RE-PUBLICATION BY OTHERS IN BOOKLETS, BROCHURES, CATALOGS AND DIRECTORIES IN THE FIELD OF BUSINESS, FINANCE, FITNESS, HEALTH, INVESTMENT, LIFESTYLE, NEWS IN THE NATURE OF CURRENT EVENTS, NUTRITION, REAL ESTATE, RETIREMENT AND TRAVEL FOR THE BABY BOOMER GENERATION; MAGAZINES, MANUALS, NEWSLETTERS, NEWSPAPERS, PAMPHLETS AND PERIODICALS IN THE FIELD OF BUSINESS, FINANCE, FITNESS, HEALTH, INVESTMENT, LIFESTYLE, NEWS IN THE NATURE OF CURRENT EVENTS, NUTRITION, REAL ESTATE, RETIREMENT AND TRAVEL FOR THE BABY BOOMER GENERATION; AGENDAS, ALBUMS FOR PHOTOS, STAMPS AND COINS, BUSINESS CARDS, BOOKMARKS, CALENDARS, DESK DIARIES; PHOTOGRAPHS AND PHOTOGRAPH STANDS; PRINTED GREETING CARDS; PRINTED EDUCATIONAL, INSTRUCTIONAL AND TEACHING MATERIALS IN THE FIELD OF BUSINESS, FINANCE, FITNESS, HEALTH, INVESTMENT, LIFESTYLE, NEWS IN THE NATURE OF CURRENT EVENTS, NUTRITION, REAL ESTATE, RETIREMENT AND TRAVEL FOR THE BABY BOOMER GENERATION; ADVERTISING SIGNS OF PAPER OR CARDBOARD, NAMELY, PROMOTIONAL POSTCARDS AND POSTERS; SERIES OF NON-FICTION BOOKS IN THE FIELD OF BUSINESS, FINANCE, FITNESS, HEALTH, INVESTMENT, LIFESTYLE, NEWS IN THE NATURE OF CURRENT EVENTS, NUTRITION, REAL ESTATE, RETIREMENT AND TRAVEL FOR THE BABY BOOMER GENERATION; WORKBOOKS IN THE FIELD OF BUSINESS, FINANCE, FITNESS, HEALTH, INVESTMENT, LIFESTYLE, NEWS IN THE NATURE OF CURRENT EVENTS, NUTRITION, REAL ESTATE, RETIREMENT AND TRAVEL FOR THE BABY BOOMER GENERATION; STATIONERY, NAMELY, LETTER-HEAD PAPER AND ENVELOPES, NOTE PADS, STATIONERY DOCUMENT COVERS, FOLDERS AND STICKERS; PENS AND PENCILS (U.S. CLS. 2, 5, 22, 23, 29, 37, 38 AND 50).

CLASS 25—CLOTHING

FOR CLOTHING ACCESSORIES, NAMELY, BANDANAS, BELTS, GLOVES, SCARVES, SWEAT BANDS, SUSPENDERS AND VISORS; CLOTHING, NAMELY, APRONS, BLOUSES, BOTTOMS, GOLF SHIRTS, GYM SHORTS, GYM SUITS, JERSEYS, JUMPERS, JUMP SUITS, KNIT SHIRTS, PANTS, POLO SHIRTS, PULL-OVERS, SHIRTS, SHORT SETS COMPRISED OF A TOP AND A BOTTOM, SMOCKS, SUITS, SWEATERS, SWEAT PANTS, SWEAT SHIRTS, SWEAT SUITS, T-SHIRTS AND VESTS; HEAD WEAR, NAMELY, CAPS, EAR MUFFS AND HATS; OUTERWEAR, NAMELY, COATS, JACKETS, RAIN WEAR AND WRAPS (U.S. CLS. 22 AND 39).

CLASS 35—ADVERTISING AND BUSINESS

FOR PROVIDING CONSUMER INFORMATION OF INTEREST TO THE BABY BOOMER GENERATION; RETAIL, WHOLESALE, MAIL-ORDER CATALOG AND ONLINE STORE SERVICES FEATURING A WIDE VARIETY OF CONSUMER GOODS AND SERVICES OF OTHERS, OF INTEREST TO THE BABY BOOMER GENERATION (U.S. CLS. 100, 101 AND 102).

CLASS 38—COMMUNICATION

FOR TELECOMMUNICATIONS SERVICES, NAMELY, BROADCASTING RADIO AND TELEVISION PROGRAMS AND FILMS VIA A GLOBAL COMPUTER NETWORK AND STREAMING OF AUDIO MATERIAL ON THE INTERNET; ELECTRONIC, ELECTRIC, AND DIGITAL TRANSMISSION OF VOICE, DATA, IMAGES, SOUND, SIGNAL AND MESSAGES; ELECTRONIC TRANSMISSION OF DATA AND DOCUMENTS VIA COMPUTER TERMINALS; ELECTRONIC TRANSMISSION OF GREETING CARDS AND MAILERS VIA A GLOBAL COMPUTER NETWORK; TRANSMISSION OF DATA, DOCUMENTS AND INFORMATION BY ELECTRONIC MEDIA, NAMELY, WEB CASTS AND ON-DEMAND RECORDING SERVICES (U.S. CLS. 100, 101 AND 104).

CLASS 41—EDUCATION AND ENTERTAINMENT

FOR EDUCATIONAL AND INSTRUCTIONAL SERVICES, NAMELY, ARRANGING AND CONDUCTING CONFERENCES, RETREATS, SEMINARS, AND WORKSHOPS IN THE FIELD OF BUSINESS, FINANCE, FITNESS, HEALTH, INVESTMENT, LIFESTYLE, NEWS IN THE NATURE OF CURRENT EVENTS, NUTRITION, REAL ESTATE, RETIREMENT AND TRAVEL FOR THE BABY BOOMER GENERATION; ENTERTAINMENT SERVICES, NAMELY, LIVE SPEAKING PERFORMANCES AND SPEAKING ENGAGEMENTS IN THE FIELD OF BUSINESS, FINANCE, FITNESS, HEALTH, INVESTMENT, LIFESTYLE, NEWS IN THE NATURE OF CURRENT EVENTS, NUTRITION, REAL ESTATE, RETIREMENT AND TRAVEL FOR THE BABY BOOMER GENERATION; PRODUCTION OF RADIO AND TELEVISION AND FILM PROGRAMS FOR TRANSMISSION VIA BROADCAST, CABLE, DIGITAL AND GLOBAL COMPUTER NETWORK AND PUBLICATION OF ACCOMPANYING MATERIALS IN THE FORM OF BOOKS, MAGAZINES AND NEWSLETTERS; PROVIDING ONLINE PUBLICATIONS IN THE NATURE OF ELECTRONIC BOOKS, ELECTRONIC MAGAZINES AND NEWSLETTERS IN THE FIELD OF BUSINESS, FINANCE, FITNESS, HEALTH, INVESTMENT, LIFESTYLE, NEWS IN THE NATURE OF CURRENT EVENTS, NUTRITION, REAL ESTATE, RETIREMENT AND TRAVEL FOR THE BABY BOOMER GENERATION; ARRANGING AND CONDUCTING EDUCATIONAL CONFERENCES IN THE FIELD OF BUSINESS, FINANCE, FITNESS, HEALTH, INVESTMENT, LIFESTYLE, NEWS IN THE NATURE OF CURRENT EVENTS, NUTRITION, REAL ESTATE, RETIREMENT AND TRAVEL FOR THE BABY BOOMER GENERATION (U.S. CLS. 100, 101 AND 107).
DAVID HOFFMAN, EXAMINING ATTORNEY

SN 78-946,310. R/A PROFITS INC., RENO, NV. FILED 8-7-2006.

R/A PROFITS

THE MARK CONSISTS OF STANDARD CHARACTERS WITHOUT CLAIM TO ANY PARTICULAR FONT, STYLE, SIZE, OR COLOR.

NO CLAIM IS MADE TO THE EXCLUSIVE RIGHT TO USE "PROFITS", APART FROM THE MARK AS SHOWN.

CLASS 9—ELECTRICAL AND SCIENTIFIC APPARATUS

FOR SOFTWARE, NAMELY, BUSINESS AND FINANCIAL SOFTWARE DESIGNED TO MONITOR PROFIT AND BREAK-EVEN POINTS FOR SMALL BUSINESSES AND FRANCHISEES (U.S. CLS. 21, 23, 26, 36 AND 38).

CLASS 35—ADVERTISING AND BUSINESS

FOR BUSINESS AND MANAGEMENT CONSULTING FOR SMALL BUSINESSES AND FRANCHISEES (U.S. CLS. 100, 101 AND 102).

JERI J. FICKES, EXAMINING ATTORNEY

SN 78-946,337. NUNES D'AGRELLA, PETER ENRIQUE, JEFFERSON VALLEY, NY. FILED 8-7-2006.

Our business is developing
yours

THE MARK CONSISTS OF STANDARD CHARACTERS WITHOUT CLAIM TO ANY PARTICULAR FONT, STYLE, SIZE, OR COLOR.

CLASS 9—ELECTRICAL AND SCIENTIFIC APPARATUS

FOR COMPUTER PROGRAMS FOR BUSINESS APPLICATIONS, NAMELY, SOFTWARE FOR COLLECTING, ORGANIZING AND STORING BUSINESS, FINANCIAL AND MARKETING INFORMATION (U.S. CLS. 21, 23, 26, 36 AND 38).

FIRST USE 1-1-1994; IN COMMERCE 1-1-1994.

CLASS 35—ADVERTISING AND BUSINESS

FOR ASSISTANCE, ADVISORY SERVICES AND CONSULTANCY WITH REGARD TO BUSINESS PLANNING, BUSINESS ANALYSIS, BUSINESS MANAGEMENT, AND BUSINESS ORGANIZATION (U.S. CLS. 100, 101 AND 102).

FIRST USE 1-1-1994; IN COMMERCE 1-1-1994.

CIMMERIAN COLEMAN, EXAMINING ATTORNEY

SN 78-946,671. CHEMISCHE FABRIK BUDENHEIM KG, 56257 BUDENHEIM, FED REP GERMANY, FILED 8-7-2006.

BUDEX

THE MARK CONSISTS OF STANDARD CHARACTERS WITHOUT CLAIM TO ANY PARTICULAR FONT, STYLE, SIZE, OR COLOR.

OWNER OF FED REP GERMANY REG. NO. 681451, DATED 9-9-1955, RENEWED AS REG. NO. 681451, DATED 12-31-2004, EXPIRES 12-31-2014.

OWNER OF U.S. REG. NOS. 2,129,904, 2,887,895 AND 3,025,160.

CLASS 1—CHEMICALS

FOR CHEMICALS FOR USE IN INDUSTRY AND SCIENCE; PHOTOGRAPHIC CHEMICALS; CHEMICAL WATER SOFTENING PREPARATIONS, ANTI-INCRUSTANTS, ION EXCHANGERS RESINS, SURFACE ACTIVE COMPOUNDS FOR GENERAL USE IN THE INDUSTRIAL ARTS AS EMULSIFYING AGENTS, DETERGENTS FOR INDUSTRIAL USE, FIRE RETARDANT COMPOSITIONS FOR COMMERCIAL AND DOMESTIC USE, CHEMICAL AGENTS FOR IMPREGNATING PAPER AND TEXTILES, CHEMICAL FLAME RETARDANTS; CHEMICALS FOR USE AS A FILLER IN THE MANUFACTURE OF PLASTICS; CHEMICAL PRODUCTS FOR INDUSTRIAL USE, NAMELY, AUXILIARY AGENTS FOR ELECTROPLATING OF METAL SURFACES, FOR THE CERAMICS AND GLASS INDUSTRIES; SOLDERING AND FLUXING CHEMICALS, PHOSPHORIC ACID SALTS; FERTILIZERS, PLANT NUTRIENT SALTS (U.S. CLS. 1, 5, 6, 10, 26 AND 46).

CLASS 3—COSMETICS AND CLEANING PREPARATIONS

FOR RUST REMOVING PREPARATIONS (U.S. CLS. 1, 4, 6, 50, 51 AND 52).

PAULA MAHONEY, EXAMINING ATTORNEY

SN 78-946,818. CHERYL G. RIXON DAVIS, BEVERLY HILLS, CA. FILED 8-7-2006.

ROCK ROYALTY

THE MARK CONSISTS OF STANDARD CHARACTERS WITHOUT CLAIM TO ANY PARTICULAR FONT, STYLE, SIZE, OR COLOR.

OWNER OF U.S. REG. NOS. 2,871,904 AND 3,030,034.

CLASS 14—JEWELRY

FOR JEWELRY (U.S. CLS. 2, 27, 28 AND 50).

CLASS 18—LEATHER GOODS

FOR BAGS, CASES AND FASHION ACCESSORIES, NAMELY, CHANGE PURSES, PURSES, HANDBAGS, TOTE BAGS, SHOULDER BAGS, BEACH BAGS, ALL-PURPOSE SPORT BAGS, CARRY BAGS, BARREL BAGS, WAIST PACKS, BACKPACKS, KNAPSACKS, SCHOOL BAGS, SATCHELS, TRAVEL BAGS, WAIST BAGS, CLUTCH BAGS, COSMETIC BAGS SOLD EMPTY, GARMENT BAGS FOR TRAVEL, JEWELRY BAGS FOR TRAVEL, LEATHER BAGS FOR PACKING MERCHANDISE, LEATHER AND TEXTILE SHOPPING BAGS, MESH SHOPPING BAGS, WALLETS, CLASPS FOR BAGS, LUGGAGE, TRAVEL BAGS, ATTACHE CASES, TRAVEL CASES SOLD EMPTY, OVERNIGHT CASES, BRIEFCASES, DOCUMENT CASES, CREDIT CARD CASES, BUSINESS CARD CASES, COSMETIC CASES SOLD EMPTY, TOILETRY CASES AND VANITY CASES SOLD EMPTY, JEWELRY CASES OF LEATHER OR TEXTILE, KEY CASES AND LEATHER KEY CHAINS, LUGGAGE TRUNKS, LUGGAGE CASES AND LUGGAGE TAGS AND STRAPS FOR LUGGAGE (U.S. CLS. 1, 2, 3, 22 AND 41).

CLASS 25—CLOTHING

FOR APPAREL, NAMELY, ATHLETIC FOOTWEAR, BANDANAS, WRIST BANDS, BASEBALL CAPS, BATHING SUITS, BATHROBES, BEACHWEAR, CLOTHING BELTS, GARTER BELTS, BLOUSES, BODY SUITS, BOOTS, BOXER SHORTS, BRASSIERES, BRIEFS, BUSTIERS, CAMISOLES, CAPS, CHEMISES, COATS, CORSETS, COVERALLS, DRESSES, DRESSING GOWNS, EVENING GOWNS, FOOTWEAR, GLOVES, GOWNS, HALTER TOPS, HATS, HEAD WEAR, HEAD BANDS, JACKETS, JEANS, JERSEYS, JOGGING SUITS, JUMP-SUITS, KIMONOS, KNEE HIGHS, KNIT SHIRTS, LEG WARMERS, LINGERIE, MINISKIRTS, MONEY BELTS, NECKWEAR, OVERALLS, OVERCOATS, PAJAMAS, PANTIES, PANTS, ROBES, SANDALS, SARONGS, SCARVES, SHIRTS, SHOES, SHORTS, SKIRTS, SKORTS, SLEEPWEAR, SLIPPERS, SLIPS, SNEAKERS, SOCKS, SUITS, SUSPENDERS, SWEATERS, SWEATSHIRTS, SWIMWEAR, T-SHIRTS, TRACKSUITS, TROUSERS AND UNDERWEAR (U.S. CLS. 22 AND 39).

RICHARD A. STRASER, EXAMINING ATTORNEY

SN 78-947,443. NCF COMPUTING & NETWORK SERVICES, INC., OCALA, FL. FILED 8-8-2006.



THE MARK CONSISTS OF STYLIZED DESIGN OF A HUMAN FACE WEARING GLASSES.

CLASS 37—CONSTRUCTION AND REPAIR

FOR INSTALLATION, MAINTENANCE AND REPAIR OF COMPUTER HARDWARE AND COMPUTER SYSTEMS (U.S. CLS. 100, 103 AND 106).

FIRST USE 0-0-2001; IN COMMERCE 0-0-2001.

CLASS 42—SCIENTIFIC, COMPUTER AND LEGAL SERVICES

FOR INSTALLATION, MAINTENANCE AND REPAIR OF COMPUTER SOFTWARE (U.S. CLS. 100 AND 101).

FIRST USE 0-0-2001; IN COMMERCE 0-0-2001.

TAMARA FRAZIER, EXAMINING ATTORNEY

SN 78-947,474. LEUENBERGER LIGHTING COMPONENTS AG, SCHUTZENGRABEN 20, SWITZERLAND, FILED 8-8-2006.

LEUENBERGER

THE MARK CONSISTS OF STANDARD CHARACTERS WITHOUT CLAIM TO ANY PARTICULAR FONT, STYLE, SIZE, OR COLOR.

CLASS 9—ELECTRICAL AND SCIENTIFIC APPARATUS

FOR ANALOG AND DIGITAL COMPONENTS FOR LIGHTING EQUIPMENT, NAMELY, BALLASTS, ELECTRICAL SOCKETS, ELECTRICAL CONTACTS, ELECTRICAL IGNITERS, TRANSFORMERS, AND ELECTRICAL SWITCHES (U.S. CLS. 21, 23, 26, 36 AND 38).

CLASS 11—ENVIRONMENTAL CONTROL APPARATUS

FOR LAMP HOLDERS (U.S. CLS. 13, 21, 23, 31 AND 34).

ODESSA BIBBINS, EXAMINING ATTORNEY

SN 78-947,513. ESCOBAR & MARTINEZ S.A. E & M S.A., BOGOTA, COLOMBIA, FILED 8-8-2006.

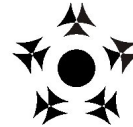

GOLTY

THE MARK CONSISTS OF A STYLIZED DESIGN OF PENTAGRAM WHERE EACH OF THE FIVE CORNERS CONSISTS OF THREE CONNECTING CONCAVED TRIANGLES. THE CURVATURE OF THESE TRIANGLES CREATES THE IMPRESSION OF TWO CIRCULAR RINGS. IN THE CENTER OF THE PENTAGRAM IS A DARK CIRCLE. BELOW THE DESIGN IS THE WORD GOLTY.

CLASS 25—CLOTHING

FOR DRESSES, SHOES, HATS (U.S. CLS. 22 AND 39).

CLASS 28—TOYS AND SPORTING GOODS

FOR ATHELETIC EQUIPMENT, NAMELY BOXING GLOVES, BASEBALL GLOVES, FENCING GLOVES AND GOLF GLOVES; GOLF BAGS; AND BALLS FOR GAMES (U.S. CLS. 22, 23, 38 AND 50).

RAY THOMAS, EXAMINING ATTORNEY

SN 78-947,551. NATIONAL GYPSUM PROPERTIES, LLC, CHARLOTTE, NC. FILED 8-8-2006.

FASTRACK

THE MARK CONSISTS OF STANDARD CHARACTERS WITHOUT CLAIM TO ANY PARTICULAR FONT, STYLE, SIZE, OR COLOR.

CLASS 17—RUBBER GOODS

FOR JOINT TREATMENT COMPOUND (U.S. CLS. 1, 5, 12, 13, 35 AND 50).

CLASS 19—NON-METALLIC BUILDING MATERIALS

FOR WALLBOARD (U.S. CLS. 1, 12, 33 AND 50).
JOANNA DUKOVIC, EXAMINING ATTORNEY

SN 78-947,561. WORLD SPORTS PRODUCTS, INC., SAINT GEORGE, UT. FILED 8-8-2006.

HEATER

THE MARK CONSISTS OF STANDARD CHARACTERS WITHOUT CLAIM TO ANY PARTICULAR FONT, STYLE, SIZE, OR COLOR.

CLASS 9—ELECTRICAL AND SCIENTIFIC APPARATUS

FOR ELECTRICAL POWER PRODUCTS, NAMELY, POWER INVERTERS AND POWER CONVERTERS; PORTABLE POWER SUPPLIES AND BACKUP POWER SUPPLIES; AND BATTERY CHARGERS; SPORTS EQUIPMENT, NAMELY, BASEBALL BATTING HELMETS (U.S. CLS. 21, 23, 26, 36 AND 38).

FIRST USE 6-1-2004; IN COMMERCE 6-1-2005.

CLASS 28—TOYS AND SPORTING GOODS

FOR SPORTS EQUIPMENT, NAMELY, BALL PITCHING MACHINES; BALL CAGES; BALL PITCHING SCREENS; BASEBALLS; BASEBALLS NOT SOFT; SOFTBALLS; TENNIS BALLS; BALL BATTING TEES; BATTING GLOVES; AND BALL RETURN APPARATUS FOR BASEBALL, SOFTBALL, AND TENNIS (U.S. CLS. 22, 23, 38 AND 50).

FIRST USE 6-1-2000; IN COMMERCE 6-1-2000.
JAMES GRIFFIN, EXAMINING ATTORNEY

SN 78-947,687. INVISIBLE CHILDREN INC., EL CAJON, CA. FILED 8-8-2006.

INVISIBLE CHILDREN

THE MARK CONSISTS OF STANDARD CHARACTERS WITHOUT CLAIM TO ANY PARTICULAR FONT, STYLE, SIZE, OR COLOR.

NO CLAIM IS MADE TO THE EXCLUSIVE RIGHT TO USE "CHILDREN", APART FROM THE MARK AS SHOWN.

CLASS 9—ELECTRICAL AND SCIENTIFIC APPARATUS

FOR PRE-RECORDED ELECTRONIC MEDIA FEATURING DOCUMENTARY, NON-FICTION, AND ENTERTAINMENT PROGRAMMING; MOTION PICTURE FILMS FEATURING DOCUMENTARIES AND NON-FICTIONAL STORIES (U.S. CLS. 21, 23, 26, 36 AND 38).

FIRST USE 6-1-2004; IN COMMERCE 6-1-2004.

CLASS 36—INSURANCE AND FINANCIAL

FOR CHARITABLE FUND RAISING; CHARITABLE SERVICES, NAMELY, PROVIDING FINANCIAL ASSISTANCE TO CHILDREN AND FAMILIES IN NEED (U.S. CLS. 100, 101 AND 102).

FIRST USE 6-1-2004; IN COMMERCE 8-1-2005.

CLASS 41—EDUCATION AND ENTERTAINMENT

FOR ENTERTAINMENT SERVICES, NAMELY, PROVIDING A SERIES OF DOCUMENTARY, NON-FICTIONAL, EDUCATIONAL AND ENTERTAINMENT PROGRAMS; PRODUCTION AND DISTRIBUTION OF DOCUMENTARY, NON-FICTIONAL, EDUCATIONAL AND ENTERTAINMENT MOTION PICTURE FILMS IN THE FIELD OF CURRENT AFFAIRS, INTERNATIONAL AFFAIRS, COMMENTARIES, AND BIOGRAPHIES; ENTERTAINMENT SERVICES IN THE NATURE OF DOCUMENTARIES AND NON-FICTIONAL PROGRAMS DISTRIBUTED BY POD CAST OR VIA GLOBAL COMPUTER NETWORK; CHARITABLE SERVICES, NAMELY, PROVIDING TRAINING IN THE FIELD OF HEALTH CARE, SAFETY, EMPLOYMENT, AND EDUCATION (U.S. CLS. 100, 101 AND 107).

FIRST USE 6-1-2004; IN COMMERCE 1-15-2005.
DOMINICK J. SALEMI, EXAMINING ATTORNEY

SN 78-947,775. EMINENCE ORGANIC SKIN CARE INC., VANCOUVER, CANADA, FILED 8-8-2006.

BOLDIJARRE

THE MARK CONSISTS OF STANDARD CHARACTERS WITHOUT CLAIM TO ANY PARTICULAR FONT, STYLE, SIZE, OR COLOR.

"THE NAME(S), PORTRAIT(S), AND/OR SIGNATURE(S) SHOWN IN THE MARK IDENTIFIES A LIVING INDIVIDUAL, WHOSE CONSENT(S) TO REGISTER IS SUBMITTED."

CLASS 41—EDUCATION AND ENTERTAINMENT

FOR EDUCATION SERVICES, NAMELY, PROVIDING CLASSES, SEMINARS AND WORKSHOPS IN THE FIELD OF SKIN CARE, BODY CARE AND BEAUTY CARE (U.S. CLS. 100, 101 AND 107).

CLASS 44—MEDICAL, BEAUTY AND AGRICULTURAL SERVICES

FOR BEAUTY SALONS; HEALTH SPA SERVICES, NAMELY, COSMETIC BODY CARE SERVICES; PROVIDING INFORMATION ABOUT BEAUTY; SKIN CARE SALONS (U.S. CLS. 100 AND 101).

CURTIS FRENCH, EXAMINING ATTORNEY

SN 78-948,185. PLASTIC TECHNIQUES, INC., GOFFSTOWN, NH. FILED 8-9-2006.

SN 78-948,557. AMERICAN ACADEMY OF ORTHOPAEDIC SURGEONS, ROSEMONT, IL. FILED S.R. 8-9-2006; AM. P.R. 7-25-2007.

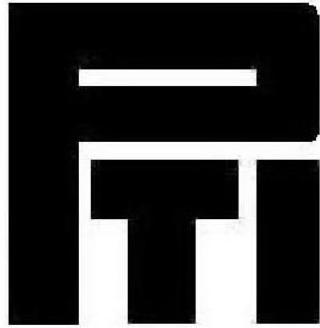

CLASS 7—MACHINERY

FOR ELECTRICALLY INSULATED BASKETS FOR USE WITH CHERRY PICKERS; COMPONENTS AND APPARATUS FOR USE WITH AERIAL LIFT BUCKETS, NAMELY, ELECTRICALLY INSULATED BUCKET LINERS, BUCKET STEPS, ALL SOLD AS A UNIT; SCABBARDS FOR CHAINSAWS FOR USE ON AERIAL LIFT BUCKETS; POWER SAW HOLDERS FOR MOUNTING ON AN AERIAL LIFT BOOM, SCUFF PADS FOR USE IN AERIAL LIFT BUCKETS; POWER TOOLS FOR USE WITH AERIAL BUCKET LIFTS, NAMELY, POWER DRIVEN WRENCHES (U.S. CLS. 13, 19, 21, 23, 31, 34 AND 35).

FIRST USE 11-19-1969; IN COMMERCE 11-19-1969.

CLASS 8—HAND TOOLS

FOR SCABBARDS FOR PRUNING SAWS FOR USE ON AERIAL LIFT BUCKETS; HAND SAW HOLDERS FOR MOUNTING ON AN AERIAL LIFT BOOM; TOOL TRAYS FOR USE WITH AERIAL BUCKET LIFTS, TOOL POUCHES FOR ATTACHMENTS TO TOOL BELTS, HAND TOOLS FOR USE WITH AERIAL BUCKET LIFTS, NAMELY, WRENCHES (U.S. CLS. 23, 28 AND 44).

FIRST USE 11-19-1969; IN COMMERCE 11-19-1969.

CLASS 9—ELECTRICAL AND SCIENTIFIC APPARATUS

FOR SAFETY EQUIPMENT FOR USE WITH AERIAL BUCKET LIFTS, NAMELY, FLASHING SAFETY AND UTILITY LIGHTS, BLANKET CANISTERS, GLOVE BOXES AND LINE HOSE BOXES, POLE HAULING LIGHTS, LINE HOSE SPREADERS, AND OUTRIGGER PADS (U.S. CLS. 21, 23, 26, 36 AND 38).

FIRST USE 11-19-1969; IN COMMERCE 11-19-1969.
DAVID COLLIER, EXAMINING ATTORNEY

OWNER OF U.S. REG. NOS. 2,147,400, 2,149,033 AND 2,357,561.

THE MARK CONSISTS OF A BLACK CIRCLE WITH THE WORDS "GETTING BETTER TOGETHER" INSIDE THE CIRCLE, AND THE WORDS "AMERICAN ACADEMY OF ORTHOPAEDIC SURGEONS" OUTSIDE THE CIRCLE.

SEC. 2(F) AMERICAN ACADEMY OF ORTHOPAEDIC SURGEONS.

CLASS 16—PAPER GOODS AND PRINTED MATTER

FOR PRINTED MATERIALS, NAMELY BROCHURES, PRINTED VISUALS IN THE NATURE OF PROMOTIONAL ITEMS, PAPER BANNERS, POSTERS IN THE FIELD OF ORTHOPAEDIC HEALTH (U.S. CLS. 2, 5, 22, 23, 29, 37, 38 AND 50).

FIRST USE 3-22-2006; IN COMMERCE 3-22-2006.

CLASS 35—ADVERTISING AND BUSINESS

FOR ASSOCIATION SERVICES, NAMELY, PROMOTING THE INTERESTS OF ORTHOPAEDIC SURGEONS AND PERSONS PRACTICING RELATED MEDICAL SPECIALTIES (U.S. CLS. 100, 101 AND 102).

FIRST USE 3-22-2006; IN COMMERCE 3-22-2006.

CLASS 41—EDUCATION AND ENTERTAINMENT

FOR EDUCATIONAL SERVICES, NAMELY, CONDUCTING SEMINARS AND CONFERENCES IN THE FIELD OF ORTHOPAEDIC HEALTH AND RELATED MEDICAL SPECIALTIES AND DISTRIBUTING COURSE MATERIALS IN CONNECTION THEREWITH (U.S. CLS. 100, 101 AND 107).

FIRST USE 3-22-2006; IN COMMERCE 3-22-2006.
MATTHEW MCDOWELL, EXAMINING ATTORNEY

SN 78-949,170. THE MINI DISTILLERY STORE LIMITED,
DUBLIN, IRELAND, FILED 8-10-2006.

SN 78-949,455. TRI-D INNOVATIONS, INC., LENEXA, KS.
FILED 8-10-2006.

THE MINI DISTILLERY STORE

THE MARK CONSISTS OF STANDARD CHARACTERS WITHOUT CLAIM TO ANY PARTICULAR FONT, STYLE, SIZE, OR COLOR.

NO CLAIM IS MADE TO THE EXCLUSIVE RIGHT TO USE "DISTILLERY STORE", APART FROM THE MARK AS SHOWN.

CLASS 33—WINES AND SPIRITS

FOR DISTILLED LIQUORS AND SPIRITS FOR HUMAN CONSUMPTION. (U.S. CLS. 47 AND 49).

CLASS 35—ADVERTISING AND BUSINESS

FOR RETAIL STORE SERVICES FEATURING INTERNATIONAL LIQUORS AND SPIRITS FOR HUMAN CONSUMPTION (U.S. CLS. 100, 101 AND 102).
ALYSSA PALADINO, EXAMINING ATTORNEY

SN 78-949,345. CONCERTS 101, LLC, TRUMBULL, CT.
FILED 8-10-2006.

CONCERTS 101

THE MARK CONSISTS OF STANDARD CHARACTERS WITHOUT CLAIM TO ANY PARTICULAR FONT, STYLE, SIZE, OR COLOR.

NO CLAIM IS MADE TO THE EXCLUSIVE RIGHT TO USE "CONCERTS", APART FROM THE MARK AS SHOWN.

CLASS 35—ADVERTISING AND BUSINESS

FOR ASSISTANCE WITH BUSINESS MANAGEMENT, PLANNING AND THE PROMOTION OF CONCERTS FOR OTHERS AND SEARCHING FOR TALENT IN CONNECTION THEREWITH (U.S. CLS. 100, 101 AND 102).

FIRST USE 3-31-2003; IN COMMERCE 3-31-2003.

CLASS 41—EDUCATION AND ENTERTAINMENT

FOR CONCERT TOUR AND PRODUCTION SERVICES, NAMELY, EVENT PLANNING (U.S. CLS. 100, 101 AND 107).

FIRST USE 3-31-2003; IN COMMERCE 3-31-2003.
JAY FLOWERS, EXAMINING ATTORNEY

JUST FUR FUN

THE MARK CONSISTS OF STANDARD CHARACTERS WITHOUT CLAIM TO ANY PARTICULAR FONT, STYLE, SIZE, OR COLOR.

CLASS 6—METAL GOODS

FOR METAL KEY CHAINS, METAL DOG TAGS (U.S. CLS. 2, 12, 13, 14, 23, 25 AND 50).

CLASS 9—ELECTRICAL AND SCIENTIFIC APPARATUS

FOR DECORATIVE MAGNETS (U.S. CLS. 21, 23, 26, 36 AND 38).

CLASS 16—PAPER GOODS AND PRINTED MATTER

FOR GREETING CARDS; BLANK WRITING JOURNALS; PAPER PARTY DECORATIONS; PAPER PARTY FAVORS; BOOK BINDINGS; PLASTIC OR PAPER BAGS FOR PACKAGING (U.S. CLS. 2, 5, 22, 23, 29, 37, 38 AND 50).

CLASS 18—LEATHER GOODS

FOR DECORATIVE PET ANIMAL CLOTHING ARTICLES AND ACCESSORIES, NAMELY BANDANAS, COLLARS, HATS, LEADS, LEASHES, COSTUMES, LEG WARMERS AND DECORATIVE TEXTILE LEG BANDS, AND DIAPERS; BACKPACKS (U.S. CLS. 1, 2, 3, 22 AND 41).

CLASS 20—FURNITURE AND ARTICLES NOT OTHERWISE CLASSIFIED

FOR PICTURE FRAMES NOT OF PRECIOUS METAL, LEATHER PICTURE FRAMES, NON-METAL DOG TAGS; PAPER PICTURE FRAMES (U.S. CLS. 2, 13, 22, 25, 32 AND 50).

CLASS 21—HOUSEWARES AND GLASS

FOR PET FEEDING DISHES, PET FOOD CONTAINERS (U.S. CLS. 2, 13, 23, 29, 30, 33, 40 AND 50).

CLASS 28—TOYS AND SPORTING GOODS

FOR PARTY FAVORS IN THE NATURE OF SMALL TOYS (U.S. CLS. 22, 23, 38 AND 50).

CLASS 31—NATURAL AGRICULTURAL PRODUCTS

FOR PET TREATS (U.S. CLS. 1 AND 46).
CHARLOTTE CORWIN, EXAMINING ATTORNEY

SN 78-949,759. MATTEL, INC., EL SEGUNDO, CA. FILED 8-10-2006.

SN 78-949,767. ADVANCED PHYTOCHEMICALS LLC, NEW YORK, NY. FILED 8-10-2006.

BARBIE AS THE ISLAND PRINCESS

THE MARK CONSISTS OF STANDARD CHARACTERS WITHOUT CLAIM TO ANY PARTICULAR FONT, STYLE, SIZE, OR COLOR.
OWNER OF U.S. REG. NOS. 689,055, 2,588,845 AND OTHERS.

CLASS 9—ELECTRICAL AND SCIENTIFIC APPARATUS

FOR ELECTRONICS, NAMELY, CALCULATORS, RADIOS INCORPORATING CLOCKS, TELEPHONES, RADIOS; MUSICAL, AUDIO AND VIDEO SOUND RECORDINGS FEATURING GAMES AND STORYTELLING; AUDIO AND VIDEO CASSETTES, CD-ROMS TAPES AND DISCS ALL FEATURING MUSIC, GAMES AND STORYTELLING; COMPUTER MOUSE, COMPUTER MOUSE PADS, COMPUTER SCREENSAVER PROGRAMS, COMPUTER GAME JOYSTICKS, VIDEO GAME CARTRIDGES, INTERACTIVE VIDEO GAME PROGRAMS, INTERACTIVE MULTIMEDIA COMPUTER GAME PROGRAMS, COMPUTER GAME CARTRIDGES; PRERECORDED COMPUTER STORYTELLING SOFTWARE; COMPUTER SOFTWARE, COMPUTER PROGRAMS AND CD-ROMS ALL FEATURING ACTIVITIES, EDUCATIONAL INFORMATION, STORIES, GAMES, AND THE LIKE FOR CHILDREN AND YOUNG ADULTS, AND FOR CREATING GRAPHIC DESIGNS FOR CREATING PRINTED MATERIALS SUCH AS GREETING CARDS, BANNERS, CALENDARS, AND THE LIKE (U.S. CLS. 21, 23, 26, 36 AND 38).

CLASS 18—LEATHER GOODS

FOR BAGS, NAMELY, BACKPACKS, CARRYING CASES, LUGGAGE, BEACH BAGS, GYM BAGS, SCHOOL BOOK BAGS, TOTE BAGS, OVERNIGHT BAGS, DUFFEL BAGS, HANDBAGS, COIN PURSES, KEY CASES, SUITCASES, FANNY PACKS, DAY PACKS, PURSES, TRUNKS, WALLETS (U.S. CLS. 1, 2, 3, 22 AND 41).

CLASS 25—CLOTHING

FOR CLOTHING, FOOTWEAR AND HEADGEAR, NAMELY, SHIRTS, PANTS, SKIRTS, SHORTS, HATS, SHOES, SOCKS, BELTS, UNDERGARMENTS, PAJAMAS, SCARVES, GLOVES AND MITTENS (U.S. CLS. 22 AND 39).

CLASS 28—TOYS AND SPORTING GOODS

FOR TOYS, GAMES AND PLAYTHINGS, NAMELY, DOLLS, DOLL CLOTHING, AND DOLL ACCESSORIES; TOY FIGURES; PLUSH TOYS; BOARD GAMES; PARLOR GAMES; MECHANICAL ACTION TOYS; FANTASY CHARACTER TOYS; INFLATABLE TOYS; LEVER ACTION TOYS; MUSICAL TOYS; CONSTRUCTION TOYS; BENDABLE TOYS; SOFT SCULPTURE TOYS; TALKING TOYS; POP UP TOYS; TOY BAKEWARE AND COOKWARE; TOY FURNITURE; TOY HOUSES, TOY BOXES; TOY VEHICLES AND ACCESSORIES THEREFOR; RIDE-ON TOYS; SAND TOYS; SKETCHING TOYS; DRAWING TOYS; AND PLAYSETS FOR AND THAT INCORPORATE THE FOREGOING; ACTION SKILL GAMES; CARD GAMES; HAND HELD UNITS FOR PLAYING ELECTRONIC GAMES; MANIPULATIVE GAMES; PARTY GAMES; PINATAS (U.S. CLS. 22, 23, 38 AND 50).
JUDITH HELFMAN, EXAMINING ATTORNEY

AP Advanced Phytochemicals

THE MARK CONSISTS OF STANDARD CHARACTERS WITHOUT CLAIM TO ANY PARTICULAR FONT, STYLE, SIZE, OR COLOR.

NO CLAIM IS MADE TO THE EXCLUSIVE RIGHT TO USE "ADVANCED PHYTOCHEMICALS", APART FROM THE MARK AS SHOWN.

CLASS 3—COSMETICS AND CLEANING PREPARATIONS

FOR PREPARATIONS FOR SKIN CARE AND TREATMENTS IN FORM OF FACE DAY CREAMS; FACE NIGHT CREAMS AND BODY, FACE, AND BATH LOTIONS; SKIN AND FACE CLEANERS; SUNSCREEN AND SUN BLOCK PREPARATIONS; SUN CARE PRODUCTS, NAMELY, AFTER-SUN CREAMS; ANTI-WRINKLE CREAMS; FACIAL MASKS AND BODY EMULSION WRAPS; FACIAL TONERS; EYE CLEANSERS, NAMELY, EYE MAKE-UP REMOVER; FACIAL CLEANSERS, EXFOLIANTS, MOISTURIZERS FOR FACE, EYES, HANDS AND BODY; SKIN LIGHTENERS; SKIN SOAPS; TOPICAL CELLULITE TREATMENT PREPARATIONS; NON-MEDICATED ANTI-BLEMISH SKIN LOTIONS; NON-MEDICATED ANTI-ACNE PREPARATIONS, NON-MEDICATED ANTI-CLOASMA PREPARATIONS, NAMELY, SKIN LOTIONS USED FOR THE TREATMENT OF FACIAL DISCOLORATION ASSOCIATED WITH PREGNANCY OR ORAL CONTRACEPTIVES; NON-MEDICATED BREAST-FIRMING CREAM PREPARATIONS (U.S. CLS. 1, 4, 6, 50, 51 AND 52).

CLASS 5—PHARMACEUTICALS

FOR NUTRITIONAL DIETARY SUPPORT SUPPLEMENTS AND NUTRITIONAL SUPPLEMENTS, NAMELY, ORGANIC HERBAL SUPPLEMENTS, PREPARATIONS AND COMPLEXES, NAMELY, NUTRITIONAL DRINK MIXES FOR USE AS MEAL REPLACEMENT, HERBAL BUD EXTRACTS IN FORM OF SYRUPS USED IN THE PREPARATION OF NUTRITIONAL DRINK MIXES; ANTI-ITCH OINTMENTS AND TINCTURES, NAMELY, A MEDICINE CONSISTING OF AN EXTRACT IN AN ALCOHOL SOLUTION (U.S. CLS. 6, 18, 44, 46, 51 AND 52).

JACLYN KIDWELL, EXAMINING ATTORNEY

SN 78-950,304. LEARN.COM, INC., SUNRISE, FL. FILED 8-11-2006.

WebRoominar

THE MARK CONSISTS OF STANDARD CHARACTERS WITHOUT CLAIM TO ANY PARTICULAR FONT, STYLE, SIZE, OR COLOR.

CLASS 35—ADVERTISING AND BUSINESS

FOR ARRANGING AND CONDUCTING BUSINESS CONFERENCES (U.S. CLS. 100, 101 AND 102).

CLASS 38—COMMUNICATION

FOR AUDIO BROADCASTING, AUDIO TELECONFERENCING, VIDEO AND AUDIO CONFERENCING VIA THE INTERNET, TELEPHONE COMMUNICATION SERVICES, ELECTRONIC TRANSMISSION OF DATA, DOCUMENTS AND MESSAGES VIA COMPUTER TERMINALS, NETWORK CONFERENCING SERVICES, NAMELY, AUDIO AND VIDEO CONFERENCING VIA THE INTERNET, PROVIDING MULTIPLE-USER ACCESS TO A GLOBAL COMPUTER INFORMATION NETWORK, PROVIDING ON-LINE CHAT ROOMS FOR TRANSMISSION OF MESSAGES AMONG COMPUTER USERS CONCERNING BUSINESS, SALES, MARKETING AND EDUCATION, PROVIDING ON-LINE QUIZZES, POLLS, COLLABORATION, DOCUMENT, COMPUTER AND APPLICATION SHARING WITH OR WITHOUT ASSOCIATED TELECONFERENCE, PROVIDING ON-LINE ELECTRONIC BULLETIN BOARDS FOR TRANSMISSION OF MESSAGES AMONG COMPUTER USERS CONCERNING BUSINESS, SALES, MARKETING AND EDUCATION, VIDEO TELECONFERENCING, TELEPHONIC VOICE MESSAGING SERVICES, VIDEO BROADCASTING AND VIDEO ON-DEMAND TRANSMISSION SERVICES (U.S. CLS. 100, 101 AND 104).

CLASS 41—EDUCATION AND ENTERTAINMENT

FOR ARRANGING AND CONDUCTING EDUCATIONAL CONFERENCES AND EDUCATIONAL SERVICES, NAMELY, CONDUCTING SEMINARS AND WORKSHOPS IN THE FIELD OF BUSINESS MANAGEMENT, SALES AND MARKETING, TEACHER TRAINING, ACCOUNTING, FINANCE, LAW AND SCIENCE (U.S. CLS. 100, 101 AND 107).

JOHN DALIER, EXAMINING ATTORNEY

SN 78-950,484. SILVER LININGS, LLC, WILLIAMSBURG, VA. FILED 8-11-2006.

CARYTOWN COFFEE SERVICE

THE MARK CONSISTS OF STANDARD CHARACTERS WITHOUT CLAIM TO ANY PARTICULAR FONT, STYLE, SIZE, OR COLOR.

NO CLAIM IS MADE TO THE EXCLUSIVE RIGHT TO USE "COFFEE SERVICE", APART FROM THE MARK AS SHOWN.

SEC. 2(F).

CLASS 30—STAPLE FOODS

FOR COFFEE; TEA (U.S. CL. 46).
FIRST USE 3-1-1979; IN COMMERCE 3-1-1979.

CLASS 43—HOTEL AND RESTAURANT SERVICES

FOR COFFEE SUPPLY SERVICES FOR OFFICES (U.S. CLS. 100 AND 101).
FIRST USE 3-1-1979; IN COMMERCE 3-1-1979.
CARYN GLASSER, EXAMINING ATTORNEY

SN 78-950,473. SILVER LININGS, LLC, WILLIAMSBURG, VA. FILED 8-11-2006.

SN 78-950,998. INTELLIGENT DIGITAL HORIZON, OAKTON, VA. FILED 8-13-2006.

CARYTOWN COFFEE & TEA CO.

THE MARK CONSISTS OF STANDARD CHARACTERS WITHOUT CLAIM TO ANY PARTICULAR FONT, STYLE, SIZE, OR COLOR.

NO CLAIM IS MADE TO THE EXCLUSIVE RIGHT TO USE "COFFEE & TEA CO.", APART FROM THE MARK AS SHOWN.

SEC. 2(F).

CLASS 30—STAPLE FOODS

FOR COFFEE; TEA (U.S. CL. 46).
FIRST USE 3-1-1979; IN COMMERCE 3-1-1979.

CLASS 43—HOTEL AND RESTAURANT SERVICES

FOR COFFEE SUPPLY SERVICES FOR OFFICES (U.S. CLS. 100 AND 101).
FIRST USE 3-1-1979; IN COMMERCE 3-1-1979.
CARYN GLASSER, EXAMINING ATTORNEY

SECURE MODEL CITY OF THE FUTURE

THE MARK CONSISTS OF STANDARD CHARACTERS WITHOUT CLAIM TO ANY PARTICULAR FONT, STYLE, SIZE, OR COLOR.

CLASS 37—CONSTRUCTION AND REPAIR

FOR INSTALLATION OF SECURITY SYSTEM (U.S. CLS. 100, 103 AND 106).
FIRST USE 4-30-2006; IN COMMERCE 12-1-2006.

CLASS 45—PERSONAL SERVICES

FOR CONSULTING SERVICES IN THE FIELD OF NATIONAL SECURITY; CONTROL OF BUILDING ENVIRONMENTAL ACCESS AND SECURITY SYSTEMS (U.S. CLS. 100 AND 101).

FIRST USE 4-30-2006; IN COMMERCE 4-30-2006.
KATHY DE JONGE, EXAMINING ATTORNEY

SN 78-951,389. JINSUNG T.E.C. CO., LTD., KYUNGKI-DO, REPUBLIC OF KOREA, FILED 8-14-2006.

SN 78-951,804. O.N.J. PRODUCTIONS, LTD., SANTA MONICA, CA. FILED 8-14-2006.



CLASS 7—MACHINERY

FOR MACHINE PARTS, NAMELY, IDLERS FOR MACHINE ENGINES; ENGINE TIMING COMPONENTS, NAMELY, CAM SPROCKETS AND CHAINS; ROLLER BEARINGS; AUTOMOTIVE PARTS, NAMELY, ENGINE AND TRANSMISSION SEALS (U.S. CLS. 13, 19, 21, 23, 31, 34 AND 35).

FIRST USE 10-22-2000; IN COMMERCE 10-22-2000.

CLASS 12—VEHICLES

FOR LAND VEHICLES PARTS, NAMELY, IDLER ARMS; REAR WHEEL SPROCKETS; PARTS OF MOTORCYCLES, NAMELY FORK SEALS (U.S. CLS. 19, 21, 23, 31, 35 AND 44).

FIRST USE 10-22-2000; IN COMMERCE 10-22-2000.
GINA HAYES, EXAMINING ATTORNEY

SN 78-951,550. BOARD OF REGENTS OF THE UNIVERSITY SYSTEM OF GEORGIA, ATLANTA, GA. FILED 8-14-2006.



SEC. 2(F) AS TO GEORGIA SOUTHWESTERN.

CLASS 25—CLOTHING

FOR CLOTHING, NAMELY, SHIRTS, T-SHIRTS, SHORTS, HATS, SWEAT SHIRTS, SWEAT PANTS, SOCKS (U.S. CLS. 22 AND 39).

FIRST USE 9-19-2005; IN COMMERCE 9-19-2005.

CLASS 41—EDUCATION AND ENTERTAINMENT

FOR EDUCATIONAL SERVICES, NAMELY, PROVIDING COURSES OF STUDY AT THE UNIVERSITY LEVEL AND ENTERTAINMENT SERVICES, NAMELY, PROVIDING INTERCOLLEGIATE SPORTING EVENTS (U.S. CLS. 100, 101 AND 107).

FIRST USE 9-19-2005; IN COMMERCE 9-19-2005.
JEFF DEFORD, EXAMINING ATTORNEY

OLIVIA

THE MARK CONSISTS OF STANDARD CHARACTERS WITHOUT CLAIM TO ANY PARTICULAR FONT, STYLE, SIZE, OR COLOR.

OWNER OF U.S. REG. NO. 2,887,394.

CLASS 3—COSMETICS AND CLEANING PREPARATIONS

FOR BLEACHING PREPARATIONS FOR LAUNDRY USE; ALL PURPOSE CLEANING PREPARATIONS; POLISHING PREPARATIONS; SCOURING LIQUIDS; GENERAL PURPOSE CLEANING, POLISHING AND ABRASIVE LIQUIDS AND POWDERS; SOAPS; PERFUMERY; ESSENTIAL OILS; COSMETICS; SHAMPOOS; DENTIFRICES; NON-MEDICATED SKIN CARE PREPARATIONS, LOTIONS FOR FACE AND BODY CARE (U.S. CLS. 1, 4, 6, 50, 51 AND 52).

CLASS 4—LUBRICANTS AND FUELS

FOR CANDLES (U.S. CLS. 1, 6 AND 15).

CLASS 5—PHARMACEUTICALS

FOR HOUSEHOLD DEODORANT; VITAMINS, MINERALS AND DIETARY AND NUTRITIONAL SUPPLEMENTS (U.S. CLS. 6, 18, 44, 46, 51 AND 52).

CLASS 9—ELECTRICAL AND SCIENTIFIC APPARATUS

FOR PRE-RECORDED COMPACT DISCS, LASER DISCS, CD ROMS, DVDS, DVD ROMS, VIDEO TAPES, CASSETTES, AND OTHER PRE-RECORDED OPTICAL, ELECTRONIC, AND MAGNETIC MEDIA FEATURING EXERCISE; AUDIO AND VISUAL RECORDINGS IN ALL FORMS, NAMELY, CASSETTE TAPES, COMPACT DISCS, PHONOGRAPH RECORDS, PRERECORDED AUDIO AND VIDEO TAPES, DISCS AND CASSETTES FEATURING EXERCISE; VIDEO CASSETTE CARTRIDGES AND VIDEO TAPES FEATURING EXERCISE, DOWNLOADABLE AUDIO AND VIDEO RECORDINGS FEATURING EXERCISE (U.S. CLS. 21, 23, 26, 36 AND 38).

CLASS 10—MEDICAL APPARATUS

FOR BREAST SELF-EXAMINATION KIT COMPRISED OF A BREAST SELF-EXAMINATION GLOVE, PERSONAL LUBRICANT, A CD AND EXPLANATORY NOTES FOR USE IN DETECTING BREAST CANCER (U.S. CLS. 26, 39 AND 44).

CLASS 14—JEWELRY

FOR PRECIOUS METALS AND THEIR ALLOYS; JEWELRY; PRECIOUS STONES; HOROLOGICAL AND CHRONOMETRIC INSTRUMENTS (U.S. CLS. 2, 27, 28 AND 50).

CLASS 28—TOYS AND SPORTING GOODS

FOR EXERCISE EQUIPMENT, NAMELY, MANUALLY-OPERATED EXERCISE EQUIPMENT (U.S. CLS. 22, 23, 38 AND 50).

CLASS 29—MEATS AND PROCESSED FOODS

FOR PREPARED MEALS COMPRISED OF ONE OR MORE OF – MEAT, FISH, POULTRY AND GAME; MEAT, FISH, POULTRY AND GAME; MEAT EXTRACTS; PRESERVED, DRIED AND COOKED FRUIT AND VEGETABLES; FRUIT JELLIES; JAMS; COMPOTES; EGGS; MILK; MILK PRODUCTS EXCLUDING ICE CREAM, ICE MILK AND FROZEN YOGURT; EDIBLE OILS AND FATS (U.S. CL. 46).

CLASS 30—STAPLE FOODS

FOR COFFEE, TEA, COCOA, SUGAR, RICE, TAPIOCA, SAGO, ARTIFICIAL COFFEE; FLOUR; CEREAL BASED SNACK FOOD; BREAD, PASTRY; FRUIT ICES; HONEY, TREACLE; YEAST, BAKING-POWDER; SALT, MUSTARD; VINEGAR; SAUCES; SPICES (U.S. CL. 46).

CLASS 31—NATURAL AGRICULTURAL PRODUCTS

FOR FRESH FRUITS; FRESH VEGETABLES; SEEDS FOR FRUIT AND VEGETABLES; LIVE PLANTS; CUT FLOWERS (U.S. CLS. 1 AND 46).

CLASS 32—LIGHT BEVERAGES

FOR MINERAL AND AERATED WATERS; NON-ALCOHOLIC DRINKS, NAMELY, FRUIT DRINKS; SYRUPS AND OTHER PREPARATIONS FOR MAKING BEVERAGES (U.S. CLS. 45, 46 AND 48).

CLASS 41—EDUCATION AND ENTERTAINMENT

FOR EDUCATION SERVICES, NAMELY PROVIDING CLASSES, SEMINARS AND WORKSHOPS IN THE FIELD OF PHYSICAL AND MENTAL HEALTH AND WELLNESS; NON-MEDICAL SELF-HELP TRAINING SERVICES IN THE FIELD OF MENTAL AND PHYSICAL HEALTH AND WELLNESS; ORGANIZING COMMUNITY CULTURAL EVENTS; PROVIDING INFORMATION IN THE FIELD OF FITNESS OVER A GLOBAL INFORMATION NETWORK (U.S. CLS. 100, 101 AND 107).

CLASS 43—HOTEL AND RESTAURANT SERVICES

FOR PROVIDING OF FOOD AND DRINK FOR PATIENTS AND GUESTS; SPA SERVICES, NAMELY, PROVIDING TEMPORARY ACCOMMODATIONS AND MEALS TO CLIENTS OF A HEALTH OR BEAUTY SPA (U.S. CLS. 100 AND 101).

CLASS 44—MEDICAL, BEAUTY AND AGRICULTURAL SERVICES

FOR PROVIDING A WEBSITE FEATURING INFORMATION IN THE FIELD OF MENTAL HEALTH AND WELLNESS; PROVIDING INFORMATION IN THE FIELD OF OVERALL MENTAL AND PHYSICAL HEALTH AND WELLNESS, OVER A GLOBAL INFORMATION NETWORK (U.S. CLS. 100 AND 101).
ELIZABETH KAJUBI, EXAMINING ATTORNEY

SN 78-951,899, PETROFAC SERVICES LIMITED, LONDON, UNITED KINGDOM, FILED 8-14-2006.

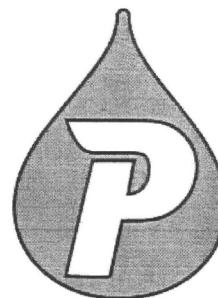

OWNER OF ERPN CMNTY TM OFC REG. NO. 4232451, DATED 4-3-2006, EXPIRES 1-7-2015.

THE MARK CONSISTS OF THE LETTER P INSIDE A DROP OF LIQUID.

CLASS 35—ADVERTISING AND BUSINESS

FOR BUSINESS MANAGEMENT; BUSINESS ADMINISTRATION; PROVIDING OFFICE FUNCTIONS; BUSINESS MANAGEMENT AND CONSULTANCY SERVICES; BENCHMARKING, NAMELY, EVALUATION OF BUSINESS ORGANIZATION PRACTICES; ADVICE IN THE FIELD OF BUSINESS MANAGEMENT; BUSINESS SERVICES, NAMELY, MANAGEMENT OF OIL REFINING AND PROCESSING FACILITIES, OIL AND GAS PRODUCTION FACILITIES, GAS TREATING FACILITIES AND PETROCHEMICAL FACILITIES FOR OTHERS; BUSINESS SERVICES, NAMELY, MANAGEMENT OF BUSINESS PROJECTS; COMMERCIAL MANAGEMENT; INDUSTRIAL MANAGEMENT ASSISTANCE; PROCUREMENT SERVICES, NAMELY, PURCHASING EQUIPMENT AND MATERIALS USED IN THE CONSTRUCTION OF HYDROCARBON AND PETROCHEMICAL FACILITIES, INCLUDING COMPRESSORS, PUMPS AND HEAT EXCHANGERS FOR OTHERS; PERSONNEL RECRUITMENT SERVICES; ADVISORY SERVICES RELATING TO PERSONNEL RECRUITMENT; PROVISION OF CONSULTANCY SERVICES IN RELATION TO BUSINESS ADMINISTRATION, BUSINESS MANAGEMENT, COMMERCIAL MANAGEMENT, INDUSTRIAL MANAGEMENT, FACILITIES MANAGEMENT; PROCUREMENT AND PERSONNEL RECRUITMENT; PROVIDING BUSINESS INFORMATION IN RELATION TO BUSINESS ADMINISTRATION, BUSINESS MANAGEMENT, COMMERCIAL MANAGEMENT, INDUSTRIAL MANAGEMENT, FACILITIES MANAGEMENT; PROCUREMENT AND PERSONNEL RECRUITMENT; ACCOUNTANCY SERVICES; ACCOUNTING SERVICES (U.S. CLS. 100, 101 AND 102).

CLASS 36—INSURANCE AND FINANCIAL

FOR INSURANCE, NAMELY, INSURANCE CONSULTATION AND ADVICE RELATING TO INSURANCE; FINANCIAL CONSULTATION; MONETARY CONSULTATION; PROJECT FINANCING FOR ENGINEERING CONSTRUCTION; INVESTMENT SERVICES, NAMELY, ASSET EVALUATION; FINANCING SERVICES; ASSET-BASED FINANCING SERVICES; FINANCIAL MANAGEMENT; INVESTMENT MANAGEMENT, NAMELY, INVESTMENT ASSET MANAGEMENT; ADVISORY SERVICES RELATING TO INSURANCE AND FINANCIAL RISK MANAGEMENT; INVESTMENT SERVICES, NAMELY, PROJECT FINANCING IN THE FIELD OF ENGINEERING/CONSTRUCTION PROJECTS; INVESTMENT MANAGEMENT; FUNDS INVESTMENT; INVESTMENT CONSULTATION; ADVICE RELATING TO INVESTMENTS; INVESTMENT SERVICES, NAMELY, INVESTMENT ASSET MANAGEMENT; PROVISION OF CONSULTANCY SERVICES IN RELATION TO INSURANCE, FINANCING, INVESTMENT, AND FINANCIAL MANAGEMENT; PROVISION OF INFORMATION IN RELATION TO INSURANCE, FINANCING, INVESTMENT, AND FINANCIAL MANAGEMENT (U.S. CLS. 100, 101 AND 102).

CLASS 37—CONSTRUCTION AND REPAIR

FOR BUILDING CONSTRUCTION; REPAIR OF BUILDINGS, OIL REFINING AND PROCESSING FACILITIES, OIL AND GAS PRODUCTION FACILITIES, GAS TREATING FACILITIES AND PETROCHEMICAL FACILITIES; INSTALLATION OF EQUIPMENT FOR REFINING AND PROCESSING OIL, EQUIPMENT FOR OIL AND GAS PRODUCTION, EQUIPMENT FOR TREATING GAS AND PETROCHEMICALS; CONSTRUCTION AND REPAIR OF BUILDINGS; BUILDING MAINTENANCE SERVICE; ONSITE CONSTRUCTION MANAGEMENT RELATING TO THE MAINTENANCE, CONSTRUCTION AND REFURBISHMENT OF BUILDINGS, PLANTS, AND FACILITIES INCLUDING INDUSTRIAL FACILITIES; CONSTRUCTION MANAGEMENT SERVICES; CONSTRUCTION OF NEW AND MODIFICATION OF EXISTING OIL REFINING AND PROCESSING FACILITIES, OIL AND GAS PRODUCTION FACILITIES, GAS TREATING FACILITIES AND PETROCHEMICAL FACILITIES; MAINTENANCE OF OIL REFINING AND PROCESSING FACILITIES, OIL AND GAS PRODUCTION FACILITIES, GAS TREATING FACILITIES AND PETROCHEMICAL FACILITIES; ON-SITE PROJECT CONSTRUCTION MANAGEMENT; PROVISION OF CONSULTANCY SERVICES IN RELATION TO CONSTRUCTING, MAINTAINING, AND REFURBISHING BUILDINGS AND INDUSTRIAL FACILITIES; PROVISION OF INFORMATION IN RELATION TO CONSTRUCTING, MAINTAINING, AND REFURBISHING BUILDINGS AND INDUSTRIAL FACILITIES (U.S. CLS. 100, 103 AND 106).

CLASS 41—EDUCATION AND ENTERTAINMENT

FOR EDUCATION, NAMELY, CONDUCTING PROGRAMS, CONFERENCES AND TRAINING EVENTS IN THE FIELDS OF OIL AND GAS OPERATIONS, SAFETY, CRISES MANAGEMENT, WELL SERVICES AND DRILLING, SPECIALIST OIL AND GAS EQUIPMENT, LOGISTICS, BUSINESS ADMINISTRATION, BUSINESS MANAGEMENT, COMMERCIAL MANAGEMENT, INDUSTRIAL MANAGEMENT, FACILITIES MANAGEMENT, PROCUREMENT AND PERSONNEL RECRUITMENT, INSURANCE, FINANCING, INVESTMENT, FINANCIAL MANAGEMENT AND ACCOUNTING SERVICES, CONSTRUCTING, MAINTAINING AND REFURBISHING BUILDINGS, PLANTS, AND FACILITIES INCLUDING INDUSTRIAL FACILITIES; TRAINING SERVICES IN THE FIELD OF OIL AND GAS OPERATIONS, SAFETY, CRISES MANAGEMENT, WELL SERVICES AND DRILLING, SPECIALIST OIL AND GAS EQUIPMENT, LOGISTICS, BUSINESS ADMINISTRATION, BUSINESS MANAGEMENT, COMMERCIAL MANAGEMENT, INDUSTRIAL MANAGEMENT, FACILITIES MANAGEMENT, PROCUREMENT AND PERSONNEL RECRUITMENT, INSURANCE, FINANCING, INVESTMENT, FINANCIAL MANAGEMENT AND AC-

COUNTING SERVICES, CONSTRUCTING, MAINTAINING AND REFURBISHING BUILDINGS, PLANTS, AND FACILITIES INCLUDING INDUSTRIAL FACILITIES; PROVIDING EDUCATIONAL COURSES IN THE FIELD OF ENGINEERING; TRAINING IN THE FIELD OF OCCUPATIONAL SAFETY; PROVISION OF CONSULTANCY SERVICES IN RELATION TO ENGINEERING EDUCATION AND OCCUPATIONAL SAFETY EDUCATION; PROVISION OF INFORMATION IN RELATION TO ENGINEERING EDUCATION AND OCCUPATIONAL SAFETY EDUCATION (U.S. CLS. 100, 101 AND 107).

CLASS 42—SCIENTIFIC, COMPUTER AND LEGAL SERVICES

FOR SCIENTIFIC RESEARCH; PROVIDING TECHNOLOGY INFORMATION IN THE OIL AND GAS INDUSTRY; RESEARCH AND DESIGN FOR OTHERS IN THE FIELD OF OIL AND GAS PRODUCTION, OIL REFINING AND PROCESSING, GAS AND PETROCHEMICAL TREATMENT; TECHNOLOGY SUPERVISION AND INSPECTION IN THE FIELD OF OIL AND GAS PRODUCTION, OIL REFINING AND PROCESSING, GAS AND PETROCHEMICAL TREATMENT; INDUSTRIAL ANALYSIS IN THE FIELD OF OIL, GAS AND PETROCHEMICALS AND RESEARCH SERVICES RELATING THERETO; DESIGN AND DEVELOPMENT OF COMPUTER HARDWARE AND SOFTWARE; ENGINEERING; CIVIL ENGINEERING; CONSTRUCTION ENGINEERING; ENGINEERING CONSULTANCY; ENGINEERING PLANNING SERVICES FOR OTHERS; ENGINEERING PROJECT STUDIES FOR OTHERS; ENGINEERING RESEARCH; ENGINEERING SURVEYING; TECHNICAL ENGINEERING; DESIGN FOR OTHERS IN THE FIELD OF ENGINEERING; ENGINEERING AND DESIGN OF OIL REFINING AND PROCESSING FACILITIES, OIL AND GAS PRODUCTION FACILITIES, GAS TREATING FACILITIES AND PETROCHEMICAL FACILITIES; TECHNICAL TESTING OF SPECIALIST OIL AND GAS EQUIPMENT, INDUSTRIAL PLANTS AND INDUSTRIAL FACILITIES FOR OTHERS; TECHNICAL CONSULTANCY SERVICES RELATING TO INFORMATION TECHNOLOGY; QUALITY CONTROL FOR OTHERS IN THE FIELDS OF OIL AND GAS PRODUCTION, OIL REFINING AND PROCESSING, GAS AND PETROCHEMICAL TREATMENT; QUALITY CONTROL TESTING FOR OTHERS IN THE FIELDS OF OIL AND GAS PRODUCTION, OIL REFINING AND PROCESSING, GAS AND PETROCHEMICAL TREATMENT; ADVISORY SERVICES RELATING TO ENVIRONMENTAL POLLUTION; ADVISORY SERVICES RELATING TO ENVIRONMENTAL PROTECTION; CONSULTING SERVICES IN THE FIELD OF ENVIRONMENTAL HAZARD ASSESSMENT; ENVIRONMENTAL SERVICES, NAMELY, DETECTION OF ENVIRONMENTAL CONTAMINATION; CONSULTANCY SERVICES IN RELATION TO COMPLIANCE WITH INDUSTRIAL HEALTH AND SAFETY LAWS AND REGULATIONS; PROVISION OF CONSULTANCY SERVICES IN RELATION TO SCIENTIFIC RESEARCH, INDUSTRIAL ANALYSIS, ENGINEERING, ENVIRONMENTAL SCIENCE, AND COMPLIANCE WITH INDUSTRIAL HEALTH AND SAFETY LAWS AND REGULATIONS; PROVISION OF INFORMATION IN RELATION TO SCIENTIFIC RESEARCH, INDUSTRIAL ANALYSIS, ENGINEERING, ENVIRONMENTAL SCIENCE, AND COMPLIANCE WITH INDUSTRIAL HEALTH AND SAFETY LAWS AND REGULATIONS (U.S. CLS. 100 AND 101).

MARGARET POWER, EXAMINING ATTORNEY

SN 78-951,905. CALVERT, CRAIG R., AUSTIN, TX. FILED 8-14-2006.

Wheatfield

THE MARK CONSISTS OF STANDARD CHARACTERS WITHOUT CLAIM TO ANY PARTICULAR FONT, STYLE, SIZE, OR COLOR.

CLASS 9—ELECTRICAL AND SCIENTIFIC APPARATUS

FOR MUSICAL SOUND RECORDINGS (U.S. CLS. 21, 23, 26, 36 AND 38).
FIRST USE 5-1-1973; IN COMMERCE 5-1-1973.

CLASS 41—EDUCATION AND ENTERTAINMENT

FOR ENTERTAINMENT IN THE NATURE OF LIVE PERFORMANCES BY A MUSICAL GROUP (U.S. CLS. 100, 101 AND 107).
FIRST USE 5-1-1973; IN COMMERCE 5-1-1973.
CARYN GLASSER, EXAMINING ATTORNEY

SN 78-952,184. KABUSHIKI KAISHA NTT DOCOMO, DOING BUSINESS AS NTT DOCOMO, INC., TOKYO, JAPAN, FILED 8-15-2006.



CLASS 9—ELECTRICAL AND SCIENTIFIC APPARATUS

FOR ROBOTS FOR ENTERTAINMENT USE INCLUDING THOSE CAPABLE OF COMMUNICATING VIA A GLOBAL COMPUTER NETWORK (U.S. CLS. 21, 23, 26, 36 AND 38).

CLASS 28—TOYS AND SPORTING GOODS

FOR GAMES, NAMELY, COIN-OPERATED VIDEO GAMES, ELECTRONIC DART GAMES AND HAND-HELD UNITS FOR PLAYING ELECTRONIC GAMES; DECORATIONS FOR CHRISTMAS TREES, TOYS, NAMELY, INFANT DEVELOPMENT TOYS, MECHANICAL TOYS AND PET TOYS; BACKGAMMON GAMES; DOLLS; DOMINOS; TOY MOBILES; PARLOR GAMES; PLAY BALLOONS (U.S. CLS. 22, 23, 38 AND 50).

CLASS 35—ADVERTISING AND BUSINESS

FOR PROVIDING BUSINESS DIRECTORY INFORMATION RELATING TO ADVERTISEMENTS, TO THE SALE OF GOODS, AND TO SHOPS CLASSIFIED BY THE TYPE OF BUSINESS VIA WIRELESS COMMUNICATION SERVICES; PROVIDING BUSINESS INFORMATION RELATING TO SALES VOLUME TRACKING AND COMMERCIAL INFORMATION VIA WIRELESS COMMUNICATION SERVICES; ADVERTISING AGENCIES; DISSEMINATION OF ADVERTISING MATTER; PREPARING ADVERTISEMENTS FOR OTHERS; THE BRINGING TOGETHER FOR THE BENEFIT OF OTHERS, OF A WIDE VARIETY OF GOODS ENABLING CUSTOMERS TO CONVENIENTLY VIEW AND PURCHASE THOSE GOODS; PROMOTING THE GOODS AND SERVICES OF OTHERS BY MEANS OF OPERATING A SHOPPING MALL WITH LINKS TO THE RETAIL WEB SITES OF OTHERS VIA WIRELESS COMMUNICATION SERVICES; COMPUTERIZED ORDERING SERVICES IN THE FIELD OF FOOD, DAILY NECESSITIES AND ENTERTAINMENT, VIA TELEPHONE, COMPUTER TERMINALS, CELLULAR TELEPHONES, PDA AND WIRELESS COMMUNICATION SERVICES; ARRANGING AND CONDUCTING OF TRADE SHOW AND BUSINESS EXHIBITIONS FOR ADVERTISING PURPOSES IN THE FIELD OF TELECOMMUNICATIONS AND COMPUTERS; RENTAL OF ADVERTISING SPACE; TELEPHONE ANSWERING SERVICES; SECRETARIAL AGENCY SERVICES FOR RECEIVING TELEPHONE CALLS; MARKET RESEARCH VIA A COMPUTER DATA BASE; BUSINESS MANAGEMENT AND CONSULTATION; SALES PROMOTION AND ADVERTISING SERVICES FOR COMMUNICATION TERMINALS AND TELECOMMUNICATION SERVICES; BUSINESS MANAGEMENT; BUSINESS ADMINISTRATION; BUSINESS MANAGEMENT CONSULTANCY; BUSINESS ORGANIZATION CONSULTANCY; BUSINESS MANAGEMENT ASSISTANCE, BUSINESS APPRAISALS; BUSINESS RESEARCH; BUSINESS ENTERPRISE RESOURCE PLANNING; EFFICIENCY EXPERTS; ADVISORY SERVICES FOR BUSINESS MANAGEMENT; RELOCATION SERVICES FOR BUSINESSES; PROMOTING THE GOODS AND SERVICES OF OTHERS BY PREPARING AND PLACING ADVERTISEMENTS IN AN ELECTRONIC MAGAZINE ACCESSED THROUGH A GLOBAL COMPUTER NETWORK AND INFORMATION SERVICES RELATING THERETO; BUSINESS ADMINISTRATION SERVICES FOR THE PROCESSING OF SALES MADE ON A GLOBAL COMPUTER NETWORK; PROVIDING AUCTION SERVICES VIA A GLOBAL COMPUTER NETWORK; WORLDWIDE BILLING SERVICES; MONITORING SERVICES INVOLVING THE USE OF TWO-WAY WIRELESS COMMUNICATION SYSTEMS, GLOBAL POSITIONING SYSTEMS, AND COMPUTER INTEGRATION SYSTEMS TO ASCERTAIN THE GEOGRAPHIC LOCATIONS OF MOTOR VEHICLES AND INDIVIDUALS FOR COMMERCIAL OR BUSINESS PURPOSES (U.S. CLS. 100, 101 AND 102).

CLASS 36—INSURANCE AND FINANCIAL

FOR RENTAL OF OFFICE SPACE FOR ADVERTISING PURPOSES; CREDIT CARD SERVICES; PROVIDING INFORMATION RELATING TO STOCK, FINANCE AND FOREIGN EXCHANGE MARKET CONDITIONS, REAL ESTATE, AND INSURANCE; REAL ESTATE MANAGEMENT SERVICES; BANKING SERVICES CONDUCTED VIA A GLOBAL COMPUTER NETWORK LINKED BY COMMON PROTOCOLS; ELECTRONIC MONEY TRANSFER; FINANCIAL SERVICES RELATING TO ELECTRONIC COMMERCE, NAMELY, PROVIDING ELECTRONIC COMMERCE SERVICES, NAMELY, TELECOMMUNICATION PREPAID DEBIT CARD SERVICES, ON-LINE FINANCIAL PLANNING RESEARCH AND ANALYSIS SERVICES; FINANCIAL SERVICES, NAMELY, AGENCIES FOR COLLECTING CHARGES FOR INFORMATION PROVIDERS RENDERED BY TELECOMMUNICATION FEE COLLECTING SYSTEM; PREPAID STORED VALUE CARD SERVICES FOR PAYMENT OF TELEPHONE CALLS, SUBWAY, BUS AND RAIL ROAD FARES, BRIDGE AND TUNNEL TOLLS, MERCHANDISE COSTS AND LOW VALUE ELECTRONIC DEBIT TRANSACTIONS; COLLECTION

AGENCY SERVICES FOR OTHERS IN THE FIELD OF ELECTRONIC COMMERCE VIA WIRELESS COMMUNICATION SERVICES; ONLINE COLLECTION AGENCY SERVICES, NAMELY, COLLECTING LIABILITIES FOR OTHERS FOR PROVIDING INFORMATION OVER COMPUTERS; ELECTRONIC FUNDS TRANSFERS AND TRANSACTIONS; PROVIDING ELECTRONIC BANKING SERVICES; COMPUTERIZED FINANCIAL AND INSURANCE INFORMATION PROVIDED VIA WIRELESS COMMUNICATION SERVICES; HOME BANKING SERVICES; INTERNET HOME BANKING (U.S. CLS. 100, 101 AND 102).

CLASS 37—CONSTRUCTION AND REPAIR

FOR INSTALLATION OF TELECOMMUNICATION NETWORKS, INSTALLATION OF COMMUNICATION EQUIPMENT, MAINTENANCE AND REPAIR OF TELECOMMUNICATION NETWORKS, MAINTENANCE AND REPAIR OF COMMUNICATION EQUIPMENT; INSTALLATION AND REPAIR OF TELECOMMUNICATION APPARATUS; INSTALLATION AND REPAIR OF COMPUTER HARDWARE; REPAIR AND MAINTENANCE OF TELECOMMUNICATION APPARATUS AND INSTRUMENTS; REPAIR AND MAINTENANCE OF COMPUTERS; INSTALLATION, REPAIR AND MAINTENANCE OF SUBMARINE CABLES, AERIAL POWER TRANSMISSION WIRE, COMMUNICATION EQUIPMENT FOR CONTROL IN BUILDINGS, TELECOMMUNICATION SYSTEMS, TELECOMMUNICATION FOR CONTROL IN BUILDING, TELECOMMUNICATION FACILITIES, DATA COMMUNICATION FACILITIES, COMPUTER SYSTEMS; BUILDING CONSTRUCTION; CONSTRUCTION OF COMMUNICATION PLANTS; INSTALLATION AND REPAIR OF TELEPHONE SETS AND TELEPHONE WIRE; RENTAL AND LEASING OF CONSTRUCTION EQUIPMENT, CIVIL ENGINEERING MACHINERY, EARTH MOVING EQUIPMENT AND EXCAVATORS; PROVIDING INFORMATION RELATING TO BUILDING CONSTRUCTION AND REPAIR; CONSULTATION AND SUPERVISION IN THE FIELD OF CONSTRUCTION; MAINTENANCE OF ELECTRICAL FACILITIES INSTALLED IN BUILDINGS, AND OF BUILDING FACILITIES; DISINFECTING TELEPHONE SETS (U.S. CLS. 100, 103 AND 106).

CLASS 38—COMMUNICATION

FOR PROVIDING CHAT ROOMS FOR TRANSMISSION OF MESSAGES AMONG COMPUTER USERS CONCERNING ENTERTAINMENT, EDUCATION, TECHNOLOGY, CULTURE, MUSIC, SPORTS, FASHION, LANGUAGE, IMAGES, LIVING INFORMATION, PERSONAL COMPUTERS, IT RELATED MATTER, CURRENT EVENTS AND LIFESTYLES; STREAMING OF AUDIO MATERIAL ON THE INTERNET (U.S. CLS. 100, 101 AND 104).

CLASS 39—TRANSPORTATION AND STORAGE

FOR TRANSPORTATION OF PASSENGERS AND/OR GOODS BY AIR, RAIL, BOATS AND VEHICLES; PACKAGING ARTICLES FOR TRANSPORTATION AND WAREHOUSE STORAGE OF GOODS; TRAVEL AGENCY SERVICES, NAMELY, MAKING RESERVATIONS AND BOOKINGS FOR TRANSPORTATION ARRANGEMENT; PROVIDING TRAVEL AND TRANSPORTATION INFORMATION (U.S. CLS. 100 AND 105).

CLASS 40—MATERIAL TREATMENT

FOR CHEMICAL TREATMENT FOR CLOTHING, LEATHER STAINING, PAPER FINISHING, ELECTROPLATING FOR METALS, CERAMIC GLAZING, GOLD-PLATING, GLASS ETCHING; INFORMATION SERVICES RELATING TO TREATMENT OF CLOTHING, LEATHER STAINING, PAPER FINISHING, ELECTROPLATING FOR METALS, FOOD TREATMENT FOR STORAGE, CERAMIC BURNING, GOLD-PLATING, FOR DYEING, GLASS ETCHING, PROVIDED VIA WIRELESS COMMUNICATION SERVICES FROM A COMPUTER DATABASE OR A GLOBAL COMPUTER NETWORK (U.S. CLS. 100, 103 AND 106).

CLASS 41—EDUCATION AND ENTERTAINMENT

FOR PRODUCTION OF TELEVISION PROGRAMS BY USING COMPUTER GRAPHICS; DEVELOPMENT AND DISSEMINATION OF EDUCATIONAL MATERIALS OF OTHERS IN THE FIELD OF COMPUTERS; PROVIDING INFORMATION RELATING TO EDUCATION AND ENTERTAINMENT, MOVIES, SPORTS, SCENIC SPOTS, PLACES OF HISTORIC INTEREST, AND RECREATION; THEATRICAL BOOKING AGENCIES; TRAINING IN THE USE AND OPERATION OF A WIDE VARIETY OF EQUIPMENT, NAMELY, COMPUTERS, CAMERAS, COMMUNICATION APPARATUS AND AUDIO-VIDEO EQUIPMENT; PUBLICATION OF BOOKS AND MAGAZINES; PROVIDING A COMPUTER GAME PLAYED BY USING COMPUTER TERMINAL TELECOMMUNICATION; RENTAL AND LEASING OF TELEVISION GAME TOYS; RENTAL OF AMUSEMENT FACILITIES EQUIPPED WITH GAME MACHINES; ELECTRONIC LIBRARIES PROVIDING ELECTRONICALLY RECORDED NEWSPAPERS, MAGAZINES, PHOTOGRAPHS, PICTURES, MUSIC, ANIMATED CARTOONS, COMPUTER PROGRAMS TO COMPUTERS LINKED TO A NETWORK; EDUCATION IN THE NATURE OF TRAINING IN THE FIELD OF SALES TECHNIQUE PROVIDED BY TELEPHONE; ORGANIZATION, BY TELEPHONE, OF SEMINARS RELATING TO SALES TECHNIQUE; EDUCATIONAL SERVICES, NAMELY, CONDUCTING SEMINARS IN THE FIELD OF INFORMATION PROCESSING; ARRANGING AND CONDUCTING EDUCATIONAL SEMINARS, SYMPOSIA AND CONFERENCES IN THE FIELD OF ENTERTAINMENT, EDUCATION, TECHNOLOGY, CULTURE, IMAGES, FASHION, NEWS, SPORTS AND LIVING INFORMATION; ORGANIZING EXHIBITIONS FOR CULTURAL AND EDUCATIONAL PURPOSES IN THE FIELDS OF ENTERTAINMENT, EDUCATION, TECHNOLOGY, CULTURE, IMAGES, FASHION, NEWS, SPORTS AND LIVING INFORMATION; RENTAL OF RECORDED MAGNETIC TAPES, GAME CARTRIDGES, MAGNETIC DISKS AND OPTICAL RECORDING MEDIA IN WHICH GAME PROGRAMS ARE RECORDED, VIDEOTAPES, SOUND RECORDINGS, RADIOS AND TELEVISIONS; LENDING LIBRARIES; PROVIDING MUSEUM FACILITIES; RENTAL OF EXHIBITION HALLS AND STADIUM FACILITIES; INFORMATION RELATING TO ENTERTAINMENT OR EDUCATION, PROVIDED VIA WIRELESS COMMUNICATION SERVICES FROM A COMPUTER DATABASE OR A GLOBAL COMPUTER NETWORK; ELECTRONIC GAMES SERVICES PROVIDED BY MEANS OF A GLOBAL COMPUTER NETWORK; ELECTRONIC LIBRARY SERVICES, NAMELY, SERVICES WHICH FEATURE NEWSPAPERS, MAGAZINES, PHOTOGRAPHS AND PICTURES VIA COMPUTER NETWORK; PROVIDING DIGITAL MUSIC NOT DOWNLOADABLE FROM A GLOBAL COMPUTER NETWORK; PROVIDING ON-LINE PUBLICATIONS, NAMELY, NEWSPAPERS, BOOKS, MAGAZINES IN THE FIELD OF ENTERTAINMENT, EDUCATION, TECHNOLOGY AND CULTURE VIA WIRELESS TELECOMMUNICATION SERVICES (U.S. CLS. 100, 101 AND 107).

CLASS 42—SCIENTIFIC, COMPUTER AND LEGAL SERVICES

FOR CONSULTATION IN THE FIELD OF CIVIL ENGINEERING (U.S. CLS. 100 AND 101).

WON TEAK OH, EXAMINING ATTORNEY

SN 78-952,561. TEQUILA CUERVO LA ROJENA, S.A. DE C.V., ZAPOPAN JALISCO, MEXICO, FILED 8-15-2006.

SN 78-952,590. TEQUILA CUERVO LA ROJENA, S.A. DE C.V., ZAPPON JALISCO, MEXICO, FILED 8-15-2006.

JOSE CUERVO BEERBUDDY

JOSE CUERVO BEER BOOSTER

THE MARK CONSISTS OF STANDARD CHARACTERS WITHOUT CLAIM TO ANY PARTICULAR FONT, STYLE, SIZE, OR COLOR.
OWNER OF U.S. REG. NOS. 711,630, 3,169,796 AND OTHERS.
THE NAME JOSE CUERVO DOES NOT IDENTIFY A LIVING INDIVIDUAL.

THE MARK CONSISTS OF STANDARD CHARACTERS WITHOUT CLAIM TO ANY PARTICULAR FONT, STYLE, SIZE, OR COLOR.
OWNER OF U.S. REG. NOS. 711,630, 3,169,796 AND OTHERS.
NO CLAIM IS MADE TO THE EXCLUSIVE RIGHT TO USE "BEER", APART FROM THE MARK AS SHOWN.
THE NAME JOSE CUERVO DOES NOT IDENTIFY A LIVING INDIVIDUAL.

CLASS 32—LIGHT BEVERAGES

FOR BEVERAGES CONTAINING BEER, NAMELY, BEER, FLAVORED BEER, AND PREPARED ALCOHOLIC COCKTAILS PRIMARILY COMPRISED OF BEER (U.S. CLS. 45, 46 AND 48).

CLASS 32—LIGHT BEVERAGES

FOR BEVERAGES CONTAINING BEER, NAMELY, BEER, FLAVORED BEER, AND PREPARED ALCOHOLIC COCKTAILS PRIMARILY COMPRISED OF BEER (U.S. CLS. 45, 46 AND 48).

CLASS 33—WINES AND SPIRITS

FOR ALCOHOLIC BEVERAGES CONTAINING TEQUILA INTENDED TO BE MIXED WITH BEER (U.S. CLS. 47 AND 49).
CYNTHIA SLOAN, EXAMINING ATTORNEY

CLASS 33—WINES AND SPIRITS

FOR ALCOHOLIC BEVERAGES CONTAINING TEQUILA INTENDED TO BE MIXED WITH BEER (U.S. CLS. 47 AND 49).
CYNTHIA SLOAN, EXAMINING ATTORNEY

SN 78-952,577. TEQUILA CUERVO LA ROJENA, S.A. DE C.V., ZAPOPAN JALISCO, MEXICO, FILED 8-15-2006.

SN 78-952,607. TEQUILA CUERVO LA ROJENA, S.A. DE C.V., ZAPOPAN JALISCO, MEXICO, FILED 8-15-2006.

BEERBUDDY

BEER BOOSTER

THE MARK CONSISTS OF STANDARD CHARACTERS WITHOUT CLAIM TO ANY PARTICULAR FONT, STYLE, SIZE, OR COLOR.

THE MARK CONSISTS OF STANDARD CHARACTERS WITHOUT CLAIM TO ANY PARTICULAR FONT, STYLE, SIZE, OR COLOR.
NO CLAIM IS MADE TO THE EXCLUSIVE RIGHT TO USE "BEER", APART FROM THE MARK AS SHOWN.

CLASS 32—LIGHT BEVERAGES

FOR BEVERAGES CONTAINING BEER, NAMELY, BEER, FLAVORED BEER, AND PREPARED ALCOHOLIC COCKTAILS PRIMARILY COMPRISED OF BEER (U.S. CLS. 45, 46 AND 48).

CLASS 32—LIGHT BEVERAGES

FOR BEVERAGES CONTAINING BEER, NAMELY, BEER, FLAVORED BEER, AND PREPARED ALCOHOLIC COCKTAILS PRIMARILY COMPRISED OF BEER (U.S. CLS. 45, 46 AND 48).

CLASS 33—WINES AND SPIRITS

FOR ALCOHOLIC BEVERAGES CONTAINING TEQUILA INTENDED TO BE MIXED WITH BEER (U.S. CLS. 47 AND 49).
CYNTHIA SLOAN, EXAMINING ATTORNEY

CLASS 33—WINES AND SPIRITS

FOR ALCOHOLIC BEVERAGES CONTAINING TEQUILA INTENDED TO BE MIXED WITH BEER (U.S. CLS. 47 AND 49).
CYNTHIA SLOAN, EXAMINING ATTORNEY

SN 78-952,744. DAVID HORVATH, LOS ANGELES, CA.
FILED 8-15-2006.

SN 78-952,748. DAVID HORVATH, LOS ANGELES, CA.
FILED 8-15-2006.

BOSSY BEAR



THE MARK CONSISTS OF STANDARD CHARACTERS WITHOUT CLAIM TO ANY PARTICULAR FONT, STYLE, SIZE, OR COLOR.

THE MARK CONSISTS OF A BEAR WITH A CROWN AND CAPE.

CLASS 9—ELECTRICAL AND SCIENTIFIC APPARATUS

FOR DVDS FEATURING CHILDREN'S EDUCATIONAL PROGRAMS, MOVIES, MUSIC AND GAMES; PRERECORDED VIDEO CASSETTES FEATURING CHILDREN'S EDUCATIONAL PROGRAMS, MOVIES, MUSIC AND GAMES (U.S. CLS. 21, 23, 26, 36 AND 38).

CLASS 9—ELECTRICAL AND SCIENTIFIC APPARATUS

FOR DVDS FEATURING CHILDREN'S EDUCATIONAL PROGRAMS, MOVIES, MUSIC AND GAMES; PRERECORDED VIDEO CASSETTES FEATURING EDUCATIONAL PROGRAMS, MOVIES, MUSIC AND GAMES (U.S. CLS. 21, 23, 26, 36 AND 38).

CLASS 16—PAPER GOODS AND PRINTED MATTER

FOR BLANK JOURNAL BOOKS; BLANK WRITING JOURNALS; COLORING BOOKS; DIARIES; ENVELOPES; NOTE BOOKS; NOTE PADS; PENCILS; PENS; STATIONERY-TYPE PORTFOLIOS; STICKERS (U.S. CLS. 2, 5, 22, 23, 29, 37, 38 AND 50).

CLASS 16—PAPER GOODS AND PRINTED MATTER

FOR BLANK JOURNAL BOOKS; BLANK WRITING JOURNALS; COLORING BOOKS; DIARIES; ENVELOPES; NOTE BOOKS; NOTE PADS; PENCILS; PENS; STATIONERY-TYPE PORTFOLIOS; STICKERS (U.S. CLS. 2, 5, 22, 23, 29, 37, 38 AND 50).

CLASS 18—LEATHER GOODS

FOR BACKPACKS; TOTE BAGS (U.S. CLS. 1, 2, 3, 22 AND 41).

CLASS 18—LEATHER GOODS

FOR BACKPACKS; TOTE BAGS (U.S. CLS. 1, 2, 3, 22 AND 41).

CLASS 21—HOUSEWARES AND GLASS

FOR MUGS (U.S. CLS. 2, 13, 23, 29, 30, 33, 40 AND 50).

CLASS 21—HOUSEWARES AND GLASS

FOR MUGS (U.S. CLS. 2, 13, 23, 29, 30, 33, 40 AND 50).

CLASS 24—FABRICS

FOR TOWELS (U.S. CLS. 42 AND 50).

CLASS 24—FABRICS

FOR TOWELS (U.S. CLS. 42 AND 50).

CLASS 28—TOYS AND SPORTING GOODS

FOR PLUSH TOYS; TOY FIGURES (U.S. CLS. 22, 23, 38 AND 50).
HENRY S. ZAK, EXAMINING ATTORNEY

CLASS 28—TOYS AND SPORTING GOODS

FOR PLUSH TOYS; TOY FIGURES (U.S. CLS. 22, 23, 38 AND 50).
HENRY S. ZAK, EXAMINING ATTORNEY

SN 78-952,752. GRACE CLINIC HOLDINGS, L.L.C., LUBBOCK, TX. FILED 8-15-2006.

SN 78-953,150. JNET COMMUNICATIONS LLC, WARREN, NJ. FILED 8-16-2006.

Grace Clinic

THE MARK CONSISTS OF STANDARD CHARACTERS WITHOUT CLAIM TO ANY PARTICULAR FONT, STYLE, SIZE, OR COLOR.

NO CLAIM IS MADE TO THE EXCLUSIVE RIGHT TO USE "CLINIC", APART FROM THE MARK AS SHOWN.

CLASS 42—SCIENTIFIC, COMPUTER AND LEGAL SERVICES

FOR MEDICAL DIAGNOSTIC LABORATORY SERVICES ASSOCIATED WITH DIRECT PATIENT CARE (U.S. CLS. 100 AND 101).

FIRST USE 10-30-2006; IN COMMERCE 10-30-2006.

CLASS 44—MEDICAL, BEAUTY AND AGRICULTURAL SERVICES

FOR MEDICAL SERVICES, NAMELY FAMILY PRACTICE, INTERNAL MEDICINE, OB/GYN, PEDIATRIC, UROLOGY, MEDICAL IMAGING, SURGERY, AND PHARMACEUTICAL ADVICE AND DISPENSING OF PHARMACEUTICALS (U.S. CLS. 100 AND 101).

FIRST USE 10-30-2006; IN COMMERCE 10-30-2006.
PETER B. BROMAGHIM, EXAMINING ATTORNEY

SN 78-952,912. TAMALPAIS MATRIX SYSTEMS LLC, MILL VALLEY, CA. FILED 8-15-2006.



NO CLAIM IS MADE TO THE EXCLUSIVE RIGHT TO USE "SYSTEMS, LLC", APART FROM THE MARK AS SHOWN.

"THE COLOR(S) BLACK, GREEN, BLUE, MEDIUM BLUE AND LIGHT BLUE IS/ARE CLAIMED AS A FEATURE OF THE MARK."

THE COLOR(S) BLACK FOR THE FRAME, LIGHT BLUE FOR THE WRITING, GREEN FOR THE TREES, MEDIUM BLUE FOR THE MOUNTAIN AND LIGHT BLUE FOR THE SKY IS/ARE CLAIMED AS A FEATURE OF THE MARK.

CLASS 35—ADVERTISING AND BUSINESS

FOR CONSULTATION SERVICES IN THE FIELD OF ACQUISITION OF ART OBJECTS FOR PURPOSES OF ENHANCEMENT OF PERSONAL AND WORK ENVIRONMENTS (U.S. CLS. 100, 101 AND 102).

CLASS 42—SCIENTIFIC, COMPUTER AND LEGAL SERVICES

FOR CONSULTATION SERVICES IN THE FIELD OF DESIGN, SELECTION, IMPLEMENTATION AND MAINTENANCE OF SYNCHRONOUS AND ASYNCHRONOUS COMMUNICATIONS NETWORKS VIA STATE OF THE ART VIDEO AND AUDIO SYSTEMS (U.S. CLS. 100 AND 101).

ELLEN PERKINS, EXAMINING ATTORNEY

JNET

Communications

NO CLAIM IS MADE TO THE EXCLUSIVE RIGHT TO USE "COMMUNICATIONS", APART FROM THE MARK AS SHOWN.

CLASS 35—ADVERTISING AND BUSINESS

FOR OPERATION OF TELEPHONE CALL CENTERS AND TELEPHONE COMMUNICATION CENTERS FOR OTHERS (U.S. CLS. 100, 101 AND 102).

FIRST USE 5-12-2003; IN COMMERCE 5-12-2003.

CLASS 37—CONSTRUCTION AND REPAIR

FOR INSTALLATION, MAINTENANCE AND REPAIR OF IN-HOME AND COMMERCIAL CABLE TELEVISION DEVICES AND WIRING (U.S. CLS. 100, 103 AND 106).

FIRST USE 5-12-2003; IN COMMERCE 5-12-2003.
JASON BLAIR, EXAMINING ATTORNEY

SN 78-953,298. EQUINOLOGY, INC., GUALALA, CA. FILED 8-16-2006.

Caninology

THE MARK CONSISTS OF STANDARD CHARACTERS WITHOUT CLAIM TO ANY PARTICULAR FONT, STYLE, SIZE, OR COLOR.

CLASS 16—PAPER GOODS AND PRINTED MATTER

FOR PRINTED INSTRUCTIONAL MATERIALS IN THE FIELDS OF CANINE HEALTH SCIENCE AND CARE, INCLUDING CANINE MASSAGE, ANATOMY, AND EXERCISE PHYSIOLOGY (U.S. CLS. 2, 5, 22, 23, 29, 37, 38 AND 50).

FIRST USE 4-14-2003; IN COMMERCE 4-14-2003.

CLASS 41—EDUCATION AND ENTERTAINMENT

FOR EDUCATIONAL SERVICES, NAMELY, INSTRUCTION IN THE FIELDS OF CANINE HEALTH SCIENCE AND CARE, INCLUDING CANINE MASSAGE, ANATOMY, AND EXERCISE PHYSIOLOGY (U.S. CLS. 100, 101 AND 107).

FIRST USE 4-14-2003; IN COMMERCE 4-14-2003.
PAUL F. GAST, EXAMINING ATTORNEY

SN 78-953,303. LITTLE ONES, LLC, LOS ANGELES, CA.
FILED 8-16-2006.

THE LITTLE ONES

THE MARK CONSISTS OF STANDARD CHARACTERS WITHOUT CLAIM TO ANY PARTICULAR FONT, STYLE, SIZE, OR COLOR.

CLASS 9—ELECTRICAL AND SCIENTIFIC APPARATUS

FOR DOWNLOADABLE MUSICAL SOUND RECORDINGS; MUSICAL SOUND RECORDINGS (U.S. CLS. 21, 23, 26, 36 AND 38).
FIRST USE 4-20-2005; IN COMMERCE 4-1-2006.

CLASS 41—EDUCATION AND ENTERTAINMENT

FOR ENTERTAINMENT IN THE NATURE OF LIVE PERFORMANCES BY A MUSICAL GROUP. (U.S. CLS. 100, 101 AND 107).
FIRST USE 4-20-2005; IN COMMERCE 4-1-2006.
ELLEN PERKINS, EXAMINING ATTORNEY

SN 78-953,634. DE 3 B.V., 7137 HG LIEVELDE, NETHERLANDS, FILED 8-16-2006.

FARMERSGOLF

THE MARK CONSISTS OF STANDARD CHARACTERS WITHOUT CLAIM TO ANY PARTICULAR FONT, STYLE, SIZE, OR COLOR.

OWNER OF ERPN CMNTY TM OFC REG. NO. 004387098, DATED 5-5-2006, EXPIRES 4-13-2015.

CLASS 16—PAPER GOODS AND PRINTED MATTER

FOR PRINTED PUBLICATIONS, NAMELY, PERIODICALS, MAGAZINES AND BOOKS, ALL IN THE FIELD OF SPORTS AND, IN PARTICULAR, VARIOUS TYPES OF GOLF SPORT; CARDS, NAMELY, POSTCARDS, NOTE CARDS, GREETING CARDS, INSTRUCTION CARDS, ALL IN THE FIELD OF SPORTS AND, IN PARTICULAR, VARIOUS TYPES OF GOLF SPORT; CALENDARS, POSTERS, PHOTOGRAPHS, STATIONERY; PLASTIC BAGS AND PLASTIC BUBBLE PACKS FOR WRAPPING AND PACKAGING (U.S. CLS. 2, 5, 22, 23, 29, 37, 38 AND 50).

CLASS 25—CLOTHING

FOR CLOTHING FOR SPORTS AND LEISURE, NAMELY, SPORT SUITS, JACKETS, RAIN-PROOF JACKETS, T-SHIRTS, TROUSERS, SHORTS, PARKAS, SWEATERS, FOOTWEAR, HEADWEAR (U.S. CLS. 22 AND 39).

CLASS 28—TOYS AND SPORTING GOODS

FOR GAMES, NAMELY BOARD GAMES, CARD GAMES; PLAYTHINGS NAMELY PLUSH TOYS, STUFFED TOYS, DOLLS; PARTY GAMES, BALLS FOR GAMES; GOLF CLUBS, GOLF GLOVES AND GOLF BAGS, WITH AND WITHOUT WHEELS (U.S. CLS. 22, 23, 38 AND 50).

CLASS 41—EDUCATION AND ENTERTAINMENT

FOR ENTERTAINMENT AND RECREATION IN THE FIELD OF SPORTS, AND IN PARTICULAR VARIOUS TYPES OF GOLF SPORT; ORGANIZING SPORTING EVENTS AND COMPETITIONS IN THE FIELD OF VARIOUS TYPES OF GOLF SPORT; ARRANGING AND PROVIDING OF TRAINING IN THE FIELD OF VARIOUS TYPES OF GOLF SPORT; PROVIDING GOLF FACILITIES; RENTAL OF GOLF EQUIPMENT, EXCEPT VEHICLES; AND INFORMATION AND CONSULTANCY RELATING TO THE AFORESAID SERVICES, INCLUDING VIA THE INTERNET (U.S. CLS. 100, 101 AND 107).
ALICE SUE CARRUTHERS, EXAMINING ATTORNEY

SN 78-953,656. DAYAN, HAY, DBA H. DAYAN & CO, LOS ANGELES, CA. FILED 8-16-2006.

HIGH DEFINITION

THE MARK CONSISTS OF STANDARD CHARACTERS WITHOUT CLAIM TO ANY PARTICULAR FONT, STYLE, SIZE, OR COLOR.

CLASS 14—JEWELRY

FOR GEMSTONES; PRECIOUS GEMSTONES; JEWELRY; NAMELY, JEWELRY MADE OF PRECIOUS METALS AND SEMI-PRECIOUS AND PRECIOUS STONES (U.S. CLS. 2, 27, 28 AND 50).

CLASS 42—SCIENTIFIC, COMPUTER AND LEGAL SERVICES

FOR GEMOLOGICAL SERVICES, NAMELY IDENTIFYING, ANALYZING, TESTING, AND GRADING OF PRECIOUS STONES AND REPORTING ON AND ISSUING CERTIFICATES RELATING TO SUCH ANALYZING, TESTING, AND GRADING (U.S. CLS. 100 AND 101).

JEFF DEFORD, EXAMINING ATTORNEY

SN 78-953,928. THE CARRINGTON TEA COMPANY LLC, PARAMUS, NJ. FILED 8-16-2006.

HEALTHY FOODS FOR A HEALTHY SOUL

THE MARK CONSISTS OF STANDARD CHARACTERS WITHOUT CLAIM TO ANY PARTICULAR FONT, STYLE, SIZE, OR COLOR.

NO CLAIM IS MADE TO THE EXCLUSIVE RIGHT TO USE "HEALTHY FOODS", APART FROM THE MARK AS SHOWN.

CLASS 5—PHARMACEUTICALS

FOR HEALTH FOOD PRODUCTS, NAMELY, FLAX SEEDS FOR USE AS A DIETARY SUPPLEMENT, HEMP SEEDS FOR USE AS A DIETARY SUPPLEMENT, HEMP PROTEIN IN POWDER FORM FOR USE AS A NUTRITIONAL INGREDIENT IN BEVERAGES, AND FLAX OIL FOR NUTRITIONAL PURPOSES (U.S. CLS. 6, 18, 44, 46, 51 AND 52).

SN 78-955,251. SCHNELLER, INC., KENT, OH. FILED 8-18-2006.

PURE COLOR

THE MARK CONSISTS OF STANDARD CHARACTERS WITHOUT CLAIM TO ANY PARTICULAR FONT, STYLE, SIZE, OR COLOR.

NO CLAIM IS MADE TO THE EXCLUSIVE RIGHT TO USE "COLOR", APART FROM THE MARK AS SHOWN.

CLASS 29—MEATS AND PROCESSED FOODS

FOR HEALTH FOOD PRODUCTS, NAMELY, COCONUT OIL (U.S. CL. 46).
MARK PILARO, EXAMINING ATTORNEY

SN 78-954,562. NORTH AMERICAN GREEN, INC., EVANSVILLE, IN. FILED 8-17-2006.

CONTURA

THE MARK CONSISTS OF STANDARD CHARACTERS WITHOUT CLAIM TO ANY PARTICULAR FONT, STYLE, SIZE, OR COLOR.

CLASS 19—NON-METALLIC BUILDING MATERIALS

FOR EROSION CONTROL MATS (U.S. CLS. 1, 12, 33 AND 50).

CLASS 31—NATURAL AGRICULTURAL PRODUCTS

FOR SPRAY-ON EROSION CONTROL MULCH (U.S. CLS. 1 AND 46).
LINDA ESTRADA, EXAMINING ATTORNEY

SN 78-954,594. ANGELS THREE, LLC, LOUISVILLE, KY. FILED 8-17-2006.

ROAD ANGEL

THE MARK CONSISTS OF STANDARD CHARACTERS WITHOUT CLAIM TO ANY PARTICULAR FONT, STYLE, SIZE, OR COLOR.

CLASS 12—VEHICLES

FOR MOTORCYCLE BELLS (U.S. CLS. 19, 21, 23, 31, 35 AND 44).
FIRST USE 7-14-2006; IN COMMERCE 7-14-2006.

CLASS 25—CLOTHING

FOR CLOTHING, NAMELY, SHIRTS (U.S. CLS. 22 AND 39).
FIRST USE 7-31-2006; IN COMMERCE 7-31-2006.
JENNIFER VASQUEZ, EXAMINING ATTORNEY

CLASS 6—METAL GOODS

FOR COLORED ARCHITECTURAL PANELS, NAMELY, WALL PANELS OF METAL (U.S. CLS. 2, 12, 13, 14, 23, 25 AND 50).

CLASS 19—NON-METALLIC BUILDING MATERIALS

FOR COLORED ARCHITECTURAL PANELS, NAMELY NON-METAL CEILING PANELS (U.S. CLS. 1, 12, 33 AND 50).

MARK PILARO, EXAMINING ATTORNEY

SN 78-955,463. DOCTORS NUTRITION, LLC, WELLINGTON, FL. FILED 8-18-2006.



THE MARK CONSISTS OF AN OUTLINE OF AN APPLE WITH A CADUCEUS INSIDE.

CLASS 5—PHARMACEUTICALS

FOR NUTRITIONALLY FORTIFIED MEAL REPLACEMENT DRINKS, BARS, COOKIES, SQUARE-SHAPED BARS AND COOKIES, POWDERS AND SHAKES; SOUPS FOR USE AS DIET MEAL REPLACEMENTS; DIETARY SUPPLEMENTS, NAMELY, VITAMINS, MULTI-VITAMIN PREPARATIONS, MINERAL SUPPLEMENTS; APETITE SUPPRESSANTS; MEDICINAL HERBAL EXTRACTS; NUTRITIONAL ADDITIVES FOR USE IN FOODS AND DIETARY SUPPLEMENTS FOR HUMAN CONSUMPTION; NUTRITIONAL SUPPLEMENTS; NUTRITIONALLY FORTIFIED BEVERAGES; FOOD SUPPLEMENTS (U.S. CLS. 6, 18, 44, 46, 51 AND 52).

CLASS 29—MEATS AND PROCESSED FOODS

FOR NON-DAIRY CREAMER; PROTEIN BASED NUTRIENT DENSE SNACK BARS; PROTEIN FOOD ADDITIVES; SALAD OILS; EDIBLE OILS; RAISINS; NUTRITIONAL OILS FOR FOOD PURPOSES (U.S. CL. 46).

CLASS 30—STAPLE FOODS

FOR COOKIES AND SQUARE-SHAPED COOKIES; SQUARE-SHAPED GRAIN-BASED FOOD BARS; NATURAL SWEETENERS; SPICES; PASTRIES; PUDDINGS; SALAD DRESSINGS; SEASONINGS; SUGARFREE PRODUCTS, NAMELY, SUGARFREE CHEWING GUM AND SUGARFREE SWEETS; BAKERY GOODS AND PRODUCTS; BAKING POWDERS; BAKING SPICES (U.S. CL. 46).

CLASS 32—LIGHT BEVERAGES

FOR SMOOTHIES (U.S. CLS. 45, 46 AND 48).
BENJAMIN OKEKE, EXAMINING ATTORNEY

SN 78-956,054. SPLASHIE.COM, INC., LOS ANGELES, CA.
FILED 8-20-2006.

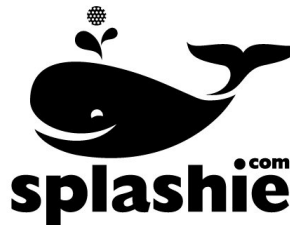
**CLASS 16—PAPER GOODS AND PRINTED MATTER**

FOR POSTERS AND BANNERS (U.S. CLS. 2, 5, 22, 23, 29, 37, 38 AND 50).

CLASS 25—CLOTHING

FOR CLOTHING, NAMELY, SHIRTS AND PANTS; FOOTWEAR; AND HEADGEAR, NAMELY, CAPS AND HATS (U.S. CLS. 22 AND 39).

CLASS 42—SCIENTIFIC, COMPUTER AND LEGAL SERVICES

FOR ON-LINE NONDOWNLOADABLE SOFTWARE FEATURING A PERSONAL GOLF SCORING SYSTEM FOR RECORDING AND TRANSMITTING GOLF SCORES AND COMPUTING HANDICAPS FOR GOLFERS (U.S. CLS. 100 AND 101).

KIMBERLY PERRY, EXAMINING ATTORNEY

SN 78-955,630. WAL-MART STORES, INC., BENTONVILLE, AR. FILED 8-18-2006.

SN 78-956,857. DAL-CON PROMOTIONS, INC., IRVINE, CA.
FILED 8-21-2006.

S★MART

LAUGHLIN 2008

CLASS 16—PAPER GOODS AND PRINTED MATTER

FOR PRINTED PUBLICATIONS, NAMELY A PERIODICAL NEWSLETTER FEATURING INFORMATION REGARDING ENVIRONMENTAL SUSTAINABILITY EFFORTS AND RESOURCES (U.S. CLS. 2, 5, 22, 23, 29, 37, 38 AND 50).

CLASS 41—EDUCATION AND ENTERTAINMENT

FOR PROVIDING ONLINE PUBLICATIONS IN THE NATURE OF A NEWSLETTER FEATURING INFORMATION REGARDING ENVIRONMENTAL SUSTAINABILITY EFFORTS AND RESOURCES (U.S. CLS. 100, 101 AND 107).

LINDA LAVACHE, EXAMINING ATTORNEY

THE MARK CONSISTS OF STANDARD CHARACTERS WITHOUT CLAIM TO ANY PARTICULAR FONT, STYLE, SIZE, OR COLOR.

OWNER OF U.S. REG. NOS. 1,739,923, 2,911,576 AND OTHERS.

NO CLAIM IS MADE TO THE EXCLUSIVE RIGHT TO USE "2008", APART FROM THE MARK AS SHOWN.

SEC. 2(F) AS TO "LAUGHLIN".

CLASS 16—PAPER GOODS AND PRINTED MATTER

FOR PHOTOGRAPHS; STATIONERY; DECALS; STICKERS; PHOTOGRAPHIC ALBUMS; PAPER BAGS; BOOKMARKS; CALENDARS; PAPER COASTERS; COMIC BOOKS; BOOKS, MAGAZINES, NEWSLETTERS AND BROCHURES ALL IN THE FIELD OF MOTORCYCLES, MOTORCYCLE EVENTS AND MOTORCYCLE RALLIES; PAPER FLAGS; FOLDERS; GREETING CARDS; MAPS; MODELING CLAY; NOTE PADS; PENS; PENCILS; POST CARDS; FINE ART PRINTS AND ARTISTIC POSTERS; STENCILS; AND PRINTED TICKETS (U.S. CLS. 2, 5, 22, 23, 29, 37, 38 AND 50).

CLASS 25—CLOTHING

FOR WEARING APPAREL, NAMELY, T-SHIRTS, SWEATSHIRTS, TANK TOPS, WOVEN SHIRTS, SWEATERS, CARDIGANS, VESTS, JACKETS, PANTS, SWEATPANTS, SHORTS, SKIRTS, DRESSES, BLOUSES, COATS, BELTS, AND UNDERWEAR; HEADWEAR, NAMELY, HATS AND CAPS; FOOTWEAR, NAMELY, SHOES, BOOTS, AND SNEAKERS (U.S. CLS. 22 AND 39).

CLASS 26—FANCY GOODS

FOR LACE TRIMMING; EMBROIDERED PATCHES FOR CLOTHING; PATCHES, BADGES, PINS AND BUTTONS FOR CLOTHING; BELT CLASPS, BROOCHES AS ACCESSORIES, NOT OF PRECIOUS METAL AND NOT AS IMITATION JEWELRY; CLOTHING BUCKLES; AND PRIZE RIBBONS (U.S. CLS. 37, 39, 40, 42 AND 50).

REBECCA POVARCHUK, EXAMINING ATTORNEY

SN 78-956,883. DAL-CON PROMOTIONS, INC., IRVINE, CA. FILED 8-21-2006.

LAUGHLIN 2007

THE MARK CONSISTS OF STANDARD CHARACTERS WITHOUT CLAIM TO ANY PARTICULAR FONT, STYLE, SIZE, OR COLOR.

OWNER OF U.S. REG. NOS. 1,739,923, 2,911,576 AND OTHERS.

NO CLAIM IS MADE TO THE EXCLUSIVE RIGHT TO USE "2007", APART FROM THE MARK AS SHOWN.

SEC. 2(F) AS TO "LAUGHLIN".

CLASS 16—PAPER GOODS AND PRINTED MATTER

FOR PHOTOGRAPHS; STATIONERY; DECALS; STICKERS; PHOTOGRAPHIC ALBUMS; PAPER BAGS; BOOKMARKS; CALENDARS; PAPER COASTERS; COMIC BOOKS; BOOKS, MAGAZINES, NEWSLETTERS AND BROCHURES ALL IN THE FIELD OF MOTORCYCLES, MOTORCYCLE EVENTS AND MOTORCYCLE RALLIES; PAPER FLAGS; FOLDERS; GREETING CARDS; MAPS; MODELING CLAY; NOTE PADS; PENS; PENCILS; POST CARDS; FINE ART PRINTS AND ARTISTIC POSTERS; STENCILS; AND PRINTED TICKETS (U.S. CLS. 2, 5, 22, 23, 29, 37, 38 AND 50).

CLASS 25—CLOTHING

FOR WEARING APPAREL, NAMELY, T-SHIRTS, SWEATSHIRTS, TANK TOPS, WOVEN SHIRTS, SWEATERS, CARDIGANS, VESTS, JACKETS, PANTS, SWEATPANTS, SHORTS, SKIRTS, DRESSES, BLOUSES, COATS, BELTS, AND UNDERWEAR; HEADWEAR, NAMELY, HATS AND CAPS; FOOTWEAR, NAMELY, SHOES, BOOTS, AND SNEAKERS (U.S. CLS. 22 AND 39).

CLASS 26—FANCY GOODS

FOR LACE TRIMMING; EMBROIDERED PATCHES FOR CLOTHING; PATCHES, BADGES, PINS AND BUTTONS FOR CLOTHING; BELT CLASPS, BROOCHES AS ACCESSORIES, NOT OF PRECIOUS METAL AND NOT AS IMITATION JEWELRY; CLOTHING BUCKLES; AND PRIZE RIBBONS (U.S. CLS. 37, 39, 40, 42 AND 50).

REBECCA POVARCHUK, EXAMINING ATTORNEY

SN 78-956,913. DAL-CON PROMOTIONS, INC., IRVINE, CA. FILED 8-21-2006.

LAUGHLIN 2006

THE MARK CONSISTS OF STANDARD CHARACTERS WITHOUT CLAIM TO ANY PARTICULAR FONT, STYLE, SIZE, OR COLOR.

OWNER OF U.S. REG. NOS. 1,739,923, 2,911,576 AND OTHERS.

NO CLAIM IS MADE TO THE EXCLUSIVE RIGHT TO USE "2006", APART FROM THE MARK AS SHOWN.

SEC. 2(F) AS TO "LAUGHLIN".

CLASS 16—PAPER GOODS AND PRINTED MATTER

FOR PHOTOGRAPHS; STATIONERY; DECALS; STICKERS; PHOTOGRAPHIC ALBUMS; PAPER BAGS; BOOKMARKS; CALENDARS; PAPER COASTERS; COMIC BOOKS; BOOKS, MAGAZINES, NEWSLETTERS AND BROCHURES ALL IN THE FIELD OF MOTORCYCLES, MOTORCYCLE EVENTS AND MOTORCYCLE RALLIES; PAPER FLAGS; FOLDERS; GREETING CARDS; MAPS; MODELING CLAY; NOTE PADS; PENS; PENCILS; POST CARDS; FINE ART PRINTS AND ARTISTIC POSTERS; STENCILS; AND PRINTED TICKETS (U.S. CLS. 2, 5, 22, 23, 29, 37, 38 AND 50).

FIRST USE 4-23-2006; IN COMMERCE 4-23-2006.

CLASS 25—CLOTHING

FOR WEARING APPAREL, NAMELY, T-SHIRTS, SWEATSHIRTS, TANK TOPS, WOVEN SHIRTS, SWEATERS, CARDIGANS, VESTS, JACKETS, PANTS, SWEATPANTS, SHORTS, SKIRTS, DRESSES, BLOUSES, COATS, BELTS, AND UNDERWEAR; HEADWEAR, NAMELY, HATS AND CAPS; FOOTWEAR, NAMELY, SHOES, BOOTS, AND SNEAKERS (U.S. CLS. 22 AND 39).

FIRST USE 4-23-2006; IN COMMERCE 4-23-2006.

CLASS 26—FANCY GOODS

FOR LACE TRIMMING; EMBROIDERED PATCHES FOR CLOTHING; PATCHES, BADGES, PINS AND BUTTONS FOR CLOTHING; BELT CLASPS, BROOCHES AS ACCESSORIES, NOT OF PRECIOUS METAL AND NOT AS IMITATION JEWELRY; CLOTHING BUCKLES; AND PRIZE RIBBONS (U.S. CLS. 37, 39, 40, 42 AND 50).

FIRST USE 4-23-2006; IN COMMERCE 4-23-2006.

REBECCA POVARCHUK, EXAMINING ATTORNEY

SN 78-957,398. WESTERN KENTUCKY UNIVERSITY, BOWLING GREEN, KY. FILED 8-22-2006.

WESTERN KENTUCKY UNIVERSITY

THE MARK CONSISTS OF STANDARD CHARACTERS WITHOUT CLAIM TO ANY PARTICULAR FONT, STYLE, SIZE, OR COLOR.

OWNER OF U.S. REG. NOS. 2,717,568, 2,801,351 AND OTHERS.

NO CLAIM IS MADE TO THE EXCLUSIVE RIGHT TO USE "UNIVERSITY", APART FROM THE MARK AS SHOWN.

SEC. 2(F).

CLASS 14—JEWELRY

FOR JEWELRY WATCHES; LAPEL PINS ; POCKET WATCHES; WRIST WATCHES (U.S. CLS. 2, 27, 28 AND 50).

FIRST USE 0-0-1966; IN COMMERCE 0-0-1966.

CLASS 16—PAPER GOODS AND PRINTED MATTER

FOR BINDERS; BUMPER STICKERS; DECALS; EVENT PROGRAMS; MAGAZINES FEATURING COLLEGE AFFAIRS AND EVENTS; PENCILS; PENS; PRINTED GUIDES FOR COLLEGE AFFAIRS AND EVENTS AND EMPLOYEE HANDBOOKS; STICKERS (U.S. CLS. 2, 5, 22, 23, 29, 37, 38 AND 50).

FIRST USE 0-0-1966; IN COMMERCE 0-0-1966.

CLASS 18—LEATHER GOODS

FOR BOOK BAGS; DUFFLE BAGS; GYM BAGS; LEATHER BAGS, SUITCASES AND WALLETS; SHOULDER BAGS; SPORTS BAGS; WALLETS (U.S. CLS. 1, 2, 3, 22 AND 41).

FIRST USE 0-0-1966; IN COMMERCE 0-0-1966.

CLASS 20—FURNITURE AND ARTICLES NOT OTHERWISE CLASSIFIED

FOR CHAIR CUSHIONS; CHAIR MATS IN THE NATURE OF A PILLOW OR SEAT LINER; DECK CHAIRS; STADIUM CUSHIONS; STOOLS (U.S. CLS. 2, 13, 22, 25, 32 AND 50).

FIRST USE 0-0-1966; IN COMMERCE 0-0-1966.

CLASS 21—HOUSEWARES AND GLASS

FOR DRINKING CUPS ; DRINKING GLASSES; MUGS; SERVING PLATTERS (U.S. CLS. 2, 13, 23, 29, 30, 33, 40 AND 50).

FIRST USE 0-0-1966; IN COMMERCE 0-0-1966.

CLASS 24—FABRICS

FOR FACE TOWELS MADE OF TEXTILE MATERIALS; GOLF TOWELS; HAND TOWELS; THROWS; TOWELS (U.S. CLS. 42 AND 50).

FIRST USE 0-0-1966; IN COMMERCE 0-0-1966.

CLASS 25—CLOTHING

FOR ATHLETIC UNIFORMS; GOLF SHIRTS; GYM SUITS; HATS; JACKETS; JOGGING SUITS; KNIT SHIRTS; NECKTIES; POLO SHIRTS; RAIN JACKETS; SHORTS; SPORT SHIRTS; SWEAT PANTS; SWEAT SHIRTS; SWEAT SUITS; T-SHIRTS; WARM UP SUITS; WIND-JACKETS (U.S. CLS. 22 AND 39).

FIRST USE 0-0-1966; IN COMMERCE 0-0-1966.

CLASS 28—TOYS AND SPORTING GOODS

FOR BASKETBALLS; CHRISTMAS TREE ORNAMENTS ; FITTED HEAD COVERS FOR GOLF CLUBS; GOLF BAGS; GOLF BALLS (U.S. CLS. 22, 23, 38 AND 50).

FIRST USE 0-0-1966; IN COMMERCE 0-0-1966.

CLASS 41—EDUCATION AND ENTERTAINMENT

FOR ARRANGING AND CONDUCTING ATHLETIC COMPETITIONS; ARRANGING OF EXHIBITIONS, SEMINARS AND CONFERENCES; EDUCATIONAL SERVICES, NAMELY, PROVIDING COURSES OF INSTRUCTION AT THE COLLEGE AND POST-GRADUATE LEVEL ; ENTERTAINMENT IN THE NATURE OF ATHLETIC TOURNAMENTS; INSTRUCTION IN THE FIELD OF ATHLETICS, INCLUDING BASKETBALL, FOOTBALL, BASEBALL, SOCCER, VOLLEYBALL AND TENNIS, TO STUDENTS AND THE GENERAL PUBLIC; PROVIDING FACILITIES FOR RECREATION ACTIVITIES; PROVIDING VARIOUS FACILITIES FOR AN ARRAY OF SPORTING EVENTS, SPORTS AND ATHLETIC COMPETITIONS AND AWARDS PROGRAMMES (U.S. CLS. 100, 101 AND 107).

FIRST USE 10-1-1942; IN COMMERCE 10-1-1942.

CLASS 43—HOTEL AND RESTAURANT SERVICES

FOR PROVIDING TEMPORARY HOUSING ACCOMMODATIONS (U.S. CLS. 100 AND 101).

FIRST USE 10-1-1942; IN COMMERCE 10-1-1942.

MICHELE SWAIN, EXAMINING ATTORNEY

SN 78-957,773. TIMI & LESLIE INC., LOS ANGELES, CA. FILED 8-22-2006.

Timi & Leslie

THE MARK CONSISTS OF STANDARD CHARACTERS WITHOUT CLAIM TO ANY PARTICULAR FONT, STYLE, SIZE, OR COLOR.

OWNER OF U.S. REG. NO. 3,193,137.

"THE NAME LESLIE IN THE MARK IDENTIFIES A LIVING INDIVIDUAL WHOSE CONSENT IS OF RECORD. THE NAME TIMI IN THE MARK IDENTIFIES A LIVING INDIVIDUAL WHOSE CONSENT IS OF RECORD."

CLASS 9—ELECTRICAL AND SCIENTIFIC APPARATUS

FOR CARRYING CASES FOR CELLULAR TELEPHONES, PORTABLE ELECTRONIC MUSIC PLAYERS, PORTABLE ELECTRONIC AUDIO AND VIDEO PLAYERS; FOR PORTABLE ELECTRONIC AUDIO AND VIDEO RECORDERS, AND PLAYERS; FOR PORTABLE ELECTRONIC COMBINATION CELLULAR TELEPHONES, AUDIO AND VIDEO RECORDERS, AND PLAYERS; FOR HANDHELD AND MOBILE DIGITAL ELECTRONIC DEVICES FOR THE SENDING AND RECEIVING OF TELEPHONE CALLS, ELECTRONIC MAIL, DIGITAL DATA AND ACCESSING THE INTERNET; FOR ELECTRONIC HANDHELD UNITS FOR THE WIRELESS RECEIPT AND/OR TRANSMISSION OF DATA AND WHICH MAY ALSO HAVE THE CAPABILITY TO TRANSMIT AND RECEIVE VOICE COMMUNICATIONS; FOR PORTABLE HANDHELD ELECTRONIC COMPUTERS; FOR ELECTRONIC PERSONAL DIGITAL ASSISTANTS; FOR ELECTRONIC DIGITAL CAMERAS; FOR ELECTRONIC HANDHELD DEVICES FOR THE WIRELESS RECEIPT AND/OR TRANSMISSION OF DATA THAT ENABLE THE USER TO KEEP TRACK OF AND/OR MANAGE PERSONAL OR BUSINESS INFORMATION; FOR PORTABLE AND HANDHELD ELECTRONIC DEVICES FOR COMMUNICATING BY VOICE AND/OR RECORDING, ORGANIZING, TRANSMITTING, RECEIVING, MANIPULATING AND REVIEWING TEXT, DATA, AUDIO AND VIDEO FILES. (U.S. CLS. 21, 23, 26, 36 AND 38).

CLASS 18—LEATHER GOODS

FOR BAGS, NAMELY, ALL-PURPOSE CARRYING BAGS FOR CARRYING TOYS (U.S. CLS. 1, 2, 3, 22 AND 41).

SN 78-957,931. BUCHANAN, ROBERT B., WHITE PLAINS, NY. FILED 8-22-2006.

CLASS 24—FABRICS

FOR TEXTILES AND TEXTILE GOODS, NAMELY CHILDREN'S BLANKETS, TOWELS, HOODED TOWELS, WASH CLOTHS AND BURP CLOTHS NOT OF PAPER. (U.S. CLS. 42 AND 50).

CLASS 25—CLOTHING

FOR CLOTHING, NAMELY APRONS AND ROBES (U.S. CLS. 22 AND 39).
ANDREW RHIM, EXAMINING ATTORNEY

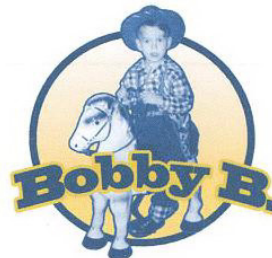

PRODUCTIONS

SN 78-957,822. TIMI & LESLIE INC., LOS ANGELES, CA. FILED 8-22-2006.

Timi & Leslie

THE MARK CONSISTS OF STANDARD CHARACTERS WITHOUT CLAIM TO ANY PARTICULAR FONT, STYLE, SIZE, OR COLOR.

OWNER OF U.S. REG. NO. 3,193,137.

"THE NAME LESLIE IN THE MARK IDENTIFIES A LIVING INDIVIDUAL WHOSE CONSENT IS OF RECORD. THE NAME TIMI IN THE MARK IDENTIFIES A LIVING INDIVIDUAL WHOSE CONSENT IS OF RECORD."

CLASS 18—LEATHER GOODS

FOR CARRYING CASES; COSMETIC BAGS SOLD EMPTY; DIAPER BAGS; MAKE-UP BAGS SOLD EMPTY; TOTE BAGS (U.S. CLS. 1, 2, 3, 22 AND 41).

FIRST USE 8-14-2000; IN COMMERCE 9-25-2000.

CLASS 24—FABRICS

FOR DIAPER CHANGING PADS NOT OF PAPER (U.S. CLS. 42 AND 50).

FIRST USE 8-14-2000; IN COMMERCE 9-25-2000.

CLASS 25—CLOTHING

FOR BABY BIBS NOT OF PAPER; CLOTH BIBS (U.S. CLS. 22 AND 39).

FIRST USE 8-14-2000; IN COMMERCE 9-25-2000.

CLASS 35—ADVERTISING AND BUSINESS

FOR COMPUTERIZED ON-LINE RETAIL STORE SERVICES IN THE FIELD OF BAGS AND CARRYING CASES; ELECTRONIC CATALOG SERVICES VIA COMPUTER FEATURING BAGS AND CARRYING CASES; ON-LINE RETAIL STORE SERVICES FEATURING BAGS AND CARRYING CASES (U.S. CLS. 100, 101 AND 102).

FIRST USE 6-23-2004; IN COMMERCE 6-23-2004.

ANDREW RHIM, EXAMINING ATTORNEY

NO CLAIM IS MADE TO THE EXCLUSIVE RIGHT TO USE "PRODUCTIONS", APART FROM THE MARK AS SHOWN.

THE COLOR(S) YELLOW AND BLUE IS/ARE CLAIMED AS A FEATURE OF THE MARK.

THE MARK CONSISTS OF THE DEPICTION OF A YOUNG BOY WEARING A COWBOY HAT, SITTING ON A HORSE, ALL IN SHADES OF BLUE AND SUPERIMPOSED ON A CIRCLE OF YELLOW GRADATIONS AND OUTLINED IN BLUE. ACROSS THE CIRCLE, BOY AND HORSE ARE THE WORDS BOBBY B IN BLUE AND OUTLINED IN YELLOW. BELOW THE CIRCLE, BOY AND HORSE IS THE WORD PRODUCTIONS IN BLUE.

CLASS 35—ADVERTISING AND BUSINESS

FOR CONSULTING SERVICES IN THE FIELD OF COMMERCIALS OR INFOMERCIALS; ADVERTISING AND PUBLICITY SERVICES, NAMELY, PROMOTING THE GOODS, SERVICES, BRAND IDENTITY, COMMERCIAL INFORMATION AND NEWS OF OTHERS THROUGH PRINT, AUDIO, VIDEO, DIGITAL AND ON-LINE MEDIA; PRODUCTION AND DISTRIBUTION OF RADIO AND TELEVISION COMMERCIALS (U.S. CLS. 100, 101 AND 102).

CLASS 41—EDUCATION AND ENTERTAINMENT

FOR PRODUCTION AND DISTRIBUTION OF RADIO AND TELEVISION PROGRAMS (U.S. CLS. 100, 101 AND 107).

KATHERINE CHANG, EXAMINING ATTORNEY

SN 78-958,276. THE PRINT OPERATIONS GROUP INC., CALGARY, ALBERTA, CANADA, FILED 8-23-2006.

POG

THE MARK CONSISTS OF STANDARD CHARACTERS WITHOUT CLAIM TO ANY PARTICULAR FONT, STYLE, SIZE, OR COLOR.

PRIORITY CLAIMED UNDER SEC. 44(D) ON CANADA APPLICATION NO. 1296447, FILED 4-3-2006, REG. NO. TMA692110, DATED 7-16-2007, EXPIRES 7-16-2022.

CLASS 35—ADVERTISING AND BUSINESS

FOR BUSINESS CONSULTATION SERVICES, NAMELY, ASSESSING BUSINESS DOCUMENT MANAGEMENT REQUIREMENTS, RECOMMENDING SOLUTIONS FOR PRODUCTIVITY IMPROVEMENTS AND COST REDUCTIONS, ASSISTING WITH THE IMPLEMENTATION OF ANY DOCUMENT MANAGEMENT SOLUTIONS THAT ARE ACQUIRED BY THE BUSINESS, AND CONDUCTING VALIDATION AND INDUSTRY BENCHMARKING STUDIES FOR THE DEPLOYED SOLUTIONS; PROCURING OF CONTRACTS FOR THE PURCHASE OF GOODS (U.S. CLS. 100, 101 AND 102).

CLASS 40—MATERIAL TREATMENT

FOR PRINTING CONSULTATION SERVICES, NAMELY, ASSESSING THIRD PARTY ELECTRONIC AND PHYSICAL PRINT REQUIREMENTS AND ASSISTING WITH THE IMPLEMENTATION OF ANY PRINT SOLUTIONS THAT ARE REQUIRED (U.S. CLS. 100, 103 AND 106).

CLASS 42—SCIENTIFIC, COMPUTER AND LEGAL SERVICES

FOR COMPUTER SOFTWARE AND HARDWARE CONSULTATION SERVICES, NAMELY, PROVIDING RECOMMENDATIONS WITH RESPECT TO HARDWARE AND SOFTWARE NEEDS; INSTALLING AND TESTING COMPUTER SOFTWARE; COMPUTER PROJECT MANAGEMENT SERVICES (U.S. CLS. 100 AND 101).

CARRIE GENOVESE, EXAMINING ATTORNEY

SN 78-958,902. LEARN.COM, INC, SUNRISE, FL. FILED 8-23-2006.

DevCenter

THE MARK CONSISTS OF STANDARD CHARACTERS WITHOUT CLAIM TO ANY PARTICULAR FONT, STYLE, SIZE, OR COLOR.

CLASS 9—ELECTRICAL AND SCIENTIFIC APPARATUS

FOR COMPUTER SOFTWARE FOR DESIGNING, CREATING, MAINTAINING, HOSTING AND IMPLEMENTING WEBSITES AND ON-LINE COLLABORATION TOOLS FOR OTHERS (U.S. CLS. 21, 23, 26, 36 AND 38).

FIRST USE 6-1-2004; IN COMMERCE 6-1-2004.

CLASS 42—SCIENTIFIC, COMPUTER AND LEGAL SERVICES

FOR COMPUTER SERVICES, NAMELY, DESIGN AND DEVELOPMENT OF ON-LINE COMPUTER SOFTWARE SYSTEMS FOR OTHERS FOR THE PURPOSE OF DESIGNING, CREATING, MAINTAINING, HOSTING AND IMPLEMENTING WEBSITES AND ON-LINE COLLABORATION TOOLS (U.S. CLS. 100 AND 101).

FIRST USE 6-1-2004; IN COMMERCE 6-1-2004.
JOHN DALIER, EXAMINING ATTORNEY

SN 78-958,952. LEARN.COM, INC., SUNRISE, FL. FILED 8-23-2006.

WebRoominar

THE MARK CONSISTS OF STANDARD CHARACTERS WITHOUT CLAIM TO ANY PARTICULAR FONT, STYLE, SIZE, OR COLOR.

CLASS 9—ELECTRICAL AND SCIENTIFIC APPARATUS

FOR COMPUTER SOFTWARE FOR AUDIO AND VIDEO CONFERENCING VIA THE INTERNET, FOR USE IN PROVIDING MULTIPLE USER ACCESS TO A GLOBAL COMPUTER INFORMATION NETWORK, AND FOR USE IN PROVIDING ON-LINE CHAT ROOMS, QUIZZES, POLLS, COLLABORATION, AND DOCUMENT, COMPUTER AND APPLICATION SHARING WITH OR WITHOUT ASSOCIATED CONFERENCING (U.S. CLS. 21, 23, 26, 36 AND 38).

CLASS 42—SCIENTIFIC, COMPUTER AND LEGAL SERVICES

FOR COMPUTER SERVICES, NAMELY, DESIGNING, CREATING, MAINTAINING, HOSTING, AND IMPLEMENTING WEB SITES FOR THE PURPOSE OF INTERACTING WITH CLIENTS FOR OTHERS (U.S. CLS. 100 AND 101).

JOHN DALIER, EXAMINING ATTORNEY

SN 78-959,341. KERTZ, MALCOLM GLEN, EL PASO, TX. FILED 8-24-2006.

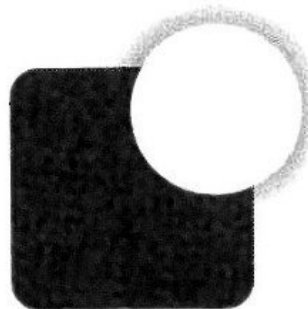
**CLASS 3—COSMETICS AND CLEANING PREPARATIONS**

FOR PERSONAL CARE AND HYGIENE PRODUCTS, NAMELY SKIN CLEANSERS, FACIAL CLEANSERS, FACE AND BODY CREAMS AND LOTIONS (U.S. CLS. 1, 4, 6, 50, 51 AND 52).

FIRST USE 4-1-2006; IN COMMERCE 4-1-2006.

CLASS 21—HOUSEWARES AND GLASS

FOR HANDHELD DEVICE FOR APPLYING PERSONAL CARE AND HYGIENE PRODUCTS TO THE FACE, NAMELY AN ELECTRIC VIBRATING PRODUCT APPLICATOR (U.S. CLS. 2, 13, 23, 29, 30, 33, 40 AND 50).

FIRST USE 5-24-2006; IN COMMERCE 5-24-2006.
MARK PILARO, EXAMINING ATTORNEY

SN 78-959,377. MITSUBISHI MATERIALS CORPORATION, CHIYODA-KU, TOKYO, JAPAN, FILED 8-24-2006.



PRIORITY CLAIMED UNDER SEC. 44(D) ON JAPAN APPLICATION NO. 2006-016838, FILED 2-27-2006, REG. NO. 5005300, DATED 11-24-2006, EXPIRES 11-24-2016.

NO CLAIM IS MADE TO THE EXCLUSIVE RIGHT TO USE "TOOLING", APART FROM THE MARK AS SHOWN.

THE COLOR(S) RED, BLUE AND WHITE IS/ARE CLAIMED AS A FEATURE OF THE MARK.

THE COLOR RED APPEARS IN THE CURVED BORDER SURROUNDING THE WORDS ON THE LEFT, TOP, AND RIGHT OF THE MARK. THE COLOR BLUE APPEARS IN THE WORDS TOOLING EXPRESS. THE COLOR WHITE APPEARS INSIDE THE CURVED BORDER, SURROUNDING THE WORDS IN THE MARK.

CLASS 7—MACHINERY

FOR CUTTING TOOLS AND INSERTS FOR INSERTION INTO POWER-OPERATED MACHINES (U.S. CLS. 13, 19, 21, 23, 31, 34 AND 35).

CLASS 40—MATERIAL TREATMENT

FOR MANUFACTURING OF CUTTING TOOLS AT THE REQUEST OF A CUSTOMER (U.S. CLS. 100, 103 AND 106).

CLASS 42—SCIENTIFIC, COMPUTER AND LEGAL SERVICES

FOR DESIGN OF CUTTING TOOLS AT THE REQUEST OF A CUSTOMER; TESTING OF CUTTING TOOLS AT THE REQUEST OF A CUSTOMER (U.S. CLS. 100 AND 101).

PRISCILLA MILTON, EXAMINING ATTORNEY

SN 78-959,772. BRUNO INDEPENDENT LIVING AIDS, INC., OCONOMOWOC, WI. FILED 8-24-2006.



OWNER OF U.S. REG. NOS. 1,774,922 AND 1,783,854.

CLASS 7—MACHINERY

FOR ACCESSIBILITY DEVICES, NAMELY WHEELCHAIR LIFTS, MOBILITY SCOOTER LIFTS, POWER WHEELCHAIR LIFTS, POWER OPERATED STAIRLIFTS AND VERTICAL PLATFORM LIFTS (U.S. CLS. 13, 19, 21, 23, 31, 34 AND 35).

FIRST USE 7-17-2006; IN COMMERCE 7-17-2006.

CLASS 12—VEHICLES

FOR PERSONAL MOBILITY DEVICES, NAMELY MANUAL WHEELCHAIRS, POWER WHEELCHAIRS AND MOTORIZED, SELF-PROPELLED, WHEELED PERSONAL MOBILITY DEVICES, NAMELY SCOOTERS (U.S. CLS. 19, 21, 23, 31, 35 AND 44).

FIRST USE 8-24-2006; IN COMMERCE 8-24-2006.

JAMES A. RAUEN, EXAMINING ATTORNEY

SN 78-960,245. CLUB LIBBY LU, INC., BIRMINGHAM, AL. FILED 8-25-2006.

LIBBY CHARMETTES

THE MARK CONSISTS OF STANDARD CHARACTERS WITHOUT CLAIM TO ANY PARTICULAR FONT, STYLE, SIZE, OR COLOR.

CLASS 14—JEWELRY

FOR JEWELRY (U.S. CLS. 2, 27, 28 AND 50).

FIRST USE 8-15-2006; IN COMMERCE 8-15-2006.

CLASS 35—ADVERTISING AND BUSINESS

FOR RETAIL STORE SERVICES IN THE FIELD OF GIRLS' CLOTHING, COSMETICS, BATH PRODUCTS FOR HAIR AND SKIN, FASHION AND HAIR ACCESSORIES, COSTUME JEWELRY, BED LINENS AND PILLOWS FEATURING A BONUS INCENTIVE PROGRAM FOR CUSTOMERS (U.S. CLS. 100, 101 AND 102).

FIRST USE 8-15-2006; IN COMMERCE 8-15-2006.

MARILYN IZZI, EXAMINING ATTORNEY

SN 78-960,724. WORLDWIDE INSURANCE NETWORK, INC., HIGH POINT, NC. FILED 8-25-2006.

SMART CHOICE INSURANCE CENTERS

THE MARK CONSISTS OF STANDARD CHARACTERS WITHOUT CLAIM TO ANY PARTICULAR FONT, STYLE, SIZE, OR COLOR.

OWNER OF U.S. REG. NOS. 2,323,761, 2,946,258 AND OTHERS.

NO CLAIM IS MADE TO THE EXCLUSIVE RIGHT TO USE "INSURANCE CENTERS", APART FROM THE MARK AS SHOWN.

CLASS 35—ADVERTISING AND BUSINESS

FOR TAX PREPARATION SERVICES (U.S. CLS. 100, 101 AND 102).

CLASS 36—INSURANCE AND FINANCIAL

FOR INSURANCE AGENCY SERVICES, NAMELY, PROPERTY AND CASUALTY INSURANCE, LIFE INSURANCE, HEALTH INSURANCE AND DISABILITY INSURANCE (U.S. CLS. 100, 101 AND 102).

CARRIE GENOVESE, EXAMINING ATTORNEY

SN 78-960,745. WORLDWIDE INSURANCE NETWORK, INC., HIGH POINT, NC. FILED 8-25-2006.

SN 78-960,787. COMMUNITY CONNECT INC., NEW YORK, NY. FILED 8-25-2006.

SMART CHOICE FINANCIAL CENTERS

THE MARK CONSISTS OF STANDARD CHARACTERS WITHOUT CLAIM TO ANY PARTICULAR FONT, STYLE, SIZE, OR COLOR.

OWNER OF U.S. REG. NOS. 2,323,164, 2,946,258 AND OTHERS.

NO CLAIM IS MADE TO THE EXCLUSIVE RIGHT TO USE "FINANCIAL CENTERS", APART FROM THE MARK AS SHOWN.

CLASS 35—ADVERTISING AND BUSINESS

FOR TAX PREPARATION SERVICES (U.S. CLS. 100, 101 AND 102).

CLASS 36—INSURANCE AND FINANCIAL

FOR INSURANCE AGENCY SERVICES, NAMELY, PROPERTY AND CASUALTY INSURANCE, LIFE INSURANCE, HEALTH INSURANCE AND DISABILITY INSURANCE (U.S. CLS. 100, 101 AND 102).

CARRIE GENOVESE, EXAMINING ATTORNEY

SN 78-960,751. P.I., INC., ATHENS, TN. FILED 8-25-2006.

PAKSTER

THE MARK CONSISTS OF STANDARD CHARACTERS WITHOUT CLAIM TO ANY PARTICULAR FONT, STYLE, SIZE, OR COLOR.

CLASS 19—NON-METALLIC BUILDING MATERIALS

FOR CHICKEN COOPS (U.S. CLS. 1, 12, 33 AND 50).
FIRST USE 4-6-1977; IN COMMERCE 4-6-1977.

CLASS 20—FURNITURE AND ARTICLES NOT OTHERWISE CLASSIFIED

FOR PLASTIC CONTAINERS AND BOXES FOR COMMERCIAL USE, NAMELY, FOR USE IN THE PROCESSING AND HANDLING OF FOOD AND LIVESTOCK (U.S. CLS. 2, 13, 22, 25, 32 AND 50).

FIRST USE 4-6-1977; IN COMMERCE 4-6-1977.

CLASS 21—HOUSEWARES AND GLASS

FOR TRAYS FOR USE IN THE PROCESSING AND HANDLING OF FOOD AND LIVESTOCK (U.S. CLS. 2, 13, 23, 29, 30, 33, 40 AND 50).

FIRST USE 4-6-1977; IN COMMERCE 4-6-1977.
JOHN GARTNER, EXAMINING ATTORNEY

GLEE.COM

THE MARK CONSISTS OF STANDARD CHARACTERS WITHOUT CLAIM TO ANY PARTICULAR FONT, STYLE, SIZE, OR COLOR.

CLASS 35—ADVERTISING AND BUSINESS

FOR ADVERTISING SERVICES, NAMELY, PROMOTING THE GOODS AND SERVICES OF OTHERS THROUGH THE DISSEMINATION OF ADVERTISING MATERIALS VIA THE INTERNET; INFORMATION IN THE FIELD OF GOVERNMENT AFFAIRS; PROVIDING INFORMATION CONCERNING EMPLOYMENT OPPORTUNITIES, CAREER DEVELOPMENT, POLITICS, AND POLITICAL PUBLIC AFFAIRS TO INDIVIDUALS OF COMMON SOCIAL AFFINITIES AND ATTRIBUTES; PROVIDING INFORMATION ABOUT THE GOODS AND SERVICES OF OTHERS VIA THE INTERNET (U.S. CLS. 100, 101 AND 102).

CLASS 38—COMMUNICATION

FOR ELECTRONIC MAIL SERVICES; PROVIDING ONLINE CHAT ROOMS FOR TRANSMISSION OF MESSAGES AMONG COMPUTER USERS CONCERNING EMPLOYMENT OPPORTUNITIES, CAREER DEVELOPMENT, POLITICS, POLITICAL PUBLIC AFFAIRS, NEWS AND CURRENT EVENTS INFORMATION CONCERNING POPULAR CULTURE, MUSIC AND ENTERTAINMENT TO INDIVIDUALS OF COMMON SOCIAL AFFINITIES AND ATTRIBUTES (U.S. CLS. 100, 101 AND 104).

CLASS 41—EDUCATION AND ENTERTAINMENT

FOR PROVIDING ONLINE NEWS AND CURRENT EVENTS INFORMATION CONCERNING POPULAR CULTURE, MUSIC AND ENTERTAINMENT TO INDIVIDUALS OF COMMON SOCIAL AFFINITIES AND ATTRIBUTES; PROVIDING ONLINE INFORMATION AND NEWS IN THE FIELD OF EMPLOYMENT TRAINING TO INDIVIDUALS OF COMMON SOCIAL AFFINITIES AND ATTRIBUTES (U.S. CLS. 100, 101 AND 107).

CLASS 42—SCIENTIFIC, COMPUTER AND LEGAL SERVICES

FOR PROVIDING CUSTOMIZED ON-LINE WEB PAGES FEATURING USER-DEFINED INFORMATION, WHICH INCLUDES SEARCH ENGINES AND ONLINE WEB LINKS TO OTHER WEB SITES (U.S. CLS. 100 AND 101).

DAVID YONTEF, EXAMINING ATTORNEY

SN 78-961,840. RIVA DEL LAGO LLC, SUNRISE BEACH, MO. FILED 8-28-2006.

RIVA D'LAGO

THE MARK CONSISTS OF STANDARD CHARACTERS WITHOUT CLAIM TO ANY PARTICULAR FONT, STYLE, SIZE, OR COLOR.

"THE FOREIGN WORDING IN THE MARK TRANSLATES INTO ENGLISH AS "SHORE OF LAKE" OR "LAKE-SHORE"."

CLASS 43—HOTEL AND RESTAURANT SERVICES

FOR HOTEL SERVICES; RESTAURANT SERVICES; CATERING SERVICES; PROVISION OF GENERAL PURPOSE FACILITIES FOR MEETINGS, CONFERENCES AND EXHIBITIONS; PROVISION OF BANQUET AND SOCIAL FUNCTION FACILITIES FOR SPECIAL OCCASIONS; AND RESERVATION SERVICES FOR HOTEL ACCOMMODATIONS FOR OTHERS (U.S. CLS. 100 AND 101).

CLASS 44—MEDICAL, BEAUTY AND AGRICULTURAL SERVICES

FOR HEALTH SPA SERVICES, NAMELY, PROVIDING FACIAL, HAIR, SKIN AND BODY TREATMENTS, MANICURE AND PEDICURE SERVICES, MASSAGE SERVICES, BODY WAXING SERVICES AND BEAUTY SALON SERVICES (U.S. CLS. 100 AND 101).

JILL C. ALT, EXAMINING ATTORNEY

SN 78-962,547. METROGROUP CORP., LINCOLN, NE. FILED 8-29-2006.



OWNER OF U.S. REG. NO. 3,167,753.

NO CLAIM IS MADE TO THE EXCLUSIVE RIGHT TO USE "THE GEOGRAPHICAL REPRESENTATION OF THE EARTH", APART FROM THE MARK AS SHOWN.

"THE COLOR(S) BLUE AND WHITE IS/ARE CLAIMED AS A FEATURE OF THE MARK."

"THE MARK CONSISTS OF THE WORD COLE IN BLUE; THE LETTER O IN COLE IS REPRESENTED BY A GLOBE OF THE EARTH SHOWN IN THE COLORS BLUE AND WHITE."

CLASS 9—ELECTRICAL AND SCIENTIFIC APPARATUS

FOR CROSS-REFERENCE DIRECTORIES AND MAIL AND TELEPHONE PROSPECT LISTS IN THE FORM OF PRERECORDED MAGNETIC TAPES, FLOPPY DISCS AND CD-ROM (U.S. CLS. 21, 23, 26, 36 AND 38).

FIRST USE 12-0-1987; IN COMMERCE 12-0-1987.

CLASS 16—PAPER GOODS AND PRINTED MATTER

FOR CROSS-REFERENCE DIRECTORIES AND MAIL AND TELEPHONE PROSPECT LISTS ON LABELS, 3 X 5 CARDS AND IN MANUSCRIPT FORMAT (U.S. CLS. 2, 5, 22, 23, 29, 37, 38 AND 50).

FIRST USE 0-0-1978; IN COMMERCE 0-0-1978.

CLASS 35—ADVERTISING AND BUSINESS

FOR LEASING CROSS-REFERENCE DIRECTORIES AND MAIL AND TELEPHONE PROSPECT LISTS (U.S. CLS. 100, 101 AND 102).

FIRST USE 0-0-1978; IN COMMERCE 0-0-1978.

DOMINICK J. SALEMI, EXAMINING ATTORNEY

SN 78-962,592. K-2 INDUSTRIES, INC. D/B/A PAVILION GIFT COMPANY, BERGEN, NY. FILED 8-29-2006.



NO CLAIM IS MADE TO THE EXCLUSIVE RIGHT TO USE CANDLES, APART FROM THE MARK AS SHOWN.

CLASS 20—FURNITURE AND ARTICLES NOT OTHERWISE CLASSIFIED

FOR PAINTED RESIN PLAQUES; HOLIDAY ORNAMENTS OF PAINTED RESIN; PAPER PHOTO FRAMES; ROSARY BOXES COMPOSED OF PAINTED RESIN; BIBLE BOXES COMPOSED OF PAINTED RESIN; BOXES COMPOSED OF PAINTED RESIN; NONMETAL GARDEN STAKES; DECORATIVE WALL CROSSES COMPOSED PRIMARILY OF PAINTED RESIN; MUSICAL SHAPES PRIMARILY COMPRISED OF PAINTED RESIN; MIRRORS AND WIND CHIMES (U.S. CLS. 2, 13, 22, 25, 32 AND 50).

CLASS 21—HOUSEWARES AND GLASS

FOR CANDLE HOLDERS; INDOOR AND OUTDOOR CANDLE ACCESSORIES, NAMELY, CANDLE RINGS, CANDLE SNUFFERS, PILLAR CANDLE PLATES, TEALIGHT CANDLE HOLDERS, TAPER CANDLE HOLDERS, VOTIVE CANDLE HOLDERS, CANDLE DISPLAY TRAYS, POTPOURRI CANDLE DISHES, NAMELY, BOWLS AND PLATES (U.S. CLS. 2, 13, 23, 29, 30, 33, 40 AND 50).

AMY MCMENAMIN, EXAMINING ATTORNEY

SN 78-962,923. TCIP, LLC, JACKSON, WY. FILED 8-29-2006.

Tahoe Rain Crazy Train

THE MARK CONSISTS OF STANDARD CHARACTERS WITHOUT CLAIM TO ANY PARTICULAR FONT, STYLE, SIZE, OR COLOR.

CLASS 29—MEATS AND PROCESSED FOODS

FOR DAIRY AND NON-DAIRY WHIPPED TOPPINGS; DAIRY BASED BEVERAGES; DAIRY-BASED FOOD BEVERAGES; TOPPINGS FOR ICE CREAM IN THE NATURE OF FRUIT TOPPING, NUT TOPPING AND PEANUT BUTTER TOPPING (U.S. CL. 46).

CLASS 30—STAPLE FOODS

FOR ICE CREAM; ICE MILK; CONFECTIONERY ICES NAMELY FROZEN YOGURT; FROZEN CONFECTIONS; SORBET; SHERBET; TOPPINGS FOR ICE CREAM IN THE NATURE OF CHOCOLATE TOPPINGS, FUDGE TOPPINGS, CARAMEL TOPPINGS, MARSHMALLOW TOPPING, BUTTERSCOTCH TOPPING, CANDY TOPPINGS AND CANDY SPRINKLE TOPPING (U.S. CL. 46).
MICHAEL LEWIS, EXAMINING ATTORNEY

CLASS 29—MEATS AND PROCESSED FOODS

FOR DAIRY AND NON-DAIRY WHIPPED TOPPINGS; DAIRY BASED BEVERAGES; DAIRY-BASED FOOD BEVERAGES; TOPPINGS FOR ICE CREAM IN THE NATURE OF FRUIT TOPPING, NUT TOPPING AND PEANUT BUTTER TOPPING (U.S. CL. 46).

CLASS 30—STAPLE FOODS

FOR ICE CREAM; ICE MILK; CONFECTIONERY ICES NAMELY FROZEN YOGURT; FROZEN CONFECTIONS; SORBET; SHERBET; TOPPINGS FOR ICE CREAM IN THE NATURE OF CHOCOLATE TOPPINGS, FUDGE TOPPINGS, CARAMEL TOPPINGS, MARSHMALLOW TOPPING, BUTTERSCOTCH TOPPING, CANDY TOPPINGS AND CANDY SPRINKLE TOPPING (U.S. CL. 46).
MICHAEL LEWIS, EXAMINING ATTORNEY

SN 78-962,951. TCIP, LLC, JACKSON, WY. FILED 8-29-2006.

SN 78-962,980. PEAK FINANCIAL MANAGEMENT, INC., WALTHAM, MA. FILED 8-29-2006.

Tahoe Dream Vanilla Bean

**PEAK FINANCIAL MANAGEMENT,
INC.**

THE MARK CONSISTS OF STANDARD CHARACTERS WITHOUT CLAIM TO ANY PARTICULAR FONT, STYLE, SIZE, OR COLOR.

NO CLAIM IS MADE TO THE EXCLUSIVE RIGHT TO USE "VANILLA BEAN", APART FROM THE MARK AS SHOWN.

THE MARK CONSISTS OF STANDARD CHARACTERS WITHOUT CLAIM TO ANY PARTICULAR FONT, STYLE, SIZE, OR COLOR.

NO CLAIM IS MADE TO THE EXCLUSIVE RIGHT TO USE "FINANCIAL MANAGEMENT, INC.", APART FROM THE MARK AS SHOWN.

CLASS 29—MEATS AND PROCESSED FOODS

FOR DAIRY AND NON-DAIRY WHIPPED TOPPINGS; DAIRY BASED BEVERAGES; DAIRY-BASED FOOD BEVERAGES; TOPPINGS FOR ICE CREAM IN THE NATURE OF FRUIT TOPPING, NUT TOPPING AND PEANUT BUTTER TOPPING (U.S. CL. 46).

CLASS 30—STAPLE FOODS

FOR ICE CREAM; ICE MILK; CONFECTIONERY ICES NAMELY FROZEN YOGURT; FROZEN CONFECTIONS; SORBET; SHERBET; TOPPINGS FOR ICE CREAM IN THE NATURE OF CHOCOLATE TOPPINGS, FUDGE TOPPINGS, CARAMEL TOPPINGS, MARSHMALLOW TOPPING, BUTTERSCOTCH TOPPING, CANDY TOPPINGS AND CANDY SPRINKLE TOPPING (U.S. CL. 46).
MICHAEL LEWIS, EXAMINING ATTORNEY

CLASS 35—ADVERTISING AND BUSINESS

FOR TAX AND TAXATION PLANNING, ADVICE, INFORMATION AND CONSULTANCY SERVICES (U.S. CLS. 100, 101 AND 102).
FIRST USE 8-7-1991; IN COMMERCE 8-7-1991.

CLASS 36—INSURANCE AND FINANCIAL

FOR ESTATE PLANNING; FINANCIAL ANALYSIS AND CONSULTATION; FINANCIAL MANAGEMENT; FINANCIAL PLANNING; FINANCIAL PORTFOLIO MANAGEMENT; INVESTMENT ADVICE; INVESTMENT MANAGEMENT; INVESTMENT SERVICES, NAMELY ASSET ACQUISITION, CONSULTATION, DEVELOPMENT AND MANAGEMENT SERVICES (U.S. CLS. 100, 101 AND 102).
FIRST USE 8-7-1991; IN COMMERCE 8-7-1991.
BRIAN PINO, EXAMINING ATTORNEY

SN 78-962,978. TCIP, LLC, JACKSON, WY. FILED 8-29-2006.

SN 78-962,986. TCIP, LLC, JACKSON, WY. FILED 8-29-2006.

Tahoe Tessy Mudpie Messy

**Tahoe Pistachio Grizzly
Mustachio**

THE MARK CONSISTS OF STANDARD CHARACTERS WITHOUT CLAIM TO ANY PARTICULAR FONT, STYLE, SIZE, OR COLOR.

NO CLAIM IS MADE TO THE EXCLUSIVE RIGHT TO USE "MUD PIE", APART FROM THE MARK AS SHOWN.

THE MARK CONSISTS OF STANDARD CHARACTERS WITHOUT CLAIM TO ANY PARTICULAR FONT, STYLE, SIZE, OR COLOR.

NO CLAIM IS MADE TO THE EXCLUSIVE RIGHT TO USE "PISTACHIO", APART FROM THE MARK AS SHOWN.

CLASS 29—MEATS AND PROCESSED FOODS

FOR DAIRY AND NON-DAIRY WHIPPED TOPPINGS; DAIRY BASED BEVERAGES; DAIRY-BASED FOOD BEVERAGES; TOPPINGS FOR ICE CREAM IN THE NATURE OF FRUIT TOPPING, NUT TOPPING AND PEANUT BUTTER TOPPING (U.S. CL. 46).

CLASS 30—STAPLE FOODS

FOR ICE CREAM; ICE MILK; CONFECTIONERY ICES NAMELY FROZEN YOGURT; FROZEN CONFECTIONS; SORBET; SHERBET; TOPPINGS FOR ICE CREAM IN THE NATURE OF CHOCOLATE TOPPINGS, FUDGE TOPPINGS, CARAMEL TOPPINGS, MARSHMALLOW TOPPING, BUTTERSCOTCH TOPPING, CANDY TOPPINGS AND CANDY SPRINKLE TOPPING (U.S. CL. 46).
MICHAEL LEWIS, EXAMINING ATTORNEY

SN 78-963,323. RG GLOBAL LIFESTYLES, INC., RANCHO SANTA MARGARITA, CA. FILED 8-29-2006.



"THE COLOR(S) YELLOW, RED, WHITE, BLACK AND GRAY IS/ARE CLAIMED AS A FEATURE OF THE MARK." THE MARK CONSISTS OF A YELLOW LETTER O JOINED TOGETHER WITH A RED LETTER C AND UNDERNEATH IS THE WORD ANGELS IN WHITE, WITH A GRAY PALM TREE, ALL ON A BLACK OVAL BACKGROUND.

CLASS 5—PHARMACEUTICALS

FOR MEAL REPLACEMENT DRINKS (U.S. CLS. 6, 18, 44, 46, 51 AND 52).

SN 78-962,993. TCIP, LLC, JACKSON, WY. FILED 8-29-2006.

CLASS 32—LIGHT BEVERAGES

FOR COFFEE-FLAVORED SOFT DRINK (U.S. CLS. 45, 46 AND 48).
ANNE E. GUSTASON, EXAMINING ATTORNEY

Tahoe Coffee Crunchy Toffee

SN 78-963,400. ZEN PILATES, LLC, GREENVILLE, SC. FILED 8-29-2006.



THE MARK CONSISTS OF STANDARD CHARACTERS WITHOUT CLAIM TO ANY PARTICULAR FONT, STYLE, SIZE, OR COLOR.

NO CLAIM IS MADE TO THE EXCLUSIVE RIGHT TO USE "COFFEE CRUNCHY TOFFEE", APART FROM THE MARK AS SHOWN.

CLASS 29—MEATS AND PROCESSED FOODS

FOR DAIRY AND NON-DAIRY WHIPPED TOPPINGS; DAIRY BASED BEVERAGES; DAIRY-BASED FOOD BEVERAGES; TOPPINGS FOR ICE CREAM IN THE NATURE OF FRUIT TOPPING, NUT TOPPING AND PEANUT BUTTER TOPPING (U.S. CL. 46).

CLASS 30—STAPLE FOODS

FOR ICE CREAM; ICE MILK; CONFECTIONERY ICES NAMELY FROZEN YOGURT; FROZEN CONFECTIONS; SORBET; SHERBET; TOPPINGS FOR ICE CREAM IN THE NATURE OF CHOCOLATE TOPPINGS, FUDGE TOPPINGS, CARAMEL TOPPINGS, MARSHMALLOW TOPPING, BUTTERSCOTCH TOPPING, CANDY TOPPINGS AND CANDY SPRINKLE TOPPING (U.S. CL. 46).
MICHAEL LEWIS, EXAMINING ATTORNEY

NO CLAIM IS MADE TO THE EXCLUSIVE RIGHT TO USE "PILATES", APART FROM THE MARK AS SHOWN. THE STIPPLING IS A FEATURE OF THE MARK AND DOES NOT INDICATE COLOR.

THE MARK CONSISTS OF THE JAPANESE KANJI CHARACTER FOR THE ENGLISH WORD "ZEN" WITH A BRUSH STROKE CAPITAL LETTER "Z" BEGINNING THE WORD "ZEN" CONNECTED TO BOTTOM RIGHT SIDE OF THE KANJI CHARACTER WITH A HORIZONTAL BRUSH STROKE UNDERSCORING THE WORD "ZEN" AND THE WORD "PILATES" UNDERNEATH THE BRUSH STROKE.

THE NON-LATIN CHARACTER(S) IN THE MARK TRANSLITERATES INTO ZEN (ZEN), AND THIS MEANS A JAPANESE SECT OF MAHAYANA BUDDHISM THAT AIMS AT ENLIGHTENMENT BY DIRECT INTUITION THROUGH MEDITATION IN ENGLISH.

CLASS 18—LEATHER GOODS

FOR ALL-PURPOSE CARRYING BAGS; ATHLETIC BAGS; GYM BAGS; SPORTS BAGS (U.S. CLS. 1, 2, 3, 22 AND 41).

CLASS 25—CLOTHING

FOR CAPS; JACKETS; PANTS; SHIRTS; SWEATERS; TOPS (U.S. CLS. 22 AND 39).

SN 78-963,787. WILSON HUNT INTERNATIONAL, LTD., SKOKIE, IL. FILED 8-30-2006.

CLASS 41—EDUCATION AND ENTERTAINMENT

FOR HEALTH CLUB SERVICES, NAMELY PROVIDING INSTRUCTION AND EQUIPMENT IN THE FIELD OF PHYSICAL EXERCISE; PHYSICAL FITNESS CONSULTATION; PHYSICAL FITNESS INSTRUCTION; PROVIDING FITNESS AND EXERCISE FACILITIES; PROVIDING INFORMATION IN THE FIELD OF EXERCISE TRAINING (U.S. CLS. 100, 101 AND 107).
FIRST USE 8-11-2006; IN COMMERCE 8-11-2006.
LINDA M. KING, EXAMINING ATTORNEY



SN 78-963,647. WILSON HUNT INTERNATIONAL INC., SKOKIE, IL. FILED 8-30-2006.

OWNER OF U.S. REG. NO. 1,560,008.
NO CLAIM IS MADE TO THE EXCLUSIVE RIGHT TO USE SPORTS, APART FROM THE MARK AS SHOWN.
THE MARK CONSISTS OF BOW-SHAPED CURVE WITH AN UNDERLYING S-CURVE SHAPE.

CLASS 28—TOYS AND SPORTING GOODS

FOR SPORTS EQUIPMENT AND ACCESSORIES, NAMELY, BASEBALLS, BASKETBALLS, SOCCER BALLS, VOLLEYBALLS, FOOTBALLS, PLAYGROUND BALLS, TENNIS BALLS, BADMINTON BIRDIES, HOCKEY PUCKS, EXERCISING BALLS (U.S. CLS. 22, 23, 38 AND 50).

CLASS 41—EDUCATION AND ENTERTAINMENT

FOR SPORTS REFEREEING (U.S. CLS. 100, 101 AND 107).
JEFF DEFORD, EXAMINING ATTORNEY

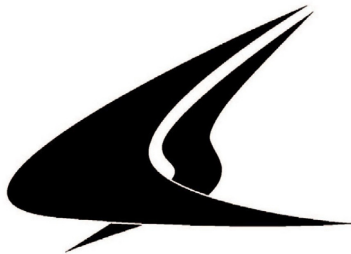

THE MARK CONSISTS OF BOW-SHAPED CURVE WITH AN UNDERLYING S-CURVE SHAPE.

CLASS 28—TOYS AND SPORTING GOODS

FOR SPORTS EQUIPMENT AND ACCESSORIES, NAMELY, BASEBALLS, BASKETBALLS, SOCCER BALLS, VOLLEYBALLS, FOOTBALLS, PLAYGROUND BALLS, TENNIS BALLS, BADMINTON SHUTTLECOCKS, HOCKEY PUCKS; EXERCISING EQUIPMENT, NAMELY, EXERCISE BALLS, EXERCISE BARS, AND EXERCISE BENCHES (U.S. CLS. 22, 23, 38 AND 50).

CLASS 41—EDUCATION AND ENTERTAINMENT

FOR SPORTS REFEREEING (U.S. CLS. 100, 101 AND 107).
BENJAMIN OKEKE, EXAMINING ATTORNEY

SN 78-963,827. WILSON HUNT INTERNATIONAL, LTD., SKOKIE, IL. FILED 8-30-2006.

OWNER OF U.S. REG. NO. 1,560,008.
THE MARK CONSISTS OF BOW-SHAPED CURVE WITH AN UNDERLYING S-CURVE SHAPE.



CLASS 28—TOYS AND SPORTING GOODS

FOR SPORTS EQUIPMENT AND ACCESSORIES, NAMELY, BASEBALLS, BASKETBALLS, SOCCER BALLS, VOLLEYBALLS, FOOTBALLS, PLAYGROUND BALLS, TENNIS BALLS, BADMINTON BIRDIES, HOCKEY PUCKS, EXERCISING BALLS (U.S. CLS. 22, 23, 38 AND 50).

CLASS 41—EDUCATION AND ENTERTAINMENT

FOR SPORTS REFEREEING (U.S. CLS. 100, 101 AND 107).

JEFF DEFORD, EXAMINING ATTORNEY

SN 78-964,245. MATA AMRITANANDAMAYI CENTER, CASTRO VALLEY, CA. FILED 8-30-2006.



OWNER OF U.S. REG. NOS. 2,163,631 AND 2,883,239. THE NAME(S), PORTRAIT(S), AND/OR SIGNATURE(S) SHOWN IN THE MARK IDENTIFIES MATA AMRITANANDAMAYI, WHOSE CONSENT(S) TO REGISTER IS SUBMITTED.

THE MARK CONSISTS OF A TWO-DIMENSIONAL GRAPHIC DESIGN HAVING A WOMAN WITH A HEART DESIGN EMBRACING ANOTHER PERSON REPRESENTED BY A CIRCLE DESIGN AND THE WORD "AMMA" APPEAR WITHIN A BANNER DESIGN THEREUNDER.

THE FOREIGN WORDING IN THE MARK TRANSLATES INTO ENGLISH AS MOTHER.

CLASS 3—COSMETICS AND CLEANING PREPARATIONS

FOR COSMETICS, NAMELY, BODY CARE, FACE CARE AND HAND CARE PRODUCTS IN THE FORM OF NOURISHING, CONDITIONING AND MOISTURIZING LIQUIDS FOR FACE AND BODY CARE, CREAMS, MASKS, AMPOULES CONTAINING NOURISHING, CONDITIONING AND MOISTURIZING LIQUIDS FOR FACE AND BODY CARE; NOURISHING, CONDITIONING AND MOISTURIZING GELS AND EMULSIONS FOR FACE AND BODY CARE; BODY OIL; SHOWER GEL; BATH GEL; FACE LOTION; BODY LOTION; HAIR OIL; SOAPS FOR BODY CARE; HAIR AND BODY SHAMPOOS; HAIR CONDITIONERS; HAIR GELS; HAIR DYES; HAIR SPRAYS; PERSONAL DEODORANTS; PERSONAL ANTIPERSPIRANTS; ESSENTIAL OILS FOR PERSONAL USE; COSMETICS, NAMELY, FACIAL MAKEUP, FOUNDATIONS, SKIN CLEANSING LOTIONS, CLEANING, SOOTHING AND REFRESHING TONICS FOR FACE CARE, NAMELY, SKIN TONERS, NON-MEDICATED ACNE PREPARATIONS, LIP LINER, MASCARA, EYELINERS, FACE POWDER, FACE CREAMS, NAIL CARE PREPARATIONS, SUN PROTECTION PREPARATIONS, NAMELY, SUN BLOCK; PERFUME; PERFUME OILS; INCENSE (U.S. CLS. 1, 4, 6, 50, 51 AND 52).

FIRST USE 12-31-2003; IN COMMERCE 12-31-2003.

CLASS 9—ELECTRICAL AND SCIENTIFIC APPARATUS

FOR DECORATIVE MAGNETS; PRE-RECORDED AUDIO CASSETTES FEATURING MUSIC, DISCOURSES, INSPIRATIONAL TALKS, INFORMATION OR A COMBINATION THEREOF ON AT LEAST ONE AMONG THE TOPICS OF HAPPINESS, SPIRITUALITY, RELIGION, SELF-HELP, PERSONAL EMPOWERMENT, HEALTH AND WELL-BEING, HEALING ARTS, RELIGIOUS CEREMONIES, CHANTING, STRESS MANAGEMENT, AYURVEDIC AND HOLISTIC HEALING OR A COMBINATION THEREOF; PRE-RECORDED VIDEO CASSETTES FEATURING MUSIC, DISCOURSES, INSPIRATIONAL TALKS, INFORMATION OR A COMBINATION THEREOF ON AT LEAST ONE AMONG THE TOPICS OF HAPPINESS, SPIRITUALITY, RELIGION, SELF-HELP, PERSONAL EMPOWERMENT, HEALTH AND WELL-BEING, HEALING ARTS, RELIGIOUS CEREMONIES, CHANTING, STRESS MANAGEMENT, AYURVEDIC AND HOLISTIC HEALING OR A COMBINATION THEREOF; PRE-RECORDED CD'S FEATURING MUSIC, DISCOURSES, INSPIRATIONAL TALKS, IMAGES, INFORMATION OR A COMBINATION THEREOF ON AT LEAST ONE AMONG THE TOPICS OF HAPPINESS, SPIRITUALITY, RELIGION, SELF-HELP, PERSONAL EMPOWERMENT, HEALTH AND WELL-BEING, HEALING ARTS, RELIGIOUS CEREMONIES, CHANTING, STRESS MANAGEMENT, AYURVEDIC AND HOLISTIC HEALING OR A COMBINATION THEREOF; PRE-RECORDED DVD'S FEATURING MUSIC, DISCOURSES, INSPIRATIONAL TALKS, INFORMATION OR A COMBINATION THEREOF ON AT LEAST ONE AMONG THE TOPICS OF HAPPINESS, SPIRITUALITY, RELIGION, SELF-HELP, PERSONAL EMPOWERMENT, HEALTH AND WELL-BEING, HEALING ARTS, RELIGIOUS CEREMONIES, CHANTING, STRESS MANAGEMENT, AYURVEDIC AND HOLISTIC HEALING OR A COMBINATION THEREOF (U.S. CLS. 21, 23, 26, 36 AND 38).

FIRST USE 12-31-2003; IN COMMERCE 12-31-2003.

CLASS 14—JEWELRY

FOR JEWELRY CHAINS; PENDANTS; JEWELRY PINS; BROOCHES; JEWELRY CHARMS; EARRINGS; JEWELRY RINGS AND TOE RINGS; BRACELETS; NECKLACES; AMULETS; JEWELRY BOXES NOT OF METAL (U.S. CLS. 2, 27, 28 AND 50).

FIRST USE 12-31-2003; IN COMMERCE 12-31-2003.

CLASS 16—PAPER GOODS AND PRINTED MATTER

FOR MOUNTED PHOTOGRAPHS; UNMOUNTED PHOTOGRAPHS; MOUNTED POSTERS; UNMOUNTED POSTERS; CALENDARS; GREETING CARDS; STICKERS; BLANK PERSONAL JOURNALS; BOOKS, BOOKLETS, MAGAZINES, PAMPHLETS AND NEWSLETTERS IN THE FIELD OF HAPPINESS, SPIRITUALITY, RELIGION, SELF-HELP, PERSONAL EMPOWERMENT, HEALTH AND WELL-BEING, HEALING ARTS, RELIGIOUS CEREMONIES, CHANTING, STRESS MANAGEMENT, AYURVEDIC AND HOLISTIC HEALING (U.S. CLS. 2, 5, 22, 23, 29, 37, 38 AND 50).

FIRST USE 12-31-2003; IN COMMERCE 12-31-2003.

CLASS 20—FURNITURE AND ARTICLES NOT OTHERWISE CLASSIFIED

FOR CUSHIONS; FLOOR CUSHIONS; PILLOWS; BACK RESTS AND PORTABLE BACK SUPPORTS FOR USE FOR SITTING OR IN PLACE OF CHAIRS; CHAIRS (U.S. CLS. 2, 13, 22, 25, 32 AND 50).

FIRST USE 12-31-2003; IN COMMERCE 12-31-2003.

CLASS 25—CLOTHING

FOR T-SHIRTS; PANTS; SWEATSHIRTS; SWEATPANTS; TOPS; PULLOVERS; JACKETS; SARIS; SALWARS, NAMELY, A WOMAN'S DRESS-LIKE GARMENT; SARONGS; BLOUSES; SHAWLS; VESTS; POLO SHIRTS; SHORTS; TIGHTS; PAJAMAS; SPORTS SHIRTS; SCARVES (U.S. CLS. 22 AND 39).

FIRST USE 12-31-2003; IN COMMERCE 12-31-2003.

CLASS 35—ADVERTISING AND BUSINESS

FOR CATALOG ORDERING SERVICES, MAIL ORDER SERVICES AND COMPUTERIZED ON-LINE RETAIL STORE SERVICES ALL FEATURING CLOTHING, PURSES, BAGS, SADDLE BAGS, TOTE BAGS, JEWELRY, COSMETICS, BODY CARE PRODUCTS, FACIAL MAKEUP, BOOKS, MAGAZINES, BROCHURES, PAMPHLETS, POSTERS, PHOTOGRAPHS, STICKERS, CUSHIONS, BACKRESTS, PILLOWS, DOLLS, CALENDARS, GREETING CARDS, PRE-RECORDED AUDIO CASSETTES, PRE-RECORDED VIDEO CASSETTES, PRE-RECORDED CD'S, PRE-RECORDED DVD'S, OR A COMBINATION THEREOF; CHARITABLE SERVICES, NAMELY, ORGANIZING AND CONDUCTING VOLUNTEER PROGRAMS AND COMMUNITY SERVICE PROJECTS; DISASTER RECOVERY SERVICES, NAMELY, BUSINESS PLANNING AND BUSINESS CONTINUITY CONSULTING; DEVELOPING AND COORDINATING VOLUNTEER PROJECTS FOR CHARITABLE ORGANIZATIONS (U.S. CLS. 100, 101 AND 102).

FIRST USE 12-31-2003; IN COMMERCE 12-31-2003.

CLASS 36—INSURANCE AND FINANCIAL

FOR ACCEPTING AND ADMINISTERING MONETARY CHARITABLE CONTRIBUTIONS; CHARITABLE FUNDRAISING (U.S. CLS. 100, 101 AND 102).

FIRST USE 12-31-2003; IN COMMERCE 12-31-2003.

CLASS 37—CONSTRUCTION AND REPAIR

FOR CHARITABLE SERVICES, NAMELY, RENOVATING AND CONSTRUCTING HOMES FOR LOW INCOME PEOPLE (U.S. CLS. 100, 103 AND 106).

FIRST USE 12-31-2003; IN COMMERCE 12-31-2003.

CLASS 43—HOTEL AND RESTAURANT SERVICES

FOR CHARITABLE SERVICES, NAMELY, PROVIDING FOOD TO NEEDY PERSONS AND DISASTER VICTIMS (U.S. CLS. 100 AND 101).

FIRST USE 12-31-2003; IN COMMERCE 12-31-2003.

CLASS 45—PERSONAL SERVICES

FOR CHARITABLE SERVICES, NAMELY, PROVIDING CLOTHING TO THE NEEDY PERSONS AND DISASTER VICTIMS (U.S. CLS. 100 AND 101).

FIRST USE 12-31-2003; IN COMMERCE 12-31-2003.

JENNIFER MARTIN, EXAMINING ATTORNEY

SN 78-964,769. CIPAR, INC., WILMINGTON, DE. FILED 8-31-2006.

TRITON WATERMAIN LINING
SYSTEM

THE MARK CONSISTS OF STANDARD CHARACTERS WITHOUT CLAIM TO ANY PARTICULAR FONT, STYLE, SIZE, OR COLOR.

NO CLAIM IS MADE TO THE EXCLUSIVE RIGHT TO USE "WATERMAIN LINING SYSTEM", APART FROM THE MARK AS SHOWN.

CLASS 17—RUBBER GOODS

FOR INTERIOR LININGS MADE OF NON-METAL MATERIAL FOR THE INSIDE OF PIPES TO PREVENT CORROSION AND CURE LEAKS (U.S. CLS. 1, 5, 12, 13, 35 AND 50).

CLASS 42—SCIENTIFIC, COMPUTER AND LEGAL SERVICES

FOR PROVIDING A DIAGNOSTIC SERVICE ON WATER PIPES TO DETERMINE PIPE STRENGTH AND WATER FLOW CHARACTERISTICS (U.S. CLS. 100 AND 101).

GEORGIA CARTY, EXAMINING ATTORNEY

SN 78-965,190. AMERICAN DAIRY SCIENCE ASSOCIATION, SAVOY, IL. FILED 8-31-2006.



NO CLAIM IS MADE TO THE EXCLUSIVE RIGHT TO USE "DAIRY SCIENCE ASSOCIATION", APART FROM THE MARK AS SHOWN.

SEC. 2(F) AS TO "AMERICAN DAIRY SCIENCE ASSOCIATION".

CLASS 16—PAPER GOODS AND PRINTED MATTER

FOR PUBLICATIONS, NAMELY, NEWSLETTERS AND JOURNALS IN THE FIELD OF DAIRY SCIENCE (U.S. CLS. 2, 5, 22, 23, 29, 37, 38 AND 50).

FIRST USE 0-0-1992; IN COMMERCE 0-0-1992.

CLASS 35—ADVERTISING AND BUSINESS

FOR ASSOCIATION SERVICES, NAMELY, PROMOTING THE INTERESTS OF EDUCATORS, SCIENTISTS AND INDUSTRIALISTS WHO ARE INVOLVED IN THE DAIRY INDUSTRY (U.S. CLS. 100, 101 AND 102).

FIRST USE 0-0-1992; IN COMMERCE 0-0-1992.

CLASS 41—EDUCATION AND ENTERTAINMENT

FOR EDUCATIONAL SERVICES, NAMELY, CONDUCTING CONFERENCES IN THE FIELD OF DAIRY AND ANIMAL SCIENCES (U.S. CLS. 100, 101 AND 107).

FIRST USE 0-0-1992; IN COMMERCE 0-0-1992.

DANNEAN HETZEL, EXAMINING ATTORNEY

SN 78-966,187. BOWMAN, DAVE, CHINO HILLS, CA. FILED 9-1-2006.

ACLARITY

THE MARK CONSISTS OF STANDARD CHARACTERS WITHOUT CLAIM TO ANY PARTICULAR FONT, STYLE, SIZE, OR COLOR.

CLASS 9—ELECTRICAL AND SCIENTIFIC APPARATUS

FOR ACCOUNTING SOFTWARE, NAMELY, SOFTWARE FOR MONITORING UNUSUAL TRANSACTIONS IN CLIENT'S ACCOUNTING SOFTWARE, INTERNET USE OR E-MAILS (U.S. CLS. 21, 23, 26, 36 AND 38).

CLASS 35—ADVERTISING AND BUSINESS

FOR ACCOUNTING SERVICES, NAMELY, ACCOUNTING, INCOME TAX PREPARATION, AUDITS, REVIEWS AND COMPILATIONS PROVIDED IN CONNECTION THEREWITH; BUSINESS INVESTIGATIONS (U.S. CLS. 100, 101 AND 102).

CLASS 45—PERSONAL SERVICES

FOR PERFORMING BUSINESS RELATED FRAUD AND FORENSIC INVESTIGATIONS (U.S. CLS. 100 AND 101).

ELISSA GARBER KON, EXAMINING ATTORNEY

SN 78-966,303. AHEAD OF THE GAME, INC., ENCINITAS, CA. FILED 9-1-2006.



THE MARK CONSISTS OF A MENDING OF A GEOMETRICALLY STYLISH CAPITAL S AND A GEOMETRICALLY STYLISH CAPITAL H, WITH THE WORDS SUPER HEAT BELOW. THE S AND H REPRESENT RAMPS LIKE THOSE USED IN VARIOUS EXTREME SPORTS (I.E. SKATEBOARDING, SNOWBOARDING, BMX, ETC.).

CLASS 16—PAPER GOODS AND PRINTED MATTER

FOR STICKERS AND POSTERS (U.S. CLS. 2, 5, 22, 23, 29, 37, 38 AND 50).

CLASS 25—CLOTHING

FOR T-SHIRTS, HATS, SWEATSHIRTS, BOARD-SHORTS, JACKETS, BEANIES (U.S. CLS. 22 AND 39).

CLASS 28—TOYS AND SPORTING GOODS

FOR CARD GAMES, BOARD GAMES, SURFBOARDS, SKATEBOARDS, SNOWBOARDS (U.S. CLS. 22, 23, 38 AND 50).

CLASS 41—EDUCATION AND ENTERTAINMENT

FOR PROVIDING ONLINE COMPUTER GAME (U.S. CLS. 100, 101 AND 107).
KIMBERLY FRYE, EXAMINING ATTORNEY

SN 78-966,930. BASF AKTIENGESELLSCHAFT, LUDWIGSHAFEN AM RHEIN, FED REP GERMANY, FILED 9-5-2006.

CELLIONIC

THE MARK CONSISTS OF STANDARD CHARACTERS WITHOUT CLAIM TO ANY PARTICULAR FONT, STYLE, SIZE, OR COLOR.

CLASS 1—CHEMICALS

FOR CHEMICAL PRODUCTS FOR INDUSTRIAL PURPOSES, NAMELY SOLUTIONS OF CELLULOSE IN IONIC LIQUIDS (U.S. CLS. 1, 5, 6, 10, 26 AND 46).

CLASS 42—SCIENTIFIC, COMPUTER AND LEGAL SERVICES

FOR TECHNICAL ADVICE ON SOLUTIONS OF CELLULOSE IN IONIC LIQUIDS (U.S. CLS. 100 AND 101).
COLLEEN KEARNEY, EXAMINING ATTORNEY

SN 78-967,329. AUDI AG, INGOLSTADT, FED REP GERMANY, FILED 9-5-2006.

RS3

THE MARK CONSISTS OF STANDARD CHARACTERS WITHOUT CLAIM TO ANY PARTICULAR FONT, STYLE, SIZE, OR COLOR.

OWNER OF U.S. REG. NOS. 2,823,068, 3,076,893 AND OTHERS.

CLASS 12—VEHICLES

FOR VEHICLES, NAMELY, AUTOMOBILES, SPORT UTILITY VEHICLES, SPORTS CARS, VANS, PICK-UP TRUCKS, ESTATE CARS, RACING CARS; ENGINES FOR LAND VEHICLES (U.S. CLS. 19, 21, 23, 31, 35 AND 44).

CLASS 25—CLOTHING

FOR CLOTHING, NAMELY, T-SHIRTS, POLO SHIRTS, JACKETS, SWEATERS; HEADGEAR, NAMELY, CAPS (U.S. CLS. 22 AND 39).

CLASS 28—TOYS AND SPORTING GOODS

FOR MODEL CARS (U.S. CLS. 22, 23, 38 AND 50).
INGRID C. EULIN, EXAMINING ATTORNEY

SN 78-967,363. AUDI AG, INGOLSTADT, FED REP GER-
MANY, FILED 9-5-2006.

SN 78-967,396. PROPAY USA, INC., OREM, UT. FILED 9-5-
2006.

RS7

PROPAYGOLD

THE MARK CONSISTS OF STANDARD CHARACTERS
WITHOUT CLAIM TO ANY PARTICULAR FONT, STYLE,
SIZE, OR COLOR.

OWNER OF U.S. REG. NOS. 2,823,068, 3,076,893 AND
OTHERS.

THE MARK CONSISTS OF STANDARD CHARACTERS
WITHOUT CLAIM TO ANY PARTICULAR FONT, STYLE,
SIZE, OR COLOR.

OWNER OF U.S. REG. NO. 3,061,051.

CLASS 12—VEHICLES

FOR VEHICLES, NAMELY, AUTOMOBILES, SPORT
UTILITY VEHICLES, SPORTS CARS, VANS, PICK-UP
TRUCKS, ESTATE CARS, RACING CARS; ENGINES
FOR LAND VEHICLES (U.S. CLS. 19, 21, 23, 31, 35 AND
44).

CLASS 35—ADVERTISING AND BUSINESS

FOR ACCOUNTS RECEIVABLE SERVICES, NAMELY,
SET UP OF MERCHANT ACCOUNTS FOR OTHERS (U.S.
CLS. 100, 101 AND 102).

CLASS 25—CLOTHING

FOR CLOTHING, NAMELY, T-SHIRTS, POLO SHIRTS,
JACKETS, SWEATERS; HEADGEAR, NAMELY, CAPS
(U.S. CLS. 22 AND 39).

CLASS 36—INSURANCE AND FINANCIAL

FOR FINANCIAL SERVICES, NAMELY, ACCOUNTS
RECEIVABLE FINANCING FOR MERCHANT AC-
COUNTS (U.S. CLS. 100, 101 AND 102).
SOPHIA S. KIM, EXAMINING ATTORNEY

CLASS 28—TOYS AND SPORTING GOODS

FOR MODEL CARS (U.S. CLS. 22, 23, 38 AND 50).
INGRID C. EULIN, EXAMINING ATTORNEY

SN 78-967,398. AUDI AG, INGOLSTADT, FED REP GER-
MANY, FILED 9-5-2006.

SN 78-967,382. AUDI AG, INGOLSTADT, FED REP GER-
MANY, FILED 9-5-2006.

RS8

S7

THE MARK CONSISTS OF STANDARD CHARACTERS
WITHOUT CLAIM TO ANY PARTICULAR FONT, STYLE,
SIZE, OR COLOR.

OWNER OF U.S. REG. NOS. 2,823,068, 3,076,893 AND
OTHERS.

THE MARK CONSISTS OF STANDARD CHARACTERS
WITHOUT CLAIM TO ANY PARTICULAR FONT, STYLE,
SIZE, OR COLOR.

OWNER OF U.S. REG. NOS. 1,917,829, 2,534,302 AND
OTHERS.

CLASS 12—VEHICLES

FOR VEHICLES, NAMELY, AUTOMOBILES, SPORT
UTILITY VEHICLES, SPORTS CARS, VANS, PICK-UP
TRUCKS, ESTATE CARS, RACING CARS; ENGINES
FOR LAND VEHICLES (U.S. CLS. 19, 21, 23, 31, 35 AND
44).

CLASS 12—VEHICLES

FOR VEHICLES, NAMELY AUTOMOBILES, SPORT
UTILITY VEHICLES, SPORTS CARS, VANS, PICK-UP
TRUCKS, ESTATE CARS, RACING CARS; ENGINES
FOR LAND VEHICLES (U.S. CLS. 19, 21, 23, 31, 35 AND
44).

CLASS 25—CLOTHING

FOR CLOTHING, NAMELY, T-SHIRTS, POLO SHIRTS,
JACKETS, SWEATERS; HEADGEAR, NAMELY, CAPS
(U.S. CLS. 22 AND 39).

CLASS 25—CLOTHING

FOR CLOTHING, NAMELY, T-SHIRTS, POLO SHIRTS,
JACKETS, SWEATERS; HEADGEAR, NAMELY CAPS
(U.S. CLS. 22 AND 39).

CLASS 28—TOYS AND SPORTING GOODS

FOR MODEL CARS (U.S. CLS. 22, 23, 38 AND 50).
INGRID C. EULIN, EXAMINING ATTORNEY

CLASS 28—TOYS AND SPORTING GOODS

FOR MODEL CARS (U.S. CLS. 22, 23, 38 AND 50).
INGRID C. EULIN, EXAMINING ATTORNEY

SN 78-967,463. AUDI AG, INGOLSTADT, FED REP GERMANY, FILED 9-5-2006.

SN 78-969,426. STARK CARPET CORP., NEW YORK, NY. FILED 9-7-2006.

RS5

THE MARK CONSISTS OF STANDARD CHARACTERS WITHOUT CLAIM TO ANY PARTICULAR FONT, STYLE, SIZE, OR COLOR.

OWNER OF U.S. REG. NOS. 2,823,068, 3,076,893 AND OTHERS.

CLASS 12—VEHICLES

FOR VEHICLES, NAMELY AUTOMOBILES, SPORT UTILITY VEHICLES, SPORTS CARS, VANS, PICK-UP TRUCKS, ESTATE CARS, RACING CARS; ENGINES FOR LAND VEHICLES (U.S. CLS. 19, 21, 23, 31, 35 AND 44).

CLASS 25—CLOTHING

FOR CLOTHING, NAMELY T-SHIRTS, POLO SHIRTS, JACKETS, SWEATERS; HEADGEAR, NAMELY CAPS (U.S. CLS. 22 AND 39).

CLASS 28—TOYS AND SPORTING GOODS

FOR MODEL CARS (U.S. CLS. 22, 23, 38 AND 50).
INGRID C. EULIN, EXAMINING ATTORNEY

SN 78-969,377. RAYTHEON COMPANY, WALTHAM, MA. FILED 9-7-2006.

MATH MOVES U

THE MARK CONSISTS OF STANDARD CHARACTERS WITHOUT CLAIM TO ANY PARTICULAR FONT, STYLE, SIZE, OR COLOR.

CLASS 36—INSURANCE AND FINANCIAL

FOR PROVIDING GRANTS TO TEACHERS, SCHOOLS, AND EDUCATIONAL ORGANIZATIONS TO SUPPORT MATH EDUCATION; PROVIDING EDUCATIONAL SCHOLARSHIPS TO STUDENTS (U.S. CLS. 100, 101 AND 102).

FIRST USE 11-1-2005; IN COMMERCE 11-1-2005.

CLASS 41—EDUCATION AND ENTERTAINMENT

FOR EDUCATIONAL SERVICES, NAMELY CONDUCTING EDUCATIONAL PROGRAMS IN THE FIELD OF MATH AND TECHNOLOGY EDUCATION AND PROVIDING INCENTIVES TO STUDENTS TO DEMONSTRATE EXCELLENCE IN THE FIELD OF MATH AND TECHNOLOGY THROUGH THE ISSUANCE OF AWARDS (U.S. CLS. 100, 101 AND 107).

FIRST USE 11-1-2005; IN COMMERCE 11-1-2005.
MICHAEL WEBSTER, EXAMINING ATTORNEY

GREY WATKINS

THE MARK CONSISTS OF STANDARD CHARACTERS WITHOUT CLAIM TO ANY PARTICULAR FONT, STYLE, SIZE, OR COLOR.

THE NAME "GREY WATKINS" IDENTIFIES A LIVING INDIVIDUAL WHOSE CONSENT IS OF RECORD.

CLASS 24—FABRICS

FOR TEXTILE FABRICS FOR USE IN CONNECTION WITH HOME AND COMMERCIAL INTERIOR DECORATING (U.S. CLS. 42 AND 50).

FIRST USE 6-1-1980; IN COMMERCE 6-1-1980.

CLASS 27—FLOOR COVERINGS

FOR WALL COVERINGS, NAMELY, VINYL WALL COVERINGS, PLASTIC WALL COVERINGS, WALLPAPER AND TEXTILE WALL COVERINGS IN THE NATURE OF WALLPAPER (U.S. CLS. 19, 20, 37, 42 AND 50).

FIRST USE 6-1-1980; IN COMMERCE 6-1-1980.

CLASS 35—ADVERTISING AND BUSINESS

FOR DISTRIBUTORSHIP AND WHOLESALE DISTRIBUTORSHIP SERVICES RELATED TO TEXTILE FABRICS, WALLCOVERINGS, HOME FURNISHINGS AND OTHER INTERIOR DESIGN PRODUCTS (U.S. CLS. 100, 101 AND 102).

FIRST USE 6-1-1980; IN COMMERCE 6-1-1980.

CLASS 42—SCIENTIFIC, COMPUTER AND LEGAL SERVICES

FOR DESIGNING TEXTILE FABRICS AND WALLCOVERINGS UPON THE REQUEST OF OTHERS (U.S. CLS. 100 AND 101).

FIRST USE 6-1-1980; IN COMMERCE 6-1-1980.
SOPHIA S. KIM, EXAMINING ATTORNEY

SN 78-970,621. ZOOLIFE INTERNATIONAL LIMITED, LONDON, UNITED KINGDOM, FILED 9-8-2006.

REEF GEL

THE MARK CONSISTS OF STANDARD CHARACTERS WITHOUT CLAIM TO ANY PARTICULAR FONT, STYLE, SIZE, OR COLOR.

OWNER OF UNITED KINGDOM REG. NO. 2328729, DATED 3-25-2005, EXPIRES 4-4-2013.

NO CLAIM IS MADE TO THE EXCLUSIVE RIGHT TO USE "GEL", APART FROM THE MARK AS SHOWN.

CLASS 5—PHARMACEUTICALS

FOR VETERINARY PREPARATIONS FOR TREATMENT OF SKIN, HAIR, ORAL, GASTROINTESTINAL, SOFT TISSUE, MUCOUS COAT, MUCOUS MEMBRANES, HORN, FEET, BEAK, TEETH, EYES, EARS, NOSE, BONE, ELECTROLYTES, NERVOUS SYSTEM, CARDIOVASCULAR SYSTEM, IMMUNE SYSTEM, UROGENITAL SYSTEM, AND REPRODUCTIVE SYSTEM; PHARMACEUTICAL PREPARATIONS FOR TREATMENT OF SKIN, HAIR, ORAL, GASTROINTESTINAL, SOFT TISSUE, MUCOUS MEMBRANES, TEETH, EYES, EARS, NOSE, BONE, ELECTROLYTES, NERVOUS SYSTEM, CARDIOVASCULAR SYSTEM, IMMUNE SYSTEM, UROGENITAL SYSTEM, AND REPRODUCTIVE SYSTEM; DIETETIC FOODS ADAPTED FOR MEDICAL USE; ANIMAL FEED ADDITIVE FOR USE AS A NUTRITIONAL SUPPLEMENT FOR MEDICAL PURPOSES; FOOD SUPPLEMENTS; DIETARY SUPPLEMENTS; MINERAL SUPPLEMENTS; NUTRITIONAL SUPPLEMENTS; VACCINES; VITAMINS (U.S. CLS. 6, 18, 44, 46, 51 AND 52).

CLASS 31—NATURAL AGRICULTURAL PRODUCTS

FOR DRINKS FOR ANIMALS; ANIMAL FEED (U.S. CLS. 1 AND 46).
MATTHEW PAPPAS, EXAMINING ATTORNEY

SN 78-970,898. DECATHLON, VILLENEUVE D'ASCQ, FRANCE, FILED 9-10-2006.

TRIBORD

THE MARK CONSISTS OF STANDARD CHARACTERS WITHOUT CLAIM TO ANY PARTICULAR FONT, STYLE, SIZE, OR COLOR.

OWNER OF FRANCE REG. NO. 063415655, DATED 3-10-2006, EXPIRES 3-9-2016.

OWNER OF U.S. REG. NO. 2,538,776.

CLASS 6—METAL GOODS

FOR FLOATING DOCKS OF METAL FOR MOORING BOATS; MOORING BOLLARDS OF METAL; ANCHOR PLATES; ANCHORS; ROPE THIMBLES OF METAL; ROPES OF METAL; MOBILE BOARDING STAIRS OF METAL, FOR PASSENGERS; STRAPS OF METAL FOR HANDLING LOADS (U.S. CLS. 2, 12, 13, 14, 23, 25 AND 50).

CLASS 21—HOUSEWARES AND GLASS

FOR DRINKING FLASKS, DRINKING FLASKS HOLDERS; INSULATING FLASKS (U.S. CLS. 2, 13, 23, 29, 30, 33, 40 AND 50).

CLASS 24—FABRICS

FOR ELASTIC WOVEN MATERIAL FOR CLOTHING; ADHESIVE FABRIC FOR APPLICATION BY HEAT; FABRIC FOR MANUFACTURING CLOTHES AND SHOES; BATH LINEN; FACE TOWELS OF FABRIC; WASHING MITTS; BATH SHEETS; LABELS OF CLOTH (U.S. CLS. 42 AND 50).

JORDAN BAKER, EXAMINING ATTORNEY

SN 78-972,548. TSI, INC., TEANECK, NJ. FILED 9-12-2006.

L
TRAINING

NO CLAIM IS MADE TO THE EXCLUSIVE RIGHT TO USE "TRAINING", APART FROM THE MARK AS SHOWN.

CLASS 9—ELECTRICAL AND SCIENTIFIC APPARATUS

FOR PRE-RECORDED COMPACT DISCS IN THE FIELD OF EMPLOYEE TRAINING (U.S. CLS. 21, 23, 26, 36 AND 38).

FIRST USE 1-2-2005; IN COMMERCE 1-2-2005.

CLASS 41—EDUCATION AND ENTERTAINMENT

FOR EMPLOYMENT TRAINING SERVICES IN THE FIELDS OF PRODUCT KNOWLEDGE, COMPUTER SYSTEMS, CUSTOMER SERVICE, SELLING STRATEGY AND MANAGEMENT (U.S. CLS. 100, 101 AND 107).

FIRST USE 1-2-2005; IN COMMERCE 1-2-2005.

CHARLOTTE CORWIN, EXAMINING ATTORNEY

SN 78-972,553. WILD PLANET ENTERTAINMENT, INC., SAN FRANCISCO, CA. FILED 9-12-2006.

PURSE PALS

THE MARK CONSISTS OF STANDARD CHARACTERS WITHOUT CLAIM TO ANY PARTICULAR FONT, STYLE, SIZE, OR COLOR.

CLASS 9—ELECTRICAL AND SCIENTIFIC APPARATUS

FOR HANDHELD ELECTRONIC DEVICES FOR INTERACTIVE PLAY WITH MINIATURE DOLLS (U.S. CLS. 21, 23, 26, 36 AND 38).

CLASS 28—TOYS AND SPORTING GOODS

FOR MINIATURE DOLL PLAYSETS WITH INTERACTIVE ELECTRONIC FEATURES (U.S. CLS. 22, 23, 38 AND 50).

SALLY SHIH, EXAMINING ATTORNEY

SN 78-972.750. INTUIT INC., MOUNTAIN VIEW, CA. FILED
9-12-2006.

FIND YOUR BALANCE

THE MARK CONSISTS OF STANDARD CHARACTERS WITHOUT CLAIM TO ANY PARTICULAR FONT, STYLE, SIZE, OR COLOR.

CLASS 9—ELECTRICAL AND SCIENTIFIC APPARATUS

FOR COMPUTER SOFTWARE FOR ACCOUNTING, TRANSACTION PROCESSING, FINANCIAL PLANNING, FINANCIAL MANAGEMENT, FINANCIAL REPORTING, BILL TRACKING, BILL PAYMENT, ONLINE BANKING, PAYROLL PREPARATION, MANAGING LEGAL INFORMATION, PREPARING LEGAL DOCUMENTS, TAX PREPARATION AND PLANNING, BUSINESS PROCESS MANAGEMENT, EXPENSE MANAGEMENT, AND INSTRUCTIONAL MANUALS SOLD AS A UNIT THEREWITH; COMPUTER SOFTWARE FOR TRACKING AND MANAGING RENTAL PROPERTY INCOME AND EXPENSES; COMPUTER SOFTWARE FOR EXPENSE TRACKING, PROJECT TRACKING, INVESTMENT TRACKING, FINANCIAL ASSET TRACKING, AND PHYSICAL ASSET TRACKING; COMPUTER SOFTWARE FOR CREATING REPORTS AND GRAPHS; COMPUTER SOFTWARE FOR DOCUMENT MANAGEMENT; COMPUTER SOFTWARE FOR MANAGING HEALTH CARE INFORMATION, PRESCRIPTION INFORMATION, MEDICAL HISTORY, MEDICAL BILLING, PATIENT RECORDS, AND OTHER MEDICAL RECORDS; COMPUTER SOFTWARE FOR MANAGING MEDICAL INSURANCE, MEDICAL PAYMENTS, EXPENSES AND BILLING; COMPUTER SOFTWARE FOR DATABASE MANAGEMENT; COMPUTER SOFTWARE FOR TIME MANAGEMENT; COMPUTER SOFTWARE FOR DATA AGGREGATION AND REPORTING; COMPUTER SOFTWARE FOR ONLINE BACKUP OF ELECTRONIC FILES (U.S. CLS. 21, 23, 26, 36 AND 38).

CLASS 35—ADVERTISING AND BUSINESS

FOR BUSINESS MANAGEMENT; BUSINESS CONSULTATION; BUSINESS CONSULTATION SERVICES IN THE FIELDS OF ACCOUNTING, FINANCIAL PLANNING, INSURANCE, INVESTMENTS, PAYROLL, TAX PREPARATION AND TAX PLANNING; PROVIDING INFORMATION, NEWS, OPINIONS, AND ADVICE IN THE FIELDS OF ACCOUNTING, PAYROLL, TAX PREPARATION AND PLANNING, AND BUSINESS VIA COMPUTER AND COMMUNICATION NETWORKS; ARRANGING AND CONDUCTING BUSINESS CONFERENCES AND TRADE SHOWS IN THE FIELDS OF FINANCE, ACCOUNTING, PAYROLL, INVESTMENTS, FINANCIAL PLANNING, TAX PREPARATION AND PLANNING, AND BUSINESS MANAGEMENT; ONLINE ORDERING SERVICES FOR SOFTWARE PRODUCTS, OFFICE SUPPLIES AND BUSINESS MANAGEMENT SERVICES; DISSEMINATION OF ADVERTISING FOR OTHERS VIA THE INTERNET; MAIL ORDER CATALOG SERVICES FEATURING SOFTWARE PRODUCTS, OFFICE SUPPLIES AND BUSINESS MANAGEMENT SERVICES; PROMOTING THE GOODS AND SERVICES OF OTHERS VIA THE INTERNET; FINANCIAL SERVICES, NAMELY PAYROLL TAX SERVICES; PROVIDING INSURANCE REFERRAL SERVICES IN THE FIELDS OF LIFE, HEALTH, HOME, DISABILITY, LONG TERM CARE, BUSINESS, MOTOR VEHICLE AND ANNUITIES; BUSINESS INFORMATION SERVICES; PROVIDING PRICE AND PRODUCT COMPARISON SERVICES VIA ELECTRONIC MEANS, NAMELY ADVICE AND INFORMATION ABOUT CUSTOMER SERVICES AND PRODUCT MANAGEMENT AND PRICES ON INTERNET SITES IN CONNECTION WITH PURCHASES MADE OVER THE INTERNET; PROVIDING COMMERCIAL INFORMATION REGARDING VENDORS IN THE FIELD OF LOANS, FINANCE, INSURANCE AND IN-

VESTMENT THROUGH COMPUTER AND COMMUNICATION NETWORKS; MANAGEMENT CONSULTING SERVICES IN THE FIELD OF HEALTH CARE; MEDICAL PATIENT RECORDS MANAGEMENT SERVICES; DATA AND RECORDS MANAGEMENT OUTSOURCING SERVICES FOR HEALTH MAINTENANCE ORGANIZATIONS; PROVIDING COMPANY REVENUE AND EARNINGS GROWTH PROJECTIONS, COMPANY STATISTICS, ECONOMIC FORECASTING AND ANALYSIS, AND MARKET ANALYSIS; PROVIDING AN ONLINE COMPUTER DATABASE IN THE FIELDS OF ECONOMICS, TAX ASSESSMENT, INCOME TAX PREPARATION, AND BUSINESS RESEARCH (U.S. CLS. 100, 101 AND 102).

CLASS 36—INSURANCE AND FINANCIAL

FOR PROVIDING INFORMATION, NEWS, OPINIONS, AND ADVICE IN THE FIELDS OF INSURANCE, INVESTMENTS, AND FINANCIAL PLANNING VIA COMPUTER AND COMMUNICATION NETWORKS; PROVIDING INFORMATION CONSISTING OF FINANCIAL NEWS, INFORMATION, OPINION, ANALYSIS AND ADVICE VIA COMPUTER AND COMMUNICATIONS NETWORKS; FINANCIAL SERVICES, NAMELY ONLINE BANKING, ONLINE BILL PAYING, PAYMENT PROCESSING, AND PAYROLL TAX DEBITING SERVICES; CREDIT CARD SERVICES; ELECTRONIC PAYMENT SERVICES, NAMELY, ELECTRONIC PROCESSING AND TRANSMISSION OF BILL PAYMENT DATA; FINANCING, CONSUMER LENDING, MORTGAGE LENDING SERVICES; PROVIDING INFORMATION IN THE FIELD OF INSURANCE; PROVIDING INSURANCE QUOTATION SERVICES IN THE FIELDS OF LIFE, HEALTH, HOME, DISABILITY, LONG TERM CARE, BUSINESS, MOTOR VEHICLE AND ANNUITIES; INVESTMENT MANAGEMENT; FINANCIAL INVESTMENT PORTFOLIO MANAGEMENT SERVICES PROVIDED VIA COMPUTER OR COMMUNICATION NETWORKS; PROVIDING ON-LINE FINANCIAL SERVICES IN THE NATURE OF LOAN APPLICATIONS THROUGH COMPUTER AND COMMUNICATION NETWORKS; SECURITIES BROKERAGE SERVICES; CREDIT REPORTING SERVICES; SECURITIES TRADING TRANSACTION EXECUTION AND TRACKING SERVICES, NAMELY ASSISTING OTHERS WITH THE COMPLETION AND TRACKING OF FINANCIAL TRANSACTIONS FOR STOCKS, BONDS, SECURITIES AND EQUITIES; SECURITIES BROKERAGE SERVICES, INVESTMENT MANAGEMENT SERVICES, FINANCIAL PORTFOLIO MANAGEMENT SERVICES PROVIDED VIA AN ON-LINE ELECTRONIC COMMUNICATIONS NETWORK; PROVIDING AN ON-LINE COMPUTER DATABASE IN THE FIELDS OF FINANCE, INVESTMENT AND TAX PAYMENT PROCESSING; PROVIDING FINANCIAL PORTFOLIO ACCOUNT INFORMATION; FINANCIAL PORTFOLIO INFORMATION PROCESSING VIA ELECTRONIC COMMUNICATION NETWORKS FOR ACCOUNT MANAGEMENT PURPOSES; LOAN FINANCING, CONSUMER LENDING SERVICES, MORTGAGE LENDING, AND PROVIDING INFORMATION ON LOANS AND LENDERS, ALL VIA ELECTRONIC MEANS; PROVIDING ONLINE INFORMATION REGARDING VENDORS IN THE FIELD OF LOANS AND FINANCE, INSURANCE AND INVESTMENT; PROVIDING ON-LINE FINANCIAL SERVICES IN THE NATURE OF LOAN APPLICATIONS (U.S. CLS. 100, 101 AND 102).

PAUL F. GAST, EXAMINING ATTORNEY

SN 78-972,916. ANTHONY, KOBIE, SACRAMENTO, CA.
FILED 9-12-2006.

SN 78-973,926. PENKY LLC, WILMINGTON, DE. FILED 9-13-2006.

INTELLECTUAL VENTURES

40WATER

THE MARK CONSISTS OF STANDARD CHARACTERS WITHOUT CLAIM TO ANY PARTICULAR FONT, STYLE, SIZE, OR COLOR.

CLASS 5—PHARMACEUTICALS

FOR VITAMIN ENHANCED DRINKS; POWDERS AND SYRUPS FOR MAKING VITAMIN ENHANCED DRINKS (U.S. CLS. 6, 18, 44, 46, 51 AND 52).

CLASS 32—LIGHT BEVERAGES

FOR MINERAL WATERS AND OTHER NON-ALCOHOLIC BEVERAGES, NAMELY, ENERGY DRINKS; FLAVORED WATERS; FRUIT FLAVORED SOFT DRINKS; FRUIT JUICES; SPORTS DRINKS; POWDERS AND SYRUPS FOR MAKING SOFT DRINKS, ENERGY DRINKS, FRUIT DRINKS AND SPORT DRINKS (U.S. CLS. 45, 46 AND 48).

JORDAN BAKER, EXAMINING ATTORNEY

SN 78-973,610. MCSPEEDY, L.L.C., NAPERVILLE, IL. FILED 9-13-2006.

FQUICK

THE MARK CONSISTS OF STANDARD CHARACTERS WITHOUT CLAIM TO ANY PARTICULAR FONT, STYLE, SIZE, OR COLOR.

CLASS 35—ADVERTISING AND BUSINESS

FOR PROVIDING ON-LINE PRODUCT INFORMATION AND PRODUCT REVIEWS IN THE FIELD OF MOTOR VEHICLES (U.S. CLS. 100, 101 AND 102).

CLASS 38—COMMUNICATION

FOR PROVIDING ON-LINE ELECTRONIC BULLETIN BOARDS AND CHAT ROOMS FOR TRANSMISSION OF MESSAGES AMONG COMPUTER USERS CONCERNING MOTOR VEHICLES (U.S. CLS. 100, 101 AND 104).

ALICE BENMAMAN, EXAMINING ATTORNEY

THE MARK CONSISTS OF STANDARD CHARACTERS WITHOUT CLAIM TO ANY PARTICULAR FONT, STYLE, SIZE, OR COLOR.

CLASS 35—ADVERTISING AND BUSINESS

FOR BUSINESS CONSULTING SERVICES; BUSINESS MANAGEMENT AND ADMINISTRATION FOR OTHERS OF INVENTIONS, TECHNOLOGIES, PRODUCTS, METHODS, PROCESSES, IDEAS, DISCOVERIES, PATENT APPLICATIONS, PATENTS, TRADEMARKS, COPYRIGHTS AND TRADE SECRETS; BUSINESS CONSULTING, MANAGEMENT AND SUPERVISION IN THE FIELD OF THE DEVELOPMENT, ACQUISITION, LICENSING AND SALE OF INTELLECTUAL PROPERTY RIGHTS, INVENTIONS, PATENT APPLICATIONS, PATENTS, TRADEMARKS, COPYRIGHTS AND TRADE SECRETS; SERVICES RELATING TO THE ANALYSIS, EVALUATION, CREATION AND BRAND ESTABLISHMENT OF TRADEMARKS; BUSINESS CONSULTING, MANAGEMENT AND SUPERVISION FOR OTHERS, NAMELY, THE EVALUATION, RECRUITING AND MANAGEMENT OF INVENTORS TO FACILITATE THE CREATION OF INVENTIONS, TECHNOLOGIES, PRODUCTS, METHODS, PROCESSES, IDEAS, AND DISCOVERIES, AND OF LEGAL, TECHNICAL, FINANCIAL AND OTHER PROFESSIONALS TO FACILITATE THE CREATION AND ADMINISTRATION OF INTELLECTUAL PROPERTY RIGHTS, INVENTIONS, PATENTS, PATENT APPLICATIONS, TRADEMARKS, COPYRIGHTS AND TRADE SECRETS; BUSINESS EVALUATION AND APPRAISALS OF INVENTIONS, TECHNOLOGIES, PRODUCTS, METHODS, PROCESSES, IDEAS, DISCOVERIES, INTELLECTUAL PROPERTY, PATENTS, PATENT APPLICATIONS, TRADEMARKS, COPYRIGHTS AND TRADE SECRETS FOR THE BENEFIT OF OTHERS; BRINGING TOGETHER, FOR THE BENEFIT OF OTHERS, INTELLECTUAL PROPERTY RIGHTS, INVENTIONS, PATENTS, PATENT APPLICATIONS, TRADEMARKS, COPYRIGHTS AND TRADE SECRETS TO FACILITATE OTHERS' ASSESSMENT AND LICENSING OF SUCH INTELLECTUAL PROPERTY ASSETS; PROMOTION OF BUSINESS OPPORTUNITIES IN THE FIELD OF INTELLECTUAL PROPERTY; PROMOTING PUBLIC AWARENESS OF THE SOCIAL, POLITICAL AND ECONOMIC IMPORTANCE AND VALUE OF INTELLECTUAL PROPERTY RIGHTS, INVENTIONS, PATENTS, PATENT APPLICATIONS, TRADEMARKS, COPYRIGHTS AND TRADE SECRETS; ASSOCIATION SERVICES, NAMELY, PROMOTING THE INTERESTS OF INVENTORS AND OTHER INTELLECTUAL PROPERTY OWNERS; LOBBYING SERVICES, NAMELY, PROMOTING THE INTERESTS OF INVENTORS AND OTHER INTELLECTUAL PROPERTY OWNERS IN THE FIELDS OF LEGISLATION AND REGULATION (U.S. CLS. 100, 101 AND 102).

CLASS 45—PERSONAL SERVICES

FOR COPYRIGHT MANAGEMENT; COPYRIGHT MANAGEMENT CONSULTING; LICENSING OF INTELLECTUAL PROPERTY; PATENT AND PATENT APPLICATION LICENSING; LEGAL SERVICES; LICENSING SERVICES FOR INVENTORS, INVESTORS, FUNDS, UNIVERSITIES, RESEARCH INSTITUTIONS, GOVERNMENTS AND COMMERCIAL AND NON-PROFIT ENTITIES IN THE FIELDS OF INVENTIONS, TECHNOLOGIES, PRODUCTS, METHODS, PROCESSES, IDEAS, DISCOVERIES, INTELLECTUAL PROPERTY, PATENTS, PATENT APPLICATIONS, TRADEMARKS, COPYRIGHTS AND TRADE SECRETS; INTELLECTUAL PROPERTY LICENSING SERVICES, NAMELY, LICENSING SERVICES FOR INVENTORS, INVESTORS, FUNDS, UNIVERSITIES, RESEARCH INSTITUTIONS, GOVERNMENTS AND COMMERCIAL AND NON-

PROFIT ENTITIES IN THE FIELDS OF INVENTIONS, TECHNOLOGIES, PRODUCTS, METHODS, PROCESSES, IDEAS, DISCOVERIES, INTELLECTUAL PROPERTY, PATENTS, PATENT APPLICATIONS, TRADEMARKS, COPYRIGHTS AND TRADE SECRETS; INTELLECTUAL PROPERTY CONSULTATION SERVICES FOR INVENTORS, UNIVERSITIES, RESEARCH INSTITUTIONS, GOVERNMENTS AND COMMERCIAL AND NON-PROFIT ENTITIES IN THE FIELDS OF INVENTIONS, TECHNOLOGIES, PRODUCTS, METHODS, PROCESSES, IDEAS, DISCOVERIES, PATENTS, PATENT APPLICATIONS, TRADEMARKS, COPYRIGHTS AND TRADE SECRETS (U.S. CLS. 100 AND 101).

ELLEN BURNS, EXAMINING ATTORNEY

SN 78-974,835. V & V SUPREMO FOODS, INC., CHICAGO, IL.
FILED 9-14-2006.



SN 78-974,434. SELLARS ABSORBENT MATERIALS, INC., MILWAUKEE, WI. FILED 9-14-2006.

EverSoak
BRAND

NO CLAIM IS MADE TO THE EXCLUSIVE RIGHT TO USE "BRAND", APART FROM THE MARK AS SHOWN.

CLASS 17—RUBBER GOODS

FOR SORBENT PRODUCTS, NAMELY, PADS, ROLLS AND SOCKS FOR ABSORBING OIL, LIQUIDS AND FLUIDS FOR USE IN INDUSTRIAL AND ENVIRONMENTAL CLEAN-UP (U.S. CLS. 1, 5, 12, 13, 35 AND 50).

CLASS 40—MATERIAL TREATMENT

FOR MANUFACTURE OF SORBENTS AND SORBENT PRODUCTS FOR ABSORBING OIL, LIQUIDS AND FLUIDS, FOR OTHERS (U.S. CLS. 100, 103 AND 106).
RONALD AIKENS, EXAMINING ATTORNEY

SN 78-974,792. V & V SUPREMO FOODS, INC., CHICAGO, IL.
FILED 9-14-2006.

ZAMORA

THE MARK CONSISTS OF STANDARD CHARACTERS WITHOUT CLAIM TO ANY PARTICULAR FONT, STYLE, SIZE, OR COLOR.

OWNER OF U.S. REG. NO. 2,520,381.

CLASS 29—MEATS AND PROCESSED FOODS

FOR UNFLAVORED AND UNSWEETENED GELATIN (U.S. CL. 46).

CLASS 30—STAPLE FOODS

FOR CORN MEAL CAKES COMMONLY KNOWN AS SOPES; FLAVORED AND SWEETENED GELATIN (U.S. CL. 46).

KAREN K. BUSH, EXAMINING ATTORNEY

OWNER OF U.S. REG. NO. 2,520,381.

CLASS 29—MEATS AND PROCESSED FOODS

FOR CHEESE, SOUR CREAM, CHORIZO (MEXICAN STYLE SAUSAGE), UNFLAVORED AND UNSWEETENED GELATIN (U.S. CL. 46).

CLASS 30—STAPLE FOODS

FOR CORN MEAL CAKES COMMONLY KNOWN AS SOPES; FLAVORED AND SWEETENED GELATIN (U.S. CL. 46).

KAREN K. BUSH, EXAMINING ATTORNEY

SN 78-974,899. LORI J. WINCHELL, SACO, ME. FILED 9-14-2006.

GOTMICE

THE MARK CONSISTS OF STANDARD CHARACTERS WITHOUT CLAIM TO ANY PARTICULAR FONT, STYLE, SIZE, OR COLOR.

CLASS 9—ELECTRICAL AND SCIENTIFIC APPARATUS

FOR MOUSE PADS FEATURING PHOTOGRAPHS OF MICE (U.S. CLS. 21, 23, 26, 36 AND 38).
FIRST USE 11-1-2003; IN COMMERCE 11-1-2003.

CLASS 16—PAPER GOODS AND PRINTED MATTER

FOR BOOKMARKS, CALENDARS, GREETING/NOTE CARDS, AND PHOTOGRAPH PRINTS FEATURING PHOTOGRAPHS OF MICE (U.S. CLS. 2, 5, 22, 23, 29, 37, 38 AND 50).

FIRST USE 11-1-2003; IN COMMERCE 11-1-2003.
STEVEN PEREZ, EXAMINING ATTORNEY

SN 79-011,440. KÖNIG, PETER, FED REP GERMANY,
FILED 1-21-2005.

wet-protect 

PRIORITY DATE OF 11-2-2004 IS CLAIMED.
OWNER OF INTERNATIONAL REGISTRATION 0851187
DATED 1-21-2005, EXPIRES 1-21-2015.

NO CLAIM IS MADE TO THE EXCLUSIVE RIGHT TO
USE WET-PROTECT, APART FROM THE MARK AS
SHOWN.

CLASS 1—CHEMICALS

FOR CHEMICAL ADDITIVES USED IN MOISTURE
REPELLENT SURFACE COATING AGENTS (U.S. CLS. 1,
5, 6, 10, 26 AND 46).

CLASS 2—PAINTS

FOR CORROSION INHIBITANTS IN THE NATURE OF
A COATING (U.S. CLS. 6, 11 AND 16).

CLASS 4—LUBRICANTS AND FUELS

FOR LUBRICANTS, NAMELY, LUBRICANTS CON-
TAINING SILICON FOR INDUSTRIAL PURPOSES; IN-
DUSTRIAL OILS USED FOR MANUFACTURING AND
MAINTAINING ELECTRIC CONTACTS IN DAMP OR
WATER ENVIRONMENTS (U.S. CLS. 1, 6 AND 15).
JAMES STEIN, EXAMINING ATTORNEY

SN 79-016,702. SZAMES BARBARA, FRANCE, FILED 5-13-
2005.

LOUISE FEUILLERE

PRIORITY DATE OF 11-15-2004 IS CLAIMED.
OWNER OF INTERNATIONAL REGISTRATION 0865835
DATED 5-13-2005, EXPIRES 5-13-2015.
THE NAME LOUISE FEUILLERE DOES NOT IDENTIFY
A LIVING INDIVIDUAL.

CLASS 3—COSMETICS AND CLEANING PRE- PARATIONS

FOR PERFUMERY, NAMELY PERFUMES, TOILET
WATERS, EAU-DE-COLOGNE (U.S. CLS. 1, 4, 6, 50, 51
AND 52).

CLASS 16—PAPER GOODS AND PRINTED MATTER

FOR CARDBOARD PACKAGING; SIGNBOARDS OF
PAPER AND CARDBOARD; PAPER AND CARDBOARD
ADVERTISING SIGNS; WRAPPING PAPER; PACKA-
GING BAGS AND POUCHES IN PLASTIC AND PAPER;
SMALL PAPER AND CARDBOARD BAGS; PAPER AND
CARDBOARD BOXES, CONTAINERS AND CARRYING
CASES, SACHETS SOLD EMPTY, NAMELY, ENVEL-
OPES AND PAPER POUCHES FOR PACKAGING; PLAS-
TIC WRAPPING FILMS, NOT FOR COMMERCIAL OR
INDUSTRIAL PURPOSES AND NOT FOR PACKAGING
FOR FOODSTUFFS (U.S. CLS. 2, 5, 22, 23, 29, 37, 38 AND
50).

CLASS 24—FABRICS

FOR FABRIC LABELS (U.S. CLS. 42 AND 50).

CLASS 25—CLOTHING

FOR CLOTHING, NAMELY, UNDERGARMENTS,
NAMELY, BRAS, BRASSIERES, PANTIES, BRIEFS, G-
STRINGS, THONGS, TOPS, CAMISOLÉS, UNDER-
SKIRTS, GARTERS, GARTER BELT; UNDERWEAR;
UNDERPANTS; BODIES, NAMELY, BODY SUITS;
UNDERCLOTHES, GIRDLES, PAREOS; WAISTCINCH-
ERS, NAMELY, GIRDLES; FOUNDATION GARMENTS,
NAMELY, CORSETS; DRESSING GOWNS, PYJAMAS
(U.S. CLS. 22 AND 39).

MARTHA FROMM, EXAMINING ATTORNEY

SN 79-017,936. OPTICOM DIPL.-ING. MICHAEL KEYHL
GMBH, FED REP GERMANY, FILED 6-28-2005.

PEVQ

THE MARK CONSISTS OF STANDARD CHARACTERS
WITHOUT CLAIM TO ANY PARTICULAR FONT, STYLE,
SIZE, OR COLOR.

PRIORITY DATE OF 2-7-2005 IS CLAIMED.
OWNER OF INTERNATIONAL REGISTRATION 0868890
DATED 6-28-2005, EXPIRES 6-28-2015.

CLASS 9—ELECTRICAL AND SCIENTIFIC APPARATUS

FOR ELECTRONIC TESTING DEVICES FOR TEST
AND MEASUREMENT, FOR MONITORING AND/OR
QUALITY-OF-SERVICE ASSURANCE AND SOFTWARE
FOR DETERMINING THE QUALITY OF COMMUNICA-
TION DEVICES (U.S. CLS. 21, 23, 26, 36 AND 38).

CLASS 42—SCIENTIFIC, COMPUTER AND LEGAL SERVICES

FOR ENGINEERING SERVICES, NAMELY, DETER-
MINING THE QUALITY OF COMMUNICATION DE-
VICES BY MEANS OF MEASUREMENT TECHNOLOGY
(U.S. CLS. 100 AND 101).

ANTHONY RINKER, EXAMINING ATTORNEY

SN 79-019,013. MOLDA AG, FED REP GERMANY, FILED 6-
28-2004.

MOLDA
DRYING · INGREDIENTS · SOLUTIONS

OWNER OF INTERNATIONAL REGISTRATION 0871680
DATED 6-28-2004, EXPIRES 6-28-2014.

NO CLAIM IS MADE TO THE EXCLUSIVE RIGHT TO
USE "DRYING INGREDIENTS", APART FROM THE MARK
AS SHOWN.

THE COLOR(S) BLUE, WHITE, GREY IS/ARE CLAIMED
AS A FEATURE OF THE MARK.

THE COLOUR BLUE APPEARS IN THE TEXT IN THE
MARK. THE COLOUR WHITE APPEARS IN THE LETTER
"O". THE COLOUR GREY APPEARS IN THE BACK-
GROUND OF THE MARK.

CLASS 5—PHARMACEUTICALS

FOR PHARMACEUTICAL AND VETERINARY PREPARATIONS FOR THE TREATMENT OF ADIPOSITY, FOOD DISORDER, CELIAC DISEASE, METABOLIC DISEASE; PHARMACEUTICAL AND VETERINARY PREPARATIONS, NAMELY, COLLAGEN MASKS FOR WOUND HEALING AND COSMETIC PURPOSES; PREPARATIONS FOR THE TREATMENT OF ADIPOSITY, FOOD DISORDER, CELIAC DISEASE, METABOLIC DISEASE; PREPARATIONS FOR HEALTHCARE, NAMELY, COLLAGEN MASKS FOR WOUND HEALING AND COSMETIC PURPOSES; SANITARY PREPARATIONS FOR MEDICAL PURPOSES; VITAMINS AND VITAMIN PREPARATIONS; MULTIVITAMINS AND MULTIVITAMIN PREPARATIONS; MINERAL NUTRITIONAL SUPPLEMENTS AND PREPARATIONS THEREOF, NAMELY, PREPARATIONS FOR THE TREATMENT OF METABOLIC INSUFFICIENCIES; MULTI-MINERAL NUTRIENTS, NAMELY, PREPARATIONS FOR THE TREATMENT OF METABOLIC INSUFFICIENCIES; DIETIC SUBSTANCES, NAMELY GRANULATED OR PULVERIZED ALGAE OR HERBS ADAPTED FOR MEDICAL USE; NUTRITIONAL ADDITIVES, NAMELY, GRANULATED OR PULVERIZED ALGAE OR HERBS FOR USE IN FOODS AND DIETARY SUPPLEMENTS ADAPTED FOR MEDICAL USE; FOODS FOR BABIES; MEDICAL PLASTERS, DRESSINGS FOR WOUNDS, BURNS, SURGERY; MATERIAL FOR STOPPING TEETH, DENTAL WAX; ALL PURPOSE DISINFECTANTS; PREPARATIONS FOR DESTROYING VERMIN; FUNGICIDES, HERBICIDES (U.S. CLS. 6, 18, 44, 46, 51 AND 52).

CLASS 29—MEATS AND PROCESSED FOODS

FOR MEAT, FISH, POULTRY AND GAME AS WELL AS PREPARATIONS THEREOF, ALSO PRESERVED, DRIED AND COOKED; MEAT EXTRACTS; PRESERVED, DRIED AND COOKED FRUITS AND VEGETABLES; JELLIES; JAMS, COMPOTES; FRUIT SAUCES, NAMELY CRANBERRY SAUCE AND APPLE SAUCE; EGGS, MILK; MILK AND DAIRY PRODUCTS, NAMELY CHEESE, YOGURT, CURD, CREAM; PREPARATIONS, NAMELY, POWDERS AND GRANULATES, FOR THE PRODUCTION OF MILK AND DAIRY PRODUCTS, EXCLUDING ICE CREAM, ICE MILK AND FROZEN YOGURT; EDIBLE OILS AND FATS; CACAO BUTTER FOR FOOD PURPOSES; SNACKS MADE OF DEHYDRATED FRUITS; READY-TO-SERVE MEALS AND PARTIAL READY-TO-SERVE MEALS, NAMELY PREPARED, PACKAGED, FROZEN, FREEZE-DRIED, DRIED, VACUUM-BELT-DRIED, AND SPRAY-DRIED MEALS CONSISTING PRIMARILY OF MEAT, FISH, POULTRY OR VEGETABLES; SOUP PREPARATIONS; SAUSAGES; NUTRITIONAL ADDITIVES, NAMELY FAT SUBSTITUTES, THAT CONTAIN ONE OR SEVERAL NUTRIENTS IN A CONCENTRATED FORM COMPOSED OF ALGAE OR HERBS, ALSO GRANULATED OR PULVERIZED NOT ADAPTED FOR MEDICAL PURPOSES; GLAZED FRUITS, NAMELY FRUITS COATED WITH CHOCOLATE OR SUGAR (U.S. CL. 46).

CLASS 30—STAPLE FOODS

FOR COFFEE, TEA, COCOA, SUGAR, RICE AND RICE PREPARATIONS, NAMELY RICE CAKES, RICE CRACKERS, RICE PUDDING; TAPIOCA, SAGO, ARTIFICIAL COFFEE; FLOUR AND PREPARATIONS MADE FROM CEREALS, NAMELY, CEREAL BASED SNACK FOODS, FLOUR BASED BAKERY AND GLUTEN-FREE BAKERY PRODUCTS, NAMELY, GLUTEN-FREE READY BAKING MIXES FOR BREADS, CAKES, WAFFLES AND PIZZA DOUGH; PASTRY AND CONFECTIONERY, NAMELY SWEETS AND CANDIES; EDIBLE FRUIT ICE; HONEY; TREACLE; YEAST, BAKING POWDER; SALT; MUSTARD; VINEGAR, SAUCES, SPICES AND COMPOSITIONS THEREOF; ICE; FARINA AND PASTA; BAKING MIXES, NAMELY, BREAD MIXES, CAKE MIXES, COOKIE MIXES, MUFFIN MIXES; BREAD, ZWIEBACK, COOKIES, WAFFERS AND MIXES THEREFORE; HONEY, SALT AND CHEESE PASTRIES; CONDIMENTS, NAMELY, CHUTNEYS, BARBECUE SAUCES, HOT SAUCES BASED ON CHILI, TOMATO SAUCES, REMOULADES, SOY SAUCES, KETCHUP, SALAD DRESSINGS; SNACKS, NAMELY, PUFFED CORN SNACKS AND RICE BASED SNACKS, READY-TO-SERVE MEALS AND PARTIAL READY-TO-SERVE

MEALS, NAMELY, PREPARED, PACKAGED, FROZEN, FREEZE-DRIED, DRIED, VACUUM-BELT-DRIED, AND SPRAY-DRIED MEALS CONSISTING PRIMARILY OF SPICES, HERBS, AND PASTA, AS WELL AS RICE, CEREALS AND BAKERY PRODUCTS; MEAT PIES AND MEAT GRAVIES; ALMOND PASTE AND MARZIPAN; MAYONNAISE; MILK PUDDING FOR ALIMENTARY PURPOSES, RICE GRUEL, WITH A MILK BASE FOR FOOD, COFFEE BEVERAGES WITH MILK, COCOA BEVERAGES WITH MILK, CHOCOLATE BEVERAGES WITH MILK; QUICHES AND PIZZA; CHOCOLATE, CHOCOLATE DRINKS; SUSHI; CONFECTIONARY AND SUGAR GOODS, NAMELY SWEETS AND CANDIES; CORNFLAKES, PROCESSED CEREALS; MALT FOR FOOD PURPOSES, MALT BISCUITS, MALT EXTRACTS FOR FOOD PURPOSES, MALT SUGAR; DIETIC FOOD, FOR NON-MEDICAL PURPOSES, NAMELY LOW CALORIC BAKING MIXES, PRE-BAKED BREAD, COOKIES AND ROLLS; NUTRITIONAL FOOD ADDITIVES FOR NON-MEDICAL PURPOSES, NAMELY, POLYDEXTROSE FOR USE AS A SUGAR SUBSTITUTE, SUCH GOODS ALSO CONTAINING CONCENTRATED DIETARY FIBERS, VITAMINS, MINERAL NUTRIENTS, TRACE ELEMENTS, EITHER SINGLY OR IN COMBINATION; FOOD FLAVORING SUBSTANCES, EXCLUDING ESSENTIAL OILS; STARCH BASED BINDING AGENTS FOR COOKING PURPOSES; GLUCOSE FOR FOOD PURPOSES; ALL AFORESAID GOODS, ALSO DRIED AND FREEZE-DRIED AND PULVERIZED AND GRANULATED; DESSERT SAUCES (U.S. CL. 46).

CLASS 40—MATERIAL TREATMENT

FOR FOOD PROCESSING, NAMELY, TREATMENT AND FINISHING OF FOOD ALSO FOR THIRD PARTIES, NAMELY, DRYING, FREEZE-DRYING, VACUUM-BELT-DRYING OR SPRAY-DRYING, COMMINUTION, GRANULATION AND COATING OF FOOD AS WELL AS CONVENIENCE PRODUCTS MANUFACTURED THROUGH THESE METHODS (U.S. CLS. 100, 103 AND 106).

CLASS 42—SCIENTIFIC, COMPUTER AND LEGAL SERVICES

FOR SERVICES OF A FOOD DESIGNER, NAMELY, FOOD PRODUCT DEVELOPMENT; QUALITY MANAGEMENT AND QUALITY ASSURANCE IN THE FIELDS OF FOOD PRODUCTION AND FOOD PROCESSING AND FOOD DISTRIBUTION AND FOOD PREPARATION (U.S. CLS. 100 AND 101).

CLASS 43—HOTEL AND RESTAURANT SERVICES

FOR PREPARATION OF FOOD (U.S. CLS. 100 AND 101).

PAMELA HIRSCHMAN, EXAMINING ATTORNEY

SN 79-019,114, COMPAGNIE GERVAIS DANONE, FRANCE, FILED 10-20-2005.

Skeletons

OWNER OF INTERNATIONAL REGISTRATION 0857706 DATED 11-5-2004, EXPIRES 11-5-2014.

CLASS 16—PAPER GOODS AND PRINTED MATTER

FOR PAPER AND PLASTIC PACKAGING BAGS AND POUCHES; PLASTIC BUBBLE PACKS FOR WRAPPING OR PACKAGING; CARDBOARD AND PAPER BOXES; STATIONERY FOR USE IN SCHOOL, OFFICE PAPER STATIONERY, WRITING AND DRAWING BOOKS, NOTE BOOKS, NOTEPADS, WRITING PAPER, ENVELOPES FOR STATIONERY USE, BOOKMARKERS, DRAWING PADS, SCRAPBOOKS, FOLDERS FOR PAPERS, FILE FOLDERS, RUBBER ERASERS; CORRECTING FLUID FOR DOCUMENTS, WRITING CHALK; PENCILS; PAMPHLETS, CATALOGUES, MANUALS, BOOKS, ALL IN THE FIELDS OF HEALTH, NUTRITION, FOOD, BEVERAGES, GAMES, AND SPORTS; COMIC STRIPS, CALENDARS, ALMANACS, DIARIES, INDEX BOOKS; GEOGRAPHICAL MAPS; POSTCARDS, GREETING CARDS; PAPER NAPKINS, TISSUES AND TABLE CLOTHS; BLACKBOARDS; POSTERS; PAPER AND CARDBOARD POSTER HOLDERS; EMBROIDERY DESIGN PATTERNS; TYPEWRITERS (U.S. CLS. 2, 5, 22, 23, 29, 37, 38 AND 50).

CLASS 28—TOYS AND SPORTING GOODS

FOR GAMES, NAMELY, BOARD GAMES; TOYS, NAMELY, CLOTHING FOR DOLLS, PARTY FAVORS IN THE NATURE OF SMALL TOYS, COSTUME MASKS, DOLLS, FURNITURE FOR DOLLS' HOUSES, DOLLS' HOUSES, PLUSH TOYS, PLAY FIGURES OF PLASTIC, WOOD, AND METAL, BUILDING GAMES OF PLASTIC, WOOD, AND METAL; DOMINOES, DICE, MARBLES; TOY MINIATURE VEHICLES; PARLOUR GAMES; GYMNASTICS APPARATUS EXCEPT FOR MATS, FISHING RODS, FISHING REELS; BALLS FOR GAMES, NAMELY, FOOTBALLS, HANDBALLS, AND VOLLEYBALLS; BOXING, FENCING AND BASEBALL GLOVES; PLAYING CARDS (U.S. CLS. 22, 23, 38 AND 50).

CLASS 29—MEATS AND PROCESSED FOODS

FOR MEAT, FISH, HAM, POULTRY, GAME, CHARCUTERIE; DRIED, PRESERVED AND COOKED FRUITS AND VEGETABLES; COMPOTES, JAMS, FRUIT COULIS, JELLIES; SOUPS; TINNED FOOD ESSENTIALLY CONTAINING MEAT, FISH, HAM, POULTRY AND GAME; PREPARED, DEHYDRATED, COOKED, PRESERVED AND DEEP-FROZEN DISHES, ESSENTIALLY CONTAINING MEAT, FISH, HAM, POULTRY AND GAME; VEGETABLE, FRUIT AND POTATO BASED SAVORY AND SWEET SNACK FOODS WITH FLAVORING OR PLAIN; POTATO CRISPS, DRIED FRUIT MIXES, PROCESSED NUTS INCLUDING PROCESSED WALNUTS, HAZELNUTS, PEANUTS AND CASHEW NUTS; COCKTAIL SNACKS MADE OF CHARCUTERIE; MILK, MILK POWDER, FLAVORED GELLED MILK; WHIPPED MILK PRODUCTS, NAMELY, WHIPPED CREAM AND TOPPING; MILK PRODUCTS NAMELY MILK DESSERTS, NAMELY, CREAM, CUSTARD CREAM, AND DAIRY-BASED WHIPPED TOPPING; YOGHURTS, DRINKING YOGHURTS, MEAT AND FISH-BASED MOUSSES, MILK-BASED MOUSSES AND CHEESE-BASED MOUSSES; CREAMS, CREAM PUDDINGS, FRESH CREAM, BUTTER, CHEESE SPREADS, CHEESES, RIPENED CHEESES, MOULD-RIPENED CHEESES, FRESH UNRIPENED CHEESES AND PICKLED CHEESES, SOFT WHITE CHEESE, PLAIN OR AROMATISED FRESH CHEESE IN PASTE OR LIQUID FORM; MILK AND DAIRY BASED BEVERAGES; MILK BEVERAGES WITH HIGH MILK CONTENT; MILK BEVERAGES CONTAINING FRUITS; PLAIN OR FLAVOURED FERMENTED MILK; EDIBLE OILS, OLIVE OIL, EDIBLE FATS (U.S. CL. 46).

CLASS 30—STAPLE FOODS

FOR COFFEE, TEA, COCOA, CHOCOLATE, BEVERAGES MADE WITH COFFEE, BEVERAGES MADE WITH COCOA, CHOCOLATE FOOD BEVERAGES NOT BEING DAIRY-BASED OR VEGETABLE-BASED, SUGAR, RICE, PUFFED RICE, TAPIOCA; FLOURS, SWEET OR SAVOURY TARTS AND PIES, PIZZAS; PLAIN, FLAVOURED AND FILLED PASTA, PROCESSED CEREALS, BREAKFAST CEREALS; PREPARED DISHES MAINLY CONTAINING PASTA; PREPARED DISHES ESSENTIALLY CONSISTING OF PASTRY; PLAIN, TOPPED, FILLED AND FLAVORED BREAD, RUSKS, BISCUITS, WAFERS, WAFFLES, CAKES, AND PASTRIES; BAKING DOUGH, BISCUIT AND PASTRY MIXTURE BASED SAVOURY AND SWEET COCKTAIL SNACKS; FROZEN CONFECTIONS, EDIBLE ICES, ICE CREAMS ESSENTIALLY MADE WITH YOGHURT, ICE CREAM, SORBETS, FROZEN YOGHURT, FLAVOURED FROZEN WATER; HONEY, SALT, MUSTARD, VINEGAR, SAUCES, SWEET SAUCES, PASTA SAUCES, SPICES (U.S. CL. 46).

CLASS 32—LIGHT BEVERAGES

FOR BEERS; STILL OR SPARKLING WATER; FRUIT AND VEGETABLE JUICES; FRUIT AND VEGETABLE BEVERAGES; LEMONADES, SOFT DRINKS, GINGER BEERS, FROZEN FRUIT BEVERAGES; PREPARATIONS FOR MAKING FRUIT DRINKS, SYRUPS FOR BEVERAGES, NON-ALCOHOLIC FRUIT OR VEGETABLE EXTRACTS USED IN THE PREPARATION OF BEVERAGES; NON-ALCOHOLIC BEVERAGES, NAMELY, CARBONATED AND NON-CARBONATED BEVERAGES, BEVERAGES CONTAINING FRUIT JUICES, BEVERAGES WITH TEA FLAVOR AND MALT BEVERAGES ALL CONTAINING LACTIC STARTERS (U.S. CLS. 45, 46 AND 48).

CLASS 38—COMMUNICATION

FOR TELECOMMUNICATIONS, NAMELY, PROVIDING ACCESS TO TELECOMMUNICATION NETWORKS; NEWS AND INFORMATION AGENCIES, NAMELY, THE TRANSMISSION OF NEWS ITEMS TO NEWS REPORTING ORGANIZATIONS; COMMUNICATIONS VIA COMPUTER TERMINALS; TRANSMISSION OF MESSAGES, IMAGES, SOUNDS AND INFORMATION, BY MEANS OF ALL TELECOMMUNICATION MEANS AND, IN PARTICULAR, BY TELEVISION, RADIO, CABLE, SATELLITE; TELEVISION AND RADIO PROGRAM BROADCASTING; CABLE TELEVISION BROADCASTING; ELECTRONIC MAIL (U.S. CLS. 100, 101 AND 104).
DANIEL CAPSHAW, EXAMINING ATTORNEY

SN 79-019,132. DIPTYQUE S.A.S., FRANCE, FILED 4-14-2005.

SN 79-019,426. MAISON CALAVAS, FRANCE, FILED 9-13-2005.

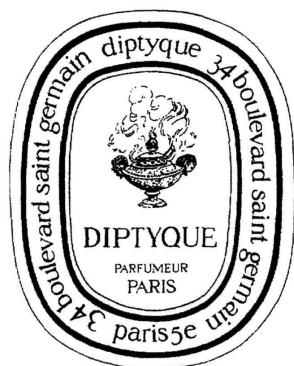

OWNER OF INTERNATIONAL REGISTRATION 0871951
DATED 4-14-2005, EXPIRES 4-14-2015.

OWNER OF U.S. REG. NO. 2,588,179.

NO CLAIM IS MADE TO THE EXCLUSIVE RIGHT TO USE "PARFUMEUR PARIS" AND "34 BOULEVARD SAINT GERMAIN PARIS 5E", APART FROM THE MARK AS SHOWN.

THE ENGLISH TRANSLATION OF THE WORD "PARFUMEUR" IN THE MARK IS "PERFUMER".

CLASS 3—COSMETICS AND CLEANING PREPARATIONS

FOR PERFUMERY, EAU-DE-PARFUM AND TOILET WATERS; SOAPS; DEODORANT PREPARATIONS FOR PERSONAL USE, NAMELY, SOAPS AND DEODORANTS; SHAMPOOS, HAIR CONDITIONERS, HAIR LOTIONS; SHAVING PREPARATIONS, NAMELY AFTER SHAVE AND PRE-SHAVE LOTIONS AND OILS, BALMS, CREAMS, FOAMS, GELS, LOTIONS AND SOAP; ESSENTIAL OILS FOR PERSONAL USE AND OILS FOR TOILET PURPOSES; POMANDERS, POTPOURRIS, PERFUMED DRAWER LINERS, FRAGRANCED SACHETS FOR DRAWERS, ROOM FRAGRANCES, INCENSE (U.S. CLS. 1, 4, 6, 50, 51 AND 52).

CLASS 4—LUBRICANTS AND FUELS

FOR LAMP OILS, CANDLES, SCENTED CANDLES; CANDLE MAKING KITS; WICKS FOR OIL LAMPS (U.S. CLS. 1, 6 AND 15).

CLASS 35—ADVERTISING AND BUSINESS

FOR ADVERTISING, PARTICULARLY SERVICES FOR THE PROMOTION OF GOODS; RETAIL STORE SERVICES RELATING TO GIFTS, LIFESTYLE PRODUCTS, SKIN CARE PRODUCTS AND PERFUMERY; RETAIL STORE SERVICES, AVAILABLE THROUGH COMPUTER COMMUNICATIONS AND INTERACTIVE TELEVISION, FEATURING GIFTS, LIFESTYLE PRODUCTS, SKIN CARE PRODUCTS AND PERFUMERY; MAIL ORDER SERVICES RELATING TO GIFTS, LIFESTYLE PRODUCTS, SKIN CARE PRODUCTS AND PERFUMERY; BUSINESS ADVICE SERVICES; FRANCHISE SERVICES, NAMELY OFFERING TECHNICAL ASSISTANCE IN THE ESTABLISHMENT AND/OR OPERATION OF RETAIL STORES OFFERING GIFTS, LIFESTYLE PRODUCTS, SKINCARE PRODUCTS AND PERFUMERY (U.S. CLS. 100, 101 AND 102).

DEBRA LEE, EXAMINING ATTORNEY

MAISON CALAVAS

THE MARK CONSISTS OF STANDARD CHARACTERS WITHOUT CLAIM TO ANY PARTICULAR FONT, STYLE, SIZE, OR COLOR.

OWNER OF INTERNATIONAL REGISTRATION 0872798
DATED 9-13-2005, EXPIRES 9-13-2015.

THE ENGLISH TRANSLATION OF THE WORD MAISON IN THE MARK IS HOUSE.

CLASS 3—COSMETICS AND CLEANING PREPARATIONS

FOR SOAPS, ESSENTIAL OILS FOR PERSONAL USE, MAKE-UP PREPARATIONS, NAMELY, POWDERS, LIPSTICKS, MASCARA, COSMETIC PENCILS, MAKE-UP FOUNDATIONS, COSMETIC SKIN, HAIR, FOOT AND HAND CARE PREPARATIONS; SUN-TANNING PREPARATIONS; PERFUMES AND SCENTED PRODUCTS, NAMELY, SCENTED SOAPS, SCENTED WATER, SCENTED WOOD, SCENTED POTPOURRI, ROOM FRAGRANCES (U.S. CLS. 1, 4, 6, 50, 51 AND 52).

CLASS 14—JEWELRY

FOR JEWELRY, PRECIOUS STONES; MAKE-UP BOXES SOLD EMPTY, MAKE-UP CASES SOLD EMPTY, POWDER COMPACTS, CASKETS OF PRECIOUS METAL AND THEIR ALLOYS (U.S. CLS. 2, 27, 28 AND 50).

CLASS 18—LEATHER GOODS

FOR HANDBAGS (U.S. CLS. 1, 2, 3, 22 AND 41).

CLASS 21—HOUSEWARES AND GLASS

FOR POWDER COMPACTS, NOT OF PRECIOUS METAL SOLD EMPTY, HAIR BRUSHES, TOILET BRUSHES, BLUSHER BRUSHES, HAIR COMBS, MAKE-UP BRUSHES, POWDER PUFFS (U.S. CLS. 2, 13, 23, 29, 30, 33, 40 AND 50).

CLASS 25—CLOTHING

FOR CLOTHING, NAMELY, DRESSES, SKIRTS, TROUSERS, SUITS, SHORTS, BERMUDA SHORTS, OVERALLS, SHIRTS, BLOUSES, T-SHIRTS, ATHLETIC SHIRTS, TANK TOPS, SWEATERS, CARDIGANS, TRAINING SUITS, JACKETS, RAINCOATS, OVERCOATS, COATS, CAPES, PONCHOS, SWIMMING SUITS, STOCKINGS, TIGHTS, SOCKS; UNDERWEAR, NAMELY, CAMISOLES, STRAPLESS BRAS, BRAS, BRIEFS, BOXER SHORTS, NIGHTGOWNS; BABY DOLLS, PAJAMAS, NEGLIGES, LEOTARDS, NECK TIES, BELTS, SUSPENDERS, SCARVES, GLOVES, STOLE, FUR COATS, FUR STOLE, FUR OVERCOATS, AND FUR CAPS (U.S. CLS. 22 AND 39).

ANDREA SAUNDERS, EXAMINING ATTORNEY

SN 79-019,514. BASF AKTIENGESELLSCHAFT, FED REP GERMANY, FILED 10-25-2005.

JUSTINX

THE MARK CONSISTS OF STANDARD CHARACTERS WITHOUT CLAIM TO ANY PARTICULAR FONT, STYLE, SIZE, OR COLOR.

PRIORITY DATE OF 4-29-2005 IS CLAIMED.
OWNER OF INTERNATIONAL REGISTRATION 0873002 DATED 10-25-2005, EXPIRES 10-25-2015.

CLASS 1—CHEMICALS

FOR CHEMICAL PRODUCTS, NAMELY, CHEMICALS FOR USE IN THE TEXTILE, LEATHER AND PAPER INDUSTRIES; CHEMICAL PRODUCTS FOR USE IN THE TEXTILE, LEATHER AND PAPER INDUSTRIES, NAMELY, CHEMICAL AUXILIARIES, UNPROCESSED ARTIFICIAL RESINS, ADHESIVES FOR INDUSTRIAL USE, FINISHING AND TANNING AGENTS; INDUSTRIAL CHEMICAL PREPARATIONS FOR USE IN THE TEXTILE INDUSTRY, NAMELY, WEAVING AGENTS, PRETREATING AGENTS, OPTICAL BRIGHTENING AGENTS, ANALOG AND DIGITAL PRINTING AGENTS, COATING AND FINISHING AGENTS (U.S. CLS. 1, 5, 6, 10, 26 AND 46).

CLASS 2—PAINTS

FOR COLOURS, NAMELY, PERMANENT COLOR REFINISH FOR TEXTILES, LEATHER, PLASTICS AND PAPER; COLOR PIGMENTS; VARNISHES, LACQUERS; DYESTUFFS, DYESTUFFS IN THE NATURE OF MORDANTS; NATURAL RESINS FOR USE IN THE MANUFACTURE OF RESINS; THERMOCROMATIC PRINTING INKS; PRINTING INKS, NAMELY, DISPERSE DYE INKS AND DYE SUBLIMATION INKS, PRINTING PASTES FOR PRINTING AND COPYING (U.S. CLS. 6, 11 AND 16).

TRICIA SONNEBORN, EXAMINING ATTORNEY

SN 79-019,527. SANKYO COMPANY, LIMITED, JAPAN, FILED 8-19-2005.

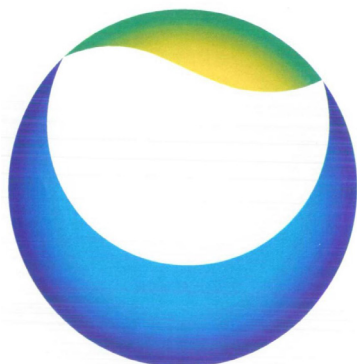

PRIORITY DATE OF 8-9-2005 IS CLAIMED.
OWNER OF INTERNATIONAL REGISTRATION 0873047 DATED 8-19-2005, EXPIRES 8-19-2015.

THE COLOR(S) BLUE, GREEN, YELLOW AND WHITE IS/ARE CLAIMED AS A FEATURE OF THE MARK.

THE UNDER PART OF THE CIRCLE IS BLUE, THE UPPER PART OF THE CIRCLE IS GREEN AND YELLOW, AND THE MIDDLE PART IS WHITE.

CLASS 1—CHEMICALS

FOR CHEMICAL FOOD PRESERVATIVES, CHEMICAL PLASTICIZERS FOR USE AS HIGH POLYMER STABILIZERS FOR PLASTICS AND PAINTS, SYNTHETIC CHEMICAL POLYMER STABILIZERS FOR USE AS LIGHT STABILIZERS FOR PLASTICS AND COATINGS, CHEMICAL ADDITIVES FOR USE IN THE MANUFACTURE OF FOODS, CHEMICAL ANTIOXIDANTS FOR USE IN THE MANUFACTURE OF DRINKS, CAKES, FLAVORING AGENTS, DAIRY PRODUCTS AND FISH PASTE PRODUCTS, CHEMICAL GERMINATION CONTROLLERS, NAMELY, GIBBERELINS FOR GRAPES, ORANGES AND FOR DOMESTIC AND AGRICULTURAL USE, DIAGNOSTIC REAGENTS FOR IN VITRO SCIENTIFIC USE, DIAGNOSTIC PREPARATIONS FOR IN VITRO BIOLOGICAL TESTS, NAMELY FOR URINE AND BLOOD TESTS, FOR BLOOD GLUCOSE TESTS, FOR CLOTTING TESTS, ALL FOR SCIENTIFIC USE, ENZYME PREPARATIONS FOR USE IN VITRO SCIENTIFIC USE, SOIL CONDITIONERS, NAMELY SOIL IMPROVING AGENTS AND PLANT GROWTH REGULATORS FOR AGRICULTURAL USE, AND TETRODOTOXINS FOR SCIENTIFIC RESEARCH USE; ADHESIVES NOT FOR STATIONERY OR HOUSEHOLD PURPOSES; PLANT GROWTH REGULATING PREPARATIONS; FERTILIZERS; CERAMIC GLAZINGS; HIGHER FATTY ACID FOR USE AS FOOD ADDITIVE; NONFERROUS METALS, NAMELY, ACTINIUM, AMERICIUM, ANTIMONY, YTTERBIUM, YTTRIUM, URANIUM, ERBIUM, GADOLINIUM, GALLIUM, CALIFORNIUM, CURIUM, SAMARIUM, DYSPROSIUM, SILICON, MERCURY, SCANDIUM, STRONTIUM, CESIUM, CERIUM, SELENIUM, BISMUTH, THALLIUM, THULIUM, TECHNETIUM, TERBIUM, TELLURIUM, THORIUM, NEODYMIUM, NEPTUNIUM, BERKELIUM, BARIUM, FERMIUM, PRAEODYMIUM, FRANCIUM, PLUTONIUM, PROTACTINIUM, PROMETHIUM, HOLMIUM, EUROPIUM, RADIUM, LANTHANUM, LITHIUM, RUBIDIUM AND RHENIUM; NON-METALLIC MINERALS, NAMELY, SULFUR, FOUNDRY SAND, KAOLIN, TALC, ROCK SALT, DIATOMACEOUS EARTH, ACID CLAY, BARITES (BARITE, HEAVY SPAR), SALTPETER (SALPETRE), NATURAL GRAPHITE, DOLOMITE, CRYOLITE, BENTONITE, BAUXITE, FLUORITE (FLORSPA), MAGNESITE, ALUNITE AND ROCK PHOSPHATE; PHOTOGRAPHIC SUPPLIES, NAMELY, BLUEPRINT PAPER, PHOTOGRAPHIC PAPER, PHOTOGRAPHIC SENSITIZERS, PHOTOGRAPHIC DRY PLATES, PHOTOGRAPHIC DEVELOPERS, FLASH POWDER, PHOTOGRAPHIC FIXERS AND UNEXPOSED PHOTOGRAPHIC FILMS; CHEMICAL TEST PAPER; ARTIFICIAL SWEETENERS; FLOUR AND STARCH FOR INDUSTRIAL PURPOSES FOR MANUFACTURING PAPER AND TEXTILES; UNPROCESSED PLASTICS IN PRIMARY FORM; PAPER PULP FOR MANUFACTURING PURPOSES AND WOOD PULP FOR MANUFACTURING (U.S. CLS. 1, 5, 6, 10, 26 AND 46).

CLASS 5—PHARMACEUTICALS

FOR FULL LINE OF PHARMACEUTICAL PREPARATIONS; VETERINARY DRUGS FOR THE TREATMENT OF DISTEMPER IN DOGS, DISTOMATOSIS IN DOGS, COCCIDIUM IN CHICKENS AND DYSENTERY IN PIGS; SANITARY PREPARATIONS FOR MEDICAL USE AND SANITARY PREPARATIONS FOR AGRICULTURAL USE, NAMELY, HERBICIDES, FUNGICIDES, INSECTICIDES, BACTERICIDES AND RODENTICIDES; OILED PAPER FOR MEDICAL PURPOSES, SANITARY MASKS; WAFER FOR WRAPPING A DOSE OF POWDERED MEDICINES; GAUZE FOR DRESSINGS; UNIT DOSE CAPSULES SOLD EMPTY FOR PHARMACEUTICALS; EYE PATCHES FOR MEDICAL USE; EAR BANDAGES, MENSTRUATION BANDAGES, MENSTRUATION TAMPONS, SANITARY NAPKINS, SANITARY PANTIES, ABSORBENT COTTON FOR MEDICAL USE; ADHESIVE PLASTERS FOR MEDICAL USE; BANDAGES FOR DRESSINGS, COLLODION FOR MEDICAL USE; BREAST-NURSING PADS, DENTAL IMPRESSION MATERIAL, DENTAL CEMENTS, DENTAL ABRASIVES, DENTAL MASTICS; BRACELETS FOR MEDICAL PURPOSES; INCONTINENCE DIAPERS; FLY CATCHING PAPER, MOTHPROOFING PAPER; LAC-

TOSE MILK SUGAR FOR BABIES, LACTOSE MILK SUGAR FOR DISPENSING USE; POWDERED MILK FOR BABIES; SEMEN FOR ARTIFICIAL INSEMINATION; DIETETIC FOODS ADAPTED FOR MEDICAL PURPOSES, DIETETIC BEVERAGES ADAPTED FOR MEDICAL PURPOSES, BABY FOODS, DIABETIC BREAD THAT IS GLUTEN FREE TO ACCOMMODATE SPECIAL MEDICAL NEEDS AND HEALTH CONDITIONS, EDIBLE PLANT FIBERS, NAMELY, DIETARY FIBERS AS ADDITIVES FOR FOOD PRODUCTS; GROUND FLAXSEED FIBERS USED IN DIETARY SUPPLEMENTS (U.S. CLS. 6, 18, 44, 46, 51 AND 52).
WILLIAM VERHOSEK, EXAMINING ATTORNEY

SN 79-020,821. INTERPUMP HYDRAULICS S.P.A., ITALY, FILED 11-11-2005.

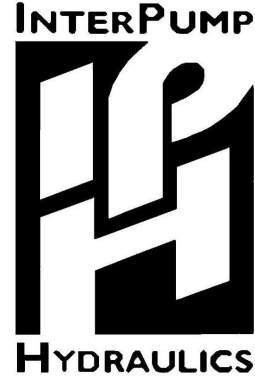

SN 79-020,120. SOLVAY CARBONATE FRANCE S.A.S., FRANCE, FILED 12-9-2005.

OWNER OF INTERNATIONAL REGISTRATION 0876611 DATED 11-11-2005, EXPIRES 11-11-2015.

NO CLAIM IS MADE TO THE EXCLUSIVE RIGHT TO USE "HYDRAULICS", APART FROM THE MARK AS SHOWN.

CLASS 7—MACHINERY

FOR MACHINES AND MACHINE TOOLS FOR THE CUTTING AND FORMING OF MATERIALS; ELECTRIC MOTORS FOR MACHINES, ENGINES NOT FOR LAND VEHICLES; MACHINE COUPLINGS, TRANSMISSION COMPONENTS, NAMELY, GEAR SPEED REDUCERS, AND GEAR SPEED MULTIPLIERS FOR INDUSTRIAL AND FARM MACHINERY; AGRICULTURAL IMPLEMENTS OTHER THAN HAND-OPERATED, NAMELY, PLOWS, HARROWS, DISK HARROWS, MOWERS, REAPERS, HARVESTERS, HAY RAKES, HAY BALERS, BROADCAST SEEDERS, MANURE SPREADERS, FERTILIZER DISTRIBUTORS, CORN HUSKERS AND ROLLERS; INCUBATORS FOR EGGS (U.S. CLS. 13, 19, 21, 23, 31, 34 AND 35).

CLASS 12—VEHICLES

FOR LAND VEHICLES; APPARATUS FOR LOCOMOTION BY LAND, AIR OR WATER, NAMELY, TRACTORS, BOATS AND AIRCRAFT (U.S. CLS. 19, 21, 23, 31, 35 AND 44).

ELIZABETH BEYER, EXAMINING ATTORNEY



OWNER OF INTERNATIONAL REGISTRATION 0874736 DATED 12-9-2005, EXPIRES 12-9-2015.

CLASS 1—CHEMICALS

FOR CHEMICALS FOR USE IN INDUSTRY, AGRICULTURE AS WELL AS ANIMAL HUSBANDRY (U.S. CLS. 1, 5, 6, 10, 26 AND 46).

CLASS 5—PHARMACEUTICALS

FOR ALL PURPOSE DISINFECTANTS; DISINFECTANT PREPARATIONS FOR COMFORT, NAMELY, DISINFECTANTS FOR SANITARY PURPOSES; DISINFECTANT PREPARATIONS FOR HYGIENE IN ANIMAL HUSBANDRY; MINERAL PREPARATIONS FOR EXTERNAL PARASITE CONTROL FOR VETERINARY USE (U.S. CLS. 6, 18, 44, 46, 51 AND 52).
PAMELA HIRSCHMAN, EXAMINING ATTORNEY

SN 79-021,059. SAINT-GOBAIN ECOPHON B.V., NETHERLANDS, FILED 11-22-2005.

MASTER

OWNER OF INTERNATIONAL REGISTRATION 0745317 DATED 9-29-2000, EXPIRES 9-29-2010.

CLASS 17—RUBBER GOODS

FOR BUILDING MATERIALS FOR SOUND ABSORBING, ACOUSTIC INSULATION AND THERMAL INSULATION; ARCHITECTURAL ACOUSTIC PRODUCTS, NAMELY, SOUND ABSORBERS AND DIFFUSERS; MINERAL WOOL FOR USE AS A BUILDING INSULATION; GLASS WOOL, GLASS FIBER AND ROCK WOOL FIBER FOR BUILDING AND CONSTRUCTION INSULATION; ACOUSTIC INSULATION BARRIER PANELS; BUILDING INSULATION; ACOUSTIC TILES; ACOUSTICAL PANELS FOR BUILDING; INSULATING TILES; INSULATING STRUCTURAL PANELS FOR PLACEMENT ON EDIFICES; METAL FOIL FOR BUILDING INSULATION; FIBERGLASS INSULATION FOR BUILDINGS; FIBERGLASS FABRIC FOR BUILDING INSULATION; FOAM SHEETING FOR USE AS A BUILDING INSULATION; FOAM INSULATION FOR USE IN BUILDING AND CONSTRUCTION; ACRYLIC-BASED, SILICONE-BASED AND URETHANE-BASED SEALANTS; INSULATING PAINT; AEROSOL FOAM SEALANTS AND ADHESIVES FOR CONSTRUCTION PARTICULARLY FOR USE IN GLAZING, SIDING AND TRIM; ADHESIVE SEALANT AND TAPE FOR INDUSTRIAL AND COMMERCIAL PURPOSES; SEALANTS FOR BUILDINGS; POLYURETHANE FILM FOR USE IN SEALING AND INSULATING; POLYURETHANE FILM FOR USE AS BUILDING INSULATION AND MOISTURE BARRIER (U.S. CLS. 1, 5, 12, 13, 35 AND 50).

SN 79-021,066. HEIDI.COM SÀRL, CH-2072 SAINT-BLAISE, SWITZERLAND, FILED 12-16-2005.



heidi.com

OWNER OF INTERNATIONAL REGISTRATION 0823235 DATED 3-26-2004, EXPIRES 3-26-2014.

THE MARK CONSISTS OF THE WORDING HEIDI.COM IN STYLIZED FONT APPEARING BELOW A STYLIZED DESIGN OF A GIRL'S HEAD.

CLASS 24—FABRICS

FOR FABRICS, NAMELY COTTON FABRIC AS WELL AS TEXTILE GOODS, NAMELY FACE TOWELS OF TEXTILE, BATH LINEN EXCEPT CLOTHING (U.S. CLS. 42 AND 50).

CLASS 25—CLOTHING

FOR CLOTHING, NAMELY SHIRTS, T-SHIRTS, SWEATSHIRTS, TROUSERS, JACKETS, DRESSES (U.S. CLS. 22 AND 39).

KAELIE KUNG, EXAMINING ATTORNEY

CLASS 19—NON-METALLIC BUILDING MATERIALS

FOR NON-METALLIC BUILDING MATERIALS NAMELY, WALL AND CEILING BOARDS, WALL AND CEILING PANELS, WALL AND CEILING TILES, SOFFITS AND FASCIA; NON-METAL FIRE-RESISTANT BOARDS AND PANELS FOR CONSTRUCTION; NON-METAL WATER-RESISTANT BOARDS AND PANELS FOR CONSTRUCTION; NON-METAL DOOR PANELS; NON-METAL SUSPENDED CEILING SYSTEMS COMPRISING PANELS; NON-METAL CEILING PANELS; FIREPROOF TILES; NON-METAL TILES; NON-METAL CLADDING FOR CONSTRUCTION AND BUILDING; SHEATHING BOARDS; CONSTRUCTION MATERIAL, NAMELY, FIBERGLASS FACED SHEATHING; WALL SYSTEMS, NAMELY, MOVABLE REUSABLE, WALL PANELS MADE PRIMARILY OF NON-METAL MATERIALS; JAPANESE STYLE INDOOR SLIDING PARTITIONS NOT OF METAL; NON-METAL CURTAIN WALLS; NON-METAL LATTICES, RUNNERS, HANGERS, PROFILES, NAMELY, BUILDING WALL AND CEILING FRAMING PRIMARILY OF NON-METAL; TRIMS, SPLICES, NAMELY, NON-METAL CONNECTORS FOR WALLS, CEILING, AND GRID SYSTEMS, AND CLIPS FOR SUSPENDED CEILINGS AND WALLS; PARTS AND FITTINGS FOR ALL THE AFORESAID GOODS, NOT INCLUDED ON OTHER CLASSES, NAMELY, NON-METAL EXPANSION JOINTS FOR WALLS AND CEILING, CONSTRUCTION ELEMENTS NOT MADE OF METAL, NAMELY, SHORES, SUPPORTS, AND BRACES; PARTS AND FITTINGS FOR ALL THE AFORESAID GOODS IN THIS CLASS, NAMELY, NON-METAL JOINERY FITTINGS (U.S. CLS. 1, 12, 33 AND 50).

INGA ERVIN, EXAMINING ATTORNEY

SN 79-021,123. SONY ERICSSON MOBILE COMMUNICATIONS AB, SWEDEN, FILED 10-11-2005.

m2m

Expanding Wireless Possibilities

PRIORITY DATE OF 4-11-2005 IS CLAIMED.

OWNER OF INTERNATIONAL REGISTRATION 0877519 DATED 10-11-2005, EXPIRES 10-11-2015.

NO CLAIM IS MADE TO THE EXCLUSIVE RIGHT TO USE "M2M", APART FROM THE MARK AS SHOWN.

CLASS 9—ELECTRICAL AND SCIENTIFIC APPARATUS

FOR TELECOMMUNICATIONS APPARATUS AND INSTRUMENTS, NAMELY, TELEPHONE HANDSETS, TELEPHONE EAR PIECES, HANDS-FREE TELEPHONE SETS AND TELEPHONE HOLDERS; CELLULAR TELEPHONES; MOBILE TELEPHONES; TELEPHONE EQUIPMENT CABINETS; TELEPHONE EQUIPMENT RACKS; TELEPHONE SWITCHING UNITS, SWITCHES AND RELAYS FOR TELEPHONE CONSOLES AND SWITCHBOARDS; AUDIO AMPLIFIERS; TELEPHONE RECEIVERS; TELEPHONES; FAX MACHINES; DISPLAY SCREENS, NAMELY, COMPUTER DISPLAY SCREENS AND DISPLAY SCREENS FOR TELEPHONES; ELECTRONIC GAMES PROGRAMS; COMPONENT PARTS FOR TELECOMMUNICATIONS APPARATUS AND INSTRUMENTS, NAMELY, FOR TELEPHONE HANDSETS, TELEPHONE EAR PIECES, HANDS-FREE TELEPHONE

SETS AND TELEPHONE HOLDERS, CELLULAR TELEPHONES, MOBILE TELEPHONES, TELEPHONE SWITCHING UNITS, SWITCHES AND RELAYS FOR TELEPHONE CONSOLES AND SWITCHBOARDS, AUDIO AMPLIFIERS, TELEPHONE RECEIVERS, BATTERIES AND CHARGERS FOR TELECOMMUNICATIONS APPARATUS AND INSTRUMENTS, NAMELY, TELEPHONE HANDSETS, TELEPHONE EAR PIECES, HANDS-FREE TELEPHONE SETS AND TELEPHONE HOLDERS, CELLULAR TELEPHONES, MOBILE TELEPHONES, HEADSETS FOR USE IN RELATION TO HANDS-FREE USE OF TELEPHONES; TELEPHONE EAR PIECES FOR USE IN RELATION TO HANDS-FREE USE OF TELEPHONES; COMPUTER KEYBOARDS AND KEYBOARDS ON OR FOR USE IN CONJUNCTION WITH MOBILE TELEPHONES; DATA PROCESSING APPARATUS, NAMELY, DATA MODEMS FOR HIGH SPEED DATA TRANSMISSIONS; MEDIA FOR RECORDING OR REPRODUCTION OF DATA, SOUND, IMAGES OR SIGNALS, NAMELY, BLANK AUDIO MAGNETIC TAPES, BLANK VIDEO MAGNETIC TAPES AND BLANK VIDEO DISCS; OPTICAL OR MAGNETIC APPARATUS AND INSTRUMENTS, NAMELY, EYEGLASSES, SUNGLASSES AND BINOCULARS; COMPUTERS, COMPUTER TERMINALS; SOFTWARE, NAMELY, COMPUTER PROGRAMS IN RECORDED FORM AND FIXED IN ELECTRONIC MEMORY CIRCUITS, ALL FOR USE WITH TELECOMMUNICATION DEVICES CONTAINING ELECTRONIC GAMES, FOR THE TRANSMISSION, REPRODUCTION, RECEIVING, ACCESSING, SEARCHING, INDEXING AND RETRIEVING OF GAMES, IMAGES, MUSIC, SOUNDS, TEXT, MOVIES, VIDEO AND ANIMATIONS IN THE FIELD OF GENERAL ENTERTAINMENT, AND DATA, FOR GENERAL DATABASE MANAGEMENT, FOR THE MANAGEMENT AND OPERATION OF WIRELESS COMMUNICATION DEVICES, FOR ENABLING AND SECURING ELECTRONIC TRANSACTIONS, AND FOR THE TRANSMISSION, REPRODUCTION, RECEIVING, ACCESSING, SEARCHING, INDEXING AND RETRIEVING OF GAMES, IMAGES, MUSIC, SOUNDS, TEXT, MOVIES, VIDEO AND ANIMATIONS IN THE FIELD OF GENERAL ENTERTAINMENT, AND DATA FROM COMPUTER OR COMMUNICATION NETWORKS; COMPUTER HARDWARE; GM COMPUTER TERMINALS; GM DEVICES FOR WIRELESS RADIO COMMUNICATIONS; GM AND CD MA RUGGED INTEGRATED CIRCUIT MODULES; PC CARDS; MEDIA FOR DATA STORAGE, NAMELY, BLANK SMART CARDS, BLANK ELECTRONIC MEMORY CHIPS AND BLANK MAGNETIC CARDS; ELECTRONIC PERSONAL ORGANIZERS; MULTI-MEDIA TERMINALS, NAMELY, COMPUTERS AND MOBILE TELEPHONES; DOWNLOADABLE ELECTRONIC PUBLICATIONS, NAMELY, MAGAZINES AND MANUALS IN THE FIELD OF TELECOMMUNICATIONS; ELECTRONIC PUBLICATIONS, NAMELY, MAGAZINES AND MANUALS RELATING TO TELECOMMUNICATIONS RECORDED ON COMPUTER MEDIA; CINEMATOGRAPHIC AND PHOTOGRAPHIC APPARATUS AND INSTRUMENTS, NAMELY, STILL AND VIDEO CAMERAS, VIEWING VIDEO SCREENS AND VIEWFINDERS, ALL ADAPTED FOR USE IN RELATION TO TELECOMMUNICATIONS DEVICES; PRINTERS; COMPONENT PARTS FOR THE FOREMENTIONED GOODS, NAMELY FOR COMPUTERS, COMPUTER TERMINALS, COMPUTER HARDWARE, GM COMPUTER TERMINALS, GM DEVICES FOR WIRELESS RADIO COMMUNICATIONS, OS AND CD MA RUGGED INTEGRATED CIRCUIT MODULES, PC CARDS, BLANK SMART CARDS, BLANK ELECTRONIC MEMORY CHIPS AND BLANK MAGNETIC CARDS, ELECTRONIC PERSONAL ORGANIZERS, MULTI-MEDIA TERMINALS, COMPUTERS AND MOBILE TELEPHONES, STILL AND VIDEO CAMERAS ADAPTED FOR USE IN RELATION TO TELECOMMUNICATIONS DEVICES, VIEWING VIDEO SCREENS AND VIEW FINDERS ADAPTED FOR USE IN RELATION TO TELECOMMUNICATIONS DEVICES, PRINTERS (U.S. CLS. 21, 23, 26, 36 AND 38).

CLASS 37—CONSTRUCTION AND REPAIR

FOR MAINTENANCE, SERVICING AND REPAIR OF COMPUTER HARDWARE AND COMPUTER OPERATING SYSTEMS; MAINTENANCE, SERVICING AND REPAIR OF TELECOMMUNICATIONS EQUIPMENT (U.S. CLS. 100, 103 AND 106).

CLASS 38—COMMUNICATION

FOR TELECOMMUNICATIONS AND DATA COMMUNICATION SERVICES, NAMELY, WIRELESS LOCAL AND LONG DISTANCE TELEPHONE, ELECTRONIC DATA TRANSMISSION, E-MAIL AND TEXT MESSAGING, PAGING, ELECTRONIC DATA TRANSMISSION PACKET AND INTERNET PROTOCOL TELEPHONY SERVICES; TELECOMMUNICATIONS CONSULTATION; PROVIDING MULTIPLE USER DEDICATED ACCESS TO THE INTERNET, TO INTRANETS AND TO EXTRANETS; PROVIDING ELECTRONIC TELECOMMUNICATIONS CONNECTIONS TO THE INTERNET, TO INTRANETS AND EXTRANETS OR DATABASES; RENTAL OF TELECOMMUNICATIONS EQUIPMENT; PROVISION OF REMOTE ACCESS TO DATA STORED ELECTRONICALLY IN CENTRAL FILES FOR REMOTE CONSULTATION, NAMELY, COMPUTER PROGRAMS IN RECORDED FORM AND FIXED IN ELECTRONIC MEMORY CIRCUITS, FOR USE IN RELATION TO TELECOMMUNICATION DEVICES FOR ELECTRONIC GAMES, FOR THE TRANSMISSION, REPRODUCTION, RECEIVING, ACCESSING, SEARCHING, INDEXING AND RETRIEVING OF GAMES, IMAGES, MUSIC, SOUNDS, TEXT, MOVIES, VIDEO AND ANIMATIONS IN THE FIELD OF GENERAL ENTERTAINMENT, AND DATA, FOR GENERAL DATABASE MANAGEMENT, FOR THE MANAGEMENT AND OPERATION OF WIRELESS COMMUNICATION DEVICES, AND FOR THE TRANSMISSION, REPRODUCTION, RECEIVING, ACCESSING, SEARCHING, INDEXING AND RETRIEVING OF GAMES, IMAGES, MUSIC, SOUNDS, TEXT, MOVIES, VIDEO AND ANIMATIONS IN THE FIELD OF GENERAL ENTERTAINMENT, AND DATA FROM COMPUTER OR COMMUNICATION NETWORKS; PROVIDING MULTIPLE-USER ACCESS TO A GLOBAL COMPUTER INFORMATION NETWORK (U.S. CLS. 100, 101 AND 104).

CLASS 41—EDUCATION AND ENTERTAINMENT

FOR TRAINING SERVICES IN RELATION TO TELECOMMUNICATIONS (U.S. CLS. 100, 101 AND 107).

CLASS 42—SCIENTIFIC, COMPUTER AND LEGAL SERVICES

FOR MAINTENANCE, SERVICING AND REPAIR OF COMPUTER SOFTWARE; COMPUTER SOFTWARE AND HARDWARE DEVELOPMENT (U.S. CLS. 100 AND 101).
JENNIFER VASQUEZ, EXAMINING ATTORNEY

SN 79-021,281. INFORMATION INTERNET LIMITED, UNITED KINGDOM, FILED 10-28-2005.

SN 79-021,551. EBM-PAPST ST. GEORGEN; GMBH & CO. KG, FED REP GERMANY, FILED 11-29-2005.



PRIORITY DATE OF 4-29-2005 IS CLAIMED.
OWNER OF INTERNATIONAL REGISTRATION 0877923 DATED 10-28-2005, EXPIRES 10-28-2015.

NO CLAIM IS MADE TO THE EXCLUSIVE RIGHT TO USE MARKETMAKER, APART FROM THE MARK AS SHOWN.

THE COLOR(S) DARK GRAY, LIGHT GRAY, BLACK, AND WHITE IS/ARE CLAIMED AS A FEATURE OF THE MARK.

THE MARK CONSISTS OF A STYLIZED LETTER M WHERE THE COLOR DARK GRAY APPEARS ON THE FRONT OF THE M, THE COLOR LIGHT GRAY APPEARS ON THE TOP AND SIDES OF THE M, THE COLOR WHITE APPEARS IN THE LINES BETWEEN THE FRONT AND THE TOP AND SIDES OF THE M. THE MARK ALSO CONSISTS OF THE WORD "MARKETMAKER" IN THE COLOR BLACK.

CLASS 35—ADVERTISING AND BUSINESS

FOR COMPUTERIZED FINANCIAL RECORDS MANAGEMENT SERVICES (U.S. CLS. 100, 101 AND 102).

CLASS 36—INSURANCE AND FINANCIAL

FOR FINANCIAL SERVICES RELATING TO SHARE TRANSACTIONS, NAMELY, BROKERAGE OF UNDERLYING SHARES, DERIVATIVES AND RELATED FINANCIAL INSTRUMENTS AND PROVISION OF FINANCIAL SPREAD BETTING SERVICES RELATING TO FINANCIAL DERIVATIVES AND FINANCIAL INSTRUMENTS; FINANCIAL SERVICES RELATING TO TRADING IN FINANCIAL DERIVATIVES, NAMELY, TRADING OF FINANCIAL DERIVATIVES FOR OTHERS AND AGENCIES FOR FINANCIAL DERIVATIVES TRADING OF OFF-EXCHANGE DERIVATIVES PRODUCTS, INCLUDING FUTURES SUCH AS ROLLING SPOT AND FORWARD CONTRACTS, OPTIONS, CONTRACTS FOR DIFFERENCES AND OTHER DERIVATIVES BASED ON CURRENCIES, PRECIOUS METALS, SHARES, INDICES, AND COMMODITIES; FINANCIAL SERVICES RELATING TO MARGINED TRANSACTION TRADING OF SHARE DERIVATIVES, NAMELY, MARGINED TRANSACTION TRADING OF SHARE DERIVATIVES FOR OTHERS; FINANCIAL SERVICES RELATING TO CONTRACTS FOR DIFFERENCES, NAMELY, TRADING IN CONTRACTS THAT MIRROR THE PERFORMANCE OF AN UNDERLYING FINANCIAL INSTRUMENT FOR OTHERS; FINANCIAL SERVICES PROVIDED OVER THE INTERNET, NAMELY, ASSISTING OTHERS WITH THE COMPLETION OF FINANCIAL TRANSACTIONS FOR STOCKS, BONDS, SECURITIES AND EQUITIES, PROVIDING ONLINE STORED VALUE ACCOUNTS IN AN ELECTRONIC ENVIRONMENT VIA AN ONLINE SOFTWARE PLATFORM; PROVISION OF FINANCIAL INFORMATION; AND FINANCIAL SPREAD BETTING SERVICES RELATING TO FINANCIAL DERIVATIVES AND FINANCIAL INSTRUMENTS (U.S. CLS. 100, 101 AND 102).
KRISTINA MORRIS, EXAMINING ATTORNEY

ebmpapst ACmaxx

THE MARK CONSISTS OF STANDARD CHARACTERS WITHOUT CLAIM TO ANY PARTICULAR FONT, STYLE, SIZE, OR COLOR.

PRIORITY DATE OF 10-25-2005 IS CLAIMED.

OWNER OF INTERNATIONAL REGISTRATION 0878756 DATED 11-29-2005, EXPIRES 11-29-2015.

OWNER OF U.S. REG. NO. 1,033,719.

CLASS 7—MACHINERY

FOR ELECTRIC DRIVE MOTORS OTHER THAN FOR LAND VEHICLES (U.S. CLS. 13, 19, 21, 23, 31, 34 AND 35).

CLASS 11—ENVIRONMENTAL CONTROL APPARATUS

FOR VENTILATING EXHAUST FANS, HOT AIR BLOWERS, VENTILATING FANS FOR COMMERCIAL AND INDUSTRIAL USE, ELECTRIC FANS, ELECTRIC HEATING FANS (U.S. CLS. 13, 21, 23, 31 AND 34).
AMY HELLA, EXAMINING ATTORNEY

SN 79-021,651. FIAT S.P.A., ITALY, FILED 12-21-2005.



PRIORITY DATE OF 11-7-2005 IS CLAIMED.

OWNER OF INTERNATIONAL REGISTRATION 0878918 DATED 12-21-2005, EXPIRES 12-21-2015.

OWNER OF U.S. REG. NOS. 2,697,187, 2,924,679 AND OTHERS.

NO CLAIM IS MADE TO THE EXCLUSIVE RIGHT TO USE "GROUP", APART FROM THE MARK AS SHOWN.

CLASS 6—METAL GOODS

FOR METAL ALLOYS FOR FURTHER MANUFACTURING SOLD IN FOIL AND POWDER FORM; MARINE ANCHORS, ANVILS, METAL BELLS, ROLLED AND CAST BUILDING MATERIALS OF METAL, NAMELY, FASCIA AND SOFFITS; ROLLED STEEL BUILDING MATERIALS; CAST IRON BUILDING MATERIALS FOR RAILROAD TRACKS; METAL RAILWAY TRACKS, METAL CHAINS; TRANSPORTABLE METAL BUILDINGS; NON ELECTRIC METAL CABLES AND METAL WIRES; METAL DOOR FRAMES; METAL TUBES AND PIPES; METAL SAFES; STEEL IN THE FORM OF BALLS; METAL NAILS AND SCREWS; SEMI-PROCESSED IRON AND LEAD ORES FOR USE IN FURTHER MANUFACTURING (U.S. CLS. 2, 12, 13, 14, 23, 25 AND 50).

CLASS 9—ELECTRICAL AND SCIENTIFIC APPARATUS

FOR CONVERTERS, TRANSFORMERS AND STRUCTURAL PARTS THEREOF, ELECTRIC STORAGE BATTERIES AND PARTS THEREOF, DRY BATTERIES, AUTOMATIC SWITCHBOARDS, ELECTRIC SWITCHES, COMMUTATORS AND CIRCUIT BREAKERS, RHEOSTATS AND ELECTRIC TRANSFORMERS, ELECTRIC FUSES, ELECTRICAL MAINS AND RAILWAY TRACKS, NAMELY, AN ELECTRONIC SIGNALING MECHANISM IN THE NATURE OF A TRAIN CONTROL SYSTEM USED IN THE RAILWAY INDUSTRY FOR DETECTING AND CONTROLLING TRAINS, GROUND FAULTS, BROKEN RAILS, POWER FAILURES, TRACK SWITCHES AND LIGHTS; ELECTRIC TRANSMITTER AND RECEIVERS FOR WIRELESS TELEVISION AND RADIO SIGNALS, ELECTRIC WIRES AND CABLES, NAVIGATION APPARATUS FOR VEHICLES IN THE NATURE OF ON-BOARD COMPUTERS; HAND HELD JOYSTICK AND INTERACTIVE REMOTE FOR PLAYING VIDEO GAMES; MAGNETICALLY CODED KEY CARDS AND CREDIT CARDS; NOTEBOOK COMPUTERS, LAPTOP COMPUTERS, COMPUTER MOUSE, MICROPROCESSORS, SCANNERS, WORD PROCESSORS, COMPUTER DOCKING STATIONS, BLANK MAGNETIC COMPUTER DISCS, ELECTRONIC POCKET PERSONAL DIGITAL ASSISTANTS; AUTOMATIC TELLER MACHINES, NAMELY, ELECTRIC DISTRIBUTION MACHINES; PRINTERS FOR USE WITH COMPUTERS; COMPUTER ELECTRONIC AMUSEMENT APPARATUS, NAMELY, VIDEO OUTPUT GAME MACHINES FOR USE WITH EXTERNAL DISPLAY SCREEN OR MONITOR; COMPUTER KEYBOARDS, ELECTRIC CONTROL PANELS, ELECTRONIC POCKET CALCULATORS, ELECTRONIC POCKET TRANSLATORS, COMPACT DISCS FEATURING MUSIC, MOVIES AND GAMES, MOUSE PADS; RECORDED COMPUTER PROGRAMS FOR EDITING IMAGES, SOUND AND VIDEO FOR USE IN DATABASE MANAGEMENT, FOR ROUTE PLANNING; AUTOMATIC VENDING MACHINES; CASH REGISTERS; FIRE EXTINGUISHERS (U.S. CLS. 21, 23, 26, 36 AND 38).

CLASS 12—VEHICLES

FOR AIRPLANES, HYDROPLANES, AIRCRAFT, HELICOPTERS; AUTOMOBILES, SPORTS CARS, MOTOR BUSES; OMNIBUSES, MOTOR HOMES, TRUCKS, TRAILERS; TRACTORS; ELECTRIC LOCOMOTIVES; BICYCLES; MOTORCYCLES; PASSENGER SHIPS AND BOATS, MOTORBOATS, SAILING SHIPS, YACHTS; VEHICLE BODIES, ENGINES, CLUTCHES, BRAKES, SAFETY BELTS, ALL FOR MOTOR LAND VEHICLES; STRUCTURAL PARTS FOR MOTOR LAND VEHICLES (U.S. CLS. 19, 21, 23, 31, 35 AND 44).

CLASS 16—PAPER GOODS AND PRINTED MATTER

FOR PAPER, CARDBOARD, PAPER CUTTERS, PENS, FOUNTAIN PENS, FELT PENS, BALLPOINT PENS, PEN HOLDERS, WRITING IMPLEMENTS, FOLDERS, DOCUMENT HOLDERS, PHOTOGRAPHS, STATIONERY, ADHESIVES FOR STATIONERY OR HOUSEHOLD PURPOSES; SCRAPBOOK ALBUMS, CARDBOARD HAT BOXES; PHOTO ALBUMS; PRINTING PAPER, PAPERWEIGHTS; PAINTBRUSHES; TYPEWRITERS; WRAPPING PAPER, PLASTIC FILMS NOT FOR COMMERCIAL OR INDUSTRIAL PURPOSES; PLASTIC SHEETS FOR WRITING, PRINTING AND MARKING; PLASTIC BAGS FOR PACKAGING; PRINTING TYPE; PRINTING BLOCKS (U.S. CLS. 2, 5, 22, 23, 29, 37, 38 AND 50).

CLASS 18—LEATHER GOODS

FOR LEATHER AND IMITATION LEATHER; LEATHER KEY CASES, ATTACHE CASES, BRIEFCASES, LEATHER SUIT BAGS, HANDBAGS, TRAVELING BAGS, SUITCASES, ATHLETIC BAGS, ALL PURPOSE SPORT BAGS EXCLUDING BAGS RELATING TO GOLF AND GOLF LIFESTYLE, VANITY CASES SOLD EMPTY, WALLETS, PURSES, BUSINESS AND GREETING CARD HOLDERS AND DOCUMENT CASES ALL OF LEATHER AND IMITATIONS OF LEATHER; ANIMAL SKINS AND HIDES; TRUNKS AND SUITCASES; UMBRELLAS, PARASOLS AND WALKING STICKS; WHIPS, HARNESS AND SADDLERY (U.S. CLS. 1, 2, 3, 22 AND 41).

CLASS 25—CLOTHING

FOR T-SHIRTS, SWEAT SHIRTS, POLO-SHIRTS, TIES, CAPS, OVERALLS, WIND RESISTANT JACKETS, WATERPROOF JACKETS, BLAZERS, PULLOVERS, COATS, ROBES, SCARVES, SWEATERS, SHIRTS, TROUSERS, BELTS, RAINCOATS, TRACK SUITS, SHORTS, GLOVES, PAJAMAS, SLIPPERS, SWIM-WEAR, OVERALL COATS, FOULARDS, FOOTWEAR (U.S. CLS. 22 AND 39).

CLASS 28—TOYS AND SPORTING GOODS

FOR TOY AND PLAYTHINGS, NAMELY, TOY MODEL CARS IN AN ASSEMBLY KIT FORM, TOY MODEL VEHICLES, TOY COLLECTION MODELS REPRODUCING AUTOMOBILES AND OTHER VEHICLES, TOY BUILDING STRUCTURES; DOLLS, DOLL CLOTHING, ACCESSORIES FOR DOLLS, SOFT SCULPTURE FELT TOYS, TOY VEHICLE TRAIN TRACKS, REAL SIZE NON OPERATING TOY REPLICAS OF AUTOMOBILES FOR ORNAMENTATION, ENTERTAINMENT AND EXHIBITION PURPOSES; PUZZLES, VIDEO GAMES, NAMELY, STAND ALONE VIDEO GAME MACHINES; AMUSEMENT APPARATUS, NAMELY PINBALL MACHINES; TENNIS RACKET BAGS, GOLF BAGS, GOLF ACCESSORY POUCHES, GOLF CLUBS, PLAYING CARDS; DECORATIONS FOR CHRISTMAS TREES (U.S. CLS. 22, 23, 38 AND 50).

CLASS 37—CONSTRUCTION AND REPAIR

FOR BUILDING CONSTRUCTION; REPAIR, MAINTENANCE AND LUBRICATION OF VEHICLES; VEHICLE SERVICE STATIONS (U.S. CLS. 100, 103 AND 106).
CARRIE GENOVESE, EXAMINING ATTORNEY

SN 79-021,678. SAATI S.P.A., ITALY, FILED 12-13-2005.



PRIORITY DATE OF 9-13-2005 IS CLAIMED.
OWNER OF INTERNATIONAL REGISTRATION 0879019 DATED 12-13-2005, EXPIRES 12-13-2015.

THE TRADEMARK COMPRISES GRAPHIC AND LITERAL ELEMENTS ARRANGED IN A SINGLE LINE; IN PARTICULAR, IT COMPRISES A CIRCLE FEATURING THE LETTER "S" IN SPECIAL TYPE OVER A SERIES OF LINES DRAWN PERPENDICULARLY; TO THE RIGHT OF THIS CIRCLE IS THE WORD "SAATIPRINT" IN SPECIAL CHARACTERS.

CLASS 1—CHEMICALS

FOR CHEMICAL PRODUCTS FOR THE USE IN THE TEXTILE INDUSTRY, NAMELY, AQUEOUS EMULSION OF PLASTIC MATERIAL POLYMERS; CHEMICAL PRODUCTS FOR THE USE IN PHOTOGRAPHIC INDUSTRY AND FOR THE MANUFACTURE FOR FILM AND SENSITIZED CLOTH, NAMELY, AQUEOUS ACID EMULSIONS FOR REGENERATION OF PICTURES FOR SILK-SCREEN PRINTING; CHEMICAL PRODUCTS TO WATERPROOF TEXTILE MATERIALS, NAMELY SOLUTIONS IN WATER OF WATERPROOFING PLASTIC MATERIALS; CHEMICALS FOR SENSITIZED CLOTHS USED IN PHOTOGRAPHY; CHEMICALS FOR BLUEPRINT CLOTHS; TEXTILE WATERPROOFING CHEMICALS; TEXTILE SIZING CHEMICALS, NAMELY, TEXTILE IMPREGNATING CHEMICALS, HUMIDIFYING PRODUCTS FOR THE TEXTILE INDUSTRY, NAMELY, MOISTENING PREPARATIONS FOR USE IN THE TEXTILE INDUSTRY; CHEMICALS FOR FINISHING IN THE TEXTILE INDUSTRY (U.S. CLS. 1, 5, 6, 10, 26 AND 46).

CLASS 24—FABRICS

FOR FABRICS FOR TEXTILE PRINTING AND SILKSCREEN PRINTING AND TEXTILES ARTICLES, NAMELY, BROCADES, COTTON FABRICS, DAMASK; DAMASK CLOTH; LINEN CLOTH; FLANNEL; JERSEY; RAYON FABRICS, SILK, FUSTIAN, CREPE FABRIC, TAFFETA, TULLE; VELVET; WOOLEN FABRIC; ZEPHYR; GUMMED WATERPROOF CLOTH; CHIFFON FABRICS; CHENILLE FABRICS; HEMP FABRICS, ELASTIC FABRICS FOR CLOTHING; FABRICS MADE OF IMITATION ANIMAL SKIN; FIBERGLASS FABRICS FOR TEXTILE USE; ADHESIVE FABRICS FOR APPLICATION BY HEAT; FELT AND NON-WOVEN TEXTILE FABRICS; FIBERGLASS FABRICS FOR TEXTILE USE; FABRICS MADE OF SYNTHETIC FIBERS; SYNTHETIC FIBER OVERLAY FABRICS; MIXED FABRICS MADE OF CHEMICAL FIBERS; WATER PROOF FABRICS FOR MANUFACTURING CLOTHING, FURNITURE AND AUTOMOBILE UPHOLSTERY, AND LUGGAGE; LAMINATED CHEMICAL FIBER FABRICS; COTTON KNITTED FABRICS; KNITTED FABRICS MADE OF CHEMICAL FIBERS; SYNTHETIC FIBER FABRICS FOR RIBBONS; MULTIPLAYER SYNTHETIC FIBER FABRICS (U.S. CLS. 42 AND 50).

CAROL SPILS, EXAMINING ATTORNEY

SN 79-021,758. PELLENC SELECTIVE TECHNOLOGIES, FRANCE, FILED 12-30-2005.



PELLENC
selective technologies

PRIORITY DATE OF 7-8-2005 IS CLAIMED.
OWNER OF INTERNATIONAL REGISTRATION 0879272 DATED 12-30-2005, EXPIRES 12-30-2015.

NO CLAIM IS MADE TO THE EXCLUSIVE RIGHT TO USE "TECHNOLOGIES", APART FROM THE MARK AS SHOWN.

THE MARK CONSISTS OF PELLENC SELECTIVE TECHNOLOGIES AND A DESIGN OF EIGHT BLACK QUADRILATERALS AND ONE GREY QUADRILATERAL, SEPARATED BY WHITE LINES.

CLASS 7—MACHINERY

FOR MACHINES, NAMELY, GOODS, MATERIALS AND WASTE SORTING AND SEPARATING MACHINES; MACHINES FOR SORTING AND SEPARATING GOODS, MATERIALS AND WASTE WITHOUT CONTACT; MOTORS AND ENGINES FOR GOODS, MATERIALS AND WASTE SORTING AND SEPARATING MACHINES; COUPLINGS AND TRANSMISSION COMPONENTS, NAMELY, BELTS AND GEARS FOR MACHINES, EXCLUDING THOSE FOR LAND VEHICLES; WASTE SORTING AND SEPARATING MACHINES; AIR-OPERATED GOODS, MATERIALS AND WASTE SORTING MACHINES, ELECTRIC PUMPS FOR MACHINES FOR SORTING GOODS, MATERIALS AND WASTE; AIR SUCTION MACHINES; BLOWING MACHINES FOR THE COMPRESSION, EXHAUSTION AND TRANSPORT OF GASES; PNEUMATIC TUBE CONVEYORS; BELT CONVEYORS; AND PARTS THEREFORE (U.S. CLS. 13, 19, 21, 23, 31, 34 AND 35).

CLASS 9—ELECTRICAL AND SCIENTIFIC APPARATUS

FOR SCIENTIFIC, PHOTOGRAPHIC, CINEMATOGRAPHIC, OPTICAL, WEIGHING, MEASURING, SIGNALING, CHECKING APPARATUS, NAMELY, LIGHT, COLOUR, SHAPE, WAVES AND SPECTRUM CAPTORS AND SENSORS, SPECTROMETERS; APPARATUS AND INSTRUMENTS FOR CONDUCTING, SWITCHING, TRANSFORMING, ACCUMULATING, REGULATING OR CONTROLLING ELECTRICITY, NAMELY, ELECTRIC SWITCHES, ELECTRIC RELAYS, CIRCUIT BREAKERS; APPARATUS FOR RECORDING, TRANSMITTING AND REPRODUCING SOUND OR IMAGES; BLANK MAGNETIC RECORDING MEDIA, NAMELY, DISKETTES, CDS, DVDS; BLANK RECORDING DISCS; CENTRAL PROCESSING UNITS FOR PROCESSING DATA; COMPUTERS; OPTICAL SCANNERS, SCANNERS; SOFTWARE FOR USE IN THE CONTROL OF SORTING AND SEPARATING MACHINES (U.S. CLS. 21, 23, 26, 36 AND 38).

SUSAN RICHARDS, EXAMINING ATTORNEY

SN 79-022,177. INTERNATIONAL HEROES BV, NETHERLANDS, FILED 12-20-2005.



OWNER OF INTERNATIONAL REGISTRATION 0767729 DATED 9-14-2001, EXPIRES 9-14-2011.
OWNER OF U.S. REG. NO. 2,995,365.

CLASS 9—ELECTRICAL AND SCIENTIFIC APPARATUS

FOR SPECTACLES (U.S. CLS. 21, 23, 26, 36 AND 38).

CLASS 18—LEATHER GOODS

FOR GOODS MADE OF LEATHER AND IMITATION LEATHER MATERIALS NOT INCLUDED IN OTHER CLASSES, NAMELY BANDS OF LEATHER, LEATHER SHOULDER BELTS, CHIN STRAPS OF LEATHER, LEATHER STRAPS, CARRYING BAGS, BRIEFCASES, BACKPACKS, FANNY PACKS, BOOK BAGS, WALLETS, PURSES, CARD CASES, KEY CASES OF LEATHER OR LEATHERBOARD; TRUNKS AND SUITCASES, ANIMAL SKINS, HIDES; COVERINGS OF LEATHER, FURNITURE COVERINGS OF LEATHER, COVERINGS OF SKINS AND FUR COVERS FOR ANIMALS, CLOTHING FOR PETS, COLLARS FOR ANIMALS, UMBRELLAS, PARASOLS AND WALKING STICKS, POCKET WALLETS, PURSES, CHANGE PURSES, CHAIN MESH PURSES AND PURSES NOT OF PRECIOUS METAL (U.S. CLS. 1, 2, 3, 22 AND 41).

RON FAIRBANKS, EXAMINING ATTORNEY

CLASS 42—SCIENTIFIC, COMPUTER AND LEGAL SERVICES

FOR SCIENTIFIC AND TECHNOLOGICAL RESEARCH, APPLICATIONS, DESIGNS AND PROGRAMMING SERVICES RELATING TO DESIGN, IMPLEMENTATION, VERIFICATION AND PRODUCTION OF INTEGRATED CIRCUITS AND RELATED SOFTWARE; DESIGN AND DEVELOPMENT OF COMPUTER HARDWARE AND SOFTWARE FOR OTHERS; DEVELOPMENT OF SOFTWARE TO VERIFY OR VALIDATE CHIP DESIGNS; LICENSING OF COMPUTER SOFTWARE; PROVIDING OF COMPUTER SOFTWARE TECHNICAL SUPPORT SERVICES, NAMELY, TROUBLESHOOTING OF COMPUTER HARDWARE AND SOFTWARE PROBLEMS (U.S. CLS. 100 AND 101).

SALLY SHIH, EXAMINING ATTORNEY

SN 79-022,215. ONESPIN SOLUTIONS GMBH, 80339 MÜNCHEN, FED REP GERMANY, FILED 11-10-2005.

Onespin

PRIORITY DATE OF 5-10-2005 IS CLAIMED.
OWNER OF INTERNATIONAL REGISTRATION 0880688
DATED 11-10-2005, EXPIRES 11-10-2015.

CLASS 9—ELECTRICAL AND SCIENTIFIC APPARATUS

FOR COMPUTER HARDWARE AND SOFTWARE FOR PROCESSING DATA; COMPUTER HARDWARE AND COMPUTER SOFTWARE FOR USE IN THE FIELD OF SEMICONDUCTOR DESIGN, IMPLEMENTATION, VERIFICATION OR PRODUCTION; VERIFICATION SOFTWARE AND HARDWARE FOR VERIFICATION AND TEST PURPOSES, NAMELY, TESTERS, EMULATORS, ACCELERATORS, FPGA-BOARDS IN THE FIELD OF SEMICONDUCTOR PRODUCTION; FORMAL VERIFICATION SOFTWARE, NAMELY, SOFTWARE TO VERIFY THAT A HARDWARE DESIGN DESCRIBED IN A HARDWARE DESCRIPTION LANGUAGE DOES NOT CONTAIN FUNCTIONAL ERRORS AND CONFORMS TO ITS TIMING SPECIFICATIONS (U.S. CLS. 21, 23, 26, 36 AND 38).

CLASS 41—EDUCATION AND ENTERTAINMENT

FOR PROVIDING OF TRAINING, ARRANGING AND CONDUCTING OF WORKSHOPS, CONFERENCES SEMINARS, TRAINING COURSES AND EDUCATIONAL SERVICES, NAMELY, COACHING AND TRAINING-ON-THE-JOB, IN THE FIELD OF SEMICONDUCTOR DESIGN, IMPLEMENTATION, VERIFICATION OR PRODUCTION (U.S. CLS. 100, 101 AND 107).

SN 79-022,851. OBSHCHESTVO S OGRANICHENNOJ; OTVETSTVENNOSTJU "GALAKTA", RUSSIAN FED., FILED 10-6-2005.



PRIORITY DATE OF 6-6-2005 IS CLAIMED.
OWNER OF INTERNATIONAL REGISTRATION 0882623
DATED 10-6-2005, EXPIRES 10-6-2015.

THE COLOR(S) RED, YELLOW, GREY, GOLD, BLACK AND WHITE IS/ARE CLAIMED AS A FEATURE OF THE MARK.

THE MARK CONSISTS OF A QUADRILATERAL IN WHICH APPEAR FOUR CIRCLES CONSISTING OF REPRESENTATIONS OF MEDALS AWARDED TO APPLICANT'S PRODUCT, IN THE MIDDLE OF THE MARK THE LETTER "B" APPEARS ON A SHIELD UNDER WHICH IS A BANNER ON WHICH THE NON-LATIN CYRILLIC CHARACTERS WHICH MAY BE TRANSLATED AS "VYMPEL;" APPEAR. IN THE MIDDLE OF THE MARK IS THE WORD POLTINA AND UNDERNEATH IS A REPRESENTATION OF THE BACK OF A 50 KOPEK RUSSIAN COIN ON WHICH A CROSS APPEARS. BENEATH THE QUADRILATERAL IS A BANNER WITH THE WORD POLTINA WRITTEN AGAIN. NO RIGHTS ARE BEING CLAIMED IN THE USE OF THE MEDALS AS PART OF THE TRADEMARK. THE COLOR RED APPEARS IN THE WORDS POLTINA, IN THE SHIELD WITH THE LETTER "B" ON IT, IN THE BANNER UNDER THE HALF-RUBLE COIN ON WHICH A CROSS APPEARS, IN THE INSIDE OF THE QUADRILATERAL BORDER AND IN THE BANNER AT THE BOTTOM OF THE DRAWING; THE COLOR YELLOW APPEARS IN THE QUADRILATERAL BORDER, AS AN OUTLINE AROUND THE OVAL AT THE BOTTOM OF THE DRAWING, AND AROUND THE BOTTOM BANNER AND IN THE DESIGN ON EITHER SIDE OF THE SHIELD; THE COLOR GRAY APPEARS IN THE SECOND AND FORTH MEDAL-

LIONS FROM THE RIGHT AND ON THE PICTURE OF THE HALF-RUBLE COIN ON WHICH THE CROSS APPEARS; THE COLOR WHITE APPEARS IN THE BACKGROUND OF THE QUADRILATERAL; THE COLOR GOLD APPEARS IN THE DESIGN AROUND THE PICTURE OF THE HALF-RUBLE COIN ON WHICH THE CROSS APPEARS AND IN THE FIRST AND THIRD MEDALLIONS FROM THE RIGHT; AND THE COLOR BLACK APPEARS IN THE OUTLINE AND WRITING OF THE HALF-RUBLE COIN AND MEDALLIONS.

THE FOREIGN WORDING IN THE MARK TRANSLATES INTO ENGLISH AS A SLANG TERM FOR "50 KOPECKS", OR "HALF A RUBLE".

THE NON-LATIN CHARACTER(S) IN THE MARK TRANSLITERATES INTO VYMPEL , AND THIS MEANS PENNANT IN ENGLISH.

SN 79-023,156. CASSONS PTY LIMITED, AUSTRALIA, FILED 8-30-2005.

CLASS 32—LIGHT BEVERAGES

FOR BEER (U.S. CLS. 45, 46 AND 48).

CLASS 33—WINES AND SPIRITS

FOR APERITIFS; ARAK; BRANDY; WINE; PIQUET; WHISKY; VODKA; GIN; DIGESTERS, NAMELY DISTILLED LIQUEURS AND SPIRITS; PREPARED ALCOHOLIC COCKTAILS, LIQUEURS, AND ALCOHOLIC BEVERAGES EXCEPT BEER, NAMELY, ALCOHOLIC BEVERAGES OF FRUIT; DISTILLED SPIRITS; DISTILLED BEVERAGES, NAMELY HYDROMEL AND MEAD, PEPPERMINT LIQUEURS, ALCOHOLIC APERITIF BITTERS, RUM, SAKE, HARD CIDER, RICE ALCOHOL, ALCOHOLIC EXTRACTS, ALCOHOLIC FRUIT EXTRACT, AND ALCOHOLIC ESSENCES (U.S. CLS. 47 AND 49).

DAYNA BROWNE, EXAMINING ATTORNEY

RJAYS

SN 79-023,032. KERBELL S.R.L., ITALY, FILED 6-24-2005.

KER BELL

THE MARK CONSISTS OF STANDARD CHARACTERS WITHOUT CLAIM TO ANY PARTICULAR FONT, STYLE, SIZE, OR COLOR.

PRIORITY DATE OF 6-24-2005 IS CLAIMED.

OWNER OF INTERNATIONAL REGISTRATION 0882736 DATED 6-24-2005, EXPIRES 6-24-2015.

THE MARK CONSISTS OF STANDARD CHARACTERS WITHOUT CLAIM TO ANY PARTICULAR FONT, STYLE, SIZE, OR COLOR.

PRIORITY DATE OF 7-22-2005 IS CLAIMED.

OWNER OF INTERNATIONAL REGISTRATION 0883057 DATED 8-30-2005, EXPIRES 8-30-2015.

CLASS 19—NON-METALLIC BUILDING MATERIALS

FOR NON-METALLIC RIGID PIPES FOR BUILDING; ASPHALT, PITCH AND BITUMEN; NON-METALLIC TRANSPORTABLE BUILDINGS; MONUMENTS, NOT OF METAL (U.S. CLS. 1, 12, 33 AND 50).

CLASS 20—FURNITURE AND ARTICLES NOT OTHERWISE CLASSIFIED

FOR FURNITURE, MIRRORS, PICTURE FRAMES (U.S. CLS. 2, 13, 22, 25, 32 AND 50).

CLASS 21—HOUSEWARES AND GLASS

FOR COMBS AND SPONGES; BRUSH-MAKING MATERIALS; UNWORKED OR SEMI-WORKED GLASS EXCEPT GLASS USED IN BUILDING (U.S. CLS. 2, 13, 23, 29, 30, 33, 40 AND 50).

DARRYL SPRUILL, EXAMINING ATTORNEY

CLASS 9—ELECTRICAL AND SCIENTIFIC APPARATUS

FOR BOOTS, SHOES, PROTECTIVE CLOTHING, HELMETS AND GLOVES FOR MOTORCYCLISTS AND CYCLISTS FOR PROTECTION AGAINST ACCIDENTS; SKI HELMETS (U.S. CLS. 21, 23, 26, 36 AND 38).

CLASS 12—VEHICLES

FOR MOTORCYCLES AND MOTORCYCLE COMPONENTS, NAMELY, MOTORCYCLE ENGINES, STRUCTURAL PARTS FOR MOTORCYCLES, HANDLEBARS, LUGGAGE RACKS, HANDLEBAR GRIPS, WHEELS, TOP BOXES IN THE NATURE OF STORAGE BOXES FOR ATTACHING TO MOTORCYCLES, SADDLE BOXES, REARVIEW MIRRORS, SIDE VIEW MIRRORS, TIRE PUMPS, KICK STANDS, FOOT PEGS, SEAT BAGS, TRUNK BAGS, FRAMES, WHEEL SUSPENSIONS AND TURN SIGNALS (U.S. CLS. 19, 21, 23, 31, 35 AND 44).

CLASS 25—CLOTHING

FOR CLOTHING, NAMELY, MOTORCYCLE SUITS, JUMPSUITS, PANTS, JACKETS, VESTS, GLOVES, HATS, CAPS, T-SHIRTS, SHIRTS, SWEATSHIRTS, NECK WARMERS, BALACLAVAS, FACE MASKS AND JERSEYS; LEATHER CHAPS; RAINWEAR; WATERPROOF OVER-BOOTS (U.S. CLS. 22 AND 39).

LEIGH LOWRY, EXAMINING ATTORNEY

SN 79-023,366. WORLD CULTURE OPEN, INC., NEW YORK, NY. FILED 8-22-2005.



OWNER OF INTERNATIONAL REGISTRATION 0883644 DATED 8-22-2005, EXPIRES 8-22-2015.

NO CLAIM IS MADE TO THE EXCLUSIVE RIGHT TO USE "WORLD CULTURE OPEN", APART FROM THE MARK AS SHOWN.

THE COLOR(S) BLACK, BLUE, GREEN, RED, YELLOW AND ORANGE IS/ARE CLAIMED AS A FEATURE OF THE MARK.

THE MARK CONSIST OF A FLOWER SHAPED DESIGN HAVING TEARDROPS IN THE COLORS BLACKS, BLUE, GREEN, RED, BLUE AND YELLOW ARRANGED CLOCK WISE FROM THE TOP AROUND AN ORANGE CENTER CIRCLE.

THE MARK CONSISTS OF THE GRAY WORDING WCO WORLD CULTURE OPEN NEXT TO A FLOWER-SHAPED DESIGN CONTAINING TEARDROPS IN THE COLORS BLACK, BLUE, GREEN, RED AND YELLOW AROUND AN ORANGE CIRCLE. NO BACKGROUND COLOR IS CLAIMED.

CLASS 35—ADVERTISING AND BUSINESS

FOR PROMOTIONAL SERVICES (U.S. CLS. 100, 101 AND 102).

CLASS 36—INSURANCE AND FINANCIAL

FOR FINANCIAL SPONSORSHIP OF MATCHES OR CONTESTS IN THE FIELDS OF MARTIAL ARTS, AEROBICS, DANCE OR MUSICAL PRODUCTIONS (U.S. CLS. 100, 101 AND 102).

CLASS 41—EDUCATION AND ENTERTAINMENT

FOR DIGITAL IMAGING SERVICES; PRODUCTION OF RADIO AND TELEVISION PROGRAMS; PRESENTATION OF LIVE PERFORMANCES IN THE NATURE OF MUSICALS, DANCE, MARTIAL ARTS, YOGA OR AEROBICS; PRODUCTION OF LIVE ENTERTAINMENT, TELEVISION AND RADIO SHOWS; IMPRESARIO SERVICES, NAMELY, ORGANIZATION OF LIVE ENTERTAINMENT SHOWS, TELEVISION AND RADIO SHOWS; ENTERTAINMENT GROUP ORGANIZING; ENTERTAINER SERVICES, NAMELY, PROVIDING LIVE ENTERTAINMENT PERFORMANCES BY ENTERTAINERS IN THE NATURE OF MUSICALS, DANCE, DRAMA, MARTIAL ARTS, YOGA AND AEROBICS; FILM PRODUCTION; DISC RECORDING; LIVE MUSIC PERFORMANCES; MUSIC-HALLS OPERATION; CHOIR OPERATION; PUBLICATION OF BOOKS; PUBLICATION OF ELECTRONIC BOOKS AND JOURNALS ONLINE; PROVIDING ONLINE, DOWNLOADABLE ELECTRONIC PUBLICATIONS IN THE NATURE OF NEWSPAPERS, MAGAZINES, NEWSLETTERS ON THE SUBJECT OF CULTURAL DIVERSITY; NEWS REPORTERS SERVICES; PHOTOGRAPHIC REPORTING; BOARDING SCHOOLS; TEACHING IN THE FIELD OF CULTURAL DIVERSITY; INSTRUCTION SERVICES, NAMELY, PROVIDING COURSES OF INSTRUCTION ON CULTURAL DIVERSITY; LIBRARY MANAGEMENT; ORGANIZATION OF EXHIBITS FOR CULTURAL AND EDUCATIONAL PURPOSES; ART GALLERY MANAGEMENT; MANAGEMENT OF EXHIBITION HOSTING IN THE NATURE OF CONSULTING AND EXECUTING EXHIBITIONS; CORRESPONDENCE COURSES IN THE FIELD OF CULTURAL DIVERSITY; PROVIDING RECREATION FACILITIES; SPORTS CENTER OPERATIONS; PHYSICAL EDUCATION; VIDEO FILMING AND RECORDING; PHOTOGRAPHY; ARRANGING AND CONDUCTING OF SEMINARS ON CULTURAL DIVERSITY; ARRANGING AND CONDUCTING OF TRAINING WORKSHOPS IN THE FIELD OF CULTURAL DIVERSITY; ARRANGEMENT OF SPECIAL EVENTS FOR OTHERS; ARRANGING AND CONDUCTING OF EDUCATIONAL CONFERENCES; ORGANIZATION OF GAMES, NAMELY, MATCHES OR CONTESTS IN THE FIELDS OF MUSICALS, DANCE, DRAMA, MARTIAL ARTS, YOGA AND AEROBICS (U.S. CLS. 100, 101 AND 107).

KIMBERLY FRYE, EXAMINING ATTORNEY

SN 79-023,432. DMG RADIO (AUSTRALIA) PTY LTD, AUSTRALIA, FILED 2-21-2006.

NOVA

THE MARK CONSISTS OF STANDARD CHARACTERS WITHOUT CLAIM TO ANY PARTICULAR FONT, STYLE, SIZE, OR COLOR.

OWNER OF INTERNATIONAL REGISTRATION 0884028 DATED 2-21-2006, EXPIRES 2-21-2016.

CLASS 38—COMMUNICATION

FOR RADIO BROADCASTING SERVICES DIRECTED TO NON-PAYING AND SUBSCRIBING CONSUMERS (U.S. CLS. 100, 101 AND 104).

CLASS 41—EDUCATION AND ENTERTAINMENT

FOR PRODUCTION OF RADIO PROGRAMS; ARRANGING AND CONDUCTING MUSICAL ENTERTAINMENT SHOWS, MUSICAL SHOWS AND ENTERTAINMENT BALLS FEATURING MUSIC AND DANCING; DISCOTHEQUE SERVICES; ENTERTAINMENT IN THE NATURE OF LIVE PERFORMANCES BY MUSICAL BANDS; CONDUCTING ENTERTAINMENT EXHIBITIONS IN THE NATURE OF NON-COMMERCIAL FAIRS, IN RELATION TO AGRICULTURE, ART AND ANTIQUES, BUILDING AND DESIGN, ENGINEERING AND MAINTENANCE, FIRE, FOOD, CRAFT, GRAPHICS AND PRINTING, HEALTHCARE, HOME AND GARDEN, HOSPITALITY, METALS AND GLASS, SPORTS AND LEISURE, TEXTILES AND TRANSPORTATION (U.S. CLS. 100, 101 AND 107).

MELVIN AXILBUND, EXAMINING ATTORNEY

SN 79-023,653. RESILUX N.V., BELGIUM, FILED 6-22-2005.

RESIGRIND

THE MARK CONSISTS OF STANDARD CHARACTERS WITHOUT CLAIM TO ANY PARTICULAR FONT, STYLE, SIZE, OR COLOR.

PRIORITY DATE OF 12-23-2004 IS CLAIMED.

OWNER OF INTERNATIONAL REGISTRATION 0884132 DATED 6-22-2005, EXPIRES 6-22-2015.

CLASS 1—CHEMICALS

FOR UNPROCESSED PLASTICS PLASTICS IN PRIMARY FORM; UNPROCESSED ARTIFICIAL RESINS FOR INDUSTRIAL USE; THE FOLLOWING UNPROCESSED MATERIALS AND COMBINATIONS THEREOF USED FOR MANUFACTURING BOTTLES AND CONTAINERS OR PREFORMS OF BOTTLES AND CONTAINERS: PLASTICS, ARTIFICIAL RESINS, RECYCLING MATERIALS MADE OF PLASTICS, RECYCLING MATERIALS MADE OF ARTIFICIAL RESINS, POLYETHYLENE TEREPHTHALATE GRANULES, NYLON. (U.S. CLS. 1, 5, 6, 10, 26 AND 46).

CLASS 7—MACHINERY

FOR MACHINE TOOLS FOR THE CUTTING AND FORMING OF MATERIALS; MACHINES, MACHINE TOOLS AND AUTOMATED MANUFACTURING MACHINES FOR PROCESSING ARTIFICIAL RESINS AND PLASTIC MATERIALS FOR THE MANUFACTURE OF BOTTLES AND OTHER CONTAINERS OR PREFORMS THEREOF; MACHINES FOR PACKING BOTTLES AND OTHER CONTAINERS FOR PREFORMS THEREOF; MACHINES FOR MANUFACTURING AND/OR PACKAGING PRODUCTS COMPOSED PRIMARILY OF POLYETHYLENE TEREPHTHALATE (PET) GRANULES (U.S. CLS. 13, 19, 21, 23, 31, 34 AND 35).

CLASS 17—RUBBER GOODS

FOR SEMI-WORKED GOODS OF PLASTIC AND/OR PLASTIC COMPOUNDS CONSISTING PRIMARILY OF POLYETHYLENE TEREPHTHALATE (PET) GRANULES FOR THE MANUFACTURE OF BOTTLES AND OTHER CONTAINERS, STOPPERS AND CLOSURES FOR CONTAINERS; PREFORMS OF BOTTLES AND OTHER CONTAINERS MADE OF PLASTIC AND/OR PLASTIC COMPOUNDS CONSISTING PRIMARILY OF POLYETHYLENE TEREPHTHALATE (PET) GRANULES; SYNTHETIC PLASTIC AS SEMI-FINISHED PRODUCTS IN FORM OF FILMS, FOILS, SHEETS, BARS, PELLETS, PLATES, RODS, PROFILES, HOSES, TUBES, BLOCKS; PLASTICS IN EXTRUDED FORM FOR USE IN MANUFACTURE (U.S. CLS. 1, 5, 12, 13, 35 AND 50).

CLASS 21—HOUSEWARES AND GLASS

FOR CONTAINERS NOT OF PRECIOUS METAL, SILVER OR GILDED FOR PACKING AND/OR PRESERVING BEVERAGES, FOODSTUFFS, COSMETIC PRODUCTS AND OTHER KITCHEN AND HOUSEHOLD PRODUCTS; HOUSEHOLD AND/OR KITCHEN CONTAINERS MADE OF PLASTIC AND/OR PLASTIC COMPOUNDS, NAMELY BOTTLES, JARS, CONTAINERS, TINS, TUBES AND CANISTERS (U.S. CLS. 2, 13, 23, 29, 30, 33, 40 AND 50).

CLASS 40—MATERIAL TREATMENT

FOR TREATMENT OF MATERIALS FOR THE MANUFACTURE OF BOTTLES AND OTHER CONTAINERS OR PREFORMS THEREOF, STOPPERS AND CLOSURES FOR CONTAINERS; TREATMENT OF ORGANIC MATERIALS, UNPROCESSED PLASTICS AND UNPROCESSED ARTIFICIAL RESINS BY MECHANICAL AND/OR CHEMICAL PROCESSING AND /OR EXTRUSION FOR THE MANUFACTURE OF BOTTLES AND OTHER CONTAINERS OR PREFORMS THEREOF, STOPPERS AND CLOSURES FOR CONTAINERS. (U.S. CLS. 100, 103 AND 106).

LINDA ORNDORFF, EXAMINING ATTORNEY

SN 79-023,927. GWS SYSTEMS OY, FINLAND, FILED 2-22-2006.

SOVELLA

OWNER OF INTERNATIONAL REGISTRATION 0858670 DATED 4-27-2005, EXPIRES 4-27-2015.

CLASS 6—METAL GOODS

FOR SMALL ITEMS OF METAL HARDWARE, NAMELY, SHELF BRACKETS, HANDLES FOR DRAWERS AND DOORS, FIXING CLAMPS, TOOL HOOKS AND TOOL STANDS, CASTORS, SHELF DIVIDERS, METAL DRAWER TRIM (U.S. CLS. 2, 12, 13, 14, 23, 25 AND 50).

CLASS 20—FURNITURE AND ARTICLES NOT OTHERWISE CLASSIFIED

FOR SHELVING; TRANSPORTABLE AND PERMANENT STORAGE RACK TROLLEYS AND DISPLAY STANDS, INDUSTRIAL FURNITURE ESPECIALLY WORKTABLES AND CHAIRS (U.S. CLS. 2, 13, 22, 25, 32 AND 50).

MICHAEL ENGEL, EXAMINING ATTORNEY

SN 79-023,946. KBA-GIORI S.A., SWITZERLAND, FILED 10-7-2005.

CToneP
COMPUTER TO OFFSET PLATE

PRIORITY DATE OF 6-14-2005 IS CLAIMED.
OWNER OF INTERNATIONAL REGISTRATION 0885116
DATED 10-7-2005, EXPIRES 10-7-2015.
OWNER OF U.S. REG. NOS. 2,910,404 AND 2,946,275.
NO CLAIM IS MADE TO THE EXCLUSIVE RIGHT TO
USE "COMPUTER TO OFFSET PLATE", APART FROM THE
MARK AS SHOWN.

CLASS 7—MACHINERY

FOR ELECTRO-MECHANICAL MACHINES FEATURING COMPUTERS AND/OR LASERS FOR USE IN THE MANUFACTURE OF PRINTING PLATES (U.S. CLS. 13, 19, 21, 23, 31, 34 AND 35).

CLASS 9—ELECTRICAL AND SCIENTIFIC APPARATUS

FOR COMPUTERS AND/OR LASERS WHICH ARE COMPONENTS OF MACHINES USED IN THE MANUFACTURE OF PRINTING PLATES (U.S. CLS. 21, 23, 26, 36 AND 38).
ESTHER BELENKER, EXAMINING ATTORNEY

SN 79-024,047. SAMES TECHNOLOGIES, FRANCE, FILED 8-10-2005.

SAMES

THE MARK CONSISTS OF STANDARD CHARACTERS WITHOUT CLAIM TO ANY PARTICULAR FONT, STYLE, SIZE, OR COLOR.

PRIORITY DATE OF 2-10-2005 IS CLAIMED.
OWNER OF INTERNATIONAL REGISTRATION 0885408
DATED 8-10-2005, EXPIRES 8-10-2015.
OWNER OF U.S. REG. NO. 1,094,245.

CLASS 7—MACHINERY

FOR LARGE INSTRUMENTS AND EQUIPMENT FOR AGRICULTURAL, VITICULTURAL AND HORTICULTURAL USE, NAMELY SPRAYING MACHINES FOR AGRICULTURAL, VITICULTURAL AND HORTICULTURAL USE, POWER OPERATED AND MOBILE SPRAYERS AND WASHER UNITS FOR SPRAYING AND WASHING AGRICULTURAL, VITICULTURAL, HORTICULTURAL PRODUCTS, AND PARTS THEREOF, TRACTOR DRAWN AGRICULTURAL AND VITICULTURAL SPRAYING MACHINES INTENDED TO SPRAY FUNGICIDES AND INSECTICIDES AND THEIR PADS, NAMELY TANKS, BEAMS AND PUMPS, AGRICULTURAL, VITICULTURAL AND HORTICULTURAL SPRAYING MACHINES COMPRISING TANKS, PUMPS, SPRAYING RAMPS, JACKS, NOZZLES, NOZZLE HOLDERS, NOZZLE FASTENING DEVICES ADAPTERS, DEVICES FOR THE CONNECTION AND/OR OBTURATION OF HYDRAULIC DUCTS, SOLD AS A UNIT, POWER-OPERATED SPRAYERS AND SPRAYING NOZZLES THEREFORE FOR USE IN AGRICULTURAL,

HORTICULTURAL AND VITICULTURAL ENVIRONMENTS; SHREDDERS, NAMELY SHREDDING MACHINES THAT ARE NOT PAPER SHREDDERS FOR OFFICES, VACUUM SHREDDERS FOR CLEANING DEBRIS, POWER SHREDDERS FOR AGRICULTURAL, VITICULTURAL AND HORTICULTURAL USE; VALVES BEING PARTS OF SPRAYING MACHINES FOR AGRICULTURAL, VITICULTURAL AND HORTICULTURAL USE; LAWNMOWERS; MOBILE OR DRIVABLE SPRAYING MACHINES, NAMELY MOBILE SPRAYING MACHINES FOR SPRAYING LIQUID HERBICIDES, PESTICIDES, FERTILIZERS AND INSECTICIDES; MACHINE PARTS, NAMELY NOZZLES WHICH ARE PARTS OF POWER-OPERATED SPRAYERS; BOOMS FOR SPRAYING MACHINES; MOTORS AND ENGINES NOT FOR LAND VEHICLES; TRANSMISSION COUPLINGS AND BELTS FOR MACHINES, NOT FOR LAND VEHICLES; WASTE DISPOSAL MACHINES, NAMELY, GRINDERS AND SHREDDING MACHINES; AUTOMATIC OR ELECTRIC SPRAY GUNS FOR APPLYING PAINT COATS ON MATERIALS; ELECTRIC PAINT-SPRAYING GUNS; SPRAY GUNS AND PUMPS FOR THE APPLICATION OF PAINT; PNEUMATIC SPRAY GUNS FOR PAINT APPLICATION; SANDING MACHINES; FLOOR POLISHING MACHINES; AIR COMPRESSORS; RECIPROCATING AIR COMPRESSORS; PAINTING MACHINES; LIQUID, POWDERY OR FIBROUS PRODUCT DISPENSING MACHINES, NAMELY SPRAYERS, PROJECTORS, SPRAY GUNS, ATOMIZERS, COATING APPLICATORS; AUTOMATIC SPRAYERS FOR ELECTROSTATIC PAINTING; AUTOMATIC; PAINT SPRAYERS FOR ELECTROSTATIC ENAMELING; AUTOMATIC AIR SPRAY HEADS FOR ELECTROSTATIC DUSTING; ELECTRIC CLEANING INSTALLATIONS FOR CLEANING AND TREATING SURFACES BEFORE APPLYING PAINT; AIRBRUSHES FOR APPLYING COLORANTS; EXTRACTORS FOR POWDERY AND FIBROUS PRODUCTS USED IN PAINT APPLICATIONS; POWDER DISTRIBUTING TANKS TO SUPPLY POWDER COATING EQUIPMENT, NAMELY POWDER SPRAYERS; ELECTRIC GENERATORS; ELECTROSTATIC GENERATORS; HIGH-VOLTAGE GENERATORS; COMPONENT PARTS FOR PAINTING MACHINES, NAMELY DISTRIBUTING TANKS FOR PAINT; COMPONENT PARTS FOR COATING MACHINE, NAMELY PRODUCT CHANGING UNITS FOR INDUSTRIAL INSTALLATIONS FOR LIQUID OR POWDERY PAINTING OR FOR FLOCKING; INDUSTRIAL ROBOTS; INDUSTRIAL ROBOTS FOR PAINT COATS; ELECTRICAL DUST-REMOVING APPARATUS, NAMELY ELECTRICAL DUST-REMOVING ROLLERS, ELECTRICAL DUST REMOVING BOOTHS, TO BE USED BEFORE PAINT COATING; DUST AND PAINT-PARTICLE SUCTION MACHINES FOR INDUSTRIAL USE; FILTERS FOR THE PAINT COATING AND DUST CLEANING MACHINES; ELECTROSTATIC FILTERS FOR THE PAINT COATING AND DUST CLEANING MACHINES; MAGNETIC TURBINES NOT FOR LAND VEHICLES FOR PAINT-COATING APPARATUS AND MACHINES; POWDER AND PAINT FILLING MACHINES FOR PAINT COATING, POWDER AND PAINT FILLING INDUSTRIAL ROBOTS, BOOTHS, SPRAYERS; DEVICES FOR DISTRIBUTING AND LOADING PRODUCTS FOR SURFACE COATING, NAMELY PAINT OR POWDER DOSING STATIONS FOR PAINT OR POWDER SPRAYING OR COATING USE, PAINT OR POWDER AUTOMATIC BOOTHS FOR PAINT OR POWDER SPRAYING OR COATING USE; ELECTRIC MACHINES FOR POLISHING (U.S. CLS. 13, 19, 21, 23, 31, 34 AND 35).

CLASS 8—HAND TOOLS

FOR HAND-HELD AND HAND-OPERATED AGRICULTURAL INSTRUMENTS, NAMELY HAND-HELD AND HAND-OPERATED AGRICULTURAL SPRAYERS AND SPRAYING NOZZLES; HAND-HELD AND HAND-OPERATED GARDENING TOOLS, NAMELY FERTILIZER SCOOPS, GARDENING SHEARS AND SCISSORS, TROWELS, WEEDING FORKS, SPADES, HOES, CUTTING TOOLS, HAND HOOKS, PUMPS, SAWS; HAND-OPERATED INSECTICIDE SPRAYERS; HAND-OPERATED LAWN CLIPPERS; NOZZLES FOR HAND-HELD SPRAY GUNS FOR AGRICULTURAL, VITICULTURAL AND HORTICULTURAL USE; HAND-OPERATED ABRASIVE WHEELS AND SANDERS; HAND-HELD SPRAY GUNS FOR ELECTROSTATIC PAINTING; HAND-HELD SPRAY GUNS FOR ELECTROSTATIC ENAMELING; HAND-HELD SPRAY GUNS FOR ELECTROSTATIC DUSTING; HAND-HELD SPRAY GUNS FOR ELECTROSTATIC FLOCKING; HAND-OPERATED SANDERS (U.S. CLS. 23, 28 AND 44).

SN 79-024,431. VESTEL ELEKTRONIK; SANAYI VE TICARET ANONIM SİRKETİ, TURKEY, FILED 6-3-2005.

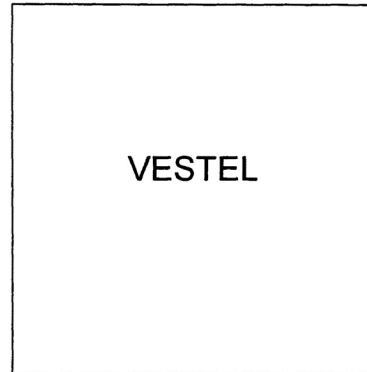

PRIORITY DATE OF 4-15-2005 IS CLAIMED.
OWNER OF INTERNATIONAL REGISTRATION 0886388
DATED 6-3-2005, EXPIRES 6-3-2015.
OWNER OF U.S. REG. NO. 2,625,584.

CLASS 9—ELECTRICAL AND SCIENTIFIC APPARATUS

FOR APPARATUS FOR CONDUCTING, SWITCHING, TRANSFORMING, ACCUMULATING, REGULATING OR CONTROLLING HIGH-VOLTAGE ELECTRICITY FOR PAINT COATING AND DUST CLEANING MACHINERY; DATA PROCESSING EQUIPMENT, NAMELY DATA PROCESSORS, DATA COMPRESSION SOFTWARE; COMPUTER PROGRAMS FOR SUPERVISION, COMMUNICATION AND APPLICATION SIMULATION IN THE FIELD OF THE PAINT COATING AND DUST CLEANING INDUSTRIES; COMPUTER SOFTWARE FOR SETTING UP PAINT-COATING SYSTEMS; DOSE DISPENSERS FOR USE WITH PAINT AND PAINT POWDER; METERS FOR FLUIDS, NAMELY METERS FOR MEASURING THE FLOW OF WATER, LIQUID PAINT, AND POWDER PAINT; RESISTIVITY MEASURING APPARATUS, NAMELY PAINT AND VARNISH RESISTIVITY METERS; PARTICLE ACCELERATORS; APPARATUS FOR ACTIVATION ANALYSIS, NAMELY FLUIDITY METERS FOR THE PURPOSE OF DETERMINING THE SPRAY PROPERTIES OF POWDER AND LIQUID PAINTS; IONIZATION APPARATUS FOR PAINT AND DUST CLEANING INDUSTRIES APPLICATIONS; ELECTRIC INSTALLATIONS FOR THE REMOTE CONTROL OF INDUSTRIAL OPERATIONS; MICROPROCESSORS FOR CHECKING PAINT-COATING APPARATUS AND MACHINES; HEAT, DUST AND LEVEL DETECTORS; ELECTRIC CONTROLLING APPARATUS FOR THE PAINT-COATING AND DUST CLEANING MACHINES; DENSIMETERS; QUANTITY INDICATORS; TEMPERATURE INDICATORS; SPEED INDICATORS; HEAT CONTROL APPARATUS, NAMELY THERMOSTATS; PRESSURE CONTROL APPARATUS, NAMELY PRESSURE CONTROL EQUIPMENT, NAMELY BLOWOUT PREVENTERS, AUTOMATIC PRESSURE CONTROL MACHINES AND INSTRUMENTS (U.S. CLS. 21, 23, 26, 36 AND 38).

CLASS 7—MACHINERY

FOR MACHINES NOT INCLUDED IN OTHER CLASSES, NAMELY BEVERAGE MAKING MACHINES IN THE NATURE OF SODA MAKING MACHINES, AIR CONDENSERS, ELECTRIC BEER PUMPS, CUTTING MACHINES, TRANSMISSION GEARS FOR MACHINES, ELECTRICAL HOUSEHOLD APPLIANCES NOT INCLUDED IN OTHER CLASSES NAMELY CLOTHES WASHING MACHINES, DISH WASHING MACHINES, COMBINED CLOTHES WASHING MACHINES AND TUMBLE DRYERS, MANGLES, DISHWASHERS, FOOD MIXING MACHINES, FOOD PROCESSORS, ELECTRIC FOOD SLICERS AND GRINDERS, VACUUM PACKING MACHINES, RACK AND TRAY CONVEYORS, FOOD WASTE DISPOSAL MACHINES, COMPRESSORS FOR REFRIGERATORS AND FREEZERS, MACHINES FOR HIGH PRESSURE CLEANING OF SURFACES USING HIGH PRESSURE WATER, FLOOR POLISHING MACHINES, VACUUM CLEANERS AND PARTS FOR VACUUM CLEANERS NAMELY HOSES AND NOZZLES, DUST BAGS AND FILTERS FOR VACUUM CLEANERS, WELDING INSTRUMENTS AND APPLIANCES NOT INCLUDED IN OTHER CLASSES, NAMELY, ELECTRIC, GAS AND LASER WELDING MACHINES; PARTS AND FITTINGS FOR ALL THE ABOVE ITEMS (U.S. CLS. 13, 19, 21, 23, 31, 34 AND 35).

CLASS 9—ELECTRICAL AND SCIENTIFIC APPARATUS

FOR SCIENTIFIC, NAUTICAL, SURVEYING, ELECTRONIC, RADIOTELEGRAPHIC, PHOTOGRAPHIC, CINEMATOGRAPHIC, OPTICAL, WEIGHING, MEASURING, SIGNALLING, MONITORING, LIFE-SAVING AND TEACHING INSTRUMENTS AND APPLIANCES, NAMELY DIRECTIONAL COMPASSES, SURVEYING TRIPODS, SCALES, BINOCULARS, CINEMATOGRAPHIC CAMERAS, PHOTOGRAPHY CAMERAS, TELESCOPES, AUTOMATIC COIN-OPERATED APPLIANCES, NAMELY TELEVISIONS, INTERCOMMUNICATION APPARATUS, NAMELY CELLULAR TELEPHONES; CASH REGISTERS; CALCULATORS; FIRE-EXTINGUISHERS; COMPUTERS; METEOROLOGICAL, PHYSICAL SCIENCE, CONTROL, SAFETY, NAVIGATIONAL, TELECOMMUNICATION AND WELDING INSTRUMENTS AND APPARATUS NOT INCLUDED IN OTHER CLASSES NAMELY BAROMETERS, HYDROMETERS, THERMOMETERS, TELEPHONES, TELEPHONE ANSWERING MACHINES, LASER WELDING DEVICES; AERIALS; ANTENNA AMPLIFIERS; TRANSFORMERS; SAFETY CONTACT PLUGS; JUNCTION BOXES; ELECTRIC SOCKETS, ELECTRIC PLUGS AND OTHER CONTACTS, NAMELY ELECTRIC CONNECTION BOXES; ACCUMULATORS; ELECTRIC WIRES AND CABLES; ELECTRICAL HOUSEHOLD APPLIANCES NOT INCLUDED IN OTHER CLASSES NAMELY

CLASS 19—NON-METALLIC BUILDING MATERIALS

FOR NON-METALLIC PAINT SPRAYING BOOTHS, NON-METALLIC BOOTHS FOR APPLICATION OF SOLID OR LIQUID PAINT COATINGS, PAINTING, DUSTING, ENAMELING AND FLOCKING BOOTHS (U.S. CLS. 1, 12, 33 AND 50).

ESTHER BELENKER, EXAMINING ATTORNEY

ELECTRIC IRONS, ELECTRIC BATTERIES, MAGNETS, MAGNETIC CORES; ELECTRICAL CIGAR AND CIGARETTE LIGHTERS FOR AUTOMOBILES; ELECTRON MICROSCOPES; RADIOLOGICAL APPARATUS FOR INDUSTRIAL PURPOSES; ELECTRON TUBES AND ELECTRONIC SEMI-CONDUCTORS; APPLIANCES, DEVICES AND INSTRUMENTS FOR RECORDING, REPRODUCING, TRANSMITTING AND AMPLIFYING SOUND AND/OR IMAGES AND/OR OTHER SIGNALS, NAMELY RADIOS, TELEVISIONS, DIGITAL VIDEO DISC PLAYERS, DIGITAL VIDEO RECORDERS, TAPE RECORDERS, DIGITAL TELEVISION RECORDERS, PERSONAL VIDEO RECORDERS, SATELLITE RECEIVERS, DIGITAL SATELLITE, TERRESTRIAL AND CABLE TELEVISION RECEIVERS AND RECORDERS, NAMELY PROGRAMMABLE DIGITAL TELEVISION RECORDERS, BLANK PHONOGRAPHIC RECORDS, PRERECORDED PHONOGRAPHIC RECORDS CONTAINING MUSIC OR FILM, BLANK AUDIO, VIDEO AND GAME TAPES AND PRE-RECORDED AUDIO, VIDEO AND GAME TAPES FEATURING MUSIC, FILMS, COMPUTER GAMES OR SOFTWARE; TEMPERATURE CONTROLLING DEVICES NOT INCLUDED IN OTHER CLASSES, NAMELY THERMOSTATS, PARTS AND FITTING FOR ALL THE ABOVE ITEMS (U.S. CLS. 21, 23, 26, 36 AND 38).

CLASS 11—ENVIRONMENTAL CONTROL APPARATUS

FOR INSTALLATIONS AND APPARATUS FOR LIGHTING, HEATING, STEAM GENERATING, COOKING, REFRIGERATING, FREEZING, DRYING, VENTILATION, AIR CONDITIONING, WATER SUPPLY PURPOSES AND SANITARY INSTALLATIONS, NAMELY LAMPS, PORTABLE ELECTRIC HEATERS, ELECTRIC BABY BOTTLE HEATERS, ELECTRIC KETTLES, ELECTRIC COFFEE MAKERS, STEAM GENERATORS; REFRIGERATORS; FREEZERS; COMBINED REFRIGERATORS AND FREEZERS; ELECTRIC DEEP FRYERS; ICE MACHINES; CLOTHES DRYERS, VENTILATION HOODS FOR STOVES, AIR CONDITIONING UNITS, METERED VALVES FOR REGULATING WATER SUPPLY AND SEPTIC TANKS; ELECTRIC LAMPS; DEHUMIDIFYING AND HUMIDIFYING INSTALLATIONS, DEVICES, APPLIANCES AND INSTRUMENTS, NAMELY HUMIDIFIERS; ELECTRICAL HOUSEHOLD APPLIANCES NOT INCLUDED IN OTHER CLASSES, NAMELY REFRIGERATORS, FREEZERS, FRIDGE FREEZERS, OVENS, MICROWAVE OVENS, DOMESTIC APPLIANCES FOR COOKING OR WARMING FOODS AND BEVERAGES NAMELY COOKING RANGES, GAS AND ELECTRIC BURNERS, GAS AND ELECTRIC STOVES, GAS AND ELECTRIC COOK TOPS, HOT AIR OVENS, MICROWAVE OVENS, TOASTERS AND HOT WATER TANKS; PARTS AND FITTING FOR ALL THE ABOVE ITEMS (U.S. CLS. 13, 21, 23, 31 AND 34).

CLASS 35—ADVERTISING AND BUSINESS

FOR ADVERTISING SERVICES, BUSINESS SERVICES, NAMELY BUSINESS CONSULTING SERVICES, AND BUSINESS MARKETING SERVICES, BUSINESS ORGANIZATION SERVICES, NAMELY BUSINESS ORGANIZATION ADVICE; THE BRINGING TOGETHER, FOR THE BENEFIT OF OTHERS, OF A VARIETY OF GOODS, EXCLUDING THE TRANSPORT THEREOF, ENABLING CUSTOMERS TO CONVENIENTLY VIEW AND PURCHASE THOSE GOODS; BUSINESS INTERMEDIARY SERVICES RELATING TO THE PURCHASE AND SALE OF AIR CONDENSERS, CUTTING MACHINES, TRANSMISSION GEARS FOR MACHINES, COMBINED WASHING MACHINES AND TUMBLE DRYERS, MANGLES, DISHWASHERS, FOOD MIXING MACHINES, FOOD PROCESSORS, ELECTRIC FOOD SLICERS AND GRINDERS, VACUUM PACKING MACHINES, RACK AND TRAY CONVEYORS, FOOD WASTE DISPOSAL MACHINES, COMPRESSORS FOR REFRIGERATORS AND FREEZERS, MACHINES FOR HIGH PRESSURE CLEANING OF SURFACES USING HIGH PRESSURE WATER, FLOOR POLISHING MACHINES, VACUUM CLEANERS AND PARTS FOR VACUUM CLEANERS, NAMELY HOSES AND NOZZLES, DUST BAGS AND FILTERS FOR VACUUM CLEANERS, WELDING INSTRUMENTS AND APPLIANCES, NAMELY ELECTRIC, GAS AND LASER WELDING MACHINES, AND PARTS AND FIT-

TINGS FOR ALL THE ABOVE ITEMS; RETAIL STORE SERVICES RELATING TO AIR CONDENSERS, CUTTING MACHINES, TRANSMISSION GEARS FOR MACHINES, COMBINED WASHING MACHINES AND TUMBLE DRYERS, MANGLES, DISHWASHERS, FOOD MIXING MACHINES, FOOD PROCESSORS, ELECTRIC FOOD SLICERS AND GRINDERS, VACUUM PACKING MACHINES, RACK AND TRAY CONVEYORS, FOOD WASTE DISPOSAL MACHINES, COMPRESSORS FOR REFRIGERATORS AND FREEZERS, MACHINES FOR HIGH PRESSURE CLEANING OF SURFACES USING HIGH PRESSURE WATER, FLOOR POLISHING MACHINES, VACUUM CLEANERS AND PARTS FOR VACUUM CLEANERS, NAMELY HOSES AND NOZZLES, DUST BAGS AND FILTERS FOR VACUUM CLEANERS, WELDING INSTRUMENTS AND APPLIANCES, NAMELY, ELECTRIC, GAS AND LASER WELDING MACHINES, AND PARTS AND FITTINGS FOR ALL THE ABOVE ITEMS (U.S. CLS. 100, 101 AND 102).

AMEETA JORDAN, EXAMINING ATTORNEY

SN 79-025,140. AGROFAIR BENELUX BV, NETHERLANDS, FILED 5-29-2006.



OWNER OF INTERNATIONAL REGISTRATION 0888290 DATED 5-29-2006, EXPIRES 5-29-2016.

NO CLAIM IS MADE TO THE EXCLUSIVE RIGHT TO USE "FAIR TRADE", APART FROM THE MARK AS SHOWN.

CLASS 29—MEATS AND PROCESSED FOODS

FOR MEAT, FISH, POULTRY AND GAME; MEAT EXTRACTS; PRESERVED, DRIED AND COOKED FRUITS AND VEGETABLES; JELLIES, JAMS; FRUIT SAUCES IN THE NATURE OF FRUIT TOPPING, FRUIT PRESERVES, FRUIT PULPS, FRUIT COMPOTES, FRUIT CONSERVES AND FRUIT-BASED SPREADS (U.S. CL. 46).

CLASS 31—NATURAL AGRICULTURAL PRODUCTS

FOR FRESH FRUITS AND VEGETABLES; SEEDS, NAMELY SEEDS DERIVED FROM FRUITS; FOODSTUFFS FOR ANIMALS (U.S. CLS. 1 AND 46).

ALLISON SCHRODY, EXAMINING ATTORNEY

SN 79-025,199. AIRSENSE ANALYTICS GMBH, FED REP GERMANY, FILED 4-13-2006.

AIRSENSE

THE MARK CONSISTS OF STANDARD CHARACTERS WITHOUT CLAIM TO ANY PARTICULAR FONT, STYLE, SIZE, OR COLOR.

PRIORITY DATE OF 11-23-2005 IS CLAIMED.
OWNER OF INTERNATIONAL REGISTRATION 0888443 DATED 4-13-2006, EXPIRES 4-13-2016.

CLASS 9—ELECTRICAL AND SCIENTIFIC APPARATUS

FOR CHEMICAL MEASURING APPARATUS FOR SCIENTIFIC RESEARCH IN LABORATORIES, NAMELY, MEASURING CUPS, SCALES AND DISPENSERS THAT MEASURE OUTPUT FOR USE IN THE DETECTION OF GASEOUS COMPOUNDS, SUCH AS TOXIC GASES OR ODORS, AND FOR USE IN THE FOOD AND CHEMICAL INDUSTRY AND ALSO IN THE SAFETY INDUSTRY (U.S. CLS. 21, 23, 26, 36 AND 38).

CLASS 42—SCIENTIFIC, COMPUTER AND LEGAL SERVICES

FOR CHEMICAL ANALYSES (U.S. CLS. 100 AND 101).
ELI HELLMAN, EXAMINING ATTORNEY

SN 79-025,944. AARHUSKARLSHAMN AB (PUBL), SWEDEN, FILED 1-13-2006.

AAK

AarhusKarlshamn

PRIORITY DATE OF 9-27-2005 IS CLAIMED.
OWNER OF INTERNATIONAL REGISTRATION 0890556 DATED 1-13-2006, EXPIRES 1-13-2016.

CLASS 1—CHEMICALS

FOR HYDRATED AND DISTILLED FATTY ACIDS, OIL-BASED SOFTENING PREPARATIONS AND LIPIDS FOR USE AS RAW MATERIAL IN THE CHEMICAL TECHNICAL INDUSTRY AS INGREDIENTS IN AND/OR FOR THE PRODUCTION OF OLEIC ACIDS, OILS FOR TANNING LEATHER, OILS FOR CURRYING LEATHER, OILS FOR THE PRESERVATION OF FOOD, RUBBER PRESERVATIVES, PAPER CHEMICALS, SOAPS, DETERGENTS, RUBBER AND PLASTIC, CANDLES, ALKYD RESINS, ALKYD VARNISH, LUBRICANTS; GLYCEROL FOR THE PRODUCTION OF COSMETICS, TOILETRIES, PHARMACEUTICAL PREPARATIONS, FOOD PRODUCTS, TOBACCO, PAINTS, PAPER, EXPLOSIVES, POLYOLS AND POLYURTHANE; FATS, OILS AND WAXES FOR COSMETIC PRODUCTS; VEGETABLE OILS AND FATS FOR THE PERFUMERY INDUSTRY AND FOR THE COSMETIC INDUSTRY; OILS AND FATS BEING RAW MATERIALS FOR MEDICAL PREPARATIONS; VEGETABLE OILS AND FATS FOR THE PHARMACEUTICAL INDUSTRY AND FOR THE DIETARY SUPPLEMENT INDUSTRY (U.S. CLS. 1, 5, 6, 10, 26 AND 46).

CLASS 3—COSMETICS AND CLEANING PREPARATIONS

FOR ESSENTIAL OILS AND FATS FOR COSMETIC PURPOSES; FATS FOR SKIN CARE PURPOSES; SKIN CARE AND CLEANSING CREAMS AND LOTIONS; SKIN CLEANSING OILS; SOAPS AND SHAMPOOS; COSMETICS (U.S. CLS. 1, 4, 6, 50, 51 AND 52).

CLASS 4—LUBRICANTS AND FUELS

FOR INDUSTRIAL OILS AND GREASES MADE FROM VEGETABLE; LUBRICATING GREASES AND CUTTING OILS MADE FROM VEGETABLE; HYDRAULIC OILS MADE FROM VEGETABLE; LUBRICATING CHAINSAW OILS; VEGETABLE OIL-BASED EMULSIONS AND EMULSION CONCENTRATE FOR USE IN/AS CUTTING OIL FOR INDUSTRIAL METAL WORKING; ALL-PURPOSE PENETRATION OILS; VEGETABLE BASED WAX FOR USE IN THE MANUFACTURE OF CANDLES; VEGETABLE BASED LAMP OILS (U.S. CLS. 1, 6 AND 15).

CLASS 5—PHARMACEUTICALS

FOR FATS FOR MEDICAL AND VETERINARY USE; FATS FOR DIETETIC FOODS FOR MEDICAL PURPOSES (U.S. CLS. 6, 18, 44, 46, 51 AND 52).

CLASS 29—MEATS AND PROCESSED FOODS

FOR EDIBLE OILS AND FATS; COCOA BUTTER FOR CONFECTIONERY AND FOOD PURPOSES; COCONUT BUTTER AND BUTTER CREAM; VEGETABLE OILS AND FATS FOR THE FOODSTUFF INDUSTRY (U.S. CL. 46).

BARBARA GAYNOR, EXAMINING ATTORNEY

SN 79-026,016. POPULAR BOOK COMPANY PTE LTD, SINGAPORE, FILED 2-3-2006.

大众书局

PRIORITY DATE OF 9-1-2005 IS CLAIMED.
OWNER OF INTERNATIONAL REGISTRATION 0890717 DATED 2-3-2006, EXPIRES 2-3-2016.

NO CLAIM IS MADE TO THE EXCLUSIVE RIGHT TO USE THE NON-LATIN CHARACTERS THAT MEAN "BOOKSTORE", APART FROM THE MARK AS SHOWN.

THE TRANSLITERATION OF THE NON-LATIN CHARACTERS IN THE MARK IS: DA ZHONG SHU JU AND THIS MEANS "THE COMMON PEOPLE'S BOOKSTORE" IN ENGLISH.

CLASS 16—PAPER GOODS AND PRINTED MATTER

FOR BOOKS AND PRINTED PERIODICALS IN THE FIELD OF LITERACY, LANGUAGE, ADULT EDUCATION, HEALTHCARE, SOCIAL DEVELOPMENT AND THE ARTS; COMIC BOOKS; PRINTED MATTER, NAMELY PRINTED CALENDARS, GIFT CARDS, CHILDREN'S ACTIVITY BOOKS, COLORING BOOKS; PRINTED TEACHING MATERIALS EXCEPT APPARATUS IN THE FIELD OF LITERACY, LANGUAGE, ADULT EDUCATION, HEALTHCARE, SOCIAL DEVELOPMENT AND THE ARTS; DIARIES; STATIONERY; PENCIL CASES; PHOTO ALBUMS; OFFICE REQUISITES, NAMELY DOCUMENT FILES; GIFT BAGS PAPER OR PLASTICS FOR PACKAGING; GIFT WRAPPING PAPER AND PAPER GIFT TAGS; ADHESIVES FOR STATIONERY OR HOUSEHOLD PURPOSES; DRAWING AND SKETCHING PADS AND PAPER; BAGS, ENVELOPES, POUCHES OF PAPER OR PLASTIC FOR PACKAGING (U.S. CLS. 2, 5, 22, 23, 29, 37, 38 AND 50).

CLASS 35—ADVERTISING AND BUSINESS

FOR BRINGING TOGETHER, FOR THE BENEFIT OF OTHERS, OF A VARIETY OF GOODS, EXCLUDING THE TRANSPORT THEREOF, ENABLING CUSTOMERS TO CONVENIENTLY VIEW AND PURCHASE THOSE GOODS IN A RETAIL OUTLET, FROM A GENERAL MERCHANDISE CATALOGUE, A GENERAL MERCHANDISE WEBSITE OR BY MAIL ORDER, NAMELY PRINTED MATTER, BOOKS, TEXT BOOKS, PERIODICALS, GENERAL GIFTS, TOYS, GAMES AND PLAYTHINGS, DECORATIONS FOR CHRISTMAS TREES, CALENDARS, MAPS, DIARIES, STATIONERY, PENCIL CASES, ARTISTS' REQUISITES AND MATERIALS, INSTRUCTIONAL AND TEACHING MATERIALS, ALBUMS, APPARATUS FOR MOUNTING PHOTOGRAPHS, CABINETS FOR STATIONERY, CARDBOARD ARTICLES, CLIPBOARDS, CLIPS, FILES, LETTER TRAYS, PAPER WEIGHTS, SCHOOL SUPPLIES STATIONERY, GIFT BAGS, PACKAGING MATERIALS, GIFT WRAPPING PAPER AND GIFT TAGS, ADHESIVES FOR STATIONERY OR HOUSEHOLD PURPOSES, OFFICE REQUISITES EXCEPT FURNITURE, DRAWING AND SKETCHING PADS AND PAPER, BAGS, ENVELOPES, POUCHES OF PAPER OR PLASTIC FOR PACKAGING AND ALL SCHOOL AND OFFICE SUPPLIES AND RELATED PRODUCTS; MARKETING AND PROMOTIONAL SERVICES; BUSINESS MERCHANDISING DISPLAY SERVICES; INFORMATION AND ADVISORY SERVICES RELATED TO RETAIL OUTLETS, MARKETING (U.S. CLS. 100, 101 AND 102).

CLASS 41—EDUCATION AND ENTERTAINMENT

FOR ARRANGING AND CONDUCTING OF WORKSHOPS, SEMINARS AND CLASSES IN THE FIELD OF LITERACY, LANGUAGE, ADULT EDUCATION, HEALTHCARE, SOCIAL DEVELOPMENT AND THE ARTS; PUBLICATION OF BOOKS, MAGAZINES, PERIODICALS; PUBLICATION OF ELECTRONIC BOOKS, JOURNALS ON-LINE; EDUCATION AND TRAINING SERVICES PROVIDED OVER A GLOBAL COMPUTER NETWORK, NAMELY SEMINARS AND COURSES IN THE FIELD OF LITERACY, LANGUAGE, ADULT EDUCATION, HEALTHCARE, SOCIAL DEVELOPMENT AND THE ARTS; ARRANGING AND CONDUCTING OF EXHIBITIONS FOR EDUCATIONAL PURPOSES IN THE FIELD OF LITERACY AND CHILDREN'S EDUCATION; PROVIDING INFORMATION IN THE FIELD OF EDUCATION, NAMELY LITERACY, LANGUAGE, ADULT EDUCATION, HEALTHCARE, SOCIAL DEVELOPMENT AND THE ARTS; EDUCATIONAL SERVICES, NAMELY CONFERENCES, CLASSES, SEMINARS AND WORKSHOPS IN THE FIELDS OF LITERACY, LANGUAGE, ADULT EDUCATION, HEALTHCARE, SOCIAL DEVELOPMENT AND THE ARTS; PRODUCTION AND RENTAL OF MOTION PICTURES AND VIDEOS; PRODUCTION OF AUDIO AND VIDEO RECORDINGS; PROVIDING ON-LINE NON-DOWNLOADABLE ELECTRONIC PUBLICATIONS IN THE NATURE OF MAGAZINES IN THE FIELD OF CHILDREN'S EDUCATIONAL MATERIALS (U.S. CLS. 100, 101 AND 107).

GISELLE AGOSTO, EXAMINING ATTORNEY

SN 79-026,166. FIT4EVER, S.L., SPAIN, FILED 7-11-2006.



OWNER OF INTERNATIONAL REGISTRATION 0891183 DATED 7-11-2006, EXPIRES 7-11-2016.

"THE COLOR(S) MAGENTA IS/ARE CLAIMED AS A FEATURE OF THE MARK."

"THE MARK CONSISTS OF THE WORDS MASSTER PLUS AND THE OUTLINE OF A BUTTERFLY DESIGN, ALL IN THE COLOR MAGENTA. THE MARK IS PRESENTED ON A TRANSPARENT BACKGROUND AND NO OTHER COLORS ARE CLAIMED."

CLASS 10—MEDICAL APPARATUS

FOR MASSAGE APPARATUS (U.S. CLS. 26, 39 AND 44).

CLASS 35—ADVERTISING AND BUSINESS

FOR RETAIL STORE SERVICES AND ONLINE RETAIL STORE SERVICES FEATURING MASSAGE APPARATUS (U.S. CLS. 100, 101 AND 102).

COLLEEN KEARNEY, EXAMINING ATTORNEY

SN 79-026,561. NOOSA SURF COMPANY PTY LTD, TEWANTIN QLD 4565, AUSTRALIA, FILED 6-22-2006.

SHORTSTRAW

THE MARK CONSISTS OF STANDARD CHARACTERS WITHOUT CLAIM TO ANY PARTICULAR FONT, STYLE, SIZE, OR COLOR.

PRIORITY DATE OF 12-23-2005 IS CLAIMED.

OWNER OF INTERNATIONAL REGISTRATION 0892378 DATED 6-22-2006, EXPIRES 6-22-2016.

CLASS 24—FABRICS

FOR TEXTILE GOODS, NAMELY, TOWELS (U.S. CLS. 42 AND 50).

CLASS 25—CLOTHING

FOR CLOTHING, NAMELY, SHORTS, BOARD SHORTS, SWIM WEAR, BOXER SHORTS, T-SHIRTS, SHIRTS, TRUNKS, SOCKS, BELTS, JEANS, JACKETS, TRACK SUITS, PANTS, CARGO PANTS, POLO SHIRTS, SKIRTS, DRESSES AND TOPS; FOOTWEAR; HEADGEAR, NAMELY, CAPS AND HATS (U.S. CLS. 22 AND 39).

EUGENIA MARTIN, EXAMINING ATTORNEY

SN 79-026,599. JÖLLENBECK GMBH, 27404 WEERTZEN, FED REP GERMANY, FILED 3-3-2006.

BattlePad

PRIORITY DATE OF 12-6-2005 IS CLAIMED.
OWNER OF INTERNATIONAL REGISTRATION 0892499
DATED 3-3-2006, EXPIRES 3-3-2016.

CLASS 9—ELECTRICAL AND SCIENTIFIC APPARATUS

FOR DEVICES FOR THE RECORDING, TRANSMISSION AND PLAYBACK OF SOUND AND IMAGES; DATA PROCESSING EQUIPMENT, NAMELY COMPUTERS, NOTEBOOK COMPUTERS AND PERSONAL DIGITAL ASSISTANTS (PDA); ANCILLARY EQUIPMENT FOR COMPUTERS, TELEVISION SETS, AND MULTIMEDIA APPARATUS, NAMELY, COMPUTER GAME PROGRAMS, JOYSTICKS, VIDEO GAME INTERACTIVE CONTROL FLOOR PADS OR MATS, VIDEO GAME MACHINES FOR USE WITH TELEVISIONS, AND DIGITAL INPUT AND OUTPUT SCANNERS; VIDEO GAME INTERACTIVE REMOTE CONTROL UNITS, COMPUTER MOUSE AND MOUSE PADS, COMPUTER GRAPHIC BOARDS, KEYBOARDS, COMPUTER KEYPADS, COMPUTER CURSOR CONTROL DEVICES, NAMELY, LIGHT PENS AND COMPUTER STYLUS, AND CONTROL PADS, MULTIFUNCTION KEYBOARDS, PLAYER-OPERATED ELECTRONIC CONTROLLERS FOR ELECTRONIC VIDEO GAME MACHINES; PLAYER-OPERATED ELECTRONIC CONTROLLERS IN THE FORM OF ACCELERATOR PEDALS, BRAKE PEDALS, STEERING WHEELS AND STEERING WHEEL COLUMNS, AND GUNS FOR ELECTRONIC GAMES AND FOR OPERATING ELECTRONIC APPARATUS; VIDEO OUTPUT GAME MACHINES AND APPARATUS FOR USE WITH TELEVISIONS; PROGRAMMABLE DIGITAL TELEVISION RECORDERS; MAGNIFYING GLASSES AND HOLDERS FOR HOLDING AND OPERATING ELECTRONIC APPARATUS WITH DISPLAYS; LIGHTING FIXTURES FOR USE IN DISPLAY LIGHTING FOR ELECTRONIC GAMES; COMPUTER INTERFACE BOARDS, UPI (UNIVERSAL PERIPHERAL INTERFACE) HARDWARE, PLUG-IN CONNECTORS, COMPUTER MEMORIES, MEMORY CARD READERS, MEMORY CARDS, COMPUTER PARALLEL PORTS AND COMPUTER SERIAL PORTS; EXTERNAL COMPUTER DISC DRIVES, BACK UP DRIVES FOR COMPUTERS, COMPUTER STORAGE DEVICES NAMELY USB FLASH DRIVES, FLASH DRIVES AND THUMB DRIVES; REMOTE CONTROL FOR CD PLAYERS, DVD PLAYERS, STEREO RECEIVERS, STEREO TUNERS, AMPLIFIERS, VIDEO RECORDERS, SOUND RECORDERS TELEVISIONS, VIDEO GAME MACHINES AND AUDIO EQUIPMENT; HEADPHONES, MICROPHONES, COMPUTER TERMINALS FOR INTERNET CONNECTIONS, COMPUTER TELEPHONY SOFTWARE; TELEPHONES FOR INTERNET USE; ACTIVE LOUDSPEAKERS; ELECTRICAL CONNECTOR CABLES AND ADAPTERS; MODEMS, BATTERIES, ACCUMULATORS, ELECTRICAL POWER SUPPLY DISTRIBUTION BOXES, ELECTRICAL POWER SUPPLY CONNECTORS AND ADAPTORS FOR USE WITH PORTABLE ELECTRONIC DEVICES, BATTERY CHARGERS, AC/DC ADAPTERS, COMPUTER NETWORK SWITCHES AND ROUTERS, TELEVISION DECODERS, FLASH CARD ADAPTERS; AND CONNECTORS AND ADAPTERS FOR CONNECTING COMPUTER PERIPHERALS, NAMELY, CABLES, CRADLE CONNECTION UNITS, AND CRADLE RECHARGING UNITS FOR PERSONAL DIGITAL ASSISTANTS (PDA'S) AND CELLULAR TELEPHONES; GOODS OF LEATHER AND PLASTIC, NAMELY PROTECTIVE BAGS, CARRYING BAGS AND BELT BAGS, PROTECTIVE SLEEVES AND CASES FOR HOLDING AND STORING DATA PROCESSING EQUIPMENT, NAMELY COMPUTERS, NOTEBOOK COMPUTERS, PERSONAL DIGITAL ASSISTANTS (PDA) VIDEO GAME MACHINES FOR USE WITH TELEVISIONS, AND MULTIMEDIA PROJECTORS; MOUNTINGS DEVICES,

NAMELY, STRAPS AND TRAY MOUNTINGS FOR ELECTRONIC GAME; IMPACT PROTECTION SPECIALTY BOXES AND PROTECTIVE HOLDERS ADAPTED FOR HOLDING AND STORING ELECTRONIC GAME PROGRAMS, NOTEBOOK COMPUTERS AND PERSONAL DIGITAL ASSISTANTS (PDA'S); ARCHIVING AND STORAGE CONTAINERS ADAPTED FOR HOLDING ELECTRONIC APPARATUS, NAMELY COMPUTERS, NOTEBOOK COMPUTERS, PERSONAL DIGITAL ASSISTANTS (PDA) VIDEO GAME MACHINES FOR USE WITH TELEVISIONS, EXTERNAL COMPUTER HARD DRIVES; MULTIMEDIA PROJECTORS, AND BLANK FLOPPY COMPUTER DISCS; BAGS AND BOXES SOLD EMPTY SPECIALLY ADAPTED FOR ELECTRONIC MEMORIES AND MEMORY CARDS; BAGS SPECIALLY ADAPTED FOR ELECTRONIC MEMORIES AND MEMORY CARDS WITH HAND HELD ELECTRONIC DEVICES, NAMELY PERSONAL DIGITAL ASSISTANTS (PDA) (U.S. CLS. 21, 23, 26, 36 AND 38).

CLASS 20—FURNITURE AND ARTICLES NOT OTHERWISE CLASSIFIED

FOR FURNITURE, NAMELY FILING AND STORAGE STANDS, BRACKETS, TRAYS AND FRAMES FOR HOLDING ELECTRONIC APPARATUS, ELECTRONIC DATA CARRIERS AND MEMORIES, ELECTRONIC APPARATUS AND APPARATUS MODULES AND FLOPPY DISKS (U.S. CLS. 2, 13, 22, 25, 32 AND 50).

CHRISTOPHER OTT, EXAMINING ATTORNEY

SN 79-026,613. JEAN LAPORTE L'ARTISAN PARFUMEUR, FRANCE, FILED 6-9-2006.

L'ETE EN DOUCE

THE MARK CONSISTS OF STANDARD CHARACTERS WITHOUT CLAIM TO ANY PARTICULAR FONT, STYLE, SIZE, OR COLOR.

PRIORITY DATE OF 5-22-2006 IS CLAIMED.

OWNER OF INTERNATIONAL REGISTRATION 0892533
DATED 6-9-2006, EXPIRES 6-9-2016.

THE FOREIGN WORDING IN THE MARK TRANSLATES INTO ENGLISH AS THE SUMMER ON THE QUIET.

CLASS 3—COSMETICS AND CLEANING PREPARATIONS

FOR SOAPS, PERFUMERY, NAMELY, SCENTED WATERS, LAVENDER WATERS, FLOWER EXTRACTS, BASES FOR FLOWER PERFUMES, OILS FOR PERFUMES AND SCENTS, AMBER AND PATCHOULI; PERFUMES; ESSENTIAL OILS; COSMETICS; HAIR LOTIONS; DEODORANTS FOR PERSONAL USE; DENTIFRICES; ROOM PERFUMES, PERFUMED SUBSTANCES FOR DIFFUSERS OF ROOM PERFUMES; EAUX DE TOILETTE; OILS AS PERFUMES FOR THE HOME, NAMELY, AROMATHERAPY OILS AND ESSENTIAL OILS FOR HOUSEHOLD USE; PERFUMING PRODUCTS FOR CREATING AMBIANCE, NAMELY, SCENTED ROOM AND LINEN SPRAYS, PERFUMING SACHETS, SCENTED OILS USED TO PRODUCE AROMAS WHEN HEATED, INCENSE; ESSENTIAL OILS OF AMBER AND PATCHOULI; MUSK; SCENTED WOOD; POTPOURRI AND PERFUMED INCENSE (U.S. CLS. 1, 4, 6, 50, 51 AND 52).

CLASS 4—LUBRICANTS AND FUELS

FOR CANDLES AND WICKS FOR LIGHTING, SCENTED CANDLES (U.S. CLS. 1, 6 AND 15).
SEAN CROWLEY, EXAMINING ATTORNEY

SN 79-026,667. ERIC RODITI, SWITZERLAND, AND ROMAIN LORENCEAU, SWITZERLAND, FILED 7-28-2006.



Give me Hope

PRIORITY DATE OF 3-16-2006 IS CLAIMED.
OWNER OF INTERNATIONAL REGISTRATION 0892695
DATED 7-28-2006, EXPIRES 7-28-2016.

CLASS 14—JEWELRY

FOR GOODS OF PRECIOUS METAL AND THEIR ALLOYS OR PLATED THEREWITH, NOT INCLUDED IN OTHER CLASSES, NAMELY, BRACELETS, NECKLACES, EARRINGS, AND PENDANTS (U.S. CLS. 2, 27, 28 AND 50).

CLASS 25—CLOTHING

FOR CLOTHING, NAMELY SHIRTS, T-SHIRTS, PULL-OVERS, TROUSERS, PANTS, AND BELTS (U.S. CLS. 22 AND 39).

RON FAIRBANKS, EXAMINING ATTORNEY

SN 79-026,722. KENZO, FRANCE, FILED 5-16-2006.



OWNER OF INTERNATIONAL REGISTRATION 0892870
DATED 5-16-2006, EXPIRES 5-16-2016.

OWNER OF U.S. REG. NOS. 1,214,902, 1,544,447 AND OTHERS.

CLASS 18—LEATHER GOODS

FOR LEATHER AND IMITATION LEATHER GOODS, NAMELY, TRAVELING BAGS, TRUNKS, SUITCASES, GARMENT BAGS FOR TRAVEL, VANITY CASES SOLD EMPTY, RUCKSACKS, SHOULDER BAGS, HANDBAGS, ATTACHÉ CASES, DOCUMENT WALLETS AND BRIEF-CASES MADE OF LEATHER, CLUTCH BAGS, WALLETS, PURSES, KEY CASES, TRAVELING SETS COMPRISED OF LUGGAGE; UMBRELLAS (U.S. CLS. 1, 2, 3, 22 AND 41).

CLASS 25—CLOTHING

FOR CLOTHING AND UNDERWEAR, NAMELY, SWEATERS, SHIRTS, T-SHIRTS, LINGERIE, BELTS, NECK SCARVES, TIES, SHAWLS, WAISTCOATS, SKIRTS, RAINCOATS, OVERCOATS, BRACES, TROUSERS, DENIM TROUSERS, PULLOVERS, DRESSES, JACKETS, SCARVES, GLOVES, TIGHTS, SOCKS, SWIMMING COSTUMES, BATH ROBES, PAJAMAS, NIGHTDRESSES, SHORTS, POCKET HANDKERCHIEFS; SHOES, BOOTS, SLIPPERS; HEADWEAR (U.S. CLS. 22 AND 39).

LEIGH LOWRY, EXAMINING ATTORNEY

SN 79-027,152. GENEX BIOSYSTEMS LIMITED, UNITED KINGDOM, FILED 7-13-2006.

LIPTIDE

THE MARK CONSISTS OF STANDARD CHARACTERS WITHOUT CLAIM TO ANY PARTICULAR FONT, STYLE, SIZE, OR COLOR.

PRIORITY DATE OF 1-18-2006 IS CLAIMED.
OWNER OF INTERNATIONAL REGISTRATION 0894027
DATED 7-13-2006, EXPIRES 7-13-2016.

CLASS 1—CHEMICALS

FOR LABORATORY CHEMICALS FOR SCIENTIFIC USE; CHEMICALS FOR USE IN MANUFACTURING PHARMACEUTICALS (U.S. CLS. 1, 5, 6, 10, 26 AND 46).

CLASS 5—PHARMACEUTICALS

FOR LABORATORY REAGENTS FOR CELL TRANSFECTIONS, ALL FOR MEDICAL USE; TRANSFECTION AGENTS FOR MEDICAL USE; TRANSFECTIONS AGENTS FOR DELIVERING PHARMACEUTICAL PREPARATIONS (U.S. CLS. 6, 18, 44, 46, 51 AND 52).

MARY ROSSMAN, EXAMINING ATTORNEY

SN 79-027,225. ACTIVE CO., LTD., JAPAN, FILED 3-3-2006.



OWNER OF INTERNATIONAL REGISTRATION 0894220
DATED 3-3-2006, EXPIRES 3-3-2016.

CLASS 12—VEHICLES

FOR STRUCTURAL PARTS AND FITTINGS OF AUTOMOBILES; TWO-WHEELED MOTOR VEHICLES AND STRUCTURAL PARTS THEREFORE; TWO-WHEELED MOTOR VEHICLE ACCESSORIES, NAMELY, FRONT FENDERS, REAR FENDERS, WINDSHIELDS, COWL FAIRINGS, SEAT FAIRINGS, CHAIN GUARDS, SEAT COVERS, AND REAR VIEW MIRRORS (U.S. CLS. 19, 21, 23, 31, 35 AND 44).

CLASS 25—CLOTHING

FOR CLOTHING, NAMELY, ALBS, ANKLETS, ANORAKS, APRONS, ASCOTS, ATHLETIC UNIFORMS, BAMBUSHKAS, BABY BUNTING, SKI BOOT BAGS, BALLOON PANTS, BANDANAS, BANDEAUX, BASEBALL CAPS, BATHING TRUNKS, BATHING CAPS, BATHING SUITS, BATHROBES, BEACH COVERUPS, BEACHWEAR, BED JACKETS, BELTS, BERETS, BERMUDA SHORTS, BIKINIS, BLAZERS, BLOOMERS, BLOUSES, BLOUSONS, BOAS, BODY SHAPERS, BODY SUITS, BOLEROS, BONNETS, BOOTIES, BOTTOMS, BOW TIES, BOXER SHORTS, BRAS, BRASSIERES, BREECHES, BRIEFS, BUSTIERS, CAFTANS, CAMISOLES, CAPES, CAPS, CARDIGANS, CASSOCKS, CHAPS, CHASUBLES, CHEMISES, CHEMISETTES, CLOGS, CLOTH DIAPERS, CLOTH BIBS, COATS, LAB COATS, COLLARS, COMBINATIONS, COMPETITORS' NUMBERS OF TEXTILE, CORSELETS, CORSETS, FOUNDATION GARMENTS, MASQUERADE COSTUMES AND MASKS SOLD IN CONNECTION THEREWITH, MASQUERADE COSTUMES, HALLOWEEN COSTUMES, COVERALLS, COVERUPS, CRAVATS, CREEPERS, CUFFS, CULOTTES, CUMMERBUNDS, DICKIES, DRESS SHIELDS, DRESSES, DRESSING GOWNS, DRY SUITS, DUNGAREES, DUSTERS, EAR MUFFS, ESPADRILLES, EVENING GOWNS, FISHING WADERS, FISHING VESTS, FLIGHT SUITS, FOUL WEATHER GEAR, FROCKS, FUR JACKETS, FUR COATS, FUR STOLE, FUR CLOAKS, GABARDINES, GAITERS, GALOSHES, GARTER BELTS, GAUCHOS, GIRDLES, GLOVES, GOLF SHIRTS, GOWNS, GREATCOATS, GYM SUITS, GYM SHORTS, HALTER TOPS, HEAD WEAR, HEAD BANDS, HOODS, HOSIERY, HOUSECOATS, INFANT DIAPER COVERS, INFANT WEAR, JACKETS, JEANS, JERKINS, JERSEYS, JODHPURS, JOGGING SUITS, JUMPERS, JUMPSUITS, KERICHIERS, KILTS, KIMONOS, KNEE HIGHS, KNICKERS, KNIT SHIRTS, LAB COATS, LAYETTES, LEATHER COATS, LEATHER JACKETS, LEG WARMERS, LEGGINGS, LEOTARDS, LIGHT-REFLECTING COATS, LIGHT-REFLECTING JACKETS, LINGERIE, LOUNGEWEAR, MAILLOTS, MANTILLAS, MANTLES, MINISKIRTS, MITTENS, MOCCASINS, MONEY BELTS, MUFFLERS, MUFFS, MUKLUKS, MUU MUUS, NECK BANDS, NECKERCHIEFS, NECKTIES, NECKWEAR, NEGLIGEES, NIGHT GOWNS, NIGHT SHIRTS, OVERALLS, OVERCOATS, OVERSHOES, PAJAMAS, PANTALOONS, PANTIES, PANTS, PANTSUITS, PANTYHOSE, PARAMENTS, PAREU, PARKAS, PEDAL PUSHERS, PEIGNOIRS, PELERINES, PELISSES, PETTICOATS, PINAFORES, PLAY SUITS, PLUS FOURS, POCKET SQUARES, POLO SHIRTS, PONCHOS, PULLOVERS, QUILTED VESTS, RAIN COATS, RAIN SUITS, RAINWEAR, ROBES, ROMPERS, RUBBERS, SARIS, SARONGS, SASHES, SCARVES, SHAWLS, SHIFTS, SHIRTS, SHORT SETS, SHORTALLS, SHORTS, SHOULDER PADS FOR CLOTHING, SHOWER CAPS, SINGLETS, SKI SUITS, SKI WEAR, SKI BIBS, SKI BOOT BAGS, SKI GLOVES, SKI MASKS, SKI PANTS, SKIRTS, SKORTS, SLACKS, SLEEP MASKS, SLEEPWEAR, SLIPPERS, SLIPS, SMOCKS, SNOW SUITS, SNOW PANTS, SNOWBOARD GLOVES, SOCKS, SPORT COATS, SPORT SHIRTS, STOCKINGS, STOLE, SUIT COATS, SUITS, SUN VISORS, SUNSUITS, SUSPENDERS, SWADDLING CLOTHES, SWEAT SHORTS, SWEAT SHIRTS, SWEAT BANDS, SWEAT SUITS, SWEAT PANTS, SWEATERS, SWEATSOCKS, SWIM TRUNKS, SWIM WEAR, SWIMSUITS, T-SHIRTS, TAILLEURS, TANGAS, TANK TOPS, TAP PANTS, TEDDIES, TENNIS WEAR, THERMAL SOCKS, THERMAL UNDERWEAR, TIES, BOW TIES, TIGHTS, TOE BOXES, TOGAS, TOPCOATS, TOPS, TANK TOPS, TOQUES, TRACKSUITS, TROUSERS, TUNICS, TURBANS, TURTLENECK SWEATERS, TURTLENECKS, TUXEDOS, UNDERCLOTHES, UNDERGARMENTS, UNDERPANTS, UNDERSHIRTS, UNDERWEAR, UNIFORMS, UNITARDS, V-NECK SWEATERS, VEILS, VESTED SUITS, VESTS, VISORS, WAISTCOATS, WARM UP SUITS, WATER SOCKS, WEDDING GOWNS, WET SUITS, WIND RESISTANT JACKETS, WINDSHIRTS, WRAPS, WRIST BANDS, ZOOT SUITS, AND ZORI; HEADGEAR, NAMELY, HATS AND CAPS; SHOES AND BOOTS NOT FOR SPORTS; GLOVES FOR DRIVING AUTOMOBILES AND TWO WHEELED VEHICLES (U.S. CLS. 22 AND 39).
SUZANNE BLANE, EXAMINING ATTORNEY

SN 79-027,264. JEWELULTRA LIMITED, UNITED KINGDOM, FILED 6-21-2006.



OWNER OF INTERNATIONAL REGISTRATION 0894369 DATED 6-21-2006, EXPIRES 6-21-2016.
OWNER OF U.S. REG. NOS. 2,684,769 AND 2,756,334.

CLASS 1—CHEMICALS

FOR CHEMICALS, NAMELY ROCK OIL PETROLEUM, SOLVENTS AND DESCALING ACIDS, ALL FOR THE PROTECTION OF CHROME, RUBBER, LEATHER, PLASTIC VINYL, FABRIC, CARPET, METALLIC AND PAINTED SURFACES IN OR ON VEHICLES (U.S. CLS. 1, 5, 6, 10, 26 AND 46).

CLASS 2—PAINTS

FOR VARNISHES, LACQUERS, GLAZES; PREPARATIONS USED FOR THE PROTECTION OF VEHICLES AGAINST CORROSION AND RUST (U.S. CLS. 6, 11 AND 16).

CLASS 3—COSMETICS AND CLEANING PREPARATIONS

FOR CLEANING PREPARATIONS FOR USE ON VEHICLES, AIRCRAFT AND MARINE CRAFT; POLISHING PREPARATIONS; LIQUID SCOURING PREPARATIONS; LIQUID ABRASIVE WAX FOR PRESERVING VEHICLES, AIRCRAFT AND MARINE CRAFT; CAR SHAMPOO, GENERAL PURPOSE ABRASIVE LIQUIDS AND POWDERS (U.S. CLS. 1, 4, 6, 50, 51 AND 52).
RONALD AIKENS, EXAMINING ATTORNEY

SN 79-027,315. LIDL STIFTUNG & CO. KG, FED REP GERMANY, FILED 6-30-2006.

PIRATINOS

THE MARK CONSISTS OF STANDARD CHARACTERS WITHOUT CLAIM TO ANY PARTICULAR FONT, STYLE, SIZE, OR COLOR.

OWNER OF INTERNATIONAL REGISTRATION 0881081 DATED 2-16-2006, EXPIRES 2-16-2016.

CLASS 29—MEATS AND PROCESSED FOODS

FOR MEAT, FISH, POULTRY AND GAME; MEAT EXTRACTS; PRESERVED, DRIED AND COOKED FRUITS AND VEGETABLES; JELLIES FOR NUTRITIONAL PURPOSES; JAMS, COMPOTES; EGGS, MILK AND MILK PRODUCTS EXCLUDING ICE CREAM, ICE MILK AND FROZEN YOGURT; EDIBLE OILS AND FATS; MEAT; SAUSAGE (U.S. CL. 46).

CLASS 30—STAPLE FOODS

FOR COFFEE, TEA, COCOA, SUGAR, RICE, TAPIOCA, SAGO, ARTIFICIAL COFFEE; FLOUR AND PROCESSED CEREALS, BREAD, HONEY, TREACLE, YEAST, BAKING-POWDER, SALT, MUSTARD; VINEGAR, SAUCES; SPICES; ICE (U.S. CL. 46).

CLASS 32—LIGHT BEVERAGES

FOR BEERS, MINERAL AND AERATED WATERS AND OTHER NON-ALCOHOLIC DRINKS, NAMELY, NON-ALCOHOLIC BEVERAGES CONTAINING FRUIT JUICES; VEGETABLE DRINKS, NON-ALCOHOLIC BEVERAGES CONTAINING VEGETABLE JUICES, VEGETABLE JUICES; LEMONADES; SYRUPS FOR MAKING BEVERAGES (U.S. CLS. 45, 46 AND 48).

JOHN DWYER, EXAMINING ATTORNEY

SN 79-027,412. PHILIPPE ROTHLIN, CH-8645 JONA, SWITZERLAND, FILED 8-11-2006.

Boreout

THE MARK CONSISTS OF STANDARD CHARACTERS WITHOUT CLAIM TO ANY PARTICULAR FONT, STYLE, SIZE, OR COLOR.

OWNER OF INTERNATIONAL REGISTRATION 0894785 DATED 8-11-2006, EXPIRES 8-11-2016.

CLASS 16—PAPER GOODS AND PRINTED MATTER

FOR PAPER, CARDBOARD AND GOODS MADE FROM THESE MATERIALS, NAMELY, DOOR HANG TAGS, POSTCARDS, GREETING CARDS; PRINTED MATTER IN THE NATURE OF BOOKS, NEWSLETTERS AND MAGAZINES ALL IN THE FIELD OF HUMAN RESOURCES MANAGEMENT, LEADERSHIP AND MOTIVATION AT WORK; PHOTOGRAPHS; STATIONERY; ADHESIVES FOR STATIONERY OR HOUSEHOLD PURPOSES; PAINTBRUSHES; PRINTED INSTRUCTIONAL, EDUCATIONAL AND TEACHING MATERIAL IN THE FIELD OF LEADERSHIP, MOTIVATION AT WORK; PRINTERS' TYPE; PRINTING BLOCKS (U.S. CLS. 2, 5, 22, 23, 29, 37, 38 AND 50).

CLASS 25—CLOTHING

FOR CLOTHING, NAMELY, SHIRTS, TEE-SHIRTS, UNDERWEAR; FOOTWEAR; HEADGEAR, NAMELY, CAPS, HEADBANDS (U.S. CLS. 22 AND 39).

CLASS 41—EDUCATION AND ENTERTAINMENT

FOR EDUCATION SERVICES, NAMELY PROVIDING CLASSES, SEMINARS, WORKSHOPS, COLLOQUIUMS, CONFERENCES, CONGRESSES AND LECTURES IN THE FIELDS OF HUMAN RESOURCES MANAGEMENT, PERSONAL MOTIVATION, EFFICIENCY IMPROVEMENT AT WORK; BUSINESS TRAINING IN THE AREA OF EMPLOYEE MOTIVATION AND ANALYSIS OF SOCIAL PROCESSES AT WORKPLACES AND THEIR INFLUENCE ON MOTIVATION; ENTERTAINMENT IN THE NATURE OF AN ON-GOING TELEVISION COMEDY SERIES, THEATRE PRODUCTIONS AND MOTION PICTURE FILM PRODUCTION; SPORTS AND CULTURAL ACTIVITIES SERVICES, NAMELY, ORGANIZING COMMUNITY SPORTING AND CULTURAL EVENTS, ORGANIZING EXHIBITIONS FOR EDUCATIONAL, CULTURAL OR ENTERTAINMENT PURPOSE (U.S. CLS. 100, 101 AND 107).

KAELIE KUNG, EXAMINING ATTORNEY

SN 79-027,435. NIPPECRAFT LIMITED, SINGAPORE 629787, SINGAPORE, FILED 12-6-2005.



PRIORITY DATE OF 10-7-2005 IS CLAIMED.
OWNER OF INTERNATIONAL REGISTRATION 0894848
DATED 12-6-2005, EXPIRES 12-6-2015.

THE MARK CONSISTS OF A DEVICE OF A FOUNTAIN.

CLASS 16—PAPER GOODS AND PRINTED MATTER

FOR TABLE NAPKINS OF PAPER; PACKING PAPER; ELECTROCARDIOGRAPH PAPER; WAXED PAPER; PAPER BOWS; PAPER FOR RECORDING MACHINES; PAPER RIBBONS; PAPER TAPES AND CARDS FOR THE RECORDAL OF COMPUTER PROGRAMS; PAPER-WEIGHTS; PASSPORT HOLDERS; PHOTOGRAPH STANDS; POSTERS; PLACE MATS OF PAPER; SHEETS FOR COLLECTING POSTAGE STAMPS; SIGNBOARDS OF PAPER OR CARDBOARD; STAMP DISPENSERS FOR POSTAGE STAMPS; TABLE CLOTHS OF PAPER; TABLE LINEN OF PAPER; TABLE MATS OF PAPER; TABLE NAPKINS OF PAPER; TISSUES OF PAPER FOR REMOVING MAKE-UP; TOWELS OF PAPER; TRAYS FOR SORTING AND COUNTING MONEY; WHITEBOARDS; WINDOW STICKERS; WRAPPING PAPER (U.S. CLS. 2, 5, 22, 23, 29, 37, 38 AND 50).

CLASS 18—LEATHER GOODS

FOR CLOTHING FOR PETS; IMITATION LEATHER; SYNTHETIC LEATHER; UMBRELLA COVERS; UMBRELLA HANDLES, UMBRELLA OR PARASOL RIBS; UMBRELLA RINGS; UMBRELLA STICKS; UMBRELLAS (U.S. CLS. 1, 2, 3, 22 AND 41).

EUGENIA MARTIN, EXAMINING ATTORNEY

SN 79-027,621. WORKING WITH COLOUR PTY LTD; ACN 069 622 215, AUSTRALIA, FILED 7-27-2006.



PRIORITY DATE OF 2-9-2006 IS CLAIMED.
OWNER OF INTERNATIONAL REGISTRATION 0895202
DATED 7-27-2006, EXPIRES 7-27-2016.

CLASS 25—CLOTHING

FOR CLOTHING, NAMELY SWIMWEAR, BEACH CLOTHES NAMELY COVER-UPS, SHORTS; BEACH SHOES, BELTS, CAPS, COATS, CYCLISTS' CLOTHING NAMELY JERSEYS, SHORTS, LEGGINGS; DRESSING GOWNS, GLOVES, HATS, HEADBANDS, HOODS, JACKETS, JERSEYS, JUMPERS, SLEEPWEAR, SHIRTS, MITTENS, SHOES, SOCKS, LINGERIE, UNDERWEAR, T-SHIRTS, TIGHTS, WATERPROOF CLOTHING NAMELY JACKETS, PARKAS, OVERPANTS; WETSUITS, WRISTBANDS (U.S. CLS. 22 AND 39).

CLASS 28—TOYS AND SPORTING GOODS

FOR GAMES AND PLAYTHINGS NAMELY BOARD GAMES, CARD GAMES; GYMNAS TIC AND SPORTING ARTICLES NOT INCLUDED IN OTHER CLASSES NAMELY BAGS FOR SKIS SNOWBOARDS AND SURF BOARDS, BODY BOARDS, COVERINGS FOR SKIS AND SNOWBOARDS, ELBOW GUARDS, HANG GLIDERS, CLIMBERS' HARNESSES, IN-LINE ROLLER SKATES, KNEE GUARDS, PARAGLIDERS, ROLLER SKATES, SAILBOARDS, SKATEBOARDS, ICE SKATES, SKI AND SNOWBOARD BINDINGS, SKIS, SNOWBOARDS, WAX FOR SKIS, SURF BOARDS, SURF SKIS, SURF BOARD LEASHES, WATERSKIS; DECORATIONS FOR CHRISTMAS TREES. (U.S. CLS. 22, 23, 38 AND 50).

JOANNA DUKOVIC, EXAMINING ATTORNEY

SN 79-027,931. SAAB AB, SWEDEN, FILED 4-21-2006.

Skeldar

SN 79-027,832. BENEQ OY, FINLAND, FILED 6-16-2006.

BENEQ

PRIORITY DATE OF 2-10-2006 IS CLAIMED.
OWNER OF INTERNATIONAL REGISTRATION 0895893
DATED 6-16-2006, EXPIRES 6-16-2016.

CLASS 7—MACHINERY

FOR MACHINES AND MACHINE TOOLS FOR USE IN CHEMICAL, PHYSICAL, OPTICAL AND MECHANICAL PROCESSES AND PRODUCTION IN THE FIELD OF FUNCTIONAL COATINGS AND NANOTECHNOLOGY, NAMELY, FOR THE APPLICATION, LAYERING AND DEPOSITION OF THIN FILMS, COATINGS, HOT AEROSOL AND ATOMIC LAYERS, AND FOR THE PRODUCTION OF NANO PARTICLES AND FUNCTIONAL COATINGS (U.S. CLS. 13, 19, 21, 23, 31, 34 AND 35).

CLASS 9—ELECTRICAL AND SCIENTIFIC APPARATUS

FOR COMPUTER SOFTWARE FOR USE IN CONTROLLING, REGULATING, SUPERVISING, MONITORING AND MANAGING CHEMICAL, PHYSICAL, OPTICAL AND MECHANICAL PROCESSES AND PRODUCTION MACHINES IN THE FIELD OF FUNCTIONAL SURFACES AND NANOTECHNOLOGY; MEASURING AND CONTROLLING APPARATUS AND INSTRUMENTS, NAMELY, THERMOMETERS, BAROMETERS, DENSITOMETERS, VISCOSITY METERS, LIQUID LEVEL METERS, FLOW METERS, AND MACHINE VISION APPLICATIONS CONSISTING OF CAMERAS, COMPUTERS AND SENSORS TO OPTICALLY MONITOR FLAME, ALL FOR USE IN CHEMICAL, PHYSICAL, OPTICAL AND MECHANICAL PROCESSES AND PRODUCTION IN THE FIELD OF FUNCTIONAL SURFACES AND NANOTECHNOLOGY (U.S. CLS. 21, 23, 26, 36 AND 38).

MICHAEL WIENER, EXAMINING ATTORNEY

THE MARK CONSISTS OF STANDARD CHARACTERS WITHOUT CLAIM TO ANY PARTICULAR FONT, STYLE, SIZE, OR COLOR.

OWNER OF INTERNATIONAL REGISTRATION 0896032
DATED 4-21-2006, EXPIRES 4-21-2016.

CLASS 9—ELECTRICAL AND SCIENTIFIC APPARATUS

FOR SCIENTIFIC, AERONAUTICAL, SURVEYING, OPTICAL, PHOTOGRAPHIC, MEASURING, CHECKING, SIGNALING AND LIFE-SAVING AND RESCUE APPARATUS AND INSTRUMENTS, NAMELY, CAMERAS; ON-BOARD COMPUTERS AND ON-BOARD COMPUTER PERIPHERAL EQUIPMENT; AIRCRAFT AVIONICS, NAMELY, AIRCRAFT AIRSPEED SENSORS; AVIONICS SOFTWARE FOR NAVIGATION; ELECTRONIC GROUND REMOTE CONTROL UNITS FOR THE OPERATION OF AIR VEHICLES, UAVS (UNMANNED AERIAL VEHICLES), VTOL (VERTICAL TAKE OFF AND LANDING) AIR VEHICLES AND HELICOPTERS; COMMUNICATION LINKS FOR TRANSMISSION OF INFORMATION BETWEEN GROUND SEGMENT AND AIR VEHICLES, NAMELY, RADIO TRANSMITTERS AND RECEIVERS (U.S. CLS. 21, 23, 26, 36 AND 38).

CLASS 12—VEHICLES

FOR VEHICLES FOR LOCOMOTION BY LAND, AIR OR WATER, NAMELY, AIRPLANES; AERONAUTICAL APPARATUS, MACHINES AND APPLIANCES, NAMELY, SPACE VEHICLES, NAMELY, LUNAR ROVERS, SHUTTLES, ROCKETS; AIRCRAFT AND AIRPLANES; HELICOPTERS; MILITARY AND CIVIL AIRCRAFT FOR THE TRANSPORT OF PERSONS AND PAYLOAD, UAVS (UNMANNED AERIAL VEHICLES) AND VTOL (VERTICAL TAKE OFF AND LANDING) AIRCRAFT; REMOTE CONTROL AIRCRAFT OTHER THAN TOYS; SPACE VEHICLES; STRUCTURAL PARTS AND FITTINGS FOR THE AFOREMENTIONED GOODS (U.S. CLS. 19, 21, 23, 31, 35 AND 44).

CLASS 42—SCIENTIFIC, COMPUTER AND LEGAL SERVICES

FOR SCIENTIFIC AND TECHNOLOGICAL CONSULTATION SERVICES AND RESEARCH AND DESIGN RELATING THERETO IN THE FIELD OF AIR VEHICLES, UAVS AND VTOL AIR VEHICLES; DESIGN AND DEVELOPMENT OF AIR VEHICLES, UAVS (UNMANNED AERIAL VEHICLES), VTOL (VERTICAL TAKE OFF AND LANDING) AIR VEHICLES; DESIGN AND DEVELOPMENT OF AIRCRAFT AVIONICS AND AVIONICS CONTROL UNITS FOR THE OPERATION OF AIR VEHICLES; UPDATING DESIGN OF AIRCRAFT AVIONICS AND AVIONICS CONTROL UNITS FOR THE OPERATION OF AIR VEHICLES (U.S. CLS. 100 AND 101).

DAYNA BROWNE, EXAMINING ATTORNEY

SN 79-028,216. OCEANIC WINE BRANDS LIMITED, HEREFORDSHIRE, UNITED KINGDOM, FILED 6-13-2006.

EQUALITY

THE MARK CONSISTS OF STANDARD CHARACTERS WITHOUT CLAIM TO ANY PARTICULAR FONT, STYLE, SIZE, OR COLOR.

PRIORITY DATE OF 12-14-2005 IS CLAIMED.
OWNER OF INTERNATIONAL REGISTRATION 0896865 DATED 6-13-2006, EXPIRES 6-13-2016.

CLASS 20—FURNITURE AND ARTICLES NOT OTHERWISE CLASSIFIED

FOR FURNITURE, MIRRORS, PICTURE FRAMES; HOUSEHOLD AND GARDEN FURNITURE OF WOOD, CORK, REED, CANE, WICKER, HORN, BONE, IVORY, WHALEBONE, SHELL, AMBER, MOTHER-OF-PEARL, MEERSCHAUM AND SUBSTITUTES FOR THESE MATERIALS, OR OF PLASTICS; METALLIC AND NON-METALLIC FURNITURE, NAMELY, GARDEN FURNITURE; PILLOWS AND CUSHIONS (U.S. CLS. 2, 13, 22, 25, 32 AND 50).

CLASS 22—CORDAGE AND FIBERS

FOR ROPES, STRING, NETS, NAMELY, INSECT PROTECTION NETS, FISHING NETS, INSECT COLLECTING NETS, TENTS, AWNINGS, TARPAULINS, SAILS, SACKS AND BAGS FOR THE TRANSPORTATION OR STORAGE OF MATERIALS IN BULK, NAMELY CLOTH BAGS, CANVAS BAGS, MESH BAGS, AND WATERPROOF BAGS; PADDING AND STUFFING MATERIALS NOT MADE OF RUBBER, PAPER OR PLASTICS, RAW FIBROUS TEXTILE MATERIALS; BAGS AND SACKS FOR TRANSPORTING BULK MATERIALS (U.S. CLS. 1, 2, 7, 19, 22, 42 AND 50).

CLASS 23—YARNS AND THREADS

FOR YARNS AND THREADS, FOR TEXTILE USE (U.S. CL. 43).

CLASS 27—FLOOR COVERINGS

FOR CARPETS, RUGS, MATS AND MATTING, LINOLEUM AND OTHER MATERIALS FOR COVERING EXISTING FLOORS; NON TEXTILE WALL HANGINGS; WALLPAPER (U.S. CLS. 19, 20, 37, 42 AND 50).

CLASS 28—TOYS AND SPORTING GOODS

FOR GAMES, NAMELY, CARD GAMES, BOARD GAMES; PLAYTHINGS, NAMELY STUFFED TOYS, DOLLS, PLASTIC TOY FIGURINES; GYMNASIAC AND SPORTING ARTICLES, NAMELY, SPORT BALLS, GYMNASIAC APPARATUS, WORK-OUT GLOVES; SPORTING GLOVES FOR BASEBALL, GOLF AND RACQUETBALL; BATS AND RACQUETS FOR BASEBALL, SOFTBALL, TENNIS, RACQUETBALL AND BADMINTON; COMPUTER AND VIDEO GAMES, NAMELY, ELECTRONIC BOARD GAMES AND ACTION-SKILL GAMES; DECORATIONS FOR CHRISTMAS TREES (U.S. CLS. 22, 23, 38 AND 50).

CLASS 29—MEATS AND PROCESSED FOODS

FOR MEAT, FISH, POULTRY AND GAME, MEAT EXTRACTS; PRESERVED, DRIED AND COOKED FRUITS AND VEGETABLES; JELLIES, JAMS, FRUIT SAUCES EXCLUDING CRANBERRY SAUCE AND APPLESAUCE; EGGS, MILK; MILK PRODUCTS, NAMELY CHEESE, COTTAGE CHEESE, YOGURT; EDIBLE OILS AND FATS; PREPARED MEALS AND SNACKS CONSISTING PRIMARILY OF MEAT, FISH, POULTRY, GAME, PROCESSED NUTS OR VEGETABLES (U.S. CL. 46).

CLASS 30—STAPLE FOODS

FOR COFFEE, TEA, COCOA, SUGAR, RICE, TAPIOCA, SAGO, ARTIFICIAL COFFEE; FLOUR; PREPARATIONS MADE FROM CEREALS, NAMELY, PROCESSED CEREALS, READY TO EAT CEREAL DERIVED FOOD BARS; BREAD, PASTRY; CONFECTIONERY, NAMELY CHOCOLATE, CANDY; FLAVOURED AND FRUIT ICES; HONEY, TREACLE; YEAST, BAKING-POWDER; SALT, MUSTARD; VINEGAR, CONDIMENT SAUCES; SPICES; ICE; PREPARED MEALS AND SNACKS CONSISTING PRIMARILY OF PASTA OR RICE (U.S. CL. 46).

CLASS 31—NATURAL AGRICULTURAL PRODUCTS

FOR AGRICULTURAL, HORTICULTURAL AND FORESTRY PRODUCTS AND GRAINS, NAMELY AGRICULTURAL GRAINS FOR PLANTING, UNPROCESSED GRAINS; LIVE ANIMALS; FRESH FRUITS AND VEGETABLES, SEEDS NAMELY SEEDS FOR HORTICULTURAL PURPOSES, PLANT SEEDS, FRUIT SEEDS, NATURAL LIVE PLANTS, NATURAL FLOWERS, FOODSTUFFS FOR ANIMALS; MALT FOR BREWING AND DISTILLING; FOOD AND BEVERAGES FOR ANIMALS (U.S. CLS. 1 AND 46).

CLASS 32—LIGHT BEVERAGES

FOR BEERS; MINERAL AND AERATED WATERS AND OTHER NON-ALCOHOLIC DRINKS, NAMELY SOFT DRINKS, LEMONADE; FRUIT DRINKS AND FRUIT JUICES; SYRUPS FOR MAKING BEVERAGES; AND OTHER PREPARATIONS, NAMELY, POWDERS, CONCENTRATES FOR MAKING BEVERAGES, NAMELY SOFT DRINKS, LEMONADE; SHANDY, DE-ALCOHOLISED DRINKS, NAMELY DAIQUIRIS; NON-ALCOHOLIC BEERS AND WINES (U.S. CLS. 45, 46 AND 48).

AMEETA JORDAN, EXAMINING ATTORNEY

SN 79-028,296. JETTER AG, 71642 LUDWIGSBURG, FED REP GERMANY, FILED 8-10-2006.

STX

PRIORITY DATE OF 3-6-2006 IS CLAIMED.
OWNER OF INTERNATIONAL REGISTRATION 0896948 DATED 8-10-2006, EXPIRES 8-10-2016.

CLASS 9—ELECTRICAL AND SCIENTIFIC APPARATUS

FOR MEMORY PROGRAMMABLE CONTROLS, NAMELY, STORE-PROGRAMMABLE CONTROLS WHICH CONTROL MOTION OF A PRODUCTION MACHINE, MOTION CONTROLLERS FOR MOVEMENT CONTROL IN A PACKING MACHINE, DRIVE AMPLIFIERS WITH CONTROL FUNCTIONS FOR PROGRAMMABLE MOTOR CONTROL AND CONTROL APPARATUS WITH INTEGRATED SOFTWARE-BASED CONTROLS FOR CONTROL PANELS IN A HARVESTER; COMPUTER PROGRAMS AND SOFTWARE USED TO MONITOR, CONTROL AND AUTOMATE FACTORY MANUFACTURING PROCESSES, FOR AUTOMATING VISUALIZATION SYSTEMS, MOTION CONTROLLERS AND MOVEMENT CONTROLS, ROBOT CONTROLS, CONTROL APPARATUSES, AND SCADA (SUPERVISORY CONTROL AND DATA ACQUISITION) SYSTEMS FOR USE WITH MEMORY PROGRAMMABLE CONTROLS RECORDED ON CDS, DVDS AND MEMORY PROGRAMMABLE DISCS; CONTROLS AND CONTROL MODULUS FOR CONTROLLING SYNCHRONOUS MOTORS OR ASYNCHRONOUS MOTORS, ESPECIALLY BRUSH-LESS DRIVES, SERVO-MOTORS, STEPPING MOTORS, DIRECT DRIVES; CONTROLS FOR POSITION CONTROL AND SPEED CONTROL OF THESE MOTORS; COMPUTER PERIPHERAL DEVICES (U.S. CLS. 21, 23, 26, 36 AND 38).

CLASS 42—SCIENTIFIC, COMPUTER AND LEGAL SERVICES

FOR DESIGN OF COMPUTER HARDWARE AND SOFTWARE FOR MEMORY-PROGRAMMABLE CONTROLS FOR OTHERS; PROVIDING TEMPORARY USE OF NON-DOWNLOADABLE COMPUTER PROGRAMS AND SOFTWARE FOR MEMORY PROGRAMMABLE CONTROLS USED TO AUTOMATE MEMORY-PROGRAMMABLE CONTROLS, MOTION CONTROLLERS AND MOVEMENT CONTROLS, ROBOT CONTROLS, CONTROL APPARATUSES, VISUALIZATION SYSTEMS, AND SCADA (SUPERVISORY CONTROL AND DATA ACQUISITION) SYSTEMS; DESIGN AND DEVELOPMENT OF COMPUTER HARDWARE AND SOFTWARE, IN PARTICULAR FOR MEMORY-PROGRAMMABLE CONTROLS (U.S. CLS. 100 AND 101).

KELLY BOULTON, EXAMINING ATTORNEY

SN 79-028,489. SKYE ELLIS, FED REP GERMANY, FILED 8-1-2006.



PRIORITY DATE OF 3-16-2006 IS CLAIMED.
OWNER OF INTERNATIONAL REGISTRATION 0897458 DATED 8-1-2006, EXPIRES 8-1-2016.

NO CLAIM IS MADE TO THE EXCLUSIVE RIGHT TO USE WATER, APART FROM THE MARK AS SHOWN.

THE COLOR(S) BLUE, ORANGE, WHITE IS/ARE CLAIMED AS A FEATURE OF THE MARK.

THE COLOR BLUE APPEARS IN THE TERM WATER AND THE WAVE DESIGN, AND THE COLOR ORANGE APPEARS IN THE PAW PRINT AND THE TERM LITTLE.

CLASS 31—NATURAL AGRICULTURAL PRODUCTS

FOR UNPROCESSED GRAINS, LIVE ANIMALS; FRESH FRUITS AND VEGETABLES; SEEDS FOR AGRICULTURAL PURPOSES, LIVING PLANTS AND FLOWERS; FOODSTUFFS FOR ANIMALS; MALT FOR BREWING AND DISTILLING (U.S. CLS. 1 AND 46).

CLASS 32—LIGHT BEVERAGES

FOR BEERS; MINERAL AND AERATED WATERS AND OTHER NON-ALCOHOLIC DRINKS, NAMELY SOFT DRINKS, SPORTS DRINKS AND ENERGY DRINKS; FRUIT DRINKS AND FRUIT JUICES; SYRUPS AND OTHER PREPARATIONS FOR MAKING BEVERAGES (U.S. CLS. 45, 46 AND 48).

JANICE L. MCMORROW, EXAMINING ATTORNEY

SN 79-028,609. AUREN SERVICIOS PROFESIONALES; AVANZADOS, S.L., SPAIN, FILED 6-20-2006.



PRIORITY DATE OF 2-9-2006 IS CLAIMED.
OWNER OF INTERNATIONAL REGISTRATION 0897874 DATED 6-20-2006, EXPIRES 6-20-2016.

THE COLOR(S) GREY AND GARNET IS/ARE CLAIMED AS A FEATURE OF THE MARK.

THE STAR IS GREY. THE NAME "AUREN" IS GARNET. THE NAME CLAIMED COMPRISES "AUREN" IN SPECIAL FONT AND THE REPRESENTATION OF A STAR AS SHOWN IN THE ENCLOSED DRAWING.

CLASS 35—ADVERTISING AND BUSINESS

FOR ADVERTISING AND MARKETING; MARKETING CONSULTING; MARKETING PLAN DEVELOPMENT; MARKET RESEARCH; BUSINESS PLANNING; BUSINESS MARKETING CONSULTATION SERVICES; ASSISTANCE WITH BUSINESS MANAGEMENT AND PLANNING; MARKET PLAN DEVELOPMENT; MARKET RESEARCH; ADMINISTRATIVE ACCOUNTING; ACCOUNT AUDITING; ACCOUNTING; BUSINESS AUDITING CONSULTATION; BUSINESS CONSULTATIONS; BUSINESS MANAGEMENT CONSULTATIONS AS WELL AS DEVELOPMENT OF PROCESSES FOR THE ANALYSIS AND THE IMPLEMENTATION OF STRATEGY PLANS AND MANAGEMENT PROJECTS; BUSINESS APPRAISAL CONSULTATION; HUMAN RESOURCES CONSULTATION; LABOR CONSULTATION; TAX CONSULTATION (U.S. CLS. 100, 101 AND 102).

CLASS 36—INSURANCE AND FINANCIAL

FOR FINANCIAL PLANNING; FINANCIAL CONSULTATION; FINANCIAL RISK MANAGEMENT CONSULTATION (U.S. CLS. 100, 101 AND 102).

CLASS 42—SCIENTIFIC, COMPUTER AND LEGAL SERVICES

FOR STUDIES ON THE FEASIBILITY OF PROJECTS AND INITIATIVES LIKELY TO UNDERGO DEVELOPMENT RELATING TO ACCREDITATION SERVICES, NAMELY, EVALUATING ORGANIZATIONS TO DETERMINE WHETHER THE ORGANIZATION CONFORMS TO AN ESTABLISHED STANDARD, ENGINEERING, CONDUCTING ENGINEERING SURVEYS, URBAN PLANNING, PLANNING OF BUILDINGS AND INFRASTRUCTURE SYSTEMS FOR BUILDINGS; INFORMATION TECHNOLOGY CONSULTATIONS IN THE NATURE OF INFORMATION TECHNOLOGY APPRAISALS, PROJECTS AND STUDIES; TECHNICAL RESEARCH IN THE FIELD OF INFORMATION TECHNOLOGY; COMPUTER CONSULTATIONS AND COMPUTER CONSULTATION IN THE FIELD OF COMPUTER SECURITY ALL IN THE NATURE OF COMPUTER AND SOFTWARE DESIGN AND DEVELOPMENT FOR OTHERS; LEGAL CONSULTATIONS (U.S. CLS. 100 AND 101).

NATALIE POLZER, EXAMINING ATTORNEY

CLASS 5—PHARMACEUTICALS

FOR PLASTERS, NAMELY, MEDICAL PLASTERS AND MEDICAL COOLING PLASTERS; MATERIAL FOR DRESSINGS, NAMELY, BINDINGS AND BANDAGES FOR DRESSINGS; FIRST-AID DRESSINGS FOR WOUNDS AND BURNS; ADHESIVE FABRICS AND FILMS FOR MEDICAL PURPOSES FOR BINDING WOUNDS; WOUND-DRESSING BANDAGES; COTTON SWABS FOR MEDICAL AND SURGICAL PURPOSES; SANITARY ARTICLES FOR WOMEN, NAMELY MATERNITY PADS, SANITARY TOWELS, PANTY LINERS, TAMPONS, SANITARY PANTS; NAPPIES FOR THE SICK, NAMELY, INCONTINENCE AND ADULT DIAPERS; INCONTINENCE PRODUCTS, NAMELY, NAPKINS AND PANTS FOR INCONTINENTS AND ABSORBENT PADS, GARMENTS AND DIAPERS FOR INCONTINENTS; MATERIAL FOR DRESSINGS, NAMELY, MEDICAL PLASTER OF PARIS DRESSINGS AND STRIPS; PADDING MATERIAL FOR MEDICAL PURPOSES, NAMELY, UNDERCAST PADDING AND PADDING BANDAGES; OPERATION ROOM COMPONENT SYSTEMS, NAMELY, OPERATION ROOM PROCEDURE TRAYS, COMPRISING ONE OR MORE OF THE FOLLOWING: DRESSING MATERIALS, UNIVERSAL DRESSINGS, GAUZE DRESSINGS, ABSORBENT GAUZE, GAUZE BALLS, COTTON PADS AND DRAINAGE DRESSINGS; FIRST-AID EQUIPMENT, NAMELY, FILLED WOUND, BURN AND SURGERY DRESSING PACKAGES AND FILLED SMALL WOUND, BURN AND SURGERY DRESSING BOXES, WOUND, BURN AND SURGERY DRESSING BANDAGE REFILLS AND TRIANGULAR SHEET MATERIAL GAUZE FOR DRESSINGS; MATERIAL FOR DRESSINGS, NAMELY, PRESSURE SLEEVES, MEDICATED AND NON-MEDICATED COMPRESSES, CHANGING CLOTHS BANDAGES; COVERING MATERIAL, NAMELY, MEDICAL AND SURGICAL WOUND-COVERING ADHESIVES, BANDAGES, FILMS, DRESSINGS AND CLEANSERS; INCISION FILMS USED FOR COVERING THE OPERATING AREA ON HUMAN BODIES AND UNMEDICATED AND NON-ADHESIVE WOUND DRESSINGS FOR TREATING FRESH AND EXUDING WOUNDS; PHARMACEUTICAL HAEMOSTATIC MATERIALS AND PRODUCTS, NAMELY, AGENTS WHICH SPEED THE COAGULATION OF BLOOD; WADDING DRESSING BANDAGES FOR MEDICAL PURPOSES; ALL PURPOSE AND MEDICAL DISINFECTANTS; FIRST-AID EQUIPMENT FOR DOMESTIC OR OTHER NON-PROFESSIONAL USE, NAMELY, MEDICAL DRESSING PACKAGES AND SMALL MEDICAL DRESSING BOXES, MEDICAL DRESSING REFILLS, TRIANGULAR SHEETS FOR MEDICAL DRESSINGS (U.S. CLS. 6, 18, 44, 46, 51 AND 52).

SN 79-028,769. LOHMANN & RAUSCHER; INTERNATIONAL GMBH & CO. KG, FED REP GERMANY, FILED 6-20-2005.

Lohmann Rauscher

THE MARK CONSISTS OF STANDARD CHARACTERS WITHOUT CLAIM TO ANY PARTICULAR FONT, STYLE, SIZE, OR COLOR.

OWNER OF INTERNATIONAL REGISTRATION 0898173 DATED 6-20-2005, EXPIRES 6-20-2015.
OWNER OF U.S. REG. NO. 2,545,662.

CLASS 3—COSMETICS AND CLEANING PREPARATIONS

FOR SOAPS; ESSENTIAL OILS; COSMETICS, IN PARTICULAR BODY LOTIONS, CREAMS; COSMETICS, IN PARTICULAR NON-MEDICATED SHAMPOOS AND NON-MEDICATED BATH PREPARATIONS (U.S. CLS. 1, 4, 6, 50, 51 AND 52).

CLASS 10—MEDICAL APPARATUS

FOR ORTHOPAEDIC ARTICLES, NAMELY ORTHOPAEDIC SUPPORT BANDAGES AND ELASTIC BINDINGS, INCLUDING FOR SPORT; ORTHOPAEDIC PLASTER CASTS OF PARIS DRESSINGS AND STRIPS; ORTHOPAEDIC SUPPORT BANDAGES; ORTHESIS, NAMELY, ORTHOPAEDIC BRACES AND SPLINTS; ARTIFICIAL LIMBS; SPLINTS FOR SURGICAL AND ORTHOPAEDIC PURPOSES; SUPPORT AND COMPRESSION STOCKINGS FOR ORTHOPAEDIC PURPOSES; SUPPORT STOCKINGS AND SUPPORT TIGHTS FOR HEALTHCARE PURPOSES; TEXTILE DRAW-SHEETS FOR SICK BEDS; LIQUID-IMPERMEABLE COVERS OF NON-WOVEN FABRICS AND POLYURETHANE FILMS FOR SICK BEDS, EXAMINATION TABLES AND AMBULANCE STRETCHERS; COVERS, NAMELY, OVERALLS, VESTS, CLOTHING OF WOVEN FABRICS, KNITTED FABRICS, NON-WOVEN FABRICS AND POLYURETHANE FILMS, FOR THE WHOLE HUMAN BODY AND DEFINED AREAS OF THE BODY FOR MEDICAL USE, NAMELY, CLOTHING TO ASSIST IN THE TREATMENT AND HEALING OF SKIN INJURIES; LAPAROTOMY SWABS FOR SURGICAL PURPOSES; OPERATION SHEETS AND STERILE SHEETS FOR USE IN SURGICAL FIELDS; GOODS FOR USE IN OPERATING THEATRES, NAMELY, SURGICAL DRAPES, OPERATING ROOM CLOTHING, OPERATING ROOM GLOVES, OPERATING ROOM DRESSING MATERIAL SYSTEMS, PRIMARILY COMPRISED OF GAUZE DRESSINGS, GAUZE BALLS, DISSECTING SWABS AND LAPAROTOMY SWABS AND OPERATING ROOM COMPONENT SYSTEMS, NAMELY PROCEDURE TRAYS, COMPRIS-

ING ONE OR MORE OF THE FOLLOWING: OPERATING ROOM DRAPES AND OPERATING ROOM CLOTHING OF VARIOUS TYPES AND QUANTITIES DETERMINED; VARIOUS TYPES AND QUANTITIES DETERMINED OF DISPOSABLE MEDICAL PRODUCTS, NAMELY, SURGICAL AND WOUND DRAINS, DISPOSABLE SYRINGES AND CANULAE, INCISE DRAPES, SUTURE MATERIALS AND OTHER DISPOSABLE COMPONENTS, NAMELY MEDICAL SWABS, COTTON TIPPED APPLICATORS, SURGICAL DRAPES, SURGICAL GOWNS, SURGICAL AND EXAMINATION GLOVES, FINGER STALLS, NAMELY, FINGER SPLINTS, READY-TO-WEAR FINGER DRESSINGS AND FINGER COTS, BANDAGES, SURGICAL INCISION DRAPES, DRAINAGE SPONGES, DISPOSABLE SCALPELS AND BLADES, INFUSION SETS AND CATHETERS; SURGICAL SUTURE MATERIAL; SURGICAL, MEDICAL, DENTAL AND VETERINARY APPARATUS AND INSTRUMENTS, NAMELY, BEAKERS, TONGUE DEPRESSORS, WOUND IRRIGATION SYRINGES, CASTING TAPE, MEDICAL SUPPORT TAPE, URINE BOTTLES, BREAST PUMPS, RECTAL SHIELDS FOR USE IN SURGERY, SLINGS, ENEMA SYRINGES, WASTE COLLECTION BAGS, ICE PACKS, TOURNIQUET COVERS, PULL-THREAD DEVICES FOR WOUND CARE AND SURGICAL PROCEDURES, DIAMOND CLEANING BLOCKS FOR CLEANING BODY CAVITIES, TRANSDERMAL DRUG DELIVERY PATCHES SOLD WITHOUT MEDICATION, WOUND IRRIGATORS, CLOTH EAR PROTECTORS FOR USE IN SURGERY, SUSPENSORIES FOR MEN DURING SURGERY; SURGICAL APRONS; CATHETERS, PULL-THREAD DEVICES FOR WOUND CARE AND SURGICAL PURPOSES; HEMODIALYSIS EQUIPMENT; MOUTH AND NOSE MASKS FOR USE BY MEDICAL PERSONNEL, SURGICAL FACE MASKS USED BY MEDICAL PERSONNEL FOR MEDICAL PURPOSES; IMMOBILISING COMPRESSION, ELASTIC AND ORTHOPAEDIC BANDAGES, OF FILM; SYNTHETIC SPLINTING BANDAGES FOR ORTHOPAEDIC PURPOSES (U.S. CLS. 26, 39 AND 44).

CLASS 24—FABRICS

FOR TEXTILE GOODS, NAMELY, BED LINEN, IN PARTICULAR FOR USE IN HOSPITALS, OPERATING THEATRES AND NURSING. (U.S. CLS. 42 AND 50).

CLASS 25—CLOTHING

FOR CLOTHING FOR USE IN OPERATING THEATRES, NAMELY, PANTS, OVERALLS, DRESSES, SHIRTS, GOWNS AND CAPS; CLOTHING FOR USE IN NURSING, NAMELY, PANTS, OVERALLS, DRESSES, SHIRTS, GOWNS AND CAPS; SUPPORT STOCKINGS AND SUPPORT TIGHTS AS CLOTHING. (U.S. CLS. 22 AND 39).

CLASS 35—ADVERTISING AND BUSINESS

FOR ADVERTISING, PROVIDING OFFICE FUNCTIONS (U.S. CLS. 100, 101 AND 102).

CLASS 39—TRANSPORTATION AND STORAGE

FOR TRANSPORTATION OF GOODS BY AIR, BOAT, RAIL, AND TRUCK; PACKAGING ARTICLES FOR TRANSPORTATION; STORAGE OF PHARMACEUTICAL, SANITARY, SURGICAL, MEDICAL, DENTAL AND VETERINARY PRODUCTS (U.S. CLS. 100 AND 105).

CLASS 44—MEDICAL, BEAUTY AND AGRICULTURAL SERVICES

FOR MEDICAL AND HYGIENIC CARE (U.S. CLS. 100 AND 101).

ANTHONY RINKER, EXAMINING ATTORNEY

SN 79-028,818. CRANEO B.V., NETHERLANDS, FILED 1-31-2006.

ENEXTRO

THE MARK CONSISTS OF STANDARD CHARACTERS WITHOUT CLAIM TO ANY PARTICULAR FONT, STYLE, SIZE, OR COLOR.

PRIORITY DATE OF 1-19-2006 IS CLAIMED.

OWNER OF INTERNATIONAL REGISTRATION 0898290 DATED 1-31-2006, EXPIRES 1-31-2016.

CLASS 6—METAL GOODS

FOR FITTINGS OF METAL FOR FURNITURE, NAMELY METAL SHELF BRACKETS FOR COMPUTER CUPBOARDS; TRANSPORTABLE BUILDINGS OF METAL. (U.S. CLS. 2, 12, 13, 14, 23, 25 AND 50).

CLASS 9—ELECTRICAL AND SCIENTIFIC APPARATUS

FOR APPARATUS AND INSTRUMENTS FOR CONDUCTING, DISTRIBUTING, INVERTING, STORAGE, CONTROLLING AND REGULATING ELECTRICITY, NAMELY POWER DISTRIBUTION BOXES AND THEIR PARTS AND FITTINGS; ELECTRICITY CONDUITS; ELECTRIC CABLES AND WIRES; CONNECTIONS FOR ELECTRIC LINES, CABLES AND WIRES; ELECTRICITY JUNCTION BOXES AND TERMINALS; ELECTRIC CONNECTIONS, CONTROL PANELS, DUCTS FOR ELECTRIC CABLES AND WIRES; CONNECTORS; JUNCTION BOXES; ELECTRIC CONTACTS AND CONNECTIONS, WIRE CONNECTORS, ELECTRIC RELAYS, INTEGRATED CIRCUITS, ELECTRIC CONDUCTORS, HOLDERS FOR ELECTRIC COILS, ELECTRONIC INDICATOR PANELS AND BOARDS, IDENTIFICATION THREADS FOR ELECTRIC WIRES, ELECTRIC INVERTERS, ELECTRIC SWITCHES, CIRCUIT BREAKERS, ELECTRICAL CIRCUIT LIMITERS, ELECTRIC CONVERTERS, ELECTRIC PLUGS; PERSONAL COMPUTERS; COMPUTER HARDWARE. (U.S. CLS. 21, 23, 26, 36 AND 38).

ANTHONY RINKER, EXAMINING ATTORNEY

SN 79-028,899. DDP, F-33130 BEGLES, FRANCE, FILED 7-24-2006.



PRIORITY DATE OF 2-3-2006 IS CLAIMED.
OWNER OF INTERNATIONAL REGISTRATION 0898513
DATED 7-24-2006, EXPIRES 7-24-2016.
OWNER OF U.S. REG. NO. 2,306,849.

CLASS 16—PAPER GOODS AND PRINTED MATTER

FOR PAPER, UNPROCESSED CARDBOARD, SEMI-PROCESSED CARDBOARD, CARDBOARD FOR STATIONERY PURPOSES, AND GOODS MADE FROM THESE MATERIALS, NAMELY, STICKERS, SCHOOL WRITING AND DRAWING BOOKS, NOTE PADS, FILE FOLDERS, PLACARDS OF PAPER AND CARDBOARD, PAPER OR CARDBOARD SIGNBOARDS, PAPER BAGS FOR PACKAGING, SMALL PAPER BAGS, ENVELOPES, PAPER POUCHES FOR PACKAGING, POSTERS, POSTCARDS, GREETING CARDS, TRANSFERS, NAMELY, DECALCOMANIAS, DRAWINGS, FIGURINES OF PAPER MÂCHÉ, ENGRAVINGS, PICTURES, STATUETTES OF PAPER MÂCHÉ (U.S. CLS. 2, 5, 22, 23, 29, 37, 38 AND 50).

CLASS 18—LEATHER GOODS

FOR LEATHER AND IMITATION LEATHER; ANIMAL SKINS AND HIDES; TRUNKS AND SUITCASES; UMBRELLAS, PARASOLS AND WALKING STICKS; WHIPS, HARNESS AND SADDLERY, SCHOOL BAGS, CARD CASES, NAMELY, WALLETS, LEATHER KEY CASES, TRAVELLING TRUNKS; UNFITTED VANITY CASES SOLD EMPTY, BRIEFCASES, SCHOOL BAGS AND CASES, SHOULDER BAGS, SUITCASES, LEATHER OR IMITATION LEATHER PURSES, BEACH BAGS, WALLETS, ROLLER BAGS, SATCHELS, RUCKSACKS, HANDBAGS, MESH SHOPPING BAGS, LEATHER SHOPPING BAGS, TEXTILE SHOPPING BAGS, SHOPPING BAGS MADE OF SKIN, DUFFLE BAGS FOR CAMPERS, HIKING BAGS FOR CAMPERS, CARRY-ON BAGS FOR CAMPERS, TRAVELLING BAGS, SCHOOL BAGS, GARMENT BAGS FOR TRAVEL, LEATHER BRIEFCASES, LEATHER TRAVELLING SETS, NAMELY, SHAVING BAGS SOLD EMPTY AND WASH BAGS FOR CARRYING TOILETRIES (U.S. CLS. 1, 2, 3, 22 AND 41).

CLASS 25—CLOTHING

FOR CLOTHING, NAMELY, BATHING SUITS, BATH ROBES, BANDANAS, SMOCKS, BODY SUITS, HOSE, MUFFLERS, DRAWERS, NAMELY, BOXER BRIEFS, BELTS, SHAWLS, DRESSING GOWNS, SWEATERS, SOCKS, SHIRTS, TIGHTS, OVERALLS, UNDERCLOTHES, SUITS, NECKTIES, PANTIES AND UNDERPANTS, UNDERWEAR, SASHES FOR WEAR, SKIRTS, PETTICOATS, TROUSERS, PULLOVERS, PAJAMAS, DRESSES, UNDERWEAR AND T-SHIRTS; WATER-PROOF CLOTHING, NAMELY, WATERPROOF JACKETS, WATERPROOF COATS, TRENCH COATS AND RAIN COATS; OUTER CLOTHING, NAMELY, SCARVES, GLOVES, WAISTCOATS, COATS AND PARKAS; FOOTWEAR, NAMELY, BATH SANDALS, BOOTS, HALF-BOOTS, SLIPPERS AND BOOTS FOR SPORTS; HEADGEAR, NAMELY, HEAD BANDS, BERETS, CAPS AND VISORS (U.S. CLS. 22 AND 39).

LANA PHAM, EXAMINING ATTORNEY

SN 79-028,985. WRH MARKETING AG, CH-8032 HINWIL, SWITZERLAND, FILED 2-15-2006.

MEMOSEAL

THE MARK CONSISTS OF STANDARD CHARACTERS WITHOUT CLAIM TO ANY PARTICULAR FONT, STYLE, SIZE, OR COLOR.

PRIORITY DATE OF 9-13-2005 IS CLAIMED.
OWNER OF INTERNATIONAL REGISTRATION 0898722
DATED 2-15-2006, EXPIRES 2-15-2016.

CLASS 16—PAPER GOODS AND PRINTED MATTER

FOR PAPER, CARDBOARD AND PLASTIC FILM FOR WRAPPING, PRE-PROCESSED BY MEANS OF PAPER CONVERSION; ENVELOPES MADE OF PAPER AND/OR CARDBOARD AND/OR PLASTIC FOR PRINTED PRODUCTS, NAMELY PRINTED AND PRINTABLE ENVELOPES; ADHESIVE TAPE FOR PAPER AND PRINTING PRODUCTS MADE OF PAPER AND/OR CARDBOARD AND/OR PLASTIC FOR STATIONERY USE; PAPER OR PLASTIC LABELS WITH AN ADHESIVE BACKING; PRINTED MATTER OF PAPER AND/OR CARDBOARD AND/OR PLASTIC, NAMELY PRINTED ENVELOPES, WRAPPERS, FOLDERS AND POCKETS FOR WRAPPING NEWSPAPER, MAGAZINES AND PERIODICALS; PAPER, CARDBOARD AND PLASTIC FOR WRAPPING AND PACKAGING; PRINTED ADHESIVE LABELS AND PRINTED ADHESIVE TAPE FOR STATIONERY USE (U.S. CLS. 2, 5, 22, 23, 29, 37, 38 AND 50).

CLASS 35—ADVERTISING AND BUSINESS

FOR ADVERTISING; DISSEMINATION OF ADVERTISING MATERIAL IN THE FORM OF PRINTED MATTER, DATA MEDIA, SAMPLES; DISTRIBUTION OF SAMPLES FOR ADVERTISING PURPOSES; SERVICES IN THE FIELD OF ADVERTISING, NAMELY BRAND MARKETING, ACQUISITION OF ADVERTISERS; CONSULTANCY IN THE FIELD OF DISSEMINATION AND USE OF ADVERTISEMENTS AND ADVERTISING MATERIAL IN THE FORM OF PRINTED MATTER, DATA MEDIA, SAMPLES; RENTAL OF ADVERTISING SPACE; DISSEMINATION OF POSTER ADVERTISING; DIRECT MAIL ADVERTISING; BUSINESS MANAGEMENT ON BEHALF OF OTHERS, NAMELY BUSINESS COORDINATION AND COORDINATION OF THE FLOW OF GOODS; BUSINESS ORGANIZATION AND MANAGEMENT CONSULTING; COLLECTING AND SYSTEMIZATION OF INFORMATION IN A DATA BANK, UPDATING OF DATA IN A DATA BANK, PERFORMING COST-PRICE ANALYSIS, PROVIDING CALL CENTER SERVICES, NAMELY CONTACT CENTERS FOR QUESTIONS (U.S. CLS. 100, 101 AND 102).

CLASS 39—TRANSPORTATION AND STORAGE

FOR DISTRIBUTION OF PRINTED MATTER, NAMELY MAGAZINES AND NEWSPAPERS, PERIODICALS, ILLUSTRATED PUBLICATIONS, BROCHURES; DISTRIBUTION OF ELECTRONIC, MAGNETIC AND OPTICAL DATA MEDIA; PACKAGING OF GOODS FOR TRANSPORTATION, NAMELY PACKAGING OF PRINTED MATTER, DATA MEDIA AND SAMPLES; STORAGE OF GOODS, NAMELY STORAGE OF NEWSPAPERS, MAGAZINES, PERIODICALS, ILLUSTRATED PUBLICATIONS, BROCHURES, ADVERTISING MATERIAL; TRANSPORT OF GOODS, NAMELY DELIVERY OF ORDERED GOODS ON BEHALF OF OTHERS (U.S. CLS. 100 AND 105).

CLASS 40—MATERIAL TREATMENT

FOR TREATMENT OF MATERIALS, NAMELY PRE-PROCESSING OF PAPER, CARDBOARD AND FILM FOR WRAPPING BY MEANS OF PAPER CONVERSION; PRINTING, NAMELY PRINTING OF WRAPPING MATERIAL ON BEHALF OF OTHERS (U.S. CLS. 100, 103 AND 106).

WARREN L. OLANDRIA, EXAMINING ATTORNEY

SN 79-029,053. BENEQ OY, FINLAND, FILED 6-16-2006.

NCLEAR

PRIORITY DATE OF 2-10-2006 IS CLAIMED.
OWNER OF INTERNATIONAL REGISTRATION 0898917
DATED 6-16-2006, EXPIRES 6-16-2016.

CLASS 7—MACHINERY

FOR MACHINES AND MACHINE TOOLS FOR USE IN CHEMICAL, PHYSICAL, OPTICAL AND MECHANICAL PROCESSES AND PRODUCTION IN THE FIELD OF FUNCTIONAL COATINGS AND NANOTECHNOLOGY, NAMELY, FOR THE APPLICATION, LAYERING AND DEPOSITION OF THIN FILMS, COATINGS, HOT AEROSOL AND ATOMIC LAYERS, AND FOR THE PRODUCTION OF NANO PARTICLES AND FUNCTIONAL COATINGS (U.S. CLS. 13, 19, 21, 23, 31, 34 AND 35).

CLASS 9—ELECTRICAL AND SCIENTIFIC APPARATUS

FOR COMPUTER SOFTWARE FOR USE IN CONTROLLING, REGULATING, SUPERVISING, MONITORING AND MANAGING CHEMICAL, PHYSICAL, OPTICAL AND MECHANICAL PROCESSES AND PRODUCTION MACHINES IN THE FIELD OF FUNCTIONAL SURFACES AND NANOTECHNOLOGY; MEASURING AND CONTROLLING APPARATUS AND INSTRUMENTS, NAMELY, THERMOMETERS, BAROMETERS, DENSITOMETERS, VISCOSITY METERS, LIQUID LEVEL METERS, FLOW METERS, AND MACHINE VISION APPLICATIONS CONSISTING OF CAMERAS, COMPUTERS AND SENSORS TO OPTICALLY MONITOR FLAME, ALL FOR USE IN CHEMICAL, PHYSICAL, OPTICAL AND MECHANICAL PROCESSES AND PRODUCTION IN THE FIELD OF FUNCTIONAL SURFACES AND NANOTECHNOLOGY (U.S. CLS. 21, 23, 26, 36 AND 38).

MICHAEL WIENER, EXAMINING ATTORNEY

SN 79-029,340. LEMAN CARDIOVASCULAR SA, SWITZERLAND, FILED 8-17-2006.

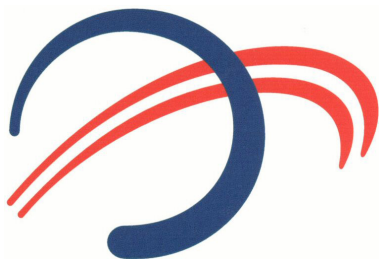

PRIORITY DATE OF 5-23-2006 IS CLAIMED.
OWNER OF INTERNATIONAL REGISTRATION 0899567
DATED 8-17-2006, EXPIRES 8-17-2016.

THE COLOR(S) BLUE AND RED IS/ARE CLAIMED AS A FEATURE OF THE MARK.

THE COLOR BLUE APPEARS IN THE BROKEN CIRCLE DESIGN AND THE COLOR RED APPEARS IN THE DUAL CURVED LINE DESIGN.

CLASS 5—PHARMACEUTICALS

FOR SURGICAL IMPLANTS COMPRISING LIVING TISSUES; HEART IMPLANTS COMPRISING LIVING TISSUE; SURGICAL IMPLANTS FOR THE CARDIOVASCULAR SYSTEM COMPRISING LIVING TISSUE; UROLOGICAL IMPLANTS COMPRISING LIVING TISSUE; HEART VALVE IMPLANTS COMPRISING LIVING TISSUE (U.S. CLS. 6, 18, 44, 46, 51 AND 52).

CLASS 10—MEDICAL APPARATUS

FOR PROSTHESES FOR THE BREAST, HAND AND LEG; HAIR AND DENTAL PROSTHESES; HEART PROSTHESES FOR USE DURING SURGICAL IMPLANTATION FOR THE TREATMENT OF CARDIOVASCULAR DISEASES, AND FOR PLASTIC AND RECONSTRUCTIVE SURGERY; HEART PROSTHESES AND PROSTHESES FOR THE CARDIO-VASCULAR SYSTEM; UROLOGICAL PROSTHESES; IMPLANTS CONSISTING OF ARTIFICIAL MATERIALS; SURGICAL IMPLANTS COMPRISING ARTIFICIAL MATERIAL; ARTIFICIAL HEART IMPLANTS AND ARTIFICIAL IMPLANTS FOR THE CARDIO-VASCULAR SYSTEM; ARTIFICIAL UROLOGICAL IMPLANTS (U.S. CLS. 26, 39 AND 44).

CLASS 42—SCIENTIFIC, COMPUTER AND LEGAL SERVICES

FOR SCIENTIFIC RESEARCH; DESIGN OF NEW PRODUCTS FOR OTHERS IN THE FIELD OF MEDICAL IMPLANTS AND PROSTHESES; LICENSING OF INTELLECTUAL PROPERTY (U.S. CLS. 100 AND 101).

CLASS 44—MEDICAL, BEAUTY AND AGRICULTURAL SERVICES

FOR SURGERY; SURGICAL IMPLANTATION OF HEART, VASCULAR AND UROLOGICAL PROSTHESES (U.S. CLS. 100 AND 101).

DANIEL CAPSHAW, EXAMINING ATTORNEY

SN 79-029,613. SWISSTECH HOLDING AG, SWITZERLAND, FILED 9-6-2006.

SOT

THE MARK CONSISTS OF STANDARD CHARACTERS WITHOUT CLAIM TO ANY PARTICULAR FONT, STYLE, SIZE, OR COLOR.

PRIORITY DATE OF 4-13-2006 IS CLAIMED.
OWNER OF INTERNATIONAL REGISTRATION 0900106
DATED 9-6-2006, EXPIRES 9-6-2016.

CLASS 1—CHEMICALS

FOR CHEMICAL ADDITIVES FOR PURIFYING OILS; CHEMICALS FOR USE IN INDUSTRY AND SCIENCE; FIRE EXTINGUISHING COMPOSITIONS (U.S. CLS. 1, 5, 6, 10, 26 AND 46).

CLASS 3—COSMETICS AND CLEANING PREPARATIONS

FOR ALL PURPOSE CLEANING PREPARATIONS; DEGREASING PREPARATIONS FOR WATER (U.S. CLS. 1, 4, 6, 50, 51 AND 52).

LINDA M. KING, EXAMINING ATTORNEY

SN 79-029,745. TIMA S.P.A., ITALY, FILED 3-28-2006.

Ruff Trigger

THE MARK CONSISTS OF STANDARD CHARACTERS WITHOUT CLAIM TO ANY PARTICULAR FONT, STYLE, SIZE, OR COLOR.

OWNER OF INTERNATIONAL REGISTRATION 0900264 DATED 3-28-2006, EXPIRES 3-28-2016.

CLASS 9—ELECTRICAL AND SCIENTIFIC APPARATUS

FOR COMPUTER PROGRAMS FOR VIDEO AND COMPUTER GAMES (U.S. CLS. 21, 23, 26, 36 AND 38).

CLASS 38—COMMUNICATION

FOR ELECTRONIC MAIL SERVICES; PROVISION OF ACCESS TO THE INTERNET FOR USERS (U.S. CLS. 100, 101 AND 104).

CLASS 42—SCIENTIFIC, COMPUTER AND LEGAL SERVICES

FOR INFORMATION AND CONSULTING SERVICES IN CONNECTION WITH SOFTWARE FOR COMPUTER GAMES (U.S. CLS. 100 AND 101).

KRISTINA MORRIS, EXAMINING ATTORNEY

SN 79-029,828. HEVERT-ARZNEIMITTEL GMBH & CO. KG, FED REP GERMANY, FILED 8-14-2006.



PRIORITY DATE OF 4-3-2006 IS CLAIMED.
OWNER OF INTERNATIONAL REGISTRATION 0900926 DATED 8-14-2006, EXPIRES 8-14-2016.

"THE COLOR(S) BLUE, YELLOW, GREEN, PINK, WHITE AND BLACK IS/ARE CLAIMED AS A FEATURE OF THE MARK."

THE COLOR BLUE APPEARS IN THE DESIGN OF A SIDE PROFILE OF A HUMAN HEAD. THE COLOR YELLOW APPEARS IN THE DESIGN IN THREE FLOWERS. THE COLOR GREEN APPEARS IN THE DESIGN OF THE STEMS AND LEAVES OF A FLOWER PLANT INSIDE OF THE SIDE PROFILE OF THE HUMAN HEAD. THE COLOR PINK APPEARS IN THE DESIGN OF FLOWER PETALS ON TWO FLOWERS. THE COLOR WHITE APPEARS INSIDE THE DESIGN OF THE SIDE PROFILE OF THE HEAD. THE COLOR BLACK APPEARS IN THE CENTRAL PORTION OF THE TWO FLOWERS HAVING PINK PETALS.

CLASS 3—COSMETICS AND CLEANING PREPARATIONS

FOR LAUNDRY BLEACH; SOAPS; PERFUMERY, ESSENTIAL OILS, COSMETICS, HAIR LOTIONS; DENTIFRICES (U.S. CLS. 1, 4, 6, 50, 51 AND 52).

CLASS 5—PHARMACEUTICALS

FOR PHARMACEUTICAL, VETERINARY AND SANITARY PREPARATIONS, NAMELY HOMEOPATHIC MEDICINES FOR USE IN TREATING HEADACHES, INFECTIONS, COLDS, BRUISES, BLEEDING, ALLERGIES, DIZZINESS, VERTIGO, FATIGUE, NEURALGIC DISORDERS, REPRODUCTIVE SYSTEM DISORDERS, CARDIAC DISORDERS, HEPATOBILIARY DISORDERS, MENOPAUSAL DISORDERS, RESPIRATORY DISORDERS, MUSCULOSKELETAL AND CONNECTIVE TISSUE DISORDERS, GASTROINTESTINAL DISORDERS, URINARY DISORDERS, SKIN DISORDERS, THYROID DISORDERS, VASCULAR DISORDERS, NERVE DISORDERS, BILE DISORDERS, IMMUNE SYSTEM DISORDERS, LYMPHATIC SYSTEM DISORDERS, MUCOSAL DISORDERS, SPLENETIC DISORDERS AND CONVULSIONS; HERBAL PHARMACEUTICAL PREPARATIONS FOR USE IN TREATING COLDS, TRANQUILIZING, CARDIAC DISORDERS, HEPATOBILIARY DISORDERS, RESPIRATORY DISORDERS, MUSCULOSKELETAL AND CONNECTIVE TISSUE DISORDERS, GASTROINTESTINAL DISORDERS, SKIN DISORDERS AND NERVE DISORDERS; PHARMACEUTICAL PREPARATIONS FOR USE IN TREATING DEFICIENCIES OR INCREASED REQUIREMENTS OF VITAMINS AND MINERALS, DIARRHEA AND FOOD INTOXICATION, GASTROINTESTINAL DISORDERS, NERVE DISORDERS AND TRANQUILIZING; LOCAL ANESTHETIC PHARMACEUTICAL PREPARATIONS; DIETARY SUPPLEMENTS, BABY FOOD, MATERIAL FOR STOPPING TEETH, DENTAL WAX; PREPARATIONS FOR DESTROYING VERMIN; FUNGICIDES, HERBICIDES (U.S. CLS. 6, 18, 44, 46, 51 AND 52).

CLASS 30—STAPLE FOODS

FOR COFFEE, TEA, COCOA, SUGAR, RICE, TAPIOCA, SAGO, ARTIFICIAL COFFEE; FLOUR; BREAD AND PASTRIES; HONEY, TREACLE; YEAST, BAKING-POWDER; SALT; MUSTARD; VINEGAR, SAUCES FOR USE AS CONDIMENTS; SPICES; ICE (U.S. CL. 46).

JAY BESCH, EXAMINING ATTORNEY

SN 79-029,852. MARC JACOBS TRADEMARKS L.L.C., UNITED STATES, FILED 8-23-2006.

LITTLE MARC

THE MARK CONSISTS OF STANDARD CHARACTERS WITHOUT CLAIM TO ANY PARTICULAR FONT, STYLE, SIZE, OR COLOR.

PRIORITY DATE OF 6-5-2006 IS CLAIMED.
OWNER OF INTERNATIONAL REGISTRATION 0900156 DATED 8-23-2006, EXPIRES 8-23-2016.

CLASS 16—PAPER GOODS AND PRINTED MATTER

FOR APPOINTMENT BOOK COVERS (U.S. CLS. 2, 5, 22, 23, 29, 37, 38 AND 50).

CLASS 18—LEATHER GOODS

FOR GOODS MADE OF LEATHER, NAMELY, DOCUMENT HOLDERS AND BRIEFCASES, TRAVELING SETS IN THE NATURE OF EMPTY CASES FOR CARRYING COSMETICS, TRAVELING LUGGAGE SETS, TRAVELING SUITCASE SETS; GOODS MADE OF LEATHER AND IMITATIONS OF LEATHER, NAMELY, TRAVELING BAGS, TRUNKS AND SUITCASES, GARMENT BAGS FOR TRAVEL, UNFITTED VANITY CASES, BACKPACKS, SHOULDER BAGS, HANDBAGS, ATTACHE CASES, CLUTCH BAGS, SMALL HANDBAGS, WALLETS, PURSES, KEY CASES, BUSINESS CARD CASES, CREDIT CARD CASES; UMBRELLAS (U.S. CLS. 1, 2, 3, 22 AND 41).

KARANENDRA S. CHHINA, EXAMINING ATTORNEY

CLASS 30—STAPLE FOODS

FOR BREAD, PASTRY AND CONFECTIONERY, NAMELY, CANDIES, ICE CREAM, FROZEN YOGHURT, ICES, COCOA, SUGAR; FLOUR AND PREPARATIONS MADE FROM CEREALS, NAMELY, BREAKFAST CEREALS, CEREAL BASED SNACK FOOD, READY TO EAT, CEREAL DERIVED FOOD BARS; HONEY, TREACLE; BEVERAGES, NAMELY, COFFEE, COCOA OR CHOCOLATE BASED, SPECIFICALLY, COCOA BEVERAGES WITH MILK, COFFEE-BASED BEVERAGE CONTAINING MILK, HOT CHOCOLATE; EDIBLE FRUIT ICES, WATER ICES, SORBETS, ICE CONFECTIONERIES, NAMELY, FRUIT ICE BAR, ICE CREAM CAKES, FROZEN CAKES, ICE CREAMS; ICE DESSERTS, NAMELY, ICE CREAM, FRUIT ICE BAR, ICE CREAM CAKES, ICED FROZEN YOGHURTS; POWDERS AND BINDERS, INCLUDED IN THIS CLASS, FOR MAKING EDIBLE ICES AND/OR SORBETS AND/OR ICE CONFECTIONERIES AND/OR FROZEN CAKES AND/OR ICE CREAMS AND/OR ICE DESSERTS AND/OR ICED YOGHURTS, NAMELY, BAKING POWDER, YEAST POWDER; AROMATIC PREPARATIONS FOR FOOD, NAMELY, CHOCOLATE POWDER AND ICE CREAM POWDER; AROMATIC PREPARATIONS FOR FOOD, NAMELY, CINNAMON, CINNAMON POWDER, GINGER (U.S. CL. 46).

SN 79-030,003. FUGAR PRODUZIONE S.P.A., ITALY, FILED 2-8-2006.

FUGAR

THE MARK CONSISTS OF STANDARD CHARACTERS WITHOUT CLAIM TO ANY PARTICULAR FONT, STYLE, SIZE, OR COLOR.

PRIORITY DATE OF 11-30-2005 IS CLAIMED.

OWNER OF INTERNATIONAL REGISTRATION 0901294 DATED 2-8-2006, EXPIRES 2-8-2016.

THE FOREIGN WORDING IN THE MARK TRANSLATES INTO ENGLISH AS TO DISPEL.

CLASS 29—MEATS AND PROCESSED FOODS

FOR EDIBLE OILS AND FATS, EGGS, BUTTER, MILK AND MILK-BASED CREAMS, CHEESES AND OTHER FOODSTUFFS BASED ON MILK, NAMELY, MILK PRODUCTS EXCLUDING ICE CREAM, ICE MILK AND FROZEN YOGURT, CHEESE POWDER, COCONUT POWDER, CREAM POWDER, MILK POWDER; MILK SUBSTITUTES, NAMELY, HEMP MILK USED AS A MILK SUBSTITUTE, RICE MILK FOR USE AS A MILK SUBSTITUTE, SOY-BASED FOOD BEVERAGE USED AS A MILK SUBSTITUTE; BEVERAGES MADE WITH MILK, NAMELY, MILK BASED BEVERAGES CONTAINING FRUIT JUICE, MILK BEVERAGES CONTAINING FRUITS, MILK-BASED BEVERAGE CONTAINING COFFEE; DESSERTS MADE WITH MILK AND DESSERTS MADE WITH CREAM, NAMELY, CARAMEL CREAM, CUSTARD CREAM; YOGHURTS, NAMELY, DRINKS BASED ON YOGHURT; SOYA MILK, NAMELY, SOY-BASED FOOD BEVERAGE USED AS A MILK SUBSTITUTE; MILK BEVERAGES, NAMELY, MILK BEVERAGES WITH HIGH MILK CONTENT, MILK BASED BEVERAGES CONTAINING FRUIT JUICE, MILK DRINKS CONTAINING FRUITS; FRUIT JELLIES, FRUIT PRESERVES, FRUIT JAMS, FRUIT COMPOTES; PROCESSED, CANNED, DRIED, OR PRESERVED FRUIT IN SYRUP; DRIED, COOKED AND FROZEN FRUITS (U.S. CL. 46).

CLASS 32—LIGHT BEVERAGES

FOR FRUIT-BASED SYRUPS, PREPARED FOR FRUIT-BASED NON-ALCOHOLIC DRINKS (U.S. CLS. 45, 46 AND 48).

CLASS 33—WINES AND SPIRITS

FOR ALCOHOLIC BEVERAGES, NAMELY, ALCOHOLIC PUNCH, BRANDY, VODKA; DISTILLED BEVERAGES FOR PASTRIES, NAMELY, DISTILLED SPIRITS, LIQUOR (U.S. CLS. 47 AND 49).

TINA BROWN, EXAMINING ATTORNEY

SN 79-030,082. SIRONA DENTAL SYSTEMS GMBH, FED REP GERMANY, FILED 8-7-2006.

inCoris

THE MARK CONSISTS OF STANDARD CHARACTERS WITHOUT CLAIM TO ANY PARTICULAR FONT, STYLE, SIZE, OR COLOR.

OWNER OF INTERNATIONAL REGISTRATION 0901494 DATED 8-7-2006, EXPIRES 8-7-2016.

CLASS 5—PHARMACEUTICALS

FOR DENTAL IMPRESSION MATERIALS FOR DENTAL USE; DENTAL MODELING WAX FOR DENTAL PURPOSES; DENTAL CERAMICS FOR ARTIFICIAL DENTURES; MATERIAL FOR CROWNS AND BRIDGES FOR DENTAL USE AND FOR ORAL PROPHYLAXIS; MATERIAL FOR MAKING DENTAL IMPRESSION SUCH AS CERAMICS OR METAL ALLOYS, MATERIALS FOR MAKING DENTAL IMPRESSIONS OF TEETH PARTS; EMBEDDING MATERIALS FOR DENTAL AND DENTAL TECHNICAL PURPOSES SUCH AS DENTAL PROSTHESES AND FITTING BODIES (U.S. CLS. 6, 18, 44, 46, 51 AND 52).

CLASS 40—MATERIAL TREATMENT

FOR DENTAL TECHNICIAN SERVICES AND DENTAL LABORATORY SERVICES INCLUDING THE MEASURING AND THE IMAGING FOR MEDICAL AND DENTAL PURPOSES AS WELL AS FOR THE MANUFACTURING OF DIMENSIONALLY ACCURATE ARTIFICIAL DENTURE PARTS SUCH AS CROWN CAPS OR DENTAL BRIDGE STRUCTURE, PREFERABLY MADE OF CERAMICS OR METAL, ON BEHALF OF THIRD PARTIES (U.S. CLS. 100, 103 AND 106).

CLASS 41—EDUCATION AND ENTERTAINMENT

FOR TRAINING SERVICES IN THE FIELD OF DENTISTRY AND DENTAL TECHNIQUES; EDUCATIONAL SERVICES, NAMELY, THEORETICAL INSTRUCTION IN THE FIELD OF DENTISTRY AND DENTAL TECHNIQUES; ORGANIZATION AND CONDUCTING EDUCATIONAL SEMINARS IN THE FIELD OF DENTISTRY AND DENTAL TECHNIQUES (U.S. CLS. 100, 101 AND 107).

KATHERINE STOIDES, EXAMINING ATTORNEY

SN 79-030,114. REGERO, FRANCE, FILED 9-12-2006.

REGERO 

OWNER OF INTERNATIONAL REGISTRATION 0901561 DATED 9-12-2006, EXPIRES 9-12-2016.

CLASS 7—MACHINERY

FOR PLANTING MACHINES FOR SEEDLINGS IN PLUGS; VEGETABLE HARVESTING EQUIPMENT (U.S. CLS. 13, 19, 21, 23, 31, 34 AND 35).

CLASS 11—ENVIRONMENTAL CONTROL APPARATUS

FOR STEAM GENERATORS; HOT WATER TANKS (U.S. CLS. 13, 21, 23, 31 AND 34).

FRANK LATTUCA, EXAMINING ATTORNEY

SN 79-030,373. JAMES MORLAND,.; ELEMENTAL ADVENTURE LTD, UNITED KINGDOM, FILED 9-8-2006.

ELEMENTAL

THE MARK CONSISTS OF STANDARD CHARACTERS WITHOUT CLAIM TO ANY PARTICULAR FONT, STYLE, SIZE, OR COLOR.

OWNER OF INTERNATIONAL REGISTRATION 0902125 DATED 9-8-2006, EXPIRES 9-8-2016.

CLASS 39—TRANSPORTATION AND STORAGE

FOR TRAVEL ARRANGEMENTS AND TRAVEL INFORMATION (U.S. CLS. 100 AND 105).

CLASS 43—HOTEL AND RESTAURANT SERVICES

FOR TRAVEL AGENCY SERVICES, NAMELY, MAKING RESERVATIONS AND BOOKING FOR TEMPORARY HOLIDAY ACCOMMODATIONS; PROVIDING TEMPORARY ACCOMMODATIONS DURING HOLIDAYS (U.S. CLS. 100 AND 101).

MORGAN WYNNE, EXAMINING ATTORNEY

SN 79-030,507. PETER BREHM, WEISENDORF, FED REP GERMANY, FILED 5-29-2006.



PRIORITY DATE OF 11-30-2005 IS CLAIMED.
OWNER OF INTERNATIONAL REGISTRATION 0902492 DATED 5-29-2006, EXPIRES 5-29-2016.

CLASS 10—MEDICAL APPARATUS

FOR SURGICAL AND ORTHOPEDIC IMPLANTS MADE OF SYNTHETIC MATERIALS; PROSTHESES FOR THE OSSEOUS CRANIUM, THE MOUTH, THE JAW, THE FACIAL AREA, AND THE SKELETAL AREA; ARTIFICIAL LIMBS; IMPLANTS MADE OF ARTIFICIAL MATERIALS FOR THE OSSEOUS CRANIUM, THE MOUTH, THE JAW, THE FACIAL AREA, AND THE SKELETAL AREA; SURGICAL AND MEDICAL INSTRUMENTS AND APPARATUS, NAMELY, TEST IMPLANTS, INSTRUMENTS AND APPARATUS USED DURING IMPLANT SURGERY, INSTRUMENTS AND APPARATUS USED FOR THE IMPLANT-SPECIFIC PREPARATION OF THE BONES, INSTRUMENTS AND APPARATUS USED FOR INSERTION AND ADJUSTMENT OF IMPLANTS, AND INSTRUMENTS AND APPARATUS USED FOR INSERTION AND ADJUSTMENT OF TEST IMPLANTS (U.S. CLS. 26, 39 AND 44).

CLASS 37—CONSTRUCTION AND REPAIR

FOR REPAIR AND MAINTENANCE OF SURGICAL INSTRUMENTS AND APPARATUS AS WELL AS OF SURGICAL AND ORTHOPEDIC IMPLANTS AND PROSTHESES (U.S. CLS. 100, 103 AND 106).

CLASS 42—SCIENTIFIC, COMPUTER AND LEGAL SERVICES

FOR DEVELOPMENT AND DESIGN OF SURGICAL AND ORTHOPEDIC PROSTHESES AND IMPLANTS AS WELL AS OF CUSTOMIZED IMPLANTS FOR THE OSSEOUS CRANIUM, THE MOUTH, JAW, AND FACIAL AREA AS WELL AS THE SKELETAL AREA FOR OTHERS (U.S. CLS. 100 AND 101).

CHRISTOPHER OTT, EXAMINING ATTORNEY

SN 79-030,630. SGGT STRABENAUSSTATTUNGEN GMBH, FED REP GERMANY, FILED 6-16-2006.

SN 79-030,665. ALFRED DUNHILL LIMITED, UNITED KINGDOM, FILED 8-18-2006.

NATURE-RAIL

PRIORITY DATE OF 3-10-2006 IS CLAIMED.
OWNER OF INTERNATIONAL REGISTRATION 0902795 DATED 6-16-2006, EXPIRES 6-16-2016.

THE COLOR(S) BLACK, BLUE AND WHITE IS/ARE CLAIMED AS A FEATURE OF THE MARK.

NATURE: BLUE; RAIL: WHITE ON DARK BLUE BACKGROUND.

THE WORD NATURE IS IN BLACK LETTERING ON A WHITE BACKGROUND AND THE WORD RAIL IS IN WHITE LETTERING ON A BLUE SQUARE BACKGROUND.

CLASS 6—METAL GOODS

FOR PRE-ASSEMBLED BUILDING PARTS, SHAPED PARTS AND PROFILE PARTS OF METAL, AND SHEETS OF METAL USED FOR CRASH BARRIERS FOR ROADS, CRASH WALL PANELS, SKID CRASH BARRIERS FOR ROADS, PROTECTIVE WALL PANELS, NOISE GUARD BARRIERS AND VISUAL CURTAIN WALL SCREENS FOR ROADS; BUILDING PARTS, SHAPED PARTS AND PROFILE PARTS OF METAL FOR CRASH BARRIERS, CRASH WALLS, SKID BARRIERS, PROTECTIVE WALLS, NOISE BARRIERS AND VISUAL SCREENS FOR ROADS AND REPLACEMENT PARTS THEREFORE; SIGNS, NON-LUMINOUS AND NON-MECHANICAL, OF METAL FOR ROADS; BOLLARDS OF METAL; GUARD BARRIERS OF METAL FOR TRAFFIC CONTROL; ROAD REFLECTORS AND PAVEMENT MARKERS OF STEEL FOR ROAD MARKING, NAMELY, PINS AND NUBS OF STEEL FOR ROAD MARKING (U.S. CLS. 2, 12, 13, 14, 23, 25 AND 50).

CLASS 9—ELECTRICAL AND SCIENTIFIC APPARATUS

FOR SAFETY TRAFFIC CONES FOR ROADS, NON-LUMINOUS, NOT OF METAL (U.S. CLS. 21, 23, 26, 36 AND 38).

CLASS 19—NON-METALLIC BUILDING MATERIALS

FOR PRE-ASSEMBLED BUILDING PARTS, SHAPED PARTS AND PROFILE PARTS, NOT OF METAL, IN THE FORM OF CRASH BARRIERS FOR ROADS OF PLASTIC, CRASH WALL PANELS, SKID CRASH BARRIERS FOR ROADS OF PLASTIC, PROTECTIVE WALL PANELS, NOISE BARRIERS AND VISUAL CURTAIN WALL SCREENS MADE OF PLASTIC FOR ROADS; BUILDING PARTS, NAMELY SHAPED PARTS AND PROFILE PARTS NOT OF METAL, FOR CRASH BARRIERS, CRASH WALLS, SKID BARRIERS, PROTECTIVE WALLS, NOISE BARRIERS AND VISUAL SCREENS FOR ROADS AND REPLACEMENT PARTS THEREOF; SIGNS, NON-LUMINOUS AND NON-MECHANICAL, NOT OF METAL, FOR ROADS; BOLLARDS MADE OF PLASTIC, BARRIERS, NOT OF METAL, FOR TRAFFIC CONTROL; GLASS GRANULES FOR ROAD MARKING; SHEETS AND STRIPS OF PLASTIC FOR ROAD MARKING; ROAD REFLECTORS AND PAVEMENT MARKERS OF PLASTIC FOR ROAD MARKING, NAMELY, PINS AND NUBS OF PLASTIC FOR ROAD MARKING (U.S. CLS. 1, 12, 33 AND 50).

CLASS 37—CONSTRUCTION AND REPAIR

FOR INSTALLATION, MAINTENANCE AND/OR REPAIR OF CRASH BARRIERS, CRASH WALLS, SKID BARRIERS, PROTECTIVE WALLS, NOISE BARRIERS AND VISUAL SCREENS FOR ROADS AND OF SIGNS FOR ROADS, BOLLARDS AND BARRIERS, ROAD MARKING SERVICES (U.S. CLS. 100, 103 AND 106).
KATHERINE STOIDES, EXAMINING ATTORNEY

ENSIGN

THE MARK CONSISTS OF STANDARD CHARACTERS WITHOUT CLAIM TO ANY PARTICULAR FONT, STYLE, SIZE, OR COLOR.

PRIORITY DATE OF 3-16-2006 IS CLAIMED.
OWNER OF INTERNATIONAL REGISTRATION 0902860 DATED 8-18-2006, EXPIRES 8-18-2016.

CLASS 9—ELECTRICAL AND SCIENTIFIC APPARATUS

FOR OPTICAL APPARATUS AND INSTRUMENTS, NAMELY, SPECTACLES, SUNGLASSES; CASES, FRAMES, CORDS AND CHAINS ALL THE FOREGOING FOR SPECTACLES AND SUNGLASSES; MAGNIFYING GLASSES; BINOCULARS; COMPUTER CARRYING CASES; SPECIALTY HOLSTER FOR CARRYING CELLULAR PHONES; CASES FOR TELEPHONES; GOGGLES FOR SPORTS (U.S. CLS. 21, 23, 26, 36 AND 38).

CLASS 16—PAPER GOODS AND PRINTED MATTER

FOR WRITING INSTRUMENTS; POUCHES FOR WRITING INSTRUMENTS; GIFT CASES IN THE NATURE OF STATIONERY SUPPLY KITS PRIMARILY COMPOSED OF WRITING INSTRUMENTS; WRITING INK AND PEN INK REFILLS, STATIONERY, STATIONERY WRITING CASES, PERSONAL ORGANIZERS, DESK SETS, FOUNTAIN PENS, BALL POINT PENS, PENCILS; PEN AND PENCIL HOLDERS; PAPER WEIGHTS, DIARIES; INK WELLS AND INK STANDS FOR WRITING INSTRUMENTS; PASSPORT HOLDERS; CHECKBOOKS; SCRAP BOOK ALBUMS; BOOK ENDS; PEN NIBS; PARTS AND FITTINGS FOR ALL THE AFORESAID GOODS (U.S. CLS. 2, 5, 22, 23, 29, 37, 38 AND 50).

CLASS 18—LEATHER GOODS

FOR GOODS MADE OF LEATHER AND IMITATIONS OF LEATHER, NAMELY, POCKET WALLETS, COIN PURSES, LUGGAGE TAGS; TRUNKS AND TRAVELING BAGS; UMBRELLAS, PARASOLS AND WALKING STICKS; CANES; ANIMAL LEASHES, NAMELY, LEADS FOR PETS; COLLARS FOR PETS; BAGS, NAMELY, LUGGAGE, ATHLETIC BAGS, COSMETIC CASES SOLD EMPTY, TOTE BAGS, BEACH BAGS, SATCHELS AND WASH BAGS FOR CARRYING TOILETRIES; SUIT-CASES; BRIEFCASES, ATTACHE CASES, DOCUMENT CASES, HOLD ALLS, POCKET WALLETS, GARMENT BAGS FOR TRAVEL, BACKPACKS, CREDIT CARD CASES AND HOLDERS, KEY CASES, WALLETS, COIN PURSES, HANDBAGS, LEATHER KEY FOBS; PARTS AND FITTINGS FOR THE AFORESAID GOODS (U.S. CLS. 1, 2, 3, 22 AND 41).

CLASS 25—CLOTHING

FOR CLOTHING, NAMELY, SHIRTS, PANTS, TROUSERS, SLACKS, JACKETS, EVENING JACKETS, TUXEDOS, BLAZERS, WIND CHEATERS, BLOUSONS, FLEECE PULLOVERS, QUILTED VESTS, SUITS, RAINCOATS, COATS, SHORTS, CARDIGANS, SWEATERS, TANKTOPS, WAIST COATS, T-SHIRTS, POLO SHIRTS, CASUAL SHIRTS, BUSINESS SHIRTS, BATH ROBES, DRESSING GOWNS, SOCKS, GOLF SHIRTS, GOLF SWEATERS, GOLF TROUSERS, GOLF SHOES, SWIMWEAR, SLEEPWEAR, UNDERWEAR, RAINWEAR, WATER-PROOF JACKETS, SWEATSHIRTS, SWEATPANTS, SWEATBANDS, CUMMERBUNDS, GLOVES, FOOTWEAR AND HEADWEAR, NAMELY, HATS, CAPS, SUN VISORS, BRACES NAMELY, SUSPENDERS; SCARVES, BELTS, TIES, GLOVES, CRAVATS, BANDANAS, WRISTBANDS, MOTORISTS CLOTHING, NAMELY, LEATHER COATS (U.S. CLS. 22 AND 39).
BERYL GARDNER, EXAMINING ATTORNEY

SN 79-030,831. PARK, CHANG HUN, REPUBLIC OF KOREA,
FILED 6-1-2006.



OWNER OF INTERNATIONAL REGISTRATION 0903194
DATED 6-1-2006, EXPIRES 6-1-2016.
"THE FOREIGN WORDING IN THE MARK TRANSLATES INTO ENGLISH AS ASIA FALL."

CLASS 25—CLOTHING

FOR KNEE TROUSERS, JACKETS, SPORTS SHIRTS, TEE-SHIRTS, CARDIGANS, VESTS, CLOTHING CAPS, HEADWEAR, BELTS, GOLF SHOES, LEATHER SHOES, SPORTS SHOES, INFANTWEAR, BLUE JEANS, SOCKS, SHORT-SLEEVED SPORTS SHIRTS, JUMPERS; SWIMSUITS, WATERPROOF JACKETS AND PANTS, UNIFORMS FOR EXERCISE (U.S. CLS. 22 AND 39).

CLASS 28—TOYS AND SPORTING GOODS

FOR GOLF CLUBS, GOLF BAGS WITH OR WITHOUT WHEELS, CADDIE BAGS FOR GOLF CLUBS, ROLLER SKATES; RODS FOR FISHING, SQUASH RACKETS, GOLF BALLS, GOLF GLOVES (U.S. CLS. 22, 23, 38 AND 50).
STEVEN R. FINE, EXAMINING ATTORNEY

SN 79-030,859. SWISSTECH HOLDING AG, SWITZERLAND,
FILED 9-6-2006.



THE MARK CONSISTS OF STANDARD CHARACTERS WITHOUT CLAIM TO ANY PARTICULAR FONT, STYLE, SIZE, OR COLOR.
PRIORITY DATE OF 4-13-2006 IS CLAIMED.
OWNER OF INTERNATIONAL REGISTRATION 0903296
DATED 9-6-2006, EXPIRES 9-6-2016.

CLASS 1—CHEMICALS

FOR CHEMICAL ADDITIVES FOR PURIFYING OILS; CHEMICALS FOR USE IN INDUSTRY AND SCIENCE; FIRE EXTINGUISHING COMPOSITIONS (U.S. CLS. 1, 5, 6, 10, 26 AND 46).

CLASS 3—COSMETICS AND CLEANING PREPARATIONS

FOR ALL PURPOSE CLEANING PREPARATIONS; DEGREASING PREPARATIONS FOR SOIL (U.S. CLS. 1, 4, 6, 50, 51 AND 52).
LINDA M. KING, EXAMINING ATTORNEY

SN 79-030,949. VINIDEX PTY LIMITED, AUSTRALIA,
FILED 3-9-2006.



THE MARK CONSISTS OF STANDARD CHARACTERS WITHOUT CLAIM TO ANY PARTICULAR FONT, STYLE, SIZE, OR COLOR.
OWNER OF INTERNATIONAL REGISTRATION 0903576
DATED 3-9-2006, EXPIRES 3-9-2016.

CLASS 11—ENVIRONMENTAL CONTROL APPARATUS

FOR WATER FILTERS; SCREENING DEVICES IN THE NATURE CYLINDRICAL CHAMBERS AND SCREENS FOR THE FILTERING, CAPTURE AND REMOVAL OF SOLIDS AND PARTICULATES FROM LIQUID WASTE SYSTEMS, DRAINAGE SYSTEMS AND SEWERAGE SYSTEMS, FOR THE PRE-TREATMENT OF LIQUID WASTE, AND FOR THE DECONTAMINATION OF LIQUID WASTE; FILTERING UNITS FOR FILTERING WATER, INCLUDING WASTE WATER, AND ANY OTHER LIQUIDS THAT ARE DISCHARGED FROM HOUSEHOLD AND INDUSTRIAL SINKS; WATER FILTERS AS PART OF HOUSEHOLD AND INDUSTRIAL INSTALLATIONS (U.S. CLS. 13, 21, 23, 31 AND 34).

CLASS 20—FURNITURE AND ARTICLES NOT OTHERWISE CLASSIFIED

FOR DRAIN TRAPS OF PLASTIC, INCLUDING DRAIN TRAPS OF PLASTIC INCORPORATING FILTERS, SCREENS, STRAINERS, GRILLS, SIEVES, GRATINGS, BASKETS OR GUARDS, AND DRAIN TRAPS OF PLASTIC FOR WASTE SYSTEMS, DRAINAGE SYSTEMS AND SEWERAGE SYSTEMS, FOR THE CAPTURE AND REMOVAL OF PARTICULATES AND SOLIDS FROM LIQUID WASTE, FOR THE PRE-TREATMENT OF LIQUID WASTE, FOR THE DECONTAMINATION OF LIQUID WASTE; ALL BEING GOODS IN THIS CLASS (U.S. CLS. 2, 13, 22, 25, 32 AND 50).
SHAILA SETTLES, EXAMINING ATTORNEY

SN 79-030,973. WILLY BOGNER GMBH & CO.; KOMMANDITGESELLSCHAFT AUF AKTIEN, FED REP GERMANY, FILED 2-21-2006.

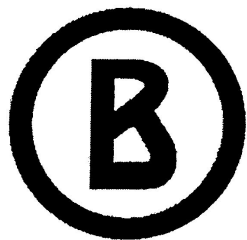

BOGNER
HOMESHOPPING

OWNER OF INTERNATIONAL REGISTRATION 0903658 DATED 2-21-2006, EXPIRES 2-21-2016.

OWNER OF U.S. REG. NOS. 3,005,318 AND 3,070,103.

NO CLAIM IS MADE TO THE EXCLUSIVE RIGHT TO USE "HOME SHOPPING", APART FROM THE MARK AS SHOWN.

CLASS 9—ELECTRICAL AND SCIENTIFIC APPARATUS

FOR BLANK MAGNETIC, OPTICAL AND OPTOELECTRONIC RECORDING AND DATA CARRIERS, NAMELY, FLOPPY DISCS, CDS AND DVDS; CINEMATOGRAPHIC FILMS, BLANK VIDEO CASSETTES AND PRERECORDED VIDEO CASSETTES FEATURING MOTION PICTURE FILMS AND DOCUMENTARIES IN THE FIELD OF SPORTS, TRAVEL, LIFESTYLE, HEALTH, LEISURE AND RECREATIONAL ACTIVITIES; PHOTOGRAPHIC SLIDE TRANSPARENCIES; DATA PROCESSING EQUIPMENT, NAMELY, CENTRAL PROCESSING UNITS FOR PROCESSING DATA, COMPUTERS; APPARATUS FOR RECORDING, TRANSMISSION OR REPRODUCTION OF SOUND OR IMAGES; PHOTOGRAPH PROJECTORS AND PROJECTION APPARATUS, VIDEO PROJECTORS, DATA PROJECTORS, LCD-PANELS, PROJECTION SCREENS, PROJECTION WALLS, NAMELY, LARGE SCALE PROJECTION SCREENS; ELECTRONIC AND OPTICAL COMMUNICATIONS INSTRUMENTS AND COMPONENTS, NAMELY, CABLE TELEVISION TRANSMITTERS FOR CONNECTING AND CONTROLLING INTERACTIVE TV, PAY-TV AND VIDEO; MAGNETIC CARDS WITH CHIPS, INCLUDING CREDIT CARDS; MOBILE TELEPHONES; DICTATING MACHINES; SPECTACLES; SPECTACLE GLASSES, SPECTACLE FRAMES, SUNGLASSES AND SPECTACLE CASES; PROTECTIVE HELMETS FOR SPORTS, NAMELY, FOR SKIING AND SNOWBOARDING; PROTECTIVE SPECTACLES FOR SPORTS, NAMELY, SKIING AND SNOWBOARDING GOGGLES (U.S. CLS. 21, 23, 26, 36 AND 38).

CLASS 16—PAPER GOODS AND PRINTED MATTER

FOR PRINTED MATTER, NAMELY, MAGAZINES FEATURING ARTICLES IN THE FIELDS OF SPORTS, TRAVEL, LIFESTYLE, HEALTH, LEISURE AND RECREATIONAL ACTIVITIES, CATALOGS IN THE FIELD OF CLOTHING, SPORTS, TRAVEL, LIFESTYLE, HEALTH, LEISURE AND RECREATIONAL ACTIVITIES, JOURNALS CONCERNING SPORTS, TRAVEL, LIFESTYLE, HEALTH, LEISURE AND RECREATIONAL ACTIVITIES, BOOKS IN THE FIELD OF SPORTS, TRAVEL, LIFESTYLE, HEALTH, LEISURE AND RECREATIONAL ACTIVITIES; CALENDARS; ADDRESS BOOKS, NOTE BOOKS, STATIONERY; PRINTED INSTRUCTIONAL AND TEACHING MATERIALS IN THE FIELD OF TRAVEL, LIFESTYLE, CLOTHING, SPORTS ACTIVITIES; PAPER, CARDBOARD AND GOODS MADE FROM THESE MATERIALS, NAMELY, COPY PAPER, NOTE PAPER, PACKING PAPER AND DRAWING PAPER, FACE TOWELS, TABLE NAPKINS, FILTER PAPER, POCKET HANDKERCHIEFS, BABY'S NAPKINS; CARRYING CASES MADE OF PAPER AND PAPER BAGS FOR PACKAGING AND SHOPPING (U.S. CLS. 2, 5, 22, 23, 29, 37, 38 AND 50).

CLASS 38—COMMUNICATION

FOR TELECOMMUNICATION SERVICES, NAMELY, TRANSMISSION OF VOICE, DATA AND DOCUMENTS, IN THE FIELD OF COLLECTING AND DELIVERING NEWS, VIA FAX, TELEX, TELEPHONE, TELEGRAMS AS WELL AS E-MAIL; PROVIDING VOICE COMMUNICATION SERVICES VIA THE INTERNET, COMMUNICATIONS SERVICES, NAMELY, TRANSMITTING STREAMED AUDIO-VISUAL RECORDINGS AND DATA, NAMELY, INFORMATION AND VIDEOS IN THE FIELDS OF SPORTS, TRAVEL, LIFESTYLE, HEALTH, LEISURE AND RECREATIONAL ACTIVITIES, VIA THE INTERNET; PROVIDING VOICE COMMUNICATION SERVICES VIA THE INTERNET; ELECTRONIC ORDER TRANSMISSION FOR BUSINESSES FOR ORDERS OF GOODS AND SERVICES AS WELL AS FORWARDING REQUESTS, INQUIRIES AND COMPLAINTS OF CUSTOMERS TO THE PRODUCERS AND/OR OFFERER OF GOODS VIA COMPUTER COMMUNICATION AND TELECOMMUNICATION (U.S. CLS. 100, 101 AND 104).

CLASS 41—EDUCATION AND ENTERTAINMENT

FOR PUBLISHING OF PRODUCTS OF A PUBLISHING HOUSE AND PRINTED MATTER, NAMELY, MAGAZINES, CATALOGUES, NEWSPAPERS AND BOOKS; ELECTRONIC PUBLISHING SERVICES, NAMELY, PUBLICATION OF NEWSPAPERS, JOURNALS AND BOOKS ON THE INTERNET FEATURING SPORTS, TRAVEL, LIFESTYLE, HEALTH, LEISURE AND RECREATIONAL ACTIVITIES; ON-LINE PUBLICATION OF ELECTRONIC MAGAZINES, JOURNALS AND BOOKS; ORGANIZATION AND CARRYING OUT OF SPORTING AND CULTURAL ACTIVITIES; PLANNING, ORGANIZING AND CONDUCTING SPORTING AND CULTURAL ACTIVITIES, NAMELY, SPORTS, CULTURAL AND ENTERTAINMENT EVENTS; ORGANIZATION OF SPORTS CAMPS, NAMELY, GOLF AND SKI CAMPS AND RENTAL OF SPORTING ARTICLES; ENTERTAINMENT, NAMELY LIVE MUSIC CONCERTS; PRODUCTION OF MOTION PICTURE FILMS AND TELEVISION (U.S. CLS. 100, 101 AND 107).

EDWARD FENNESSY, EXAMINING ATTORNEY

SN 79-031,353. VCTRIX GROUP S.R.L., ITALY, FILED 5-9-2006.

clear view

PRIORITY DATE OF 2-1-2006 IS CLAIMED.
OWNER OF INTERNATIONAL REGISTRATION 0904615
DATED 5-9-2006, EXPIRES 5-9-2016.

COMPRISES THE PHRASE "CLEAR VIEW" IN WHICH THE FIRST WORD IS IN THICK LOWER-CASE TYPE AND THE SECOND HAS AN INITIAL CAPITAL LETTER WITH THE OTHER LETTERS IN THICK LOWER-CASE TYPE, AMONG WHICH THE LETTER "E" IS LARGER THAN THE OTHER LETTERS AND THE "V" IS LEANING UPWARDS AND IS OF A NON-UNIFORM THICKNESS.

CLASS 17—RUBBER GOODS

FOR ADHESIVE-BACKED PLASTIC FILMS FOR THE USE IN THE MANUFACTURE OF TILES AND TILE FACINGS; ADHESIVE TAPE FOR INDUSTRIAL OR COMMERCIAL USE, NAMELY, ADHESIVE TAPE FOR USE IN THE MANUFACTURING OF FLOOR TILES AND TILE FACINGS (U.S. CLS. 1, 5, 12, 13, 35 AND 50).

CLASS 19—NON-METALLIC BUILDING MATERIALS

FOR CERAMIC, WOOD, GLASS, NON-METAL TILES FOR FLOORING AND FACING, ADHESIVE BAKED CERAMIC, WOOD, GLASS, NON-METAL TILES FOR FLOORING AND FACING AND FOR DECORATIVE USE (U.S. CLS. 1, 12, 33 AND 50).

MEGAN WHITNEY, EXAMINING ATTORNEY

SN 79-031,472. MEINL BANK AKTIENGESELLSCHAFT, AUSTRIA, FILED 9-25-2006.

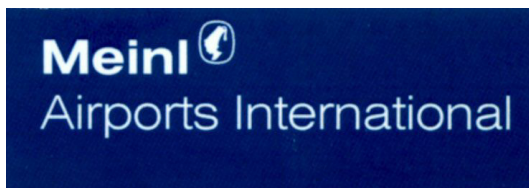

PRIORITY DATE OF 5-10-2006 IS CLAIMED.
OWNER OF INTERNATIONAL REGISTRATION 0904934
DATED 9-25-2006, EXPIRES 9-25-2016.

NO CLAIM IS MADE TO THE EXCLUSIVE RIGHT TO USE "AIRPORTS INTERNATIONAL", APART FROM THE MARK AS SHOWN.

THE COLOR(S) BLUE AND WHITE IS/ARE CLAIMED AS A FEATURE OF THE MARK.

THE MARK CONSISTS OF THE WORDING MEINL AIRPORTS INTERNATIONAL AND SILHOUETTE OF A TURKISH BOY WEARING A HAT WITH A TASSEL. THE COLOR WHITE APPEARS IN THE WORDING MEINL AIRPORTS INTERNATIONAL AND IN THE DESIGN ELEMENT OF THE SILHOUETTE; THE COLOR BLUE APPEARS GENERALLY AS THE BACKGROUND OF THE MARK.

CLASS 35—ADVERTISING AND BUSINESS

FOR BUSINESS MANAGEMENT; BUSINESS ADMINISTRATION NAMELY, BUSINESS ADMINISTRATION CONSULTANCY, BUSINESS ADMINISTRATION AND OFFICE WORK (U.S. CLS. 100, 101 AND 102).

CLASS 36—INSURANCE AND FINANCIAL

FOR FINANCIAL AFFAIRS NAMELY, FINANCIAL CONSULTATION, FINANCIAL DUE DILIGENCE; MONETARY AFFAIRS NAMELY, MONETARY EXCHANGE; CAPITAL INVESTMENT NAMELY, CAPITAL INVESTMENT CONSULTATION, EQUITY CAPITAL INVESTMENT; REAL ESTATE AFFAIRS, IN PARTICULAR REAL ESTATE APPRAISAL, RENTAL OF OFFICES (REAL ESTATE), LEASING OF REAL ESTATE, REAL ESTATE, REAL ESTATE AGENCIES, REAL ESTATE MANAGEMENT; RENT COLLECTION; HOUSING AGENCIES, IN PARTICULAR AS REGARDS TO PURCHASE AND SALE OF REAL ESTATE (U.S. CLS. 100, 101 AND 102).

CLASS 42—SCIENTIFIC, COMPUTER AND LEGAL SERVICES

FOR ARCHITECTURAL DESIGN CONSULTATION; ARCHITECTURAL DESIGN; DESIGN OF INTERIOR DECOR; ENGINEERING; RESEARCH AND DEVELOPMENT FOR OTHERS NAMELY, PRODUCT RESEARCH AND DEVELOPMENT, SCIENTIFIC RESEARCH AND DEVELOPMENT; CONSTRUCTION DRAFTING; TECHNICAL PROJECT STUDIES NAMELY, TECHNICAL SURVEYING; LAND SURVEYING (U.S. CLS. 100 AND 101).

RICHARD WHITE, EXAMINING ATTORNEY

SN 79-031,681. MINAGAWA AKIRA, JAPAN, FILED 9-8-2006.



OWNER OF INTERNATIONAL REGISTRATION 0905398
DATED 9-8-2006, EXPIRES 9-8-2016.

CLASS 18—LEATHER GOODS

FOR FOLDING BRIEFCASES; SHOULDER BAGS; GLADSTONE BAGS; BRIEFCASES; SUITCASES; CARRY-ON BAGS; LUGGAGE TRUNKS; HANDBAGS; BOSTON BAGS; SCHOOL CHILDREN'S BACKPACKS; BACKPACKS; BUSINESS CARD CASES; SHOPPING BAGS; PURSES; KEY CASES; WALLETS. (U.S. CLS. 1, 2, 3, 22 AND 41).

CLASS 24—FABRICS

FOR WOVEN FABRICS; KNITTED FABRICS; FELT; NON-WOVEN TEXTILE FABRICS; GUMMED WATER-PROOF CLOTH; VINYL COATED CLOTH; RUBBERIZED CLOTH; LEATHER CLOTH, NAMELY, CLOTH PROCESSED WITH LEATHER AND SYNTHETIC LEATHER FOR THE FURTHER MANUFACTURE OF CLOTHING; TOWELS OF TEXTILE; HANDKERCHIEFS; LINEN QUILTS CASES; PILLOWCASES; TABLE NAPKINS OF TEXTILE; UNFITTED COVERS OF TEXTILE FOR FURNITURE SEATS; CURTAINS; TABLE CLOTH NOT OF PAPER. (U.S. CLS. 42 AND 50).

CLASS 25—CLOTHING

FOR CLOTHING AND OUTERWEAR; NAMELY JACKETS, SUITS, SKIRTS, TROUSERS, SMOCKS, COATS, SWEATERS, SHIRTS, CUFFS, COLLARS, NIGHTWEAR, UNDERWEAR, SWIMWEAR, SWIMMING CAPS, APRONS, COLLAR PROTECTORS, SOCKS, STOCKINGS, FUR STOLEES, SHAWLS, SCARVES, GLOVES, BABIES' DIAPERS OF TEXTILE, NECKTIES, NECKERCHIEFS, MUFFLERS, EAR MUFFS, BELTS, FOOTWEAR; SHOES, BOOTS, SANDALS, SLIPPERS; HEADGEAR; NAMELY, HATS AND CAPS; JAPANESE TRADITIONAL CLOTHING, NAMELY, SLEEPING ROBES, SOCKS AND WOODEN CLOGS. (U.S. CLS. 22 AND 39).

JULIE WATSON, EXAMINING ATTORNEY

SN 79-031,705. EUROFORM A/S, DENMARK, FILED 8-23-2006.

JetLogo

THE MARK CONSISTS OF STANDARD CHARACTERS WITHOUT CLAIM TO ANY PARTICULAR FONT, STYLE, SIZE, OR COLOR.

PRIORITY DATE OF 8-9-2006 IS CLAIMED.

OWNER OF INTERNATIONAL REGISTRATION 0905458 DATED 8-23-2006, EXPIRES 8-23-2016.

CLASS 38—COMMUNICATION

FOR PROVIDING MULTIPLE USER ACCESS TO A GLOBAL COMPUTER NETWORK, PROVIDING TELECOMMUNICATIONS CONNECTIONS TO A GLOBAL COMPUTER NETWORK, COMPUTER AIDED TRANSMISSION OF MESSAGES, DATA AND PICTURES (U.S. CLS. 100, 101 AND 104).

CLASS 42—SCIENTIFIC, COMPUTER AND LEGAL SERVICES

FOR CONSULTANCY IN THE FIELD OF COMPUTER HARDWARE FOR OTHERS, DESIGN OF COMPUTER SYSTEMS FOR OTHERS (U.S. CLS. 100 AND 101).

PAUL F. GAST, EXAMINING ATTORNEY

SN 79-031,734. BAUMANN PHILIPPE, FRANCE, FILED 7-21-2006.

ONTOMANTICS

The ontology of business semantics

THE MARK CONSISTS OF STANDARD CHARACTERS WITHOUT CLAIM TO ANY PARTICULAR FONT, STYLE, SIZE, OR COLOR.

PRIORITY DATE OF 1-23-2006 IS CLAIMED.

OWNER OF INTERNATIONAL REGISTRATION 0905542 DATED 7-21-2006, EXPIRES 7-21-2016.

NO CLAIM IS MADE TO THE EXCLUSIVE RIGHT TO USE "THE ONTOLOGY OF BUSINESS SEMANTICS", APART FROM THE MARK AS SHOWN.

CLASS 35—ADVERTISING AND BUSINESS

FOR ADVERTISING; BUSINESS MANAGEMENT; BUSINESS ADMINISTRATION; OFFICE FUNCTIONS; BUSINESS ORGANISATION AND MANAGEMENT CONSULTING; ACCOUNTING; COMPUTERIZED FILE MANAGEMENT; PUBLICATION OF ADVERTISING TEXTS; PUBLIC RELATIONS (U.S. CLS. 100, 101 AND 102).

CLASS 36—INSURANCE AND FINANCIAL

FOR INSURANCE SERVICES, NAMELY, INSURANCE BROKERAGE, INSURANCE AGENCIES, INSURANCE ADMINISTRATION, INSURANCE CONSULTATION; FINANCIAL AFFAIRS, NAMELY, FINANCIAL MANAGEMENT, FINANCIAL PLANNING, FINANCIAL INVESTMENT IN THE FIELD OF SECURITIES AND REAL ESTATE; MONETARY AFFAIRS, NAMELY, MONETARY EXCHANGE; REAL ESTATE BUSINESS, NAMELY, REAL ESTATE AGENCY AND BROKERAGE; ELECTRONIC FUNDS TRANSFER; HOME BANKING; ISSUING OF CREDIT CARDS AND TRAVELERS' CHECKS; REAL ESTATE APPRAISAL; REAL ESTATE MANAGEMENT; FINANCING SERVICES; FINANCIAL ANALYSIS; FINANCIAL CONSULTING; FINANCIAL EVALUATIONS OF REAL ESTATE, FOR INSURANCE PURPOSES, AND FOR BANKING PURPOSES (U.S. CLS. 100, 101 AND 102).

CLASS 42—SCIENTIFIC, COMPUTER AND LEGAL SERVICES

FOR EVALUATIONS, ASSESSMENTS AND RESEARCH IN THE FIELDS OF SCIENCE AND TECHNOLOGY PROVIDED BY ENGINEERS; DESIGN AND DEVELOPMENT OF COMPUTERS AND SOFTWARE FOR OTHERS; COMPUTER SOFTWARE DEVELOPMENT; LEGAL SERVICES; RESEARCH AND DEVELOPMENT OF NEW PRODUCTS FOR THIRD PARTIES; CONDUCTING TECHNICAL STUDIES IN THE FIELD OF COMPUTER SOFTWARE FOR INFORMATION MODELING, INFORMATION AGGREGATION, INFORMATION INFERENCING, SEMANTIC DATA MODELING AND ONTOLOGY-BASED BUSINESS APPLICATION DEVELOPMENT AND COMPUTER SYSTEM INTEGRATION SOLUTIONS; ARCHITECTURAL DESIGN; DESIGN, DEVELOPMENT, INSTALLATION, MAINTENANCE, UPDATING AND RENTAL OF SOFTWARE; COMPUTER PROGRAMMING; COMPUTER CONSULTING; NON-PHYSICAL DATA CONVERSION OF COMPUTER PROGRAMS AND DATA; CONVERSION OF DOCUMENTS FROM A PHYSICAL MEDIUM TO AN ELECTRONIC MEDIUM; INTELLECTUAL PROPERTY CONSULTING (U.S. CLS. 100 AND 101).

JEAN IM, EXAMINING ATTORNEY

SN 79-031,869. ARISTOCRAT TECHNOLOGIES AUSTRALIA PTY LTD, AUSTRALIA, FILED 3-29-2006.



OWNER OF INTERNATIONAL REGISTRATION 0905992 DATED 3-29-2006, EXPIRES 3-29-2016.
THE MARK IS NOT IN COLOR.

CLASS 9—ELECTRICAL AND SCIENTIFIC APPARATUS

FOR COMPUTER HARDWARE AND COMPUTER SOFTWARE BEING COMPUTER HARDWARE AND COMPUTER SOFTWARE FOR GAMING PURPOSES; GAMING MACHINES ADAPTED FOR USE WITH AN EXTERNAL DISPLAY SCREEN; PARTS AND ACCESSORIES FOR GAMING MACHINES IN THIS CLASS, NAMELY SOFTWARE MODULES, STORAGE MEDIA AND COMPONENTS, AND ERASABLE READ-ONLY MEMORY (EPROM) CHIPS; BLANK MAGNETIC DATA CARRIERS, BLANK RECORDING DISCS; BLANK COMPACT DISCS; BLANK VERSATILE DISCS; ELECTRONIC SYSTEMS FOR LINKING GAMING AND POKER MACHINES, NAMELY CONTROLLERS, DISPLAYS, MACHINE INTERFACE CARDS, COMPUTER BOARDS, METRES, COMPUTER SOFTWARE AND FIRMWARE AND ELECTRICAL WIRES AND CABLES; COMPUTER PERIPHERALS. (U.S. CLS. 21, 23, 26, 36 AND 38).

CLASS 28—TOYS AND SPORTING GOODS

FOR GAMING MACHINES OTHER THAN THOSE ADAPTED FOR USE WITH AN EXTERNAL DISPLAY SCREEN INCLUDING POKER MACHINES FEATURING GAMES OF CHANCE OR GAMES OF MIXED CHANCE AND SKILL OR PSEUDO SKILL; GAMING MACHINES OTHER THAN THOSE ADAPTED FOR USE WITH AN EXTERNAL DISPLAY SCREEN INCLUDING POKER MACHINES COMPRISED OF SOFTWARE MODULES AND COMPONENTS INCLUDING GAME SYMBOLS, MATHEMATICS, SOUND EFFECTS AND OTHER CONFIGURABLE ITEMS EMBEDDED IN ERASABLE PROGRAMMABLE READ-ONLY MEMORY (U.S. CLS. 22, 23, 38 AND 50).

DOMINICK J. SALEMI, EXAMINING ATTORNEY

SN 79-031,903. TRANSFORMACIONES METALÚRGICAS, S.A. -; TRANSMESA, SPAIN, FILED 1-3-2006.

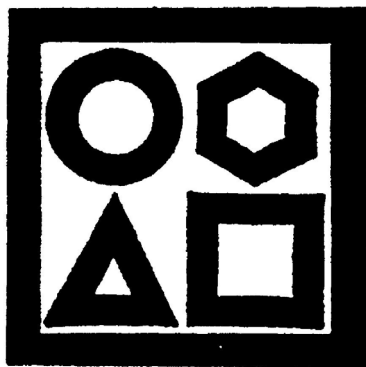

OWNER OF INTERNATIONAL REGISTRATION 0498851 DATED 1-3-1986, EXPIRES 1-3-2016.

CLASS 6—METAL GOODS

FOR PRECISION TUBES MADE IN CARBON IRON OF LOW AND MIDDLE ALLOY (U.S. CLS. 2, 12, 13, 14, 23, 25 AND 50).

CLASS 7—MACHINERY

FOR MACHINES AND MACHINE TOOLS USED FOR METALLURGICAL TRANSFORMATIONS, NAMELY, PUNCHER MACHINES, STRETCHING BEDS, AND MACHINES USED FOR COLD STRETCHING OF METALS AND FOR HARD-DRAWN METALS (U.S. CLS. 13, 19, 21, 23, 31, 34 AND 35).

CLASS 13—FIREARMS

FOR IRON TUBES FOR FIREARMS (U.S. CLS. 2 AND 9).
ARETHA SOMERVILLE, EXAMINING ATTORNEY

SN 79-032,313. PLANOLITH GMBH; MESSTECHNIK - SONDERMASCHINENBAU, 63741 ASCHAFFENBURG, FED REP GERMANY, FILED 9-26-2006.

Planolith

THE MARK CONSISTS OF STANDARD CHARACTERS WITHOUT CLAIM TO ANY PARTICULAR FONT, STYLE, SIZE, OR COLOR.

PRIORITY DATE OF 6-28-2006 IS CLAIMED.
OWNER OF INTERNATIONAL REGISTRATION 0907004 DATED 9-26-2006, EXPIRES 9-26-2016.

CLASS 6—METAL GOODS

FOR CONSTRUCTION ELEMENTS MADE OF METAL, NAMELY, SUPPORTS, BRACKETS AND BRACES; TRANSPORTABLE BUILDINGS OF METAL; MATERIALS OF METAL FOR RAILWAY TRACKS; NON-ELECTRIC CABLES AND WIRES OF COMMON METAL; IRONMONGERY, NAMELY, METAL BOLTS, METAL CLAMPS; SMALL ITEMS OF METAL HARDWARE, NAMELY, NUTS AND WASHERS; PIPES AND TUBES OF METAL; METAL SAFES; GOODS OF COMMON METALS, NAMELY METAL CASINGS; IRON ORE (U.S. CLS. 2, 12, 13, 14, 23, 25 AND 50).

CLASS 7—MACHINERY

FOR MACHINES FOR WORKING METAL, WOOD, STONE, PLASTIC, AND FOR THE SEMI-CONDUCTOR INDUSTRY, CHEMICAL INDUSTRY, FOOD AND BEVERAGES INDUSTRY, AUTOMOBILE INDUSTRY, BUILDING INDUSTRY, AGRICULTURE, MINING, TEXTILE INDUSTRY, SUGAR INDUSTRY, NAMELY LATHES, BORING MACHINES, ELECTRIC PLANES, AND STRUCTURAL PARTS THEREOF; PACKING MACHINES; MACHINE TOOLS FOR THE CUTTING AND FORMING OF MATERIALS; ELECTRIC MOTORS AND ENGINES FOR MACHINES; METAL COUPLINGS AND TRANSMISSION COMPONENTS FOR MACHINES; AGRICULTURAL IMPLEMENTS, NAMELY SEED DRILLS; INCUBATORS FOR EGGS; ADJUSTABLE PLATFORM COMPOSED OF GRANITE AND METAL FOR THE MANUFACTURE OF GOODS IN THE SEMI-CONDUCTOR INDUSTRY, CHEMICAL INDUSTRY, FOOD AND BEVERAGES INDUSTRY, AUTOMOBILE INDUSTRY, BUILDING INDUSTRY, AGRICULTURE, MINING, TEXTILE INDUSTRY, AND SUGAR INDUSTRY (U.S. CLS. 13, 19, 21, 23, 31, 34 AND 35).

CLASS 9—ELECTRICAL AND SCIENTIFIC APPARATUS

FOR SCIENTIFIC, NAUTICAL, SURVEYING, PHOTOGRAPHIC, CINEMATOGRAPHIC, OPTICAL, WEIGHING, MEASURING, SIGNALING, CHECKING, LIFE-SAVING AND TEACHING APPARATUS AND INSTRUMENTS, NAMELY CAMERAS, SCALES, AND EMERGENCY SIGNAL TRANSMITTERS; APPARATUS AND INSTRUMENTS FOR CONDUCTING, SWITCHING, TRANSFORMING, ACCUMULATING, REGULATING OR CONTROLLING ELECTRICITY, NAMELY VOLTAGE REGULATORS AND VOLTAGE STABILIZERS; APPARATUS FOR RECORDING, TRANSMISSION OR REPRODUCTION OF SOUND OR IMAGES, NAMELY DIGITAL VIDEO CAMERAS AND RECORDERS, COMPUTER HARDWARE; AUTOMATIC VENDING MACHINES; CASH REGISTERS; CALCULATORS; COMPUTER HARDWARE FOR DATA PROCESSING; FIRE-EXTINGUISHING APPARATUS (U.S. CLS. 21, 23, 26, 36 AND 38).

CLASS 19—NON-METALLIC BUILDING MATERIALS

FOR NON-METAL BUILDING MATERIALS, NAMELY GRANITE FOUNDATIONS, SLABS, COLUMNS, AND WALL BOARDS; NON METALLIC RIGID PIPES FOR BUILDING, ASPHALT, PITCH AND BITUMEN; NON-METALLIC TRANSPORTABLE BUILDINGS; MONUMENTS OF STONE (U.S. CLS. 1, 12, 33 AND 50).

CLASS 37—CONSTRUCTION AND REPAIR

FOR BUILDING CONSTRUCTION AND REPAIR; INSTALLATION OF MACHINERY AND BUILDING FOUNDATIONS, BUILDING SCAFFOLDS, WORKING AND BUILDING PLATFORM (U.S. CLS. 100, 103 AND 106).

CLASS 40—MATERIAL TREATMENT

FOR TREATMENT OF MATERIALS FOR THE MANUFACTURE OF GRANITE AND CERAMIC GOODS (U.S. CLS. 100, 103 AND 106).

KAPIL BHANOT, EXAMINING ATTORNEY

SN 79-032,434. KABUSHIKI KAISHA FAST RETAILING; (D/B/A FAST RETAILING CO., LTD.), JAPAN, FILED 5-24-2006.

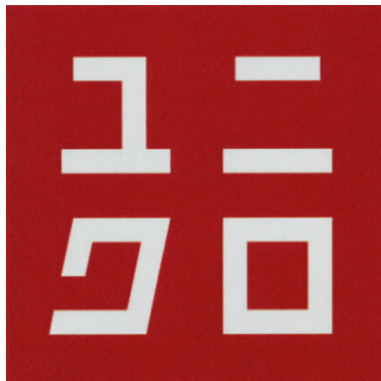

PRIORITY DATE OF 5-22-2006 IS CLAIMED.
OWNER OF INTERNATIONAL REGISTRATION 0907318
DATED 5-24-2006, EXPIRES 5-24-2016.

THE COLOR(S) RED AND WHITE IS/ARE CLAIMED AS A FEATURE OF THE MARK.

THE COLOR WHITE APPEARS IN THE FOREIGN CHARACTERS AND THE COLOR RED APPEARS IN THE BACKGROUND.

THE TRANSLITERATION OF THE NON-LATIN CHARACTERS IN THE MARK IS: YUNIKURO.

CLASS 9—ELECTRICAL AND SCIENTIFIC APPARATUS

FOR EYEGLASSES, SPECTACLES AND SUNGLASSES; STRAPS FOR MOBILE PHONES (U.S. CLS. 21, 23, 26, 36 AND 38).

CLASS 18—LEATHER GOODS

FOR BAGS, NAMELY, SPORTS BAGS, BABY CARRYING BAGS, BEACH BAGS, BELT BAGS, BOOK BAGS, BOSTON BAGS, CARRY-ALL BAGS, CARRY-ON BAGS, COSMETIC BAGS SOLD EMPTY, DIAPER BAGS, DUFFEL BAGS, HIKING BAGS, GARMENT BAGS FOR TRAVEL AND LEATHER AND IMITATION LEATHER BAGS; POUCHES, NAMELY, FELT POUCHES, POUCHES MADE OF COTTON, POUCHES OF LEATHER AND DRAWSTRING POUCHES; UMBRELLAS; PARASOLS; CLOTHING FOR DOMESTIC PETS; VANITY CASES SOLD EMPTY AND UNFITTED; SLING BAGS FOR CARRYING BABIES; LEATHER SHOPPING BAGS; UNWORKED OR SEMI-WORKED LEATHER (U.S. CLS. 1, 2, 3, 22 AND 41).

CLASS 24—FABRICS

FOR BED BLANKETS; BED SHEETS; FUTONS AND QUILTS; FUTON, QUILT AND PILLOW CASES; UNFITTED FUTON TICKING FABRIC; PILLOWCASES; MOSQUITO NETS; WOVEN FABRICS NOT FOR WEAR; FABRICS, NAMELY, WOVEN FABRICS, CHEMICAL FIBER FABRIC, COTTON BASE MIXED FABRIC, COTTON FABRIC, CURTAIN FABRIC, ELASTIC FABRIC FOR CLOTHING, ELASTIC YEARN MIXED FABRIC, FABRIC FOR BOOTS AND SHOES, FABRIC OF IMITATION ANIMAL SKIN, FIBERGLASS FABRIC, GAUZE FABRIC, HEMP BASE MIXED FABRIC, JEANS FABRIC, JERSEY FABRIC, LINEN FABRICS, MESH-WOVEN FABRICS, MIXED FIBER FABRIC, AND NYLON FABRIC; KNITTED FABRIC; FELT AND NON WOVEN TEXTILE FABRICS; FELTS; OILCLOTHS; GUMMED WATER-PROOF CLOTHS; VINYL CLOTH TEXTILES FOR USE IN MANUFACTURING CLOTHING, HOME AND COMMERCIAL INTERIORS; RUBBERIZED CLOTHS; FILTERING MATERIALS FOR TEXTILE, NAMELY, CHEESECLOTH; TABLE NAPKINS OF TEXTILE; DISH CLOTHS; UNFITTED FABRIC FURNITURE SEAT COVERS; WALL HANGINGS OF TEXTILE, NAMELY, CLOTH POSTERS; CURTAINS; SHOWER CURTAINS; TABLE CLOTHS NOT OF PAPER; FITTED TOILET LID COVERS MADE OF FABRIC OR FABRIC SUBSTITUTES; TISSUE CASE COVERS OF TEXTILE; TISSUE BOX COVERS OF TEXTILE; LABELS OF CLOTH; BILLIARD CLOTHS (U.S. CLS. 42 AND 50).

CLASS 25—CLOTHING

FOR CLOTHING, NAMELY, SHIRTS, T-SHIRTS, PANTS, JEANS, JACKETS, COATS, DRESSES, SKIRTS, SOCKS, TIGHTS, GLOVES, VESTS, UNDERWEAR, ANORAKS; RAINWEAR, WIND RESISTANT JACKETS, SWEATSHIRTS, TANK TOPS, PULLOVERS, KNIT SHIRTS, CARDIGANS, BELTS, PARKAS, MUFFLERS, AND HEADWEAR; GARTER BELTS; SOCK SUSPENDERS; SUSPENDERS; SWEATERS; WAISTBANDS; BELTS FOR CLOTHING; FOOTWEAR; MASQUERADE COSTUMES; SPORTS CLOTHING, NAMELY, PANTS, OVERUNIFORMS, JERSEYS, SHIRTS, COATS, JACKETS AND BOOTS FOR SPORTS (U.S. CLS. 22 AND 39).

SANJEEV VOHRA, EXAMINING ATTORNEY

SN 79-032,481. ASPRIA HOLDINGS B.V., NETHERLANDS, FILED 10-5-2006.

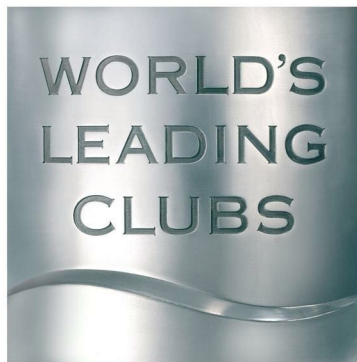

OWNER OF INTERNATIONAL REGISTRATION 0907425 DATED 10-5-2006, EXPIRES 10-5-2016.

NO CLAIM IS MADE TO THE EXCLUSIVE RIGHT TO USE "CLUBS", APART FROM THE MARK AS SHOWN.

THE COLOR(S) BLACK, WHITE, AND GRAY IS/ARE CLAIMED AS A FEATURE OF THE MARK.

THE COLORS BLACK AND GRAY APPEAR IN THE WORDING, AND THE COLORS BLACK, GRAY AND WHITE APPEAR THROUGHOUT THE MARK IN VARIATIONS.

CLASS 16—PAPER GOODS AND PRINTED MATTER

FOR PHOTOGRAPHS; STATIONERY; PRINTED MATTER, NAMELY BOOKS, MAGAZINES, CATALOGUES AND BROCHURES ALL IN THE FIELD OF HEALTH AND FITNESS CLUBS, TENNIS CLUBS AND/OR RACQUET CLUBS, AND GENTLEMEN CLUBS; INSTRUCTIONAL AND TEACHING MATERIAL ALL IN THE FIELD OF HEALTH AND FITNESS CLUBS AND TENNIS AND OR OTHER RACQUET CLUBS, AND WRITING INSTRUMENTS AND MATERIALS, NAMELY PENS (U.S. CLS. 2, 5, 22, 23, 29, 37, 38 AND 50).

CLASS 25—CLOTHING

FOR CLOTHING, NAMELY SHIRTS, SKIRTS, SHORTS, TROUSER AND SOCKS, FOOTWEAR; HEADGEAR, NAMELY CAPS AND HATS (U.S. CLS. 22 AND 39).

CLASS 28—TOYS AND SPORTING GOODS

FOR GYM SPORTING ARTICLES, NAMELY, WEIGHT LIFTING MACHINES; EXERCISE EQUIPMENT, NAMELY, CLIMBERS, STEPPERS, EXERCISE BENCHES AND EXERCISE WEIGHTS, PILATES MACHINES, AND ROWING MACHINES; SPORTS EQUIPMENT NAMELY TENNIS RACQUETS, BADMINTON RACQUETS AND SQUASH RACQUETS, AND GOLF CLUBS (U.S. CLS. 22, 23, 38 AND 50).

CLASS 44—MEDICAL, BEAUTY AND AGRICULTURAL SERVICES

FOR BEAUTY SALONS FOR HUMAN BEINGS; PROVIDING RESERVATIONS AND BOOKINGS FOR OTHERS FOR BEAUTY TREATMENTS AT HEALTH SPAS AND BEAUTY SALONS, PROVIDING INFORMATION ABOUT BEAUTY AND BEAUTY PRODUCTS (U.S. CLS. 100 AND 101).

TEJBIR SINGH, EXAMINING ATTORNEY

SN 79-032,590. LUFTHANSA TECHNIK AG, FED REP GERMANY, FILED 11-23-2006.



PRIORITY DATE OF 8-28-2006 IS CLAIMED. OWNER OF INTERNATIONAL REGISTRATION 0907771 DATED 11-23-2006, EXPIRES 11-23-2016.

OWNER OF U.S. REG. NO. 3,216,056. THE COLOR(S) YELLOW AND GREY IS/ARE CLAIMED AS A FEATURE OF THE MARK.

THE COLOR YELLOW APPEARS IN THE LETTERS AND DESIGN AS THE "A" AND "S" AND THE LINE SURROUNDING THE MARK; THE COLOR GREY APPEARS AS THE LETTERS "ERO" AND "LEEPER"

CLASS 12—VEHICLES

FOR AIRPLANES AND STRUCTURAL PARTS THEREFOR, NAMELY, AIRPLANE SEATS, AIRPLANE BEDS, AIRPLANE SEATS WHICH CAN BE CONVERTED INTO COUCHES OR BEDS (U.S. CLS. 19, 21, 23, 31, 35 AND 44).

CLASS 39—TRANSPORTATION AND STORAGE

FOR TRANSPORTATION OF PASSENGERS BY AIR, NAMELY, TRANSPORTATION OF PERSONS WITH AIRPLANES (U.S. CLS. 100 AND 105).

KATHERINE E. HALMEN, EXAMINING ATTORNEY

SN 79-032,615. BAYROL SCANDINAVIA A/S, DENMARK, FILED 9-27-2006.



OWNER OF INTERNATIONAL REGISTRATION 0907822 DATED 9-27-2006, EXPIRES 9-27-2016.

NO CLAIM IS MADE TO THE EXCLUSIVE RIGHT TO USE "SWIM", APART FROM THE MARK AS SHOWN.

CLASS 1—CHEMICALS

FOR ADHESIVES FOR LAYING CERAMIC SWIMMING POOL TILES; WATER CLEANSING CHEMICALS, NAMELY, WATER PURIFYING CHEMICALS AND WATER TREATMENT CHEMICALS FOR SWIMMING POOLS; CHEMICALS FOR REGULATION OF PH VALUE FOR USE IN SWIMMING POOLS, AND CHLORINE PREPARATIONS FOR USE IN SWIMMING POOLS (U.S. CLS. 1, 5, 6, 10, 26 AND 46).

CLASS 6—METAL GOODS

FOR METAL SWIMMING POOLS AND METAL HOSES FOR SWIMMING POOLS (U.S. CLS. 2, 12, 13, 14, 23, 25 AND 50).

CLASS 7—MACHINERY

FOR MACHINE-DRIVEN PUMPS FOR SWIMMING POOLS, NAMELY, PUMPS FOR CIRCULATION OF WATER IN SWIMMING POOLS, INCLUDING SUCH PUMPS WITH BUILT-IN FILTER HOLDERS; SWIMMING POOL SWEEPERS (U.S. CLS. 13, 19, 21, 23, 31, 34 AND 35).

CLASS 19—NON-METALLIC BUILDING MATERIALS

FOR NON-METAL SWIMMING POOLS (U.S. CLS. 1, 12, 33 AND 50).

CLASS 28—TOYS AND SPORTING GOODS

FOR TOYS AND SPORTING ARTICLES FOR USE IN THE WATER AND IN SWIMMING POOLS, NAMELY, BALLS, WATER SKIS, WATER SQUIRTING TOYS, DIVING TOYS, FLIPPERS FOR USE IN SCUBA DIVING; SWIMMING AIDS FOR RECREATIONAL USE, NAMELY, ARM AND BODY FLOATS (U.S. CLS. 22, 23, 38 AND 50).

PATRICIA EVANKO, EXAMINING ATTORNEY

SN 79-032,744. LAICA S.P.A., ITALY, FILED 9-15-2006.

The logo for BIFLUX features the word "BIFLUX" in a bold, black, sans-serif font. Below the text are two thick, wavy horizontal lines that resemble water ripples.

PRIORITY DATE OF 5-11-2006 IS CLAIMED.
OWNER OF INTERNATIONAL REGISTRATION 0908152 DATED 9-15-2006, EXPIRES 9-15-2016.

CLASS 11—ENVIRONMENTAL CONTROL APPARATUS

FOR WATER FILTERS TO BE APPLIED TO CARAFES AND CONTAINERS FOR DOMESTIC USE (U.S. CLS. 13, 21, 23, 31 AND 34).

CLASS 21—HOUSEWARES AND GLASS

FOR WATER FILTERING CONTAINERS FOR DOMESTIC USE NOT OF PRECIOUS METAL AND CARAFES (U.S. CLS. 2, 13, 23, 29, 30, 33, 40 AND 50).

TINA BROWN, EXAMINING ATTORNEY

SN 79-032,754. MAYER & GRAMMELSPACHER DIANA-WERK; GMBH & CO. KG, FED REP GERMANY, FILED 11-13-2006.

The logo for PANTHER consists of the word "PANTHER" in a bold, black, serif font.

THE MARK CONSISTS OF STANDARD CHARACTERS WITHOUT CLAIM TO ANY PARTICULAR FONT, STYLE, SIZE, OR COLOR.

PRIORITY DATE OF 5-16-2006 IS CLAIMED.
OWNER OF INTERNATIONAL REGISTRATION 0908178 DATED 11-13-2006, EXPIRES 11-13-2016.

CLASS 13—FIREARMS

FOR FIREARMS; AIR AND GAS PRESSURE WEAPONS, AND PARTS THEREOF; AMMUNITION AND PROJECTILES, IN PARTICULAR FOR AIR AND GAS PRESSURE WEAPONS (U.S. CLS. 2 AND 9).

CLASS 35—ADVERTISING AND BUSINESS

FOR ADVERTISING, BUSINESS MANAGEMENT, BUSINESS ADMINISTRATION; WHOLESALE OR MAIL ORDERING SERVICES IN THE FIELD OF FIREARMS, AIR AND GAS PRESSURE WEAPONS; ONLINE STORE SERVICES IN THE FIELD OF FIREARMS, AIR AND GAS PRESSURE WEAPONS; PRESENTATION OF GOODS AND SERVICES ON COMMUNICATION MEDIA FOR RETAIL PURPOSES (U.S. CLS. 100, 101 AND 102).

JOHN DALIER, EXAMINING ATTORNEY

SN 79-032,759. BIO-LOGIC, F-38640 CLAIX, FRANCE, FILED 11-8-2006.

The logo for VSP consists of the letters "VSP" in a large, bold, black, serif font.

THE MARK CONSISTS OF STANDARD CHARACTERS WITHOUT CLAIM TO ANY PARTICULAR FONT, STYLE, SIZE, OR COLOR.

PRIORITY DATE OF 5-12-2006 IS CLAIMED.
OWNER OF INTERNATIONAL REGISTRATION 0908189 DATED 11-8-2006, EXPIRES 11-8-2016.

CLASS 9—ELECTRICAL AND SCIENTIFIC APPARATUS

FOR SCIENTIFIC INSTRUMENT, NAMELY, POTENTIostat NOT FOR MEDICAL USE, FOR USE IN THE FIELDS OF MATERIALS RESEARCH, CORROSION AND ELECTROCHEMICAL ANALYSIS, AND FOR TEACHING IN ELECTROCHEMISTRY, PILOTTED BY SOFTWARE FOR ACQUISITION AND PROCESSING OF DATA AND FOR USE IN CORROSION ANALYSIS (U.S. CLS. 21, 23, 26, 36 AND 38).

CLASS 42—SCIENTIFIC, COMPUTER AND LEGAL SERVICES

FOR SCIENTIFIC ANALYSIS AND RESEARCH IN ELECTRONICS AND ELECTROCHEMICALS PROVIDED BY ENGINEERS; RESEARCH AND DEVELOPMENT OF NEW PRODUCTS (U.S. CLS. 100 AND 101).

HOWARD B. LEVINE, EXAMINING ATTORNEY

SN 79-032,977. PIRELLI TYRE SPA, ITALY, FILED 12-28-2005.

The logo for SCORPION consists of the word "SCORPION" in a bold, black, serif font.

THE MARK CONSISTS OF STANDARD CHARACTERS WITHOUT CLAIM TO ANY PARTICULAR FONT, STYLE, SIZE, OR COLOR.

PRIORITY DATE OF 11-14-2005 IS CLAIMED.
OWNER OF INTERNATIONAL REGISTRATION 0908725 DATED 12-28-2005, EXPIRES 12-28-2015.

CLASS 14—JEWELRY

FOR JEWELRY; BELT BUCKLES OF PRECIOUS METALS; BRACELETS OF PRECIOUS METALS; BROOCHES; CUFF-LINKS; DIAMONDS; EARRINGS; NECKLACES; PEARLS; PRECIOUS METALS AND THEIR ALLOYS; RINGS; BRACELETS, CHARMS; EARRINGS IN PRECIOUS METAL OR COATED THEREWITH; PRECIOUS STONES; HOROLOGICAL AND CHRONOMETRIC INSTRUMENTS, NAMELY TIMEPIECES, WRISTWATCHES, WATCHES, CLOCKS AND PARTS THEREOF (U.S. CLS. 2, 27, 28 AND 50).

CLASS 18—LEATHER GOODS

FOR HANDBAGS, SUITCASES, WALLETS, BRIEF-CASES, SCHOOL BAGS, HANDBAGS FOR MEN, TRUNKS FOR TRAVEL, LEATHER AND IMITATION LEATHER (U.S. CLS. 1, 2, 3, 22 AND 41).

CLASS 25—CLOTHING

FOR CLOTHING ARTICLES FOR MEN, WOMEN AND CHILDREN, NAMELY, SHIRTS, BLOUSES, SKIRTS, COATS, TROUSERS, PANTS, VESTS, JERSEYS, PAJAMAS, SOCKS AND STOCKINGS, SINGLET, CORSETS, GARTERS, UNDERPANTS, PETTICOATS, HATS, HEAD SCARVES, NECKTIES, RAINCOATS, OVERCOATS, GREATCOATS, BATHING SUITS, SPORTS OVERALLS, WIND-RESISTANT JACKETS, SKI PANTS, BELTS, FUR COATS, SCARVES, GLOVES, DRESSING GOWNS, FOOTWEAR, NOT FOR GOLF OR SAFETY WORK, NAMELY, SHOES, SPORTS SHOES, SLIPPERS AND BOOTS, ALL OF THE AFORESAID GOODS TO BE USED IN THE PROMOTION OF TIRE SALES (U.S. CLS. 22 AND 39).

CLASS 28—TOYS AND SPORTING GOODS

FOR ARCADE-TYPE ELECTRONIC VIDEO GAMES, SAIL BOARDS FOR BOARD SAILING, CASES FOR TENNIS BALLS, GUT FOR TENNIS RACKETS, RACKETS FOR TENNIS, TABLE TENNIS BALLS, TABLE TENNIS BATS, TABLE TENNIS NETS, TABLE TENNIS PADDLE CASES, TABLE TENNIS PADDLES, TABLE TENNIS RACKETS, TENNIS BALLS, TENNIS RACKET STRINGS, BASKETBALLS, VOLLEY BALLS, HANDBALLS, RACKETBALLS, SOCCER GOALS, RUGBY BALLS, SOCCER BALLS, SPORT BALLS (U.S. CLS. 22, 23, 38 AND 50).

CARRIE GENOVESE, EXAMINING ATTORNEY

CLASS 7—MACHINERY

FOR MACHINES AND EQUIPMENT FOR MANUFACTURING PRINTED CIRCUIT BOARDS; MACHINES AND EQUIPMENT FOR MANUFACTURING AND PROCESSING ELECTRONIC PRINTED CIRCUIT BOARDS, NAMELY, PLACING MACHINES FOR MOUNTING ELECTRICAL COMPONENTS ON PRINTED CIRCUIT BOARDS; MACHINES AND EQUIPMENT WHICH AUTOMATICALLY MOUNT SEMICONDUCTORS, DIODES, CONDENSERS, RESISTORS AND OTHER ELECTRONIC PARTS ON CIRCUIT BOARDS; MACHINES AND EQUIPMENT WHICH AUTOMATICALLY MOUNT IC (INTEGRATED CIRCUIT) CHIPS AND OTHER ELECTRONIC PARTS ON PRINTED CIRCUIT BOARDS (U.S. CLS. 13, 19, 21, 23, 31, 34 AND 35).

CLASS 9—ELECTRICAL AND SCIENTIFIC APPARATUS

FOR TESTING APPARATUS AND INSTRUMENTS FOR PRINTED CIRCUIT BOARDS, NAMELY, TRANSFORMERS AND ELECTRONIC CIRCUIT CARDS; TESTING APPARATUS AND INSTRUMENTS FOR PRINTED CIRCUIT BOARDS AND THEIR PARTS, NAMELY, TRANSFORMERS AND ELECTRONIC CIRCUIT CARDS; ENCODED ELECTRONIC CHIP CARDS MOUNTED WITH IC (INTEGRATED CIRCUIT) CHIP FOR IDENTIFYING PARTICULAR USERS OF COMPUTERS; RF (RADIO FREQUENCY) TAGS; TAG-TYPE NON-CONTACT DATA CARRIERS MOUNTED WITH IC (INTEGRATED CIRCUIT) CHIP FOR IDENTIFYING PARTICULAR USERS OF COMPUTERS; RADIO FREQUENCY IDENTIFICATION TAGS; IC (INTEGRATED CIRCUIT) CHIPS FOR IDENTIFYING PARTICULAR USERS OF COMPUTERS ATTACHED WITH ADHESIVE LABELS; COMPUTERS FOR READING CARDS AND INFORMATION RECORDED IN COMPUTER CHIPS; IC (INTEGRATED CIRCUIT) CHIPS FOR COMPUTER PRINTERS, TONER CARTRIDGES AND INK JET CARTRIDGES; DETECTORS, NAMELY, RADAR DETECTORS; TELECOMMUNICATION MACHINES AND APPARATUS, NAMELY, TELEPHONES, CELLULAR PHONES AND FACSIMILE MACHINES; RADIO COMMUNICATION MACHINES AND APPARATUS, NAMELY, MULTI-CHANNEL RADIOS FOR FIXED STATIONS, PORTABLE RADIOS, RADIO PAGERS AND RADIO RECEIVERS; TELEMETERING MACHINES AND INSTRUMENTS; PARTS AND ACCESSORIES FOR TELECOMMUNICATION MACHINES AND APPARATUS, NAMELY, CELLULAR TELEPHONE BATTERIES, CASES AND CHARGERS; ELECTRONIC MACHINES, APPARATUS AND THEIR PARTS, NAMELY, COMPUTERS; ELECTRONIC CIRCUITS NOT RECORDED WITH COMPUTER PROGRAMS; ELECTRONIC PUBLICATIONS, NAMELY, BOOKS, MAGAZINES, MANUALS AND NEWSPAPERS FEATURING ELECTRONICS, HEALTH AND TELECOMMUNICATIONS RECORDED ON COMPUTER MEDIA; REMOTE-CONTROL DEVICES FOR TELECOMMUNICATION MACHINES AND APPARATUS, NAMELY, REMOTE CONTROLS FOR TELEPHONES CELLULAR TELEPHONES AND FACSIMILE MACHINES; REMOTE-CONTROL DEVICES FOR RADIO COMMUNICATION MACHINES AND APPARATUS, NAMELY, REMOTE CONTROLS FOR RADIOS, PORTABLE RADIOS, RADIO RECEIVERS AND RADIO PAGERS; ANTI-THEFT WARNING APPARATUS, NAMELY, ANTI-THEFT ALARMS; ELECTRIC THEFT PREVENTION INSTALLATIONS, NAMELY, BIOMETRIC ACCESS CONTROLS; READING AND WRITING APPARATUS FOR RECORDED INFORMATION OF ELECTRONIC SYMPATHETIC VIBRATION TAGS, NAMELY, RFID READERS AND RADIO FREQUENCY IDENTIFICATION (RFID) TAGS; AND ELECTRONIC TAGS FOR GOODS (U.S. CLS. 21, 23, 26, 36 AND 38).

SN 79-033,194. OMRON CORPORATION, JAPAN, FILED 10-16-2006.

**CLASS 40—MATERIAL TREATMENT**

FOR PROVIDING INFORMATION IN RELATION TO CUSTOM ASSEMBLING OF PRINTED CIRCUIT BOARDS; CUSTOM ASSEMBLING OF INTEGRATED CIRCUITS, MASKS, ELECTRONIC CHIPS OR COMPUTER CHIPS; PROVIDING INFORMATION IN RELATION TO MANUFACTURING, PROCESSING OR CUSTOM ASSEMBLING OF SEMICONDUCTOR CHIP (U.S. CLS. 100, 103 AND 106).

PRIORITY DATE OF 7-12-2006 IS CLAIMED.
OWNER OF INTERNATIONAL REGISTRATION 0909227
DATED 10-16-2006, EXPIRES 10-16-2016.

CLASS 42—SCIENTIFIC, COMPUTER AND LEGAL SERVICES

FOR COMPUTER SOFTWARE DESIGN FOR OTHERS, COMPUTER PROGRAMMING, OR MAINTENANCE OF COMPUTER SOFTWARE; CREATING OR MAINTAINING WEB SITES FOR OTHERS; PROVIDING ON-LINE NON-DOWNLOADABLE SOFTWARE FOR USE IN DATABASE MANAGEMENT, FOR USE AS SPREADSHEET, AND FOR WORD PROCESSING; RENTAL OF MEASURING APPARATUS; REMOTE SUPERVISING AND MONITORING OF COMPUTER SYSTEMS OF OTHERS RELATING TO TELECOMMUNICATION MACHINES AND APPARATUS; REMOTE SUPERVISING AND MONITORING OF COMPUTER SECURITY SYSTEMS; REMOTE SUPERVISING AND MONITORING OF COMPUTER SECURITY SYSTEMS AND PROVIDING INFORMATION IN RELATION TO REMOTE SUPERVISING AND MONITORING OF COMPUTER SECURITY SYSTEMS (U.S. CLS. 100 AND 101).

ANGELA GAW, EXAMINING ATTORNEY

CLASS 7—MACHINERY

FOR BELT CONVEYORS; CONVEYING BELTS; MACHINES FOR METALWORKING, NAMELY, GRINDERS, MILLING MACHINES, LATHES, DRILL PRESSES, HYDRAULIC PRESSES, MECHANICAL PRESSES, METAL EXTRUSION PRESSES, OIL HYDRAULIC PRESSES, PUNCHING PRESSES, STAMPING PRESSES, PLYWOOD PRESSES; METALWORKING MACHINES TOOLS; MILLING CUTTERS, GEAR CUTTERS, RECHARGEABLE HEDGE CUTTERS, TREE STUMP CUTTERS, TRENCH CUTTERS; MACHINES AND INSTALLATIONS FOR THE RUBBER INDUSTRY, NAMELY, INDUSTRIAL MACHINE PRESSES, MANIPULATORS, AGITATORS, TRIMMING MACHINES, AND ROLLING MILLS; MACHINES FOR PROCESSING RUBBER, NAMELY, MIXING MACHINES, GRINDING MACHINES, CRUSHING MACHINES, SHREDDERS, VULCANIZATION MACHINES, TIRE BUILDING MACHINES, BEAD MAKING MACHINE USED IN PROCESS OF PRODUCTION OF TIRES, APEXING MACHINE IN PROCESS OF PRODUCTION OF TIRES; MILLING CUTTER MACHINE TOOLS; RUBBER FORMING MACHINES AND INSTRUMENTS. (U.S. CLS. 13, 19, 21, 23, 31, 34 AND 35).

SN 79-033,207. MATADOR HOLDING, A.S., SLOVAKIA, FILED 6-6-2006.

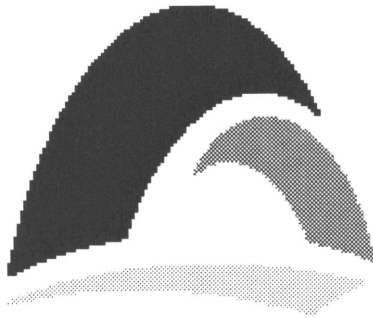

PRIORITY DATE OF 12-9-2005 IS CLAIMED.
OWNER OF INTERNATIONAL REGISTRATION 0909343
DATED 6-6-2006, EXPIRES 6-6-2016.

CLASS 6—METAL GOODS

FOR CONSTRUCTION ELEMENTS MADE OF METAL, NAMELY, SHORES, SUPPORTS AND BRACES, FRAMEWORK OF METAL FOR BUILDING, ANCHOR PLATES; BINDINGS OF METAL; INGOTS OF COMMON METAL; METAL ALLOYS FOR FURTHER MANUFACTURING; METAL GOODS, NAMELY, METAL TILES, METAL FLOOR TILES, METAL ROOFING TILES, SHEET METAL, SHEET METAL LININGS, STEEL IN SHEET, ROD, BAR AND/OR BILLET FORM, ZINC-COATED STEEL SHEETS; METAL DOOR PANELS, METAL DOOR FRAMES, METAL DOOR UNITS, PAINT SPRAY BOOTHS OF METAL, METAL BINS, BASKETS OF COMMON METALS, METAL BOXES, SAFETY DEPOSIT BOXES, TOOL BOXES OF METAL, CONTAINERS OF METAL FOR TRANSPORT, METAL CHESTS, STORAGE PALLETS OF METAL, LOADING AND UNLOADING PALLETS OF METAL, POSTS OF METAL; BELLS, BEAMS, BILLETS; FOUNDRY CHILL-MOULDINGS OF METAL, METALLIC MOULDS FOR METAL CASTING, METAL MOULDS FOR FORMING AND PRESSING OF METALS FOR AUTOMOBILE PARTS; METAL MOULDS FOR PRESSING RUBBER AND PLASTIC PRODUCTS. (U.S. CLS. 2, 12, 13, 14, 23, 25 AND 50).

CLASS 8—HAND TOOLS

FOR HAND TOOLS NAMELY, RAMMERS, PUNCH PLIERS, CHISELS, BITS FOR HAND DRILLS, PLANES, SAWS, BLADES FOR HAND SAWS, MULTI-PURPOSE SHEARS, METAL-CUTTING SCISSORS, BITS FOR HAND TOOLS, PUNCHES, HAMMERS, BUSH HAMMERS, FOUNDRY LADLES, PUNCHING DIES, INSTRUMENTS FOR PUNCHING, BLADE SHARPENING INSTRUMENTS, CAULKING GUNS, BORERS, VICES, CRIMPING IRONS NOT FOR USE WITH HAIR, BRANDING IRONS, MOULDING IRONS, PLANERS, DRILLS, SHOVELS; MANUALLY OPERATED WORKSHOP TOOLS, NAMELY, MANUALLY OPERATED GRINDING WHEELS, MANUALLY OPERATED MILLING CUTTERS, HAND OPERATED SHEARS, MANUALLY OPERATED HAMMERS, MANUALLY OPERATED SHARPENING WHEELS. (U.S. CLS. 23, 28 AND 44).

CLASS 12—VEHICLES

FOR PNEUMATIC TIRES FOR VEHICLES; PNEUMATIC TIRES INNER TUBES AND REPLACEMENT PARTS; LAND VEHICLES, THEIR PARTS AND SPARE PARTS, NAMELY AUTOMOBILE CHASSIS, BODIES FOR VEHICLES, VEHICLES SEATS, MUDGUARDS OF MOTOR VEHICLES OR BICYCLES, DOORS FOR VEHICLES, BUMPERS FOR VEHICLES, UNDERCARRIAGES FOR VEHICLES, RIMS FOR VEHICLE WHEELS. (U.S. CLS. 19, 21, 23, 31, 35 AND 44).

CLASS 17—RUBBER GOODS

FOR RAW OR SEMI-WORKED RUBBER; SHOCK ABSORBING BUFFERS OF RUBBER FOR INDUSTRIAL MACHINERY AND VEHICLES; SYNTHETIC RUBBER; SEMI-PROCESSED PLASTIC IN THE FORM OF FILMS, SHEETS, TUBES, BARS, PLATES, PROFILES TUBES OR RODS; GOODS OF SYNTHETIC MATERIAL INCLUDED IN THIS CLASS, NAMELY, SYNTHETIC PADDING AND STUFFING MATERIALS, NAMELY, PLASTIC WADDINGS; GOODS MADE OF RUBBER, SYNTHETIC RUBBER AND PLASTICS INCLUDED IN THIS CLASS, NAMELY, ACRYLIC RUBBER, FOAM RUBBER, RUBBER FOR USE IN THE MANUFACTURE OF TIRES, LATEX RUBBER FOR USE IN THE MANUFACTURE OF TIRES, RUBBER FOR RECAPPING TIRES; ELECTRICAL INSULATING RUBBER PRODUCTS, GENERAL PURPOSE SILICONE RUBBER SEALANT, INDUSTRIAL PACKAGING CONTAINERS OF RUBBER, NON-METAL, PLASTIC AND RUBBER HOSES FOR INDUSTRIAL APPLICATIONS, RUBBER BAGS FOR MERCHANDISE PACKAGING, RUBBER BANDS FOR COMMERCIAL

AND INDUSTRIAL USES, RUBBER BARS AND RODS, RUBBER SEALANT FOR CAULKING AND ADHESIVE PURPOSES, RUBBER SHEETS, RUBBER SHOCK ABSORBERS FOR INDUSTRIAL MACHINERY, RUBBER SLEEVES FOR PROTECTING PARTS OF MACHINERY, RUBBER THREAD NOT FOR TEXTILE USE, RUBBER TUBES AND PIPES, RUBBER WHEEL CHOCKS, STUFFING OF RUBBER, UNFITTED PROTECTIVE RUBBER SHEETS FOR AUTOMOBILE SEATS, VALVES OF RUBBER OR VULCANIZED FIBER NOT INCLUDING MACHINE ELEMENTS, WASHERS OF RUBBER OR VULCANIZED FIBER (U.S. CLS. 1, 5, 12, 13, 35 AND 50).

CLASS 42—SCIENTIFIC, COMPUTER AND LEGAL SERVICES

FOR CHEMICAL RESEARCH; MECHANICAL RESEARCH; SCIENTIFIC RESEARCH; INDUSTRIAL RESEARCH IN THE FIELD OF AUTOMOBILE INDUSTRY; RESEARCH AND DEVELOPMENT OF NEW PRODUCTS FOR THIRD PARTIES; INDUSTRIAL DESIGN; PROFESSIONAL ADVICE AND CONSULTING INCLUDED IN THE FIELD OF AUTOMOBILE INDUSTRY AND MECHANICAL ENGINEERING. (U.S. CLS. 100 AND 101).

ANTHONY RINKER, EXAMINING ATTORNEY

SN 79-033,302. DADANCO PTY LTD; (A.C.N. 071 719 858), HINDMARSH SA 5007, AUSTRALIA, FILED 11-21-2006.



PRIORITY DATE OF 9-29-2006 IS CLAIMED.
OWNER OF INTERNATIONAL REGISTRATION 0909548
DATED 11-21-2006, EXPIRES 11-21-2016.

CLASS 11—ENVIRONMENTAL CONTROL APPARATUS

FOR APPARATUS FOR HEATING, COOLING AND AIR CONDITIONING, PARTS AND ACCESSORIES THEREFORE NAMELY ELECTRIC HEATING FANS, HOT-AIR SPACE HEATING APPARATUS, AIR CONDITIONERS NAMELY, SPLIT-SYSTEM AIR CONDITIONERS AND DUCTED-TYPE AIR CONDITIONERS AND COMPONENT PARTS THEREOF SOLD AS A UNIT (U.S. CLS. 13, 21, 23, 31 AND 34).

CLASS 35—ADVERTISING AND BUSINESS

FOR WHOLESALE AND RETAIL STORE SERVICES AND WHOLESALE DISTRIBUTORSHIPS FEATURING COMMERCIAL AND INDUSTRIAL AIR CONDITIONING SYSTEMS (U.S. CLS. 100, 101 AND 102).

CLASS 42—SCIENTIFIC, COMPUTER AND LEGAL SERVICES

FOR DESIGN FOR OTHERS IN THE FIELD OF COMMERCIAL AND INDUSTRIAL AIR CONDITIONING SYSTEMS (U.S. CLS. 100 AND 101).

TASNEEM HUSSAIN, EXAMINING ATTORNEY

SN 79-033,520. DADANCO PTY LTD; (A.C.N. 074 719 858), HINDMARSH SA 5007, AUSTRALIA, FILED 11-21-2006.

BREATHING LIFE INTO YOUR BUILDING

THE MARK CONSISTS OF STANDARD CHARACTERS WITHOUT CLAIM TO ANY PARTICULAR FONT, STYLE, SIZE, OR COLOR.

PRIORITY DATE OF 9-29-2006 IS CLAIMED.
OWNER OF INTERNATIONAL REGISTRATION 0910154
DATED 11-21-2006, EXPIRES 11-21-2016.

CLASS 11—ENVIRONMENTAL CONTROL APPARATUS

FOR APPARATUS FOR HEATING, COOLING AND AIR CONDITIONING, PARTS AND ACCESSORIES THEREFORE, NAMELY ELECTRIC HEATING FANS, HOT-AIR SPACE HEATING APPARATUS, AIR CONDITIONERS, NAMELY SPLIT-SYSTEM AIR CONDITIONERS AND DUCTED-TYPE AIR CONDITIONERS AND COMPONENT PARTS THEREOF SOLD AS A UNIT (U.S. CLS. 13, 21, 23, 31 AND 34).

CLASS 35—ADVERTISING AND BUSINESS

FOR WHOLESALE AND RETAIL STORE SERVICES AND WHOLESALE DISTRIBUTORSHIPS FEATURING COMMERCIAL AND INDUSTRIAL AIR CONDITIONING SYSTEMS (U.S. CLS. 100, 101 AND 102).

CLASS 42—SCIENTIFIC, COMPUTER AND LEGAL SERVICES

FOR DESIGN FOR OTHERS IN THE FIELD OF COMMERCIAL AND INDUSTRIAL AIR CONDITIONING SYSTEMS (U.S. CLS. 100 AND 101).

TASNEEM HUSSAIN, EXAMINING ATTORNEY

SN 79-033,521. DADANCO PTY LTD; (A.C.N. 071 719 858), HINDMARSH SA 5007, AUSTRALIA, FILED 11-21-2006.

DADANCO STARLINE

THE MARK CONSISTS OF STANDARD CHARACTERS WITHOUT CLAIM TO ANY PARTICULAR FONT, STYLE, SIZE, OR COLOR.

PRIORITY DATE OF 9-29-2006 IS CLAIMED.
OWNER OF INTERNATIONAL REGISTRATION 0910155
DATED 11-21-2006, EXPIRES 11-21-2016.

CLASS 11—ENVIRONMENTAL CONTROL APPARATUS

FOR APPARATUS FOR HEATING, COOLING AND AIR CONDITIONING, PARTS AND ACCESSORIES THEREFORE NAMELY ELECTRIC HEATING FANS, HOT-AIR SPACE HEATING APPARATUS, AIR CONDITIONERS, NAMELY SPLIT-SYSTEM AIR CONDITIONERS AND DUCTED-TYPE AIR CONDITIONERS AND COMPONENT PARTS THEREOF, SOLD AS A UNIT (U.S. CLS. 13, 21, 23, 31 AND 34).

CLASS 35—ADVERTISING AND BUSINESS

FOR WHOLESALE AND RETAIL STORE SERVICES AND WHOLESALE DISTRIBUTORSHIPS FEATURING COMMERCIAL AND INDUSTRIAL AIR CONDITIONING SYSTEMS (U.S. CLS. 100, 101 AND 102).

CLASS 42—SCIENTIFIC, COMPUTER AND LEGAL SERVICES

FOR DESIGN FOR OTHERS IN THE FIELD OF COMMERCIAL AND INDUSTRIAL AIR CONDITIONING SYSTEMS (U.S. CLS. 100 AND 101).

TASNEEM HUSSAIN, EXAMINING ATTORNEY

SN 79-033,522. DADANCO PTY LTD; (A.C.N. 071 719 858), HINDMARSH SA 5007, AUSTRALIA, FILED 11-21-2006.

DADANCO

THE MARK CONSISTS OF STANDARD CHARACTERS WITHOUT CLAIM TO ANY PARTICULAR FONT, STYLE, SIZE, OR COLOR.

PRIORITY DATE OF 9-29-2006 IS CLAIMED.

OWNER OF INTERNATIONAL REGISTRATION 0910156 DATED 11-21-2006, EXPIRES 11-21-2016.

CLASS 11—ENVIRONMENTAL CONTROL APPARATUS

FOR APPARATUS FOR HEATING, COOLING AND AIR CONDITIONING, PARTS AND ACCESSORIES THEREFORE NAMELY ELECTRIC HEATING FANS, HOT-AIR SPACE HEATING APPARATUS, AIR CONDITIONERS NAMELY SPLIT-SYSTEM AIR CONDITIONERS AND DUCTED-TYPE AIR CONDITIONERS AND COMPONENT PARTS THEREOF SOLD AS A UNIT (U.S. CLS. 13, 21, 23, 31 AND 34).

CLASS 35—ADVERTISING AND BUSINESS

FOR WHOLESALE AND RETAIL STORE SERVICES AND WHOLESALE DISTRIBUTORSHIPS FEATURING COMMERCIAL AND INDUSTRIAL AIR CONDITIONING SYSTEMS (U.S. CLS. 100, 101 AND 102).

CLASS 42—SCIENTIFIC, COMPUTER AND LEGAL SERVICES

FOR DESIGN FOR OTHERS IN THE FIELD OF COMMERCIAL AND INDUSTRIAL AIR CONDITIONING SYSTEMS (U.S. CLS. 100 AND 101).

TASNEEM HUSSAIN, EXAMINING ATTORNEY

SN 79-033,523. DADANCO PTY LTD; ACN 071 719 858, HINDMARSH SA 5007, AUSTRALIA, FILED 11-21-2006.

INFFUSER

THE MARK CONSISTS OF STANDARD CHARACTERS WITHOUT CLAIM TO ANY PARTICULAR FONT, STYLE, SIZE, OR COLOR.

PRIORITY DATE OF 9-29-2006 IS CLAIMED.

OWNER OF INTERNATIONAL REGISTRATION 0910157 DATED 11-21-2006, EXPIRES 11-21-2016.

CLASS 11—ENVIRONMENTAL CONTROL APPARATUS

FOR APPARATUS FOR HEATING, COOLING AND AIR CONDITIONING, PARTS AND ACCESSORIES THEREFORE, NAMELY ELECTRIC HEATING FANS, HOT-AIR SPACE HEATING APPARATUS, AIR CONDITIONERS, NAMELY SPLIT-SYSTEM AIR CONDITIONERS, AND DUCTED-TYPE AIR CONDITIONERS AND COMPONENT PARTS THEREOF SOLD AS A UNIT (U.S. CLS. 13, 21, 23, 31 AND 34).

CLASS 35—ADVERTISING AND BUSINESS

FOR WHOLESALE AND RETAIL STORE SERVICES AND WHOLESALE DISTRIBUTORSHIPS FEATURING COMMERCIAL AND INDUSTRIAL AIR CONDITIONING SYSTEMS (U.S. CLS. 100, 101 AND 102).

CLASS 42—SCIENTIFIC, COMPUTER AND LEGAL SERVICES

FOR DESIGN FOR OTHERS IN THE FIELD OF COMMERCIAL AND INDUSTRIAL AIR CONDITIONING SYSTEMS (U.S. CLS. 100 AND 101).

TASNEEM HUSSAIN, EXAMINING ATTORNEY

SN 79-033,593. LIDL STIFTUNG & CO. KG, FED REP GERMANY, FILED 12-11-2006.

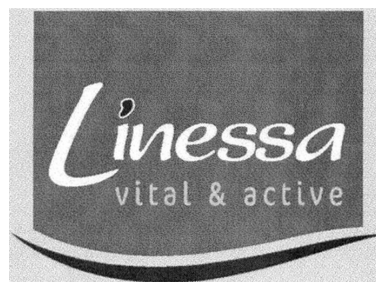

OWNER OF INTERNATIONAL REGISTRATION 0899887 DATED 5-3-2006, EXPIRES 5-3-2016.

CLASS 29—MEATS AND PROCESSED FOODS

FOR MEAT, FISH, POULTRY AND GAME; MEAT EXTRACTS; PRESERVED, DRIED AND COOKED VEGETABLES; MEAT, FISH, FRUIT AND VEGETABLE PRESERVES; MEAT, FISH AND VEGETABLE JELLIES, FRUIT JELLIES NOT CONFECTIONERY; JAMS, MARMALADES; EGGS, MILK AND MILK PRODUCTS EXCLUDING ICE CREAM, ICE MILK AND FROZEN YOGURT; EDIBLE OILS AND FATS; FROZEN, PREPARED, PACKAGED READY-TO-SERVE MEALS CONSISTING PRIMARILY OF MEAT, FISH, POULTRY OR VEGETABLES; ALL AFOREMENTIONED GOODS ESPECIALLY LOW CALORIE AND LOW FAT (U.S. CL. 46).

CLASS 30—STAPLE FOODS

FOR COFFEE, TEA, COCOA, SUGAR, RICE, TAPIOCA, ARTIFICIAL COFFEE; FLOUR AND CEREAL PREPARATIONS IN THE NATURE OF CEREAL-BASED SNACK FOODS, MUESLI; BREAD, PASTRY AND CONFECTIONERY, NAMELY, CANDY; EDIBLE ICES; HONEY TREACLE; YEAST, BAKING POWDER; SALT, MUSTARD; VINEGAR, SAUCES, CONDIMENTS, NAMELY, PEPPER SAUCE, MALT FOR FOOD PURPOSES; SPICES; ALL AFOREMENTIONED GOODS ESPECIALLY LOW CALORIE AND LOW FAT (U.S. CL. 46).

CLASS 31—NATURAL AGRICULTURAL PRODUCTS

FOR AGRICULTURAL, HORTICULTURAL AND FORESTRY PRODUCTS, NAMELY, SEEDS, BULBS, GRAINS FOR PLANTING; FRESH FRUITS AND VEGETABLES; FOODSTUFFS FOR ANIMALS; MALT FOR BREWING AND DISTILLING; ALL AFOREMENTIONED GOODS ESPECIALLY LOW CALORIE AND LOW FAT (U.S. CLS. 1 AND 46).

CLASS 32—LIGHT BEVERAGES

FOR BEERS; MINERAL AND AERATED WATERS AND OTHER NON-ALCOHOLIC DRINKS, NAMELY CARBONATED BEVERAGES; FRUIT DRINKS AND JUICES; SYRUPS FOR MAKING BEVERAGES AND OTHER PREPARATIONS FOR MAKING BEVERAGES, NAMELY, FRUIT DRINKS AND FRUIT JUICE DRINKS; ALL AFOREMENTIONED GOODS ESPECIALLY LOW CALORIE AND LOW FAT (U.S. CLS. 45, 46 AND 48).
WILLIAM VERHOSEK, EXAMINING ATTORNEY

SN 79-033,900. CLARIANT AG, SWITZERLAND, FILED 12-5-2006.

COLORFORWARD

THE MARK CONSISTS OF STANDARD CHARACTERS WITHOUT CLAIM TO ANY PARTICULAR FONT, STYLE, SIZE, OR COLOR.

PRIORITY DATE OF 8-16-2006 IS CLAIMED.
OWNER OF INTERNATIONAL REGISTRATION 0911385 DATED 12-5-2006, EXPIRES 12-5-2016.

CLASS 9—ELECTRICAL AND SCIENTIFIC APPARATUS

FOR OPTICAL DATA MEDIA, NAMELY, CDS AND DVDS CONTAINING INFORMATION REGARDING COLOR FORECASTING (U.S. CLS. 21, 23, 26, 36 AND 38).

CLASS 16—PAPER GOODS AND PRINTED MATTER

FOR PRINTED MATTER, PARTICULARLY, BROCHURES AND MANUALS IN THE FIELD OF COLOR FORECASTING (U.S. CLS. 2, 5, 22, 23, 29, 37, 38 AND 50).
CHRISTOPHER OTT, EXAMINING ATTORNEY

SN 79-034,031. CLARIANT AG, SWITZERLAND, FILED 7-11-2006.

DEXICOM

THE MARK CONSISTS OF STANDARD CHARACTERS WITHOUT CLAIM TO ANY PARTICULAR FONT, STYLE, SIZE, OR COLOR.

PRIORITY DATE OF 4-3-2006 IS CLAIMED.
OWNER OF INTERNATIONAL REGISTRATION 0911793 DATED 7-11-2006, EXPIRES 7-11-2016.

CLASS 1—CHEMICALS

FOR CHEMICALS USED IN INDUSTRY, SCIENCE AND PHOTOGRAPHY, AS WELL AS IN AGRICULTURE, HORTICULTURE AND FORESTRY; UNPROCESSED ARTIFICIAL RESINS AS RAW MATERIALS IN THE FORM OF POWDERS, LIQUIDS OR PASTES; UNPROCESSED PLASTICS; MANURES; FIRE EXTINGUISHING COMPOSITIONS; CHEMICAL SUBSTANCES FOR PRESERVING FOODSTUFFS; CHEMICALS FOR TREATMENT OF GAS AND OIL INSTALLATIONS, NAMELY, CHEMICALS USED FOR REMOVING DEPOSITS FROM GAS AND OIL INSTALLATIONS, CHEMICALS USED FOR REMOVING GASES FROM GAS AND OIL INSTALLATIONS, CHEMICALS USED FOR SEPARATING FLUIDS IN GAS AND OIL INSTALLATIONS (U.S. CLS. 1, 5, 6, 10, 26 AND 46).

CLASS 42—SCIENTIFIC, COMPUTER AND LEGAL SERVICES

FOR SCIENTIFIC RESEARCH AND DEVELOPMENT; INDUSTRIAL ANALYSIS AND RESEARCH SERVICES, NAMELY, CHEMICAL RESEARCH, MECHANICAL RESEARCH OR PRODUCT RESEARCH; SERVICES FOR PRODUCT DEVELOPMENT USED IN THE TREATMENT OF GAS AND OIL INSTALLATIONS (U.S. CLS. 100 AND 101).

CHRISTOPHER OTT, EXAMINING ATTORNEY

SN 79-034,061. LIBERTY GLOBAL EUROPE N.V., NETHERLANDS, FILED 7-10-2006.

I am **RED**

PRIORITY DATE OF 5-31-2006 IS CLAIMED.
OWNER OF INTERNATIONAL REGISTRATION 0911885 DATED 7-10-2006, EXPIRES 7-10-2016.

THE COLOR(S) RED AND GREY IS/ARE CLAIMED AS A FEATURE OF THE MARK.

THE MARK CONSISTS OF THE WORDING "I AM RED", THE COLOR GREY APPEARS IN THE WORDING "I AM" AND THE COLOR RED APPEARS IN THE WORD "RED". THE WHITE IN THE DRAWING REPRESENTS BACKGROUND AND IS NOT CLAIMED AS A FEATURE OF THE MARK.

CLASS 38—COMMUNICATION

FOR BROADCASTING SERVICES AND PROVISION OF TELECOMMUNICATION ACCESS TO FILMS, TV PROGRAMMES AND DOCUMENTARIES PROVIDED VIA A VIDEO-ON-DEMAND SERVICE; BROADCASTING SERVICES AND PROVISION OF TELECOMMUNICATION ACCESS TO FILMS, TV PROGRAMMES AND DOCUMENTARIES PROVIDED VIA A VIDEO-ON-DEMAND SERVICE VIA THE INTERNET; PAY-PER-VIEW TELEVISION TRANSMISSION SERVICES AND VIDEO-ON-DEMAND TRANSMISSION SERVICES. (U.S. CLS. 100, 101 AND 104).

CLASS 41—EDUCATION AND ENTERTAINMENT

FOR ENTERTAINMENT IN THE NATURE OF ONGOING TELEVISION PROGRAMS IN THE FIELD OF NEWS, DRAMA, LIFESTYLE, FASHION, COMEDY, CHARITY, GOSSIP, ENVIRONMENTAL ISSUES, POLITICS, NUTRITION, TECHNOLOGY, TRAVELING, MUSIC AND HEALTHY LIVING; PUBLISHING OF ELECTRONIC PUBLICATIONS, NAMELY, TELEVISION PROGRAMME GUIDES. (U.S. CLS. 100, 101 AND 107).

JAMES LOVELACE, EXAMINING ATTORNEY

SN 79-034.142. NIEDAX GMBH & CO. KG GESELLSCHAFT FÜR VERLEGUNGSMATERIAL, LINZ/RHEIN, FED REP GERMANY, FILED 8-3-2006.



OWNER OF INTERNATIONAL REGISTRATION 0912173 DATED 8-3-2006, EXPIRES 8-3-2016.

CLASS 6—METAL GOODS

FOR COMMON METALS AND THEIR ALLOYS FOR FURTHER MANUFACTURE, METAL BUILDING MATERIALS, NAMELY, BARS OF METAL; MATERIALS OF METAL FOR RAILWAY TRACK CONSTRUCTION; NON-ELECTRIC CABLES AND NON-ELECTRIC WIRES OF COMMON METAL; IRONMONGERY, NAMELY, METAL BOLTS, METAL CLAMPS, METAL CABLE CLIPS; SMALL ITEMS OF METAL HARDWARE, NAMELY, SCREWS, NAILS, NUTS; PIPES AND TUBES OF METAL; METAL WALL PLUGS, RAILS OF METAL, METAL JOISTS, METAL HOLDERS FOR AFFIXING CABLES, METAL CLAMPS FOR CABLES AND PIPES, CABLE CLIPS OF METAL, METAL PIPE MUFFS, METAL PRESSURE SCREWS, METAL CABLE FITTINGS; FIXING MATERIALS, NAMELY, CLIPS OF METAL FOR AFFIXING CABLES, RODS AND BARS; STEEL TAPE; METAL CEILING HOOKS; CABLE CONDUITS OF METAL, NAMELY, INSTALLATION CONDUITS OF METAL; PROTECTIVE CONDUITS AND CABLING CONDUITS AND PARTS AND FITTINGS THEREFORE, NAMELY, METAL CONDUITS, METAL CAPS FOR METAL CONDUITS, METAL PARTITIONS FOR ELECTRICAL BOXES, SPACER BRACKETS OF METAL, STOP ENDS, NAMELY, CONDUIT STOPS OF METAL, METAL FASTENER CLIPS FOR METAL CONDUITS, METAL HANGING RAILS, METAL WALL SILLS, NAMELY, WALL PANELS OF METAL, METAL CAP FASTENERS, METAL MOUNTING RAILS FOR SUPPORTING CONDUITS, SLOTTED, PERFORATED AND EARTHING TAPE, NAMELY, IRON STRIPS FOR SUPPORTING CONDUITS, ALL THE AFORESAID GOODS FOR UNDERFLOOR, SCREED-EMBEDDED, OVERFLOOR, HOLLOW-FLOOR AND DOUBLE-FLOOR CONDUIT SYSTEMS; MATERIAL FOR THE INSTALLATION OF AERIALS, NAMELY, METAL CHIMNEY BANDS FOR PROTECTION AGAINST LIGHTNING, METAL EQUIPMENT CONDUITS FOR PROTECTION OF ELECTRICAL DEVICES, METAL PROTECTIVE CONDUITS FOR PROTECTION AGAINST MECHANICAL FORCE EFFECTS, METAL CABLING CONDUITS FOR ELECTRICAL WIRING, METAL MOUNTING RAILS FOR SUPPORTING CONDUITS, SLOT-PERFORATED EARTHING STEEL TAPE, CABLE SUPPORT SYSTEMS COMPRISED OF METAL CABLE CONDUITS AND METAL MOUNTING RAILS FOR SUPPORTING CONDUITS, METAL JUMPER TROUGH, METAL DISTRIBUTION TROUGH, METAL SCAFFOLDING STIRRUPS FOR CABLES, METAL CABLE LADDERS, METAL WIRE MESH CABLE-TRAYS USED IN BUILDING CONSTRUCTION, METAL CONNECTORS FOR CONDUITS, EARTHING, BONDING CONDUCTORS FOR PROTECTION AGAINST LIGHTNING, EQUIPOTENTIAL BONDING CONDUCTORS FOR PROTECTION AGAINST LIGHTNING, METAL BUSBARS, FASTENING MATERIALS, NAMELY, CLIPS OF METAL FOR AFFIXING BUSBARS, STEEL TAPE, METAL CEILING CLIPS FOR AFFIXING EQUIPOTENTIAL BONDING CONDUCTORS, ACCESSORIES FOR INSTALLATION OF CONDUITS, NAMELY, SPACER BRACKETS OF METAL, END PIECES OF METAL FOR CABLE CONDUITS, METAL FASTENING CLAMPS,

METAL HANGING RAILS AND METAL HOLLOW-SPACE FASTENING CLIPS AND PIPE CLIPS FOR AFFIXING DEVICES AT PIPES AND TUBES; WALL PLUGS OF METAL; METAL HOLDERS FOR ROOF CONDUCTORS FOR PROTECTION AGAINST LIGHTNING (U.S. CLS. 2, 12, 13, 14, 23, 25 AND 50).

CLASS 9—ELECTRICAL AND SCIENTIFIC APPARATUS

FOR APPARATUS AND INSTRUMENTS FOR CONDUCTING, SWITCHING, TRANSFORMING, ACCUMULATING, REGULATING AND CONTROLLING ELECTRICITY, NAMELY, ELECTRICAL RELAYS, ELECTRICAL TRANSFORMERS, ELECTRICAL FUSES, VOLTAGE REGULATORS FOR ELECTRICAL POWER, ELECTRICAL CONDUCTORS; ELECTRIC INSTALLATION MATERIALS FOR ELECTRICAL INSTALLATIONS, NAMELY, LAMP ELECTRIC SOCKETS, WEAK-CURRENT THREADED ELECTRIC SOCKETS, ILLUMINATION ELECTRIC SOCKETS, THREADED ELECTRIC SOCKETS, DWARF ELECTRIC SOCKETS, FIXING PLATES FOR ELECTRIC CABLES AND ELECTRIC WIRES, NAMELY, ELECTRIC SWITCH PLATES AND ELECTRICAL OUTLET PLATES; ELECTRIC INSTALLATION CONDUITS, NAMELY, PLASTIC CABLE CONDUITS FOR USE IN ELECTRICAL INSTALLATIONS, PLASTIC PROTECTIVE CONDUITS FOR USE IN ELECTRICAL INSTALLATIONS, CABLING CONDUITS OF PLASTIC FOR ELECTRIC CABLES AND ELECTRIC APPARATUS AND FOR INSTALLING BUILT-IN ELECTRICAL DEVICES, NAMELY, SWITCHES, BUTTONS, SOCKETS, BRANCH BOXES, CONNECTOR BOXES, ELECTRIC CONNECTION PARTS, AERIALS, CABLE CLIPS, JUNCTION BOXES, CLAMPS, LIGHT REGULATORS, CABLE PIPES FOR ELECTRIC CABLES, CONNECTOR MUFFS FOR ELECTRIC CABLES AND WIRES, ELECTRIC RELAYS, SWITCHING DEVICES, FUSES, DISTRIBUTION BOXES, CABLING CONDUITS FOR ELECTRIC CABLES, THREADED, PLUG-IN AND SCREWLESS TERMINALS FOR ELECTRIC CABLES AND WIRES, CABLE CONNECTORS, CABLE CONNECTORS, OVERVOLTAGE DEVICES, LIGHTNING CONDUCTORS, LUSTER TERMINALS, TIME SWITCHES, AND MOTION DETECTORS, ALL THE AFORESAID GOODS FOR UNDERFLOOR, SCREED-EMBEDDED, OVERFLOOR, HOLLOW-FLOOR AND DOUBLE-FLOOR SYSTEMS; USED TOOLS IN THE FIELD OF ELECTROTECHNICS, NAMELY, VOLTAGE TESTERS; LIGHTNING PROTECTION EQUIPMENT, NAMELY, ELECTRICAL LIGHTNING CONDUCTORS AND EARTHED POLES, NAMELY, LIGHTNING RODS; ELECTRICAL BRANCH BOXES; AERIALS (U.S. CLS. 21, 23, 26, 36 AND 38).

CLASS 17—RUBBER GOODS

FOR RUBBER, NAMELY, NATURAL RUBBER AND SYNTHETIC RUBBER, GUTTA-PERCHA, RUBBER GUM, ASBESTOS GUM, MICA AND GOODS MADE FROM THESE MATERIALS, NAMELY GASKETS FOR WEATHER-PROOFING AND FOR INSECT-PROOFING, RUBBER LIDS AND CAPS FOR INDUSTRIAL PACKAGING, INSULATION COVERS FOR INDUSTRIAL MACHINERY, EXTRUDED PLASTICS IN THE FORM OF BARS, BLOCKS AND PELLETS FOR USE IN MANUFACTURING; PACKAGING, STOPPING AND INSULATION MATERIALS FOR ELECTRICAL BOXES, NAMELY, RUBBER TUBES, RUBBER PLATES, ASBESTOS PLATES AND FOAMED POLYSTYRENE PLATES; PLASTIC FLEXIBLE TUBES FOR DELIVERING FLUIDS FROM ONE END OF THE TUBE TO THE OTHER END OF THE TUBE, OIL AND PETROL RESISTANT RUBBER RINGS FOR USE AS A PIPE CONNECTION SEAL, RINGS OF RUBBER FOR USE AS A PIPE CONNECTION SEAL, NIPPLE SEALS OF RUBBER AND SEALING STOPPERS OF PLASTIC FOR PIPE CONNECTIONS FOR ELECTRICAL PIPE, PROTECTIVE FLEXIBLE-PIPE GLANDS OF RUBBER FOR FLEXIBLE PIPES OF PLASTIC, PLASTIC PROTECTIVE FLEXIBLE PIPES OF PVC FOR ELECTRICAL CABLES (U.S. CLS. 1, 5, 12, 13, 35 AND 50).

CLASS 20—FURNITURE AND ARTICLES NOT OTHERWISE CLASSIFIED

FOR BLIND PLUGS FOR ELECTRICAL BRANCH BOXES, AND END PIECES FOR CABLE CONDUITS, BOTH OF THE AFOREMENTIONED GOODS ARE OF PLASTIC, WOOD, CORK, REED, CANE, HORN, BONE, IVORY, WHALEBONE, SHELL, AMBER, MOTHER-OF-PEARL, MEERSCHAUM AND SUBSTITUTES FOR ALL THESE MATERIALS; TERMINAL SLEEVES OF PLASTIC FOR INSTALLATION MATERIAL FOR PLASTIC PIPES; FASTENERS OF PLASTIC FOR INSTALLATION MATERIAL FOR FASTENING TUBES AND PIPES; REGULATING SCREWS OF PLASTIC FOR ELECTRICAL INSTALLATIONS; BLIND PLUGS OF PLASTIC FOR ELECTRICAL PIPE AND ELECTRICAL BOX, WITH SLITS FOR BRANCH BOXES AND PIPES; NON-METAL HARDWARE, NAMELY, NON-METAL COUNTER NUTS FOR PLASTIC CONNECTORS FOR ELECTRICAL INSTALLATIONS; PROFILE RAILS OF PLASTIC; NON-METAL FASTENERS, NAMELY, BODY-BOUND RIVETS; NON-METAL ROOF CONDUIT BRACKETS; NON-METAL FLAT ROOF CONDUIT BRACKETS; NON-METAL CONDUIT AND ROD BRACKETS, ALL OF THE AFORESAID GOODS ARE COMPRISED OF A MIXTURE OF MATERIALS, PLASTIC PREDOMINATING; NON-METAL GUTTER CLAMPS, PLUGS, NOT OF METAL, NAMELY, DOWELS, NOT OF METAL (U.S. CLS. 2, 13, 22, 25, 32 AND 50).

MARY MUNSON, EXAMINING ATTORNEY

SN 79-034,159. LIBERTY GLOBAL EUROPE N.V., NETHERLANDS, FILED 7-10-2006.

I AM RED

THE MARK CONSISTS OF STANDARD CHARACTERS WITHOUT CLAIM TO ANY PARTICULAR FONT, STYLE, SIZE, OR COLOR.

PRIORITY DATE OF 5-31-2006 IS CLAIMED.
OWNER OF INTERNATIONAL REGISTRATION 0912234 DATED 7-10-2006, EXPIRES 7-10-2016.

CLASS 38—COMMUNICATION

FOR BROADCASTING SERVICES AND PROVISION OF TELECOMMUNICATION ACCESS TO FILMS, TV PROGRAMMES AND DOCUMENTARIES PROVIDED VIA A VIDEO-ON-DEMAND SERVICE; BROADCASTING SERVICES AND PROVISION OF TELECOMMUNICATION ACCESS TO FILMS, TV PROGRAMMES AND DOCUMENTARIES PROVIDED VIA A VIDEO-ON-DEMAND SERVICE VIA THE INTERNET; PAY-PER-VIEW TELEVISION TRANSMISSION SERVICES AND VIDEO-ON-DEMAND TRANSMISSION SERVICES. (U.S. CLS. 100, 101 AND 104).

CLASS 41—EDUCATION AND ENTERTAINMENT

FOR ENTERTAINMENT IN THE NATURE OF ONGOING TELEVISION PROGRAMS IN THE FIELD OF NEWS, DRAMA, LIFESTYLE, FASHION, COMEDY, CHARITY, GOSSIP, ENVIRONMENTAL ISSUES, POLITICS, NUTRITION, TECHNOLOGY, TRAVELING, MUSIC AND HEALTHY LIVING; PUBLISHING OF ELECTRONIC PUBLICATIONS, NAMELY, TELEVISION PROGRAMME GUIDES. (U.S. CLS. 100, 101 AND 107).

JAMES LOVELACE, EXAMINING ATTORNEY

SN 79-034,187. KING OF HOUSTON PTE LTD, SINGAPORE, FILED 10-19-2006.

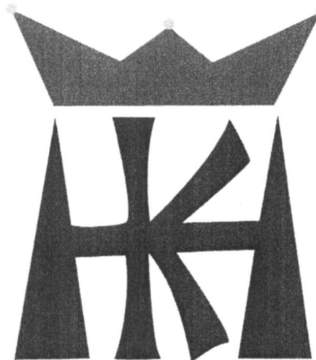

PRIORITY DATE OF 9-19-2006 IS CLAIMED.
OWNER OF INTERNATIONAL REGISTRATION 0912313 DATED 10-19-2006, EXPIRES 10-19-2016.

"THE MARK CONSISTS OF THE LETTERS "K" AND "H" AND A DESIGN PORTION COMPRISING A STYLIZED CROWN."

CLASS 35—ADVERTISING AND BUSINESS

FOR BUSINESS INFORMATION SERVICES; ASSISTANCE WITH BUSINESS MANAGEMENT AND PLANNING; ADVERTISING SERVICES RELATING TO BOOKS, NAMELY, RENTAL OF ADVERTISING SPACE ON THE INTERNET; PROVISION OF SPACE ON WEBSITES FOR ADVERTISING GOODS AND SERVICES, NAMELY, RENTAL OF ADVERTISING SPACE ON WEB SITES; ON-LINE RETAIL STORE SERVICES FEATURING BOOKS, NOVELS AND COMIC BOOKS; COMPILATION AND PROVISION OF ON-LINE BUSINESS INFORMATION AND BUSINESS INFORMATION ABOUT CONSUMER GOODS; INFORMATION, ADVISORY AND CONSULTANCY SERVICES RELATING TO THE AFORESAID (U.S. CLS. 100, 101 AND 102).

CLASS 41—EDUCATION AND ENTERTAINMENT

FOR ENTERTAINMENT SERVICES AND PROVISION OF ENTERTAINMENT SERVICES THROUGH THE MEDIA OF PUBLICATIONS, NAMELY, ON-LINE PUBLICATION OF ELECTRONIC BOOKS, NOVELS AND COMIC BOOKS AND JOURNALS; INFORMATION, ADVISORY AND CONSULTATION SERVICES RELATING TO THE PUBLICATION OF BOOKS (U.S. CLS. 100, 101 AND 107).

CLASS 42—SCIENTIFIC, COMPUTER AND LEGAL SERVICES

FOR LICENSING OF INTELLECTUAL PROPERTY; LICENSING OF INTELLECTUAL PROPERTY RIGHTS; LICENSING OF COPYRIGHT; ADVISORY SERVICES RELATING TO INTELLECTUAL PROPERTY LICENSING; PROFESSIONAL ADVISORY SERVICES RELATING TO LICENSING OF COPYRIGHTS; CREATING AND MAINTAINING WEBSITES FOR OTHERS; HOSTING THE WEBSITES OF OTHERS ON A COMPUTER SERVER FOR A GLOBAL COMPUTER NETWORK; INFORMATION, ADVISORY AND CONSULTING SERVICES RELATING TO THE AFORESAID (U.S. CLS. 100 AND 101).

RENEE MCCRAY, EXAMINING ATTORNEY

SN 79-034,274. EUROPEAN ENERGY EXCHANGE AG, 04109 LEIPZIG, FED REP GERMANY, FILED 9-28-2006.

SN 79-035,522. "PIK CENTR CO., LTD", RUSSIAN FED., FILED 12-18-2006.

Carbix

THE MARK CONSISTS OF STANDARD CHARACTERS WITHOUT CLAIM TO ANY PARTICULAR FONT, STYLE, SIZE, OR COLOR.

PRIORITY DATE OF 4-12-2006 IS CLAIMED.

OWNER OF INTERNATIONAL REGISTRATION 0912599 DATED 9-28-2006, EXPIRES 9-28-2016.

CLASS 36—INSURANCE AND FINANCIAL

FOR FINANCIAL AFFAIRS, NAMELY CALCULATING EXCHANGE RELATED INDEXES FOR FINANCIAL AND COMMODITY EX-CHANGES; OPERATING AN EXCHANGE, NAMELY FINANCIAL AND COMMODITY EXCHANGE; PAYMENT TRANSACTION SERVICES AND SETTLING OF ACCOUNTS, NAMELY FINANCIAL CLEARING SERVICES AND ELECTRONIC PROCESSING AND TRANSMISSION ELECTRONIC PAYMENTS VIA A GLOBAL COMPUTER NETWORK; FINANCIAL CONSULTING RELATING TO THE CONCEPTION, FOUNDING AND OPERATING OF AN EXCHANGE; FINANCIAL ANALYSES; FINANCIAL EVALUATIONS RELATING TO INSURANCE, BANKING AND REAL ESTATE, FINANCING SERVICES; FINANCING AND CREDIT RISK INSURANCE, NAMELY FACTORING; MONEY LENDING AGAINST SECURITY; DEBT COLLECTION AGENCIES, STOCK EXCHANGE PRICE QUOTATIONS; FINANCING, NAMELY GRANTING OF LOANS; SAFE DEPOSIT BOX SERVICES FOR VALUABLES; FUNDS INVESTMENT BROKERAGE; MONETARY AFFAIRS, NAMELY ISSUING OF TRAVELLERS' CHECKS, STOCK BROKERAGE, EXCHANGING MONEY, CREDIT CONSULTING, CREDIT AGENCIES, FINANCIAL RESEARCH; INSURANCE, NAMELY INSURANCE BROKERAGE; FINANCIAL MANAGEMENT; REAL ESTATE SERVICES, NAMELY REAL ESTATE AND APARTMENT AGENCIES AND MORTGAGE LENDING AGENCIES; RENTAL OF REAL ESTATE; RENTAL OF OFFICE SPACE; SERVICES OF REAL ESTATE AGENTS; VALUATION OF REAL ESTATE; REAL ESTATE MANAGEMENT; AND FINANCIAL CONSULTING IN THE ENERGY SECTOR (U.S. CLS. 100, 101 AND 102).

CLASS 39—TRANSPORTATION AND STORAGE

FOR POWER SUPPLY SERVICES, NAMELY TRANSPORTATION AND DISTRIBUTION OF ELECTRICITY, GAS AND HEAT, TRANSPORT THROUGH PIPELINES OF GAS AND LIQUID AND SOLID MATTERS, NAMELY OIL (U.S. CLS. 100 AND 105).

CLASS 42—SCIENTIFIC, COMPUTER AND LEGAL SERVICES

FOR TECHNICAL CONSULTATION IN THE ENERGY SECTOR; LICENSING OF INTELLECTUAL PROPERTY (U.S. CLS. 100 AND 101).

DAYNA BROWNE, EXAMINING ATTORNEY

KIRA PLASTININA

OWNER OF INTERNATIONAL REGISTRATION 0916343 DATED 12-18-2006, EXPIRES 12-18-2016.

"THE NAME(S), PORTRAIT(S), AND/OR SIGNATURE(S) SHOWN IN THE MARK IDENTIFIES KIRA PLASTININA, WHOSE CONSENT(S) TO REGISTER IS SUBMITTED."

CLASS 3—COSMETICS AND CLEANING PREPARATIONS

FOR ADHESIVES FOR COSMETIC USE, AFTER SUN CREAMS, AFTER-SHAVE, AFTER-SHAVE BALMS, AFTER-SHAVE CREAMS, AFTER-SHAVE EMULSIONS, AFTER-SHAVE GEL, AFTER-SHAVE LOTIONS, AFTER-SUN LOTIONS, AGE RETARDANT GEL, AGE RETARDANT LOTION, AGE SPOT REDUCING CREAMS, ALCOHOL FOR CLEANING PURPOSES, ALL PURPOSE CLEANING PREPARATIONS, ALL PURPOSE COTTON SWABS FOR PERSONAL USE, ALL-PURPOSE CLEANERS, AMBERGRIS, ALMOND SOAPS, ANTIBACTERIAL SOAP, ANTIPERSPIRANTS FOR PERSONAL USE, ANTI-AGING CREAM, ANTI-WRINKLE CREAM, AROMATHERAPY CREAMS, AROMATHERAPY LOTIONS, AROMATHERAPY OILS, ARTIFICIAL EYELASHES, ARTIFICIAL FINGERNAILS, ASTRINGENTS FOR COSMETIC PURPOSES, BABY OILS, BABY POWDERS, BABY SHAMPOO, BAR SOAP, BATH FOAM, BATH GEL, BATH LOTION, BATH OILS FOR COSMETIC PURPOSES, BATH SALTS, BEAUTY CREAMS, BEAUTY CREAMS FOR BODY CARE, BEAUTY GELS, BEAUTY LOTIONS, BEAUTY MASKS, BEAUTY MILKS, BERGAMOT OIL, BLEACHING PREPARATIONS FOR COSMETIC PURPOSES, BLUSH, BODY AND BEAUTY CARE COSMETICS, BODY ART PENS, BODY CREAM, BODY CREAM SOAP, BODY DEODORANT IN PILL FORM, BODY EMULSIONS, BODY LOTION, BODY MASK CREAM, BODY MILK, BODY OIL, BODY SCRUB, BODY SPRAYS, BODY WASHES, CHALK FOR COSMETIC USE, CLEANSING CREAMS, COCOA BUTTER FOR COSMETIC PURPOSES, COLD CREAM, COLOGNE, COLORING PREPARATIONS FOR COSMETIC PURPOSES, COMPACTS CONTAINING MAKE-UP, COSMETIC BALLS, COSMETIC CREAMS, COSMETIC FACIAL BLOTTER PAPERS, COSMETIC MILKS, COSMETIC OILS, COSMETIC PADS, COSMETIC PENCILS, COSMETIC PREPARATIONS FOR SKIN RENEWAL, COSMETIC PREPARATIONS AGAINST SUNBURN, COSMETIC PREPARATIONS FOR BODY CARE, COSMETIC PREPARATIONS FOR EYE LASHES, COSMETIC PREPARATIONS FOR THE CARE OF MOUTH AND TEETH, COSMETIC ROUGES, COSMETIC SOAPS, COSMETIC SUN-PROTECTING PREPARATIONS, COSMETIC SUN-TANNING PREPARATIONS, COSMETICS, COSMETICS NAMELY, COMPACTS, LIP PRIMER, LIP REPAIRERS; COTTON FOR COSMETIC PURPOSES; COTTON STICKS FOR COSMETIC PURPOSES; CREAM SOAPS; CREAMS FOR CELLULITE REDUCTION; CREAMY FACE POWDER; CREAMY FOUNDATION; CUTICLE CONDITIONERS; CUTICLE CREAM; CUTICLE REMOVING PREPARATIONS; DECORATIVE TRANSFERS AND SKIN JEWELS FOR COSMETIC PURPOSES; DEODORANT FOR PERSONAL USE; DEODORANT SOAP; DEPLATORIES; EAU DE PARFUM; EAU DE TOILETTE; EPILATORY STRIPS; ESSENTIAL OILS; EXFOLIANT CREAMS; EYE COMPRESSES FOR COSMETIC PURPOSES; EYE CREAM; EYE MAKE-UP; EYE MAKE-UP REMOVER; EYE PENCILS; EYE SHADOW; EYEBROW COLORS; EYEBROW PENCILS; EYELINER; EYELINER PENCILS; FACE AND BODY CREAMS; FACE MILK AND LOTIONS; FACE POWDER; FACIAL MAKE-UP; FALSE EYELASHES; FALSE NAILS; FOAMS CONTAINING COSMETICS AND SUNSCREENS; FOUNDATION MAKE-UP; GAUZE FOR COSMETIC PURPOSES; GEL EYE MASKS; HAIR BALSAM; HAIR BLEACH; HAIR BLEACHES; HAIR CARE CREAMS; HAIR CARE PREPARATIONS; HAIR CLEANING PREPARATIONS; HAIR COLOR; HAIR COLOR REMOVERS; HAIR CONDITIONER; HAIR DRESSINGS FOR MEN; HAIR DRESSINGS FOR WOMEN; HAIR FIXERS; HAIR GEL; HAIR LOTIONS; HAIR MOUSSES; HAIR OILS; HAIR RELAXING PREPARATIONS; HAIR REMOVING CREAM; HAIR SPRAY; HAIR STRAIGHTENING PREPARATIONS;

HAIR STYLING PREPARATIONS; HAIR TONICS; HAND CLEANING PREPARATIONS; HAND CREAMS; HAND LOTIONS; HAND SOAPS; HENNA FOR COSMETIC PURPOSES; LIP BALM; LIP CREAM; LIP GLOSS; LIP LINER; LIPSTICK; LIPSTICK HOLDERS; LIQUID SOAPS FOR HANDS, FACE AND BODY; LIQUID PERFUMES; LOTIONS FOR FACE AND BODY CARE; MAKE UP FOUNDATIONS; MAKE UP REMOVING PREPARATIONS; MAKE-UP; MAKE-UP PENCILS; MAKE-UP POWDER; MAKE-UP PRODUCTS FOR THE FACE AND BODY; MASCARAS; MASSAGE OILS; MINERAL SALT IN THE NATURE OF BATH SALTS NOT FOR MEDICAL PURPOSES; MOISTURIZING MILKS; NAIL CARE PREPARATIONS; NAIL CREAM; NAIL ENAMELS; NAIL HARDENERS; NAIL POLISH; NAIL STRENGTHENERS; NAIL TIPS; NAIL VARNISH FOR COSMETIC PURPOSES; NAIL-POLISH REMOVERS; NATURAL ESSENTIAL OILS; NATURAL MINERAL MAKE-UP; NON-MEDICATED ACNE TREATMENT PREPARATIONS; NON-MEDICATED BATH PREPARATIONS; NON-MEDICATED BODY SOAKS; NON-MEDICATED FOOT CREAM; NON-MEDICATED LIP CARE PREPARATIONS; NON-MEDICATED LIP PROTECTOR; NON-MEDICATED OINTMENTS FOR THE PREVENTION AND TREATMENT OF SUNBURN; NON-MEDICATED SCALP TREATMENT CREAM; NON-MEDICATED SKIN CARE PREPARATIONS; NON-MEDICATED SKIN CREAMS; NON-MEDICATED SUN CARE PREPARATIONS; NON-MEDICATED TOILETRIES; NUTRITIONAL OILS FOR COSMETIC PURPOSES; OIL BATHS FOR HAIR CARE; OILS FOR HAIR CONDITIONING; PARAFFIN WAX FOR COSMETIC PURPOSES; PENCILS FOR COSMETIC PURPOSES; PERFUME OILS; PERFUME OILS FOR THE MANUFACTURE OF COSMETIC PREPARATIONS; PERFUMED CREAMS; PERFUMED EXTRACTS FOR TISSUES AND PERFUMES; PERFUMED PASTE; PERFUMED POWDERS; PERFUMED SOAPS; PERFUMERY; PERFUMING SACHETS; PRE-SHAVE CREAMS; ROSE OIL FOR COSMETIC PURPOSES; ROUGES; SHAMPOOS; SHAMPOO-CONDITIONERS; SHAVING BALM; SHAVING CREAMS; SHAVING FOAM; SHAVING GELS; SHAVING LOTIONS; SHAVING PREPARATIONS; SHAVING SOAP; SHOWER AND BATH GEL; SHOWER CREAMS; SKIN AND BODY TOPICAL LOTIONS, CREAMS AND OILS FOR COSMETIC USE; SKIN ABRASIVE PREPARATIONS; SKIN BRONZING CREAMS; SKIN CLEANSING CREAM; SKIN CLEANSING LOTION; SKIN CONDITIONERS; SKIN CREAMS; SKIN LOTIONS; SKIN SOAP; SUN CARE LOTIONS; SUN CREAMS; SUN SCREEN PREPARATIONS; SUNTANNING PREPARATIONS; SYNTHETIC PERFUMERY; TALCUM POWDERS; TOILET SOAPS; TOILET WATER; TOOTHPASTES (U.S. CLS. 1, 4, 6, 50, 51 AND 52).

CLASS 9—ELECTRICAL AND SCIENTIFIC APPARATUS

FOR FRAMES FOR SPECTACLES AND SUNGLASSES; ANTI-DAZZLE SPECTACLES; SPECTACLES; CHILDREN'S EYE GLASSES; PROTECTIVE GLASSES; READING GLASSES; SPORTS GLASSES; SUNGLASSES (U.S. CLS. 21, 23, 26, 36 AND 38).

CLASS 14—JEWELRY

FOR JEWELRY, NAMELY, AMULETS; ANKLE BRACELETS; BADGES OF PRECIOUS METAL; BODY-PIERCING RINGS; BODY-PIERCING STUDS; BRACELETS; BRACELETS OF PRECIOUS METAL; BRONZE JEWELRY; BROOCHES; CHARMS; BOXES FOR TIMEPIECES; CHRONOGRAPHS FOR USE AS WATCHES; CLIP EARRINGS; CLOCK AND WATCH HANDS; CLOCKS; CLOISONNE PINS; COLLECTIBLE COINS; COMMEMORATIVE COINS; COMMEMORATIVE STATUARY CUPS MADE OF PRECIOUS METAL; COSTUME JEWELRY; CUFF-LINKS; DESKTOP STATUARY MADE OF PRECIOUS METAL; DIALS FOR CLOCK-AND-WATCH-MAKING; DIAMOND BELTS; DIVING WATCHES; DRAWER PULLS OF PRECIOUS METAL; EAR CLIPS; EAR STUDS; EARRINGS; FANCY KEYRINGS OF PRECIOUS METALS; FIGURES OF PRECIOUS METAL; IDENTIFICATION BRACELETS; JEWEL CHAINS; JEWEL PENDANTS; JEWELRY; JEWELRY BOXES; JEWELRY CASES; JEWELRY CASKETS; JEWELRY FOR THE HEAD; JEWELRY PINS FOR USE ON HATS; JEWELRY WATCHES; JEWELRY, NAMELY,

CROSSES; JEWELRY, NAMELY, PRECIOUS METAL PLATED REAL LEAVES AND FLOWERS; KEY CHAINS OF PRECIOUS METAL; KEY HOLDERS OF PRECIOUS METALS; KEY RINGS OF PRECIOUS METAL; LAPEL PINS; LEATHER JEWELRY AND ACCESSORY BOXES; MEDALLIONS; MEDALS; NECK CHAINS; NECKLACES; NECKTIE FASTENERS; NON-MONETARY COINS; ORNAMENTAL LAPEL PINS; ORNAMENTAL PINS; ORNAMENTS OF PRECIOUS METAL; PENDANTS; PENDULUM CLOCKS; PINS BEING JEWELRY; POCKET WATCHES; RINGS BEING JEWELRY; SCULPTURES MADE OF PRECIOUS METAL; SHIRT STUDS; STATUETTES OF PRECIOUS METAL; TIARAS; WATCH CHAINS; WATCH CASES; WATCH BRACELETS; WATCH BANDS AND STRAPS; WATCH PARTS; WATCH STRAPS; WATCHES; WOODEN JEWELLERY BOXES; WORKS OF ART OF PRECIOUS METAL; WRIST WATCHES (U.S. CLS. 2, 27, 28 AND 50).

CLASS 18—LEATHER GOODS

FOR RAINPROOF PARASOLS; PARASOLS (U.S. CLS. 1, 2, 3, 22 AND 41).

CLASS 21—HOUSEWARES AND GLASS

FOR PERFUME SPRAYERS; COMBS; FLASKS (U.S. CLS. 2, 13, 23, 29, 30, 33, 40 AND 50).

CLASS 25—CLOTHING

FOR BANDANAS; NECKERCHIEFS; UNDERWEAR; OVERALLS; BOAS; ANKLE BOOTS; BREECHES; TROUSERS; BRASSIERES; VEILS; ASCOTS; LEGGINGS; GAITERS; VESTS; SPORTS JERSEYS; HOSIERY; HOODS; COLLAR PROTECTORS; CAP VISORS; TIGHTS; COMBINATIONS; WET SUITS FOR WATER-SKIING AND SUBAQUA; SUITS; BATHING SUITS; MASQUERADE COSTUMES; BEACHWEAR; JACKETS; CAMISOLES; T-SHIRTS; SPORTS SHIRTS WITH SHORT SLEEVES; SHIRT FRONTS; FUR STOLE; SOCKS; BATH SLIPPERS; BEACH SHOES; AFTER SKI BOOTS; CLIMBING BOOTS; FOOTBALL BOOTS AND STUDS THEREFORE; HIKING BOOTS; HORSE-RIDING BOOTS; MOTORCYCLIST BOOTS; SKI AND SNOWBOARD SHOES AND PARTS THEREOF; SOCCER BOOTS; ANGLERS' SHOES; ATHLETIC SHOES; BALLET SHOES; BASEBALL SHOES; BOWLING SHOES; BOXING SHOES; CYCLING SHOES; GOLF SHOES; HANDBALL SHOES; HOCKEY SHOES; RUGBY SHOES; TENNIS SHOES; VOLLEYBALL SHOES; PUMPS; FOOTWEAR; JERSEYS; LEATHER BELTS; LEATHER COATS; LEATHER HEADWEAR; LEATHER JACKETS; LEATHER PANTS; SUITS OF LEATHER; TROUSERS OF LEATHER; TOPCOATS; RAINCOATS; TRENCH COATS; PARKAS; PELERINES; GLOVES; PAJAMAS; SCARVES; FROCKS; WATERPROOF JACKETS AND PANTS; HEADBANDS; GARTERS; SUSPENDER BELTS FOR WOMEN; LACE BOOTS; BELTS; MONEY BELTS; PULLOVERS; SHIRTS; FOOTWEAR MADE OF WOOD; SANDALS; BOOTS; SARIS; SWEATERS; UNDERPANTS; GYMNASTIC SHOES; SLIPPERS; SHOES; TURBANS; HEAD WEAR; APRONS; DRESSING GOWNS; SHOWER CAPS; STOCKINGS; SHAWLS; SKULL CAPS; BATHING CAPS; SASHES; PELISSES; CANVAS SHOES; SKIRTS; PETTICOATS (U.S. CLS. 22 AND 39).

JOHN DWYER, EXAMINING ATTORNEY

SN 79-035,584. ZUCKERFORSCHUNG TULLN; GESELLSCHAFT M.B.H., AUSTRIA, FILED 1-5-2007.

LIMOS

PRIORITY DATE OF 7-5-2006 IS CLAIMED.
OWNER OF INTERNATIONAL REGISTRATION 0916516
DATED 1-5-2007, EXPIRES 1-5-2017.

CLASS 9—ELECTRICAL AND SCIENTIFIC APPARATUS

FOR COMPUTER SOFTWARE USED TO CALCULATE THE OPTIMAL DOSAGE OF LIME OR CALCIUM NEEDED TO PURIFY LIQUIDS (U.S. CLS. 21, 23, 26, 36 AND 38).

CLASS 42—SCIENTIFIC, COMPUTER AND LEGAL SERVICES

FOR DESIGN AND DEVELOPMENT OF COMPUTER SOFTWARE, ESPECIALLY FOR THE CALCULATION OF DOSAGES ACCORDING TO THE DEMAND BASED ON MEASURING DATA (U.S. CLS. 100 AND 101).

ADA HAN, EXAMINING ATTORNEY

SN 79-037,209. S.C.SUPREMIA GRUP S.R.L., ALBA-IULIA; JUD. ALBA, ROMANIA, FILED 9-27-2006.



Ingredientul performantei tale!

SN 79-035,943. ERBER AKTIENGESELLSCHAFT, AUSTRIA, FILED 9-7-2006.

NGPs

PRIORITY DATE OF 3-7-2006 IS CLAIMED.
OWNER OF INTERNATIONAL REGISTRATION 0917390
DATED 9-7-2006, EXPIRES 9-7-2016.

CLASS 5—PHARMACEUTICALS

FOR VETERINARY PREPARATIONS FOR ANIMAL HUSBANDRY, NAMELY, NATURAL GROWTH PROMOTERS; PREPARATIONS FOR DESTROYING VERMIN; FUNGICIDES; HERBICIDES (U.S. CLS. 6, 18, 44, 46, 51 AND 52).

CLASS 31—NATURAL AGRICULTURAL PRODUCTS

FOR FOODSTUFFS FOR ANIMALS; SOY BEAN AND FISH MEAL FOR ANIMAL FEED; GRAINS FOR ANIMAL FEED; NATURAL ADDITIVES FOR FODDER, NOT FOR MEDICAL PURPOSES, INCLUDING MINERAL ADDITIVES; ANIMAL FODDER (U.S. CLS. 1 AND 46).

DAVID TOOLEY, EXAMINING ATTORNEY

OWNER OF INTERNATIONAL REGISTRATION 0920763
DATED 9-27-2006, EXPIRES 9-27-2016.

NO CLAIM IS MADE TO THE EXCLUSIVE RIGHT TO USE "GRUP" AND "INGREDIENTE ALIMENTARE", APART FROM THE MARK AS SHOWN.

THE COLOR(S) BLUE, GREEN AND BLACK IS/ARE CLAIMED AS A FEATURE OF THE MARK.

THE MARK CONSISTS OF A BLUE INCOMPLETE OVAL WITH A GREEN LEAF IN THE OPENING OF THE OVAL. THE BLUE WORDING "SUPREMIA" AND THE GREEN WORDING "INGREDIENTE ALIMENTARE" APPEAR INSIDE THE INCOMPLETE OVAL DESIGN. THE BLACK WORDING "INGREDIENTUL PERFORMANTEI TALE!" APPEARS BELOW THE INCOMPLETE OVAL DESIGN. THE COLOR WHITE THAT APPEARS IN: (1) THE GREEN LEAF DESIGN, (2) THE WORDING "GRUP" WRITTEN WITHIN A BLUE BAR, AND (3) WITHIN THE OVAL DESIGN IS NOT A FEATURE OF THE MARK, BUT RATHER REPRESENTS A TRANSPARENCY THROUGH TO THE BACKGROUND OF THE MARK.

THE ENGLISH TRANSLATION OF THE FOREIGN WORDING "GRUP," "INGREDIENTE ALIMENTARE" AND "INGREDIENTUL PERFORMANTEI TALE!" IS "GROUP," "FOOD INGREDIENTS" AND "THE INGREDIENT OF YOUR PERFORMANCE!"

CLASS 1—CHEMICALS

FOR EMULSIFIERS FOR USE IN THE MANUFACTURE OF FOODS (U.S. CLS. 1, 5, 6, 10, 26 AND 46).

CLASS 2—PAINTS

FOR FOOD DYES (U.S. CLS. 6, 11 AND 16).

CLASS 29—MEATS AND PROCESSED FOODS

FOR FORMED TEXTURED VEGETABLE PROTEIN FOR USE AS A MEAT EXTENDER OR MEAT SUBSTITUTE; UNFORMED TEXTURED VEGETABLE PROTEIN FOR USE AS A MEAT EXTENDER OR MEAT SUBSTITUTE (U.S. CL. 46).

CLASS 30—STAPLE FOODS

FOR SPICES; EXTRACTS USED AS FLAVORING; FLAVORING SYRUP; FOOD ADDITIVES FOR NON-NUTRITIONAL PURPOSES FOR USE AS A FLAVORING, INGREDIENT OR FILLER; FOOD FLAVORINGS (U.S. CL. 46).

MEGAN WHITNEY, EXAMINING ATTORNEY

SN 79-037,243. TAKASAGO KORYO KOGYO KABUSHIKI KAISHA, TA TAKASAGO INTERNATIONAL CORPORATION, OHTA-KU; TOKYO 144-8721, JAPAN, FILED 2-15-2007.

Aromagical Informatics

PRIORITY DATE OF 11-15-2006 IS CLAIMED.
OWNER OF INTERNATIONAL REGISTRATION 0920874 DATED 2-15-2007, EXPIRES 2-15-2017.
NO CLAIM IS MADE TO THE EXCLUSIVE RIGHT TO USE "INFORMATICS", APART FROM THE MARK AS SHOWN.

CLASS 1—CHEMICALS

FOR CHEMICALS FOR USE IN THE MANUFACTURE OF PHARMACEUTICAL PREPARATIONS, DRUG BUILDING BLOCKS, ELECTROPHOTOGRAPHIC LIGHT SENSITIVE PHOTOCONDUCTORS, LIQUID CRYSTALS, PERFUME, NON-ESSENTIAL FOOD FLAVORINGS, COSMETICS, TOILET WATER AND AGRICULTURAL CHEMICALS (U.S. CLS. 1, 5, 6, 10, 26 AND 46).

CLASS 3—COSMETICS AND CLEANING PREPARATIONS

FOR PERFUME AND TOILET WATER (U.S. CLS. 1, 4, 6, 50, 51 AND 52).

CLASS 30—STAPLE FOODS

FOR FOOD FLAVORINGS NOT BEING ESSENTIAL OILS (U.S. CL. 46).
BARBARA A. LOUGHRAN, EXAMINING ATTORNEY

CLASS 30—STAPLE FOODS

FOR YEAST, YEAST EXTRACTS, YEAST PRODUCTS, NAMELY, YEAST POWDER; FOOD SUPPLEMENTS AND FOOD INGREDIENTS, NOT FOR MEDICAL USE, NAMELY, FOOD ADDITIVES FOR NON-NUTRITIONAL PURPOSES FOR USE AS A FLAVORING, INGREDIENT OR FILLER; FOOD FLAVORINGS; FLAVORINGS FOR BEVERAGES (U.S. CL. 46).
PAULA MAHONEY, EXAMINING ATTORNEY

SN 79-038,286. TYMATIC LIMITED, MAYFIELD, EAST SUSSEX TN20 6RJ, UNITED KINGDOM, FILED 3-22-2007.

TYMATIC

THE MARK CONSISTS OF STANDARD CHARACTERS WITHOUT CLAIM TO ANY PARTICULAR FONT, STYLE, SIZE, OR COLOR.
PRIORITY DATE OF 9-27-2006 IS CLAIMED.
OWNER OF INTERNATIONAL REGISTRATION 0923631 DATED 3-22-2007, EXPIRES 3-22-2017.

CLASS 6—METAL GOODS

FOR METAL WIRES FOR BINDING (U.S. CLS. 2, 12, 13, 14, 23, 25 AND 50).

CLASS 7—MACHINERY

FOR MACHINES FOR BINDING BUILDING COMPONENTS; MACHINES FOR BINDING METALLIC REINFORCING BARS; PARTS AND FITTINGS FOR ALL THE AFORESAID GOODS (U.S. CLS. 13, 19, 21, 23, 31, 34 AND 35).
LAURIE KAUFMAN, EXAMINING ATTORNEY

SN 79-037,388. DSM IP ASSETS B.V., NETHERLANDS, FILED 3-6-2007.

SENSARITE

THE MARK CONSISTS OF STANDARD CHARACTERS WITHOUT CLAIM TO ANY PARTICULAR FONT, STYLE, SIZE, OR COLOR.
PRIORITY DATE OF 9-26-2006 IS CLAIMED.
OWNER OF INTERNATIONAL REGISTRATION 0921189 DATED 3-6-2007, EXPIRES 3-6-2017.

CLASS 1—CHEMICALS

FOR CHEMICAL AND BIOCHEMICAL ADDITIVES USED IN THE MANUFACTURE OF FOOD; CHEMICAL AND BIOCHEMICAL ADDITIVES FOR USE AS FLAVORINGS IN THE FOOD INDUSTRY; CHEMICAL AND BIOCHEMICAL ADDITIVES FOR PRESERVING FOODSTUFFS (U.S. CLS. 1, 5, 6, 10, 26 AND 46).

CLASS 29—MEATS AND PROCESSED FOODS

FOR FOOD SUPPLEMENTS AND FOOD INGREDIENTS, NOT FOR MEDICAL USE, NAMELY, PROTEINS FOR USE AS A FOOD ADDITIVES FOR USE IN DAIRY-BASED FOODS AND BEVERAGES AND BAKERY PRODUCTS (U.S. CL. 46).

SN 79-038,805. MERCK KGAA, FED REP GERMANY, FILED 4-5-2007.

PERFOROMIST

THE MARK CONSISTS OF STANDARD CHARACTERS WITHOUT CLAIM TO ANY PARTICULAR FONT, STYLE, SIZE, OR COLOR.
PRIORITY DATE OF 10-11-2006 IS CLAIMED.
OWNER OF INTERNATIONAL REGISTRATION 0925023 DATED 4-5-2007, EXPIRES 4-5-2017.

CLASS 5—PHARMACEUTICALS

FOR PHARMACEUTICAL PREPARATIONS, NAMELY PREPARATIONS AND FORMULATIONS FOR THE TREATMENT OF RESPIRATORY DISORDERS, ASTHMA, ALLERGIES AND ALLERGIC EMERGENCIES (U.S. CLS. 6, 18, 44, 46, 51 AND 52).

CLASS 10—MEDICAL APPARATUS

FOR MEDICAL INSTRUMENTS AND APPARATUS FOR THE TREATMENT OF RESPIRATORY DISORDERS, ASTHMA, ALLERGIES AND ALLERGIC EMERGENCIES (U.S. CLS. 26, 39 AND 44).
NAAKWAMA ANKRAH, EXAMINING ATTORNEE

SECTION 2.— INTERNATIONAL CLASSIFICATION

The short titles associated below with the international class numbers are terms designed merely for quick identification and are not an official part of the international classification. The full names of international classes are given in section 6.1 of the trademark rules of practice.

The designation "U.S. Cl." appearing in this section refers to the U.S. class in effect prior to Sep. 1, 1973 rather than the international class which applies to applications filed on or after that date. For adoption of international classification see notice in the OFFICIAL GAZETTE of Jun. 26, 1973 (911 O.G. TM 210).

Application in one class

CLASS 1—CHEMICALS

SN 76-669,098. ALLAIRE, ROSS, UPLAND, CA. FILED 11-16-2006.

VARIX

THE MARK CONSISTS OF STANDARD CHARACTERS WITHOUT CLAIM TO ANY PARTICULAR FONT, STYLE, SIZE, OR COLOR.

FOR CHEMICAL AGENTS USED TO COAT LEAD PLATES IN BATTERIES TO PREVENT SULFATE BUILD-UP (U.S. CLS. 1, 5, 6, 10, 26 AND 46).

FIRST USE 8-7-2006; IN COMMERCE 8-7-2006.
KELLY BOULTON, EXAMINING ATTORNEY

CLASS 1—(Continued).

SN 76-675,093. F.W. WEBB COMPANY, BEDFORD, MA. FILED 4-5-2007.

PurePro

THE MARK CONSISTS OF STANDARD CHARACTERS WITHOUT CLAIM TO ANY PARTICULAR FONT, STYLE, SIZE, OR COLOR.

OWNER OF U.S. REG. NO. 2,931,465.

FOR CHEMICALS FOR BOILER SYSTEM TREATMENTS, NAMELY HYDRONIC SYSTEM CLEANERS AND BOILER CLEANERS, BOILER LEAK SEALANTS, CHEMICAL OIL ADDITIVES, AND MISCELLANEOUS CHEMICALS, NAMELY, FURNACE CEMENT AND WATER DETECTING PASTE (U.S. CLS. 1, 5, 6, 10, 26 AND 46).

FIRST USE 1-31-2006; IN COMMERCE 1-31-2006.
CAROLINE WOOD, EXAMINING ATTORNEY

SN 76-675,101. F.W. WEBB COMPANY, BEDFORD, MA. FILED 4-5-2007.

SN 76-674,724. TOOLS FOR INDUSTRY, HILTON HEAD ISLAND, SC. FILED 3-28-2007.

OUTERGUARD

THE MARK CONSISTS OF STANDARD CHARACTERS WITHOUT CLAIM TO ANY PARTICULAR FONT, STYLE, SIZE, OR COLOR.

FOR CHEMICAL COMPOUNDS HAVING CORROSION RESISTANCE AND LUBRICATING PROPERTIES (U.S. CLS. 1, 5, 6, 10, 26 AND 46).

NAAKWAMA ANKRAH, EXAMINING ATTORNEY



OWNER OF U.S. REG. NO. 2,931,465.

THE COLOR(S) RED AND BLUE IS/ARE CLAIMED AS A FEATURE OF THE MARK.

THE COLORS RED AND BLUE APPEAR IN THE DESIGN OF THE MARK. THE COLOR RED APPEARS AS THE COLOR OF THE ELLIPSE. THE COLOR BLUE APPEARS AS THE COLOR OF THE LETTERS IN THE WORD "PURE-PRO".

FOR CHEMICALS FOR BOILER SYSTEM TREATMENTS, NAMELY HYDRONIC SYSTEM CLEANERS AND BOILER CLEANERS, BOILER LEAK SEALANTS, CHEMICAL OIL ADDITIVES, AND MISCELLANEOUS CHEMICALS, NAMELY, FURNACE CEMENT AND WATER DETECTING PASTE (U.S. CLS. 1, 5, 6, 10, 26 AND 46).

FIRST USE 1-31-2006; IN COMMERCE 1-31-2006.
CAROLINE WOOD, EXAMINING ATTORNEY

CLASS 1—(Continued).

SN 77-009,302. RIKA INTERNATIONAL LIMITED, GREAT-BRITAIN, MANCHESTER, ENGLAND, FILED 9-28-2006.

RiKACLEAR

THE MARK CONSISTS OF STANDARD CHARACTERS WITHOUT CLAIM TO ANY PARTICULAR FONT, STYLE, SIZE, OR COLOR.

PRIORITY CLAIMED UNDER SEC. 44(D) ON ERPNCMNTY TM OFC APPLICATION NO. 005339866, FILED 9-27-2006.

FOR CHEMICALS FOR USE IN THE MANUFACTURE OF RESINS, SUCH AS POLYESTER, EPOXY AND ALKYD RESINS AND THE SUBSEQUENT MOULDINGS AND EXTRUSION OPERATIONS THEREOF (U.S. CLS. 1, 5, 6, 10, 26 AND 46).

ERNEST SHOSHO, EXAMINING ATTORNEY

SN 77-093,733. SEASHELL TECHNOLOGY, LLC, LA JOLLA, CA. FILED 1-29-2007.

DNAdel

THE MARK CONSISTS OF STANDARD CHARACTERS WITHOUT CLAIM TO ANY PARTICULAR FONT, STYLE, SIZE, OR COLOR.

FOR BIOLOGICAL PREPARATIONS FOR MEDICAL PURPOSES, NAMELY, GOLD CARRIER PARTICLES FOR DELIVERY OF DNA TO BE USED FOR RESEARCH AND DEVELOPMENT (U.S. CLS. 1, 5, 6, 10, 26 AND 46).

FIRST USE 1-25-2007; IN COMMERCE 1-25-2007.

KELLY MCCOY, EXAMINING ATTORNEY

SN 77-099,197. COXE WOODFINISHING INDUSTRIES, GALAX, VA. FILED 2-5-2007.

FINAL TOUCH HARDWOOD FLOOR FILLER

THE MARK CONSISTS OF STANDARD CHARACTERS WITHOUT CLAIM TO ANY PARTICULAR FONT, STYLE, SIZE, OR COLOR.

NO CLAIM IS MADE TO THE EXCLUSIVE RIGHT TO USE "HARDWOOD FLOOR FILLER", APART FROM THE MARK AS SHOWN.

FOR HARDWOOD FLOOR WOOD FILLER (U.S. CLS. 1, 5, 6, 10, 26 AND 46).

JAMES GRIFFIN, EXAMINING ATTORNEY

CLASS 1—(Continued).

SN 77-102,220. S & S CHEMICAL, DURANGO, CO. FILED 2-8-2007.

HICHAIN

THE MARK CONSISTS OF STANDARD CHARACTERS WITHOUT CLAIM TO ANY PARTICULAR FONT, STYLE, SIZE, OR COLOR.

FOR ALCOHOL FOR USE IN THE MANUFACTURE OF PAINTS AND OTHER COATINGS; ALCOHOL FOR USE IN THE MANUFACTURE OF PERFUMES (U.S. CLS. 1, 5, 6, 10, 26 AND 46).

FIRST USE 6-1-2004; IN COMMERCE 6-1-2004.

TEJBIR SINGH, EXAMINING ATTORNEY

SN 77-102,227. S & S CHEMICAL, DURANGO, CO. FILED 2-8-2007.

PRECISIONMelt

THE MARK CONSISTS OF STANDARD CHARACTERS WITHOUT CLAIM TO ANY PARTICULAR FONT, STYLE, SIZE, OR COLOR.

FOR POLYETHYLENE RESINS (U.S. CLS. 1, 5, 6, 10, 26 AND 46).

FIRST USE 10-1-2004; IN COMMERCE 10-1-2004.

TEJBIR SINGH, EXAMINING ATTORNEY

SN 77-123,909. TURF RESTORE, ST. CHARLES, MO. FILED 3-6-2007.

Advantage Turf Restore

THE MARK CONSISTS OF STANDARD CHARACTERS WITHOUT CLAIM TO ANY PARTICULAR FONT, STYLE, SIZE, OR COLOR.

NO CLAIM IS MADE TO THE EXCLUSIVE RIGHT TO USE "TURF RESTORE", APART FROM THE MARK AS SHOWN.

FOR PLANT GROWTH STIMULANT, COMPATIBLE WITH FERTILIZERS TO ENHANCE THE EFFECTIVENESS OF FERTILIZERS, FOR AGRICULTURAL AND COMMERCIAL USE (U.S. CLS. 1, 5, 6, 10, 26 AND 46).

FIRST USE 2-12-2006; IN COMMERCE 2-12-2006.

MICHAEL LITZAU, EXAMINING ATTORNEY

CLASS 1—(Continued).

SN 77-125,347. TRANSNATIONAL ROOFING PRODUCTS COMPANY, REYNOLDSBURG, OH. FILED 3-8-2007.

STATITE

THE MARK CONSISTS OF STANDARD CHARACTERS WITHOUT CLAIM TO ANY PARTICULAR FONT, STYLE, SIZE, OR COLOR.

FOR BONDING ADHESIVE FOR EPDM ROOFING MATERIAL (U.S. CLS. 1, 5, 6, 10, 26 AND 46).
KENNETH E. SHARPERSON, EXAMINING ATTORNEY

CLASS 1—(Continued).

SN 77-130,018. FOXFIRE ENTERPRISES, INC., WEST, TX. FILED 3-13-2007.



THE COLOR(S) RED AND WHITE IS/ARE CLAIMED AS A FEATURE OF THE MARK.

THE MARK CONSISTS OF A FOX HEAD TURNED SLIGHTLY TO THE RIGHT WITH A SLIGHTLY OPENED MOUTH. IT IS OUTLINED IN RED WITH WHITE INTERIOR.

FOR WATERPROOFING CHEMICAL COMPOSITIONS FOR ARTICLES OF MASONRY, WOOD AND OTHER BUILDING AND/OR CONSTRUCTION SURFACES (U.S. CLS. 1, 5, 6, 10, 26 AND 46).

FIRST USE 12-31-1995; IN COMMERCE 12-31-1995.
CIMMERIAN COLEMAN, EXAMINING ATTORNEY

SN 77-125,439. TRANSNATIONAL ROOFING PRODUCTS COMPANY, REYNOLDSBURG, OH. FILED 3-8-2007.

STARITE

THE MARK CONSISTS OF STANDARD CHARACTERS WITHOUT CLAIM TO ANY PARTICULAR FONT, STYLE, SIZE, OR COLOR.

FOR BONDING ADHESIVE FOR EPDM ROOFING MATERIAL (U.S. CLS. 1, 5, 6, 10, 26 AND 46).
KENNETH E. SHARPERSON, EXAMINING ATTORNEY

SN 77-134,043. FISHER SCIENTIFIC COMPANY L.L.C., PITTSBURG, PA. FILED 3-19-2007.

ECOSAFPAK

SN 77-125,845. THE WECK CORPORATION, NEW YORK, NY. FILED 3-8-2007.

GRACIOUS HOME

THE MARK CONSISTS OF STANDARD CHARACTERS WITHOUT CLAIM TO ANY PARTICULAR FONT, STYLE, SIZE, OR COLOR.

FOR CHEMICALLY-TREATED PAPER FOR THE PREVENTION OF TARNISHING (U.S. CLS. 1, 5, 6, 10, 26 AND 46).

FIRST USE 11-21-2006; IN COMMERCE 11-21-2006.
DAVID H. STINE, EXAMINING ATTORNEY

THE MARK CONSISTS OF STANDARD CHARACTERS WITHOUT CLAIM TO ANY PARTICULAR FONT, STYLE, SIZE, OR COLOR.

FOR CHEMICAL PREPARATIONS FOR SCIENTIFIC PURPOSES, NAMELY, LIQUID AND POWDER CHEMICALS FOR SCIENTIFIC PURPOSES THAT ARE PACKAGED IN GLASS OR PLASTIC CONTAINERS WITH A CORRUGATED CARDBOARD OUTER PACKAGE (U.S. CLS. 1, 5, 6, 10, 26 AND 46).

FIRST USE 4-30-2007; IN COMMERCE 4-30-2007.
COLLEEN KEARNEY, EXAMINING ATTORNEY

CLASS 1—(Continued).

SN 77-135,357. AGROFRESH INC., PHILADELPHIA, PA. FILED 3-20-2007.

SMARTTAB

THE MARK CONSISTS OF STANDARD CHARACTERS WITHOUT CLAIM TO ANY PARTICULAR FONT, STYLE, SIZE, OR COLOR.

OWNER OF U.S. REG. NO. 2,751,304.
FOR CHEMICALS FOR MAINTAINING THE LIFE, PRESERVING THE FRESHNESS AND REGULATING THE RIPENING PROCESS AND GROWTH OF FRUITS, VEGETABLES AND CROPS (U.S. CLS. 1, 5, 6, 10, 26 AND 46).

LINDA M. KING, EXAMINING ATTORNEY

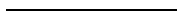

SN 77-136,042. GENE THERAPY SYSTEMS, INC., SAN DIEGO, CA. FILED 3-20-2007.

MAXPAK

THE MARK CONSISTS OF STANDARD CHARACTERS WITHOUT CLAIM TO ANY PARTICULAR FONT, STYLE, SIZE, OR COLOR.

FOR REAGENTS AND CELL CULTURE MEDIA FOR SCIENTIFIC, LABORATORY AND MEDICAL RESEARCH USE; CELLS FOR SCIENTIFIC, LABORATORY AND MEDICAL RESEARCH USE (U.S. CLS. 1, 5, 6, 10, 26 AND 46).

KYLE PEETE, EXAMINING ATTORNEY



SN 77-136,062. BIAGRO WESTERN SALES, INC., VISALIA, CA. FILED 3-20-2007.

TURF-PHITE

THE MARK CONSISTS OF STANDARD CHARACTERS WITHOUT CLAIM TO ANY PARTICULAR FONT, STYLE, SIZE, OR COLOR.

FOR AGRICULTURAL AND HORTICULTURAL FERTILIZERS (U.S. CLS. 1, 5, 6, 10, 26 AND 46).

SIMON TENG, EXAMINING ATTORNEY

CLASS 1—(Continued).

SN 77-136,065. BIAGRO WESTERN SALES, INC., VISALIA, CA. FILED 3-20-2007.

HUMI-PHITE

THE MARK CONSISTS OF STANDARD CHARACTERS WITHOUT CLAIM TO ANY PARTICULAR FONT, STYLE, SIZE, OR COLOR.

FOR AGRICULTURAL AND HORTICULTURAL FERTILIZERS (U.S. CLS. 1, 5, 6, 10, 26 AND 46).
SIMON TENG, EXAMINING ATTORNEY



SN 77-137,761. CORN PRODUCTS INTERNATIONAL, INC., WESTCHESTER, IL. FILED 3-22-2007.



THE COLOR(S) BLACK, GOLD AND GREEN IS/ARE CLAIMED AS A FEATURE OF THE MARK.

THE MARK CONSISTS OF AN INFINITY SYMBOL IN BLACK WITH A GOLD ELEMENT EXTENDING INSIDE ONE LOOP AND A GREEN ELEMENT EXTENDING INSIDE THE OTHER LOOP.

FOR MODIFIED STARCH - POLYESTER GRAFT COPOLYMER OBTAINED IN PELLET FORM AND SOLD IN BULK TO BE USED IN FILM BLOWING AND MOLDING MATERIALS (U.S. CLS. 1, 5, 6, 10, 26 AND 46).

WILLIAM P. SHANAHAN, EXAMINING ATTORNEY



SN 77-139,499. SWEET SOLUTIONS INC., EDISON, NJ. FILED 3-23-2007.

EZ-SWEETZ

THE MARK CONSISTS OF STANDARD CHARACTERS WITHOUT CLAIM TO ANY PARTICULAR FONT, STYLE, SIZE, OR COLOR.

FOR ARTIFICIAL SWEETENERS (U.S. CLS. 1, 5, 6, 10, 26 AND 46).

KRISTIN DAHLING, EXAMINING ATTORNEY

CLASS 1—(Continued).

SN 77-139,975. ENVIRONMENTAL BIOTECH INTERNATIONAL, SARASOTA, FL. FILED 3-26-2007.

Spill Sweep

THE MARK CONSISTS OF STANDARD CHARACTERS WITHOUT CLAIM TO ANY PARTICULAR FONT, STYLE, SIZE, OR COLOR.

FOR CHEMICAL COMPOSITION FOR SOLIDIFICATION OF FLUIDS AND FOR ABSORBING SPILLS (U.S. CLS. 1, 5, 6, 10, 26 AND 46).

LOURDES AYALA, EXAMINING ATTORNEY

CLASS 1—(Continued).

SN 77-141,678. MONSANTO TECHNOLOGY, LLC, ST. LOUIS, MO. FILED 3-27-2007.

COOLGAIN

THE MARK CONSISTS OF STANDARD CHARACTERS WITHOUT CLAIM TO ANY PARTICULAR FONT, STYLE, SIZE, OR COLOR.

FOR BIOTECHNOLOGY FORMED COLD TOLERANT GENES FOR USE IN THE PRODUCTION OF AGRICULTURAL SEED TO ENHANCE PLANT'S GROWTH THEREFROM (U.S. CLS. 1, 5, 6, 10, 26 AND 46).

ANDREA BUTLER, EXAMINING ATTORNEY

SN 77-140,415. ADVANCED BIONOMICS, INCORPORATED, OAK CREEK, WI. FILED 3-26-2007.

BioSweep

THE MARK CONSISTS OF STANDARD CHARACTERS WITHOUT CLAIM TO ANY PARTICULAR FONT, STYLE, SIZE, OR COLOR.

FOR CHEMICAL ADDITIVES FOR USE IN THE MANUFACTURE OF SAWDUST-BASED FLOOR SWEEPING COMPOUND (U.S. CLS. 1, 5, 6, 10, 26 AND 46).

DAWN FELDMAN, EXAMINING ATTORNEY

SN 77-142,337. JEEN INTERNATIONAL CORPORATION, FAIRFIELD, NJ. FILED 3-28-2007.

JEECHEM

THE MARK CONSISTS OF STANDARD CHARACTERS WITHOUT CLAIM TO ANY PARTICULAR FONT, STYLE, SIZE, OR COLOR.

FOR CHEMICALS USED IN THE MANUFACTURE OF PERSONAL CARE, COSMETIC, PHARMACEUTICAL, HOUSEHOLD AND INDUSTRIAL PRODUCTS (U.S. CLS. 1, 5, 6, 10, 26 AND 46).

FIRST USE 5-8-1996; IN COMMERCE 5-8-1996.

DANIEL CAPSHAW, EXAMINING ATTORNEY

SN 77-141,664. MONSANTO TECHNOLOGY, LLC, ST. LOUIS, MO. FILED 3-27-2007.

AQUAGRO

THE MARK CONSISTS OF STANDARD CHARACTERS WITHOUT CLAIM TO ANY PARTICULAR FONT, STYLE, SIZE, OR COLOR.

FOR BIOTECHNOLOGY FORMED DROUGHT TOLERANT GENES FOR USE IN THE PRODUCTION OF AGRICULTURAL SEED TO ENHANCE PLANT'S GROWTH THEREFROM (U.S. CLS. 1, 5, 6, 10, 26 AND 46).

ANDREA BUTLER, EXAMINING ATTORNEY

SN 77-142,353. JEEN INTERNATIONAL CORPORATION, FAIRFIELD, NJ. FILED 3-28-2007.

JEECIDE

THE MARK CONSISTS OF STANDARD CHARACTERS WITHOUT CLAIM TO ANY PARTICULAR FONT, STYLE, SIZE, OR COLOR.

FOR CHEMICAL PRESERVATIVES USED IN THE MANUFACTURE OF PERSONAL CARE, COSMETIC, PHARMACEUTICAL, HOUSEHOLD AND INDUSTRIAL PRODUCTS (U.S. CLS. 1, 5, 6, 10, 26 AND 46).

FIRST USE 1-14-1996; IN COMMERCE 1-14-1996.

DANIEL CAPSHAW, EXAMINING ATTORNEY

CLASS 1—(Continued).

SN 77-142,363. JEEN INTERNATIONAL CORPORATION, FAIRFIELD, NJ. FILED 3-28-2007.

JEENATE

THE MARK CONSISTS OF STANDARD CHARACTERS WITHOUT CLAIM TO ANY PARTICULAR FONT, STYLE, SIZE, OR COLOR.

FOR POLYMER COMPOSITIONS USED IN THE MANUFACTURE OF PERSONAL CARE, COSMETIC, PHARMACEUTICAL, HOUSEHOLD AND INDUSTRIAL PRODUCTS (U.S. CLS. 1, 5, 6, 10, 26 AND 46).

FIRST USE 10-20-1997; IN COMMERCE 10-20-1997.
DANIEL CAPSHAW, EXAMINING ATTORNEY

SN 77-144,092. JEEN INTERNATIONAL CORPORATION, FAIRFIELD, NJ. FILED 3-29-2007.

JEEMIDE

THE MARK CONSISTS OF STANDARD CHARACTERS WITHOUT CLAIM TO ANY PARTICULAR FONT, STYLE, SIZE, OR COLOR.

FOR CHEMICALS USED IN THE MANUFACTURE OF PERSONAL CARE, COSMETIC, PHARMACEUTICAL, HOUSEHOLD AND INDUSTRIAL PRODUCTS; NAMELY, ALKANOLAMIDE COMPOUNDS (U.S. CLS. 1, 5, 6, 10, 26 AND 46).

FIRST USE 6-4-1996; IN COMMERCE 6-4-1996.
DANIEL CAPSHAW, EXAMINING ATTORNEY

SN 77-144,220. APPLERA CORPORATION, FOSTER CITY, CA. FILED 3-29-2007.

APPLERA

THE MARK CONSISTS OF STANDARD CHARACTERS WITHOUT CLAIM TO ANY PARTICULAR FONT, STYLE, SIZE, OR COLOR.

OWNER OF U.S. REG. NO. 3,130,445.
FOR ASSAYS AND REAGENTS FOR USE IN GENETIC RESEARCH; BIOCHEMICAL REAGENTS COMMONLY KNOWN AS PROBES, FOR DETECTING AND ANALYZING MOLECULES IN PROTEIN OR NUCLEOTIDE ARRAYS; CHEMICAL REAGENTS FOR NON-MEDICAL PURPOSES; DIAGNOSTIC PREPARATIONS FOR SCIENTIFIC OR RESEARCH USE; GENETIC IDENTITY TESTS COMPRISED OF REAGENTS; NUCLEIC ACID SEQUENCES AND CHEMICAL REAGENTS FOR OTHER THAN MEDICAL AND VETERINARY PURPOSES; PATERNITY IDENTITY TESTS COMPRISED OF REAGENTS; REAGENTS FOR SCIENTIFIC OR MEDICAL RESEARCH USE (U.S. CLS. 1, 5, 6, 10, 26 AND 46).
KEVIN DINALLO, EXAMINING ATTORNEY

CLASS 1—(Continued).

SN 77-146,688. HUDSON BAY MINING AND SMELTING CO., LIMITED, WINNIPEG, MANITOBA, CANADA, FILED 4-2-2007.



OWNER OF CANADA REG. NO. TMA555453, DATED 12-13-2001, EXPIRES 12-13-2016.

FOR ZINC OXIDE, ZINC OXIDE POWDER, ZINC OXIDE PELLETS (U.S. CLS. 1, 5, 6, 10, 26 AND 46).
FIRST USE 12-31-1976; IN COMMERCE 12-31-1976.
PATRICIA EVANKO, EXAMINING ATTORNEY

SN 77-147,854. BIAGRO WESTERN SALES, INC., VISALIA, CA. FILED 4-3-2007.

GRO-PHITE

THE MARK CONSISTS OF STANDARD CHARACTERS WITHOUT CLAIM TO ANY PARTICULAR FONT, STYLE, SIZE, OR COLOR.

FOR AGRICULTURAL AND HORTICULTURAL FERTILIZERS (U.S. CLS. 1, 5, 6, 10, 26 AND 46).
SIMON TENG, EXAMINING ATTORNEY

SN 77-150,340. LALLEMAND USA, INC., MONTREAL, CANADA, FILED 4-6-2007.

PROVITAE

THE MARK CONSISTS OF STANDARD CHARACTERS WITHOUT CLAIM TO ANY PARTICULAR FONT, STYLE, SIZE, OR COLOR.

FOR BACTERIA FOR USE IN FOOD MANUFACTURE (U.S. CLS. 1, 5, 6, 10, 26 AND 46).
FIRST USE 7-19-2006; IN COMMERCE 7-19-2006.
THEODORE MCBRIDE, EXAMINING ATTORNEY

CLASS 1—(Continued).

SN 77-153,061. CHITEC TECHNOLOGY CO., LTD., TAIPEI HSIEN, TAIWAN, FILED 4-10-2007.

Zuran

THE MARK CONSISTS OF A CAPITAL LETTER "Z" FOLLOWED BY THE LOWER-CASE LETTERS "U", "R", "A" AND "N".

FOR CHEMICALS FOR USE IN INDUSTRY, NAMELY, FLAME RETARDANTS, OPTICAL BRIGHTENERS, INDUSTRIAL DEVELOPERS, ANTI-OXIDANTS, PLASTIC CHEMICAL ADDITIVES, PLASTIC ANTI-AGING ADDITIVES, PLASTIC STABILIZERS, UV ABSORBERS, ANTI-UV CHEMICALS, PROCESSING ADDITIVES FOR SYNTHETIC RESINS, CHEMICALS FOR THE RUBBER INDUSTRY (U.S. CLS. 1, 5, 6, 10, 26 AND 46).

FIRST USE 8-18-2006; IN COMMERCE 2-16-2007.
STEVEN PEREZ, EXAMINING ATTORNEY

SN 77-173,278. SASOL NORTH AMERICA INC., HOUSTON, TX. FILED 5-4-2007.

AEROLOX

THE MARK CONSISTS OF STANDARD CHARACTERS WITHOUT CLAIM TO ANY PARTICULAR FONT, STYLE, SIZE, OR COLOR.

FOR HIGH PORE VOLUME CALCINED ALUMINA (U.S. CLS. 1, 5, 6, 10, 26 AND 46).

MICHAEL LITZAU, EXAMINING ATTORNEY

SN 77-173,299. SASOL NORTH AMERICA INC., HOUSTON, TX. FILED 5-4-2007.

AEROPAL

THE MARK CONSISTS OF STANDARD CHARACTERS WITHOUT CLAIM TO ANY PARTICULAR FONT, STYLE, SIZE, OR COLOR.

FOR HIGH PORE VOLUME, LOW BULK DENSITY BOEHMITE ALUMINA (U.S. CLS. 1, 5, 6, 10, 26 AND 46).

MICHAEL LITZAU, EXAMINING ATTORNEY

CLASS 1—(Continued).

SN 77-174,007. ROHM AND HAAS ELECTRONIC MATERIALS LLC, MARLBOROUGH, MA. FILED 5-7-2007.



The logo for 'enlight' features the word in a lowercase, sans-serif font. The 'e' is blue, and the 'n' is yellow. The 'i' is blue with a yellow sunburst design above it. The 'l' is blue, and the 'i' is blue. The 'g' is blue, and the 'h' is blue. The 't' is blue.

THE COLOR(S) BLUE AND YELLOW IS/ARE CLAIMED AS A FEATURE OF THE MARK.

THE MARK CONSISTS OF THE WORD "ENLIGHT" WITH A SUN DESIGN IN PLACE OF THE DOT OVER THE LETTER "I" AND THE "N" REPLACED BY THE GREEK LETTER ETA. THE LETTERS "E" AND "LIGHT" ARE IN BLUE AND THE "ETA" AND THE SUN DESIGN ARE IN YELLOW. THE COLOR WHITE REPRESENTS TRANSPARENT AREAS AND IS NOT PART OF THE MARK.

FOR CHEMICALS FOR USE IN THE MANUFACTURE OF PHOTOVOLTAIC AND SOLAR DEVICES, CELLS AND MODULE (U.S. CLS. 1, 5, 6, 10, 26 AND 46).

JENNIFER DIXON, EXAMINING ATTORNEY

SN 77-179,835. GOLDSCHMIDT GMBH, ESSEN, FED REP GERMANY, FILED 5-14-2007.

SPHINGOKINE

THE MARK CONSISTS OF STANDARD CHARACTERS WITHOUT CLAIM TO ANY PARTICULAR FONT, STYLE, SIZE, OR COLOR.

PRIORITY CLAIMED UNDER SEC. 44(D) ON FED REP GERMANY APPLICATION NO. 30621061.4, FILED 4-4-2007, REG. NO. 30621061.4, DATED 4-30-2006, EXPIRES 4-30-2016.

FOR CHEMICAL USED IN INDUSTRY, NAMELY, ACTIVE INGREDIENTS AND AUXILIARIES FOR THE PRODUCTION OF COSMETIC PREPARATIONS FOR SKIN HAIR AND HAIR CARE (U.S. CLS. 1, 5, 6, 10, 26 AND 46).

PAUL F. GAST, EXAMINING ATTORNEY

SN 78-693,765. ACCREDITED INDUSTRIES AND ASSOCIATES, INC., GLENDALE, CA. FILED 8-16-2005.

Vigoranic

THE MARK CONSISTS OF STANDARD CHARACTERS WITHOUT CLAIM TO ANY PARTICULAR FONT, STYLE, SIZE, OR COLOR.

FOR CHEMICALS USED IN AGRICULTURE, HORTICULTURE AND FORESTRY, NAMELY CHEMICAL PREPARATIONS FOR THE TREATMENT OF PLANTS AND CROPS; CHEMICAL SUBSTANCES FOR PRESERVING FOODSTUFFS; AND MANURES (U.S. CLS. 1, 5, 6, 10, 26 AND 46).

FIRST USE 1-1-2005; IN COMMERCE 1-1-2005.

JOSETTE BEVERLY, EXAMINING ATTORNEY

CLASS 1—(Continued).

SN 78-761,757. BAICOR, L.C., LOGAN, UT. FILED 11-28-2005.

SOIL STIMULATOR

THE MARK CONSISTS OF STANDARD CHARACTERS WITHOUT CLAIM TO ANY PARTICULAR FONT, STYLE, SIZE, OR COLOR.

SEC. 2(F).

FOR FERTILIZERS (U.S. CLS. 1, 5, 6, 10, 26 AND 46).
FIRST USE 4-2-2001; IN COMMERCE 4-2-2001.

ELISSA GARBER KON, EXAMINING ATTORNEY

SN 78-786,347. MIDWEST INDUSTRIAL SUPPLY, INC.,
CANTON, OH. FILED 1-6-2006.

HAUL PRO

THE MARK CONSISTS OF STANDARD CHARACTERS WITHOUT CLAIM TO ANY PARTICULAR FONT, STYLE, SIZE, OR COLOR.

OWNER OF U.S. REG. NO. 1,264,594.

NO CLAIM IS MADE TO THE EXCLUSIVE RIGHT TO USE "PRO", APART FROM THE MARK AS SHOWN.

FOR CHEMICAL DUST CONTROL AGENTS FOR USE ON HAUL ROADS (U.S. CLS. 1, 5, 6, 10, 26 AND 46).

ODESSA BIBBINS, EXAMINING ATTORNEY

SN 78-882,763. MULTISORB TECHNOLOGIES, INC., BUF-
FALO, NY. FILED 5-12-2006.

FrostSorb

THE MARK CONSISTS OF STANDARD CHARACTERS WITHOUT CLAIM TO ANY PARTICULAR FONT, STYLE, SIZE, OR COLOR.

FOR CHEMICAL COMPOSITIONS, NAMELY, DESIC-
CANTS AND HUMECTANTS TO CONTROL THE
AMOUNT OF MOISTURE AND FROST IN A FREEZER
(U.S. CLS. 1, 5, 6, 10, 26 AND 46).

CHARLES L. JENKINS, EXAMINING ATTORNEY

CLASS 1—(Continued).SN 78-938,276. TURFGRASS MANAGEMENT, INC., DBA
GRIGG BROS., ALBION, ID. FILED 7-26-2006.**INTAKE**

THE MARK CONSISTS OF STANDARD CHARACTERS WITHOUT CLAIM TO ANY PARTICULAR FONT, STYLE, SIZE, OR COLOR.

FOR FERTILIZERS (U.S. CLS. 1, 5, 6, 10, 26 AND 46).

FIRST USE 2-28-1996; IN COMMERCE 2-28-1996.

SUSAN RICHARDS, EXAMINING ATTORNEY

SN 78-943,341. HERREMA-KIMMEL, LLC, COSTA MESA,
CA. FILED 8-2-2006.



NO CLAIM IS MADE TO THE EXCLUSIVE RIGHT TO USE "BIO" AND THE DESIGN OF THE RECYCLING SYMBOL, APART FROM THE MARK AS SHOWN.

FOR BIODEGRADABLE THERMOPLASTIC FOR USE IN MANUFACTURING NOT USED IN ANTI-FOULING COATINGS, NAMELY, UNPROCESSED PLASTICS IN ALL FORMS, POLYMER BEADS AND POLYMER COMPOSITIONS FOR USE IN MANUFACTURING OF COMMERCIAL AND INDUSTRIAL GOODS (U.S. CLS. 1, 5, 6, 10, 26 AND 46).

KELLY CHOE, EXAMINING ATTORNEY

SN 78-945,480. MINN-CHEM, INC., SANBORN, MN. FILED
8-4-2006.

NATURO

THE MARK CONSISTS OF STANDARD CHARACTERS WITHOUT CLAIM TO ANY PARTICULAR FONT, STYLE, SIZE, OR COLOR.

FOR LAWN CARE FERTILIZER (U.S. CLS. 1, 5, 6, 10, 26 AND 46).

FIRST USE 3-2-1990; IN COMMERCE 3-2-1990.

DAVID COLLIER, EXAMINING ATTORNEY

CLASS 1—(Continued).

SN 78-963,337. 20/20 GENESYSTEMS, INC., ROCKVILLE, MD. FILED 8-29-2006.



OWNER OF U.S. REG. NO. 2,631,768.
NO CLAIM IS MADE TO THE EXCLUSIVE RIGHT TO USE "A DIVISION OF" AND "INC", APART FROM THE MARK AS SHOWN.

FOR CHEMICAL ANALYSIS KITS, COMPRISED OF A CHEMICAL REAGENT FOR DETERMINING THE PRESENCE OF PROTEIN AND PH, SWABS FOR PROTEIN DETECTION AND PH DETERMINATION, A CONTROL SWAB, AND AN INSTRUCTION SHEET FOR USE IN RAPID SCREENING FOR THE PRESENCE OF BIOHAZARDOUS MATERIALS USED AS BIOTERRORISM AGENTS (U.S. CLS. 1, 5, 6, 10, 26 AND 46).

FIRST USE 6-1-2006; IN COMMERCE 6-14-2006.
LINDA ORNDORFF, EXAMINING ATTORNEY

SN 78-970,988. ASAHI KASEI CORPORATION, OSAKA, JAPAN, FILED 9-11-2006.

旭化成DFR

NO CLAIM IS MADE TO THE EXCLUSIVE RIGHT TO USE "DFR", APART FROM THE MARK AS SHOWN.

THE NON-LATIN CHARACTERS IN THE MARK TRANSLITERATE TO "ASAHI KA SEI" AND THIS MEANS "RISING SUN CHEMICAL FORMATION" IN ENGLISH.

FOR PHOTSENSITIVE DRY FILMS FOR USE IN THE MANUFACTURE OF PRINTED CIRCUITS, LEAD FRAMES, WAFER BUMPS, NAMELY, DRY FILM PHOTORESIST (U.S. CLS. 1, 5, 6, 10, 26 AND 46).

KATHERINE CHANG, EXAMINING ATTORNEY

CLASS 1—(Continued).

SN 79-024,090. HENKEL KGAA, FED REP GERMANY, FILED 3-1-2006.

Flextec

THE MARK CONSISTS OF STANDARD CHARACTERS WITHOUT CLAIM TO ANY PARTICULAR FONT, STYLE, SIZE, OR COLOR.

PRIORITY DATE OF 9-10-2005 IS CLAIMED.
OWNER OF INTERNATIONAL REGISTRATION 0885536 DATED 3-1-2006, EXPIRES 3-1-2016.

FOR CHEMICALS USED IN THE MANUFACTURE OF ADHESIVES AND SEALANTS, NAMELY, SILANE MODIFIED POLYMERS (U.S. CLS. 1, 5, 6, 10, 26 AND 46).
WILLIAM ROSSMAN, EXAMINING ATTORNEY

SN 79-031,720. NOVOZYMES SWITZERLAND AG, SWITZERLAND, FILED 11-9-2006.

CEREZYME

THE MARK CONSISTS OF STANDARD CHARACTERS WITHOUT CLAIM TO ANY PARTICULAR FONT, STYLE, SIZE, OR COLOR.

PRIORITY DATE OF 9-15-2006 IS CLAIMED.
OWNER OF INTERNATIONAL REGISTRATION 0905507 DATED 11-9-2006, EXPIRES 11-9-2016.

FOR ENZYMES FOR USE IN THE BREWING INDUSTRY (U.S. CLS. 1, 5, 6, 10, 26 AND 46).
DAVID H. STINE, EXAMINING ATTORNEY

CLASS 2—PAINTS

SN 76-543,695. CORRO-SHIELD INTERNATIONAL, INC., ROSEMONT, IL. FILED 8-29-2003.

CORRO-COTE

OWNER OF U.S. REG. NO. 2,326,051.
FOR EPOXY RESIN AND EPOXY HARDENER PROTECTIVE COATING FOR FLOORS, WALLS AND METAL SURFACES (U.S. CLS. 6, 11 AND 16).
FIRST USE 0-0-1993; IN COMMERCE 0-0-1993.
JOHN E. MICHOS, EXAMINING ATTORNEY

CLASS 2—(Continued).

SN 77-007,503. NAZDAR COMPANY, SHAWNEE, KS. FILED 9-26-2006.

CLING-ON

THE MARK CONSISTS OF STANDARD CHARACTERS WITHOUT CLAIM TO ANY PARTICULAR FONT, STYLE, SIZE, OR COLOR.

FOR UV-CURABLE SCREEN PRINTING INKS (U.S. CLS. 6, 11 AND 16).

JASON TURNER, EXAMINING ATTORNEY

SN 77-011,171. REEL WINGS DECOY CO. INC., FARGO, ND. FILED 3-2-2007.



NO CLAIM IS MADE TO THE EXCLUSIVE RIGHT TO USE "BIRD", APART FROM THE MARK AS SHOWN.

THE COLOR(S) BLUE AND BLACK IS/ARE CLAIMED AS A FEATURE OF THE MARK.

THE COLOR BLUE APPEARS IN THE WORDING BLUE AND IN THE EYE DESIGN. THE COLOR BLACK APPEARS IN THE BIRD DESIGN, IN THE LETTERING ISI AND N AND IN THE EYE DESIGN.

FOR COLORANTS, PAINTS AND DYES FOR GENERAL INDUSTRIAL USE (U.S. CLS. 6, 11 AND 16).

FIRST USE 3-15-2006; IN COMMERCE 3-15-2006.

TIMOTHY FINNEGAN, EXAMINING ATTORNEY

SN 77-134,406. GACO WESTERN, LLC, TUKWILLA, WA. FILED 3-19-2007.

GACOSHIELD

THE MARK CONSISTS OF STANDARD CHARACTERS WITHOUT CLAIM TO ANY PARTICULAR FONT, STYLE, SIZE, OR COLOR.

OWNER OF U.S. REG. NOS. 2,261,891, 3,071,751 AND OTHERS.

FOR PROTECTIVE COATINGS FOR ARCHITECTURAL USES, NAMELY, FOR SURFACE AND SUBSURFACE APPLICATION TO FLOORS, DECKS, ROOFS, WALLS, AND OTHER SIMILAR SURFACES ON AND WITHIN COMMERCIAL AND RESIDENTIAL BUILDINGS AND FIXED STRUCTURES (U.S. CLS. 6, 11 AND 16).

AMY BROZENIC, EXAMINING ATTORNEY

CLASS 2—(Continued).

SN 77-141,598. ICI PAINTS (PUERTO RICO) INC., CAROLINA, PUERTO RICO, FILED 3-27-2007.

PRIMEMASTER

THE MARK CONSISTS OF STANDARD CHARACTERS WITHOUT CLAIM TO ANY PARTICULAR FONT, STYLE, SIZE, OR COLOR.

FOR COATINGS IN THE NATURE OF PAINT AND PRIMER (U.S. CLS. 6, 11 AND 16).

BRIAN CALLAGHAN, EXAMINING ATTORNEY

SN 77-143,002. INNOVATION BRANDS CORP., LOS ANGELES, CA. FILED 3-28-2007.

Twist 'N Paint

THE MARK CONSISTS OF STANDARD CHARACTERS WITHOUT CLAIM TO ANY PARTICULAR FONT, STYLE, SIZE, OR COLOR.

FOR COATINGS, NAMELY, STAINS AND CLEAR FINISHES FOR EXTERIOR AND INTERIOR USE ON A VARIETY OF SUBSTRATES (U.S. CLS. 6, 11 AND 16).

RICHARD A. STRASER, EXAMINING ATTORNEY

SN 78-846,500. PURCOM QUIMICA LTDA., BARUERI, SÃO PAULO, BRAZIL, FILED 3-27-2006.



FOR SPRAYABLE ELASTOMERIC PROTECTIVE COATINGS FOR APPLICATIONS REQUIRING RESISTANCE TO CHEMICAL SUBSTANCES, NAMELY ON ROOFS, WALLS, BUILDING FOUNDATIONS AND STORAGE TANKS FOR LIQUID AND DRY SUBSTANCES (U.S. CLS. 6, 11 AND 16).

STEVEN R. FINE, EXAMINING ATTORNEY

CLASS 2—(Continued).

SN 78-934,859. DESIGN MASTER COLOR TOOL, INC., BOULDER, CO. FILED 7-21-2006.

DESIGN MASTER PERFECT TOUCH COLOR COLLECTION

THE MARK CONSISTS OF STANDARD CHARACTERS WITHOUT CLAIM TO ANY PARTICULAR FONT, STYLE, SIZE, OR COLOR.

OWNER OF U.S. REG. NOS. 1,461,554, 1,531,527 AND 2,972,522.

NO CLAIM IS MADE TO THE EXCLUSIVE RIGHT TO USE "COLOR COLLECTION", APART FROM THE MARK AS SHOWN.

FOR AEROSOL SPRAY PAINTS PRODUCED IN A VARIETY OF COLORS, NAMELY, AEROSOL SPRAY PAINTS FOR ADDING COLORS AND FINISHES TO FLOWERS, FOLIAGES, BOXES, BASKETS, WREATHS, DRIED MATERIALS, WOODEN DECORATIONS AND FLORAL DECORATIVE ACCESSORIES AND ORNAMENTS. (U.S. CLS. 6, 11 AND 16).

SUSAN RICHARDS, EXAMINING ATTORNEY

SN 78-941,878. CURRENT INC., EAST HAVEN, CT. FILED 8-1-2006.



"THE COLOR(S) GRAY, BLUE, BLACK AND WHITE IS/ ARE CLAIMED AS A FEATURE OF THE MARK."

"THE MARK CONSISTS OF THE COLOR BLACK APPEARS IN THE BACKGROUND; THE COLOR WHITE APPEARS IN THE LITERAL ELEMENT OF THE MARK AND THE OUTLINE OF THE WAVES; THE COLOR GREY APPEARS IN THE CURVED LINES ON EITHER SIDE OF THE LITERAL ELEMENT; THE COLOR BLUE APPEARS IN THE WAVES."

FOR LIQUID SOUND DAMPING COATING FOR USE ON, BOAT HULLS, MUFFLERS, SHAFT TUNNELS, HATCHES, AIR INTAKES, MACHINERY SPACES, GENERATOR COVERS, BOW THRUSTERS, BULKHEADS, CEILINGS, ENGINE COVERS, CAR WHEEL WELLS, FIREWALL, TRUNKS, DOORS, RUNNING BOARDS, INTERIORS, AIR HANDLERS, EXHAUST STACKS, SORTING MACHINES, PUMP COVERS, DUCT WORK, COMPRESSOR ENCLOSURES, VACUUMS, EMERGENCY VEHICLES, CONSTRUCTION VEHICLES, BOB-SLEDS, SPEAKER ENCLOSURES, TRASH CARTS, METAL STAIRS, AIRCRAFT COWLS, COMMERCIAL AIR SILENCERS, SOUND ROOMS, RAIL CARS, BUSES, LIMOS, ICE BUCKETS, TRAILER FLOORS, METAL TABLES, METAL SINKS, METAL TARGETS, PRINTER COVERS, MACHINERY GUARDS, METAL SHROUDS, HOT TUBS, BOTTLE SORTERS, CAN SORTERS, BINS, CHUTES, HOPPERS, FAN HOUSINGS, BLOWER HOUSINGS, METAL PARTITIONS, ROOF PANELS, SOUND SUPPRESSORS, BAFFLES, COMPUTER CASES, VENTILATION DUCTS, RVs, TRUCK CABS, PUMP ENCLOSURES (U.S. CLS. 6, 11 AND 16).

FIRST USE 8-1-2003; IN COMMERCE 1-2-2004.

HOWARD B. LEVINE, EXAMINING ATTORNEY

CLASS 2—(Continued).

SN 78-943,491. THE TESTOR CORPORATION, ROCKFORD, IL. FILED 8-2-2006.



THE MARK CONSISTS OF A THREE DIMENSIONAL CONFIGURATION OF A BOTTLE USED TO CONTAIN THE GOODS. THE DOTTED OUTLINE OF THE THREADS AND THE OPENING ARE NOT CLAIMED AS A FEATURE OF THE MARK.

SEC. 2(F).

FOR PAINTS, LACQUERS, DOPES, CLEAR AND PIGMENTED COATINGS IN THE NATURE OF PAINTS, PAINT PRIMERS, PAINT THINNERS, AND PAINT SEALERS ALL FOR USE WITH MODEL AIRPLANES, MODEL VEHICLES AND THE LIKE (U.S. CLS. 6, 11 AND 16).

FIRST USE 1-0-1950; IN COMMERCE 1-0-1950.
SUSAN RICHARDS, EXAMINING ATTORNEY

SN 78-961,500. THE GLIDDEN COMPANY, STRONGSVILLE, OH. FILED 8-28-2006.

SUPER WASHABLE FLAT

NO CLAIM IS MADE TO THE EXCLUSIVE RIGHT TO USE "WASHABLE FLAT", APART FROM THE MARK AS SHOWN.

FOR COATINGS IN THE NATURE OF PAINT (U.S. CLS. 6, 11 AND 16).

FIRST USE 5-1-2006; IN COMMERCE 5-1-2006.

RICHARD WHITE, EXAMINING ATTORNEY

CLASS 3—COSMETICS AND CLEANING PREPARATIONS

SN 76-512,532. AMOREPACIFIC CORPORATION, SEOUL, REPUBLIC OF KOREA, FILED 5-8-2003.

IOPE REGENERATION MASSAGE CREAM

NO CLAIM IS MADE TO THE EXCLUSIVE RIGHT TO USE "REGENERATION MASSAGE CREAM", APART FROM THE MARK AS SHOWN.

FOR MASSAGE CREAMS WITH A SKIN REGENERATING EFFECT, NOURISHING CREAMS WITH A SKIN REGENERATING EFFECT (U.S. CLS. 1, 4, 6, 50, 51 AND 52).

RUDY R. SINGLETON, EXAMINING ATTORNEY

SN 76-660,536. MORGAN, MORRIS, RIVERTON, UT. FILED 5-24-2006.

PROFESSIONAL'S EDGE

THE MARK CONSISTS OF STANDARD CHARACTERS WITHOUT CLAIM TO ANY PARTICULAR FONT, STYLE, SIZE, OR COLOR.

FOR INDUSTRIAL, COMMERCIAL AND HOUSEHOLD CLEANING PREPARATIONS, EXCLUDING CLEANING PREPARATIONS FOR USE IN THE MARINE INDUSTRY, AND EXCLUDING SPECIFICALLY PREPARATIONS FOR USE IN CLEANING INTERIORS OF TANKS IN SHIPPING VESSELS IN THE MARINE INDUSTRY (U.S. CLS. 1, 4, 6, 50, 51 AND 52).

FIRST USE 1-2-2004; IN COMMERCE 1-2-2004.
INGA ERVIN, EXAMINING ATTORNEY

SN 76-671,560. GARCOA, INC., CALABASAS, CA. FILED 1-19-2007.

HYDROLAGE

THE MARK CONSISTS OF STANDARD CHARACTERS WITHOUT CLAIM TO ANY PARTICULAR FONT, STYLE, SIZE, OR COLOR.

FOR HAIR AND SKIN CARE PRODUCTS, NAMELY, SHAMPOO, CONDITIONER, HAIR SPRAY, HAIR GEL, NON-MEDICATED HAIR SERUMS, HAIR POMADE, HAIR CREAM, HAIR STYLING PREPARATIONS; EXFOLIATING CREAMS, SKIN CLEANSER, FACIAL SCRUB, NON-MEDICATED SKIN ASTRINGENT, SKIN MOISTURIZER AND NIGHT CREAM; HAND AND BODY MOISTURIZER, BATH AND SHOWER GEL, BATH OIL, ANTI-WRINKLE CREAM, MOISTURE CREAM AND UNDER EYE ENHANCERS (U.S. CLS. 1, 4, 6, 50, 51 AND 52).

FIRST USE 7-2-2006; IN COMMERCE 7-2-2006.
RUSS HERMAN, EXAMINING ATTORNEY

CLASS 3—(Continued).

SN 76-673,308. LADIES PISSED OFF CAR CARE KIT INC., NORTH MIAMI, FL. FILED 2-28-2007.

LADIES PISSED OFF! CAR CARE KIT

THE MARK CONSISTS OF STANDARD CHARACTERS WITHOUT CLAIM TO ANY PARTICULAR FONT, STYLE, SIZE, OR COLOR.

NO CLAIM IS MADE TO THE EXCLUSIVE RIGHT TO USE "CAR CARE KIT", APART FROM THE MARK AS SHOWN.

FOR KITS FOR PERFORMING COSMETIC AND MECHANICAL MAINTENANCE ON AN AUTOMOBILE COMPRISING OF CLEANING PREPARATIONS FOR AUTOMOBILES, DETERGENTS FOR AUTOMOBILES, STAIN REMOVERS FOR AUTOMOBILES, AUTOMOBILE LEATHER POLISHES AND CLEANERS, AND TIRE DRESSINGS (U.S. CLS. 1, 4, 6, 50, 51 AND 52).

SIMON TENG, EXAMINING ATTORNEY

SN 77-003,377. JOHNSON PUBLISHING COMPANY, INC., CHICAGO, IL. FILED 9-20-2006.

PERFECT FINISH

THE MARK CONSISTS OF STANDARD CHARACTERS WITHOUT CLAIM TO ANY PARTICULAR FONT, STYLE, SIZE, OR COLOR.

FOR FOUNDATION MAKEUP (U.S. CLS. 1, 4, 6, 50, 51 AND 52).

FIRST USE 10-0-1973; IN COMMERCE 10-0-1973.
BERYL GARDNER, EXAMINING ATTORNEY

SN 77-005,726. MBL/TIGI PRODUCTS, CARROLLTON, TX. FILED 9-22-2006.

DAMAGED BLONDE

THE MARK CONSISTS OF STANDARD CHARACTERS WITHOUT CLAIM TO ANY PARTICULAR FONT, STYLE, SIZE, OR COLOR.

FOR HAIR CARE PRODUCTS AND PREPARATIONS, NAMELY, HAIR SHAMPOO, HAIR CONDITIONER, HAIR STYLING PREPARATIONS, HAIR COLOR, HAIR PROCESSING SOLUTIONS, NAMELY, PERMANENT WAVE PREPARATIONS, HAIR STRAIGHTENING PREPARATIONS, HAIR BLEACH AND HAIR BLEACHING PRODUCTS, NAMELY, HAIR BLEACHING PREPARATIONS (U.S. CLS. 1, 4, 6, 50, 51 AND 52).

JOHN WILKE, EXAMINING ATTORNEY

CLASS 3—(Continued).

SN 77-007,308. DALA BEAUTY LLC, OCEAN, NJ. FILED 9-26-2006.

LAVANILA LABORATORIES

THE MARK CONSISTS OF STANDARD CHARACTERS WITHOUT CLAIM TO ANY PARTICULAR FONT, STYLE, SIZE, OR COLOR.

NO CLAIM IS MADE TO THE EXCLUSIVE RIGHT TO USE "LABORATORIES", APART FROM THE MARK AS SHOWN.

FOR AFTER-SUN LOTIONS; BATH LOTION; BATHING LOTIONS; BEAUTY LOTIONS; BODY LOTION; BODY LOTIONS; BODY MILKS; BODY OIL; BODY POWDER; BODY SCRUB; BODY SPRAY USED AS A PERSONAL DEODORANT AND AS FRAGRANCE; FACE AND BODY BEAUTY CREAMS; FACE AND BODY CREAMS; FACE AND BODY LOTIONS; FACE MILK AND LOTIONS; FACIAL LOTION; FACIAL WASHES; FRAGRANCE EMITTING WICKS FOR ROOM FRAGRANCE; FRAGRANCES FOR PERSONAL USE; HAIR CARE LOTIONS; LIQUID PERFUMES; LIQUID SOAPS FOR HANDS, FACE AND BODY; LOTIONS FOR FACE AND BODY CARE; PERFUME; PERFUME OILS; PERFUME OILS FOR THE MANUFACTURE OF COSMETIC PREPARATIONS; PERFUMED CREAMS; PERFUMED POWDER; PERFUMED SOAP; PERFUMED SOAPS; PERFUMED TALCUM POWDER; PERFUMES; PERFUMING SACHETS; ROOM FRAGRANCES; SCENTED BODY SPRAY; SOAPS FOR BODY CARE (U.S. CLS. 1, 4, 6, 50, 51 AND 52).

JAMES MACFARLANE, EXAMINING ATTORNEY

CLASS 3—(Continued).

SN 77-023,587. CAROLINA HERRERA LTD., NEW YORK, NY. FILED 10-18-2006.

LOVE CAROLINA HERRERA

THE MARK CONSISTS OF STANDARD CHARACTERS WITHOUT CLAIM TO ANY PARTICULAR FONT, STYLE, SIZE, OR COLOR.

OWNER OF U.S. REG. NOS. 2,703,036, 2,998,695 AND OTHERS.

THE NAME CAROLINA HERRERA IDENTIFIES A LIVING INDIVIDUAL WHOSE CONSENT IS OF RECORD.

FOR PERFUMERY, SHAVING FOAM AND SHAVING GEL, AFTER-SHAVE LOTIONS, AFTER-SHAVE GELS AND AFTER-SHAVE BALMS, SOAPS, TALCUM POWDER, SCENTED SKIN LOTIONS AND CREAMS, BATH AND SHOWER GELS, BATH SALTS, AFTER BATH SPLASH; BODY POWDER, DEODORANTS FOR PERSONAL USE (U.S. CLS. 1, 4, 6, 50, 51 AND 52).

SHANNON TWOHIG, EXAMINING ATTORNEY

SN 77-019,745. SOAPWORKS COMPANY, INC., LOS ANGELES, CA. FILED 10-12-2006.

PURE CLEANING POWER

THE MARK CONSISTS OF STANDARD CHARACTERS WITHOUT CLAIM TO ANY PARTICULAR FONT, STYLE, SIZE, OR COLOR.

NO CLAIM IS MADE TO THE EXCLUSIVE RIGHT TO USE "CLEANING", APART FROM THE MARK AS SHOWN.

FOR CLEANING PRODUCTS FOR HOUSEHOLD USE, NAMELY, LIQUID LAUNDRY DETERGENT, POWDERED LAUNDRY DETERGENT, LIQUID FABRIC SOFTENER, FABRIC SOFTENER SHEETS, LIQUID DISHWASHER SOAP, POWDERED DISHWASHER SOAP, LIQUID DISH SOAP, POWDERED OXYGEN BLEACH, LIQUID OXYGEN BLEACH, GLASS CLEANER, ALL PURPOSE CLEANER, SPOT REMOVER, DISPOSABLE WIPES IMPREGNATED WITH CHEMICALS OR COMPOUNDS FOR HOUSEHOLD USE, WOOD CLEANER, LIQUID LAUNDRY DETERGENT FOR BABY USE, BLEACH FOR HOUSEHOLD USE (U.S. CLS. 1, 4, 6, 50, 51 AND 52).

PRISCILLA MILTON, EXAMINING ATTORNEY

SN 77-024,160. COLLAZO, LISA, UPLAND, CA. FILED 10-18-2006.

S E W A
sun.earth.water.air

THE MARK CONSISTS OF STANDARD CHARACTERS WITHOUT CLAIM TO ANY PARTICULAR FONT, STYLE, SIZE, OR COLOR.

FOR LIQUID SOAP; BAR SOAP; BODY LOTION; BODY CREAM; FACIAL LOTION; FACIAL CREAM; FACIAL OIL; BODY OIL; BATH SALTS; HAIR OIL; BODY SCRUB; FACIAL SCRUB; SKIN TONER; BATH OIL; CUTICLE OIL; LIP BALM; LIP SCRUB; PERFUMERY; DRIED HERBAL PREPARATION FOR USE AS A SKIN TONER (U.S. CLS. 1, 4, 6, 50, 51 AND 52).

REBECCA POVARCHUK, EXAMINING ATTORNEY

CLASS 3—(Continued).

SN 77-025,057. HOWE, BRUCE L., VISTA, CA. FILED 10-19-2006.



NO CLAIM IS MADE TO THE EXCLUSIVE RIGHT TO USE "ORGANIKS", APART FROM THE MARK AS SHOWN. THE COLOR(S) BROWN IS/ARE CLAIMED AS A FEATURE OF THE MARK.

THE MARK CONSISTS OF THE WORD ORGANIKS WITH THE STYLIZED K HAVING A COMPOUND LEAF THEREON. THE ENTIRE MARK APPEARS IN THE COLOR BROWN.

FOR BATH OILS FOR COSMETIC PURPOSES; BODY AND BEAUTY CARE COSMETICS; CLEANSING CREAMS; COSMETIC CREAMS; COSMETIC CREAMS FOR SKIN CARE; COSMETIC OILS; COSMETIC PREPARATIONS FOR BODY CARE; COSMETIC PREPARATIONS FOR SKIN RENEWAL; COSMETIC SOAPS; COSMETIC SUN-PROTECTING PREPARATIONS; COSMETIC SUN-TANNING PREPARATIONS; COSMETICS; FACE CREAMS FOR COSMETIC USE; FOAMS CONTAINING COSMETICS AND SUNSCREENS; FOUNDATION; NUTRITIONAL OILS FOR COSMETIC PURPOSES; SHAMPOOS; SOAPS; TONERS; TOPICAL SKIN SPRAYS FOR COSMETIC PURPOSES (U.S. CLS. 1, 4, 6, 50, 51 AND 52).

INGRID C. EULIN, EXAMINING ATTORNEY

SN 77-026,705. CARGO COSMETICS CORP., TORONTO, CANADA, FILED 10-23-2006.

SUEDEBLUSH

THE MARK CONSISTS OF STANDARD CHARACTERS WITHOUT CLAIM TO ANY PARTICULAR FONT, STYLE, SIZE, OR COLOR.

FOR HAIR CARE, BATH AND COSMETIC PRODUCTS, NAMELY, EYE SHADOW, EYE LINER, MASCARA, BLUSH, LIP LINER, BROW PENCILS, LIPSTICK, LIP GLOSS, LIP BALMS, COSMETIC AND LIP COLOR PALETTES, COSMETIC COMPACTS INCLUDING PALETTES OF FACIAL AND/OR LIP COLORS SOLD AS A UNIT WITH OR WITHOUT AN APPLICATOR, UNDER-EYE CONCEALERS, FOUNDATIONS, FOUNDATIONS WITH SUNSCREEN, FACE POWDERS, SOAPS, BATH OIL, SKIN MOISTURIZER, FRAGRANCES AND PERFUMES FOR PERSONAL USE, DEODORANTS, TALCUM POWDER, SHAMPOO, CONDITIONER, HAIR STYLING GELS AND SPRAY, NAIL POLISH, SKIN CREAMS AND POWDERS, FOR USE AS A BRONZER, SUN TAN LOTION, SUN SCREENS, FACIAL CLEANSER AND FACIAL TONER (U.S. CLS. 1, 4, 6, 50, 51 AND 52).

BARBARA A. GOLD, EXAMINING ATTORNEY

CLASS 3—(Continued).

SN 77-033,829. MANA PRODUCTS, INC., LONG ISLAND CITY, NY. FILED 11-1-2006.

Glamorous Green

THE MARK CONSISTS OF STANDARD CHARACTERS WITHOUT CLAIM TO ANY PARTICULAR FONT, STYLE, SIZE, OR COLOR.

NO CLAIM IS MADE TO THE EXCLUSIVE RIGHT TO USE "GREEN", APART FROM THE MARK AS SHOWN.

FOR NON-MEDICATED SHAMPOO AND CONDITIONERS; NON-MEDICATED SKINCARE PREPARATIONS; AND COSMETICS (U.S. CLS. 1, 4, 6, 50, 51 AND 52).

JENNIFER MARTIN, EXAMINING ATTORNEY

SN 77-035,612. MBL/TIGI PRODUCTS, CARROLLTON, TX. FILED 11-2-2006.

HEALTHY BLONDE

THE MARK CONSISTS OF STANDARD CHARACTERS WITHOUT CLAIM TO ANY PARTICULAR FONT, STYLE, SIZE, OR COLOR.

FOR COSMETICS; FRAGRANCES FOR PERSONAL USE, NAMELY, EAU DE TOILETTE, PERFUME AND ESSENTIAL OILS; FRAGRANCES FOR ROOMS AND AUTOMOBILES; HAIR CARE PRODUCTS, NAMELY, HAIR SHAMPOO, HAIR LOTIONS, HAIR CONDITIONERS, HAIR CREAMS, HAIR WAXES, HAIR SPRAYS, HAIR GELS, HAIR COLOR GELS AND CONDITIONERS, HAIR POMADES, HAIR MOUSSES AND HAIR CARE PREPARATIONS; SKIN CARE PRODUCTS, NAMELY, NON-MEDICATED SKIN CARE PREPARATIONS, COLD CREAMS, FACIAL CREAMS, EXFOLIANTS, BEAUTY, FACIAL AND BODY MASKS, FACIAL AND SKIN CLEANSERS. (U.S. CLS. 1, 4, 6, 50, 51 AND 52).

CORY BOONE, EXAMINING ATTORNEY

CLASS 3—(Continued).

SN 77-038,471. FLAT CREEK MOUNTAIN, INC., ASHEVILLE, NC. FILED 11-7-2006.

FLOWER SENTIMENTS

THE MARK CONSISTS OF STANDARD CHARACTERS WITHOUT CLAIM TO ANY PARTICULAR FONT, STYLE, SIZE, OR COLOR.

NO CLAIM IS MADE TO THE EXCLUSIVE RIGHT TO USE "FLOWER", APART FROM THE MARK AS SHOWN.

FOR AFTER-SHAVE GEL; AFTER-SHAVE LOTIONS; AFTER-SUN LOTIONS; AGE RETARDANT LOTION; ALL PURPOSE CLEANING PREPARATIONS; ALL-PURPOSE CLEANERS; ANTIBACTERIAL SKIN SOAPS; ANTIPERSPIRANTS; ANTI-AGING CREAM; ANTI-STATIC DRYER SHEETS; ANTI-WRINKLE CREAM; AROMATHERAPY CREAMS; AROMATHERAPY LOTIONS; AROMATHERAPY OILS; AROMATHERAPY PILLOWS COMPRISING POTPOURRI IN FABRIC CONTAINERS; ASTRINGENTS FOR COSMETIC PURPOSES; BABY HAIR CONDITIONER; BABY LOTION; BABY OIL; BABY POWDER; BABY SHAMPOO; BABY WIPES; BATH BEADS; BATH CRYSTALS; BATH FOAM; BATH GEL; BATH LOTION; BATH MILKS; BATH OIL; BATH PEARLS; BATH POWDER; BEAUTY MASKS; BLUSH; BLUSHER; BODY CONCEALERS; BODY CREAM; BODY EMULSIONS; BODY LOTION; BODY MASK CREAM; BODY MASK LOTION; BODY MASK POWDER; BODY MASKS; BODY MILKS; BODY OIL; BODY POWDER; BODY SCRUB; BODY SPRAY USED AS A PERSONAL DEODORANT AND AS FRAGRANCE; BODY SPRAYS; BREATH FRESHENER; BUBBLE BATH; COCOA BUTTER FOR COSMETIC PURPOSES; COLD CREAM; COLOGNE; COMPACTS CONTAINING MAKE-UP; COSMETIC BALLS; COSMETIC PADS; COSMETIC PENCILS; COSMETIC PREPARATIONS FOR SKIN RENEWAL; COSMETICS; COSMETICS NAMELY, COMPACTS; COTTON BALLS FOR COSMETIC PURPOSES; COTTON FOR COSMETIC PURPOSES; COTTON PUFFS FOR COSMETIC PURPOSES; COTTON STICKS FOR COSMETIC PURPOSES; COTTON SWABS FOR COSMETIC PURPOSES; CREAMS FOR CELLULITE REDUCTION; CUTICLE CONDITIONERS; CUTICLE CREAM; CUTICLE REMOVING PREPARATIONS; DEODORANT SOAP; DEODORANTS FOR PERSONAL USE; DEODORANTS AND ANTIPERSPIRANTS; DEODORANTS FOR CLOTHING OR TEXTILES; DEPILATORIES; DEPILATORY CREAMS; DETERGENT SOAP; DISH DETERGENTS; DISPOSABLE WIPES IMPREGNATED WITH CHEMICALS OR COMPOUNDS FOR PERSONAL HYGIENE; DRYER SHEETS IMPREGNATED WITH CLEANING GEL AND BAGS FOR USE IN CONNECTION THEREWITH; DUSTING POWDER; EAU DE COLOGNE; EAU DE PARFUM; EAU DE TOILETTE; EMERY BOARDS; ESSENTIAL OILS FOR FOOD FLAVORINGS; ESSENTIAL OILS FOR PERSONAL USE; ESSENTIAL OILS FOR USE IN THE MANUFACTURE OF SCENTED PRODUCTS; EXFOLIANTS FOR SKIN; EYE COMPRESSES FOR COSMETIC PURPOSES; EYE CREAM; EYE GELS; EYE MAKEUP; EYE MAKEUP REMOVER; EYE PENCILS; EYE SHADOW; EYEBROW PENCILS; EYELINERS; FABRIC SOFTENERS; FACE CREAMS; FACE POWDER; FACIAL CLEANSERS; FACIAL CONCEALERS; FACIAL CREAMS; FACIAL EMULSIONS; FACIAL LOTIONS; FACIAL MAKEUP; FACIAL MASKS; FACIAL SCRUBS; FALSE NAILS; FEMININE DEODORANT SPRAYS; FINGERNAIL SCULPTURING OVERLAYS; FOOD FLAVORING, BEING ESSENTIAL OILS; FOOT DEODORANT SPRAY; FOUNDATION MAKEUP; FRAGRANCE EMITTING WICKS FOR ROOM FRAGRANCE; FRAGRANCES FOR PERSONAL USE; HAIR BLEACH; HAIR BLEACHING PREPARATIONS; HAIR CARE PREPARATIONS; HAIR CLEANING PREPARATIONS; HAIR CONDITIONERS; HAIR GEL; HAIR LOTIONS; HAIR MOUSSE; HAIR POMADES; HAIR RINSES; HAIR SHAMPOO; HAIR SPRAY; HAIR STYLING PREPARATIONS; HAND CREAM; HAND LOTIONS; HAND SOAPS; INCENSE; LIP BALM; LIP CREAM; LIP GLOSS; LIP GLOSS PALATTE; LIP LINER; LIPSTICK; LIQUID SOAPS FOR BODY;

CLASS 3—(Continued).

LIQUID SOAPS FOR FACE; LIQUID SOAPS FOR HANDS; LIQUID SOAPS FOR HANDS, FACE AND BODY; MAKEUP; MAKE-UP REMOVER; MASCARA; MASSAGE OIL; MEDICATED SOAP; MOISTURIZING MILKS; MOUTHWASH; NAIL ENAMEL; NAIL GLITTER; NAIL GROOMING PRODUCTS, NAMELY, TIPS, GLUE, LACQUER AND GLITTER; NAIL HARDENERS; NAIL POLISH; NAIL POLISH BASE COAT; NAIL POLISH REMOVER; NAIL POLISH TOP COAT; NAIL STRENGTHENERS; NAIL TIPS; NIGHT CREAM; NON-MEDICATED BATH SALTS; NON-MEDICATED BODY SOAKS; NON-MEDICATED FOOT CREAM; NON-MEDICATED FOOT POWDER; NON-MEDICATED HAIR CARE PREPARATIONS; NON-MEDICATED LIP BALM; NON-MEDICATED LIP CARE PREPARATIONS; NON-MEDICATED LIP PROTECTOR; NON-MEDICATED MOUTH RINSE; NON-MEDICATED OINTMENTS FOR THE PREVENTION AND TREATMENT OF SUNBURN; NON-MEDICATED SKIN CARE PREPARATIONS; NON-MEDICATED STIMULATING LOTIONS FOR THE SKIN; PERFUME; PERFUME OILS; PERFUMERY; PERSONAL DEODORANTS; PETROLEUM JELLY FOR COSMETIC PURPOSES; POMANDERS; POTPOURRI; PRE-MOISTENED COSMETIC TISSUES; PRE-MOISTENED COSMETIC TOWELETES; PRE-MOISTENED COSMETIC WIPES; PUMICE STONES FOR PERSONAL USE; ROOM FRAGRANCES; ROUGE; SACHETS; SACHET-LIKE EYE PILLOWS CONTAINING FRAGRANCES; SCENTED BODY SPRAY; SCENTED CERAMIC STONES; SCENTED LINEN SPRAYS; SCENTED OILS USED TO PRODUCE AROMAS WHEN HEATED; SCENTED PINE CONES; SCENTED ROOM SPRAYS; SCULPTING GEL; SHAMPOO-CONDITIONERS; SHAVING BALM; SHAVING CREAM; SHAVING FOAM; SHAVING GEL; SHAVING LOTION; SHAVING PREPARATIONS; SHAVING SOAP; SHOWER GEL; SKIN ABRASIVE PREPARATIONS; SKIN CARE PRODUCTS, NAMELY, NON-MEDICATED SKIN SERUM; SKIN CLARIFIERS; SKIN CLEANSERS; SKIN CLEANSING CREAM; SKIN CLEANSING LOTION; SKIN CONCEALERS; SKIN CONDITIONERS; SKIN CREAM; SKIN EMOLLIENTS; SKIN, FACIAL AND BODY CONCEALERS; SKIN GELS FOR ACCELERATING, ENHANCING OR EXTENDING TANS; SKIN LIGHTENERS; SKIN LIGHTENING CREAMS; SKIN LOTION; SKIN MASKS; SKIN MOISTURIZER; SKIN MOISTURIZER MASKS; SKIN SOAP; SKIN TEXTURIZERS; SKIN TONERS; SKIN WHITENING CREAMS; STYLING GELS; STYLING LOTIONS; SUN BLOCK; SUN BLOCK PREPARATIONS; SUN CARE LOTIONS; SUN CREAMS; SUN SCREEN; SUN SCREEN PREPARATIONS; SUN TAN GEL; SUN TAN LOTION; SUN TAN OIL; SUNTANNING PREPARATIONS; TALCUM POWDER; TOILET SOAP; TOILET WATER; TOPICAL SKIN SPRAYS FOR COSMETIC PURPOSES; VANISHING CREAM; WATERLESS SOAP; AND WRINKLE REMOVING SKIN CARE PREPARATIONS (U.S. CLS. 1, 4, 6, 50, 51 AND 52).

CARYN GLASSER, EXAMINING ATTORNEY

SN 77-039,456. BARKER, JANILYN, S., CHARLESTON, SC. FILED 11-8-2006.

Finding Emu!

THE MARK CONSISTS OF STANDARD CHARACTERS WITHOUT CLAIM TO ANY PARTICULAR FONT, STYLE, SIZE, OR COLOR.

NO CLAIM IS MADE TO THE EXCLUSIVE RIGHT TO USE "EMU", APART FROM THE MARK AS SHOWN.

FOR EMU BODY OIL, EMU HAIR OIL (U.S. CLS. 1, 4, 6, 50, 51 AND 52).

FIRST USE 2-23-2005; IN COMMERCE 2-23-2005.

ARETHA SOMERVILLE, EXAMINING ATTORNEY

CLASS 3—(Continued).

SN 77-064,564. CARIBA INTERNATIONAL CORP, SAFETY HARBOR, FL. FILED 12-14-2006.

MIAMI XTREME

THE MARK CONSISTS OF STANDARD CHARACTERS WITHOUT CLAIM TO ANY PARTICULAR FONT, STYLE, SIZE, OR COLOR.

NO CLAIM IS MADE TO THE EXCLUSIVE RIGHT TO USE "MIAMI", APART FROM THE MARK AS SHOWN.

FOR SHAMPOOS FOR BABIES, STYLING GELS, BODY DEODORANTS, BODY LOTIONS, HAIR CONDITIONERS, HAIR CARE SHAMPOOS (U.S. CLS. 1, 4, 6, 50, 51 AND 52).

TINA BROWN, EXAMINING ATTORNEY

SN 77-066,464. SHOOTING STAR INTERNATIONAL, TORRANCE, CA. FILED 12-18-2006.

DESIGNER TIPS

THE MARK CONSISTS OF STANDARD CHARACTERS WITHOUT CLAIM TO ANY PARTICULAR FONT, STYLE, SIZE, OR COLOR.

OWNER OF U.S. REG. NO. 2,746,464.

NO CLAIM IS MADE TO THE EXCLUSIVE RIGHT TO USE "TIPS", APART FROM THE MARK AS SHOWN.

FOR NAIL GROOMING PRODUCTS, NAMELY, ARTIFICIAL NAILS (U.S. CLS. 1, 4, 6, 50, 51 AND 52).

DAVID H. STINE, EXAMINING ATTORNEY

SN 77-073,910. KAWALLI FASHION INC., LAWRENCEVILLE, GA. FILED 12-31-2006.

KAWALLI ALABASTA

THE MARK CONSISTS OF STANDARD CHARACTERS WITHOUT CLAIM TO ANY PARTICULAR FONT, STYLE, SIZE, OR COLOR.

FOR PERFUMES, AND SKIN CARE PRODUCTS NAMELY HAND, FACE AND BODY CREAMS, OILS NAMELY BATH OILS, BODY OILS, MASSAGE OILS, POWDERS NAMELY FOR FACE AND BODY AND LOTIONS NAMELY FOR HAND AND BODY; HAIR CARE PREPARATIONS (U.S. CLS. 1, 4, 6, 50, 51 AND 52).

FIRST USE 12-26-2006; IN COMMERCE 12-26-2006.

SCOTT BIBB, EXAMINING ATTORNEY

CLASS 3—(Continued).

SN 77-075,717. NADEAN ENTERPRISES, INC., FORT WORTH, TX. FILED 1-4-2007.

NEI

THE MARK CONSISTS OF STANDARD CHARACTERS WITHOUT CLAIM TO ANY PARTICULAR FONT, STYLE, SIZE, OR COLOR.

FOR HAIR CARE PRODUCTS, NAMELY, SHAMPOOS, CONDITIONERS, HAIR COLOR, OIL TREATMENTS, STRAIGHTENERS, CREAMS AND MASKS; SKIN CARE PRODUCTS, NAMELY, LOTIONS, OILS, MOISTURIZERS AND CREAMS (U.S. CLS. 1, 4, 6, 50, 51 AND 52).

EVELYN BRADLEY, EXAMINING ATTORNEY

SN 77-082,326. BERGMAN, KARRIE E., REDMOND, WA. FILED 1-12-2007.



NO CLAIM IS MADE TO THE EXCLUSIVE RIGHT TO USE KITS, APART FROM THE MARK AS SHOWN.

THE MARK CONSISTS OF A STYLIZED KOALA BEAR WEARING PANTS AND A SHIRT AND CARRYING A HANDBAG OVER ITS SHOULDER.

FOR MAKE-UP KITS COMPRISED OF COSMETICS AND GROOMING AIDS (U.S. CLS. 1, 4, 6, 50, 51 AND 52).

COLLEEN DOMBROW, EXAMINING ATTORNEY

CLASS 3—(Continued).

SN 77-086,380. REJUVADERM, INC., HOUSTON, TX. FILED 1-19-2007.

ESFERA

THE MARK CONSISTS OF STANDARD CHARACTERS WITHOUT CLAIM TO ANY PARTICULAR FONT, STYLE, SIZE, OR COLOR.

THE FOREIGN WORDING IN THE MARK TRANSLATES INTO ENGLISH AS SPHERE.

FOR ADHESIVES FOR COSMETIC USE; ALOE VERA GEL FOR COSMETIC PURPOSES; ASTRINGENTS FOR COSMETIC PURPOSES; BATH OILS FOR COSMETIC PURPOSES; BLEACHING PREPARATIONS FOR COSMETIC PURPOSES; BODY AND BEAUTY CARE COSMETICS; CHALK FOR COSMETIC USE; CLEANER FOR COSMETIC BRUSHES; CLEANSING CREAMS; COCOA BUTTER FOR COSMETIC PURPOSES; COLORING PREPARATIONS FOR COSMETIC PURPOSES; CONCEALERS; COSMETIC BALLS; COSMETIC CREAMS; COSMETIC CREAMS FOR SKIN CARE; COSMETIC FACIAL BLOTTER PAPER; COSMETIC MILKS; COSMETIC OILS; COSMETIC OILS FOR THE EPIDERMIS; COSMETIC PADS; COSMETIC PENCILS; COSMETIC PREPARATIONS AGAINST SUNBURN; COSMETIC PREPARATIONS FOR BODY CARE; COSMETIC PREPARATIONS FOR EYE LASHES; COSMETIC PREPARATIONS FOR SKIN RENEWAL; COSMETIC PREPARATIONS FOR THE CARE OF MOUTH AND TEETH; COSMETIC PRODUCTS IN THE FORM OF AEROSOLS FOR SKIN CARE; COSMETIC PRODUCTS IN THE FORM OF AEROSOLS FOR SKINCARE; COSMETIC ROUGES; COSMETIC SOAPS; COSMETIC SUN-PROTECTING PREPARATIONS; COSMETIC SUN-TANNING PREPARATIONS; COSMETIC SUNTAN LOTIONS; COSMETICS; COSMETICS NAMELY, COMPACTS; COSMETICS, NAMELY LIP PRIMER; COTTON BALLS FOR COSMETIC PURPOSES; COTTON BUDS FOR COSMETIC PURPOSES; COTTON FOR COSMETIC PURPOSES; COTTON PUFFS FOR COSMETIC PURPOSES; COTTON STICKS FOR COSMETIC PURPOSES; COTTON SWABS FOR COSMETIC PURPOSES; DECORATIVE TRANSFERS AND SKIN JEWELS FOR COSMETIC PURPOSES; EYE COMPRESSES FOR COSMETIC PURPOSES; FACE CREAMS FOR COSMETIC USE; FOAMS CONTAINING COSMETICS AND SUNSCREENS; FOUNDATION; GAUZE FOR COSMETIC PURPOSES; GREASES FOR COSMETIC PURPOSES; HENNA FOR COSMETIC PURPOSES; MAKE-UP KITS COMPRISED OF SKIN CARE PRODUCTS, NAMELY BODY AND BEAUTY CARE PREPARATIONS, COSMETICS, PERFUMES, ESSENTIAL OILS FOR PERSONAL USE AND BODYSOAPS; NAIL VARNISH FOR COSMETIC PURPOSES; NUTRITIONAL OILS FOR COSMETIC PURPOSES; PARAFFIN WAX FOR COSMETIC PURPOSES; PENCILS FOR COSMETIC PURPOSES; PERFUME OILS FOR THE MANUFACTURE OF COSMETIC PREPARATIONS; PETROLEUM JELLY FOR COSMETIC PURPOSES; PRE-MOISTENED COSMETIC TISSUES; PRE-MOISTENED COSMETIC TOWELLETTES; PRE-MOISTENED COSMETIC WIPES; ROSE OIL FOR COSMETIC PURPOSES; SHAMPOOS; SOAPS; TONERS; TOPICAL SKIN SPRAYS FOR COSMETIC PURPOSES (U.S. CLS. 1, 4, 6, 50, 51 AND 52).

JOHN WILKE, EXAMINING ATTORNEY

CLASS 3—(Continued).

SN 77-088,139. DEENTERPRISES, INC., BROADVIEW, IL. FILED 1-22-2007.

NOMMA PLUS

THE MARK CONSISTS OF STANDARD CHARACTERS WITHOUT CLAIM TO ANY PARTICULAR FONT, STYLE, SIZE, OR COLOR.

FOR COSMETIC FINGERNAIL PRODUCT, NAMELY ACRYLIC LIQUID USED TO FORM AN ARTIFICIAL FINGERNAIL (U.S. CLS. 1, 4, 6, 50, 51 AND 52).

FIRST USE 6-30-2006; IN COMMERCE 6-30-2006.

WON TEAK OH, EXAMINING ATTORNEY

SN 77-089,066. ORALINE, INC., CORTLAND, NY. FILED 1-23-2007.

OraLine

THE MARK CONSISTS OF STANDARD CHARACTERS WITHOUT CLAIM TO ANY PARTICULAR FONT, STYLE, SIZE, OR COLOR.

SEC. 2(F).

FOR TOOTH PASTE (U.S. CLS. 1, 4, 6, 50, 51 AND 52).

FIRST USE 12-31-1999; IN COMMERCE 12-31-1999.

MARTHA FROMM, EXAMINING ATTORNEY

CLASS 3—(Continued).

SN 77-089,094. LG HOUSEHOLD & HEALTH CARE LTD., SEOUL, REPUBLIC OF KOREA, FILED 1-23-2007.



THE FOREIGN WORDING IN THE MARK TRANSLATES INTO ENGLISH AS "SHADOW & LIGHT."

FOR SKIN MILK LOTION; PERFUMES; CLEANSING CREAM; BATH SOAPS; LIPSTICKS; FACIAL ESSENCE IN THE NATURE OF ESSENTIAL OILS; HAIR SHAMPOOS; EYE SHADOWS; TOILET WATER; HAIR DYE; POWDERED DETERGENT SOAP; FALSE EYELASHES; FALSE NAILS; PRE-MOISTENED COSMETIC WIPES IMPREGNATED WITH COSMETIC LOTIONS; LIQUID SOAPS; PERFUMERY IN THE NATURE OF ELECAM-PANE FRAGRANCE; HAIR RINSE; HAIR SPRAY; HAIR MOUSSE; HAIR ESSENCE IN THE NATURE OF ESSENTIAL OILS; SUN SCREEN LOTION; DEPILOYATORY PREPARATIONS; COLOR-REMOVING PREPARATIONS FOR HAIR; FABRIC SOFTENERS FOR LAUNDRY USE; NON-MEDICATED MOUTHWASHES; NON-MEDICATED DENTAL RINSES; FOUNDATION CREAM MAKEUP; CHEEK COLORS, NAMELY, BLUSH; BLUSHERS; EYE LINER; NAIL POLISH; NOURISHING BODY CREAM; ANTISTATIC PREPARATIONS FOR HOUSEHOLD PURPOSES, NAMELY, ANTI-STATIC DRYER SHEETS AND ANTI-STATIC SPRAY FOR CLOTHING; NAIL DECOLORANTS, NAMELY, NAIL POLISH REMOVERS; BEAUTY MASKS; BEAUTY MASK PACK COMPRISED OF FACIAL MOISTURIZER; TOILET SOAPS; DETERGENTS PREPARED FROM PETROLEUM FOR HOUSEHOLD CLEANING USE; RINSE IN THE FORM OF DETERGENT FOR CLOTHING; TOILET BOWL DETERGENTS; DISHWASHING DETERGENTS; BABY OIL; LIP GLOSS; LIP BALM; MASSAGE CREAM; BODY LOTION; HAIR GEL; NON-MEDICATED PROTECTIVE PREPARATIONS FOR LIPS; AFTER SHAVE LOTION; SHAVING FOAM; SHAVING CREAM (U.S. CLS. 1, 4, 6, 50, 51 AND 52).

MICHAEL SOUDERS, EXAMINING ATTORNEY

CLASS 3—(Continued).

SN 77-090,201. ROCKLINE INDUSTRIES, INC., SHEBOYGAN, WI. FILED 1-24-2007.

CHANGING OUR ENVIRONMENTAL
FOOTPRINT

THE MARK CONSISTS OF STANDARD CHARACTERS WITHOUT CLAIM TO ANY PARTICULAR FONT, STYLE, SIZE, OR COLOR.

FOR CLEANING CLOTHS AND WIPES IMPREGNATED WITH CLEANING CHEMICALS; DISPOSABLE HOUSEHOLD CLEANING WIPES IMPREGNATED WITH CLEANSING COMPOUNDS; BABY WIPES; PRE-MOISTENED BABY WIPES; DISPOSABLE WIPES AND TOWELETTES IMPREGNATED WITH CHEMICALS OR COMPOUNDS FOR PERSONAL HYGIENE USE; PRE-MOISTENED WIPES IMPREGNATED WITH CHEMICALS OR COMPOUNDS FOR PERSONAL HYGIENE, NAMELY, WET WIPES, MAKE-UP REMOVER WIPES AND MOIST TOILET WIPES AND TISSUE; DRY-WATER ACTIVATED WIPES IMPREGNATED WITH CLEANSING COMPOUNDS FOR PERSONAL HYGIENE; PRE-MOISTENED COSMETIC TOWELETTES; PRE-MOISTENED COSMETIC WIPES AND TOWELETTES (U.S. CLS. 1, 4, 6, 50, 51 AND 52).

ANDREA SAUNDERS, EXAMINING ATTORNEY

SN 77-097,344. AMOREPACIFIC CORPORATION, SEOUL, REPUBLIC OF KOREA, FILED 2-1-2007.

HYDROAID SERUM

THE MARK CONSISTS OF STANDARD CHARACTERS WITHOUT CLAIM TO ANY PARTICULAR FONT, STYLE, SIZE, OR COLOR.

NO CLAIM IS MADE TO THE EXCLUSIVE RIGHT TO USE "SERUM", APART FROM THE MARK AS SHOWN.

FOR NON-MEDICATED NOURISHING CREAMS FOR THE SKIN; NAIL POLISH REMOVERS; EYEBROW PENCILS; ROUGE; LIPSTICKS; MASCARAS; FACIAL MASK CONSISTING OF COSMETIC MATERIAL IMPREGNATED WITH COSMETICS AND APPLIED TO FACE FOR SOFTENING AND PURIFYING THE SKIN OF THE FACE; BODY GELS FOR MASSAGE USE; MASSAGE OIL; NAIL POLISH; NAIL ENAMELS; HAIR OILS; HAIR CARE PREPARATIONS; HAIR COLOR; HAIR WAVING LOTIONS; HAIR BLEACHES; BATH ADDITIVES IN THE NATURE OF CRYSTALS, GELS AND LIQUIDS, NAMELY, LIQUID BODY MILKS, LIQUID BATH SOAPS AND BUBBLE BATH FOR COSMETIC PURPOSES; VANISHING CREAMS; BATH OIL FOR COSMETIC PURPOSES; BATH POWDER FOR COSMETIC PURPOSES; BAY RUMS; BABY OIL; BABY POWDER; BLUSHERS; PERFUMED POWDER; NON-MEDICATED BATH SALTS; NON-MEDICATED FRAGRANCE, NAMELY, FRAGRANCES FOR PERSONAL USE AND ROOM FRAGRANCES; SUN CARE LOTIONS; SUNSCREEN LOTIONS; SUNSCREEN CREAMS; SUN TAN OIL; SUN-TANNING PREPARATIONS FOR COSMETIC PURPOSES; SHAVING CREAMS; BEAUTY MILK; SKIN MOISTURIZER; EYELINERS; EYE MAKE-UP REMOVERS; EYE SHADOW; AFTER SHAVE LOTIONS; EAU DE COLOGNE; DEODORANTS FOR PERSONAL USE; NON-MEDICATED SKIN CARE PREPARATIONS, NAMELY, SKIN TONERS; SKIN LOTIONS; SKIN EMOLLIENTS AND SKIN CLARIFIERS; LIP POLISHER; NON-MEDICATED LIP CARE PREPARATIONS, NAMELY, LIP NEUTRALIZER AND LIP CONDITIONERS; NON-MEDICATED LIP PROTECTOR;

CLASS 3—(Continued).

NON-MEDICATED COSMETIC PREPARATIONS FOR BODY SLIMMING PURPOSES, NAMELY, BODY SLIMMING CREAMS, BODY SLIMMING LOTIONS, NAMELY, LOTIONS FOR CELLULITE REDUCTION, BODY SLIMMING GELS AND BODY SLIMMING OILS, NAMELY, OILS FOR CELLULITE REDUCTION; COLD CREAMS; COLD WAVING SOLUTIONS; SOLID FACE MAKE UP POWDER SOLD IN COMPACT; MUSTACHE WAX; SKIN CLEANSING CREAM FOR COSMETIC PURPOSES; DEPILATORY WAX; DEPILATORIES; FOUNDATIONS, NAMELY, LIQUID FOUNDATION, CREAMY FOUNDATION AND MAKE-UP FOUNDATIONS; PERMANENT HAIR WAVING LOTIONS; FACE POWDER; POTPOURRI; SKIN WHITENING CREAMS; HAND CREAMS; PERFUMES; HAIR GELS; HAIR LACQUERS; HAIR LOTIONS; HAIR MOUSSE; HAIR SPRAY; HAIR CONDITIONERS; HAIR CREAMS; HAIR TONIC; MAKE-UP POWDER; HYDROGEN PEROXIDE FOR USE ON THE HAIR; ASTRINGENTS FOR COSMETIC PURPOSES; PENCILS FOR COSMETIC PURPOSES; MINERAL SALT IN THE NATURE OF BATH SALTS NOT FOR MEDICAL PURPOSES; SKIN CLEANSING MILK; TALCUM POWDERS; LAVENDER OIL FOR COSMETIC PURPOSES; BERGAMOT OIL FOR COSMETIC PURPOSES; AMBERGRIS; JASMINE OIL FOR COSMETIC PURPOSES; ROSE OIL FOR COSMETIC PURPOSES; SYNTHETIC PERFUMERY; MUSK PERFUMERY; INCENSE STICKS; FUMIGATING INCENSES; ADHESIVES FOR AFFIXING FALSE HAIR; FALSE EYELASHES; ADHESIVES FOR AFFIXING FALSE EYELASHES; FALSE NAILS; PRE-MOISTENED TISSUES IMPREGNATED WITH COSMETIC LOTIONS; COTTON STICKS FOR COSMETIC PURPOSES; BEAUTY MASKS; ADHESIVES FOR COSMETIC USE; COTTON SWABS FOR COSMETIC PURPOSES; SOAP POWDER; DETERGENTS PREPARED FROM PETROLEUM FOR HOUSEHOLD USE; INDUSTRIAL SOAPS; DRY CLEANING FLUIDS; SHAVING SOAP; LIQUID SOAPS; DEODORANT SOAP; CLEANING PREPARATIONS FOR CLEANING WASTE PIPES; DETERGENT SOAP WITH TEXTILE BRIGHTENING INGREDIENTS; SKIN POLISHING RICE BRAN; NON-MEDICATED DOUCHES; LAUNDRY SOAPS; DISINFECTANT SOAP; ALMOND SOAP; GLASS CLEANING PREPARATIONS; FABRIC SOFTENERS FOR LAUNDRY USE; WINDSHIELD WASHING FLUID; TOILET BOWL DETERGENTS; BATH SOAPS; SKIN SOAPS; HAIR SHAMPOOS; CREAM SOAPS; HAIR RINSES; COSMETIC SOAPS; NON-MEDICATED MOUTH WASH AND RINSE; NON-MEDICATED DENTAL RINSE; DENTURE CLEANING PREPARATIONS, NAMELY, DENTURE POLISH AND DENTURE CLEANER; TOOTH POWDERS; TOOTH PASTE; BEAUTY SERUMS; SKIN CARE PRODUCTS, NAMELY, NON-MEDICATED SKIN SERUM; BODY CREAMS; BODY LOTIONS; FACIAL CLEANSING FOAMS; SKIN CLEANSING LOTION; SKIN CLEANSING OILS; LIP GLOSS; NON-MEDICATED SKIN CREAMS FOR MASSAGE USE; LIP LINER; NON-MEDICATED LIP BALM; COLOGNE WATER; EAU DE TOILETTE; SKIN EXFOLIATOR LOTIONS AND CREAMS; PRE-MOISTENED COSMETIC TISSUES HAVING THE HORNY LAYER REMOVAL EFFECT; COSMETIC FACIAL BLOTting PAPERS, NAMELY, OIL BLOTting SHEETS FOR THE SKIN; SKIN CLEANSERS; TOOTH WHITENING PREPARATIONS, NAMELY, TOOTH WHITENING CREAMS, TOOTH WHITENING GELS AND TOOTH WHITENING PASTES; NON-MEDICATED MOISTURIZING NUTRITIONAL HAIR ESSENCE IN THE FORM OF LOTIONS AND OILS (U.S. CLS. 1, 4, 6, 50, 51 AND 52).

AMY MCMENAMIN, EXAMINING ATTORNEY

CLASS 3—(Continued).

SN 77-103,646. BATH & BODY WORKS BRAND MANAGEMENT, INC., REYNOLDSBURG, OH. FILED 2-9-2007.

CALM COOL & PROTECTED

THE MARK CONSISTS OF STANDARD CHARACTERS WITHOUT CLAIM TO ANY PARTICULAR FONT, STYLE, SIZE, OR COLOR.

FOR PERSONAL CARE PRODUCTS, NAMELY, AEROSOL TANNING BODY SPRAY, BODY BRONZER, BODY MOISTURIZER, BODY SHIMMER, BODY WASH, BRONZING BODY LOTION, EAU DE TOILETTE, EAU DE TOILETTE SPRAY, FACE SUN BLOCK, FACE BRONZER, SOAP FOR THE FACE IN THE FORM OF PETALS, GRADUAL BODY TANNING LOTION AND CREAM, GRADUAL FACIAL TANNING LOTION AND CREAM, LEG BRONZER, LIP SUN BLOCK, NON-MEDICATED LIP PROTECTOR, POST-SUN TANNING LOTION FOR THE BODY, POST-SUN TANNING LOTION FOR THE FACE, PRE-SUN TANNING LOTION FOR THE BODY, PRE-SUN TANNING LOTION FOR THE FACE, SELF-TANNING PREPARATIONS, SELF-TANNING CREAM AND LOTION, SELF-TANNING FACIAL PADS, SKIN BRONZING CREAM, SUN BLOCK FOR THE BODY, SUN BLOCK FOR THE FACE, SUN SCREEN, SUNLESS TANNING LOTION AND CREAM FOR THE BODY AND FACE, SUNTAN LOTION FOR THE BODY, SUNTAN LOTION FOR THE FACE, TINTED FACE LOTION (U.S. CLS. 1, 4, 6, 50, 51 AND 52).

GISELLE AGOSTO, EXAMINING ATTORNEY

SN 77-107,004. PHILOSOPHY, INC., PHOENIX, AZ. FILED 2-14-2007.

THE AGING LIP

THE MARK CONSISTS OF STANDARD CHARACTERS WITHOUT CLAIM TO ANY PARTICULAR FONT, STYLE, SIZE, OR COLOR.

NO CLAIM IS MADE TO THE EXCLUSIVE RIGHT TO USE "LIP", APART FROM THE MARK AS SHOWN.

FOR LIP BALM; NON-MEDICATED LIP CARE PREPARATIONS (U.S. CLS. 1, 4, 6, 50, 51 AND 52).

ANTHONY RINKER, EXAMINING ATTORNEY

CLASS 3—(Continued).

SN 77-107,388. PHILOSOPHY, INC., PHOENIX, AZ. FILED 2-14-2007.

WOW, POW, POMEGRANATE

THE MARK CONSISTS OF STANDARD CHARACTERS WITHOUT CLAIM TO ANY PARTICULAR FONT, STYLE, SIZE, OR COLOR.

NO CLAIM IS MADE TO THE EXCLUSIVE RIGHT TO USE "POMEGRANATE", APART FROM THE MARK AS SHOWN.

FOR BABY LOTION; BABY POWDER; BABY SHAMPOO; BODY SCRUB; COSMETIC FACIAL BLOTting PAPERS; COSMETIC PADS; COSMETIC PENCILS; COSMETIC PREPARATIONS FOR THE CARE OF MOUTH AND TEETH; COSMETICS; DEPILATORIES; FACIAL SCRUBS; FRAGRANCES FOR PERSONAL USE; HAIR CARE PREPARATIONS; NAIL CARE PREPARATIONS; NON-MEDICATED BATH PREPARATIONS; NON-MEDICATED FOOT CREAM; NON-MEDICATED LIP CARE PREPARATIONS; NON-MEDICATED SKIN CARE PREPARATIONS; NON-MEDICATED SUN CARE PREPARATIONS; NON-MEDICATED TOILETRIES; PERFUMED POWDER; PERSONAL DEODORANTS; SCENTED ROOM SPRAYS; SHAVING PREPARATIONS; SHOWER AND BATH GEL (U.S. CLS. 1, 4, 6, 50, 51 AND 52).

ANTHONY RINKER, EXAMINING ATTORNEY

SN 77-107,408. PHILOSOPHY, INC., PHOENIX, AZ. FILED 2-14-2007.

TANGERINE YOU MAKE ME DREAM

THE MARK CONSISTS OF STANDARD CHARACTERS WITHOUT CLAIM TO ANY PARTICULAR FONT, STYLE, SIZE, OR COLOR.

NO CLAIM IS MADE TO THE EXCLUSIVE RIGHT TO USE "TANGERINE", APART FROM THE MARK AS SHOWN.

FOR BABY LOTION; BABY POWDER; BABY SHAMPOO; BODY SCRUB; COSMETIC FACIAL BLOTting PAPERS; COSMETIC PADS; COSMETIC PENCILS; COSMETIC PREPARATIONS FOR THE CARE OF MOUTH AND TEETH; COSMETICS; DEPILATORIES; FACIAL SCRUBS; FRAGRANCES FOR PERSONAL USE; HAIR CARE PREPARATIONS; NAIL CARE PREPARATIONS; NON-MEDICATED BATH PREPARATIONS; NON-MEDICATED FOOT CREAM; NON-MEDICATED LIP CARE PREPARATIONS; NON-MEDICATED SKIN CARE PREPARATIONS; NON-MEDICATED SUN CARE PREPARATIONS; NON-MEDICATED TOILETRIES; PERFUMED POWDER; PERSONAL DEODORANTS; SCENTED ROOM SPRAYS; SHAVING PREPARATIONS; SHOWER AND BATH GEL (U.S. CLS. 1, 4, 6, 50, 51 AND 52).

ANTHONY RINKER, EXAMINING ATTORNEY

CLASS 3—(Continued).

SN 77-107,433. PHILOSOPHY, INC., PHOENIX, AZ. FILED 2-14-2007.

IT'S TIME FOR LIME

THE MARK CONSISTS OF STANDARD CHARACTERS WITHOUT CLAIM TO ANY PARTICULAR FONT, STYLE, SIZE, OR COLOR.

NO CLAIM IS MADE TO THE EXCLUSIVE RIGHT TO USE "LIME", APART FROM THE MARK AS SHOWN.

FOR BABY LOTION; BABY POWDER; BABY SHAMPOO; BODY SCRUB; COSMETIC FACIAL BLOTting PAPERS; COSMETIC PADS; COSMETIC PENCILS; COSMETIC PREPARATIONS FOR THE CARE OF MOUTH AND TEETH; COSMETICS; DEPILATORIES; FACIAL SCRUBS; FRAGRANCES FOR PERSONAL USE; HAIR CARE PREPARATIONS; NAIL CARE PREPARATIONS; NON-MEDICATED BATH PREPARATIONS; NON-MEDICATED FOOT CREAM; NON-MEDICATED LIP CARE PREPARATIONS; NON-MEDICATED SKIN CARE PREPARATIONS; NON-MEDICATED SUN CARE PREPARATIONS; NON-MEDICATED TOILETRIES; PERFUMED POWDER; PERSONAL DEODORANTS; SCENTED ROOM SPRAYS; SHAVING PREPARATIONS; SHOWER AND BATH GEL (U.S. CLS. 1, 4, 6, 50, 51 AND 52).

ANTHONY RINKER, EXAMINING ATTORNEY

SN 77-107,513. PHILOSOPHY, INC., PHOENIX, AZ. FILED 2-14-2007.

AGING HAIR

THE MARK CONSISTS OF STANDARD CHARACTERS WITHOUT CLAIM TO ANY PARTICULAR FONT, STYLE, SIZE, OR COLOR.

NO CLAIM IS MADE TO THE EXCLUSIVE RIGHT TO USE "HAIR", APART FROM THE MARK AS SHOWN.

FOR HAIR CARE PREPARATIONS (U.S. CLS. 1, 4, 6, 50, 51 AND 52).

ANTHONY RINKER, EXAMINING ATTORNEY

CLASS 3—(Continued).

SN 77-107,991. PHILOSOPHY, INC., PHOENIX, AZ. FILED 2-15-2007.

I LOVE GRAPEFRUIT

THE MARK CONSISTS OF STANDARD CHARACTERS WITHOUT CLAIM TO ANY PARTICULAR FONT, STYLE, SIZE, OR COLOR.

NO CLAIM IS MADE TO THE EXCLUSIVE RIGHT TO USE "GRAPEFRUIT", APART FROM THE MARK AS SHOWN.

FOR BABY LOTION; BABY POWDER; BABY SHAMPOO; BODY SCRUB; COSMETIC FACIAL BLOTting PAPERS; COSMETIC PADS; COSMETIC PENCILS; COSMETIC PREPARATIONS FOR THE CARE OF MOUTH AND TEETH; COSMETICS; DEPILATORIES; FACIAL SCRUBS; FRAGRANCES FOR PERSONAL USE; HAIR CARE PREPARATIONS; NAIL CARE PREPARATIONS; NON-MEDICATED BATH PREPARATIONS; NON-MEDICATED FOOT CREAM; NON-MEDICATED LIP CARE PREPARATIONS; NON-MEDICATED SKIN CARE PREPARATIONS; NON-MEDICATED SUN CARE PREPARATIONS; NON-MEDICATED TOILETRIES; PERFUMED POWDER; PERSONAL DEODORANTS; SCENTED ROOM SPRAYS; SHAVING PREPARATIONS; SHOWER AND BATH GEL (U.S. CLS. 1, 4, 6, 50, 51 AND 52).

ANTHONY RINKER, EXAMINING ATTORNEY

CLASS 3—(Continued).

SN 77-113,019. INGREDIENTS CORPORATION, OXNARD, CA. FILED 2-21-2007.

ORGANIC COUTURE Hair Care

THE MARK CONSISTS OF STANDARD CHARACTERS WITHOUT CLAIM TO ANY PARTICULAR FONT, STYLE, SIZE, OR COLOR.

NO CLAIM IS MADE TO THE EXCLUSIVE RIGHT TO USE "ORGANIC AND HAIR CARE", APART FROM THE MARK AS SHOWN.

FOR 3-IN-1 HAIR CONDITIONERS; 3-IN-1 HAIR SHAMPOOS; HAIR BALSAM; HAIR CARE CREAMS; HAIR CARE KITS COMPRISING NON-MEDICATED HAIR CARE PREPARATIONS, NAMELY, SHAMPOOS, CONDITIONERS AND GELS; HAIR CARE LOTIONS; HAIR COLORANTS; HAIR CONDITIONERS; HAIR CREAMS; HAIR GELS; HAIR LACQUERS; HAIR LOTIONS; HAIR MOUSSES; HAIR NOURISHERS; HAIR RINSES; HAIR SHAMPOO; HAIR SPRAY; HAIR STRAIGHTENING PREPARATIONS; HAIR STYLING GEL; HAIR STYLING PREPARATIONS; HAIR STYLING SPRAY; HAIR TONICS (U.S. CLS. 1, 4, 6, 50, 51 AND 52).

JACQUELINE A. LAVINE, EXAMINING ATTORNEY

SN 77-117,857. KLEEN CONCEPTS, LLC, SCOTTSDALE, AZ. FILED 2-28-2007.

KLEEN CONCEPTS

REFLECT TO PROTECT

THE MARK CONSISTS OF STANDARD CHARACTERS WITHOUT CLAIM TO ANY PARTICULAR FONT, STYLE, SIZE, OR COLOR.

FOR NON-MEDICATED SKIN CARE PREPARATIONS AND SUN CARE LOTION (U.S. CLS. 1, 4, 6, 50, 51 AND 52).

FIRST USE 1-30-2007; IN COMMERCE 1-30-2007.
RUDY R. SINGLETON, EXAMINING ATTORNEY

THE MARK CONSISTS OF STANDARD CHARACTERS WITHOUT CLAIM TO ANY PARTICULAR FONT, STYLE, SIZE, OR COLOR.

NO CLAIM IS MADE TO THE EXCLUSIVE RIGHT TO USE "CLEAN", APART FROM THE MARK AS SHOWN.

FOR CANNED PRESSURIZED AIR FOR DUSTING AND CLEANING PURPOSES; CLEANING PREPARATIONS FOR CONSUMER ELECTRONICS, PHOTOGRAPHY EQUIPMENT, LENSES, SENSORS, MEDICAL SUPPLIES, AND OPTIC EQUIPMENT; IMPREGNATED CLEANING CLOTHS (U.S. CLS. 1, 4, 6, 50, 51 AND 52).

MORENO, PAUL, EXAMINING ATTORNEY

CLASS 3—(Continued).

SN 77-119,853. CASTER, 75008 PARIS, FRANCE, FILED 3-1-2007.

PHYTOLACTUM

THE MARK CONSISTS OF STANDARD CHARACTERS WITHOUT CLAIM TO ANY PARTICULAR FONT, STYLE, SIZE, OR COLOR.

OWNER OF FRANCE REG. NO. 94513648, DATED 3-31-1994, RENEWED AS REG. NO. 94513648, DATED 1-22-2004, EXPIRES 1-22-2014.

OWNER OF U.S. REG. NOS. 2,788,095, 3,213,624 AND OTHERS.

FOR COSMETICS, HAIR LOTIONS, SHAMPOOS, HAIR CARE PREPARATIONS (U.S. CLS. 1, 4, 6, 50, 51 AND 52).
GENE MACIOL, EXAMINING ATTORNEY

SN 77-120,094. ISLAND SOAP CO., LLC, KAPAA, HI. FILED 3-1-2007.

SURFER'S SALVE

THE MARK CONSISTS OF STANDARD CHARACTERS WITHOUT CLAIM TO ANY PARTICULAR FONT, STYLE, SIZE, OR COLOR.

NO CLAIM IS MADE TO THE EXCLUSIVE RIGHT TO USE "SALVE", APART FROM THE MARK AS SHOWN.
SEC. 2(F).

FOR NON-MEDICATED LIP BALM, NON-MEDICATED SKIN SALVES (U.S. CLS. 1, 4, 6, 50, 51 AND 52).
FIRST USE 9-28-2001; IN COMMERCE 9-28-2001.
JACLYN KIDWELL, EXAMINING ATTORNEY

SN 77-120,183. CASTER, 75008 PARIS, FRANCE, FILED 3-1-2007.

PHYTONECTAR

THE MARK CONSISTS OF STANDARD CHARACTERS WITHOUT CLAIM TO ANY PARTICULAR FONT, STYLE, SIZE, OR COLOR.

OWNER OF FRANCE REG. NO. 003007076, DATED 1-31-2000, EXPIRES 1-31-2010.

OWNER OF U.S. REG. NOS. 2,788,095, 3,213,624 AND OTHERS.

FOR SHAMPOOS, HAIR LOTIONS AND PLANT BASED HAIR CARE PREPARATIONS (U.S. CLS. 1, 4, 6, 50, 51 AND 52).
GENE MACIOL, EXAMINING ATTORNEY

CLASS 3—(Continued).

SN 77-120,209. CASTER, 75008 PARIS, FRANCE, FILED 3-1-2007.

PHYTOKARITE

THE MARK CONSISTS OF STANDARD CHARACTERS WITHOUT CLAIM TO ANY PARTICULAR FONT, STYLE, SIZE, OR COLOR.

OWNER OF FRANCE REG. NO. 013082997, DATED 2-8-2001, EXPIRES 2-8-2011.

OWNER OF U.S. REG. NOS. 2,788,095, 3,213,624 AND OTHERS.

FOR COSMETICS, HAIR LOTIONS, SHAMPOOS, HAIR CARE PREPARATIONS (U.S. CLS. 1, 4, 6, 50, 51 AND 52).
GENE MACIOL, EXAMINING ATTORNEY

SN 77-120,251. CASTER, 75008 PARIS, FRANCE, FILED 3-1-2007.

PHYTONEUTRE

THE MARK CONSISTS OF STANDARD CHARACTERS WITHOUT CLAIM TO ANY PARTICULAR FONT, STYLE, SIZE, OR COLOR.

OWNER OF FRANCE REG. NO. 1686976, DATED 8-13-1991, RENEWED AS REG. NO. 1686976, DATED 7-4-2001, EXPIRES 7-4-2011.

OWNER OF U.S. REG. NOS. 2,788,095, 3,213,624 AND OTHERS.

THE ENGLISH TRANSLATION OF THE WORD "NEUTRE" IN THE MARK IS "NEUTRAL".

FOR COSMETICS, HAIR LOTIONS, SHAMPOOS, HAIR CARE PREPARATIONS (U.S. CLS. 1, 4, 6, 50, 51 AND 52).
GENE MACIOL, EXAMINING ATTORNEY

SN 77-120,276. CASTER, 75008 PARIS, FRANCE, FILED 3-1-2007.

PHYTOLOOK

THE MARK CONSISTS OF STANDARD CHARACTERS WITHOUT CLAIM TO ANY PARTICULAR FONT, STYLE, SIZE, OR COLOR.

OWNER OF FRANCE REG. NO. 003007041, DATED 1-31-2000, EXPIRES 1-31-2010.

OWNER OF U.S. REG. NOS. 2,788,095, 3,213,624 AND OTHERS.

FOR TOILET SOAPS, PERFUMERY PRODUCTS, NAMELY, PERFUMERY AND PERFUMED POWDER, ESSENTIAL OILS FOR PERSONAL CARE, COSMETICS, HAIR LOTIONS, SHAMPOOS, HAIR CARE PREPARATIONS (U.S. CLS. 1, 4, 6, 50, 51 AND 52).
GENE MACIOL, EXAMINING ATTORNEY

CLASS 3—(Continued).

SN 77-120,779. REED, ANN, LOS ANGELES, CA. FILED 3-2-2007.

CURE

aromatherapy products

NO CLAIM IS MADE TO THE EXCLUSIVE RIGHT TO USE "AROMATHERAPY PRODUCTS", APART FROM THE MARK AS SHOWN.

FOR BATH SALTS; ESSENTIAL OILS; MASSAGE OIL (U.S. CLS. 1, 4, 6, 50, 51 AND 52).
PRISCILLA MILTON, EXAMINING ATTORNEY

SN 77-120,902. CASTER, 75008 PARIS, FRANCE, FILED 3-2-2007.

PHYTO POLLEINE

THE MARK CONSISTS OF STANDARD CHARACTERS WITHOUT CLAIM TO ANY PARTICULAR FONT, STYLE, SIZE, OR COLOR.

OWNER OF FRANCE REG. NO. 1473564, DATED 10-18-1978, RENEWED AS REG. NO. 1473564, DATED 1-13-1998, EXPIRES 1-13-2008.

OWNER OF U.S. REG. NOS. 2,788,095, 3,213,624 AND OTHERS.

FOR ESSENTIAL OILS FOR PERSONAL CARE, COSMETICS, NON MEDICAL PREPARATIONS FOR THE CARE OF THE HAIR, NAMELY, HAIR LOTIONS, HAIR CREAMS, HAIR OILS (U.S. CLS. 1, 4, 6, 50, 51 AND 52).
GENE MACIOL, EXAMINING ATTORNEY

SN 77-123,705. LANCOME PARFUMS ET BEAUTE & CIE, PARIS, FRANCE, FILED 3-6-2007.

HYDRA COMPACT

THE MARK CONSISTS OF STANDARD CHARACTERS WITHOUT CLAIM TO ANY PARTICULAR FONT, STYLE, SIZE, OR COLOR.

OWNER OF U.S. REG. NO. 2,429,529.

NO CLAIM IS MADE TO THE EXCLUSIVE RIGHT TO USE "COMPACT", APART FROM THE MARK AS SHOWN.

FOR MAKEUP PREPARATIONS, NAMELY, FOUNDATION CREAMS AND POWDERS (U.S. CLS. 1, 4, 6, 50, 51 AND 52).

JOHN WILKE, EXAMINING ATTORNEY

CLASS 3—(Continued).

SN 77-126,341. OKSISTERHOOD, INC TM, JACKSONVILLE, FL. FILED 3-9-2007.

O'SHEA

shea butter and more

THE MARK CONSISTS OF STANDARD CHARACTERS WITHOUT CLAIM TO ANY PARTICULAR FONT, STYLE, SIZE, OR COLOR.

NO CLAIM IS MADE TO THE EXCLUSIVE RIGHT TO USE "SHEA BUTTER", APART FROM THE MARK AS SHOWN.

FOR BABY OIL; BABY OILS; BATH OIL; BATH OILS; BATH OILS FOR COSMETIC PURPOSES; BERGAMOT OIL; BODY OIL; BODY OILS; COSMETIC OILS; COSMETIC OILS FOR THE EPIDERMIS; ESSENTIAL OILS; ESSENTIAL OILS AS PERFUME FOR LAUNDRY PURPOSES; ESSENTIAL OILS FOR PERSONAL USE; ESSENTIAL OILS FOR USE IN THE MANUFACTURE OF SCENTED PRODUCTS; LAVENDER OIL; MASSAGE OIL; MASSAGE OILS; NATURAL ESSENTIAL OILS; NUTRITIONAL OILS FOR COSMETIC PURPOSES; OIL BATHS FOR HAIR CARE; OILS FOR HAIR CONDITIONING; OILS FOR TOILETRY PURPOSES; PEPPERMINT OIL; PERFUME OILS; PERFUME OILS FOR THE MANUFACTURE OF COSMETIC PREPARATIONS; ROSE OIL FOR COSMETIC PURPOSES; SCENTED OILS USED TO PRODUCE AROMAS WHEN HEATED; SKIN AND BODY TOPICAL LOTIONS, CREAMS AND OILS FOR COSMETIC USE; SUN TAN OIL; TOILET WATER CONTAINING SNAKE OIL; 3-IN-1 HAIR CONDITIONERS; 3-IN-1 HAIR SHAMPOOS; BABY HAIR CONDITIONER; CONDITIONERS; EXFOLIANTS FOR BODY; GEL FOR HAIR; HAIR CARE CREAMS; HAIR CARE LOTIONS; HAIR CARE PREPARATIONS; HAIR CONDITIONER; HAIR CONDITIONERS; HAIR CONDITIONERS FOR BABIES; HAIR CREAMS; HAIR DRESSINGS FOR MEN; HAIR DRESSINGS FOR WOMEN; HAIR GEL; HAIR GELS; HAIR LOTIONS; HAIR MOUSSE; HAIR MOUSSES; HAIR NOURISHERS; HAIR OILS; HAIR POMADES; HAIR RELAXERS; HAIR RELAXING PREPARATIONS; HAIR RINSES; HAIR RINSES; HAIR SHAMPOO; HAIR SPRAY; HAIR STRAIGHTENING PREPARATIONS; HAIR STYLING GEL; HAIR STYLING PREPARATIONS; HAIR STYLING SPRAY; HAIR TONIC; HAIR TONICS; HAIR WAVING LOTION; LOTIONS FOR BODY; MOUSSE FOR HAIR AND BODY; POMADES FOR HAIR; WAX STRIPS FOR REMOVING BODY HAIR; CUTICLE CONDITIONERS; HAIR CARE KITS COMPRISING NON-MEDICATED HAIR CARE PREPARATIONS, NAMELY, SHEA BUTTER; SHAMPOO-CONDITIONERS; SKIN CONDITIONERS; WOOD CONDITIONER, BRIGHTENER AND RENEWER; BEAUTY CREAMS FOR BODY CARE; BODY AND BEAUTY CARE COSMETICS; BODY CREAM; BODY CREAMS; BODY DEODORANT IN PILL FORM; BODY EMULSIONS; BODY LOTION; BODY LOTIONS; BODY MASK CREAM; BODY MASK LOTION; BODY MASKS; BODY MILK; BODY MILKS; BODY SCRUB; BODY SPRAY USED AS A PERSONAL DEODORANT AND AS FRAGRANCE; BODY SPRAYS; BODY SPRAYS, NAMELY WATER IN ATOMIZED CONTAINERS USED TO PRODUCE A COOLING EFFECT; BODY WASHES; CONCEALERS FOR FACE; COSMETIC PREPARATIONS FOR BODY CARE; DEODORANTS FOR BODY CARE; FACE AND BODY BEAUTY CREAMS; FACE AND BODY CREAMS; FACE AND BODY LOTIONS; FACE AND BODY MILK; FACIAL SCRUBS; LIQUID SOAPS FOR HANDS, FACE AND BODY; LOTIONS FOR FACE AND BODY CARE; MAKE-UP PRODUCTS FOR THE FACE AND BODY; NON-MEDICATED BODY SOAKS; SCENTED BODY SPRAY; SOAPS FOR BODY CARE; TONING LOTION, FOR THE FACE, BODY AND HANDS; BATH SALTS; BATH SALTS; MINERAL SALT IN THE NATURE OF BATH SALTS NOT FOR MEDICAL PURPOSES; BABY SHAMPOO; CARPET SHAMPOO; SHAMPOOS; SHAMPOOS FOR BABIES; BODY CREAM SOAP; BODY POWDER; AFTER-SHAVE LOTIONS; AFTER-SUN LOTIONS; AGE RETARDANT LOTION; AROMATHERAPY LOTIONS; BABY LOTION; BATH LOTION; BATHING LOTIONS; BEAUTY LO-

CLASS 3—(Continued).

TIONS; BODY MASK POWDER; COSMETIC SUNTAN LOTIONS; EYE LOTIONS; FACE MILK AND LOTIONS; FACIAL LOTION; HAND LOTIONS; LOTIONS FOR BEARDS; LOTIONS FOR CELLULITE REDUCTION; LOTIONS FOR STRENGTHENING THE NAILS; SHAVING LOTION; SHAVING LOTIONS; SKIN CLEANSING LOTION; SKIN LOTION; SKIN LOTIONS; STYLING LOTIONS; SUN CARE LOTIONS; SUN TAN LOTION; SUN-BLOCK LOTIONS; TISSUES IMPREGNATED WITH COSMETIC LOTIONS; MOISTURIZING MILKS; SKIN MOISTURIZER; SKIN MOISTURIZER MASKS; ALOE VERA GEL FOR COSMETIC PURPOSES; ASTRINGENTS FOR COSMETIC PURPOSES; BLEACHING PREPARATIONS FOR COSMETIC PURPOSES; CLEANSING CREAMS; COCOA BUTTER FOR COSMETIC PURPOSES; COLORING PREPARATIONS FOR COSMETIC PURPOSES; COSMETIC CREAMS; COSMETIC CREAMS FOR SKIN CARE; COSMETIC FACIAL BLOTTER PAPER; COSMETIC MILKS; COSMETIC PREPARATIONS AGAINST SUNBURN; COSMETIC PREPARATIONS FOR SKIN RENEWAL; COSMETIC PREPARATIONS FOR THE CARE OF MOUTH AND TEETH; COSMETIC ROUGES; COSMETIC SOAPS; COSMETIC SUN-PROTECTING PREPARATIONS; COSMETIC SUN-TANNING PREPARATIONS; COSMETICS; COSMETICS NAMELY, COMPACTS; COTTON FOR COSMETIC PURPOSES; COTTON PUFFS FOR COSMETIC PURPOSES; COTTON STICKS FOR COSMETIC PURPOSES; MAKE-UP KITS COMPRISED OF LIPSTICK, LIP CREAM, LIP BALM, SKIN LOTION, FACE LOTION PRIMARILY COMPRISED OF SHEA BUTTER; HAIR CARE KITS COMPRISED OF NON-MEDICATED HAIR CARE PREPARATIONS, NAMELY, SHAMPOO, CONDITIONER, HAIR CREAMS, HAIR EMOLLIENTS, HAIR LOTIONS PRIMARILY COMPRISED OF SHEA BUTTER (U.S. CLS. 1, 4, 6, 50, 51 AND 52).

AMY MCMENAMIN, EXAMINING ATTORNEY

SN 77-128,153. UNILEVER SUPPLY CHAIN, INC., CLINTON, CT. FILED 3-12-2007.

FLIPPIN' CITRUS SQUIRT

THE MARK CONSISTS OF STANDARD CHARACTERS WITHOUT CLAIM TO ANY PARTICULAR FONT, STYLE, SIZE, OR COLOR.

NO CLAIM IS MADE TO THE EXCLUSIVE RIGHT TO USE "CITRUS", APART FROM THE MARK AS SHOWN.

FOR HAIR SHAMPOO; BODY WASHES (U.S. CLS. 1, 4, 6, 50, 51 AND 52).

LINDSEY RUBIN, EXAMINING ATTORNEY

CLASS 3—(Continued).

SN 77-130,838. LEADING EDGE MARKETING, INC., NASSAU, NEW PROVIDENCE, BAHAMAS, FILED 3-14-2007.



NO CLAIM IS MADE TO THE EXCLUSIVE RIGHT TO USE "DERMATOLOGIQUE", APART FROM THE MARK AS SHOWN.

THE COLOR(S) WHITE AND RED IS/ARE CLAIMED AS A FEATURE OF THE MARK.

THE MARK CONSISTS OF WHITE CROSS ON RED BACKGROUND TITLED DIAGONALLY.

FOR SKIN AND BODY TOPICAL LOTIONS, CREAMS AND OILS FOR COSMETIC USE (U.S. CLS. 1, 4, 6, 50, 51 AND 52).

DOMINICK J. SALEMI, EXAMINING ATTORNEY

SN 77-132,321. JAFER LIMITED, HAMILTON, BERMUDA, FILED 3-15-2007.

SECRETOS DE SEDA BY YANBAL

THE MARK CONSISTS OF STANDARD CHARACTERS WITHOUT CLAIM TO ANY PARTICULAR FONT, STYLE, SIZE, OR COLOR.

OWNER OF U.S. REG. NOS. 1,241,758, 3,131,255 AND OTHERS.

THE ENGLISH TRANSLATION OF THE WORDING "SECRETOS DE SEDA" IS "SECRETS OF SILK," OR "SILK SECRETS."

FOR PERFUMES, EAU DE PERFUME, TOILET WATER, COLOGNE, FRAGRANCES FOR PERSONAL USE, TOILET SOAP, LIQUID SOAPS, BODY LOTIONS, DEODORANT FOR PERSONAL USE AND ANTIPERSPIRANTS (U.S. CLS. 1, 4, 6, 50, 51 AND 52).

CURTIS FRENCH, EXAMINING ATTORNEY

SN 77-132,693. LANCOME PARFUMS ET BEAUTE & CIE, PARIS, FRANCE, FILED 3-16-2007.

PEUT-ETRE

THE MARK CONSISTS OF STANDARD CHARACTERS WITHOUT CLAIM TO ANY PARTICULAR FONT, STYLE, SIZE, OR COLOR.

THE ENGLISH TRANSLATION OF PEUT-ETRE IS MAY BE.

FOR PERFUMERY PRODUCTS, NAMELY, PERFUMES, EAU DE COLOGNE, PERFUMED WATER, SKIN LOTIONS, SOAPS, BATH AND SHOWER FOAMING COMPOSITIONS AND GELS (U.S. CLS. 1, 4, 6, 50, 51 AND 52).

JOHN WILKE, EXAMINING ATTORNEY

CLASS 3—(Continued).

SN 77-134,977. GRUNRICK ENTERPRISES INC., NESCONSET, NY. FILED 3-20-2007.

Sandsations

THE MARK CONSISTS OF STANDARD CHARACTERS WITHOUT CLAIM TO ANY PARTICULAR FONT, STYLE, SIZE, OR COLOR.

FOR AFTER SUN CREAMS; AFTER-SUN LOTIONS; BODY AND BEAUTY CARE COSMETICS; BODY MASK POWDER; BODY POWDER; COSMETIC SUN-PROTECTING PREPARATIONS; COSMETIC SUN-TANNING PREPARATIONS; COSMETIC SUNTAN LOTIONS; DEODORANTS FOR BODY CARE; DUSTING POWDER; LIP BALM; LIP BALM; NON-MEDICATED LIP CARE PREPARATIONS; NON-MEDICATED LIP PROTECTOR; NON-MEDICATED OINTMENTS FOR THE PREVENTION AND TREATMENT OF SUNBURN; NON-MEDICATED SUN CARE PREPARATIONS; PERFUMED POWDER; PERFUMED POWDERS; PERFUMED TALCUM POWDER; SKIN BRONZING CREAMS; SKIN GELS FOR ACCELERATING, ENHANCING OR EXTENDING TANS; SUN BLOCK; SUN BLOCK PREPARATIONS; SUN CARE LOTIONS; SUN CREAMS; SUN SCREEN; SUN SCREEN PREPARATIONS; SUN TAN GEL; SUN TAN LOTION; SUN TAN OIL; SUN-BLOCK LOTIONS; SUNSCREEN CREAM; SUNSCREEN CREAMS; SUNTAN CREAMS; SUNTANNING PREPARATIONS; TALCUM POWDER; TALCUM POWDERS; TANNING CREAMS (U.S. CLS. 1, 4, 6, 50, 51 AND 52).

THEODORE MCBRIDE, EXAMINING ATTORNEY

SN 77-135,317. JAFER LIMITED, HAMILTON, BERMUDA, FILED 3-20-2007.

CCORI PASION

THE MARK CONSISTS OF STANDARD CHARACTERS WITHOUT CLAIM TO ANY PARTICULAR FONT, STYLE, SIZE, OR COLOR.

OWNER OF U.S. REG. NO. 2,251,817.
THE ENGLISH TRANSLATION OF THE WORDING "PASION" IS "PASSION."

FOR PERFUMES, EAU DE PERFUME, FRAGRANCES FOR PERSONAL USE, TOILET WATER, COLOGNE, TOILET SOAP, DEODORANT FOR PERSONAL USE, ANTIPERSPIRANTS, TALCUM POWDER, BODY LOTIONS, HAIR SHAMPOO, HAIR CONDITIONERS, HAIR CARE CREAMS, HAIR GELS, HAIR RINSES, HAIR STYLING PREPARATIONS, HAIR SHAMPOO-CONDITIONERS, HAIR CARE PREPARATIONS, FACIAL LOTIONS, HAND LOTIONS, HAND CREAMS, FACIAL CREAMS AND BODY CREAMS (U.S. CLS. 1, 4, 6, 50, 51 AND 52).

CURTIS FRENCH, EXAMINING ATTORNEY

CLASS 3—(Continued).

SN 77-136,014. BESS, EDWARD, NEW YORK, NY. FILED 3-20-2007.

PRIVATE EYE

THE MARK CONSISTS OF STANDARD CHARACTERS WITHOUT CLAIM TO ANY PARTICULAR FONT, STYLE, SIZE, OR COLOR.

FOR MAKEUP KITS COMPRISED OF EYELINERS, EYE PENCILS, EYE SHADOWS AND MASCARA SOLD IN A BOX (U.S. CLS. 1, 4, 6, 50, 51 AND 52).

FIRST USE 2-1-2007; IN COMMERCE 3-1-2007.

MARGERY A. TIERNEY, EXAMINING ATTORNEY

SN 77-136,144. CHAPPELL, MELISSA A, MARTINEZ, CA. FILED 3-21-2007.

THE MARK CONSISTS OF THE WORDS "SKULL JUICE" IN OLD ENGLISH FONT WITH LIPSTICK KISS IN BLACK AND WHITE.

FOR BODY AND BEAUTY CARE COSMETICS (U.S. CLS. 1, 4, 6, 50, 51 AND 52).

TASHIA BUNCH, EXAMINING ATTORNEY

SN 77-136,330. INNIVATION, LLC, CINCINNATI, OH. FILED 3-21-2007.

URINE TROUBLE!

THE MARK CONSISTS OF STANDARD CHARACTERS WITHOUT CLAIM TO ANY PARTICULAR FONT, STYLE, SIZE, OR COLOR.

NO CLAIM IS MADE TO THE EXCLUSIVE RIGHT TO USE "URINE", APART FROM THE MARK AS SHOWN.

FOR STAIN REMOVERS; PET ODOR REMOVERS (U.S. CLS. 1, 4, 6, 50, 51 AND 52).

FIRST USE 7-25-2005; IN COMMERCE 7-25-2005.

RICHARD A. STRASER, EXAMINING ATTORNEY

CLASS 3—(Continued).

SN 77-136,446. OLD BLUE LLC, LAKE GENEVA, WI. FILED 3-21-2007.

THE FEELGOOD T-SHIRT COMPANY

THE MARK CONSISTS OF STANDARD CHARACTERS WITHOUT CLAIM TO ANY PARTICULAR FONT, STYLE, SIZE, OR COLOR.

NO CLAIM IS MADE TO THE EXCLUSIVE RIGHT TO USE "COMPANY", APART FROM THE MARK AS SHOWN. FOR COSMETICS; FRAGRANCES FOR PERSONAL USE; POTPOURRI; SCENTED ROOM SPRAYS; NON-MEDICATED TOILETRIES (U.S. CLS. 1, 4, 6, 50, 51 AND 52).

DAVID TAYLOR, EXAMINING ATTORNEY

SN 77-136,805. PHYSICIANS FORMULA, INC., AZUSA, CA. FILED 3-21-2007.

BLEMISH RX

THE MARK CONSISTS OF STANDARD CHARACTERS WITHOUT CLAIM TO ANY PARTICULAR FONT, STYLE, SIZE, OR COLOR.

NO CLAIM IS MADE TO THE EXCLUSIVE RIGHT TO USE "BLEMISH", APART FROM THE MARK AS SHOWN. FOR COSMETICS (U.S. CLS. 1, 4, 6, 50, 51 AND 52).

JACLYN KIDWELL, EXAMINING ATTORNEY

SN 77-137,097. LAURENT D PRODUCT, INC. D/B/A PRIVE PRODUCTS, LOS ANGELES, CA. FILED 3-21-2007.

FLASH BRILLIANCE

THE MARK CONSISTS OF STANDARD CHARACTERS WITHOUT CLAIM TO ANY PARTICULAR FONT, STYLE, SIZE, OR COLOR.

FOR HAIR CARE PRODUCTS, NAMELY, SHAMPOOS, CONDITIONERS, HAIR OILS, HAIR CREAMS, HAIR LOTIONS, STYLING GELS, MOUSSES AND WAXES, HAIR SPRAYS AND HAIR STYLING PREPARATIONS TO IMPART SHINE TO THE HAIR (U.S. CLS. 1, 4, 6, 50, 51 AND 52).

BRIAN CALLAGHAN, EXAMINING ATTORNEY

CLASS 3—(Continued).

SN 77-138,239. JAFER LIMITED, HAMILTON, BERMUDA, FILED 3-22-2007.

100%balance

FOR HAIR SHAMPOO, HAIR CONDITIONERS, HAIR CARE CREAMS, HAIR DETANGLER, HAIR COLORING PREPARATIONS, HAIR DYE, HAIR COLOR, HAIR BLEACH, PERMANENT WAVE PREPARATIONS, HAIR FIXERS, HAIR LACQUERS, HAIR DECOLORANTS, HAIR SPRAY, HAIR RINSES, HAIR GELS, HAIR STYLING PREPARATIONS, HAIR SHAMPOO-CONDITIONERS, HAIR CARE PREPARATIONS, SHOWER GEL, COSMETICS, SKIN EMOLLIENTS, FACIAL CLEANSERS, ASTRINGENTS FOR COSMETIC PURPOSES, SKIN CLEANSING LOTION, COLD CREAMS, NIGHT CREAM, SKIN CLEANSING CREAM, SKIN CREAMS, VANISHING CREAM, SKIN MOISTURIZERS, WRINKLE REMOVING SKIN CARE PREPARATIONS, SKIN CLARIFIERS, EXFOLIATING CREAM, SKIN LIGHTENERS, SKIN LOTIONS, SKIN TONERS, HAND CREAMS, FACE CREAMS, BODY CREAMS, COSMETIC CREAMS, FACIAL LOTIONS, HAND LOTIONS, BODY LOTIONS, AND GELS FOR THE FACE, HANDS AND BODY (U.S. CLS. 1, 4, 6, 50, 51 AND 52).

CURTIS FRENCH, EXAMINING ATTORNEY

SN 77-138,402. DWON WILSON, ST. LOUIS, MO. FILED 3-23-2007.



THE MARK CONSISTS OF DRAWING OF DONKEY WITH CIGARATTE HANGING OUT OF MOUTH, A CIRCLE WITH A SLASH THROUGH IT SURROUNDING THE DONKEY AND THE WORDS "DON'T ASS" IN THE BOTTOM RIGHT SIDE OF THE CIRCLE.

FOR FRAGRANCES FOR AUTOMOBILES (U.S. CLS. 1, 4, 6, 50, 51 AND 52).

PRISCILLA MILTON, EXAMINING ATTORNEY

CLASS 3—(Continued).

SN 77-138,431. NANCY BRAUN, WEST HOLLYWOOD, CA.
FILED 3-23-2007.

INSTINT SALON

THE MARK CONSISTS OF STANDARD CHARACTERS WITHOUT CLAIM TO ANY PARTICULAR FONT, STYLE, SIZE, OR COLOR.

NO CLAIM IS MADE TO THE EXCLUSIVE RIGHT TO USE "SALON", APART FROM THE MARK AS SHOWN.

FOR HAIR STYLING PRODUCTS, NAMELY, GELS, LOTIONS, WAXES, MOUSSE, AND SPRAYS; HAIR CARE PRODUCTS, NAMELY SHAMPOOS, CONDITIONERS, POMADES, VOLUMIZING FOAMS, SETTING LOTIONS, HAIRSPRAY; HAIR COLORING PRODUCTS, NAMELY, GELS, CREMES, DYES, POWDERS, AND LIQUIDS; HAIR COLORING PREPARATIONS; HAIR COLORS (U.S. CLS. 1, 4, 6, 50, 51 AND 52).

C. DIONNE CLYBURN, EXAMINING ATTORNEY

SN 77-138,640. MASCOTTE HOLDINGS, INC., NEW YORK, NY. FILED 3-23-2007.

THE PAST TELLS EVERYTHING

THE MARK CONSISTS OF STANDARD CHARACTERS WITHOUT CLAIM TO ANY PARTICULAR FONT, STYLE, SIZE, OR COLOR.

FOR COSMETICS; FACIAL MAKEUP, CONCEALERS, BLUSHERS, FACIAL POWDERS, FOUNDATION MAKEUP, EYE MAKEUP, EYE PENCILS, EYEBROW PENCILS, MASCARA, FALSE EYELASHES, FACE AND BODY GLITTER, COSMETIC COMPACTS, COSMETIC PENCILS, LIPSTICK, LIPSTICK CASES, LIPSTICK HOLDERS, LIP GLOSS, LIP POMADES, LIP PENCILS, MAKEUP REMOVERS, MAKEUP APPLICATORS IN THE NATURE OF COTTON SWABS FOR COSMETIC PURPOSES, EYE CREAMS, FACIAL CLEANSERS, TONERS, FACIAL EXFOLIANTS AND SCRUBS, FACIAL CREAMS, FACIAL MOISTURIZERS, FACIAL LOTIONS AND NON-MEDICATED FACIAL TREATMENTS, WRINKLE REMOVING SKIN CARE PREPARATIONS, NAIL POLISHES, NAIL POLISH BASE COAT, NAIL POLISH TOP COAT, NAIL STRENGTHENERS, NAIL HARDENERS, NAIL POLISH REMOVERS, NAIL CREAMS, CUTICLE REMOVING PREPARATIONS, NAIL TIPS, AND NAIL BUFFING PREPARATIONS; BEAUTY MILKS, SKIN MOISTURIZERS AND SKIN MOISTURIZER MASKS, SKIN CONDITIONERS, HAND CREAMS, MASSAGE OILS, ESSENTIAL OILS FOR PERSONAL USE, TALCUM POWDER, PERFUMED POWDERS, BATH BEADS, BATH CRYSTALS, BATH FOAM, BATH GELS, BATH OILS, BATH POWDERS, BATH SALTS, FACE WASH, SKIN CLEANSERS, SKIN HIGHLIGHTER, BODY SCRUBS, BODY FRAGRANCES, FRAGRANCES FOR PERSONAL USE, BODY AND HAND LOTIONS, BODY GELS, SHOWER GELS, BODY OILS, BODY POWDERS, BODY EXFOLIANTS, BODY MASKS, BODY MASK CREAMS AND LOTIONS, SHAVING PREPARATIONS, AFTER SHAVE LOTIONS, SHAVING BALM, SHAVING CREAM, SHAVING GEL, SKIN ABRASIVE PREPARATIONS, NON-MEDICATED SKIN CREAMS AND SKIN LOTIONS FOR RELIEVING RAZOR BURNS, NON-MEDICATED LIP CARE PREPARATIONS, LIP CREAM, SUNSCREEN PREPARATIONS, SUNTANNING PREPARATIONS AND AFTER-SUN LOTIONS; COSMETIC SUN-PROTECTING PREPARATIONS; SUN TAN OILS; SELF-TANNING

CLASS 3—(Continued).

PREPARATIONS, NAMELY, SELF TANNING MILK AND CREAM, ACCELERATED TANNING CREAM, SELF-TANNING LOTIONS, GELS AND SPRAYS; PERFUME, PERFUME OILS, COLOGNE, EAU DE TOILETTE, EAU DE PERFUME, EAU DE COLOGNE AND TOILETTE WATER; TOOTHPASTE, DEODORANT AND ANTIPERSPIRANT; COSMETIC PADS, PRE-MOISTENED COSMETIC WIPES, PRE-MOISTENED COSMETIC TISSUES AND TOWELETTES; COTTON STICKS FOR COSMETIC PURPOSES; ALL PURPOSE COTTON SWABS FOR PERSONAL USE AND COSMETIC PURPOSES; NON-MEDICATED TOPICAL SKIN CREAMS, OINTMENTS, GELS, TONERS, LOTIONS, SPRAYS AND POWDERS; AROMATHERAPY CREAMS, LOTIONS AND OILS; HAIR CARE PRODUCTS, NAMELY, SHAMPOOS, CONDITIONERS, MOUSSE, GELS, FROSTS, CREAMS, RINSES, SPRAYS, HAIR COLOR, HAIR WAVING LOTION, PERMANENT WAVE PREPARATIONS, HAIR LIGHTENERS, HAIR DYES, HAIR EMOLLIENTS, HAIR MASCARA, HAIR POMADES, HAIR COLOR REMOVERS, HAIR RELAXING PREPARATIONS, HAIR STYLING PREPARATIONS, HAIR REMOVING CREAM, AND HAIR CARE PREPARATIONS; ASTRINGENTS FOR COSMETIC PURPOSES; BABY WIPES; DISPOSABLE WIPES IMPREGNATED WITH CHEMICALS OR COMPOUNDS FOR PERSONAL HYGIENE AND HOUSEHOLD USE; INCENSE; ROOM FRAGRANCES; FRAGRANCE EMITTING WICKS FOR ROOM FRAGRANCES; SACHETS; SACHET-LIKE EYE PILLOWS CONTAINING FRAGRANCES; SCENTED CERAMIC STONES; SCENTED LINEN SPRAYS AND SCENTED ROOM SPRAYS; SCENTED OILS USED TO PRODUCE AROMAS WHEN HEATED; SCENTED PINE CONES; POTPOURRI; AROMATHERAPY PILLOWS COMPRISING POTPOURRI IN FABRIC CONTAINERS (U.S. CLS. 1, 4, 6, 50, 51 AND 52).

CHRISTOPHER OTT, EXAMINING ATTORNEY

SN 77-138,667. LANCOME PARFUMS ET BEAUTE & CIE, PARIS, FRANCE, FILED 3-23-2007.

MAGIQUE SOLEIL

THE MARK CONSISTS OF STANDARD CHARACTERS WITHOUT CLAIM TO ANY PARTICULAR FONT, STYLE, SIZE, OR COLOR.

OWNER OF U.S. REG. NO. 2,019,118.

NO CLAIM IS MADE TO THE EXCLUSIVE RIGHT TO USE "SOLEIL", APART FROM THE MARK AS SHOWN.

FOR PRESSED AND LOOSE POWDERS FOR THE FACE AND THE BODY AND LIQUID HIGHLIGHTER FOR THE BODY (U.S. CLS. 1, 4, 6, 50, 51 AND 52).

JOHN WILKE, EXAMINING ATTORNEY

CLASS 3—(Continued).

SN 77-139,748. WITHEROW, HOLLY K, SCHERERVILLE, IN. FILED 3-25-2007.

LaPiel Couture

THE MARK CONSISTS OF STANDARD CHARACTERS WITHOUT CLAIM TO ANY PARTICULAR FONT, STYLE, SIZE, OR COLOR.

NO CLAIM IS MADE TO THE EXCLUSIVE RIGHT TO USE "LA PIEL", APART FROM THE MARK AS SHOWN.

THE ENGLISH TRANSLATION OF THE WORD "LA PIEL" IN THE MARK IS "THE SKIN".

FOR BEAUTY CREAMS FOR BODY CARE; BODY AND BEAUTY CARE COSMETICS; COSMETIC CREAMS FOR SKIN CARE; COSMETIC PREPARATIONS FOR BODY CARE; COSMETIC PREPARATIONS FOR SKIN RENEWAL; EXFOLIANTS FOR SKIN; FACE AND BODY BEAUTY CREAMS; FACE AND BODY CREAMS; FACE AND BODY LOTIONS; FOAMS CONTAINING COSMETICS AND SUNSCREENS; LOTIONS FOR FACE AND BODY CARE; LOTIONS FOR SKIN; MAKE-UP FOR THE FACE AND BODY; NON-MEDICATED LIP CARE PREPARATIONS; NON-MEDICATED OINTMENTS FOR THE PREVENTION AND TREATMENT OF SUNBURN; NON-MEDICATED SKIN CARE PREPARATIONS; NON-MEDICATED SKIN CREAMS; NON-MEDICATED STIMULATING LOTIONS FOR THE SKIN; NON-MEDICATED SUN CARE PREPARATIONS; SHOWER AND BATH GEL; SKIN AND BODY TOPICAL LOTIONS, CREAMS AND OILS FOR COSMETIC USE; SKIN BRONZING CREAMS; SKIN CARE PREPARATIONS, NAMELY CHEMICAL PEELS FOR SKIN; SKIN CARE PREPARATIONS, NAMELY FRUIT ACID PEELS FOR SKIN; SKIN CARE PRODUCTS, NAMELY, NON-MEDICATED SKIN SERUM; SKIN CLARIFIERS; SKIN CLEANSERS; SKIN CLEANSING CREAM; SKIN CLEANSING LOTION; SKIN CONDITIONERS; SKIN CREAM; SKIN CREAMS; SKIN CREAMS IN LIQUID AND IN SOLID FORM; SKIN CREAMS IN LIQUID AND SOLID; SKIN CREAMS IN LIQUID AND SOLID FORM; SKIN EMOLLIENTS; SKIN GELS FOR ACCELERATING, ENHANCING OR EXTENDING TANS; SKIN LIGHTENING CREAMS; SKIN LOTION; SKIN LOTIONS; SKIN MASKS; SKIN MOISTURIZER; SKIN MOISTURIZER MASKS; SKIN POLISHING RICE BRAN (ARAI-NUKA); SKIN TONERS; SKIN WHITENING CREAMS; SKIN WHITENING PREPARATIONS; SOAPS FOR BODY CARE; SUN CARE LOTIONS; TONING LOTION, FOR THE FACE, BODY AND HANDS; TOPICAL HERBAL CREAM FOR FIRING AND ENHANCING BREASTS; TOPICAL SKIN SPRAYS FOR COSMETIC PURPOSES (U.S. CLS. 1, 4, 6, 50, 51 AND 52).

AHSEN KHAN, EXAMINING ATTORNEY

SN 77-139,875. PHILOSOPHY, INC., PHOENIX, AZ. FILED 3-26-2007.

THE BIG BLOW OFF

THE MARK CONSISTS OF STANDARD CHARACTERS WITHOUT CLAIM TO ANY PARTICULAR FONT, STYLE, SIZE, OR COLOR.

FOR HAIR CARE PREPARATIONS (U.S. CLS. 1, 4, 6, 50, 51 AND 52).

FIRST USE 1-22-2007; IN COMMERCE 1-22-2007.

JENNIFER VASQUEZ, EXAMINING ATTORNEY

CLASS 3—(Continued).

SN 77-139,890. PHILOSOPHY, INC., PHOENIX, AZ. FILED 3-26-2007.

THE DAMAGE IS DONE

THE MARK CONSISTS OF STANDARD CHARACTERS WITHOUT CLAIM TO ANY PARTICULAR FONT, STYLE, SIZE, OR COLOR.

FOR NON-MEDICATED SKIN CARE PREPARATIONS (U.S. CLS. 1, 4, 6, 50, 51 AND 52).

FIRST USE 8-30-2006; IN COMMERCE 8-30-2006.

JENNIFER VASQUEZ, EXAMINING ATTORNEY

SN 77-139,901. PHILOSOPHY, INC., PHOENIX, AZ. FILED 3-26-2007.

CREATIVE JUICE

THE MARK CONSISTS OF STANDARD CHARACTERS WITHOUT CLAIM TO ANY PARTICULAR FONT, STYLE, SIZE, OR COLOR.

OWNER OF U.S. REG. NO. 2,470,509.

FOR HAIR CARE PREPARATIONS; NON-MEDICATED BATH PREPARATIONS; SHOWER AND BATH GEL (U.S. CLS. 1, 4, 6, 50, 51 AND 52).

FIRST USE 1-25-2007; IN COMMERCE 1-25-2007.

JENNIFER VASQUEZ, EXAMINING ATTORNEY

SN 77-140,100. DINAIR AIRBRUSH MAKEUP SYSTEM, INC., NORTH HOLLYWOOD, CA. FILED 3-26-2007.

Dinair

THE MARK CONSISTS OF STANDARD CHARACTERS WITHOUT CLAIM TO ANY PARTICULAR FONT, STYLE, SIZE, OR COLOR.

FOR AIRBRUSHABLE MAKEUP FOR BODY, FACE AND HAIR, IN A RANGE OF COLORS (U.S. CLS. 1, 4, 6, 50, 51 AND 52).

FIRST USE 1-1-1990; IN COMMERCE 1-1-1990.

WOODROW HARTZOG, EXAMINING ATTORNEY

CLASS 3—(Continued).

SN 77-140,387. NOW HEALTH GROUP, INC., BLOOMINGDALE, IL. FILED 3-26-2007.

AS NATURAL AS POSSIBLE

THE MARK CONSISTS OF STANDARD CHARACTERS WITHOUT CLAIM TO ANY PARTICULAR FONT, STYLE, SIZE, OR COLOR.

FOR PERSONAL CARE PRODUCTS, NAMELY, COSMETICS; BATH AND BODY SOAPS; SKIN, FACE AND BODY CARE PRODUCTS, NAMELY, SKIN RENEWAL CREAMS AND LOTIONS, NON-MEDICATED BODY CREAMS, NAMELY, JOINT SUPPORT CREAMS AND LOTIONS, BODY BUTTERS, BATH AND SKIN GELS; SKIN SERUMS, SKIN CLEANSERS, SKIN MOISTURIZERS, SKIN CONDITIONERS, SKIN MASKS, CLAY BODY POWDERS, SKIN TONERS, SKIN TEXTURIZERS, AND VEGETABLE AND FRUIT OILS FOR COSMETIC PURPOSES; PERSONAL DEODORANTS; ESSENTIAL OILS; TOOTHPASTE AND MOUTHWASH; AND HAIR CARE PRODUCTS, NAMELY, SHAMPOOS, CONDITIONERS AND COLORING (U.S. CLS. 1, 4, 6, 50, 51 AND 52).

REBECCA SMITH, EXAMINING ATTORNEY

SN 77-140,463. NOW HEALTH GROUP, INC., BLOOMINGDALE, IL. FILED 3-26-2007.

FAMILY PURE, FAMILY SAFE

THE MARK CONSISTS OF STANDARD CHARACTERS WITHOUT CLAIM TO ANY PARTICULAR FONT, STYLE, SIZE, OR COLOR.

FOR PERSONAL CARE PRODUCTS, NAMELY, COSMETICS; BATH AND BODY SOAPS; SKIN, FACE AND BODY CARE PRODUCTS, NAMELY, SKIN RENEWAL CREAMS AND LOTIONS, NON-MEDICATED BODY CREAMS, NAMELY, JOINT SUPPORT CREAMS AND LOTIONS, BODY BUTTERS, BATH AND SKIN GELS; SKIN SERUMS, SKIN CLEANSERS, SKIN MOISTURIZERS, SKIN CONDITIONERS, SKIN MASKS, CLAY BODY POWDERS, SKIN TONERS, SKIN TEXTURIZERS, AND VEGETABLE AND FRUIT OILS FOR COSMETIC PURPOSES; PERSONAL DEODORANTS; ESSENTIAL OILS; TOOTHPASTE AND MOUTHWASH; AND HAIR CARE PRODUCTS, NAMELY, SHAMPOOS, CONDITIONERS AND COLORING (U.S. CLS. 1, 4, 6, 50, 51 AND 52).

REBECCA SMITH, EXAMINING ATTORNEY

CLASS 3—(Continued).

SN 77-140,527. CHANEL, INC., NEW YORK, NY. FILED 3-26-2007.

SOFT CRYSTAL LUMIÈRE

THE MARK CONSISTS OF STANDARD CHARACTERS WITHOUT CLAIM TO ANY PARTICULAR FONT, STYLE, SIZE, OR COLOR.

OWNER OF U.S. REG. NOS. 1,451,673, 3,155,052 AND OTHERS.

THE FOREIGN WORDING IN THE MARK TRANSLATES INTO ENGLISH AS DAYLIGHT OR LAMPLIGHT.

FOR INGREDIENT USED AS A COMPONENT IN COSMETICS (U.S. CLS. 1, 4, 6, 50, 51 AND 52).

INGA ERVIN, EXAMINING ATTORNEY

SN 77-140,875. YUE HUI, GUANGZHOU, GUANGDONG, CHINA, FILED 3-26-2007.

HERBICOS

THE MARK CONSISTS OF STANDARD CHARACTERS WITHOUT CLAIM TO ANY PARTICULAR FONT, STYLE, SIZE, OR COLOR.

FOR BEAUTY MASKS; FACIAL CLEANSING MILK; HAIR LOTIONS; NON-MEDICATED ACNE TREATMENT PREPARATIONS; ROSE OIL FOR COSMETIC PURPOSES; NON-MEDICATED SKIN CARE PREPARATIONS; COSMETICS; PERFUMES; SPOT REMOVER; ANTI-WRINKLE CREAMS (U.S. CLS. 1, 4, 6, 50, 51 AND 52).

LAURIE MAYES, EXAMINING ATTORNEY

SN 77-140,961. FACEFACTS BY LORI, INC., WOODMERE, NY. FILED 3-27-2007.

FACEFACTS

THE MARK CONSISTS OF STANDARD CHARACTERS WITHOUT CLAIM TO ANY PARTICULAR FONT, STYLE, SIZE, OR COLOR.

FOR COSMETICS (U.S. CLS. 1, 4, 6, 50, 51 AND 52).

FIRST USE 9-1-2005; IN COMMERCE 9-1-2005.

REBECCA EISINGER, EXAMINING ATTORNEY

CLASS 3—(Continued).

SN 77-141,232. HOLYFIELD, LOUISE, DALLAS, TX. FILED 3-27-2007.

Transform+

THE MARK CONSISTS OF STANDARD CHARACTERS WITHOUT CLAIM TO ANY PARTICULAR FONT, STYLE, SIZE, OR COLOR.

FOR NON-MEDICATED SKIN CARE PREPARATIONS; HAIR CARE PREPARATIONS; BODY CARE PRODUCTS, NAMELY, BODY SOAPS, BODY CREAMS, BODY LOTIONS, BODY POWDERS, NON-MEDICATED DEODORANTS AND ANTI-PERSPIRANTS; NON-MEDICATED SUNCARE PRODUCTS, NAMELY, SUNSCREEN, SUN BLOCK AND SUN TANNING PREPARATIONS; PREPARATIONS TO PROTECT THE SKIN FROM THE SUN, NAMELY, NON-MEDICATED SUN CREAMS AND NON-MEDICATED AFTER-SUN LOTIONS; BATH PRODUCTS, NAMELY, BATH BEADS, BATH FOAM, BATH GELS, BATH LOTION, BATH OIL, BATH POWDER, AND NON-MEDICATED BATH SALTS; PERFUME, COLOGNE, COSMETICS AND MAKEUP (U.S. CLS. 1, 4, 6, 50, 51 AND 52).

GINA FINK, EXAMINING ATTORNEY

SN 77-141,238. ALTIERI BROTHERS, INC., BURBANK, CA. FILED 3-27-2007.

POWERHAIR

THE MARK CONSISTS OF STANDARD CHARACTERS WITHOUT CLAIM TO ANY PARTICULAR FONT, STYLE, SIZE, OR COLOR.

FOR COSMETICS, NAMELY, SHAMPOO, SKIN LOTIONS, SKIN CREAMS, HAIR CONDITIONERS, GELS, CREAMS AND SPRAYS USED TO INCREASE THE CURLINESS OF HAIR, HAIR STYLING PREPARATIONS, HAIR WAVING LOTION, HAIR COLOR, HAIR GEL, HAIR SPRAY, BATH AND SHOWER GELS, BATH SALTS, BATH BEADS, BATH OILS, BODY CREAMS, SKIN CLEANSING CREAMS, SKIN MOISTURIZERS, FACIAL MASKS, BEAUTY MASKS, BODY AND FACIAL SCRUBS, SKIN AND TOILET SOAPS, ESSENTIAL OILS FOR PERSONAL USE, MAKEUP, BLUSH, MASCARA, LIP GLOSS, LIPSTICK, EYE LINER, EYE SHADOW, NAIL POLISH, PERFUMED BODY OILS, AND PERFUMED SOAPS (U.S. CLS. 1, 4, 6, 50, 51 AND 52).

PATRICIA EVANKO, EXAMINING ATTORNEY

CLASS 3—(Continued).

SN 77-141,283. MARTINEZ, BRANDON, LOS ANGELES, CA. FILED 3-27-2007.



THE PRODUCT

BRANDON MARTINEZ

NO CLAIM IS MADE TO THE EXCLUSIVE RIGHT TO USE "PRODUCT", APART FROM THE MARK AS SHOWN.

THE NAME "BRANDON MARTINEZ" IN THE MARK IDENTIFIES A LIVING INDIVIDUAL WHOSE CONSENT IS OF RECORD.

THE MARK CONSISTS OF THE WORDING "B. THE PRODUCT BRANDON MARTINEZ" IN STYLIZED FONT

FOR SHAMPOO; SHAMPOO FOR COLOR; HAIR CONDITIONER; HAIR CONDITIONER FOR COLOR; LEAVE IN HAIR CONDITIONER; HAIR SPRAY; HAIR CARE PREPARATIONS IN PASTE FORM; POMADE (U.S. CLS. 1, 4, 6, 50, 51 AND 52).

MICHAEL GAAFAR, EXAMINING ATTORNEY

SN 77-141,392. SWIFT, TAYLOR, HENDERSONVILLE, TN. FILED 3-27-2007.

LOVE, LOVE, LOVE

THE MARK CONSISTS OF STANDARD CHARACTERS WITHOUT CLAIM TO ANY PARTICULAR FONT, STYLE, SIZE, OR COLOR.

FOR COLOGNE; PERFUME (U.S. CLS. 1, 4, 6, 50, 51 AND 52).

MICHAEL KEATING, EXAMINING ATTORNEY

SN 77-141,412. PETERSON, GERRY K., ARLINGTON, TX. FILED 3-27-2007.

PISTOL PETE'S

THE MARK CONSISTS OF STANDARD CHARACTERS WITHOUT CLAIM TO ANY PARTICULAR FONT, STYLE, SIZE, OR COLOR.

FOR ALL-PURPOSE CLEANERS (U.S. CLS. 1, 4, 6, 50, 51 AND 52).

FIRST USE 3-0-2006; IN COMMERCE 3-0-2006.

BRIAN CALLAGHAN, EXAMINING ATTORNEY

CLASS 3—(Continued).

SN 77-141,536. THE PROCTER & GAMBLE COMPANY, CINCINNATI, OH. FILED 3-27-2007.



THE MARK CONSISTS OF DRAWING OF WAVY CAPSULE DEVICE...
FOR NON-MEDICATED SKIN CARE PREPARATIONS (U.S. CLS. 1, 4, 6, 50, 51 AND 52).
GEOFFREY FOSDICK, EXAMINING ATTORNEY

SN 77-141,686. PERFUMELAND OF ORLANDO, INC., ORLANDO, FL. FILED 3-27-2007.

DERMASHINE

THE MARK CONSISTS OF STANDARD CHARACTERS WITHOUT CLAIM TO ANY PARTICULAR FONT, STYLE, SIZE, OR COLOR.
FOR FACE AND BODY MUD MASKS, BATH SALTS, FACIAL CREAMS, BODY CREAMS, EYE CREAMS, HAND CREAMS, HAIR SHAMPOOS, BODY LOTIONS, FACIAL MOISTURIZERS, MAKE UP REMOVER, ASTRINGENTS FOR COSMETIC PURPOSES, FACIAL TONERS AND FACIAL SOAPS (U.S. CLS. 1, 4, 6, 50, 51 AND 52).
TAMARA FRAZIER, EXAMINING ATTORNEY

SN 77-141,936. BOTANTONE INTERNATIONAL, INCORPORATED, ARCADIA, CA. FILED 3-27-2007.

BOTANTONE

THE MARK CONSISTS OF STANDARD CHARACTERS WITHOUT CLAIM TO ANY PARTICULAR FONT, STYLE, SIZE, OR COLOR.
FOR BEAUTY CREAMS FOR BODY CARE; CONDITIONERS; COSMETIC CREAMS FOR SKIN CARE; COSMETIC PREPARATIONS FOR BODY CARE; COSMETIC PREPARATIONS FOR SKIN RENEWAL; LOTIONS FOR FACE AND BODY CARE; HAIR CARE PREPARATIONS; MAKE-UP PRODUCTS FOR THE FACE AND BODY; NON-MEDICATED SKIN CARE PREPARATIONS; SKIN CLARIFIERS; SKIN CLEANSERS; SKIN CLEANSING CREAM; SKIN CLEANSING LOTION; SKIN CONDITIONERS; SKIN LIGHTENING CREAMS; SKIN MASKS; SKIN MOISTURIZER; SKIN TONERS; SKIN WHITENING CREAMS; SUN CARE LOTIONS (U.S. CLS. 1, 4, 6, 50, 51 AND 52).
MARGERY A. TIERNEY, EXAMINING ATTORNEY

CLASS 3—(Continued).

SN 77-141,945. GUYS WITH TRUCKS, INC., HIGH SPRINGS, FL. FILED 3-27-2007.

LoveBug Wipes

THE MARK CONSISTS OF STANDARD CHARACTERS WITHOUT CLAIM TO ANY PARTICULAR FONT, STYLE, SIZE, OR COLOR.
NO CLAIM IS MADE TO THE EXCLUSIVE RIGHT TO USE "WIPES", APART FROM THE MARK AS SHOWN.
FOR DISPOSABLE WIPES IMPREGNATED WITH CLEANSING COMPOUNDS FOR USE ON ANY VEHICLES, WATERCRAFT, AIRPLANES (U.S. CLS. 1, 4, 6, 50, 51 AND 52).
SANI KHOURI, EXAMINING ATTORNEY

SN 77-142,078. JUDY ANDERSON, TAOS, NM. FILED 3-28-2007.

LICK MY FACE

THE MARK CONSISTS OF STANDARD CHARACTERS WITHOUT CLAIM TO ANY PARTICULAR FONT, STYLE, SIZE, OR COLOR.
FOR NON-MEDICATED GROOMING PREPARATIONS FOR DOGS, NAMELY, MOUTH RINSE, TOOTH-PASTE AND BREATH FRESHENER (U.S. CLS. 1, 4, 6, 50, 51 AND 52).
PAUL F. GAST, EXAMINING ATTORNEY

SN 77-142,079. JUDY ANDERSON, TAOS, NM. FILED 3-28-2007.



THE MARK CONSISTS OF THE WORDS "LICK MY FACE", WITH THE LETTER "I" DOTTED WITH A DOG'S PAW PRINT, APPEARING ABOVE THE IMAGE OF A DOG BEARING HIS TEETH WITH A SPARKLING SMILE AND WAGGING HIS TAIL, AND THE WORDS "I [HEART] MY DOGGIE" TO THE LEFT OF THE DOG.
FOR NON-MEDICATED GROOMING PREPARATIONS FOR DOGS, NAMELY, MOUTH RINSE, TOOTH-PASTE AND BREATH FRESHENER (U.S. CLS. 1, 4, 6, 50, 51 AND 52).
PAUL F. GAST, EXAMINING ATTORNEY

CLASS 3—(Continued).

SN 77-142,328. PHILOSOPHY, INC., PHOENIX, AZ. FILED 3-28-2007.

THE GIFT OF BEAUTIFUL HANDS

THE MARK CONSISTS OF STANDARD CHARACTERS WITHOUT CLAIM TO ANY PARTICULAR FONT, STYLE, SIZE, OR COLOR.

FOR HAND CREAMS; HAND SOAPS; BODY SCRUB; DEPILATORIES; NON-MEDICATED SKIN CARE PREPARATIONS; NON-MEDICATED SUN CARE PREPARATIONS; NAIL CARE PREPARATIONS; PERFUMED POWDER (U.S. CLS. 1, 4, 6, 50, 51 AND 52).

JENNIFER VASQUEZ, EXAMINING ATTORNEY

SN 77-142,335. PHILOSOPHY, INC., PHOENIX, AZ. FILED 3-28-2007.

THE GIFT OF BEAUTIFUL HAIR

THE MARK CONSISTS OF STANDARD CHARACTERS WITHOUT CLAIM TO ANY PARTICULAR FONT, STYLE, SIZE, OR COLOR.

FOR HAIR CARE PREPARATIONS (U.S. CLS. 1, 4, 6, 50, 51 AND 52).

JENNIFER VASQUEZ, EXAMINING ATTORNEY

SN 77-142,348. PHILOSOPHY, INC., PHOENIX, AZ. FILED 3-28-2007.

THE GIFT OF BEAUTIFUL SKIN

THE MARK CONSISTS OF STANDARD CHARACTERS WITHOUT CLAIM TO ANY PARTICULAR FONT, STYLE, SIZE, OR COLOR.

FOR BAR SOAP; BODY SCRUB; COSMETIC FACIAL BLOTting PAPERS; COSMETIC PADS; COSMETIC PENCILS; COSMETICS; DEPILATORIES; FACIAL SCRUBS; FRAGRANCES FOR PERSONAL USE; NAIL CARE PREPARATIONS; NON-MEDICATED BATH PREPARATIONS; NON-MEDICATED LIP CARE PREPARATIONS; NON-MEDICATED SKIN CARE PREPARATIONS; NON-MEDICATED SUN CARE PREPARATIONS; NON-MEDICATED TOILETRIES; PERFUMED POWDER; PERSONAL DEODORANTS; SHAVING PREPARATIONS; SHOWER AND BATH GEL (U.S. CLS. 1, 4, 6, 50, 51 AND 52).

JENNIFER VASQUEZ, EXAMINING ATTORNEY

CLASS 3—(Continued).

SN 77-142,546. LUMESH COSMETICS INC., TEANECK, NJ. FILED 3-28-2007.

LuMESH

THE MARK CONSISTS OF STANDARD CHARACTERS WITHOUT CLAIM TO ANY PARTICULAR FONT, STYLE, SIZE, OR COLOR.

FOR COSMETICS, SKIN LOTION, SKIN SOAP, FACE LOTION, EXFOLIANTS FOR SKIN, SKIN TONERS, SHOWER GELS, FACIAL SCRUBS, BODY SCRUB, BATH OIL, BODY OIL, NAIL POLISH, PERFUME, FACIAL CLEANSERS, SKIN MOISTURIZER, NON-MEDICATED FOOT CREAM (U.S. CLS. 1, 4, 6, 50, 51 AND 52).

SHARON MEIER, EXAMINING ATTORNEY

SN 77-142,925. LOUISE HOLYFIELD, DALLAS, TX. FILED 3-28-2007.

Great Skin Care Does Not
End At The Chin!

THE MARK CONSISTS OF STANDARD CHARACTERS WITHOUT CLAIM TO ANY PARTICULAR FONT, STYLE, SIZE, OR COLOR.

FOR NON-MEDICATED SKIN CARE PREPARATIONS; BODY CARE PRODUCTS, NAMELY, BODY SOAPS, BODY CREAMS, BODY LOTIONS; NON-MEDICATED SUNCARE PRODUCTS, NAMELY, SUNSCREEN, SUN BLOCK AND SUN TANNING PREPARATIONS; PREPARATIONS TO PROTECT THE SKIN FROM THE SUN, NAMELY, NON-MEDICATED SUN CREAMS AND NON-MEDICATED AFTER-SUN LOTIONS; BATH PRODUCTS, NAMELY, BATH BEADS, BATH FOAM, BATH GELS, BATH LOTION, BATH OIL, BATH POWDER, AND NON-MEDICATED BATH SALTS (U.S. CLS. 1, 4, 6, 50, 51 AND 52).

GINA FINK, EXAMINING ATTORNEY

SN 77-143,106. FNC MEDICAL CORPORATION, VENTURA, CA. FILED 3-28-2007.

SYNORA

THE MARK CONSISTS OF STANDARD CHARACTERS WITHOUT CLAIM TO ANY PARTICULAR FONT, STYLE, SIZE, OR COLOR.

FOR SKIN CARE PRODUCTS, NAMELY LOTIONS, NIGHT CREAMS, AND CLEANSING CREAMS (U.S. CLS. 1, 4, 6, 50, 51 AND 52).

THEODORE MCBRIDE, EXAMINING ATTORNEY

CLASS 3—(Continued).

SN 77-143,199. ALPHA SPECIALTY PRODUCTS, BEVERLY HILLS, CA. FILED 3-28-2007.

Retroformin

THE MARK CONSISTS OF STANDARD CHARACTERS WITHOUT CLAIM TO ANY PARTICULAR FONT, STYLE, SIZE, OR COLOR.

FOR COSMETIC CREAMS FOR SKIN CARE; ANTI-WRINKLE CREAM; ANTI-WRINKLE CREAMS (U.S. CLS. 1, 4, 6, 50, 51 AND 52).

DAVID H. STINE, EXAMINING ATTORNEY

CLASS 3—(Continued).

SN 77-143,805. RGS LABS INTERNATIONAL INC., PALM CITY, FL. FILED 3-29-2007.

RGS LABS

THE MARK CONSISTS OF STANDARD CHARACTERS WITHOUT CLAIM TO ANY PARTICULAR FONT, STYLE, SIZE, OR COLOR.

NO CLAIM IS MADE TO THE EXCLUSIVE RIGHT TO USE "LABS", APART FROM THE MARK AS SHOWN.

FOR AUTOMOBILE WAX; AUTOMOBILE CLEANERS (U.S. CLS. 1, 4, 6, 50, 51 AND 52).

FIRST USE 4-0-2004; IN COMMERCE 4-0-2004.

JENNIFER VASQUEZ, EXAMINING ATTORNEY

SN 77-143,261. WEISS, JODY R., NEW YORK, NY. FILED 3-29-2007.

Eco-Sensual

THE MARK CONSISTS OF STANDARD CHARACTERS WITHOUT CLAIM TO ANY PARTICULAR FONT, STYLE, SIZE, OR COLOR.

FOR COSMETICS (U.S. CLS. 1, 4, 6, 50, 51 AND 52).

FIRST USE 3-7-2007; IN COMMERCE 3-7-2007.

TEJBIR SINGH, EXAMINING ATTORNEY

SN 77-143,831. RGS LABS INTERNATIONAL INC., PALM CITY, FL. FILED 3-29-2007.

FW1

THE MARK CONSISTS OF STANDARD CHARACTERS WITHOUT CLAIM TO ANY PARTICULAR FONT, STYLE, SIZE, OR COLOR.

FOR AUTOMOBILE WAX; AUTOMOBILE CLEANERS (U.S. CLS. 1, 4, 6, 50, 51 AND 52).

FIRST USE 4-0-2004; IN COMMERCE 4-0-2004.

JENNIFER VASQUEZ, EXAMINING ATTORNEY

SN 77-143,592. ABERCROMBIE & FITCH TRADING CO., NEW ALBANY, OH. FILED 3-29-2007.

LOST WINDS

THE MARK CONSISTS OF STANDARD CHARACTERS WITHOUT CLAIM TO ANY PARTICULAR FONT, STYLE, SIZE, OR COLOR.

FOR COLOGNE; FRAGRANCES FOR PERSONAL USE; PERFUME; BODY LOTION; BODY SPRAYS; BODY WASHES; DEODORANTS AND ANTIPERSPIRANTS; DEODORANTS FOR BODY CARE; BODY SPRAY USED AS A PERSONAL DEODORANT AND AS FRAGRANCE (U.S. CLS. 1, 4, 6, 50, 51 AND 52).

JOHN WILKE, EXAMINING ATTORNEY

SN 77-143,839. RGS LABS INTERNATIONAL INC., PALM CITY, FL. FILED 3-29-2007.

LAB TESTED, PIT PROVEN

THE MARK CONSISTS OF STANDARD CHARACTERS WITHOUT CLAIM TO ANY PARTICULAR FONT, STYLE, SIZE, OR COLOR.

FOR AUTOMOBILE WAX; AUTOMOBILE CLEANERS (U.S. CLS. 1, 4, 6, 50, 51 AND 52).

FIRST USE 4-0-2004; IN COMMERCE 4-0-2004.

JENNIFER VASQUEZ, EXAMINING ATTORNEY

CLASS 3—(Continued).

SN 77-144,207. HOUSE OF CHEATHAM, INC., STONE MOUNTAIN, GA. FILED 3-29-2007.

TRENDS NATURAL THERAPY

THE MARK CONSISTS OF STANDARD CHARACTERS WITHOUT CLAIM TO ANY PARTICULAR FONT, STYLE, SIZE, OR COLOR.

NO CLAIM IS MADE TO THE EXCLUSIVE RIGHT TO USE NATURAL THERAPY, APART FROM THE MARK AS SHOWN.

FOR HAIR CARE PREPARATIONS (U.S. CLS. 1, 4, 6, 50, 51 AND 52).

FIRST USE 1-1-2005; IN COMMERCE 1-1-2005.
CARYN GLASSER, EXAMINING ATTORNEY

CLASS 3—(Continued).

SN 77-146,373. L.C. LICENSING, INC., NEW YORK, NY. FILED 4-2-2007.

DOGGY JET SET

THE MARK CONSISTS OF STANDARD CHARACTERS WITHOUT CLAIM TO ANY PARTICULAR FONT, STYLE, SIZE, OR COLOR.

NO CLAIM IS MADE TO THE EXCLUSIVE RIGHT TO USE "SET", APART FROM THE MARK AS SHOWN.

FOR GIFT SET CONTAINING PERFUME, LEAVE IN HAIR CONDITIONING MIST, TOY AND BOWL FOR PETS (U.S. CLS. 1, 4, 6, 50, 51 AND 52).

CHARLES L. JENKINS, EXAMINING ATTORNEY

SN 77-144,385. JUNG, WOO SEOK, MONTGOMERYVILLE, PA. FILED 3-29-2007.

FINGER TO TOE

THE MARK CONSISTS OF STANDARD CHARACTERS WITHOUT CLAIM TO ANY PARTICULAR FONT, STYLE, SIZE, OR COLOR.

FOR PUMICE STONES FOR PERSONAL USE; HAND LOTIONS; FOOT POWDER; NON-MEDICATED BODY SOAKS; BODY LOTIONS; BODY SCRUB; CUTICLE CONDITIONERS; CUTICLE CREAM (U.S. CLS. 1, 4, 6, 50, 51 AND 52).

DAVID TOOLEY, EXAMINING ATTORNEY

SN 77-147,018. THE PROCTER & GAMBLE COMPANY, CINCINNATI, OH. FILED 4-3-2007.

CLASSIC COTTON

THE MARK CONSISTS OF STANDARD CHARACTERS WITHOUT CLAIM TO ANY PARTICULAR FONT, STYLE, SIZE, OR COLOR.

NO CLAIM IS MADE TO THE EXCLUSIVE RIGHT TO USE "COTTON", APART FROM THE MARK AS SHOWN.

FOR LAUNDRY DETERGENT (U.S. CLS. 1, 4, 6, 50, 51 AND 52).

GEOFFREY FOSDICK, EXAMINING ATTORNEY

SN 77-145,936. THE PROCTER & GAMBLE COMPANY, CINCINNATI, OH. FILED 4-2-2007.



OWNER OF U.S. REG. NOS. 1,005,694, 2,783,130 AND OTHERS.

THE MARK CONSISTS OF A STYLIZED CURL RUNNING THROUGH THE WORD PANTENE WITH PRO-V BELOW THE WORD PANTENE.

FOR HAIR CARE PREPARATIONS (U.S. CLS. 1, 4, 6, 50, 51 AND 52).

FIRST USE 1-23-2006; IN COMMERCE 1-23-2006.
GEOFFREY FOSDICK, EXAMINING ATTORNEY

SN 77-147,317. JAFER LIMITED, HAMILTON, BERMUDA, FILED 4-3-2007.



OWNER OF U.S. REG. NOS. 2,251,818 AND 3,127,558.
NO CLAIM IS MADE TO THE EXCLUSIVE RIGHT TO USE "SPORT", APART FROM THE MARK AS SHOWN.

FOR PERFUMES, EAU DE PERFUME, FRAGRANCES FOR PERSONAL USE, TOILET WATER, COLOGNE, AFTER-SHAVE LOTIONS, TOILET SOAP, DEODORANT FOR PERSONAL USE, ANTIPERSPIRANTS, TALCUM POWDER, BODY LOTIONS, HAIR SHAMPOO, HAIR CONDITIONERS, HAIR SHAMPOO-CONDITIONERS, HAIR CARE PREPARATIONS, FACIAL LOTIONS, HAND LOTIONS, BODY LOTIONS, HAND CREAMS, FACIAL CREAMS AND BODY CREAMS (U.S. CLS. 1, 4, 6, 50, 51 AND 52).

CURTIS FRENCH, EXAMINING ATTORNEY

CLASS 3—(Continued).

SN 77-148,030. MAJEED, MUHAMMED, PISCATAWAY, NJ.
FILED 4-4-2007.

ACNEZERO

THE MARK CONSISTS OF STANDARD CHARACTERS WITHOUT CLAIM TO ANY PARTICULAR FONT, STYLE, SIZE, OR COLOR.

FOR NON-MEDICATED ACNE TREATMENT PREPARATIONS (U.S. CLS. 1, 4, 6, 50, 51 AND 52).
THEODORE MCBRIDE, EXAMINING ATTORNEY

SN 77-149,893. DISNEY ENTERPRISES, INC., BURBANK, CA. FILED 4-5-2007.

WHERE IMAGINATION BEGINS

THE MARK CONSISTS OF STANDARD CHARACTERS WITHOUT CLAIM TO ANY PARTICULAR FONT, STYLE, SIZE, OR COLOR.

FOR BABY SHAMPOO, LOTIONS, OILS, POWDERS AND WIPES; AFTER-SHAVE LOTIONS; ANTIPERSPIRANTS; AROMATHERAPY OILS; ARTIFICIAL EYELASHES AND FINGERNAILS; BATH GELS; BATH POWDER; BEAUTY MASKS; BLUSH; BODY CREAMS, LOTIONS, AND POWDERS; BREATH FRESHENER; BUBBLE BATH; COLOGNE; COSMETICS; DENTIFRICES; DEODORANTS FOR PERSONAL USE; DUSTING POWDER; ESSENTIAL OILS FOR PERSONAL USE; EYE LINER; EYE SHADOWS; EYEBROW PENCILS; FACE POWDER; FACIAL CREAMS; FACIAL LOTION; FACIAL MASKS; FACIAL SCRUBS; FRAGRANCE EMITTING WICKS FOR ROOM FRAGRANCE; FRAGRANCES FOR PERSONAL USE; HAIR GEL; HAIR CONDITIONERS; HAIR SHAMPOO; HAIR MOUSSE; HAIR CREAMS; HAIR SPRAY; HAND CREAM; HAND LOTIONS; HAND SOAPS; LIP BALM; LIPSTICK; LIPSTICK HOLDERS; LIP GLOSS; LIQUID SOAPS; MAKE-UP; MASCARA; MOUTHWASH; NAIL CARE PREPARATIONS; NAIL GLITTER; NAIL HARDENERS; NAIL POLISH; PERFUME; POTPOURRI; ROOM FRAGRANCES; SHAVING CREAM; SKIN SOAP; TALCUM POWDERS; TOILET WATER; SKIN CREAMS; SKIN MOISTURIZER; SUN BLOCK; SUN SCREEN (U.S. CLS. 1, 4, 6, 50, 51 AND 52).

BRIDGETT SMITH, EXAMINING ATTORNEY

SN 77-151,485. THE PROCTER & GAMBLE COMPANY, CINCINNATI, OH. FILED 4-9-2007.

WHITEBOND PROTECTION

THE MARK CONSISTS OF STANDARD CHARACTERS WITHOUT CLAIM TO ANY PARTICULAR FONT, STYLE, SIZE, OR COLOR.

FOR NON-MEDICATED ORAL CARE PREPARATIONS, NAMELY TOOTHPASTE (U.S. CLS. 1, 4, 6, 50, 51 AND 52).

FIRST USE 8-3-2004; IN COMMERCE 8-3-2004.
GEOFFREY FOSDICK, EXAMINING ATTORNEY

CLASS 3—(Continued).

SN 77-151,580. PHILOSOPHY, INC., PHOENIX, AZ. FILED 4-9-2007.

INNER PEACE

THE MARK CONSISTS OF STANDARD CHARACTERS WITHOUT CLAIM TO ANY PARTICULAR FONT, STYLE, SIZE, OR COLOR.

FOR BABY LOTION; BABY POWDER; BABY SHAMPOO; BAR SOAP; BODY SCRUB; COSMETIC FACIAL BLOTTING PAPERS; COSMETIC PADS; COSMETIC PENCILS; COSMETIC PREPARATIONS FOR THE CARE OF MOUTH AND TEETH; COSMETICS; DEPILATORIES; FACIAL SCRUBS; FRAGRANCES FOR PERSONAL USE; HAIR CARE PREPARATIONS; NAIL CARE PREPARATIONS; NON-MEDICATED BATH PREPARATIONS; NON-MEDICATED LIP CARE PREPARATIONS; NON-MEDICATED SKIN CARE PREPARATIONS; NON-MEDICATED SUN CARE PREPARATIONS; NON-MEDICATED TOILETRIES; PERFUMED POWDER; PERSONAL DEODORANTS; SCENTED ROOM SPRAYS; SHAVING PREPARATIONS; SHOWER AND BATH GEL (U.S. CLS. 1, 4, 6, 50, 51 AND 52).

JENNIFER VASQUEZ, EXAMINING ATTORNEY

SN 77-156,468. AMPRO INDUSTRIES, INC., MEMPHIS, TN. FILED 4-13-2007.

PARTY ICE

THE MARK CONSISTS OF STANDARD CHARACTERS WITHOUT CLAIM TO ANY PARTICULAR FONT, STYLE, SIZE, OR COLOR.

FOR HAIR BLEACH, HAIR CARE CREAMS, HAIR CARE LOTIONS, HAIR CLEANING PREPARATIONS, HAIR CONDITIONERS, HAIR DRESSING, HAIR DYE, HAIR EMOLLIENTS, HAIR GEL, HAIR OILS, HAIR RELAXERS, HAIR SHAMPOO, PRE-SHAVE CREAMS, AFTER-SHAVE CREAMS, AFTER-SHAVE GELS (U.S. CLS. 1, 4, 6, 50, 51 AND 52).

SUNG IN, EXAMINING ATTORNEY

SN 77-158,473. NOXELL CORPORATION, HUNT VALLEY, MD. FILED 4-17-2007.

VIVID IMPACT

THE MARK CONSISTS OF STANDARD CHARACTERS WITHOUT CLAIM TO ANY PARTICULAR FONT, STYLE, SIZE, OR COLOR.

FOR COSMETICS (U.S. CLS. 1, 4, 6, 50, 51 AND 52).
TONJA GASKINS, EXAMINING ATTORNEY

CLASS 3—(Continued).

SN 77-158,478. NOXELL CORPORATION, HUNT VALLEY, MD. FILED 4-17-2007.

EVERY WOMAN IS A QUEEN

THE MARK CONSISTS OF STANDARD CHARACTERS WITHOUT CLAIM TO ANY PARTICULAR FONT, STYLE, SIZE, OR COLOR.

FOR COSMETICS (U.S. CLS. 1, 4, 6, 50, 51 AND 52).
TONJA GASKINS, EXAMINING ATTORNEY

CLASS 3—(Continued).

SN 77-173,188. AVAA, LLC, ROLLING HILLS ESTATES, CA. FILED 5-4-2007.

ARTEASE

THE MARK CONSISTS OF STANDARD CHARACTERS WITHOUT CLAIM TO ANY PARTICULAR FONT, STYLE, SIZE, OR COLOR.

FOR BEAUTY CREAMS FOR BODY CARE; BODY AND BEAUTY CARE COSMETICS; CONDITIONERS; COSMETIC CREAMS FOR SKIN CARE; COSMETIC PRODUCTS IN THE FORM OF AEROSOLS FOR SKIN CARE; DEODORANTS FOR BODY CARE; EXFOLIANTS FOR HAIR AND SKIN; GEL FOR HAIR; HAIR BLEACHING PREPARATIONS; HAIR CARE CREAMS; HAIR CARE KITS COMPRISING NON-MEDICATED HAIR CARE PREPARATIONS, NAMELY, SHAMPOOS AND CONDITIONERS; HAIR CARE LOTIONS; HAIR CARE PREPARATIONS; HAIR CLEANING PREPARATIONS; HAIR COLOR; HAIR COLOR REMOVERS; HAIR COLORANTS; HAIR COLORING PREPARATIONS; HAIR CONDITIONERS; HAIR CREAMS; HAIR DECOLORANTS; HAIR DRESSINGS FOR MEN; HAIR DRESSINGS FOR WOMEN; HAIR DYES; HAIR EMOLLIENTS; HAIR FIXERS; HAIR FROSTS; HAIR GELS; HAIR LIGHTENERS; HAIR LOTIONS; HAIR MOUSSES; HAIR NOURISHERS; HAIR OILS; HAIR POMADES; HAIR RELAXERS; HAIR RINSES; HAIR SHAMPOO; HAIR SPRAY; HAIR STRAIGHTENING PREPARATIONS; HAIR STYLING GEL; HAIR STYLING SPRAY; LOTIONS FOR FACE AND BODY CARE; LOTIONS FOR HAIR AND SKIN CARE; NON-MEDICATED LIP CARE PREPARATIONS; NON-MEDICATED SKIN CARE PREPARATIONS; NON-MEDICATED SUN CARE PREPARATIONS; SKIN CARE PRODUCTS, NAMELY, NON-MEDICATED SKIN SERUM; AFTER-SHAVE CREAMS; AROMATHERAPY CREAMS; ASTRINGENTS FOR COSMETIC PURPOSES; BATH OILS FOR COSMETIC PURPOSES; BEAUTY CREAMS; BODY CREAM SOAP; BODY CREAMS; CLEANSING CREAMS; COLD CREAM; CONCEALERS; COSMETIC OILS; COSMETIC PREPARATIONS AGAINST SUNBURN; COSMETIC PREPARATIONS FOR BODY CARE; COSMETIC PREPARATIONS FOR EYE LASHES; COSMETIC PREPARATIONS FOR SKIN RENEWAL; COSMETIC PRODUCTS IN THE FORM OF AEROSOLS FOR SKINCARE; COSMETIC SOAPS; COSMETICS; COSMETICS, NAMELY LIP PRIMER; COSMETICS, NAMELY, LIP REPAIRERS; CUTICLE CREAM; DEPILATORY CREAMS; EXFOLIANT CREAMS; EYE CREAM; FACE AND BODY CREAMS; FACIAL CLEANSERS; FACIAL MAKE-UP; FACIAL SCRUBS; FACIAL WASHES; HAND CREAMS; LIP CREAM; MOUSSE FOR HAIR AND SKIN; NAIL CREAM; NAIL VARNISH FOR COSMETIC PURPOSES; NIGHT CREAM; SKIN AND BODY TOPICAL LOTIONS, CREAMS AND OILS FOR COSMETIC USE; SKIN CLEANSERS; SKIN CREAMS; SOAPS; BATH GELS; BEAUTY GELS; EYE GELS; HAIR GEL; SHOWER AND BATH GEL; LIP GLOSS; VANISHING CREAM; FRAGRANCES FOR PERSONAL USE; BODY MASK POWDER; BODY POWDER; FACE POWDER; FACIAL CONCEALER; MAKE-UP POWDER; MAKE UP FOUNDATIONS; HAIR WAVING LOTION (U.S. CLS. 1, 4, 6, 50, 51 AND 52).

EUGENIA MARTIN, EXAMINING ATTORNEY

SN 77-161,033. THE PROCTER & GAMBLE COMPANY, CINCINNATI, OH. FILED 4-19-2007.

LAVENDER LILAC MOMENT

THE MARK CONSISTS OF STANDARD CHARACTERS WITHOUT CLAIM TO ANY PARTICULAR FONT, STYLE, SIZE, OR COLOR.

NO CLAIM IS MADE TO THE EXCLUSIVE RIGHT TO USE "LAVENDER LILAC", APART FROM THE MARK AS SHOWN.

FOR LAUNDRY DETERGENT (U.S. CLS. 1, 4, 6, 50, 51 AND 52).

GEOFFREY FOSDICK, EXAMINING ATTORNEY

SN 77-172,752. LANGE, EILLEN, NEW YORK, NY. FILED 5-4-2007.

SHANIA STARLIGHT

THE MARK CONSISTS OF STANDARD CHARACTERS WITHOUT CLAIM TO ANY PARTICULAR FONT, STYLE, SIZE, OR COLOR.

THE NAME(S), PORTRAIT(S), AND/OR SIGNATURE(S) SHOWN IN THE MARK IDENTIFIES EILLEN LANGE, A/ K/A SHANIA TWAIN, WHOSE CONSENT(S) TO REGISTER IS SUBMITTED.

FOR FRAGRANCES FOR PERSONAL USE AND NON-MEDICATED SKIN CARE PREPARATIONS (U.S. CLS. 1, 4, 6, 50, 51 AND 52).

DEIRDRE ROBERTSON, EXAMINING ATTORNEY

CLASS 3—(Continued).

SN 77-174,115. SCHERING-PLOUGH HEALTHCARE PRODUCTS, INC., MEMPHIS, TN. FILED 5-7-2007.

LITTLE MISS COPPERTONE

THE MARK CONSISTS OF STANDARD CHARACTERS WITHOUT CLAIM TO ANY PARTICULAR FONT, STYLE, SIZE, OR COLOR.

OWNER OF U.S. REG. NOS. 567,828, 1,529,228 AND OTHERS.

FOR SUNTANNING AND SUNCARE PREPARATIONS; NAMELY, OILS, LOTIONS, MOISTURIZERS, SUNSCREENS, SUN BLOCKS, AND PREPARATIONS TO ASSIST IN TANNING THE SKIN (U.S. CLS. 1, 4, 6, 50, 51 AND 52).

PRISCILLA MILTON, EXAMINING ATTORNEY

CLASS 3—(Continued).

SN 77-178,776. ABERCROMBIE & FITCH TRADING CO., NEW ALBANY, OH. FILED 5-11-2007.



THE NAME(S), PORTRAIT(S), AND/OR SIGNATURE(S) SHOWN IN THE MARK DOES NOT IDENTIFY A PARTICULAR LIVING INDIVIDUAL.

THE MARK CONSISTS OF A MISCELLANEOUS DESIGN WITH THE TERM GILLY H.

FOR COLOGNE; FRAGRANCES FOR PERSONAL USE; PERFUME; BEAUTY LOTIONS; BODY LOTIONS; HAND LOTIONS; BEAUTY CREAMS; BEAUTY CREAMS FOR BODY CARE; BODY AND BEAUTY CARE COSMETICS; MAKE-UP (U.S. CLS. 1, 4, 6, 50, 51 AND 52).

JOHN WILKE, EXAMINING ATTORNEY

SN 77-178,756. ABERCROMBIE & FITCH TRADING CO., NEW ALBANY, OH. FILED 5-11-2007.



THE MARK CONSISTS OF A MISCELLANEOUS DESIGN. FOR COLOGNE; FRAGRANCES FOR PERSONAL USE; PERFUME; BEAUTY LOTIONS; BODY LOTIONS; HAND LOTIONS; BEAUTY CREAMS; BEAUTY CREAMS FOR BODY CARE; BODY AND BEAUTY CARE COSMETICS; MAKE-UP (U.S. CLS. 1, 4, 6, 50, 51 AND 52).

JOHN WILKE, EXAMINING ATTORNEY

SN 77-178,790. ABERCROMBIE & FITCH TRADING CO., NEW ALBANY, OH. FILED 5-11-2007.



THE NAME(S), PORTRAIT(S), AND/OR SIGNATURE(S) SHOWN IN THE MARK DOES NOT IDENTIFY A PARTICULAR LIVING INDIVIDUAL.

THE MARK CONSISTS OF A MISCELLANEOUS DESIGN WITH THE TERM GILLY H.

FOR COLOGNE; FRAGRANCES FOR PERSONAL USE; PERFUME; BEAUTY LOTIONS; BODY LOTIONS; HAND LOTIONS; BEAUTY CREAMS; BEAUTY CREAMS FOR BODY CARE; BODY AND BEAUTY CARE COSMETICS; MAKE-UP (U.S. CLS. 1, 4, 6, 50, 51 AND 52).

JOHN WILKE, EXAMINING ATTORNEY

CLASS 3—(Continued).

SN 77-179,461. ZHIPI MCDUGALD, THOUSAND OAKS, CA. FILED 5-12-2007.



THE MARK CONSISTS OF WORDS AND FLOWERS IN BETWEEN THE WORDS

FOR COSMETIC PREPARATIONS FOR EYE LASHES; EYE CREAM; EYE GELS; EYE LOTIONS; EYE MAKE-UP; EYE MAKE-UP REMOVER; UNDER-EYE ENHANCERS; AFTER SUN CREAMS; AFTER-SUN LOTIONS; COSMETIC SUN-TANNING PREPARATIONS; SELF-TANNING PREPARATIONS; SUN TAN GEL; SUN TAN LOTION; LIP GLOSS; LIP POLISHER; ANTI-WRINKLE CREAMS; WRINKLE REMOVING SKIN CARE PREPARATIONS; TOOTH WHITENING CREAMS; TOOTH WHITENING GELS; ANTI-AGING CREAM; ANTI-FRECKLE CREAMS; BEAUTY CREAMS; BEAUTY CREAMS FOR BODY CARE; BODY AND BEAUTY CARE COSMETICS; BODY GLITTER; BODY LOTIONS; BODY MASK CREAM; BODY MASK LOTION; BODY MILK; BODY OILS; BODY SCRUB; BODY SPRAYS; BODY WASHES; COSMETIC CREAMS; COSMETIC CREAMS FOR SKIN CARE; COSMETIC PREPARATIONS FOR BODY CARE; CREAMS FOR CELLULITE REDUCTION; CUTICLE CREAM; FACE CREAMS; FACE CREAMS FOR COSMETIC USE; MAKE-UP FOR THE FACE AND BODY; SKIN BRONZING CREAMS; SKIN CLEANSING CREAM; TANNING CREAMS; TONING LOTION, FOR THE FACE, BODY AND HANDS (U.S. CLS. 1, 4, 6, 50, 51 AND 52).

KATHLEEN M. VANSTON, EXAMINING ATTORNEY

SN 77-181,675. HILLYARD ENTERPRISES, INC., ST. JOSEPH, MO. FILED 5-15-2007.

ULTRATHANE

THE MARK CONSISTS OF STANDARD CHARACTERS WITHOUT CLAIM TO ANY PARTICULAR FONT, STYLE, SIZE, OR COLOR.

OWNER OF U.S. REG. NOS. 848,082 AND 1,507,715.
FOR URETHANE FLOOR FINISH (U.S. CLS. 1, 4, 6, 50, 51 AND 52).
FIRST USE 4-23-1964; IN COMMERCE 4-23-1964.
TOBY BULLOFF, EXAMINING ATTORNEY

CLASS 3—(Continued).

SN 77-189,173. LOUISE HOLYFIELD, DALLAS, TX. FILED 5-24-2007.

PRES

THE MARK CONSISTS OF STANDARD CHARACTERS WITHOUT CLAIM TO ANY PARTICULAR FONT, STYLE, SIZE, OR COLOR.

FOR NON-MEDICATED SKIN CARE PREPARATIONS; HAIR CARE PREPARATIONS; BODY CARE PRODUCTS, NAMELY, BODY SOAPS, BODY CREAMS, BODY LOTIONS, BODY POWDERS, NON-MEDICATED DEODORANTS AND ANTI-PERSPIRANTS; NON-MEDICATED SUNCARE PRODUCTS, NAMELY, SUNSCREEN, SUN BLOCK AND SUN TANNING PREPARATIONS; PREPARATIONS TO PROTECT THE SKIN FROM THE SUN, NAMELY, NON-MEDICATED SUN CREAMS AND NON-MEDICATED AFTER-SUN LOTIONS; BATH PRODUCTS, NAMELY, BATH BEADS, BATH FOAM, BATH GELS, BATH LOTION, BATH OIL, BATH POWDER, AND NON-MEDICATED BATH SALTS; PERFUME, COLOGNE, COSMETICS AND MAKEUP (U.S. CLS. 1, 4, 6, 50, 51 AND 52).

GINA FINK, EXAMINING ATTORNEY

SN 77-199,338. AVEDA CORPORATION, MINNEAPOLIS, MN. FILED 6-6-2007.

SCALP REMEDY

THE MARK CONSISTS OF STANDARD CHARACTERS WITHOUT CLAIM TO ANY PARTICULAR FONT, STYLE, SIZE, OR COLOR.

OWNER OF U.S. REG. NO. 3,273,469.
NO CLAIM IS MADE TO THE EXCLUSIVE RIGHT TO USE "SCALP", APART FROM THE MARK AS SHOWN.
FOR HAIR CARE PREPARATIONS (U.S. CLS. 1, 4, 6, 50, 51 AND 52).

FIRST USE 12-31-1997; IN COMMERCE 12-31-1997.
KEVIN DINALLO, EXAMINING ATTORNEY

SN 77-227,386. KOSE CORPORATION, CHUO-KU, JAPAN, FILED 7-11-2007.

STAR ILLUSION

THE MARK CONSISTS OF STANDARD CHARACTERS WITHOUT CLAIM TO ANY PARTICULAR FONT, STYLE, SIZE, OR COLOR.

FOR COSMETICS, COSMETIC SOAPS, COTTON FOR COSMETIC USE AND HAIR CARE PREPARATIONS (U.S. CLS. 1, 4, 6, 50, 51 AND 52).

REBECCA GILBERT, EXAMINING ATTORNEY

CLASS 3—(Continued).

SN 78-393,783. L'OREAL USA CREATIVE, INC., NEW YORK, NY. FILED 3-31-2004.

GET SMOOTH

THE MARK CONSISTS OF STANDARD CHARACTERS WITHOUT CLAIM TO ANY PARTICULAR FONT, STYLE, SIZE, OR COLOR.
FOR HAIR CARE PREPARATIONS (U.S. CLS. 1, 4, 6, 50, 51 AND 52).
ZACHARY BELLO, EXAMINING ATTORNEY

SN 78-485,151. DERMAZONE SOLUTIONS, INC., ST. PETERSBURG, FL. FILED 9-17-2004.

SPOIL ME

THE MARK CONSISTS OF STANDARD CHARACTERS WITHOUT CLAIM TO ANY PARTICULAR FONT, STYLE, SIZE, OR COLOR.
FOR NON-MEDICATED SKIN CARE PREPARATIONS, NAMELY, MOISTURIZERS, CREAMS, AND LOTIONS; NON-MEDICAL MOISTURIZERS, CREAMS AND LOTIONS IN THE NATURE OF COSMETICS; TOPICAL PREPARATIONS, NAMELY, BODY AND SKIN MOISTURIZERS (U.S. CLS. 1, 4, 6, 50, 51 AND 52).
FIRST USE 5-1-2003; IN COMMERCE 5-1-2003.
MICHAEL KAZAZIAN, EXAMINING ATTORNEY

SN 78-620,257. VITAMIN SHOPPE INDUSTRIES INC., NORTH BERGEN, NJ. FILED 4-29-2005.

KYLA

THE MARK CONSISTS OF STANDARD CHARACTERS WITHOUT CLAIM TO ANY PARTICULAR FONT, STYLE, SIZE, OR COLOR.
FOR HAIR CARE PRODUCTS, NAMELY, SHAMPOO, HAIR CONDITIONER, HAIR GEL, HAIR MOUSSE, HAIR STYLING PREPARATIONS AND HAIR SPRAY; PERSONAL CARE PRODUCTS, NAMELY, NON-MEDICATED HAND, FACE AND BODY LOTIONS, CREAMS AND GELS; TOOTHPASTE, DENTIFRICES, MOUTHWASH, DEODORANT, ANTIPERSPIRANTS, SOAPS FOR PERSONAL USE, SHAVING CREAM, AFTER SHAVE LOTION AND GEL (U.S. CLS. 1, 4, 6, 50, 51 AND 52).
SEAN CROWLEY, EXAMINING ATTORNEY

CLASS 3—(Continued).

SN 78-661,139. CAF, LLC, MAPLE VALLEY, WA. FILED 6-29-2005.



THE COLOR GRAY IS INTENDED TO INDICATE SHADING OR CONTRAST ONLY
FOR CLEANING AND DEGREASING PREPARATION FOR USE ON DRIVE THRU AND CAR WASH EQUIPMENT, AUTOMOTIVE PARTS, GAS STATION PUMP DISPENSERS, RESTAURANT EQUIPMENT, AND FOR HOUSEHOLD AND JANITORIAL USE (U.S. CLS. 1, 4, 6, 50, 51 AND 52).
FIRST USE 3-16-2005; IN COMMERCE 5-26-2005.
JOHN SCHUYLER YARD, EXAMINING ATTORNEY

SN 78-668,156. COSMÉTIQUES FRANCE-LAURE (1970) INC., MONTREAL, CANADA, FILED 7-12-2005.

DERMOLYSE

THE MARK CONSISTS OF STANDARD CHARACTERS WITHOUT CLAIM TO ANY PARTICULAR FONT, STYLE, SIZE, OR COLOR.
PRIORITY CLAIMED UNDER SEC. 44(D) ON CANADA APPLICATION NO. 1261172, FILED 6-14-2005, REG. NO. 672704, DATED 9-14-2006, EXPIRES 9-14-2021.
FOR SKIN CARE COSMETICS, NAMELY, FACE LOTIONS, FACIAL CREAMS, HAND CREAM, HAND LOTION, BODY CREAM, BODY LOTION AND BODY POWDER (U.S. CLS. 1, 4, 6, 50, 51 AND 52).
BERYL GARDNER, EXAMINING ATTORNEY

SN 78-699,667. COT'N WASH, INC., ARDMORE, PA. FILED 8-24-2005.



NO CLAIM IS MADE TO THE EXCLUSIVE RIGHT TO USE WASH, APART FROM THE MARK AS SHOWN.
FOR LAUNDRY DETERGENT (U.S. CLS. 1, 4, 6, 50, 51 AND 52).
FIRST USE 9-2-1982; IN COMMERCE 9-2-1982.
WARREN L. OLANDRIA, EXAMINING ATTORNEY

CLASS 3—(Continued).

SN 78-756,991. JAVIER CASAS CASTILLO, SAN PEDRO GARZA GARCÍA, MEXICO, FILED 11-18-2005.

JAYT

THE MARK CONSISTS OF STANDARD CHARACTERS WITHOUT CLAIM TO ANY PARTICULAR FONT, STYLE, SIZE, OR COLOR.

FOR NON-MEDICATED HAIR AND BODY CARE PREPARATIONS, NAMELY SOAPS, HAIR LOTIONS, CONDITIONERS, SHAMPOOS (U.S. CLS. 1, 4, 6, 50, 51 AND 52).

FIRST USE 1-27-1977; IN COMMERCE 1-27-1977.
RICHARD WHITE, EXAMINING ATTORNEY

CLASS 3—(Continued).

SN 78-882,225. MAGCHEM INC., BOUCHERVILLE, CANADA, FILED 5-12-2006.

SOCOSTRIP

THE MARK CONSISTS OF STANDARD CHARACTERS WITHOUT CLAIM TO ANY PARTICULAR FONT, STYLE, SIZE, OR COLOR.

PRIORITY CLAIMED UNDER SEC. 44(D) ON CANADA APPLICATION NO. 1300722, FILED 5-8-2006, REG. NO. TMA687,171, DATED 5-8-2007, EXPIRES 5-8-2022.

FOR AIRCRAFT PAINT STRIPPERS (U.S. CLS. 1, 4, 6, 50, 51 AND 52).

HENRY S. ZAK, EXAMINING ATTORNEY

SN 78-896,379. JOHN M. VAN ZANDT, UPLAND, CA. FILED 5-30-2006.

NATURESENCE

THE MARK CONSISTS OF STANDARD CHARACTERS WITHOUT CLAIM TO ANY PARTICULAR FONT, STYLE, SIZE, OR COLOR.

FOR BODY CREAMS; BODY OILS; BODY POWDER; CLEANSING CREAMS; COSMETIC CREAMS FOR SKIN CARE; PERFUME; PERFUMED CREAMS; SKIN CLEANSING CREAM; SKIN CLEANSING LOTION; SKIN MOISTURIZER (U.S. CLS. 1, 4, 6, 50, 51 AND 52).

DAWN HAN, EXAMINING ATTORNEY

SN 78-775,863. VINCENZO TORRE, RONCHI, ITALY, FILED 12-19-2005.

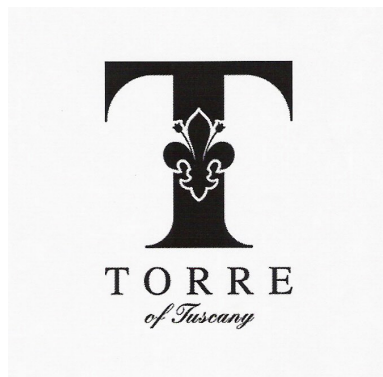

NO CLAIM IS MADE TO THE EXCLUSIVE RIGHT TO USE "OF TUSCANY", APART FROM THE MARK AS SHOWN.

THE FOREIGN WORDING IN THE MARK TRANSLATES INTO ENGLISH AS TOWER.

FOR SKIN SOAPS; PERFUMERY; ESSENTIAL OILS; COSMETICS, NAMELY, LIPSTICKS, LIP GLOSSES, MAKEUP POWDER, SKIN CREAMS, SKIN LOTIONS, BLUSHERS, MASCARA, EYELINER, EYE SHADOW, EYE PENCILS, SKIN MOISTURIZING CREAMS, NON-MEDICATED SKIN CLEANSING PREPARATIONS, NAIL POLISH, NAIL VARNISH, BATH SALTS, DEODORANTS FOR PERSONAL USE AND ANTIPERSPIRANTS, HAIR LOTIONS; DENTRIFICES (U.S. CLS. 1, 4, 6, 50, 51 AND 52).

MARY BOAGNI, EXAMINING ATTORNEY

SN 78-907,615. VICTORIA'S SECRET STORES BRAND MANAGEMENT, INC., REYNOLDSBURG, OH. FILED 6-14-2006.

COVER STORY

THE MARK CONSISTS OF STANDARD CHARACTERS WITHOUT CLAIM TO ANY PARTICULAR FONT, STYLE, SIZE, OR COLOR.

FOR PERSONAL CARE PRODUCTS, NAMELY, AFTERSHAVE, ANTIPERSPIRANT, ARTIFICIAL NAILS, BATH BEADS, BATH OIL, BATH SALTS, BLUSH, BODY GLITTER, BODY OIL, BODY SCRUB, BUBBLE BATH, COLOGNE, CREAM FOR THE BODY, CREAM FOR THE CUTICLES, CREAM FOR THE EYES, CREAM FOR THE FACE, CREAM FOR THE HANDS, ESSENTIAL OILS, EXFOLIATORS FOR THE SKIN, EYE GELS, EYE MAKEUP PENCILS, EYE SHADOW, FACE HIGHLIGHTER, FACIAL MASKS, FACE MIST, FACE SCRUB, FOUNDATION, FRAGRANT BODY SPLASH, FRAGRANT BODY MIST, HAIR CONDITIONER, HAIR DYES, HAIR GLITTER, HAIR HIGHLIGHTER, HAIR MASCARA, HAIR POMADE, HAIR RINSES, HAIR REMOVING CREAMS, HAIR SHAMPOO, HAIR SPRAY, HAIR STRAIGHTENER, HAIR STYLING GEL, HAIR STYLING MOUSSE, LOTION FOR THE BODY, LOTION FOR THE HANDS,

CLASS 3—(Continued).

LOTION FOR THE FACE, LIP BALM, LIP GLOSS, LIP LINER, LIP MAKEUP PENCILS, LIPSTICK, MAKEUP FOR THE BODY, MAKEUP FOR THE FACE, MAKEUP REMOVER, MASCARA, NAIL POLISH, NAIL POLISH REMOVER, NAIL STENCILS, NON-MEDICATED BLEMISH STICK, NON-MEDICATED CLEANSER FOR THE FACE, NON-MEDICATED FOOT SPRAY, NON-MEDICATED MASSAGE OINTMENT, OIL BLOTting SHEETS FOR THE SKIN, PERFUME, POWDER FOR THE BODY, POWDER FOR THE FACE, PUMICE STONES FOR PERSONAL USE, SALT SCRUBS FOR THE SKIN, SHAVING CREAM, SHOWER GEL, SKIN BRONZING CREAM, SOAP FOR THE BODY, SOAP FOR THE FACE, SOAP FOR THE HANDS, SUN BLOCK FOR THE BODY, SUN BLOCK FOR THE FACE, SUNTAN LOTION FOR THE BODY, SUNTAN LOTION FOR THE FACE, SUNLESS TANNING LOTION FOR THE BODY, SUNLESS TANNING LOTION FOR THE FACE, PRE-SUNTANNING LOTION FOR THE BODY, PRE-SUNTANNING LOTION FOR THE FACE, POST-SUNTANNING LOTION FOR THE BODY, POST-SUNTANNING LOTION FOR THE FACE, AND TALCUM POWDER (U.S. CLS. 1, 4, 6, 50, 51 AND 52).

KAPIL BHANOT, EXAMINING ATTORNEY

SN 78-907,618. VICTORIA'S SECRET STORES BRAND MANAGEMENT, INC., REYNOLDSBURG, OH. FILED 6-14-2006.

NIGHT AFTER NIGHT

THE MARK CONSISTS OF STANDARD CHARACTERS WITHOUT CLAIM TO ANY PARTICULAR FONT, STYLE, SIZE, OR COLOR.

FOR PERSONAL CARE PRODUCTS, NAMELY, AFTERSHAVE, ANTIPERSPIRANT, ARTIFICIAL NAILS, BATH BEADS, BATH OIL, BATH SALTS, BLUSH, BODY GLITTER, BODY OIL, BODY SCRUB, BUBBLE BATH, COLOGNE, CREAM FOR THE BODY, CREAM FOR THE CUTICLES, CREAM FOR THE EYES, CREAM FOR THE FACE, CREAM FOR THE HANDS, ESSENTIAL OILS, EXFOLIATORS FOR THE SKIN, EYE GELS, EYE MAKEUP PENCILS, EYE SHADOW, FACE HIGHLIGHTER, FACIAL MASKS, FACE MIST, FACE SCRUB, FOUNDATION, FRAGRANT BODY SPLASH, FRAGRANT BODY MIST, HAIR CONDITIONER, HAIR DYES, HAIR GLITTER, HAIR HIGHLIGHTER, HAIR MASCARA, HAIR POMADE, HAIR RINSES, HAIR REMOVING CREAMS, HAIR SHAMPOO, HAIR SPRAY, HAIR STRAIGHTENER, HAIR STYLING GEL, HAIR STYLING MOUSSE, LOTION FOR THE BODY, LOTION FOR THE HANDS, LOTION FOR THE FACE, LIP BALM, LIP GLOSS, LIP LINER, LIP MAKEUP PENCILS, LIPSTICK, MAKEUP FOR THE BODY, MAKEUP FOR THE FACE, MAKEUP REMOVER, MASCARA, NAIL POLISH, NAIL POLISH REMOVER, NAIL STENCILS, NON-MEDICATED BLEMISH STICK, NON-MEDICATED CLEANSER FOR THE FACE, NON-MEDICATED FOOT SPRAY, NON-MEDICATED MASSAGE OINTMENT, OIL BLOTting SHEETS FOR THE SKIN, PERFUME, POWDER FOR THE BODY, POWDER FOR THE FACE, PUMICE STONES FOR PERSONAL USE, SALT SCRUBS FOR THE SKIN, SHAVING CREAM, SHOWER GEL, SKIN BRONZING CREAM, SOAP FOR THE BODY, SOAP FOR THE FACE, SOAP FOR THE HANDS, SUN BLOCK FOR THE BODY, SUN BLOCK FOR THE FACE, SUNTAN LOTION FOR THE BODY, SUNTAN LOTION FOR THE FACE, SUNLESS TANNING LOTION FOR THE BODY, SUNLESS TANNING LOTION FOR THE FACE, PRE-SUNTANNING LOTION FOR THE BODY, PRE-SUNTANNING LOTION FOR THE FACE, POST-SUNTANNING LOTION FOR THE BODY, POST-SUNTANNING LOTION FOR THE FACE, AND TALCUM POWDER (U.S. CLS. 1, 4, 6, 50, 51 AND 52).

KAPIL BHANOT, EXAMINING ATTORNEY

CLASS 3—(Continued).

SN 78-908,288. LANCOME PARFUMS ET BEAUTE & CIE, PARIS, FRANCE, FILED 6-14-2006.

POP CHERUB

THE MARK CONSISTS OF STANDARD CHARACTERS WITHOUT CLAIM TO ANY PARTICULAR FONT, STYLE, SIZE, OR COLOR.

PRIORITY CLAIMED UNDER SEC. 44(D) ON ERPNCMNTY TM OFC APPLICATION NO. 5129366, FILED 6-12-2006, REG. NO. 5129366, DATED 5-31-2007, EXPIRES 6-12-2016.

FOR COSMETICS, NAMELY, CREAMS, GELS, MILKS, POWDERS AND LOTIONS FOR THE FACE, BODY AND HANDS; MAKEUP PRODUCTS, NAMELY, MASCARA, EYE LINER, EYE SHADOW, EYEBROW PENCIL, LIPSTICKS, NAIL POLISH, BLUSH, FOUNDATION CREAMS AND POWDER, BODY DEODORANTS (U.S. CLS. 1, 4, 6, 50, 51 AND 52).

MATTHEW MCDOWELL, EXAMINING ATTORNEY

SN 78-918,527. COLGATE-PALMOLIVE COMPANY, HOBOKEN, NJ. FILED 6-28-2006.

OWNER OF U.S. REG. NOS. 2,276,146 AND 2,415,599, FOR FABRIC SOFTENERS (U.S. CLS. 1, 4, 6, 50, 51 AND 52).

WILLIAM VERHOSEK, EXAMINING ATTORNEY

CLASS 3—(Continued).

SN 78-923,000. NEAT FEAT PRODUCTS LIMITED, AUCKLAND, NEW ZEALAND, FILED 7-5-2006.

NEAT
3B
Action
Cream

OWNER OF NEW ZEALAND REG. NO. 644558, DATED 2-28-2002, EXPIRES 8-28-2008.

NO CLAIM IS MADE TO THE EXCLUSIVE RIGHT TO USE "CREAM", APART FROM THE MARK AS SHOWN.

THE MARK COMPRISES THE WORD "NEAT" BETWEEN TWO LINES, ABOVE "3B", WHICH IS IN TURN ABOVE "ACTION", WHICH IS IN TURN ABOVE "CREAM."

FOR PERSONAL DEODORANTS; ANTIPERSPIRANTS; PERFUMERY PREPARATIONS AND PERFUMES; NON-MEDICATED TOILETRIES AND NON-MEDICATED TOILET PREPARATIONS, NAMELY RASH AND CHAFING CREAM AND RASH AND CHAFING POWDER; SKIN CREAMS (U.S. CLS. 1, 4, 6, 50, 51 AND 52).

DAVID TAYLOR, EXAMINING ATTORNEY

SN 78-923,703. VICTORIA'S SECRET STORES BRAND MANAGEMENT, INC., REYNOLDSBURG, OH. FILED 7-6-2006.

PAINTED LOVE

THE MARK CONSISTS OF STANDARD CHARACTERS WITHOUT CLAIM TO ANY PARTICULAR FONT, STYLE, SIZE, OR COLOR.

FOR PERSONAL CARE PRODUCTS NAMELY SMOOTHING BODY SCRUB, WHIPPED BODY CREAM, BODY BUTTER, INTENSIVE BODY LOTIONS, HAND CREAM, COSMETIC ASTRINGENT FOR THE FACE, COSMETIC ASTRINGENT FOR THE SKIN, BATH BEADS, BATH OIL, BATH SALTS, BLUSH, BODY GLITTER, BODY MIST, BODY OIL, BODY SCRUB, BODY WASH, BUBBLE BATH, COLOGNE, CREAM FOR THE BODY, CREAM FOR THE CUTICLES, CREAM FOR THE EYES, CREAM FOR THE FACE, CREAM FOR THE FEET, CREAM FOR THE HANDS, ESSENTIAL OILS FOR PERSONAL USE, EXFOLIATING PREPARATIONS FOR THE SKIN, EYE GELS, EYE MAKEUP PENCILS, EYE MASKS, EYE SHADOW, FACE HIGHLIGHTER, FACE MASKS, FACE MIST, FACE SCRUB, NON-MEDICATED FOOT SOAKS, FACE TONERS, FOUNDATION, FRAGRANT BODY SPLASH, FRAGRANT BODY MIST, HAIR CONDITIONER, HAIR DYES, HAIR HIGHLIGHTER, HAIR RINSES, HAIR SHAMPOO, HAIR SPRAY, HAIR STRAIGHTENER, HAIR STYLING GEL, HAIR STYLING MOUSSE, LOTION FOR THE BODY, LOTION FOR THE FACE, LOTION FOR THE FEET, LOTION FOR THE HANDS, LIP BALM, LIP GLOSS, LIP LINER, LIP MAKEUP PENCILS, LIPSTICK, MAKEUP FOR THE BODY, MAKEUP FOR THE FACE, MAKEUP REMOVER, MASCARA, MASSAGE CREAM, MASSAGE LOTION, MASSAGE OIL, NAIL POLISH, NAIL POLISH REMOVER, NAIL STEN-

CLASS 3—(Continued).

CILS, NON-MEDICATED BLEMISH STICK, NON-MEDICATED CLEANSER FOR THE FACE, NON-MEDICATED FOOT SPRAY, NON-MEDICATED MASSAGE OINTMENT, OIL BLOTTING SHEETS FOR THE SKIN, PERFUME, POWDER FOR THE BODY, POWDER FOR THE FACE, PUMICE STONES FOR PERSONAL USE, SALT SCRUBS FOR THE SKIN, SHAVING CREAM, SHAVING GELS, SHOWER CREAM, SHOWER GEL, SKIN BRONZING CREAM, SOAP FOR THE BODY, SOAP FOR THE FACE, SOAP FOR THE HANDS, SUN BLOCK FOR THE BODY, SUN BLOCK FOR THE FACE, SUNTAN LOTION FOR THE BODY, SUNTAN LOTION FOR THE FACE, SUNLESS TANNING LOTION FOR THE BODY, SUNLESS TANNING LOTION FOR THE FACE, PRE-SUNTANNING LOTION FOR THE BODY, PRE-SUNTANNING LOTION FOR THE FACE, POST-SUNTANNING LOTION FOR THE BODY, POST-SUNTANNING LOTION FOR THE FACE, TOILET SOAPS, HAIR SHAMPOOS, SCENTED DRAWER SACHETS; PERSONAL FRAGRANCES, NAMELY COLOGNE, PERFUME, TOILET WATER, AND ESSENTIAL OILS FOR PERSONAL USE; BATH POWDER; NON-MEDICATED FOOT POWDER; BODY POWDER; BATH, HAND AND BODY LOTIONS (U.S. CLS. 1, 4, 6, 50, 51 AND 52).

KAPIL BHANOT, EXAMINING ATTORNEY

SN 78-926,481. LANCOME PARFUMS ET BEAUTE & CIE, PARIS, FRANCE, FILED 7-11-2006.

SOURCILS DESIGN

THE MARK CONSISTS OF STANDARD CHARACTERS WITHOUT CLAIM TO ANY PARTICULAR FONT, STYLE, SIZE, OR COLOR.

PRIORITY CLAIMED UNDER SEC. 44(D) ON FRANCE APPLICATION NO. 063405108, FILED 1-23-2006, REG. NO. 063405108, DATED 1-23-2006, EXPIRES 1-23-2016.

OWNER OF U.S. REG. NO. 1,910,992.

NO CLAIM IS MADE TO THE EXCLUSIVE RIGHT TO USE "SOURCILS", APART FROM THE MARK AS SHOWN. THE FOREIGN WORDING IN THE MARK TRANSLATES INTO ENGLISH AS EYEBROWS.

FOR EYEBROW PENCILS (U.S. CLS. 1, 4, 6, 50, 51 AND 52).

MATTHEW MCDOWELL, EXAMINING ATTORNEY

CLASS 3—(Continued).

SN 78-926,491. KIMPEN, S.A. DE C.V., MERIDA, MEXICO, FILED 7-11-2006.

MASTER BRITE

THE MARK CONSISTS OF STANDARD CHARACTERS WITHOUT CLAIM TO ANY PARTICULAR FONT, STYLE, SIZE, OR COLOR.
OWNER OF MEXICO REG. NO. 853,447, DATED 9-27-2004, EXPIRES 8-31-2014.
FOR BLEACHING PREPARATIONS AND OTHER SUBSTANCES, NAMELY, GENERAL PURPOSE CLEANING, POLISHING AND ABRASIVE LIQUIDS AND POWDERS FOR HOUSEHOLD LAUNDRY USE; ALL PURPOSE CLEANING PREPARATIONS, POLISHING PREPARATIONS, SCOURING POWDERS AND LIQUIDS AND ABRASIVE PREPARATIONS FOR HOUSEHOLD PURPOSES (U.S. CLS. 1, 4, 6, 50, 51 AND 52).
TRACY CROSS, EXAMINING ATTORNEY

SN 78-936,321. WESTERN HOLDINGS, LLC, CHEYENNE, WY. FILED 7-24-2006.

STEM CELL MARKER SKIN REPAIR

THE MARK CONSISTS OF STANDARD CHARACTERS WITHOUT CLAIM TO ANY PARTICULAR FONT, STYLE, SIZE, OR COLOR.
NO CLAIM IS MADE TO THE EXCLUSIVE RIGHT TO USE STEM CELL AND SKIN REPAIR, APART FROM THE MARK AS SHOWN.
FOR COSMETICS (U.S. CLS. 1, 4, 6, 50, 51 AND 52).
PATRICIA EVANKO, EXAMINING ATTORNEY

CLASS 3—(Continued).

SN 78-937,709. CARGO COSMETICS CORP., TORONTO, CANADA, FILED 7-26-2006.

PLANT LOVE

THE MARK CONSISTS OF STANDARD CHARACTERS WITHOUT CLAIM TO ANY PARTICULAR FONT, STYLE, SIZE, OR COLOR.
NO CLAIM IS MADE TO THE EXCLUSIVE RIGHT TO USE "PLANT", APART FROM THE MARK AS SHOWN.
FOR HAIR CARE, BATH AND COSMETIC PRODUCTS, NAMELY, EYE SHADOW, EYE LINER, MASCARA, BLUSH, LIP LINER, BROW PENCILS, LIPSTICK, LIPSTICK SOLD IN BIODEGRADABLE CASES, BIODEGRADABLE LIPSTICK CASES, LIP GLOSS, LIP BALMS, COSMETIC COMPACTS INCLUDING PALETTES OF FACIAL AND/OR LIP COLORS SOLD AS A UNIT WITH OR WITHOUT AN APPLICATORS, UNDER-EYE CONCEALERS, FOUNDATIONS, FOUNDATIONS WITH SUNSCREEN, FACE POWDERS, FACIAL AND BODY SOAPS, BATH OIL, SKIN MOISTURIZER, FRAGRANCES AND PERFUMES FOR PERSONAL USE, DEODORANTS FOR PERSONAL USE, TALCUM POWDER, HAIR SHAMPOO, HAIR CONDITIONER, HAIR STYLING GELS AND SPRAY, NAIL POLISH, SKIN CREAMS AND POWDERS FOR USE AS A BRONZER, SUN TAN LOTION, SUN SCREENS, FACIAL CLEANSER AND FACIAL TONER (U.S. CLS. 1, 4, 6, 50, 51 AND 52).
BARBARA A. GOLD, EXAMINING ATTORNEY

SN 78-938,885. MISS BEVERLY HILLS INC., LOS ANGELES, CA. FILED 7-27-2006.

MISS BEVERLY HILLS

THE MARK CONSISTS OF STANDARD CHARACTERS WITHOUT CLAIM TO ANY PARTICULAR FONT, STYLE, SIZE, OR COLOR.
NO CLAIM IS MADE TO THE EXCLUSIVE RIGHT TO USE "MISS BEVERLY HILLS", APART FROM THE MARK AS SHOWN.
FOR BODY AND BEAUTY CARE COSMETICS; LIQUID PERFUMES; NON-MEDICATED TOILETRIES (U.S. CLS. 1, 4, 6, 50, 51 AND 52).
KEVON CHISOLM, EXAMINING ATTORNEY

CLASS 3—(Continued).

SN 78-939,464. MASCOLO, KYARA, CARROLLTON, TX.
FILED 7-27-2006.

I LOVE PET HEAD

THE MARK CONSISTS OF STANDARD CHARACTERS WITHOUT CLAIM TO ANY PARTICULAR FONT, STYLE, SIZE, OR COLOR.

FOR NON-MEDICATED GROOMING PREPARATIONS FOR CATS, DOGS, AND HOUSEHOLD PETS, NAMELY SHAMPOOS, CONDITIONERS, BREATH FRESHENERS, DENTIFRICES AND PERFUMES (U.S. CLS. 1, 4, 6, 50, 51 AND 52).

YONG KIM, EXAMINING ATTORNEY

SN 78-939,553. MASCOLO, KYARA, CARROLLTON, TX.
FILED 7-27-2006.



THE MARK CONSISTS OF THE WORD I AND THEN A HEART SYMBOL AND THEN THE WORDS BED HEAD.

FOR NON-MEDICATED GROOMING PREPARATIONS FOR CATS, DOGS, AND HOUSEHOLD PETS, NAMELY, SHAMPOOS, CONDITIONERS, BREATH FRESHENERS, DENTIFRICES AND PERFUMES (U.S. CLS. 1, 4, 6, 50, 51 AND 52).

TONI HICKEY, EXAMINING ATTORNEY

SN 78-946,631. CHRIS CHON, BETHESDA, MD. FILED 8-7-2006.

FRESHMINERALS

THE MARK CONSISTS OF STANDARD CHARACTERS WITHOUT CLAIM TO ANY PARTICULAR FONT, STYLE, SIZE, OR COLOR.

FOR BATH GELS; BLUSH; BLUSH PENCILS; EYE CREAM; EYE PENCILS; EYESHADOWS; FACIAL CLEANSERS; FOUNDATIONS; LIP GLOSS; LIPSTICK; MASCARA; NAIL POLISH; SHOWER GELS; SKIN CREAM (U.S. CLS. 1, 4, 6, 50, 51 AND 52).

FIRST USE 7-15-2006; IN COMMERCE 7-15-2006.

PAULA MAHONEY, EXAMINING ATTORNEY

CLASS 3—(Continued).

SN 78-946,684. DOUGLAS J. KEY, M.D., P.C., DBA KEY LASER INSTITUTE FOR AESTHETIC MEDICINE, PORTLAND, OR. FILED 8-7-2006.

EFFLEURER

THE MARK CONSISTS OF STANDARD CHARACTERS WITHOUT CLAIM TO ANY PARTICULAR FONT, STYLE, SIZE, OR COLOR.

THE ENGLISH TRANSLATION OF EFFLEURER IS "TO STROKE LIGHTLY."

FOR PERSONAL CARE PRODUCTS FOR THE SKIN, NAMELY, LOTIONS AND CREAMS (U.S. CLS. 1, 4, 6, 50, 51 AND 52).

PAUL E. FAHRENKOPF, EXAMINING ATTORNEY

SN 78-951,083. MANA PRODUCTS, INC., LONG ISLAND CITY, NY. FILED 8-13-2006.

Peptox

THE MARK CONSISTS OF STANDARD CHARACTERS WITHOUT CLAIM TO ANY PARTICULAR FONT, STYLE, SIZE, OR COLOR.

FOR COSMETICS AND NON-MEDICATED SKINCARE PREPARATIONS (U.S. CLS. 1, 4, 6, 50, 51 AND 52).

JENNIFER MARTIN, EXAMINING ATTORNEY

SN 78-952,725. FNC MEDICAL CORPORATION, VENTURA, CA. FILED 8-15-2006.

QT

THE MARK CONSISTS OF STANDARD CHARACTERS WITHOUT CLAIM TO ANY PARTICULAR FONT, STYLE, SIZE, OR COLOR.

FOR SHAMPOO AND FOAMING SOLUTION FOR CLEANING AND CONDITIONING THE COAT, MANE AND TAIL OF ANIMALS (U.S. CLS. 1, 4, 6, 50, 51 AND 52).

HENRY S. ZAK, EXAMINING ATTORNEY

CLASS 3—(Continued).

SN 78-952,749. FNC MEDICAL CORPORATION, VENTURA, CA. FILED 8-15-2006.

CLASS 3—(Continued).

SN 78-961,425. VICTORIA'S SECRET STORES BRAND MANAGEMENT, INC., REYNOLDSBURG, OH. FILED 8-28-2006.

KNOW KNOT

THE MARK CONSISTS OF STANDARD CHARACTERS WITHOUT CLAIM TO ANY PARTICULAR FONT, STYLE, SIZE, OR COLOR.

FOR NON-MEDICATED MANE, COAT AND TAIL CONDITIONER FOR ANIMALS (U.S. CLS. 1, 4, 6, 50, 51 AND 52).

HENRY S. ZAK, EXAMINING ATTORNEY

GOING PLATINUM

THE MARK CONSISTS OF STANDARD CHARACTERS WITHOUT CLAIM TO ANY PARTICULAR FONT, STYLE, SIZE, OR COLOR.

NO CLAIM IS MADE TO THE EXCLUSIVE RIGHT TO USE "PLATINUM", APART FROM THE MARK AS SHOWN.

FOR PERSONAL CARE PRODUCTS NAMELY BODY WASH, SMOOTHING BODY SCRUB, WHIPPED BODY CREAM, BODY BUTTER, BODY LOTIONS, HAND CREAM, ASTRINGENT FOR THE FACE, ASTRINGENT FOR THE SKIN, BATH BEADS, BATH OIL, BATH SALTS, BLUSH, BODY GLITTER, BODY MIST, BODY OIL, BODY SCRUB, BODY WASH, BUBBLE BATH, COLOGNE, CREAM FOR THE BODY, CREAM FOR THE CUTICLES, CREAM FOR THE EYES, CREAM FOR THE FACE, CREAM FOR THE FEET, CREAM FOR THE HANDS, ESSENTIAL OILS FOR PERSONAL USE, EXFOLIATING PREPARATIONS FOR THE SKIN, EYE GELS, EYE MAKEUP PENCILS, EYE MASKS, EYE SHADOW, FACE HIGHLIGHTER, FACE MASKS, FACE MIST, FACE SCRUB, NON-MEDICATED FOOT SOAKS, FACE TONERS, FOUNDATION, FRAGRANT BODY SPLASH, FRAGRANT BODY MIST, HAIR CONDITIONER, HAIR HIGHLIGHTER, HAIR RINSES, HAIR SHAMPOO, HAIR SPRAY, HAIR STRAIGHTENING PREPARATIONS, HAIR STYLING GEL, HAIR STYLING MOUSSE, LOTION FOR THE BODY, LOTION FOR THE FACE, LOTION FOR THE FEET, LOTION FOR THE HANDS, LIP BALM, LIP GLOSS, LIP LINER, LIP MAKEUP PENCILS, LIPSTICK, MAKEUP FOR THE BODY, MAKEUP FOR THE FACE, MAKEUP REMOVER, MASCARA, MASSAGE CREAM, MASSAGE LOTION, MASSAGE OIL, NAIL POLISH, NAIL POLISH REMOVER, NAIL STENCILS, NON-MEDICATED BLEMISH STICK, NON-MEDICATED CLEANSER FOR THE FACE, NON-MEDICATED FOOT SPRAY, NON-MEDICATED MASSAGE OINTMENT, OIL BLOTTING SHEETS FOR THE SKIN, PERFUME, POWDER FOR THE BODY, POWDER FOR THE FACE, POWDER FOR THE FEET, PUMICE STONES FOR PERSONAL USE, SALT SCRUBS FOR THE SKIN, SHAVING CREAM, SHAVING GELS, SHOWER CREAM, SHOWER GEL, SKIN BRONZING CREAM, SOAP FOR THE BODY, SOAP FOR THE FACE, SOAP FOR THE HANDS, SUN BLOCK FOR THE BODY, SUN BLOCK FOR THE FACE, SUNTAN LOTION FOR THE BODY, SUNTAN LOTION FOR THE FACE, SUNLESS TANNING LOTION FOR THE BODY, SUNLESS TANNING LOTION FOR THE FACE, PRE-SUNTANNING LOTION FOR THE BODY, PRE-SUNTANNING LOTION FOR THE FACE, POST-SUNTANNING LOTION FOR THE BODY, POST-SUNTANNING LOTION FOR THE FACE, TOILET SOAPS, HAIR SHAMPOOS, SCENTED DRAWER SACHETS; PERSONAL FRAGRANCES, NAMELY COLOGNE, PERFUME, TOILET WATER, AND ESSENTIAL OILS FOR PERSONAL USE; BATH POWDER, NON-MEDICATED FOOT POWDER, BODY POWDER; BATH, HAND AND BODY LOTIONS, HOME FRAGRANCES (U.S. CLS. 1, 4, 6, 50, 51 AND 52).

ALICIA COLLINS, EXAMINING ATTORNEY

SN 78-956,122. MANA PRODUCTS, INC., LONG ISLAND CITY, NY. FILED 8-20-2006.

Mega-Lift

THE MARK CONSISTS OF STANDARD CHARACTERS WITHOUT CLAIM TO ANY PARTICULAR FONT, STYLE, SIZE, OR COLOR.

FOR COSMETICS; NON-MEDICATED SKIN CARE PREPARATIONS (U.S. CLS. 1, 4, 6, 50, 51 AND 52).

JENNIFER MARTIN, EXAMINING ATTORNEY

SN 78-956,125. MANA PRODUCTS, INC., LONG ISLAND CITY, NY. FILED 8-20-2006.

Powder Prints

THE MARK CONSISTS OF STANDARD CHARACTERS WITHOUT CLAIM TO ANY PARTICULAR FONT, STYLE, SIZE, OR COLOR.

NO CLAIM IS MADE TO THE EXCLUSIVE RIGHT TO USE "POWDER", APART FROM THE MARK AS SHOWN.

FOR COSMETICS (U.S. CLS. 1, 4, 6, 50, 51 AND 52).

JOHN DALIER, EXAMINING ATTORNEY

CLASS 3—(Continued).

SN 78-964,997. MONDO-MER, INC., NEW YORK, NY. FILED 8-31-2006.



The logo for Rejuvenex Factor features the word "Rejuvenex" in a large, elegant, cursive script. Below it, the word "FACTOR" is written in a smaller, bold, sans-serif font. A thin, curved line underlines the word "Rejuvenex".

OWNER OF U.S. REG. NO. 1,975,771.
THE MARK CONSISTS OF THE WORDS "REJUVENEX FACTOR" IN STYLIZED LETTERS WITH A LEAF DESIGN BEHIND THE LETTER "R".
FOR SKIN CREAM (U.S. CLS. 1, 4, 6, 50, 51 AND 52).
MICHAEL KAZAZIAN, EXAMINING ATTORNEY

SN 78-965,250. L. C. LICENSING, INC., NEW YORK, NY. FILED 8-31-2006.

GRAPHITE BLUE BY REALITIES

THE MARK CONSISTS OF STANDARD CHARACTERS WITHOUT CLAIM TO ANY PARTICULAR FONT, STYLE, SIZE, OR COLOR.

OWNER OF U.S. REG. NO. 1,663,741.
FOR COSMETICS, NAMELY; NAIL POLISH AND LIPSTICK, PERFUMES, COLOGNES, TOILET SOAP, POTPOURRI, PERSONAL CLEANING AND BATH PRODUCTS, NAMELY, SOAPS, FACE AND BODY POWDERS; PERSONAL CARE PRODUCTS, NAMELY, SKIN MOISTURIZER, BATH OILS, SKIN CLEANSERS, SKIN SCRUBS, SHOWER GELS, BUBBLE BATH, AFTER SHAVE LOTION, PERSONAL DEODORANT; HAIR CARE PRODUCTS, NAMELY; SHAMPOO, CONDITIONER, STYLING COMPOUNDS; TANNING AND SUN PRODUCTS, NAMELY, SUN TAN GEL, SUN TAN LOTION, AND SUN TAN OIL (U.S. CLS. 1, 4, 6, 50, 51 AND 52).

G. MAYERSCHOFF, EXAMINING ATTORNEY

CLASS 3—(Continued).

SN 78-966,029. AMOREPACIFIC CORPORATION, SEOUL, REPUBLIC OF KOREA, FILED 9-1-2006.



The logo for IOPE RENEWING SKIN FILLER features the word "IOPE" in a large, bold, sans-serif font. Below it, the words "RENEWING SKIN FILLER" are written in a smaller, bold, sans-serif font.

PRIORITY CLAIMED UNDER SEC. 44(D) ON REPUBLIC OF KOREA APPLICATION NO. 40-2006-0040, FILED 8-9-2006, REG. NO. 40-0709451, DATED 5-11-2007, EXPIRES 5-11-2017.

OWNER OF U.S. REG. NO. 2,297,281.

NO CLAIM IS MADE TO THE EXCLUSIVE RIGHT TO USE SKIN FILLER, APART FROM THE MARK AS SHOWN.
FOR EYE SHADOW; SOLID MAKE-UP POWDER FOR COMPACTS; CREAMY FOUNDATION; ROUGE; LIPSTICKS; NON-MEDICATED NOURISHING CREAMS FOR THE SKIN; NAIL POLISH REMOVERS; EYEBROW PENCILS; MASCARAS; FACIAL PACK CONSISTING OF COSMETIC MATERIAL IMPREGNATED WITH COSMETICS AND APPLIED TO THE FACE FOR SOFTENING AND PURIFYING THE SKIN OF THE FACE; BODY GELS FOR MASSAGE USE; MASSAGE OIL; NAIL POLISH; NAIL ENAMELS; HAIR OILS; HAIR CARE PREPARATIONS; HAIR COLOR; HAIR WAVING LOTIONS; HAIR BLEACHES; ADDITIVES FOR COSMETIC BATHS, NAMELY, BUBBLE BATH AND BATH BEADS; VANISHING CREAMS; BATH OIL FOR COSMETIC PURPOSES; BATH POWDER FOR COSMETIC PURPOSES; BAY RUMS; BABY OIL; BABY POWDER; BLUSHERS; PERFUMED POWDER; NON-MEDICATED BATH SALTS; NON-MEDICATED FRAGRANCE, NAMELY, FRAGRANCES FOR PERSONAL USE AND ROOM FRAGRANCES; SUNSCREEN LOTIONS; SUNSCREEN CREAMS; SUN TAN OIL; SUN-TANNING PREPARATIONS FOR COSMETIC PURPOSES; SHAVING CREAMS; BEAUTY MILK; SKIN MOISTURIZER; EYELINERS; EYE MAKE-UP REMOVERS; AFTER SHAVE LOTIONS; EAU DE COLOGNE; DEODORANTS FOR PERSONAL USE; SKIN LOTIONS; LIP POLISHER; NON-MEDICATED LIP CARE PREPARATIONS; NON-MEDICATED COSMETIC PREPARATIONS FOR BODY SLIMMING PURPOSES, NAMELY, BODY SLIMMING CREAMS, BODY SLIMMING LOTIONS, BODY SLIMMING GELS AND BODY SLIMMING OILS; COLD CREAMS; COLD WAVING SOLUTIONS; MUSTACHE WAX; SKIN CLEANSING CREAM FOR COSMETIC PURPOSES; DEPILATORY WAX; DEPILATORIES; PERMANENT WAVE PREPARATIONS; FACE POWDER; POTPOURRI; SKIN WHITENING CREAMS; HAND CREAMS; PERFUMES; HAIR GELS; HAIR LACQUERS; HAIR LOTIONS; HAIR MOUSSE; HAIR SPRAY; HAIR CONDITIONERS; HAIR CREAMS; HAIR TONIC; MAKE-UP POWDER; ASTRINGENTS FOR COSMETIC PURPOSES; PENCILS FOR COSMETIC PURPOSES; MINERAL SALT IN THE NATURE OF BATH SALTS NOT FOR MEDICAL PURPOSES; SKIN CLEANSING MILK; TALCUM POWDERS; LAVENDER OIL FOR COSMETIC PURPOSES; VANILLA PERFUMERY; BERGAMOT OIL FOR COSMETIC PURPOSES; AMBERGRIS; JASMINE OIL FOR COSMETIC PURPOSES; ROSE OIL FOR COSMETIC PURPOSES; SYNTHETIC PERFUMERY; MINT PERFUMERY; MUSK PERFUMERY; INCENSE STICKS; FUMIGATING INCENSES; ADHESIVES FOR AFFIXING FALSE HAIR; FALSE EYELASHES; ADHESIVES FOR AFFIXING FALSE EYELASHES; FALSE NAILS; PRE-MOISTENED TISSUES IMPREGNATED WITH COSMETIC LOTIONS; COTTON STICKS FOR COSMETIC PURPOSES; BEAUTY MASKS; ADHESIVES FOR COSMETIC USE; COTTON SWABS FOR COSMETIC PURPOSES; SOAP POWDER; DETERGENTS PREPARED FROM PETROLEUM FOR HOUSEHOLD USE; INDUSTRIAL SOAPS; DRY CLEANING FLUIDS; SHAVING SOAP; LIQUID SOAPS; DEODORANT SOAP; CLEANING PREPARATIONS FOR CLEANING WASTE PIPES; SOAP FOR BRIGHTENING TEXTILE; SKIN POLISHING RICE BRAN; NON-MEDICATED DOUCHES; LAUNDRY SOAPS; DISINFECTANT SOAP; ALMOND SOAP; GLASS CLEANING PREPARATIONS; FABRIC SOFTENERS FOR LAUNDRY USE; WINDSHIELD WASHING FLUID;

CLASS 3—(Continued).

TOILET BOWL DETERGENTS; BATH SOAPS; SKIN SOAPS; HAIR SHAMPOOS; CREAM SOAPS; HAIR RINSES; COSMETIC SOAPS; NON-MEDICATED MOUTH WASH AND RINSE; NON-MEDICATED DENTAL RINSE; DENTURE CLEANING PREPARATIONS, NAMELY, DENTURE POLISH AND DENTURE CLEANER; TOOTH POWDERS; TOOTH PASTE; MOISTURIZING ESSENCE IN THE NATURE OF MILKY LOTION; BODY CREAMS; BODY LOTIONS; FACIAL CLEANSING FOAMS; SKIN CLEANSING LOTION; SKIN CLEANSING OILS; LIP GLOSS; NON-MEDICATED CREAMS FOR MASSAGE USE; LIP LINER; NON-MEDICATED LIP BALM; COLOGNE WATER; EAU DE TOILETTE; SKIN CLEANSERS; TOOTH WHITENING PREPARATIONS, NAMELY, TOOTH WHITENING CREAMS, TOOTH WHITENING GELS AND TOOTH WHITENING PASTES (U.S. CLS. 1, 4, 6, 50, 51 AND 52).

THOMAS MANOR, EXAMINING ATTORNEY

SN 78-968,839. MAGDALENE, INC., NASHVILLE, TN. FILED 9-7-2006.

THISTLE FARMS

THE MARK CONSISTS OF STANDARD CHARACTERS WITHOUT CLAIM TO ANY PARTICULAR FONT, STYLE, SIZE, OR COLOR.

FOR BATH AND BODY PRODUCTS, NAMELY, NON-PETROLEUM LIP BALM, BODY BALM, AND SALT SCRUB (U.S. CLS. 1, 4, 6, 50, 51 AND 52).

FIRST USE 2-14-2001; IN COMMERCE 2-14-2001.

JAMES A. RAUEN, EXAMINING ATTORNEY

SN 78-973,589. N.V. PERRICONE LLC, MERIDEN, CT. FILED 9-13-2006.

SYNERGY ANTI-AGING AROMATIC

THE MARK CONSISTS OF STANDARD CHARACTERS WITHOUT CLAIM TO ANY PARTICULAR FONT, STYLE, SIZE, OR COLOR.

NO CLAIM IS MADE TO THE EXCLUSIVE RIGHT TO USE "ANTI-AGING AROMATICS", APART FROM THE MARK AS SHOWN.

FOR BEAUTY SERUMS; COLOGNE; PERFUME; SKIN CLEANSERS; SKIN CONDITIONERS; SKIN LOTIONS; SKIN TONERS; TOILET WATER (U.S. CLS. 1, 4, 6, 50, 51 AND 52).

DAWN FELDMAN, EXAMINING ATTORNEY

CLASS 3—(Continued).

SN 78-974,250. JAFER LIMITED, HAMILTON, HM, BERMUDA, FILED 9-14-2006.

**PERFECT LINER**

NO CLAIM IS MADE TO THE EXCLUSIVE RIGHT TO USE "LINER", APART FROM THE MARK AS SHOWN.

THE MARK CONSISTS OF THE WORDS PERFECT LINER AND A DESIGN OF A SQUARE WITH A SLASH.

FOR EYE LINER, LIP LINER, COSMETIC PENCILS, EYE PENCILS, EYEBROW PENCILS, EYELINER PENCILS, MAKE-UP PENCILS, AND PENCILS FOR COSMETIC PURPOSES (U.S. CLS. 1, 4, 6, 50, 51 AND 52).

BILL DAWE, EXAMINING ATTORNEY

SN 79-008,221. YVES SAINT LAURENT PARFUMS, FRANCE, FILED 12-23-2004.

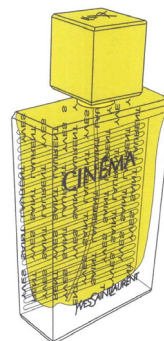

PRIORITY DATE OF 6-29-2004 IS CLAIMED. OWNER OF INTERNATIONAL REGISTRATION 0841259 DATED 12-23-2004, EXPIRES 12-23-2014.

OWNER OF U.S. REG. NOS. 853,369, 2,172,541 AND OTHERS.

"THE NAME(S), PORTRAIT(S), AND/OR SIGNATURE(S) SHOWN IN THE MARK IDENTIFIES YVES SAINT LAURENT, WHOSE CONSENT(S) TO REGISTER IS SUBMITTED."

THE COLOR(S) GOLD, YELLOW AND BLACK IS/ARE CLAIMED AS A FEATURE OF THE MARK.

THE COLOR GOLD APPEARS IN THE BAND ON TOP OF THE PERFUME BOTTLE; THE COLOR YELLOW APPEARS IN THE BOTTLE TOP AND IN THE ENTER OF THE BOTTLE, AND THE COLOR BLACK APPEARS IN THE ETCHED WORDING "CINEMA" AND "YVES SAINT LAURENT" ON THE FRONT OF THE BOTTLE AND THE ETCHED WORDING "YVES SAINT LAURENT" THAT IS REPEATED VERTICALLY ACROSS THE BOTTLE."

THE MARK CONSISTS OF A CONFIGURATION OF A BOTTLE FOR THE GOODS FEATURING ON ONE SIDE HORIZONTAL GROOVES AND LETTERS ENGRAVED VERTICALLY IN THE MATERIAL IN VARIATION OF THE WORDING YVES SAINT LAURENT, AND THE

CLASS 3—(Continued).

WORDING CINEMA AND YVESSAINTLAURENT ON THE FRONT OF THE BOTTLE. THE COLOR GOLD APPEARS IN THE BAND ON TOP OF THE PERFUME BOTTLE; THE COLOR YELLOW APPEARS IN THE BOTTLE TOP AND IN THE CENTER OF THE BOTTLE, AND THE COLOR BLACK APPEARS IN THE ETCHED WORDING "CINEMA" AND "YVES SAINT LAURENT" ON THE FRONT OF THE BOTTLE AND THE ETCHED WORDING "YVES SAINT LAURENT" THAT IS REPEATED VERTICALLY ACROSS THE BOTTLE."

FOR PERFUMES, EAUX-DE-TOILETTE, DEODORANTS FOR PERSONAL USE; ESSENTIAL OILS FOR PERSONAL USE; PERFUMED CREAMS AND LOTIONS FOR FACE AND BODY CARE PURPOSES; PERFUMED MILK FOR BODY CARE; PERFUMED SOAPS AND SHOWER GELS (U.S. CLS. 1, 4, 6, 50, 51 AND 52).

CARRIE GENOVESE, EXAMINING ATTORNEY

SN 79-010,979. MOSCHINO S.P.A., ITALY, FILED 11-3-2004.



OWNER OF INTERNATIONAL REGISTRATION 0849785 DATED 11-3-2004, EXPIRES 11-3-2014.

THE COLOR(S) RED AND GOLD IS/ARE CLAIMED AS A FEATURE OF THE MARK.

THE COLOR RED APPEARS IN THE DEPICTION OF THE RIBBON ON THE BOTTLE TOP; THE COLOR GOLD APPEARS IN THE DEPICTION OF THE LITERAL ELEMENT, THE BUTTON ON THE RIBBON, AND THE HEART-SHAPED TOP.

THE MARK IS A THREE-DIMENSIONAL DESIGN THAT CONSISTS OF A BOTTLE WITH AN ARBITRARY GOLD COLORED HEART SHAPED TOP, A RED RIBBON WITH A GOLD BUTTON PLACED JUST BELOW THE TOP, AND THE WORDS MOSCHINO IN GOLD DIRECTLY ABOVE THE TERM COUTURE!

THE FOREIGN WORDING IN THE MARK TRANSLATES INTO ENGLISH AS SMALL FLY.

FOR PERFUMES, COSMETICS, SOAPS, BATH FOAMS, TALC POWDER, NAMELY, TALCUM POWDER, BODY LOTIONS AND BODY CREAMS, PRODUCTS FOR THE CARE OF THE BODY, NAMELY, BODY MILK, BODY SCRUB, BODY POWDER, BODY OILS, BODY SPRAYS, DEODORANT FOR BODY CARE (U.S. CLS. 1, 4, 6, 50, 51 AND 52).

MICHAEL TANNER, EXAMINING ATTORNEY

CLASS 3—(Continued).

SN 79-027,869. MORABITO, F-75008 PARIS, FRANCE, FILED 3-16-2006.

MORABITO

OWNER OF INTERNATIONAL REGISTRATION 0514815 DATED 7-29-1987, EXPIRES 7-29-2007.

OWNER OF U.S. REG. NOS. 857,670, 1,638,814 AND OTHERS.

SEC. 2(F).

FOR SOAPS; PERFUMERY, ESSENTIAL OILS, COSMETICS, HAIR LOTIONS; DENTIFRICES (U.S. CLS. 1, 4, 6, 50, 51 AND 52).

MICHAEL SOUDERS, EXAMINING ATTORNEY

SN 79-028,001. LATIMO S.A., LUXEMBOURG, FILED 6-16-2006.

BOUDOIR

PRIORITY DATE OF 2-14-2006 IS CLAIMED.

OWNER OF INTERNATIONAL REGISTRATION 0896212 DATED 6-16-2006, EXPIRES 6-16-2016.

FOR POLISHING PREPARATIONS (U.S. CLS. 1, 4, 6, 50, 51 AND 52).

MICHAEL WIENER, EXAMINING ATTORNEY

SN 79-033,253. FRIDDA DORSCH, S.L., SPAIN, FILED 10-26-2006.

FRIDDA DORSCH

OWNER OF INTERNATIONAL REGISTRATION 0854798 DATED 8-2-2005, EXPIRES 8-2-2015.

"THE NAME(S), PORTRAIT(S), AND/OR SIGNATURE(S) SHOWN IN THE MARK IDENTIFIES FRIDDA DORSCH, A LIVING INDIVIDUAL, , WHOSE CONSENT(S) TO REGISTER IS SUBMITTED."

FOR SOAPS; PERFUMERY, ESSENTIAL OILS, COSMETICS, HAIR LOTIONS; AND DENTIFRICES (U.S. CLS. 1, 4, 6, 50, 51 AND 52).

MICHAEL TANNER, EXAMINING ATTORNEY

CLASS 3—(Continued).

SN 79-034,622. NANSDISWARPERSAD P. LACHMAN-SINGH; REKHA S.; LACHMANSINGH, NETHERLANDS, FILED 8-25-2006.

SPEEDY HIBIGENS

THE MARK CONSISTS OF STANDARD CHARACTERS WITHOUT CLAIM TO ANY PARTICULAR FONT, STYLE, SIZE, OR COLOR.

PRIORITY DATE OF 3-31-2006 IS CLAIMED.

OWNER OF INTERNATIONAL REGISTRATION 0913632 DATED 8-25-2006, EXPIRES 8-25-2016.

FOR HAIR COLOR CREAM (PERMANENT); RICH HENNA HAIR COLOR ON NATURAL BASE; ANTI DANDRUFF SHAMPOO; HAIR COLOR POWDERS AND CREAM; HAIR BLEACHING POWDERS; HAIR OILS; HAIR SPRAY; HAIR COLOR CREAM IN 27 COLORS; PROTEIN SHAMPOO; COSMETICS (U.S. CLS. 1, 4, 6, 50, 51 AND 52).

KARANENDRA S. CHHINA, EXAMINING ATTORNEY

CLASS 4—(Continued).

SN 77-015,197. LEE HELMS, INC., CHESTERFIELD, MO. FILED 10-5-2006.

TRIDEN

THE MARK CONSISTS OF STANDARD CHARACTERS WITHOUT CLAIM TO ANY PARTICULAR FONT, STYLE, SIZE, OR COLOR.

FOR ALL PURPOSE LUBRICANTS; AUTOMOTIVE LUBRICANTS; INDUSTRIAL LUBRICANTS; LUBRICATING GREASES (U.S. CLS. 1, 6 AND 15).

FIRST USE 7-19-2004; IN COMMERCE 7-19-2004.

PAUL E. FAHRENKOPF, EXAMINING ATTORNEY

CLASS 4—LUBRICANTS AND FUELS

SN 76-674,559. MEXITAN PRODUCTS, INC., SPRING HILL, KS. FILED 3-26-2007.

COCOCandleNUTS

FOR CANDLES, SCENTED CANDLES, PERFUMED CANDLES AND CANDLES FOR AROMATHERAPY (U.S. CLS. 1, 6 AND 15).

FIRST USE 3-2-2007; IN COMMERCE 3-2-2007.

NAAKWAMA ANKRAH, EXAMINING ATTORNEY

SN 77-092,961. STERLIN, JOHN L, SEATTLE, WA. FILED 1-28-2007.

Romanza Candles

THE MARK CONSISTS OF STANDARD CHARACTERS WITHOUT CLAIM TO ANY PARTICULAR FONT, STYLE, SIZE, OR COLOR.

NO CLAIM IS MADE TO THE EXCLUSIVE RIGHT TO USE "CANDLES", APART FROM THE MARK AS SHOWN. FOR CANDLES (U.S. CLS. 1, 6 AND 15).

GINA HAYES, EXAMINING ATTORNEY

SN 76-674,574. PEACE STORE, INC., SANTA BARBARA, CA. FILED 3-26-2007.

HAPPY IS HERE

THE MARK CONSISTS OF STANDARD CHARACTERS WITHOUT CLAIM TO ANY PARTICULAR FONT, STYLE, SIZE, OR COLOR.

FOR CANDLES (U.S. CLS. 1, 6 AND 15).

BARBARA RUTLAND, EXAMINING ATTORNEY

SN 77-110,373. GLOWBY CORPORATION, SAN DIEGO, CA. FILED 2-18-2007.

Glowby Candle

SN 76-674,748. DAYS FERRY PRODUCTIONS, INC., ENCINO, CA. FILED 3-28-2007.

THE WOMEN WHO RAISED ME

THE MARK CONSISTS OF STANDARD CHARACTERS WITHOUT CLAIM TO ANY PARTICULAR FONT, STYLE, SIZE, OR COLOR.

FOR CANDLES (U.S. CLS. 1, 6 AND 15).

CARYN GLASSER, EXAMINING ATTORNEY

THE MARK CONSISTS OF STANDARD CHARACTERS WITHOUT CLAIM TO ANY PARTICULAR FONT, STYLE, SIZE, OR COLOR.

NO CLAIM IS MADE TO THE EXCLUSIVE RIGHT TO USE "CANDLE", APART FROM THE MARK AS SHOWN. FOR CANDLES (U.S. CLS. 1, 6 AND 15).

FRED CARL, EXAMINING ATTORNEY

CLASS 4—(Continued).

SN 77-126,533. CANDLECOUTURE, LLC, SOUTHFIELD, MI.
FILED 3-9-2007.

candlecouture

THE MARK CONSISTS OF STANDARD CHARACTERS
WITHOUT CLAIM TO ANY PARTICULAR FONT, STYLE,
SIZE, OR COLOR.

FOR CANDLES (U.S. CLS. 1, 6 AND 15).
MICHAEL WIENER, EXAMINING ATTORNEY

SN 77-129,518. DESIREPATH MISSISSIPPI, LLC, ROSWELL,
GA. FILED 3-13-2007.



OWNER OF U.S. REG. NOS. 2,413,413, 2,697,806 AND
OTHERS.

NO CLAIM IS MADE TO THE EXCLUSIVE RIGHT TO
USE "CANDLES", APART FROM THE MARK AS SHOWN.

THE MARK CONSISTS OF A LEAF DESIGN AND THE
THE WORDS "ASPEN BAY CANDLES" IN STYLIZED
FORM.

FOR CANDLES (U.S. CLS. 1, 6 AND 15).
FIRST USE 9-1-1996; IN COMMERCE 9-1-1996.
SCOTT SISUN, EXAMINING ATTORNEY

SN 77-140,589. CITGO PETROLEUM CORPORATION,
HOUSTON, TX. FILED 3-26-2007.

MYSTIK JT-6 LO-TEMP EXTREME

THE MARK CONSISTS OF STANDARD CHARACTERS
WITHOUT CLAIM TO ANY PARTICULAR FONT, STYLE,
SIZE, OR COLOR.

OWNER OF U.S. REG. NOS. 767,007, 2,938,173 AND
OTHERS.

FOR MOTOR LUBRICATING OILS AND MULTI-
PURPOSE GREASES (U.S. CLS. 1, 6 AND 15).

GEOFFREY FOSDICK, EXAMINING ATTORNEY

CLASS 4—(Continued).

SN 77-141,243. MCMORRIS, SANDRA, PEMBROKE PINES,
FL. FILED 3-27-2007.

BURTHA'S BUTT WAX

THE MARK CONSISTS OF STANDARD CHARACTERS
WITHOUT CLAIM TO ANY PARTICULAR FONT, STYLE,
SIZE, OR COLOR.

NO CLAIM IS MADE TO THE EXCLUSIVE RIGHT TO
USE "WAX", APART FROM THE MARK AS SHOWN.

FOR WAX LUBRICANT USED TO EASE THE CUT-
TING OF METAL OR DRILLING OF HOLES THROUGH
WOOD OR METAL (U.S. CLS. 1, 6 AND 15).

PATRICIA EVANKO, EXAMINING ATTORNEY

SN 77-141,360. LANCASTER COLONY CORPORATION,
COLUMBUS, OH. FILED 3-27-2007.

PETS RULE

THE MARK CONSISTS OF STANDARD CHARACTERS
WITHOUT CLAIM TO ANY PARTICULAR FONT, STYLE,
SIZE, OR COLOR.

FOR CANDLES (U.S. CLS. 1, 6 AND 15).

IRENE D. WILLIAMS, EXAMINING ATTORNEY

SN 77-147,133. LANCASTER COLONY CORPORATION,
COLUMBUS, OH. FILED 4-3-2007.

JUST FOR YOU

THE MARK CONSISTS OF STANDARD CHARACTERS
WITHOUT CLAIM TO ANY PARTICULAR FONT, STYLE,
SIZE, OR COLOR.

FOR CANDLES (U.S. CLS. 1, 6 AND 15).

IRENE D. WILLIAMS, EXAMINING ATTORNEY

CLASS 4—(Continued).

SN 77-149,581. AMERICAN MUSEUM OF NATURAL HISTORY, NEW YORK, NY. FILED 4-5-2007.

AMNH EXPEDITIONS

THE MARK CONSISTS OF STANDARD CHARACTERS WITHOUT CLAIM TO ANY PARTICULAR FONT, STYLE, SIZE, OR COLOR.
FOR DECORATIVE CANDLES (U.S. CLS. 1, 6 AND 15).
REBECCA SMITH, EXAMINING ATTORNEY

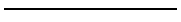

SN 77-178,761. ABERCROMBIE & FITCH TRADING CO., NEW ALBANY, OH. FILED 5-11-2007.



THE MARK CONSISTS OF A MISCELLANEOUS DESIGN.
FOR CANDLES; PERFUMED CANDLES; SCENTED CANDLES (U.S. CLS. 1, 6 AND 15).
JOHN WILKE, EXAMINING ATTORNEY

CLASS 4—(Continued).

SN 77-178,778. ABERCROMBIE & FITCH TRADING CO., NEW ALBANY, OH. FILED 5-11-2007.



THE NAME(S), PORTRAIT(S), AND/OR SIGNATURE(S) SHOWN IN THE MARK DOES NOT IDENTIFY A PARTICULAR LIVING INDIVIDUAL.
THE MARK CONSISTS OF A MISCELLANEOUS DESIGN WITH THE TERM GILLY H.
FOR CANDLES; PERFUMED CANDLES; SCENTED CANDLES (U.S. CLS. 1, 6 AND 15).
JOHN WILKE, EXAMINING ATTORNEY

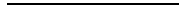

SN 77-178,785. ABERCROMBIE & FITCH TRADING CO., NEW ALBANY, OH. FILED 5-11-2007.



THE NAME(S), PORTRAIT(S), AND/OR SIGNATURE(S) SHOWN IN THE MARK DOES NOT IDENTIFY A PARTICULAR LIVING INDIVIDUAL.
THE MARK CONSISTS OF A MISCELLANEOUS DESIGN WITH THE TERM GILLY H.
FOR CANDLES; PERFUMED CANDLES; SCENTED CANDLES (U.S. CLS. 1, 6 AND 15).
JOHN WILKE, EXAMINING ATTORNEY

CLASS 4—(Continued).

SN 78-723,110. PETRO-CANADA, CALGARY, CANADA, FILED 9-29-2005.

ENDURATEX

THE MARK CONSISTS OF STANDARD CHARACTERS WITHOUT CLAIM TO ANY PARTICULAR FONT, STYLE, SIZE, OR COLOR.

PRIORITY CLAIMED UNDER SEC. 44(D) ON CANADA APPLICATION NO. 1,273,735, FILED 9-28-2005, REG. NO. TMA687232, DATED 5-8-2007, EXPIRES 5-8-2022.

FOR LUBRICANTS, NAMELY INDUSTRIAL LUBRICANTS (U.S. CLS. 1, 6 AND 15).

RENEE SERVANCE, EXAMINING ATTORNEY

CLASS 5—(Continued).

SN 76-565,756. PRASCO, LLC, CINCINNATI, OH. FILED 12-17-2003.

UNLIMIT

THE MARK CONSISTS OF STANDARD CHARACTERS WITHOUT CLAIM TO ANY PARTICULAR FONT, STYLE, SIZE, OR COLOR.

FOR PHARMACEUTICAL PREPARATIONS, NAMELY, PREPARATIONS FOR THE TREATMENT OF RESPIRATORY AILMENTS, COMBINED COUGH AND COLD TREATMENT PREPARATIONS, COUGH TREATMENT PREPARATIONS, COLD TREATMENT PREPARATIONS, COMBINED DECONGESTANT/ ANTIHISTAMINE/ANTISECRETORY PREPARATIONS, COMBINED ANTIHISTAMINE/ANTISECRETORY PREPARATIONS, COMBINED ANTITUSSIVE/DECONGESTANT/ ANTIHISTAMINE PREPARATIONS, COMBINED ANTITUSSIVE AND ANTIHISTAMINE PREPARATIONS, COMBINED DECONGESTANT/ ANTIHISTAMINE PREPARATIONS, ANTIHISTAMINES, ANTITUSSIVES, DECONGESTANTS, EXPECTORANTS, ANTISECRETORY PREPARATIONS, GASTROINTESTINAL TREATMENT PREPARATIONS, DIURETIC PREPARATIONS, CORTICOSTEROID PREPARATIONS, DERMATOLOGIC DISORDER TREATMENT PREPARATIONS, MIGRAINE TREATMENT PREPARATIONS, CALCIUM CHANNEL BLOCKING PREPARATIONS, KERATOLYTIC AGENTS, ANTI-NAUSEA PREPARATIONS, ANTI-ULCER PREPARATIONS, ANTI-ACNE SKIN CLEANSER PREPARATIONS, DERMATOLOGICALS, URINARY ANTISPASMODIC PREPARATIONS, ANTI-HYPERTENSION PREPARATIONS, HYPOTENSIVE AGENTS, HORMONE REPLACEMENT THERAPY PREPARATIONS, ANOREXIGENICS, ESTROGEN PREPARATIONS, ANTICONVULSANTS, ANTIFUNGALS, CONTRACEPTIVES, ANTIDEPRESSANTS, AND URINARY ANTI-INFECTIVES (U.S. CLS. 6, 18, 44, 46, 51 AND 52).

MICHAEL SOUDERS, EXAMINING ATTORNEY

CLASS 5—PHARMACEUTICALS

SN 76-526,769. COLDX APS, HAVDRUP, DENMARK, FILED 7-1-2003.

TROXZN

OWNER OF DENMARK REG. NO. VR20070204, DATED 6-22-2007, EXPIRES 6-22-2017.

FOR MINERAL SUPPLEMENTS; FOOD SUPPLEMENTS; PHARMACEUTICAL PREPARATIONS FOR THE TREATMENT AND PREVENTION OF ALLERGIES, ALLERGIC REACTIONS OR OTHER UPPER RESPIRATORY INFECTIONS OR INFLAMMATIONS; ALLERGY MEDICATIONS; AND ALLERGY RELIEF MEDICATIONS (U.S. CLS. 6, 18, 44, 46, 51 AND 52).

ALEXANDER L. POWERS, EXAMINING ATTORNEY

SN 76-632,730. BTI BIOTECHNOLOGY INSTITUTE, S.L., ALAVA, SPAIN, FILED 3-8-2005.

TINY

THE MARK CONSISTS OF STANDARD CHARACTERS WITHOUT CLAIM TO ANY PARTICULAR FONT, STYLE, SIZE, OR COLOR.

FOR BLOOD PLASMA (U.S. CLS. 6, 18, 44, 46, 51 AND 52).

KAELIE KUNG, EXAMINING ATTORNEY

CLASS 5—(Continued).

SN 76-649,344. BECKETT CORPORATION, IRVING, TX. FILED 10-27-2005.

SKEETER STOPPER

THE MARK CONSISTS OF STANDARD CHARACTERS WITHOUT CLAIM TO ANY PARTICULAR FONT, STYLE, SIZE, OR COLOR.

NO CLAIM IS MADE TO THE EXCLUSIVE RIGHT TO USE "SKEETER", APART FROM THE MARK AS SHOWN.

FOR PACKETS CONTAINING MOSQUITO LARVICIDE AND PESTICIDE FOR INSERTION INTO WATER FILTERS USED WITH DECORATIVE PONDS AND FOUNTAINS (U.S. CLS. 6, 18, 44, 46, 51 AND 52).

KAREN BRACEY, EXAMINING ATTORNEY

SN 76-663,173. JSJ PHARMACEUTICALS, DOYLESTOWN, PA. FILED 7-17-2006.

EASY PAD

THE MARK CONSISTS OF STANDARD CHARACTERS WITHOUT CLAIM TO ANY PARTICULAR FONT, STYLE, SIZE, OR COLOR.

NO CLAIM IS MADE TO THE EXCLUSIVE RIGHT TO USE "PAD", APART FROM THE MARK AS SHOWN.

FOR DERMATOLOGICAL PHARMACEUTICAL PRODUCTS (U.S. CLS. 6, 18, 44, 46, 51 AND 52).

ELLEN PERKINS, EXAMINING ATTORNEY

SN 76-663,323. VITAMARK INTERNATIONAL, INC., HOUSTON, TX. FILED 7-19-2006.

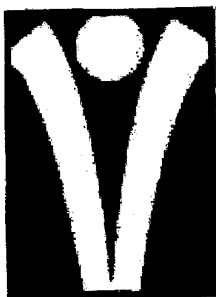

OWNER OF U.S. REG. NO. 3,173,760.

THE MARK CONSISTS OF A SPLIT ARCHED V WITH A CIRCLE AT THE CREST OF THE OPENING AT THE TOP OF THE V.

FOR HOUSE MARK FOR A FULL LINE OF NUTRITIONAL AND DIETARY SUPPLEMENTS SOLD THROUGH A MULTI-LEVEL MARKETING GROUP (U.S. CLS. 6, 18, 44, 46, 51 AND 52).

FIRST USE 9-1-2002; IN COMMERCE 9-1-2002.

ANDREA HACK, EXAMINING ATTORNEY

CLASS 5—(Continued).

SN 76-664,493. MCNEIL NUTRITIONALS, LLC, FORT WASHINGTON, PA. FILED 8-11-2006.

FLAVOR GLIDES

THE MARK CONSISTS OF STANDARD CHARACTERS WITHOUT CLAIM TO ANY PARTICULAR FONT, STYLE, SIZE, OR COLOR.

NO CLAIM IS MADE TO THE EXCLUSIVE RIGHT TO USE "FLAVOR", APART FROM THE MARK AS SHOWN.

FOR VITAMINS AND DIETARY SUPPLEMENTS (U.S. CLS. 6, 18, 44, 46, 51 AND 52).

ELISSA GARBER KON, EXAMINING ATTORNEY

SN 76-664,494. MCNEIL NUTRITIONALS, LLC, FORT WASHINGTON, PA. FILED 8-11-2006.

ACTIVE NUTRITION FOR GIRLS

THE MARK CONSISTS OF STANDARD CHARACTERS WITHOUT CLAIM TO ANY PARTICULAR FONT, STYLE, SIZE, OR COLOR.

NO CLAIM IS MADE TO THE EXCLUSIVE RIGHT TO USE "NUTRITION FOR GIRLS", APART FROM THE MARK AS SHOWN.

FOR VITAMINS AND DIETARY SUPPLEMENTS (U.S. CLS. 6, 18, 44, 46, 51 AND 52).

ELISSA GARBER KON, EXAMINING ATTORNEY

SN 76-667,785. RRM ENTERPRISES LP, MARINA DEL REY, CA. FILED 10-20-2006.

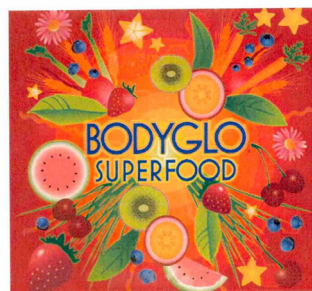

NO CLAIM IS MADE TO THE EXCLUSIVE RIGHT TO USE "SUPERFOOD", APART FROM THE MARK AS SHOWN.

THE COLOR(S) RED, PINK, ORANGE, YELLOW, GREEN AND BLUE IS/ARE CLAIMED AS A FEATURE OF THE MARK.

THE WORDING BODYGLO AND THE BLUEBERRIES APPEAR IN BLUE; THE OUTLINE OF THE WORDING BODYGLO, THE STARS, THE MIDDLE SECTION OF THE CONCENTRIC CIRCLES AND THE INSIDE OF THE COCONUTS APPEAR IN YELLOW; ALL STEMS AND LEAVES, THE KIWIS, AND THE RIND OF THE WATERMELON APPEAR GREEN; THE INSIDE OF THE WATERMELON APPEAR PINK AND THE DAISIES APPEAR PINK; AND THE COLOR RED APPEARS IN THE STRAWBERRIES, CHERRIES, AND OUTSIDE BACKGROUND OF THE DRAWING.

FOR NUTRITIONAL SUPPLEMENTS AND DIETARY SUPPLEMENTS (U.S. CLS. 6, 18, 44, 46, 51 AND 52).

FIRST USE 7-18-2005; IN COMMERCE 7-18-2005.

JANICE L. MCMORROW, EXAMINING ATTORNEY

CLASS 5—(Continued).

SN 76-674,294. TAIN, FRANCES, CAMBRIDGE, MA. FILED 3-20-2007.

TAKE THE DIRE OUT OF DIARRHEA

THE MARK CONSISTS OF STANDARD CHARACTERS WITHOUT CLAIM TO ANY PARTICULAR FONT, STYLE, SIZE, OR COLOR.

FOR ANTI-DIARRHEA MEDICATION (U.S. CLS. 6, 18, 44, 46, 51 AND 52).

BRIAN PINO, EXAMINING ATTORNEY

SN 76-674,505. WHOLENESS FOR THE PLANET, INC., LEXINGTON, KY. FILED 3-23-2007.

BRIGHT STAR

THE MARK CONSISTS OF STANDARD CHARACTERS WITHOUT CLAIM TO ANY PARTICULAR FONT, STYLE, SIZE, OR COLOR.

FOR NUTRITIONAL AND DIETARY SUPPLEMENTS (U.S. CLS. 6, 18, 44, 46, 51 AND 52).

FIRST USE 3-16-2007; IN COMMERCE 3-16-2007.
PRISCILLA MILTON, EXAMINING ATTORNEY

SN 76-674,595. THEODORE O. MANDISH, LLC, MIMS, FL. FILED 3-26-2007.

CITRACURE

THE MARK CONSISTS OF STANDARD CHARACTERS WITHOUT CLAIM TO ANY PARTICULAR FONT, STYLE, SIZE, OR COLOR.

FOR MEDICATED SKIN CARE PREPARATIONS, NAMELY, ORGANIC ANTI-BACTERIAL AND ANTI-FUNGAL COMPOUNDS DESIGNED TO SUPPORT HEALTHY SKIN (U.S. CLS. 6, 18, 44, 46, 51 AND 52).

BARBARA GAYNOR, EXAMINING ATTORNEY

SN 76-674,607. PRIORITY VISION, INC., FEMANDINA BEACH, FL. FILED 3-26-2007.

NIP THE GRIP

THE MARK CONSISTS OF STANDARD CHARACTERS WITHOUT CLAIM TO ANY PARTICULAR FONT, STYLE, SIZE, OR COLOR.

FOR PHARMACEUTICAL PREPARATION; NAMELY, A PREPARATION TO SUPPRESS, REDUCE, ELIMINATE, REPLACE, OR TO SUBSTITUTE FOR, THE USE OF TOBACCO PRODUCTS (U.S. CLS. 6, 18, 44, 46, 51 AND 52).

BARBARA RUTLAND, EXAMINING ATTORNEY

CLASS 5—(Continued).

SN 76-676,053. GENOTEC NUTRITIONALS INC., DEER PARK, NY. FILED 4-26-2007.

SUGAR BLASTER

THE MARK CONSISTS OF STANDARD CHARACTERS WITHOUT CLAIM TO ANY PARTICULAR FONT, STYLE, SIZE, OR COLOR.

NO CLAIM IS MADE TO THE EXCLUSIVE RIGHT TO USE "SUGAR", APART FROM THE MARK AS SHOWN.

FOR DIETARY SUPPLEMENT (U.S. CLS. 6, 18, 44, 46, 51 AND 52).

ANNE MADDEN, EXAMINING ATTORNEY

SN 76-676,054. GENOTEC NUTRITIONALS INC., DEER PARK, NY. FILED 4-26-2007.

SUGAR DESTROYER

THE MARK CONSISTS OF STANDARD CHARACTERS WITHOUT CLAIM TO ANY PARTICULAR FONT, STYLE, SIZE, OR COLOR.

NO CLAIM IS MADE TO THE EXCLUSIVE RIGHT TO USE "SUGAR", APART FROM THE MARK AS SHOWN.

FOR DIETARY SUPPLEMENT (U.S. CLS. 6, 18, 44, 46, 51 AND 52).

ANNE MADDEN, EXAMINING ATTORNEY

SN 77-008,399. EDWARD GEISTLICH SOHNE AG FUR CHEMISCHE INDUSTRIE, WOLHUSEN, SWITZERLAND, FILED 9-27-2006.

OSTEO-GIDE

THE MARK CONSISTS OF STANDARD CHARACTERS WITHOUT CLAIM TO ANY PARTICULAR FONT, STYLE, SIZE, OR COLOR.

OWNER OF SWITZERLAND REG. NO. 467039, DATED 6-4-1999, EXPIRES 6-4-2009.

FOR NATURALLY-DERIVED MEMBRANE FOR USE IN ORTHOPEDIC SURGERY (U.S. CLS. 6, 18, 44, 46, 51 AND 52).

ROSELLE HERRERA, EXAMINING ATTORNEY

CLASS 5—(Continued).

SN 77-010,670. TOYO SHINYAKU CO., LTD., FUKUOKA-SHI, FUKUOKA-KEN, JAPAN, FILED 9-29-2006.

Toyo-KanSho

THE MARK CONSISTS OF STANDARD CHARACTERS WITHOUT CLAIM TO ANY PARTICULAR FONT, STYLE, SIZE, OR COLOR.

THE ENGLISH TRANSLATION OF THE JAPANESE WORD "TOYO" IS "TRANSOCEANIC", "ASIAN COUNTRIES", "THE EAST", "PRESENT USE," AND "APPOINTMENT"; AND OF "KANSHO" IS "SUGAR CANE", "SWEET POTATO", "CHINESE BOOK" AND "QUIET PLACE".

FOR NUTRITIONAL SUPPLEMENT ADDITIVES FOR USE IN COSMETICS, FOODS AND BEVERAGES; DIETARY SUPPLEMENTS; NUTRITIONAL SUPPLEMENTS; NUTRACEUTICALS FOR USE AS A DIETARY SUPPLEMENT (U.S. CLS. 6, 18, 44, 46, 51 AND 52).

ROBERT STRUCK, EXAMINING ATTORNEY

CLASS 5—(Continued).

SN 77-032,740. MEDTECH PRODUCTS, INC., IRVINGTON, NY, FILED 10-30-2006.

NEW SKIN BLISTERSHIELD

THE MARK CONSISTS OF STANDARD CHARACTERS WITHOUT CLAIM TO ANY PARTICULAR FONT, STYLE, SIZE, OR COLOR.

OWNER OF U.S. REG. NOS. 1,259,764, 1,757,962 AND OTHERS.

SEC. 2(F).
FOR LIQUID, FILM, AND GEL DRESSINGS FOR PREVENTATIVE AND THERAPEUTIC PURPOSES INCLUDING PROTECTION OF SKIN AGAINST PRESSURE AND FRICTION, AND FOR PREVENTION OF BLISTERS AND CALLUSES (U.S. CLS. 6, 18, 44, 46, 51 AND 52).

JILL C. ALT, EXAMINING ATTORNEY

SN 77-012,431. DIAL BRANDS, INC., SCOTTSDALE, AZ, FILED 10-3-2006.

ACTIVATED TRICLOSAN

THE MARK CONSISTS OF STANDARD CHARACTERS WITHOUT CLAIM TO ANY PARTICULAR FONT, STYLE, SIZE, OR COLOR.

NO CLAIM IS MADE TO THE EXCLUSIVE RIGHT TO USE TRICLOSAN, APART FROM THE MARK AS SHOWN.

FOR ANTIBACTERIAL AND ANTIMICROBIAL HAND SANITIZERS FOR HOUSEHOLD, INDUSTRIAL AND INSTITUTIONAL USE (U.S. CLS. 6, 18, 44, 46, 51 AND 52).

WENDY GOODMAN, EXAMINING ATTORNEY

SN 77-038,760. AJG BRANDS, INC., WALTHAM, MA, FILED 11-7-2006.

VENASTAT

THE MARK CONSISTS OF STANDARD CHARACTERS WITHOUT CLAIM TO ANY PARTICULAR FONT, STYLE, SIZE, OR COLOR.

FOR DIETARY AND NUTRITIONAL SUPPLEMENTS; PHARMACEUTICAL PREPARATIONS FOR THE TREATMENT OF CIRCULATORY ISSUES AND TO SUPPORT BLOOD FLOW (U.S. CLS. 6, 18, 44, 46, 51 AND 52).

FIRST USE 9-1-1998; IN COMMERCE 9-1-1998.

YAT SYE, LEE, EXAMINING ATTORNEY

SN 77-027,355. FUN ENERGY FOODS INC., MARKHAM, CANADA, FILED 10-23-2006.

Kickbutt amped energy ballz

THE MARK CONSISTS OF STANDARD CHARACTERS WITHOUT CLAIM TO ANY PARTICULAR FONT, STYLE, SIZE, OR COLOR.

NO CLAIM IS MADE TO THE EXCLUSIVE RIGHT TO USE "ENERGY BALLS", APART FROM THE MARK AS SHOWN.

FOR DIETARY AND NUTRITIONAL SUPPLEMENTS (U.S. CLS. 6, 18, 44, 46, 51 AND 52).

FIRST USE 9-1-2004; IN COMMERCE 8-18-2005.

KATHERINE E. HALMEN, EXAMINING ATTORNEY

SN 77-043,386. MOBLEY PRODUCTS, INC. D/B/A WONDER WAFERS INTERNATIONAL, FORT WORTH, TX, FILED 11-14-2006.

NU CAR

THE MARK CONSISTS OF STANDARD CHARACTERS WITHOUT CLAIM TO ANY PARTICULAR FONT, STYLE, SIZE, OR COLOR.

FOR AIR FRESHENERS, AIR FRESHENER WAFERS, AIR FRESHENER CONCENTRATES, FRAGRANCE IMPREGNATED WAFERS, AND CONTAINERS, PACKAGING, AND DOCUMENTATION PROVIDED THEREWITH (U.S. CLS. 6, 18, 44, 46, 51 AND 52).

FIRST USE 12-31-2000; IN COMMERCE 12-31-2000.

ODESSA BIBBINS, EXAMINING ATTORNEY

CLASS 5—(Continued).

SN 77-043,460. BAYER CONSUMER CARE AG, CH-4052 BASEL, SWITZERLAND, FILED 11-14-2006.

SANATOGEN

THE MARK CONSISTS OF STANDARD CHARACTERS WITHOUT CLAIM TO ANY PARTICULAR FONT, STYLE, SIZE, OR COLOR.

OWNER OF SWITZERLAND REG. NO. P424651, DATED 11-11-1994, EXPIRES 11-11-2014.

OWNER OF U.S. REG. NO. 53,028.
FOR VITAMIN AND MINERAL PREPARATIONS FOR MEDICAL USE (U.S. CLS. 6, 18, 44, 46, 51 AND 52).
MICHELE SWAIN, EXAMINING ATTORNEY

CLASS 5—(Continued).

SN 77-091,287. Z-MEDICA CORPORATION, WALLINGFORD, CT. FILED 1-25-2007.

QUIKCLOT SPORT

THE MARK CONSISTS OF STANDARD CHARACTERS WITHOUT CLAIM TO ANY PARTICULAR FONT, STYLE, SIZE, OR COLOR.

OWNER OF U.S. REG. NOS. 2,798,757 AND 3,134,377.
NO CLAIM IS MADE TO THE EXCLUSIVE RIGHT TO USE "SPORT", APART FROM THE MARK AS SHOWN.

FOR CHEMICALS THAT AID IN THE COAGULATION OF BLOOD FOR HUMAN MEDICINAL USE (U.S. CLS. 6, 18, 44, 46, 51 AND 52).

JANICE L. MCMORROW, EXAMINING ATTORNEY

SN 77-054,139. CHERRYDALE MANUFACTURING, L.L.C., ALLENTOWN, PA. FILED 11-30-2006.

BARTONS THE CHOCOLATE MAKERS CHOCOLATE!

THE MARK CONSISTS OF STANDARD CHARACTERS WITHOUT CLAIM TO ANY PARTICULAR FONT, STYLE, SIZE, OR COLOR.

OWNER OF U.S. REG. NOS. 669,032, 2,923,935 AND OTHERS.

FOR MEAL REPLACEMENT BARS; VITAMIN AND MINERAL FORMED AND PACKAGED AS BARS (U.S. CLS. 6, 18, 44, 46, 51 AND 52).

HANNO RITTNER, EXAMINING ATTORNEY

SN 77-091,291. Z-MEDICA CORPORATION, WALLINGFORD, CT. FILED 1-25-2007.

QUIKCLOT SPORT SILVER

THE MARK CONSISTS OF STANDARD CHARACTERS WITHOUT CLAIM TO ANY PARTICULAR FONT, STYLE, SIZE, OR COLOR.

OWNER OF U.S. REG. NOS. 2,798,757 AND 3,134,377.
NO CLAIM IS MADE TO THE EXCLUSIVE RIGHT TO USE "SPORT SILVER", APART FROM THE MARK AS SHOWN.

FOR CHEMICALS THAT AID IN THE COAGULATION OF BLOOD FOR HUMAN MEDICINAL USE (U.S. CLS. 6, 18, 44, 46, 51 AND 52).

JANICE L. MCMORROW, EXAMINING ATTORNEY

SN 77-086,926. THE HARTZ MOUNTAIN CORPORATION, SECAUCUS, NJ. FILED 1-19-2007.

HARTZ BUGDANA

THE MARK CONSISTS OF STANDARD CHARACTERS WITHOUT CLAIM TO ANY PARTICULAR FONT, STYLE, SIZE, OR COLOR.

OWNER OF U.S. REG. NOS. 782,948, 3,222,910 AND OTHERS.

FOR INSECTICIDE COATED BANDANA FOR DOGS (U.S. CLS. 6, 18, 44, 46, 51 AND 52).

WON TEAK OH, EXAMINING ATTORNEY

SN 77-097,124. CADBURY IRELAND LTD., COOLOCK, DUBLIN 5, IRELAND, FILED 2-1-2007.

MOUNTAIN MENTHOL

THE MARK CONSISTS OF STANDARD CHARACTERS WITHOUT CLAIM TO ANY PARTICULAR FONT, STYLE, SIZE, OR COLOR.

NO CLAIM IS MADE TO THE EXCLUSIVE RIGHT TO USE "MENTHOL", APART FROM THE MARK AS SHOWN.
FOR LOZENGES AND COUGH DROPS (U.S. CLS. 6, 18, 44, 46, 51 AND 52).

FIRST USE 10-31-1998; IN COMMERCE 10-31-1998.

KEVON CHISOLM, EXAMINING ATTORNEY

CLASS 5—(Continued).

SN 77-097,825. IDEAVILLAGE PRODUCTS CORP., FAIRFIELD, NJ. FILED 2-2-2007.

SPRAY SCIENCE

THE MARK CONSISTS OF STANDARD CHARACTERS WITHOUT CLAIM TO ANY PARTICULAR FONT, STYLE, SIZE, OR COLOR.

NO CLAIM IS MADE TO THE EXCLUSIVE RIGHT TO USE "SPRAY", APART FROM THE MARK AS SHOWN.

FOR VITAMINS; MINERAL SUPPLEMENTS; AMINO ACIDS FOR NUTRITIONAL PURPOSES; HERBAL EXTRACTS IN THE NATURE OF DIETARY SUPPLEMENTS; HERBAL EXTRACTS IN THE NATURE OF NUTRITIONAL SUPPLEMENTS; NUTRITIONAL SUPPLEMENTS; BOTANICALS IN THE NATURE OF DIETARY SUPPLEMENTS; BOTANICALS IN THE NATURE OF NUTRITIONAL SUPPLEMENTS; DIETARY SUPPLEMENTS; DIETARY FOOD SUPPLEMENTS (U.S. CLS. 6, 18, 44, 46, 51 AND 52).

MICHAEL LITZAU, EXAMINING ATTORNEY

SN 77-098,659. HENNENFENT, GREGORY S, BARRINGTON, IL. FILED 2-3-2007.

Maggie's Gluten-Free Goodies

THE MARK CONSISTS OF STANDARD CHARACTERS WITHOUT CLAIM TO ANY PARTICULAR FONT, STYLE, SIZE, OR COLOR.

NO CLAIM IS MADE TO THE EXCLUSIVE RIGHT TO USE "GLUTEN-FREE GOODIES", APART FROM THE MARK AS SHOWN.

FOR GLUTEN-FREE FOOD TO ACCOMMODATE SPECIAL MEDICAL AND HEALTH CONDITIONS (U.S. CLS. 6, 18, 44, 46, 51 AND 52).

BRENDAN REGAN, EXAMINING ATTORNEY

SN 77-102,067. ONLINE FUTURE INC., PORT ST. LUCIE, FL. FILED 2-7-2007.

Freshen your body Freshen your life

THE MARK CONSISTS OF STANDARD CHARACTERS WITHOUT CLAIM TO ANY PARTICULAR FONT, STYLE, SIZE, OR COLOR.

FOR MEDICINAL CHEWING GUM FOR SUPPLYING VITAMINS AND HERBS (U.S. CLS. 6, 18, 44, 46, 51 AND 52).

FIRST USE 7-3-1997; IN COMMERCE 1-1-2006.
CARYN GLASSER, EXAMINING ATTORNEY

CLASS 5—(Continued).

SN 77-105,953. THE BODY STUDIO CORP, COHASSET, MA. FILED 2-13-2007.

Born to be natural

THE MARK CONSISTS OF STANDARD CHARACTERS WITHOUT CLAIM TO ANY PARTICULAR FONT, STYLE, SIZE, OR COLOR.

FOR BABY FOOD AND BABY NUTRITIONAL SUPPLEMENTS AND VITAMINS (U.S. CLS. 6, 18, 44, 46, 51 AND 52).

FLORENTINA BLANDU, EXAMINING ATTORNEY

SN 77-107,983. TARGACEPT, INC., WINSTON-SALEM, NC. FILED 2-15-2007.

AMPLIXA

THE MARK CONSISTS OF STANDARD CHARACTERS WITHOUT CLAIM TO ANY PARTICULAR FONT, STYLE, SIZE, OR COLOR.

FOR PHARMACEUTICAL PREPARATIONS FOR THE TREATMENT OF CENTRAL NERVOUS SYSTEM DISORDERS (U.S. CLS. 6, 18, 44, 46, 51 AND 52).

ANDREA BUTLER, EXAMINING ATTORNEY

SN 77-110,725. STANDARD PROCESS INC., PALMYRA, WI. FILED 2-19-2007.

FROM SEED TO SUPPLEMENT

THE MARK CONSISTS OF STANDARD CHARACTERS WITHOUT CLAIM TO ANY PARTICULAR FONT, STYLE, SIZE, OR COLOR.

FOR DIETARY SUPPLEMENTS; PHARMACEUTICAL PREPARATIONS FOR THE TREATMENT OF DRY SKIN; DIETARY SUPPLEMENTS, NAMELY, FOOD CONCENTRATES IN THE FORM OF CAPSULES, TABLETS, PERLE CAPSULES, LIQUID AND POWDER; NUTRITIONAL SUPPLEMENTS, NAMELY, MULTI-VITAMIN FOOD BARS (U.S. CLS. 6, 18, 44, 46, 51 AND 52).

JAMES STEIN, EXAMINING ATTORNEY

CLASS 5—(Continued).

SN 77-113,393. SOLVAY PHARMACEUTICALS, INC., MAR-
IETTA, GA. FILED 2-22-2007.

COMPASSIA

THE MARK CONSISTS OF STANDARD CHARACTERS
WITHOUT CLAIM TO ANY PARTICULAR FONT, STYLE,
SIZE, OR COLOR.

FOR PHARMACEUTICAL PREPARATIONS FOR THE
TREATMENT OF NEUROLOGICAL DISORDERS (U.S.
CLS. 6, 18, 44, 46, 51 AND 52).

ARETHA SOMERVILLE, EXAMINING ATTORNEY

CLASS 5—(Continued).

SN 77-126,061. HALL, MICKEY A., COSTA MESA, CA. FILED
3-8-2007.

METABAL

THE MARK CONSISTS OF STANDARD CHARACTERS
WITHOUT CLAIM TO ANY PARTICULAR FONT, STYLE,
SIZE, OR COLOR.

FOR FOOD SUPPLEMENTS (U.S. CLS. 6, 18, 44, 46, 51
AND 52).

FIRST USE 8-1-1991; IN COMMERCE 8-1-1991.
LEE-ANNE BERNS, EXAMINING ATTORNEY

SN 77-124,389. Z-MEDICA CORPORATION, WALLING-
FORD, CT. FILED 3-7-2007.

VETCLOT OC

THE MARK CONSISTS OF STANDARD CHARACTERS
WITHOUT CLAIM TO ANY PARTICULAR FONT, STYLE,
SIZE, OR COLOR.

NO CLAIM IS MADE TO THE EXCLUSIVE RIGHT TO
USE "OC", APART FROM THE MARK AS SHOWN.

FOR CHEMICALS THAT AID IN THE COAGULATION
OF BLOOD FOR VETERINARY MEDICINAL USE (U.S.
CLS. 6, 18, 44, 46, 51 AND 52).

FIRST USE 1-12-2007; IN COMMERCE 1-12-2007.
JANICE L. MCMORROW, EXAMINING ATTORNEY

SN 77-129,367. VITA LICENSING, INC., MALVERN, PA.
FILED 3-13-2007.

ORTHOCOMP

THE MARK CONSISTS OF STANDARD CHARACTERS
WITHOUT CLAIM TO ANY PARTICULAR FONT, STYLE,
SIZE, OR COLOR.

FOR IMPLANT CEMENT FOR BONES (U.S. CLS. 6, 18,
44, 46, 51 AND 52).

JASON ROTH, EXAMINING ATTORNEY

SN 77-124,462. MITSUI CHEMICALS, INC., TOKYO, JAPAN,
FILED 3-7-2007.

TENCHU

THE MARK CONSISTS OF STANDARD CHARACTERS
WITHOUT CLAIM TO ANY PARTICULAR FONT, STYLE,
SIZE, OR COLOR.

THE ENGLISH TRANSLATION OF TENCHU IS HEA-
VEN'S PUNISHMENT.

FOR PREPARATIONS FOR KILLING WEEDS AND
DESTROYING VERMIN; INSECTICIDES; PESTICIDES;
VERMICIDES; FUNGICIDES; HERBICIDES; GERMI-
CIDES (U.S. CLS. 6, 18, 44, 46, 51 AND 52).

REBECCA EISINGER, EXAMINING ATTORNEY

SN 77-130,840. BIOTAB NUTRACEUTICALS, INC., PASADE-
NA, CA. FILED 3-14-2007.



THE MARK CONSISTS OF ARC MADE UP OF CIRCLES
STARTING FROM LARGER AND CONSISTENTLY RE-
DUCED IN SIZE UNTIL THE ARC ENDS WITH A STAR
GRAPHIC AND THE STYLIZED TEXT OF THE WORDING
"ALTERIL (SOMNIA LATORIL)".

FOR SLEEPING PILLS/TABLETS (U.S. CLS. 6, 18, 44,
46, 51 AND 52).

DOMINICK J. SALEMI, EXAMINING ATTORNEY

CLASS 5—(Continued).

SN 77-130,876. RADIANT HEALTH CLINIC LLC, PORTLAND, OR. FILED 3-14-2007.

Radiant Health Products

THE MARK CONSISTS OF STANDARD CHARACTERS WITHOUT CLAIM TO ANY PARTICULAR FONT, STYLE, SIZE, OR COLOR.

NO CLAIM IS MADE TO THE EXCLUSIVE RIGHT TO USE "HEALTH PRODUCTS", APART FROM THE MARK AS SHOWN.

FOR DIETARY AND NUTRITIONAL SUPPLEMENTS; HERBAL SUPPLEMENTS; HOMEOPATHIC SUPPLEMENTS; VITAMIN AND MINERAL SUPPLEMENTS (U.S. CLS. 6, 18, 44, 46, 51 AND 52).

WILLIAM VERHOSEK, EXAMINING ATTORNEY

CLASS 5—(Continued).

SN 77-132,303. CHRISTY, JOSEPH, TEMPE, AZ. FILED 3-15-2007.

THYADINE

THE MARK CONSISTS OF STANDARD CHARACTERS WITHOUT CLAIM TO ANY PARTICULAR FONT, STYLE, SIZE, OR COLOR.

FOR DIETARY AND NUTRITIONAL SUPPLEMENTS (U.S. CLS. 6, 18, 44, 46, 51 AND 52).

FIRST USE 1-1-2007; IN COMMERCE 1-1-2007.

SARA THOMAS, EXAMINING ATTORNEY

SN 77-131,627. SYNERFIED CAPITAL INC., MIAMI, FL. FILED 3-15-2007.



THE MARK CONSISTS OF NODORO WITH THE N AND O INSIDE SQUARES.

FOR ANTIFUNGAL CREAMS FOR MEDICAL USE; FUNGAL MEDICATIONS (U.S. CLS. 6, 18, 44, 46, 51 AND 52).

BRIAN PINO, EXAMINING ATTORNEY

SN 77-133,354. URBAN NUTRITION, LLC, NEW YORK, NY. FILED 3-16-2007.

RESTAID

THE MARK CONSISTS OF STANDARD CHARACTERS WITHOUT CLAIM TO ANY PARTICULAR FONT, STYLE, SIZE, OR COLOR.

FOR SLEEP SUPPLEMENTS, NAMELY, SLEEPING CAPSULES AND TABLETS (U.S. CLS. 6, 18, 44, 46, 51 AND 52).

SIMON TENG, EXAMINING ATTORNEY

SN 77-131,704. IVOCLAR VIVADENT, INC., AMHERST, NY. FILED 3-15-2007.

MULTILINK SPRINT

THE MARK CONSISTS OF STANDARD CHARACTERS WITHOUT CLAIM TO ANY PARTICULAR FONT, STYLE, SIZE, OR COLOR.

OWNER OF U.S. REG. NO. 3,001,741.

FOR MATERIALS FOR USE IN DENTISTRY, NAMELY MATERIALS FOR THE MANUFACTURE OF DENTAL IMPRESSIONS, MODELS, CROWNS AND BRIDGES, INLAYS, DENTURES, VENEERS, AND PROTECTIVE COATINGS; DENTAL MATERIALS FOR RELINING; DENTAL TOOTH FILLING MATERIALS; DENTAL LUTING CEMENTS; DENTAL AMALGAMS; DENTAL MATERIALS FOR PULP PROTECTION AND ROOT TREATMENT; MATERIALS FOR REPAIRING TOOTH DEFECTS; DENTAL ADHESIVE AGENTS; DENTAL COMPOSITES AND CEMENTS; CAVITY LINING MATERIALS; ENDODONTIC FILLING MATERIALS; DENTAL VENEERS. (U.S. CLS. 6, 18, 44, 46, 51 AND 52).

FIRST USE 2-14-2007; IN COMMERCE 2-14-2007.

JACLYN KIDWELL, EXAMINING ATTORNEY

SN 77-133,620. COLEMAN, ELLINOR, NORTHRIDGE, CA. FILED 3-16-2007.

RATIONS NUTRITIONAL SUPPORT

THE MARK CONSISTS OF STANDARD CHARACTERS WITHOUT CLAIM TO ANY PARTICULAR FONT, STYLE, SIZE, OR COLOR.

NO CLAIM IS MADE TO THE EXCLUSIVE RIGHT TO USE "NUTRITIONAL SUPPORT", APART FROM THE MARK AS SHOWN.

FOR VITAMIN AND MINERAL SUPPLEMENTS; DIETARY AND NUTRITIONAL SUPPLEMENTS (U.S. CLS. 6, 18, 44, 46, 51 AND 52).

B. PARADEWELAI, EXAMINING ATTORNEY

CLASS 5—(Continued).

SN 77-134,768. OPTIMUM NUTRITION, INC., AURORA, IL.
FILED 3-19-2007.

HYDROWHEY

THE MARK CONSISTS OF STANDARD CHARACTERS WITHOUT CLAIM TO ANY PARTICULAR FONT, STYLE, SIZE, OR COLOR.

OWNER OF U.S. REG. NO. 2,941,256.
FOR DIETARY AND NUTRITIONAL SUPPLEMENTS
(U.S. CLS. 6, 18, 44, 46, 51 AND 52).
ELLEN BURNS, EXAMINING ATTORNEY

CLASS 5—(Continued).

SN 77-135,736. AIM INTERNATIONAL, INC., NAMPA, ID.
FILED 3-20-2007.

AIM PEAK ENDURANCE

THE MARK CONSISTS OF STANDARD CHARACTERS WITHOUT CLAIM TO ANY PARTICULAR FONT, STYLE, SIZE, OR COLOR.

OWNER OF U.S. REG. NOS. 1,946,451, 2,222,707 AND OTHERS.

FOR DIETARY NUTRITIONAL SUPPLEMENT, NAMELY ADENOSINE TRIPHOSPHATE (ATP) TO PROVIDE ENERGY, REDUCE FATIGUE, AND IMPROVE MENTAL PERFORMANCE AND MUSCLE STRENGTH AND RECOVERY (U.S. CLS. 6, 18, 44, 46, 51 AND 52).

FIRST USE 12-10-2006; IN COMMERCE 12-10-2006.
MARY MUNSON, EXAMINING ATTORNEY

SN 77-135,662. MARTEX NUTRITION, INC., MIAMI, FL.
FILED 3-20-2007.

Vitamin Wonders

NO CLAIM IS MADE TO THE EXCLUSIVE RIGHT TO USE "VITAMIN", APART FROM THE MARK AS SHOWN.

THE COLOR(S) WHITE, GOLD, AND GREEN IS/ARE CLAIMED AS A FEATURE OF THE MARK.

THE COLOR GOLD APPEAR IN THE WORD VITAMIN WONDERS, THE OUTLINE OF THE POND, THE STEM OF THE LEAVES, AND THE WITHIN THE LEAVES; THE COLOR GREEN APPEARS IN THE LEAF; THE COLOR WHITE IS WITHIN INSIDE OF THE CIRCLES REPRESENTING THE POND.

FOR MIXED VITAMIN PREPARATIONS; MULTI-VITAMIN PREPARATIONS; VITAMIN B PREPARATIONS; VITAMIN C PREPARATIONS; VITAMIN D PREPARATIONS; VITAMIN AND MINERAL FORMED AND PACKAGED AS BARS; VITAMIN AND MINERAL PREPARATIONS FOR MEDICAL USE; VITAMIN AND MINERAL PREPARATIONS FOR USE AS INGREDIENTS IN THE FOOD AND PHARMACEUTICAL INDUSTRY; VITAMIN AND MINERAL SUPPLEMENTS; VITAMIN DROPS; VITAMIN ENRICHED WATER; VITAMIN FORTIFIED BEVERAGES; VITAMIN PREPARATIONS; VITAMIN SUPPLEMENT IN TABLET FORM FOR USE IN MAKING AN EFFERVESCENT BEVERAGE WHEN ADDED TO WATER; VITAMIN SUPPLEMENTS; VITAMIN TABLETS; VITAMINS (U.S. CLS. 6, 18, 44, 46, 51 AND 52).

FIRST USE 3-14-2007; IN COMMERCE 3-15-2007.
GINA HAYES, EXAMINING ATTORNEY

SN 77-136,942. ADVANTAGE MARKETING, INC., SALT LAKE CITY, UT. FILED 3-21-2007.

CARBON FUSION

THE MARK CONSISTS OF STANDARD CHARACTERS WITHOUT CLAIM TO ANY PARTICULAR FONT, STYLE, SIZE, OR COLOR.

NO CLAIM IS MADE TO THE EXCLUSIVE RIGHT TO USE "CARBON", APART FROM THE MARK AS SHOWN.

FOR LIQUID NUTRITIONAL SUPPLEMENTS (U.S. CLS. 6, 18, 44, 46, 51 AND 52).

LAURIE KAUFMAN, EXAMINING ATTORNEY

SN 77-136,994. ADVANTAGE MARKETING, INC., SALT LAKE CITY, UT. FILED 3-21-2007.

CARDIO FUSION

THE MARK CONSISTS OF STANDARD CHARACTERS WITHOUT CLAIM TO ANY PARTICULAR FONT, STYLE, SIZE, OR COLOR.

NO CLAIM IS MADE TO THE EXCLUSIVE RIGHT TO USE "CARDIO", APART FROM THE MARK AS SHOWN.

FOR LIQUID NUTRITIONAL SUPPLEMENTS (U.S. CLS. 6, 18, 44, 46, 51 AND 52).

LAURIE KAUFMAN, EXAMINING ATTORNEY

CLASS 5—(Continued).

SN 77-138,061. MEDICAL MARKETING RESOURCES INC.,
DBA THE KITCHEN TABLE BAKERS, SYOSSET, NY.
FILED 3-22-2007.

The Kitchen Table Bakers

THE MARK CONSISTS OF STANDARD CHARACTERS
WITHOUT CLAIM TO ANY PARTICULAR FONT, STYLE,
SIZE, OR COLOR.

NO CLAIM IS MADE TO THE EXCLUSIVE RIGHT TO
USE "BAKERS", APART FROM THE MARK AS SHOWN.

FOR BISCUITS, BREAD, BREAD ROLLS, CAKES,
CEREAL PRODUCTS, CONFECTIONERY, CRACKERS,
NOODLES, FISH SAUCE, RELISH, SAUCES, CEREAL-
BASED SNACK-FOODS AND PREPARED DIETARY
ITEMS THAT ARE GLUTEN-FREE TO ACCOMMODATE
SPECIAL MEDICAL AND HEALTH CONDITIONS (U.S.
CLS. 6, 18, 44, 46, 51 AND 52).

FIRST USE 5-1-2003; IN COMMERCE 5-1-2003.
STEVEN PEREZ, EXAMINING ATTORNEY

SN 77-138,201. SEPRACOR INC., MARLBOROUGH, MA.
FILED 3-22-2007.

Xopenex

OWNER OF U.S. REG. NOS. 2,350,721 AND 3,124,312.
FOR PHARMACEUTICAL PREPARATIONS AND SUB-
STANCES FOR TREATMENT OF RESPIRATORY DIS-
ORDERS (U.S. CLS. 6, 18, 44, 46, 51 AND 52).
SUSAN RICHARDS, EXAMINING ATTORNEY

SN 77-138,451. THE ANDERSONS, INC., MAUMEE, OH.
FILED 3-23-2007.

GRUBOUT

THE MARK CONSISTS OF STANDARD CHARACTERS
WITHOUT CLAIM TO ANY PARTICULAR FONT, STYLE,
SIZE, OR COLOR.

FOR INSECTICIDES (U.S. CLS. 6, 18, 44, 46, 51 AND
52).

FIRST USE 3-20-2007; IN COMMERCE 3-20-2007.
MARK SPARACINO, EXAMINING ATTORNEY

CLASS 5—(Continued).

SN 77-138,574. BOEHRINGER INGELHEIM VETMEDICA
GMBH, INGELHEIM AM RHEIN, FED REP GERMANY,
FILED 3-23-2007.

DISAL

THE MARK CONSISTS OF STANDARD CHARACTERS
WITHOUT CLAIM TO ANY PARTICULAR FONT, STYLE,
SIZE, OR COLOR.

FOR DIURETICS FOR ANIMALS (U.S. CLS. 6, 18, 44,
46, 51 AND 52).

FIRST USE 1-1-1983; IN COMMERCE 1-1-1983.

VERNA BETH RIRIE, EXAMINING ATTORNEY

SN 77-139,549. LOBSONS INTERNATIONAL, INC., LONG
VALLEY, NJ. FILED 3-24-2007.

ALTAIGOLD

THE MARK CONSISTS OF STANDARD CHARACTERS
WITHOUT CLAIM TO ANY PARTICULAR FONT, STYLE,
SIZE, OR COLOR.

FOR ANIMAL FEED ADDITIVE FOR USE AS A
NUTRITIONAL SUPPLEMENT FOR MEDICAL PUR-
POSES; ANIMAL FEED SUPPLEMENTS; DIETARY
AND NUTRITIONAL SUPPLEMENTS; DIETARY DRINK
MIX FOR USE AS A MEAL REPLACEMENT; DIETARY
FIBER AS AN ADDITIVE FOR FOOD PRODUCTS;
DIETARY FOOD SUPPLEMENTS; DIETARY SUPPLE-
MENTAL DRINKS; DIETARY SUPPLEMENTS; DIET-
ARY SUPPLEMENTS FOR ANIMALS; DIETARY
SUPPLEMENTS FOR HUMAN CONSUMPTION; FISH,
PICKLES, PRESERVED OLIVES AND DIETARY FOODS
AND FOOD-ITEMS THAT ARE GLUTEN-FREE TO
ACCOMMODATE SPECIAL MEDICAL AND HEALTH
CONDITIONS; FOOD SUPPLEMENTS; FOOD SUPPLE-
MENTS, NAMELY, ANTI-OXIDANTS; HERBAL SUP-
PLEMENTS; HOMEOPATHIC SUPPLEMENTS; MEAL
REPLACEMENT AND DIETARY SUPPLEMENT DRINK
MIXES; MINERAL NUTRITIONAL SUPPLEMENTS;
MINERAL SUPPLEMENTS; NUTRACEUTICALS FOR
USE AS A DIETARY SUPPLEMENT; NUTRITIONAL
ADDITIVES FOR USE IN FOODS AND DIETARY
SUPPLEMENTS FOR HUMAN CONSUMPTION; NUTRI-
TIONAL SUPPLEMENTS; NUTRITIONAL SUPPLE-
MENTS IN LOTION FORM SOLD AS A COMPONENT
OF NUTRITIONAL SKIN CARE PRODUCTS; POW-
DERED NUTRITIONAL SUPPLEMENT DRINK MIX;
VITAMIN AND MINERAL SUPPLEMENTS; VITAMIN
SUPPLEMENT IN TABLET FORM FOR USE IN MAK-
ING AN EFFERVESCENT BEVERAGE WHEN ADDED
TO WATER; VITAMIN SUPPLEMENTS (U.S. CLS. 6, 18,
44, 46, 51 AND 52).

PETER CHENG, EXAMINING ATTORNEY

CLASS 5—(Continued).

SN 77-139,641. ROCKMORE INDUSTRIES, LLC, BOISE, ID. FILED 3-24-2007.

LEAN FAST

THE MARK CONSISTS OF STANDARD CHARACTERS WITHOUT CLAIM TO ANY PARTICULAR FONT, STYLE, SIZE, OR COLOR.

NO CLAIM IS MADE TO THE EXCLUSIVE RIGHT TO USE FAST, APART FROM THE MARK AS SHOWN.

FOR DIETARY SUPPLEMENTS (U.S. CLS. 6, 18, 44, 46, 51 AND 52).

FIRST USE 2-15-2007; IN COMMERCE 2-21-2007.
EDWARD NELSON, EXAMINING ATTORNEY

SN 77-139,752. RUGART, ERIC S, WAYNE, PA. FILED 3-25-2007.

Tidy Chef

THE MARK CONSISTS OF STANDARD CHARACTERS WITHOUT CLAIM TO ANY PARTICULAR FONT, STYLE, SIZE, OR COLOR.

FOR BISCUITS, BREAD, BREAD ROLLS, CAKES, CEREAL PRODUCTS, CONFECTIONERY, CRACKERS, NOODLES, FISH SAUCE, RELISH, SAUCES, CEREAL-BASED SNACK-FOODS AND PREPARED DIETARY ITEMS THAT ARE GLUTEN-FREE TO ACCOMMODATE SPECIAL MEDICAL AND HEALTH CONDITIONS; FOOD SUPPLEMENTS; NUTRITIONAL ADDITIVES FOR USE IN FOODS AND DIETARY SUPPLEMENTS FOR HUMAN CONSUMPTION (U.S. CLS. 6, 18, 44, 46, 51 AND 52).

WARREN L. OLANDRIA, EXAMINING ATTORNEY

SN 77-139,756. H&N HERBS, ARCADIA, CA. FILED 3-25-2007.

ampm flex

THE MARK CONSISTS OF STANDARD CHARACTERS WITHOUT CLAIM TO ANY PARTICULAR FONT, STYLE, SIZE, OR COLOR.

FOR DIETARY AND NUTRITIONAL SUPPLEMENTS; DIETARY SUPPLEMENTS; DIETARY SUPPLEMENTS FOR HUMAN CONSUMPTION; HERBAL SUPPLEMENTS; NUTRACEUTICALS FOR USE AS A DIETARY SUPPLEMENT; NUTRITIONAL SUPPLEMENTS (U.S. CLS. 6, 18, 44, 46, 51 AND 52).

FIRST USE 10-20-2006; IN COMMERCE 10-20-2006.
KAPIL BHANOT, EXAMINING ATTORNEY

CLASS 5—(Continued).

SN 77-139,879. SCHERING-PLOUGH HEALTHCARE PRODUCTS, INC., MEMPHIS, TN. FILED 3-26-2007.



OWNER OF U.S. REG. NOS. 191,089, 1,255,028 AND OTHERS.

THE MARK CONSISTS OF DR. SCHOLL'S FOR HER AND DESIGN.

FOR MEDICATED CORN REMOVING PREPARATIONS; BLISTER TREATMENT PREPARATIONS; CORN CUSHIONS, CALLUS CUSHIONS (U.S. CLS. 6, 18, 44, 46, 51 AND 52).

FIRST USE 12-11-2006; IN COMMERCE 12-11-2006.
PRISCILLA MILTON, EXAMINING ATTORNEY

SN 77-140,318. LAURSEN, MARK, SEDONA, AZ. FILED 3-26-2007.

PERFECT PEACE

THE MARK CONSISTS OF STANDARD CHARACTERS WITHOUT CLAIM TO ANY PARTICULAR FONT, STYLE, SIZE, OR COLOR.

FOR HERB TEAS FOR MEDICINAL PURPOSES (U.S. CLS. 6, 18, 44, 46, 51 AND 52).

LAURIE MAYES, EXAMINING ATTORNEY

SN 77-140,337. LAURSEN, MARK, SEDONA, AZ. FILED 3-26-2007.

FLY NO CRY

THE MARK CONSISTS OF STANDARD CHARACTERS WITHOUT CLAIM TO ANY PARTICULAR FONT, STYLE, SIZE, OR COLOR.

NO CLAIM IS MADE TO THE EXCLUSIVE RIGHT TO USE "FLY", APART FROM THE MARK AS SHOWN.

FOR HERBAL SUPPLEMENTS FOR USE WHILE FLYING (U.S. CLS. 6, 18, 44, 46, 51 AND 52).

LAURIE MAYES, EXAMINING ATTORNEY

CLASS 5—(Continued).

SN 77-140,402. GEORGE K ZOOROB, COLORADO SPRINGS, CO. FILED 3-26-2007.

INFLAMAGIC

THE MARK CONSISTS OF STANDARD CHARACTERS WITHOUT CLAIM TO ANY PARTICULAR FONT, STYLE, SIZE, OR COLOR.
FOR VITAMINS AND DIETARY SUPPLEMENTS (U.S. CLS. 6, 18, 44, 46, 51 AND 52).
FIRST USE 2-14-2002; IN COMMERCE 2-12-2003.
DAWN FELDMAN, EXAMINING ATTORNEY

SN 77-140,420. ZOOROB, GEORGE K, COLORADO SPRINGS, CO. FILED 3-26-2007.

**HELPS RELIEVE MUSCLE &
JOINT DISCOMFORT LIKE MAGIC**

THE MARK CONSISTS OF STANDARD CHARACTERS WITHOUT CLAIM TO ANY PARTICULAR FONT, STYLE, SIZE, OR COLOR.
OWNER OF U.S. REG. NOS. 2,932,976 AND 2,973,940.
FOR VITAMINS AND DIETARY SUPPLEMENT (U.S. CLS. 6, 18, 44, 46, 51 AND 52).
FIRST USE 2-14-2002; IN COMMERCE 2-12-2003.
DAWN FELDMAN, EXAMINING ATTORNEY

SN 77-140,595. PATENTHEALTH, LLC, CANTON, OH. FILED 3-26-2007.

APATRIM

THE MARK CONSISTS OF STANDARD CHARACTERS WITHOUT CLAIM TO ANY PARTICULAR FONT, STYLE, SIZE, OR COLOR.
FOR DIETARY SUPPLEMENTS FOR WEIGHT LOSS (U.S. CLS. 6, 18, 44, 46, 51 AND 52).
ANDREA HACK, EXAMINING ATTORNEY

CLASS 5—(Continued).

SN 77-140,674. MAJEED, MUHAMMED, PISCATAWAY, NJ. FILED 3-26-2007.

RESVENOX

THE MARK CONSISTS OF STANDARD CHARACTERS WITHOUT CLAIM TO ANY PARTICULAR FONT, STYLE, SIZE, OR COLOR.
FOR DIETARY SUPPLEMENTS (U.S. CLS. 6, 18, 44, 46, 51 AND 52).
THEODORE MCBRIDE, EXAMINING ATTORNEY

SN 77-140,728. VEDCO, INC., ST. JOSEPH, MO. FILED 3-26-2007.

BACTIFUR

THE MARK CONSISTS OF STANDARD CHARACTERS WITHOUT CLAIM TO ANY PARTICULAR FONT, STYLE, SIZE, OR COLOR.
FOR VETERINARY PHARMACEUTICAL PREPARATIONS, NAMELY, ANTIBIOTICS (U.S. CLS. 6, 18, 44, 46, 51 AND 52).
DAVID TOOLEY, EXAMINING ATTORNEY

SN 77-140,766. INTERNATURAL, LLC, HENDERSON, NV. FILED 3-26-2007.

ULTRAZEN

THE MARK CONSISTS OF STANDARD CHARACTERS WITHOUT CLAIM TO ANY PARTICULAR FONT, STYLE, SIZE, OR COLOR.
FOR HERBAL SUPPLEMENT, NUTRITIONAL SUPPLEMENT, DIETARY SUPPLEMENT, VITAMIN SUPPLEMENT (U.S. CLS. 6, 18, 44, 46, 51 AND 52).
PAMELA HIRSCHMAN, EXAMINING ATTORNEY

CLASS 5—(Continued).

SN 77-140,767. NEUROGISTICS CORPORATION, NEW BRAUNFELS, TX. FILED 3-26-2007.

NEUROGISTICS

THE MARK CONSISTS OF STANDARD CHARACTERS WITHOUT CLAIM TO ANY PARTICULAR FONT, STYLE, SIZE, OR COLOR.

FOR NUTRITIONAL SUPPLEMENTS (U.S. CLS. 6, 18, 44, 46, 51 AND 52).

FIRST USE 8-28-2006; IN COMMERCE 8-28-2006.
CARRIE GENOVESE, EXAMINING ATTORNEY

SN 77-140,835. ZISOOK, SHELDON, CHICAGO, IL. FILED 3-26-2007.

ENHANCE-IT

THE MARK CONSISTS OF STANDARD CHARACTERS WITHOUT CLAIM TO ANY PARTICULAR FONT, STYLE, SIZE, OR COLOR.

FOR DIETARY SUPPLEMENTS (U.S. CLS. 6, 18, 44, 46, 51 AND 52).

HEATHER SAPP, EXAMINING ATTORNEY

SN 77-141,045. SCHEL, CHARLES L., MCCORMICK, SC. FILED 3-27-2007.

COLDONE

THE MARK CONSISTS OF STANDARD CHARACTERS WITHOUT CLAIM TO ANY PARTICULAR FONT, STYLE, SIZE, OR COLOR.

FOR DIETARY SUPPLEMENT FOR HUMAN CONSUMPTION FOR THE RELIEF OF SYMPTOMS RELATED TO THE COMMON COLD AND FLU (U.S. CLS. 6, 18, 44, 46, 51 AND 52).

SALLY SHIH, EXAMINING ATTORNEY

CLASS 5—(Continued).

SN 77-141,298. PREMIUM SELECT BIOTECH, LLC, ALBURN, VT. FILED 3-27-2007.



NO CLAIM IS MADE TO THE EXCLUSIVE RIGHT TO USE "LLC", APART FROM THE MARK AS SHOWN.

THE MARK CONSISTS OF STYLIZED WHITE LETTERS "PSB" ON A GRAY BACKGROUND, WHITE BLOCK LETTERS "LLC".

FOR ANIMAL FEED SUPPLEMENTS; FEED SUPPLEMENTS FOR LIVESTOCK (U.S. CLS. 6, 18, 44, 46, 51 AND 52).

FIRST USE 1-1-2006; IN COMMERCE 3-1-2006.
GEORGE LORENZO, EXAMINING ATTORNEY

SN 77-141,323. MEGA-PRO NUTRITION, INC., ST. GEORGE, UT. FILED 3-27-2007.

VASOPRO

THE MARK CONSISTS OF STANDARD CHARACTERS WITHOUT CLAIM TO ANY PARTICULAR FONT, STYLE, SIZE, OR COLOR.

FOR DIETARY AND NUTRITIONAL SUPPLEMENTS (U.S. CLS. 6, 18, 44, 46, 51 AND 52).

FIRST USE 5-4-1999; IN COMMERCE 5-4-1999.
EDWARD NELSON, EXAMINING ATTORNEY

SN 77-141,405. DAIWA PHARMACEUTICAL CO., LTD., TOKYO, JAPAN, FILED 3-27-2007.

BFPB

THE MARK CONSISTS OF STANDARD CHARACTERS WITHOUT CLAIM TO ANY PARTICULAR FONT, STYLE, SIZE, OR COLOR.

FOR NUTRACEUTICALS FOR USE AS DIETARY SUPPLEMENTS; NUTRITIONAL AND DIETARY SUPPLEMENTS; FUNCTIONAL FOODS AND FUNCTIONAL FOOD ADDITIVES, NAMELY, DRIED PURIFIED FILTRATE OF BACILLUS SUBTILLIS NATTO CULTURE FOR USE AS A DIETARY SUPPLEMENT (U.S. CLS. 6, 18, 44, 46, 51 AND 52).

IRENE D. WILLIAMS, EXAMINING ATTORNEY

CLASS 5—(Continued).

SN 77-141,460. ELI LILLY AND COMPANY, INDIANAPOLIS, IN. FILED 3-27-2007.

CLASS 5—(Continued).

SN 77-141,464. ELI LILLY AND COMPANY, INDIANAPOLIS, IN. FILED 3-27-2007.

RHEVOW

RHEVOWE

THE MARK CONSISTS OF STANDARD CHARACTERS WITHOUT CLAIM TO ANY PARTICULAR FONT, STYLE, SIZE, OR COLOR.

FOR PHARMACEUTICAL PREPARATIONS, NAMELY, PHARMACEUTICAL PREPARATIONS FOR THE TREATMENT OF ALCOHOL USE DISORDERS, ANXIETY, BONE AND SKELETAL DISEASES AND DISORDERS, BLOOD DISEASES AND DISORDERS, CANCER, CARDIOVASCULAR DISEASES, CENTRAL NERVOUS SYSTEM DISEASES AND DISORDERS, DIABETES, DIABETIC NEUROPATHY, ENDOCRINE DISEASES AND DISORDERS, GASTROINTESTINAL DISEASES AND DISORDERS, HORMONAL DISEASES AND DISORDERS, INFLAMMATION AND INFLAMMATORY DISEASES AND DISORDERS, LIVER DISEASES AND DISORDERS, KIDNEY DISEASES AND DISORDERS, NEURODEGENERATIVE DISEASES AND DISORDERS, NEUROLOGICAL DISORDERS, OBESITY, OPHTHALMOLOGIC CONDITIONS AND DISEASES, PAIN, PERIPHERAL NERVOUS SYSTEM DISEASES AND DISORDERS, REPRODUCTIVE SYSTEM DISEASES AND DISORDERS, SEXUAL DYSFUNCTION, UROLOGICAL DISORDERS, DYSLIPIDEMIA, SLEEP DISORDERS, MIGRAINES, METABOLIC DISEASES AND DISORDERS; PHARMACEUTICAL PREPARATIONS FOR THE PREVENTION OF DIABETES; ANTI-PSYCHOTIC AGENTS; AND ANTIDEPRESSANTS (U.S. CLS. 6, 18, 44, 46, 51 AND 52).

SANI KHOURI, EXAMINING ATTORNEY

THE MARK CONSISTS OF STANDARD CHARACTERS WITHOUT CLAIM TO ANY PARTICULAR FONT, STYLE, SIZE, OR COLOR.

FOR PHARMACEUTICAL PREPARATIONS, NAMELY, PHARMACEUTICAL PREPARATIONS FOR THE TREATMENT OF ALCOHOL USE DISORDERS, ANXIETY, BONE AND SKELETAL DISEASES AND DISORDERS, BLOOD DISEASES AND DISORDERS, CANCER, CARDIOVASCULAR DISEASES, CENTRAL NERVOUS SYSTEM DISEASES AND DISORDERS, DIABETES, DIABETIC NEUROPATHY, ENDOCRINE DISEASES AND DISORDERS, GASTROINTESTINAL DISEASES AND DISORDERS, HORMONAL DISEASES AND DISORDERS, INFLAMMATION AND INFLAMMATORY DISEASES AND DISORDERS, LIVER DISEASES AND DISORDERS, KIDNEY DISEASES AND DISORDERS, NEURODEGENERATIVE DISEASES AND DISORDERS, NEUROLOGICAL DISORDERS, OBESITY, OPHTHALMOLOGIC CONDITIONS AND DISEASES, PAIN, PERIPHERAL NERVOUS SYSTEM DISEASES AND DISORDERS, REPRODUCTIVE SYSTEM DISEASES AND DISORDERS, SEXUAL DYSFUNCTION, UROLOGICAL DISORDERS, DYSLIPIDEMIA, SLEEP DISORDERS, MIGRAINES, METABOLIC DISEASES AND DISORDERS; PHARMACEUTICAL PREPARATIONS FOR THE PREVENTION OF DIABETES; ANTI-PSYCHOTIC AGENTS; AND ANTIDEPRESSANTS (U.S. CLS. 6, 18, 44, 46, 51 AND 52).

SANI KHOURI, EXAMINING ATTORNEY

CLASS 5—(Continued).

SN 77-141,467. ELI LILLY AND COMPANY, INDIANAPOLIS, IN. FILED 3-27-2007.

CLASS 5—(Continued).

SN 77-141,570. ELI LILLY AND COMPANY, INDIANAPOLIS, IN. FILED 3-27-2007.

RIAVOW

REAVOW

THE MARK CONSISTS OF STANDARD CHARACTERS WITHOUT CLAIM TO ANY PARTICULAR FONT, STYLE, SIZE, OR COLOR.

FOR PHARMACEUTICAL PREPARATIONS, NAMELY, PHARMACEUTICAL PREPARATIONS FOR THE TREATMENT OF ALCOHOL USE DISORDERS, ANXIETY, BONE AND SKELETAL DISEASES AND DISORDERS, BLOOD DISEASES AND DISORDERS, CANCER, CARDIOVASCULAR DISEASES, CENTRAL NERVOUS SYSTEM DISEASES AND DISORDERS, DIABETES, DIABETIC NEUROPATHY, ENDOCRINE DISEASES AND DISORDERS, GASTROINTESTINAL DISEASES AND DISORDERS, HORMONAL DISEASES AND DISORDERS, INFLAMMATION AND INFLAMMATORY DISEASES AND DISORDERS, LIVER DISEASES AND DISORDERS, KIDNEY DISEASES AND DISORDERS, NEURODEGENERATIVE DISEASES AND DISORDERS, NEUROLOGICAL DISORDERS, OBESITY, OPHTHALMOLOGIC CONDITIONS AND DISEASES, PAIN, PERIPHERAL NERVOUS SYSTEM DISEASES AND DISORDERS, REPRODUCTIVE SYSTEM DISEASES AND DISORDERS, SEXUAL DYSFUNCTION, UROLOGICAL DISORDERS, DYSLIPIDEMIA, SLEEP DISORDERS, MIGRAINES, METABOLIC DISEASES AND DISORDERS; PHARMACEUTICAL PREPARATIONS FOR THE PREVENTION OF DIABETES; ANTI-PSYCHOTIC AGENTS; AND ANTIDEPRESSANTS (U.S. CLS. 6, 18, 44, 46, 51 AND 52).

SANI KHOURI, EXAMINING ATTORNEY

THE MARK CONSISTS OF STANDARD CHARACTERS WITHOUT CLAIM TO ANY PARTICULAR FONT, STYLE, SIZE, OR COLOR.

FOR PHARMACEUTICAL PREPARATIONS, NAMELY, PHARMACEUTICAL PREPARATIONS FOR THE TREATMENT OF ALCOHOL USE DISORDERS, ANXIETY, BONE AND SKELETAL DISEASES AND DISORDERS, BLOOD DISEASES AND DISORDERS, CANCER, CARDIOVASCULAR DISEASES, CENTRAL NERVOUS SYSTEM DISEASES AND DISORDERS, DIABETES, DIABETIC NEUROPATHY, ENDOCRINE DISEASES AND DISORDERS, GASTROINTESTINAL DISEASES AND DISORDERS, HORMONAL DISEASES AND DISORDERS, INFLAMMATION AND INFLAMMATORY DISEASES AND DISORDERS, LIVER DISEASES AND DISORDERS, KIDNEY DISEASES AND DISORDERS, NEURODEGENERATIVE DISEASES AND DISORDERS, NEUROLOGICAL DISORDERS, OBESITY, OPHTHALMOLOGIC CONDITIONS AND DISEASES, PAIN, PERIPHERAL NERVOUS SYSTEM DISEASES AND DISORDERS, REPRODUCTIVE SYSTEM DISEASES AND DISORDERS, SEXUAL DYSFUNCTION, UROLOGICAL DISORDERS, DYSLIPIDEMIA, SLEEP DISORDERS, MIGRAINES, METABOLIC DISEASES AND DISORDERS; PHARMACEUTICAL PREPARATIONS FOR THE PREVENTION OF DIABETES; ANTI-PSYCHOTIC AGENTS; AND ANTIDEPRESSANTS (U.S. CLS. 6, 18, 44, 46, 51 AND 52).

SANI KHOURI, EXAMINING ATTORNEY

CLASS 5—(Continued).

SN 77-141,573. ELI LILLY AND COMPANY, INDIANAPOLIS, IN. FILED 3-27-2007.

REEVOW

THE MARK CONSISTS OF STANDARD CHARACTERS WITHOUT CLAIM TO ANY PARTICULAR FONT, STYLE, SIZE, OR COLOR.

FOR PHARMACEUTICAL PREPARATIONS, NAMELY, PHARMACEUTICAL PREPARATIONS FOR THE TREATMENT OF ALCOHOL USE DISORDERS, ANXIETY, BONE AND SKELETAL DISEASES AND DISORDERS, BLOOD DISEASES AND DISORDERS, CANCER, CARDIOVASCULAR DISEASES, CENTRAL NERVOUS SYSTEM DISEASES AND DISORDERS, DIABETES, DIABETIC NEUROPATHY, ENDOCRINE DISEASES AND DISORDERS, GASTROINTESTINAL DISEASES AND DISORDERS, HORMONAL DISEASES AND DISORDERS, INFLAMMATION AND INFLAMMATORY DISEASES AND DISORDERS, LIVER DISEASES AND DISORDERS, KIDNEY DISEASES AND DISORDERS, NEURODEGENERATIVE DISEASES AND DISORDERS, NEUROLOGICAL DISORDERS, OBESITY, OPHTHALMOLOGIC CONDITIONS AND DISEASES, PAIN, PERIPHERAL NERVOUS SYSTEM DISEASES AND DISORDERS, REPRODUCTIVE SYSTEM DISEASES AND DISORDERS, SEXUAL DYSFUNCTION, UROLOGICAL DISORDERS, DYSLIPIDEMIA, SLEEP DISORDERS, MIGRAINES, METABOLIC DISEASES AND DISORDERS; PHARMACEUTICAL PREPARATIONS FOR THE PREVENTION OF DIABETES; ANTI-PSYCHOTIC AGENTS; AND ANTIDEPRESSANTS (U.S. CLS. 6, 18, 44, 46, 51 AND 52).
SANI KHOURI, EXAMINING ATTORNEY

CLASS 5—(Continued).

SN 77-141,577. ELI LILLY AND COMPANY, INDIANAPOLIS, IN. FILED 3-27-2007.

REEVOWE

THE MARK CONSISTS OF STANDARD CHARACTERS WITHOUT CLAIM TO ANY PARTICULAR FONT, STYLE, SIZE, OR COLOR.

FOR PHARMACEUTICAL PREPARATIONS, NAMELY, PHARMACEUTICAL PREPARATIONS FOR THE TREATMENT OF ALCOHOL USE DISORDERS, ANXIETY, BONE AND SKELETAL DISEASES AND DISORDERS, BLOOD DISEASES AND DISORDERS, CANCER, CARDIOVASCULAR DISEASES, CENTRAL NERVOUS SYSTEM DISEASES AND DISORDERS, DIABETES, DIABETIC NEUROPATHY, ENDOCRINE DISEASES AND DISORDERS, GASTROINTESTINAL DISEASES AND DISORDERS, HORMONAL DISEASES AND DISORDERS, INFLAMMATION AND INFLAMMATORY DISEASES AND DISORDERS, LIVER DISEASES AND DISORDERS, KIDNEY DISEASES AND DISORDERS, NEURODEGENERATIVE DISEASES AND DISORDERS, NEUROLOGICAL DISORDERS, OBESITY, OPHTHALMOLOGIC CONDITIONS AND DISEASES, PAIN, PERIPHERAL NERVOUS SYSTEM DISEASES AND DISORDERS, REPRODUCTIVE SYSTEM DISEASES AND DISORDERS, SEXUAL DYSFUNCTION, UROLOGICAL DISORDERS, DYSLIPIDEMIA, SLEEP DISORDERS, MIGRAINES, METABOLIC DISEASES AND DISORDERS; PHARMACEUTICAL PREPARATIONS FOR THE PREVENTION OF DIABETES; ANTI-PSYCHOTIC AGENTS; AND ANTIDEPRESSANTS (U.S. CLS. 6, 18, 44, 46, 51 AND 52).
SANI KHOURI, EXAMINING ATTORNEY

SN 77-141,625. TRUETONIQS, LLC, LONGMONT, CO. FILED 3-27-2007.

TRUETONIQS

THE MARK CONSISTS OF STANDARD CHARACTERS WITHOUT CLAIM TO ANY PARTICULAR FONT, STYLE, SIZE, OR COLOR.

FOR DIETARY SUPPLEMENTS, NAMELY, WATER-BASED HERBAL-ENHANCED BEVERAGES (U.S. CLS. 6, 18, 44, 46, 51 AND 52).
JENNIFER MARTIN, EXAMINING ATTORNEY

CLASS 5—(Continued).

SN 77-141,642. BIOFARMA, NEUILLY-SUR-SEINE, FRANCE, FILED 3-27-2007.

ACEON

THE MARK CONSISTS OF STANDARD CHARACTERS WITHOUT CLAIM TO ANY PARTICULAR FONT, STYLE, SIZE, OR COLOR.

OWNER OF U.S. REG. NO. 2,445,516.
FOR PHARMACEUTICALS, NAMELY, A PRESCRIPTION CARDIO-VASCULAR PREPARATION FOR INHIBITING ANGIOTENSIN CONVERTING ENZYME (U.S. CLS. 6, 18, 44, 46, 51 AND 52).
FIRST USE 8-0-1999; IN COMMERCE 8-0-1999.
MICHAEL KEATING, EXAMINING ATTORNEY

SN 77-141,724. PROMAX NUTRITION CORP., CONCORD, CA. FILED 3-27-2007.

XPRESS PACKS

THE MARK CONSISTS OF STANDARD CHARACTERS WITHOUT CLAIM TO ANY PARTICULAR FONT, STYLE, SIZE, OR COLOR.

NO CLAIM IS MADE TO THE EXCLUSIVE RIGHT TO USE "PACKS", APART FROM THE MARK AS SHOWN.
FOR NUTRITIONAL SUPPLEMENTS (U.S. CLS. 6, 18, 44, 46, 51 AND 52).
ANDREA K. NADELMAN, EXAMINING ATTORNEY

SN 77-141,726. PROMAX NUTRITION CORP., CONCORD, CA. FILED 3-27-2007.

XPRESS YOURSELF

THE MARK CONSISTS OF STANDARD CHARACTERS WITHOUT CLAIM TO ANY PARTICULAR FONT, STYLE, SIZE, OR COLOR.

FOR NUTRITIONAL SUPPLEMENTS (U.S. CLS. 6, 18, 44, 46, 51 AND 52).
ANDREA K. NADELMAN, EXAMINING ATTORNEY

CLASS 5—(Continued).

SN 77-142,059. GASPARI NUTRITION INC., LAKEWOOD, NJ. FILED 3-27-2007.

SOMATROPEX

THE MARK CONSISTS OF STANDARD CHARACTERS WITHOUT CLAIM TO ANY PARTICULAR FONT, STYLE, SIZE, OR COLOR.

FOR DIETARY SUPPLEMENTS (U.S. CLS. 6, 18, 44, 46, 51 AND 52).
TRACY WHITTAKER-BROWN, EXAMINING ATTORNEY

SN 77-142,069. LIGHTHOUSE COMPUTER, INC., FOUNTAIN HILLS, AZ. FILED 3-27-2007.

DESERT FOREST NUTRITIONALS

THE MARK CONSISTS OF STANDARD CHARACTERS WITHOUT CLAIM TO ANY PARTICULAR FONT, STYLE, SIZE, OR COLOR.

NO CLAIM IS MADE TO THE EXCLUSIVE RIGHT TO USE "NUTRITIONALS", APART FROM THE MARK AS SHOWN.
FOR DIETARY AND NUTRITIONAL SUPPLEMENTS; FOOD SUPPLEMENTS (U.S. CLS. 6, 18, 44, 46, 51 AND 52).
FIRST USE 11-0-2003; IN COMMERCE 11-0-2003.
KIMBERLY PERRY, EXAMINING ATTORNEY

SN 77-142,073. LIGHTHOUSE COMPUTER, INC., FOUNTAIN HILLS, AZ. FILED 3-27-2007.



NO CLAIM IS MADE TO THE EXCLUSIVE RIGHT TO USE "NUTRITIONALS", APART FROM THE MARK AS SHOWN.

THE MARK CONSISTS OF THE WORDS DESERT AND FOREST, WITH THE IMAGE OF A PLANT BLOOMING INTO A SUN, ALL OF WHICH IS ABOVE TWO LINES WITH THE WORD NUTRITIONALS IN BETWEEN THEM.
FOR DIETARY AND NUTRITIONAL SUPPLEMENTS; FOOD SUPPLEMENTS (U.S. CLS. 6, 18, 44, 46, 51 AND 52).
FIRST USE 11-0-2003; IN COMMERCE 11-0-2003.
KIMBERLY PERRY, EXAMINING ATTORNEY

CLASS 5—(Continued).

SN 77-142,081. JOEL A SACH M.D., INC., TARZANA, CA. FILED 3-28-2007.

COCOLAX

THE MARK CONSISTS OF STANDARD CHARACTERS WITHOUT CLAIM TO ANY PARTICULAR FONT, STYLE, SIZE, OR COLOR.
FOR LAXATIVES; DIETARY AND NUTRITIONAL SUPPLEMENTS (U.S. CLS. 6, 18, 44, 46, 51 AND 52).
TARAH HARDY, EXAMINING ATTORNEY

SN 77-142,098. NUTRI88, INC., ORANGE, CA. FILED 3-28-2007.

Women's BioX

THE MARK CONSISTS OF STANDARD CHARACTERS WITHOUT CLAIM TO ANY PARTICULAR FONT, STYLE, SIZE, OR COLOR.
NO CLAIM IS MADE TO THE EXCLUSIVE RIGHT TO USE "WOMEN'S", APART FROM THE MARK AS SHOWN.
FOR DIETARY AND NUTRITIONAL SUPPLEMENTS (U.S. CLS. 6, 18, 44, 46, 51 AND 52).
BARNEY CHARLON, EXAMINING ATTORNEY

SN 77-142,509. NATURAL PREMIER SUPPLEMENTS CORP., MIAMI, FL. FILED 3-28-2007.

HOOTRIM

THE MARK CONSISTS OF STANDARD CHARACTERS WITHOUT CLAIM TO ANY PARTICULAR FONT, STYLE, SIZE, OR COLOR.
FOR DIETARY SUPPLEMENTS AND DIETARY SUPPLEMENT SPRAYS (U.S. CLS. 6, 18, 44, 46, 51 AND 52).
FRED MANDIR, EXAMINING ATTORNEY

CLASS 5—(Continued).

SN 77-142,543. HOFFMANN-LA ROCHE INC., NUTLEY, NJ. FILED 3-28-2007.



OWNER OF U.S. REG. NOS. 29,994, 1,075,819 AND OTHERS.
THE COLOR(S) BLUE AND BLACK IS/ARE CLAIMED AS A FEATURE OF THE MARK.
THE MARK CONSISTS OF TWO HEXAGONS ONE ABOVE THE OTHER WITH THE WORD ROCHE APPEARING IN THE LOWER HEXAGON. THE UPPER HEXAGON IS BLUE AND THE LOWER HEXAGON IS OUTLINED IN BLACK. THE TERM ROCHE IS IN BLACK.
FOR PHARMACEUTICAL PREPARATIONS FOR THE TREATMENT OF NERVOUS SYSTEM DISORDERS (U.S. CLS. 6, 18, 44, 46, 51 AND 52).
FIRST USE 6-1-2006; IN COMMERCE 6-1-2006.
SHARON MEIER, EXAMINING ATTORNEY

SN 77-142,551. HOFFMANN-LA ROCHE INC., NUTLEY, NJ. FILED 3-28-2007.



OWNER OF U.S. REG. NOS. 29,994, 1,075,819 AND OTHERS.
THE COLOR(S) GREEN AND BLACK IS/ARE CLAIMED AS A FEATURE OF THE MARK.
THE MARK CONSISTS OF TWO HEXAGONS ONE ABOVE THE OTHER WITH THE WORD ROCHE APPEARING IN THE LOWER HEXAGON. THE UPPER HEXAGON IS GREEN AND THE LOWER HEXAGON IS OUTLINED IN BLACK. THE TERM ROCHE IS IN BLACK.
FOR PHARMACEUTICAL PREPARATIONS FOR THE TREATMENT OF VIRAL AND INFECTIOUS DISEASES AND FOR THE TREATMENT OF CANCER (U.S. CLS. 6, 18, 44, 46, 51 AND 52).
FIRST USE 8-7-2006; IN COMMERCE 8-7-2006.
SHARON MEIER, EXAMINING ATTORNEY

CLASS 5—(Continued).

SN 77-142,851. CHEMTURA CORPORATION, MIDDLEBURY, CT. FILED 3-28-2007.

TERRACLOR

THE MARK CONSISTS OF STANDARD CHARACTERS WITHOUT CLAIM TO ANY PARTICULAR FONT, STYLE, SIZE, OR COLOR.

OWNER OF U.S. REG. NO. 827,443.
FOR AGRICULTURAL CHEMICALS, NAMELY FUNGICIDES, MITICIDES, HERBICIDES AND INSECTICIDES (U.S. CLS. 6, 18, 44, 46, 51 AND 52).
FIRST USE 11-11-1954; IN COMMERCE 11-11-1954.
MATTHEW PAPPAS, EXAMINING ATTORNEY

SN 77-143,057. KERDOON, DAVID, LOS ANGELES, CA. FILED 3-28-2007.

MIXLIXIR

THE MARK CONSISTS OF STANDARD CHARACTERS WITHOUT CLAIM TO ANY PARTICULAR FONT, STYLE, SIZE, OR COLOR.

FOR DIETARY SUPPLEMENTAL DRINKS (U.S. CLS. 6, 18, 44, 46, 51 AND 52).
FIRST USE 6-7-2003; IN COMMERCE 6-7-2003.
LAURA KOVALSKY, EXAMINING ATTORNEY

SN 77-143,924. KENTUCKY PERFORMANCE PRODUCTS, LLC, VERSAILLES, KY. FILED 3-29-2007.

ENDUREXTRA

THE MARK CONSISTS OF STANDARD CHARACTERS WITHOUT CLAIM TO ANY PARTICULAR FONT, STYLE, SIZE, OR COLOR.

FOR NON-MEDICATED ANIMAL FEED SUPPLEMENTS (U.S. CLS. 6, 18, 44, 46, 51 AND 52).
GEORGIA CARTY, EXAMINING ATTORNEY

CLASS 5—(Continued).

SN 77-144,233. APPLERA CORPORATION, FOSTER CITY, CA. FILED 3-29-2007.

APPLERA

THE MARK CONSISTS OF STANDARD CHARACTERS WITHOUT CLAIM TO ANY PARTICULAR FONT, STYLE, SIZE, OR COLOR.

OWNER OF U.S. REG. NO. 3,130,445.
FOR BIOLOGICAL AND CHEMICAL PREPARATIONS AND REAGENTS FOR MEDICAL OR VETERINARY USE; DIAGNOSTIC REAGENTS FOR CLINICAL OR MEDICAL LABORATORY USE; DIAGNOSTIC REAGENTS FOR IN VITRO USE IN BIOCHEMISTRY, CLINICAL CHEMISTRY AND MICROBIOLOGY; MEDICAL DIAGNOSTIC REAGENTS; MEDICAL DIAGNOSTIC REAGENTS AND ASSAYS FOR TESTING OF BODY FLUIDS; NUCLEIC ACID SEQUENCES AND CHEMICAL REAGENTS FOR MEDICAL AND VETERINARY PURPOSES; REAGENTS FOR MEDICAL USE (U.S. CLS. 6, 18, 44, 46, 51 AND 52).

KEVIN DINALLO, EXAMINING ATTORNEY

SN 77-146,645. BRAND, CHARLES, BOULDER, CO. FILED 4-2-2007.

Legendary Herbs

THE MARK CONSISTS OF STANDARD CHARACTERS WITHOUT CLAIM TO ANY PARTICULAR FONT, STYLE, SIZE, OR COLOR.

NO CLAIM IS MADE TO THE EXCLUSIVE RIGHT TO USE "HERBS", APART FROM THE MARK AS SHOWN.
FOR DIETARY AND NUTRITIONAL SUPPLEMENTS (U.S. CLS. 6, 18, 44, 46, 51 AND 52).
TEJBIR SINGH, EXAMINING ATTORNEY

SN 77-147,208. PROMAX NUTRITION CORP., CONCORD, CA. FILED 4-3-2007.

PERFORMANCE THROUGH NUTRITION

THE MARK CONSISTS OF STANDARD CHARACTERS WITHOUT CLAIM TO ANY PARTICULAR FONT, STYLE, SIZE, OR COLOR.

FOR NUTRITIONAL SUPPLEMENTS (U.S. CLS. 6, 18, 44, 46, 51 AND 52).
ANDREA K. NADELMAN, EXAMINING ATTORNEY

CLASS 5—(Continued).

SN 77-149,720. JOHNSON & JOHNSON, NEW BRUNSWICK, NJ. FILED 4-5-2007.

CLASS 5—(Continued).

SN 77-152,902. ELI LILLY AND COMPANY, INDIANAPOLIS, IN. FILED 4-10-2007.

OVULE

THE MARK CONSISTS OF STANDARD CHARACTERS WITHOUT CLAIM TO ANY PARTICULAR FONT, STYLE, SIZE, OR COLOR.

OWNER OF U.S. REG. NO. 2,768,725.
FOR VAGINAL MOISTURIZERS (U.S. CLS. 6, 18, 44, 46, 51 AND 52).
STEVEN JACKSON, EXAMINING ATTORNEY



SN 77-149,901. DISNEY ENTERPRISES, INC., BURBANK, CA. FILED 4-5-2007.

EFFIENTT

WHERE IMAGINATION BEGINS

THE MARK CONSISTS OF STANDARD CHARACTERS WITHOUT CLAIM TO ANY PARTICULAR FONT, STYLE, SIZE, OR COLOR.

FOR BABY FOOD, POWDERED BABY MILK; ADHESIVE BANDAGES, VITAMIN SUPPLEMENTS, AND FIRST AID KITS (U.S. CLS. 6, 18, 44, 46, 51 AND 52).
BRIDGETT SMITH, EXAMINING ATTORNEY



SN 77-150,867. OLUFEMI, ADELAKUN, MIAMI, FL. FILED 4-6-2007.

MENTHOREX

THE MARK CONSISTS OF STANDARD CHARACTERS WITHOUT CLAIM TO ANY PARTICULAR FONT, STYLE, SIZE, OR COLOR.

FOR PRE- MOISTENED MEDICATED WIPES; PRE-MOISTENED MEDICATED TISSUE; MEDICATED PRE-MOISTENED TOWELETES; SANITARY NAPKIN (U.S. CLS. 6, 18, 44, 46, 51 AND 52).
CAROL SPILS, EXAMINING ATTORNEY

THE MARK CONSISTS OF STANDARD CHARACTERS WITHOUT CLAIM TO ANY PARTICULAR FONT, STYLE, SIZE, OR COLOR.

FOR PHARMACEUTICAL PREPARATIONS, NAMELY, PHARMACEUTICAL PREPARATIONS FOR THE TREATMENT OF ALCOHOL USE DISORDERS, ANXIETY, BONE AND SKELETAL DISEASES AND DISORDERS, BLOOD DISEASES AND DISORDERS, CANCER, CARDIOVASCULAR DISEASES, CENTRAL NERVOUS SYSTEM DISEASES AND DISORDERS, DIABETES, DIABETIC NEUROPATHY, ENDOCRINE DISEASES AND DISORDERS, GASTROINTESTINAL DISEASES AND DISORDERS, HORMONAL DISEASES AND DISORDERS, INFLAMMATION AND INFLAMMATORY DISEASES AND DISORDERS, LIVER DISEASES AND DISORDERS, KIDNEY DISEASES AND DISORDERS, NEURODEGENERATIVE DISEASES AND DISORDERS, NEUROLOGICAL DISORDERS, OBESITY, OPHTHALMOLOGIC CONDITIONS AND DISEASES, PAIN, PERIPHERAL NERVOUS SYSTEM DISEASES AND DISORDERS, REPRODUCTIVE SYSTEM DISEASES AND DISORDERS, SEXUAL DYSFUNCTION, UROLOGICAL DISORDERS, DYSLIPIDEMIA, SLEEP DISORDERS, MIGRAINES, METABOLIC DISEASES AND DISORDERS; PHARMACEUTICAL PREPARATIONS FOR THE PREVENTION OF DIABETES; ANTI-PSYCHOTIC AGENTS; AND ANTIDEPRESSANTS (U.S. CLS. 6, 18, 44, 46, 51 AND 52).
SANI KHOURI, EXAMINING ATTORNEY

CLASS 5—(Continued).

SN 77-152,933. ELI LILLY AND COMPANY, INDIANAPOLIS, IN. FILED 4-10-2007.

REDDEVANT

THE MARK CONSISTS OF STANDARD CHARACTERS WITHOUT CLAIM TO ANY PARTICULAR FONT, STYLE, SIZE, OR COLOR.

FOR PHARMACEUTICAL PREPARATIONS, NAMELY, PHARMACEUTICAL PREPARATIONS FOR THE TREATMENT OF ALCOHOL USE DISORDERS, ANXIETY, BONE AND SKELETAL DISEASES AND DISORDERS, BLOOD DISEASES AND DISORDERS, CANCER, CARDIOVASCULAR DISEASES, CENTRAL NERVOUS SYSTEM DISEASES AND DISORDERS, DIABETES, DIABETIC NEUROPATHY, ENDOCRINE DISEASES AND DISORDERS, GASTROINTESTINAL DISEASES AND DISORDERS, HORMONAL DISEASES AND DISORDERS, INFLAMMATION AND INFLAMMATORY DISEASES AND DISORDERS, LIVER DISEASES AND DISORDERS, KIDNEY DISEASES AND DISORDERS, NEURODEGENERATIVE DISEASES AND DISORDERS, NEUROLOGICAL DISORDERS, OBESITY, OPHTHALMOLOGIC CONDITIONS AND DISEASES, PAIN, PERIPHERAL NERVOUS SYSTEM DISEASES AND DISORDERS, REPRODUCTIVE SYSTEM DISEASES AND DISORDERS, SEXUAL DYSFUNCTION, UROLOGICAL DISORDERS, DYSLIPIDEMIA, SLEEP DISORDERS, MIGRAINES, METABOLIC DISEASES AND DISORDERS; PHARMACEUTICAL PREPARATIONS FOR THE PREVENTION OF DIABETES; ANTI-PSYCHOTIC AGENTS; AND ANTIDEPRESSANTS (U.S. CLS. 6, 18, 44, 46, 51 AND 52).

SANI KHOURI, EXAMINING ATTORNEY

CLASS 5—(Continued).

SN 77-152,937. ELI LILLY AND COMPANY, INDIANAPOLIS, IN. FILED 4-10-2007.

EFFYENT

THE MARK CONSISTS OF STANDARD CHARACTERS WITHOUT CLAIM TO ANY PARTICULAR FONT, STYLE, SIZE, OR COLOR.

FOR PHARMACEUTICAL PREPARATIONS, NAMELY, PHARMACEUTICAL PREPARATIONS FOR THE TREATMENT OF ALCOHOL USE DISORDERS, ANXIETY, BONE AND SKELETAL DISEASES AND DISORDERS, BLOOD DISEASES AND DISORDERS, CANCER, CARDIOVASCULAR DISEASES, CENTRAL NERVOUS SYSTEM DISEASES AND DISORDERS, DIABETES, DIABETIC NEUROPATHY, ENDOCRINE DISEASES AND DISORDERS, GASTROINTESTINAL DISEASES AND DISORDERS, HORMONAL DISEASES AND DISORDERS, INFLAMMATION AND INFLAMMATORY DISEASES AND DISORDERS, LIVER DISEASES AND DISORDERS, KIDNEY DISEASES AND DISORDERS, NEURODEGENERATIVE DISEASES AND DISORDERS, NEUROLOGICAL DISORDERS, OBESITY, OPHTHALMOLOGIC CONDITIONS AND DISEASES, PAIN, PERIPHERAL NERVOUS SYSTEM DISEASES AND DISORDERS, REPRODUCTIVE SYSTEM DISEASES AND DISORDERS, SEXUAL DYSFUNCTION, UROLOGICAL DISORDERS, DYSLIPIDEMIA, SLEEP DISORDERS, MIGRAINES, METABOLIC DISEASES AND DISORDERS; PHARMACEUTICAL PREPARATIONS FOR THE PREVENTION OF DIABETES; ANTI-PSYCHOTIC AGENTS; AND ANTIDEPRESSANTS (U.S. CLS. 6, 18, 44, 46, 51 AND 52).

SANI KHOURI, EXAMINING ATTORNEY

SN 77-153,342. THE PROCTER & GAMBLE COMPANY, CINCINNATI, OH. FILED 4-10-2007.

FEBREZE TO GO

THE MARK CONSISTS OF STANDARD CHARACTERS WITHOUT CLAIM TO ANY PARTICULAR FONT, STYLE, SIZE, OR COLOR.

FOR DEODORANTS FOR CLOTHING OR TEXTILES (U.S. CLS. 6, 18, 44, 46, 51 AND 52).

GEOFFREY FOSDICK, EXAMINING ATTORNEY

CLASS 5—(Continued).

SN 77-156,703. JUDY SINGER, INC., LOS ANGELES, CA. FILED 4-13-2007.

PURE, ALL-NATURAL
PRODUCTS. PURE,
ALL-NATURAL RESULTS.

THE MARK CONSISTS OF STANDARD CHARACTERS WITHOUT CLAIM TO ANY PARTICULAR FONT, STYLE, SIZE, OR COLOR.

NO CLAIM IS MADE TO THE EXCLUSIVE RIGHT TO USE "PURE, ALL-NATURAL PRODUCTS", APART FROM THE MARK AS SHOWN.

FOR DIETARY AND NUTRITIONAL SUPPLEMENTS; HERBAL SUPPLEMENTS; MINERAL SUPPLEMENTS; PAIN RELIEF MEDICATION; VITAMIN SUPPLEMENTS (U.S. CLS. 6, 18, 44, 46, 51 AND 52).

FIRST USE 5-21-2006; IN COMMERCE 5-21-2006.
GENE MACIOL, EXAMINING ATTORNEY



SN 77-157,378. VEDCO, INC., ST. JOSEPH, MO. FILED 4-16-2007.

NOVACEF

THE MARK CONSISTS OF STANDARD CHARACTERS WITHOUT CLAIM TO ANY PARTICULAR FONT, STYLE, SIZE, OR COLOR.

FOR VETERINARY PHARMACEUTICAL PREPARATIONS, NAMELY, ANTIBIOTICS (U.S. CLS. 6, 18, 44, 46, 51 AND 52).

DAVID TOOLEY, EXAMINING ATTORNEY



SN 77-157,431. SYNERFIED CAPITAL INC., MIAMI, FL. FILED 4-16-2007.

NodorO

THE MARK CONSISTS OF NODORO WITH THE N AND O INSIDE SQUARES.

FOR ANTIBIOTIC CREAMS; ANTIFUNGAL CREAMS FOR MEDICAL USE; FUNGAL MEDICATIONS (U.S. CLS. 6, 18, 44, 46, 51 AND 52).

BRIAN PINO, EXAMINING ATTORNEY

CLASS 5—(Continued).

SN 77-159,567. CHOXTICA, INC., TAMPA, FL. FILED 4-18-2007.

CHOXIDANT

THE MARK CONSISTS OF STANDARD CHARACTERS WITHOUT CLAIM TO ANY PARTICULAR FONT, STYLE, SIZE, OR COLOR.

FOR NUTRITIONAL SUPPLEMENT FOR DRINK MIXES (U.S. CLS. 6, 18, 44, 46, 51 AND 52).

WON TEAK OH, EXAMINING ATTORNEY



SN 77-163,799. GLAXOSMITHKLINE BIOLOGICALS, S.A., RIXENSART, BELGIUM, FILED 4-24-2007.

VAMMRIX

THE MARK CONSISTS OF STANDARD CHARACTERS WITHOUT CLAIM TO ANY PARTICULAR FONT, STYLE, SIZE, OR COLOR.

OWNER OF ERPN CMNTY TM OFC REG. NO. 002946200, DATED 11-22-2004, EXPIRES 11-25-2012.

FOR VACCINES FOR HUMAN USE (U.S. CLS. 6, 18, 44, 46, 51 AND 52).

BRENDAN REGAN, EXAMINING ATTORNEY



SN 77-164,076. SCHERING CORPORATION, KENILWORTH, NJ. FILED 4-24-2007.



THE MARK CONSISTS OF CLOUDS, STARS, AND MOON.

FOR ANTIHISTAMINE PREPARATION, DECONGESTANT PREPARATION, ANTIHISTAMINE/DECONGESTANT PREPARATION, AND ANTIHISTAMINE/DECONGESTANT/ANALGESIC PREPARATION (U.S. CLS. 6, 18, 44, 46, 51 AND 52).

ANGELA GAW, EXAMINING ATTORNEY

CLASS 5—(Continued).

SN 77-164,192. RELIANT PHARMACEUTICALS, INC., LIBERTY CORNER, NJ. FILED 4-24-2007.

POWERFUL. PROVEN. PURE.

THE MARK CONSISTS OF STANDARD CHARACTERS WITHOUT CLAIM TO ANY PARTICULAR FONT, STYLE, SIZE, OR COLOR.

FOR PHARMACEUTICAL PREPARATIONS, NAMELY VITAMIN PREPARATIONS AND NUTRACEUTICALS THAT CONTAIN FATTY ACIDS USED TO TREAT CARDIOVASCULAR ILLNESSES; NUTRACEUTICALS FOR THE TREATMENT OF CARDIOVASCULAR ILLNESS; VITAMIN PREPARATIONS (U.S. CLS. 6, 18, 44, 46, 51 AND 52).

LESLIE RICHARDS, EXAMINING ATTORNEY

SN 77-164,206. RELIANT PHARMACEUTICALS, INC., LIBERTY CORNER, NJ. FILED 4-24-2007.

PROVEN. POWERFUL. PURE

THE MARK CONSISTS OF STANDARD CHARACTERS WITHOUT CLAIM TO ANY PARTICULAR FONT, STYLE, SIZE, OR COLOR.

FOR PHARMACEUTICAL PREPARATIONS, NAMELY VITAMIN PREPARATIONS AND NUTRACEUTICALS THAT CONTAIN FATTY ACIDS USED TO TREAT CARDIOVASCULAR ILLNESSES; NUTRACEUTICALS FOR THE TREATMENT OF CARDIOVASCULAR ILLNESS; VITAMIN PREPARATIONS (U.S. CLS. 6, 18, 44, 46, 51 AND 52).

LESLIE RICHARDS, EXAMINING ATTORNEY

SN 77-166,263. GLAXOSMITHKLINE BIOLOGICALS, S.A., RIXENSART, BELGIUM, FILED 4-26-2007.

COHIBRIX

THE MARK CONSISTS OF STANDARD CHARACTERS WITHOUT CLAIM TO ANY PARTICULAR FONT, STYLE, SIZE, OR COLOR.

FOR VACCINES FOR HUMAN USE (U.S. CLS. 6, 18, 44, 46, 51 AND 52).

BRENDAN REGAN, EXAMINING ATTORNEY

CLASS 5—(Continued).

SN 77-170,779. VITACOST.COM INC., DEERFIELD BEACH, FL. FILED 5-2-2007.



NO CLAIM IS MADE TO THE EXCLUSIVE RIGHT TO USE "C", APART FROM THE MARK AS SHOWN.

THE MARK CONSISTS OF THE WORD ADVAN FOLLOWED BY THE LETTER C IN A CIRCLE.

FOR DIETARY AND NUTRITIONAL SUPPLEMENTS FEATURING VITAMIN C (U.S. CLS. 6, 18, 44, 46, 51 AND 52).

FIRST USE 5-2-2007; IN COMMERCE 5-2-2007.

JOHN KELLY, EXAMINING ATTORNEY

SN 77-172,498. SEPRACOR INC., MARLBOROUGH, MA. FILED 5-3-2007.



FOR PHARMACEUTICAL PREPARATIONS AND SUBSTANCES FOR USE IN TREATING RESPIRATORY CONDITIONS AND FOR THE TREATMENT OF CHRONIC OBSTRUCTIVE PULMONARY DISEASE (U.S. CLS. 6, 18, 44, 46, 51 AND 52).

SUSAN RICHARDS, EXAMINING ATTORNEY

SN 77-173,191. NUTRI-PET RESEARCH, INC., MANALAPAN, NJ. FILED 5-4-2007.

NUPRO

THE MARK CONSISTS OF STANDARD CHARACTERS WITHOUT CLAIM TO ANY PARTICULAR FONT, STYLE, SIZE, OR COLOR.

FOR NUTRITIONAL SUPPLEMENTS FOR PETS (U.S. CLS. 6, 18, 44, 46, 51 AND 52).

FIRST USE 2-0-1989; IN COMMERCE 4-1-1990.

ELI HELLMAN, EXAMINING ATTORNEY

CLASS 5—(Continued).

SN 77-174,603. OGLESBY, MICHAEL A., MEMPHIS, TN.
FILED 5-7-2007.



THE COLOR(S) RED AND WHITE YELLOW AND BLACK IS/ARE CLAIMED AS A FEATURE OF THE MARK.

THE MARK CONSISTS OF THE MARK CONSISTS OF A RED CIRCLE WITH A YELLOW LINE THROUGH IT WITH A BLACK MARTIAL ARTS FIGURE AGAINST A YELLOW BACKGROUND WITH THE WORDS KUNG FU DONG IN WHITE WITH YELLOW STARS ON THE TOP OF THE CIRCLE AND YELLOW STARS AT THE BOTTOM SEPARATED BY A STAR IN WHITE WITH ONE RED STAR ON THE LEFT SIDE OF THE YELLOW LINE.

FOR NUTRITIONAL SUPPLEMENTS (U.S. CLS. 6, 18, 44, 46, 51 AND 52).
GINA HAYES, EXAMINING ATTORNEY

SN 77-179,243. VEDCO, INC., ST. JOSEPH, MO. FILED 5-11-2007.

ELASTI-VED

THE MARK CONSISTS OF STANDARD CHARACTERS WITHOUT CLAIM TO ANY PARTICULAR FONT, STYLE, SIZE, OR COLOR.

FOR ELASTIC ADHESIVE TAPE FOR VETERINARY USE (U.S. CLS. 6, 18, 44, 46, 51 AND 52).

FIRST USE 11-30-2006; IN COMMERCE 11-30-2006.

DAVID TOOLEY, EXAMINING ATTORNEY

SN 77-180,443. SYNGENTA LIMITED, GUILDFORD, SURREY, UNITED KINGDOM, FILED 5-14-2007.

QUADRIS TRIO

THE MARK CONSISTS OF STANDARD CHARACTERS WITHOUT CLAIM TO ANY PARTICULAR FONT, STYLE, SIZE, OR COLOR.

FOR PESTICIDES, HERBICIDES, FUNGICIDES, INSECTICIDES; PREPARATIONS FOR DESTROYING VERMIN, ALL FOR AGRICULTURAL USE (U.S. CLS. 6, 18, 44, 46, 51 AND 52).

KEVON CHISOLM, EXAMINING ATTORNEY

CLASS 5—(Continued).

SN 77-180,527. NEUROGESX, INC., SAN CARLOS, CA.
FILED 5-14-2007.

DRUVERO

THE MARK CONSISTS OF STANDARD CHARACTERS WITHOUT CLAIM TO ANY PARTICULAR FONT, STYLE, SIZE, OR COLOR.

FOR TRANSDERMAL PATCH CONTAINING PHARMACEUTICAL PREPARATIONS TO TREAT PAIN; PHARMACEUTICAL PREPARATIONS FOR USE IN PAIN TREATMENT; ANALGESICS; TOPICAL ANESTHETICS (U.S. CLS. 6, 18, 44, 46, 51 AND 52).

LYDIA BELZER, EXAMINING ATTORNEY

SN 77-180,704. NEUROGESX, INC., SAN CARLOS, CA.
FILED 5-14-2007.

PELCOVA

THE MARK CONSISTS OF STANDARD CHARACTERS WITHOUT CLAIM TO ANY PARTICULAR FONT, STYLE, SIZE, OR COLOR.

FOR TRANSDERMAL PATCH CONTAINING PHARMACEUTICAL PREPARATIONS TO TREAT PAIN; PHARMACEUTICAL PREPARATIONS FOR USE IN PAIN TREATMENT; ANALGESICS; TOPICAL ANESTHETICS (U.S. CLS. 6, 18, 44, 46, 51 AND 52).

LYDIA BELZER, EXAMINING ATTORNEY

SN 77-182,139. BAYER AKTIENGESELLSCHAFT, LEVERKUSEN-BAYERWERK, FED REP GERMANY, FILED 5-16-2007.

WOLVERINE

THE MARK CONSISTS OF STANDARD CHARACTERS WITHOUT CLAIM TO ANY PARTICULAR FONT, STYLE, SIZE, OR COLOR.

FOR PREPARATIONS FOR KILLING WEEDS AND DESTROYING VERMIN; INSECTICIDES, HERBICIDES, FUNGICIDES (U.S. CLS. 6, 18, 44, 46, 51 AND 52).

THEODORE MCBRIDE, EXAMINING ATTORNEY

CLASS 5—(Continued).

SN 77-184,574. MARTEX NUTRITION,INC, MIAMI, FL. FILED 5-18-2007.



NO CLAIM IS MADE TO THE EXCLUSIVE RIGHT TO USE 100% WHEY, APART FROM THE MARK AS SHOWN. THE COLOR(S) ORANGE, YELLOW, GREY AND BLUE IS/ARE CLAIMED AS A FEATURE OF THE MARK.

THE COLOR YELLOW APPEARS IN THE NUMBER "100%." THE COLORS ORANGE AND YELLOW APPEAR IN THE WORD "WHEY;" THE COLOR ORANGE APPEARS IN THE WORD "GEN;" THE COLORS GREY AND BLUE APPEAR IN THE CIRCULAR SPHERE DESIGN.

FOR POWDERED NUTRITIONAL SUPPLEMENT DRINK MIX; DIETARY DRINK MIX FOR USE AS A MEAL REPLACEMENT; DIETARY SUPPLEMENTS; DIETARY SUPPLEMENTS FOR HUMAN CONSUMPTION; MEAL REPLACEMENT AND DIETARY SUPPLEMENT DRINK MIXES (U.S. CLS. 6, 18, 44, 46, 51 AND 52).

FIRST USE 4-20-2007; IN COMMERCE 4-20-2007.
GINA HAYES, EXAMINING ATTORNEY

SN 77-185,041. MARTEX NUTRITION,INC, MIAMI, FL. FILED 5-18-2007.



NO CLAIM IS MADE TO THE EXCLUSIVE RIGHT TO USE RAPID WEIGHTLOSS SYSTEM AND THERMO GENETICS, APART FROM THE MARK AS SHOWN.

THE COLOR(S) YELLOW, ORANGE, BLACK, GREEN, BROWN AND WHITE IS/ARE CLAIMED AS A FEATURE OF THE MARK.

THE COLORS ORANGE AND YELLOW APPEAR IN THE WORDS "THERMO GENETICS," THE COLOR YELLOW APPEARS IN THE WORDING "RAPID WEIGHTLOSS SYSTEM;" THE COLOR BLACK APPEARS IN THE BACKGROUND OF THE RECTANGLE SURROUNDING THE MARK; THE COLOR GREEN APPEARS AS THE BACKGROUND COLOR ON THE INSIDE OF THE CAPSULE; THE COLOR WHITE APPEARS AROUND THE BORDER OF THE CAPSULE, THE BORDER OF THE HEXAGON DESIGN WITHIN THE CAPSULE, AS A LINE GOING THROUGH THE CAPSULE, AND AS A SPACE ON THE RIGHT OF THE CAPSULE; THE COLOR WHITE ALSO APPEARS IN THE OUTLINE OF THE STYLIZED LETTER "G" AND THE WORD "TECH;" THE COLOR BROWN APPEARS AS A LIQUID SHOWN WITHIN THE DESIGN OF THE CAPSULE.

FOR DIETARY AND NUTRITIONAL SUPPLEMENTS; DIETARY FOOD SUPPLEMENTS; DIETARY SUPPLEMENTS; DIETARY SUPPLEMENTS FOR HUMAN CONSUMPTION; NUTRITIONAL SUPPLEMENTS (U.S. CLS. 6, 18, 44, 46, 51 AND 52).

FIRST USE 4-20-2007; IN COMMERCE 4-20-2007.
GINA HAYES, EXAMINING ATTORNEY

CLASS 5—(Continued).

SN 77-186,077. SCHERING-PLOUGH HEALTHCARE PRODUCTS, INC., MEMPHIS, TN. FILED 5-21-2007.

DR. SCHOLL'S

THE MARK CONSISTS OF STANDARD CHARACTERS WITHOUT CLAIM TO ANY PARTICULAR FONT, STYLE, SIZE, OR COLOR.

OWNER OF U.S. REG. NOS. 512,484, 2,017,964 AND OTHERS.

FOR PHARMACEUTICAL PREPARATION FOR THE REMOVAL OF SKIN TAGS (U.S. CLS. 6, 18, 44, 46, 51 AND 52).

PRISCILLA MILTON, EXAMINING ATTORNEY

SN 77-189,141. RELIANT PHARMACEUTICALS, INC., LIBERTY CORNER, NJ. FILED 5-24-2007.

LOVAZA

THE MARK CONSISTS OF STANDARD CHARACTERS WITHOUT CLAIM TO ANY PARTICULAR FONT, STYLE, SIZE, OR COLOR.

FOR PHARMACEUTICAL PREPARATIONS FOR THE TREATMENT OF CARDIOVASCULAR CONDITIONS (U.S. CLS. 6, 18, 44, 46, 51 AND 52).

LESLIE RICHARDS, EXAMINING ATTORNEY

SN 77-190,359. SCHERING-PLOUGH HEALTHCARE PRODUCTS, INC., MEMPHIS, TN. FILED 5-25-2007.



OWNER OF U.S. REG. NOS. 512,484, 2,771,386 AND OTHERS.

THE MARK CONSISTS OF DR. SCHOLL'S IN COMPLETELY SHADED OVAL WITHIN OVAL.

FOR PHARMACEUTICAL PREPARATION FOR THE REMOVAL OF SKIN TAGS (U.S. CLS. 6, 18, 44, 46, 51 AND 52).

PRISCILLA MILTON, EXAMINING ATTORNEY

CLASS 5—(Continued).

SN 77-193,906. SCHERING-PLOUGH HEALTHCARE PRODUCTS, INC., MEMPHIS, TN. FILED 5-31-2007.



OWNER OF U.S. REG. NOS. 511,379, 2,703,163 AND OTHERS.
THE MARK CONSISTS OF DR. SCHOLL'S IN COMPLETELY SHADED OVAL WITHIN OVAL.
FOR PHARMACEUTICAL PREPARATION FOR USE IN THE REMOVAL OF WARTS (U.S. CLS. 6, 18, 44, 46, 51 AND 52).
FIRST USE 2-27-2004; IN COMMERCE 2-27-2004.
PRISCILLA MILTON, EXAMINING ATTORNEY

SN 77-193,920. SCHERING-PLOUGH HEALTHCARE PRODUCTS, INC., MEMPHIS, TN. FILED 5-31-2007.

DR. SCHOLL'S

THE MARK CONSISTS OF STANDARD CHARACTERS WITHOUT CLAIM TO ANY PARTICULAR FONT, STYLE, SIZE, OR COLOR.
OWNER OF U.S. REG. NOS. 511,379, 512,484 AND 1,255,028.
FOR PHARMACEUTICAL PREPARATION FOR USE IN THE REMOVAL OF WARTS (U.S. CLS. 6, 18, 44, 46, 51 AND 52).
FIRST USE 2-27-2004; IN COMMERCE 2-27-2004.
PRISCILLA MILTON, EXAMINING ATTORNEY

SN 77-194,100. STRYKER CORPORATION, KALAMAZOO, MI. FILED 5-31-2007.

VERTAPLEX

THE MARK CONSISTS OF STANDARD CHARACTERS WITHOUT CLAIM TO ANY PARTICULAR FONT, STYLE, SIZE, OR COLOR.
OWNER OF U.S. REG. NO. 2,851,972.
FOR BONE CEMENT FOR MEDICAL PURPOSES (U.S. CLS. 6, 18, 44, 46, 51 AND 52).
DAVID C. REIHNER, EXAMINING ATTORNEY

CLASS 5—(Continued).

SN 77-204,635. HOFFMANN-LA ROCHE INC., NUTLEY, NJ. FILED 6-13-2007.



OWNER OF U.S. REG. NOS. 29,994, 1,075,819 AND OTHERS.
THE COLOR(S) GREEN AND BLACK IS/ARE CLAIMED AS A FEATURE OF THE MARK.
THE MARK CONSISTS OF TWO HEXAGONS ONE ABOVE THE OTHER WITH THE WORD ROCHE APPEARING IN THE LOWER HEXAGON. THE UPPER HEXAGON IS GREEN AND THE LOWER HEXAGON IS OUTLINED IN BLACK. THE TERM ROCHE IS IN BLACK.
FOR PHARMACEUTICAL PREPARATIONS FOR TREATING DIABETES (U.S. CLS. 6, 18, 44, 46, 51 AND 52).
SHARON MEIER, EXAMINING ATTORNEY

SN 77-204,636. HOFFMANN-LA ROCHE INC., NUTLEY, NJ. FILED 6-13-2007.



OWNER OF U.S. REG. NOS. 29,994, 1,075,819 AND OTHERS.
THE COLOR(S) GREEN AND BLACK IS/ARE CLAIMED AS A FEATURE OF THE MARK.
THE MARK CONSISTS OF TWO HEXAGONS ONE ABOVE THE OTHER WITH THE WORD ROCHE APPEARING IN THE LOWER HEXAGON. THE UPPER HEXAGON IS GREEN AND THE LOWER HEXAGON IS OUTLINED IN BLACK. THE TERM ROCHE IS IN BLACK.
FOR PHARMACEUTICAL PREPARATION USED FOR WEIGHT LOSS AND THE LONG TERM MANAGEMENT OF WEIGHT (U.S. CLS. 6, 18, 44, 46, 51 AND 52).
FIRST USE 2-14-2007; IN COMMERCE 2-14-2007.
SHARON MEIER, EXAMINING ATTORNEY

CLASS 5—(Continued).

SN 77-209,039. VEDCO, INC., ST. JOSEPH, MO. FILED 6-18-2007.

ION-AID

THE MARK CONSISTS OF STANDARD CHARACTERS WITHOUT CLAIM TO ANY PARTICULAR FONT, STYLE, SIZE, OR COLOR.

FOR ORAL ELECTROLYTE FOR VETERINARY USE (U.S. CLS. 6, 18, 44, 46, 51 AND 52).
DAVID TOOLEY, EXAMINING ATTORNEY



SN 77-211,554. CSL BEHRING L.L.C., KING OF PRUSSIA, PA. FILED 6-21-2007.

BE WELL. PASS IT ON

THE MARK CONSISTS OF STANDARD CHARACTERS WITHOUT CLAIM TO ANY PARTICULAR FONT, STYLE, SIZE, OR COLOR.

FOR INFLUENZA VACCINES FOR HUMAN USE (U.S. CLS. 6, 18, 44, 46, 51 AND 52).
FRANK LATTUCA, EXAMINING ATTORNEY



SN 78-181,529. CLEAR PRODUCTS, INC., SAN DIEGO, CA. FILED 11-4-2002.

CLEAR MIGRAINE

NO CLAIM IS MADE TO THE EXCLUSIVE RIGHT TO USE "MIGRAINE", APART FROM THE MARK AS SHOWN. FOR HERBAL SUPPLEMENTS FOR THE RELIEF OF MIGRAINE HEADACHES (U.S. CLS. 6, 18, 44, 46, 51 AND 52).
JORDAN BAKER, EXAMINING ATTORNEY

CLASS 5—(Continued).

SN 78-341,503. SHAMAN PHYTOCEUTICALS, LLC, CHATTANOOGA, TN. FILED 12-16-2003.

FLEX EZ

THE MARK CONSISTS OF STANDARD CHARACTERS WITHOUT CLAIM TO ANY PARTICULAR FONT, STYLE, SIZE, OR COLOR.

FOR ANALGESICS, NAMELY, BOTANICAL OINTMENTS FOR MUSCLE AND JOINT PAIN IN HUMANS (U.S. CLS. 6, 18, 44, 46, 51 AND 52).
FIRST USE 11-1-2003; IN COMMERCE 11-1-2003.
TINA L. SNAPP, EXAMINING ATTORNEY



SN 78-370,711. BIOTECH INTERNATIONAL CORPORATION DBA BIOTECH CORPORATION, GLASTONBURY, CT. FILED 2-19-2004.

MIGRAVIN

THE MARK CONSISTS OF STANDARD CHARACTERS WITHOUT CLAIM TO ANY PARTICULAR FONT, STYLE, SIZE, OR COLOR.

FOR DIETARY SUPPLEMENTS FOR THE TREATMENT AND ALLEVIATION OF PAIN CAUSED BY COMMON AND MIGRAINE HEADACHES (U.S. CLS. 6, 18, 44, 46, 51 AND 52).
CURTIS FRENCH, EXAMINING ATTORNEY

CLASS 5—(Continued).

SN 78-389,053. NUTRACEA, EL DORADO HILLS, CA. FILED 3-23-2004.

NutraPhoods

THE MARK CONSISTS OF STANDARD CHARACTERS WITHOUT CLAIM TO ANY PARTICULAR FONT, STYLE, SIZE, OR COLOR.

FOR NUTRITIONAL SUPPLEMENTS AND DIETARY SUPPLEMENTS (U.S. CLS. 6, 18, 44, 46, 51 AND 52).
JENNIFER KRISP, EXAMINING ATTORNEY

CLASS 5—(Continued).

SN 78-773,932. APC COMPANY, INC., ANKENY, IA. FILED 12-15-2005.



THE COLOR(S) GREEN AND BLUE IS/ARE CLAIMED AS A FEATURE OF THE MARK.

THE MARK CONSISTS OF STYLIZED LETTERS "APC" IN GREEN WITH 2 OVERLAPPING, PARTIALLY CIRCULAR DESIGNS. THE LEFT CIRCULAR IS GREEN AND THE RIGHT CIRCULAR IS BLUE.

FOR ANIMAL FEED ADDITIVES FOR NUTRITIONAL PURPOSES, NAMELY, ANIMAL BLOOD, SERUM AND PLASMA THAT DOES NOT CONTAIN PLATELETS, ALL FOR USE AS FEED INGREDIENT (U.S. CLS. 6, 18, 44, 46, 51 AND 52).

FIRST USE 11-4-2005; IN COMMERCE 11-4-2005.
ANDREA SAUNDERS, EXAMINING ATTORNEY

SN 78-492,265. FX LIFE SCIENCES INTERNATIONAL GMBH, 6301 ZUG, SWITZERLAND, FILED 9-30-2004.



NO CLAIM IS MADE TO THE EXCLUSIVE RIGHT TO USE "CERTIFIED", APART FROM THE MARK AS SHOWN.

FOR ALL NATURAL HEALTH FOOD SUPPLEMENTS NAMELY, HEALTH SUPPLEMENTS FROM HERBAL, ANIMAL AND FISH SOURCES WHICH ARE IN THE FORM OF GROUND OR DRY PRODUCT, IN SOLUTION OR AS AN EXTRACT OF HERBAL, ANIMAL OR FISH SOURCES (U.S. CLS. 6, 18, 44, 46, 51 AND 52).
DAWN HAN, EXAMINING ATTORNEY

SN 78-782,912. WAKODO COMPANY LIMITED, TOKYO, JAPAN, FILED 12-30-2005.



THE FOREIGN WORDING IN THE MARK TRANSLATES INTO ENGLISH AS "SUPPORTING FLAVORS."

THE NON-LATIN CHARACTER(S) IN THE MARK TRANSLITERATES INTO "MIKAKU OUEN", AND THIS MEANS "SUPPORTING FLAVORS" IN ENGLISH.

FOR BABY FOOD (U.S. CLS. 6, 18, 44, 46, 51 AND 52).
FIRST USE 8-23-2001; IN COMMERCE 11-1-2004.
ALEX KEAM, EXAMINING ATTORNEY

CLASS 5—(Continued).

SN 78-816,243. MARIGOT LIMITED, CARRIGALINE, IRELAND, FILED 2-16-2006.

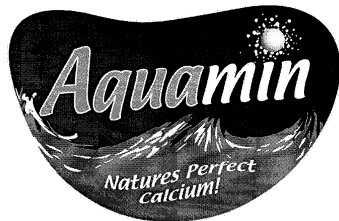

PRIORITY CLAIMED UNDER SEC. 44(D) ON ERPN CMNTY TM OFC APPLICATION NO. 4802419, FILED 12-22-2005, REG. NO. 4802419, DATED 4-20-2007, EXPIRES 12-22-2015.

NO CLAIM IS MADE TO THE EXCLUSIVE RIGHT TO USE "NATURE'S PERFECT CALCIUM", APART FROM THE MARK AS SHOWN.

THE MARK CONSISTS, IN PART, OF WAVES BELOW THE WORD "AQUAMIN" WITH THE LETTER "I" DOTTED WITH A SUN.

FOR NUTRITIONAL ADDITIVES, NAMELY, SEAWEED BASED ADDITIVES AND ALGAE BASED ADDITIVES FOR USE IN FOOD AND FOR USE IN VITAMIN AND MINERAL SUPPLEMENTS FOR HUMAN CONSUMPTION (U.S. CLS. 6, 18, 44, 46, 51 AND 52).

LINDA E. BLOHM, EXAMINING ATTORNEY

SN 78-839,230. RECKITT & COLMAN (OVERSEAS) LIMITED, HULL, UNITED KINGDOM, FILED 3-16-2006.

STREPSILS

THE MARK CONSISTS OF STANDARD CHARACTERS WITHOUT CLAIM TO ANY PARTICULAR FONT, STYLE, SIZE, OR COLOR.

OWNER OF U.S. REG. NO. 2,422,467.

FOR THROAT LOZENGES (U.S. CLS. 6, 18, 44, 46, 51 AND 52).

ROBERT STRUCK, EXAMINING ATTORNEY

SN 78-853,307. OHM & KARMA VENTURES, INC., NORTH-RIDGE, CA. FILED 4-4-2006.



NO CLAIM IS MADE TO THE EXCLUSIVE RIGHT TO USE "HERBS" AND "SPECIAL FORMULAS", APART FROM THE MARK AS SHOWN.

FOR HERBAL SUPPLEMENTS (U.S. CLS. 6, 18, 44, 46, 51 AND 52).

FIRST USE 6-1-2005; IN COMMERCE 6-1-2005.

TRACY CROSS, EXAMINING ATTORNEY

CLASS 5—(Continued).

SN 78-871,312. BREATH LIMITED, BIGGIN HILL, UNITED KINGDOM, FILED 4-27-2006.

i-Bude

THE MARK CONSISTS OF STANDARD CHARACTERS WITHOUT CLAIM TO ANY PARTICULAR FONT, STYLE, SIZE, OR COLOR.

FOR PHARMACEUTICAL AND MEDICINAL PREPARATIONS AND SUBSTANCES FOR THE PREVENTION AND TREATMENT OF DISEASES AND DISORDERS OF THE RESPIRATORY SYSTEM INCLUDING ASTHMA, CHRONIC OBSTRUCTIVE PULMONARY DISEASE (COPD), BREATHLESSNESS, CYSTIC FIBROSIS, PULMONARY HYPERTENSION AND OTHER RESPIRATORY DISEASES AND TREATMENT PREPARATIONS THEREFOR THAT CAN BE ADMINISTERED TO A PATIENT THROUGH ABSORPTION THROUGH THE LUNG; PHARMACEUTICAL PREPARATIONS, NAMELY, PREPARATIONS FOR THE PREVENTION AND TREATMENT OF CANCERS; PHARMACEUTICAL PREPARATIONS, NAMELY, PLATELET STIMULATING FACTORS; PHARMACEUTICAL CARDIOVASCULAR PREPARATIONS; PHARMACEUTICAL PREPARATIONS FOR THE TREATMENT OF CARDIOVASCULAR DISEASE, UROLOGICAL DISORDERS, GASTROINTESTINAL DISORDERS, ALLERGIES, DIABETES, HYPERTENSION, ERECTILE DYSFUNCTION, SEXUAL DYSFUNCTION, STROKE, CANCER, MIGRAINES, OBESITY AND RESPIRATORY DISEASES, FUNGAL DISORDERS; PHARMACEUTICAL PREPARATIONS, NAMELY, ANTI-INFLAMMATORY ANALGESICS; PHARMACEUTICAL PREPARATIONS, NAMELY, CHOLESTEROL REDUCERS, SMOKING CESSATION PREPARATIONS, MEDICATED TISSUE AND SKIN REPAIR PREPARATIONS; PHARMACEUTICAL PREPARATIONS FOR THE TREATMENT OF DIABETES, CANCER; PHARMACEUTICAL PREPARATIONS COMPRISING PROTEIN KINASE OR PHOSPHATASE FOR USE IN THE TREATMENT OF CANCER AND PARKINSON'S DISEASE; PHARMACEUTICAL PREPARATIONS AFFECTING SIGNAL TRANSDUCTION PATHWAYS FOR USE IN THE TREATMENT OF INFLAMMATORY DISEASES, AUTOIMMUNE DISEASES, AND PSYCHIATRIC DISEASES; PHARMACEUTICAL PREPARATIONS FOR THE PREVENTION AND/OR TREATMENT OF CANCER, CARCINOMAS AND SARCOMAS; PHARMACEUTICAL PREPARATIONS FOR THE PREVENTION AND/OR TREATMENT OF TUMORS OF ANY DESCRIPTION; PHARMACEUTICAL PREPARATIONS FOR THE TREATMENT OF PAINS, FEVER, ANGINA, OTORHINOLARYNGOLOGY, GASTRIC AND LIVER ILLNESSES, HEART ILLNESSES, ARTERIAL AND VENOUS ILLNESSES, RHEUMATIC ILLNESSES; ANALGESICS; FROSTBITE SALVE FOR PHARMACEUTICAL PURPOSES; HEMORRHOID TREATMENT PREPARATIONS; PHARMACEUTICAL PREPARATIONS FOR THE TREATMENT OF HEADACHES; BATH SALTS FOR MEDICAL PURPOSES; MEDICATED MOUTHWASHES; HERBAL MUD PACKS FOR THERAPEUTIC PURPOSES; TRANQUILIZERS; SEDATIVES; TOBACCO FREE CIGARETTES FOR MEDICAL PURPOSES; MEDICINES FOR ALLEVIATING CONSTIPATION; CONTRACEPTIVE PREPARATIONS; RADIOLOGICAL CONTRAST SUBSTANCES FOR MEDICAL PURPOSES, NAMELY, CONTRAST MEDIA FOR IN-VIVO IMAGING; CORN REMEDIES, NAMELY, CORN CREAMS, CORN PADS AND CORN PLASTERS; COTTON FOR MEDICAL PURPOSES; DIAGNOSTIC PREPARATIONS FOR MEDICAL PURPOSES; PHARMACEUTICAL PREPARATIONS FOR THE TREATMENT OF PAIN, FEVER, ANGINA, OTORHINOLARYNGOLOGY, GASTRIC AND LIVER ILLNESSES, HEART ILLNESSES, ARTERIAL AND VENOUS ILLNESSES, RHEUMATIC ILLNESSES; MINERAL WATER FOR MEDICAL PURPOSES; PHARMACEUTICAL PREPARATIONS FOR THE TREATMENT OF TREMORS, SMOOTH MUSCLE DISORDERS, HEADACHES, WRINKLES, HYPERHYDROSIS, SPORTS INJURIES, NAMELY, INJURED OR TORN

CLASS 5—(Continued).

SKIN, MUSCLE, LIGAMENTS, OR BONE; PHARMACEUTICAL PREPARATIONS FOR THE TREATMENT OF PAIN, NAMELY, SMOOTH MUSCLE PAIN, STRIATED MUSCLE PAIN, CARDIAC MUSCLE PAIN, NEUROPATHIC PAIN, INFLAMMATORY PAIN, VISCERAL PAIN, CHRONIC PAIN, ACUTE PAIN, TRAUMATIC INJURY PAIN, REFERRED PAIN, GROWING PAIN, HUNGER PAIN, INTRACTABLE PAIN, LABOR PAIN, ORGANIC PAIN, PHANTOM LIMB PAIN, POST-PRANDIAL PAIN, PSYCHOGENIC PAIN, BACK PAIN, POST-STROKE PAIN, CANCER PAIN, NOCICEPTIVE PAIN, HEADACHE PAIN, PROSTATIC PAIN, AND BLADDER PAIN; PHARMACEUTICAL PREPARATIONS FOR THE TREATMENT OF MUSCLE DYSTONIAS, NERVE DISORDERS, SPASMODIC STRIATED, SMOOTH OR CARDIAC MUSCLES; PHARMACEUTICAL PREPARATIONS FOR THE TREATMENT OF CEREBRAL PALSY; PHARMACEUTICAL PREPARATIONS AND SUBSTANCES, NAMELY ANTI-INFECTIVE, ANTI-BACTERIALS, ANTIBIOTICS, ANTIVIRALS, ANTIDIABETIC PREPARATIONS, CARDIOVASCULAR PREPARATIONS, HEMOSTATIC AGENTS; PHARMACEUTICAL PREPARATIONS AND SUBSTANCES FOR THE TREATMENT OF CANCER, HIV, OBESITY AND RESPIRATORY AND UROLOGIC DISORDERS AND DISEASES; PHARMACEUTICAL PREPARATIONS AND SUBSTANCES FOR THE TREATMENT OF ACUTE ISCHEMIC STROKE AND TRAUMATIC BRAIN INJURY (TBI); CEREBRAL VASODILATORS; PRESCRIPTION PHARMACEUTICAL PREPARATIONS AND SUBSTANCES FOR THE PREVENTION AND TREATMENT OF DISEASES AND DISORDERS OF THE RESPIRATORY SYSTEM, PERIPHERAL NERVOUS SYSTEM, CARDIOVASCULAR SYSTEM, GASTRO-INTESTINAL SYSTEM; PRESCRIPTION PHARMACEUTICAL PREPARATIONS AND SUBSTANCES FOR USE IN PAIN CONTROL; ANESTHETICS FOR SURGICAL AND NON-SURGICAL USE; PHARMACEUTICAL PREPARATIONS FOR USE IN ONCOLOGY FOR THE PREVENTION AND TREATMENT OF DISORDERS; PRESCRIPTION PHARMACEUTICAL PREPARATIONS AND SUBSTANCES FOR THE TREATMENT AND PREVENTION OF DIABETES; VACCINES; DIETETIC SUBSTANCES ADAPTED FOR MEDICAL PURPOSES; NEBULES FOR INHALATION, NAMELY LIQUID DRUG FORMULATIONS DESIGNED FOR DELIVERY TO THE PATIENT VIA A NEBULISER FOR ADMINISTRATION TO THE LUNG (U.S. CLS. 6, 18, 44, 46, 51 AND 52).

KATHY DE JONGE, EXAMINING ATTORNEY

CLASS 5—(Continued).

VASCULAR DISEASE, UROLOGICAL DISORDERS, GASTROINTESTINAL DISORDERS, ALLERGIES, DIABETES, HYPERTENSION, ERECTILE DYSFUNCTION, SEXUAL DYSFUNCTION, STROKE, CANCER, MIGRAINES, OBESITY AND RESPIRATORY DISEASES, FUNGAL DISORDERS; PHARMACEUTICAL PREPARATIONS, NAMELY, ANTI-INFLAMMATORY ANALGESICS; PHARMACEUTICAL PREPARATIONS, NAMELY, CHOLESTEROL REDUCERS, SMOKING CESSATION PREPARATIONS, MEDICATED TISSUE AND SKIN REPAIR PREPARATIONS; PHARMACEUTICAL PREPARATIONS FOR THE TREATMENT OF DIABETES, CANCER; PHARMACEUTICAL PREPARATIONS COMPRISING PROTEIN KINASE OR PHOSPHATASE FOR USE IN THE TREATMENT OF CANCER AND PARKINSON'S DISEASE; PHARMACEUTICAL PREPARATIONS AFFECTING SIGNAL TRANSDUCTION PATHWAYS FOR USE IN THE TREATMENT OF INFLAMMATORY DISEASES, AUTOIMMUNE DISEASES, AND PSYCHIATRIC DISEASES; PHARMACEUTICAL PREPARATIONS FOR THE PREVENTION AND/OR TREATMENT OF CANCER, CARCINOMAS AND SARCOMAS; PHARMACEUTICAL PREPARATIONS FOR THE PREVENTION AND/OR TREATMENT OF TUMORS OF ANY DESCRIPTION; PHARMACEUTICAL PREPARATIONS FOR THE TREATMENT OF PAINS, FEVER, ANGINA, OTORHINOLARYNGOLOGY, GASTRIC AND LIVER ILLNESSES, HEART ILLNESSES, ARTERIAL AND VENOUS ILLNESSES, RHEUMATIC ILLNESSES; ANALGESICS; FROSTBITE SALVE FOR PHARMACEUTICAL PURPOSES; HEMORRHOID TREATMENT PREPARATIONS; PHARMACEUTICAL PREPARATIONS FOR THE TREATMENT OF HEADACHES; BATH SALTS FOR MEDICAL PURPOSES; MEDICATED MOUTHWASHES; HERBAL MUD PACKS FOR THERAPEUTIC PURPOSES; TRANQUILIZERS; SEDATIVES; TOBACCO FREE CIGARETTES FOR MEDICAL PURPOSES; MEDICINES FOR ALLEVIATING CONSTIPATION; CONTRACEPTIVE PREPARATIONS; RADIOLOGICAL CONTRAST SUBSTANCES FOR MEDICAL PURPOSES, NAMELY, CONTRAST MEDIA FOR IN-VIVO IMAGING; CORN REMEDIES, NAMELY, CORN CREAMS, CORN PADS AND CORN PLASTERS; COTTON FOR MEDICAL PURPOSES; DIAGNOSTIC PREPARATIONS FOR MEDICAL PURPOSES; PHARMACEUTICAL PREPARATIONS FOR THE TREATMENT OF PAIN, FEVER, ANGINA, OTORHINOLARYNGOLOGY, GASTRIC AND LIVER ILLNESSES, HEART ILLNESSES, ARTERIAL AND VENOUS ILLNESSES, RHEUMATIC ILLNESSES; MINERAL WATER FOR MEDICAL PURPOSES; PHARMACEUTICAL PREPARATIONS FOR THE TREATMENT OF TREMORS, SMOOTH MUSCLE DISORDERS, HEADACHES, WRINKLES, HYPERHYDRISIS, SPORTS INJURIES, NAMELY, INJURED OR TORN SKIN, MUSCLE, LIGAMENTS, OR BONE; PHARMACEUTICAL PREPARATIONS FOR THE TREATMENT OF PAIN, NAMELY, SMOOTH MUSCLE PAIN, STRIATED MUSCLE PAIN, CARDIAC MUSCLE PAIN, NEUROPATHIC PAIN, INFLAMMATORY PAIN, VISCERAL PAIN, CHRONIC PAIN, ACUTE PAIN, TRAUMATIC INJURY PAIN, REFERRED PAIN, GROWING PAIN, HUNGER PAIN, INTRACTABLE PAIN, LABOR PAIN, ORGANIC PAIN, PHANTOM LIMB PAIN, POST-PRANDIAL PAIN, PSYCHOGENIC PAIN, BACK PAIN, POST-STROKE PAIN, CANCER PAIN, NOCICEPTIVE PAIN, HEADACHE PAIN, PROSTATIC PAIN, AND BLADDER PAIN; PHARMACEUTICAL PREPARATIONS FOR THE TREATMENT OF MUSCLE DYSTONIAS, NERVE DISORDERS, SPASMODIC STRIATED, SMOOTH OR CARDIAC MUSCLES; PHARMACEUTICAL PREPARATIONS FOR THE TREATMENT OF CEREBRAL PALSY; PHARMACEUTICAL PREPARATIONS AND SUBSTANCES, NAMELY ANTI-INFECTIVE, ANTI-BACTERIALS, ANTIBIOTICS, ANTIVIRALS, ANTIDIABETIC PREPARATIONS, CARDIOVASCULAR PREPARATIONS, HEMOSTATIC AGENTS; PHARMACEUTICAL PREPARATIONS AND SUBSTANCES FOR THE TREATMENT OF CANCER, HIV, OBESITY AND RESPIRATORY AND UROLOGIC DISORDERS AND DISEASES; PHARMACEUTICAL PREPARATIONS AND SUBSTANCES FOR THE TREATMENT OF ACUTE ISCHEMIC STROKE AND TRAUMATIC BRAIN INJURY (TBI); CEREBRAL VASODILATORS; PRESCRIPTION PHARMACEUTICAL PREPARATIONS AND SUBSTANCES FOR THE PREVENTION AND TREATMENT OF DISEASES AND DISORDERS OF THE RESPIRATORY SYSTEM, PERIPHERAL NERVOUS SYSTEM,

SN 78-871,316, BREATH LIMITED, BIGGIN HILL, UNITED KINGDOM, FILED 4-27-2006.

i-Bud

THE MARK CONSISTS OF STANDARD CHARACTERS WITHOUT CLAIM TO ANY PARTICULAR FONT, STYLE, SIZE, OR COLOR.

FOR PHARMACEUTICAL AND MEDICINAL PREPARATIONS AND SUBSTANCES FOR THE PREVENTION AND TREATMENT OF DISEASES AND DISORDERS OF THE RESPIRATORY SYSTEM INCLUDING ASTHMA, CHRONIC OBSTRUCTIVE PULMONARY DISEASE (COPD), BREATHLESSNESS, CYSTIC FIBROSIS, PULMONARY HYPERTENSION AND OTHER RESPIRATORY DISEASES AND TREATMENT PREPARATIONS THEREFOR THAT CAN BE ADMINISTERED TO A PATIENT THROUGH ABSORPTION THROUGH THE LUNG; PHARMACEUTICAL PREPARATIONS, NAMELY, PREPARATIONS FOR THE PREVENTION AND TREATMENT OF CANCERS; PHARMACEUTICAL PREPARATIONS, NAMELY, PLATELET STIMULATING FACTORS; PHARMACEUTICAL CARDIOVASCULAR PREPARATIONS; PHARMACEUTICAL PREPARATIONS FOR THE TREATMENT OF CARDIO-

CLASS 5—(Continued).

CARDIOVASCULAR SYSTEM, GASTRO-INTESTINAL SYSTEM; PRESCRIPTION PHARMACEUTICAL PREPARATIONS AND SUBSTANCES FOR USE IN PAIN CONTROL; ANESTHETICS FOR SURGICAL AND NON-SURGICAL USE; PHARMACEUTICAL PREPARATIONS FOR USE IN ONCOLOGY FOR THE PREVENTION AND TREATMENT OF DISORDERS; PRESCRIPTION PHARMACEUTICAL PREPARATIONS AND SUBSTANCES FOR THE TREATMENT AND PREVENTION OF DIABETES; VACCINES; DIETETIC SUBSTANCES ADAPTED FOR MEDICAL PURPOSES; NEBULES FOR INHALATION, NAMELY LIQUID DRUG FORMULATIONS DESIGNED FOR DELIVERY TO THE PATIENT VIA A NEBULISER FOR ADMINISTRATION TO THE LUNG (U.S. CLS. 6, 18, 44, 46, 51 AND 52).

KATHY DE JONGE, EXAMINING ATTORNEY

SN 78-872,402. EON BEVERAGE, GROUP, INC., BEDFORD, TX. FILED 4-28-2006.



NO CLAIM IS MADE TO THE EXCLUSIVE RIGHT TO USE "BLACK CHERRY VITAMIN PACKED LOW IN SUGAR GREAT TASTING", APART FROM THE MARK AS SHOWN.

THE NAME(S), PORTRAIT(S), AND/OR SIGNATURE(S) SHOWN IN THE MARK DOES NOT IDENTIFY A PARTICULAR LIVING INDIVIDUAL.

THE COLOR(S) RED, PINK, BLACK, WHITE, YELLOW, BLUE AND GREEN ARE IS/ARE CLAIMED AS A FEATURE OF THE MARK.

THE MARK CONSISTS OF THE COLORS RED AND PINK APPEAR AS A STRIPED BACKGROUND DESIGN, WITH A DESIGN OF A FOOTBALL PLAYER IN RED, PINK AND WHITE WEARING NUMBER "45" IN WHITE IMPOSED OVER A BLUE AND BLACK BANNER WITH THE WORD "RUDY!" ON EITHER SIDE OF THE FOOTBALL PLAYER IN YELLOW AND RED, OVER THE WORDING "PRESENTS" IN WHITE ON A PINK BANNER, AND "FLYING COLORS" IN YELLOW AND OUTLINED IN PINK, OVER WHITE AND PINK WINGS, WITH THE WORDING "BLACK" IN BLUE WITH PINK OUTLINE AND "CHERRY" IN PINK BELOW, OVER A YELLOW STAR DESIGN, IN A WHITE WING DESIGN, ALL ABOVE A DESIGN OF PINK CHERRIES WITH BLACK STEMS AND GREEN LEAVES, AND WHITE AND BLUE CLOUDS, WITH STARS CONTAINING THE WORDING "VITAMIN PACKED," "LOW IN SUGAR" AND "GREAT TASTING" IN WHITE WITH PINK OUTLINES, OVER YELLOW STARS AND PINK CIRCLES.

FOR VITAMIN AND NUTRITIONALLY FORTIFIED BEVERAGES (U.S. CLS. 6, 18, 44, 46, 51 AND 52).

LAURA KOVALSKY, EXAMINING ATTORNEY

CLASS 5—(Continued).

SN 78-896,085. ASCENTA HEALTH LIMITED, DARTMOUTH, CANADA, FILED 5-30-2006.



PRIORITY CLAIMED UNDER SEC. 44(D) ON CANADA APPLICATION NO. 1288807, FILED 1-27-2006, REG. NO. TMA688734, DATED 5-31-2007, EXPIRES 5-31-2022.

FOR DIETARY AND NUTRITIONAL SUPPLEMENTS (U.S. CLS. 6, 18, 44, 46, 51 AND 52).

FIRST USE 5-0-2002; IN COMMERCE 2-0-2004.

WILLIAM VERHOSEK, EXAMINING ATTORNEY

SN 78-897,757. SMARTSCIENCE LABORATORIES, INC., ODESSA, FL. FILED 6-1-2006.

MarathonMAX

THE MARK CONSISTS OF STANDARD CHARACTERS WITHOUT CLAIM TO ANY PARTICULAR FONT, STYLE, SIZE, OR COLOR.

FOR ANALGESIC PREPARATIONS; TOPICAL ANALGESICS; TOPICAL ANESTHETICS (U.S. CLS. 6, 18, 44, 46, 51 AND 52).

LINDA LAVACHE, EXAMINING ATTORNEY

SN 78-902,198. GUNA INC., ALBUQUERQUE, NM. FILED 6-6-2006.

FOR HOMEOPATHIC PHARMACEUTICALS FOR USE IN THE TREATMENT OF FOR HORMONAL DISORDERS AND PREVENTION OF OSTEOPOROSIS (U.S. CLS. 6, 18, 44, 46, 51 AND 52).

FIRST USE 3-15-2006; IN COMMERCE 3-15-2006.

WENDY GOODMAN, EXAMINING ATTORNEY

CLASS 5—(Continued).

SN 78-911,366. BREATH LIMITED, BIGGIN HILL, UNITED KINGDOM, FILED 6-19-2006.

i-Cort

THE MARK CONSISTS OF STANDARD CHARACTERS WITHOUT CLAIM TO ANY PARTICULAR FONT, STYLE, SIZE, OR COLOR.

FOR PHARMACEUTICAL AND MEDICINAL PREPARATIONS AND SUBSTANCES FOR THE PREVENTION AND TREATMENT OF DISEASES AND DISORDERS OF THE RESPIRATORY SYSTEM INCLUDING ASTHMA, CHRONIC OBSTRUCTIVE PULMONARY DISEASE (COPD), BREATHLESSNESS, CYSTIC FIBROSIS, PULMONARY HYPERTENSION AND OTHER RESPIRATORY DISEASES AND TREATMENT PREPARATIONS THEREFOR THAT CAN BE ADMINISTERED TO A PATIENT THROUGH ABSORPTION THROUGH THE LUNG; PHARMACEUTICAL PREPARATIONS, NAMELY, PREPARATIONS FOR THE PREVENTION AND TREATMENT OF CANCERS; PHARMACEUTICAL PREPARATIONS, NAMELY, PLATELET STIMULATING FACTORS; PHARMACEUTICAL CARDIOVASCULAR PREPARATIONS; PHARMACEUTICAL PREPARATIONS FOR THE TREATMENT OF CARDIOVASCULAR DISEASE, UROLOGICAL DISORDERS, GASTROINTESTINAL DISORDERS, ALLERGIES, DIABETES, HYPERTENSION, ERECTILE DYSFUNCTION, SEXUAL DYSFUNCTION, STROKE, CANCER, MIGRAINES, OBESITY AND RESPIRATORY DISEASES, FUNGAL DISORDERS; PHARMACEUTICAL PREPARATIONS, NAMELY, ANTI-INFLAMMATORY ANALGESICS; PHARMACEUTICAL PREPARATIONS, NAMELY, CHOLESTEROL REDUCERS, SMOKING CESSATION PREPARATIONS, MEDICATED TISSUE AND SKIN REPAIR PREPARATIONS; PHARMACEUTICAL PREPARATIONS FOR THE TREATMENT OF DIABETES, CANCER; PHARMACEUTICAL PREPARATIONS COMPRISING PROTEIN KINASE OR PHOSPHATASE FOR USE IN THE TREATMENT OF CANCER AND PARKINSON'S DISEASE; PHARMACEUTICAL PREPARATIONS AFFECTING SIGNAL TRANSDUCTION PATHWAYS FOR USE IN THE TREATMENT OF INFLAMMATORY DISEASES, AUTOIMMUNE DISEASES, AND PSYCHIATRIC DISEASES; PHARMACEUTICAL PREPARATIONS FOR THE PREVENTION AND/OR TREATMENT OF CANCER, CARCINOMAS AND SARCOMAS; PHARMACEUTICAL PREPARATIONS FOR THE PREVENTION AND/OR TREATMENT OF TUMORS OF ANY DESCRIPTION; PHARMACEUTICAL PREPARATIONS FOR THE TREATMENT OF PAINS, FEVER, ANGINA, OTORHINOLARYNGOLOGY, GASTRIC AND LIVER ILLNESSES, HEART ILLNESSES, ARTERIAL AND VENOUS ILLNESSES, RHEUMATIC ILLNESSES; ANALGESICS; FROSTBITE SALVE FOR PHARMACEUTICAL PURPOSES; HEMORRHOID TREATMENT PREPARATIONS; PHARMACEUTICAL PREPARATIONS FOR THE TREATMENT OF HEADACHES; BATH SALTS FOR MEDICAL PURPOSES; MEDICATED MOUTHWASHES; HERBAL MUD PACKS FOR THERAPEUTIC PURPOSES; TRANQUILIZERS; SEDATIVES; TOBACCO FREE CIGARETTES FOR MEDICAL PURPOSES; MEDICINES FOR ALLEVIATING CONSTIPATION; CONTRACEPTIVE PREPARATIONS; RADIOLOGICAL CONTRAST SUBSTANCES FOR MEDICAL PURPOSES, NAMELY, CONTRAST MEDIA FOR IN-VIVO IMAGING; CORN REMEDIES, NAMELY, CORN CREAMS, CORN PADS AND CORN PLASTERS; COTTON FOR MEDICAL PURPOSES; DIAGNOSTIC PREPARATIONS FOR MEDICAL PURPOSES; PHARMACEUTICAL PREPARATIONS FOR THE TREATMENT OF PAIN, FEVER, ANGINA, OTORHINOLARYNGOLOGY, GASTRIC AND LIVER ILLNESSES, HEART ILLNESSES, ARTERIAL AND VENOUS ILLNESSES, RHEUMATIC ILLNESSES; MINERAL WATER FOR MEDICAL PURPOSES; PHARMACEUTICAL PREPARATIONS FOR THE TREATMENT OF TREMORS, SMOOTH MUSCLE DISORDERS, HEADACHES, WRINKLES, HYPERHYDROSIS, SPORTS INJURIES, NAMELY, INJURED OR TORN

CLASS 5—(Continued).

SKIN, MUSCLE, LIGAMENTS, OR BONE; PHARMACEUTICAL PREPARATIONS FOR THE TREATMENT OF PAIN, NAMELY, SMOOTH MUSCLE PAIN, STRIATED MUSCLE PAIN, CARDIAC MUSCLE PAIN, NEUROPATHIC PAIN, INFLAMMATORY PAIN, VISCERAL PAIN, CHRONIC PAIN, ACUTE PAIN, TRAUMATIC INJURY PAIN, REFERRED PAIN, GROWING PAIN, HUNGER PAIN, INTRACTABLE PAIN, LABOR PAIN, ORGANIC PAIN, PHANTOM LIMB PAIN, POST-PRANDIAL PAIN, PSYCHOGENIC PAIN, BACK PAIN, POST-STROKE PAIN, CANCER PAIN, NOCICEPTIVE PAIN, HEADACHE PAIN, PROSTATIC PAIN, AND BLADDER PAIN; PHARMACEUTICAL PREPARATIONS FOR THE TREATMENT OF MUSCLE DYSTONIAS, NERVE DISORDERS, SPASMODIC STRIATED, SMOOTH OR CARDIAC MUSCLES; PHARMACEUTICAL PREPARATIONS FOR THE TREATMENT OF CEREBRAL PALSY; PHARMACEUTICAL PREPARATIONS AND SUBSTANCES, NAMELY ANTI-INFECTIVE, ANTI-BACTERIALS, ANTIBIOTICS, ANTIVIRALS, ANTIDIABETIC PREPARATIONS, CARDIOVASCULAR PREPARATIONS, HEMOSTATIC AGENTS; PHARMACEUTICAL PREPARATIONS AND SUBSTANCES FOR THE TREATMENT OF CANCER, HIV, OBESITY AND RESPIRATORY AND UROLOGIC DISORDERS AND DISEASES; PHARMACEUTICAL PREPARATIONS AND SUBSTANCES FOR THE TREATMENT OF ACUTE ISCHEMIC STROKE AND TRAUMATIC BRAIN INJURY (TBI); CEREBRAL VASODILATORS; PRESCRIPTION PHARMACEUTICAL PREPARATIONS AND SUBSTANCES FOR THE PREVENTION AND TREATMENT OF DISEASES AND DISORDERS OF THE RESPIRATORY SYSTEM, PERIPHERAL NERVOUS SYSTEM, CARDIOVASCULAR SYSTEM, GASTRO-INTESTINAL SYSTEM; PRESCRIPTION PHARMACEUTICAL PREPARATIONS AND SUBSTANCES FOR USE IN PAIN CONTROL; ANESTHETICS FOR SURGICAL AND NON-SURGICAL USE; PHARMACEUTICAL PREPARATIONS FOR USE IN ONCOLOGY FOR THE PREVENTION AND TREATMENT OF DISORDERS; PRESCRIPTION PHARMACEUTICAL PREPARATIONS AND SUBSTANCES FOR THE TREATMENT AND PREVENTION OF DIABETES; VACCINES; DIETETIC SUBSTANCES ADAPTED FOR MEDICAL PURPOSES; NEBULES FOR INHALATION, NAMELY LIQUID DRUG FORMULATIONS DESIGNED FOR DELIVERY TO THE PATIENT VIA A NEBULISER FOR ADMINISTRATION TO THE LUNG (U.S. CLS. 6, 18, 44, 46, 51 AND 52).

KATHY DE JONGE, EXAMINING ATTORNEY

SN 78-913,391. GANEDEN BIOTECH, INC., MAYFIELD HEIGHTS, OH. FILED 6-21-2006.

RELIEF BEYOND BELIEF

THE MARK CONSISTS OF STANDARD CHARACTERS WITHOUT CLAIM TO ANY PARTICULAR FONT, STYLE, SIZE, OR COLOR.

FOR PILLS, TABLETS, CAPSULES, AND CAPLETS FOR THE DIETARY MANAGEMENT OF PSORIASIS, SKIN DISORDERS, ARTHRITIS, INFLAMMATION, BONE AND JOINT PROBLEMS, PAIN, CHOLESTEROL, DIABETES, LACTOSE INTOLERANCE, DIGESTIVE PROBLEMS, GAS, BLOATING, CONSTIPATION, DIARRHEA, CRAMPS, ABDOMINAL DISCOMFORT, GASTROINTESTINAL PROBLEMS, ACID REFLUX/GERD, COLDS, FLU, FEVER, COUGH, BRONCHIAL PROBLEMS, SORE THROAT, ALLERGIES, HAY FEVER, SINUS PROBLEMS, MENOPAUSE, MIGRAINES, STRESS, SLEEPING DISORDERS, CHRONIC FATIGUE, HORMONAL IMBALANCE, ACNE, AND FOR BOOSTING THE IMMUNE SYSTEM; NUTRACEUTICALS FOR USE AS A DIETARY SUPPLEMENT (U.S. CLS. 6, 18, 44, 46, 51 AND 52).

CARRIE GENOVESE, EXAMINING ATTORNEY

CLASS 5—(Continued).

SN 78-919,883. BAYER CONSUMER CARE AG, BASEL, SWITZERLAND, FILED 6-29-2006.

Protect Today. Prevent Tomorrow

THE MARK CONSISTS OF STANDARD CHARACTERS WITHOUT CLAIM TO ANY PARTICULAR FONT, STYLE, SIZE, OR COLOR.

FOR DIETETIC SUBSTANCES ADAPTED FOR MEDICAL USE, NAMELY, NUTRITIONAL SUPPLEMENTS AND VITAMIN AND MINERAL PREPARATIONS; SANITARY PREPARATIONS FOR MEDICAL PURPOSES, NAMELY, NUTRITIONAL SUPPLEMENTS AND VITAMIN AND MINERAL PREPARATIONS (U.S. CLS. 6, 18, 44, 46, 51 AND 52).

RICHARD WHITE, EXAMINING ATTORNEY

SN 78-935,316. EPIGENESIS PHARMACEUTICALS, LLC, CRANBURY, NJ. FILED 7-21-2006.

EPIGENE.COM

THE MARK CONSISTS OF STANDARD CHARACTERS WITHOUT CLAIM TO ANY PARTICULAR FONT, STYLE, SIZE, OR COLOR.

NO CLAIM IS MADE TO THE EXCLUSIVE RIGHT TO USE ".COM", APART FROM THE MARK AS SHOWN.

FOR MEDICAL DIAGNOSTIC AND THERAPEUTIC PREPARATIONS, ALL FOR ADMINISTRATION VIA DIVERSE ROUTES OF ADMINISTRATION INCLUDING THROUGH THE RESPIRATORY AIRWAYS, AND, MEDICAL DEVICES FOR ADMINISTERING THE PHARMACEUTICALS, SOLD FILLED, THE PREPARATIONS INCLUDING NUCLEOTIDES, PROTEINS AND ORGANIC MOLECULES FOR MEDICAL USE, INCLUDING MACROMOLECULES SUCH AS ANTI-SENSE OLIGONUCLEOTIDES AND ENZYMES AND SMALL AND INORGANIC MOLECULES FOR TREATMENT OF HUMAN AND NON-HUMAN ANIMAL RESPIRATORY, CENTRAL NERVOUS SYSTEM, NEOPLASTIC, ENDOCRINE, IMMUNE AND CARDIOVASCULAR AILMENTS, INCLUDING BRONCHOCONSTRICTION, DIFFICULT BREATHING, IMPEDED AND OBSTRUCTED LUNG AIRWAYS, ALLERGY(IES) AND/OR INFLAMMATION, WHICH IN SOME CASES ARE ADENOSINE RECEPTOR ASSOCIATED SYMPTOMS; PHARMACEUTICAL PREPARATIONS FOR TESTING, AND PREVENTING AND THERAPEUTICALLY TREATING RESPIRATORY, AIRWAY AND PULMONARY DISEASES AND CONDITIONS, SUCH AS ASTHMA, PULMONARY VASCONCONSTRICTION, INFLAMMATION,

CLASS 5—(Continued).

ALLERGIES, IMPEDED RESPIRATION, ACUTE RESPIRATORY DISEASE SYNDROME (ARDS), RENAL DAMAGE AND FAILURE, ISCHEMIA RESULTING FROM THE ADMINISTRATION OF CERTAIN DRUGS, INCLUDING ADENOSINE AND OTHER DRUGS FOR, FOR EXAMPLE, TREATING SUPRA VENTRICULAR TACHYCARDIA (SVT), ADENOSINE STRESS TESTS, INFANTILE RESPIRATORY DISTRESS SYNDROME (INFANTILE RDS), PAIN, CYSTIC FIBROSIS, ALLERGIC RHINITIS, ALLERGIC BRONCHITIS, PULMONARY HYPERTENSION, PULMONARY VASCONCONSTRICTION, EMPHYSEMA, CHRONIC OBSTRUCTIVE PULMONARY DISEASE (COPD), AS WELL AS CANCERS INCLUDING LEUKEMIAS, LYMPHOMAS, CARCINOMAS, AND THE LIKE, EG COLON CANCER, BREAST CANCER, LUNG CANCER, PANCREATIC CANCER, HEPATOCELLULAR CARCINOMA, KIDNEY CANCER, MELANOMA, ETC. AS WELL AS METASTATIC CANCERS, EG, CANCERS WHICH METASTASIZED TO THE LUNG(S), BREAST, LIVER AND PROSTATE (U.S. CLS. 6, 18, 44, 46, 51 AND 52).

DAVID I, EXAMINING ATTORNEY

SN 78-937,000. NICOX SA, 06560 VALBONNE, FRANCE, FILED 7-25-2006.

ATRRELIF

THE MARK CONSISTS OF STANDARD CHARACTERS WITHOUT CLAIM TO ANY PARTICULAR FONT, STYLE, SIZE, OR COLOR.

PRIORITY CLAIMED UNDER SEC. 44(D) ON FRANCE APPLICATION NO. 06/3439356, FILED 7-6-2006, REG. NO. 063439356, DATED 7-6-2006, EXPIRES 7-6-2016.

FOR PHARMACEUTICAL PREPARATIONS AND SUBSTANCES FOR THE TREATMENT OF RESPIRATORY SYSTEMS DISEASE, GASTROINTESTINAL SYSTEMS DISEASE, ENDOCRINE SYSTEMS DISEASE, CARDIOVASCULAR SYSTEMS DISEASE, CENTRAL NERVOUS SYSTEM DISEASE, PERIPHERAL NERVOUS SYSTEMS DISEASE, MUSCULOSKELETAL SYSTEMS DISEASE, UNARY SYSTEM DISEASE, INTEGUMENTARY SYSTEM DISEASE, REPRODUCTIVE SYSTEM DISEASE, SKIN AND SCALP DISEASE, CANCER, DIABETES, THROMBOSIS, ARTHRITIS, PAIN, INFLAMMATION, BLOOD DISEASE AND DISORDERS, SKIN DISEASE, COLD, COUGHS, INFLUENZA, VERTIGO, NAUSEA, VOMITING, MIGRAINE, MOUTH AND GUM DISEASE, BURNS; DIETETIC SUBSTANCES FOR MEDICAL USE NAMELY MEAL REPLACEMENT BARS, MEAL REPLACEMENT DRINK MIXES, MINERALS, VITAMINS; MEDICAL PLASTERS; MATERIAL FOR DRESSING, NAMELY BANDAGES, AND GAUZES (U.S. CLS. 6, 18, 44, 46, 51 AND 52).

MICHAEL LEWIS, EXAMINING ATTORNEY

CLASS 5—(Continued).

SN 78-938,573. BRADLEY PHARMACEUTICALS, INC., FAIRFIELD, NJ. FILED 7-27-2006.

RELIEF PAD

THE MARK CONSISTS OF STANDARD CHARACTERS WITHOUT CLAIM TO ANY PARTICULAR FONT, STYLE, SIZE, OR COLOR.

NO CLAIM IS MADE TO THE EXCLUSIVE RIGHT TO USE "PAD", APART FROM THE MARK AS SHOWN.

FOR MEDICATED TOPICAL PREPARATIONS FOR HUMAN USE TO PREVENT OR ALLEVIATE THE SYMPTOMS OF PRURITUS, ECZEMA, DERMATITIS AND OTHER SKIN DISORDERS, AND APPLICATORS OR PADS SOLD AS A COMPONENT THEREWITH (U.S. CLS. 6, 18, 44, 46, 51 AND 52).

ESTHER BELENKER, EXAMINING ATTORNEY

CLASS 5—(Continued).

SN 78-939,554. MASCOLO, KYARA, CARROLLTON, TX. FILED 7-27-2006.



THE MARK CONSISTS OF THE WORD I AND THEN A HEART SYMBOL AND THEN THE WORDS BED HEAD.

FOR MEDICATED GROOMING PREPARATIONS FOR CATS, DOGS, AND HOUSEHOLD PETS, NAMELY, SHAMPOOS, CONDITIONERS, BREATH FRESHENERS, DENTIFRICES AND PERFUMES (U.S. CLS. 6, 18, 44, 46, 51 AND 52).

TONI HICKEY, EXAMINING ATTORNEY

SN 78-949,568. STRYKER NETHERLANDS B.V., WAARDENBURG, NETHERLANDS, FILED 8-10-2006.

BONECARRIER

THE MARK CONSISTS OF STANDARD CHARACTERS WITHOUT CLAIM TO ANY PARTICULAR FONT, STYLE, SIZE, OR COLOR.

FOR KIT CONTAINING BONE CEMENT PREPARATIONS, BONE REPAIR COMPOUNDS, AND OTHER NATURAL AND SYNTHETIC FILLER AND EXTENDER MATERIALS FOR USE IN ORTHOPEDIC SURGERY (U.S. CLS. 6, 18, 44, 46, 51 AND 52).

CHRISTINE COOPER, EXAMINING ATTORNEY

SN 78-939,188. ROBERTSON, M.G., VIRGINIA BEACH, VA. FILED 7-27-2006.

Pat's Mind Advantage

THE MARK CONSISTS OF STANDARD CHARACTERS WITHOUT CLAIM TO ANY PARTICULAR FONT, STYLE, SIZE, OR COLOR.

FOR DIETARY FOOD SUPPLEMENTS; DIETARY SUPPLEMENTS; FOOD SUPPLEMENTS; FOOD SUPPLEMENTS, NAMELY, ANTI-OXIDANTS; MINERAL NUTRITIONAL SUPPLEMENTS; MINERAL SUPPLEMENTS; NUTRACEUTICALS FOR USE AS A DIETARY SUPPLEMENT; NUTRITIONAL ADDITIVES FOR USE IN FOODS AND DIETARY SUPPLEMENTS FOR HUMAN CONSUMPTION; NUTRITIONAL SUPPLEMENTS; VITAMIN AND MINERAL SUPPLEMENTS; VITAMIN SUPPLEMENTS (U.S. CLS. 6, 18, 44, 46, 51 AND 52).

SUNG IN, EXAMINING ATTORNEY

SN 78-953,807. AMDM GROUP, LLC, HIGHLAND VILLAGE, TX. FILED 8-16-2006.

EARVANTAGE

THE MARK CONSISTS OF STANDARD CHARACTERS WITHOUT CLAIM TO ANY PARTICULAR FONT, STYLE, SIZE, OR COLOR.

FOR HOMEOPATHIC PHARMACEUTICALS FOR USE IN THE TREATMENT OF CANINE OTITIS EXTERNA, BACTERIAL INFECTIONS OF THE EAR, YEAST INFECTIONS OF THE EAR, AND EAR CHEMISTRY IMBALANCES, INFLAMMATION AND ITCHING (U.S. CLS. 6, 18, 44, 46, 51 AND 52).

RAY THOMAS, EXAMINING ATTORNEY

CLASS 5—(Continued).

SN 78-957,677. KRAMER LABORATORIES, INC., MIAMI, FL. FILED 8-22-2006.

BIEN STAR

THE MARK CONSISTS OF STANDARD CHARACTERS WITHOUT CLAIM TO ANY PARTICULAR FONT, STYLE, SIZE, OR COLOR.

THE FOREIGN WORDING IN THE MARK TRANSLATES INTO ENGLISH AS "WELL."

FOR ANALGESICS, DIETARY SUPPLEMENTS, NATURAL DIETARY SUPPLEMENTS FOR CLEANSING THE COLON, PHARMACEUTICAL PREPARATIONS FOR THE TREATMENT OF COUGHS AND COLDS, EAR DROPS, PHARMACEUTICAL PREPARATIONS FOR THE TREATMENT OF WOUNDS, PHARMACEUTICAL PREPARATIONS FOR FOOT CARE, PHARMACEUTICAL PREPARATIONS TO AID DIGESTION, NAMELY ANTACIDS AND ANTI-GAS PREPARATIONS; PHARMACEUTICAL PREPARATIONS FOR FEMININE HYGIENE, NAMELY DOUCHES AND FEMININE HYGIENE PADS; ELECTROLYTES (U.S. CLS. 6, 18, 44, 46, 51 AND 52).

BERYL GARDNER, EXAMINING ATTORNEY

CLASS 5—(Continued).

SN 78-964,015. SISEL INTERNATIONAL, LLC, SPRINGVILLE, UT. FILED 8-30-2006.

SISEL

THE MARK CONSISTS OF STANDARD CHARACTERS WITHOUT CLAIM TO ANY PARTICULAR FONT, STYLE, SIZE, OR COLOR.

FOR DIETARY AND NUTRITIONAL SUPPLEMENTS; VITAMIN, MINERAL, HERBAL AND NUTRITIONAL SEAWEED PREPARATIONS INTENDED TO ENHANCE AND STIMULATE THE IMMUNE SYSTEM, INCREASE METABOLISM, PROTECT AGAINST INFECTIONS, REDUCE INFLAMMATION, IMPROVE DIGESTION, REDUCE AGING AND DEGENERATIVE CONDITIONS, ENHANCE EXTENSION, REGENERATION, ENERGY, ANTI-AGING, AND STEM CELL ACTIVATION, AND RESTORE YOUTHFUL FUNCTIONS (U.S. CLS. 6, 18, 44, 46, 51 AND 52).

ANTHONY RINKER, EXAMINING ATTORNEY

SN 78-962,132. HEALTHY PETS, INC., UNION CITY, CA. FILED 8-28-2006.

TRANQUIL-TABS

THE MARK CONSISTS OF STANDARD CHARACTERS WITHOUT CLAIM TO ANY PARTICULAR FONT, STYLE, SIZE, OR COLOR.

FOR NUTRITIONAL SUPPLEMENTS FOR PETS (U.S. CLS. 6, 18, 44, 46, 51 AND 52).

FIRST USE 5-1-2006; IN COMMERCE 5-1-2006.

MICHAEL WEBSTER, EXAMINING ATTORNEY

SN 78-966,798. PACIFIC ARROW LIMITED, HONG KONG, HONG KONG, FILED 9-4-2006.

Xanifolia

THE MARK CONSISTS OF STANDARD CHARACTERS WITHOUT CLAIM TO ANY PARTICULAR FONT, STYLE, SIZE, OR COLOR.

FOR PLANT EXTRACTS FOR MEDICAL, VETERINARY AND PHARMACEUTICAL PURPOSES (U.S. CLS. 6, 18, 44, 46, 51 AND 52).

DOMINIC FATHY, EXAMINING ATTORNEY

CLASS 5—(Continued).

SN 79-026,271. MEDICINAL HONEY COMPANY PTY LTD, AUSTRALIA, FILED 4-11-2006.

MediGold

THE MARK CONSISTS OF STANDARD CHARACTERS WITHOUT CLAIM TO ANY PARTICULAR FONT, STYLE, SIZE, OR COLOR.

PRIORITY DATE OF 4-6-2006 IS CLAIMED.

OWNER OF INTERNATIONAL REGISTRATION 0891512 DATED 4-11-2006, EXPIRES 4-11-2016.

FOR PHARMACEUTICAL, VETERINARY AND SANITARY PREPARATIONS, NAMELY, PHARMACEUTICAL PREPARATIONS FOR TOPICAL APPLICATION AND FOR INGESTION FOR COUNTERACTING BACTERIAL INFECTIONS, BURN INJURIES, VIRUSES AND FUNGI, PHARMACEUTICAL PREPARATIONS FOR TREATING COLDS, VETERINARY PREPARATIONS FOR TREATING PAIN, SANITARY PREPARATIONS FOR MEDICAL USE, VIRUCIDES, ANTIBACTERIAL PREPARATIONS FOR MEDICAL PURPOSES, ANTIFUNGAL CREAMS FOR MEDICAL USE, ANTIMICROBIALS FOR DERMATOLOGIC USE, DERMATOLOGICAL PHARMACEUTICAL PRODUCTS, MEDICATED THROAT SPRAY, MEDICINAL CREAMS FOR SKIN CARE, MEDICINAL PREPARATIONS FOR THE MOUTH AND AS SPRAYS, MEDICATED LIP BALMS, MEDICATED SKIN CREAMS; DIETETIC FOODS ADAPTED FOR MEDICAL USE, FOOD FOR BABIES CONTAINING MEDICINAL HONEY, AND ANTIMICROBIAL HONEY; PHARMACEUTICAL, VETERINARY AND SANITARY PREPARATIONS AND FORMULATIONS CONTAINING OR BASED ON MEDICINAL OR ANTIMICROBIAL HONEY, NAMELY, PROCESSED BEE POLLEN FOR MEDICINAL OR THERAPEUTIC PURPOSES, MEDICATED SKIN CARE CREAMS AND BALMS WITH ACTIVE HONEY AND ALOE VERA, MEDICATED FOOT CARE CREAMS AND BALMS WITH ACTIVE HONEY AND ALOE VERA, MEDICATED FACIAL CREAMS AND BALMS WITH ACTIVE HONEY AND ALOE VERA, MEDICATED BODY CARE CREAMS AND BALMS WITH ACTIVE HONEY AND ALOE VERA, MEDICATED NIPPLE BALM WITH PURIFIED LANOLIN AND ACTIVE HONEY, PHARMACEUTICAL PREPARATIONS FOR TREATING COLDS, VETERINARY PREPARATIONS FOR TREATING PAIN, SANITARY PREPARATIONS FOR MEDICAL USE; MEDICAL PLASTERS, MATERIALS FOR DRESSINGS, NAMELY, PHARMACEUTICAL PREPARATIONS FOR TREATING WOUNDS, FOR SKIN DISORDERS, FOR USE IN DERMATOLOGY; BANDAGES FOR DRESSINGS, BANDAGES AND DRESSINGS FOR WOUNDS, NAMELY, BANDAGES AND DRESSINGS CONTAINING HONEY, ACTIVE HONEY AND STERILIZED ACTIVE HONEY, WOUND DRESSINGS, BANDAGES FOR SKIN WOUNDS, BURN DRESSINGS; MATERIAL FOR STOPPING TEETH, DENTAL WAX; ALL PURPOSE DISINFECTANTS; FUNGICIDES (U.S. CLS. 6, 18, 44, 46, 51 AND 52).

JEFFERY COWARD, EXAMINING ATTORNEY

CLASS 5—(Continued).

SN 79-030,749. EBWE PHARMA GES.M.B.H. NFG. KG, AUSTRIA, FILED 9-12-2006.

MEMOPROVE

THE MARK CONSISTS OF STANDARD CHARACTERS WITHOUT CLAIM TO ANY PARTICULAR FONT, STYLE, SIZE, OR COLOR.

OWNER OF INTERNATIONAL REGISTRATION 0841314 DATED 12-14-2004, EXPIRES 12-14-2014.

FOR PHARMACEUTICAL AND VETERINARY PREPARATIONS USED FOR TREATMENT OF CANCER, CENTRAL NERVOUS SYSTEM DISEASES, IMMUNOLOGICAL DEFICIENCIES AND HEART AND CIRCULATORY PROBLEMS; FOOD SUPPLEMENTS FOR MEDICAL USE (U.S. CLS. 6, 18, 44, 46, 51 AND 52).

JOANNA DUKOVIC, EXAMINING ATTORNEY

SN 79-030,750. EBWE PHARMA GES.M.B.H. NFG. KG, AUSTRIA, FILED 9-12-2006.

B-GENIO

THE MARK CONSISTS OF STANDARD CHARACTERS WITHOUT CLAIM TO ANY PARTICULAR FONT, STYLE, SIZE, OR COLOR.

OWNER OF INTERNATIONAL REGISTRATION 0841315 DATED 12-14-2004, EXPIRES 12-14-2014.

FOR PHARMACEUTICAL AND VETERINARY PREPARATIONS USED FOR TREATMENT OF CANCER, CENTRAL NERVOUS SYSTEM DISEASES, IMMUNOLOGICAL DEFICIENCIES AND HEART AND CIRCULATORY PROBLEMS; FOOD SUPPLEMENTS FOR MEDICAL USE (U.S. CLS. 6, 18, 44, 46, 51 AND 52).

JOANNA DUKOVIC, EXAMINING ATTORNEY

SN 79-030,760. MAKE HOBO MARKETING GMBH, FED REP GERMANY, FILED 8-21-2006.

mr_ease

PRIORITY DATE OF 3-8-2006 IS CLAIMED.

OWNER OF INTERNATIONAL REGISTRATION 0902988 DATED 8-21-2006, EXPIRES 8-21-2016.

FOR PREPARATIONS FOR HEALTH CARE, NAMELY TOPICAL PREPARATIONS FOR THE RELAXATION OF THE ANAL SPHINCTER; AND MEDICATED OINTMENTS AND CREAMS FOR USE IN THE RELAXATION OF THE ANAL SPHINCTER (U.S. CLS. 6, 18, 44, 46, 51 AND 52).

KENNETH E. SHARPERSON, EXAMINING ATTORNEY

CLASS 5—(Continued).

SN 79-030,802. AESCULAP AG & CO. KG, FED REP GERMANY, FILED 7-21-2006.



OWNER OF INTERNATIONAL REGISTRATION 0903103 DATED 7-21-2006, EXPIRES 7-21-2016.

OWNER OF U.S. REG. NO. 1,586,825.

NO CLAIM IS MADE TO THE EXCLUSIVE RIGHT TO USE "SPONGE", APART FROM THE MARK AS SHOWN.

THE COLOR(S) GREEN, GREY AND BLACK IS/ARE CLAIMED AS A FEATURE OF THE MARK.

THE COLOR GRAY IS LOCATED IN ENDO AND THE E IN SPONGE. THE COLOR BLACK IS IN THE REMAINING LETTERING AND THE LOWEST CURVED LINE AND LAST TWO CRESCENT SHAPES OF THE DESIGN. THE COLOR GREEN IS LOCATED IN THE OBLONG AND REMAINING CRESCENT SHAPES IN THE DESIGN.

FOR SURGICAL DRAINAGE DRESSINGS, NAMELY, OPEN-PORE SPONGE WITH DRAIN FOR TREATMENT OF ANASTOMOTIC LEAK IN THE LOW RECTAL AREA (U.S. CLS. 6, 18, 44, 46, 51 AND 52).

TRACY WHITTAKER-BROWN, EXAMINING ATTORNEY

CLASS 5—(Continued).

SN 79-034,016. SHOGOO PHARMACEUTICALS AG, SWITZERLAND, FILED 11-28-2006.

FemiFect

THE MARK CONSISTS OF STANDARD CHARACTERS WITHOUT CLAIM TO ANY PARTICULAR FONT, STYLE, SIZE, OR COLOR.

OWNER OF INTERNATIONAL REGISTRATION 0911717 DATED 11-28-2006, EXPIRES 11-28-2016.

FOR PHARMACEUTICAL PREPARATIONS FOR THE TREATMENT OF VULVOVAGINITIS, INFECTIOUS VAGINITIS, HORMONAL VAGINITIS AND IRRITANT VAGINITIS; PHARMACEUTICAL AND VETERINARY PRODUCTS, NAMELY FOR THE TREATMENT OF VULVOVAGINITIS, INFECTIOUS VAGINITIS, HORMONAL VAGINITIS AND IRRITANT VAGINITIS; SANITARY PRODUCTS FOR MEDICAL PURPOSES; DIETETIC SUBSTANCES ADAPTED FOR MEDICAL USE, FOOD FOR BABIES; MEDICAL PLASTERS, MATERIALS FOR DRESSINGS, NAMELY GAUZE; MATERIAL FOR STOPPING TEETH AND DENTAL WAX; ALL PURPOSE DISINFECTANTS; PREPARATIONS FOR DESTROYING VERMIN; FUNGICIDES, HERBICIDES (U.S. CLS. 6, 18, 44, 46, 51 AND 52).

SUZANNE BLANE, EXAMINING ATTORNEY

SN 79-031,943. FRESENIUS MEDICAL CARE DEUTSCHLAND GMBH, FED REP GERMANY, FILED 10-19-2006.

EPOLOGIC

THE MARK CONSISTS OF STANDARD CHARACTERS WITHOUT CLAIM TO ANY PARTICULAR FONT, STYLE, SIZE, OR COLOR.

OWNER OF INTERNATIONAL REGISTRATION 0906068 DATED 10-19-2006, EXPIRES 10-19-2016.

FOR PHARMACEUTICAL PREPARATIONS FOR THE TREATMENT OF ANAEMIA (U.S. CLS. 6, 18, 44, 46, 51 AND 52).

LINDA M. KING, EXAMINING ATTORNEY

SN 79-038,521. BOEHRINGER INGELHEIM VETMEDICA GMBH, FED REP GERMANY, FILED 5-4-2007.



PRIORITY DATE OF 1-25-2007 IS CLAIMED.

OWNER OF INTERNATIONAL REGISTRATION 0924285 DATED 5-4-2007, EXPIRES 5-4-2017.

FOR VACCINES FOR SWINE (U.S. CLS. 6, 18, 44, 46, 51 AND 52).

VERNA BETH RIRIE, EXAMINING ATTORNEY

SN 79-031,947. FRESENIUS MEDICAL CARE DEUTSCHLAND GMBH, 61352 BAD HOMBURG, FED REP GERMANY, FILED 10-19-2006.

FERROLOGIC

THE MARK CONSISTS OF STANDARD CHARACTERS WITHOUT CLAIM TO ANY PARTICULAR FONT, STYLE, SIZE, OR COLOR.

OWNER OF INTERNATIONAL REGISTRATION 0906077 DATED 10-19-2006, EXPIRES 10-19-2016.

FOR PHARMACEUTICAL PREPARATIONS FOR THE TREATMENT OF IRON DEFICIENCY (U.S. CLS. 6, 18, 44, 46, 51 AND 52).

LINDA M. KING, EXAMINING ATTORNEY

SN 79-038,670. BIOFARMA, FRANCE, FILED 3-9-2007.

VALICORAM

PRIORITY DATE OF 10-5-2006 IS CLAIMED.

OWNER OF INTERNATIONAL REGISTRATION 0924707 DATED 3-9-2007, EXPIRES 3-9-2017.

FOR PHARMACEUTICAL PREPARATIONS FOR THE TREATMENT OF CARDIO-VASCULAR DISEASES (U.S. CLS. 6, 18, 44, 46, 51 AND 52).

MICHAEL KEATING, EXAMINING ATTORNEY

CLASS 5—(Continued).

SN 79-038,671. BIOFARMA, FRANCE, FILED 3-9-2007.

VALARTIM

PRIORITY DATE OF 10-5-2006 IS CLAIMED.
 OWNER OF INTERNATIONAL REGISTRATION 0924708
 DATED 3-9-2007, EXPIRES 3-9-2017.
 FOR PHARMACEUTICAL PREPARATIONS FOR THE
 TREATMENT OF CARDIO-VASCULAR DISEASES (U.S.
 CLS. 6, 18, 44, 46, 51 AND 52).
 MICHAEL KEATING, EXAMINING ATTORNEY

CLASS 6—(Continued).

SN 77-020,861. ALUMINIUM SYSTEMS NZ LIMITED, MT
 WELLINGTON, NEW ZEALAND, FILED 10-13-2006.

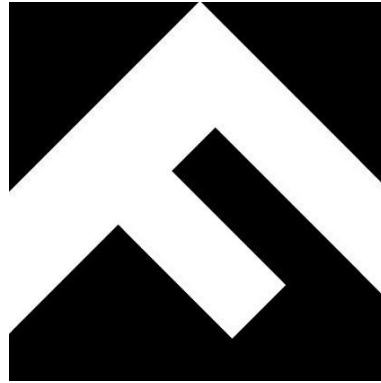

CLASS 6—METAL GOODS

SN 76-669,849. SLINGMAX, INC., ASTON, PA. FILED 12-4-
 2006.

GATOR-MAX

THE MARK CONSISTS OF STANDARD CHARACTERS
 WITHOUT CLAIM TO ANY PARTICULAR FONT, STYLE,
 SIZE, OR COLOR.
 FOR METAL SLINGS USED IN RIGGING; WIRE-
 ROPE SLINGS; METAL SLINGS FOR HEAVY LIFTING,
 LOADING, MOVING AND TOWING; MULTI-PART METAL
 SLING USED TO HOIST OBJECTS; FLEXIBLE
 METAL SLING FOR HEAVY LIFT CONNECTIONS;
 BRAIDED METAL SLINGS FOR LIFTING, MOVING
 AND TOWING HEAVY OBJECTS (U.S. CLS. 2, 12, 13,
 14, 23, 25 AND 50).
 FIRST USE 1-0-1999; IN COMMERCE 9-0-1999.
 CAROLYN GRAY, EXAMINING ATTORNEY

OWNER OF NEW ZEALAND REG. NO. 709637, DATED 3-
 16-2004, EXPIRES 3-16-2014.
 FOR ALUMINUM EXTRUSION PRODUCTS,
 NAMELY, EXTRUDED HOLLOW SECTIONS; METAL
 BUILDING STRUCTURES, NAMELY, WINDOWS,
 DOORS AND PARTITIONS; PARTS AND FITTINGS
 FOR METAL WINDOWS, NAMELY, METAL WINDOW
 FRAMES; PARTS AND FITTINGS FOR METAL DOORS,
 NAMELY, METAL DOOR FRAMES; PARTS AND FIT-
 TINGS FOR METAL PARTITIONS, NAMELY, METAL
 PARTITION FRAMES (U.S. CLS. 2, 12, 13, 14, 23, 25 AND
 50).
 DAVID MURRAY, EXAMINING ATTORNEY

SN 77-007,268. ALLIED TUBE & CONDUIT CORPORATION,
 HARVEY, IL. FILED 9-26-2006.

SS 40

THE MARK CONSISTS OF STANDARD CHARACTERS
 WITHOUT CLAIM TO ANY PARTICULAR FONT, STYLE,
 SIZE, OR COLOR.
 FOR METAL PIPES (U.S. CLS. 2, 12, 13, 14, 23, 25 AND
 50).
 FIRST USE 4-4-1973; IN COMMERCE 4-4-1973.
 RAMONA ORTIGA, EXAMINING ATTORNEY

SN 77-020,999. LOUGHEED, ELAINE K., ERICKSON, MAN-
 ITOBA, CANADA, FILED 10-13-2006.

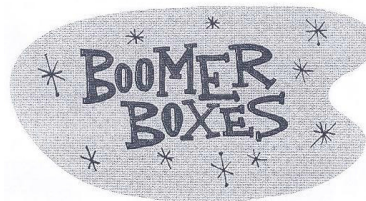

PRIORITY CLAIMED UNDER SEC. 44(D) ON CANADA
 APPLICATION NO. 1298123, FILED 4-18-2006, REG. NO.
 TMA690,759, DATED 6-26-2007, EXPIRES 6-26-2022.
 NO CLAIM IS MADE TO THE EXCLUSIVE RIGHT TO
 USE "BOXES", APART FROM THE MARK AS SHOWN.
 FOR TIN STORAGE BOXES FOR NOSTALGIC MEM-
 ORABILIA (U.S. CLS. 2, 12, 13, 14, 23, 25 AND 50).
 DAVID TAYLOR, EXAMINING ATTORNEY

CLASS 6—(Continued).

SN 77-035,613. CASCADE NUT & BOLT, INC., SALEM, OR. FILED 11-2-2006.

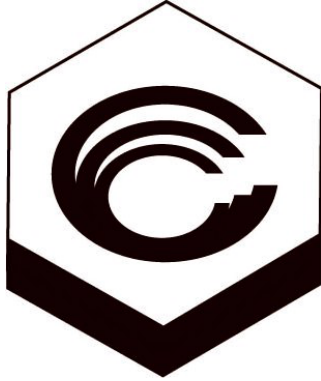

THE MARK CONSISTS OF A HEXAGON SHAPED NUT WITH THREADS IN THE SHAPE OF A "C".
FOR METAL NUTS, BOLTS, SCREWS, NAILS, CHAINS, RODS, RIVETS, ANCHORS, WASHERS AND PINS (U.S. CLS. 2, 12, 13, 14, 23, 25 AND 50).
FIRST USE 6-2-1997; IN COMMERCE 6-2-1997.
MICHAEL ENGEL, EXAMINING ATTORNEY

SN 77-069,268. ACUMENT INTELLECTUAL PROPERTIES LLC, TROY, MI. FILED 12-21-2006.

SPR

THE MARK CONSISTS OF STANDARD CHARACTERS WITHOUT CLAIM TO ANY PARTICULAR FONT, STYLE, SIZE, OR COLOR.
OWNER OF U.S. REG. NO. 2,245,003.
FOR METAL FASTENERS, NAMELY, AN EXPANDABLE RIVET AND A FRANGIBLE, PARTIALLY DISPOSABLE STEM USED TO EXPAND THE RIVET (U.S. CLS. 2, 12, 13, 14, 23, 25 AND 50).
FIRST USE 1-1-1997; IN COMMERCE 10-27-1998.
ROBERT C. CLARK JR., EXAMINING ATTORNEY

SN 77-069,962. OVERHEAD DOOR CORPORATION, LEWISVILLE, TX. FILED 12-21-2006.

QUIET GLIDE SERIES

THE MARK CONSISTS OF STANDARD CHARACTERS WITHOUT CLAIM TO ANY PARTICULAR FONT, STYLE, SIZE, OR COLOR.
NO CLAIM IS MADE TO THE EXCLUSIVE RIGHT TO USE "SERIES", APART FROM THE MARK AS SHOWN.
FOR RESIDENTIAL METAL GARAGE DOORS (U.S. CLS. 2, 12, 13, 14, 23, 25 AND 50).
WON TEAK OH, EXAMINING ATTORNEY

CLASS 6—(Continued).

SN 77-082,107. MEDI-RAY, INC., TUCKAHOE, NY. FILED 1-12-2007.



"THE MARK CONSISTS OF THE DEVICE OF A METAL POURING POT WHICH IS POURING MOLTEN METAL, AND THE WORDING MEDI RAY."
FOR LEAD METAL SHIPPING CONTAINERS FOR RADIOACTIVE PHARMACEUTICALS (U.S. CLS. 2, 12, 13, 14, 23, 25 AND 50).
WON TEAK OH, EXAMINING ATTORNEY

SN 77-097,629. DRAPER, INC, SPICELAND, IN. FILED 2-2-2007.

DRAPER

THE MARK CONSISTS OF STANDARD CHARACTERS WITHOUT CLAIM TO ANY PARTICULAR FONT, STYLE, SIZE, OR COLOR.
THE FOREIGN WORDING IN THE MARK TRANSLATES INTO ENGLISH AS "TO DRAPE."
SEC. 2(F).
FOR METAL VIDEO PROJECTOR WALL AND CEILING MOUNTS AND BRACKETS; METAL VIDEO PROJECTOR LIFTS; METAL FLAT PANEL SCREEN WALL AND CEILING MOUNTS AND BRACKETS; METAL CLOCK GUARDS; METAL STORAGE HOOKS AND BRACKETS FOR VOLLEYBALL AND BADMINTON NETS, POLES AND ACCESSORIES (U.S. CLS. 2, 12, 13, 14, 23, 25 AND 50).
FIRST USE 0-0-1985; IN COMMERCE 0-0-1985.
MARY MUNSON, EXAMINING ATTORNEY

CLASS 6—(Continued).

SN 77-124,007. GRANBY INDUSTRIES LIMITED PARTNER-
SHIP, OAKVILLE, CANADA, FILED 3-7-2007.

GRANBY STEEL TANKS

THE MARK CONSISTS OF STANDARD CHARACTERS
WITHOUT CLAIM TO ANY PARTICULAR FONT, STYLE,
SIZE, OR COLOR.

OWNER OF U.S. REG. NOS. 2,432,792 AND 2,443,789.
NO CLAIM IS MADE TO THE EXCLUSIVE RIGHT TO
USE STEEL TANKS, APART FROM THE MARK AS
SHOWN.

SEC. 2(F) AS TO GRANBY.
FOR STEEL STORAGE TANKS FOR RESIDENTIAL
AND COMMERCIAL USE, SOLD EMPTY (U.S. CLS. 2,
12, 13, 14, 23, 25 AND 50).

FIRST USE 1-1-1955; IN COMMERCE 1-1-1955.
LEIGH CAROLINE CASE, EXAMINING ATTORNEY

SN 77-124,010. GRANBY INDUSTRIES LIMITED PARTNER-
SHIP, OAKVILLE, CANADA, FILED 3-7-2007.

RESERVOIRS D'ACIER GRANBY

THE MARK CONSISTS OF STANDARD CHARACTERS
WITHOUT CLAIM TO ANY PARTICULAR FONT, STYLE,
SIZE, OR COLOR.

OWNER OF U.S. REG. NOS. 2,432,792 AND 2,443,789.
NO CLAIM IS MADE TO THE EXCLUSIVE RIGHT TO
USE RESERVOIRS D'ACIER, APART FROM THE MARK AS
SHOWN.

THE ENGLISH TRANSLATION OF "RESERVOIRS
D'ACIER" IS "STEEL TANKS."
SEC. 2(F) AS TO GRANBY.

FOR STEEL STORAGE TANKS FOR RESIDENTIAL
AND COMMERCIAL USE, SOLD EMPTY (U.S. CLS. 2,
12, 13, 14, 23, 25 AND 50).

FIRST USE 1-1-1955; IN COMMERCE 1-1-1955.
LEIGH CAROLINE CASE, EXAMINING ATTORNEY

SN 77-134,339. P.I. INC., ATHENS, TN. FILED 3-19-2007.

SAMSON POOLS

THE MARK CONSISTS OF STANDARD CHARACTERS
WITHOUT CLAIM TO ANY PARTICULAR FONT, STYLE,
SIZE, OR COLOR.

NO CLAIM IS MADE TO THE EXCLUSIVE RIGHT TO
USE "POOLS", APART FROM THE MARK AS SHOWN.

FOR METAL SWIMMING POOLS (U.S. CLS. 2, 12, 13,
14, 23, 25 AND 50).

JOHN WILKE, EXAMINING ATTORNEY

CLASS 6—(Continued).

SN 77-136,233. FURNITURE LEISURE, INC., BUNNELL, FL.
FILED 3-21-2007.

UBrace

THE MARK CONSISTS OF STANDARD CHARACTERS
WITHOUT CLAIM TO ANY PARTICULAR FONT, STYLE,
SIZE, OR COLOR.

FOR METAL HARDWARE IN THE NATURE OF
CIRCULAR COLLAR BRACES FOR FASTENING UM-
BRELLA POLES TO TABLES (U.S. CLS. 2, 12, 13, 14, 23,
25 AND 50).

FIRST USE 2-15-2007; IN COMMERCE 2-15-2007.
NICHOLAS ALTREE, EXAMINING ATTORNEY

SN 77-139,177. GAC STORAGE, LLC, LAS VEGAS, NV.
FILED 3-23-2007.

**GREAT AMERICAN STORAGE
SOLUTIONS**

THE MARK CONSISTS OF STANDARD CHARACTERS
WITHOUT CLAIM TO ANY PARTICULAR FONT, STYLE,
SIZE, OR COLOR.

FOR METAL LOCKS; METAL CHAINS; METAL
CABLE WIRE (U.S. CLS. 2, 12, 13, 14, 23, 25 AND 50).

TINA BROWN, EXAMINING ATTORNEY

SN 77-139,297. GAC STORAGE, LLC, LAS VEGAS, NV.
FILED 3-23-2007.



FOR METAL LOCKS; METAL CHAINS; METAL
CABLE WIRE (U.S. CLS. 2, 12, 13, 14, 23, 25 AND 50).

TINA BROWN, EXAMINING ATTORNEY

CLASS 6—(Continued).

SN 77-140,676. ACUMENT INTELLECTUAL PROPERTIES, LLC, TROY, MI. FILED 3-26-2007.

MAG-FORM

THE MARK CONSISTS OF STANDARD CHARACTERS WITHOUT CLAIM TO ANY PARTICULAR FONT, STYLE, SIZE, OR COLOR.

FOR METAL THREADED FASTENERS, NAMELY, SCREWS, NUTS, BOLTS AND STUDS (U.S. CLS. 2, 12, 13, 14, 23, 25 AND 50).

FIRST USE 6-0-1994; IN COMMERCE 12-13-1996.
ANGELA GAW, EXAMINING ATTORNEY

CLASS 6—(Continued).

SN 77-141,082. METALS USA BUILDING PRODUCTS, L.P., HOUSTON, TX. FILED 3-27-2007.



RHINO - PAN

THE MARK CONSISTS OF A STYLIZED RHINOCERUS. FOR METAL ROOF SYSTEM AND COMPONENTS COMPRISING OF RISER PANELS MADE OF A HIGH PERFORMANCE METAL ALLOY (U.S. CLS. 2, 12, 13, 14, 23, 25 AND 50).

FIRST USE 5-31-2006; IN COMMERCE 5-31-2006.
SHAUNIA CARLYLE, EXAMINING ATTORNEY

SN 77-141,066. METALS USA BUILDING PRODUCTS, L.P., DALLAS, TX. FILED 3-27-2007.

ELITEWOOD

THE MARK CONSISTS OF STANDARD CHARACTERS WITHOUT CLAIM TO ANY PARTICULAR FONT, STYLE, SIZE, OR COLOR.

FOR METAL ROOF AND PATIO SYSTEM COMPONENTS COMPRISING OF BEAMS, POSTS, RAFTERS, TUBES, AND SINGLE SKIN AND STRUCTURAL INSULATED ROOF PANELS, ALL MADE OF ALUMINUM OR METAL ALLOY (U.S. CLS. 2, 12, 13, 14, 23, 25 AND 50).

SHAUNIA CARLYLE, EXAMINING ATTORNEY

SN 77-141,088. METALS USA BUILDING PRODUCTS, L.P., HOUSTON, TX. FILED 3-27-2007.



THE MARK CONSISTS OF A STYLIZED RHINOCERUS. FOR METAL ROOF SYSTEM AND COMPONENTS COMPRISING OF RISER PANELS MADE OF A HIGH PERFORMANCE METAL ALLOY (U.S. CLS. 2, 12, 13, 14, 23, 25 AND 50).

SHAUNIA CARLYLE, EXAMINING ATTORNEY

SN 77-141,073. METALS USA BUILDING PRODUCTS, L.P., HOUSTON, TX. FILED 3-27-2007.

RHINO-PAN

THE MARK CONSISTS OF STANDARD CHARACTERS WITHOUT CLAIM TO ANY PARTICULAR FONT, STYLE, SIZE, OR COLOR.

FOR METAL ROOF SYSTEM AND COMPONENTS COMPRISING OF RISER PANELS MADE OF A HIGH PERFORMANCE METAL ALLOY (U.S. CLS. 2, 12, 13, 14, 23, 25 AND 50).

FIRST USE 5-31-2006; IN COMMERCE 5-31-2006.
SHAUNIA CARLYLE, EXAMINING ATTORNEY

SN 77-141,169. DAB DOOR COMPANY, INC., HIALEAH GARDENS, FL. FILED 3-27-2007.

CLEAR VISION

THE MARK CONSISTS OF STANDARD CHARACTERS WITHOUT CLAIM TO ANY PARTICULAR FONT, STYLE, SIZE, OR COLOR.

FOR METAL GARAGE DOORS (U.S. CLS. 2, 12, 13, 14, 23, 25 AND 50).

JENNIFER MARTIN, EXAMINING ATTORNEY

CLASS 6—(Continued).

SN 77-141,877. AIR-O FASTENERS INC., KAYSVILLE, UT.
FILED 3-27-2007.



NO CLAIM IS MADE TO THE EXCLUSIVE RIGHT TO USE "BRAND FASTENERS", APART FROM THE MARK AS SHOWN.

FOR METAL FASTENERS, NAMELY, NAILS, STAPLES, BRADS, PINS, RIVETS, SCREWS; NAILS; RIVETS, CRAMPS AND NAILS OF METAL (U.S. CLS. 2, 12, 13, 14, 23, 25 AND 50).

FIRST USE 1-5-2006; IN COMMERCE 4-19-2006.
AHSEN KHAN, EXAMINING ATTORNEY

SN 77-143,731. TTX COMPANY, CHICAGO, IL. FILED 3-29-2007.

YELLOW DOG

THE MARK CONSISTS OF STANDARD CHARACTERS WITHOUT CLAIM TO ANY PARTICULAR FONT, STYLE, SIZE, OR COLOR.

FOR METAL CLAMPS (U.S. CLS. 2, 12, 13, 14, 23, 25 AND 50).

GIANCARLO CASTRO, EXAMINING ATTORNEY

SN 77-147,344. A.M. CASTLE & CO., FRANKLIN PARK, IL.
FILED 4-3-2007.

OLIVER

THE MARK CONSISTS OF STANDARD CHARACTERS WITHOUT CLAIM TO ANY PARTICULAR FONT, STYLE, SIZE, OR COLOR.

FOR CARBON AND ALLOY STEEL PLATE (U.S. CLS. 2, 12, 13, 14, 23, 25 AND 50).

PAUL CROWLEY, EXAMINING ATTORNEY

CLASS 6—(Continued).

SN 77-162,349. BRICO PRODUCTS LLC, DENVER, CO.
FILED 4-20-2007.

SCULPTUREALL

THE MARK CONSISTS OF STANDARD CHARACTERS WITHOUT CLAIM TO ANY PARTICULAR FONT, STYLE, SIZE, OR COLOR.

FOR UNIQUE MOUNTING SYSTEM COMPRISED OF METAL BRACKETS USED FOR DISPLAYING VARIOUS DECORATIVE OBJECTS ON A WALL OR OTHER VERTICAL SURFACE (U.S. CLS. 2, 12, 13, 14, 23, 25 AND 50).

BRIDGETT SMITH, EXAMINING ATTORNEY

SN 77-171,766. SGM ENTERPRISES, LLC, GREENVILLE, SC.
FILED 5-3-2007.

RANGER

THE MARK CONSISTS OF STANDARD CHARACTERS WITHOUT CLAIM TO ANY PARTICULAR FONT, STYLE, SIZE, OR COLOR.

FOR METAL LOCKS, METAL CROSSBAR LOCKS, METAL DEADBOLT LOCKS, METAL PUCK LOCK AND HASP SOLD AS A UNIT, METAL LOCK IN THE NATURE OF INSIDE LOCKING PINS, METAL ROLL BOLT LOCKS, METAL SIDE ROLL BOLT LOCKS, METAL LOCK BOXES IN THE NATURE OF GUARDS FOR LOCKS, AND METAL GUARDS FOR LOCKS IN THE NATURE OF LOCK BOXES (U.S. CLS. 2, 12, 13, 14, 23, 25 AND 50).

FIRST USE 1-19-2004; IN COMMERCE 1-19-2004.

KARANENDRA S. CHHINA, EXAMINING ATTORNEY

SN 78-520,265. ALANOD ALUMINIUM-VEREDLUNG GMBH & CO. KG, 58256 ENNEPETAL, FED REP GERMANY, FILED 11-19-2004.

MIRO SUPER SILVER

THE MARK CONSISTS OF STANDARD CHARACTERS WITHOUT CLAIM TO ANY PARTICULAR FONT, STYLE, SIZE, OR COLOR.

OWNER OF U.S. REG. NOS. 2,162,287, 2,814,480 AND 3,087,991.

NO CLAIM IS MADE TO THE EXCLUSIVE RIGHT TO USE "SILVER", APART FROM THE MARK AS SHOWN.

FOR METALLIC TAPES, STRIPS AND BLANKS, IN PARTICULAR OF ALUMINUM HAVING A SURFACE COATING FOR REFLECTING OPTICAL RADIATION (U.S. CLS. 2, 12, 13, 14, 23, 25 AND 50).

HENRY S. ZAK, EXAMINING ATTORNEY

CLASS 6—(Continued).

SN 78-681,677. NELSON STUD WELDING, INC., ELYRIA, OH. FILED 7-29-2005.



OWNER OF U.S. REG. NOS. 726,143 AND 726,203.
FOR METAL WELDABLE STUDS AND METAL FASTENERS, NAMELY, STEEL FASTENERS, METAL STUDS AND BOLTS, WELD STUDS, WELDED BOLTS, STUD FASTENERS, SHEAR CONNECTORS, HEADED ANCHORS, WELDED HEADED ANCHORS, WELDED DEFORMED BAR ANCHORS, REINFORCING BARS AND STUDS, CONCRETE ANCHORS, CONCRETE ANCHOR STUDS, DEFORMED BAR ANCHOR STUDS, EXTERNALLY THREADED FASTENERS, INTERNALLY THREADED FASTENERS, PUNCHING SHEAR RESISTOR (PSR) STUDS, INSERTS, PORTS, PIPE HANGERS, CABLE HANGERS, BOSSES, STEEL BOLTS, TENSION BOLTS, NUTS, SHEET METAL BRACKETS, GROUNDING STUDS, PLASTIC CAP GROUND STUDS, METAL NUT GROUND STUDS, FIR-TREE STUDS, COARSE THREADED STUDS, WIDE TOP WIDE FLANGE STUDS, TRIM STUDS, COLLAR STUDS, FULL BASE AND REDUCED BASE STUDS, COLD FORMED ENGINEERED COMPONENTS, COLD FORMED NET SHAPES, COLD FORMED ECCENTRIC OR ASYMMETRIC PARTS, ANTI-SKID STUDS, WEAR PROTECTION STUDS, ANTI-CORROSION STUDS, REFRACTORY ANCHORS AND INSULATION STUDS, CAPACITOR DISCHARGE (CD) STUDS, RECTANGULAR STUDS, ROUND CORNER SQUARE STUDS, EYE-BOLT AND J BOLT STUDS; METAL FERRULES, NAMELY, FERRULES FOR WELDING AT AN ANGLE TO A BASE PLATE, WELDING TO CURVED SURFACES, WELDING TO EDGES OF BASE PLATES, WELDING INTO FILLETS AND ONTO HEELS, RECTANGULAR FERRULES, WELDING TO VERTICAL SURFACES, WELDING THROUGH METAL DECK, REFRACTORY ANCHOR FERRULES, SPECIAL APPLICATION FERRULES, STAND FERRULES (U.S. CLS. 2, 12, 13, 14, 23, 25 AND 50).

PAUL E. FAHRENKOPF, EXAMINING ATTORNEY

SN 78-795,150. OUTDOOR KITCHEN CONCEPTS, INC., LAS VEGAS, NV. FILED 1-19-2006.

MODBAR

THE MARK CONSISTS OF STANDARD CHARACTERS WITHOUT CLAIM TO ANY PARTICULAR FONT, STYLE, SIZE, OR COLOR.

FOR INTERCHANGEABLE AND SWITCHABLE METAL BARS AND BOLTS FOR ASSEMBLING AND INSTALLING OUTDOOR KITCHENS (U.S. CLS. 2, 12, 13, 14, 23, 25 AND 50).

CARRIE GENOVESE, EXAMINING ATTORNEY

CLASS 6—(Continued).

SN 78-950,109. MITCHEL AND MITCHEL CO., CHICAGO, IL. FILED 8-11-2006.

BUCKY

THE MARK CONSISTS OF STANDARD CHARACTERS WITHOUT CLAIM TO ANY PARTICULAR FONT, STYLE, SIZE, OR COLOR.

FOR CABINET JEWELRY, NAMELY DECORATIVE METAL TILES FOR USE ON HOME FURNISHINGS (U.S. CLS. 2, 12, 13, 14, 23, 25 AND 50).

CURTIS FRENCH, EXAMINING ATTORNEY

SN 78-958,290. VICTAULIC COMPANY OF AMERICA, EASTON, PA. FILED 8-23-2006.

FIRELOCK EZ

THE MARK CONSISTS OF STANDARD CHARACTERS WITHOUT CLAIM TO ANY PARTICULAR FONT, STYLE, SIZE, OR COLOR.

OWNER OF U.S. REG. NO. 2,612,076.
FOR METAL PIPE COUPLINGS AND JOINTS (U.S. CLS. 2, 12, 13, 14, 23, 25 AND 50).

FIRST USE 3-1-2005; IN COMMERCE 3-1-2005.
JACLYN KIDWELL, EXAMINING ATTORNEY

SN 78-962,649. DEERE & COMPANY, MOLINE, IL. FILED 8-29-2006.

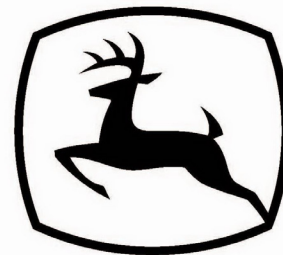

OWNER OF U.S. REG. NOS. 2,580,000, 2,729,766 AND OTHERS.

THE MARK CONSISTS OF A LEAPING DEER INSIDE OF A SINGLE CLOSED BORDER.

FOR METAL AUTO VANITY LICENSE PLATES, TIN CANS FOR CANDY AND POPCORN, SOLD EMPTY; NON-LUMINOUS AND NON-MECHANICAL METAL SIGNS (U.S. CLS. 2, 12, 13, 14, 23, 25 AND 50).

FIRST USE 12-1-2000; IN COMMERCE 12-1-2000.
FRED CARL, EXAMINING ATTORNEY

CLASS 6—(Continued).

SN 79-038,308. OVAKO HOLDINGS AB, SWEDEN, FILED 3-28-2007.

OVAROCK

THE MARK CONSISTS OF STANDARD CHARACTERS WITHOUT CLAIM TO ANY PARTICULAR FONT, STYLE, SIZE, OR COLOR.

PRIORITY DATE OF 3-19-2007 IS CLAIMED. OWNER OF INTERNATIONAL REGISTRATION 0923659 DATED 3-28-2007, EXPIRES 3-28-2017.

FOR UNWROUGHT OR SEMI-WROUGHT STEEL, PRODUCTS OF STEEL, NAMELY BARS, WIRE AND WIRE ROD, TUBES AND RINGS OF STEEL, HARD CHROMIUM PLATED STEEL BARS AND STEEL TUBES, FORGINGS (U.S. CLS. 2, 12, 13, 14, 23, 25 AND 50).

ADA HAN, EXAMINING ATTORNEY

SN 79-038,646. LAZARO ITUARTE INTERNACIONAL, S.A., SPAIN, FILED 3-14-2007.

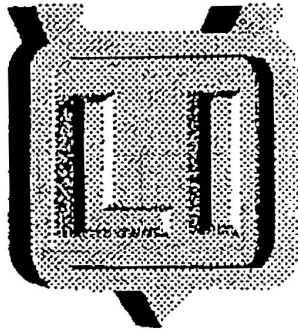

OWNER OF INTERNATIONAL REGISTRATION 0924647 DATED 3-14-2007, EXPIRES 3-14-2017.

FOR MANUAL METAL VALVES (U.S. CLS. 2, 12, 13, 14, 23, 25 AND 50).

PATRICIA EVANKO, EXAMINING ATTORNEY

CLASS 7—MACHINERY

SN 76-665,183. COLLAPSING STABILIZER TOOL, LTD., BRECKENRIDGE, TX. FILED 8-28-2006.

STABLE-MATE

FOR OIL AND GAS WELL DOWNHOLE DRILL STRING STABILIZERS (U.S. CLS. 13, 19, 21, 23, 31, 34 AND 35).

SHANNON TWOHIG, EXAMINING ATTORNEY

CLASS 7—(Continued).

SN 76-673,995. KING TECHNOLOGY OF MISSOURI, INC., O'FALLON, MO. FILED 3-13-2007.



NO CLAIM IS MADE TO THE EXCLUSIVE RIGHT TO USE "SIPHON", APART FROM THE MARK AS SHOWN.

FOR UTILITY WATER PUMPS FOR USE IN REMOVING WATER FROM IRRIGATION VALVES BOXES, METER PITS, PIPE TRENCHES AND OTHER AREAS WHERE WATER MAY ACCUMULATE (U.S. CLS. 13, 19, 21, 23, 31, 34 AND 35).

FIRST USE 10-26-2006; IN COMMERCE 10-26-2006. MARY CRAWFORD, EXAMINING ATTORNEY

SN 76-674,495. KADANT, INC., QUEENSBURY, NY. FILED 3-23-2007.

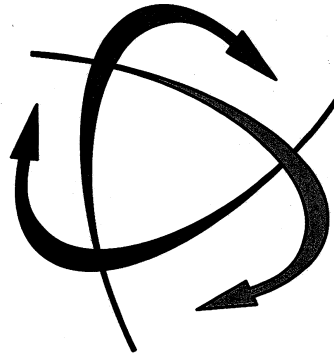

FOR HYDRAULIC PUMPING SYSTEM AND COMPONENTS THEREFOR (U.S. CLS. 13, 19, 21, 23, 31, 34 AND 35).

FIRST USE 6-0-2003; IN COMMERCE 6-0-2003. ZACHARY BELLO, EXAMINING ATTORNEY

SN 76-674,496. KADANT, INC., QUEENSBURY, NY. FILED 3-23-2007.

UNIGY

FOR HYDRAULIC PUMPING SYSTEM AND COMPONENTS THEREFOR (U.S. CLS. 13, 19, 21, 23, 31, 34 AND 35).

FIRST USE 6-0-2003; IN COMMERCE 6-0-2003. ZACHARY BELLO, EXAMINING ATTORNEY

CLASS 7—(Continued).

SN 76-674,746. LEAR BAYLOR, INC., GARDEN GROVE, CA.
FILED 3-28-2007.

POWERSURGE

THE MARK CONSISTS OF STANDARD CHARACTERS WITHOUT CLAIM TO ANY PARTICULAR FONT, STYLE, SIZE, OR COLOR.

FOR MARINE ELECTRIC POWER PLANTS, NAMELY, ELECTRIC BOAT MOTORS; GEARS FOR BOATS AND ELECTRICAL CONTROLLERS FOR MOTORS, ALL SOLD AS A COMPONENT PART OF ELECTRIC BOAT MOTORS (U.S. CLS. 13, 19, 21, 23, 31, 34 AND 35).
MICHAEL GAAFAR, EXAMINING ATTORNEY

SN 76-675,641. ADMIX, INC., MANCHESTER, NH. FILED 4-18-2007.

BOSTON SHEARMILL

THE MARK CONSISTS OF STANDARD CHARACTERS WITHOUT CLAIM TO ANY PARTICULAR FONT, STYLE, SIZE, OR COLOR.

OWNER OF U.S. REG. NO. 2,076,609.
NO CLAIM IS MADE TO THE EXCLUSIVE RIGHT TO USE SHEARMILL, APART FROM THE MARK AS SHOWN.
FOR MACHINES FOR BLENDING, SMOOTHING, EMULSIFYING, DISPERSING AND REDUCTION OF PARTICLE SIZE OF MATERIALS (U.S. CLS. 13, 19, 21, 23, 31, 34 AND 35).
FIRST USE 10-7-2003; IN COMMERCE 3-8-2004.
ALYSSA PALADINO, EXAMINING ATTORNEY

SN 76-675,766. NOVELLUS SYSTEMS, INC., SAN JOSE, CA.
FILED 4-20-2007.

L3510

THE MARK CONSISTS OF STANDARD CHARACTERS WITHOUT CLAIM TO ANY PARTICULAR FONT, STYLE, SIZE, OR COLOR.

FOR MACHINES FOR REMOVING LIGHT-SENSITIVE ORGANIC POLYMERS FROM SEMICONDUCTOR CHIPS DURING THE MANUFACTURE OF SAID CHIPS, AND PARTS FOR SUCH MACHINES (U.S. CLS. 13, 19, 21, 23, 31, 34 AND 35).
WILLIAM BRECKENFELD, EXAMINING ATTORNEY

CLASS 7—(Continued).

SN 76-675,767. NOVELLUS SYSTEMS, INC., SAN JOSE, CA.
FILED 4-20-2007.

PEP3510

THE MARK CONSISTS OF STANDARD CHARACTERS WITHOUT CLAIM TO ANY PARTICULAR FONT, STYLE, SIZE, OR COLOR.

FOR MACHINES FOR REMOVING LIGHT-SENSITIVE ORGANIC POLYMERS FROM SEMICONDUCTOR CHIPS DURING THE MANUFACTURE OF SAID CHIPS, AND PARTS FOR SUCH MACHINES (U.S. CLS. 13, 19, 21, 23, 31, 34 AND 35).
WILLIAM BRECKENFELD, EXAMINING ATTORNEY

SN 76-676,999. NOVELLUS SYSTEMS, INC., SAN JOSE, CA.
FILED 5-17-2007.

NOVELLIUM

THE MARK CONSISTS OF STANDARD CHARACTERS WITHOUT CLAIM TO ANY PARTICULAR FONT, STYLE, SIZE, OR COLOR.

OWNER OF U.S. REG. NOS. 1,503,743, 3,072,929 AND OTHERS.
FOR ALUMINUM ALLOY SOLD AS A PART OF MACHINES FOR MANUFACTURING SEMICONDUCTORS (U.S. CLS. 13, 19, 21, 23, 31, 34 AND 35).
WILLIAM BRECKENFELD, EXAMINING ATTORNEY

SN 76-677,353. BOIS FORTE BAND OF CHIPPEWA INDIANS, NETT LAKE, MN. FILED 5-24-2007.

POWERSTORM

THE MARK CONSISTS OF STANDARD CHARACTERS WITHOUT CLAIM TO ANY PARTICULAR FONT, STYLE, SIZE, OR COLOR.

OWNER OF U.S. REG. NO. 3,182,428.
FOR STATIONARY VEHICLE WASHING MACHINES AND REPLACEMENT PARTS THEREFOR (U.S. CLS. 13, 19, 21, 23, 31, 34 AND 35).
KATHY DE JONGE, EXAMINING ATTORNEY

CLASS 7—(Continued).

SN 77-013,342. BALTIMORE DREDGES, LLC, BALTIMORE, MD. FILED 10-4-2006.

SWINGING-DRAGON

THE MARK CONSISTS OF STANDARD CHARACTERS WITHOUT CLAIM TO ANY PARTICULAR FONT, STYLE, SIZE, OR COLOR.
OWNER OF U.S. REG. NOS. 586,574 AND 687,887.
FOR DREDGES, DREDGING MACHINES AND STRUCTURAL PARTS THEREOF (U.S. CLS. 13, 19, 21, 23, 31, 34 AND 35).
SOPHIA S. KIM, EXAMINING ATTORNEY

CLASS 7—(Continued).

SN 77-014,881. SHOP VAC CORPORATION, WILLIAMSPORT, PA. FILED 10-5-2006.

UP.LITE

THE MARK CONSISTS OF STANDARD CHARACTERS WITHOUT CLAIM TO ANY PARTICULAR FONT, STYLE, SIZE, OR COLOR.
FOR VACUUM CLEANERS (U.S. CLS. 13, 19, 21, 23, 31, 34 AND 35).
LINDA ORNDORFF, EXAMINING ATTORNEY

SN 77-033,483. DAYTON PROGRESS CORPORATION, DAYTON, OH. FILED 10-31-2006.

SN 77-014,876. SHOP VAC CORPORATION, WILLIAMSPORT, PA. FILED 10-5-2006.

UPLITE

THE MARK CONSISTS OF STANDARD CHARACTERS WITHOUT CLAIM TO ANY PARTICULAR FONT, STYLE, SIZE, OR COLOR.
FOR VACUUM CLEANERS (U.S. CLS. 13, 19, 21, 23, 31, 34 AND 35).
LINDA ORNDORFF, EXAMINING ATTORNEY

VERSAPLUS

THE MARK CONSISTS OF STANDARD CHARACTERS WITHOUT CLAIM TO ANY PARTICULAR FONT, STYLE, SIZE, OR COLOR.
FOR MACHINE TOOLS AND DIES FOR METAL FABRICATING AND STAMPING, NAMELY PUNCHES, PUNCH BLANKS, PUNCH PLATES, GUIDE BUSHINGS, LOCKING DEVICES COOPERATING THEREWITH, MATRICES, GUIDES, AND PILOTS (U.S. CLS. 13, 19, 21, 23, 31, 34 AND 35).
FIRST USE 3-30-2004; IN COMMERCE 3-30-2004.
AMY HELLA, EXAMINING ATTORNEY

SN 77-038,104. OAK LAWN MARKETING, INC., NAKA-KU, NAGOYA, JAPAN, FILED 11-6-2006.

SN 77-014,880. SHOP VAC CORPORATION, WILLIAMSPORT, PA. FILED 10-5-2006.

UP-LITE

THE MARK CONSISTS OF STANDARD CHARACTERS WITHOUT CLAIM TO ANY PARTICULAR FONT, STYLE, SIZE, OR COLOR.
FOR VACUUM CLEANERS (U.S. CLS. 13, 19, 21, 23, 31, 34 AND 35).
LINDA ORNDORFF, EXAMINING ATTORNEY

STYLEPLUS POWER JUICER

THE MARK CONSISTS OF STANDARD CHARACTERS WITHOUT CLAIM TO ANY PARTICULAR FONT, STYLE, SIZE, OR COLOR.
NO CLAIM IS MADE TO THE EXCLUSIVE RIGHT TO USE "POWER JUICER", APART FROM THE MARK AS SHOWN.
FOR ELECTRIC JUICERS (U.S. CLS. 13, 19, 21, 23, 31, 34 AND 35).
MELVIN AXILBUND, EXAMINING ATTORNEY

CLASS 7—(Continued).

SN 77-040,167. TEMA MARKETING AG, ZUG, SWITZERLAND, FILED 11-9-2006.

TEMA Multi-Line

THE MARK CONSISTS OF STANDARD CHARACTERS WITHOUT CLAIM TO ANY PARTICULAR FONT, STYLE, SIZE, OR COLOR.

PRIORITY CLAIMED UNDER SEC. 44(D) ON ERPNCMNTY TM OFC APPLICATION NO. 005098561, FILED 5-9-2006, REG. NO. 005098561, DATED 1-6-2007, EXPIRES 9-5-2016.

OWNER OF U.S. REG. NO. 2,665,536.

THE ENGLISH TRANSLATION OF THE WORD TEMA IN THE MARK IS THEME.

FOR COUPLINGS FOR MACHINES, HYDRAULIC COUPLINGS FOR MACHINES, ELECTRIC COUPLINGS FOR MACHINES, PNEUMATIC COUPLINGS FOR MACHINES, COUPLING SYSTEMS CONSISTING OF, OR A COMBINATION OF, QUICK-CONNECT COUPLINGS FOR GASES AND/OR FLUIDS, SPECIFICALLY HYDRAULIC, ELECTRIC, AND PNEUMATIC COUPLINGS FOR MACHINES (U.S. CLS. 13, 19, 21, 23, 31, 34 AND 35).

TINA BROWN, EXAMINING ATTORNEY

SN 77-094,413. VON SCHRADER COMPANY, RACINE, WI. FILED 1-30-2007.

ESPRIT

THE MARK CONSISTS OF STANDARD CHARACTERS WITHOUT CLAIM TO ANY PARTICULAR FONT, STYLE, SIZE, OR COLOR.

FOR UPHOLSTERY CLEANING MACHINES (U.S. CLS. 13, 19, 21, 23, 31, 34 AND 35).

FIRST USE 2-23-1998; IN COMMERCE 2-23-1998.

BERNICE MIDDLETON, EXAMINING ATTORNEY

CLASS 7—(Continued).

SN 77-096,783. ABUNDANCE ELECTRICAL (SHENZHEN) CO., LTD., SHENZHEN, GUANGDONG, CHINA, FILED 2-1-2007.

ABUND

THE MARK CONSISTS OF STANDARD CHARACTERS WITHOUT CLAIM TO ANY PARTICULAR FONT, STYLE, SIZE, OR COLOR.

FOR VALVES FOR PUMPS; PUMP CONTROL VALVES; ELECTRIC PUMPS; OIL PUMPS FOR USE IN MOTORS AND ENGINES; PNEUMATIC PUMPS; EMISSION REDUCTION UNITS FOR MOTORS AND ENGINES, NAMELY PCV VALVES; EMISSION REDUCTION UNITS FOR MOTORS AND ENGINES, NAMELY EGR VALVES; COMPRESSED AIR PUMPS; AIR SUCTION MACHINES; CENTRIFUGAL PUMPS; VACUUM PUMPS AS MACHINES; FUEL FILTERS; OIL FILTERS FOR MECHANICAL PURPOSES; HYDRAULIC DOOR CLOSERS; HYDRAULIC DOOR OPENERS; PNEUMATIC DOOR CLOSERS; VACUUM CLEANERS; STEAM CLEANING MACHINES (U.S. CLS. 13, 19, 21, 23, 31, 34 AND 35).

FIRST USE 6-0-1996; IN COMMERCE 8-0-1996.

CARYN GLASSER, EXAMINING ATTORNEY

SN 77-114,828. CALUMET ABRASIVES CO., INC., HAMMOND, IN. FILED 2-23-2007.

WELDERASER

THE MARK CONSISTS OF STANDARD CHARACTERS WITHOUT CLAIM TO ANY PARTICULAR FONT, STYLE, SIZE, OR COLOR.

FOR GRINDING WHEELS AND CUTOFF WHEELS FOR USE WITH PORTABLE AND STATIONERY POWER OPERATED TOOLS (U.S. CLS. 13, 19, 21, 23, 31, 34 AND 35).

FIRST USE 1-9-1950; IN COMMERCE 1-9-1950.

BRIAN NEVILLE, EXAMINING ATTORNEY

SN 77-115,926. STEVE CHANDLER, GERMANTOWN, TN. FILED 2-26-2007.

Titan

THE MARK CONSISTS OF STANDARD CHARACTERS WITHOUT CLAIM TO ANY PARTICULAR FONT, STYLE, SIZE, OR COLOR.

FOR EXHAUST AIR JACKS (U.S. CLS. 13, 19, 21, 23, 31, 34 AND 35).

FIRST USE 10-31-2006; IN COMMERCE 10-31-2006.

DOMINIC J. FERRAIUOLO, EXAMINING ATTORNEY

CLASS 7—(Continued).

SN 77-118,726. MTD PRODUCTS INC, VALLEY CITY, OH. FILED 2-28-2007.

TIME SAVER

THE MARK CONSISTS OF STANDARD CHARACTERS WITHOUT CLAIM TO ANY PARTICULAR FONT, STYLE, SIZE, OR COLOR.

FOR POWER OPERATED LAWN AND GARDEN EQUIPMENT, NAMELY, RIDING LAWN MOWERS, ZERO TURN RIDING LAWN MOWERS, WALK-BEHIND LAWN MOWERS, CHIPPER, SHREDDERS, LEAF VACUUMS, TILLERS, EDGERS, STRING TRIMMERS, BLOWERS, SNOW THROWERS, AND LOG SPLITTERS AND STRUCTURAL PARTS FOR FOREGOING GOODS (U.S. CLS. 13, 19, 21, 23, 31, 34 AND 35).

FIRST USE 8-0-2006; IN COMMERCE 8-0-2006.
NATALIE POLZER, EXAMINING ATTORNEY

CLASS 7—(Continued).

SN 77-122,771. GREEN, C. RAYMOND, JACKSON, CA. FILED 3-5-2007.

CATCHING WIND POWER

THE MARK CONSISTS OF STANDARD CHARACTERS WITHOUT CLAIM TO ANY PARTICULAR FONT, STYLE, SIZE, OR COLOR.

NO CLAIM IS MADE TO THE EXCLUSIVE RIGHT TO USE WIND POWER, APART FROM THE MARK AS SHOWN.

FOR WIND TURBINES (U.S. CLS. 13, 19, 21, 23, 31, 34 AND 35).

MICHELE SWAIN, EXAMINING ATTORNEY

SN 77-130,048. TOPAIR, INC., PARMA, ID. FILED 3-13-2007.

SN 77-119,754. WETHERILL ASSOCIATES, INC., ROYERSFORD, PA. FILED 3-1-2007.

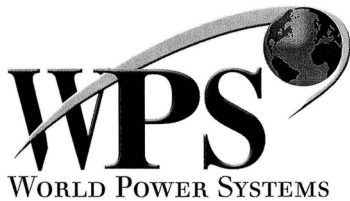

NO CLAIM IS MADE TO THE EXCLUSIVE RIGHT TO USE "POWER SYSTEMS", APART FROM THE MARK AS SHOWN.

THE MARK CONSISTS OF LITERAL ELEMENT OF THE MARK WITH A GLOBE BEING CRADLED BY AN ARC.

FOR MACHINE PARTS NAMELY, BEARING HOUSINGS, BEARING INSERTS, BEARINGS AND BUSHINGS FOR VEHICLE AND INDUSTRIAL USES; AND MOTOR VEHICLE PARTS, NAMELY, ELECTRIC STARTERS AND REPLACEMENT PARTS THEREOF AND ALTERNATORS AND REPLACEMENT PARTS THEREOF, ALL OF THE FORGOING FOR MOTOR VEHICLE ENGINES, AUTOMOBILE ENGINES, VAN ENGINES, TRUCK ENGINES, BOAT ENGINES, AND STATIONARY POWER GENERATING ENGINES (U.S. CLS. 13, 19, 21, 23, 31, 34 AND 35).

SANDRA MANIOS, EXAMINING ATTORNEY

TOP GREEN

THE MARK CONSISTS OF STANDARD CHARACTERS WITHOUT CLAIM TO ANY PARTICULAR FONT, STYLE, SIZE, OR COLOR.

FOR AGRICULTURAL MACHINERY, NAMELY, HARVESTERS (U.S. CLS. 13, 19, 21, 23, 31, 34 AND 35).

FIRST USE 3-1-2002; IN COMMERCE 3-1-2002.
WOODROW HARTZOG, EXAMINING ATTORNEY

SN 77-134,527. FRUT LLC, WESTERVILLE, OH. FILED 3-19-2007.



THE MARK CONSISTS OF FRUT WITH A LONG U SYMBOL OVER THE U.

FOR ELECTRIC MIXER ACCESSORIES, NAMELY, MULTI-PURPOSE MIXER BLADES FOR ELECTRIC KITCHEN MIXERS AND ELECTRIC PAINT MIXERS (U.S. CLS. 13, 19, 21, 23, 31, 34 AND 35).

PETER CHENG, EXAMINING ATTORNEY

CLASS 7—(Continued).

SN 77-139,070. SEALED AIR CORPORATION (US), ELMWOOD PARK, NJ. FILED 3-23-2007.

PACKTIGER

THE MARK CONSISTS OF STANDARD CHARACTERS WITHOUT CLAIM TO ANY PARTICULAR FONT, STYLE, SIZE, OR COLOR.

FOR MACHINES FOR MANUFACTURING AND DISPENSING PACKING MATERIALS (U.S. CLS. 13, 19, 21, 23, 31, 34 AND 35).

MICHELLE DUBOIS, EXAMINING ATTORNEY

SN 77-139,825. RAM INDUSTRIES, LLC, LEESPORT, PA. FILED 3-26-2007.

ENH₃ANCER AIR COOLED

NO CLAIM IS MADE TO THE EXCLUSIVE RIGHT TO USE "AIR COOLED", APART FROM THE MARK AS SHOWN.

THE MARK CONSISTS OF THE WORDS "ENH₃ANCER AIR COOLED" WITH THE CHEMICAL SYMBOL FOR AMMONIA, A CAPITAL "NH" WITH A SUBSCRIPT 3, IN THE MIDDLE OF THE FIRST WORD AND IN LARGER FONT THAN THE REST OF THE LETTERS IN THE MARK.

FOR AIR COOLED AC VARIABLE FREQUENCY DRIVES THAT ARE USED TO CONTROL SMALL AND MEDIUM-SIZED MOTORS IN APPLICATIONS, NAMELY MANUFACTURING PROCESS EQUIPMENT, COMPRESSORS, HVAC AND PUMPS (U.S. CLS. 13, 19, 21, 23, 31, 34 AND 35).

FIRST USE 8-1-2005; IN COMMERCE 8-1-2005.

JEFF DEFORD, EXAMINING ATTORNEY

CLASS 7—(Continued).

SN 77-140,568. RAM INDUSTRIES, LLC, LEESPORT, PA. FILED 3-26-2007.

ENH₃ANCER LIQUID COOLED

NO CLAIM IS MADE TO THE EXCLUSIVE RIGHT TO USE "LIQUID COOLED", APART FROM THE MARK AS SHOWN.

THE MARK CONSISTS OF THE WORDS ENH₃ANCER LIQUID COOLED WITH THE CHEMICAL SYMBOL FOR AMMONIA, A CAPITAL NH WITH A SUBSCRIPT 3, IN THE MIDDLE OF THE FIRST WORD AND IN LARGER FONT THAN THE REST OF THE LETTERS IN THE MARK.

FOR LIQUID COOLED AC VARIABLE FREQUENCY DRIVES THAT ARE USED TO CONTROL SMALL AND MEDIUM-SIZED MOTORS IN APPLICATIONS, NAMELY MANUFACTURING PROCESS EQUIPMENT, COMPRESSORS, HVAC AND PUMPS (U.S. CLS. 13, 19, 21, 23, 31, 34 AND 35).

JEFF DEFORD, EXAMINING ATTORNEY

SN 77-140,943. MALAKIMAN, SHAHRIAR (SHAWN), SAN JOSE, CA. FILED 3-27-2007.

EZTURNER

THE MARK CONSISTS OF STANDARD CHARACTERS WITHOUT CLAIM TO ANY PARTICULAR FONT, STYLE, SIZE, OR COLOR.

FOR MACHINE TO LIFT AND ROTATE A LOAD SUCH AS A STACK OF PAPER IN A WORK AND TURN PRINTING OPERATION (U.S. CLS. 13, 19, 21, 23, 31, 34 AND 35).

FIRST USE 9-15-2003; IN COMMERCE 9-15-2003.

JASON BLAIR, EXAMINING ATTORNEY

SN 77-141,023. COMPONENTS & EQUIPMENT INTERNATIONAL, INC, KENT, OH. FILED 3-27-2007.

ZIPP 

THE MARK CONSISTS OF THE WORD ZIPP AND A CHECKERED FLAG.

FOR AIR-OPERATED POWER TOOLS, NAMELY, IMPACT WRENCHES, RACHET WRENCHES, SCREWDRIVERS, RIVETERS, SAWS, SHEARS, HAMMERS, DRILLS, GRINDERS, SANDERS, BLOWERS, SPRAY GUNS (U.S. CLS. 13, 19, 21, 23, 31, 34 AND 35).

FIRST USE 8-27-1990; IN COMMERCE 8-27-1990.

TANYA AMOS, EXAMINING ATTORNEY

CLASS 7—(Continued).

SN 77-141,030. COMPONENTS & EQUIPMENT INTERNATIONAL, INC, KENT, OH. FILED 3-27-2007.

GREENIE MEANIE

THE MARK CONSISTS OF STANDARD CHARACTERS WITHOUT CLAIM TO ANY PARTICULAR FONT, STYLE, SIZE, OR COLOR.

FOR AIR-OPERATED POWER TOOLS, NAMELY, IMPACT WRENCHES, RACHET WRENCHES, SCREWDRIVERS, RIVETERS, SAWS, SHEARS, HAMMERS, DRILLS, GRINDERS, SANDERS, BLOWERS, SPRAY GUNS (U.S. CLS. 13, 19, 21, 23, 31, 34 AND 35).

TANYA AMOS, EXAMINING ATTORNEY

CLASS 7—(Continued).

SN 77-153,724. LAM RESEARCH CORPORATION, FREMONT, CA. FILED 4-11-2007.

KIYO

THE MARK CONSISTS OF STANDARD CHARACTERS WITHOUT CLAIM TO ANY PARTICULAR FONT, STYLE, SIZE, OR COLOR.

THE FOREIGN WORDING IN THE MARK TRANSLATES INTO ENGLISH AS "CLEAN" OR "PURE" OR "CONTRIBUTE."

FOR MACHINES FOR THE MANUFACTURE OF SEMICONDUCTORS AND SUBSTRATES CONTAINING SEMICONDUCTORS (U.S. CLS. 13, 19, 21, 23, 31, 34 AND 35).

FIRST USE 0-0-2004; IN COMMERCE 0-0-2004.
MATTHEW PAPPAS, EXAMINING ATTORNEY

SN 77-142,452. ATS AUTOMATION TECHNOLOGY SCHWOPE, INC., LIVONIA, MI. FILED 3-28-2007.

ASS End of Arm Tooling

THE MARK CONSISTS OF STANDARD CHARACTERS WITHOUT CLAIM TO ANY PARTICULAR FONT, STYLE, SIZE, OR COLOR.

NO CLAIM IS MADE TO THE EXCLUSIVE RIGHT TO USE "END OF ARM TOOLING", APART FROM THE MARK AS SHOWN.

FOR COMPONENTS FOR ROBOTIC END OF ARM TOOLING, NAMELY GRIPPER AND GRIPPER FINGER (U.S. CLS. 13, 19, 21, 23, 31, 34 AND 35).

ROSELLE HERRERA, EXAMINING ATTORNEY

SN 77-166,870. ILLINOIS TOOL WORKS INC., GLENVIEW, IL. FILED 4-26-2007.

FLOORMASTER

THE MARK CONSISTS OF STANDARD CHARACTERS WITHOUT CLAIM TO ANY PARTICULAR FONT, STYLE, SIZE, OR COLOR.

OWNER OF U.S. REG. NOS. 2,410,495 AND 2,617,397.
FOR PNEUMATIC POWERED HAND TOOLS, NAMELY, STAPLERS (U.S. CLS. 13, 19, 21, 23, 31, 34 AND 35).

FIRST USE 4-12-2007; IN COMMERCE 4-12-2007.
PAUL CROWLEY, EXAMINING ATTORNEY

SN 77-142,496. POWERMATE CORPORATION, AURORA, IL. FILED 3-28-2007.

ATG

THE MARK CONSISTS OF STANDARD CHARACTERS WITHOUT CLAIM TO ANY PARTICULAR FONT, STYLE, SIZE, OR COLOR.

FOR PORTABLE ELECTRIC GENERATORS (U.S. CLS. 13, 19, 21, 23, 31, 34 AND 35).

JORDAN BAKER, EXAMINING ATTORNEY

SN 77-180,382. NORDSON CORPORATION, WESTLAKE, OH. FILED 5-14-2007.

UltraMax

THE MARK CONSISTS OF STANDARD CHARACTERS WITHOUT CLAIM TO ANY PARTICULAR FONT, STYLE, SIZE, OR COLOR.

FOR MACHINERY FOR DISPENSING LIQUID ONTO A GLASS SUBSTRATE FOR USE IN FLAT PANEL DISPLAYS (U.S. CLS. 13, 19, 21, 23, 31, 34 AND 35).

TAMARA FRAZIER, EXAMINING ATTORNEY

CLASS 7—(Continued).

SN 77-181,643. VSM GROUP AKTIEBOLAG, HUSKVARNA, SWEDEN, FILED 5-15-2007.

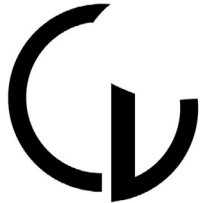

THE MARK CONSISTS OF A STYLIZED VERSION OF THE LETTERS C AND V.
FOR SEWING MACHINES AND PARTS THEREFOR (U.S. CLS. 13, 19, 21, 23, 31, 34 AND 35).
ANDREA HACK, EXAMINING ATTORNEY

SN 77-196,538. NORDSON CORPORATION, WESTLAKE, OH. FILED 6-4-2007.

BOWTIE

THE MARK CONSISTS OF STANDARD CHARACTERS WITHOUT CLAIM TO ANY PARTICULAR FONT, STYLE, SIZE, OR COLOR.
FOR HOT MELT ADHESIVE DISPENSING MACHINERY, NAMELY, GUNS, MANIFOLDS, AND MODULES (U.S. CLS. 13, 19, 21, 23, 31, 34 AND 35).
TAMARA FRAZIER, EXAMINING ATTORNEY

SN 78-473,300. SEMICONDUCTOR PROCESS EQUIPMENT CORP., VALENCIA, CA. FILED 8-25-2004.

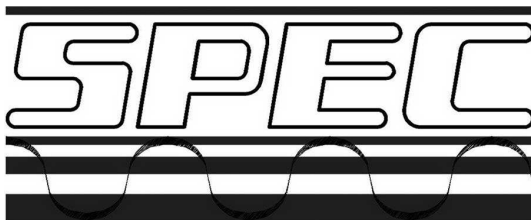

FOR SEMICONDUCTOR WAFER PROCESSING EQUIPMENT (U.S. CLS. 13, 19, 21, 23, 31, 34 AND 35).
FIRST USE 4-1-1986; IN COMMERCE 4-1-1986.
JOHN SCHUYLER YARD, EXAMINING ATTORNEY

CLASS 7—(Continued).

SN 78-567,857. SARGENT, RONALD J., FORT MYERS, FL. FILED 2-15-2005.

WIDGETEER

THE MARK CONSISTS OF STANDARD CHARACTERS WITHOUT CLAIM TO ANY PARTICULAR FONT, STYLE, SIZE, OR COLOR.
FOR VACUUM PUMP FOR EXTRACTING AIR FROM A PLASTIC STORAGE BAG, OR GLASS STORAGE CONTAINER, OR PLASTIC STORAGE CONTAINER AND RESEALING THE BAG OR CONTAINER FOR DOMESTIC HOUSEHOLD USE (U.S. CLS. 13, 19, 21, 23, 31, 34 AND 35).
COLLEEN DOMBROW, EXAMINING ATTORNEY

SN 78-689,892. GOSS INTERNATIONAL AMERICAS, INC., DOVER, NH. FILED 8-10-2005.

AUTOPLATE

THE MARK CONSISTS OF STANDARD CHARACTERS WITHOUT CLAIM TO ANY PARTICULAR FONT, STYLE, SIZE, OR COLOR.
FOR PRINTING PRESS AND PARTS THEREFOR (U.S. CLS. 13, 19, 21, 23, 31, 34 AND 35).
ALYSSA PALADINO, EXAMINING ATTORNEY

SN 78-786,714. CYCLO TOOLMAKERS, INC., LONGMONT, CO. FILED 1-6-2006.

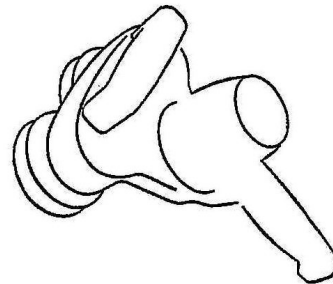

THE MARK CONSISTS OF STYLIZED RENDITION OF A DUAL-HEAD ORBITAL POLISHER.
SEC. 2(F).
FOR ELECTRIC AND AIR POWERED POLISHERS (U.S. CLS. 13, 19, 21, 23, 31, 34 AND 35).
FIRST USE 6-1-1987; IN COMMERCE 6-1-1987.
AMY MCMENAMIN, EXAMINING ATTORNEY

CLASS 7—(Continued).

SN 78-791,152. BLOUNT, INC., PORTLAND, OR. FILED 1-13-2006.

SUPER CHISEL

THE MARK CONSISTS OF STANDARD CHARACTERS WITHOUT CLAIM TO ANY PARTICULAR FONT, STYLE, SIZE, OR COLOR.
SEC. 2(F).
FOR SAW CHAIN FOR CHAIN SAWS (U.S. CLS. 13, 19, 21, 23, 31, 34 AND 35).
FIRST USE 9-0-1982; IN COMMERCE 9-0-1982.
PETER B. BROMAGHIM, EXAMINING ATTORNEY

SN 78-796,536. STRUCTUS BUILDING TECHNOLOGIES, INC., BEND, OR. FILED 1-21-2006.

DOUBLE BARREL HOPPER

THE MARK CONSISTS OF STANDARD CHARACTERS WITHOUT CLAIM TO ANY PARTICULAR FONT, STYLE, SIZE, OR COLOR.
NO CLAIM IS MADE TO THE EXCLUSIVE RIGHT TO USE "HOPPER", APART FROM THE MARK AS SHOWN.
FOR MACHINES, NAMELY, DRYWALL MUD HOPPERS (U.S. CLS. 13, 19, 21, 23, 31, 34 AND 35).
PRISCILLA MILTON, EXAMINING ATTORNEY

SN 78-808,711. ABERDEEN ROAD COMPANY, EMIGSVILLE, PA. FILED 2-7-2006.

TURBO-TAC

THE MARK CONSISTS OF STANDARD CHARACTERS WITHOUT CLAIM TO ANY PARTICULAR FONT, STYLE, SIZE, OR COLOR.
FOR AGRICULTURAL MACHINES, NAMELY, SPREADERS FOR USE WITH INSECTICIDES AND PESTICIDES; TRACTOR-TOWED APPLICATORS FOR USE WITH INSECTICIDES AND PESTICIDES (U.S. CLS. 13, 19, 21, 23, 31, 34 AND 35).
JENNY PARK, EXAMINING ATTORNEY

CLASS 7—(Continued).

SN 78-812,067. THE GENERATOR CONNECTION, INC., BARRINGTON, NH. FILED 2-10-2006.

THE NEW ENGLANDER EDITION

THE MARK CONSISTS OF STANDARD CHARACTERS WITHOUT CLAIM TO ANY PARTICULAR FONT, STYLE, SIZE, OR COLOR.
NO CLAIM IS MADE TO THE EXCLUSIVE RIGHT TO USE "EDITION", APART FROM THE MARK AS SHOWN.
FOR NATURAL GAS AND LIQUID PROPANE FUELED STANDBY ELECTRIC GENERATORS (U.S. CLS. 13, 19, 21, 23, 31, 34 AND 35).
FIRST USE 4-19-2004; IN COMMERCE 4-27-2004.
ROBIN CHOSID, EXAMINING ATTORNEY

SN 78-813,673. KABUSHIKI KAISHA FUJIMI INC. ALSO TRADING AS FUJIMI INC., KIYOSU-SHI, AICHI-KEN, JAPAN, FILED 2-13-2006.

SURFIN

THE MARK CONSISTS OF STANDARD CHARACTERS WITHOUT CLAIM TO ANY PARTICULAR FONT, STYLE, SIZE, OR COLOR.
FOR POLISHING PADS FOR INDUSTRIAL POLISHING MACHINES FOR USE IN THE MANUFACTURE OF SEMICONDUCTORS, ELECTRONIC CIRCUITS, HARD DISCS, CERAMICS, SAPPHIRES, CRYSTALS, GLASSES, PLASTICS, COMPUTER CHIPS, METALLIC OXIDES AND METALLIC MATERIALS (U.S. CLS. 13, 19, 21, 23, 31, 34 AND 35).
FIRST USE 12-0-1980; IN COMMERCE 12-0-1985.
STEVEN R. FINE, EXAMINING ATTORNEY

CLASS 7—(Continued).

SN 78-817,050. PACKERS PLUS ENERGY SERVICES INC., CALGARY, CANADA, FILED 2-16-2006.

STACKFRAC

THE MARK CONSISTS OF STANDARD CHARACTERS WITHOUT CLAIM TO ANY PARTICULAR FONT, STYLE, SIZE, OR COLOR.

PRIORITY CLAIMED UNDER SEC. 44(D) ON CANADA APPLICATION NO. 1278383, FILED 11-3-2005, REG. NO. 673562, DATED 9-27-2006, EXPIRES 9-27-2015.

FOR OIL AND GAS WELL COMPLETION SYSTEMS COMPRISED OF PACKERS, FRACPORTS FOR THE PLACEMENT OF FLUIDS OR FLUID CONTROL OUT OF WELLS, BALL SEATS VALVES, CERAMIC OR METAL BALLS FOR USE IN THE FLOW OF FLUIDS, WELLBORE CASING, TUBING, CIRCULATING VALVES, CENTRALIZERS, WIRELINE RETRIEVABLE BALL SEATS, HYDRAULIC ANCHORS, OPEN HOLE ANCHORS, ALL USED IN OIL AND GAS WELL COMPLETIONS (U.S. CLS. 13, 19, 21, 23, 31, 34 AND 35).

FIRST USE 4-0-2002; IN COMMERCE 8-0-2002.
MICHAEL LEWIS, EXAMINING ATTORNEY

SN 78-930,330. BEERS MICHAEL, AUSTIN, TX. FILED 7-15-2006.

PLUG BOSS

THE MARK CONSISTS OF STANDARD CHARACTERS WITHOUT CLAIM TO ANY PARTICULAR FONT, STYLE, SIZE, OR COLOR.

NO CLAIM IS MADE TO THE EXCLUSIVE RIGHT TO USE "PLUG", APART FROM THE MARK AS SHOWN.

FOR WINCHES (U.S. CLS. 13, 19, 21, 23, 31, 34 AND 35).
FIRST USE 3-12-2006; IN COMMERCE 5-20-2006.
KELLY CHOE, EXAMINING ATTORNEY

SN 78-942,276. DAYTON SUPERIOR DELAWARE CORPORATION, DBA DAYTON SUPERIOR CORPORATION, DAYTON, OH. FILED 8-1-2006.

TAPER-LOCK

THE MARK CONSISTS OF STANDARD CHARACTERS WITHOUT CLAIM TO ANY PARTICULAR FONT, STYLE, SIZE, OR COLOR.

FOR MACHINES FOR USE IN TAPERING, THREADING, AND SPLICING REBAR FOR REINFORCED CONCRETE APPLICATIONS (U.S. CLS. 13, 19, 21, 23, 31, 34 AND 35).

CAROL SPILS, EXAMINING ATTORNEY

CLASS 7—(Continued).

SN 78-942,495. MOLD-MASTERS LIMITED, GEORGETOWN, ONTARIO, CANADA, FILED 8-1-2006.

RHEO-FLOW

THE MARK CONSISTS OF STANDARD CHARACTERS WITHOUT CLAIM TO ANY PARTICULAR FONT, STYLE, SIZE, OR COLOR.

FOR NOZZLES AND MANIFOLDS FOR PLASTIC MOLDING MACHINES AND PARTS THEREOF (U.S. CLS. 13, 19, 21, 23, 31, 34 AND 35).

LOURDES AYALA, EXAMINING ATTORNEY

SN 78-948,907. SKS INDUSTRIES, INC., COMMERCE, CA. FILED 8-9-2006.

DYNA 4

THE MARK CONSISTS OF STANDARD CHARACTERS WITHOUT CLAIM TO ANY PARTICULAR FONT, STYLE, SIZE, OR COLOR.

NO CLAIM IS MADE TO THE EXCLUSIVE RIGHT TO USE "4", APART FROM THE MARK AS SHOWN.

FOR AIR FILTERS FOR MECHANICAL PURPOSES; AIR FILTERS FOR VEHICLE MOTORS AND ENGINES; FUEL FILTERS; OIL FILTERS; OIL FILTERS FOR MECHANICAL PURPOSES; OIL FILTERS FOR MOTORS AND ENGINES; FUEL FILTERS FOR MOTORS AND ENGINES (U.S. CLS. 13, 19, 21, 23, 31, 34 AND 35).

SETH A. RAPPAPORT, EXAMINING ATTORNEY

SN 78-949,981. BRUNSWICK CORPORATION, LAKE FOREST, IL. FILED 8-11-2006.

ZEUS

THE MARK CONSISTS OF STANDARD CHARACTERS WITHOUT CLAIM TO ANY PARTICULAR FONT, STYLE, SIZE, OR COLOR.

FOR MARINE ENGINE AND MARINE ENGINE DRIVES (U.S. CLS. 13, 19, 21, 23, 31, 34 AND 35).

GRETTA YAO, EXAMINING ATTORNEY

CLASS 7—(Continued).

SN 78-956,885. CHICAGO MANIFOLD PRODUCTS CO., WHEELING, IL. FILED 8-21-2006.



NO CLAIM IS MADE TO THE EXCLUSIVE RIGHT TO USE "ROLLER", APART FROM THE MARK AS SHOWN.

THE MARK CONSISTS OF THE WORDS "CUSTOM ROLLER SOLUTIONS" ACCOMPANIED BY A PERSPECTIVE VIEW OF THREE ROLLERS BEARING ON THEIR ENDS, RESPECTIVELY, THE INITIALS "C", "R" AND "S," FOR RUBBER AND PLASTIC ROLLERS USED IN MACHINERY FOR MATERIALS MOVEMENT (U.S. CLS. 13, 19, 21, 23, 31, 34 AND 35).

PETER CHENG, EXAMINING ATTORNEY

SN 78-965,210. INNOVATION DIRECT LLC, CLEVELAND, OH. FILED 8-31-2006.

TURBODRY

THE MARK CONSISTS OF STANDARD CHARACTERS WITHOUT CLAIM TO ANY PARTICULAR FONT, STYLE, SIZE, OR COLOR.

FOR POWER TOOLS, NAMELY HAND-HELD DUAL ACTION BLOWER AND VACUUM TOOLS AND ATTACHMENTS FOR SAME; TOOL FOR AUTO BODY CARE, NAMELY A COMBINED LIQUID SPRAYER AND VACUUM FOR WASHING, CLEANING AND/OR DRYING; POWER OPERATED BLOWERS AND POWER OPERATED SPRAYERS (U.S. CLS. 13, 19, 21, 23, 31, 34 AND 35).

INGA ERVIN, EXAMINING ATTORNEY

SN 78-969,253. OUTOKUMPU TECHNOLOGY OY, ESPOO, FINLAND, FILED 9-7-2006.

CARPCO

THE MARK CONSISTS OF STANDARD CHARACTERS WITHOUT CLAIM TO ANY PARTICULAR FONT, STYLE, SIZE, OR COLOR.

OWNER OF U.S. REG. NO. 634,559.
FOR MACHINES AND APPARATUSES, ALL FOR USE IN SEPARATING MATERIALS, NAMELY PHYSICAL SEPARATORS USED IN THE ELECTROSTATIC, MAGNETIC AND GRAVITY SEPARATION OF DIFFERENT TYPES OF ORES, MINERALS, PLASTICS, CHEMICALS AND OTHER MATERIALS FROM EACH OTHER (U.S. CLS. 13, 19, 21, 23, 31, 34 AND 35).

FIRST USE 1-0-1948; IN COMMERCE 1-0-1948.
AMY MCMENAMIN, EXAMINING ATTORNEY

CLASS 7—(Continued).

SN 79-013,250. VIET S.P.A., ITALY, FILED 4-22-2005.



OWNER OF INTERNATIONAL REGISTRATION 0856464 DATED 4-22-2005, EXPIRES 4-22-2015.

NO CLAIM IS MADE TO THE EXCLUSIVE RIGHT TO USE "ITALIA", APART FROM THE MARK AS SHOWN.

THE ENGLISH TRANSLATION OF THE WORD VIET IN THE MARK IS VIETNAMESE SOLDIER, AND THE ENGLISH TRANSLATION OF THE WORD ITALIA IN THE MARK IS ITALY.

FOR WOODWORKING MACHINERY, NAMELY WIDE BELT SANDING MACHINES, BRUSHING SANDING MACHINES, ELECTRIC SANDERS, AIR-OPERATED SANDERS, POLISHING MACHINES FOR USE IN POLISHING WOOD, PROFILE POLISHING MACHINES, NAMELY, POLISHING MACHINES FOR USE IN POLISHING PROFILES, NAMELY, SECTIONS OF WOOD AND PANELS MADE OF WOOD BY-PRODUCTS (U.S. CLS. 13, 19, 21, 23, 31, 34 AND 35).

NANCY CLARKE, EXAMINING ATTORNEY

SN 79-028,122. KLAUS HOFMANN, FED REP GERMANY, FILED 4-10-2006.

ZeroClamp

THE MARK CONSISTS OF STANDARD CHARACTERS WITHOUT CLAIM TO ANY PARTICULAR FONT, STYLE, SIZE, OR COLOR.

PRIORITY DATE OF 10-14-2005 IS CLAIMED.
OWNER OF INTERNATIONAL REGISTRATION 0896528 DATED 4-10-2006, EXPIRES 4-10-2016.

FOR COUPLINGS AND PARTS THEREFOR FOR MACHINES; BRAKES AND PARTS THEREFOR FOR MACHINES (U.S. CLS. 13, 19, 21, 23, 31, 34 AND 35).

VERNA BETH RIRIE, EXAMINING ATTORNEY

CLASS 7—(Continued).

SN 79-030,700. PRIMA S.R.L., I-20157 MILANO, ITALY,
FILED 4-26-2006.

Prima 

OWNER OF INTERNATIONAL REGISTRATION 0902920
DATED 4-26-2006, EXPIRES 4-26-2016.

THE TRADEMARK CONSISTS IN THE WORD "PRIMA" IN SMALL BLOCK CHARACTERS WHERE THE FIRST LETTER "P" IS IN BLOCK CAPITAL. AT THE END OF SAID WORD THERE ARE TWO GEOMETRICAL FIGURES, PUT SIDE BY SIDE, THAT MAKE UP, BY AND LARGE, THE SHAPE OF A "L": EACH FIGURE IS MADE BY A RECTANGULAR TRAPEZIUM THAT REPRESENTS A SEMICIRCULAR APPENDIX NEXT TO THE VERTEX OF UNION OF THE GREATER BASE WITH THE OBLIQUE SIDE. THE TRAPEZIUMS OF THE TWO FIGURES ARE PLACED WITH THEIR RELATIVE OBLIQUE SIDES PARALLEL AND PUT CLOSED TOGETHER.

THE FOREIGN WORDING IN THE MARK TRANSLATES INTO ENGLISH AS BEFORE.

FOR DRILLING AND BINDING MACHINES, NAMELY, SPIRAL BINDING MACHINES FOR INDUSTRIAL USE AND REPLACEMENT PARTS AND ACCESSORIES THEREFOR (U.S. CLS. 13, 19, 21, 23, 31, 34 AND 35).

CHRISTOPHER OTT, EXAMINING ATTORNEY

SN 79-037,642. SENSE EDM AS, NORWAY, FILED 2-13-2007.

ULTRASINGLE

THE MARK CONSISTS OF STANDARD CHARACTERS WITHOUT CLAIM TO ANY PARTICULAR FONT, STYLE, SIZE, OR COLOR.

PRIORITY DATE OF 1-24-2007 IS CLAIMED.
OWNER OF INTERNATIONAL REGISTRATION 0921867
DATED 2-13-2007, EXPIRES 2-13-2017.

FOR DRILLING MACHINES, DRILLING RIGS, DRILLING DERRICKS, DRILLING BITS, ALL FOR THE USE IN OIL AND GAS INDUSTRY (U.S. CLS. 13, 19, 21, 23, 31, 34 AND 35).

LINDA POWELL, EXAMINING ATTORNEY

CLASS 8—HAND TOOLS

SN 77-103,693. ZHANG, LINGCHENG, ZHEJIANG, CHINA,
FILED 2-9-2007.

Lena

FOR HAIR PERMANENT CLIPPERS; NAIL FILES; HAIR RAZORS; ELECTRIC AND NON-ELECTRIC HAIR CLIPPERS; EYELASH CURLERS; RAZOR BLADES; ELECTRIC AND NON-ELECTRIC FINGERNAIL AND MANICURE IMPLEMENTS, NAMELY, NAIL CLIPPERS, CUTICLE SCISSORS, AND CUTICLE PUSHERS (U.S. CLS. 23, 28 AND 44).

RICHARD A. STRASER, EXAMINING ATTORNEY

SN 77-116,342. EASCO HAND TOOLS, INC., SIMSBURY, CT.
FILED 2-26-2007.

STEELGRIP

THE MARK CONSISTS OF STANDARD CHARACTERS WITHOUT CLAIM TO ANY PARTICULAR FONT, STYLE, SIZE, OR COLOR.

OWNER OF U.S. REG. NO. 1,526,506.

SEC. 2(F).

FOR HAND TOOLS, NAMELY, PLIERS, HAMMERS, WRENCHES, SCREWDRIVERS, LOCKING PLIERS, ADJUSTABLE WRENCHES, SOCKETS AND RATCHETING WRENCHES (U.S. CLS. 23, 28 AND 44).

KIMBERLY FRYE, EXAMINING ATTORNEY

SN 77-129,368. MARSHALL, KENNETH, ELKTON, VA.
FILED 3-13-2007.

Lap Square

THE MARK CONSISTS OF STANDARD CHARACTERS WITHOUT CLAIM TO ANY PARTICULAR FONT, STYLE, SIZE, OR COLOR.

NO CLAIM IS MADE TO THE EXCLUSIVE RIGHT TO USE "SQUARE", APART FROM THE MARK AS SHOWN.

FOR HAND TOOLS, NAMELY, SQUARES (U.S. CLS. 23, 28 AND 44).

BENJAMIN OKEKE, EXAMINING ATTORNEY

CLASS 8—(Continued).

SN 77-138,438. CONNORS, LINDA, READING, MA. FILED 3-23-2007.



NO CLAIM IS MADE TO THE EXCLUSIVE RIGHT TO USE "SCISSORS", APART FROM THE MARK AS SHOWN. THE COLOR(S) YELLOW, BLUE, GOLD, AND WHITE IS/ARE CLAIMED AS A FEATURE OF THE MARK.

THE MARK CONSISTS OF STYLIZED WORD UNCOMMON IN YELLOW ABOVE STYLIZED WORK SCISSORS IN BLUE ABOVE STYLIZED PICTURE OF GOLD SCISSORS ALL AGAINST A WHITE BACKGROUND IN A BLUE OUTLINED BOX.

FOR SCISSORS (U.S. CLS. 23, 28 AND 44).
FIRST USE 5-27-2005; IN COMMERCE 5-27-2005.
ROBIN CHOSID, EXAMINING ATTORNEY

CLASS 8—(Continued).

SN 77-141,875. B2X CORPORATION, JERSEY CITY, NJ. FILED 3-27-2007.

B2X

THE MARK CONSISTS OF STANDARD CHARACTERS WITHOUT CLAIM TO ANY PARTICULAR FONT, STYLE, SIZE, OR COLOR.

FOR HAND OPERATED FOOD PROCESSOR, HAND OPERATED FOOD CHOPPER (U.S. CLS. 23, 28 AND 44).
THEODORE MCBRIDE, EXAMINING ATTORNEY

SN 77-141,190. COLLIER, MEI, LONG BEACH, CA. FILED 3-27-2007.

MoTool

THE MARK CONSISTS OF STANDARD CHARACTERS WITHOUT CLAIM TO ANY PARTICULAR FONT, STYLE, SIZE, OR COLOR.

FOR MULTI-FUNCTION HAND TOOLS COMPRISED OF HAMMERS, RATCHET WRENCHES, AXES, SCREWDRIVERS, FILES AND PLIERS (U.S. CLS. 23, 28 AND 44).
JENNIFER MARTIN, EXAMINING ATTORNEY

SN 77-144,391. JUNG, WOO SEOK, MONTGOMERYVILLE, PA. FILED 3-29-2007.

FINGER TO TOE

THE MARK CONSISTS OF STANDARD CHARACTERS WITHOUT CLAIM TO ANY PARTICULAR FONT, STYLE, SIZE, OR COLOR.

FOR MANICURE IMPLEMENTS, NAMELY, NAIL FILES, NAIL CLIPPERS, CUTICLE PUSHERS, TWEEZERS, NAIL AND CUTICLE SCISSORS, NAIL BUFFERS, NAIL AND CUTICLE NIPPERS, SAFETY SCISSORS, CUTICLE TRIMMERS, CUTICLE CUTTERS, CALLUS RASPS; MANICURE SETS; PEDICURE SETS (U.S. CLS. 23, 28 AND 44).

DAVID TOOLEY, EXAMINING ATTORNEY

SN 77-141,500. VALTRA, INC., PICO RIVERA, CA. FILED 3-27-2007.



THE MARK CONSISTS OF A FIGURE OF THE HAND WITH THE WORDING "GOOD HAND" ON IT. FOR HAND TOOLS, NAMELY, CLAMPS (U.S. CLS. 23, 28 AND 44).

FIRST USE 9-18-1995; IN COMMERCE 9-18-1995.
LESLIE RICHARDS, EXAMINING ATTORNEY

SN 77-149,903. DISNEY ENTERPRISES, INC., BURBANK, CA. FILED 4-5-2007.

WHERE IMAGINATION BEGINS

THE MARK CONSISTS OF STANDARD CHARACTERS WITHOUT CLAIM TO ANY PARTICULAR FONT, STYLE, SIZE, OR COLOR.

FOR KNIVES, FORKS, SPOONS, NAIL CLIPPERS (U.S. CLS. 23, 28 AND 44).

BRIDGETT SMITH, EXAMINING ATTORNEY

CLASS 8—(Continued).

SN 78-861,622. KLEIN TOOLS, INC., CHICAGO, IL. FILED 4-14-2006.

KLEIN

THE MARK CONSISTS OF STANDARD CHARACTERS WITHOUT CLAIM TO ANY PARTICULAR FONT, STYLE, SIZE, OR COLOR.

OWNER OF U.S. REG. NOS. 619,012, 1,653,472 AND OTHERS.

SEC. 2(F).

FOR HAND TOOLS, NAMELY, AWLS, TOOL BELTS, BOLT CUTTERS, CABLE CUTTERS, CABLE PREPARATION TOOLS IN THE NATURE OF HAND CABLE SPLICERS, CHISELS, CONDUIT BENDERS, WIRE CRIMPING TOOLS, NON-ELECTRIC DRILLS, FISH TAPES FOR PULLING CABLES, HAMMERS, KNIFE SHARPENERS, KNIVES, NUT DRIVERS, STRUCTURAL PARTS OF PLIERS IN THE NATURE OF PLASTIC PLIER HANDLES, PLIERS, PUNCHES, SAWS, SCISSORS, SCREWDRIVERS, HAND HOOKS, SNIPS, SPlicing CLAMPS, TAPPING TOOLS, WIRE CUTTERS, WIRE GRIPPERS, WIRE STRIPPERS, WRENCHES (U.S. CLS. 23, 28 AND 44).

FIRST USE 1-1-1955; IN COMMERCE 1-1-1955.

LYDIA BELZER, EXAMINING ATTORNEY

SN 78-952,225. ONTEL PRODUCTS CORPORATION, FAIRFIELD, NJ. FILED 8-15-2006.

KITCHEN KING PRO

THE MARK CONSISTS OF STANDARD CHARACTERS WITHOUT CLAIM TO ANY PARTICULAR FONT, STYLE, SIZE, OR COLOR.

NO CLAIM IS MADE TO THE EXCLUSIVE RIGHT TO USE "KITCHEN OR PRO", APART FROM THE MARK AS SHOWN.

FOR HAND-OPERATED FOOD CHOPPER; HAND-OPERATED FOOD PROCESSOR (U.S. CLS. 23, 28 AND 44).

BRENDAN REGAN, EXAMINING ATTORNEY

SN 78-960,769. HEB GROCERY COMPANY, LP, SAN ANTONIO, TX. FILED 8-25-2006.

COCINAWARE

THE MARK CONSISTS OF STANDARD CHARACTERS WITHOUT CLAIM TO ANY PARTICULAR FONT, STYLE, SIZE, OR COLOR.

THE ENGLISH TRANSLATION OF THE WORD COCINA IN THE MARK IS "KITCHEN."

FOR FLATWARE (U.S. CLS. 23, 28 AND 44).

ZACHARY BELLO, EXAMINING ATTORNEY

CLASS 8—(Continued).

SN 78-969,284. TAYLOR BRANDS LLC, KINGSPORT, TN. FILED 9-7-2006.

JOSEPH RODGERS

THE MARK CONSISTS OF STANDARD CHARACTERS WITHOUT CLAIM TO ANY PARTICULAR FONT, STYLE, SIZE, OR COLOR.

THE NAME "JOSEPH RODGERS" SHOWN IN THE MARK DOES NOT IDENTIFY A PARTICULAR LIVING INDIVIDUAL.

FOR CUTLERY, NAMELY KNIVES (U.S. CLS. 23, 28 AND 44).

ODESSA BIBBINS, EXAMINING ATTORNEY

SN 79-029,499. OUTILS RUBIS SA, SWITZERLAND, FILED 8-29-2006.

rubis

OWNER OF INTERNATIONAL REGISTRATION 0775403 DATED 1-3-2002, EXPIRES 1-3-2012.

OWNER OF U.S. REG. NOS. 1,569,285, 2,475,233 AND OTHERS.

FOR HAND TOOLS FOR INDUSTRIAL AND PERSONAL USE, NAMELY TWEEZERS, SCISSORS, NIPPERS AND NAIL CUTTERS (U.S. CLS. 23, 28 AND 44).

SHARON MEIER, EXAMINING ATTORNEY

CLASS 8—(Continued).

SN 79-030,870. HANGZHOU GREAT STAR TOOLS CO., LTD., CHINA, FILED 9-26-2006.



OWNER OF INTERNATIONAL REGISTRATION 0903337 DATED 9-26-2006, EXPIRES 9-26-2016.

FOR HAND-OPERATED GRINDING INSTRUMENTS, NAMELY MANUALLY OPERATED GRINDING WHEELS AND GRINDSTONES; SMALL AGRICULTURAL IMPLEMENTS, NAMELY TILLER, HOES, TROWELS AND FORKS; HAND TOOLS FOR FORESTRY AND GARDEN, NAMELY TROWELS, WEEDING FORKS, SPADES, HOES; HAND TOOLS OTHER THAN POWER-OPERATED, NAMELY CHISELS, HAMMERS, AXES, SPANNERS AND WRENCHES, DRILLS, CUTTING TOOLS, FILES, SCREW TAPS, PLANES, PLIERS, SCREWDRIVER; HAND-OPERATED INSTRUMENTS OTHER THAN POWER-OPERATED, NAMELY SPREADERS, TUBE CUTTERS, THREE-JAW GEAR PULLERS; SPECIAL HAND TOOLS, NAMELY SPATULAS FOR SPREADING HOT WAX, SHOE LASTS, DRYWALL MIXER, PUTTY KNIVES, MUD PANS, WHETSTONES, SANDERS, CORNER TOOLS, PAINTING MIXER, PAINTING ROLLER, PAINT BRUSH; MASONRY TOOLS, NAMELY MASONS' TROWELS, MASONS' EDGER, MASONS' GROOVER; GRAVING TOOLS, NAMELY ENGRAVERS; TWEEZERS; KNIVES; SCISSORS (U.S. CLS. 23, 28 AND 44).

JASON BLAIR, EXAMINING ATTORNEY

CLASS 9—(Continued).

SN 76-173,211. AMERICAN AIRPOWER HERITAGE MUSEUM, MIDLAND, TX. FILED 11-30-2000.



APPLICANT ASSERTS THIS IS NOT A PORTRAIT OF AN INDIVIDUAL, BUT AN IMAGE CONTRIVED FROM THE HEADS OF THE PAINTERS DURING WORLD WAR II.

THE MARK CONSISTS OF A BLACK AND WHITE DRAWING OF THE MARK THAT CONTAINS A PHOTOGRAPHIC IMAGE.

FOR COMPUTER SOFTWARE FOR USE WITH AVIATION ARTWORK WHICH PROVIDES AVIATION ARTWORK FOR DISPLAY, CREATING IMAGES, ARCHIVING ARTWORK DISPLAYING GRAPHICS AND CHARTS OF HISTORICAL DATA (U.S. CLS. 21, 23, 26, 36 AND 38).

MARGERY A. TIERNEY, EXAMINING ATTORNEY

SN 76-274,990. TRIPWIRE, INC., PORTLAND, OR. FILED 6-20-2001.

EVERYWHERE

FOR COMPUTER SOFTWARE FOR FILE SYSTEM SECURITY (U.S. CLS. 21, 23, 26, 36 AND 38).

REBECCA GILBERT, EXAMINING ATTORNEY

SN 76-574,125. COSEL CO., LTD., TOYAMA, JAPAN, FILED 2-5-2004.

COSEL

THE MARK CONSISTS OF STANDARD CHARACTERS WITHOUT CLAIM TO ANY PARTICULAR FONT, STYLE, SIZE, OR COLOR.

OWNER OF U.S. REG. NO. 1,863,576.

FOR (BASED ON USE IN COMMERCE) ELECTRICAL TRANSFORMERS; POWER SUPPLY CONVERTERS; SWITCHING REGULATORS; (BASED ON INTENT TO USE) RFI POWER LINE FILTERS; EMC POWER LINE FILTERS; EMI FILTERS; AND POWER LINE FILTERS (U.S. CLS. 21, 23, 26, 36 AND 38).

FIRST USE 8-0-1992; IN COMMERCE 8-0-1992.

MICHAEL SOUDERS, EXAMINING ATTORNEY

CLASS 9—ELECTRICAL AND SCIENTIFIC APPARATUS

SN 75-069,976. APOTHECARY PRODUCTS, INC., BURNSVILLE, MN. FILED 3-11-1996.

STEALTH

FOR EAR MUFF HEARING PROTECTOR (U.S. CLS. 21, 23, 26, 36 AND 38).

KAREN K. BUSH, EXAMINING ATTORNEY

CLASS 9—(Continued).

SN 76-602,996. TCI INTERNATIONAL, INC., FREMONT, CA. FILED 7-20-2004.

RAVEN

FOR COMPUTER HARDWARE, COMPUTER MONITORS, SIGNAL AND SPECTRUM PROCESSORS, ANTENNAS, AUDIO AND VIDEO RECEIVERS AND COMPUTER SOFTWARE FOR WIDE BAND SIGNAL ACQUISITION, LOCATION AND ANALYSIS IN THE FIELD OF SIGNAL INTELLIGENCE AND SPECTRUM FINDING AND MONITORING (U.S. CLS. 21, 23, 26, 36 AND 38).

FIRST USE 5-0-2002; IN COMMERCE 5-0-2002.
STANLEY I. OSBORNE, EXAMINING ATTORNEY

SN 76-616,054. ROBERT JOHN PRODUCTS LLC, SPARTA, NJ. FILED 10-14-2004.

RAPID SECURITY PACK

THE MARK CONSISTS OF STANDARD CHARACTERS WITHOUT CLAIM TO ANY PARTICULAR FONT, STYLE, SIZE, OR COLOR.

NO CLAIM IS MADE TO THE EXCLUSIVE RIGHT TO USE SECURITY PACK, APART FROM THE MARK AS SHOWN.

FOR PERSONAL SAFETY SYSTEM, NAMELY, A KIT FOR EMERGENCIES CONTAINING AN EMERGENCY ESCAPE SMOKE HOOD, FLASHLIGHTS, ALARM WHISTLES ON A LANYARD, EMERGENCY PACKS OF WATER, 52-PIECE FIRST AID KITS, ARAMID FIBER GLOVES, PROTECTIVE SAFETY WORK GLOVES, SOLAR COLLECTORS, NAMELY SOLAR WRAPS, GLOW STICKS, FOOD BARS, DUST MASKS, TISSUES AND COOL PACKS, ALL SOLD AS A UNIT (U.S. CLS. 21, 23, 26, 36 AND 38).

ELLEN B. AWRICH, EXAMINING ATTORNEY

SN 76-622,543. TELEX COMMUNICATIONS, INC., BURNSVILLE, MN. FILED 11-29-2004.

RAVEN

THE MARK CONSISTS OF STANDARD CHARACTERS WITHOUT CLAIM TO ANY PARTICULAR FONT, STYLE, SIZE, OR COLOR.

FOR MICROPHONES (U.S. CLS. 21, 23, 26, 36 AND 38).
CARRIE GENOVESE, EXAMINING ATTORNEY

CLASS 9—(Continued).

SN 76-654,051. SPANLINK COMMUNICATIONS CANADA INC., LONGUEUIL, QUEBEC, CANADA, FILED 1-25-2006.

CALABRIO

THE MARK CONSISTS OF STANDARD CHARACTERS WITHOUT CLAIM TO ANY PARTICULAR FONT, STYLE, SIZE, OR COLOR.

FOR COMPUTER SOFTWARE USED IN THE FIELD OF WORKFORCE MANAGEMENT, NAMELY QUALITY MANAGEMENT SOFTWARE AND MANAGEMENT INFORMATION REPORTING SOFTWARE (U.S. CLS. 21, 23, 26, 36 AND 38).

FIRST USE 4-26-2000; IN COMMERCE 4-26-2000.
WILLIAM ROSSMAN, EXAMINING ATTORNEY

SN 76-657,651. 3SOFT CO., LTD., SEOUL, REPUBLIC OF KOREA, FILED 3-31-2006.

PRIORITY CLAIMED UNDER SEC. 44(D) ON REPUBLIC OF KOREA APPLICATION NO. KR40-2006-00, FILED 3-9-2006, REG. NO. 0699824, DATED 2-2-2007, EXPIRES 2-26-2017.

THE COLOR(S) BLACK AND ORANGE IS/ARE CLAIMED AS A FEATURE OF THE MARK.

THE NUMBER "3" AND THE LETTERS "S", "F", AND "T" ARE BLACK. THE STYLIZED LETTER "O" IS ORANGE.

THE MARK CONSISTS OF THE NUMBER "3" AND THE LETTERS "S", "F", AND "T" ARE BLACK. THE STYLIZED LETTER "O" IS ORANGE.

FOR VIDEO GAME MACHINES FOR USE WITH TELEVISION; BLANK CD-ROMS FOR SOUND OR VIDEO RECORDING; PERSONAL DIGITAL ASSISTANTS; SEMI-CONDUCTORS; MP3 PLAYERS; BLANK OPTICAL DISKS; MICROPHONES; ELECTRONIC AGENDAS; PORTABLE COMMUNICATIONS APPARATUS, NAMELY, MOBILE TELEPHONES; PORTABLE MULTIMEDIA PLAYERS (U.S. CLS. 21, 23, 26, 36 AND 38).

MICHAEL KEATING, EXAMINING ATTORNEY

SN 76-665,234. FUSHAN ENTERPRISES, FREMONT, CA. FILED 8-28-2006.

PurTONE

FOR AUDIO SPEAKERS; HOME THEATER AUDIO SYSTEMS COMPOSED OF SPEAKERS, AMPLIFIERS, AND PERSONAL STEREOS; COMPACT DISK PLAYERS, STEREO RECEIVERS, STEREO TUNERS, STEREO AMPLIFIERS, RADIOS INCORPORATING CLOCKS, MP3 PLAYERS, AND DVD PLAYERS (U.S. CLS. 21, 23, 26, 36 AND 38).

FIRST USE 1-0-2006; IN COMMERCE 1-0-2006.
CARRIE GENOVESE, EXAMINING ATTORNEY

CLASS 9—(Continued).

SN 76-666,311. INTERNATIONAL DIGITAL ENTERPRISE ALLIANCE, INC., ALEXANDRIA, VA. FILED 9-18-2006.

IDEALINK

THE MARK CONSISTS OF STANDARD CHARACTERS WITHOUT CLAIM TO ANY PARTICULAR FONT, STYLE, SIZE, OR COLOR.

FOR PROVIDING DOWNLOADABLE SOFTWARE FOR CALIBRATION OF PROOFING AND PLATE-MAKING SYSTEMS TO IMPLEMENT PRINT STANDARDS (U.S. CLS. 21, 23, 26, 36 AND 38).

FIRST USE 4-25-2006; IN COMMERCE 4-25-2006.
ELISSA GARBER KON, EXAMINING ATTORNEY

CLASS 9—(Continued).

SN 76-670,615. HANCHETT ENTRY SYSTEMS, INC., PHOENIX, AZ. FILED 12-20-2006.

H E S

THE MARK CONSISTS OF STANDARD CHARACTERS WITHOUT CLAIM TO ANY PARTICULAR FONT, STYLE, SIZE, OR COLOR.

FOR ACCESS CONTROL AND SECURITY DEVICES, NAMELY, ELECTROMECHANICAL LOCKS, ELECTROMECHANICAL STRIKES, ELECTRONIC AND ELECTROMECHANICAL SENSORS FOR DETERMINING THE LOCKED OR UNLOCKED CONDITION OF AN ELECTROMECHANICAL STRIKE, ELECTRONIC AND ELECTROMECHANICAL SENSORS FOR DETERMINING THE LOCKED OR UNLOCKED CONDITION OF AN ELECTROMECHANICAL LOCK, POWER SUPPLIES AND POWER CONTROLLERS FOR ELECTROMECHANICAL LOCKS AND STRIKES, ELECTRICAL CABLES AND ELECTRICAL CONNECTORS FOR USE WITH NETWORKS FOR ELECTROMECHANICAL LOCKS AND STRIKES (U.S. CLS. 21, 23, 26, 36 AND 38).

FIRST USE 2-1-1998; IN COMMERCE 2-1-1998.
MICHAEL GAAFAR, EXAMINING ATTORNEY

SN 76-674,153. OLMSTEAD, JOSEPH DAVID, DBA BEAUMONDE PRODUCTIONS, DAMMERON VALLEY, UT. FILED 3-16-2007.

NATIONAL PARK EXPLORER

THE MARK CONSISTS OF STANDARD CHARACTERS WITHOUT CLAIM TO ANY PARTICULAR FONT, STYLE, SIZE, OR COLOR.

OWNER OF U.S. REG. NO. 2,654,265.
NO CLAIM IS MADE TO THE EXCLUSIVE RIGHT TO USE "NATIONAL PARK", APART FROM THE MARK AS SHOWN.

FOR PRE-RECORDED VIDEOTAPES, DVDS, CDS AND MOTION PICTURE FILMS, FEATURING SCENERY AND WILDLIFE IN THE US NATIONAL PARKS (U.S. CLS. 21, 23, 26, 36 AND 38).

FIRST USE 12-18-1989; IN COMMERCE 12-25-1989.
EDWARD NELSON, EXAMINING ATTORNEY

SN 76-670,592. HANCHETT ENTRY SYSTEMS, INC., PHOENIX, AZ. FILED 12-20-2006.

h. e. s.

SN 76-674,781. REDBIRD FLIGHT SIMULATION, INC., AUSTIN, TX. FILED 3-29-2007.

REDBIRD

FOR ACCESS CONTROL AND SECURITY DEVICES, NAMELY, ELECTROMECHANICAL LOCKS, ELECTROMECHANICAL STRIKES, ELECTRONIC AND ELECTROMECHANICAL SENSORS FOR DETERMINING THE LOCKED OR UNLOCKED CONDITION OF AN ELECTROMECHANICAL STRIKE, ELECTRONIC AND ELECTROMECHANICAL SENSORS FOR DETERMINING THE LOCKED OR UNLOCKED CONDITION OF AN ELECTROMECHANICAL LOCK, POWER SUPPLIES AND POWER CONTROLLERS FOR ELECTROMECHANICAL LOCKS AND STRIKES, ELECTRICAL CABLES AND ELECTRICAL CONNECTORS FOR USE WITH NETWORKS FOR ELECTROMECHANICAL LOCKS AND STRIKES (U.S. CLS. 21, 23, 26, 36 AND 38).

FIRST USE 2-1-1998; IN COMMERCE 2-1-1998.
MICHAEL GAAFAR, EXAMINING ATTORNEY

THE MARK CONSISTS OF STANDARD CHARACTERS WITHOUT CLAIM TO ANY PARTICULAR FONT, STYLE, SIZE, OR COLOR.

FOR FLIGHT SIMULATOR (U.S. CLS. 21, 23, 26, 36 AND 38).

STEVEN PEREZ, EXAMINING ATTORNEY

CLASS 9—(Continued).

SN 76-675,094. F.W. WEBB COMPANY, BEDFORD, MA.
FILED 4-5-2007.



OWNER OF U.S. REG. NO. 2,931,465.
THE COLOR(S) RED AND BLUE IS/ARE CLAIMED AS A
FEATURE OF THE MARK.

THE COLORS RED AND BLUE APPEAR IN THE DESIGN
OF THE MARK. THE COLOR RED APPEARS AS THE
COLOR OF THE ELLIPSE. THE COLOR BLUE APPEARS AS
THE COLOR OF THE LETTERS IN THE WORD "PURE-
PRO".

FOR DIGITAL PROGRAMMABLE HEATING AND
COOLING THERMOSTATS, DIGITAL NON-PROGRAM-
MABLE HEATING AND COOLING THERMOSTATS,
DIGITAL NONPROGRAMMABLE HEATING THERMO-
STATS, COMBUSTION TEST EQUIPMENT, NAMELY,
SMOKE TESTERS AND SMOKE TEST PAPER FOR
MEASURING THE SMOKE NUMBER OF A FLUE GAS
SAMPLE; OIL BURNER TEST EQUIPMENT, NAMELY,
CAD CELL RELAY AND FLAME DETECTOR EYE
TESTER, THERMOSTAT CIRCUIT METER, PRESSURE
TESTER, OIL BURNER PUMP TESTER AND SUCTION
LINE ANALYZER (U.S. CLS. 21, 23, 26, 36 AND 38).

FIRST USE 1-31-2006; IN COMMERCE 1-31-2006.
CAROLINE WOOD, EXAMINING ATTORNEY

SN 76-676,317. THOMAS G. FARIA CORPORATION, UN-
CASVILLE, CT. FILED 5-2-2007.

VTERM

THE MARK CONSISTS OF STANDARD CHARACTERS
WITHOUT CLAIM TO ANY PARTICULAR FONT, STYLE,
SIZE, OR COLOR.

FOR TOUCH SCREEN DISPLAY MONITORS FOR
TEXT MESSAGING AND DISPLAY OF OPERATING
INFORMATION AND E-MAILS (U.S. CLS. 21, 23, 26, 36
AND 38).

FIRST USE 3-1-2007; IN COMMERCE 3-1-2007.
STEVEN PEREZ, EXAMINING ATTORNEY

CLASS 9—(Continued).

SN 77-000,507. STUDIO NETWORK SOLUTIONS, LLC, ST.
LOUIS, MO. FILED 9-15-2006.

**TOOLS FOR CREATIVE
WORKGROUPS**

THE MARK CONSISTS OF STANDARD CHARACTERS
WITHOUT CLAIM TO ANY PARTICULAR FONT, STYLE,
SIZE, OR COLOR.

NO CLAIM IS MADE TO THE EXCLUSIVE RIGHT TO
USE "TOOLS", APART FROM THE MARK AS SHOWN.

FOR COMPUTER HARDWARE FOR ELECTRONIC
MEDIA STORAGE AND COMPUTER SOFTWARE FOR
THE STORAGE OF ELECTRONIC DATA (U.S. CLS. 21,
23, 26, 36 AND 38).

JAMES LOVELACE, EXAMINING ATTORNEY

SN 77-000,879. BLU-RAY DISC ASSOCIATION, UNIVERSAL
CITY, CA. FILED 9-15-2006.



THE MARK CONSISTS OF THE LETTER A WITH A
BACKGROUND OF A GLOBE WITH LATITUDE AND
LONGITUDE LINES WITHIN A HEXAGON.

FOR OPTICAL DISC PLAYERS AND RECORDERS
FOR AUDIO, VIDEO AND COMPUTER DATA; BLANK
OPTICAL DISCS; PRE-RECORDED OPTICAL DISCS
FEATURING MUSIC, MOVIES, GAMES, TEXT DATA
IN THE FIELD OF MUSIC, MOVIES, TELEVISION AND
GAMES, STILL IMAGES IN THE FIELD OF MUSIC,
MOVIES, TELEVISION, AND GAMES, AND MOTION
PICTURES; TELEVISION SETS; VIDEO CAMERAS; DI-
GITAL STILL CAMERAS; PERSONAL COMPUTERS;
DIGITAL SATELLITE BROADCASTING SYSTEMS,
NAMELY, RECEIVERS, TRANSMITTERS AND ANTEN-
NAS FOR SATELLITE BROADCASTING; VIDEO GAME
MACHINES FOR USE WITH TELEVISIONS; ALL OF
THE FOREGOING GOODS FOR USE WITH OPTICAL
DISCS AS RECORDING OR RECORDED MEDIA, AND
EACH BEARING A REGION CODE INDICATOR OR
DESIGNATOR (U.S. CLS. 21, 23, 26, 36 AND 38).

JEAN IM, EXAMINING ATTORNEY

CLASS 9—(Continued).

SN 77-002,069. L.C. LICENSING, INC., NEW YORK, NY. FILED 9-19-2006.

DANA BUCHMAN

THE MARK CONSISTS OF STANDARD CHARACTERS WITHOUT CLAIM TO ANY PARTICULAR FONT, STYLE, SIZE, OR COLOR.

OWNER OF U.S. REG. NOS. 1,493,081, 1,884,379 AND OTHERS.

FOR EYEWEAR, NAMELY, EYEGLASSES, SUNGLASSES AND LENSES (U.S. CLS. 21, 23, 26, 36 AND 38). REBECCA GAN, EXAMINING ATTORNEY

SN 77-002,481. LADYBUG TECHNOLOGIES LLC, SANTA ROSA, CA. FILED 9-19-2006.

LADYBUG T&M

THE MARK CONSISTS OF STANDARD CHARACTERS WITHOUT CLAIM TO ANY PARTICULAR FONT, STYLE, SIZE, OR COLOR.

NO CLAIM IS MADE TO THE EXCLUSIVE RIGHT TO USE "T&M", APART FROM THE MARK AS SHOWN.

FOR RADIO FREQUENCY AND MICROWAVE TEST AND MEASUREMENT EQUIPMENT, NAMELY, POWER METERS, S-PARAMETERS, NETWORK ANALYZERS, FREQUENCY TIME DOMAIN MONITORS, OSCILLOSCOPES, SCALARS, SPECTRUM ANALYZERS, AND PARAMETER METERS (U.S. CLS. 21, 23, 26, 36 AND 38). KHANH LE, EXAMINING ATTORNEY

SN 77-002,550. LADYBUG TECHNOLOGIES LLC, SANTA ROSA, CA. FILED 9-19-2006.

LADY BUG MEASUREMENTS

THE MARK CONSISTS OF STANDARD CHARACTERS WITHOUT CLAIM TO ANY PARTICULAR FONT, STYLE, SIZE, OR COLOR.

NO CLAIM IS MADE TO THE EXCLUSIVE RIGHT TO USE "MEASUREMENTS", APART FROM THE MARK AS SHOWN.

FOR RADIO FREQUENCY AND MICROWAVE TEST AND MEASUREMENT EQUIPMENT, NAMELY, POWER METERS, S-PARAMETER METERS, NETWORK ANALYZERS, FREQUENCY TIME DOMAIN MONITORS, OSCILLOSCOPES, SCALARS, SPECTRUM ANALYZERS, AND PARAMETER METERS (U.S. CLS. 21, 23, 26, 36 AND 38). KHANH LE, EXAMINING ATTORNEY

CLASS 9—(Continued).

SN 77-002,593. LADYBUG TECHNOLOGIES LLC, SANTA ROSA, CA. FILED 9-19-2006.

LADYBUG INSTRUMENTS

THE MARK CONSISTS OF STANDARD CHARACTERS WITHOUT CLAIM TO ANY PARTICULAR FONT, STYLE, SIZE, OR COLOR.

NO CLAIM IS MADE TO THE EXCLUSIVE RIGHT TO USE "INSTRUMENTS", APART FROM THE MARK AS SHOWN.

FOR RADIO FREQUENCY AND MICROWAVE TEST AND MEASUREMENT EQUIPMENT, NAMELY, POWER METERS, S-PARAMETERS, NETWORK ANALYZERS, FREQUENCY TIME DOMAIN MONITORS, OSCILLOSCOPES, SCALARS, SPECTRUM ANALYZERS, AND PARAMETER METERS. (U.S. CLS. 21, 23, 26, 36 AND 38). KHANH LE, EXAMINING ATTORNEY

SN 77-002,656. LADYBUG TECHNOLOGIES LLC, SANTA ROSA, CA. FILED 9-19-2006.

LADY BUG TEST EQUIPMENT

THE MARK CONSISTS OF STANDARD CHARACTERS WITHOUT CLAIM TO ANY PARTICULAR FONT, STYLE, SIZE, OR COLOR.

NO CLAIM IS MADE TO THE EXCLUSIVE RIGHT TO USE "TEST EQUIPMENT", APART FROM THE MARK AS SHOWN.

FOR RADIO FREQUENCY AND MICROWAVE TEST AND MEASUREMENT EQUIPMENT, NAMELY, POWER METERS, S-PARAMETER METERS, NETWORK ANALYZERS, FREQUENCY TIME DOMAIN MONITORS, OSCILLOSCOPES, SCALARS, SPECTRUM ANALYZERS, AND PARAMETER METERS (U.S. CLS. 21, 23, 26, 36 AND 38). KHANH LE, EXAMINING ATTORNEY

CLASS 9—(Continued).

SN 77-003,261. LADYBUG TECHNOLOGIES LLC, SANTA ROSA, CA. FILED 9-20-2006.

LADY BUG TECHNOLOGIES LLC

THE MARK CONSISTS OF STANDARD CHARACTERS WITHOUT CLAIM TO ANY PARTICULAR FONT, STYLE, SIZE, OR COLOR.

NO CLAIM IS MADE TO THE EXCLUSIVE RIGHT TO USE "TECHNOLOGIES LLC", APART FROM THE MARK AS SHOWN.

FOR RADIO FREQUENCY AND MICROWAVE TEST AND MEASUREMENT EQUIPMENT, NAMELY, POWER METERS, S-PARAMETER METERS, NETWORK ANALYZERS, FREQUENCY TIME DOMAIN MONITORS, OSCILLOSCOPES, SCALARS, SPECTRUM ANALYZERS, AND PARAMETER METERS (U.S. CLS. 21, 23, 26, 36 AND 38).

FIRST USE 5-0-2006; IN COMMERCE 5-0-2006.
KHANH LE, EXAMINING ATTORNEY

SN 77-007,794. THOMAS & BETTS INTERNATIONAL, INC., WILMINGTON, DE. FILED 9-26-2006.

HI-TECH

THE MARK CONSISTS OF STANDARD CHARACTERS WITHOUT CLAIM TO ANY PARTICULAR FONT, STYLE, SIZE, OR COLOR.

FOR HI-VOLTAGE ELECTRICAL FUSES FOR DISTRIBUTION AND TRANSMISSION OF ELECTRICAL POWER (U.S. CLS. 21, 23, 26, 36 AND 38).

GINA HAYES, EXAMINING ATTORNEY

SN 77-008,249. SUNRISE TECHNOLOGIES, INC., RAYNHAM, MA. FILED 9-27-2006.

BrownBetty

THE MARK CONSISTS OF STANDARD CHARACTERS WITHOUT CLAIM TO ANY PARTICULAR FONT, STYLE, SIZE, OR COLOR.

FOR WIRELESS COMMUNICATION DEVICE, NAMELY, AN ELECTRONIC OUTDOOR LIGHTING PHOTOCONTROL FOR AUTOMATICALLY ILLUMINATING STREET LAMPS INCORPORATING A WIRELESS COMMUNICATION MODULE FOR ELECTRONIC, ELECTRIC AND DIGITAL TRANSMISSION OF VOICE, DATA, IMAGES, SIGNALS AND MESSAGES (U.S. CLS. 21, 23, 26, 36 AND 38).

ROBERT STRUCK, EXAMINING ATTORNEY

CLASS 9—(Continued).

SN 77-008,327. INVENTION MACHINE CORPORATION, BOSTON, MA. FILED 9-27-2006.

GOLDFIRE RESEARCHER

THE MARK CONSISTS OF STANDARD CHARACTERS WITHOUT CLAIM TO ANY PARTICULAR FONT, STYLE, SIZE, OR COLOR.

OWNER OF U.S. REG. NO. 3,050,490.

NO CLAIM IS MADE TO THE EXCLUSIVE RIGHT TO USE "RESEARCHER", APART FROM THE MARK AS SHOWN.

FOR SOFTWARE FOR PROBLEM-SOLVING, IDEATION, SOLUTION GENERATION, AND TO ACCELERATE INNOVATION; SOFTWARE FOR KNOWLEDGE EXTRACTION AND RETRIEVAL SEARCHING AND QUERY SEARCHING INCLUDING NATURAL LANGUAGE SEARCHES IN DATA BASES AND KNOWLEDGE BASES; SOFTWARE FOR CREATING DATA BASES AND KNOWLEDGE BASES; SOFTWARE FOR PROBLEM-SOLVING ANALYSIS; SOFTWARE FOR NATURAL LANGUAGE QUERY PROCESSING; SEARCH ENGINE SOFTWARE (U.S. CLS. 21, 23, 26, 36 AND 38).

FIRST USE 9-5-2006; IN COMMERCE 9-5-2006.
RAY THOMAS, EXAMINING ATTORNEY

SN 77-008,772. PIPELINE INSPECTION CO., LTD., HOUSTON, TX. FILED 9-27-2006.



"THE MARK CONSISTS OF PICTURE OF MAN IN HARD-HAT AND GOGGLES HOLDING AN INSTRUMENT. THE WORD SPY IS PRINTED ON THE LEFT BREAST OF THE MAN'S SHIRT."

FOR AN INSTRUMENT, NAMELY A WAND WITH A SPRING AND AN ELECTRONIC SENSOR FOR USE IN DETECTING IMPERFECTIONS IN COATINGS AND FILMS (U.S. CLS. 21, 23, 26, 36 AND 38).

FIRST USE 4-1-2006; IN COMMERCE 4-1-2006.
FRED CARL, EXAMINING ATTORNEY

CLASS 9—(Continued).

SN 77-009,364. MICRO ELECTRONICS LTD., HONG KONG, HONG KONG, FILED 9-28-2006.



THE COLOR(S) ORANGE AND BLUE IS/ARE CLAIMED AS A FEATURE OF THE MARK.

THE COLOR ORANGE APPEARS IN THE LETTER "I," AND THE COLOR BLUE APPEARS IN THE WORDING "PLUS."

FOR ACCESSORIES FOR PORTABLE DIGITAL VIDEO AND AUDIO PLAYERS, NAMELY, FM TRANSMITTERS, CRADLES, SPEAKER DOCKINGS, RF REMOTE CONTROLS, DIGITAL VOICE RECORDERS, BATTERY CHARGERS, AND BATTERY PACKS (U.S. CLS. 21, 23, 26, 36 AND 38).

MARGARET POWER, EXAMINING ATTORNEY

SN 77-009,735. OLYMPUS CORPORATION, TOKYO, JAPAN, FILED 9-28-2006.

MOVIE 8

THE MARK CONSISTS OF STANDARD CHARACTERS WITHOUT CLAIM TO ANY PARTICULAR FONT, STYLE, SIZE, OR COLOR.

OWNER OF U.S. REG. NO. 1,470,250.

SEC. 2(F).

FOR VIDEO CAMERAS (U.S. CLS. 21, 23, 26, 36 AND 38).

JUSTINE D. PARKER, EXAMINING ATTORNEY

SN 77-013,253. ERICKSON BEAMON, LTD., NEW YORK, NY. FILED 10-4-2006.

ERICKSON BEAMON

THE MARK CONSISTS OF STANDARD CHARACTERS WITHOUT CLAIM TO ANY PARTICULAR FONT, STYLE, SIZE, OR COLOR.

OWNER OF U.S. REG. NOS. 2,101,111, 2,101,112 AND 2,101,113.

THE NAME(S), PORTRAIT(S), AND/OR SIGNATURE(S) SHOWN IN THE MARK DOES NOT IDENTIFY A PARTICULAR LIVING INDIVIDUAL.

FOR EYEGLASSES, SUNGLASSES, EYEGLASS AND SUNGLASS FRAMES, EYEGLASS AND SUNGLASS CASES (U.S. CLS. 21, 23, 26, 36 AND 38).

KATHERINE STOIDES, EXAMINING ATTORNEY

CLASS 9—(Continued).

SN 77-014,694. OSTERBERG, JAMES, LOS ANGELES, CA. FILED 10-5-2006.

IGGY POP

THE MARK CONSISTS OF STANDARD CHARACTERS WITHOUT CLAIM TO ANY PARTICULAR FONT, STYLE, SIZE, OR COLOR.

"IGGY POP" IDENTIFIES A LIVING INDIVIDUAL WHOSE CONSENT IS OF RECORD.

FOR SERIES OF MUSICAL SOUND RECORDINGS AND PRERECORDED COMPACT DISCS, VIDEOTAPES, VIDEODISCS, VIDEOCASSETTES, CD-ROMS, DVDS, DATS, OPTICAL DISCS AND LASERDISCS, ALL FEATURING MUSIC; DOWNLOADABLE AUDIO AND VIDEO RECORDINGS FEATURING MUSIC; DOWNLOADABLE RING TONES, MUSIC, MP3S, MUSIC VIDEOS, GRAPHICS, ELECTRONIC GAMES, DIGITAL IMAGES AND VIDEOS FOR WIRELESS COMMUNICATION DEVICES ALL FEATURING MUSIC (U.S. CLS. 21, 23, 26, 36 AND 38).

FIRST USE 12-1-1970; IN COMMERCE 12-1-1970.

SCOTT SISUN, EXAMINING ATTORNEY

SN 77-016,627. CNS SOFTWARE, LLC, CARY, NC. FILED 10-9-2006.

WINRADAR

THE MARK CONSISTS OF STANDARD CHARACTERS WITHOUT CLAIM TO ANY PARTICULAR FONT, STYLE, SIZE, OR COLOR.

FOR COMPUTER SOFTWARE FOR COMPUTER NETWORK MANAGEMENT (U.S. CLS. 21, 23, 26, 36 AND 38).

FIRST USE 4-10-2006; IN COMMERCE 7-3-2006.

TARAH HARDY, EXAMINING ATTORNEY

SN 77-016,864. FORCEONE, LLC, NEWARK, OH. FILED 10-9-2006.

THIN BLUE LINE

THE MARK CONSISTS OF STANDARD CHARACTERS WITHOUT CLAIM TO ANY PARTICULAR FONT, STYLE, SIZE, OR COLOR.

FOR PROTECTIVE CLOTHING, NAMELY, BALLISTIC RESISTANT, BULLETPROOF, AND BLAST PROOF CLOTHING AND GARMENTS (U.S. CLS. 21, 23, 26, 36 AND 38).

FIRST USE 10-1-2000; IN COMMERCE 10-1-2000.

JAMES STEIN, EXAMINING ATTORNEY

CLASS 9—(Continued).

SN 77-018,642. UBISOFT INC., SAN FRANCISCO, CA. FILED 10-11-2006.

Mind Quiz

THE MARK CONSISTS OF STANDARD CHARACTERS WITHOUT CLAIM TO ANY PARTICULAR FONT, STYLE, SIZE, OR COLOR.

NO CLAIM IS MADE TO THE EXCLUSIVE RIGHT TO USE "QUIZ", APART FROM THE MARK AS SHOWN.

FOR GAME SOFTWARE AND ELECTRONIC GAME PROGRAMS, NAMELY SOFTWARE GAMES RECORDED ON CD-ROM AND DIGITAL VIDEO DISCS FOR COMPUTERS; SOFTWARE GAMES RECORDED ON CD-ROMS, DIGITAL VIDEO DISCS, AND CARTRIDGES FOR CONSOLE AND INDIVIDUAL, PORTABLE GAMING SYSTEMS; SOFTWARE GAMES THAT ARE DOWNLOADABLE FROM A REMOTE COMPUTER SITE AND ELECTRONIC GAME SOFTWARE FOR MOBILE PHONES, PERSONAL DIGITAL ASSISTANTS, AND HANDHELD COMPUTERS (U.S. CLS. 21, 23, 26, 36 AND 38).

CHRISTINA SOBRAL, EXAMINING ATTORNEY

SN 77-020,446. OPTOMA CORPORATION, SHINDIAN CITY, TAIPEI, TAIWAN, FILED 10-13-2006.

Panoview

OWNER OF U.S. REG. NO. 3,171,854.
FOR PROJECTOR SCREENS; DIGITAL CAMERAS;
NETWORK CAMERAS FOR INTERNET PROTOCOL
USE (U.S. CLS. 21, 23, 26, 36 AND 38).

PAUL F. GAST, EXAMINING ATTORNEY

SN 77-020,705. AMERICAN UNDERWATER PRODUCTS,
SAN LEANDRO, CA. FILED 10-13-2006.

DA VINCI

THE MARK CONSISTS OF STANDARD CHARACTERS WITHOUT CLAIM TO ANY PARTICULAR FONT, STYLE, SIZE, OR COLOR.

FOR DIVING EQUIPMENT, NAMELY, DIVE COMPUTERS, BUOYANCY COMPENSATORS, REGULATORS, REBREATHERS, DIVING MASKS, SNORKELS, WETSUITS, DRY SUITS, DIVING BOOTS AND DIVING GLOVES (U.S. CLS. 21, 23, 26, 36 AND 38).

CAROLYN CATALDO, EXAMINING ATTORNEY

CLASS 9—(Continued).

SN 77-022,065. DRIVE SENTRY, INC., SAN JOSE, CA. FILED 10-16-2006.

PROTECT ME

THE MARK CONSISTS OF STANDARD CHARACTERS WITHOUT CLAIM TO ANY PARTICULAR FONT, STYLE, SIZE, OR COLOR.

FOR COMPUTER SOFTWARE FOR SECURING COMPUTER SYSTEMS AND COMPUTER NETWORKS, NAMELY SOFTWARE TO PREVENT OR CONTROL COMPUTER VIRUSES, SPY-WARE, AD-WARE OR OPERATION OF ANY UNAUTHORIZED OR UNINTENDED SOFTWARE RESIDENT ON, IN OR AS PART OF A COMPUTER SYSTEM (U.S. CLS. 21, 23, 26, 36 AND 38).

TIMOTHY FINNEGAN, EXAMINING ATTORNEY

SN 77-022,985. MUSICAL ELECTRONICS LIMITED, KWUN TONG, KOWLOON, HONG KONG, FILED 10-17-2006.

 The logo for AVITON features a stylized 'A' symbol on the left, composed of two curved lines meeting at a point, resembling a lens or a stylized letter. To the right of this symbol, the word 'AVITON' is written in a bold, uppercase, sans-serif font.

PRIORITY CLAIMED UNDER SEC. 44(D) ON HONG KONG APPLICATION NO. 300731015, FILED 9-28-2006, REG. NO. 300731015, DATED 9-28-2006, EXPIRES 9-28-2013.

FOR CD PLAYERS, CD PLAYERS WITH RADIO, CD PLAYERS WITH MP3, ID3, PLL TUNING AND WMA; HOME AUDIO ENTERTAINMENT SYSTEMS, NAMELY SYSTEMS COMPRISING OF CD PLAYERS, RADIOS, CASSETTE PLAYERS, TUNERS OR ANY COMBINATION OF THE AFORESAID; LOUDSPEAKERS; PORTABLE, NAMELY, HANDHELD CD PLAYERS; HARD DRIVES FOR COMPUTERS; JUKE BOXES, JUKE BOXES WITH VIDEO FACILITIES; MP3 PLAYERS; RADIO SERVICE TRANSCEIVERS; CAR NAVIGATION SYSTEMS COMPRISED OF ON-BOARD COMPUTERS; VOICE ACTIVATED CAR NAVIGATION SYSTEMS COMPRISED OF ON-BOARD COMPUTERS; GPS (GLOBAL POSITIONING SYSTEMS); LCD AND DIGITAL LIGHT PROCESSING PROJECTORS; DIGITAL VIDEO RECORDER; CAMERAS, DIGITAL CAMERAS; DIGITAL AUDIO BROADCASTING (DAB) PLAYERS; SATELLITE RADIOS; DVD PLAYERS; MP3 PLAYER ACCESSORIES, NAMELY HEADPHONES, PORTABLE SPEAKERS, AC ADAPTORS, CAR-KITS COMPRISED OF CAR LIGHTER ADAPTOR, MICROPHONES, SPEAKERS, CONNECTIONS CABLES, REMOTE CONTROL AND MEMORY CARDS; HANDHELD AND POCKET-SIZED DIGITAL AUDIO AND VIDEO DISC PLAYERS; HANDHELD AND POCKET-SIZED DIGITAL AUDIO AND VIDEO DISC PLAYER ACCESSORIES, NAMELY HEADPHONES, PORTABLE SPEAKERS, AC ADAPTOR, CAR KITS COMPRISED OF ELECTRONIC SECURITY ALARMS, VIDEO RECORDERS AND MONITORS, REMOTE CONTROL AND MEMORY CARDS; ELECTRONIC DEVICES FOR DETECTING PHYSICAL IMBALANCE OF PATIENTS TO PROTECT AGAINST FALLS; ELECTRONIC HEADBANDS FOR DROWSY DRIVERS USED TO DETECT AND MAINTAIN CONSCIOUSNESS OF PERSONS (U.S. CLS. 21, 23, 26, 36 AND 38).

JEAN IM, EXAMINING ATTORNEY

CLASS 9—(Continued).

SN 77-027,340. SCH BUSINESS SOLUTIONS L.L.C., HOUSTON, TX. FILED 10-23-2006.

DI TAX

THE MARK CONSISTS OF STANDARD CHARACTERS WITHOUT CLAIM TO ANY PARTICULAR FONT, STYLE, SIZE, OR COLOR.

NO CLAIM IS MADE TO THE EXCLUSIVE RIGHT TO USE "TAX", APART FROM THE MARK AS SHOWN.

FOR COMPUTER SOFTWARE FOR APPLICATION AND DATABASE INTEGRATION (U.S. CLS. 21, 23, 26, 36 AND 38).

KELLY BOULTON, EXAMINING ATTORNEY

SN 77-032,208. SEAGRAVE FIRE APPARATUS LLC, CLINTONVILLE, WI. FILED 10-30-2006.

INTELUS

THE MARK CONSISTS OF STANDARD CHARACTERS WITHOUT CLAIM TO ANY PARTICULAR FONT, STYLE, SIZE, OR COLOR.

FOR FIREFIGHTING VEHICLES AND APPARATUS, NAMELY, FIRE ENGINES, FIRE TRUCKS, RESCUE TRUCKS, BRUSH TRUCKS, TANKER TRUCKS, AND PUMPER TRUCKS, AND AERIAL PLATFORMS AND LADDERS THEREFOR (U.S. CLS. 21, 23, 26, 36 AND 38).

STEVEN R. FINE, EXAMINING ATTORNEY

SN 77-032,547. DATACOLOR HOLDING AG, LUZERN, SWITZERLAND, FILED 10-30-2006.

PAINTMAKER

THE MARK CONSISTS OF STANDARD CHARACTERS WITHOUT CLAIM TO ANY PARTICULAR FONT, STYLE, SIZE, OR COLOR.

SEC. 2(F).

FOR COMPUTER PROGRAMS FOR USE IN PAINT MATCHING (U.S. CLS. 21, 23, 26, 36 AND 38).

FIRST USE 11-1-1983; IN COMMERCE 11-1-1983.

DANIEL CAPSHAW, EXAMINING ATTORNEY

CLASS 9—(Continued).

SN 77-034,700. BROADCOM CORPORATION, IRVINE, CA. FILED 11-1-2006.

SES

THE MARK CONSISTS OF STANDARD CHARACTERS WITHOUT CLAIM TO ANY PARTICULAR FONT, STYLE, SIZE, OR COLOR.

FOR COMPUTER HARDWARE; INTEGRATED CIRCUITS; COMPUTER CHIPSETS; INTEGRATED CIRCUIT CHIPSETS; FIRMWARE FOR SETTING UP AND ENABLING WIRELESS CONNECTIONS (U.S. CLS. 21, 23, 26, 36 AND 38).

ALICE BENMAMAN, EXAMINING ATTORNEY

SN 77-034,881. EZ-CAM SOLUTIONS, INC., NEW YORK, NY. FILED 11-2-2006.

EZ-CAM

THE MARK CONSISTS OF STANDARD CHARACTERS WITHOUT CLAIM TO ANY PARTICULAR FONT, STYLE, SIZE, OR COLOR.

SEC. 2(F).

FOR SOFTWARE FOR COMPUTER ASSISTED DESIGN AND COMPUTER ASSISTED MANUFACTURING IN A VARIETY OF FIELDS (U.S. CLS. 21, 23, 26, 36 AND 38).

FIRST USE 9-1-1999; IN COMMERCE 9-1-1999.

WOODROW HARTZOG, EXAMINING ATTORNEY

SN 77-037,778. LOMBARDI SOFTWARE, INC., AUSTIN, TX. FILED 11-6-2006.

LOMBARDI EPP

THE MARK CONSISTS OF STANDARD CHARACTERS WITHOUT CLAIM TO ANY PARTICULAR FONT, STYLE, SIZE, OR COLOR.

OWNER OF U.S. REG. NOS. 2,468,580, 2,521,350 AND 3,003,866.

NO CLAIM IS MADE TO THE EXCLUSIVE RIGHT TO USE "EPP", APART FROM THE MARK AS SHOWN.

SEC. 2(F) AS TO "LOMBARDI".

FOR COMPUTER SOFTWARE FOR MANAGING BUSINESS PROCESSES (U.S. CLS. 21, 23, 26, 36 AND 38).

IRENE D. WILLIAMS, EXAMINING ATTORNEY

CLASS 9—(Continued).

SN 77-039,507. TRANSAMERICAN AUTO PARTS COMPANY, LLC, COMPTON, CA. FILED 11-8-2006.

POLE POSITION

THE MARK CONSISTS OF STANDARD CHARACTERS WITHOUT CLAIM TO ANY PARTICULAR FONT, STYLE, SIZE, OR COLOR.

FOR COMPUTER SOFTWARE FOR USE IN FINANCIAL CALCULATIONS IN THE FIELD OF AUTOMOBILE PARTS AND ACCESSORIES SALES (U.S. CLS. 21, 23, 26, 36 AND 38).

NAKIA HENRY, EXAMINING ATTORNEY

SN 77-040,021. GROUP PHOTOGRAPHERS ASSOCIATION, INC., SPOKANE VALLEY, WA. FILED 11-8-2006.

**MOBILE ORDER
& DATA ENTRY**

NO CLAIM IS MADE TO THE EXCLUSIVE RIGHT TO USE "MOBILE ORDER & DATA ENTRY", APART FROM THE MARK AS SHOWN.

THE COLOR(S) BLACK, RED, GREEN, BLUE AND GREY IS/ARE CLAIMED AS A FEATURE OF THE MARK.

THE MARK CONSISTS OF BLACK SQUARE CONTAINING A RED M, GREEN O, BLUE D AND GREY E AND THE WORD MARK MOBILE ORDER DATA ENTRY ALSO APPEARING IN BLACK TO THE RIGHT OF THE BLACK SQUARE.

FOR COMPUTER SOFTWARE FOR ENTERING ORDER INFORMATION FOR PHOTOGRAPHIC PRODUCTS (U.S. CLS. 21, 23, 26, 36 AND 38).

FIRST USE 10-1-2006; IN COMMERCE 11-6-2006.
DAYNA BROWNE, EXAMINING ATTORNEY

SN 77-042,760. VIVID ENTERTAINMENT, LLC, LOS ANGELES, CA. FILED 11-13-2006.

VIVID GIRL

THE MARK CONSISTS OF STANDARD CHARACTERS WITHOUT CLAIM TO ANY PARTICULAR FONT, STYLE, SIZE, OR COLOR.

OWNER OF U.S. REG. NOS. 2,909,731, 3,149,671 AND OTHERS.

NO CLAIM IS MADE TO THE EXCLUSIVE RIGHT TO USE "GIRL", APART FROM THE MARK AS SHOWN.

FOR AUDIO RECORDINGS FEATURING EROTICA AND SEXUALLY ORIENTED STORIES (U.S. CLS. 21, 23, 26, 36 AND 38).

GIANCARLO CASTRO, EXAMINING ATTORNEY

CLASS 9—(Continued).

SN 77-044,284. EPSON AMERICA, INC., LONG BEACH, CA. FILED 11-15-2006.

CHIEF MEMORY OFFICER

THE MARK CONSISTS OF STANDARD CHARACTERS WITHOUT CLAIM TO ANY PARTICULAR FONT, STYLE, SIZE, OR COLOR.

OWNER OF U.S. REG. NO. 3,157,338.

FOR PRINTERS, SCANNERS, AND DIGITAL IMAGING SOFTWARE FOR PROCESSING IMAGES, GRAPHICS, AND TEXT (U.S. CLS. 21, 23, 26, 36 AND 38).

FIRST USE 4-30-2005; IN COMMERCE 4-30-2005.

BERNICE MIDDLETON, EXAMINING ATTORNEY

SN 77-044,936. GAME PLAN TECHNOLOGIES, INC., OMAHA, NE. FILED 11-15-2006.

MEDIABLASTER

THE MARK CONSISTS OF STANDARD CHARACTERS WITHOUT CLAIM TO ANY PARTICULAR FONT, STYLE, SIZE, OR COLOR.

FOR COMPUTER SOFTWARE FOR USE BY COACHING PERSONNEL OF AMATEUR, COLLEGE AND PROFESSIONAL ATHLETE PROGRAMS THAT PROVIDES REAL TIME INTEGRATED SPORTS/GAME-PLAN MANAGEMENT INTELLIGENCE BY ANNOTATING COMPONENTS OF THE SPORTING EVENT FROM THE HOST COMPUTER DATA BASE AND PRESENTING IT IN EASY TO UNDERSTAND USER INTERFACE (U.S. CLS. 21, 23, 26, 36 AND 38).

DAHLIA GEORGE, EXAMINING ATTORNEY

CLASS 9—(Continued).

SN 77-045,036. INNOCORP. LTD., VERONA, WI. FILED 11-15-2006.



THE MARK CONSISTS OF STYLIZED REPRESENTATION OF AN ANALOG CLOCK FACE.
 FOR ELECTRONIC DEVICE FOR VISUALIZING THE EFFECTS OF PERSONAL PHYSICAL ATTRIBUTES OF ALCOHOL INTOXICATION FOR NON MEDICAL PURPOSES (U.S. CLS. 21, 23, 26, 36 AND 38).
 FIRST USE 6-26-2006; IN COMMERCE 6-26-2006.
 JAY FLOWERS, EXAMINING ATTORNEY

CLASS 9—(Continued).

SN 77-046,616. LG ELECTRONICS INC., SEOUL, REPUBLIC OF KOREA, FILED 11-17-2006.

BlackRuby

THE MARK CONSISTS OF STANDARD CHARACTERS WITHOUT CLAIM TO ANY PARTICULAR FONT, STYLE, SIZE, OR COLOR.
 FOR COMPUTER MONITORS, CCTV (CLOSED CIRCUIT TELEVISION), NOTEBOOK COMPUTERS, COMPUTER SERVERS, COMPUTERS, PRINTERS FOR USE WITH COMPUTERS, COMPUTER PROGRAMS AND SOFTWARE FOR DATABASE MANAGEMENT, WORD PROCESSING, MUSIC DOWNLOADS FROM THE INTERNET, AND FOR SENDING, STORING, ACCESSING AND RECEIVING EMAILS AND TEXT MESSAGES; PERSONAL DIGITAL ASSISTANTS, SEMICONDUCTORS, TELEVISION RECEIVERS, MOBILE TELEPHONES, FACSIMILE APPARATUS, CAMCORDERS, VIDEO CAMERAS, DIGITAL CAMERAS (U.S. CLS. 21, 23, 26, 36 AND 38).
 ADA HAN, EXAMINING ATTORNEY

SN 77-045,039. INNOCORP. LTD., VERONA, WI. FILED 11-15-2006.

INTOXICLOCK

THE MARK CONSISTS OF STANDARD CHARACTERS WITHOUT CLAIM TO ANY PARTICULAR FONT, STYLE, SIZE, OR COLOR.
 FOR ELECTRONIC DEVICE FOR VISUALIZING THE EFFECTS OF PERSONAL PHYSICAL ATTRIBUTES OF ALCOHOL INTOXICATION FOR NON MEDICAL PURPOSES (U.S. CLS. 21, 23, 26, 36 AND 38).
 FIRST USE 6-26-2006; IN COMMERCE 6-26-2006.
 JAY FLOWERS, EXAMINING ATTORNEY

SN 77-048,002. TIMEHRI TECHNOLOGIES, LLC, SANTA CLARITA, CA. FILED 11-20-2006.

SalonSoft

THE MARK CONSISTS OF STANDARD CHARACTERS WITHOUT CLAIM TO ANY PARTICULAR FONT, STYLE, SIZE, OR COLOR.
 FOR COMPUTER SOFTWARE FOR THE BUSINESS MANAGEMENT OF SALONS (U.S. CLS. 21, 23, 26, 36 AND 38).
 FIRST USE 1-30-2001; IN COMMERCE 11-15-2002.
 DAHLIA GEORGE, EXAMINING ATTORNEY

CLASS 9—(Continued).

SN 77-048,886. INDUSTRIAL AUTOMATION SPECIALISTS CORP., HAMPTON, VA. FILED 11-21-2006.

CLASS 9—(Continued).

SN 77-049,601. SEIKO EPSON KABUSHIKI KAISHA, TA SEIKO EPSON CORPORATION, TOKYO, JAPAN, FILED 11-22-2006.



+LESS DESIGN

NO CLAIM IS MADE TO THE EXCLUSIVE RIGHT TO USE "SECURE" OR "DIGITAL NUMERICAL CONTROL", APART FROM THE MARK AS SHOWN.

THE COLOR(S) RED, WHITE, BLUE, AND GRAY IS/ARE CLAIMED AS A FEATURE OF THE MARK.

THE MARK CONSISTS OF A RED ROUND TOP KEY WITH THE WORD "SECURE" WRITTEN IN WHITE OVER IT. THE KEY IS POSITIONED OVER THE LETTER "D" OF "DNC" WHICH IS COLORED BLUE. DIRECTLY UNDER THE ABOVE LETTERS ARE THE WORDS DIRECT NUMERICAL CONTROL IN THE SAME SHADE OF BLUE AS THE "DNC" LETTERS. BACKGROUND IS GREY.

FOR COMPUTER HARDWARE IN THE NATURE OF DIRECT NUMERICAL CONTROL FOR TRANSITIONING PROGRAMS FROM COMPUTERS TO COMPUTER NUMERICAL CONTROL MACHINES (U.S. CLS. 21, 23, 26, 36 AND 38).

FIRST USE 6-1-2006; IN COMMERCE 6-1-2006.
KELLY CHOE, EXAMINING ATTORNEY

THE MARK CONSISTS OF STANDARD CHARACTERS WITHOUT CLAIM TO ANY PARTICULAR FONT, STYLE, SIZE, OR COLOR.

PRIORITY CLAIMED UNDER SEC. 44(D) ON JAPAN APPLICATION NO. 2006-48590, FILED 5-26-2006, REG. NO. 5021419, DATED 1-26-2007, EXPIRES 1-26-2017.

FOR DIGITAL CAMERAS; DIGITAL AUDIO PLAYERS; DIGITAL VIDEO CAMERAS; DIGITAL VIDEO DISC RECORDERS; DIGITAL VIDEO DISC PLAYERS; TELEVISION MONITORS; TELEVISION RECEIVERS; PORTABLE NAVIGATION SYSTEMS; CELLULAR PHONES; INTEGRATED CIRCUITS; LARGE SCALE INTEGRATED CIRCUITS; INK JET PRINTERS; LASER PRINTERS; SCANNERS; LIQUID CRYSTAL DISPLAY PROJECTORS; PERSONAL COMPUTERS; PERSONAL DIGITAL ASSISTANTS (PDAS) (U.S. CLS. 21, 23, 26, 36 AND 38).

ANDREA HACK, EXAMINING ATTORNEY

SN 77-049,218. BEST WESTERN INTERNATIONAL, INC., PHOENIX, AZ. FILED 11-21-2006.

SN 77-052,316. HAMMOND POWER SOLUTIONS INC., GUELPH, CANADA, FILED 11-28-2006.

NO DRAWING-SENSORY MARK

HPS SUPERSAVER

THE MARK CONSISTS OF THE SOUND OF A HAND KNOCKING ON A DOOR TWICE.

FOR COMPUTER SOFTWARE, NAMELY, SOFTWARE THAT PROVIDES HOTEL, MOTEL AND RESORT HOTEL INFORMATION, RESERVATIONS, AND DISCOUNTS ON STAYS THAT MAY BE DOWNLOADED FROM A GLOBAL COMPUTER NETWORK (U.S. CLS. 21, 23, 26, 36 AND 38).

JASON BLAIR, EXAMINING ATTORNEY

THE MARK CONSISTS OF STANDARD CHARACTERS WITHOUT CLAIM TO ANY PARTICULAR FONT, STYLE, SIZE, OR COLOR.

PRIORITY CLAIMED UNDER SEC. 44(D) ON CANADA APPLICATION NO. 1,312,613, FILED 8-2-2006, REG. NO. TMA689,343, DATED 6-7-2007, EXPIRES 6-7-2022.

FOR ELECTRICAL TRANSFORMERS (U.S. CLS. 21, 23, 26, 36 AND 38).

CIMMERIAN COLEMAN, EXAMINING ATTORNEY

CLASS 9—(Continued).

SN 77-052,742. AUDIO VIDEO SPECIALISTS LTD., CENTRAL HONG KONG, CHINA, FILED 11-29-2006.

NUWIRE

THE MARK CONSISTS OF STANDARD CHARACTERS WITHOUT CLAIM TO ANY PARTICULAR FONT, STYLE, SIZE, OR COLOR.

FOR AUDIO, VIDEO AND ELECTRONIC CABLES, WIRES, AND CONNECTORS; AMPLIFIERS, AUDIO SPEAKERS, SPEAKER MOUNTS, AUDIO VIDEO RECEIVERS, AUDIO TUNERS, CD PLAYERS, SUBWOOFERS, MP3 PLAYERS, HEAD PHONES, CASSETTE PLAYERS, RADIOS, CD HOLDERS, AND CONVERTERS; WIRELESS COMPUTER PERIPHERALS, WIRELESS CABLE REPLACEMENTS, NAMELY, DIGITAL DEVICES THAT REPLACE AUDIO VIDEO CABLES BY WIRELESSLY TRANSMITTING SIGNALS BETWEEN 2 OR MORE AUDIO VIDEO COMPONENTS USING A VARIETY OF DIGITAL WIRELESS TECHNOLOGIES (U.S. CLS. 21, 23, 26, 36 AND 38).

RENEE SERVANCE, EXAMINING ATTORNEY

SN 77-055,852. PUNCHKICK INTERACTIVE, INC., CLEVELAND, OH. FILED 12-2-2006.



[punchkick interactive]

NO CLAIM IS MADE TO THE EXCLUSIVE RIGHT TO USE "INTERACTIVE", APART FROM THE MARK AS SHOWN.

"THE COLOR(S) GREEN AND WHITE IS/ARE CLAIMED AS A FEATURE OF THE MARK."

"THE MARK CONSISTS OF THE COLOR WHITE APPEARS IN THE WORDING PUNCH KICK. THE COLOR GREEN APPEARS IN THE WORDING PUNCHKICK INTERACTIVE AND IN THE DESIGN ELEMENTS."

FOR COMPUTER APPLICATION SOFTWARE FOR MOBILE PHONES; COMPUTER HARDWARE AND COMPUTER SOFTWARE PROGRAMS FOR THE INTEGRATION OF TEXT, AUDIO, GRAPHICS, STILL IMAGE AND MOVING PICTURES INTO AN INTERACTIVE DELIVERY FOR MULTIMEDIA APPLICATIONS; COMPUTER SOFTWARE TO ENABLE THE TRANSMISSION OF PHOTOGRAPHS TO MOBILE TELEPHONES; COMPUTER SOFTWARE, NAMELY, SOFTWARE DEVELOPMENT TOOLS FOR THE CREATION OF MOBILE INTERNET APPLICATIONS AND CLIENT INTERFACES; DOWNLOADABLE MP3 FILES, MP3 RECORDINGS, ONLINE DISCUSSION BOARDS, WEB CASTS, POD CASTS FEATURING MUSIC, AUDIO BOOKS AND NEWS BROADCASTS; WEB SITE DEVELOPMENT SOFTWARE (U.S. CLS. 21, 23, 26, 36 AND 38).

FIRST USE 6-0-2006; IN COMMERCE 6-0-2006.

TIMOTHY FINNEGAN, EXAMINING ATTORNEY

CLASS 9—(Continued).

SN 77-059,525. VISYX TECHNOLOGIES, INC., SUNNYVALE, CA. FILED 12-7-2006.



FOR FLUID PROPERTY SENSORS, FLUID CONDITION SENSORS, FLUID LEVEL SENSORS, FLUID QUALITY SENSORS, FLUID COMPOSITION SENSORS, DENSITY SENSORS, DIELECTRIC CONSTANT SENSORS, VISCOSITY SENSORS, CONDUCTIVITY SENSORS, RESISTIVITY SENSORS, IMPEDANCE SPECTROSCOPY SENSORS, TEMPERATURE SENSORS, VIBRATION SENSORS, TIMING SENSORS, PRESSURE SENSORS, PROXIMITY SENSORS, ULTRASONIC SENSORS AND SENSOR CONTROL MODULES FOR MONITORING AND/OR CONTROLLING SYSTEMS, PROCESSES AND ASSETS; FLUID PROPERTY SENSORS, FLUID CONDITION SENSORS, FLUID LEVEL SENSORS, FLUID QUALITY SENSORS, FLUID COMPOSITION SENSORS, DENSITY SENSORS, DIELECTRIC CONSTANT SENSORS, VISCOSITY SENSORS, CONDUCTIVITY SENSORS, RESISTIVITY SENSORS, IMPEDANCE SPECTROSCOPY SENSORS, TEMPERATURE SENSORS, VIBRATION SENSORS, TIMING SENSORS, PRESSURE SENSORS, PROXIMITY SENSORS, ULTRASONIC SENSORS AND SENSOR CONTROL MODULES FOR EVALUATING AND MONITORING SOLIDS, SEMI-SOLIDS, EMULSIONS, FLUIDS AND MULTIPHASE SYSTEMS; COMPUTER SOFTWARE TO CONTROL SENSORS, SENSOR CONTROL MODULES AND PROCESS CONTROL SYSTEMS; COMPUTER SOFTWARE USED FOR THE MANIPULATION OF INFORMATION FROM SENSORS, SENSOR CONTROL MODULES AND PROCESS CONTROL SYSTEMS (U.S. CLS. 21, 23, 26, 36 AND 38).

CAROL SPILS, EXAMINING ATTORNEY

SN 77-060,063. SELF ESTEM SEMINARS, INC., SANTA BARBARA, CA. FILED 12-8-2006.

JACK CANFIELD THE SUCCESS PRINCIPLES

THE MARK CONSISTS OF STANDARD CHARACTERS WITHOUT CLAIM TO ANY PARTICULAR FONT, STYLE, SIZE, OR COLOR.

NO CLAIM IS MADE TO THE EXCLUSIVE RIGHT TO USE "SUCCESS PRINCIPLES", APART FROM THE MARK AS SHOWN.

THE NAME JACK CANFIELD IDENTIFIES A LIVING INDIVIDUAL WHOSE CONSENT IS OF RECORD.

FOR PRE-RECORDED AUDIO CASSETTE TAPES, AUDIO COMPACT DISCS, ALL IN THE FIELD OF INSPIRATION, SELF-ESTEEM AND PERSONAL DEVELOPMENT (U.S. CLS. 21, 23, 26, 36 AND 38).

BRENDAN REGAN, EXAMINING ATTORNEY

CLASS 9—(Continued).

SN 77-061,624. RADU,MARY E., ST. HELENA, CA. AND MANN,CHERYL D., OAKLAND, CA. FILED 12-11-2006.

Roadmap to Meaningful Midlife

THE MARK CONSISTS OF STANDARD CHARACTERS WITHOUT CLAIM TO ANY PARTICULAR FONT, STYLE, SIZE, OR COLOR.

FOR DIGITAL MATERIALS, NAMELY, CDS, DVDS, DOWNLOADABLE AUDIO AND COMPLEMENTARY DATA FILES IN THE NATURE OF A WORKBOOK EACH FEATURING STEP BY STEP INSTRUCTIONS IN LIFE VISIONING AND PLANNING PROCESSES (U.S. CLS. 21, 23, 26, 36 AND 38).

FIRST USE 1-0-2005; IN COMMERCE 1-0-2005.
HANNO RITTRER, EXAMINING ATTORNEY

SN 77-065,266. AUGEN OPTICOS, S.A. DE C.V., CHULA VISTA, CA. FILED 12-15-2006.



THE MARK CONSISTS OF THE WORDING "AUGEN," STYLIZED, WITH A DESIGN TO THE LEFT OF THE WORDING, NAMELY, A TRIANGLE WITH A CURVED SIDE INSIDE OF A CIRCLE.

FOR OPHTHALMIC LENSES (U.S. CLS. 21, 23, 26, 36 AND 38).

WANDA KAY PRICE, EXAMINING ATTORNEY

SN 77-069,174. MANGO, WILLIAM, JACKSONVILLE, FL. AND PONDER, JAMES S., JACKSONVILLE, FL. FILED 12-21-2006.

Gett Money Entertainment

THE MARK CONSISTS OF STANDARD CHARACTERS WITHOUT CLAIM TO ANY PARTICULAR FONT, STYLE, SIZE, OR COLOR.

NO CLAIM IS MADE TO THE EXCLUSIVE RIGHT TO USE "ENTERTAINMENT", APART FROM THE MARK AS SHOWN.

FOR COMPACT DISCS AND AUDIO TAPES FEATURING PRE-RECORDED MUSIC (U.S. CLS. 21, 23, 26, 36 AND 38).

RICHARD WHITE, EXAMINING ATTORNEY

CLASS 9—(Continued).

SN 77-072,181. HARMAN INTERNATIONAL INDUSTRIES, INCORPORATED, NORTHRIDGE, CA. FILED 12-27-2006.

JBL ON STAGE

THE MARK CONSISTS OF STANDARD CHARACTERS WITHOUT CLAIM TO ANY PARTICULAR FONT, STYLE, SIZE, OR COLOR.

OWNER OF U.S. REG. NOS. 3,027,602, 3,121,896 AND 3,175,423.

FOR AUDIO EQUIPMENT, NAMELY, AMPLIFIERS AND LOUD SPEAKERS (U.S. CLS. 21, 23, 26, 36 AND 38).
FIRST USE 7-11-2004; IN COMMERCE 7-11-2004.

ALEX KEAM, EXAMINING ATTORNEY

SN 77-074,045. FRYETTE,STEVEN M., BURBANK, CA. FILED 1-1-2007.

MEMPHIS

THE MARK CONSISTS OF STANDARD CHARACTERS WITHOUT CLAIM TO ANY PARTICULAR FONT, STYLE, SIZE, OR COLOR.

FOR MUSICAL INSTRUMENT AMPLIFIERS AND ACCOMPANYING COMPONENTS, NAMELY, SOUND AMPLIFIERS, STEREO AMPLIFIERS, PRE-AMPLIFIERS, SPEAKERS, POWER SUPPLIES, SPEAKER CABINETS, SPEAKER ENCLOSURES; SOUND PROCESSING AND MODIFYING DEVICES, NAMELY, DELAY-REVERBERATION AND DISTORTION-AFFECT UNITS FOR THE PURPOSE OF MODIFYING MUSICAL INSTRUMENT SOUNDS (U.S. CLS. 21, 23, 26, 36 AND 38).

LINDA POWELL, EXAMINING ATTORNEY

SN 77-074,316. ELBIT SYSTEMS LTD., HAIFA 31053, ISRAEL, FILED 1-2-2007.

MaXess

THE MARK CONSISTS OF STANDARD CHARACTERS WITHOUT CLAIM TO ANY PARTICULAR FONT, STYLE, SIZE, OR COLOR.

FOR COMMUNICATION APPARATUS FOR REAL-TIME DATA, AUDIO AND VIDEO TRANSMISSION; COMPUTER SOFTWARE AND HARDWARE PROVIDING ACCESS TO WIRELESS LOCAL AREA NETWORKS AND FOR ORGANIZING AND MANAGING SAID NETWORKS; PARTS AND FITTINGS FOR THE ABOVE PRODUCTS (U.S. CLS. 21, 23, 26, 36 AND 38).

DEIRDRE ROBERTSON, EXAMINING ATTORNEY

CLASS 9—(Continued).

SN 77-074,379. TELEMANAGER TECHNOLOGIES, INC., NEWARK, NJ. FILED 1-2-2007.

TELEMANAGER

THE MARK CONSISTS OF STANDARD CHARACTERS WITHOUT CLAIM TO ANY PARTICULAR FONT, STYLE, SIZE, OR COLOR.

FOR COMPUTER HARDWARE AND SOFTWARE SYSTEMS FOR USE BY PHARMACIES TO AUTOMATE AND MANAGE THE SCHEDULING OF DRUG PRESCRIPTION REFILLS AND THE PLACEMENT OF DRUG PRESCRIPTION REFILL ORDERS FOR DRUG STORES AND PHARMACIES (U.S. CLS. 21, 23, 26, 36 AND 38).

FIRST USE 8-12-1997; IN COMMERCE 8-12-1997. JENNIFER VASQUEZ, EXAMINING ATTORNEY

CLASS 9—(Continued).

SN 77-078,983. THOMSON, BOULOGNE-BILLANCOURT, FRANCE, FILED 1-9-2007.



NO CLAIM IS MADE TO THE EXCLUSIVE RIGHT TO USE "CELL", APART FROM THE MARK AS SHOWN.

THE MARK CONSISTS OF THE WORDS CELL FUSION IN STYLIZED LETTERING, WITH TWO INTERLOCKING OVALS BEHIND THE LETTERS, ONE BEHIND THE WORD CELL AND THE "FU" OF FUSION, AND THE OTHER BEHIND THE WORD FUSION..

FOR TELEPHONES (U.S. CLS. 21, 23, 26, 36 AND 38). WILLIAM P. SHANAHAN, EXAMINING ATTORNEY

SN 77-081,656. TAXSTREAM, LLC, HOBOKEN, NJ. FILED 1-12-2007.

LEXSTREAM

SN 77-076,417. MICROSOFT CORPORATION, REDMOND, WA. FILED 1-4-2007.

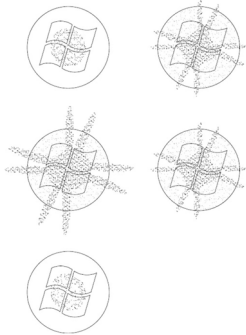

OWNER OF U.S. REG. NOS. 1,816,354, 2,849,117 AND OTHERS.

THE MARK CONSISTS OF AN ANIMATION MARK FEATURING A FLAG IMAGE WITH A CIRCLE BACKGROUND, WHICH ILLUMINATES DURING THE ANIMATION SEQUENCE AS SHOWN IN THE STIPPLING IN THE VARIOUS PANELS OF THE DRAWING.

FOR OPERATING SYSTEM SOFTWARE (U.S. CLS. 21, 23, 26, 36 AND 38). AHSEN KHAN, EXAMINING ATTORNEY

THE MARK CONSISTS OF STANDARD CHARACTERS WITHOUT CLAIM TO ANY PARTICULAR FONT, STYLE, SIZE, OR COLOR.

FOR COMPUTER SOFTWARE FOR STORING AND CONSOLIDATING ACCOUNTING INFORMATION, NAMELY, INCOME STATEMENTS, CASH FLOW STATEMENTS, BALANCE SHEETS AND ALL FOOT-NOTE DISCLOSURES, NEEDED IN ORDER TO PREPARE AN ANNUAL REPORT OR 10-K STATEMENT (U.S. CLS. 21, 23, 26, 36 AND 38).

FIRST USE 3-20-2007; IN COMMERCE 3-20-2007. MORGAN WYNNE, EXAMINING ATTORNEY

SN 77-082,837. DRAPER, INC., SPICELAND, IN. FILED 1-15-2007.

DRAPER

THE MARK CONSISTS OF STANDARD CHARACTERS WITHOUT CLAIM TO ANY PARTICULAR FONT, STYLE, SIZE, OR COLOR.

SEC. 2(F). FOR PROJECTION SCREENS (U.S. CLS. 21, 23, 26, 36 AND 38).

FIRST USE 0-0-1957; IN COMMERCE 0-0-1957. RICHARD WHITE, EXAMINING ATTORNEY

CLASS 9—(Continued).

SN 77-089,003. KRISHEL, SCOTT, SAN DIEGO, CA. FILED 1-23-2007.

**DR. SCOTT'S HEALTH CARE
SECRETS**

THE MARK CONSISTS OF STANDARD CHARACTERS WITHOUT CLAIM TO ANY PARTICULAR FONT, STYLE, SIZE, OR COLOR.

NO CLAIM IS MADE TO THE EXCLUSIVE RIGHT TO USE "HEALTH CARE SECRETS", APART FROM THE MARK AS SHOWN.

FOR DOWNLOADABLE MP3 FILES, MP3 RECORDINGS, ONLINE DISCUSSION BOARDS, WEB CASTS AND POD CASTS ALL FEATURING AUDIO BOOKS AND NEWS BROADCASTS; DIGITAL MATERIALS, NAMELY, AUDIO BOOKS FEATURING INFORMATION ON HEALTH CARE; DVDS FEATURING DIFFERENT COMPONENTS OF HEALTH CARE (U.S. CLS. 21, 23, 26, 36 AND 38).

FIRST USE 1-1-2006; IN COMMERCE 1-1-2006.
JOHN WILKE, EXAMINING ATTORNEY

CLASS 9—(Continued).

SN 77-096,918. HUSSEY, JAMES G, CUMMING, GA. FILED 2-1-2007.

GSFX

THE MARK CONSISTS OF STANDARD CHARACTERS WITHOUT CLAIM TO ANY PARTICULAR FONT, STYLE, SIZE, OR COLOR.

FOR COMPUTER SOFTWARE FOR DATA TRANSFER IN CELL PHONES (U.S. CLS. 21, 23, 26, 36 AND 38).

FIRST USE 11-4-2002; IN COMMERCE 12-27-2005.
IRENE D. WILLIAMS, EXAMINING ATTORNEY

SN 77-095,481. HUGHLEY, JAY W., LAPLACE, LA. FILED 1-31-2007.



NO CLAIM IS MADE TO THE EXCLUSIVE RIGHT TO USE "RECORDS", APART FROM THE MARK AS SHOWN.

THE COLOR(S) BLACK, GOLD, RED, WHITE, GRAY AND TAN IS/ARE CLAIMED AS A FEATURE OF THE MARK.

THE HANDS APPEAR IN TAN THE TERM REBORN RECORDS, THE CROSS, THE DEPICTION OF THE BABY AND THE OUTLINE OF THE RECORD APPEAR IN BLACK, THE WORDING REBORN RECORDS IS OUTLINED IN GOLD AND THERE ARE GOLD RAYS APPEARING FROM THE BABY, THE SHADOW OF THE TERM RECORDS IS IN RED, THE GROOVES OF THE RECORD APPEAR IN WHITE AND THE WORDING, MORE THAN JUST A RECORD LABEL - IT'S A WAY TO NEW LIFE APPEARS IN GRAY.

FOR MUSICAL SOUND RECORDINGS (U.S. CLS. 21, 23, 26, 36 AND 38).

ELLEN PERKINS, EXAMINING ATTORNEY

SN 77-099,420. MULTIMEDIA GAMES, INC., AUSTIN, TX. FILED 2-5-2007.

THE HOT SPOT

THE MARK CONSISTS OF STANDARD CHARACTERS WITHOUT CLAIM TO ANY PARTICULAR FONT, STYLE, SIZE, OR COLOR.

OWNER OF U.S. REG. NOS. 3,051,644 AND 3,142,958.
FOR GAMING MACHINES, NAMELY ELECTRONIC SLOT AND BINGO MACHINES (U.S. CLS. 21, 23, 26, 36 AND 38).

ELIZABETH HUGHITT, EXAMINING ATTORNEY

CLASS 9—(Continued).

SN 77-101,395. STREETZ MEDIA, INDIAN HEAD, MD.
FILED 2-7-2007.

Streetz
MOBILE

NO CLAIM IS MADE TO THE EXCLUSIVE RIGHT TO USE "MOBILE", APART FROM THE MARK AS SHOWN.

THE MARK CONSISTS OF THE STREETZ MOBILE LOGO CONSISTS OF THE WORD STREETZ ON TOP WITH OUR SPECIAL FONT AND ON THE BOTTOM OF THE LOGO THE WORD MOBILE..

FOR COMPUTER HARDWARE AND COMPUTER SOFTWARE PROGRAMS FOR THE INTEGRATION OF TEXT, AUDIO, GRAPHICS, STILL IMAGE AND MOVING PICTURES INTO AN INTERACTIVE DELIVERY FOR MULTIMEDIA APPLICATIONS; COMPUTER SOFTWARE FOR MANIPULATING DIGITAL AUDIO INFORMATION FOR USE IN AUDIO MEDIA APPLICATIONS; COMPUTER SOFTWARE FOR USE IN THE ENCRYPTION AND DECRYPTION OF DIGITAL FILES, INCLUDING AUDIO, VIDEO, TEXT, BINARY, STILL IMAGES, GRAPHICS AND MULTIMEDIA FILES; COMPUTER SOFTWARE FOR USE IN THE SAFEGUARDING OF DIGITAL FILES, INCLUDING AUDIO, VIDEO, TEXT, BINARY, STILL IMAGES, GRAPHICS AND MULTIMEDIA FILES; COMPUTER SOFTWARE TO ENHANCE THE AUDIO-VISUAL CAPABILITIES OF MULTIMEDIA APPLICATIONS, NAMELY, FOR THE INTEGRATION OF TEXT, AUDIO, GRAPHICS, STILL IMAGES AND MOVING PICTURES; DOWNLOADABLE MULTIMEDIA FILE CONTAINING ARTWORK, TEXT, AUDIO, VIDEO, GAMES, AND INTERNET WEB LINKS RELATING TO URBAN CONSUMERS; MEDIA PLAYERS; PORTABLE MEDIA PLAYERS; VIDEO MAGAZINE RECORDED ON ELECTRONIC MEDIA FEATURING STREETZ MAGAZINE (U.S. CLS. 21, 23, 26, 36 AND 38).

JILL C. ALT, EXAMINING ATTORNEY

SN 77-102,809. MULTIMEDIA GAMES, INC., AUSTIN, TX.
FILED 2-8-2007.

HOT SPOT JACKPOT

THE MARK CONSISTS OF STANDARD CHARACTERS WITHOUT CLAIM TO ANY PARTICULAR FONT, STYLE, SIZE, OR COLOR.

OWNER OF U.S. REG. NOS. 3,051,644 AND 3,142,958.

NO CLAIM IS MADE TO THE EXCLUSIVE RIGHT TO USE "JACKPOT", APART FROM THE MARK AS SHOWN.

FOR GAMING MACHINES, NAMELY ELECTRONIC SLOT AND BINGO MACHINES (U.S. CLS. 21, 23, 26, 36 AND 38).

ELIZABETH HUGHITT, EXAMINING ATTORNEY

CLASS 9—(Continued).

SN 77-103,010. MULTIMEDIA GAMES, INC., AUSTIN, TX.
FILED 2-8-2007.

SOS Jackpot

THE MARK CONSISTS OF STANDARD CHARACTERS WITHOUT CLAIM TO ANY PARTICULAR FONT, STYLE, SIZE, OR COLOR.

NO CLAIM IS MADE TO THE EXCLUSIVE RIGHT TO USE "JACKPOT", APART FROM THE MARK AS SHOWN.

FOR GAMING MACHINES, NAMELY, ELECTRONIC SLOT AND BINGO MACHINES; VIDEO LOTTERY TERMINALS (U.S. CLS. 21, 23, 26, 36 AND 38).

ELIZABETH HUGHITT, EXAMINING ATTORNEY

SN 77-104,885. BOMGAR CORPORATION, RIDGELAND, MS. FILED 2-12-2007.

**The Remote Support
Appliance Leader**

THE MARK CONSISTS OF STANDARD CHARACTERS WITHOUT CLAIM TO ANY PARTICULAR FONT, STYLE, SIZE, OR COLOR.

NO CLAIM IS MADE TO THE EXCLUSIVE RIGHT TO USE "REMOTE SUPPORT APPLIANCE", APART FROM THE MARK AS SHOWN.

FOR COMPUTER HARDWARE AND SOFTWARE, NAMELY, COMPUTER HARDWARE AND SOFTWARE FOR USE IN ACCESSING, USING AND CONTROLLING REMOTE COMPUTER SYSTEMS AND SOFTWARE; COMPUTER HARDWARE AND SOFTWARE FOR USE IN MONITORING, DIAGNOSING AND TROUBLESHOOTING REMOTE COMPUTER SYSTEMS AND SOFTWARE; COMPUTER HARDWARE AND SOFTWARE FOR USE IN ADMINISTERING AND AUDITING COMPUTER SYSTEMS AND SOFTWARE; COMPUTER HARDWARE AND SOFTWARE FOR USE IN DELIVERING AND DEPLOYING SOFTWARE APPLICATIONS AND DATA OVER THE INTERNET AND/OR TO REMOTE USERS; COMPUTER HARDWARE AND SOFTWARE FOR USE IN EDUCATING REMOTE USERS CONCERNING THE USE OF COMPUTER SOFTWARE; COMPUTER HARDWARE AND SOFTWARE FOR USE IN INSTALLING AND UNINSTALLING COMPUTER SOFTWARE (U.S. CLS. 21, 23, 26, 36 AND 38).

ELLEN B. AWRICH, EXAMINING ATTORNEY

CLASS 9—(Continued).

SN 77-106,231. DIGITAL CITIZEN, L.L.C., BROOKLYN, NY. FILED 2-13-2007.

DIGITAL CITIZEN

THE MARK CONSISTS OF STANDARD CHARACTERS WITHOUT CLAIM TO ANY PARTICULAR FONT, STYLE, SIZE, OR COLOR.

NO CLAIM IS MADE TO THE EXCLUSIVE RIGHT TO USE "DIGITAL", APART FROM THE MARK AS SHOWN.

FOR COMPUTER SOFTWARE FOR PROCESSING DIGITAL MUSIC FILES (U.S. CLS. 21, 23, 26, 36 AND 38).
VIVIAN MICZNIK FIRST, EXAMINING ATTORNEY

SN 77-107,710. PRACTICAL VIDEO SOLUTIONS, INC., BROOKLINE, MA. FILED 2-14-2007.

VIDEOGENIX

THE MARK CONSISTS OF STANDARD CHARACTERS WITHOUT CLAIM TO ANY PARTICULAR FONT, STYLE, SIZE, OR COLOR.

FOR VIDEO SECURITY APPARATUS, NAMELY CAMERAS, PORTABLE VIDEO SECURITY SYSTEMS, VIDEO RECORDERS, ROUTERS, SWITCHES, CABLES, COVERT CAMERAS AND SERVERS; COMPUTER SOFTWARE FOR A SECURE NETWORK VIDEO MONITORING SYSTEM (U.S. CLS. 21, 23, 26, 36 AND 38).

FIRST USE 3-1-2005; IN COMMERCE 3-1-2005.
H. M. FISHER, EXAMINING ATTORNEY

SN 77-107,973. MILLENNIUM INTERNATIONAL DEVELOPMENT CORPORATION, BOCA RATON, FL. FILED 2-15-2007.

FLO n STOP

THE MARK CONSISTS OF STANDARD CHARACTERS WITHOUT CLAIM TO ANY PARTICULAR FONT, STYLE, SIZE, OR COLOR.

FOR ELECTRONIC VALVES FOR CONTROLLING GAS OR FLUIDS (U.S. CLS. 21, 23, 26, 36 AND 38).
AMY ALFIERI, EXAMINING ATTORNEY

CLASS 9—(Continued).

SN 77-109,250. ADVANCED BIOMETRIC SOLUTIONS, INC., NEW YORK, NY. FILED 2-16-2007.

EXTO

THE MARK CONSISTS OF STANDARD CHARACTERS WITHOUT CLAIM TO ANY PARTICULAR FONT, STYLE, SIZE, OR COLOR.

FOR COMPUTER SOFTWARE FOR IDENTIFICATION AND VERIFICATION OF BIOMETRIC DATA IN THE AREA OF BIOMETRIC SECURITY (U.S. CLS. 21, 23, 26, 36 AND 38).

WANDA KAY PRICE, EXAMINING ATTORNEY

SN 77-109,585. THOMSON LEARNING INC., STAMFORD, CT. FILED 2-16-2007.

GO! CHEMISTRY

THE MARK CONSISTS OF STANDARD CHARACTERS WITHOUT CLAIM TO ANY PARTICULAR FONT, STYLE, SIZE, OR COLOR.

NO CLAIM IS MADE TO THE EXCLUSIVE RIGHT TO USE "CHEMISTRY", APART FROM THE MARK AS SHOWN.

FOR EDUCATIONAL DOWNLOADABLE AUDIO FILES, MULTIMEDIA FILES, TEXT FILES, EMAILS, WRITTEN DOCUMENTS, AUDIO MATERIAL, VIDEO MATERIAL FEATURING INFORMATION IN THE FORM OF DOWNLOADABLE SHORT EDUCATIONAL/ TRAINING COMMUNICATIONS IN THE FIELD OF CHEMISTRY VIA MOBILE DEVICES (U.S. CLS. 21, 23, 26, 36 AND 38).

LOURDES AYALA, EXAMINING ATTORNEY

CLASS 9—(Continued).

SN 77-111,293. JAYBIRD AUDIO, LLC, DRAPER, UT. FILED 2-20-2007.



THE MARK CONSISTS OF STYLIZED JB. FOR PORTABLE STEREO SYSTEMS COMPOSED OF STEREO TUNERS, STEREO AMPLIFIERS, STEREO RECEIVERS, AND SPEAKERS; PERSONAL STEREO SYSTEMS COMPOSED OF STEREO TUNERS, STEREO AMPLIFIERS, STEREO RECEIVERS, AND SPEAKERS; EARPHONES; RADIO FREQUENCY RECEIVERS; AND MP3 PLAYERS (U.S. CLS. 21, 23, 26, 36 AND 38). PAMELA HIRSCHMAN, EXAMINING ATTORNEY

SN 77-111,303. JAYBIRD AUDIO, LLC, DRAPER, UT. FILED 2-20-2007.



THE MARK CONSISTS OF STYLIZED JB WITHIN A CIRCLE. FOR PORTABLE STEREO SYSTEMS COMPOSED OF STEREO TUNERS, STEREO AMPLIFIERS, STEREO RECEIVERS, AND SPEAKERS; PERSONAL STEREO SYSTEMS COMPOSED OF STEREO TUNERS, STEREO AMPLIFIERS, STEREO RECEIVERS, AND SPEAKERS; EARPHONES; RADIO FREQUENCY RECEIVERS; AND MP3 PLAYERS (U.S. CLS. 21, 23, 26, 36 AND 38). PAMELA HIRSCHMAN, EXAMINING ATTORNEY

CLASS 9—(Continued).

SN 77-111,434. PSYCHOBILLY LLC, MELBOURNE, FL. FILED 2-20-2007.

Choppers Inc.

THE MARK CONSISTS OF STANDARD CHARACTERS WITHOUT CLAIM TO ANY PARTICULAR FONT, STYLE, SIZE, OR COLOR. NO CLAIM IS MADE TO THE EXCLUSIVE RIGHT TO USE "INC.", APART FROM THE MARK AS SHOWN. FOR VIDEO GAME SOFTWARE (U.S. CLS. 21, 23, 26, 36 AND 38). ALLISON HOLTZ, EXAMINING ATTORNEY

SN 77-112,561. ZORWARE, INC., WACO, TX. FILED 2-21-2007.

THE POWER OF WIRELESS

THE MARK CONSISTS OF STANDARD CHARACTERS WITHOUT CLAIM TO ANY PARTICULAR FONT, STYLE, SIZE, OR COLOR. NO CLAIM IS MADE TO THE EXCLUSIVE RIGHT TO USE "WIRELESS", APART FROM THE MARK AS SHOWN. FOR COMPUTER SOFTWARE DESIGNED TO FACILITATE COMMUNICATION BETWEEN FRANCHISORS AND FRANCHISEES WITH RESPECT TO ORDER FULFILLMENT, ORDER MANAGEMENT, DISPATCHING, INVOICING, PAYMENTS AND INVENTORY MANAGEMENT (U.S. CLS. 21, 23, 26, 36 AND 38). SETH A. RAPPAPORT, EXAMINING ATTORNEY

SN 77-112,681. ZORWARE, INC., WACO, TX. FILED 2-21-2007.

ZWARE MOBILE

THE MARK CONSISTS OF STANDARD CHARACTERS WITHOUT CLAIM TO ANY PARTICULAR FONT, STYLE, SIZE, OR COLOR. NO CLAIM IS MADE TO THE EXCLUSIVE RIGHT TO USE "MOBILE", APART FROM THE MARK AS SHOWN. FOR COMPUTER SOFTWARE DESIGNED TO FACILITATE COMMUNICATION BETWEEN FRANCHISORS AND FRANCHISEES WITH RESPECT TO ORDER FULFILLMENT, ORDER MANAGEMENT, DISPATCHING, INVOICING, PAYMENTS AND INVENTORY MANAGEMENT (U.S. CLS. 21, 23, 26, 36 AND 38). SETH A. RAPPAPORT, EXAMINING ATTORNEY

CLASS 9—(Continued).

SN 77-112,723. ILLINOIS TOOL WORKS INC., GLENVIEW, IL. FILED 2-21-2007.

ITW

THE MARK CONSISTS OF STANDARD CHARACTERS WITHOUT CLAIM TO ANY PARTICULAR FONT, STYLE, SIZE, OR COLOR.

OWNER OF U.S. REG. NOS. 2,624,665, 3,162,173 AND OTHERS.

FOR ELECTRIC CONNECTORS (U.S. CLS. 21, 23, 26, 36 AND 38).

TEJBIR SINGH, EXAMINING ATTORNEY

SN 77-112,906. ALLFLEX NEW ZEALAND LIMITED, PALMERSTON NORTH, NEW ZEALAND, FILED 2-21-2007.

THE ACE IN TRACEABILITY

THE MARK CONSISTS OF STANDARD CHARACTERS WITHOUT CLAIM TO ANY PARTICULAR FONT, STYLE, SIZE, OR COLOR.

FOR ELECTRONIC IDENTIFICATION TAGS AND BUTTONS FOR ANIMALS AND LIVESTOCK; REMOTE ELECTRONIC IDENTIFICATION SYSTEMS NAMELY RADIO FREQUENCY TAGS, BOLI, TRANSPONDERS, SCANNERS, READERS AND ANTENNAE FOR ANIMALS AND LIVESTOCK; ELECTRONIC SCALES; COMPUTER SOFTWARE AND COMPUTER HARDWARE FOR USE IN CONJUNCTION WITH THE AFOREMENTIONED GOODS FOR COLLECTION, TRACEABILITY AND MANAGEMENT OF DATA AND OTHER INFORMATION RELATING TO QUALITY CONTROL AND ASSURANCE CONNECTED WITH AGRICULTURE, LIVESTOCK FARMING AND MEAT PROCESSING; INSTRUCTIONAL BOOKS AND MANUALS BOTH PRINTED AND ELECTRONIC FOR THE AFORESAID GOODS (U.S. CLS. 21, 23, 26, 36 AND 38).

PAUL E. FAHRENKOPF, EXAMINING ATTORNEY

SN 77-113,096. 10X SOLUTIONS, INC., BRADFORDWOODS, PA. FILED 2-22-2007.

USURGE

THE MARK CONSISTS OF STANDARD CHARACTERS WITHOUT CLAIM TO ANY PARTICULAR FONT, STYLE, SIZE, OR COLOR.

FOR COMPUTER SOFTWARE, NAMELY, COMPUTER PROGRAMS USED BY BUSINESSES TO CONDUCT PERFORMANCE REVIEWS AND GOAL ASSESSMENTS FOR OR OF EMPLOYEES, INDEPENDENT CONTRACTS AND OTHERS PROVIDING SERVICES (U.S. CLS. 21, 23, 26, 36 AND 38).

TIMOTHY FINNEGAN, EXAMINING ATTORNEY

CLASS 9—(Continued).

SN 77-114,455. CARL ZEISS OPTICAL, INCORPORATED, CHESTER, VA. FILED 2-23-2007.

RAPID Z

THE MARK CONSISTS OF STANDARD CHARACTERS WITHOUT CLAIM TO ANY PARTICULAR FONT, STYLE, SIZE, OR COLOR.

FOR RIFLE SCOPES AND SPOTTING SCOPES (U.S. CLS. 21, 23, 26, 36 AND 38).

Laurie Mayes, Examining Attorney

SN 77-116,645. TERVELA INC., NEW YORK, NY. FILED 2-26-2007.

RETHINKING DATA MESSAGING

THE MARK CONSISTS OF STANDARD CHARACTERS WITHOUT CLAIM TO ANY PARTICULAR FONT, STYLE, SIZE, OR COLOR.

NO CLAIM IS MADE TO THE EXCLUSIVE RIGHT TO USE "DATA MESSAGING", APART FROM THE MARK AS SHOWN.

FOR COMPUTER HARDWARE; COMPUTER NETWORKING HARDWARE; COMPUTER HARDWARE FOR MESSAGE CACHING AND MANAGEMENT OF DATA COMMUNICATIONS SYSTEMS; TELECOMMUNICATIONS AND DATA NETWORKING HARDWARE, NAMELY DEVICES FOR TRANSPORTING AND AGGREGATING VOICE, DATA, AND VIDEO COMMUNICATIONS ACROSS MULTIPLE NETWORK INFRASTRUCTURES AND COMMUNICATIONS PROTOCOLS; COMPUTER SOFTWARE, MIDDLEWARE AND FIRMWARE FOR DATA COMMUNICATIONS, DATA TRANSMISSION, ELECTRONIC MESSAGING, AND TRANSPORTING AND AGGREGATING VOICE, DATA AND VIDEO COMMUNICATIONS ACROSS MULTIPLE NETWORK INFRASTRUCTURES AND COMMUNICATIONS PROTOCOLS; AND USER MANUALS SOLD THEREWITH AS A UNIT (U.S. CLS. 21, 23, 26, 36 AND 38).

FIRST USE 7-3-2006; IN COMMERCE 7-3-2006.

SALLY SHIH, EXAMINING ATTORNEY

CLASS 9—(Continued).

SN 77-117,176. ABEKAS, INC., MENLO PARK, CA. FILED 2-27-2007.

CLASS 9—(Continued).

SN 77-120,813. ABUNDANCE ELECTRICAL (SHENZHEN) CO., LTD., SHENZHEN, GUANGDONG, CHINA, FILED 3-2-2007.

DVEOUS

THE MARK CONSISTS OF STANDARD CHARACTERS WITHOUT CLAIM TO ANY PARTICULAR FONT, STYLE, SIZE, OR COLOR.

FOR VIDEO AND TELEVISION PROGRAM PRODUCTION EQUIPMENT, NAMELY, CONTROL PANEL WITH INTEGRATED MONITOR, SPEAKERS AND COMPUTER HARDWARE AND PERIPHERALS FOR CREATING, MANIPULATING, ENHANCING AND MODIFYING VIDEO IMAGES; COMPUTER SOFTWARE FOR CREATING, MANIPULATING, ENHANCING AND MODIFYING VIDEO IMAGES (U.S. CLS. 21, 23, 26, 36 AND 38).

FIRST USE 6-1-1996; IN COMMERCE 6-7-1996.
LOURDES AYALA, EXAMINING ATTORNEY

ABUND

THE MARK CONSISTS OF STANDARD CHARACTERS WITHOUT CLAIM TO ANY PARTICULAR FONT, STYLE, SIZE, OR COLOR.

FOR ELECTRIC COILS; ELECTRIC CONTROL DEVICES FOR HEATING AND ENERGY MANAGEMENT; ELECTRIC SWITCHES; SOLENOID VALVES AS ELECTROMAGNETIC SWITCHES; CONTROL VALVES FOR REGULATING THE FLOW OF GASES AND LIQUIDS; ELECTRIC LIGHT DIMMERS; ELECTRIC RELAYS; CURRENT RECTIFIERS; ELECTRIC CONVERTERS; ELECTRIC CIRCUIT CLOSERS; CHARGED COUPLING DEVICES; VOLTAGE SURGE PROTECTORS; ELECTRIC CONTROL PANELS; CABLE CONNECTORS; CONNECTORS FOR ELECTRONIC CIRCUIT; ELECTRIC JUNCTION BOXES; SAFETY CONTACT PLUGS; ELECTRIC PLUGS; PLUG CONNECTORS; ELECTRIC SOCKETS; MOVEABLE SOCKETS; ELECTRICAL DISTRIBUTION BOXES; AUTOMATIC SWITCHBOARDS (U.S. CLS. 21, 23, 26, 36 AND 38).

FIRST USE 6-0-1996; IN COMMERCE 8-0-1996.
CARYN GLASSER, EXAMINING ATTORNEY

SN 77-118,026. TRANSPARENT LANGUAGE, INC., NA-SHUA, NH. FILED 2-28-2007.

SN 77-120,883. SYL, LLC, WILMINGTON, DE. FILED 3-2-2007.

TALKER

THE MARK CONSISTS OF STANDARD CHARACTERS WITHOUT CLAIM TO ANY PARTICULAR FONT, STYLE, SIZE, OR COLOR.

FOR EDUCATIONAL SOFTWARE FEATURING INSTRUCTION IN FOREIGN LANGUAGES (U.S. CLS. 21, 23, 26, 36 AND 38).

FIRST USE 2-23-2004; IN COMMERCE 2-23-2004.
APRIL ROACH, EXAMINING ATTORNEY

**STANLEY B. BY STANLEY
BLACKER**

THE MARK CONSISTS OF STANDARD CHARACTERS WITHOUT CLAIM TO ANY PARTICULAR FONT, STYLE, SIZE, OR COLOR.

OWNER OF U.S. REG. NOS. 2,359,880, 2,862,769 AND OTHERS.

"THE NAME(S), PORTRAIT(S), AND/OR SIGNATURE(S) SHOWN IN THE MARK DOES NOT IDENTIFY A PARTICULAR LIVING INDIVIDUAL."

FOR OPTICAL FRAMES, SUNGLASSES AND READING GLASSES (U.S. CLS. 21, 23, 26, 36 AND 38).
BRENDAN REGAN, EXAMINING ATTORNEY

CLASS 9—(Continued).

SN 77-121,460. LEUPOLD & STEVENS, INC., BEAVERTON, OR. FILED 3-2-2007.

MATCH 13

THE MARK CONSISTS OF STANDARD CHARACTERS WITHOUT CLAIM TO ANY PARTICULAR FONT, STYLE, SIZE, OR COLOR.

NO CLAIM IS MADE TO THE EXCLUSIVE RIGHT TO USE "13", APART FROM THE MARK AS SHOWN.

FOR VISUAL DISPLAY FEATURE OF OPTICAL LENS SCOPES AND RANGEFINDERS, NAMELY, INTERCHANGEABLE RETICLES (U.S. CLS. 21, 23, 26, 36 AND 38).

FIRST USE 1-19-2007; IN COMMERCE 1-19-2007.
LINDA POWELL, EXAMINING ATTORNEY

SN 77-121,951. SALAR, INC., BALTIMORE, MD. FILED 3-5-2007.

TeamNotes

THE MARK CONSISTS OF STANDARD CHARACTERS WITHOUT CLAIM TO ANY PARTICULAR FONT, STYLE, SIZE, OR COLOR.

FOR COMPUTER SOFTWARE FOR USE IN THE HEALTHCARE FIELD, NAMELY, SOFTWARE FOR MANAGING, STORING, ANALYZING, MAINTAINING, PROCESSING, STRUCTURING, REVIEWING, BUILDING, EDITING, DISTRIBUTING, COMMUNICATING, ORGANIZING, SHARING, REFERENCING, MONITORING AND INTEGRATING HEALTHCARE INFORMATION; COMPUTER SOFTWARE FOR AUTOMATING CLINICAL AND ADMINISTRATIVE HEALTHCARE PROCESSES (U.S. CLS. 21, 23, 26, 36 AND 38).

DAVID I, EXAMINING ATTORNEY

SN 77-121,956. SALAR, INC., BALTIMORE, MD. FILED 3-5-2007.

TeamRelay

THE MARK CONSISTS OF STANDARD CHARACTERS WITHOUT CLAIM TO ANY PARTICULAR FONT, STYLE, SIZE, OR COLOR.

FOR COMPUTER SOFTWARE FOR USE IN THE HEALTHCARE FIELD, NAMELY, SOFTWARE FOR MANAGING, STORING, ANALYZING, MAINTAINING, PROCESSING, STRUCTURING, REVIEWING, BUILDING, EDITING, DISTRIBUTING, COMMUNICATING, ORGANIZING, SHARING, REFERENCING, MONITORING AND INTEGRATING HEALTHCARE INFORMATION; COMPUTER SOFTWARE FOR AUTOMATING CLINICAL AND ADMINISTRATIVE HEALTHCARE PROCESSES (U.S. CLS. 21, 23, 26, 36 AND 38).

DAVID I, EXAMINING ATTORNEY

CLASS 9—(Continued).

SN 77-121,964. SALAR, INC., BALTIMORE, MD. FILED 3-5-2007.

TeamQuery

THE MARK CONSISTS OF STANDARD CHARACTERS WITHOUT CLAIM TO ANY PARTICULAR FONT, STYLE, SIZE, OR COLOR.

FOR COMPUTER SOFTWARE FOR USE IN THE HEALTHCARE FIELD, NAMELY, SOFTWARE FOR MANAGING, STORING, ANALYZING, MAINTAINING, PROCESSING, STRUCTURING, REVIEWING, BUILDING, EDITING, DISTRIBUTING, COMMUNICATING, ORGANIZING, SHARING, REFERENCING, MONITORING AND INTEGRATING HEALTHCARE INFORMATION; COMPUTER SOFTWARE FOR AUTOMATING CLINICAL AND ADMINISTRATIVE HEALTHCARE PROCESSES (U.S. CLS. 21, 23, 26, 36 AND 38).

DAVID I, EXAMINING ATTORNEY

SN 77-123,235. 80-20 SOFTWARE, INC., BELLEVUE, WA. FILED 3-6-2007.

DOCUMENT MANAGEMENT EXTENSIONS

THE MARK CONSISTS OF STANDARD CHARACTERS WITHOUT CLAIM TO ANY PARTICULAR FONT, STYLE, SIZE, OR COLOR.

OWNER OF U.S. REG. NO. 2,381,968.

NO CLAIM IS MADE TO THE EXCLUSIVE RIGHT TO USE "EXTENSIONS", APART FROM THE MARK AS SHOWN.

SEC. 2(F).

FOR COMPUTER SOFTWARE FOR USE IN A DATABASE FOR DOCUMENT AND ELECTRONIC INFORMATION MANAGEMENT, AND FOR CONTROLLING ACCESS TO DOCUMENTS AND ELECTRONIC INFORMATION (U.S. CLS. 21, 23, 26, 36 AND 38).

FIRST USE 3-0-1998; IN COMMERCE 3-0-1998.

MICHAEL LITZAU, EXAMINING ATTORNEY

CLASS 9—(Continued).

SN 77-123,492. EXPRESS METRIX LLC, SEATTLE, WA. FILED 3-6-2007.

EXPRESS SOFTWARE
IDENTIFICATION DATABASE

THE MARK CONSISTS OF STANDARD CHARACTERS WITHOUT CLAIM TO ANY PARTICULAR FONT, STYLE, SIZE, OR COLOR.

OWNER OF U.S. REG. NOS. 2,690,241, 3,067,962 AND OTHERS.

NO CLAIM IS MADE TO THE EXCLUSIVE RIGHT TO USE "SOFTWARE IDENTIFICATION", APART FROM THE MARK AS SHOWN.

FOR COMPUTER PROGRAMS FOR MEASURING AND REPORTING ON THE PROGRAMS AND DATA FILES PRESENT ON COMPUTER STORAGE DEVICES, AND USER MANUALS SOLD AS A UNIT THEREWITH (U.S. CLS. 21, 23, 26, 36 AND 38).

FIRST USE 7-7-2004; IN COMMERCE 7-7-2004.

RICHARD A. STRASER, EXAMINING ATTORNEY

SN 77-125,104. GREG VISSCHER, PLEASANTON, CA. FILED 3-7-2007.

Coffee Compass

THE MARK CONSISTS OF STANDARD CHARACTERS WITHOUT CLAIM TO ANY PARTICULAR FONT, STYLE, SIZE, OR COLOR.

NO CLAIM IS MADE TO THE EXCLUSIVE RIGHT TO USE "COMPASS", APART FROM THE MARK AS SHOWN.

FOR SATELLITE NAVIGATIONAL SYSTEM, NAMELY, GLOBAL POSITIONING SYSTEM THAT PROVIDES DIRECTION AND DISTANCE TO CLOSEST LOCATIONS OF MULTIPLE PREDETERMINED LOCATIONS UTILIZING THE GLOBAL POSITIONING SYSTEM AND AN ELECTRONIC COMPASSING SENSOR (U.S. CLS. 21, 23, 26, 36 AND 38).

CHRISTINA SOBRAL, EXAMINING ATTORNEY

SN 77-125,434. SAM STATHIS, NEW YORK, NY. FILED 3-8-2007.

THEOCAD

THE MARK CONSISTS OF STANDARD CHARACTERS WITHOUT CLAIM TO ANY PARTICULAR FONT, STYLE, SIZE, OR COLOR.

FOR COMPUTER PROGRAMS RECORDED ON DATA MEDIA (SOFTWARE) DESIGNED FOR USE IN CONSTRUCTION AND AUTOMATED MANUFACTURING (CAD/CAM) (U.S. CLS. 21, 23, 26, 36 AND 38).

APRIL ROACH, EXAMINING ATTORNEY

CLASS 9—(Continued).

SN 77-125,466. CRANE CO., STAMFORD, CT. FILED 3-8-2007.

MERCHANT

THE MARK CONSISTS OF STANDARD CHARACTERS WITHOUT CLAIM TO ANY PARTICULAR FONT, STYLE, SIZE, OR COLOR.

FOR VENDING MACHINES, AND PARTS AND FITTINGS THEREFOR (U.S. CLS. 21, 23, 26, 36 AND 38).

BERNICE MIDDLETON, EXAMINING ATTORNEY

SN 77-125,552. THE WECK CORPORATION, NEW YORK, NY. FILED 3-8-2007.

GRACIOUS HOME

THE MARK CONSISTS OF STANDARD CHARACTERS WITHOUT CLAIM TO ANY PARTICULAR FONT, STYLE, SIZE, OR COLOR.

OWNER OF U.S. REG. NOS. 947,721 AND 2,284,659.

FOR TAPE MEASURES (U.S. CLS. 21, 23, 26, 36 AND 38).

FIRST USE 3-21-2002; IN COMMERCE 3-21-2002.

DAVID H. STINE, EXAMINING ATTORNEY

SN 77-125,662. IET SOLUTIONS, LLC, FRAMINGHAM, MA. FILED 3-8-2007.

IET

THE MARK CONSISTS OF STANDARD CHARACTERS WITHOUT CLAIM TO ANY PARTICULAR FONT, STYLE, SIZE, OR COLOR.

FOR COMPUTER PROGRAMS FOR HELP DESK APPLICATIONS, INFORMATION TECHNOLOGY ASSET IDENTIFICATION, TRACKING, AND MANAGEMENT, AND INFORMATION TECHNOLOGY SERVICE MANAGEMENT; COMPUTER PROGRAMS FOR ACCESSING, ANALYZING, AND PERSONALIZING DECISION-MAKING INFORMATION, BUSINESS MODELING TRENDS, AND PERFORMANCE MANAGEMENT; COMPUTER PROGRAMS FOR TRACKING PERFORMANCE OF AN ORGANIZATION'S CUSTOMER RELATIONS; COMPUTER PROGRAMS FOR MEASURING AND ANALYZING ACTUAL BUSINESS DATA ON INFORMATION TECHNOLOGY SUPPORT AND SERVICES AGAINST KEY PERFORMANCE INDICATORS; COMPUTER PROGRAMS FOR TRACKING, RESEARCHING AND CONFIRMING COMPUTER NETWORK PROBLEMS (U.S. CLS. 21, 23, 26, 36 AND 38).

FIRST USE 10-30-2003; IN COMMERCE 10-30-2003.

MARK SPARACINO, EXAMINING ATTORNEY

CLASS 9—(Continued).

SN 77-125,714. IET SOLUTIONS, LLC, FRAMINGHAM, MA. FILED 3-8-2007.



THE MARK CONSISTS OF MISCELLANEOUS DESIGN. FOR COMPUTER PROGRAMS FOR HELP DESK APPLICATIONS, INFORMATION TECHNOLOGY ASSET IDENTIFICATION, TRACKING, AND MANAGEMENT, AND INFORMATION TECHNOLOGY SERVICE MANAGEMENT; COMPUTER PROGRAMS FOR ACCESSING, ANALYZING, AND PERSONALIZING DECISION-MAKING INFORMATION, BUSINESS MODELING TRENDS, AND PERFORMANCE MANAGEMENT; COMPUTER PROGRAMS FOR TRACKING PERFORMANCE OF AN ORGANIZATION'S CUSTOMER RELATIONS; COMPUTER PROGRAMS FOR MEASURING AND ANALYZING ACTUAL BUSINESS DATA ON INFORMATION TECHNOLOGY SUPPORT AND SERVICES AGAINST KEY PERFORMANCE INDICATORS; COMPUTER PROGRAMS FOR TRACKING, RESEARCHING AND CONFIRMING COMPUTER NETWORK PROBLEMS (U.S. CLS. 21, 23, 26, 36 AND 38).

FIRST USE 4-30-2003; IN COMMERCE 10-30-2003. MARK SPARACINO, EXAMINING ATTORNEY

SN 77-126,653. ADVANCED LIQUID LOGIC, INC., MORRISVILLE, NC. FILED 3-9-2007.

NANOLYTICS

THE MARK CONSISTS OF STANDARD CHARACTERS WITHOUT CLAIM TO ANY PARTICULAR FONT, STYLE, SIZE, OR COLOR.

FOR MICROFLUIDIC FLUID HANDLING DEVICE, NAMELY, CHIPS AND PRINTED CIRCUIT BOARDS FOR HANDLING FLUIDS FOR A DIVERSE RANGE OF APPLICATIONS; CARTRIDGES FOR INTERFACING THE CHIPS AND PRINTED CIRCUIT BOARDS WITH AN ANALYZER INSTRUMENT; AND ANALYZER INSTRUMENTS FOR OPERATING THE CHIPS AND PRINTED CIRCUIT BOARDS (U.S. CLS. 21, 23, 26, 36 AND 38).

ALEXANDER L. POWERS, EXAMINING ATTORNEY

CLASS 9—(Continued).

SN 77-127,494. IGT, RENO, NV. FILED 3-9-2007.



NO CLAIM IS MADE TO THE EXCLUSIVE RIGHT TO USE "FIVE TIMES" AND "5X", APART FROM THE MARK AS SHOWN.

THE MARK CONSISTS OF THE WORDS FIVE TIMES GOLD WRITTEN AT THE TOP AND BOTTOM OF AN OVAL DESIGN WITH THE TERM 5X IN THE MIDDLE OF THE OVAL.

FOR GAMING MACHINES, NAMELY, DEVICES WHICH ACCEPT A WAGER AND COMPONENTS THEREFOR, NAMELY, CONTROLLERS, DISPLAYS, BUTTON PANELS, BOLSTERS, ELECTRICAL WIRING, AND COMPUTER HARDWARE AND SOFTWARE ASSOCIATED THEREWITH (U.S. CLS. 21, 23, 26, 36 AND 38).

FIRST USE 6-27-2005; IN COMMERCE 7-8-2005. INGRID C. EULIN, EXAMINING ATTORNEY

SN 77-128,151. ROMAN, ROBERT RICHARD, HENDERSON, NV. FILED 3-12-2007.



"THE COLOR(S) BROWN AND ORANGE IS/ARE CLAIMED AS A FEATURE OF THE MARK."

THE MARK CONSISTS OF ORANGE FIRE AND WATER SYMBOL WITH BROWN STYLIZED LETTERING.

FOR REMOTE CONTROLS FOR DECORATIVE FIRE FEATURES IN THE NATURE OF BOWLS, TROUGHS, TIKI TORCHES AND FIREPITS. (U.S. CLS. 21, 23, 26, 36 AND 38).

PRISCILLA MILTON, EXAMINING ATTORNEY

CLASS 9—(Continued).

SN 77-128,316. ILLINOIS TOOL WORKS INC., GLENVIEW, IL. FILED 3-12-2007.

MILLERMATIC

THE MARK CONSISTS OF STANDARD CHARACTERS WITHOUT CLAIM TO ANY PARTICULAR FONT, STYLE, SIZE, OR COLOR.
OWNER OF U.S. REG. NOS. 583,436, 1,713,078 AND OTHERS.
FOR WELDING HELMET (U.S. CLS. 21, 23, 26, 36 AND 38).
FIRST USE 3-0-2002; IN COMMERCE 3-0-2002.
PAUL CROWLEY, EXAMINING ATTORNEY

SN 77-128,779. WEATHER CENTRAL, INC., MADISON, WI. FILED 3-12-2007.

ARTSTAR

THE MARK CONSISTS OF STANDARD CHARACTERS WITHOUT CLAIM TO ANY PARTICULAR FONT, STYLE, SIZE, OR COLOR.
FOR COMPUTERS AND COMPUTER PROGRAMS FOR GENERATING VIDEO IMAGE GRAPHICS (U.S. CLS. 21, 23, 26, 36 AND 38).
SAIMA MAKHDOOM, EXAMINING ATTORNEY

SN 77-129,122. AGRICULTURAL MODELING AND TRAINING SYSTEMS, LLC, LANSING, NY. FILED 3-13-2007.

AMTS.Cattle

THE MARK CONSISTS OF STANDARD CHARACTERS WITHOUT CLAIM TO ANY PARTICULAR FONT, STYLE, SIZE, OR COLOR.
NO CLAIM IS MADE TO THE EXCLUSIVE RIGHT TO USE "CATTLE", APART FROM THE MARK AS SHOWN.
FOR COMPUTER SOFTWARE FOR ANIMAL AGRICULTURE RATION FORMULATION (U.S. CLS. 21, 23, 26, 36 AND 38).
FIRST USE 11-11-2005; IN COMMERCE 11-11-2005.
STANLEY I. OSBORNE, EXAMINING ATTORNEY

CLASS 9—(Continued).

SN 77-129,696. SIEMENS POWER TRANSMISSION & DISTRIBUTION, INC., WENDELL, NC. FILED 3-13-2007.

AUTO-TOPPER

THE MARK CONSISTS OF STANDARD CHARACTERS WITHOUT CLAIM TO ANY PARTICULAR FONT, STYLE, SIZE, OR COLOR.
FOR GROUP OPERATED CIRCUIT DISCONNECT APPARATUS FOR OVERHEAD ELECTRICAL POWER LINES (U.S. CLS. 21, 23, 26, 36 AND 38).
FIRST USE 8-0-1980; IN COMMERCE 8-0-1980.
BARBARA A. GOLD, EXAMINING ATTORNEY

SN 77-129,729. SIEMENS POWER TRANSMISSION & DISTRIBUTION, INC., WENDELL, NC. FILED 3-13-2007.

AUTO-PAK

THE MARK CONSISTS OF STANDARD CHARACTERS WITHOUT CLAIM TO ANY PARTICULAR FONT, STYLE, SIZE, OR COLOR.
FOR GROUP OPERATED CIRCUIT DISCONNECT APPARATUS FOR OVERHEAD ELECTRICAL POWER LINES (U.S. CLS. 21, 23, 26, 36 AND 38).
FIRST USE 12-31-1992; IN COMMERCE 12-31-1992.
BARBARA A. GOLD, EXAMINING ATTORNEY

SN 77-129,775. SIEMENS POWER TRANSMISSION & DISTRIBUTION, INC., WENDELL, NC. FILED 3-13-2007.

BRIDGES ELECTRIC

THE MARK CONSISTS OF STANDARD CHARACTERS WITHOUT CLAIM TO ANY PARTICULAR FONT, STYLE, SIZE, OR COLOR.
NO CLAIM IS MADE TO THE EXCLUSIVE RIGHT TO USE "ELECTRIC", APART FROM THE MARK AS SHOWN.
FOR GROUP OPERATED CIRCUIT DISCONNECT APPARATUS FOR OVERHEAD ELECTRICAL POWER LINES (U.S. CLS. 21, 23, 26, 36 AND 38).
FIRST USE 12-31-1963; IN COMMERCE 12-31-1963.
BARBARA A. GOLD, EXAMINING ATTORNEY

CLASS 9—(Continued).

SN 77-129,842. SIEMENS POWER TRANSMISSION & DISTRIBUTION, INC., WENDELL, NC. FILED 3-13-2007.



The logo for Bridges Electric features the word "Bridges" in a large, bold, italicized sans-serif font. Below it, the word "ELECTRIC" is written in a smaller, bold, sans-serif font, enclosed within a dark rectangular box.

THE MARK CONSISTS OF THE MARK CONSISTS OF THE WORD BRIDGES ABOVE A BAND INCLUDING THE WORD ELECTRIC.

FOR GROUP OPERATED CIRCUIT DISCONNECT APPARATUS FOR OVERHEAD ELECTRICAL POWER LINES (U.S. CLS. 21, 23, 26, 36 AND 38).

FIRST USE 12-31-1992; IN COMMERCE 12-31-1992.

BARBARA A. GOLD, EXAMINING ATTORNEY

SN 77-130,726. CONTEGO, INC., BOZEMAN, MT. FILED 3-14-2007.

vibe vault

THE MARK CONSISTS OF STANDARD CHARACTERS WITHOUT CLAIM TO ANY PARTICULAR FONT, STYLE, SIZE, OR COLOR.

FOR PROTECTIVE CARRYING CASES AND SPECIALTY CARRYING HOLSTERS, BOTH FOR PORTABLE ELECTRONIC DEVICES, NAMELY, CELL PHONES, MP3 PLAYERS, MUSIC PLAYERS, VIDEO PLAYERS, PAGERS AND PERSONAL DIGITAL ASSISTANTS; CARRYING CASES FOR PORTABLE ELECTRONIC DEVICES THAT ARE SPECIFICALLY ADAPTED FOR ATTACHMENT TO COMPUTER DOCKING STATIONS (U.S. CLS. 21, 23, 26, 36 AND 38).

FIRST USE 12-1-2006; IN COMMERCE 12-1-2006.

NICHOLAS ALTREE, EXAMINING ATTORNEY

SN 77-131,396. GREEN, TIMOTHY, LOS ANGELES, CA. FILED 3-14-2007.

Trainer Tim

THE MARK CONSISTS OF STANDARD CHARACTERS WITHOUT CLAIM TO ANY PARTICULAR FONT, STYLE, SIZE, OR COLOR.

NO CLAIM IS MADE TO THE EXCLUSIVE RIGHT TO USE "TRAINER", APART FROM THE MARK AS SHOWN.

FOR DIGITAL MATERIALS, NAMELY, DVDS FEATURING EDUCATIONAL INFORMATION REGARDING NUTRITION AND EXERCISE (U.S. CLS. 21, 23, 26, 36 AND 38).

MARTHA FROMM, EXAMINING ATTORNEY

CLASS 9—(Continued).

SN 77-131,861. LA LOOP, LLC, NEW YORK, NY. FILED 3-15-2007.

LE FLASH

THE MARK CONSISTS OF STANDARD CHARACTERS WITHOUT CLAIM TO ANY PARTICULAR FONT, STYLE, SIZE, OR COLOR.

FOR CARRYING CASES FOR HOLDING ELECTRONIC DEVICES, NAMELY, PERSONAL DIGITAL ASSISTANTS (PDA), MOBILE PHONES AND DIGITAL CAMERAS (U.S. CLS. 21, 23, 26, 36 AND 38).

FIRST USE 2-0-2007; IN COMMERCE 2-0-2007.

STEVEN R. FOSTER, EXAMINING ATTORNEY

SN 77-131,972. FSV PAYMENT SYSTEMS, INC., HOUSTON, TX. FILED 3-15-2007.

Paychek Plus

THE MARK CONSISTS OF STANDARD CHARACTERS WITHOUT CLAIM TO ANY PARTICULAR FONT, STYLE, SIZE, OR COLOR.

NO CLAIM IS MADE TO THE EXCLUSIVE RIGHT TO USE PAYCHECK, APART FROM THE MARK AS SHOWN. FOR MAGNETICALLY ENCODED DEBIT CARDS (U.S. CLS. 21, 23, 26, 36 AND 38).

FIRST USE 10-30-2002; IN COMMERCE 10-30-2002.

ZHALEH DELANEY, EXAMINING ATTORNEY

SN 77-132,455. STRONG, ERIC C., PITTSBURGH, PA. FILED 3-15-2007.



The logo for StrongCard features the word "StrongCard" in a stylized, rounded sans-serif font. The letter "C" in "Card" is significantly larger and more decorative, with a thick, curved shape that loops around the end of the word.

THE MARK CONSISTS OF STRONGCARD IN STYLIZED SCRIPT WITH THE C IN THE FORM/SHAPE OF A MUSCUL.

FOR ENCODED SMART CARDS CONTAINING PROGRAMMING USED TO PAY FOR GOODS AND SERVICES (U.S. CLS. 21, 23, 26, 36 AND 38).

ANGELA M. MICHELI, EXAMINING ATTORNEY

CLASS 9—(Continued).

SN 77-132,751. KAUFMAN, HALL & ASSOCIATES, INC., SKOKIE, IL. FILED 3-16-2007.



OWNER OF U.S. REG. NOS. 1,534,120, 2,559,393 AND OTHERS.

NO CLAIM IS MADE TO THE EXCLUSIVE RIGHT TO USE "SOFTWARE SUITE", APART FROM THE MARK AS SHOWN.

FOR BUSINESS AND FINANCIAL PLANNING SOFTWARE FOR USE IN THE HEALTH CARE INDUSTRY, NAMELY COMPUTER PROGRAMS FOR USE IN DATABASE MANAGEMENT, DATA ANALYSIS, STRATEGIC PLANNING, MODELING, MANAGEMENT, GENERATING REPORTS, AND CONNECTING OTHER SOFTWARE MODULES (U.S. CLS. 21, 23, 26, 36 AND 38).

FIRST USE 6-0-2006; IN COMMERCE 6-0-2006.
WANDA KAY PRICE, EXAMINING ATTORNEY

CLASS 9—(Continued).

SN 77-132,754. KAUFMAN, HALL & ASSOCIATES, INC., SKOKIE, IL. FILED 3-16-2007.



OWNER OF U.S. REG. NOS. 1,534,120, 2,559,393 AND OTHERS.

NO CLAIM IS MADE TO THE EXCLUSIVE RIGHT TO USE "BUDGET ADVISOR", APART FROM THE MARK AS SHOWN.

FOR BUSINESS AND FINANCIAL PLANNING SOFTWARE FOR USE IN THE HEALTH CARE INDUSTRY, NAMELY, COMPUTER PROGRAMS FOR DATABASE MANAGEMENT, DATA ANALYSIS, STRATEGIC PLANNING, MODELING AND GENERATING REPORTS (U.S. CLS. 21, 23, 26, 36 AND 38).

FIRST USE 6-0-2006; IN COMMERCE 6-0-2006.
WANDA KAY PRICE, EXAMINING ATTORNEY

SN 77-132,943. XPRESSYSTEMS, INC., NEW PRAGUE, MN. FILED 3-16-2007.

XpresSystems

THE MARK CONSISTS OF STANDARD CHARACTERS WITHOUT CLAIM TO ANY PARTICULAR FONT, STYLE, SIZE, OR COLOR.

FOR RFID READERS; RADIO FREQUENCY IDENTIFICATION (RFID) CREDENTIALS, NAMELY, CARDS AND TAGS, AND READERS FOR RADIO FREQUENCY IDENTIFICATION CREDENTIALS; RADIO FREQUENCY IDENTIFICATION (RFID) TAGS (U.S. CLS. 21, 23, 26, 36 AND 38).

DAVID ELTON, EXAMINING ATTORNEY

SN 77-132,753. KAUFMAN, HALL & ASSOCIATES, INC., SKOKIE, IL. FILED 3-16-2007.



OWNER OF U.S. REG. NOS. 1,534,120, 2,559,393 AND OTHERS.

NO CLAIM IS MADE TO THE EXCLUSIVE RIGHT TO USE "MARKET ADVISOR", APART FROM THE MARK AS SHOWN.

FOR BUSINESS AND FINANCIAL PLANNING SOFTWARE FOR USE IN THE HEALTH CARE INDUSTRY, NAMELY, COMPUTER PROGRAMS FOR DATABASE MANAGEMENT, DATA ANALYSIS, STRATEGIC PLANNING, MODELING AND GENERATING REPORTS (U.S. CLS. 21, 23, 26, 36 AND 38).

FIRST USE 6-0-2006; IN COMMERCE 6-0-2006.
WANDA KAY PRICE, EXAMINING ATTORNEY

SN 77-133,377. CONTOUR DESIGN, INC., WINDHAM, NH. FILED 3-16-2007.

PERFIT

THE MARK CONSISTS OF STANDARD CHARACTERS WITHOUT CLAIM TO ANY PARTICULAR FONT, STYLE, SIZE, OR COLOR.

FOR COMPUTER CURSOR CONTROL DEVICES, NAMELY, COMPUTER MOUSE (U.S. CLS. 21, 23, 26, 36 AND 38).

FIRST USE 2-0-1999; IN COMMERCE 2-0-1999.
LYDIA BELZER, EXAMINING ATTORNEY

CLASS 9—(Continued).

SN 77-133,614. DIOPTICS MEDICAL PRODUCTS, SAN LUIS OBISPO, CA. FILED 3-16-2007.

polarluma

THE MARK CONSISTS OF STANDARD CHARACTERS WITHOUT CLAIM TO ANY PARTICULAR FONT, STYLE, SIZE, OR COLOR.

FOR CASES FOR SPECTACLES AND SUNGLASSES; FRAMES FOR SPECTACLES AND SUNGLASSES; LENSES FOR SUNGLASSES; SUNGLASS LENSES; SUNGLASSES (U.S. CLS. 21, 23, 26, 36 AND 38).

B. PARADEWELAI, EXAMINING ATTORNEY

SN 77-133,805. HY TWO, LLC, COHOES, NY. FILED 3-18-2007.



NO CLAIM IS MADE TO THE EXCLUSIVE RIGHT TO USE "HEX", APART FROM THE MARK AS SHOWN.

THE MARK CONSISTS OF THE STYLIZED WORD "HEX" AND A POLYGONAL BAND DESIGN

FOR CARBON NANO TUBES, NAMELY, TUBULAR CARBON MOLECULES USED IN EXTREMELY SMALL SCALE ELECTRONIC AND MECHANICAL APPLICATIONS; NANO TUBES, NAMELY, TUBULAR CARBON MOLECULES USED IN EXTREMELY SMALL SCALE ELECTRONIC AND MECHANICAL APPLICATIONS; CONDUCTIVE FIBERS, NAMELY, FIBERS FOR CONDUCTING ELECTRICAL CHARGES AND STATIC ELECTRICAL CHARGES (U.S. CLS. 21, 23, 26, 36 AND 38).

FIRST USE 1-1-2007; IN COMMERCE 3-1-2007.

B. PARADEWELAI, EXAMINING ATTORNEY

SN 77-134,460. HDR POWER SYSTEMS, INC., COLUMBUS, OH. FILED 3-19-2007.

HALMAR

THE MARK CONSISTS OF STANDARD CHARACTERS WITHOUT CLAIM TO ANY PARTICULAR FONT, STYLE, SIZE, OR COLOR.

OWNER OF U.S. REG. NO. 1,635,375.
FOR SILICON CONTROLLED RECTIFIER POWER CONTROLLERS (U.S. CLS. 21, 23, 26, 36 AND 38).

FIRST USE 12-31-1968; IN COMMERCE 12-31-1968.

MICHAEL LITZAU, EXAMINING ATTORNEY

CLASS 9—(Continued).

SN 77-134,469. ARCADE FIRE MUSIC LLC, LOS ANGELES, CA. FILED 3-19-2007.

THE ARCADE FIRE

THE MARK CONSISTS OF STANDARD CHARACTERS WITHOUT CLAIM TO ANY PARTICULAR FONT, STYLE, SIZE, OR COLOR.

FOR SERIES OF MUSICAL SOUND RECORDINGS AND PRERECORDED COMPACT DISCS, VIDEOTAPES, VIDEODISCS, VIDEOCASSETTES, CD-ROMS, DVDS, DIGITAL AUDIO TAPES, MP3S, OPTICAL DISCS AND LASERDISCS, ALL FEATURING MUSIC; DOWNLOADABLE AUDIO AND VIDEO RECORDINGS FEATURING MUSIC; DOWNLOADABLE RING TONES, MUSIC, DOWNLOADABLE OR TRANSFERABLE COMPUTER FILES IN MP3 FORMAT, MUSIC VIDEOS, GRAPHICS; ELECTRONIC GAME SOFTWARE; DOWNLOADABLE DIGITAL IMAGES AND MUSIC VIDEOS FOR WIRELESS COMMUNICATION DEVICES, ALL FEATURING MUSIC (U.S. CLS. 21, 23, 26, 36 AND 38).

LEIGH CAROLINE CASE, EXAMINING ATTORNEY

SN 77-134,865. BLACK DIAMOND VIDEO, INC., ALAMEDA, CA. FILED 3-19-2007.



NO CLAIM IS MADE TO THE EXCLUSIVE RIGHT TO USE "VIDEO", APART FROM THE MARK AS SHOWN.

THE MARK CONSISTS OF A COMBINATION OF FOUR RHOMBUS FOLLOWS BY THE WORDS BLACK DIAMOND VIDEO.

FOR VIDEO TRANSMISSION APPARATUS; HARDWARE FOR VIDEO PROCESSING, NAMELY, VIDEO PROCESSORS, VIDEO SIGNAL SWITCHES, CONVERTERS, ELECTRONIC SCALERS FOR AUDIO AND VIDEO SIGNALS, AND CONNECTION CABLES FOR VIDEO INPUT/OUTPUT AND TRANSMISSION AND PROCESSING APPARATUS (U.S. CLS. 21, 23, 26, 36 AND 38).

FIRST USE 4-1-2004; IN COMMERCE 5-1-2005.

JENNIFER MARTIN, EXAMINING ATTORNEY

SN 77-135,052. CHEMADVISOR, INC., PITTSBURGH, PA. FILED 3-20-2007.

GHSAdvisor

THE MARK CONSISTS OF STANDARD CHARACTERS WITHOUT CLAIM TO ANY PARTICULAR FONT, STYLE, SIZE, OR COLOR.

FOR COMPUTER SOFTWARE FOR CLASSIFYING CHEMICAL SUBSTANCES AND MIXTURES ACCORDING TO THE GLOBALLY HARMONIZED SYSTEM OF CLASSIFICATION AND LABELLING OF CHEMICALS (U.S. CLS. 21, 23, 26, 36 AND 38).

REGINA DRUMMOND, EXAMINING ATTORNEY

CLASS 9—(Continued).

SN 77-135,363. NOVA ELECTRONICS INC., COLCHESTER, CT. FILED 3-20-2007.

S500

THE MARK CONSISTS OF STANDARD CHARACTERS WITHOUT CLAIM TO ANY PARTICULAR FONT, STYLE, SIZE, OR COLOR.
FOR EMERGENCY WARNING LIGHTS (U.S. CLS. 21, 23, 26, 36 AND 38).
CORY BOONE, EXAMINING ATTORNEY

SN 77-135,418. NOVA ELECTRONICS INC., COLCHESTER, CT. FILED 3-20-2007.

N500

THE MARK CONSISTS OF STANDARD CHARACTERS WITHOUT CLAIM TO ANY PARTICULAR FONT, STYLE, SIZE, OR COLOR.
FOR EMERGENCY WARNING LIGHTS (U.S. CLS. 21, 23, 26, 36 AND 38).
CORY BOONE, EXAMINING ATTORNEY

SN 77-135,429. W2BI, INC., UNION, NJ. FILED 3-20-2007.

Q-SECURE

THE MARK CONSISTS OF STANDARD CHARACTERS WITHOUT CLAIM TO ANY PARTICULAR FONT, STYLE, SIZE, OR COLOR.
FOR COMPUTER SOFTWARE FOR DEVICE MANAGEMENT OF MOBILE TELEPHONES AND SMART DEVICES, NAMELY, POCKET PERSONAL COMPUTERS, PERSONAL DIGITAL ASSISTANTS, HANDHELD ELECTRONIC WIRELESS COMMUNICATION DEVICES, TABLET PERSONAL COMPUTERS, MP3 PLAYERS, MULTI-FUNCTION ELECTRONIC WIRELESS DIGITAL DEVICES FOR MANAGING, PLAYING AND RECORDING AUDIO, TEXT, AND DATA FILES, AND PERSONAL MESSAGING DEVICES; FOR THE REGISTERING OF USERS; CONFIGURING COMPANY AND USER PROFILES; ISSUING LICENSES TO COMPANIES AND USERS; ORGANIZING DEVICES INTO GROUPS AND DEPLOYING COMMON SOFTWARE APPLICATIONS, CONFIGURATIONS AND SETTINGS; SOFTWARE FOR DEVICE ASSET MANAGEMENT, VIEWING DEVICE ASSETS, AND VIEWING DEVICE FILES; SOFTWARE FOR REMOTE LAUNCHING OF COMMANDS ON THE SPECIFIED DEVICES; SOFTWARE FOR GENERATION OF OPERATIONAL REPORTS FOR SPECIFIED DEVICES; SOFTWARE FOR TRACKING DEVICES, LOCKING SELECTED DEVICES, AND DISABLING OR RESETTING SELECTED DEVICES (U.S. CLS. 21, 23, 26, 36 AND 38).
ESTHER BELENKER, EXAMINING ATTORNEY

CLASS 9—(Continued).

SN 77-135,444. NOVA ELECTRONICS INC., COLCHESTER, CT. FILED 3-20-2007.

P500

THE MARK CONSISTS OF STANDARD CHARACTERS WITHOUT CLAIM TO ANY PARTICULAR FONT, STYLE, SIZE, OR COLOR.
FOR EMERGENCY WARNING LIGHTS (U.S. CLS. 21, 23, 26, 36 AND 38).
CORY BOONE, EXAMINING ATTORNEY

SN 77-135,604. AUERSOFT LLC, MESA, AZ. FILED 3-20-2007.

V-INVOICE

THE MARK CONSISTS OF STANDARD CHARACTERS WITHOUT CLAIM TO ANY PARTICULAR FONT, STYLE, SIZE, OR COLOR.
FOR COMPUTER SOFTWARE FOR CONVERSION OF ELECTRONIC INVOICES TO DATABASE DOCUMENTS (U.S. CLS. 21, 23, 26, 36 AND 38).
KAREN SEVERSON, EXAMINING ATTORNEY

SN 77-135,758. GAMO USA, CORP., FT. LAUDERDALE, FL. FILED 3-20-2007.

CANNIBAL EYE

THE MARK CONSISTS OF STANDARD CHARACTERS WITHOUT CLAIM TO ANY PARTICULAR FONT, STYLE, SIZE, OR COLOR.
FOR GOGGLES FOR SPORTS (U.S. CLS. 21, 23, 26, 36 AND 38).
STEVEN JACKSON, EXAMINING ATTORNEY

CLASS 9—(Continued).

SN 77-135,924. BALLY GAMING, INC., LAS VEGAS, NV.
FILED 3-20-2007.

777 COLLECT

THE MARK CONSISTS OF STANDARD CHARACTERS WITHOUT CLAIM TO ANY PARTICULAR FONT, STYLE, SIZE, OR COLOR.

NO CLAIM IS MADE TO THE EXCLUSIVE RIGHT TO USE "777", APART FROM THE MARK AS SHOWN.

FOR GAMING DEVICES, NAMELY SLOT MACHINES, WITH OR WITHOUT VIDEO OUTPUT (U.S. CLS. 21, 23, 26, 36 AND 38).

FIRST USE 2-7-2005; IN COMMERCE 2-7-2005.
PAULA MAHONEY, EXAMINING ATTORNEY

SN 77-136,105. ESLINGER, AARON D., COLORADO SPRINGS, CO. FILED 3-20-2007.

Critter Kinetics

THE MARK CONSISTS OF STANDARD CHARACTERS WITHOUT CLAIM TO ANY PARTICULAR FONT, STYLE, SIZE, OR COLOR.

FOR DOWNLOADABLE VIDEO RECORDINGS FOR CHILDREN FEATURING INSTRUCTIONAL EXERCISES BASED ON TYPICAL ANIMAL MOVEMENTS AND POSITIONS AND PRE-RECORDED CDS, VIDEO TAPES, LASER DISKS AND DVDS FOR CHILDREN FEATURING INSTRUCTIONAL EXERCISES BASED ON TYPICAL ANIMAL MOVEMENTS AND POSITIONS (U.S. CLS. 21, 23, 26, 36 AND 38).

GIANCARLO CASTRO, EXAMINING ATTORNEY

SN 77-136,135. DAYMEN PHOTO MARKETING LP, MARKHAM, ONTARIO, CANADA, FILED 3-21-2007.

PRIMUS AW

THE MARK CONSISTS OF STANDARD CHARACTERS WITHOUT CLAIM TO ANY PARTICULAR FONT, STYLE, SIZE, OR COLOR.

FOR BAGS, HARD AND SOFT COVERED CASES, BACKPACKS, BELT PACKS, SHOULDER BAGS, MESSENGER BAGS, POCKETS AND POUCHES, ALL DESIGNED FOR CARRYING PHOTOGRAPHIC, VIDEOGRAPHIC, OPTICAL, AUDIO, AND ELECTRONIC EQUIPMENT; FILM ORGANIZERS, NAMELY, CASES FOR CARRYING EXPOSED AND UNEXPOSED CAMERA FILM; CELL PHONE POUCHES; WAIST HARNESES AND SHOULDER HARNESES DESIGNED FOR USE WITH THE FOREGOING GOODS (U.S. CLS. 21, 23, 26, 36 AND 38).

APRIL ROACH, EXAMINING ATTORNEY

CLASS 9—(Continued).

SN 77-136,521. TITAN TOOL COMPANY, FAIRVIEW, PA.
FILED 3-21-2007.

TAPASSIST

THE MARK CONSISTS OF STANDARD CHARACTERS WITHOUT CLAIM TO ANY PARTICULAR FONT, STYLE, SIZE, OR COLOR.

FOR AUTOMATIC DEPTH SENSOR FOR USE WITH A TOOL SUPPORT AND POSITIONING ARM (U.S. CLS. 21, 23, 26, 36 AND 38).

MARY ROSSMAN, EXAMINING ATTORNEY

SN 77-136,550. ADOBE SYSTEMS INCORPORATED, SAN JOSE, CA. FILED 3-21-2007.

SEE WHAT'S POSSIBLE

THE MARK CONSISTS OF STANDARD CHARACTERS WITHOUT CLAIM TO ANY PARTICULAR FONT, STYLE, SIZE, OR COLOR.

FOR COMPUTER SOFTWARE FOR CREATING, VIEWING, MANIPULATING, EDITING, MANAGING, INDEXING, CATALOGUING, SORTING, ORGANIZING, STORING, TRANSFERRING, SYNCHRONIZING, PRINTING, AND EXCHANGING DIGITAL PHOTOGRAPHS, DIGITAL AND GRAPHIC IMAGES, DATA, TEXT, AUDIO, VIDEO, MULTIMEDIA AND INTERACTIVE DOCUMENTS AND WORKS, TEXT DOCUMENTS, AND RECORDED INFORMATION; COMPUTER SOFTWARE FOR TRANSFERRING DIGITAL PHOTOGRAPHS, DIGITAL AND GRAPHIC IMAGES, DATA, TEXT, AUDIO, VIDEO, MULTIMEDIA AND INTERACTIVE DOCUMENTS AND WORKS, TEXT DOCUMENTS, AND RECORDED INFORMATION TO CD-ROM DISCS AND DIGITAL VIDEO DISCS; COMPUTER SOFTWARE FOR TRANSFERRING DIGITAL PHOTOGRAPHS, DIGITAL AND GRAPHIC IMAGES, DATA, TEXT, AUDIO, VIDEO, MULTIMEDIA AND INTERACTIVE DOCUMENTS AND WORKS, TEXT DOCUMENTS, AND RECORDED INFORMATION FOR USE OVER COMPUTER NETWORKS, WIRELESS NETWORKS AND GLOBAL COMMUNICATION NETWORKS; COMPUTER PROGRAMS AND COMPUTER TUTORIAL SOFTWARE FOR CREATING GREETING CARDS, CALENDARS, BOOKS, DOCUMENTS, AUTOMATED PDF SLIDE SHOWS, AND WEB PHOTO GALLERIES AND ALBUMS; FILE MANAGEMENT SOFTWARE FOR OPENING AND CONVERTING PHOTOGRAPHIC, DIGITAL, AND GRAPHIC IMAGES, DATA, TEXT, DOCUMENTS, AUDIO, VIDEO, MULTIMEDIA WORKS, AND RECORDED INFORMATION TO VARIOUS FILE FORMATS; AND USERS' MANUALS AND INSTRUCTIONAL BOOKS SOLD AS A UNIT THEREWITH (U.S. CLS. 21, 23, 26, 36 AND 38).

GIANCARLO CASTRO, EXAMINING ATTORNEY

CLASS 9—(Continued).

SN 77-136,830. CRC HEALTH GROUP, INC., CUPERTINO, CA. FILED 3-21-2007.

CATS

THE MARK CONSISTS OF STANDARD CHARACTERS WITHOUT CLAIM TO ANY PARTICULAR FONT, STYLE, SIZE, OR COLOR.

FOR COMPUTER SOFTWARE AND INSTRUCTIONAL MANUALS, NAMELY, COMPUTER SOFTWARE USED FOR TRACKING AND ASSESSING THE SEVERITY OF MENTAL HEALTH DISORDERS AND ADDICTIVE BEHAVIORS OVER TIME AND RELATED INSTRUCTIONAL MANUALS SOLD THEREWITH (U.S. CLS. 21, 23, 26, 36 AND 38).

JACLYN KIDWELL, EXAMINING ATTORNEY

CLASS 9—(Continued).

SN 77-137,048. LOWENSTEIN, CHAIM, JACKSONVILLE, FL. AND KANE, TOM JR., SAINT PAUL, MN. FILED 3-21-2007.

Armor FaStor

THE MARK CONSISTS OF STANDARD CHARACTERS WITHOUT CLAIM TO ANY PARTICULAR FONT, STYLE, SIZE, OR COLOR.

FOR COMPUTER PERIPHERALS (U.S. CLS. 21, 23, 26, 36 AND 38).

FIRST USE 11-2-2006; IN COMMERCE 11-8-2006.

JULIE THOMAS, EXAMINING ATTORNEY

SN 77-137,005. NETFORENSICS, INC., EDISON, NJ. FILED 3-21-2007.

NETFORENSICS

THE MARK CONSISTS OF STANDARD CHARACTERS WITHOUT CLAIM TO ANY PARTICULAR FONT, STYLE, SIZE, OR COLOR.

OWNER OF U.S. REG. NO. 2,332,889.
FOR COMPUTER SOFTWARE AND HARDWARE FOR NETWORK SECURITY PURPOSES (U.S. CLS. 21, 23, 26, 36 AND 38).

FIRST USE 5-26-1999; IN COMMERCE 5-26-1999.

CAROLINE WOOD, EXAMINING ATTORNEY

SN 77-137,168. ROOSEVELT, CHARLES B, ENGLEWOOD, CO. FILED 3-21-2007.

Nanomals

THE MARK CONSISTS OF STANDARD CHARACTERS WITHOUT CLAIM TO ANY PARTICULAR FONT, STYLE, SIZE, OR COLOR.

FOR PROTECTIVE CARRYING CASES FOR PORTABLE MUSIC PLAYERS NAMELY MP3 PLAYERS (U.S. CLS. 21, 23, 26, 36 AND 38).

MICHAEL LITZAU, EXAMINING ATTORNEY

SN 77-137,033. SEMANTIC RESEARCH, INC., SAN DIEGO, CA. FILED 3-21-2007.

TripletSphere

THE MARK CONSISTS OF STANDARD CHARACTERS WITHOUT CLAIM TO ANY PARTICULAR FONT, STYLE, SIZE, OR COLOR.

FOR COMPUTER SOFTWARE FOR THE COLLECTION, EDITING, ORGANIZING, MODIFYING, BOOK MARKING, TRANSMISSION, STORAGE AND SHARING OF DATA AND INFORMATION (U.S. CLS. 21, 23, 26, 36 AND 38).

MARILYN IZZI, EXAMINING ATTORNEY

SN 77-137,252. MARTIN, JEFFREY E, HORSHAM, PA. FILED 3-22-2007.

OWNER OF U.S. REG. NO. 1,990,874.
FOR MUSICAL SOUND RECORDINGS (U.S. CLS. 21, 23, 26, 36 AND 38).

FIRST USE 10-25-1976; IN COMMERCE 5-13-1990.

TINA BROWN, EXAMINING ATTORNEY

CLASS 9—(Continued).

SN 77-137,311. CONAIR CORPORATION, STAMFORD, CT.
FILED 3-22-2007.

CURL DIMENSIONS

THE MARK CONSISTS OF STANDARD CHARACTERS WITHOUT CLAIM TO ANY PARTICULAR FONT, STYLE, SIZE, OR COLOR.

NO CLAIM IS MADE TO THE EXCLUSIVE RIGHT TO USE "CURL", APART FROM THE MARK AS SHOWN.

FOR ELECTRIC HAIR CURLING IRONS; ELECTRIC HAIR STRAIGHTENING IRONS (U.S. CLS. 21, 23, 26, 36 AND 38).

MARY MUNSON, EXAMINING ATTORNEY

SN 77-137,322. FAZTECH, INC., FREMONT, NE. FILED 3-22-2007.

Flowave

THE MARK CONSISTS OF STANDARD CHARACTERS WITHOUT CLAIM TO ANY PARTICULAR FONT, STYLE, SIZE, OR COLOR.

FOR BATTERY CHARGERS NOT FOR MEDICAL USE (U.S. CLS. 21, 23, 26, 36 AND 38).

ZHALEH DELANEY, EXAMINING ATTORNEY

SN 77-137,621. ADVANCED DIGITAL DATA, INC., FLANDERS, NJ. FILED 3-22-2007.

ADD ENERGY E3

THE MARK CONSISTS OF STANDARD CHARACTERS WITHOUT CLAIM TO ANY PARTICULAR FONT, STYLE, SIZE, OR COLOR.

OWNER OF U.S. REG. NO. 2,353,721.

NO CLAIM IS MADE TO THE EXCLUSIVE RIGHT TO USE "ENERGY", APART FROM THE MARK AS SHOWN.

FOR BUSINESS MANAGEMENT SOFTWARE FOR USE IN THE ENERGY DISTRIBUTION FIELD AND INSTRUCTION MANUALS SOLD AS A UNIT (U.S. CLS. 21, 23, 26, 36 AND 38).

DOMINICK J. SALEMI, EXAMINING ATTORNEY

CLASS 9—(Continued).

SN 77-137,650. SUMITOMO ELECTRIC INDUSTRIES, LTD., OSAKA-SHI, OSAKA, JAPAN, FILED 3-22-2007.

TENO-R

THE MARK CONSISTS OF STANDARD CHARACTERS WITHOUT CLAIM TO ANY PARTICULAR FONT, STYLE, SIZE, OR COLOR.

FOR COMPUTER SOFTWARE, NAMELY PEER-TO-PEER FILE SHARING SOFTWARE AND DATA MANAGEMENT SOFTWARE USED FOR THE PURPOSE OF RECEIVING, TRANSMITTING, CREATING, STORING, RETRIEVING, SHARING, VIEWING, PREVIEWING, PRINTING, EDITING, ANNOTATING, ORGANIZING AND MANAGING INFORMATION, SITES, FILES, DOCUMENTS, SOUND RECORDINGS, PICTURES, MOVIES, MEDIA FILES AND OTHER RESOURCES ON COMPUTER NETWORKS AND IN COMPUTERS (U.S. CLS. 21, 23, 26, 36 AND 38).

DAVID TOOLEY, EXAMINING ATTORNEY

SN 77-137,654. THE FANFARE GROUP, INC., MOUNTAIN VIEW, CA. FILED 3-22-2007.

ITEST

THE MARK CONSISTS OF STANDARD CHARACTERS WITHOUT CLAIM TO ANY PARTICULAR FONT, STYLE, SIZE, OR COLOR.

FOR COMPUTER SOFTWARE FOR SYSTEMS VERIFICATION TESTING; COMPUTER SOFTWARE FOR TESTING AND ANALYZING THE PERFORMANCE AND INTEGRITY OF DEVICES AND PRODUCT FEATURES IN THE FIELD OF PRODUCT AND/OR SYSTEMS DESIGN, THE FIELD OF PRODUCT QUALITY ASSURANCE, AND THE FIELD OF PRODUCT AND/OR SYSTEMS TESTING; COMPUTER SOFTWARE FOR PRODUCT, DEVICE, AND/OR SYSTEM DESIGN MODELING AND TESTING; COMPUTER SOFTWARE FOR USE IN DEVICE, PRODUCT AND/OR SYSTEM TEST PLANNING, TEST CASE DESIGN, TEST EXECUTION, TEST AUTOMATION, DEFECT ANALYSIS AND DOCUMENTATION, AND TEST RESULT TRACKING AND REPORTING (U.S. CLS. 21, 23, 26, 36 AND 38).

LA TONIA FISHER, EXAMINING ATTORNEY

SN 77-137,675. PACIFIC LINK TRADE USA, INC., DALTON, GA. FILED 3-22-2007.

MACH 1

THE MARK CONSISTS OF STANDARD CHARACTERS WITHOUT CLAIM TO ANY PARTICULAR FONT, STYLE, SIZE, OR COLOR.

FOR SUNGLASSES (U.S. CLS. 21, 23, 26, 36 AND 38).

RENEE SERVANCE, EXAMINING ATTORNEY

CLASS 9—(Continued).

SN 77-137,951. BRENNER, RON DAVID, PARK CITY, UT.
FILED 3-22-2007.

WaterHound

THE MARK CONSISTS OF STANDARD CHARACTERS WITHOUT CLAIM TO ANY PARTICULAR FONT, STYLE, SIZE, OR COLOR.

FOR LEAK DETECTING DEVICE FOR WATER SUPPLIED HOME APPLIANCES CONSISTING OF WATER SENSOR, CONTROL UNIT WITH AUDIBLE ALARM AND WATER VALVES (U.S. CLS. 21, 23, 26, 36 AND 38).
NAKIA HENRY, EXAMINING ATTORNEY

SN 77-137,980. MEPOS ELECTRONICS LTD., KAOHSIUNG CITY, TAIWAN, FILED 3-22-2007.



FOR DISTRIBUTION TRANSFORMERS, ELECTRIC TRANSFORMERS, ELECTRIC VOLTAGE TRANSFORMERS, VOLTAGE STABILIZERS, VOLTAGE REGULATORS, CURRENT CONVERTERS, ELECTRIC CONVERTERS, BATTERY CHARGERS, HIGH-FREQUENCY SWITCHING POWER SUPPLIES, ELECTRICAL POWER SUPPLIES, VOLTAGE STABILIZING POWER SUPPLY, POWER CONTROLLERS, VOLTAGE MONITOR MODULES, UNINTERRUPTIBLE ELECTRIC POWER SUPPLIES (U.S. CLS. 21, 23, 26, 36 AND 38).

FIRST USE 3-14-2007; IN COMMERCE 3-14-2007.
JAY FLOWERS, EXAMINING ATTORNEY

SN 77-138,204. EMERSON ELECTRIC CO., ST. LOUIS, MO.
FILED 3-22-2007.

SEE IT. FIND IT. SOLVE IT.

THE MARK CONSISTS OF STANDARD CHARACTERS WITHOUT CLAIM TO ANY PARTICULAR FONT, STYLE, SIZE, OR COLOR.

FOR PORTABLE FIBER OPTIC INSPECTION CAMERAS (U.S. CLS. 21, 23, 26, 36 AND 38).
GENE MACIOL, EXAMINING ATTORNEY

CLASS 9—(Continued).

SN 77-138,309. BRITT ALLCROFT PRODUCTIONS, LLC,
SANTA MONICA, CA. FILED 3-22-2007.

CUBLEY

THE MARK CONSISTS OF STANDARD CHARACTERS WITHOUT CLAIM TO ANY PARTICULAR FONT, STYLE, SIZE, OR COLOR.

FOR COMPUTER SOFTWARE PROGRAMS AND PRE-RECORDED COMPACT DISCS, DIGITAL VIDEO DISCS (DVD), VIDEO RECORDINGS, VIDEO DISC RECORDINGS, CD-ROMS, AUDIO RECORDINGS, AUDIO CASSETTES, PHONOGRAPH RECORDS AND VIDEO TAPES ALL FEATURING ENTERTAINMENT FOR CHILDREN (U.S. CLS. 21, 23, 26, 36 AND 38).

CHARISMA HAMPTON, EXAMINING ATTORNEY

SN 77-138,327. BRITT ALLCROFT PRODUCTIONS, LLC,
SANTA MONICA, CA. FILED 3-22-2007.

CUBLEY AND THE CITY KIDS

THE MARK CONSISTS OF STANDARD CHARACTERS WITHOUT CLAIM TO ANY PARTICULAR FONT, STYLE, SIZE, OR COLOR.

FOR COMPUTER SOFTWARE PROGRAMS AND PRE-RECORDED COMPACT DISCS, DIGITAL VIDEO DISCS (DVD), VIDEO RECORDINGS, VIDEO DISC RECORDINGS, CD-ROMS, AUDIO RECORDINGS, AUDIO CASSETTES, PHONOGRAPH RECORDS AND VIDEO TAPES ALL FEATURING ENTERTAINMENT FOR CHILDREN (U.S. CLS. 21, 23, 26, 36 AND 38).

CHARISMA HAMPTON, EXAMINING ATTORNEY

SN 77-138,403. NEXSEM, INC., IRVINE, CA. FILED 3-23-2007.

NEXSEM

THE MARK CONSISTS OF STANDARD CHARACTERS WITHOUT CLAIM TO ANY PARTICULAR FONT, STYLE, SIZE, OR COLOR.

FOR INTEGRATED CIRCUITS (U.S. CLS. 21, 23, 26, 36 AND 38).

FIRST USE 2-29-2004; IN COMMERCE 2-29-2004.
PRISCILLA MILTON, EXAMINING ATTORNEY

CLASS 9—(Continued).

SN 77-138,448. LUMASENSE TECHNOLOGIES, INC., SANTA CLARA, CA. FILED 3-23-2007.

FOCAL POINT

THE MARK CONSISTS OF STANDARD CHARACTERS WITHOUT CLAIM TO ANY PARTICULAR FONT, STYLE, SIZE, OR COLOR.

FOR FIBER OPTIC TEMPERATURE GAUGES FOR MEDICAL APPLICATIONS (U.S. CLS. 21, 23, 26, 36 AND 38).

FIRST USE 1-22-2007; IN COMMERCE 1-22-2007.
MARK SPARACINO, EXAMINING ATTORNEY

SN 77-138,533. NOVATE, LLC, OVERLAND PARK, KS. FILED 3-23-2007.

VOLTBOLT

THE MARK CONSISTS OF STANDARD CHARACTERS WITHOUT CLAIM TO ANY PARTICULAR FONT, STYLE, SIZE, OR COLOR.

FOR LOCKING ELECTRICAL POWER CORDS AND LOCKING ELECTRICAL EXTENSION CORDS (U.S. CLS. 21, 23, 26, 36 AND 38).

FIRST USE 4-14-2007; IN COMMERCE 6-11-2007.
PRISCILLA MILTON, EXAMINING ATTORNEY

SN 77-138,721. BOWE BELL + HOWELL SCANNERS, L.L.C., WHEELING, IL. FILED 3-23-2007.

INFINITY WF

THE MARK CONSISTS OF STANDARD CHARACTERS WITHOUT CLAIM TO ANY PARTICULAR FONT, STYLE, SIZE, OR COLOR.

FOR OPTICAL SCANNERS (U.S. CLS. 21, 23, 26, 36 AND 38).

DAVID MURRAY, EXAMINING ATTORNEY

CLASS 9—(Continued).

SN 77-138,782. AXYGEN, INC., UNION CITY, CA. FILED 3-23-2007.

AXCELL

THE MARK CONSISTS OF STANDARD CHARACTERS WITHOUT CLAIM TO ANY PARTICULAR FONT, STYLE, SIZE, OR COLOR.

FOR LABORATORY STORAGE TUBES; LOCKABLE PETRI DISHES USED IN LABORATORY RESEARCH; PLATES, GLASS SLIDES OR CHIPS HAVING MULTI-WELL ARRAYS THAT CAN BE USED IN CHEMICAL ANALYSIS, BIOLOGICAL ANALYSIS OR PATTERNING FOR SCIENTIFIC, LABORATORY OR MEDICAL RESEARCH USE; LABORATORY EQUIPMENT AND SUPPLIES NAMELY, TEST TUBES; LABORATORY EQUIPMENT, NAMELY, PLASTIC, RUBBER AND ELASTOMER CLOSURES, SEALS AND STOPPERS FOR LABORATORY BOTTLES; LABORATORY FILTERS; FILTERS FOR USE IN LABORATORY EQUIPMENT THE BIOPHARMACEUTICAL INDUSTRY (U.S. CLS. 21, 23, 26, 36 AND 38).

DANIEL CAPSHAW, EXAMINING ATTORNEY

SN 77-138,862. AGASTHA, INC., FORT HILLS, NC. FILED 3-23-2007.

AGASTHA

THE MARK CONSISTS OF STANDARD CHARACTERS WITHOUT CLAIM TO ANY PARTICULAR FONT, STYLE, SIZE, OR COLOR.

FOR COMPUTER SOFTWARE FOR CONTROLLING AND MANAGING PATIENT MEDICAL INFORMATION (U.S. CLS. 21, 23, 26, 36 AND 38).

FIRST USE 4-15-2003; IN COMMERCE 4-15-2003.
MICHAEL LITZAU, EXAMINING ATTORNEY

SN 77-138,901. LITEPOINT CORPORATION, SUNNYVALE, CA. FILED 3-23-2007.

LitePoint

THE MARK CONSISTS OF STANDARD CHARACTERS WITHOUT CLAIM TO ANY PARTICULAR FONT, STYLE, SIZE, OR COLOR.

FOR CIRCUIT TESTERS; WIRELESS ELECTRONIC TESTING EQUIPMENT, NAMELY, TESTERS FOR WIRELESS SYSTEMS (U.S. CLS. 21, 23, 26, 36 AND 38).

FIRST USE 1-1-2001; IN COMMERCE 1-1-2001.
PAUL F. GAST, EXAMINING ATTORNEY

CLASS 9—(Continued).

SN 77-138,907. DOOR CONTROL SERVICES, INC., BEN WHEELER, TX. FILED 3-23-2007.

Security Opening Solutions

THE MARK CONSISTS OF STANDARD CHARACTERS WITHOUT CLAIM TO ANY PARTICULAR FONT, STYLE, SIZE, OR COLOR.

FOR ELECTRIC DOOR OPENERS; ELECTRONIC DOOR OPENERS (U.S. CLS. 21, 23, 26, 36 AND 38).
HOWARD FRIEDMAN, EXAMINING ATTORNEY

SN 77-138,908. METROPCS WIRELESS, INC., DALLAS, TX. FILED 3-23-2007.

METRO TONES

THE MARK CONSISTS OF STANDARD CHARACTERS WITHOUT CLAIM TO ANY PARTICULAR FONT, STYLE, SIZE, OR COLOR.

NO CLAIM IS MADE TO THE EXCLUSIVE RIGHT TO USE "TONES", APART FROM THE MARK AS SHOWN.

FOR DOWNLOADABLE RINGTONES FOR CELLULAR DEVICES (U.S. CLS. 21, 23, 26, 36 AND 38).
TINA KUAN, EXAMINING ATTORNEY

SN 77-138,938. WRIGHTSOFT CORPORATION, LEXINGTON, MA. FILED 3-23-2007.

RIGHT-J

THE MARK CONSISTS OF STANDARD CHARACTERS WITHOUT CLAIM TO ANY PARTICULAR FONT, STYLE, SIZE, OR COLOR.

FOR COMPUTER SOFTWARE FOR USE IN CALCULATING HEATING, COOLING, AND VENTILATION LOADS (U.S. CLS. 21, 23, 26, 36 AND 38).

FIRST USE 9-0-1985; IN COMMERCE 1-0-1986.
STEVEN R. FINE, EXAMINING ATTORNEY

CLASS 9—(Continued).

SN 77-138,956. CLARKE ENGINEERING TECHNOLOGIES, INC., ROSELLE, IL. FILED 3-23-2007.

FLIGHTMASTER

THE MARK CONSISTS OF STANDARD CHARACTERS WITHOUT CLAIM TO ANY PARTICULAR FONT, STYLE, SIZE, OR COLOR.

FOR A MODELING AND GUIDANCE SYSTEM, NAMELY, MICROPROCESSOR BASED HARDWARE AND SOFTWARE USED FOR TARGETING DRIFT CLOUD MOVEMENT IN AERIAL APPLICATIONS OF PESTICIDES (U.S. CLS. 21, 23, 26, 36 AND 38).

ANDREA SAUNDERS, EXAMINING ATTORNEY

SN 77-138,999. PROFESSIONAL VIRTUAL SPORTS LLC, TAMPA, FL. FILED 3-23-2007.

**2 MINUTE WARNING**

THE MARK CONSISTS OF A FANCIFUL REPRESENTATION OF A FOOTBALL APPEARS ABOVE THE WORDS OF THE MARK..

FOR GAMING MACHINES (U.S. CLS. 21, 23, 26, 36 AND 38).

JOHN DALIER, EXAMINING ATTORNEY

SN 77-139,125. RIENSTRA, JANET, SANTA BARBARA, CA. FILED 3-23-2007.

METASTATION

THE MARK CONSISTS OF STANDARD CHARACTERS WITHOUT CLAIM TO ANY PARTICULAR FONT, STYLE, SIZE, OR COLOR.

FOR PRERECORDED RECORDS, AUDIO CASSETTES, COMPACT DISCS, DVDS, CD-ROMS, LASER DISCS AND VIDEO DISCS FEATURING MUSIC, MUSICAL PERFORMANCES, YOGA EXERCISE INSTRUCTION AND/OR YOGA EXERCISE DEMONSTRATION; SOUND AND VISUAL RECORDINGS AND DOWNLOADABLE SOUND AND VIDEO RECORDINGS FEATURING MUSIC, MUSICAL PERFORMANCES, YOGA EXERCISE INSTRUCTION AND/OR YOGA EXERCISE DEMONSTRATION; MULTIMEDIA SOFTWARE RECORDED ON CD-ROM FEATURING MUSIC, MUSIC-BASED ENTERTAINMENT, YOGA EXERCISE INSTRUCTION AND/OR YOGA EXERCISE DEMONSTRATION (U.S. CLS. 21, 23, 26, 36 AND 38).

MICHELLE DUBOIS, EXAMINING ATTORNEY

CLASS 9—(Continued).

SN 77-139,254. NATHAN, NANDA, WESTFORD, MA. FILED 3-23-2007.

PRINTEL

THE MARK CONSISTS OF STANDARD CHARACTERS WITHOUT CLAIM TO ANY PARTICULAR FONT, STYLE, SIZE, OR COLOR.

FOR PRINTERS; COMPUTER PRINTERS (U.S. CLS. 21, 23, 26, 36 AND 38).

KATHERINE CONNOLLY, EXAMINING ATTORNEY

SN 77-139,467. SOUTHPEAK INTERACTIVE LLC, MID-LOTHIAN, VA. FILED 3-23-2007.

SOUTHPEAK GAMES

THE MARK CONSISTS OF STANDARD CHARACTERS WITHOUT CLAIM TO ANY PARTICULAR FONT, STYLE, SIZE, OR COLOR.

OWNER OF U.S. REG. NOS. 2,279,627, 2,312,135 AND OTHERS.

NO CLAIM IS MADE TO THE EXCLUSIVE RIGHT TO USE "GAMES", APART FROM THE MARK AS SHOWN.

FOR SOFTWARE AND ELECTRONIC GAMES, NAMELY SOFTWARE GAMES RECORDED ON CD-ROM AND DIGITAL VIDEO DISCS FOR COMPUTERS; SOFTWARE GAMES RECORDED ON CD-ROMS, DIGITAL VIDEO DISCS, AND CARTRIDGES FOR CONSOLE AND INDIVIDUAL PORTABLE GAMING SYSTEMS; SOFTWARE GAMES THAT ARE DOWNLOADABLE FROM A REMOTE COMPUTER SITE; AND SOFTWARE GAMES FOR MOBILE PHONES, PERSONAL DIGITAL ASSISTANTS, AND HANDHELD COMPUTERS (U.S. CLS. 21, 23, 26, 36 AND 38).

ANDREW RHIM, EXAMINING ATTORNEY

SN 77-139,623. MEADE INSTRUMENTS CORPORATION, IRVINE, CA. FILED 3-24-2007.

MYSKY

THE MARK CONSISTS OF STANDARD CHARACTERS WITHOUT CLAIM TO ANY PARTICULAR FONT, STYLE, SIZE, OR COLOR.

FOR PORTABLE HAND-HELD ELECTRONIC DEVICES FOR (A) IDENTIFYING CELESTIAL OBJECTS, (B) IDENTIFYING GEOGRAPHICAL SITES, (C) REMOTELY POSITIONING TELESCOPES, SPOTTING SCOPES, CAMERAS, BINOCULARS, AND NIGHT VISION ELECTRONIC DEVICES, AND (D) RECORDING, DOWNLOADING, ORGANIZING, TRANSMITTING, MANIPULATING, AND REVIEWING TEXT, DATA, AUDIO AND VIDEO FILES (U.S. CLS. 21, 23, 26, 36 AND 38).

HENRY S. ZAK, EXAMINING ATTORNEY

CLASS 9—(Continued).

SN 77-139,629. NICHOLAS, KARL B, SAN RAFAEL, CA. FILED 3-24-2007.

GeneDoc

THE MARK CONSISTS OF STANDARD CHARACTERS WITHOUT CLAIM TO ANY PARTICULAR FONT, STYLE, SIZE, OR COLOR.

FOR COMPUTER SOFTWARE FOR SCIENTIFIC ANALYSIS OF GENETIC SEQUENCES (U.S. CLS. 21, 23, 26, 36 AND 38).

HENRY S. ZAK, EXAMINING ATTORNEY

SN 77-139,657. SHAMIR OPTICAL INDUSTRY LTD., UPPER GALILEE, ISRAEL, FILED 3-25-2007.

Shamir Smart Office

THE MARK CONSISTS OF STANDARD CHARACTERS WITHOUT CLAIM TO ANY PARTICULAR FONT, STYLE, SIZE, OR COLOR.

OWNER OF U.S. REG. NO. 2,407,597.

FOR OPTICAL LENSES FOR SPECTACLES AND OPTICAL INSTRUMENTS; SPECTACLES; CONTACT LENSES; CONTAINERS FOR OPTICAL LENSES, SPECTACLES AND CONTACT LENSES; CASES, HOLDERS, PARTS AND FITTINGS FOR THE AFOREMENTIONED GOODS; COMPUTER SOFTWARE FOR PRODUCTION OF OPTICAL LENSES (U.S. CLS. 21, 23, 26, 36 AND 38).

RICHARD A. STRASER, EXAMINING ATTORNEY

SN 77-139,659. SHAMIR OPTICAL INDUSTRY LTD., UPPER GALILEE, ISRAEL, FILED 3-25-2007.

Shamir Smart Attitude

THE MARK CONSISTS OF STANDARD CHARACTERS WITHOUT CLAIM TO ANY PARTICULAR FONT, STYLE, SIZE, OR COLOR.

OWNER OF U.S. REG. NOS. 2,407,597 AND 3,082,266.

FOR OPTICAL LENSES FOR SPECTACLES AND OPTICAL INSTRUMENTS; SPECTACLES; CONTACT LENSES; CONTAINERS FOR OPTICAL LENSES, SPECTACLES AND CONTACT LENSES; CASES, HOLDERS, PARTS AND FITTINGS FOR THE AFOREMENTIONED GOODS; COMPUTER SOFTWARE FOR PRODUCTION OF OPTICAL LENSES (U.S. CLS. 21, 23, 26, 36 AND 38).

RICHARD A. STRASER, EXAMINING ATTORNEY

CLASS 9—(Continued).

SN 77-139,739. J.E.T. LLC, ORLANDO, FL. FILED 3-25-2007.

DatAzz

THE MARK CONSISTS OF STANDARD CHARACTERS WITHOUT CLAIM TO ANY PARTICULAR FONT, STYLE, SIZE, OR COLOR.

FOR DIGITAL MEDIA, NAMELY, DVDS FEATURING TRAVEL AND PARTY GUIDE (U.S. CLS. 21, 23, 26, 36 AND 38).

TARAH HARDY, EXAMINING ATTORNEY

CLASS 9—(Continued).

SN 77-140,336. ADVANCED BIONOMICS, INCORPORATED, OAK CREEK, WI. FILED 3-26-2007.

FireStrike

THE MARK CONSISTS OF STANDARD CHARACTERS WITHOUT CLAIM TO ANY PARTICULAR FONT, STYLE, SIZE, OR COLOR.

FOR FIRE EXTINGUISHERS (U.S. CLS. 21, 23, 26, 36 AND 38).

DAWN FELDMAN, EXAMINING ATTORNEY

SN 77-140,342. BUDHWANI, KARIM I., BIRMINGHAM, AL. FILED 3-26-2007.

imbrosia

THE MARK CONSISTS OF STANDARD CHARACTERS WITHOUT CLAIM TO ANY PARTICULAR FONT, STYLE, SIZE, OR COLOR.

FOR COMPUTER SOFTWARE FOR MANAGING ELECTRONIC MEDICAL RECORDS AND RELATED BUSINESS, REGULATORY, AND INDUSTRY INFORMATION, NAMELY, COMPUTER SOFTWARE FOR CAPTURING, ORGANIZING, ANALYZING, AND MANAGING PATIENT INFORMATION, ELECTRONIC MEDICAL RECORDS, MEDICAL BILLING AND CLAIM INFORMATION, RESOURCE AND PARTNER INFORMATION, MEDICAL CODES, MEDICATION INFORMATION, ACCOUNTING, CUSTOMER SERVICE, LOGISTICS, APPOINTMENT SCHEDULING, PLANNING AND RELATED INFORMATION, LOGIC, TOOLS AND UTILITIES (U.S. CLS. 21, 23, 26, 36 AND 38).

FIRST USE 3-21-2007; IN COMMERCE 3-21-2007.
SALLY SHIH, EXAMINING ATTORNEY

SN 77-139,853. ROBISON, MIKE F, MYERSVILLE, MD. FILED 3-26-2007.

THE FITNESS GAUGE

THE MARK CONSISTS OF STANDARD CHARACTERS WITHOUT CLAIM TO ANY PARTICULAR FONT, STYLE, SIZE, OR COLOR.

FOR PEDOMETERS (U.S. CLS. 21, 23, 26, 36 AND 38).
MARTHA FROMM, EXAMINING ATTORNEY

SN 77-140,120. JACT MEDIA LLC, DALLAS, TX. FILED 3-26-2007.

EAMONN

THE MARK CONSISTS OF STANDARD CHARACTERS WITHOUT CLAIM TO ANY PARTICULAR FONT, STYLE, SIZE, OR COLOR.

FOR DOWNLOADABLE SOFTWARE FOR USE IN TRACKING THE AMOUNT OF TIME SPENT PLAYING ONLINE VIDEO GAMES, CREDITING POINTS FOR THE AMOUNT OF TIME SPENT PLAYING ONLINE VIDEO GAMES, MANAGING THE POINTS CREDITED WHILE PLAYING ONLINE VIDEO GAMES (U.S. CLS. 21, 23, 26, 36 AND 38).

FIRST USE 3-30-2005; IN COMMERCE 3-30-2005.
MARK SPARACINO, EXAMINING ATTORNEY

SN 77-140,433. SSC IP RESERVE, LLC, PROVO, UT. FILED 3-26-2007.

LIVE LIFE IN CRESCENDO

THE MARK CONSISTS OF STANDARD CHARACTERS WITHOUT CLAIM TO ANY PARTICULAR FONT, STYLE, SIZE, OR COLOR.

FOR PRE-RECORDED ELECTRONIC MEDIA PRODUCTS, NAMELY AUDIOTAPES, VIDEO TAPES, CDS, DVDS, AND COMPUTER SOFTWARE, ALL IN THE FIELDS OF BUSINESS LEADERSHIP AND MANAGEMENT, PERSONAL LEADERSHIP AND PERFORMANCE, MANAGING AND DEVELOPING LIFE ENHANCEMENT AND PERSONAL ACHIEVEMENT, EXCELLENCE AND EVERYDAY GREATNESS (U.S. CLS. 21, 23, 26, 36 AND 38).

GIANCARLO CASTRO, EXAMINING ATTORNEY

CLASS 9—(Continued).

SN 77-140,659. MILBANK MANUFACTURING CO., KANSAS CITY, MO. FILED 3-26-2007.

RESI-PAK

THE MARK CONSISTS OF STANDARD CHARACTERS WITHOUT CLAIM TO ANY PARTICULAR FONT, STYLE, SIZE, OR COLOR.

FOR ELECTRIC METERS, ELECTRIC METER SOCKETS, ELECTRICAL POWER CONNECTORS, CIRCUIT BREAKERS, ELECTRIC CIRCUIT CLOSERS (U.S. CLS. 21, 23, 26, 36 AND 38).

JILL C. ALT, EXAMINING ATTORNEY

CLASS 9—(Continued).

SN 77-140,741. DSCI, FREEHOLD, NJ. FILED 3-26-2007.

FROM PLUTO YOU CAN SEE EVERYTHING

THE MARK CONSISTS OF STANDARD CHARACTERS WITHOUT CLAIM TO ANY PARTICULAR FONT, STYLE, SIZE, OR COLOR.

FOR COMPUTER SOFTWARE FOR CREATING SEARCHABLE DATABASES OF INFORMATION AND DATA (U.S. CLS. 21, 23, 26, 36 AND 38).

CARYN GLASSER, EXAMINING ATTORNEY

SN 77-140,691. WIRELESS HIGHWAYS, INC., FALLS CHURCH, VA. FILED 3-26-2007.

REVERBIFY

THE MARK CONSISTS OF STANDARD CHARACTERS WITHOUT CLAIM TO ANY PARTICULAR FONT, STYLE, SIZE, OR COLOR.

FOR ADAPTIVE ANTENNAS FOR WIRELESS COMMUNICATIONS; NAMELY, COMMERCIAL TELECOMMUNICATIONS AND GOVERNMENTAL COMMUNICATIONS (U.S. CLS. 21, 23, 26, 36 AND 38).

G. MAYERSCHOFF, EXAMINING ATTORNEY

SN 77-140,986. FS TECHNOLOGY LLC, PLANO, TX. FILED 3-27-2007.

TORGARD

THE MARK CONSISTS OF STANDARD CHARACTERS WITHOUT CLAIM TO ANY PARTICULAR FONT, STYLE, SIZE, OR COLOR.

FOR PROTECTIVE CLOTHING CONSISTING OF MIDDLE AND UPPER BODY PROTECTION (U.S. CLS. 21, 23, 26, 36 AND 38).

ESTHER A. BORSUK, EXAMINING ATTORNEY

SN 77-140,719. SURVIVAIR RESPIRATORS, LLC, SANTA ANA, CA. FILED 3-26-2007.

WARRIOR

THE MARK CONSISTS OF STANDARD CHARACTERS WITHOUT CLAIM TO ANY PARTICULAR FONT, STYLE, SIZE, OR COLOR.

FOR SELF-CONTAINED BREATHING APPARATUS FOR USE BY INDUSTRIAL WORKERS, FIREFIGHTERS, SAFETY WORKERS, HAZARDOUS MATERIALS WORKERS, RESCUE WORKERS, AND CONSTRUCTION WORKERS (U.S. CLS. 21, 23, 26, 36 AND 38).

CARRIE GENOVESE, EXAMINING ATTORNEY

SN 77-140,987. FAZTECH, INC., FREMONT, NE. FILED 3-27-2007.

Wave Factor

THE MARK CONSISTS OF STANDARD CHARACTERS WITHOUT CLAIM TO ANY PARTICULAR FONT, STYLE, SIZE, OR COLOR.

FOR BATTERY CHARGERS (U.S. CLS. 21, 23, 26, 36 AND 38).

ZHALEH DELANEY, EXAMINING ATTORNEY

CLASS 9—(Continued).

SN 77-141,157. FAZTECH, INC., FREMONT, NE. FILED 3-27-2007.

ZNRG

THE MARK CONSISTS OF STANDARD CHARACTERS WITHOUT CLAIM TO ANY PARTICULAR FONT, STYLE, SIZE, OR COLOR.
FOR BATTERY CHARGERS (U.S. CLS. 21, 23, 26, 36 AND 38).
ZHALEH DELANEY, EXAMINING ATTORNEY

CLASS 9—(Continued).

SN 77-141,557. SERVA SOFTWARE, LLC, WICHITA FALLS, TX. FILED 3-27-2007.

TWAVER

THE MARK CONSISTS OF STANDARD CHARACTERS WITHOUT CLAIM TO ANY PARTICULAR FONT, STYLE, SIZE, OR COLOR.
FOR SOFTWARE FOR USE IN THE TELECOMMUNICATIONS INDUSTRY, NAMELY, SWITCHING AND CONNECTION SOFTWARE FOR TELECOMMUNICATIONS (U.S. CLS. 21, 23, 26, 36 AND 38).
FIRST USE 9-28-2004; IN COMMERCE 9-28-2004.
BARBARA A. LOUGHRAN, EXAMINING ATTORNEY

SN 77-141,162. ALLIANT TECHSYSTEMS INC., EDINA, MN. FILED 3-27-2007.

NITREX

THE MARK CONSISTS OF STANDARD CHARACTERS WITHOUT CLAIM TO ANY PARTICULAR FONT, STYLE, SIZE, OR COLOR.
OWNER OF U.S. REG. NO. 2,051,560.
FOR TELESCOPIC GUN SIGHTS; GUN SCOPES; RIFLE SCOPES; RED DOT GUN SIGHTS; BINOCULARS; HUNTING BINOCULARS; RANGE FINDERS; AND ARCHERY EQUIPMENT, NAMELY, TELESCOPIC BOW SIGHTS (U.S. CLS. 21, 23, 26, 36 AND 38).
LINDA M. KING, EXAMINING ATTORNEY

SN 77-141,665. COGITON, INC., SEATTLE, WA. FILED 3-27-2007.

COGITON

SN 77-141,380. ZANER-BLOSER, INC., COLUMBUS, OH. FILED 3-27-2007.

ZB Spelling Connections

THE MARK CONSISTS OF STANDARD CHARACTERS WITHOUT CLAIM TO ANY PARTICULAR FONT, STYLE, SIZE, OR COLOR.
NO CLAIM IS MADE TO THE EXCLUSIVE RIGHT TO USE "SPELLING", APART FROM THE MARK AS SHOWN.
FOR EDUCATIONAL SOFTWARE FEATURING INSTRUCTION IN SPELLING (U.S. CLS. 21, 23, 26, 36 AND 38).
FIRST USE 10-1-1995; IN COMMERCE 10-1-1995.
PAUL F. GAST, EXAMINING ATTORNEY

THE MARK CONSISTS OF STANDARD CHARACTERS WITHOUT CLAIM TO ANY PARTICULAR FONT, STYLE, SIZE, OR COLOR.
FOR COMPUTER SOFTWARE DEVELOPMENT TOOLS; GRAPHICAL PROGRAMMING LANGUAGE SOFTWARE (U.S. CLS. 21, 23, 26, 36 AND 38).
JULIE GUTTADAURO, EXAMINING ATTORNEY

CLASS 9—(Continued).

SN 77-141,688. SIGIL GAMES ONLINE, INC., CARLSBAD, CA. FILED 3-27-2007.



NO CLAIM IS MADE TO THE EXCLUSIVE RIGHT TO USE "GAMES ONLINE", APART FROM THE MARK AS SHOWN.

THE MARK CONSISTS OF THE WORD SIGIL WITH THE STYLIZED S EMBEDDED IN A STONE AND THE WORDS GAMES ONLINE IN SMALLER SIZE BELOW THE LETTERS IGIL MAKING UP THE WORD SIGIL.

FOR ELECTRONIC GAME SOFTWARE RECORDED ON CD-ROMS AND DVDS FOR CONSOLE AND PORTABLE GAMING SYSTEMS; ELECTRONIC GAME SOFTWARE FOR MOBILE PHONES, PERSONAL DIGITAL ASSISTANTS, AND HANDHELD COMPUTERS RECORDED ON COMPUTER MEDIA; DOWNLOADABLE ELECTRONIC GAME SOFTWARE FOR MOBILE PHONES, PERSONAL DIGITAL ASSISTANTS, AND HANDHELD COMPUTERS; VIDEO GAME MACHINES SOLD AS A UNIT FOR PLAYING SOFTWARE GAMES RECORDED ON CD-ROMS AND DVDS FOR USE WITH TELEVISIONS AND COMPUTERS; PRE-RECORDED CD-ROMS AND DVDS FEATURING ACTION AND ADVENTURE PRODUCTIONS; DOWNLOADABLE ELECTRONIC PUBLICATIONS IN THE NATURE OF NEWSLETTERS AND MAGAZINES FEATURING ACTION AND ADVENTURE GAMES (U.S. CLS. 21, 23, 26, 36 AND 38).

CHRISTINA SOBRAL, EXAMINING ATTORNEY

SN 77-141,728. B2X CORPORATION, JERSEY CITY, NJ. FILED 3-27-2007.

B2X

THE MARK CONSISTS OF STANDARD CHARACTERS WITHOUT CLAIM TO ANY PARTICULAR FONT, STYLE, SIZE, OR COLOR.

FOR TELEVISION MONITORS, CAMERAS, VIDEO CAMERAS, PRINTERS, SCANNERS, TELEPHONES, CELLULAR TELEPHONES, PERSONAL DIGITAL ASSISTANTS (PDAS), MP3 PLAYERS (U.S. CLS. 21, 23, 26, 36 AND 38).

THEODORE MCBRIDE, EXAMINING ATTORNEY

CLASS 9—(Continued).

SN 77-141,757. GLOBE HOLDING COMPANY, LLC, PITTSFIELD, NH. FILED 3-27-2007.

SILIZONE

THE MARK CONSISTS OF STANDARD CHARACTERS WITHOUT CLAIM TO ANY PARTICULAR FONT, STYLE, SIZE, OR COLOR.

FOR FLAME RESISTANT SILICONE FOAM PADDING FOR USE IN FIRE SUITS, USED BY FIREFIGHTERS, EMERGENCY MEDICAL PERSONNEL, SEARCH AND RESCUE PERSONNEL, AND OTHER EMERGENCY RESPONDERS (U.S. CLS. 21, 23, 26, 36 AND 38).

FIRST USE 3-0-2007; IN COMMERCE 3-0-2007.

JENNIFER VASQUEZ, EXAMINING ATTORNEY

SN 77-141,773. TAKE-TWO INTERACTIVE SOFTWARE, INC., NEW YORK, NY. FILED 3-27-2007.

CIVILIZATION IV BEYOND THE SWORD

THE MARK CONSISTS OF STANDARD CHARACTERS WITHOUT CLAIM TO ANY PARTICULAR FONT, STYLE, SIZE, OR COLOR.

OWNER OF U.S. REG. NOS. 1,729,552 AND 3,241,619.

SEC. 2(F) AS TO "CIVILIZATION IV".

FOR COMPUTER GAME PROGRAMS, COMPUTER GAME SOFTWARE AND COMPUTER GAME CARTRIDGES, AND INSTRUCTION MANUALS SOLD THEREWITH (U.S. CLS. 21, 23, 26, 36 AND 38).

TARAH HARDY, EXAMINING ATTORNEY

SN 77-141,774. E&B COMPANY, SAN DIEGO, CA. FILED 3-27-2007.

ClipFlex

THE MARK CONSISTS OF STANDARD CHARACTERS WITHOUT CLAIM TO ANY PARTICULAR FONT, STYLE, SIZE, OR COLOR.

FOR COMPUTER CARRYING CASES; CARRYING CASES FOR RADIO PAGERS; CASES FOR ELECTRONIC DIARIES; CASES FOR MOBILE PHONES; CASES FOR TELEPHONES (U.S. CLS. 21, 23, 26, 36 AND 38).

TARAH HARDY, EXAMINING ATTORNEY

CLASS 9—(Continued).

SN 77-141,801. SOURCE CODE SYSTEMS, LLC, WAUSAU, WI. FILED 3-27-2007.

DOCUTOPIA

THE MARK CONSISTS OF STANDARD CHARACTERS WITHOUT CLAIM TO ANY PARTICULAR FONT, STYLE, SIZE, OR COLOR.

FOR COMPUTER SOFTWARE FOR DOCUMENT MANAGEMENT (U.S. CLS. 21, 23, 26, 36 AND 38).
CHRISTINE COOPER, EXAMINING ATTORNEY

SN 77-141,834. PAPAGEORGIU, NANCY MARIE, TENAFLY, NJ. AND PAPAGEORGIU, GUS, TENAFLY, NJ. FILED 3-27-2007.

DAEDALEYE

THE MARK CONSISTS OF STANDARD CHARACTERS WITHOUT CLAIM TO ANY PARTICULAR FONT, STYLE, SIZE, OR COLOR.

FOR READING GLASS MONOCLES; CORRECTIVE GLASSES; MAGNIFYING GLASSES; MAGNIFYING GLASSES THAT FIT ON THE USER'S FACE IN THE MANNER OF EYEGLASSES; OPTICAL GLASSES; OPERA GLASSES; READING GLASSES; READING EYEGLASSES; SPECTACLE GLASSES; SPORTS GLASSES; CASES FOR SPECTACLES AND SUNGLASSES; EYEGLASS CASES; MONOCLES; SUNGLASSES; SUNGLASS LENSES; FRAMES FOR SPECTACLES AND SUNGLASSES; OPTICAL FRAMES; MONOCULAR FRAMES (U.S. CLS. 21, 23, 26, 36 AND 38).
LINDA M. KING, EXAMINING ATTORNEY

SN 77-141,851. AWARE, INC., BEDFORD, MA. FILED 3-27-2007.

BWP

THE MARK CONSISTS OF STANDARD CHARACTERS WITHOUT CLAIM TO ANY PARTICULAR FONT, STYLE, SIZE, OR COLOR.

FOR COMPUTER SOFTWARE, NAMELY SOFTWARE THAT ENABLES DEVELOPERS AND INTEGRATORS TO RAPIDLY BUILD AND DEPLOY MULTIMODAL BIOMETRIC DATA WORKFLOW SOLUTIONS IN SUPPORT OF A SERVICE-ORIENTED ARCHITECTURE (U.S. CLS. 21, 23, 26, 36 AND 38).
FIRST USE 3-1-2007; IN COMMERCE 3-1-2007.

LINDA M. KING, EXAMINING ATTORNEY

CLASS 9—(Continued).

SN 77-141,870. BILANTIC SOFTWARE, LLC, ALBERTSON, NY. FILED 3-27-2007.

SNEAKADOO

THE MARK CONSISTS OF STANDARD CHARACTERS WITHOUT CLAIM TO ANY PARTICULAR FONT, STYLE, SIZE, OR COLOR.

FOR COMPUTER SOFTWARE FOR USE IN CONTROLLING THE VISIBILITY OF APPLICATIONS APPEARING ON COMPUTER SCREENS (U.S. CLS. 21, 23, 26, 36 AND 38).

FIRST USE 3-27-2007; IN COMMERCE 3-27-2007.
WILLIAM VERHOSEK, EXAMINING ATTORNEY

SN 77-141,951. NIELSON, JAMES VERNAL, PORTLAND, OR. FILED 3-27-2007.

Herbin Legends

THE MARK CONSISTS OF STANDARD CHARACTERS WITHOUT CLAIM TO ANY PARTICULAR FONT, STYLE, SIZE, OR COLOR.

FOR MOTION PICTURE FILMS ABOUT CANNABIS AND CANNABIS USERS (U.S. CLS. 21, 23, 26, 36 AND 38).

KATHLEEN M. VANSTON, EXAMINING ATTORNEY

SN 77-142,031. CUMMINGS, TODD F, FAIRFIELD, CT. FILED 3-27-2007.

Cadiddle

THE MARK CONSISTS OF STANDARD CHARACTERS WITHOUT CLAIM TO ANY PARTICULAR FONT, STYLE, SIZE, OR COLOR.

FOR VOICE MAIL SOFTWARE (U.S. CLS. 21, 23, 26, 36 AND 38).

RONALD MCMORROW, EXAMINING ATTORNEY

CLASS 9—(Continued).

SN 77-142,138. TAKE-TWO INTERACTIVE SOFTWARE, INC., NEW YORK, NY. FILED 3-28-2007.

CIVILIZATION IV WARLORDS

THE MARK CONSISTS OF STANDARD CHARACTERS WITHOUT CLAIM TO ANY PARTICULAR FONT, STYLE, SIZE, OR COLOR.

OWNER OF U.S. REG. NOS. 1,729,552 AND 3,241,619. SEC. 2(F) "CIVILIZATION IV".

FOR COMPUTER GAME PROGRAMS, COMPUTER GAME SOFTWARE AND COMPUTER GAME CARTRIDGES, AND INSTRUCTION MANUALS SOLD THEREWITH (U.S. CLS. 21, 23, 26, 36 AND 38).

FIRST USE 7-24-2006; IN COMMERCE 7-24-2006. TARAH HARDY, EXAMINING ATTORNEY

SN 77-142,208. LUTRON ELECTRONICS CO., INC., COOPERSBURG, PA. FILED 3-28-2007.

VIERTI

THE MARK CONSISTS OF STANDARD CHARACTERS WITHOUT CLAIM TO ANY PARTICULAR FONT, STYLE, SIZE, OR COLOR.

FOR ELECTRIC LIGHTING CONTROL APPARATUS, NAMELY DIMMERS (U.S. CLS. 21, 23, 26, 36 AND 38).

TARAH HARDY, EXAMINING ATTORNEY

SN 77-142,262. RESILIENCE-NMPST, LLC, NEW YORK, NY. FILED 3-28-2007.

NMPST

THE MARK CONSISTS OF STANDARD CHARACTERS WITHOUT CLAIM TO ANY PARTICULAR FONT, STYLE, SIZE, OR COLOR.

FOR DVDS FEATURING PHYSICAL EXERCISE PROGRAMS (U.S. CLS. 21, 23, 26, 36 AND 38).

JANICE L. MCMORROW, EXAMINING ATTORNEY

CLASS 9—(Continued).

SN 77-142,289. COMMEX TECHNOLOGIES LTD., TEL AVIV, ISRAEL, FILED 3-28-2007.

COMMEX

THE MARK CONSISTS OF STANDARD CHARACTERS WITHOUT CLAIM TO ANY PARTICULAR FONT, STYLE, SIZE, OR COLOR.

FOR SEMICONDUCTORS, SEMICONDUCTOR CHIPS, COMPUTER HARDWARE AND COMPUTER SOFTWARE FOR THE OPTIMIZATION OF COMPUTER PERFORMANCE WHILE DECREASING POWER CONSUMPTION (U.S. CLS. 21, 23, 26, 36 AND 38).

MELVIN AXILBUND, EXAMINING ATTORNEY

SN 77-142,361. ALLIANT TECHSYSTEMS INC., EDINA, MN. FILED 3-28-2007.

INTENSITY

THE MARK CONSISTS OF STANDARD CHARACTERS WITHOUT CLAIM TO ANY PARTICULAR FONT, STYLE, SIZE, OR COLOR.

FOR TELESCOPIC GUN SIGHTS; GUN SCOPES; RIFLE SCOPES; RED DOT GUN SIGHTS; BINOCULARS; HUNTING BINOCULARS; RANGE FINDERS; AND ARCHERY EQUIPMENT, NAMELY, TELESCOPIC BOW SIGHTS (U.S. CLS. 21, 23, 26, 36 AND 38).

LINDA M. KING, EXAMINING ATTORNEY

SN 77-142,371. DYMO AB, LANDSKRONA 26143, SWEDEN, FILED 3-28-2007.

DYMO

THE MARK CONSISTS OF STANDARD CHARACTERS WITHOUT CLAIM TO ANY PARTICULAR FONT, STYLE, SIZE, OR COLOR.

OWNER OF U.S. REG. NOS. 702,685, 1,310,765 AND OTHERS.

FOR COMPUTER SOFTWARE AND COMPUTER HARDWARE FOR USE IN THE FIELD OF DOCUMENT MANAGEMENT FOR INDEXING, SCANNING, IMAGING, MANAGING, STORING, ARCHIVING AND RETRIEVING DOCUMENTS (U.S. CLS. 21, 23, 26, 36 AND 38).

KATHLEEN LORENZO, EXAMINING ATTORNEY

CLASS 9—(Continued).

SN 77-142,420. MARAUDER CORPORATION, INDIAN WELLS, CA. FILED 3-28-2007.



NO CLAIM IS MADE TO THE EXCLUSIVE RIGHT TO USE "SMALL BUSINESS BILLING AND DEBT COLLECTION SOFTWARE", APART FROM THE MARK AS SHOWN.

THE MARK CONSISTS OF A DEPICTION OF A RUBBER STAMP AND THE WORD "PAID" THAT IS CIRCLED AS IF HAVING JUST BEEN STAMPED. BOLD LETTERING OF THE WORD "BILL" FOLLOWED BY "COLLECTOR" IN NON-BOLD FONT. PHRASE "SMALL BUSINESS BILLING AND COLLECTION SOFTWARE", FOLLOWED BY "IN A BOX", AGAINST A BACKGROUND BOX THAT SLANTS DIAGONALLY DOWN ON THE LEFT-HAND SIDE.

FOR COMPUTER SOFTWARE FOR USE IN DEBT COLLECTION (U.S. CLS. 21, 23, 26, 36 AND 38).

FIRST USE 4-1-2005; IN COMMERCE 4-1-2005.
MARY ROSSMAN, EXAMINING ATTORNEY

SN 77-142,558. VIDEX, INC., CORVALLIS, OR. FILED 3-28-2007.

CYBERKEY

THE MARK CONSISTS OF STANDARD CHARACTERS WITHOUT CLAIM TO ANY PARTICULAR FONT, STYLE, SIZE, OR COLOR.

OWNER OF U.S. REG. NOS. 2,424,186, 2,751,496 AND 3,079,745.

SEC. 2(F).

FOR ELECTRONIC KEYS FOR USE WITH ELECTRONIC LOCKS (U.S. CLS. 21, 23, 26, 36 AND 38).

FIRST USE 5-7-2000; IN COMMERCE 5-7-2000.
JENNIFER VASQUEZ, EXAMINING ATTORNEY

SN 77-142,682. OXYGEN PLUS, INC., EDINA, MN. FILED 3-28-2007.

O+MINI

THE MARK CONSISTS OF STANDARD CHARACTERS WITHOUT CLAIM TO ANY PARTICULAR FONT, STYLE, SIZE, OR COLOR.

FOR RESPIRATORS OTHER THAN FOR ARTIFICIAL RESPIRATION; BREATHING APPARATUS FOR NON MEDICAL USE, NAMELY, COMPRESSED OXYGEN AND AIR CARTRIDGES SOLD AS A UNIT WITH STORAGE PACKS FOR THE COMPRESSED OXYGEN AND AIR CARTRIDGES; RESPIRATORY MASK FILTERS; PRESSURE GAUGES; AIR FLOW SWITCHES; ELECTRIC OR ELECTRONIC SENSORS FOR AIR QUALITY; EYEGLASSES; SPECTACLES, NAMELY, GOGGLES (U.S. CLS. 21, 23, 26, 36 AND 38).

EDWARD NELSON, EXAMINING ATTORNEY

CLASS 9—(Continued).

SN 77-142,768. HART ASSOCIATES, INC., DEDHAM, MA. FILED 3-28-2007.

DAT

THE MARK CONSISTS OF STANDARD CHARACTERS WITHOUT CLAIM TO ANY PARTICULAR FONT, STYLE, SIZE, OR COLOR.

FOR COMPUTER SOFTWARE FOR GENERATING, CREATING AND USING INTERACTIVE REPORTS FOR FINANCIAL ANALYSIS (U.S. CLS. 21, 23, 26, 36 AND 38).

RICHARD A. STRASER, EXAMINING ATTORNEY

SN 77-142,829. INMEDIUS, INC., PITTSBURGH, PA. FILED 3-28-2007.

INMEDIUS HORIZON

THE MARK CONSISTS OF STANDARD CHARACTERS WITHOUT CLAIM TO ANY PARTICULAR FONT, STYLE, SIZE, OR COLOR.

OWNER OF U.S. REG. NO. 3,113,352.

FOR COMPUTER SOFTWARE FOR USE IN MANAGING INFORMATION PERTAINING TO TECHNICAL PUBLICATIONS (U.S. CLS. 21, 23, 26, 36 AND 38).

ODESSA BIBBINS, EXAMINING ATTORNEY

SN 77-142,858. AUTOMOTIVE SERVICE ASSOCIATION, BEDFORD, TX. FILED 3-28-2007.



OWNER OF U.S. REG. NO. 3,170,834.

THE MARK CONSISTS OF THE UNDERSCORED WORDS ONDEMAND WITH A STAR AND A SWOOSH DESIGN.

FOR COMPUTER SOFTWARE DOWNLOADABLE FROM THE GLOBAL COMPUTER NETWORK USED BY THE AUTOMOTIVE SERVICE INDUSTRY FOR USE IN DATABASE MANAGEMENT OF ASSOCIATION MEMBERSHIP DIRECTORY, BENEFIT PROGRAMS AND INFORMATION, INDUSTRY STATISTICS AND LEGISLATIVE INITIATIVES IMPACTING THE AUTOMOTIVE SERVICE INDUSTRY (U.S. CLS. 21, 23, 26, 36 AND 38).

FIRST USE 5-0-2005; IN COMMERCE 5-0-2005.
DAWN FELDMAN, EXAMINING ATTORNEY

CLASS 9—(Continued).

SN 77-142,893. BUCK'S INC., OMAHA, NE. FILED 3-28-2007.

PUMP NOW

THE MARK CONSISTS OF STANDARD CHARACTERS WITHOUT CLAIM TO ANY PARTICULAR FONT, STYLE, SIZE, OR COLOR.

FOR MAGNETICALLY ENCODED CARDS USED TO ACTIVATE GASOLINE PUMPS (U.S. CLS. 21, 23, 26, 36 AND 38).

JACQUELINE A. LAVINE, EXAMINING ATTORNEY

SN 77-143,065. BLAZING LIZARD, CHAMPAIGN, IL. FILED 3-28-2007.

Pirates vs Ninjas

THE MARK CONSISTS OF STANDARD CHARACTERS WITHOUT CLAIM TO ANY PARTICULAR FONT, STYLE, SIZE, OR COLOR.

FOR INTERACTIVE VIDEO GAME PROGRAMS (U.S. CLS. 21, 23, 26, 36 AND 38).

ROSELLE HERRERA, EXAMINING ATTORNEY

SN 77-143,101. BALLY GAMING, INC., LAS VEGAS, NV. FILED 3-28-2007.

AROUND THE WORLD

THE MARK CONSISTS OF STANDARD CHARACTERS WITHOUT CLAIM TO ANY PARTICULAR FONT, STYLE, SIZE, OR COLOR.

FOR GAMING DEVICES, NAMELY SLOT MACHINES, WITH OR WITHOUT VIDEO OUTPUT (U.S. CLS. 21, 23, 26, 36 AND 38).

PAULA MAHONEY, EXAMINING ATTORNEY

CLASS 9—(Continued).

SN 77-143,107. COLLABNET, INC., BRISBANE, CA. FILED 3-28-2007.



OWNER OF U.S. REG. NOS. 2,591,636 AND 3,215,006.
THE MARK CONSISTS OF A STYLIZED FLOWER WITH WORD OPENCOLLABNET.

FOR COMPUTER SOFTWARE, NAMELY COMPUTER SOFTWARE DEVELOPMENT TOOLS FOR DESIGN AND DEVELOPMENT OF OPEN-SOURCE AND PROPRIETARY SOFTWARE PROGRAMS; COMPUTER SOFTWARE AND COMPUTER SOFTWARE DEVELOPMENT TOOLS FOR DESIGN AND DEVELOPMENT OF OPEN-SOURCE AND PROPRIETARY SOFTWARE PROGRAMS, NAMELY, SOFTWARE AND WEB-BASED SOFTWARE PLATFORMS THAT SERVE AS THE INFRASTRUCTURE FOR DEVELOPERS TO USE SOFTWARE TOOLS FOR THE COLLABORATIVE DEVELOPMENT OF SOFTWARE PROGRAMS; DOWNLOADABLE ELECTRONIC PUBLICATIONS, NAMELY SOFTWARE MANUALS, WHITE PAPERS, ARTICLES, BOOKS, GUIDES, WEBCASTS, PODCASTS AND STREAMING AUDIO/VIDEO IN THE FIELDS OF COMPUTER SOFTWARE DEVELOPMENT, COMPUTER SOFTWARE DEVELOPMENT TOOLS, OPEN-SOURCE DEVELOPMENT TOOLS, COMPUTER SOFTWARE, OPEN-SOURCE DEVELOPMENT COMMUNITIES, COMPUTER AND TECHNOLOGY, SOFTWARE TRAINING, AND TECHNICAL SUPPORT RESOURCE (U.S. CLS. 21, 23, 26, 36 AND 38).

FIRST USE 10-20-2006; IN COMMERCE 10-20-2006.

CAROLINE WOOD, EXAMINING ATTORNEY

SN 77-143,247. D.A. KOPP & ASSOCIATES, INC., TOTOWA, NJ. FILED 3-28-2007.

DYDACOMP

THE MARK CONSISTS OF STANDARD CHARACTERS WITHOUT CLAIM TO ANY PARTICULAR FONT, STYLE, SIZE, OR COLOR.

FOR COMPUTER SOFTWARE FOR TRACKING ORDERS, INVENTORY, SALES FOR MAIL ORDER BUSINESS THAT MAY BE DOWNLOADED FROM A GLOBAL COMPUTER NETWORK (U.S. CLS. 21, 23, 26, 36 AND 38).

FIRST USE 11-11-1985; IN COMMERCE 11-11-1985.

BERYL GARDNER, EXAMINING ATTORNEY

CLASS 9—(Continued).

SN 77-143,330. BRADLEY, RANDY, PARADISE VALLEY, AZ. FILED 3-29-2007.

adPowerTools

THE MARK CONSISTS OF STANDARD CHARACTERS WITHOUT CLAIM TO ANY PARTICULAR FONT, STYLE, SIZE, OR COLOR.

FOR COMPUTER PROGRAMS FOR MANAGING DIRECTORY DATA IN THE FIELD OF NETWORK ACCOUNT MANAGEMENT (U.S. CLS. 21, 23, 26, 36 AND 38).

PAUL F. GAST, EXAMINING ATTORNEY

CLASS 9—(Continued).

SN 77-143,521. COHEN, ERIC, MIAMI, FL. FILED 3-29-2007.

EYE ON YOUR PET

THE MARK CONSISTS OF STANDARD CHARACTERS WITHOUT CLAIM TO ANY PARTICULAR FONT, STYLE, SIZE, OR COLOR.

FOR TRANSMITTER AND RECEIVER USED TO LOCATE LOST PETS (U.S. CLS. 21, 23, 26, 36 AND 38).

BILL DAWE, EXAMINING ATTORNEY

SN 77-143,405. RENAISSANCE DATA SYSTEMS INC., BIRMINGHAM, AL. FILED 3-29-2007.

SmartReference

THE MARK CONSISTS OF STANDARD CHARACTERS WITHOUT CLAIM TO ANY PARTICULAR FONT, STYLE, SIZE, OR COLOR.

FOR COMPUTER SOFTWARE USED TO ACQUIRE AND REPORT INFORMATION ABOUT MAINFRAME APPLICATIONS FOR THE PURPOSE OF RESEARCH, AUDITS AND PROJECT MANAGEMENT, IN THE FORM OF HISTORY FILES AND CROSS REFERENCE REPORTS (U.S. CLS. 21, 23, 26, 36 AND 38).

KAREN BRACEY, EXAMINING ATTORNEY

SN 77-143,546. COMRENT INTERNATIONAL, LLC, OWINGS, MD. FILED 3-29-2007.

VOLTLOC

THE MARK CONSISTS OF STANDARD CHARACTERS WITHOUT CLAIM TO ANY PARTICULAR FONT, STYLE, SIZE, OR COLOR.

FOR PORTABLE MEDIUM VOLTAGE POWER CABLE DEVICES (U.S. CLS. 21, 23, 26, 36 AND 38).

TARAH HARDY, EXAMINING ATTORNEY

SN 77-143,510. TEACUP SOFTWARE, NEW YORK, NY. FILED 3-29-2007.

Teacup Software

THE MARK CONSISTS OF STANDARD CHARACTERS WITHOUT CLAIM TO ANY PARTICULAR FONT, STYLE, SIZE, OR COLOR.

NO CLAIM IS MADE TO THE EXCLUSIVE RIGHT TO USE "SOFTWARE", APART FROM THE MARK AS SHOWN. FOR DESKTOP PUBLISHING SOFTWARE; COMPUTER GRAPHICS SOFTWARE (U.S. CLS. 21, 23, 26, 36 AND 38).

FIRST USE 3-26-2003; IN COMMERCE 3-26-2003.

KATHLEEN M. VANSTON, EXAMINING ATTORNEY

SN 77-143,637. TOXAIR, LLC, ORLAND PARK, IL. FILED 3-29-2007.



AirHound

THE MARK CONSISTS OF A STYLIZED DOG.. FOR APPARATUS FOR TESTING AIR QUALITY (U.S. CLS. 21, 23, 26, 36 AND 38).

FIRST USE 10-30-2006; IN COMMERCE 1-1-2007.

TARAH HARDY, EXAMINING ATTORNEY

CLASS 9—(Continued).

SN 77-143,721. DIVERSIFIED TECHNOLOGY CORP.,
BLOOMSBURG, PA. FILED 3-29-2007.

VUB

THE MARK CONSISTS OF STANDARD CHARACTERS
WITHOUT CLAIM TO ANY PARTICULAR FONT, STYLE,
SIZE, OR COLOR.

FOR COMPUTER SOFTWARE FOR USE BY UTILI-
TIES, MUNICIPALITIES, AND MUNICIPAL AUTHORI-
TIES FOR PURPOSES OF BILLING AND CUSTOMER
CARE (U.S. CLS. 21, 23, 26, 36 AND 38).

PATRICIA EVANKO, EXAMINING ATTORNEY

SN 77-143,735. MIDWAY HOME ENTERTAINMENT INC.,
CHICAGO, IL. FILED 3-29-2007.

FIRE UP YOUR MIND

THE MARK CONSISTS OF STANDARD CHARACTERS
WITHOUT CLAIM TO ANY PARTICULAR FONT, STYLE,
SIZE, OR COLOR.

FOR COMPUTER AND VIDEO GAME PROGRAMS
RECORDED ON CARTRIDGES, DISCS, CD-ROMS, CAS-
SETTES, TAPES AND MINI DISCS; VIDEO AND COM-
PUTER GAME SOFTWARE (U.S. CLS. 21, 23, 26, 36 AND
38).

BRIAN CALLAGHAN, EXAMINING ATTORNEY

SN 77-143,903. CBS STUDIOS INC., NEW YORK, NY. FILED
3-29-2007.

DASH 4 CASH

THE MARK CONSISTS OF STANDARD CHARACTERS
WITHOUT CLAIM TO ANY PARTICULAR FONT, STYLE,
SIZE, OR COLOR.

FOR DVDS FEATURING A COMEDY TELEVISION
SERIES (U.S. CLS. 21, 23, 26, 36 AND 38).

CYNTHIA SLOAN, EXAMINING ATTORNEY

CLASS 9—(Continued).

SN 77-143,907. CBS STUDIOS INC., NEW YORK, NY. FILED
3-29-2007.

DASH 2 CASH

THE MARK CONSISTS OF STANDARD CHARACTERS
WITHOUT CLAIM TO ANY PARTICULAR FONT, STYLE,
SIZE, OR COLOR.

FOR DVDS FEATURING A COMEDY TELEVISION
SERIES (U.S. CLS. 21, 23, 26, 36 AND 38).

CYNTHIA SLOAN, EXAMINING ATTORNEY

SN 77-144,032. JACOB & COMPANY WATCHES, INC., NEW
YORK, NY. FILED 3-29-2007.



OWNER OF U.S. REG. NOS. 2,676,899, 3,072,203 AND
OTHERS.

NO CLAIM IS MADE TO THE EXCLUSIVE RIGHT TO
USE & CO., APART FROM THE MARK AS SHOWN.

FOR EYEGLASSES AND SUNGLASSES (U.S. CLS. 21,
23, 26, 36 AND 38).

LINDSEY RUBIN, EXAMINING ATTORNEY

SN 77-144,040. WESCOR, INC., LOGAN, UT. FILED 3-29-2007.

CYTOPRO MAGNUM

THE MARK CONSISTS OF STANDARD CHARACTERS
WITHOUT CLAIM TO ANY PARTICULAR FONT, STYLE,
SIZE, OR COLOR.

OWNER OF U.S. REG. NO. 1,839,877.
FOR SAMPLE CHAMBERS FOR LABORATORY CEN-
TRIFUGES (U.S. CLS. 21, 23, 26, 36 AND 38).

SCOTT SISUN, EXAMINING ATTORNEY

CLASS 9—(Continued).

SN 77-144,046. AMADA CO., LTD., ISEHARA-SHI KANAGAWA, JAPAN, FILED 3-29-2007.

BENDCAM

THE MARK CONSISTS OF STANDARD CHARACTERS WITHOUT CLAIM TO ANY PARTICULAR FONT, STYLE, SIZE, OR COLOR.

FOR SOFTWARE AND INSTRUCTION MANUALS THEREFOR SOLD AS A UNIT FOR USE IN CONTROLLING METALWORKING MACHINES (U.S. CLS. 21, 23, 26, 36 AND 38).

FIRST USE 11-0-1998; IN COMMERCE 11-0-1998.
KHANH LE, EXAMINING ATTORNEY

SN 77-144,222. WILSON, TRAVIS T., OAKLAND, CA. FILED 3-29-2007.

Facetmap

THE MARK CONSISTS OF STANDARD CHARACTERS WITHOUT CLAIM TO ANY PARTICULAR FONT, STYLE, SIZE, OR COLOR.

FOR COMPUTER SOFTWARE FOR CREATING SEARCHABLE DATABASES OF INFORMATION AND DATA; COMPUTER SOFTWARE FOR SEARCHING DATA RESOURCES THAT HAVE EACH BEEN CATEGORIZED IN MANY WAYS THAT MAY BE DOWNLOADED FROM A GLOBAL COMPUTER NETWORK (U.S. CLS. 21, 23, 26, 36 AND 38).

FIRST USE 12-24-2001; IN COMMERCE 3-9-2004.
KAREN BRACEY, EXAMINING ATTORNEY

SN 77-144,228. ACTIFY, INC., SAN FRANCISCO, CA. FILED 3-29-2007.

DESIGNSHARE

THE MARK CONSISTS OF STANDARD CHARACTERS WITHOUT CLAIM TO ANY PARTICULAR FONT, STYLE, SIZE, OR COLOR.

FOR COMPUTER SOFTWARE, NAMELY, SOFTWARE THAT INTEGRATES PROJECT MANAGEMENT, COLLABORATION AND REPORTING TOOLS INTO REAL-TIME SHARED RESOURCE FOR IMPROVING AND FACILITATING GROUP PROJECT PERFORMANCE IN THE AREA OF COMPUTER GRAPHICS AND CAD MODELS (U.S. CLS. 21, 23, 26, 36 AND 38).

KAREN BRACEY, EXAMINING ATTORNEY

CLASS 9—(Continued).

SN 77-144,278. IAN LEO WOLFF, SAN PEDRO GARZA GARCIA, MEXICO, AND LUIS DANIEL PRESTAMO, SANTA CATARINA, MEXICO, FILED 3-29-2007.

Save the Planet and Win

THE MARK CONSISTS OF STANDARD CHARACTERS WITHOUT CLAIM TO ANY PARTICULAR FONT, STYLE, SIZE, OR COLOR.

FOR COMPUTER SOFTWARE THAT ADMINISTERS AND SELLS POLLUTANT EMISSION REDUCTION CREDITS (U.S. CLS. 21, 23, 26, 36 AND 38).

ELLEN B. AWRICH, EXAMINING ATTORNEY

SN 77-144,347. APPLERA CORPORATION, FOSTER CITY, CA. FILED 3-29-2007.

APPLERA

THE MARK CONSISTS OF STANDARD CHARACTERS WITHOUT CLAIM TO ANY PARTICULAR FONT, STYLE, SIZE, OR COLOR.

OWNER OF U.S. REG. NO. 3,130,445.

FOR LABORATORY INSTRUMENTS FOR OTHER THAN MEDICAL OR VETERINARY USE, NAMELY, NUCLEIC ACID SEQUENCERS AND SYNTHESIZERS, GENETIC ANALYZERS, THERMAL CYCLER, CYTOMETER, PROTEIN AND PEPTIDE SYNTHESIZERS, MASS SPECTROMETER AND CHROMATOGRAPH, HIGH-THROUGHPUT INSTRUMENT FOR PREPARATION OF NUCLEIC ACID SAMPLES, LABORATORY ROBOTS, AND ACCESSORIES TO AND PARTS OF THE ABOVE INSTRUMENTS; LABORATORY SUPPLIES, FOR OTHER THAN MEDICAL OR VETERINARY USE, NAMELY, PLASTIC CONSUMABLES, RACK, VIALS, CAPS, SEPTA, NEEDLES, BOTTLES, FLASK, FILTER, TUBES, AND SEALS, PLASTIC TRAY COVER, MICRO PLATE, PIPETTE TIPS, REAGENT RESERVOIR, OPTICAL HEAT FIELD COVERS, PLASTIC CARDS, AND PLASTIC CAPILLARY ARRAYS; COMPUTER SOFTWARE USED FOR COLLECTION, STORAGE, ORGANIZATION, ANALYSIS, INTEGRATION AND COMMUNICATION OF INFORMATION FOR SCIENTIFIC, RESEARCH, FORENSICS AND PATERNITY USE; COMPUTER SOFTWARE FOR SCIENTIFIC ANALYSIS OF GENETIC SEQUENCES; COMPUTER SOFTWARE USED TO MONITOR AND CONTROL LABORATORY INSTRUMENTS; COMPUTER SOFTWARE USED TO REMOTELY MONITOR AND CONTROL LABORATORY INSTRUMENTS (U.S. CLS. 21, 23, 26, 36 AND 38).

KEVIN DINALLO, EXAMINING ATTORNEY

CLASS 9—(Continued).

SN 77-144,367. KUMSUNG GBS CO., LTD, KYUNGGI-DO, REPUBLIC OF KOREA, FILED 3-29-2007.



THE MARK CONSISTS OF A FOUR-SIDED BORDER. INSIDE THE BORDER IS A DRAWING OF A TURTLE SHIP WITH THE WORD "GOBUKSON" UNDERNEATH IT.

THE FOREIGN WORDING IN THE MARK TRANSLATES INTO ENGLISH AS TURTLE SHIP.

FOR AUTOMATIC STEAM IRON PRESSING MACHINE FOR INDUSTRIAL PURPOSES (U.S. CLS. 21, 23, 26, 36 AND 38).

IRA J. GOODSaid, EXAMINING ATTORNEY

SN 77-144,804. LUTRON ELECTRONICS CO., INC., COOPERSBURG, PA. FILED 3-30-2007.

ECO-DIM

THE MARK CONSISTS OF STANDARD CHARACTERS WITHOUT CLAIM TO ANY PARTICULAR FONT, STYLE, SIZE, OR COLOR.

OWNER OF U.S. REG. NO. 3,148,730. FOR ELECTRIC LIGHTING CONTROL APPARATUS, NAMELY DIMMERS (U.S. CLS. 21, 23, 26, 36 AND 38).

FIRST USE 3-13-2007; IN COMMERCE 3-13-2007.

TARAH HARDY, EXAMINING ATTORNEY

SN 77-146,447. MULTIMEDIA GAMES, INC., AUSTIN, TX. FILED 4-2-2007.

LUCKY SPIN

THE MARK CONSISTS OF STANDARD CHARACTERS WITHOUT CLAIM TO ANY PARTICULAR FONT, STYLE, SIZE, OR COLOR.

OWNER OF U.S. REG. NO. 3,029,682. NO CLAIM IS MADE TO THE EXCLUSIVE RIGHT TO USE "SPIN", APART FROM THE MARK AS SHOWN.

FOR GAMING MACHINES, NAMELY ELECTRONIC SLOT AND BINGO MACHINES; VIDEO LOTTERY TERMINALS (U.S. CLS. 21, 23, 26, 36 AND 38).

ELIZABETH HUGHITT, EXAMINING ATTORNEY

CLASS 9—(Continued).

SN 77-146,706. DSCI, FREEHOLD, NJ. FILED 4-2-2007.

MIRAGE-PRIDE

THE MARK CONSISTS OF STANDARD CHARACTERS WITHOUT CLAIM TO ANY PARTICULAR FONT, STYLE, SIZE, OR COLOR.

FOR COMPUTER PROGRAMS FOR USE WITH DESKTOP WORKSTATIONS AND LAPTOPS TO CREATE A VEHICLE SIMULATION SYSTEM (U.S. CLS. 21, 23, 26, 36 AND 38).

CARYN GLASSER, EXAMINING ATTORNEY

SN 77-149,080. LG ELECTRONICS MOBILECOMM U.S.A., INC., SAN DIEGO, CA. FILED 4-5-2007.

RUMOR

THE MARK CONSISTS OF STANDARD CHARACTERS WITHOUT CLAIM TO ANY PARTICULAR FONT, STYLE, SIZE, OR COLOR.

FOR MOBILE TELEPHONES (U.S. CLS. 21, 23, 26, 36 AND 38).

RUSS HERMAN, EXAMINING ATTORNEY

SN 77-149,433. AUDIO AND VIDEO LABS, INC., PENNSAUKEN, NJ. FILED 4-5-2007.

MEDLEY

THE MARK CONSISTS OF STANDARD CHARACTERS WITHOUT CLAIM TO ANY PARTICULAR FONT, STYLE, SIZE, OR COLOR.

FOR DISC PUBLISHING DEVICE, NAMELY, AUTOMATED CD/DVD DUPLICATOR AND DISC PRINTER (U.S. CLS. 21, 23, 26, 36 AND 38).

CHRISTOPHER OTT, EXAMINING ATTORNEY

CLASS 9—(Continued).

SN 77-150,080. DSCI, FREEHOLD, NJ. FILED 4-5-2007.

MIRAGE-IMAGINE

THE MARK CONSISTS OF STANDARD CHARACTERS WITHOUT CLAIM TO ANY PARTICULAR FONT, STYLE, SIZE, OR COLOR.

FOR COMPUTER SOFTWARE FOR USE IN BUILDING VIRTUAL DATABASES FROM BASIC 3-DIMENSIONAL BUILDING BLOCKS, INCLUDING GRAPHICS, MODELS, AND MESH DATA, TO CREATE A VIRTUAL REPRESENTATION OF A WORLD (U.S. CLS. 21, 23, 26, 36 AND 38).

CARYN GLASSER, EXAMINING ATTORNEY

SN 77-151,518. ELSEVIER LIMITED, KIDLINGTON, OXFORD,, UNITED KINGDOM, FILED 4-9-2007.

POLYMER

THE MARK CONSISTS OF STANDARD CHARACTERS WITHOUT CLAIM TO ANY PARTICULAR FONT, STYLE, SIZE, OR COLOR.

FOR ELECTRONIC DOWNLOADABLE PUBLICATIONS, NAMELY, JOURNALS IN THE FIELDS OF SCIENCE AND TECHNOLOGY (U.S. CLS. 21, 23, 26, 36 AND 38).

FIRST USE 5-31-1998; IN COMMERCE 5-31-1998.
MICHELE SWAIN, EXAMINING ATTORNEY

SN 77-155,392. FAZTECH, INC., FREMONT, NE. FILED 4-12-2007.



THE COLOR(S) WHITE, BLACK AND GREEN IS/ARE CLAIMED AS A FEATURE OF THE MARK.

THE MARK CONSISTS OF FOUR WAVES, EACH OF WHICH IS THE COLOR GREEN WITH A STREAK OF WHITE TOWARD THE TOP OF WAVE AND BLACK IN MIDDLE.

FOR BATTERY CHARGERS (U.S. CLS. 21, 23, 26, 36 AND 38).
ZHALEH DELANEY, EXAMINING ATTORNEY

CLASS 9—(Continued).

SN 77-155,450. FAZTECH, INC., FREMONT, NE. FILED 4-12-2007.

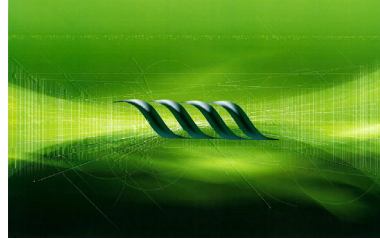

THE COLOR(S) WHITE, BLACK AND GREEN IS/ARE CLAIMED AS A FEATURE OF THE MARK.

THE MARK CONSISTS OF FOUR WAVES, EACH OF WHICH IS THE COLOR GREEN WITH A STREAK OF WHITE TOWARD THE TOP OF THE WAVE AND BLACK IN MIDDLE, ALL ON A BACKGROUND IN VARIOUS SHADES OF GREEN ALSO FEATURING FAINT WHITE LINES AND CIRCLES. AN ENERGY BURST IN THE COLOR LIGHT GREEN EMANATES FROM EITHER SIDE OF THE WAVE DESIGN.

FOR BATTERY CHARGERS (U.S. CLS. 21, 23, 26, 36 AND 38).
ZHALEH DELANEY, EXAMINING ATTORNEY

SN 77-156,469. FAZTECH, INC., FREMONT, NE. FILED 4-13-2007.

ELECTRICOLOGY

THE MARK CONSISTS OF STANDARD CHARACTERS WITHOUT CLAIM TO ANY PARTICULAR FONT, STYLE, SIZE, OR COLOR.

FOR BATTERY CHARGERS (U.S. CLS. 21, 23, 26, 36 AND 38).
ZHALEH DELANEY, EXAMINING ATTORNEY

SN 77-156,671. SPX CORPORATION, CHARLOTTE, NC. FILED 4-13-2007.

U-CONTROL

THE MARK CONSISTS OF STANDARD CHARACTERS WITHOUT CLAIM TO ANY PARTICULAR FONT, STYLE, SIZE, OR COLOR.

FOR CONTROLS FOR BOILERS (U.S. CLS. 21, 23, 26, 36 AND 38).
WANDA KAY PRICE, EXAMINING ATTORNEY

CLASS 9—(Continued).

SN 77-158,177. TRANSPARENT LANGUAGE, INC., NASHUA, NH. FILED 4-17-2007.

CL-150 TECHNOLOGY MATRIX
FOR CRITICAL LANGUAGES

THE MARK CONSISTS OF STANDARD CHARACTERS WITHOUT CLAIM TO ANY PARTICULAR FONT, STYLE, SIZE, OR COLOR.

NO CLAIM IS MADE TO THE EXCLUSIVE RIGHT TO USE "TECHNOLOGY MATRIX FOR CRITICAL LANGUAGES", APART FROM THE MARK AS SHOWN.

FOR EDUCATIONAL SOFTWARE FEATURING INSTRUCTION FOR FOREIGN LANGUAGES AND INSTRUCTION MANUALS SOLD AS A UNIT (U.S. CLS. 21, 23, 26, 36 AND 38).

FIRST USE 7-24-2006; IN COMMERCE 7-24-2006.
APRIL ROACH, EXAMINING ATTORNEY

SN 77-158,849. WEBROOT SOFTWARE, INC., BOULDER, CO. FILED 4-17-2007.

THE BEST SECURITY IN AN
UNSECURED WORLD

THE MARK CONSISTS OF STANDARD CHARACTERS WITHOUT CLAIM TO ANY PARTICULAR FONT, STYLE, SIZE, OR COLOR.

FOR COMPUTER SOFTWARE FOR MONITORING THE ACTIVITIES OF A COMPUTER USER, PREVENTING THE EXECUTION OF UNAUTHORIZED PROGRAMS, AND DETERRING ACCESS TO OFFENSIVE CONTENT ON THE INTERNET; COMPUTER SOFTWARE IN THE FIELD OF SECURITY TO ENABLE MONITORING, SECURING AND PROTECTION OF COMPUTER NETWORKS, NAMELY SOFTWARE THAT SCANS FOR ONLINE THREATS TO MONITOR, SECURE AND PROTECT COMPUTER NETWORKS AND APPLICATIONS BY RESTRICTING ACCESS TO AND BY COMPUTER NETWORKS TO AND OF UNDESIRE VIRUSES, THREATS, SPYWARE DOWNLOADS AND COMMUNICATION, PHISHING, WORMS AND OTHER POTENTIALLY THREATENING COMPUTER CODE; COMPUTER SOFTWARE FOR PROVIDING SECURITY FEATURES TO DETECT, IDENTIFY, BLOCK AND DELETE TROJAN HORSE PROGRAMS, ADWARE PROGRAMS, SYSTEM MONITOR AND OTHER SPYWARE PROGRAMS; COMPUTER SOFTWARE DESIGNED TO REMOVE BY-PRODUCTS INHERENTLY CREATED FROM 'SURFING' THE INTERNET; ANTI-VIRUS SOFTWARE (U.S. CLS. 21, 23, 26, 36 AND 38).

JANET LEE, EXAMINING ATTORNEY

CLASS 9—(Continued).

SN 77-164,415. CONAIR CORPORATION, STAMFORD, CT. FILED 4-24-2007.

PRO WAVES

THE MARK CONSISTS OF STANDARD CHARACTERS WITHOUT CLAIM TO ANY PARTICULAR FONT, STYLE, SIZE, OR COLOR.

NO CLAIM IS MADE TO THE EXCLUSIVE RIGHT TO USE "PRO", APART FROM THE MARK AS SHOWN.

FOR ELECTRIC HAIR CRIMPER; ELECTRIC HAIR CURLERS; ELECTRIC HAIR CURLING IRONS; ELECTRIC HAIR ROLLERS; ELECTRIC HAIR STRAIGHTENING IRONS; ELECTRIC HAND-HELD HAIR STYLING IRONS (U.S. CLS. 21, 23, 26, 36 AND 38).

MARY MUNSON, EXAMINING ATTORNEY

SN 77-164,928. NIPPON DENKI KABUSHIKI KAISHA, DBA NEC CORPORATION, MINATO-KU, TOKYO, JAPAN, FILED 4-25-2007.

SIGMASYSTEMCENTER

THE MARK CONSISTS OF STANDARD CHARACTERS WITHOUT CLAIM TO ANY PARTICULAR FONT, STYLE, SIZE, OR COLOR.

FOR COMPUTER SOFTWARE FOR NETWORK MANAGEMENT; COMPUTER HARDWARE AND SOFTWARE FOR INTEGRATING COMPUTER SERVERS, DATA STORAGE HARDWARE AND SOFTWARE, COMPUTER NETWORKING HARDWARE AND COMPUTER NETWORKING SOFTWARE; COMPUTER SOFTWARE FOR CONTROLLING, ADMINISTRATING AND MANAGING NETWORKS; NETWORK MANAGEMENT SOFTWARE FOR LOCAL AND GLOBAL COMPUTER NETWORKS AND FOR COMPUTER COMMUNICATION INFORMATION NETWORKS; NETWORK ACCESS SERVER OPERATING SOFTWARE; COMPUTERS; COMPUTER SERVERS; NETWORK ACCESS SERVER HARDWARE; COMPUTER NETWORKING HARDWARE (U.S. CLS. 21, 23, 26, 36 AND 38).

DOMINIC J. FERRAIUOLO, EXAMINING ATTORNEY

SN 77-167,859. SPRAYING SYSTEMS CO., WHEATON, IL. FILED 4-27-2007.

SPRAYWEB

THE MARK CONSISTS OF STANDARD CHARACTERS WITHOUT CLAIM TO ANY PARTICULAR FONT, STYLE, SIZE, OR COLOR.

FOR SOFTWARE THAT PROVIDES REMOTE INTERNET AND INTRANET CONNECTIVITY TO A SPRAY SYSTEM OR SPRAY APPLICATION, INCLUDING OPCXML TECHNOLOGY (U.S. CLS. 21, 23, 26, 36 AND 38).

MARCIE MILONE, EXAMINING ATTORNEY

CLASS 9—(Continued).

SN 77-168,939. TELEBRANDS CORPORATION, FAIRFIELD, NJ. FILED 4-30-2007.

AMBERVISION

THE MARK CONSISTS OF STANDARD CHARACTERS WITHOUT CLAIM TO ANY PARTICULAR FONT, STYLE, SIZE, OR COLOR.
 FOR SUNGLASSES (U.S. CLS. 21, 23, 26, 36 AND 38).
 FIRST USE 7-1-1987; IN COMMERCE 7-1-1987.
 CORY BOONE, EXAMINING ATTORNEY

SN 77-169,999. LINOTYPE GMBH, BAD HOMBURG, FED REP GERMANY, FILED 5-1-2007.

TEMPO

THE MARK CONSISTS OF STANDARD CHARACTERS WITHOUT CLAIM TO ANY PARTICULAR FONT, STYLE, SIZE, OR COLOR.
 FOR COMPUTER SOFTWARE FOR GENERATING TYPEFACE DESIGNS AND ORNAMENTAL DESIGNS; TYPEFACES, TYPE FONTS AND TYPE DESIGNS OF ALPHANUMERICAL CHARACTERS AND TYPOGRAPHICAL SYMBOLS RECORDED ON MACHINE READABLE MEDIA (U.S. CLS. 21, 23, 26, 36 AND 38).
 FIRST USE 0-0-1985; IN COMMERCE 0-0-1985.
 GRETTA YAO, EXAMINING ATTORNEY

SN 77-170,020. LINOTYPE GMBH, BAD HOMBURG, FED REP GERMANY, FILED 5-1-2007.

UMBRA

THE MARK CONSISTS OF STANDARD CHARACTERS WITHOUT CLAIM TO ANY PARTICULAR FONT, STYLE, SIZE, OR COLOR.
 FOR COMPUTER SOFTWARE FOR GENERATING TYPEFACE DESIGNS AND ORNAMENTAL DESIGNS; TYPEFACES, TYPE FONTS AND TYPE DESIGNS OF ALPHANUMERICAL CHARACTERS AND TYPOGRAPHICAL SYMBOLS RECORDED ON MACHINE READABLE MEDIA (U.S. CLS. 21, 23, 26, 36 AND 38).
 FIRST USE 0-0-1985; IN COMMERCE 0-0-1985.
 GRETTA YAO, EXAMINING ATTORNEY

CLASS 9—(Continued).

SN 77-170,419. BALLY GAMING, INC., LAS VEGAS, NV. FILED 5-1-2007.

ALL AMERICAN

THE MARK CONSISTS OF STANDARD CHARACTERS WITHOUT CLAIM TO ANY PARTICULAR FONT, STYLE, SIZE, OR COLOR.
 FOR GAMING DEVICES, NAMELY SLOT MACHINES, WITH OR WITHOUT VIDEO OUTPUT (U.S. CLS. 21, 23, 26, 36 AND 38).
 PAULA MAHONEY, EXAMINING ATTORNEY

SN 77-172,931. COLEMAN CABLE, INC., WAUKEGAN, IL. FILED 5-4-2007.

HANDY-PULL

THE MARK CONSISTS OF STANDARD CHARACTERS WITHOUT CLAIM TO ANY PARTICULAR FONT, STYLE, SIZE, OR COLOR.
 FOR EXTENSION CORDS, ELECTRICAL POWER CORDS, ELECTRICAL PLUG ENDS OF EXTENSION AND POWER CORDS, CORD SETS COMPRISED OF EXTENSION CORDS, ELECTRICAL POWER CORDS AND ELECTRICAL PLUG ENDS OF EXTENSION AND POWER CORDS (U.S. CLS. 21, 23, 26, 36 AND 38).
 KATHERINE E. HALMEN, EXAMINING ATTORNEY

SN 77-173,249. TAKE-TWO INTERACTIVE SOFTWARE, INC., NEW YORK, NY. FILED 5-4-2007.



OWNER OF U.S. REG. NO. 2,391,635.
 THE MARK CONSISTS OF A STYLIZED R WITH A STAR ON THE RIGHT.
 FOR ENTERTAINMENT SOFTWARE, NAMELY, GAME DISCS AND DOWNLOADABLE GAME SOFTWARE FOR USE WITH PERSONAL COMPUTERS, VIDEO GAME CONSOLES, HAND HELD GAMING DEVICES (U.S. CLS. 21, 23, 26, 36 AND 38).
 FIRST USE 10-31-1999; IN COMMERCE 10-31-1999.
 TARAH HARDY, EXAMINING ATTORNEY

CLASS 9—(Continued).

SN 77-173,581. BALLY GAMING, INC., LAS VEGAS, NV. FILED 5-4-2007.

DOUBLE KICKER

THE MARK CONSISTS OF STANDARD CHARACTERS WITHOUT CLAIM TO ANY PARTICULAR FONT, STYLE, SIZE, OR COLOR.

FOR GAMING DEVICES, NAMELY SLOT MACHINES, WITH OR WITHOUT VIDEO OUTPUT (U.S. CLS. 21, 23, 26, 36 AND 38).

PAULA MAHONEY, EXAMINING ATTORNEY

SN 77-173,989. LUTRON ELECTRONICS CO., INC., COOPERSBURG, PA. FILED 5-7-2007.

LUMÉA

THE MARK CONSISTS OF STANDARD CHARACTERS WITHOUT CLAIM TO ANY PARTICULAR FONT, STYLE, SIZE, OR COLOR.

OWNER OF U.S. REG. NOS. 1,600,535 AND 2,089,039. FOR LIGHT DIMMERS (U.S. CLS. 21, 23, 26, 36 AND 38).

FIRST USE 11-30-1988; IN COMMERCE 11-30-1988. TARAH HARDY, EXAMINING ATTORNEY

SN 77-174,606. RIVERBED TECHNOLOGY, INC., SAN FRANCISCO, CA. FILED 5-7-2007.

riverbed

OWNER OF U.S. REG. NOS. 2,931,934 AND 3,271,696. FOR EMBEDDED SERVER AND NETWORKING SOFTWARE SOLD AS AN INTEGRAL COMPONENT OF COMPUTER HARDWARE TO IMPROVE THE PERFORMANCE OF COMPUTER APPLICATIONS, SERVERS, DATA STORAGE AND COMMUNICATIONS PROTOCOLS USED IN WIDE AREA AND GLOBAL NETWORKS (U.S. CLS. 21, 23, 26, 36 AND 38).

FIRST USE 2-0-2006; IN COMMERCE 2-0-2006. TEJBIR SINGH, EXAMINING ATTORNEY

CLASS 9—(Continued).

SN 77-174,979. DAYMEN PHOTO MARKETING LP, MARKHAM, ONTARIO, CANADA, FILED 5-7-2007.

ALTUS

THE MARK CONSISTS OF STANDARD CHARACTERS WITHOUT CLAIM TO ANY PARTICULAR FONT, STYLE, SIZE, OR COLOR.

FOR BAGS, HARD AND SOFT COVERED CASES, RUCKSACKS, HOLDALLS, BACKPACKS WITH ROLLING WHEELS, BACKPACKS WITHOUT ROLLING WHEELS, BELT PACKS, POCKETS, TOTE BAGS, SHOULDER BAGS, MESSENGER BAGS AND POUCHES, ALL DESIGNED FOR CARRYING PHOTOGRAPHIC, CINEMATOGRAPHIC, VIDEOGRAPHIC, OPTICAL, AUDIO, ELECTRONIC AND COMPUTER EQUIPMENT; FILM ORGANIZERS, NAMELY, CASES FOR CARRYING EXPOSED AND UNEXPOSED CAMERA FILM; CELL PHONE POUCHES; WAIST HARNESES AND SHOULDER HARNESES DESIGNED FOR USE WITH THE FOREGOING GOODS (U.S. CLS. 21, 23, 26, 36 AND 38).

APRIL ROACH, EXAMINING ATTORNEY

SN 77-175,191. AIRCELL LLC, LOUISVILLE, CO. FILED 5-8-2007.

AIRCELL AXXESS

THE MARK CONSISTS OF STANDARD CHARACTERS WITHOUT CLAIM TO ANY PARTICULAR FONT, STYLE, SIZE, OR COLOR.

FOR COMPUTER AND TELECOMMUNICATIONS NETWORK HARDWARE AND SOFTWARE FOR IMPLEMENTING LOCAL AREA NETWORKS ONBOARD AIRCRAFTS TO ENABLE USERS TO TRANSMIT AND RECEIVE VOICE, VIDEO, AND DATA WITHIN THE AIRCRAFTS, BETWEEN THE AIRCRAFTS, BETWEEN THE AIRCRAFTS AND THE GROUND, AND BETWEEN THE GROUND AND THE AIRCRAFTS; LOCAL AREA NETWORK ACCESS POINTS FOR COMMUNICATING WITH COMPUTER AND TELECOMMUNICATIONS USERS LOCATED ONBOARD AIRCRAFTS FOR TRANSMITTING AND RECEIVING VOICE, VIDEO, AND DATA WITHIN THE AIRCRAFTS, BETWEEN THE AIRCRAFTS, BETWEEN THE AIRCRAFTS AND THE GROUND, AND BETWEEN THE GROUND AND THE AIRCRAFTS; COMPUTER AND TELECOMMUNICATIONS NETWORK HARDWARE AND SOFTWARE FOR

CLASS 9—(Continued).

TRANSMITTING AND RECEIVING VOICE, VIDEO, AND DATA BETWEEN COMPUTER AND TELECOMMUNICATIONS USERS, LOCATED ONBOARD AN AIRCRAFT, AND COMPUTER, AND TELECOMMUNICATIONS SYSTEMS LOCATED ONBOARD THE AIRCRAFT, COMPUTER AND TELECOMMUNICATION SYSTEMS LOCATED ONBOARD ANOTHER AIRCRAFT, AND COMPUTER AND TELECOMMUNICATIONS SYSTEMS LOCATED ON THE GROUND; COMPUTER AND TELECOMMUNICATIONS NETWORK ACCESS SERVER HARDWARE AND SOFTWARE ONBOARD AIRCRAFTS FOR TRANSMITTING AND RECEIVING VOICE, VIDEO, AND DATA FROM THE GROUND TO IDENTIFIED USERS LOCATED ONBOARD THE AIRCRAFTS, FROM IDENTIFIED USERS LOCATED ONBOARD THE AIRCRAFTS TO THE GROUND, AND FROM IDENTIFIED USERS LOCATED ONBOARD ONE AIRCRAFT TO IDENTIFIED USERS ONBOARD ANOTHER AIRCRAFT, AND BETWEEN IDENTIFIED USERS WITHIN AN AIRCRAFT (U.S. CLS. 21, 23, 26, 36 AND 38).

BRENDAN MCCAULEY, EXAMINING ATTORNEY

SN 77-175,198. AIRCELL LLC, LOUISVILLE, CO. FILED 5-8-2007.

AIRCELL ON BOARD

THE MARK CONSISTS OF STANDARD CHARACTERS WITHOUT CLAIM TO ANY PARTICULAR FONT, STYLE, SIZE, OR COLOR.

OWNER OF U.S. REG. NOS. 2,552,129 AND 2,606,334.

FOR COMPUTER AND TELECOMMUNICATIONS NETWORK HARDWARE AND SOFTWARE FOR IMPLEMENTING LOCAL AREA NETWORKS ONBOARD AIRCRAFTS TO ENABLE USERS TO TRANSMIT AND RECEIVE VOICE, VIDEO, AND DATA WITHIN THE AIRCRAFTS, BETWEEN THE AIRCRAFTS, BETWEEN THE AIRCRAFTS AND THE GROUND, AND BETWEEN THE GROUND AND THE AIRCRAFTS; LOCAL AREA NETWORK ACCESS POINTS FOR COMMUNICATING WITH COMPUTER AND TELECOMMUNICATIONS USERS LOCATED ONBOARD AIRCRAFTS FOR TRANSMITTING AND RECEIVING VOICE, VIDEO, AND DATA WITHIN THE AIRCRAFTS, BETWEEN THE AIRCRAFTS, BETWEEN THE AIRCRAFTS AND THE GROUND, AND BETWEEN THE GROUND AND THE AIRCRAFTS; COMPUTER AND TELECOMMUNICATIONS NETWORK HARDWARE AND SOFTWARE FOR TRANSMITTING AND RECEIVING VOICE, VIDEO, AND DATA BETWEEN COMPUTER AND TELECOMMUNICATIONS USERS, LOCATED ONBOARD AN AIRCRAFT, AND COMPUTER, AND TELECOMMUNICATIONS SYSTEMS LOCATED ONBOARD THE AIRCRAFT, COMPUTER AND TELECOMMUNICATION SYSTEMS LOCATED ONBOARD ANOTHER AIRCRAFT, AND COMPUTER AND TELECOMMUNICATIONS SYSTEMS LOCATED ON THE GROUND; COMPUTER AND TELECOMMUNICATIONS NETWORK ACCESS SERVER HARDWARE AND SOFTWARE ONBOARD AIRCRAFTS FOR TRANSMITTING AND RECEIVING VOICE, VIDEO, AND DATA FROM THE GROUND TO IDENTIFIED USERS LOCATED ONBOARD THE AIRCRAFTS, FROM IDENTIFIED USERS LOCATED ONBOARD THE AIRCRAFTS TO THE GROUND, AND FROM IDENTIFIED USERS LOCATED ONBOARD ONE AIRCRAFT TO IDENTIFIED USERS ONBOARD ANOTHER AIRCRAFT, AND BETWEEN IDENTIFIED USERS WITHIN AN AIRCRAFT (U.S. CLS. 21, 23, 26, 36 AND 38).

BRENDAN MCCAULEY, EXAMINING ATTORNEY

CLASS 9—(Continued).

SN 77-175,201. AIRCELL LLC, LOUISVILLE, CO. FILED 5-8-2007.

IN TOUCH, IN FLIGHT

THE MARK CONSISTS OF STANDARD CHARACTERS WITHOUT CLAIM TO ANY PARTICULAR FONT, STYLE, SIZE, OR COLOR.

OWNER OF U.S. REG. NOS. 2,307,311 AND 2,600,307.

FOR COMPUTER AND TELECOMMUNICATIONS NETWORK HARDWARE AND SOFTWARE FOR IMPLEMENTING LOCAL AREA NETWORKS ONBOARD AIRCRAFTS TO ENABLE USERS TO TRANSMIT AND RECEIVE VOICE, VIDEO, AND DATA WITHIN THE AIRCRAFTS, BETWEEN THE AIRCRAFTS, BETWEEN THE AIRCRAFTS AND THE GROUND, AND BETWEEN THE GROUND AND THE AIRCRAFTS; LOCAL AREA NETWORK ACCESS POINTS FOR COMMUNICATING WITH COMPUTER AND TELECOMMUNICATIONS USERS LOCATED ONBOARD AIRCRAFTS FOR TRANSMITTING AND RECEIVING VOICE, VIDEO, AND DATA WITHIN THE AIRCRAFTS, BETWEEN THE AIRCRAFTS, BETWEEN THE AIRCRAFTS AND THE GROUND, AND BETWEEN THE GROUND AND THE AIRCRAFTS; COMPUTER AND TELECOMMUNICATIONS NETWORK HARDWARE AND SOFTWARE FOR TRANSMITTING AND RECEIVING VOICE, VIDEO, AND DATA BETWEEN COMPUTER AND TELECOMMUNICATIONS USERS, LOCATED ONBOARD AN AIRCRAFT, AND COMPUTER, AND TELECOMMUNICATIONS SYSTEMS LOCATED ONBOARD THE AIRCRAFT, COMPUTER AND TELECOMMUNICATION SYSTEMS LOCATED ONBOARD ANOTHER AIRCRAFT, AND COMPUTER AND TELECOMMUNICATIONS SYSTEMS LOCATED ON THE GROUND; COMPUTER AND TELECOMMUNICATIONS NETWORK ACCESS SERVER HARDWARE AND SOFTWARE ONBOARD AIRCRAFTS FOR TRANSMITTING AND RECEIVING VOICE, VIDEO, AND DATA FROM THE GROUND TO IDENTIFIED USERS LOCATED ONBOARD THE AIRCRAFTS, FROM IDENTIFIED USERS LOCATED ONBOARD THE AIRCRAFTS TO THE GROUND, AND FROM IDENTIFIED USERS LOCATED ONBOARD ONE AIRCRAFT TO IDENTIFIED USERS ONBOARD ANOTHER AIRCRAFT, AND BETWEEN IDENTIFIED USERS WITHIN AN AIRCRAFT (U.S. CLS. 21, 23, 26, 36 AND 38).

BRENDAN MCCAULEY, EXAMINING ATTORNEY

SN 77-176,020. NIZDIL, MARK C., GLENDALE, CA. FILED 5-8-2007.

KANGA KASH

THE MARK CONSISTS OF STANDARD CHARACTERS WITHOUT CLAIM TO ANY PARTICULAR FONT, STYLE, SIZE, OR COLOR.

FOR GAMING DEVICES, NAMELY, GAMING MACHINES, SLOT MACHINES, BINGO MACHINES AND VIDEO LOTTERY TERMINALS (U.S. CLS. 21, 23, 26, 36 AND 38).

DEZMONA MIZELLE, EXAMINING ATTORNEY

CLASS 9—(Continued).

SN 77-178,070. FAZTECH, INC., FREMONT, NE. FILED 5-10-2007.

Fazakas Wave

THE MARK CONSISTS OF STANDARD CHARACTERS WITHOUT CLAIM TO ANY PARTICULAR FONT, STYLE, SIZE, OR COLOR.

FOR BATTERY CHARGERS (U.S. CLS. 21, 23, 26, 36 AND 38).

ZHALEH DELANEY, EXAMINING ATTORNEY

SN 77-178,107. FAZTECH, INC., FREMONT, NE. FILED 5-10-2007.

Fazakas Labs

THE MARK CONSISTS OF STANDARD CHARACTERS WITHOUT CLAIM TO ANY PARTICULAR FONT, STYLE, SIZE, OR COLOR.

NO CLAIM IS MADE TO THE EXCLUSIVE RIGHT TO USE "LABS", APART FROM THE MARK AS SHOWN.

FOR BATTERY CHARGERS (U.S. CLS. 21, 23, 26, 36 AND 38).

ZHALEH DELANEY, EXAMINING ATTORNEY

SN 77-178,742. LG ELECTRONICS MOBILECOMM U.S.A., INC., SAN DIEGO, CA. FILED 5-11-2007.

VENUS

THE MARK CONSISTS OF STANDARD CHARACTERS WITHOUT CLAIM TO ANY PARTICULAR FONT, STYLE, SIZE, OR COLOR.

FOR MOBILE TELEPHONES (U.S. CLS. 21, 23, 26, 36 AND 38).

RUSS HERMAN, EXAMINING ATTORNEY

CLASS 9—(Continued).

SN 77-181,635. SPX CORPORATION, CHARLOTTE, NC. FILED 5-15-2007.

PEGISYS

THE MARK CONSISTS OF STANDARD CHARACTERS WITHOUT CLAIM TO ANY PARTICULAR FONT, STYLE, SIZE, OR COLOR.

FOR SCIENTIFIC APPARATUS AND INSTRUMENTS, NAMELY, ELECTRONIC AUTOMOTIVE DIAGNOSTIC APPARATUS IN THE NATURE OF SCAN TOOLS FOR USE IN DIAGNOSTIC TESTING AND LIVE DATA RETRIEVAL FOR COMPUTERIZED AUTOMOBILE SYSTEMS; SCIENTIFIC APPARATUS AND INSTRUMENTS, NAMELY, CODE READERS FOR USE IN RETRIEVING AND CLEARING DIAGNOSTIC TROUBLE CODES FOR COMPUTERIZED AUTOMOBILE SYSTEMS; COMPUTERS, NAMELY, HANDHELD ELECTRONIC VEHICLE DIAGNOSTIC COMPUTER AND SOFTWARE FOR USE IN INTERFACING WITH A VEHICLE'S ONBOARD COMPUTER (U.S. CLS. 21, 23, 26, 36 AND 38).

WANDA KAY PRICE, EXAMINING ATTORNEY

SN 77-185,714. ALAWAR ENTERTAINMENT, INC., ALEXANDRIA, VA. FILED 5-21-2007.

Stand O'Food

THE MARK CONSISTS OF STANDARD CHARACTERS WITHOUT CLAIM TO ANY PARTICULAR FONT, STYLE, SIZE, OR COLOR.

FOR COMPUTER GAME SOFTWARE: ELECTRONIC GAME SOFTWARE; DOWNLOADABLE COMPUTER GAME VIA THE INTERNET AND WIRELESS DEVICES (U.S. CLS. 21, 23, 26, 36 AND 38).

FIRST USE 12-22-2006; IN COMMERCE 12-22-2006.

JENNIFER MARTIN, EXAMINING ATTORNEY

SN 77-186,644. ADRENALIN GAMING, LLC., LADERA RANCH, CA. FILED 5-22-2007.

HAPPY HOUR

THE MARK CONSISTS OF STANDARD CHARACTERS WITHOUT CLAIM TO ANY PARTICULAR FONT, STYLE, SIZE, OR COLOR.

FOR GAMING MACHINES, NAMELY, SLOT MACHINES WITH OR WITHOUT VIDEO OUTPUT; COMPUTERIZED VIDEO TABLE GAMES FOR GAMING PURPOSES (U.S. CLS. 21, 23, 26, 36 AND 38).

FIRST USE 3-13-2003; IN COMMERCE 3-13-2003.

ERIN FALK, EXAMINING ATTORNEY

CLASS 9—(Continued).

SN 77-190,219. ATI TECHNOLOGIES ULC, CALGARY, ALBERTA, CANADA, FILED 5-25-2007.

HYDRAVISION

THE MARK CONSISTS OF STANDARD CHARACTERS WITHOUT CLAIM TO ANY PARTICULAR FONT, STYLE, SIZE, OR COLOR.

FOR COMPUTER SOFTWARE FOR USE WITH GRAPHICS CHIPS, CARDS OR BOARDS, NAMELY, DEVICE DRIVERS AND DESKTOP MANAGEMENT TOOLS FOR MULTI-MONITOR SYSTEMS (U.S. CLS. 21, 23, 26, 36 AND 38).

FIRST USE 12-31-1995; IN COMMERCE 12-31-1995. MICHAEL W. BAIRD, EXAMINING ATTORNEY

CLASS 9—(Continued).

SN 77-198,241. SEIKO EPSON KABUSHIKI KAISHA, TOKYO, JAPAN, FILED 6-5-2007.

TFP

THE MARK CONSISTS OF STANDARD CHARACTERS WITHOUT CLAIM TO ANY PARTICULAR FONT, STYLE, SIZE, OR COLOR.

FOR INK JET PRINTERS, PRINT HEADS FOR INK JET PRINTERS (U.S. CLS. 21, 23, 26, 36 AND 38). AISHA SALEM, EXAMINING ATTORNEY

SN 77-190,267. PRÜFTECHNIK DIETER BUSCH AG, ISMANNING, FED REP GERMANY, FILED 5-25-2007.

AXALIGN

THE MARK CONSISTS OF STANDARD CHARACTERS WITHOUT CLAIM TO ANY PARTICULAR FONT, STYLE, SIZE, OR COLOR.

FOR APPARATUS AND INSTRUMENTS FOR MEASURING THE ALIGNMENT STATUS OF MACHINE TOOLS (U.S. CLS. 21, 23, 26, 36 AND 38).

JOSETTE BEVERLY, EXAMINING ATTORNEY

SN 77-201,033. LG ELECTRONICS MOBILECOMM U.S.A., INC., SAN DIEGO, CA. FILED 6-8-2007.

VIBETOUCH

THE MARK CONSISTS OF STANDARD CHARACTERS WITHOUT CLAIM TO ANY PARTICULAR FONT, STYLE, SIZE, OR COLOR.

FOR KEYPADS FOR MOBILE COMMUNICATIONS DEVICES (U.S. CLS. 21, 23, 26, 36 AND 38). RUSS HERMAN, EXAMINING ATTORNEY

SN 77-193,045. BOWE BELL + HOWELL COMPANY, DURHAM, NC. FILED 5-30-2007.

TRACK N TRACE

THE MARK CONSISTS OF STANDARD CHARACTERS WITHOUT CLAIM TO ANY PARTICULAR FONT, STYLE, SIZE, OR COLOR.

FOR COMPUTER SOFTWARE FOR USE IN OPERATING MAIL PROCESSING DEVICES; COMPUTER SOFTWARE FOR MONITORING DOCUMENTS AND MAILPIECES IN AUTOMATED MAIL PROCESSING DEVICES; COMPUTER SOFTWARE FOR USE IN DOCUMENT SORTING TO CONNECT SORTING MACHINES TO AN ELECTRONIC NETWORK (U.S. CLS. 21, 23, 26, 36 AND 38).

FIRST USE 0-0-2002; IN COMMERCE 0-0-2002. DAVID MURRAY, EXAMINING ATTORNEY

SN 77-218,683. NIPPON DENKI KABUSHIKI KAISHA, DBA NEC CORPORATION, MINATO-KU, TOKYO, JAPAN, FILED 6-29-2007.

NCHICO-SERVER

THE MARK CONSISTS OF STANDARD CHARACTERS WITHOUT CLAIM TO ANY PARTICULAR FONT, STYLE, SIZE, OR COLOR.

FOR NETWORKING HARDWARE FOR WIRELESS COMMUNICATIONS; NETWORK APPARATUS, NAMELY, COMPUTER SERVERS; PORTABLE COMPUTERS FOR THE WIRELESS RECEPTION AND/OR TRANSMISSION OF TEXT DATA, VIDEO AND AUDIO; NETWORKING SOFTWARE FOR WIRELESS COMMUNICATIONS AND CONNECTIVITY (U.S. CLS. 21, 23, 26, 36 AND 38).

DOMINIC J. FERRAIUOLO, EXAMINING ATTORNEY

CLASS 9—(Continued).

SN 78-241,293. 3COM CORPORATION, SANTA CLARA, CA. FILED 4-23-2003.

VCX

FOR COMPUTER TELEPHONY SOFTWARE THAT ENABLES TELEPHONE ACTIVITIES TO BE PERFORMED THROUGH A COMPUTER (U.S. CLS. 21, 23, 26, 36 AND 38).

ALEXANDER L. POWERS, EXAMINING ATTORNEY

SN 78-241,591. SYMON COMMUNICATIONS, INC., PLANO, TX. FILED 4-24-2003.

**SYMON ENTERPRISE
SERVER**

OWNER OF U.S. REG. NOS. 2,912,745, 2,918,295 AND 3,094,942.

NO CLAIM IS MADE TO THE EXCLUSIVE RIGHT TO USE "ENTERPRISE SERVER", APART FROM THE MARK AS SHOWN.

FOR COMPUTER SOFTWARE THAT ALLOWS AN ORGANIZATION TO COLLECT INFORMATION AND DATA FROM OTHER APPLICATION SOURCES, TRANSFORM AND INTEGRATE INCOMPATIBLE APPLICATION INFORMATION AND DATA AND CREATE REAL-TIME AND HISTORICAL INFORMATION AND DATA THAT CAN BE COMMUNICATED TO OTHERS AND VIEWED IN DIFFERENT FORMATS AND VISUAL DISPLAYS; USER TRAINING MANUALS AND INSTALLATION GUIDES SOLD AS A UNIT THEREWITH (U.S. CLS. 21, 23, 26, 36 AND 38).

DORITT L. CARROLL, EXAMINING ATTORNEY

SN 78-361,815. BUSHNELL INC., OVERLAND PARK, KS. FILED 2-3-2004.

BUCKHORN

THE MARK CONSISTS OF STANDARD CHARACTERS WITHOUT CLAIM TO ANY PARTICULAR FONT, STYLE, SIZE, OR COLOR.

OWNER OF U.S. REG. NO. 1,778,320.

SEC. 2(F).

FOR TELESCOPIC RIFLESOPES AND BINOCULARS (BASED ON AN INTENT TO USE) (U.S. CLS. 21, 23, 26, 36 AND 38).

FIRST USE 2-0-1992; IN COMMERCE 2-0-1992.

TONI HICKEY, EXAMINING ATTORNEY

CLASS 9—(Continued).

SN 78-402,575. TRIOSYN HOLDING INC., MIRABEL, CANADA, FILED 4-15-2004.

TRIOSYN T-1000

THE MARK CONSISTS OF STANDARD CHARACTERS WITHOUT CLAIM TO ANY PARTICULAR FONT, STYLE, SIZE, OR COLOR.

PRIORITY CLAIMED UNDER SEC. 44(D) ON CANADA APPLICATION NO. 1209248, FILED 3-11-2004, REG. NO. TMA684,415, DATED 3-23-2007, EXPIRES 3-23-2022.

OWNER OF U.S. REG. NO. 2,441,736.

FOR DISPOSABLE FACEMASK WHICH PROVIDES PROTECTION AGAINST AIRBORNE PARTICULATES, CERTAIN MICROORGANISMS AND CHEMICAL AGENTS (U.S. CLS. 21, 23, 26, 36 AND 38).

MICHELE SWAIN, EXAMINING ATTORNEY

SN 78-495,669. DEUTSCHE TELEKOM AG, BONN, FED REP GERMANY, FILED 10-6-2004.

T-VISION

THE MARK CONSISTS OF STANDARD CHARACTERS WITHOUT CLAIM TO ANY PARTICULAR FONT, STYLE, SIZE, OR COLOR.

OWNER OF FED REP GERMANY REG. NO. 39735305, DATED 9-1-1997, RENEWED AS REG. NO. 39735305, DATED 7-31-2007, EXPIRES 7-31-2017.

OWNER OF U.S. REG. NOS. 2,807,787, 2,908,563 AND OTHERS.

FOR ELECTRIC, ELECTRONIC, OPTICAL, MEASURING, SIGNALING, CONTROLLING AND TEACHING APPARATUS AND INSTRUMENTS, ALL FOR USE WITH TELECOMMUNICATIONS, NAMELY, APPARATUS FOR PRODUCING SOUND, IMAGES OR DATA; BLANK MAGNETIC AND OPTICAL DATA CARRIERS; DATA PROCESSORS; COMPUTERS, NAMELY, MICROCOMPUTERS, MINICOMPUTERS, COMPUTER CENTRAL PROCESSORS, COMPUTER MONITORS, COMPUTER KEYBOARDS, COMPUTER TERMINALS, COMPUTER MEMORIES, COMPUTER LASER PRINTERS, COMPUTER IMPACT PRINTERS, COMPUTER DOT MATRIX PRINTERS, COMPUTERS AND INSTRUCTIONAL MANUALS SOLD AS A UNIT; COMPUTER MEMORY HARDWARE; COMPUTER INTERFACE APPARATUS, NAMELY, COMPUTER INTERFACE BOARDS, COMPUTER MOUSE AND MOUSE PAD, COMPUTER PERIPHERALS AND PARTS THEREOF; COMPUTER SOFTWARE PROGRAMS FOR USE IN OPERATING TELECOMMUNICATIONS AND BUSINESS MANAGEMENT SYSTEMS AND RELATED INSTRUCTION MANUALS SOLD AS A UNIT; COMPUTER SOFTWARE FOR FINANCIAL ACCOUNTING, FOR THE PROVISION OF ONLINE INFORMATION SERVICES IN THE FIELD OF NEWS, SPORTS, ENTERTAINMENT, CULTURE, BUSINESS AND FINANCE, WEATHER AND TRAVEL, NETWORK MANAGEMENT, COMPUTER PROXY, FOR CONTROLLING ACCESS AND ALARM MONITORING OF HOMES, APARTMENTS, BUILDINGS AND OTHER PROPERTIES, BILLING ANALYSIS, NETWORK ACCESS CONTROL AND FOR CREATING AND MAINTAINING FIREWALLS; COMPUTER SOFTWARE PROGRAMS FOR ACCESSING A GLOBAL COMPUTER NETWORK AND INTERACTIVE COMPUTER COMMUNICATIONS NETWORKS; OPTI-

CLASS 9—(Continued).

CAL FIBERS SOLD AS A COMPONENT OF FIBER OPTICAL CABLES; FIBER OPTIC CABLES; OPTICAL SCANNERS; OPTICAL CHARACTER READERS; OPTICAL BLANK DISCS; OPTICAL GLASS FOR SIGNAL TRANSMISSION; OPTIC TRANSMITTERS FOR RADIO, TELEPHONE; OPTIC RECEIVERS FOR TELEPHONE, AUDIO, VIDEO; OPTICAL SIGNAL PROCESSORS; OPTIC TELECOMMUNICATIONS SWITCHES; OPTICAL ATTENUATORS; OPTICAL AMPLIFIERS; OPTICAL CHARACTER RECOGNITION APPARATUS, FOR USE IN THE TELECOMMUNICATIONS FIELD, AND PARTS THEREOF; TELEPHONE LOCAL AREA NETWORKS; TELECOMMUNICATION AUDIO, VIDEO AND DATA COMMUNICATIONS SYSTEMS, NAMELY, DIGITAL AND ANALOGUE SIGNAL TRANSMITTERS; RECEIVERS AND CONVERTERS FOR USE WITH TELEPHONE, AUDIO, VIDEO; RADIO AND TELEPHONE TRANSMITTERS; COMMUNICATION RECEIVERS AND SERVERS FOR TELEPHONE, AUDIO, VIDEO; TELEPHONE ANSWERING MACHINES; TELEPROMPTERS; TELETYPEWRITERS AND PARTS THEREOF, NAMELY, CALLER IDENTIFICATION BOXES, DIALING ASSEMBLIES, TELEPHONE UNITS, AUDIO OPERATED RELAYS, AUDIO/VIDEO SIGNAL AND OPTICAL FILTERS, PROTECTORS AND AUTOMATIC SIGNALING AND CONTROL EQUIPMENT, TELEMETERS, WIRELESS AND CELLULAR TELEPHONES, AND RADIO PAGERS; INTERCOMS; FACSIMILE MACHINE; ELECTRONIC MAIL APPARATUS FOR ELECTRONIC EXCHANGE OF DATA IMAGES AND MESSAGES; ELECTRICAL WIRE; ELECTRICAL WIRE CONNECTORS; INTEGRATED CIRCUITS; PRINTED CIRCUITS; ELECTRIC CIRCUITS; CIRCUIT BREAKERS; PRINTED CIRCUIT BOARDS; CIRCUIT CONNECTORS; ELECTRICAL CONTROLLERS; ELECTRICAL CONVERTERS; ELECTRICAL CONDUCTORS; ELECTRICAL FUSES; ELECTRIC LUMINESCENT DISPLAY PANELS; ELECTRICAL SWITCH PLATES; ELECTRIC PLUGS; ELECTRIC COILS; ANTENNAS; ELECTRICAL CABLES; COMPUTER CABLES; COMPUTER CHIPS; SILICON CHIPS; CHRONOGRAPHS FOR USE AS SPECIALIZED TIME RECORDING APPARATUS; COMPUTER BUFFERS; BLANK COMPUTER DISCS; BLANK COMPUTER FLOPPY DISKS; COMPUTER HARD DISCS; ACOUSTIC CONDUITS; ELECTRICAL CONDUITS; FIBER OPTIC CONDUITS AND PARTS THEREOF; COMPACT DISC PLAYERS; AUDIO AND VIDEO TAPE RECORDERS; AUDIO AND VIDEOTAPE PLAYERS; AUDIO AND VIDEOCASSETTE RECORDERS; AUDIO AND VIDEOCASSETTE PLAYERS; BLANK AUDIO AND VIDEOTAPES, CASSETTES, DISCS AND MICROFICHE; AUDIO AND VIDEO TAPES, CASSETTES, DISCS AND MICROFICHE FEATURING INFORMATION CONCERNING TELECOMMUNICATIONS, AND CONCERNING PERSONAL AND BUSINESS MANAGEMENT SYSTEMS; AUDIO AND VIDEO RECORDINGS IN THE FIELD OF TELECOMMUNICATIONS, INFORMATION TECHNOLOGY AND SAFETY; TELEVISION AND TELEVISION PERIPHERAL EQUIPMENT, NAMELY, CAMERAS, SET TOP BOXES, REMOTE CONTROL UNITS FOR INTERACTIVE AND NON-INTERACTIVE USE; VIDEO MONITORS; AUTOMATIC VENDING MACHINES AND TIMING MECHANISMS THEREFOR AND PARTS THEREOF; MACHINE READABLE, MAGNETICALLY ENCODED CARDS, NAMELY, PREPAID TELEPHONE CALLING CARDS AND CREDIT CARDS; BLANK SMART CARDS; MAGNETIC CODED CARD READERS; DATA PROCESSORS AND READERS; WORD PROCESSORS; MICROPROCESSORS; ELECTRONIC ENCRYPTION UNITS; DEMAGNETIZERS FOR MAGNETIC TAPES AND PARTS THEREOF; LASERS NOT FOR MEDICAL USE; LIGHT EMITTING DIODES; LIGHT EMITTING DIODE DISPLAYS; COMPUTER, DATA AND VIDEO NETWORKING AND CONFERENCING EQUIPMENT, NAMELY, TELECONFERENCING EQUIPMENT AND AUDIOVISUAL TEACHING EQUIPMENT IN THE NATURE OF OVERHEAD FILM, PHOTOGRAPHIC AND SLIDE PROJECTORS; PROJECTION SCREENS; COMPUTER BASED INFORMATION DISPLAY EQUIPMENT, NAMELY, COMPUTERS WHICH DISPLAY INFORMATION ON AN OVERHEAD SCREEN; PORTABLE DEVICES, NAMELY, LAPTOPS, HANDHELD AND POCKET COMPUTERS, WIRELESS FAX MACHINES; PERSONAL COMMUNICATIONS EQUIPMENT, NAMELY, PERSONAL DIGITAL ASSISTANTS; CALCULATORS AND RELATED PERIPHERALS; SATELLITE PROCESSORS, SATELLITE AND SATELLITE

CLASS 9—(Continued).

COMMUNICATION EARTH STATIONS BOTH STATIONARY AND MOVEABLE; COMPUTER GAME PROGRAMS FOR CHILDREN AND ADULTS; VIDEO AND COMPUTER GAME CARTRIDGES; AUDIO AND VIDEO RECORDINGS IN THE FIELD OF NEWS, SPORTS, ENTERTAINMENT, CULTURE, BUSINESS AND FINANCE, WEATHER AND TRAVEL; PRERECORDED COMPACT DISCS, AUDIOCASSETTE TAPES, VIDEOCASSETTE TAPES, DIGITAL AUDIOTAPES AND DIGITAL VIDEO DISCS FEATURING MUSICAL, VARIETY, NEWS AND COMEDY SHOWS; CARRYING CASES FOR POCKET CALCULATORS AND CELL PHONES (U.S. CLS. 21, 23, 26, 36 AND 38).

TEJBIR SINGH, EXAMINING ATTORNEY

SN 78-498,369. POWER QUOTIENT INTERNATIONAL CO., LTD, TAIPEI, TAIWAN, FILED 10-12-2004.

FOR COMPUTER MEMORIES, NAMELY, DYNAMIC RANDOM ACCESS MEMORY (DRAM) MODULES (U.S. CLS. 21, 23, 26, 36 AND 38).

MAUREEN DALL, EXAMINING ATTORNEY

SN 78-499,764. SANDISK CORPORATION, MILPITAS, CA. FILED 10-14-2004.

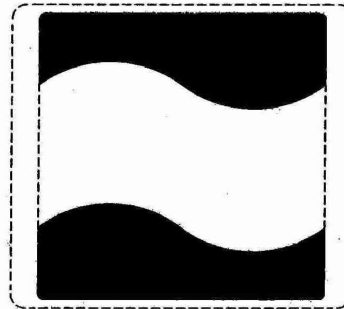

THE MARK CONSISTS OF TWO WAVY LINES. SEC. 2(F).

FOR SEMICONDUCTOR MEMORY DEVICES, NAMELY, INTEGRATED CIRCUITS, ELECTRONIC CIRCUIT CARDS AND CARTRIDGES, AND OTHER SEMICONDUCTOR DEVICES, NAMELY, FLASH MEMORY CARDS, CARTRIDGES, ADAPTERS, CONVERTERS, CONTROLLERS, PLAYERS, READERS, STORAGE MODULES, AND COMPUTER PERIPHERALS; PORTABLE AUDIO AND VIDEO PLAYERS/RECORDERS WHICH USE SEMICONDUCTOR DEVICES AS RECORDING MEDIA; AND COMPUTER OPERATING PROGRAMS FOR SEMICONDUCTOR MEMORY DEVICES (U.S. CLS. 21, 23, 26, 36 AND 38).

FIRST USE 10-30-2001; IN COMMERCE 10-30-2001.

DAVID MURRAY, EXAMINING ATTORNEY

CLASS 9—(Continued).

SN 78-583,563. LA DOLFINA S.A., CAPITAL FEDERAL, ARGENTINA, FILED 3-9-2005.

LA DOLFINA ADOLFO CAMBIASO

THE MARK CONSISTS OF STANDARD CHARACTERS WITHOUT CLAIM TO ANY PARTICULAR FONT, STYLE, SIZE, OR COLOR.

PRIORITY CLAIMED UNDER SEC. 44(D) ON ARGENTINA APPLICATION NO. 2540834, FILED 9-10-2004, REG. NO. 2135221, DATED 1-3-2007, EXPIRES 1-3-2017.

THE NAME ADOLFO CAMBIASO IDENTIFIES A LIVING INDIVIDUAL WHOSE CONSENT IS OF RECORD.

FOR CAMERAS, MOVIE CAMERAS, AND EXPOSED CINEMATOGRAPHIC, CAMERA AND SLIDE FILM, EYEGLASSES, COMPUTERS, PROTECTIVE HELMETS (U.S. CLS. 21, 23, 26, 36 AND 38).

MICHAEL SOUDERS, EXAMINING ATTORNEY

SN 78-607,200. HILTON TRADING CORPORATION, MIAMI, FL. FILED 4-12-2005.



THE COLOR(S) WHITE, BLACK AND YELLOW IS/ARE CLAIMED AS A FEATURE OF THE MARK.

THE MARK CONSISTS OF A COLORED OPENED LEDGER BOOK. THE COLOR YELLOW APPEARS IN THE PAGES OF THE BOOK; THE COLOR BLACK APPEARS IN THE OUTLINE OF THE PAGES OF THE BOOK; THE WHITE COLOR APPEARS IN THE CAPITAL LETTER A, IN ALL THE NUMERALS OF THE MARK, IN THE BINDER RINGS, IN THE MIDDLE PAGES OF THE BOOK, BETWEEN THE YELLOW TOP PAGES AND THE BOOK OUTLINE; AND IN THE WORD ACCULOG.

FOR COMPUTER SOFTWARE FOR CASH HANDLING AND PROCESSING SYSTEMS AND APPARATUS, NAMELY CURRENCY COUNTERS, BANKNOTES COUNTING MACHINES, AND CURRENCY BATCHERS, FOR CASH HANDLING MANAGEMENT OF BANKS, RETAILERS, INCLUDING SUPERMARKETS, THEATERS, CLOTHING STORES, AND RELIGIOUS INSTITUTIONS, INCLUDING CHURCHES; NOT FOR INSURANCE PROCESSING AND PAYMENT; NOT FOR ACTIVITIES LOG OF PHYSICAL AND COMPUTER EVENTS TAKING PLACE WITHIN BUILDINGS AND CAMPUSES (U.S. CLS. 21, 23, 26, 36 AND 38).

FIRST USE 1-27-2005; IN COMMERCE 4-28-2005.

KATHRYN COWARD, EXAMINING ATTORNEY

CLASS 9—(Continued).

SN 78-608,599. TC LICENSE, LTD., HUMMELSTOWN, PA. FILED 4-14-2005.

POWERED BY DAT

THE MARK CONSISTS OF STANDARD CHARACTERS WITHOUT CLAIM TO ANY PARTICULAR FONT, STYLE, SIZE, OR COLOR.

OWNER OF U.S. REG. NOS. 2,288,525, 2,455,907 AND OTHERS.

FOR COMPUTER HARDWARE AND SOFTWARE FOR USE IN THE TRANSPORTATION INDUSTRY FOR MANAGEMENT AND TRACKING FREIGHT LOAD AND CARRIER INFORMATION FROM CUSTOMER DEMAND TO POST DELIVERY AUDIT, CREATING AND SENDING INVOICES, PROCESSING PAYMENTS, RECORDING ACCOUNTS RECEIVABLE AND ACCOUNTS PAYABLE, AUTOMATED METER READING, SECURITY MONITORING, ENVIRONMENTAL MONITORING, CARRIER MONITORING, POINT-OF-SALE MONITORING, AND COMPLIANCE AND INSURANCE INFORMATION (U.S. CLS. 21, 23, 26, 36 AND 38).

FIRST USE 3-6-2005; IN COMMERCE 3-6-2005.

KHANH LE, EXAMINING ATTORNEY

SN 78-615,257. UMG RECORDINGS, INC., SANTA MONICA, CA. FILED 4-22-2005.

MACHETE MUSIC

THE MARK CONSISTS OF STANDARD CHARACTERS WITHOUT CLAIM TO ANY PARTICULAR FONT, STYLE, SIZE, OR COLOR.

NO CLAIM IS MADE TO THE EXCLUSIVE RIGHT TO USE "MUSIC", APART FROM THE MARK AS SHOWN.

FOR PRE-RECORDED AUDIO TAPES, DISCS AND CASSETTES, VIDEO TAPES, DISCS AND CASSETTES, DIGITAL AUDIO AND AUDIO VIDEO TAPES AND DISCS, CDS, DVDS, LASER DISCS, AND PHONOGRAPH RECORDS FEATURING MUSIC AND MUSIC-RELATED ENTERTAINMENT; THEATRICAL AND MUSICAL SOUND AND VIDEO RECORDINGS; VIRTUAL REALITY GAME SOFTWARE; DOWNLOADABLE RING TONES, MUSIC, GRAPHICS, COMPUTER GAME SOFTWARE, AND VIDEO RECORDINGS FEATURING MUSIC AND MUSIC-RELATED ENTERTAINMENT FOR WIRELESS COMMUNICATION DEVICES; COMPUTER AND VIDEO GAME EQUIPMENT CONTAINING MEMORY DEVICES, NAMELY, COMPUTER AND VIDEO GAME SOFTWARE, CARTRIDGES AND TAPE CASSETTES, JOYSTICKS AND INTERACTIVE REMOTE CONTROL UNITS; AND COMPUTER MOUSE PADS (U.S. CLS. 21, 23, 26, 36 AND 38).

LINDA M. KING, EXAMINING ATTORNEY

CLASS 9—(Continued).

SN 78-647,797. CORE GAMER CORP., GARDENA, CA.
FILED 6-10-2005.

CORE GAMER

THE MARK CONSISTS OF STANDARD CHARACTERS WITHOUT CLAIM TO ANY PARTICULAR FONT, STYLE, SIZE, OR COLOR.

NO CLAIM IS MADE TO THE EXCLUSIVE RIGHT TO USE "GAMER", APART FROM THE MARK AS SHOWN.

FOR VIDEO GAME ACCESSORIES, NAMELY, COMPUTER GAME AND TV GAME JOYSTICKS, COMPUTER GAME AND TV GAME CONTROLLER PADS, COMPUTER GAME AND TV GAME STEERING WHEELS, COMPUTER GAME AND TV GAME MEMORY CARDS, COMPUTER GAME AND TV GAME BATTERIES AND POWER ADAPTERS, COMPUTER GAME AND TV GAME AUDIO MICROPHONE AND SPEAKERS, COMPUTER GAME AND TV GAME REMOTE CONTROLLERS; COMPUTER GAME AND TV GAME AUDIO AND VIDEO MACHINES FOR USE WITH TELEVISIONS, COMPUTER GAME AND TV GAME CONTROLLERS, ELECTRICAL ADAPTERS AND CABLES USED FOR CONNECTING GAMING ACCESSORIES TO GAME CONSOLES, TELEVISIONS, MONITORS, AND/OR PERSONAL COMPUTERS; CARRYING AND STORAGE CASES FOR ELECTRONIC COMPUTER AND VIDEO GAMES AND COMPUTER AND VIDEO GAME EQUIPMENT; COSMETIC ACCESSORIES FOR COMPUTER AND VIDEO GAME CONSOLES AND PERIPHERALS, NAMELY, DECORATIVE COVERS THAT CAN BE ATTACHED AND DETACHED (U.S. CLS. 21, 23, 26, 36 AND 38).

DOMINIC J. FERRAIUOLO, EXAMINING ATTORNEY

SN 78-659,849. ASTEC INTERNATIONAL LIMITED, KWUN TONG, KOWLON, HONG KONG, FILED 6-28-2005.

iMP

THE MARK CONSISTS OF STANDARD CHARACTERS WITHOUT CLAIM TO ANY PARTICULAR FONT, STYLE, SIZE, OR COLOR.

OWNER OF U.S. REG. NOS. 2,721,919 AND 2,742,824.

FOR AC/DC RECTIFIERS, POWER SUPPLIES, BATTERY CHARGERS AND POWER DISTRIBUTION ELEMENTS COMPRISED OF BUS CONVERTERS, BUS BARS, AC/DC CONVERTERS, DC/DC CONVERTERS, POWER SUPPLIES, POWER SUPPLY CONTROLLERS, POWER SUPPLY CONTROL AND MONITORING SOFTWARE, CIRCUIT BREAKERS AND ELECTRICAL FUSES (U.S. CLS. 21, 23, 26, 36 AND 38).

TEJBIR SINGH, EXAMINING ATTORNEY

CLASS 9—(Continued).

SN 78-677,512. HITACHI CABLE, LTD., CHIYODA-KU, TOKYO 100-8166, JAPAN, FILED 7-25-2005.

WHOLLYFLEX

THE MARK CONSISTS OF STANDARD CHARACTERS WITHOUT CLAIM TO ANY PARTICULAR FONT, STYLE, SIZE, OR COLOR.

OWNER OF JAPAN REG. NO. 4924939, DATED 1-27-2006, EXPIRES 1-27-2016.

FOR OPTICAL COMPONENTS, NAMELY, OPTICAL FIBER CABLES, OPTICAL FIBER CORDS, FIBER OPTICS, OPTICAL FIBER CONNECTORS, OPTICAL FIBER BUNDLES, OPTICAL FIBER NETWORKS COMPRISED PRIMARILY OF OPTICAL FIBER CABLES, OPTICAL FIBER NETWORKS COMPRISED PRIMARILY OF FIBER OPTICS, OPTICAL FIBER NETWORKS COMPRISED PRIMARILY OF OPTICAL FIBER CONNECTORS, OPTICAL FIBER NETWORKS COMPRISED PRIMARILY OF OPTICAL COUPLERS, OPTICAL FIBER NETWORKS COMPRISED PRIMARILY OF OPTICAL MULTIPLEXERS, OPTICAL FIBER NETWORKS COMPRISED PRIMARILY OF FIBER OPTIC TRANSMITTERS AND RECEIVERS, OPTICAL FIBER NETWORKS COMPRISED PRIMARILY OF OPTICAL FILTERS, OPTICAL FIBER NETWORKS COMPRISED PRIMARILY OF FIBER OPTIC TELECOMMUNICATION SWITCHES; OPTICAL FIBER TERMINALS, OPTICAL FIBER SCOPES, OPTICAL FILTERS, OPTICAL MIRRORS, OPTICAL SCANNERS, OPTICAL COUPLERS, OPTICAL MULTIPLEXERS, FIBER OPTIC LIGHT AND IMAGE CONDUITS, FIBER OPTIC CABLE ASSEMBLIES, FIBER OPTIC SIGNAL AMPLIFIERS, FIBER OPTIC TRANSMITTERS AND RECEIVERS, FIBER OPTICS COMMUNICATION SYSTEMS COMPRISED PRIMARILY OF OPTICAL FIBER CABLES, FIBER OPTICS COMMUNICATION SYSTEMS COMPRISED PRIMARILY OF FIBER OPTICS, FIBER OPTICS COMMUNICATION SYSTEMS COMPRISED PRIMARILY OF OPTICAL FIBER CONNECTORS, FIBER OPTICS COMMUNICATION SYSTEMS COMPRISED PRIMARILY OF OPTICAL COUPLERS, FIBER OPTICS COMMUNICATION SYSTEMS COMPRISED PRIMARILY OF OPTICAL MULTIPLEXERS, FIBER OPTICS COMMUNICATION SYSTEMS COMPRISED PRIMARILY OF FIBER OPTIC TRANSMITTERS AND RECEIVERS, FIBER OPTICS COMMUNICATION SYSTEMS COMPRISED PRIMARILY OF OPTICAL FILTERS, FIBER OPTICS COMMUNICATION SYSTEMS COMPRISED PRIMARILY OF FIBER OPTIC TELECOMMUNICATIONS SWITCHES; AND TELECOMMUNICATIONS SWITCHES TO TRANSMIT AND RECEIVE AND DISTRIBUTE VOICE, DATA, VIDEO AND FACSIMILE COMMUNICATIONS; CABLES AND WIRES, NAMELY, ELECTRIC AND ELECTRONIC CABLES AND WIRES, PROBE CABLES FOR ELECTRICAL OR OPTICAL SIGNAL TRANSMISSION, LOW CAPACITANCE MICRO MINIATURE MULTI-COAXIAL CABLES, COAXIAL CABLES, RUBBER COVERED ELECTRICAL WIRES, RUBBER COVERED ELECTRONIC WIRES, RUBBER COVERED TELECOMMUNICATION WIRES, SPECIAL COVERED CABLES FOR ELECTRICAL OR OPTICAL SIGNAL TRANSMISSION, BARE ELECTRICAL WIRES, BARE ELECTRONIC WIRES, BARE TELECOMMUNICATION WIRES, PLASTIC COVERED ELECTRICAL WIRES, PLASTIC COVERED ELECTRONIC WIRES, PLASTIC COVERED TELECOMMUNICATION WIRES, TELECOMMUNICATION CABLES, POWER CABLES, MAGNETIC ELECTRICAL WIRES, MAGNETIC ELECTRONIC WIRES, MAGNETIC TELECOMMUNICATION WIRES AND RESISTANCE WIRES; ELECTRIC, ELECTRONIC AND OPTICAL FIBER CABLE COMPONENTS, NAMELY, TERMINAL BOXES, JUNCTION BOXES, JUNCTION SLEEVES AND PROTECTIVE SHEATHS; ELECTRIC AND ELECTRONIC PARTS AND COMPONENTS, NAMELY, CONNECTORS, CIRCUIT BOARDS, ELECTRODES, INTEGRATED CIRCUITS, LARGE SCALE INTEGRATED CIRCUITS, MICROPROCESSORS, INVERTERS, RELAYS, CONTROLLERS, ACCUMULATORS, ACCUMULATOR BOXES, RESISTORS, SWITCHES, BATTERIES, BATTERY CHARGERS, AMPLIFIERS, AMMETERS, COMMUTATORS, CIRCUIT BREAKERS, CIRCUIT CLOSERS, ACOUSTIC COUPLERS, COILS AND ELECTROMAGNETIC COILS; ELECTRIC OR MAGNETIC METERS AND TESTERS,

CLASS 9—(Continued).

NAMELY, PHASE INDICATORS, OSCILLOGRAPHS, CIRCUIT TESTERS, ANTENNA PARAMETER MEASURING APPARATUS, MAGNETOMETERS, FREQUENCY METERS, WATT HOUR METERS, RESISTANCE MEASURING INSTRUMENTS, VOLTMETERS, WAVE-METERS, WATTMETERS AND OSCILLATORS; TELECOMMUNICATIONS HARDWARE, NAMELY, DEVICES FOR TRANSPORTING AND AGGREGATING VOICE, DATA, AND VIDEO COMMUNICATIONS ACROSS MULTIPLE NETWORK INFRASTRUCTURE AND COMMUNICATIONS PROTOCOLS (U.S. CLS. 21, 23, 26, 36 AND 38).

MICHAEL KAZAZIAN, EXAMINING ATTORNEY

SN 78-701,777. GROOVE TALENT LTD., KOWLOON, HONG KONG, FILED 8-26-2005.

SHADOW

THE MARK CONSISTS OF STANDARD CHARACTERS WITHOUT CLAIM TO ANY PARTICULAR FONT, STYLE, SIZE, OR COLOR.

FOR FULL LINE OF ACCESSORIES FOR COMPUTERS, LAPTOPS, PDA'S, MP3 PLAYERS AND OTHER PORTABLE AND HANDHELD DIGITAL ELECTRONIC DEVICES, NAMELY, ELECTRICAL CONNECTORS, ELECTRICAL WIRES, ELECTRICAL CABLES, AND ADAPTORS; HEADPHONES AND EARPHONES; DOCKING STATIONS TO DOCK PORTABLE OR HANDHELD DIGITAL ELECTRONIC DEVICES TO AUXILIARY AUDIO AND VIDEO COMPONENTS; POWER SUPPLIES; BATTERY PACKS COMPRISED PRIMARILY OF A BATTERY ASSEMBLY AND INTERFACE FOR CONNECTING TO AND POWERING PORTABLE AND HANDHELD DIGITAL ELECTRONIC DEVICES; BATTERY CHARGERS; STEREO AMPLIFIER AND SPEAKER BASE STATIONS COMPOSED OF ENCLOSURES FOR SPEAKERS; AUTOMOBILE STEREO ADAPTERS; AUDIO TAPE, CASSETTE AND VIDEO RECORDERS; RADIO RECEIVERS; RADIO TRANSMITTERS; IMAGE SCANNERS; VIDEO MONITORS, NAMELY, VIEWERS TO CONNECT TO AND VIEW CONTENT ON PORTABLE OR HANDHELD DIGITAL ELECTRONIC DEVICES; CARRYING CASES, SACKS, AND BAGS, ALL FOR USE WITH COMPUTERS, LAPTOPS, PDA'S, MP3 PLAYERS AND OTHER PORTABLE AND HANDHELD DIGITAL ELECTRONIC DEVICES; AUDIO-VIDEO PRODUCTS, NAMELY, BLANK CDS, DVDS, AND CASSETTE TAPES, AUDIO-VIDEO TAPE AND CASSETTE RECORDERS, AUDIO-VIDEO TAPE AND CASSETTE PLAYERS, AUDIO-VIDEO RECEIVERS AND AUDIO-VIDEO AMPLIFIERS; AND MANUALS SUPPLIED THEREWITH (U.S. CLS. 21, 23, 26, 36 AND 38).

TONI HICKEY, EXAMINING ATTORNEY

CLASS 9—(Continued).

SN 78-727,913. ISYS AUTOMATION, INC., SAN DIEGO, CA. FILED 10-6-2005.

LonPhone

THE MARK CONSISTS OF STANDARD CHARACTERS WITHOUT CLAIM TO ANY PARTICULAR FONT, STYLE, SIZE, OR COLOR.

FOR COMPUTER PROGRAMS FOR REMOTE MONITORING AND CONTROL OF NETWORK DATA AND EQUIPMENT VIA CELLPHONE (U.S. CLS. 21, 23, 26, 36 AND 38).

ANDREW RHIM, EXAMINING ATTORNEY

SN 78-729,970. F4W, INC., LAKE MARY, FL. FILED 10-10-2005.

F4W

THE MARK CONSISTS OF STANDARD CHARACTERS WITHOUT CLAIM TO ANY PARTICULAR FONT, STYLE, SIZE, OR COLOR.

FOR SOFTWARE FOR VOICE, VIDEO, CHAT AND TEXT COMMUNICATIONS OVER A WIRELESS NETWORK (U.S. CLS. 21, 23, 26, 36 AND 38).

MATTHEW PAPPAS, EXAMINING ATTORNEY

SN 78-749,181. MATSUSHITA ELECTRIC INDUSTRIAL CO., LTD., OSAKA, JAPAN, FILED 11-8-2005.

BD MULTI

THE MARK CONSISTS OF STANDARD CHARACTERS WITHOUT CLAIM TO ANY PARTICULAR FONT, STYLE, SIZE, OR COLOR.

PRIORITY CLAIMED UNDER SEC. 44(D) ON JAPAN APPLICATION NO. 2005101410, FILED 10-28-2005.

FOR OPTICAL DISC DRIVES; OPTICAL DISC PLAYERS; AND OPTICAL DISC RECORDERS (U.S. CLS. 21, 23, 26, 36 AND 38).

HOWARD B. LEVINE, EXAMINING ATTORNEY

CLASS 9—(Continued).

SN 78-756,382. DANIEL, SIMON RICHARD, SURREY, UNITED KINGDOM, FILED 11-17-2005.

MOIXA

THE MARK CONSISTS OF STANDARD CHARACTERS WITHOUT CLAIM TO ANY PARTICULAR FONT, STYLE, SIZE, OR COLOR.

OWNER OF UNITED KINGDOM REG. NO. 2345732, DATED 5-14-2004, EXPIRES 10-11-2013.

FOR (BASED ON INTENT TO USE) CONSUMER BATTERY PRODUCTS, NAMELY, ALKALINE DRY CELLS, BATTERIES, RECHARGEABLE BATTERIES, BATTERY CHARGERS, HEAVY DUTY BATTERIES, AUTOMOTIVE BATTERIES, INDUSTRIAL BATTERIES; (BASED ON INTENT TO USE) AND (BASED ON 44(E)) COMPUTERS; COMPUTER HARDWARE; MODEMS; COMPUTER SOFTWARE FOR BROWSING OR ACCESSING THE INTERNET, FOR VISUALIZING INTERNET ACCESS, FOR CONTROL OF APPLICATIONS IN THE FIELD OF SOLAR TECHNOLOGIES, WIND, OR OFF-GRID POWER GENERATION TECHNOLOGIES, OR FOR MANAGING THE CHARGING OF RECHARGEABLE BATTERIES, PORTABLE ELECTRONIC DEVICES, AND PHONES; SOUND SYSTEMS, NAMELY AUDIO RECEIVERS, AMPLIFIERS, AND SPEAKERS; OPTICAL SYSTEMS, NAMELY OPTICAL READERS, SCANNERS, AND CABLES; SCIENTIFIC EQUIPMENT, NAMELY, OPTICAL SENSORS, ELECTRONIC SENSORS, AND QUANTUM SENSORS FOR MEASURING MICROSCOPIC, NANO AND QUANTUM PLANCK LENGTH EFFECTS VIA QUANTUM MEASUREMENT MEANS; LIFE-SAVING APPARATUS, NAMELY, LIFE SAVING RAFTS; VENDING MACHINES; FIRE EXTINGUISHERS; STORAGE DEVICES, NAMELY CD STORAGE RACKS AND COMPUTER HARD DRIVES; PHONE ACCESSORIES, NAMELY CELL PHONE COVERS AND DEVICES FOR HANDS-FREE USE OF MOBILE PHONES (U.S. CLS. 21, 23, 26, 36 AND 38).

JASON BLAIR, EXAMINING ATTORNEY

SN 78-757,556. T.C. CONNECTION CORPORATION, ROAD TOWN, BR. VIRGIN ISLANDS, FILED 11-18-2005.

SIGNALSPHERE

THE MARK CONSISTS OF STANDARD CHARACTERS WITHOUT CLAIM TO ANY PARTICULAR FONT, STYLE, SIZE, OR COLOR.

FOR COMPUTER HARDWARE FOR COMMUNICATIONS, GRAPHICS, EXTENDED MULTIMEDIA, AUDIO, VIDEO, GAMES, TELEVISION; COMPUTER SOFTWARE FOR DEVELOPMENT OF MULTIMEDIA APPLICATIONS; VIDEO GAMES SOFTWARE; SOFTWARE FOR MEDIA CONTENT MANAGEMENT; PRE-PRODUCTION AND POST PRODUCTION DATA EXCHANGE SOFTWARE, NAMELY, SOFTWARE FOR MEDIA CONTENT MANAGEMENT AND FOR THE INTEGRATION OF TEXT, AUDIO, GRAPHICS, STILL IMAGES AND MOVING PICTURES; TELECOMMUNICATIONS NETWORKING SOFTWARE FOR WIRELESS NETWORK COMMUNICATIONS AND CONNECTIVITY; EXTENDED MULTIMEDIA SOFTWARE RECORDED ON MAGNETIC MEDIA FEATURING STORIES IN THE FIELD OF TRAVEL, SCIENCE, TECHNOLOGY, SHOPPING; CHILDREN'S EDUCATIONAL SOFTWARE FEATURING INSTRUCTION IN THE FIELD OF GRAPHICS,

CLASS 9—(Continued).

ANIMATION, INTERACTIVE COMMUNICATIONS, MOVIES, ART, SPORTS, AND MUSIC VIDEOS; COMPUTER SOFTWARE FOR WIRELESS CONTENT DELIVERY; COMPUTER SOFTWARE FOR THE AUTOMATIC CONFIGURATION OF COMPUTER NETWORKS; SECURITY SOFTWARE FOR INFORMATION ACCESS CONTROL AND SECURE COMMUNICATIONS; SOFTWARE FOR COMMUNICATIONS AND TELECOMMUNICATIONS BETWEEN COMPUTER USERS AND GLOBAL COMPUTER NETWORKS; COMPUTER UTILITY SOFTWARE FOR USE WITH TELECOMMUNICATIONS EQUIPMENT AND DEVICES; COMPUTER SOFTWARE FOR USE IN RECORDING, ORGANIZING, TRANSMITTING, MANIPULATING, AND REVIEWING TEXT, DATA, GRAPHICS, AUDIO FILES, VIDEO FILES AND ELECTRONIC GAMES IN CONNECTION WITH COMPUTERS, TELEVISION SET-TOP BOXES, MUSIC PLAYERS, VIDEO PLAYERS, MEDIA PLAYERS, CELLULAR PHONES, AND PORTABLE AND HANDHELD DIGITAL ELECTRONIC DEVICES; COMPUTER SOFTWARE FOR ACCESSING, BROWSING AND SEARCHING ONLINE DATABASES; COMPUTER SOFTWARE TO ENABLE USERS TO DISTRIBUTE GRAPHICS, AUDIO, VIDEO, TEXT AND OTHER MULTIMEDIA CONTENT, INCLUDING MUSIC, CONCERTS, VIDEOS, RADIO, TELEVISION, NEWS, SPORTS, GAMES, CULTURAL EVENTS, AND ENTERTAINMENT-RELATED AND EDUCATIONAL PROGRAMS VIA COMMUNICATIONS NETWORKS; COMPUTER SOFTWARE FOR IDENTIFYING, LOCATING, GROUPING, DISTRIBUTING, AND MANAGING DATA AND LINKS BETWEEN COMPUTER SERVERS AND USERS CONNECTED TO ELECTRONIC COMMUNICATIONS NETWORKS; PERSONAL DIGITAL ASSISTANTS (PDAS); ENTERTAINMENT SYSTEMS COMPRISING TELEVISIONS, SET TOP BOX, VIDEO GAME PLAYERS; HOME THEATER AND STEREO SYSTEMS CONSISTING OF, IN WHOLE OR IN PART, LCD PANELS, AMPLIFIERS, RADIOS AND AUDIO SPEAKER SYSTEMS, DIGITAL VIDEO RECORDERS, MP3 PLAYERS, DIGITAL AUDIO PLAYERS, DIGITAL AUDIO RECORDERS, BLANK DIGITAL STORAGE DISCS, CDR AND CDRW PLAYERS, MAGNETIC PLAYERS, MAGNETIC RECORDERS, TELEVISION SETS, MONITORS FOR TELEVISION AND COMPUTERS, LCD MONITORS, HEADPHONES, CONVERTERS, REMOTE CONTROLS FOR TELEVISIONS, DVD-PLAYERS, SOUND RECORDING APPARATUS WITH LASER SCANNING SYSTEMS, RECEIVERS FOR TELEPHONIC COMMUNICATIONS; MP3 PLAYERS; MEDIA STORAGE, NAMELY, BLANK DIGITAL VIDEO DISCS; VIDEO CASSETTE RECORDING AND PLAYER MACHINES; GPS NAVIGATIONAL DISPLAYS AND AUTOMOTIVE VISUAL DISPLAYS, NAMELY, LIQUID CRYSTAL DISPLAYS; HIGH DEFINITION TELEVISION SETS; HAND-HELD DEVICES, NAMELY, HANDHELD DEVICES HAVING PROGRAMMABLE CAPACITY AND CAPACITY TO COMMUNICATE BY ELECTRONIC, DIGITAL, MICROWAVE, BROADBAND, ANALOG, RADIO, AND SATELLITE USING VOICE, GRAPHICS, VIDEO, DATA, SENSORY, INFRARED, ULTRAVIOLET, AND LASER AUDIO TRANSMISSIONS IN THE NATURE OF ELECTRONIC PERSONAL ORGANIZERS, MOBILE PHONES, SMARTPHONES, PORTABLE AND POCKET-SIZE PERSONAL COMPUTERS; PALM TOP COMPUTERS IN THE NATURE OF ELECTRONIC PERSONAL ORGANIZERS; PERSONAL NAVIGATIONAL GLOBAL POSITIONING SYSTEMS (GPS); HANDHELD AND PORTABLE MULTIMEDIA PLAYERS; SMART COMPUTERS HAVING CONTEXT, USER AND LOCATION AWARENESS AND WHICH MAY BE OUTFITTED AND ADAPTABLE WITH MODEM, MEMORY, PC MCIA SLOTS, DISK DRIVES, KEYBOARD, AND MONITOR; MOBILE DIGITAL DEVICES WITH COMPUTER NOTEBOOK FUNCTIONALITY AND CONNECTIVITY IN A HANDHELD PORTABLE MICRO-SIZED FORM IN THE NATURE OF HANDHELD PERSONAL COMPUTERS; INTERACTIVE COMMUNICATION DEVICES, NAMELY, TELEPHONES; COMPUTER COMMUNICATION AND NETWORKING PRODUCTS, NAMELY, PARALLEL COMMUNICATION INTERFACE NETWORK ADAPTER, ELECTRONIC SERIAL COMMUNICATION CIRCUIT CARDS, ELECTRONIC SYNCHRONOUS COMMUNICATION CIRCUIT CARDS, ELECTRONIC TELEPHONY CIRCUIT CARDS; OPERATING SYSTEM SOFTWARE, BIOS SOFTWARE, COMPUTER DRIVER UTILITIES PROGRAMS FOR GRAPHICS DEVICES, NAMELY, DIGITAL DEVICES IN THE NATURE OF MOBILE AND

CLASS 9—(Continued).

HANDHELD PHONES; REMOTE DEVICES IN THE NATURE OF PORTABLE MICRO SIZED COMPUTERS WITH NOTEBOOK FUNCTIONALITY FOR THE MOBILE ENTERPRISE HAVING CAPABILITIES OF REMOTE DESKTOP, REMOTE EMAIL AND TRANSPARENCY ACCESS TO DATA; SMART COMPUTERS HAVING CONTEXT, USER AND LOCATION AWARENESS AND WITH INTEGRATED MULTIDIMENSIONAL DATA, SOUND, VIDEO AND GRAPHICS; PUBLIC KIOSKS IN THE NATURE OF COMPUTER TERMINALS, AND PORTABLE COMPUTER TERMINALS BOTH ALLOWING DIAL-UP CONNECTIVITY AND PERSONAL COMPUTER ACCESS; COMMUNICATION DEVICES HAVING CAPACITY FOR ACQUISITION, MULTIPLEXING, TRANSMISSION, ENCODING, COMPRESSION, FILTERING, TRANSFORMING, DECOMPRESSION, DECODING, DEMULTIPLEXING AND RECEPTION OF COMMUNICATIONS DATA IN THE NATURE OF SMART PHONES; PORTABLE COMPUTERS; PORTABLE INTERACTIVE LEARNING COMPUTERS; VOICE-OVER SOFTWARE FOR TRANSMITTING AND RECEIVING COMMUNICATION SIGNALS, GAMES AND OTHER DATA; UTILITY CONTROL, COMPONENTS AND PERIPHERALS FOR DE-INTERLACING SIGNALS ON DIGITAL DISPLAY, NAMELY, CRT MONITORS, DVI DISPLAYS, LCD PANELS, HDTV DISPLAYS; DATA PROCESSORS, DIGITAL SIGNAL PROCESSORS, COMPUTER INTERFACE BOARDS, COMPUTER GRAPHICS BOARDS, GRAPHICS CARDS; SEMICONDUCTORS; INTEGRATED CIRCUITS; COMPUTER CHIPS; COMPUTER CHIP SETS; VIDEO AND GRAPHICS ACCELERATOR CHIPS, CIRCUIT BOARDS; DRIVER UTILITIES FOR COMPUTER GRAPHICS; AUDIO AND VIDEO COMPUTER ACCELERATOR BOARDS; COMPUTER PERIPHERALS FOR DATA COMPRESSION AND DECOMPRESSION, MODULATION AND DEMODULATION; COMPUTER MEMORY HARDWARE; AND PRINTED MATERIALS FOR THE AFORESAID GOODS SOLD AS A UNIT (U.S. CLS. 21, 23, 26, 36 AND 38).

SARA THOMAS, EXAMINING ATTORNEY

SN 78-760,864. INFOETHER, INC., HERNDON, VA. FILED 11-25-2005.

INDI

THE MARK CONSISTS OF STANDARD CHARACTERS WITHOUT CLAIM TO ANY PARTICULAR FONT, STYLE, SIZE, OR COLOR.

FOR COMPUTER FIRMWARE FOR THE PURPOSE OF MANAGING PERSONAL INFORMATION INCLUDING ENTITIES, CONTENT, EVENTS AND TIMES, LOCATIONS, RESOURCES, GOALS, IDENTITIES, PASSWORDS, AND ACCOUNT INFORMATION; COMPUTER FIRMWARE FOR THE PURPOSE OF MANAGING PERSONAL AND/OR BUSINESS INFORMATION INCLUDING ENTITIES, CONTENT, EVENTS, LOCATIONS, RESOURCES, GOALS, IDENTITIES, PASSWORDS, AND ACCOUNT INFORMATION; COMPUTER FIRMWARE FOR THE PURPOSE OF MANAGING PERSONAL AND/OR BUSINESS APPLICATIONS AND INFORMATION INCLUDING USER ACCESS INFORMATION AND RELATED DATA; COMPUTER FIRMWARE FOR THE COLLECTION, EDITING, ORGANIZING, MODIFYING, BOOKMARKING, TRANSMISSION, STORAGE AND SHARING OF DATA AND INFORMATION; COMPUTER FIRMWARE FOR MANAGEMENT OF INFORMATION ONTOLOGIES AND SEMANTIC RELATIONSHIPS BETWEEN OBJECTS AND THEIR RELATIONSHIPS; AND COMPUTER FIRMWARE FOR MANAGEMENT OF INFORMATION ABOUT OBJECTS AND THE RELATIONSHIP BETWEEN OBJECTS IN CLASS 009. (U.S. CLS. 21, 23, 26, 36 AND 38).

DAVID ELTON, EXAMINING ATTORNEY

CLASS 9—(Continued).

SN 78-763,815. DISNEY ENTERPRISES, INC., BURBANK, CA. FILED 11-30-2005.

HAVERSHAM HALL

THE MARK CONSISTS OF STANDARD CHARACTERS WITHOUT CLAIM TO ANY PARTICULAR FONT, STYLE, SIZE, OR COLOR.

FOR AUDIO CASSETTE RECORDERS; AUDIO CASSETTE PLAYERS; PRE-RECORDED AUDIO CASSETTES, AUDIO DISCS AND COMPACT DISCS FEATURING MUSIC, STORIES AND GAMES FOR CHILDREN; AUDIO SPEAKERS; BINOCULARS; CALCULATORS; CAMCORDERS; CAMERAS; PRE-RECORDED CD-ROMS FEATURING COMPUTER GAMES AND ACTIVITIES FOR CHILDREN; CELLULAR TELEPHONES; CELLULAR TELEPHONE ACCESSORIES, NAMELY, HEADPHONES; CELLULAR TELEPHONE CASES; FACE PLATES FOR CELLULAR TELEPHONES; COMPACT DISC PLAYERS; COMPACT DISC RECORDERS; COMPUTER GAME PROGRAMS; COMPUTER GAME CARTRIDGES AND DISCS; COMPUTERS; COMPUTER HARDWARE; COMPUTER KEYBOARDS; COMPUTER MONITORS; COMPUTER MOUSE; COMPUTER DISC DRIVES; CORDLESS TELEPHONES; DECORATIVE MAGNETS; DIGITAL CAMERAS; PRE-RECORDED DVDS, DIGITAL VIDEO DISCS AND VIDEO CASSETTES FEATURING LIVE ACTION AND ANIMATED ENTERTAINMENT FOR CHILDREN, MOTION PICTURE FILMS, AND TELEVISION SHOWS; DVD PLAYERS; DVD RECORDERS; ELECTRONIC PERSONAL ORGANIZERS; EYEGLASS CASES; EYEGLASSES; HEADPHONES; KARAOKE MACHINES; MICROPHONES; MP3 PLAYERS; MODEMS AS PART OF A COMPUTER; MOUSE PADS; MOTION PICTURE FILMS, FEATURING LIVE ACTION DRAMA AND COMEDY AND ANIMATED ENTERTAINMENT; PAGERS; PERSONAL STEREO; PERSONAL DIGITAL ASSISTANTS; PRINTERS; RADIOS; SUNGLASSES; TELEPHONES; TELEVISION SETS; VIDEO CAMERAS; VIDEO CASSETTE RECORDERS; VIDEO CASSETTE PLAYERS; VIDEO GAME CARTRIDGES; VIDEO GAME DISCS; VIDEO PHONES; WALKIE-TALKIES; WRIST AND ARM RESTS FOR USE WITH COMPUTERS (U.S. CLS. 21, 23, 26, 36 AND 38).

PAUL CROWLEY, EXAMINING ATTORNEY

CLASS 9—(Continued).

SN 78-765,971. THE COCA-COLA COMPANY, ATLANTA, GA. FILED 12-2-2005.



PRIORITY CLAIMED UNDER SEC. 44(D) ON ERPNCMNTY TM OFC APPLICATION NO. CTM00475388, FILED 11-30-2005.

THE COLOR(S) AQUA, YELLOW, GREEN, RED AND GRAY IS/ARE CLAIMED AS A FEATURE OF THE MARK. THE MARK CONSISTS OF FIVE ELEMENTS IN THE SHAPE OF DROPS PRESENTED IN THE PARTICULAR ARRANGEMENT AS SHOWN IN THE DRAWING AND IN THE COLORS AQUA, YELLOW, GREEN, RED AND GRAY. THE COLORS APPEAR IN THE DROP DESIGNS FROM TOP TO BOTTOM IN THIS ORDER: AQUA, YELLOW, GREEN, RED AND GRAY.

FOR PRE-RECORDED CDS, VIDEO TAPES, LASER DISKS, DOWNLOADABLE RECORDINGS, AND DVDS FEATURING MUSICAL, DRAMATIC, ANIMATION, MIXED MEDIA, AND MULTIMEDIA ENTERTAINMENT PERFORMANCES (U.S. CLS. 21, 23, 26, 36 AND 38).

TERESA M. RUPP, EXAMINING ATTORNEY

SN 78-773,700. GEMSTONE SYSTEMS, INC., BEAVERTON, OR. FILED 12-14-2005.

**GEMFIRE ENTERPRISE DATA
FABRIC**

THE MARK CONSISTS OF STANDARD CHARACTERS WITHOUT CLAIM TO ANY PARTICULAR FONT, STYLE, SIZE, OR COLOR.

NO CLAIM IS MADE TO THE EXCLUSIVE RIGHT TO USE "ENTERPRISE DATA FABRIC", APART FROM THE MARK AS SHOWN.

FOR COMPUTER SOFTWARE, NAMELY, SOFTWARE TO DELIVER, STORE AND MANAGE DATA AND STREAMS OF DATA COMING IN WITHIN SHORT INTERVALS OF TIME ACROSS COMPUTER APPLICATIONS (U.S. CLS. 21, 23, 26, 36 AND 38).

ANDREA SAUNDERS, EXAMINING ATTORNEY

CLASS 9—(Continued).

SN 78-779,607. INTEL CORPORATION, SANTA CLARA, CA. FILED 12-22-2005.



OWNER OF U.S. REG. NOS. 914,978, 939,641 AND OTHERS.

FOR TAPE RECORDERS; FLOPPY DISC DRIVES; ELECTRONIC SECURITY APPARATUS AND SURVEILLANCE APPARATUS, NAMELY, COMPUTER HARDWARE, COMPUTER CHIPS AND MICROPROCESSORS OPTIMIZED FOR ELECTRONIC SECURITY SURVEILLANCE; ALGORITHM SOFTWARE PROGRAMS FOR THE OPERATION AND CONTROL OF COMPUTERS; COMPUTER OPERATING SYSTEM SOFTWARE; COMPUTER OPERATING SYSTEMS; COMPUTER SYSTEM EXTENSIONS, TOOLS AND UTILITIES IN THE FIELD OF APPLICATION SOFTWARE FOR CONNECTING PERSONAL COMPUTERS, NETWORKS, TELECOMMUNICATIONS APPARATUS AND GLOBAL COMPUTER NETWORK APPLICATIONS; COMPUTERIZED TELECOMMUNICATIONS AND NETWORKING EQUIPMENT CONSISTING OF OPERATING SYSTEM SOFTWARE, MODEMS, CAMERAS, HEADSETS, MICROPHONES, CABLES AND ADAPTORS; COMPUTER GAME PROGRAMS; MOUNTING RACKS FOR COMPUTER HARDWARE, COMPUTER CABINETS AND COMPUTER HOLDERS TO HOUSE COMPUTER HARDWARE; COMPUTER HARDWARE AND SOFTWARE FOR ENHANCING AND PROVIDING REAL-TIME TRANSFER, TRANSMISSION, RECEPTION, PROCESSING AND DIGITIZING OF AUDIO AND VIDEO GRAPHICS INFORMATION; COMPUTER FIRMWARE, NAMELY, COMPUTER OPERATING SYSTEM SOFTWARE, COMPUTER UTILITY SOFTWARE AND OTHER COMPUTER SOFTWARE USED TO MAINTAIN AND OPERATE COMPUTER SYSTEMS; COMPUTERS; HANDHELD COMPUTERS; MICROCOMPUTERS; MINICOMPUTERS; MEMORY BOARDS; PERSONAL DIGITAL ASSISTANTS; CELLULAR TELEPHONES; SMART PHONES; PORTABLE AND HANDHELD ELECTRONIC PERSONAL ORGANIZERS; COMPUTER HARDWARE; INTEGRATED CIRCUITS; INTEGRATED CIRCUIT MEMORIES; INTEGRATED CIRCUIT CHIPS; COMPUTER CHIP SETS; SEMICONDUCTOR PROCESSORS; SEMICONDUCTOR PROCESSOR CHIPS; SEMICONDUCTOR CHIPS; MICROPROCESSORS; PRINTED CIRCUIT BOARDS; ELECTRONIC CIRCUIT BOARDS; COMPUTER MOTHERBOARDS AND DAUGHTERBOARDS; COMPUTER MEMORIES; COMPUTER OPERATING SYSTEMS; MICROCONTROLLERS; DATA PROCESSORS; CENTRAL PROCESSING UNITS; SEMICONDUCTOR MEMORY DEVICES, NAMELY, SEMICONDUCTOR MEMORIES AND SEMICONDUCTOR MEMORY UNITS; SOFTWARE PROGRAMMABLE PROCESSORS; DIGITAL AND OPTICAL MICROPROCESSORS; COMPUTER PERIPHERALS; VIDEO CIRCUIT BOARDS; AUDIO CIRCUIT BOARDS; AUDIO-VIDEO CIRCUIT BOARDS; VIDEO GRAPHIC ACCELERATOR; MULTIMEDIA ACCELERATOR BOARDS; VIDEO PROCESSORS; VIDEO PROCESSOR BOARDS; BLANK ELECTRONIC CHIP CARDS, BLANK SMART CARDS, ELECTRONIC CIRCUIT CARDS, FLASH MEMORY CARDS, GRAPHICS CARDS, MAGNETIC CARDS, MICROCHIP CARDS, PCMCIA CARDS, SOUND CARDS, VIDEO CAPTURE CARDS, VIDEO DISPLAY CARDS, ALL FOR THE RECORDAL AND TRANSMISSION OF DATA; MODEMS; COMPUTER HARDWARE AND SOFTWARE FOR PROCESSING, STORAGE, RETRIEVAL, TRANSMISSION, DISPLAY, INPUT, OUTPUT, COMPRESSING, DECOMPRESSING, MODIFYING, BROADCASTING AND PRINTOUT OF DATA; COMPUTER INPUT AND OUTPUT DEVICES, NAMELY, COMPUTER MICE, TRACKBALLS, COMPUTER MOUSE TOUCHPADS, KEYBOARDS, SCANNERS,

CLASS 9—(Continued).

COMPUTER CAMERAS; COMPUTER WORK STATIONS COMPRISING PROCESSORS, CENTRAL PROCESSING UNITS, COMPUTER MONITORS, COMPUTER PERIPHERALS, COMPUTER PRINTERS; COMPUTER DATA MEMORIES; STORAGE DEVICES, NAMELY, JUMP DRIVES, FLASH DRIVES AND THUMB DRIVES; SECURITY SYSTEMS FOR COMPUTER HARDWARE AND SOFTWARE, NAMELY, FIREWALLS, NETWORK ACCESS SERVER HARDWARE FOR CREATING AND MAINTAINING FIREWALLS, VIRTUAL PRIVATE NETWORK (VPN) COMPUTER HARDWARE AND COMPUTER SERVER OPERATING SOFTWARE FOR CREATING AND MAINTAINING FIREWALLS, SOFTWARE FOR ENSURING THE SECURITY OF COMPUTER NETWORKS, SOFTWARE FOR ACCESS CONTROL AND SECURITY, COMPUTER HARDWARE AND SOFTWARE FOR USE IN PROTECTING COMPUTER NETWORKS FROM DATA THEFT OR DAMAGE BY UNAUTHORIZED USERS; COMPONENTS FOR COMPUTERS AND PRINTED CIRCUITS, NAMELY INTEGRATED CIRCUIT BOARDS, PRINTED CIRCUIT BOARDS AND ELECTRICAL CIRCUIT BOARDS; COMPUTER VOICE ACCELERATOR BOARDS; COMPUTER VOICE, DATA, IMAGE AND VIDEO ACCELERATOR BOARDS; FLASH MEMORY BOARDS AND FLASH MEMORY CARDS; MEMORY SYSTEMS FOR COMPUTERS COMPRISING COMPUTER HARD DRIVES, BACK-UP DRIVES, CD AND DVD DRIVES, FLOPPY DISK DRIVES, MAGNETIC TAPE DRIVES, OPTICAL DISK DRIVES, AND MEMORY CARDS; TELECOMMUNICATIONS EQUIPMENT AND COMPUTER NETWORKS, NAMELY COMPUTER PROCESSING AND OPERATING SYSTEMS; HEADSETS FOR USE WITH COMPUTERS; COMPUTER MICE; MICROPHONES; ELECTRIC CABLES AND PLUG ADAPTERS; COMPUTER TERMINALS AND PRINTERS FOR USE THEREWITH; VIDEO DISPLAY UNITS, NAMELY, COMPUTER MONITORS, ELECTRIC LUMINESCENT DISPLAY PANELS, FLAT PANEL DISPLAY SCREENS, LCD DISPLAYS AND LED DISPLAYS; TELECOMMUNICATIONS APPARATUS AND INSTRUMENTS, NAMELY, COMPUTER ROUTERS, HUBS, SERVERS AND SWITCHES; CAMERAS; COMPUTER HARDWARE AND SOFTWARE FOR THE TRANSMISSION AND RECEIPT OF FACSIMILES; COMPUTER HARDWARE AND SOFTWARE FOR THE DEVELOPMENT, MAINTENANCE, AND USE OF LOCAL AND WIDE AREA COMPUTER NETWORKS; COMPUTER HARDWARE AND SOFTWARE FOR THE DEVELOPMENT, MAINTENANCE, AND USE OF INTERACTIVE AUDIO-VIDEO COMPUTER CONFERENCE SYSTEMS; COMPUTER HARDWARE AND SOFTWARE FOR THE RECEIPT, DISPLAY, AND USE OF BROADCAST VIDEO, AUDIO, AND DIGITAL DATA SIGNALS; SET-TOP BOXES, ELECTRONIC CONTROL DEVICES FOR THE INTERFACE AND CONTROL OF COMPUTERS AND GLOBAL COMPUTER AND TELECOMMUNICATIONS NETWORKS WITH TELEVISION AND CABLE BROADCASTS AND EQUIPMENT; APPARATUS FOR TESTING AND PROGRAMMING INTEGRATED CIRCUITS; COMPUTER PERIPHERAL MEMORY APPARATUS AND DEVICES, NAMELY, COMPUTER PERIPHERALS; COMPUTER FIRMWARE, NAMELY, COMPUTER OPERATING SYSTEMS SOFTWARE; FIXED FUNCTION COMPUTER SERVERS; COMPUTER NETWORKING HARDWARE; SEMICONDUCTOR DEVICES; COMPUTER HARDWARE AND SOFTWARE FOR CREATING, FACILITATING, AND MANAGING REMOTE ACCESS TO AND COMMUNICATION WITH LOCAL AREA NETWORKS (LANS), VIRTUAL PRIVATE NETWORKS (VPN), WIDE AREA NETWORKS (WANS) AND GLOBAL COMPUTER NETWORKS; COMPUTER NETWORK ROUTER, SWITCH, HUB AND SERVER OPERATING SOFTWARE; COMPUTER SOFTWARE AND HARDWARE FOR USE IN PROVIDING MULTIPLE USER ACCESS TO A GLOBAL COMPUTER INFORMATION NETWORK FOR SEARCHING, RETRIEVING, TRANSFERRING, MANIPULATING AND DISSEMINATING A WIDE RANGE OF INFORMATION; COMPUTER SOFTWARE TOOLS FOR THE FACILITATION OF THIRD PARTY SOFTWARE APPLICATIONS; COMPUTER HARDWARE AND SOFTWARE FOR WIRELESS NETWORK COMMUNICATIONS; DOWNLOADABLE ELECTRONIC PUBLICATIONS IN THE NATURE OF NEWSLETTERS, BOOKS, MAGAZINES, JOURNALS, BROCHURES AND WHITE PAPERS IN THE AREA OF ELECTRONICS, SEMICONDUCTORS AND INTE-

CLASS 9—(Continued).

GRATED ELECTRONIC APPARATUS AND DEVICES, COMPUTERS, TELECOMMUNICATIONS, ENTERTAINMENT, TELEPHONY, AND WIRED AND WIRELESS TELECOMMUNICATIONS; PRE-RECORDED MAGNETIC DATA CARRIERS, FLOPPY DISCS, AND OPTICAL DISCS FEATURING INSTRUCTIONAL MATERIALS RELATING TO COMPUTERS; STRUCTURAL PARTS AND FITTINGS FOR ALL THE AFORESAID GOODS; INSTRUCTIONAL MANUALS SOLD AS A UNIT WITH THE AFOREMENTIONED GOODS AND ELECTRONIC INSTRUCTIONAL MANUALS DOWNLOADABLE FROM A GLOBAL COMPUTER NETWORK (U.S. CLS. 21, 23, 26, 36 AND 38).

TARAH HARDY, EXAMINING ATTORNEY

SN 78-782,389. CLIPPER DATA LIMITED, TRURO, GREAT BRITAIN, FILED 12-29-2005.

VISION

THE MARK CONSISTS OF STANDARD CHARACTERS WITHOUT CLAIM TO ANY PARTICULAR FONT, STYLE, SIZE, OR COLOR.

PRIORITY CLAIMED UNDER SEC. 44(D) ON ERPN CMNTY TM OFC APPLICATION NO. 004590551, FILED 9-14-2005, REG. NO. 004590551, DATED 10-3-2006, EXPIRES 9-13-2015.

FOR DIVE COMPUTERS, DECOMPRESSION DIVE COMPUTERS; ELECTRONIC SENSORS FOR MONITORING AND CONTROLLING OXYGEN, CARBON DIOXIDE AND/OR NITROGEN LEVELS AND/OR GAS CYLINDER PRESSURE IN SELF-CONTAINED UNDERWATER BREATHING APPARATUS; GAS CYLINDER PRESSURE SENSORS, OXYGEN PRESSURE SENSORS, CARBON DIOXIDE PRESSURE SENSORS, TEMPERATURE SENSORS, PRESSURE SENSORS; ANALYTICAL, SIMULATION AND PLANNING SOFTWARE FOR USE WITH SELF-CONTAINED UNDERWATER BREATHING APPARATUS, CLOSED CIRCUIT RE-BREATHERS, AND SEMI-CLOSED CIRCUIT RE-BREATHERS FOR ANALYZING PERFORMANCE OF UNDERWATER BREATHING APPARATUS; ANALYTICAL, SIMULATION AND PLANNING SOFTWARE FOR MONITORING, RECORDING, CONTROL AND WARNING OF OXYGEN PARTIAL PRESSURE; ANALYTICAL, SIMULATION AND PLANNING SOFTWARE FOR MONITORING, RECORDING, CONTROL AND WARNING OF CARBON DIOXIDE CONTENT; ANALYTICAL, SIMULATION AND PLANNING SOFTWARE FOR MONITORING, RECORDING, COMPARISON, ANALYSIS AND WARNING OF DIVE DEPTH, DIVE TIME, DIVE PROFILE, AMBIENT TEMPERATURE, WATER TEMPERATURE, ATMOSPHERIC PRESSURE, TIME, DATE, BATTERY VOLTAGE, BATTERY STATUS, SCRUBBER STATUS, SCRUBBER DURATION, SCRUBBER PERFORMANCE, ASSENT WARNINGS, DECOMPRESSION CEILINGS, DECOMPRESSION TIMES, DECOMPRESSION SAFETY MARGINS AND SURFACE INTERVAL BETWEEN DIVES; DATA PROCESSORS FOR DIVE COMPUTERS AND DECOMPRESSION COMPUTERS; DATA COMMUNICATIONS EQUIPMENT, NAMELY, LED DISPLAY UNITS AND ELECTRONIC DISPLAY UNITS FOR THE DISPLAY OF CONTENT MAINTAINED IN DIGITAL

CLASS 9—(Continued).

FORM, LIQUID CRYSTAL DISPLAY UNITS, AND AUDIBLE ELECTRONIC WARNING DEVICES, NAMELY, MONO-TONE AND MULTI-FREQUENCY PIEZO OPERATED BUZZERS AND SPEAKERS FOR USE WITH OR TO CONTROL SELF-CONTAINED UNDERWATER BREATHING APPARATUS, CLOSED CIRCUIT RE-BREATHERS, AND SEMI-CLOSED CIRCUIT RE-BREATHERS; COMPUTER SOFTWARE FOR LOGGING, ANALYZING, CONTROLLING AND RECORDING INFORMATION REGARDING DIVE STATISTICS, OXYGEN, CARBON DIOXIDE AND NITROGEN LEVELS, GAS CYLINDER PRESSURE AND PERFORMANCE OF CONTROL SELF-CONTAINER UNDERWATER BREATHING APPARATUS, CLOSED CIRCUIT RE-BREATHERS, SEMI-CLOSED CIRCUIT RE-BREATHERS; COMPUTERS FOR USE WITH OR TO CONTROL SELF-CONTAINED UNDERWATER BREATHING APPARATUS, CLOSED CIRCUIT RE-BREATHERS, SEMI-CLOSED CIRCUIT RE-BREATHERS; ELECTRONIC OR AUTOMATIC VALVES FOR UNDERWATER BREATHING APPARATUS (U.S. CLS. 21, 23, 26, 36 AND 38).

STANLEY I. OSBORNE, EXAMINING ATTORNEY

SN 78-782,458. ENER1 HOLDINGS, INC., FORT LAUDERDALE, FL. FILED 12-29-2005.

ENERFUEL

THE MARK CONSISTS OF STANDARD CHARACTERS WITHOUT CLAIM TO ANY PARTICULAR FONT, STYLE, SIZE, OR COLOR.

FOR ELECTRO-CHEMICAL FUEL CELLS FOR GENERATING ELECTRICITY (U.S. CLS. 21, 23, 26, 36 AND 38).

LYDIA BELZER, EXAMINING ATTORNEY

SN 78-783,204. SAMSUNG ELECTRONICS CO., LTD., SUWON-SI, GYEONGGI-DO, REPUBLIC OF KOREA, FILED 12-30-2005.

SIDP

THE MARK CONSISTS OF STANDARD CHARACTERS WITHOUT CLAIM TO ANY PARTICULAR FONT, STYLE, SIZE, OR COLOR.

PRIORITY CLAIMED UNDER SEC. 44(D) ON REPUBLIC OF KOREA APPLICATION NO. 40-2005-0060, FILED 12-23-2005, REG. NO. 0680694, DATED 10-4-2006, EXPIRES 10-4-2016.

FOR SEMICONDUCTORS (U.S. CLS. 21, 23, 26, 36 AND 38).

DAVID MILLER, EXAMINING ATTORNEY

CLASS 9—(Continued).

SN 78-784,142. IAN FLEMING PUBLICATIONS LIMITED, LONDON., UNITED KINGDOM, FILED 1-3-2006.

BLOOD FEVER

THE MARK CONSISTS OF STANDARD CHARACTERS WITHOUT CLAIM TO ANY PARTICULAR FONT, STYLE, SIZE, OR COLOR.

FOR ANIMATED CARTOON MOTION PICTURE FILMS, DOWNLOADABLE ANIMATED CARTOON MOTION PICTURES AND DOWNLOADABLE TV SHOWS ABOUT FICTIONAL STORIES AND CHARACTERS, VIDEO DISCS, OPTICAL DISCS, AND VIDEO TAPES CONTAINING RECORDED ANIMATED CARTOONS; COMPUTER GAME SOFTWARE, COMPUTER GAME CARTRIDGES, INTERACTIVE MULTIMEDIA COMPUTER GAME PROGRAMS; MULTIMEDIA SOFTWARE RECORDED ON CD-ROM FEATURING FICTIONAL STORIES AND CHARACTERS; APPARATUS FOR RECORDING AND/OR REPRODUCING SOUND AND/OR IMAGES AND/OR TEXT AND/OR DATA, NAMELY, AUDIO TAPE RECORDERS, CD PLAYERS, MINI-DISC PLAYERS, DIGITAL MUSIC PLAYERS, MP3 PLAYERS, MOBILE TELEPHONES, PERSONAL DIGITAL ASSISTANTS AND COMPUTER GAME EQUIPMENT CONTAINING MEMORY DEVICES NAMELY, OPTICAL DISCS; LASER DISCS AND DVDS FEATURING FICTIONAL STORIES AND CHARACTERS; ELECTRONIC PUBLICATIONS, NAMELY, BOOKS, BROCHURES, MAGAZINES, BOOKLETS, CATALOGS, NEWSLETTERS, PAMPHLETS, PERIODICALS, PHOTOGRAPHS AND SCRAPBOOKS FEATURING FICTIONAL STORIES AND CHARACTERS RECORDED ON COMPUTER MEDIA; ELECTRONIC PUBLICATIONS, NAMELY, COMIC BOOKS AND COMIC STRIPS FEATURING FICTIONAL STORIES AND CHARACTERS RECORDED ON COMPUTER MEDIA; AUDIO BOOKS ON CASSETTE, COMPACT DISC, COMPUTER DISC, AND DOWNLOADABLE DIGITAL FILES CONTAINING AUDIO BOOKS, ALL FEATURING FICTIONAL STORIES AND CHARACTERS; DOWNLOADABLE ELECTRONIC PUBLICATIONS IN THE NATURE OF BOOKS, BROCHURES, MAGAZINES, BOOKLETS, CATALOGS, NEWSLETTERS, PAMPHLETS, PERIODICALS, PHOTOGRAPHS AND SCRAPBOOKS IN THE FIELD OF FICTION STORIES AND CHARACTERS; MUSICAL SOUND RECORDINGS IN THE FORM OF PHONOGRAPH RECORDS, COMPUTER DISCS, CDS, LASER DISCS, AUDIO TAPES AND DOWNLOADABLE DIGITAL AUDIO FILES FEATURING MUSICAL SOUND RECORDINGS; VIDEO RECORDINGS IN THE FORM OF DISCS AND TAPES FEATURING FICTIONAL STORIES AND CHARACTERS; PRERECORDED VIDEO AND AUDIO CASSETTES, CARTRIDGES, AND DOWNLOADABLE COMPUTER AUDIO FILES FEATURING FICTIONAL STORIES AND CHARACTERS; PHOTOGRAPHIC CAMERAS; ELECTRONIC AGENDAS; ELECTRONIC POCKET TRANSLATORS; TEACHING APPARATUS AND INSTRUMENTS NAMELY, CHILDREN'S EDUCATIONAL SOFTWARE; COMPUTERS; COMPUTER PERIPHERALS; APPARATUS FOR GAMES ADAPTED FOR USE WITH TELEVISION RECEIVERS ONLY, NAMELY, INTERACTIVE VIDEO GAME MACHINES FOR USE WITH TELEVISIONS AND COMPUTER MONITORS; SPECTACLES; SUNGLASSES; MAGNIFYING GLASSES; BINOCULARS; DIRECTIONAL COMPASSES; EYEGGLASS LENSES AND CONTACT LENSES; GOGGLES FOR SPORTS; BREATHING APPARATUS FOR DIVERS, NAMELY, REBREATHERS, SCUBA DIVER'S MASKS, DIVING SUITS; SPECTACLE FRAMES; CHAINS NOT MADE OF PRECIOUS METAL AND CORDS, FOR SPECTACLES; SPECTACLES; CARRYING CASES AND CONTAINERS FOR SPECTACLES, CONTACT LENSES, COMPUTER DISKS, AND COMPACT DISCS; PARTS FOR ALL THE AFORESAID GOODS (U.S. CLS. 21, 23, 26, 36 AND 38).

MARY CRAWFORD, EXAMINING ATTORNEY

ç

CLASS 9—(Continued).

SN 78-784,833. BENNETT, DAWN J., CHEVY CHASE, MD. FILED 1-4-2006.

**DAWN J. BENNETT'S
FAIRYTALE FINANCES**

THE MARK CONSISTS OF STANDARD CHARACTERS WITHOUT CLAIM TO ANY PARTICULAR FONT, STYLE, SIZE, OR COLOR.

NO CLAIM IS MADE TO THE EXCLUSIVE RIGHT TO USE "FINANCES", APART FROM THE MARK AS SHOWN. THE NAME DAWN J. BENNETT IDENTIFIES A LIVING INDIVIDUAL WHOSE CONSENT IS OF RECORD.

FOR PRE-RECORDED VIDEO TAPES AND DISCS FEATURING ADVICE, DISCUSSION AND EDUCATION ON BUSINESS AND FINANCE; PRE-RECORDED AUDIO TAPES AND DISCS FEATURING ADVICE, DISCUSSION AND EDUCATION ON BUSINESS AND FINANCE (U.S. CLS. 21, 23, 26, 36 AND 38).
ASMAT KHAN, EXAMINING ATTORNEY

SN 78-807,649. VOX R&D LIMITED, BLETCHLEY, UNITED KINGDOM, FILED 2-6-2006.

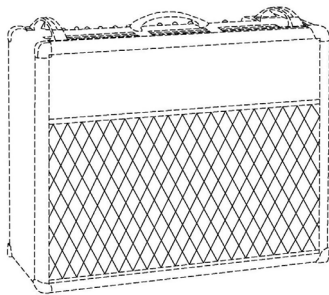

THE MARK CONSISTS OF A REPETITIVE DIAMOND PATTERN ON THE CLOTH SPEAKER GRILL OF A MUSICAL INSTRUMENT AMPLIFIER. THE DOTTED LINES SHOWN ON THE DRAWING ARE FOR PURPOSES OF POSITIONING ONLY AND DO NOT COMPRISE A FEATURE OF THE MARK.

SEC. 2(F).
FOR MUSICAL INSTRUMENT AMPLIFIERS (U.S. CLS. 21, 23, 26, 36 AND 38).
FIRST USE 0-0-1958; IN COMMERCE 0-0-1958.
LEIGH LOWRY, EXAMINING ATTORNEY

CLASS 9—(Continued).

SN 78-814,810. SRS LABS, INC., SANTA ANA, CA. FILED 2-14-2006.

CIRCLE SURROUND AUTOMOTIVE

THE MARK CONSISTS OF STANDARD CHARACTERS WITHOUT CLAIM TO ANY PARTICULAR FONT, STYLE, SIZE, OR COLOR.

OWNER OF U.S. REG. NO. 1,864,599.
NO CLAIM IS MADE TO THE EXCLUSIVE RIGHT TO USE "SURROUND AUTOMOTIVE", APART FROM THE MARK AS SHOWN.

FOR STEREO HEAD UNITS, NAMELY, CAR HEAD UNITS, CD HEAD UNITS, DVD HEAD UNITS, VIDEO COMPACT DISC HEAD UNITS, MP3 HEAD UNITS, SINGLE-DIN HEAD UNITS, DOUBLE-DIN HEAD UNITS, IN-DASH CD, DVD, VIDEO COMPACT DISC, AND MP3 HEAD UNITS, IN-DASH CD, DVD, VIDEO COMPACT DISC; AND MP3 PLAYER HEAD UNITS, SATELLITE RADIO HEAD UNITS AND ND RADIO HEAD UNITS; IN-DASH CAR CD, DVD, VIDEO COMPACT DISC, AND MP3 CAR STEREO; CD, DVD, VIDEO COMPACT DISC, AND MP3 DECK; DIGITAL MEDIA CAR PLAYERS; MOBILE MULTIMEDIA CONTROLS FOR AN AUTOMOTIVE ENTERTAINMENT SYSTEM, NAMELY, STEREO AND VIDEO MONITORS AND SPEAKERS; RECEIVERS, NAMELY, DIGITAL AUDIO RECEIVERS, CD RECEIVERS, IN-DASH CD, DVD, VIDEO COMPACT DISC, AND MP3 RECEIVERS AND AM/FM RECEIVERS; CAR AUDIO SYSTEMS, NAMELY, CAR AUDIO CD, DVD, VIDEO COMPACT DISC, AND MP3 SYSTEMS; CAR AUDIO PLAYERS; CD, DVD, VIDEO COMPACT DISC, AND MP3 CAR STEREO; RADIO TUNERS; CD, DVD, VIDEO COMPACT DISC, AND MP3 PLAYERS; AMPLIFIERS, NAMELY, CAR POWER AMPLIFIERS AND AUDIO AMPLIFIERS; DIGITAL PREAMPLIFIERS; AMPLIFIER PROCESSORS; AMPLIFIER EQUALIZERS; AMPLIFIER CROSSOVERS; REAR SEAT ENTERTAINMENT SYSTEMS, NAMELY, DVD, VIDEO COMPACT DISCS, CD, MP3, DIGITAL MEDIA PLAYERS, AND VIDEO DISPLAY AND AUDIO PLAYBACK SYSTEMS; FAMILY ENTERTAINMENT SYSTEMS, NAMELY, DVD, VIDEO COMPACT DISC, CD, MP3, DIGITAL MEDIA PLAYERS, AND VIDEO DISPLAY AND AUDIO PLAYBACK SYSTEMS; REAR SEAT VIDEO SYSTEMS, NAMELY, DVD, VIDEO COMPACT DISC, (SD, MP3, DIGITAL MEDIA PLAYERS, AND VIDEO DISPLAY AND AUDIO PLAY SYSTEMS; REAR SEAT VIDEO SYSTEMS, NAMELY, DVD, VIDEO COMPACT DISC, CD, MP3, DIGITAL MEDIA PLAYERS, AND VIDEO DISPLAY AND AUDIO PLAY BACK SYSTEMS; HEADREST DISPLAYS; CONSOLE ENTERTAINMENT SYSTEMS, NAMELY, MULTIMEDIA PLAYBACK SYSTEMS WHICH INCLUDE DVD, VIDEO COMPACT DISC, CD, MP3, DIGITAL MEDIA AND CASSETTE PLAYER SYSTEMS, NAVIGATION SYSTEMS, VIDEO DISPLAY AND AUDIO PLAYBACK SYSTEMS, AND RADIO RECEIVERS; APPARATUS FOR USE IN PROCESSING AUDIO ELECTRONIC SIGNALS TO CREATE AN ENHANCED AUDIO IMAGE FROM PLAYBACK OF THE AUDIO SIGNALS THROUGH SPEAKERS; SOFTWARE FOR USE IN PROCESSING OR RECORDING ANALOG OR DIGITAL ELECTRONIC SIGNALS FOR USE IN THE AUDIO OR AUDIO-VISUAL FIELDS (U.S. CLS. 21, 23, 26, 36 AND 38).
KELLY CHOE, EXAMINING ATTORNEY

CLASS 9—(Continued).

SN 78-822,042. TRIDENT MICROSYSTEMS, INC., SUNNYVALE, CA. FILED 2-23-2006.

PCM

THE MARK CONSISTS OF STANDARD CHARACTERS WITHOUT CLAIM TO ANY PARTICULAR FONT, STYLE, SIZE, OR COLOR.

FOR COMPUTER HARDWARE; INTEGRATED CHIPS FOR USE IN TELEVISIONS FOR COLOR RESOLUTION IMPROVEMENT; COMPUTER SOFTWARE FOR IMPROVING COLOR RESOLUTION IN TELEVISIONS. (U.S. CLS. 21, 23, 26, 36 AND 38).

LOURDES AYALA, EXAMINING ATTORNEY

CLASS 9—(Continued).

SN 78-838,259. HYTWO, LLC, COHOES, NY. FILED 3-15-2006.

Thrust

THE MARK CONSISTS OF STANDARD CHARACTERS WITHOUT CLAIM TO ANY PARTICULAR FONT, STYLE, SIZE, OR COLOR.

FOR ANTENNAS; APPARATUS FOR CONVERTING ELECTRONIC RADIATION TO ELECTRICAL ENERGY, NAMELY PHOTOVOLTAIC SOLAR MODULES; APPARATUS FOR CONVERTING ELECTRONIC RADIATION TO ELECTRICAL ENERGY, NAMELY PHOTOVOLTAIC SOLAR-THERMAL HYBRID MODULES; APPARATUS FOR TESTING GAS, LIQUIDS AND SOLIDS; BULLET-PROOF VESTS AND CLOTHING; CARBON DIOXIDE DETECTORS; CARBON NANO TUBES, NAMELY, TUBULAR CARBON MOLECULES USED IN EXTREMELY SMALL SCALE ELECTRONIC AND MECHANICAL APPLICATIONS; CENTRAL PROCESSING UNIT (CPU) COOLERS; CENTRAL PROCESSING UNIT (CPU) FANS; CONDUCTIVE FIBERS, NAMELY, FIBERS FOR CONDUCTING ELECTRICAL CHARGES AND STATIC ELECTRICAL CHARGES; CONVERTERS; ELECTRIC CAPACITORS; ELECTRIC CONTROL DEVICES FOR HEATING AND ENERGY MANAGEMENT; ELECTRIC CONVERTERS; ELECTRIC RESISTORS; ELECTRIC WIRES AND CABLES; ELECTRIC, ELECTRONIC OR ELECTROCHEMICAL OXYGEN MONITORS AND SENSORS FOR ENVIRONMENTAL USE; ELECTRICAL RESISTANCE HEATING WIRES AND ELECTRICAL CONTROLLERS THEREFOR; ELECTRODES; ELECTROLYSERS; ELECTRONIC MEMORIES; ELECTRONIC SEMI-CONDUCTORS; GRAPHITE ELECTRODES; HEAT SINKS FOR USE IN COMPUTERS; INSTRUMENTS FOR DETECTING AND MEASURING TWO-DIMENSIONAL DISTRIBUTION OF FORCE AND PRESSURE; INTERNAL COOLING FANS FOR COMPUTERS; LABORATORY FILTERS; LIQUID CRYSTAL DISPLAY (LCD) PROJECTORS; LIQUID CRYSTAL DISPLAYS; NANO TUBES, NAMELY, TUBULAR CARBON MOLECULES USED IN EXTREMELY SMALL SCALE ELECTRONIC AND MECHANICAL APPLICATIONS; PHOTOMETERS; POLLUTANT SENSORS; QUANTUM DOTS, NAMELY, CRYSTALLINE SEMI-CONDUCTOR MATERIAL; SOLAR HEAT COLLECTION PANELS; STRUCTURED SEMI-CONDUCTOR WAFERS; TEMPERATURE CONTROLLER FOR CONTROLLING TEMPERATURE OF MEDICAL INSTRUMENTS AND CONTAINERS FOR MEDICAL FLUIDS; TEMPERATURE CONTROLLERS FOR WARMING AND COOLING MEDICAL AND SURGICAL LIQUIDS EQUIPMENT AND INSTRUMENTS; TEMPERATURE INDICATORS; TEMPERATURE SENSORS; TEMPERATURE SENSORS USED IN THE MEDICAL FIELD TO MEASURE TEMPERATURE OF MEDICAL SOLUTIONS; TRANSFORMERS; TRANSISTORS (U.S. CLS. 21, 23, 26, 36 AND 38).

FRED CARL, EXAMINING ATTORNEY

SN 78-835,517. NEW GENERATION COMPUTING, INC., MIAMI LAKES, FL. FILED 3-13-2006.

IT Realized

THE MARK CONSISTS OF STANDARD CHARACTERS WITHOUT CLAIM TO ANY PARTICULAR FONT, STYLE, SIZE, OR COLOR.

NO CLAIM IS MADE TO THE EXCLUSIVE RIGHT TO USE "IT", APART FROM THE MARK AS SHOWN.

FOR APPAREL INDUSTRY COMPUTER SOFTWARE FOR APPAREL PRODUCTION AND MACHINE CONTROL, INVENTORY MANAGEMENT, ACCOUNTS RECEIVABLES, ACCOUNT PAYABLES, GLOBAL SOURCING AND VISIBILITY SYSTEMS, PRODUCT LIFE CYCLE MANAGEMENT, ENTERPRISE RESOURCE MANAGEMENT SYSTEMS AND MARKETING, OR A COMBINATION THEREOF (U.S. CLS. 21, 23, 26, 36 AND 38).

FIRST USE 3-13-2006; IN COMMERCE 3-13-2006.
MATTHEW PAPPAS, EXAMINING ATTORNEY

CLASS 9—(Continued).

SN 78-849,978. KABUSHIKI KAISHA HITACHI HIGH-TECHNOLOGIES, D/B/A HITACHI HIGH TECHNOLOGIES CORPORATION, TOKYO, JAPAN, FILED 3-30-2006.

nanoDUE'T

THE MARK CONSISTS OF STANDARD CHARACTERS WITHOUT CLAIM TO ANY PARTICULAR FONT, STYLE, SIZE, OR COLOR.

FOR SCANNING ELECTRON MICROSCOPES; SCANNING TRANSMISSION ELECTRON MICROSCOPES; FOCUSED ION BEAM SYSTEM FOR THE DESIGN, INSPECTION AND MANUFACTURE OF SEMICONDUCTORS; COMPATIBLE SPECIMEN HOLDERS FOR SCANNING ELECTRON MICROSCOPES; SCANNING TRANSMISSION ELECTRON MICROSCOPES; SCANNING TRANSMISSION ELECTRON MICROSCOPES, AND FOCUSED ION BEAM SYSTEMS; ELECTRONIC DEVICES TO INTEGRATE FOCUSED ION BEAM SYSTEMS WITH A SCANNING TRANSMISSION ELECTRON MICROSCOPE OR A TRANSMISSION ELECTRON MICROSCOPE FOR THE DESIGN, INSPECTION AND MANUFACTURE OF SEMICONDUCTORS (U.S. CLS. 21, 23, 26, 36 AND 38).

ALYSSA PALADINO, EXAMINING ATTORNEY

SN 78-850,729. VIMICRO CORPORATION, BEIJING, CHINA, FILED 3-30-2006.

VINNO

THE MARK CONSISTS OF STANDARD CHARACTERS WITHOUT CLAIM TO ANY PARTICULAR FONT, STYLE, SIZE, OR COLOR.

FOR INTEGRATED CIRCUITS FOR PROVIDING MULTIMEDIA FUNCTIONS (U.S. CLS. 21, 23, 26, 36 AND 38).

CHRISTINE COOPER, EXAMINING ATTORNEY

CLASS 9—(Continued).

SN 78-854,360. HOOPS L. P., MEMPHIS, TN. FILED 4-5-2006.



OWNER OF U.S. REG. NOS. 2,861,210, 3,056,500 AND OTHERS.

NO CLAIM IS MADE TO THE EXCLUSIVE RIGHT TO USE "MEMPHIS", APART FROM THE MARK AS SHOWN. THE MARK CONSISTS OF A PICTURE OF A BEAR'S HEAD.

FOR AUDIO RECORDINGS AND VIDEO RECORDINGS IN THE FIELD OF BASKETBALL; AUDIO, VIDEO, COMPUTER AND LASER DISCS, PRE-RECORDED AUDIO AND VIDEO CASSETTES, PRE-RECORDED AUDIO AND VIDEO TAPES, PRE-RECORDED COMPACT DISCS, PRE-RECORDED COMPUTER DISCS, ALL RELATED TO BASKETBALL; COMPUTER ACCESSORIES, NAMELY MOUSE PADS, MICE, DISC CASES, COMPUTER CARRY-ON CASES, KEYBOARD WRIST PADS, COMPUTER MONITOR CARDBOARD FRAMES, ALL RELATED TO BASKETBALL; COMPUTER PROGRAMS FOR VIEWING INFORMATION, STATISTICS OR TRIVIA ABOUT BASKETBALL; COMPUTER SOFTWARE, NAMELY SCREEN SAVERS FEATURING BASKETBALL THEMES, COMPUTER SOFTWARE TO ACCESS AND VIEW COMPUTER WALLPAPER, COMPUTER BROWSERS, COMPUTER SKINS AND COMPUTER CURSORS; COMPUTER GAME SOFTWARE; VIDEO GAME SOFTWARE, VIDEO GAME CARTRIDGES AND VIDEO GAME MACHINES FOR USE WITH TELEVISIONS; WIRELESS TELEPHONES; RADIOS, TELEPHONES, AND CELL PHONE ACCESSORIES, NAMELY FACE PLATES AND CELL PHONE COVERS; VIDEO MONITORS, COMPUTER MONITORS, BINOCULARS; SUNGLASSES; EYEGLASS FRAMES; EYEWEAR STRAPS AND CHAINS; EYEGLASS AND SUNGLASS CASES; MAGNETS; DISPOSABLE CAMERAS; CREDIT CARDS AND PRE-PAID TELEPHONE CALLING CARDS MAGNETICALLY ENCODED, DOWNLOADABLE VIDEO RECORDINGS, VIDEO STREAM RECORDINGS, AND AUDIO RECORDINGS IN THE FIELD OF BASKETBALL PROVIDED OVER THE INTERNET; DOWNLOADABLE COMPUTER SOFTWARE FOR VIEWING DATABASES OF INFORMATION, STATISTICAL INFORMATION, TRIVIA, POLLING INFORMATION, AND INTERACTIVE POLLING IN THE FIELD OF BASKETBALL PROVIDED OVER THE INTERNET; DOWNLOADABLE COMPUTER GAME SOFTWARE; VIDEO GAME PROGRAMS, INTERACTIVE VIDEO GAMES AND TRIVIA GAME SOFTWARE PROVIDED OVER THE INTERNET; DOWNLOADABLE COMPUTER SOFTWARE FOR USE AS SCREENSAVERS, WALLPAPER, BROWSERS, SKINS, AVATARS AND CURSORS OVER THE INTERNET; DOWNLOADABLE ELECTRONIC PUBLICATIONS IN THE NATURE OF MAGAZINES, NEWSLETTERS, COLORING BOOKS, GAME SCHEDULES ALL IN THE FIELD OF BASKETBALL PROVIDED OVER THE INTERNET; DOWNLOADABLE CATALOGS PROVIDED OVER THE INTERNET FEATURING AN ARRAY OF BASKETBALL-THEMED PRODUCTS (U.S. CLS. 21, 23, 26, 36 AND 38).

JOHN SCHUYLER YARD, EXAMINING ATTORNEY

CLASS 9—(Continued).

SN 78-863,088. UNIVERSAL DE DESARROLLOS ELECTRONICOS, S.A., TERASSA, BARCELONA, SPAIN, FILED 4-17-2006.

WONDERFUL '50s

THE MARK CONSISTS OF STANDARD CHARACTERS WITHOUT CLAIM TO ANY PARTICULAR FONT, STYLE, SIZE, OR COLOR.

PRIORITY CLAIMED UNDER SEC. 44(D) ON ERPN CMNTY TM OFC APPLICATION NO. 4973673, FILED 3-22-2006, REG. NO. 4973673, DATED 5-3-2007, EXPIRES 3-22-2016.

FOR SLOT MACHINES (U.S. CLS. 21, 23, 26, 36 AND 38).

BRIAN PINO, EXAMINING ATTORNEY

SN 78-865,144. SMAKTONES, STUDIO CITY, CA. FILED 4-19-2006.



THE COLOR(S) BLACK, WHITE, GRAY, GREEN, GOLD, PURPLE AND ORANGE IS/ARE CLAIMED AS A FEATURE OF THE MARK.

THE MARK CONSISTS OF THE WORDING SMAKTONES IN WHITE LETTERING AND A DESIGN OF A FACE WEARING SUNGLASSES. THE OUTER EDGE OF THE FACE DESIGN IS A THIN LINE OF GRAY AND A THIN LINE OF BLACK. THE FACE IS GREEN, THE SUNGLASS FRAME IS GOLD AND OUTLINED IN BLACK. THE TOP PART OF THE LENS IS PURPLE AND THE LOWER PART OF THE LENS IS ORANGE. THE MOUTH AND NOSE IS BLACK. THE RECTANGULAR BACKGROUND IS BLACK.

FOR DOWNLOADABLE RING TONES AND WALL-PAPER GRAPHICS VIA THE INTERNET AND WIRELESS DEVICES FOR USE ON CELLULAR TELEPHONES (U.S. CLS. 21, 23, 26, 36 AND 38).

WENDY GOODMAN, EXAMINING ATTORNEY

SN 78-869,285. H2SCAN CORPORATION, VALENCIA, CA. FILED 4-25-2006.

H2SCAN

THE MARK CONSISTS OF STANDARD CHARACTERS WITHOUT CLAIM TO ANY PARTICULAR FONT, STYLE, SIZE, OR COLOR.

FOR HYDROGEN SENSING SYSTEMS COMPRISED OF HYDROGEN DETECTORS, SENSORS AND MONITORS FOR COMMERCIAL AND INDUSTRIAL USE (U.S. CLS. 21, 23, 26, 36 AND 38).

FIRST USE 0-0-1998; IN COMMERCE 0-0-1999.

RONALD MCMORROW, EXAMINING ATTORNEY

CLASS 9—(Continued).

SN 78-875,061. WESTERMARCK, JOEL C., LAUDERHILL, FL. FILED 5-3-2006.

TeleMonitor

THE MARK CONSISTS OF STANDARD CHARACTERS WITHOUT CLAIM TO ANY PARTICULAR FONT, STYLE, SIZE, OR COLOR.

FOR ELECTRONIC COMMUNICATIONS DEVICE COMPRISED OF DEDICATED SPECIAL PURPOSE MODEMS FOR UPLOADING GLUCOSE OR BLOOD SUGAR DATA AND OTHER MEDICAL INFORMATION RECEIVED FROM WEIGHT SCALES, PEDOMETERS, BLOOD GLUCOSE METERS, BLOOD SUGAR MONITORS AND BLOOD PRESSURE MONITORS (U.S. CLS. 21, 23, 26, 36 AND 38).

FIRST USE 4-1-2006; IN COMMERCE 4-10-2006.

AMY MCMENAMIN, EXAMINING ATTORNEY

SN 78-875,888. CEPIA LLC, ST. LOUIS, MO. FILED 5-3-2006.

COLOR PULSE

THE MARK CONSISTS OF STANDARD CHARACTERS WITHOUT CLAIM TO ANY PARTICULAR FONT, STYLE, SIZE, OR COLOR.

NO CLAIM IS MADE TO THE EXCLUSIVE RIGHT TO USE "COLOR", APART FROM THE MARK AS SHOWN.

FOR STORAGE RACKS SPECIALLY ADAPTED FOR AUDIO AND VISUAL MEDIA ENHANCED BY RED-GREEN-BLUE (RGB) LIGHTING; CASES FOR CELLULAR PHONES, PAGERS, AND DIGITAL VIDEO AND DIGITAL AUDIO PLAYERS ENHANCED BY RGB LIGHTING; ELECTRONIC DOCKING STATIONS FOR DIGITAL VIDEO AND DIGITAL AUDIO PLAYERS ENHANCED BY RGB LIGHTING; ELECTRIC LUMINESCENT DISPLAY PANELS; LCD PANELS; LIGHTING CONTROL PANELS (U.S. CLS. 21, 23, 26, 36 AND 38).

DAVID YONTEF, EXAMINING ATTORNEY

CLASS 9—(Continued).

SN 78-879,931. ATLANTA HOCKEY CLUB, LLC, ATLANTA, GA. FILED 5-9-2006.

SCORE FOR SCHOOLS

THE MARK CONSISTS OF STANDARD CHARACTERS WITHOUT CLAIM TO ANY PARTICULAR FONT, STYLE, SIZE, OR COLOR.

FOR DVDS, CDS, AND VIDEO TAPE RECORDINGS FEATURING EDUCATIONAL PROGRAMS AND THE PROMOTION OF SUCH EDUCATIONAL PROGRAMS; CAMERAS; PORTABLE AND HANDHELD DIGITAL ELECTRONIC DEVICES AND SOFTWARE FOR RECORDING, ORGANIZING, TRANSMITTING, MANIPULATING, AND REVIEWING TEXT, DATA, AUDIO, IMAGE, AND VIDEO FILES; SOFTWARE FOR USE IN TEACHING; COMPUTER GAME SOFTWARE AND PROGRAMS; JOYSTICKS; DIGITAL VIDEO GAMES, VIDEO GAMES SOFTWARE AND CARTRIDGES; DIGITAL VIDEO GAMES RECORDER; DOWNLOADABLE AUDIO, SPOKEN WORD, VIDEO RECORDINGS AND MEDIA CONTENT FEATURING MUSIC, GAME, AND EDUCATIONAL PROGRAMS AND THE PROMOTION OF SUCH EDUCATIONAL PROGRAMS, ALL FOR USE ON COMPUTER OR OTHER MEDIA PLAYER (U.S. CLS. 21, 23, 26, 36 AND 38).

ZACHARY BELLO, EXAMINING ATTORNEY

SN 78-880,553. EARTHSEARCH COMMUNICATIONS, INC., MARIETTA, GA. FILED 5-10-2006.

Technology That Delivers

THE MARK CONSISTS OF STANDARD CHARACTERS WITHOUT CLAIM TO ANY PARTICULAR FONT, STYLE, SIZE, OR COLOR.

FOR COMPUTER SOFTWARE AND HARDWARE DEVICES IN THE NATURE OF MOVEMENT SENSORS, ELECTRIC NAVIGATIONAL INSTRUMENTS, NAMELY, ELECTRONIC NAVIGATIONAL SYSTEMS, NAMELY, A GLOBAL POSITIONING SYSTEM (GPS) PROVIDING MOTOR VEHICLE LOCATION, FOR PROVIDING MOTOR VEHICLE FLEET MANAGEMENT DATA REPORTING; COMPUTER SOFTWARE AND HARDWARE DEVICES FOR MOTOR VEHICLE THEFT PREVENTION, NAMELY, MOVEMENT SENSORS, REMOTE CONTROLS, USED FOR DOOR LOCKING/UNLOCKING AND REMOTE CONTROLS USED FOR DISABLING OR MOTOR VEHICLES; ELECTRIC NAVIGATIONAL INSTRUMENTS, NAMELY, ELECTRONIC SATELLITE NAVIGATIONAL SYSTEMS, NAMELY, A GLOBAL POSITIONING SYSTEM (GPS) PROVIDING DRIVING DIRECTIONS AND MOTOR VEHICLE LOCATION; AND COMPUTER SOFTWARE AND HARDWARE DEVICES IN THE NATURE OF MOVEMENT SENSORS AND REMOTE VEHICLE OPERATING SENSORS FOR MOTOR VEHICLE SPEED MONITORING (U.S. CLS. 21, 23, 26, 36 AND 38).

MICHAEL LEWIS, EXAMINING ATTORNEY

CLASS 9—(Continued).

SN 78-890,318. REMEND INC., SAN MATEO, CA. FILED 5-23-2006.



FOR COMPUTER SOFTWARE FOR MANAGING AND DISTRIBUTING DATA, DOCUMENTS, INTERNAL AND EXTERNAL COMMUNICATIONS, PARTNER RELATIONSHIPS, VENDOR RELATIONSHIPS AND REPORTING IN THE FIELD OF FINANCIAL AND MORTGAGE LENDING SERVICES (U.S. CLS. 21, 23, 26, 36 AND 38).
FIRST USE 12-1-2001; IN COMMERCE 12-1-2001.
GIANCARLO CASTRO, EXAMINING ATTORNEY

SN 78-897,844. AMERICAN SOCIETY OF ANESTHESIOLOGISTS, INC., WASHINGTON, DC. FILED 6-1-2006.

Reverse CROSSWALK

THE MARK CONSISTS OF STANDARD CHARACTERS WITHOUT CLAIM TO ANY PARTICULAR FONT, STYLE, SIZE, OR COLOR.

OWNER OF U.S. REG. NO. 2,004,932.
NO CLAIM IS MADE TO THE EXCLUSIVE RIGHT TO USE "REVERSE", APART FROM THE MARK AS SHOWN.
SEC. 2(F) AS TO "CROSSWALK".
FOR PRE-RECORDED CDS FEATURING MEDICAL CODES USED FOR BILLING PURPOSES (U.S. CLS. 21, 23, 26, 36 AND 38).
FIRST USE 1-0-2003; IN COMMERCE 1-0-2003.
MELISSA VALLILLO, EXAMINING ATTORNEY

SN 78-899,857. SEMISOUTH LABORATORIES, INC., STARKVILLE, MS. FILED 6-3-2006.

DREAMFET

THE MARK CONSISTS OF STANDARD CHARACTERS WITHOUT CLAIM TO ANY PARTICULAR FONT, STYLE, SIZE, OR COLOR.

FOR POWER SWITCHES; TRANSISTORS (U.S. CLS. 21, 23, 26, 36 AND 38).
FIRST USE 5-1-2006; IN COMMERCE 5-1-2006.
DARRYL SPRUILL, EXAMINING ATTORNEY

CLASS 9—(Continued).

SN 78-910,317. ASPYR MEDIA, INC., AUSTIN, TX. FILED 6-16-2006.

GAMERHOOD

THE MARK CONSISTS OF STANDARD CHARACTERS WITHOUT CLAIM TO ANY PARTICULAR FONT, STYLE, SIZE, OR COLOR.

FOR COMPUTER SOFTWARE, NAMELY, DOWNLOADABLE SOFTWARE FOR COMPUTER GAMES PROVIDED VIA THE INTERNET, PEER TO PEER NETWORKS, WIDE AREA NETWORKS, LOCAL AREA NETWORKS, VIRTUAL PRIVATE NETWORKS, AND GLOBAL COMPUTER NETWORKS; COMPUTER GAME SOFTWARE; COMPUTER GAME PROGRAMS; VIDEO GAME SOFTWARE; COMPUTER PERIPHERALS AND COMPUTER GAME SOFTWARE FOR COMPUTER, VIDEO AND ELECTRONIC GAMES (U.S. CLS. 21, 23, 26, 36 AND 38).

KATHERINE M. DUBRAY, EXAMINING ATTORNEY

CLASS 9—(Continued).

SN 78-911,148. INTELLIGENT DECISIONS, INC., ASHBURN, VA. FILED 6-19-2006.

iDEdge
SERVER

OWNER OF U.S. REG. NO. 2,783,294.
NO CLAIM IS MADE TO THE EXCLUSIVE RIGHT TO USE "SERVER", APART FROM THE MARK AS SHOWN.

THE MARK CONSISTS OF STYLIZED WORDS "ID EDGE SERVER".

FOR RACKMOUNT OR TOWER DESIGNED NETWORK ACCESS SERVER HARDWARE CONSISTING OF INDUSTRY AND COMMERCIAL STANDARD INTEGRATED CIRCUITS (U.S. CLS. 21, 23, 26, 36 AND 38).

SOPHIA S. KIM, EXAMINING ATTORNEY

SN 78-912,781. USA TECHNOLOGIES, INC., MALVERN, PA. FILED 6-20-2006.

SN 78-911,061. TEAM UTILITY SERVICES, INC., MAPLE GROVE, MN. FILED 6-19-2006.



NO CLAIM IS MADE TO THE EXCLUSIVE RIGHT TO USE "MEDICAL", APART FROM THE MARK AS SHOWN.

THE COLOR(S) BLUE AND BLACK IS/ARE CLAIMED AS A FEATURE OF THE MARK.

THE COLOR BLUE APPEARS IN THE WORD CENBION AND THE GLOBE DEVICE, AND THE COLOR BLACK APPEARS IN THE WORDING PUTTING INVENTORY IN ITS PLACE AND MEDICAL.

FOR COMPUTER SOFTWARE FOR THE MEDICAL INDUSTRY, NAMELY, COMPUTER SOFTWARE FOR PRODUCT SUPPLY CHAIN AND INVENTORY MANAGEMENT FOR CARDIAC CATHETERIZATION, ELECTROPHYSIOLOGY AND RADIOLOGY LABS (U.S. CLS. 21, 23, 26, 36 AND 38).

FIRST USE 1-15-2006; IN COMMERCE 1-15-2006.
KATHERINE CHANG, EXAMINING ATTORNEY

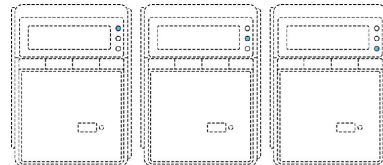

THE COLOR(S) BLUE IS/ARE CLAIMED AS A FEATURE OF THE MARK.

THE MARK CONSISTS OF A SEQUENCE OF THREE VERTICAL BLUE LED LIGHTS, ILLUMINATED IN DESCENDING SEQUENCE AND THEN REPEATING IN DESCENDING SEQUENCE, PLACED CONSPICUOUSLY ON THE FRONT OF THE GOODS. THE MATTER SHOWN BY THE DOTTED LINES IS NOT PART OF THE MARK AND SERVES ONLY TO SHOW THE POSITION OF THE MARK ON THE GOODS.

FOR ELECTRONIC FEE INTAKE CONTROLLERS USED FOR OPERATING ONE OR MORE DEVICES, NAMELY, VENDING MACHINES, COMPUTERS, COMPUTER PERIPHERALS, FAX MACHINES, COPIERS, BEVERAGE DISPENSER, OR FOOD DISPENSERS WITH MAGNETIC CARDS, SMART CARDS, OR RFID CARDS; INTEGRATED VENDING MACHINES AND VENDING MACHINE CONTROLLERS OPERATED WITH MAGNETIC CARDS, SMART CARDS, OR RFID CARDS (U.S. CLS. 21, 23, 26, 36 AND 38).

FIRST USE 3-22-2006; IN COMMERCE 3-22-2006.
STEVEN R. FOSTER, EXAMINING ATTORNEY

CLASS 9—(Continued).

SN 78-922,414. GARMIN LTD., GEORGE TOWN, CAYMAN ISLANDS, FILED 7-5-2006.

HotFix

THE MARK CONSISTS OF STANDARD CHARACTERS WITHOUT CLAIM TO ANY PARTICULAR FONT, STYLE, SIZE, OR COLOR.

FOR COMPUTER SOFTWARE, NAMELY AN APPLICATION ALLOWING ENHANCED SATELLITE ACQUISITION, SOLD AS A COMPONENT PART OF A GLOBAL POSITIONING SYSTEM (GPS) (U.S. CLS. 21, 23, 26, 36 AND 38).

AMOS T. MATTHEWS, JR., EXAMINING ATTORNEY

SN 78-923,094. TFM ENTERTAINMENT, LLC., ATLANTA, GA. FILED 7-5-2006.

kanga kidz

THE MARK CONSISTS OF STANDARD CHARACTERS WITHOUT CLAIM TO ANY PARTICULAR FONT, STYLE, SIZE, OR COLOR.

NO CLAIM IS MADE TO THE EXCLUSIVE RIGHT TO USE "KIDS", APART FROM THE MARK AS SHOWN.

FOR AUDIO DIGITAL TAPES FEATURING INSPIRATIONAL AND MOTIVATIONAL SONGS; AUDIO TAPES FEATURING INSPIRATIONAL AND MOTIVATIONAL SONGS; CHILDREN'S EDUCATIONAL MUSIC CDS AND DVDS; CHILDREN'S VIDEO TAPES; COMPUTER GAME TAPES; DOWNLOADABLE MOTION PICTURES AND TV SHOWS ABOUT INSPIRATIONAL AND MOTIVATIONAL SUBJECT MATTERS FOR CHILDREN; DOWNLOADABLE MULTIMEDIA FILE CONTAINING ARTWORK, TEXT, AUDIO, VIDEO, GAMES, AND INTERNET WEB LINKS RELATING TO INSPIRATIONAL AND MOTIVATIONAL SONGS AND GAMES; DVDS FEATURING INSPIRATIONAL AND MOTIVATIONAL SINGERS AND PLAY ACTING PERFORMANCES; PRE-RECORDED CD'S, VIDEO TAPES, LASER DISKS AND DVD'S FEATURING INSPIRATIONAL AND MOTIVATIONAL SONGS AND MUSIC; PRERECORDED AUDIO TAPES FEATURING INSPIRATIONAL AND MOTIVATIONAL SONGS; PRERECORDED DIGITAL AUDIO TAPE FEATURING INSPIRATIONAL AND MOTIVATIONAL SONGS; PRERECORDED VIDEO TAPES FEATURING INSPIRATIONAL AND MOTIVATIONAL PERFORMERS; TRADING CARD CD'S; VIDEO TAPES FEATURING INSPIRATIONAL AND MOTIVATIONAL SINGERS AND ACTING PERFORMANCES (U.S. CLS. 21, 23, 26, 36 AND 38).

FIRST USE 7-1-2006; IN COMMERCE 7-1-2006.

IRENE D. WILLIAMS, EXAMINING ATTORNEY

CLASS 9—(Continued).

SN 78-923,603. GROUP 1 SOFTWARE INC., LANHAM, MD. FILED 7-6-2006.



OWNER OF U.S. REG. NOS. 1,393,103 AND 1,518,711.
NO CLAIM IS MADE TO THE EXCLUSIVE RIGHT TO USE "SOFTWARE", APART FROM THE MARK AS SHOWN.
FOR PRE-RECORDED COMPUTER PROGRAMS FOR USE IN DATA RECEIPT AND DELIVERY, MANAGEMENT AND INTEGRATION, DATABASE TECHNOLOGY FOR BUSINESS SOLUTIONS AND PROCESS OUTSOURCING, CUSTOMER COMMUNICATION AND INSTRUCTION MANUALS SOLD AS A UNIT (U.S. CLS. 21, 23, 26, 36 AND 38).

FIRST USE 4-25-1985; IN COMMERCE 4-25-1985.
MELISSA VALLILLO, EXAMINING ATTORNEY

SN 78-923,846. INFOLOGIX, INC., BENSALEM, PA. FILED 7-6-2006.



FOR COMPUTER SOFTWARE FOR USE IN DATABASE MANAGEMENT FOR HEALTHCARE FACILITIES TO IMPROVE WORKFLOW EFFICIENCIES RELATED TO ASSETS AND PERSONNEL, AND TO PROVIDE HEALTHCARE MANAGEMENT BETTER VISIBILITY OF THE LOCATION AND MOVEMENT OF ASSETS THROUGHOUT THE HEALTHCARE FACILITY AND HEALTHCARE WORKFLOW (U.S. CLS. 21, 23, 26, 36 AND 38).

MELISSA VALLILLO, EXAMINING ATTORNEY

SN 78-924,062. AIRPAX CORPORATION LLC, FREDERICK, MD. FILED 7-6-2006.

E-PLEX

THE MARK CONSISTS OF STANDARD CHARACTERS WITHOUT CLAIM TO ANY PARTICULAR FONT, STYLE, SIZE, OR COLOR.

FOR ELECTRIC POWER DISTRIBUTION CONTROL AND MONITORING SYSTEMS COMPRISING USER INTERFACE MODULES, POWER DISTRIBUTION MODULES, MACHINE INTERFACE MODULES, SENSORS, AND SOFTWARE (U.S. CLS. 21, 23, 26, 36 AND 38).

FIRST USE 0-0-1999; IN COMMERCE 0-0-1999.

GINA HAYES, EXAMINING ATTORNEY

CLASS 9—(Continued).

SN 78-924,139. CARD, MICHAEL P, SYRACUSE, NY. FILED 7-7-2006.

Sapphire

THE MARK CONSISTS OF STANDARD CHARACTERS WITHOUT CLAIM TO ANY PARTICULAR FONT, STYLE, SIZE, OR COLOR.

FOR DATABASE MANAGEMENT SOFTWARE FOR GENERAL USE (U.S. CLS. 21, 23, 26, 36 AND 38).
MICHAEL SOUDERS, EXAMINING ATTORNEY

SN 78-925,650. IP CARRIER CONSULTING GROUP, INC., PIPERSVILLE, PA. FILED 7-10-2006.

p-Mobile

THE MARK CONSISTS OF STANDARD CHARACTERS WITHOUT CLAIM TO ANY PARTICULAR FONT, STYLE, SIZE, OR COLOR.

FOR SOFTWARE FOR ENABLING THE REFORMATTING AND TRANSMISSION OF DIGITAL CONTENT (U.S. CLS. 21, 23, 26, 36 AND 38).

ALEXANDER L. POWERS, EXAMINING ATTORNEY

SN 78-928,031. COLE-PARMER INSTRUMENT COMPANY, VERNON HILLS, IL. FILED 7-12-2006.

ECTESTRS

THE MARK CONSISTS OF STANDARD CHARACTERS WITHOUT CLAIM TO ANY PARTICULAR FONT, STYLE, SIZE, OR COLOR.

OWNER OF U.S. REG. NOS. 2,422,829, 2,970,178 AND OTHERS.

SEC. 2(F).

FOR INSTRUMENTS FOR MEASURING CONDUCTIVITY IN SCIENTIFIC AND LABORATORY ENVIRONMENTS (U.S. CLS. 21, 23, 26, 36 AND 38).

FIRST USE 4-0-2000; IN COMMERCE 4-0-2000.

JOANNA DUKOVIC, EXAMINING ATTORNEY

CLASS 9—(Continued).

SN 78-928,166. DRS TEST & ENERGY MANAGEMENT, INC., HUNTSVILLE, AL. FILED 7-12-2006.

SCATE

THE MARK CONSISTS OF STANDARD CHARACTERS WITHOUT CLAIM TO ANY PARTICULAR FONT, STYLE, SIZE, OR COLOR.

FOR ELECTRONIC TEST AND MEASUREMENT DEVICES FOR TESTING THE PERFORMANCE OF ELECTRONIC WEAPON SYSTEM COMPONENTS AND THEIR COMMERCIAL EQUIVALENTS, FOR TRACKING PREVENTATIVE MAINTENANCE REQUIREMENTS, AND COMPUTER HARDWARE AND SOFTWARE FOR USE IN STORING AND RETRIEVING DIGITAL TECHNICAL MANUALS THEREFOR RECORDED ON COMPUTER MEDIA (U.S. CLS. 21, 23, 26, 36 AND 38).

JOHN DWYER, EXAMINING ATTORNEY

SN 78-928,919. CALREC AUDIO LIMITED, YORKSHIRE, UNITED KINGDOM, FILED 7-13-2006.

HD signal processing

PRIORITY CLAIMED UNDER SEC. 44(D) ON UNITED KINGDOM APPLICATION NO. 005011895, FILED 3-27-2006, REG. NO. 005011895, DATED 2-9-2007, EXPIRES 3-27-2016.

NO CLAIM IS MADE TO THE EXCLUSIVE RIGHT TO USE "HD SIGNAL PROCESSING", APART FROM THE MARK AS SHOWN.

THE MARK APPEARS IN BLOCK LETTER FORMAT WITH A "WATER DROP" DESIGN USED TO DOT THE LETTER "I" IN THE WORD "PROCESSING".

FOR SOUND, AUDIO AND VIDEO-MIXING AND ROUTING EQUIPMENT AND INSTRUMENTS, NAMELY SOUND-MIXERS AND ROUTERS, AUDIO-MIXERS AND ROUTERS AND VIDEO-MIXERS AND ROUTERS; MICROPHONES; VIDEO-MIXING AND PROCESSING APPARATUS, NAMELY VIDEO-SWITCHERS AND ROUTERS; DIGITAL SIGNAL-PROCESSING SYSTEMS FOR SOUND-MIXING CONSOLES AND VIDEO-MIXING CONSOLES, NAMELY DIGITAL-SIGNAL PROCESSORS (U.S. CLS. 21, 23, 26, 36 AND 38).

CORY BOONE, EXAMINING ATTORNEY

CLASS 9—(Continued).

SN 78-928,983. BLU-RAY DISC ASSOCIATION, UNIVERSAL CITY, CA. FILED 7-13-2006.

BEYOND HIGH DEFINITION

THE MARK CONSISTS OF STANDARD CHARACTERS WITHOUT CLAIM TO ANY PARTICULAR FONT, STYLE, SIZE, OR COLOR.

NO CLAIM IS MADE TO THE EXCLUSIVE RIGHT TO USE "HIGH DEFINITION", APART FROM THE MARK AS SHOWN.

FOR OPTICAL DISC PLAYERS AND RECORDERS FOR AUDIO, VIDEO AND COMPUTER DATA; BLANK OPTICAL DISCS; PRE-RECORDED OPTICAL DISCS FEATURING MUSIC, MOVIES, GAMES, TEXT DATA IN THE FIELD OF MUSIC, MOVIES, TELEVISION AND GAMES, STILL IMAGES IN THE FIELD OF MUSIC, MOVIES, TELEVISION, AND GAMES, AND MOTION PICTURES; TELEVISION SETS; VIDEO CAMERAS; DIGITAL STILL CAMERAS; PERSONAL COMPUTERS; DIGITAL SATELLITE BROADCASTING SYSTEMS, NAMELY, RECEIVERS, TRANSMITTERS AND ANTENNAS FOR SATELLITE BROADCASTING; VIDEO GAME MACHINES FOR USE WITH TELEVISIONS; ALL OF THE FOREGOING GOODS FOR USE WITH OPTICAL DISCS AS RECORDING OR RECORDED MEDIA, AND EACH BEARING A REGION CODE INDICATOR OR DESIGNATOR (U.S. CLS. 21, 23, 26, 36 AND 38).

JEAN IM, EXAMINING ATTORNEY

SN 78-932,652. SONY KABUSHIKI KAISHA ALSO TRADING AS SONY CORPORATION, TOKYO, JAPAN, FILED 7-19-2006.



NO CLAIM IS MADE TO THE EXCLUSIVE RIGHT TO USE "NOISE CANCELING", APART FROM THE MARK AS SHOWN.

THE MARK CONSISTS OF A BLACK RECTANGLE WITH A HIGHLY STYLIZED DESIGN OF THE LETTERS NC AND THE WORDS NOISE CANCELING VERTICALLY SITUATED TO THE RIGHT THEREOF AND SEPARATED BY A LINE.

FOR HEADPHONES (U.S. CLS. 21, 23, 26, 36 AND 38).
THOMAS MANOR, EXAMINING ATTORNEY

CLASS 9—(Continued).

SN 78-934,295. ACCESS SYSTEMS AMERICAS, INC., SUNNYVALE, CA. FILED 7-20-2006.



NO CLAIM IS MADE TO THE EXCLUSIVE RIGHT TO USE "ACCESS", APART FROM THE MARK AS SHOWN.

FOR COMPUTER STORAGE HARDWARE; COMPUTER HARDWARE AND PERIPHERALS, NAMELY MODEMS, APPARATUS FOR RECORDATION, TRANSMISSION AND REPRODUCTION OF TEXT, DATA, IMAGES, SOUND AND GRAPHICS; PORTABLE MEDIA PLAYERS; INPUT DEVICES, NAMELY COMPUTER MICE AND KEYPADS; STORAGE DEVICES, NAMELY COMPUTER HARD DRIVES; ELECTRONIC PUBLICATIONS, NAMELY E-BOOKS ON FICTION AND NON-FICTION TOPICS, NAMELY HISTORY, POLITICS, SCIENCE, COMPUTERS, TECHNOLOGY, CURRENT AFFAIRS AND THE ARTS AND REFERENCE BOOKS AND MANUALS ON HISTORY, POLITICS, SCIENCE, COMPUTERS, TECHNOLOGY, CURRENT AFFAIRS AND THE ARTS, ALL RECORDED ON COMPUTER MEDIA; E-BOOK DISPLAYS, NAMELY LED AND LCD FLAT PANEL DISPLAYS; GLOBAL POSITIONING SYSTEM RECEIVERS; PORTABLE OR FIXED RADIO FREQUENCY RADIO AND TELEPHONE TRANSMITTERS AND RECEIVERS; PRINTERS; BATTERY CHARGERS; DIGITAL AUDIO PLAYERS AND RECORDERS; DIGITAL MULTIMEDIA PLAYERS, NAMELY DIGITAL VIDEO PLAYERS AND RECORDERS; CAMERAS (U.S. CLS. 21, 23, 26, 36 AND 38).

PETER CHENG, EXAMINING ATTORNEY

SN 78-936,720. WILLIAM DATA SYSTEMS LIMITED, EAST GRINSTEAD, UNITED KINGDOM, FILED 7-25-2006.



THE MARK CONSISTS OF STANDARD CHARACTERS WITHOUT CLAIM TO ANY PARTICULAR FONT, STYLE, SIZE, OR COLOR.

FOR COMPUTER SOFTWARE FOR MANAGEMENT AND MONITORING OF ADVANCED PEER-TO-PEER NETWORKING (APPN) AND HIGH PERFORMANCE ROUTE (HPR) NETWORKS (U.S. CLS. 21, 23, 26, 36 AND 38).

FIRST USE 5-4-2006; IN COMMERCE 7-4-2006.
GIANCARLO CASTRO, EXAMINING ATTORNEY

CLASS 9—(Continued).

SN 78-938,385. SOXLAB, INC., HERMOSA BEACH, CA. FILED 7-26-2006.

Closed-Loop Methodology

THE MARK CONSISTS OF STANDARD CHARACTERS WITHOUT CLAIM TO ANY PARTICULAR FONT, STYLE, SIZE, OR COLOR.
FOR COMPUTER SOFTWARE FOR COMPLIANCE MANAGEMENT (U.S. CLS. 21, 23, 26, 36 AND 38).
RAUL CORDOVA, EXAMINING ATTORNEY

SN 78-938,543. MH INSTRUMENTS, INC., TRABUCO CANYON, CA. FILED 7-27-2006.

CRANKCASE

THE MARK CONSISTS OF STANDARD CHARACTERS WITHOUT CLAIM TO ANY PARTICULAR FONT, STYLE, SIZE, OR COLOR.
FOR AUDIO EQUIPMENT FOR VEHICLES, NAMELY, STEREOs, SPEAKERS, AMPLIFIERS, VOLUME CONTROLLERS, EQUALIZERS, CROSSOVERS AND SPEAKER HOUSINGS (U.S. CLS. 21, 23, 26, 36 AND 38).
FIRST USE 1-31-2006; IN COMMERCE 4-5-2006.
MEGAN WHITNEY, EXAMINING ATTORNEY

SN 78-938,785. EFFECTUR, INC., GREENSBORO, NC. FILED 7-27-2006.

Effectur Peace of Mind Options

THE MARK CONSISTS OF STANDARD CHARACTERS WITHOUT CLAIM TO ANY PARTICULAR FONT, STYLE, SIZE, OR COLOR.
OWNER OF U.S. REG. NO. 2,994,636.
FOR COMPUTER SOFTWARE FOR PROCESSING FINANCIAL INFORMATION FOR USE IN INCOME TAX ANALYSIS BY TAX PROFESSIONALS (U.S. CLS. 21, 23, 26, 36 AND 38).
LYDIA BELZER, EXAMINING ATTORNEY

CLASS 9—(Continued).

SN 78-938,977. CITY ELECTRICAL FACTORS LIMITED, KENILWORTH, WARWICKSHIRE, UNITED KINGDOM, FILED 7-27-2006.



FOR ELECTRICAL SWITCHES, ELECTRICAL CEILING SWITCHES, ELECTRIC CEILING ROSES IN THE NATURE OF ELECTRIC CEILING FIXTURES AND CEILING MEDALLIONS SOLD AS A UNIT; ELECTRICAL SOCKETS AND SOCKET OUTLETS, COAXIAL CABLE SOCKET OUTLETS, SATELLITE CONNECTION SOCKETS, ELECTRICAL FLOOR SOCKETS; TELEPHONE SOCKET OUTLETS; FUSED ELECTRICAL CONNECTION UNITS AND PLUGS, MODULAR WIRING DEVICES, NAMELY, COMBINATION ELECTRICAL SOCKETS AND OUTLETS COMPRISING INPUTS FOR DATA, CABLE, TELEPHONE, AND ELECTRICITY; ELECTRICAL POWER DISTRIBUTION UNITS (U.S. CLS. 21, 23, 26, 36 AND 38).
MICHAEL KEATING, EXAMINING ATTORNEY

SN 78-941,784. COOKING WITH UNCLE TONY, LLC, HAMPTON, VA. FILED 7-31-2006.

**Cooking With Uncle Tony,
Giving your guest
nothing but the best!,
www.cookingwithuncleony.com**

THE MARK CONSISTS OF STANDARD CHARACTERS WITHOUT CLAIM TO ANY PARTICULAR FONT, STYLE, SIZE, OR COLOR.
FOR PRE-RECORDED CD'S, VIDEO TAPES, LASER DISKS AND DVD'S FEATURING COOKING (U.S. CLS. 21, 23, 26, 36 AND 38).
ESTHER BELENKER, EXAMINING ATTORNEY

CLASS 9—(Continued).

SN 78-943,918. SOVEREIGN DEED, LLC, VERNON HILLS, IL. FILED 8-3-2006.

SOVEREIGN DEED MONTHLY

THE MARK CONSISTS OF STANDARD CHARACTERS WITHOUT CLAIM TO ANY PARTICULAR FONT, STYLE, SIZE, OR COLOR.

NO CLAIM IS MADE TO THE EXCLUSIVE RIGHT TO USE "MONTHLY", APART FROM THE MARK AS SHOWN.

FOR DOWNLOADABLE ELECTRONIC PUBLICATIONS IN THE NATURE OF BOOKLETS, BOOKS, BROCHURES, BULLETINS, BUSINESS FORMS, TRAINING MANUALS, INSTRUCTION SHEETS, MANUALS, MAPS, NEWS BULLETINS, NEWSPAPERS, ORDER FORMS, PAMPHLETS, PARTIAL FORMS, CHARTS, FORMS, GRAPHS, GUIDES, INSTRUCTIONAL MATERIALS, EDUCATIONAL MATERIALS, TEACHING MATERIALS, PERIODICALS, QUICK REFERENCE POCKET GUIDES, RESEARCH REPORTS AND ROAD MAPS IN THE FIELD OF SECURITY, SAFETY, AND EMERGENCY; DOWNLOADABLE ELECTRONIC PUBLICATIONS IN THE NATURE OF INSTRUCTIONAL MATERIALS IN THE FIELD OF TELECOMMUNICATIONS; DOWNLOADABLE ELECTRONIC PUBLICATIONS IN THE NATURE OF VISUAL INFORMATIONAL GRAPHICS IN THE FIELDS OF SECURITY, SAFETY, EMERGENCY, MILITARY, MILITARY TACTICS AND STRATEGIES; AND DOWNLOADABLE PROMOTIONAL MATERIALS, NAMELY, BOOKLETS, BOOKS, BROCHURES, BULLETINS, BUSINESS FORMS, TRAINING MANUALS, INSTRUCTION SHEETS, MANUALS, MAPS, NEWS BULLETINS, NEWSPAPERS, ORDER FORMS, PAMPHLETS, PARTIAL FORMS, CHARTS, FORMS, GRAPHS, GUIDES, INSTRUCTIONAL MATERIALS, EDUCATIONAL MATERIALS, TEACHING MATERIALS, PERIODICALS, QUICK REFERENCE POCKET GUIDES, RESEARCH REPORTS AND ROAD MAPS (U.S. CLS. 21, 23, 26, 36 AND 38).

VERNA BETH RIRIE, EXAMINING ATTORNEY

CLASS 9—(Continued).

SN 78-944,659. 1800 BLK ENTERTAINMENT, LLC, LOS ANGELES, CA. FILED 8-3-2006.

LIL BOB GOTTI

THE MARK CONSISTS OF STANDARD CHARACTERS WITHOUT CLAIM TO ANY PARTICULAR FONT, STYLE, SIZE, OR COLOR.

THE NAME(S), PORTRAIT(S), AND/OR SIGNATURE(S) SHOWN IN THE MARK IDENTIFIES BOBBY WASHINGTON, WHOSE CONSENT(S) TO REGISTER IS OF RECORD.

FOR MUSICAL SOUND RECORDINGS; AUDIO-VISUAL RECORDINGS, NAMELY, COMPACT DISCS, TAPE CASSETTES, RECORDS, CD-ROMS, VHS VIDEO TAPES, DVDS, AND LASER DISCS ALL FEATURING MUSIC, SPORTS, TELEVISION PROGRAMS AND MOVIES; VIDEO GAME SOFTWARE; VIDEO GAME COMPUTER SOFTWARE ADAPTED FOR USE WITH TELEVISION RECEIVERS AND COMPUTERS; DOWNLOADABLE TEXT, VIDEO RECORDINGS, AUDIO RECORDINGS AND STILL IMAGES FEATURING MUSIC, SPORTS, TELEVISION PROGRAMS AND MOVIES VIA WIRELESS DEVICES, NAMELY, CELL PHONES, PERSONAL DIGITAL ASSISTANTS AND PORTABLE ENTERTAINMENT AND GAMING DEVICES; DOWNLOADABLE MUSIC, POLYPHONIC AND MASTER RING TONES, VOICE TONES, VOICE MESSAGES, RING BACKS AND INTERACTIVE GAMES VIA WIRELESS DEVICES, NAMELY, CELL PHONES, PERSONAL DIGITAL ASSISTANTS AND PORTABLE ENTERTAINMENT AND GAMING DEVICES (U.S. CLS. 21, 23, 26, 36 AND 38).

JAY BESCH, EXAMINING ATTORNEY

SN 78-944,014. SIRIUS SATELLITE RADIO INC., NEW YORK, NY. FILED 8-3-2006.

STRATUS

THE MARK CONSISTS OF STANDARD CHARACTERS WITHOUT CLAIM TO ANY PARTICULAR FONT, STYLE, SIZE, OR COLOR.

FOR EQUIPMENT FOR RECEIVING SATELLITE RADIO BROADCAST TRANSMISSIONS, NAMELY RADIOS AND RECEIVERS (U.S. CLS. 21, 23, 26, 36 AND 38).

PAULA MAHONEY, EXAMINING ATTORNEY

CLASS 9—(Continued).

SN 78-944,696. 1800 BLK ENTERTAINMENT, LLC, LOS ANGELES, CA. FILED 8-3-2006.

THA GOTTI BOYZ

THE MARK CONSISTS OF STANDARD CHARACTERS WITHOUT CLAIM TO ANY PARTICULAR FONT, STYLE, SIZE, OR COLOR.

THE NAME(S), PORTRAIT(S), AND/OR SIGNATURE(S) SHOWN IN THE MARK IDENTIFIES BOBBY WASHINGTON, CHRISTOPHER WILLIAMS, GARY BELCHER, AND TIMOTHY RANDOLPH, WHOSE CONSENT(S) TO REGISTER IS OF RECORD.

FOR MUSICAL SOUND RECORDINGS; AUDIO-VISUAL RECORDINGS, NAMELY, COMPACT DISCS, TAPE CASSETTES, RECORDS, CD-ROMS, VHS VIDEO TAPES, DVDS, AND LASER DISCS ALL FEATURING MUSIC, SPORTS, TELEVISION PROGRAMS AND MOVIES; VIDEO GAME SOFTWARE; VIDEO GAME COMPUTER SOFTWARE ADAPTED FOR USE WITH TELEVISION RECEIVERS AND COMPUTERS; DOWNLOADABLE TEXT, VIDEO RECORDINGS, AUDIO RECORDINGS AND STILL IMAGES FEATURING MUSIC, SPORTS, TELEVISION PROGRAMS AND MOVIES VIA WIRELESS DEVICES, NAMELY, CELL PHONES, PERSONAL DIGITAL ASSISTANTS AND PORTABLE ENTERTAINMENT AND GAMING DEVICES; DOWNLOADABLE MUSIC, POLYPHONIC AND MASTER RING TONES, VOICE TONES, VOICE MESSAGES, RING BACKS AND INTERACTIVE GAMES VIA WIRELESS DEVICES, NAMELY, CELL PHONES, PERSONAL DIGITAL ASSISTANTS AND PORTABLE ENTERTAINMENT AND GAMING DEVICES (U.S. CLS. 21, 23, 26, 36 AND 38).

JAY BESCH, EXAMINING ATTORNEY

SN 78-945,512. ENVOX GROUP AB, STOCKHOLM, SWEDEN, FILED 8-4-2006.

ENVOX CT CONNECT

THE MARK CONSISTS OF STANDARD CHARACTERS WITHOUT CLAIM TO ANY PARTICULAR FONT, STYLE, SIZE, OR COLOR.

OWNER OF U.S. REG. NO. 2,308,386.

NO CLAIM IS MADE TO THE EXCLUSIVE RIGHT TO USE "CT", APART FROM THE MARK AS SHOWN.

FOR COMPUTER SOFTWARE FOR THE CREATION, OPERATION AND MANAGEMENT OF COMPUTER TELEPHONY COMMUNICATIONS APPLICATIONS, NAMELY, VOICE CALL CONTROL SERVER SOFTWARE USED TO CONNECT VOICE AND DATA APPLICATIONS FOR THE CONTROL AND PRESENTATION OF INFORMATION ON COMPUTER HARDWARE AND COMMUNICATION DEVICES BASED ON VOICE-DATA INTEGRATION SOFTWARE FOR TRANSPORTING VOICE, DATA, AND VIDEO COMMUNICATIONS ACROSS MULTIPLE NETWORK INFRASTRUCTURES AND COMMUNICATIONS PROTOCOLS (U.S. CLS. 21, 23, 26, 36 AND 38).

FIRST USE 8-7-1995; IN COMMERCE 8-7-1995.

JAY FLOWERS, EXAMINING ATTORNEY

CLASS 9—(Continued).

SN 78-946,610. APPLERA CORPORATION, FOSTER CITY, CA. FILED 8-7-2006.

VERITI

THE MARK CONSISTS OF STANDARD CHARACTERS WITHOUT CLAIM TO ANY PARTICULAR FONT, STYLE, SIZE, OR COLOR.

FOR COMPUTER SOFTWARE USED FOR THE COLLECTION, ORGANIZATION, ANALYSIS, INTEGRATION AND COMMUNICATION OF SCIENTIFIC DATA FOR SCIENTIFIC, RESEARCH, AND DIAGNOSTICS USE; COMPUTER SOFTWARE USED TO OPERATE LABORATORY INSTRUMENTS FOR SCIENTIFIC AND RESEARCH USE; LABORATORY EQUIPMENT FOR SCIENTIFIC AND RESEARCH USE, NAMELY, NUCLEIC ACID SEQUENCERS AND SYNTHESIZERS, GENETIC ANALYZERS, THERMAL CYCLER, CYTOMETER, PROTEIN AND PEPTIDE SYNTHESIZERS, MASS SPECTROMETER AND CHROMATOGRAPH, LABORATORY ROBOTS; LABORATORY SUPPLIES FOR SCIENTIFIC AND RESEARCH USE, NAMELY, RACK, VIALS, CAPS, SEPTA, NEEDLES, BOTTLES, FLASK, FILTER, TUBES, AND SEALS, PLASTIC TRAY COVER, MICRO PLATE, PIPETTE TIPS, REAGENT RESERVOIR, OPTICAL HEAT FIELD COVERS, AND PLASTIC CAPILLARY ARRAYS (U.S. CLS. 21, 23, 26, 36 AND 38).

TINA KUAN, EXAMINING ATTORNEY

SN 78-946,982. IRM CORPORATION, DALLAS, TX. FILED 8-8-2006.

CATELYTICS

THE MARK CONSISTS OF STANDARD CHARACTERS WITHOUT CLAIM TO ANY PARTICULAR FONT, STYLE, SIZE, OR COLOR.

FOR COMPUTER SOFTWARE USED IN THE MARKETING FIELD OF THE FOOD AND BEVERAGE INDUSTRY THAT PROVIDES REAL-TIME, INTEGRATED BUSINESS MANAGEMENT INTELLIGENCE BY COMBINING INFORMATION FROM VARIOUS DATABASES AND PRESENTING IT IN AN EASY-TO-UNDERSTAND USER INTERFACE (U.S. CLS. 21, 23, 26, 36 AND 38).

MICHAEL KEATING, EXAMINING ATTORNEY

CLASS 9—(Continued).

SN 78-946,993. IRM CORPORATION, DALLAS, TX. FILED 8-8-2006.

DISCOVERY DASHBOARD

THE MARK CONSISTS OF STANDARD CHARACTERS WITHOUT CLAIM TO ANY PARTICULAR FONT, STYLE, SIZE, OR COLOR.

NO CLAIM IS MADE TO THE EXCLUSIVE RIGHT TO USE "DASHBOARD", APART FROM THE MARK AS SHOWN.

FOR COMPUTER SOFTWARE FOR USE IN THE MARKETING FIELD THAT PROVIDES REAL-TIME, INTEGRATED BUSINESS MANAGEMENT INTELLIGENCE BY COMBINING INFORMATION FROM VARIOUS DATABASES AND PRESENTING IT IN AN EASY-TO-UNDERSTAND USER INTERFACE (U.S. CLS. 21, 23, 26, 36 AND 38).

KATHERINE M. DUBRAY, EXAMINING ATTORNEY

CLASS 9—(Continued).

SN 78-948,832. BICYCLE CITY, LLC, CINCINNATI, OH. FILED 8-9-2006.

BICYCLE CITY

THE MARK CONSISTS OF STANDARD CHARACTERS WITHOUT CLAIM TO ANY PARTICULAR FONT, STYLE, SIZE, OR COLOR.

FOR VIDEO TAPES, CD-ROMS, COMPACT DISCS, DVDS, AND MP3 FILES FEATURING INFORMATION ABOUT ALTERNATIVE COMMUNITIES, NAMELY ENVIRONMENTALLY-FRIENDLY RESIDENTIAL AND COMMERCIAL PLANNED COMMUNITIES; COMPUTER SOFTWARE FOR ACCESSING AND MANIPULATING INFORMATION IN THE FIELD OF ENVIRONMENTALLY-FRIENDLY RESIDENTIAL AND COMMERCIAL PLANNED COMMUNITIES AND FACILITATING THE PURCHASE AND SALE OF REAL ESTATE; COMPUTER SOFTWARE GAMES IN THE FIELD OF ENVIRONMENTALLY-FRIENDLY RESIDENTIAL AND COMMERCIAL PLANNED COMMUNITIES (U.S. CLS. 21, 23, 26, 36 AND 38).

DANIEL BRODY, EXAMINING ATTORNEY

SN 78-948,853. BROADCOM CORPORATION, IRVINE, CA. FILED 8-9-2006.

BROADRANGE

THE MARK CONSISTS OF STANDARD CHARACTERS WITHOUT CLAIM TO ANY PARTICULAR FONT, STYLE, SIZE, OR COLOR.

FOR COMPUTER HARDWARE; INTEGRATED CIRCUITS; COMPUTER CHIPSETS; INTEGRATED CIRCUIT CHIPSETS; COMPUTER HARDWARE, INTEGRATED CIRCUITS, COMPUTER CHIPSETS, AND INTEGRATED CIRCUIT CHIPSETS FOR COMMUNICATION, WIRELESS COMMUNICATION AND CONNECTIVITY; FIRMWARE FOR USING AND CONTROLLING WIRELESS BROADBAND COMMUNICATION TECHNOLOGY AND TO ENABLE COMMUNICATION AND WIRELESS COMMUNICATION; COMPUTER SOFTWARE FOR COMMUNICATION, WIRELESS COMMUNICATION, AND CONNECTIVITY, AND FOR CONTROLLING AND USING INTEGRATED CIRCUITS; COMPUTER SOFTWARE EMBEDDED OR CONTAINED IN COMPUTER HARDWARE FOR COMMUNICATION, WIRELESS COMMUNICATION, AND CONNECTIVITY, AND FOR CONTROLLING AND USING INTEGRATED CIRCUITS; AND MANUALS SOLD AS A UNIT WITH THE FOREGOING AND DOWNLOADABLE FROM A GLOBAL COMPUTER NETWORK (U.S. CLS. 21, 23, 26, 36 AND 38).

ALICE BENMAMAN, EXAMINING ATTORNEY

SN 78-947,102. H.D.N. HOLDINGS CORPORATION, LEOMINSTER, MA. FILED 8-8-2006.

K-9 SOUNDGUARD

THE MARK CONSISTS OF STANDARD CHARACTERS WITHOUT CLAIM TO ANY PARTICULAR FONT, STYLE, SIZE, OR COLOR.

NO CLAIM IS MADE TO THE EXCLUSIVE RIGHT TO USE "K-9", APART FROM THE MARK AS SHOWN.

FOR PERSONAL SECURITY ALARMS TO FEND OFF DOGS FROM ATTACKING (U.S. CLS. 21, 23, 26, 36 AND 38).

COLLEEN DOMBROW, EXAMINING ATTORNEY

CLASS 9—(Continued).

SN 78-948,868. BICYCLE CITY, LLC, CINCINNATI, OH. FILED 8-9-2006.

CIUDAD DE LA BICICLETA

THE MARK CONSISTS OF STANDARD CHARACTERS WITHOUT CLAIM TO ANY PARTICULAR FONT, STYLE, SIZE, OR COLOR.

"THE FOREIGN WORDING IN THE MARK TRANSLATES INTO ENGLISH AS BICYCLE CITY."

FOR VIDEO TAPES, CD-ROMS, COMPACT DISCS, DVDS, AND MP3 FILES FEATURING INFORMATION ABOUT ALTERNATIVE COMMUNITIES, NAMELY ENVIRONMENTALLY-FRIENDLY RESIDENTIAL AND COMMERCIAL PLANNED COMMUNITIES; COMPUTER SOFTWARE FOR ACCESSING AND MANIPULATING INFORMATION IN THE FIELD OF ENVIRONMENTALLY-FRIENDLY RESIDENTIAL AND COMMERCIAL PLANNED COMMUNITIES AND FACILITATING THE PURCHASE AND SALE OF REAL ESTATE; COMPUTER SOFTWARE GAMES IN THE FIELD OF ENVIRONMENTALLY-FRIENDLY RESIDENTIAL AND COMMERCIAL PLANNED COMMUNITIES (U.S. CLS. 21, 23, 26, 36 AND 38).

DANIEL BRODY, EXAMINING ATTORNEY

CLASS 9—(Continued).

SN 78-949,071. GMCS PRODUCTS LIMITED, CENTRAL, HONG KONG, FILED 8-10-2006.

The logo for LIFETRONS features the word "LIFETRONS" in a bold, sans-serif font. The letter "I" is stylized with a vertical bar to its left. The entire word is underlined with a thick black line.

FOR TELEPHONES, USB TELEPHONES, CORDLESS TELEPHONES; MULTI-MEDIA APPARATUS, NAMELY MP3 PLAYERS AND CD PLAYERS; COMPUTER PERIPHERALS, NAMELY USB DEVICES; ACCESSORIES OF APPARATUS FOR SHORT-RANGE TRANSMISSION OF DIGITAL VOICE AND DATA THAT SUPPORTS POINT-TO-POINT AND MULTI-POINT APPLICATIONS, NAMELY COMPONENT PARTS FOR DIGITAL TRANSMITTERS; RECHARGEABLE BATTERIES; BATTERIES; BATTERIES FOR CHARGING ELECTRIC AND ELECTRONIC APPLIANCES; BATTERIES FOR CHARGING RECHARGEABLE BATTERIES; BATTERY CHARGERS; CHARGERS FOR BATTERIES; GALVANIC BATTERIES; GRIDS FOR BATTERIES, NAMELY EXTERNAL BATTERIES; HIGH TENSION BATTERIES; SOLAR BATTERIES; BATTERY BOXES; AND BATTERY JARS (U.S. CLS. 21, 23, 26, 36 AND 38).

JASON BLAIR, EXAMINING ATTORNEY

SN 78-949,043. FONIX CORPORATION, SANDY, UT. FILED 8-10-2006.

FREEDOM OF SPEECH

THE MARK CONSISTS OF STANDARD CHARACTERS WITHOUT CLAIM TO ANY PARTICULAR FONT, STYLE, SIZE, OR COLOR.

OWNER OF U.S. REG. NO. 2,251,577.

FOR COMPUTER HARDWARE AND SOFTWARE IN THE FIELD OF VOICE RECOGNITION AND TEXT-TO-SPEECH, FOR USE IN SPEECH ENGINE SOFTWARE AND VOICE-ENABLED SOFTWARE APPLICATIONS, NAMELY, SPEECH-BASED TELEPHONE SERVICES, VOICE SERVERS, EMBEDDED PROCESSORS, DESKTOP COMPUTER APPLICATIONS, CONSOLE VIDEO GAMES, COMPUTER VIDEO GAMES, WIRELESS MOBILE DEVICES, HANDHELD AND IN-VEHICLE NAVIGATION SYSTEMS FEATURING GLOBAL POSITIONING SYSTEM (GPS) FUNCTIONALITY, AND PERSONAL DIGITAL ASSISTANTS (PDAS) (U.S. CLS. 21, 23, 26, 36 AND 38).

FIRST USE 4-30-1998; IN COMMERCE 4-30-1998.
INGA ERVIN, EXAMINING ATTORNEY

SN 78-949,756. KIVA SYSTEMS, INC., WOBURN, MA. FILED 8-10-2006.

KIVA SYSTEMS

THE MARK CONSISTS OF STANDARD CHARACTERS WITHOUT CLAIM TO ANY PARTICULAR FONT, STYLE, SIZE, OR COLOR.

NO CLAIM IS MADE TO THE EXCLUSIVE RIGHT TO USE "SYSTEMS", APART FROM THE MARK AS SHOWN.

FOR AUTOMATED MATERIAL HANDLING SYSTEM COMPOSED OF COMPUTER SOFTWARE FOR THE PROCESSING AND FILLING OF ORDERS AT A COMPANY'S WAREHOUSE FOR DISTRIBUTION AND MANUFACTURING OPERATIONS, COMPUTER HARDWARE, INDUSTRIAL EQUIPMENT, NAMELY, MOBILE DRIVE UNITS, CONFIGURABLE INVENTORY PODS, INVENTORY STATIONS, AND MAINTENANCE STATIONS, ALL FOR THE PROCESSING AND FILLING OF ORDERS AT A COMPANY'S WAREHOUSE FOR DISTRIBUTION AND MANUFACTURING OPERATIONS (U.S. CLS. 21, 23, 26, 36 AND 38).

FIRST USE 2-17-2005; IN COMMERCE 2-17-2005.
DAVID I, EXAMINING ATTORNEY

CLASS 9—(Continued).

SN 78-950,010. BRUNSWICK CORPORATION, LAKE FOREST, IL. FILED 8-11-2006.

PRECISION PILOT

THE MARK CONSISTS OF STANDARD CHARACTERS WITHOUT CLAIM TO ANY PARTICULAR FONT, STYLE, SIZE, OR COLOR.

NO CLAIM IS MADE TO THE EXCLUSIVE RIGHT TO USE "PILOT", APART FROM THE MARK AS SHOWN.

FOR COMPUTER HARDWARE AND SOFTWARE FOR USE IN PILOTING A MARINE VESSEL (U.S. CLS. 21, 23, 26, 36 AND 38).

REBECCA GAN, EXAMINING ATTORNEY

SN 78-950,558. OPTRIA, LLC, MAITLAND, FL. FILED 8-11-2006.

Optria

THE MARK CONSISTS OF STANDARD CHARACTERS WITHOUT CLAIM TO ANY PARTICULAR FONT, STYLE, SIZE, OR COLOR.

FOR COMPUTER SOFTWARE FOR USE IN CUSTOMER RELATIONSHIP MANAGEMENT (CRM) (U.S. CLS. 21, 23, 26, 36 AND 38).

FIRST USE 4-22-2005; IN COMMERCE 8-16-2005.
TASHIA BUNCH, EXAMINING ATTORNEY

SN 78-950,601. ENVISION PERIPHERALS, INC., FREMONT, CA. FILED 8-11-2006.

SOMETHING TO SEE

THE MARK CONSISTS OF STANDARD CHARACTERS WITHOUT CLAIM TO ANY PARTICULAR FONT, STYLE, SIZE, OR COLOR.

FOR COMPUTER MONITORS, NAMELY CRT AND LCD MONITORS, LCD TELEVISION MONITORS AND PLASMA TELEVISIONS (U.S. CLS. 21, 23, 26, 36 AND 38).

FIRST USE 11-1-2003; IN COMMERCE 11-1-2003.
SETH A. RAPPAPORT, EXAMINING ATTORNEY

CLASS 9—(Continued).

SN 78-952,189. SPECTRUM CONTROLS, INC., BELLEVUE, WA. FILED 8-15-2006.

CONNECTS

THE MARK CONSISTS OF STANDARD CHARACTERS WITHOUT CLAIM TO ANY PARTICULAR FONT, STYLE, SIZE, OR COLOR.

FOR COMPUTER SOFTWARE THAT ENABLES VARIOUS USER APPLICATIONS TO COMMUNICATE WITH ONE OR MORE HARDWARE DEVICES (U.S. CLS. 21, 23, 26, 36 AND 38).

FIRST USE 10-15-2002; IN COMMERCE 10-15-2002.
KATHERINE CHANG, EXAMINING ATTORNEY

SN 78-952,379. NSI MANAGEMENT COMPANY, BROUSSARD, LA. FILED 8-15-2006.

OIL FIELD COMMANDER

THE MARK CONSISTS OF STANDARD CHARACTERS WITHOUT CLAIM TO ANY PARTICULAR FONT, STYLE, SIZE, OR COLOR.

NO CLAIM IS MADE TO THE EXCLUSIVE RIGHT TO USE "OIL FIELD", APART FROM THE MARK AS SHOWN.

FOR COMPUTER SOFTWARE SUITE TO MANAGE AND PROVIDE ANALYTICAL TESTS AGAINST DATA GENERATED ON OIL AND GAS PRODUCTION SITES (U.S. CLS. 21, 23, 26, 36 AND 38).

FIRST USE 3-2-2006; IN COMMERCE 5-30-2006.
JIM RINGLE, EXAMINING ATTORNEY

CLASS 9—(Continued).

SN 78-952,638. GOLDEN STATE INSTRUMENT COMPANY, TUSTIN, CA. FILED 8-15-2006.



NO CLAIM IS MADE TO THE EXCLUSIVE RIGHT TO USE THE PICTORIAL REPRESENTATION OF THE STATE OF CALIFORNIA, APART FROM THE MARK AS SHOWN. THE MARK CONSISTS OF THE LETTERS GSI INSIDE OF A DRAWING OF THE STATE OF CALIFORNIA.

FOR CAMERAS; INFRARED CAMERAS; DIGITAL VIDEO RECORDERS; MULTIPLEXERS; ELECTRICAL POWER SUPPLIES; SIRENS; AUDIO SPEAKERS; COMMUNICATIONS SERVERS COMPUTER HARDWARE; TRANSFORMERS; CAMERA FILTERS (U.S. CLS. 21, 23, 26, 36 AND 38).

FIRST USE 1-0-1993; IN COMMERCE 10-28-1993.
ALEX KEAM, EXAMINING ATTORNEY

SN 78-953,176. ALERT LOGIC, INC., HOUSTON, TX. FILED 8-16-2006.

ALERTLOGIC

THE MARK CONSISTS OF STANDARD CHARACTERS WITHOUT CLAIM TO ANY PARTICULAR FONT, STYLE, SIZE, OR COLOR.

FOR COMPUTER NETWORK THREAT MANAGEMENT SOFTWARE; COMPUTER HARDWARE IN THE NATURE OF SECURITY APPLIANCES THAT WORK WITH OUR PROPRIETARY SOFTWARE TO GATHER AND ANALYZE NETWORK SECURITY STATISTICS ON CORPORATE NETWORKS (U.S. CLS. 21, 23, 26, 36 AND 38).

FIRST USE 4-15-2002; IN COMMERCE 8-20-2004.
EMILY CARLSEN, EXAMINING ATTORNEY

CLASS 9—(Continued).

SN 78-954,337. STAR STRUCK, LLC, HIGHLAND PARK, IL. FILED 8-17-2006.

CRYSTAL CLEAR

THE MARK CONSISTS OF STANDARD CHARACTERS WITHOUT CLAIM TO ANY PARTICULAR FONT, STYLE, SIZE, OR COLOR.

FOR BATTERIES; ELECTRICAL CELLS FOR FURNISHING ELECTRICAL CURRENT; BATTERIES FOR HEARING AIDS (U.S. CLS. 21, 23, 26, 36 AND 38).

FIRST USE 5-21-1992; IN COMMERCE 5-21-1992.
RAY THOMAS, EXAMINING ATTORNEY

SN 78-954,755. BRISTOL TECHNOLOGIES, INC., BOZEMAN, MT. FILED 8-17-2006.

Bristol Focus

THE MARK CONSISTS OF STANDARD CHARACTERS WITHOUT CLAIM TO ANY PARTICULAR FONT, STYLE, SIZE, OR COLOR.

FOR COMPUTER OPERATING PROGRAMS; COMPUTERS AND INSTRUCTIONAL MANUALS SOLD AS A UNIT; OPERATING SYSTEM PROGRAMS (U.S. CLS. 21, 23, 26, 36 AND 38).

FIRST USE 7-25-2006; IN COMMERCE 7-25-2006.
SCOTT SISUN, EXAMINING ATTORNEY

SN 78-955,837. JOHN FRANZOZA, NEW YORK, NY. AND BRYAN OSORIO, NEW YORK, NY. FILED 8-18-2006.

PYP Entertainment

THE MARK CONSISTS OF STANDARD CHARACTERS WITHOUT CLAIM TO ANY PARTICULAR FONT, STYLE, SIZE, OR COLOR.

NO CLAIM IS MADE TO THE EXCLUSIVE RIGHT TO USE "ENTERTAINMENT", APART FROM THE MARK AS SHOWN.

FOR MUSICAL SOUND RECORDINGS (U.S. CLS. 21, 23, 26, 36 AND 38).

SCOTT SISUN, EXAMINING ATTORNEY

CLASS 9—(Continued).

SN 78-956,480. BIOFORCE NANOSCIENCES, INC., AMES, IA. FILED 8-21-2006.

Nano eNabler

THE MARK CONSISTS OF STANDARD CHARACTERS WITHOUT CLAIM TO ANY PARTICULAR FONT, STYLE, SIZE, OR COLOR.

NO CLAIM IS MADE TO THE EXCLUSIVE RIGHT TO USE "NANO", APART FROM THE MARK AS SHOWN.

FOR SCIENTIFIC AND/OR LABORATORY EQUIPMENT AND AUTOMATED LIQUID HANDLING APPARATUS, NAMELY A FEMTOLITER FLUID-DISPENSING UNIT APPLYING SAMPLE FLUIDS TO THE SURFACES OF TREATED SUBSTRATES. (U.S. CLS. 21, 23, 26, 36 AND 38).

JORDAN BAKER, EXAMINING ATTORNEY

SN 78-956,644. CPR SOLUTIONS GROUP, LLC, CHARLESTON, WV. FILED 8-21-2006.

ONTIME

THE MARK CONSISTS OF STANDARD CHARACTERS WITHOUT CLAIM TO ANY PARTICULAR FONT, STYLE, SIZE, OR COLOR.

FOR SOFTWARE FOR TIME AND ATTENDANCE MANAGEMENT (U.S. CLS. 21, 23, 26, 36 AND 38).

ANNE MADDEN, EXAMINING ATTORNEY

SN 78-958,106. ADE CORPORATION, WESTWOOD, MA. FILED 8-22-2006.

AFS

THE MARK CONSISTS OF STANDARD CHARACTERS WITHOUT CLAIM TO ANY PARTICULAR FONT, STYLE, SIZE, OR COLOR.

OWNER OF U.S. REG. NO. 2,379,499.

FOR EVALUATION MACHINES AND ASSOCIATED OPERATING SOFTWARE FOR SEMICONDUCTOR-BASED PRODUCTS (U.S. CLS. 21, 23, 26, 36 AND 38).

FIRST USE 6-30-2003; IN COMMERCE 6-30-2003.

JEFF DEFORD, EXAMINING ATTORNEY

CLASS 9—(Continued).

SN 78-959,238. CHESAPEAKE ENERGY CORPORATION, OKLAHOMA CITY, OK. FILED 8-24-2006.

CHK TITLE PRO

THE MARK CONSISTS OF STANDARD CHARACTERS WITHOUT CLAIM TO ANY PARTICULAR FONT, STYLE, SIZE, OR COLOR.

NO CLAIM IS MADE TO THE EXCLUSIVE RIGHT TO USE "TITLE PRO", APART FROM THE MARK AS SHOWN. FOR COMPUTER SOFTWARE FOR COMPILING, TRACKING AND REPORTING LAND TITLE INFORMATION IN THE OIL AND GAS INDUSTRY (U.S. CLS. 21, 23, 26, 36 AND 38).

GRETTA YAO, EXAMINING ATTORNEY

SN 78-959,337. PLANNING SYSTEMS, INC., RESTON, VA. FILED 8-24-2006.

PADS

THE MARK CONSISTS OF STANDARD CHARACTERS WITHOUT CLAIM TO ANY PARTICULAR FONT, STYLE, SIZE, OR COLOR.

FOR COMPUTER HARDWARE; ELECTRONIC EQUIPMENT, NAMELY RADIO RECEIVER AND RADIO-TRANSMITTING DROPSONDE UNITS; COMPUTER SOFTWARE FOR IMPROVING DELIVERY ACCURACY OF GUIDED AND BALLISTIC PARACHUTE CARGO (U.S. CLS. 21, 23, 26, 36 AND 38).

FIRST USE 9-27-2001; IN COMMERCE 9-27-2001.

DAVID H. STINE, EXAMINING ATTORNEY

SN 78-959,639. ISOCHRON, INC., AUSTIN, TX. FILED 8-24-2006.

VENDCAST EMBEDDED

THE MARK CONSISTS OF STANDARD CHARACTERS WITHOUT CLAIM TO ANY PARTICULAR FONT, STYLE, SIZE, OR COLOR.

OWNER OF U.S. REG. NO. 2,322,342.

NO CLAIM IS MADE TO THE EXCLUSIVE RIGHT TO USE "EMBEDDED", APART FROM THE MARK AS SHOWN.

FOR COMPUTER HARDWARE AND SOFTWARE FOR ELECTRONICALLY CAPTURING, STORING AND ANALYZING INFORMATION FROM VENDING MACHINES (U.S. CLS. 21, 23, 26, 36 AND 38).

SUSAN STIGLITZ, EXAMINING ATTORNEY

CLASS 9—(Continued).

SN 78-959,680. AOL LLC, DULLES, VA. FILED 8-24-2006.

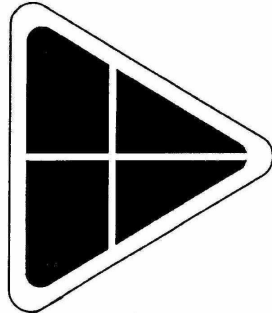

FOR COMPUTER SOFTWARE FOR DATA, TEXT, GRAPHICS, AND IMAGE TRANSMISSION; COMPUTER COMMUNICATIONS SOFTWARE TO ALLOW CUSTOMERS TO ACCESS NETWORKED COMPUTERS, COMPUTER SOFTWARE, DATABASES, COMMUNICATIONS SERVICES, AND ELECTRONIC COMMUNICATIONS NETWORKS; COMPUTER SOFTWARE FOR FACILITATING REAL-TIME INTERACTION AND COMMUNICATION BETWEEN COMPUTER USERS VIA COMPUTER NETWORKS; COMPUTER SOFTWARE FOR BROWSING AND SEARCHING AMONG ELECTRONIC COMMUNICATIONS NETWORKS, COMPUTERS, COMPUTER SOFTWARE, AND DATABASES; COMPUTER SOFTWARE THAT SYNCHRONIZES DATA AND COMPUTER SOFTWARE APPLICATIONS WITHIN A LOCAL AREA NETWORK OR ONLINE COMPUTER SYSTEM; COMPUTER SOFTWARE THAT SYNCHRONIZES DATA BETWEEN DISPARATE FORMATS; COMPUTER SOFTWARE FOR ENSURING SECURITY AND SAFETY ON COMPUTERS AND COMPUTER NETWORKS; AND INSTRUCTION AND USER MANUALS SOLD AS A UNIT WITH ALL OF THE FOREGOING SOFTWARE (U.S. CLS. 21, 23, 26, 36 AND 38).

JANICE L. MCMORROW, EXAMINING ATTORNEY

SN 78-959,741. CYTOVIVA, INC., AUBURN, AL. FILED 8-24-2006.



OWNER OF U.S. REG. NO. 3,135,824.

THE COLOR(S) GREEN, BLUE, TEAL GREEN, AND BLACK IS/ARE CLAIMED AS A FEATURE OF THE MARK.

THE MARK CONSISTS OF THE WORD "CYTOVIVA." THE "O" IN "CYTOVIVA" IS A CIRCLE WITH A DESIGN INSIDE CONTAINING TWO ADDITIONAL CIRCLES. THE COLOR GREEN APPEARS IN THE BOTTOM LEFT CIRCLE IN THE CIRCLE DESIGN, THE COLOR BLUE APPEARS IN THE TOP RIGHT CIRCLE IN THE CIRCLE DESIGN, THE COLOR TEAL GREEN APPEARS IN THE BACKGROUND OF THE CIRCLE DESIGN, AND THE COLOR BLACK APPEARS IN THE WORDING CYTOVIVA.

FOR MICROSCOPE PARTS, NAMELY, UNIVERSAL ADAPTERS TO BE USED WITH MICROSCOPES THAT ENABLE ONE TO OBSERVE HIGH CONTRAST, HIGH RESOLUTION IMAGES OF LIVING, FIXED, AND NON-BIOLOGICAL SAMPLES; OPTICALLY IMAGING EMULSIONS; AND NANO-MATERIALS (U.S. CLS. 21, 23, 26, 36 AND 38).

FIRST USE 11-15-2004; IN COMMERCE 12-4-2004.
LINDA ORNDORFF, EXAMINING ATTORNEY

CLASS 9—(Continued).

SN 78-959,874. CYTOVIVA, INC., AUBURN, AL. FILED 8-24-2006.

**CYTOVIVA DUAL MODE
FLUORESCENCE**

THE MARK CONSISTS OF STANDARD CHARACTERS WITHOUT CLAIM TO ANY PARTICULAR FONT, STYLE, SIZE, OR COLOR.

OWNER OF U.S. REG. NO. 3,135,824.

NO CLAIM IS MADE TO THE EXCLUSIVE RIGHT TO USE "DUAL MODE FLUORESCENCE", APART FROM THE MARK AS SHOWN.

FOR MICROSCOPE PARTS, NAMELY, UNIVERSAL MODULES USED WITH A MICROSCOPE THAT ENABLE ONE TO SHIFT FROM A DARKFIELD IMAGE TO A FLUORESCENT-STAINED IMAGE AND A MODE TO SEE THEM BOTH AT THE SAME TIME (U.S. CLS. 21, 23, 26, 36 AND 38).

FIRST USE 3-28-2006; IN COMMERCE 3-28-2006.
LINDA ORNDORFF, EXAMINING ATTORNEY

SN 78-960,671. RIVULET COMMUNICATIONS, INC., PORTSMOUTH, NH. FILED 8-25-2006.



OWNER OF U.S. REG. NO. 2,941,793.

THE COLOR(S) BLUE, BLACK, GOLD, WHITE IS/ARE CLAIMED AS A FEATURE OF THE MARK.

THE MARK CONSISTS OF AN OUTER RECTANGULAR BOX WITH A SMALLER SQUARE BOX INSIDE THE RECTANGULAR BOX. THE WORD RIVULET APPEARS INSIDE THE RECTANGLE, JUST ABOVE THE SQUARE BOX. A SQUIGGLY LINE APPEARS SITUATED TOWARDS THE RIGHT SIDE OF THE INNER SQUARE BOX. THE COLOR WHITE APPEARS AS THE COLOR OF THE WORD RIVULET. THE COLOR BLUE APPEARS AS THE COLOR OF THE RECTANGULAR BACKGROUND DESIGN IN THE MARK WHICH CARRIES THE WORDING RIVULET AND ALL OTHER ELEMENTS OF THE MARK. RIVULET IS SITUATED ABOVE A BLACK SQUARE THAT IS INSIDE OF THE BLUE RECTANGLE. INSIDE THE BLACK BOX IS A GOLD SQUIGGLY LINE SITUATED TOWARDS THE RIGHT OF THE BOX.

FOR COMPUTER HARDWARE AND SOFTWARE SOLD TOGETHER AS A UNIT FOR USE IN THE FIELD OF COMMUNICATIONS, NAMELY, VOICE, VIDEO AND DATA REAL-TIME APPLICATIONS, NETWORK MANAGEMENT, SERVICE MANAGEMENT, EQUIPMENT MANAGEMENT, AND USER MANAGEMENT, ALL AS APPLIED IN TELECOMMUNICATIONS AND DATA COMMUNICATIONS NETWORKS (U.S. CLS. 21, 23, 26, 36 AND 38).

FIRST USE 9-19-2005; IN COMMERCE 9-19-2005.
JAMES MACFARLANE, EXAMINING ATTORNEY

CLASS 9—(Continued).

SN 78-960,855. IDEAL INDUSTRIES, INC., SYCAMORE, IL.
FILED 8-25-2006.



THE MARK CONSISTS OF THE TERM "POWERPLUG" WITH THE TERM "POWER" IN A FIRST COLOR WITH A FIRST CONTRASTING BACKGROUND AND THE TERM "PLUG" IN A SECOND COLOR WITH A SECOND CONTRASTING BACKGROUND.

FOR ELECTRICAL WIRE CONNECTORS (U.S. CLS. 21, 23, 26, 36 AND 38).

GIANCARLO CASTRO, EXAMINING ATTORNEY

SN 78-961,055. GDX NETWORK, INC., DENVER, CO. FILED 8-25-2006.

GDX

THE MARK CONSISTS OF STANDARD CHARACTERS WITHOUT CLAIM TO ANY PARTICULAR FONT, STYLE, SIZE, OR COLOR.

FOR COMPUTER HARDWARE FOR USE ON A GLOBAL BUSINESS COMMUNICATION NETWORK USED FOR FACILITATION OF TRUSTED DATA EXCHANGE; COMPUTER SERVERS FOR USE ON A GLOBAL BUSINESS COMMUNICATION NETWORK USED FOR FACILITATION OF TRUSTED DATA EXCHANGE; COMPUTER SOFTWARE FOR USE IN PROVIDING INTERNET-BASED AND NETWORK-BASED COMPUTER VIRUS PROTECTION AS WELL AS FOR ELECTRONIC SCREENING OF DATA TRANSMISSIONS FOR COMPUTER VIRUSES AND OTHER MALICIOUS OR UNDESIRE CONTENT FOR USE ON A GLOBAL BUSINESS COMMUNICATION NETWORK USED FOR FACILITATION OF TRUSTED DATA EXCHANGE (U.S. CLS. 21, 23, 26, 36 AND 38).

MICHAEL TANNER, EXAMINING ATTORNEY

SN 78-961,983. HARRIS CORPORATION, MELBOURNE, FL.
FILED 8-28-2006.

MICROMAX

THE MARK CONSISTS OF STANDARD CHARACTERS WITHOUT CLAIM TO ANY PARTICULAR FONT, STYLE, SIZE, OR COLOR.

FOR BROADCAST TRANSMITTER EXCITERS AND PARTS THEREFOR (U.S. CLS. 21, 23, 26, 36 AND 38).

BENJAMIN OKEKE, EXAMINING ATTORNEY

CLASS 9—(Continued).

SN 78-962,500. PLANNING SYSTEMS, INC., RESTON, VA.
FILED 8-29-2006.



NO CLAIM IS MADE TO THE EXCLUSIVE RIGHT TO USE "PRECISION AIRDROP", APART FROM THE MARK AS SHOWN.

FOR COMPUTER HARDWARE; ELECTRONIC EQUIPMENT, NAMELY RADIO RECEIVER AND RADIO-TRANSMITTING DROPSONDE UNITS; COMPUTER SOFTWARE FOR IMPROVING DELIVERY ACCURACY OF GUIDED AND BALLISTIC PARACHUTE CARGO (U.S. CLS. 21, 23, 26, 36 AND 38).

FIRST USE 4-9-2002; IN COMMERCE 4-9-2002.

DAVID H. STINE, EXAMINING ATTORNEY

SN 78-964,159. RUNCO INTERNATIONAL INC., UNION CITY, CA. FILED 8-30-2006.

DUNLAVY

THE MARK CONSISTS OF STANDARD CHARACTERS WITHOUT CLAIM TO ANY PARTICULAR FONT, STYLE, SIZE, OR COLOR.

FOR HOME THEATRE PRODUCTS, NAMELY, SPEAKERS, PROJECTORS, LCD DISPLAY MONITORS, PLASMA DISPLAY MONITORS AND VIDEO PROCESSORS (U.S. CLS. 21, 23, 26, 36 AND 38).

CAROLYN CATALDO, EXAMINING ATTORNEY

CLASS 9—(Continued).

SN 78-966,891. SEGA CORPORATION, TOKYO, JAPAN, FILED 9-5-2006.

CLASS 9—(Continued).

SN 78-969,026. ADT SERVICES AG, 8200 SCHAFFHAUSEN, SWITZERLAND, FILED 9-7-2006.

CRUMPLETECH

THE MARK CONSISTS OF STANDARD CHARACTERS WITHOUT CLAIM TO ANY PARTICULAR FONT, STYLE, SIZE, OR COLOR.

FOR VIDEO GAME SOFTWARE; COMPUTER GAME PROGRAMS; VIDEO GAME PROGRAMS FOR HOME GAME MACHINES; VIDEO GAME PROGRAMS FOR HAND-HELD GAME MACHINES; VIDEO GAME PROGRAMS FOR MOBILE TELEPHONES; VIDEO GAME PROGRAMS FOR ARCADE GAME MACHINES (U.S. CLS. 21, 23, 26, 36 AND 38).

ROBIN CHOSID, EXAMINING ATTORNEY

ADT

THE MARK CONSISTS OF STANDARD CHARACTERS WITHOUT CLAIM TO ANY PARTICULAR FONT, STYLE, SIZE, OR COLOR.

OWNER OF U.S. REG. NOS. 710,708, 1,141,155 AND OTHERS.

FOR ELECTRIC MONITORING APPARATUS, NAMELY, RADIO SIGNAL TRANSMITTERS AND RECEIVERS, AND ANTENNAS; REMOTE CONTROL UNITS FOR PERSONAL EMERGENCY RESPONSE SYSTEMS AND BURGLAR ALARM SYSTEMS; INTERCOMS; MOTION SENSORS, AND ENVIRONMENTAL SENSORS IN THE NATURE OF PASSIVE INFRARED SENSORS, TEMPERATURE SENSORS AND WINDOW AND DOOR CONTACT SENSORS; TELEPHONE COMMUNICATION BASE STATIONS, NAMELY, DIGITAL ALARM COMMUNICATION TRANSMITTERS; ELECTRIC MONITORING APPARATUS, NAMELY, COMPUTER HARDWARE AND SOFTWARE USED TO MONITOR AND TRACK MOVEMENT ACTIVITY, HEALTH CONDITIONS AND ENVIRONMENTAL CONDITIONS, AND USED TO TRANSMIT ELECTRONIC MESSAGES AND DATA VIA COMMUNICATIONS NETWORKS; AND ELECTRIC MONITORING APPARATUS, NAMELY, COMPUTER HARDWARE AND PERIPHERALS (U.S. CLS. 21, 23, 26, 36 AND 38).

FIRST USE 12-12-2005; IN COMMERCE 12-12-2005.
DORITT L. CARROLL, EXAMINING ATTORNEY

SN 78-967,941. TULMAR SAFETY SYSTEMS INC., HAWKESBURY, CANADA, FILED 9-6-2006.

SN 78-973,669. MONSTER CABLE PRODUCTS, INC., BRISBANE, CA. FILED 9-13-2006.

HAMMERHEAD

THE MARK CONSISTS OF STANDARD CHARACTERS WITHOUT CLAIM TO ANY PARTICULAR FONT, STYLE, SIZE, OR COLOR.

PRIORITY CLAIMED UNDER SEC. 44(D) ON CANADA APPLICATION NO. 1,308,206, FILED 7-7-2006, REG. NO. TM688755, DATED 5-31-2007, EXPIRES 5-31-2022.

FOR LIFE PRESERVERS AND LIFE JACKETS (U.S. CLS. 21, 23, 26, 36 AND 38).

FIRST USE 3-31-2004; IN COMMERCE 1-31-2006.
ADA HAN, EXAMINING ATTORNEY



NO CLAIM IS MADE TO THE EXCLUSIVE RIGHT TO USE "INTELLIGENT HOME CONTROL", APART FROM THE MARK AS SHOWN.

FOR RESIDENTIAL CONTROL SYSTEM COMPRISING CONTROL PROTOCOL SOFTWARE FEATURING INTEROPERABILITY STANDARDS, COMPUTER HARDWARE AND CONTROLLERS FOR CENTRALIZED HOME CONTROL, NAMELY, FOR CONTROLLING RESIDENTIAL LIGHTING, TELEPHONE SYSTEMS, HEATING, VENTILATION, AIR CONDITIONING SYSTEMS, AND AUDIO AND VIDEO DEVICES (U.S. CLS. 21, 23, 26, 36 AND 38).

JEFF DEFORD, EXAMINING ATTORNEY

CLASS 9—(Continued).

SN 78-974,860. A10 NETWORKS, INC., SAN JOSE, CA. FILED 9-14-2006.

IP TO ID

THE MARK CONSISTS OF STANDARD CHARACTERS WITHOUT CLAIM TO ANY PARTICULAR FONT, STYLE, SIZE, OR COLOR.

NO CLAIM IS MADE TO THE EXCLUSIVE RIGHT TO USE "IP", APART FROM THE MARK AS SHOWN.

FOR COMPUTER HARDWARE AND SOFTWARE FOR RESOLVING INTERNET PROTOCOL (IP) ADDRESSES (U.S. CLS. 21, 23, 26, 36 AND 38).

DAVID TAYLOR, EXAMINING ATTORNEY

SN 78-978,773. TRADEMAVEN GROUP, LLC, CHICAGO, IL. FILED 2-14-2006.

AUTOMAVEN

THE MARK CONSISTS OF STANDARD CHARACTERS WITHOUT CLAIM TO ANY PARTICULAR FONT, STYLE, SIZE, OR COLOR.

FOR DOWNLOADABLE SOFTWARE RELATING TO FINANCIAL INVESTMENTS AND FOR AN ELECTRONIC TRADING PLATFORM FOR TRADING SECURITIES, INVESTMENT SECURITIES, COMMODITIES, CURRENCIES, OPTIONS, AND DERIVATIVES (U.S. CLS. 21, 23, 26, 36 AND 38).

FIRST USE 8-0-2004; IN COMMERCE 8-0-2004.

DAVID YONTEF, EXAMINING ATTORNEY

CLASS 9—(Continued).

SN 79-020,499. SCHNEIDER ELECTRIC INDUSTRIES SAS, FRANCE, FILED 12-22-2005.

OSITRACK

THE MARK CONSISTS OF STANDARD CHARACTERS WITHOUT CLAIM TO ANY PARTICULAR FONT, STYLE, SIZE, OR COLOR.

PRIORITY DATE OF 7-5-2005 IS CLAIMED.

OWNER OF INTERNATIONAL REGISTRATION 0875836 DATED 12-22-2005, EXPIRES 12-22-2015.

FOR SCIENTIFIC AND ELECTRONIC APPARATUS AND INSTRUMENTS, AND ELECTRONIC DETECTION AND CONTROL APPARATUS, NAMELY, PORTABLE TERMINALS, NAMELY, PERSONAL RADIO TERMINALS, PORTABLE COMPUTER TERMINALS, PORTABLE CONTROLLING TERMINALS, PORTABLE MONITORING TERMINALS; ELECTRICAL CONNECTION BOXES; ELECTRONICALLY ENCODED BADGES; RADIO-FREQUENCY IDENTIFICATION TAG READERS, REMOTE RADIO TRANSMITTING AND RECEIVING STATIONS, SIGNAL RECEIVING STATIONS; RADIO-FREQUENCY IDENTIFICATION TAGS, RADIO-FREQUENCY IDENTIFICATION CREDENTIALS, NAMELY, CARDS AND TAGS, AND READERS FOR RADIO-FREQUENCY CREDENTIALS; RADIO-FREQUENCY IDENTIFICATION DEVICES AND SYSTEMS, NAMELY, RADIO-FREQUENCY IDENTIFICATION PERSONAL RADIO TERMINALS, RADIO-FREQUENCY IDENTIFICATION PORTABLE COMPUTER TERMINALS, RADIO-FREQUENCY IDENTIFICATION PORTABLE CONTROLLING TERMINALS, RADIO-FREQUENCY IDENTIFICATION PORTABLE MONITORING TERMINALS; RADIO-FREQUENCY IDENTIFICATION COMPUTER STATIONS, RADIO-FREQUENCY IDENTIFICATION CONTROLLING STATIONS, RADIO-FREQUENCY IDENTIFICATION MONITORING STATIONS; RADIO-FREQUENCY IDENTIFICATION CONFIGURATION BADGES, RADIO-FREQUENCY IDENTIFICATION BADGES, RADIO-FREQUENCY IDENTIFICATION TAGS, RADIO-FREQUENCY IDENTIFICATION STANDARD SYSTEM TAGS (U.S. CLS. 21, 23, 26, 36 AND 38).

LINDA MICKLEBURGH, EXAMINING ATTORNEY

SN 79-026,456. BERNAFON AG, SWITZERLAND, FILED 7-3-2006.

OASIS

THE MARK CONSISTS OF STANDARD CHARACTERS WITHOUT CLAIM TO ANY PARTICULAR FONT, STYLE, SIZE, OR COLOR.

OWNER OF INTERNATIONAL REGISTRATION 0892044 DATED 7-3-2006, EXPIRES 7-3-2016.

FOR COMPUTER SOFTWARE, NAMELY, SOFTWARE FOR ELECTRONIC INSTRUMENTS USED FOR ADJUSTMENT AND FITTING OF HEARING AIDS (U.S. CLS. 21, 23, 26, 36 AND 38).

COLLEEN KEARNEY, EXAMINING ATTORNEY

CLASS 9—(Continued).

SN 79-026,899. TELEVIC, NAAMLOZE VENNOOTSCHAP, BELGIUM, FILED 5-8-2006.

TELEVIC

THE MARK CONSISTS OF STANDARD CHARACTERS WITHOUT CLAIM TO ANY PARTICULAR FONT, STYLE, SIZE, OR COLOR.

PRIORITY DATE OF 4-27-2006 IS CLAIMED. OWNER OF INTERNATIONAL REGISTRATION 0893341 DATED 5-8-2006, EXPIRES 5-8-2016.

FOR SCIENTIFIC INSTRUMENTS, NAMELY, MICROSCOPES AND TELESCOPES; NAUTICAL INSTRUMENTS, NAMELY, SEXTANTS AND COMPASSES; SURVEYING MACHINES AND INSTRUMENTS; PHOTOGRAPHIC EQUIPMENT, NAMELY, CAMERAS, EXPOSURE METERS, PROJECTORS; CINEMATOGRAPHIC MACHINES AND APPARATUS; OPTICAL EQUIPMENT, NAMELY, CABLES, FILTERS AND DISK DRIVES; WEIGHING EQUIPMENT, NAMELY, SCALES AND BALANCES; MEASURING APPARATUS, NAMELY, TAPE RULERS AND TAPE MEASURES; SIGNAL PROCESSORS; APPARATUS AND INSTRUMENTS FOR CONDUCTING, SWITCHING, TRANSFORMING, ACCUMULATING, REGULATING OR CONTROLLING ELECTRICITY, NAMELY, ELECTRICITY ADAPTERS AND ELECTRICITY CONDUITS; APPARATUS FOR RECORDING, TRANSMISSION OR REPRODUCTION OF SOUND OR IMAGES; ELECTRONIC APPARATUS AND INSTRUMENTS FOR DIGITAL OR ANALOGOUS REGISTRATION, TRANSMISSION AND REPRODUCTION OF MESSAGES AND DATA, NAMELY, DIGITAL AUDIO PLAYERS AND MOBILE DATA RECEIVERS; BLANK MAGNETIC DATA CARRIERS; CASH REGISTERS, CALCULATORS, DATA PROCESSORS AND COMPUTERS; OPERATING SYSTEMS SOFTWARE FOR USE IN MULTIMEDIA AND COMMUNICATIONS MARKETS, EXCLUDING PC SOFTWARE FOR AUDIO CONFERENCING AND VIDEO CONFERENCING (U.S. CLS. 21, 23, 26, 36 AND 38).
TOBY BULLOFF, EXAMINING ATTORNEY

CLASS 9—(Continued).

SN 79-029,228. CHINT GROUP CO., LTD., CHINA, FILED 6-20-2006.

正泰

OWNER OF INTERNATIONAL REGISTRATION 0899257 DATED 6-20-2006, EXPIRES 6-20-2016.

THE FIRST CHINESE CHARACTER IN THE MARK MEANS "STRAIGHT, UPRIGHT OR PERPENDICULAR"; THE SECOND CHINESE CHARACTER IN THE MARK TRANSLATES TO "PEACEFUL, SAFE"; THE TWO CHINESE CHARACTERS HAVE NO MEANING IN COMBINATION.

THE TRANSLITERATION OF THE FIRST CHINESE CHARACTER IN THE MARK IS "ZHENG", THE SECOND CHINESE CHARACTER IN THE MARK TRANSLITERATES INTO "TAI".

FOR COMPUTERS; FACSIMILE MACHINES; WEIGHING EQUIPMENT, NAMELY, SCALES AND BALANCES; TAPE MEASURES; INTERCOMMUNICATION APPARATUS, NAMELY, TELEPHONES; PHOTOGRAPHY CAMERAS; ELECTROTECHNIC INSTRUMENTS, NAMELY, ELECTROTECHNICAL VIBRATION METERS, EXPOSURE METERS, MANOMETERS, WATT-HOUR METERS; ELECTRIC WIRES; LOW VOLTAGE ELECTRIC COMPONENTS, NAMELY, VOLTMETERS, CIRCUIT BREAKERS, TRANSFORMERS, ELECTRIC RESISTANCES, CURRENT RECTIFIERS, ELECTRIC RELAYS. (U.S. CLS. 21, 23, 26, 36 AND 38).

TEJBIR SINGH, EXAMINING ATTORNEY

SN 79-028,024. INFINITI LIMITED, IRVINE, UNITED KINGDOM, FILED 7-26-2006.

PANTHER

THE MARK CONSISTS OF STANDARD CHARACTERS WITHOUT CLAIM TO ANY PARTICULAR FONT, STYLE, SIZE, OR COLOR.

PRIORITY DATE OF 2-10-2006 IS CLAIMED. OWNER OF INTERNATIONAL REGISTRATION 0896274 DATED 7-26-2006, EXPIRES 7-26-2016.

FOR COMPUTER SOFTWARE FOR USE IN THE FIELDS OF FINANCIAL SERVICES, INTELLIGENCE SERVICES AND BACKGROUND INVESTIGATION AND RESEARCH SERVICES THAT DETECTS FRAUDULENT ACTIVITY BY OBTAINING AND ANALYZING PERSONAL AND BUSINESS DATA, INCLUDING HOME AND BUSINESS ADDRESSES, TELEPHONE RECORDS, FINANCIAL TRANSACTIONS, PASSPORT RECORDS AND OTHER PERSONAL INFORMATION (U.S. CLS. 21, 23, 26, 36 AND 38).
BENJAMIN OKEKE, EXAMINING ATTORNEY

SN 79-030,504. VISUALMARK INTERNACIONAL, S.L., SPAIN, FILED 10-9-2006.

**Spinlight**

PRIORITY DATE OF 9-28-2006 IS CLAIMED. OWNER OF INTERNATIONAL REGISTRATION 0902487 DATED 10-9-2006, EXPIRES 10-9-2016.

FOR APPARATUS FOR REPRODUCING IMAGES, NAMELY LIQUID CRYSTAL DISPLAY (LCD) PROJECTORS, TELEVISIONS, COMPUTER DISPLAY MONITORS (U.S. CLS. 21, 23, 26, 36 AND 38).
CURTIS FRENCH, EXAMINING ATTORNEY

CLASS 9—(Continued).

SN 79-031,251. NEXANS, FRANCE, FILED 10-6-2006.

UFLEX

THE MARK CONSISTS OF STANDARD CHARACTERS WITHOUT CLAIM TO ANY PARTICULAR FONT, STYLE, SIZE, OR COLOR.

PRIORITY DATE OF 5-2-2006 IS CLAIMED.
OWNER OF INTERNATIONAL REGISTRATION 0904340 DATED 10-6-2006, EXPIRES 10-6-2016.
FOR SOFTWARE FOR PREDICTING CABLE BEHAVIOR (U.S. CLS. 21, 23, 26, 36 AND 38).
NANCY CLARKE, EXAMINING ATTORNEY

SN 79-032,402. COLEBROOK BOSSON SAUNDERS PRODUCTS LIMITED, UNITED KINGDOM, FILED 11-27-2006.

GISELLE

THE MARK CONSISTS OF STANDARD CHARACTERS WITHOUT CLAIM TO ANY PARTICULAR FONT, STYLE, SIZE, OR COLOR.

OWNER OF INTERNATIONAL REGISTRATION 0907187 DATED 11-27-2006, EXPIRES 11-27-2016.
FOR SUPPORT ARMS SPECIALLY ADAPTED FOR MOUNTING TELEVISIONS AND COMPUTER MONITORS (U.S. CLS. 21, 23, 26, 36 AND 38).
VERNA BETH RIRIE, EXAMINING ATTORNEY

SN 79-032,524. CCP HF., COMPANY NR. 450697-3469, ICELAND, FILED 6-9-2006.

EVE ONLINE

THE MARK CONSISTS OF STANDARD CHARACTERS WITHOUT CLAIM TO ANY PARTICULAR FONT, STYLE, SIZE, OR COLOR.

PRIORITY DATE OF 12-23-2005 IS CLAIMED.
OWNER OF INTERNATIONAL REGISTRATION 0907568 DATED 6-9-2006, EXPIRES 6-9-2016.
OWNER OF U.S. REG. NO. 2,805,666.
NO CLAIM IS MADE TO THE EXCLUSIVE RIGHT TO USE "ONLINE", APART FROM THE MARK AS SHOWN.
FOR COMPUTER GAME DISCS; COMPUTER GAME PROGRAMS; COMPUTER GAME SOFTWARE; DVDS AND VIDEOTAPES FEATURING MOVIES AND TELEVISION PROGRAMS IN THE FIELD OF COMPUTER GAMES; COMPUTER GAME SOFTWARE DOWNLOADABLE VIA THE INTERNET. (U.S. CLS. 21, 23, 26, 36 AND 38).
DANIEL BRODY, EXAMINING ATTORNEY

CLASS 9—(Continued).

SN 79-036,194. HORIBA, LTD., JAPAN, FILED 1-22-2007.

MINIFLOW

THE MARK CONSISTS OF STANDARD CHARACTERS WITHOUT CLAIM TO ANY PARTICULAR FONT, STYLE, SIZE, OR COLOR.

OWNER OF INTERNATIONAL REGISTRATION 0918002 DATED 1-22-2007, EXPIRES 1-22-2017.
FOR CIRCULATION SYSTEM FOR PARTICLE SIZE DISTRIBUTION ANALYZERS, CONSISTING OF AN ULTRASONIC PROBE, FLOW CELL AND PUMP, FOR USE IN THE FIELD OF RESEARCH AND DEVELOPMENT OR QUALITY ASSURANCE TESTING; RECIRCULATOR FOR PARTICLE SIZE DISTRIBUTION ANALYZERS, CONSISTING OF AN ULTRASONIC PROBE, FLOW CELL AND PUMP, FOR USE IN THE FIELD OF RESEARCH AND DEVELOPMENT OR QUALITY ASSURANCE TESTING (U.S. CLS. 21, 23, 26, 36 AND 38).
DAWN FELDMAN, EXAMINING ATTORNEY

SN 79-036,299. VICTOR COMPANY OF JAPAN, LIMITED, JAPAN, FILED 12-21-2006.

Sophisti

THE MARK CONSISTS OF STANDARD CHARACTERS WITHOUT CLAIM TO ANY PARTICULAR FONT, STYLE, SIZE, OR COLOR.

OWNER OF INTERNATIONAL REGISTRATION 0918279 DATED 12-21-2006, EXPIRES 12-21-2016.
FOR HOME THEATRE SYSTEMS COMPOSED OF TELEVISION MONITORS AND DVD PLAYERS; TELEVISION SETS; STEREO RECEIVERS AND COMPONENTS THEREFOR, NAMELY, STEREO AMPLIFIERS, TUNERS, AUDIO SPEAKERS; RADIO TUNERS AND RECEIVERS; AUDIO TAPE RECORDERS AND PLAYERS; VIDEO TAPE RECORDERS AND PLAYERS; AUDIO DISC RECORDERS AND PLAYERS; VIDEO DISC RECORDERS AND PLAYERS; AND NETWORK MEDIA PLAYERS, NAMELY, EQUIPMENT WHICH PLAYS VIDEO, PHOTO AND MUSIC ACCUMULATED THROUGH PC BY WIRELESS NETWORK WITH TELEVISION AND AUDIO SYSTEM (U.S. CLS. 21, 23, 26, 36 AND 38).
VERNA BETH RIRIE, EXAMINING ATTORNEY

CLASS 9—(Continued).

SN 79-037,045. GAMESA INNOVATION & TECHNOLOGY, S.L., SPAIN, FILED 2-13-2007.

CLASS 9—(Continued).

SN 79-037,047. GAMESA INNOVATION & TECHNOLOGY, S.L., E-31013 PAMPLONA, SPAIN, FILED 2-13-2007.

WindONE WindNet

PRIORITY DATE OF 10-2-2006 IS CLAIMED.
OWNER OF INTERNATIONAL REGISTRATION 0920368
DATED 2-13-2007, EXPIRES 2-13-2017.

FOR APPARATUS AND INSTRUMENTS FOR CONDUCTING, SWITCHING, TRANSFORMING, ACCUMULATING, REGULATING OR CONTROLLING ELECTRICITY, NAMELY, ELECTRIC SWITCHES, ADAPTERS, ELECTRICITY CONDUITS, ELECTRIC WIRES, VOLTAGE REGULATORS FOR ELECTRIC POWER, ELECTRICAL CONDUCTORS; DATA PROCESSORS; CENTRAL PROCESSING UNITS FOR PROCESSING INFORMATION, DATA, SOUND OR IMAGES; DATA PROCESSING COMPUTERS, COMPUTERS, ALL FOR OPERATING AND CONTROL OF WIND TURBINES (U.S. CLS. 21, 23, 26, 36 AND 38).

CHRISIE B. KING, EXAMINING ATTORNEY

PRIORITY DATE OF 10-2-2006 IS CLAIMED.
OWNER OF INTERNATIONAL REGISTRATION 0920370
DATED 2-13-2007, EXPIRES 2-13-2017.

FOR APPARATUS AND INSTRUMENTS FOR CONDUCTING, SWITCHING, TRANSFORMING, ACCUMULATING, REGULATING OR CONTROLLING ELECTRICITY, NAMELY, ELECTRIC SWITCHES, ADAPTERS, ELECTRICITY CONDUITS, ELECTRIC WIRES, VOLTAGE REGULATORS FOR ELECTRIC POWER, ELECTRICAL CONDUCTORS; DATA PROCESSORS; CENTRAL PROCESSING UNITS FOR PROCESSING INFORMATION, DATA, SOUND OR IMAGES; DATA PROCESSING COMPUTERS, COMPUTERS, ALL FOR OPERATING AND CONTROL OF WIND TURBINES (U.S. CLS. 21, 23, 26, 36 AND 38).

CHRISIE B. KING, EXAMINING ATTORNEY

SN 79-037,046. GAMESA INNOVATION & TECHNOLOGY, S.L., E-31013 PAMPLONA, SPAIN, FILED 2-13-2007.

SN 79-038,344. AUTOFORM ENGINEERING GMBH, SWITZERLAND, FILED 3-5-2007.

GRIDMATE SIGMA

PRIORITY DATE OF 8-31-2006 IS CLAIMED.
OWNER OF INTERNATIONAL REGISTRATION 0920369
DATED 2-13-2007, EXPIRES 2-13-2017.

FOR APPARATUS AND INSTRUMENTS FOR CONDUCTING, SWITCHING, TRANSFORMING, ACCUMULATING, REGULATING OR CONTROLLING ELECTRICITY, NAMELY, ELECTRIC SWITCHES, ADAPTERS, ELECTRICITY CONDUITS, ELECTRIC WIRES, VOLTAGE REGULATORS FOR ELECTRIC POWER, ELECTRICAL CONDUCTORS; DATA PROCESSORS; CENTRAL PROCESSING UNITS FOR PROCESSING INFORMATION, DATA, SOUND OR IMAGES; DATA PROCESSING COMPUTERS, COMPUTERS, ALL FOR OPERATING AND CONTROL OF WIND TURBINES (U.S. CLS. 21, 23, 26, 36 AND 38).

CHRISIE B. KING, EXAMINING ATTORNEY

THE MARK CONSISTS OF STANDARD CHARACTERS WITHOUT CLAIM TO ANY PARTICULAR FONT, STYLE, SIZE, OR COLOR.

PRIORITY DATE OF 11-3-2006 IS CLAIMED.
OWNER OF INTERNATIONAL REGISTRATION 0923756
DATED 3-5-2007, EXPIRES 3-5-2017.

FOR COMPUTER SOFTWARE FOR SHEET METAL FORMING TECHNOLOGY, PARTICULARLY FOR THE DESIGN AND OPTIMISATION OF STURDY MANUFACTURING PROCESSES (U.S. CLS. 21, 23, 26, 36 AND 38).

JASON BLAIR, EXAMINING ATTORNEY

CLASS 10—MEDICAL APPARATUS

SN 76-609,285. TAKIRON CO., LTD., CHUO-KU, OSAKA, JAPAN, FILED 8-30-2004.

TAKIRON

THE MARK CONSISTS OF STANDARD CHARACTERS WITHOUT CLAIM TO ANY PARTICULAR FONT, STYLE, SIZE, OR COLOR.

OWNER OF JAPAN REG. NO. 5020323, DATED 1-19-2007, EXPIRES 1-19-2017.

FOR SURGICAL, MEDICAL, DENTAL, VETERINARY APPARATUS AND INSTRUMENTS AND ORTHOPEDIC ARTICLES, NAMELY, DRILL BITS, TAPS, DRIVERS, BENDERS, FORCEPS AND JIGS FOR IMPLANTATION FOR SURGICAL APPLICATIONS, BONE SCREWS, PINS, NAILS, WASHERS, PLATES, ARTIFICIAL CARTILAGE AND SURGICAL IMPLANTS COMPRISING ARTIFICIAL MATERIALS; ARTIFICIAL LIMBS, EYES AND TEETH; SUTURES; BIORESORBABLE FIXATION BONE IMPLANTS COMPOSED OF ARTIFICIAL MATERIALS FOR OSTEOSYNTHETIC USE (U.S. CLS. 26, 39 AND 44).
SANI KHOURI, EXAMINING ATTORNEY

SN 76-659,863. DIGITAL WEB GROUP INC, TUCSON, AZ. FILED 5-10-2006.

SILICONEWORKS INTERNATIONAL

THE MARK CONSISTS OF STANDARD CHARACTERS WITHOUT CLAIM TO ANY PARTICULAR FONT, STYLE, SIZE, OR COLOR.

NO CLAIM IS MADE TO THE EXCLUSIVE RIGHT TO USE "INTERNATIONAL", APART FROM THE MARK AS SHOWN.

FOR SILICONE BREAST PROSTHESES (U.S. CLS. 26, 39 AND 44).

FIRST USE 1-0-2000; IN COMMERCE 2-0-2000.
KATHERINE CHANG, EXAMINING ATTORNEY

SN 77-022,090. C. R. BARD, INC., MURRAY HILL, NJ. FILED 10-16-2006.

AGENTO

THE MARK CONSISTS OF STANDARD CHARACTERS WITHOUT CLAIM TO ANY PARTICULAR FONT, STYLE, SIZE, OR COLOR.

FOR ENDOTRACHEAL TUBES AND PARTS AND FITTINGS THEREFOR; AND COATING FOR ENDOTRACHEAL TUBES SOLD AS A COMPONENT OF THE FINISHED TUBES (U.S. CLS. 26, 39 AND 44).

DOMINIC FATHY, EXAMINING ATTORNEY

CLASS 10—(Continued).

SN 77-022,638. JIMMYJANE, INC., SAN FRANCISCO, CA. FILED 10-17-2006.



THE MARK CONSISTS OF A BENT OVAL, WITH A 'COLLAR' AT THE BEND IN THE OVAL, THREE SEMI-CIRCLES AT THE TOP RIGHT OF THE OVAL, A HALF-CIRCLE AT THE FAR RIGHT OF THE OVAL, AND THREE LINES BISECTING THE OVAL AT VARIOUS POINTS TO SUGGEST 3-DIMENSIONALITY.

FOR ADULT SEXUAL AIDS, NAMELY, VIBRATORS, MOTORS AND BATTERIES THEREFOR, SOLD AS A UNIT (U.S. CLS. 26, 39 AND 44).

JERI J. FICKES, EXAMINING ATTORNEY

SN 77-022,998. MUSICAL ELECTRONICS LIMITED, KWUN TONG, KOWLOON, HONG KONG, FILED 10-17-2006.



PRIORITY CLAIMED UNDER SEC. 44(D) ON HONG KONG APPLICATION NO. 300731015, FILED 9-28-2006, REG. NO. 300731015, DATED 9-28-2006, EXPIRES 9-28-2013.

FOR HANDHELD DEVICES FOR CHEMICAL AND PERSONAL HEALTHCARE FOR PROVIDING ACU-POINT LOCATION AND ELECTRICAL MICROCURRENT THERAPY; HANDHELD DEVICES FOR PROVIDING ELECTRO-ACUPUNCTURE, ACUPRESSURE AND PAIN MANAGEMENT; MEDICAL HANDHELD DEVICES FOR MEASURING ELECTRICAL RESISTANCE OF THE SKIN; BLOOD PRESSURE MONITORS; BLOOD PRESSURE MEASURING DEVICES; CUFFLESS BLOOD PRESSURE AND PULSE RATE CALCULATORS; MEDICAL ELECTRONIC DEVICES FOR DETECTING VITAL HEALTH SIGNALS; BLOOD GLUCOSE METERS; CHOLESTEROLS METERS; TELECAP DEVICE TO PROVIDE CONTINUOUS POSITIVE AIRWAY PRESSURE (U.S. CLS. 26, 39 AND 44).

JEAN IM, EXAMINING ATTORNEY

SN 77-039,633. GEBR. BRASSELER GMBH & CO. KG, LEMGO, FED REP GERMANY, FILED 11-8-2006.

CERAPOST

THE MARK CONSISTS OF STANDARD CHARACTERS WITHOUT CLAIM TO ANY PARTICULAR FONT, STYLE, SIZE, OR COLOR.

FOR DENTAL ROOT POSTS AND ROOT POST SYSTEMS COMPRISED PRIMARILY OF ROOT POSTS, CYLINDRICAL AND TAPERED FILES, MATCHING BURS, REPAIR POSTS, CERAMIC ROOT POSTS, ROOT POSTS OF ZIRCONIUM OXIDE, CASSETTES FOR STORAGE AND STERILIZATION (U.S. CLS. 26, 39 AND 44).

PAULA MAHONEY, EXAMINING ATTORNEY

CLASS 10—(Continued).

SN 77-040,450. VERTIFLEX, INC., SAN CLEMENTE, CA. FILED 11-9-2006.

Phantom

THE MARK CONSISTS OF STANDARD CHARACTERS WITHOUT CLAIM TO ANY PARTICULAR FONT, STYLE, SIZE, OR COLOR.

FOR MEDICAL DEVICES, NAMELY SPINAL IMPLANTS AND INTERBODY DEVICES FOR USE IN SPINAL SURGERY (U.S. CLS. 26, 39 AND 44).
ERNEST SHOSHO, EXAMINING ATTORNEY

SN 77-040,472. VERTIFLEX, INC., SAN CLEMENTE, CA. FILED 11-9-2006.

Protégé

THE MARK CONSISTS OF STANDARD CHARACTERS WITHOUT CLAIM TO ANY PARTICULAR FONT, STYLE, SIZE, OR COLOR.

FOR MEDICAL DEVICES, NAMELY SPINAL IMPLANTS AND INTERVERTEBRAL SPACERS (U.S. CLS. 26, 39 AND 44).
ERNEST SHOSHO, EXAMINING ATTORNEY

SN 77-042,826. ASAHI INTECC CO., LTD., AICHI, JAPAN, FILED 11-13-2006.

FIELDER

THE MARK CONSISTS OF STANDARD CHARACTERS WITHOUT CLAIM TO ANY PARTICULAR FONT, STYLE, SIZE, OR COLOR.

FOR MEDICAL INSTRUMENTS AND APPARATUS, NAMELY, MEDICAL GUIDE WIRES, PTCA (PERCUTANEOUS TRANSLUMINAL CORONARY ANGIOPLASTY) GUIDE WIRES (U.S. CLS. 26, 39 AND 44).
MARK PILARO, EXAMINING ATTORNEY

CLASS 10—(Continued).

SN 77-060,438. LIFESCIENCE SOLUTIONS, LLC, CHARLOTTE, NC. FILED 12-8-2006.

TRANSWORLD HEART

THE MARK CONSISTS OF STANDARD CHARACTERS WITHOUT CLAIM TO ANY PARTICULAR FONT, STYLE, SIZE, OR COLOR.

NO CLAIM IS MADE TO THE EXCLUSIVE RIGHT TO USE "HEART", APART FROM THE MARK AS SHOWN.

FOR MEDICAL DEVICES, NAMELY, IMPLANTABLE PULSE GENERATORS CAPABLE OF REMOTE INTERROGATION FOR REAL TIME WIRELESS REMOTE MONITORING OF ORGANS AND TISSUE (U.S. CLS. 26, 39 AND 44).
JOHN KELLY, EXAMINING ATTORNEY

SN 77-065,451. LINVATEC CORPORATION, LARGO, FL. FILED 12-15-2006.

XO BUTTON

THE MARK CONSISTS OF STANDARD CHARACTERS WITHOUT CLAIM TO ANY PARTICULAR FONT, STYLE, SIZE, OR COLOR.

NO CLAIM IS MADE TO THE EXCLUSIVE RIGHT TO USE "BUTTON", APART FROM THE MARK AS SHOWN.

FOR SURGICAL IMPLANTS COMPRISING ARTIFICIAL MATERIAL (U.S. CLS. 26, 39 AND 44).
NORA BUCHANAN WILL, EXAMINING ATTORNEY

SN 77-073,893. ORIGINAL DIAMOND DESIGNS, INC., SARASOTA, FL. FILED 12-31-2006.

Sensory Belt

THE MARK CONSISTS OF STANDARD CHARACTERS WITHOUT CLAIM TO ANY PARTICULAR FONT, STYLE, SIZE, OR COLOR.

NO CLAIM IS MADE TO THE EXCLUSIVE RIGHT TO USE "BELT", APART FROM THE MARK AS SHOWN.

FOR ABDOMINAL BELTS (U.S. CLS. 26, 39 AND 44).
FIRST USE 11-27-2006; IN COMMERCE 11-27-2006.
ARETHA SOMERVILLE, EXAMINING ATTORNEY

CLASS 10—(Continued).

SN 77-081,194. TERUMO KABUSHIKI KAISHA A/K/A TERUMO CORPORATION, SHIBUYA-KU, JAPAN, FILED 1-11-2007.

RUNTHROUGH

THE MARK CONSISTS OF STANDARD CHARACTERS WITHOUT CLAIM TO ANY PARTICULAR FONT, STYLE, SIZE, OR COLOR.

OWNER OF JAPAN REG. NO. 4515499, DATED 10-19-2001, EXPIRES 10-19-2011.

FOR MEDICAL GUIDEWIRES (U.S. CLS. 26, 39 AND 44).

G. MAYERSCHOFF, EXAMINING ATTORNEY

SN 77-101,688. C. R. BARD, INC., MURRAY HILL, NJ. FILED 2-7-2007.

PROXIMA

THE MARK CONSISTS OF STANDARD CHARACTERS WITHOUT CLAIM TO ANY PARTICULAR FONT, STYLE, SIZE, OR COLOR.

FOR MEDICAL DEVICES AND APPARATUS, NAMELY, CATHETERS, CATHETER VALVES, AND PARTS AND FITTINGS THEREFOR (U.S. CLS. 26, 39 AND 44).

GINA HAYES, EXAMINING ATTORNEY

SN 77-128,775. VGX PHARMACEUTICALS, BLUE BELL, PA. FILED 3-12-2007.

CELLECTRA

THE MARK CONSISTS OF STANDARD CHARACTERS WITHOUT CLAIM TO ANY PARTICULAR FONT, STYLE, SIZE, OR COLOR.

FOR MEDICAL APPARATUS FOR DELIVERING NUCLEIC ACID MOLECULES, FOR EXAMPLE PLASMIDS, OR VACCINES TO MAMMALS OR CELLS VIA ELECTROPORATION (U.S. CLS. 26, 39 AND 44).

SAIMA MAKHDOOM, EXAMINING ATTORNEY

CLASS 10—(Continued).

SN 77-130,603. PFIZER HEALTH AB, STOCKHOLM, SWEDEN, FILED 3-14-2007.

QUICKTRA

THE MARK CONSISTS OF STANDARD CHARACTERS WITHOUT CLAIM TO ANY PARTICULAR FONT, STYLE, SIZE, OR COLOR.

FOR MEDICAL DEVICES FOR INJECTING PHARMACEUTICALS (U.S. CLS. 26, 39 AND 44).

HEATHER SAPP, EXAMINING ATTORNEY

SN 77-133,866. ERIC J. DUHON, LAS VEGAS, NV. FILED 3-18-2007.

VACUULIZER

THE MARK CONSISTS OF STANDARD CHARACTERS WITHOUT CLAIM TO ANY PARTICULAR FONT, STYLE, SIZE, OR COLOR.

FOR A MOTOR DRIVEN APPARATUS THAT COLLECTS, VACUUMS AND FILTERS WASTE PARTICLES AND MATERIALS FROM THE PROCESSING OF VARIOUS MATERIALS SUCH AS METAL WORKING, PLASTIC WORKING, WOOD WORKING, AND THE LIKE (U.S. CLS. 26, 39 AND 44).

ALLISON HOLTZ, EXAMINING ATTORNEY

SN 77-134,867. RIDLEY, JAMES, EUGENE, OR. FILED 3-19-2007.

DentureMasters

NO CLAIM IS MADE TO THE EXCLUSIVE RIGHT TO USE "DENTURE", APART FROM THE MARK AS SHOWN.

THE MARK CONSISTS OF THE WORD "DENTURE" SURROUNDED BY A BORDER. THE BORDER CONNECTS TO THE LEFT OF THE LETTER 'M' WHICH IS CONNECTED, ON THE RIGHT, TO A SOLID BOX CONTAINING THE WORD "MASTERS". AT A GLANCE THE LOGO READS "DENTURE MASTERS".

FOR DENTAL IMPLANTS; DENTURES (U.S. CLS. 26, 39 AND 44).

FIRST USE 2-0-2007; IN COMMERCE 2-0-2007.

SCOTT SISUN, EXAMINING ATTORNEY

CLASS 10—(Continued).

SN 77-136,172. GRANIT MEDICAL INNOVATION, LLC, NEW YORK, NY. FILED 3-21-2007.

CLASS 10—(Continued).

SN 77-138,521. INVENTIO, INC., CHARLESTOWN, IN. FILED 3-23-2007.

COREiT FNB

Catheter Solutions

THE MARK CONSISTS OF STANDARD CHARACTERS WITHOUT CLAIM TO ANY PARTICULAR FONT, STYLE, SIZE, OR COLOR.

NO CLAIM IS MADE TO THE EXCLUSIVE RIGHT TO USE "FNB", APART FROM THE MARK AS SHOWN.

FOR SURGICAL INSTRUMENTS FOR USE IN FLEXIBLE ENDOSCOPIC SURGERY, NAMELY, BIOPSY NEEDLE INSTRUMENTS (U.S. CLS. 26, 39 AND 44).

HEATHER BIDDULPH, EXAMINING ATTORNEY

THE MARK CONSISTS OF STANDARD CHARACTERS WITHOUT CLAIM TO ANY PARTICULAR FONT, STYLE, SIZE, OR COLOR.

NO CLAIM IS MADE TO THE EXCLUSIVE RIGHT TO USE "CATHETER", APART FROM THE MARK AS SHOWN.

FOR CATHETERS (U.S. CLS. 26, 39 AND 44).

DAVID TOOLEY, EXAMINING ATTORNEY

SN 77-137,261. CHANG, STANLEY F., FRESNO, CA. FILED 3-22-2007.

SN 77-138,809. CHOLESTECH CORPORATION, HAYWARD, CA. FILED 3-23-2007.

LEFTWARD GUIDE

VASOSENSE

THE MARK CONSISTS OF STANDARD CHARACTERS WITHOUT CLAIM TO ANY PARTICULAR FONT, STYLE, SIZE, OR COLOR.

NO CLAIM IS MADE TO THE EXCLUSIVE RIGHT TO USE "GUIDE", APART FROM THE MARK AS SHOWN.

FOR MEDICAL DEVICE, NAMELY AN ENDOSCOPE GUIDE FOR USE IN FLEXIBLE COLONOSCOPY AND SIGMOIDOSCOPY (U.S. CLS. 26, 39 AND 44).

JENNIFER KRISP, EXAMINING ATTORNEY

THE MARK CONSISTS OF STANDARD CHARACTERS WITHOUT CLAIM TO ANY PARTICULAR FONT, STYLE, SIZE, OR COLOR.

FOR MEDICAL DEVICES, NAMELY A NONINVASIVE AUTOMATED ENDOTHELIAL FUNCTION ASSESSMENT DEVICE FOR CARDIOVASCULAR DIAGNOSIS (U.S. CLS. 26, 39 AND 44).

COLLEEN DOMBROW, EXAMINING ATTORNEY

SN 77-137,473. H.H. BROWN SHOE TECHNOLOGIES, INC., GREENWICH, CT. FILED 3-22-2007.

SN 77-138,945. BRAD ROSS, STONEWALL, MANITOBA, CANADA, FILED 3-23-2007.

KÜR X

PTDIAL

THE MARK CONSISTS OF STANDARD CHARACTERS WITHOUT CLAIM TO ANY PARTICULAR FONT, STYLE, SIZE, OR COLOR.

FOR ORTHOPEDIC SOLES; ORTHOTIC INSERTS FOR FOOTWEAR (U.S. CLS. 26, 39 AND 44).

BARNEY CHARLON, EXAMINING ATTORNEY

THE MARK CONSISTS OF STANDARD CHARACTERS WITHOUT CLAIM TO ANY PARTICULAR FONT, STYLE, SIZE, OR COLOR.

FOR THERAPEUTIC MEDICAL DEVICE FOR MUSCLE COMPRESSION BY THE APPLICATION OF MECHANICAL PRESSURE TO THE BODY (U.S. CLS. 26, 39 AND 44).

G. MAYERSCHOFF, EXAMINING ATTORNEY

CLASS 10—(Continued).

SN 77-139,407. XTENT, INC., MENLO PARK, CA. FILED 3-23-2007.

THE RIGHT SIZE. FOR LIFE.

THE MARK CONSISTS OF STANDARD CHARACTERS WITHOUT CLAIM TO ANY PARTICULAR FONT, STYLE, SIZE, OR COLOR.

FOR MEDICAL DEVICES USED IN VASCULAR PROCEDURES, NAMELY, MEDICAL STENTS, VASCULAR INTRODUCER SHEATHS, AND MEDICAL GUIDE WIRES; STENTS; STENT DELIVERY SYSTEMS; CATHETERS; ANGIOPLASTY CATHETERS; DRUG DELIVERY CATHETERS (U.S. CLS. 26, 39 AND 44).

MICHAEL LEWIS, EXAMINING ATTORNEY

SN 77-139,462. TALLEY, LAURA B., MANAKIN SABOT, VA. FILED 3-23-2007.

GETHERDONE

THE MARK CONSISTS OF STANDARD CHARACTERS WITHOUT CLAIM TO ANY PARTICULAR FONT, STYLE, SIZE, OR COLOR.

FOR MASSAGING APPARATUS FOR PERSONAL USE (U.S. CLS. 26, 39 AND 44).

KAREN K. BUSH, EXAMINING ATTORNEY

SN 77-139,509. GLANGCHAI, LUZ-CRISTAL SANCHEZ, AUSTIN, TX. AND FELKL, JAKUB, AUSTIN, TX. FILED 3-24-2007.

NANOTaxi

THE MARK CONSISTS OF STANDARD CHARACTERS WITHOUT CLAIM TO ANY PARTICULAR FONT, STYLE, SIZE, OR COLOR.

FOR DRUG DELIVERY SYSTEMS (U.S. CLS. 26, 39 AND 44).

NAAKWAMA ANKRAH, EXAMINING ATTORNEY

CLASS 10—(Continued).

SN 77-139,711. BRESSI, JAMES M, FOLSOM, PA. FILED 3-25-2007.

TriThera

THE MARK CONSISTS OF STANDARD CHARACTERS WITHOUT CLAIM TO ANY PARTICULAR FONT, STYLE, SIZE, OR COLOR.

FOR LIGHT EMITTING DEVICES, NAMELY, LAMPS AND LED DEVICES FOR TREATMENT OF A VARIETY OF SKIN CONDITIONS; LIGHT-BASED MEDICAL DEVICES, NAMELY, A LIGHT EMITTING DIODE (LED) DEVICE FOR INCREASING THE HUMAN BODY'S OWN PRODUCTION OF COLLAGEN; PHOTOTHERAPEUTIC APPARATUS FOR MEDICAL PURPOSES, NAMELY A LED (LIGHT-EMITTING DIODE) LIGHT SOURCE FOR MEDICAL AND AESTHETIC SKIN TREATMENTS; ELECTROMEDICAL REHABILITATIVE AND PAIN MANAGEMENT PRODUCTS FOR CLINICAL AND HOME USE, NAMELY, ELECTRICAL NERVE AND MUSCLE STIMULATORS, ULTRASONIC STIMULATORS, MAGNET THERAPY STIMULATORS AND LASER THERAPY STIMULATORS; SKIN CARE ANALYZERS AND LIGHT THERAPY EQUIPMENT, NAMELY, A BLACK-LIGHT BLUE LAMP UNIT FOR USE IN IDENTIFICATION OF A VARIETY OF SKIN CONDITIONS; ULTRASONIC THERAPY MACHINES AND APPARATUS; INFRARED RADIATOR UNITS FOR THERAPEUTIC PURPOSES; HEAT LAMPS FOR MEDICAL USE; HEATING CUSHIONS FOR MEDICAL PURPOSES; HEATING PADS FOR MEDICAL PURPOSES; MEDICAL APPARATUS, NAMELY, ELECTRIC HEATING DEVICES FOR CURATIVE TREATMENT; THERAPEUTIC SAUNAS; ULTRAVIOLET LAMPS FOR MEDICAL PURPOSES; ULTRAVIOLET RADIATOR UNITS FOR THERAPEUTIC PURPOSES; BEAUTY AND COSMETIC STERILIZING POUCHES; STERILIZATION UNITS FOR MEDICAL INSTRUMENTS; STERILIZATION UNITS FOR MEDICAL PURPOSES; PHOTOTHERAPEUTIC APPARATUS FOR MEDICAL PURPOSES; LASERS FOR MEDICAL USE; LASERS FOR THE COSMETIC TREATMENT OF THE FACE AND SKIN (U.S. CLS. 26, 39 AND 44).

PAUL E. FAHRENKOPF, EXAMINING ATTORNEY

SN 77-140,617. DR.'S OWN, INC., SAN DIEGO, CA. FILED 3-26-2007.

INSERT COMFORT HERE!

THE MARK CONSISTS OF STANDARD CHARACTERS WITHOUT CLAIM TO ANY PARTICULAR FONT, STYLE, SIZE, OR COLOR.

FOR FOOT ORTHOTICS, ORTHOTIC FOOT CUSHIONS, ARCH SUPPORTS FOR BOOTS OR SHOES (U.S. CLS. 26, 39 AND 44).

FIRST USE 1-15-2007; IN COMMERCE 1-15-2007.

ADA HAN, EXAMINING ATTORNEY

CLASS 10—(Continued).

SN 77-140,706. INSOUND MEDICAL, INC., NEWARK, CA. FILED 3-26-2007.

INVISIBLY BETTER

THE MARK CONSISTS OF STANDARD CHARACTERS WITHOUT CLAIM TO ANY PARTICULAR FONT, STYLE, SIZE, OR COLOR.
FOR HEARING AIDS (U.S. CLS. 26, 39 AND 44).
BRIAN PINO, EXAMINING ATTORNEY

SN 77-141,106. ENDOGYN LTD., ROTTHALMUENSTER, FED REP GERMANY, FILED 3-27-2007.

GlaDiaThOR

THE MARK CONSISTS OF STANDARD CHARACTERS WITHOUT CLAIM TO ANY PARTICULAR FONT, STYLE, SIZE, OR COLOR.
FOR MEDICAL INSTRUMENTS FOR USE IN ENDO-SCOPIC SURGERY (U.S. CLS. 26, 39 AND 44).
JILL C. ALT, EXAMINING ATTORNEY

SN 77-141,247. IMMUNOSTICS INC, OCEAN, NJ. FILED 3-27-2007.

SPECIFIC

THE MARK CONSISTS OF STANDARD CHARACTERS WITHOUT CLAIM TO ANY PARTICULAR FONT, STYLE, SIZE, OR COLOR.
FOR IMMUNOCHEMICAL MEDICAL APPARATUS FOR TESTING AND DETECTING FECAL OCCULT BLOOD NAMELY, FOR HUMAN HEMOGLOBIN (U.S. CLS. 26, 39 AND 44).
FIRST USE 5-1-2005; IN COMMERCE 4-1-2006.
RICHARD WHITE, EXAMINING ATTORNEY

CLASS 10—(Continued).

SN 77-141,549. ENDOCARE, INC., IRVINE, CA. FILED 3-27-2007.

TCAP

THE MARK CONSISTS OF STANDARD CHARACTERS WITHOUT CLAIM TO ANY PARTICULAR FONT, STYLE, SIZE, OR COLOR.
OWNER OF U.S. REG. NO. 2,438,029.
FOR MEDICAL DEVICES AND INSTRUMENTS FOR USE IN SURGICAL APPLICATIONS, NAMELY, CRYOPROBES, TEMPERATURE SENSING PROBES, AND IMAGING DEVICES FOR TREATING PROSTATE CANCER (U.S. CLS. 26, 39 AND 44).
G. MAYERSCHOFF, EXAMINING ATTORNEY

SN 77-142,114. CROSSTEX INTERNATIONAL, INC., HAUPPAUGE, NY. FILED 3-28-2007.

SANI-TUBE

THE MARK CONSISTS OF STANDARD CHARACTERS WITHOUT CLAIM TO ANY PARTICULAR FONT, STYLE, SIZE, OR COLOR.
OWNER OF U.S. REG. NO. 2,099,087.
FOR NYLON TUBINGS FOR STERILIZING MEDICAL INSTRUMENTS (U.S. CLS. 26, 39 AND 44).
FIRST USE 1-1-1992; IN COMMERCE 1-1-1992.
CARYN GLASSER, EXAMINING ATTORNEY

SN 77-142,207. FOURNITURES HOSPITALIERES CORPORATION FRANCE, HEIMSBRUNN, FRANCE, FILED 3-28-2007.

ACADEMIA

THE MARK CONSISTS OF STANDARD CHARACTERS WITHOUT CLAIM TO ANY PARTICULAR FONT, STYLE, SIZE, OR COLOR.
OWNER OF FRANCE REG. NO. 98742054, DATED 7-10-1998, EXPIRES 7-10-2008.
OWNER OF U.S. REG. NO. 2,551,657.
FOR SURGICAL, MEDICAL APPARATUS AND INSTRUMENTS, NAMELY, ORTHOPEDIC ARTICLES, NAMELY, ORTHOPEDIC BELTS, BRACES AND SUPPORTS; SUTURES; PROSTHESIS, NAMELY, HIP PROSTHESIS, KNEE PROSTHESIS, SHOULDER PROSTHESIS, BREAST AND HAND PROSTHESIS; IMPLANTS, NAMELY, OCULAR, ORTHOPEDIC JOINT IMPLANTS; BONE IMPLANTS COMPOSED OF ARTIFICIAL MATERIALS (U.S. CLS. 26, 39 AND 44).
DAVID MURRAY, EXAMINING ATTORNEY

CLASS 10—(Continued).

SN 77-142,659. ASAHI KASEI MEDICAL CORPORATION, TOKYO 101-8481, JAPAN, FILED 3-28-2007.

CUREFLO

THE MARK CONSISTS OF STANDARD CHARACTERS WITHOUT CLAIM TO ANY PARTICULAR FONT, STYLE, SIZE, OR COLOR.

FOR MEDICAL APPARATUS OR INSTRUMENTS FOR BLOOD PURIFICATION; ARTIFICIAL KIDNEYS; HEMODIALYZERS; HEMOFILTERS; HEMODIAFILTERS; BLOOD FILTERS; PLASMA SEPARATORS; PLASMA COMPONENTS FRACTIONATORS (U.S. CLS. 26, 39 AND 44).

SUSAN STIGLITZ, EXAMINING ATTORNEY

CLASS 10—(Continued).

SN 77-144,349. APPLERA CORPORATION, FOSTER CITY, CA. FILED 3-29-2007.

APPLERA

THE MARK CONSISTS OF STANDARD CHARACTERS WITHOUT CLAIM TO ANY PARTICULAR FONT, STYLE, SIZE, OR COLOR.

OWNER OF U.S. REG. NO. 3,130,445.

FOR MEDICAL LABORATORY AND DIAGNOSTIC INSTRUMENTS, NAMELY, NUCLEIC ACID SEQUENCERS AND SYNTHESIZERS, GENETIC ANALYZERS, THERMAL CYCLER, CYTOMETER, PROTEIN AND PEPTIDE SYNTHESIZERS, MASS SPECTROMETER AND CHROMATOGRAPH, HIGH-THROUGHPUT INSTRUMENT FOR PREPARATION OF NUCLEIC ACID SAMPLES, LABORATORY ROBOTS, AND ACCESSORIES TO AND PARTS OF THE ABOVE INSTRUMENTS; MEDICAL AND DIAGNOSTIC LABORATORY SUPPLIES, NAMELY, PLASTIC CONSUMABLES, RACK, VIALS, CAPS, SEPTA, NEEDLES, BOTTLES, FLASK, FILTER, TUBES, AND SEALS, PLASTIC TRAY COVER, MICRO PLATE, PIPETTE TIPS, REAGENT RESERVOIR, OPTICAL HEAT FIELD COVERS, PLASTIC CARDS, AND PLASTIC CAPILLARY ARRAYS (U.S. CLS. 26, 39 AND 44).

KEVIN DINALLO, EXAMINING ATTORNEY

SN 77-143,476. NEUROSOFT CORP., BOCA RATON, FL. FILED 3-29-2007.

is-3

THE MARK CONSISTS OF STANDARD CHARACTERS WITHOUT CLAIM TO ANY PARTICULAR FONT, STYLE, SIZE, OR COLOR.

FOR ACUPUNCTURE NEEDLES; ELECTRONIC STIMULATOR FOR NERVE; NERVE STIMULATOR APPARATUS (U.S. CLS. 26, 39 AND 44).

FIRST USE 10-2-2006; IN COMMERCE 10-4-2006.

JEAN IM, EXAMINING ATTORNEY

SN 77-149,751. PRESSURE PRODUCTS MEDICAL SUPPLIES INC., SANTA BARBARA, CA. FILED 4-5-2007.



THE COLOR(S) RED, GREY, WHITE AND BLACK IS/ARE CLAIMED AS A FEATURE OF THE MARK.

THE MARK CONSISTS OF THE WORDS, "SITE", IN RED AND "LIGHT" IN BLACK AGAINST A GREY BACKGROUND WITH A WHITE BACKGROUND IN THE SHAPE OF A SEARCHLIGHT BEAM REPLACING THE GREY BACKGROUND AND RADIATING FROM THE DOT OVER THE LETTER "I" IN THE WORD, "SITE".

FOR MEDICAL LIGHT FOR USE IN SURGICAL THEATERS, NAMELY A BATTERY POWERED, LED, PORTABLE, COMPACT, HIGH INTENSITY, AND ORIENTABLE LIGHT WITH A UNIVERSAL MOUNTING SURFACE OR FITTING (U.S. CLS. 26, 39 AND 44).

TIMOTHY FINNEGAN, EXAMINING ATTORNEY

CLASS 10—(Continued).

SN 77-149,906. DISNEY ENTERPRISES, INC., BURBANK, CA. FILED 4-5-2007.

WHERE IMAGINATION BEGINS

THE MARK CONSISTS OF STANDARD CHARACTERS WITHOUT CLAIM TO ANY PARTICULAR FONT, STYLE, SIZE, OR COLOR.

FOR BABY BOTTLES; BABY BOTTLE LINERS; FEEDING BOTTLE VALVES; FEEDING BOTTLE TEATS; CUPS ADAPTED FOR FEEDING BABIES AND CHILDREN; BABY PACIFIERS; TEETHING RINGS (U.S. CLS. 26, 39 AND 44).

BRIDGETT SMITH, EXAMINING ATTORNEY

CLASS 10—(Continued).

SN 77-172,274. VERTEBRAL TECHNOLOGIES, INC., MINNETONKA, MN. FILED 5-3-2007.

MINI 360°

THE MARK CONSISTS OF STANDARD CHARACTERS WITHOUT CLAIM TO ANY PARTICULAR FONT, STYLE, SIZE, OR COLOR.

NO CLAIM IS MADE TO THE EXCLUSIVE RIGHT TO USE "MINI", APART FROM THE MARK AS SHOWN.

FOR MEDICAL AND SURGICAL APPARATUS AND INSTRUMENTS, NAMELY, ORTHOPEDIC FIXATION DEVICE USED IN ORTHOPEDIC TRANSPLANT AND/OR IMPLANT SURGERY (U.S. CLS. 26, 39 AND 44).

MELISSA VALLILLO, EXAMINING ATTORNEY

SN 77-152,722. PFIZER HEALTH AB, STOCKHOLM, SWEDEN, FILED 4-10-2007.

GOQUICK

THE MARK CONSISTS OF STANDARD CHARACTERS WITHOUT CLAIM TO ANY PARTICULAR FONT, STYLE, SIZE, OR COLOR.

FOR MEDICAL DEVICES FOR INJECTING PHARMACEUTICALS (U.S. CLS. 26, 39 AND 44).

HEATHER SAPP, EXAMINING ATTORNEY

SN 77-172,815. AROBELLA MEDICAL, LLC, MINNETONKA, MN. FILED 5-4-2007.

Safe in Sound Technology

THE MARK CONSISTS OF STANDARD CHARACTERS WITHOUT CLAIM TO ANY PARTICULAR FONT, STYLE, SIZE, OR COLOR.

NO CLAIM IS MADE TO THE EXCLUSIVE RIGHT TO USE "SOUND TECHNOLOGY", APART FROM THE MARK AS SHOWN.

FOR MEDICAL ULTRASOUND APPARATUS (U.S. CLS. 26, 39 AND 44).

CIMMERIAN COLEMAN, EXAMINING ATTORNEY

SN 77-171,814. OLYMPUS AMERICA, INC., CENTER VALLEY, PA. FILED 5-3-2007.



THE COLOR(S) BLUE, PURPLE, VIOLET IS/ARE CLAIMED AS A FEATURE OF THE MARK.

THE MARK CONSISTS OF THE STYLIZED WORD ENDOCLEANER SHOWN IN THE COLORS BLUE AND PURPLE, WITH A VIOLET SHADOW OF THE PRODUCT GOING THROUGH THE LETTER C AND UNDER THE REMAINDER OF THE MARK. THERE IS ALSO A BLUE AND PURPLE BRUSH DESIGN ABOVE THE LETTERS EANNER IN THE MARK.

FOR ENDOSCOPIC EQUIPMENT, NAMELY, BRUSHES FOR CLEANING CHANNELS OF MEDICAL ENDOSCOPES (U.S. CLS. 26, 39 AND 44).

JENNIFER HETU, EXAMINING ATTORNEY

SN 77-188,317. ALLERGAN, INC., IRVINE, CA. FILED 5-23-2007.

NATRELLE GUMMY BEAR

THE MARK CONSISTS OF STANDARD CHARACTERS WITHOUT CLAIM TO ANY PARTICULAR FONT, STYLE, SIZE, OR COLOR.

NO CLAIM IS MADE TO THE EXCLUSIVE RIGHT TO USE "GUMMY BEAR", APART FROM THE MARK AS SHOWN.

FOR ARTIFICIAL BREAST IMPLANTS, NAMELY, SILICONE BREAST IMPLANTS; BREAST IMPLANTS CONSISTING OF ARTIFICIAL MATERIALS (U.S. CLS. 26, 39 AND 44).

SIMON TENG, EXAMINING ATTORNEY

CLASS 10—(Continued).

SN 77-188,320. ALLERGAN, INC., IRVINE, CA. FILED 5-23-2007.

NATRELLE GUMMI BEAR

THE MARK CONSISTS OF STANDARD CHARACTERS WITHOUT CLAIM TO ANY PARTICULAR FONT, STYLE, SIZE, OR COLOR.

NO CLAIM IS MADE TO THE EXCLUSIVE RIGHT TO USE "GUMMI BEAR", APART FROM THE MARK AS SHOWN.

FOR ARTIFICIAL BREAST IMPLANTS, NAMELY, SILICONE BREAST IMPLANTS; BREAST IMPLANTS CONSISTING OF ARTIFICIAL MATERIALS (U.S. CLS. 26, 39 AND 44).

SIMON TENG, EXAMINING ATTORNEY

SN 78-488,966. TAKIRON CO., LTD., OSAKA, JAPAN, FILED 9-24-2004.

OSTEOTRANS

THE MARK CONSISTS OF STANDARD CHARACTERS WITHOUT CLAIM TO ANY PARTICULAR FONT, STYLE, SIZE, OR COLOR.

OWNER OF JAPAN REG. NO. 4889113, DATED 8-19-2005, EXPIRES 8-19-2015.

FOR BIORESORBABLE FIXATION BONE IMPLANTS COMPOSED OF ARTIFICIAL MATERIALS FOR OSTEO-SYNTHETIC USE (U.S. CLS. 26, 39 AND 44).

SANI KHOURI, EXAMINING ATTORNEY

SN 78-515,158. GUIDANCE ENDODONTICS, LLC, ALBUQUERQUE, NM. FILED 11-11-2004.

GUIDANCE ENDODONTIC SYSTEM

THE MARK CONSISTS OF STANDARD CHARACTERS WITHOUT CLAIM TO ANY PARTICULAR FONT, STYLE, SIZE, OR COLOR.

NO CLAIM IS MADE TO THE EXCLUSIVE RIGHT TO USE "ENDODONTIC SYSTEM", APART FROM THE MARK AS SHOWN.

FOR ENDODONTIC INSTRUMENTS, NAMELY, DENTAL DRILLS AND FILES (U.S. CLS. 26, 39 AND 44).

DANIEL BRODY, EXAMINING ATTORNEY

CLASS 10—(Continued).

SN 78-585,166. AIR TECHNIQUES, INC., HICKSVILLE, NY. FILED 3-11-2005.

ACCENT

THE MARK CONSISTS OF STANDARD CHARACTERS WITHOUT CLAIM TO ANY PARTICULAR FONT, STYLE, SIZE, OR COLOR.

FOR DIGITAL INTRAORAL SENSORS FOR X-RAYS (U.S. CLS. 26, 39 AND 44).

ALICIA COLLINS, EXAMINING ATTORNEY

SN 78-688,601. MICROVENTION, INC., ALISO VIEJO, CA. FILED 8-9-2005.

V-GRIP

THE MARK CONSISTS OF STANDARD CHARACTERS WITHOUT CLAIM TO ANY PARTICULAR FONT, STYLE, SIZE, OR COLOR.

FOR MEDICAL APPARATUS AND INSTRUMENTS, NAMELY, DEVICES USED TO CONTROL THE DELIVERY OF AN IMPLANT INTO THE VASCULATURE OF A HUMAN PATIENT (U.S. CLS. 26, 39 AND 44).

RAY THOMAS, EXAMINING ATTORNEY

SN 78-691,095. GLOBUS MEDICAL, INC., AUDUBON, PA. FILED 8-11-2005.

PIVOT

THE MARK CONSISTS OF STANDARD CHARACTERS WITHOUT CLAIM TO ANY PARTICULAR FONT, STYLE, SIZE, OR COLOR.

FOR SURGICAL INSTRUMENTS USED IN MINIMALLY INVASIVE SPINAL PROCEDURES, NAMELY, TUBES AND HOLDERS USED TO INSERT SPINAL RODS AND SCREWS (U.S. CLS. 26, 39 AND 44).

FIRST USE 8-22-2005; IN COMMERCE 8-22-2005.

ELLEN PERKINS, EXAMINING ATTORNEY

CLASS 10—(Continued).

SN 78-841,440. HOWMEDICA OSTEONICS CORP., MAHWAH, NJ. FILED 3-20-2006.

RADIUS

THE MARK CONSISTS OF STANDARD CHARACTERS WITHOUT CLAIM TO ANY PARTICULAR FONT, STYLE, SIZE, OR COLOR.

OWNER OF U.S. REG. NO. 2,978,388.
FOR ORTHOPEDIC IMPLANTS AND ORTHOPEDIC INSTRUMENTS FOR THE IMPLANTATION OF ORTHOPEDIC IMPLANTS, NONE OF THE FOREGOING FOR USE IN RELATION TO THE ARM (U.S. CLS. 26, 39 AND 44).

FIRST USE 1-15-2007; IN COMMERCE 1-15-2007.
CHRISTOPHER OTT, EXAMINING ATTORNEY

CLASS 10—(Continued).

SN 78-911,443. EXACTECH, INC., GAINESVILLE, FL. FILED 6-19-2006.

A GREAT DAY IN THE O.R.

THE MARK CONSISTS OF STANDARD CHARACTERS WITHOUT CLAIM TO ANY PARTICULAR FONT, STYLE, SIZE, OR COLOR.

FOR MEDICAL DEVICES NAMELY, ORTHOPEDIC IMPLANTS COMPOSED OF PROCESSED ORTHO-BIOLOGIC MATERIALS AND RELATED INSTRUMENTATION, AND FIXATION HARDWARE, NAMELY SCREWS, CABLES AND HOOKS, AND WRITTEN INSTRUCTIONS INCLUDED THEREWITH (U.S. CLS. 26, 39 AND 44).

FIRST USE 11-22-2002; IN COMMERCE 11-22-2002.
TAMARA FRAZIER, EXAMINING ATTORNEY

SN 78-897,075. ACANDIS GMBH & CO. KG, PFINZTAL, FED REP GERMANY, FILED 5-31-2006.

ACANDIS

THE MARK CONSISTS OF STANDARD CHARACTERS WITHOUT CLAIM TO ANY PARTICULAR FONT, STYLE, SIZE, OR COLOR.

PRIORITY CLAIMED UNDER SEC. 44(D) ON FED REP GERMANY APPLICATION NO. 5137161, FILED 5-30-2006, REG. NO. 005137161, DATED 6-4-2007, EXPIRES 5-30-2016.

FOR SURGICAL, MEDICAL, VETERINARY, AND DENTAL APPARATUS AND INSTRUMENTS, NAMELY MEDICAL STENTS, ORTHOPAEDIC IMPLANTS, MEDICAL IMPLANTS FROM DEGRADABLE AND NON-DEGRADABLE ARTIFICIAL MATERIALS AND MEDICAL INSTRUMENTS FOR USE IN MINIMALLY INVASIVE GENERAL SURGERY (U.S. CLS. 26, 39 AND 44).

SOPHIA S. KIM, EXAMINING ATTORNEY

SN 78-922,667. INNERSPACE, INC., SANTA ANA, CA. FILED 7-5-2006.

OXIFLOW

THE MARK CONSISTS OF STANDARD CHARACTERS WITHOUT CLAIM TO ANY PARTICULAR FONT, STYLE, SIZE, OR COLOR.

FOR MEDICAL MONITORING AND ACCESS DEVICES, NAMELY BLOOD FLOW PROBES FOR USE IN NEUROSURGERY (U.S. CLS. 26, 39 AND 44).

CARYN GLASSER, EXAMINING ATTORNEY

SN 78-903,919. BOSTON SCIENTIFIC SCIMED, INC., MAPLE GROVE, MN. FILED 6-8-2006.

GDC SR+ FINESSE

THE MARK CONSISTS OF STANDARD CHARACTERS WITHOUT CLAIM TO ANY PARTICULAR FONT, STYLE, SIZE, OR COLOR.

OWNER OF U.S. REG. NOS. 1,834,531 AND 2,837,734.
FOR EMBOLIZATION COILS (U.S. CLS. 26, 39 AND 44).

DAVID COLLIER, EXAMINING ATTORNEY

SN 78-927,961. SYNCRO MEDICAL INNOVATIONS, INC., MACON, GA. FILED 7-12-2006.

**ENHANCING THE HEALING
HANDS OF MEDICINE**

THE MARK CONSISTS OF STANDARD CHARACTERS WITHOUT CLAIM TO ANY PARTICULAR FONT, STYLE, SIZE, OR COLOR.

FOR ENTERAL FEEDING TUBE; MEDICAL PRODUCTS, DEVICES AND APPARATUS, NAMELY, FEEDING TUBES (U.S. CLS. 26, 39 AND 44).

HEATHER SAPP, EXAMINING ATTORNEY

CLASS 10—(Continued).

SN 78-943,767. MARTIN MANUFACTURING COMPANY, LLC, ROCKY MOUNT, NC. FILED 8-3-2006.

Zero Lift

THE MARK CONSISTS OF STANDARD CHARACTERS WITHOUT CLAIM TO ANY PARTICULAR FONT, STYLE, SIZE, OR COLOR.

NO CLAIM IS MADE TO THE EXCLUSIVE RIGHT TO USE "LIFT", APART FROM THE MARK AS SHOWN.

FOR PATIENT EXAMINATION SYSTEMS COMPRISED OF PATIENT EXAMINATION TABLES AND WHEELCHAIRS ADAPTED TO BE CONNECTED TOGETHER (U.S. CLS. 26, 39 AND 44).

FIRST USE 6-15-2006; IN COMMERCE 6-15-2006.

SONYA STEPHENS, EXAMINING ATTORNEY

SN 78-960,551. CORDIS CORPORATION, MIAMI LAKES, FL. FILED 8-25-2006.

CYPHER ELITE

THE MARK CONSISTS OF STANDARD CHARACTERS WITHOUT CLAIM TO ANY PARTICULAR FONT, STYLE, SIZE, OR COLOR.

OWNER OF U.S. REG. NOS. 2,782,642 AND 2,800,826.

FOR MEDICAL DEVICES, NAMELY, STENTS (U.S. CLS. 26, 39 AND 44).

KHANH LE, EXAMINING ATTORNEY

SN 78-977,493. BINN AND PARTNERS LLC, NEW YORK, NY. FILED 2-1-2006.

XPRESSPA

THE MARK CONSISTS OF STANDARD CHARACTERS WITHOUT CLAIM TO ANY PARTICULAR FONT, STYLE, SIZE, OR COLOR.

FOR WOODEN MASSAGER, PLASTIC MASSAGER, MASSAGE BALLS, MASSAGE ROLLER, BATTERY OPERATED MASSAGER, SCALP MASSAGER, FOOT REFLEXOLOGY BOARD, AND HAIR BRUSH MASSAGER (U.S. CLS. 26, 39 AND 44).

DOMINIC J. FERRAIUOLO, EXAMINING ATTORNEY

CLASS 10—(Continued).

SN 79-018,095. MEDICREA INTERNATIONAL, FRANCE, FILED 10-11-2005.

JAWS

THE MARK CONSISTS OF STANDARD CHARACTERS WITHOUT CLAIM TO ANY PARTICULAR FONT, STYLE, SIZE, OR COLOR.

PRIORITY DATE OF 4-29-2005 IS CLAIMED.

OWNER OF INTERNATIONAL REGISTRATION 0869373 DATED 10-11-2005, EXPIRES 10-11-2015.

FOR SURGICAL AND MEDICAL IMPLANT DEVICES COMPOSED OF ARTIFICIAL MATERIALS, NAMELY, A VERTEBRAL STAPLE-SHAPED IMPLANT FOR USE IN IMPLANTING IN TWO OR MORE VERTEBRAE DURING VERTEBRAL OSTEOSYNTHESIS PROCEDURES (U.S. CLS. 26, 39 AND 44).

DEBRA LEE, EXAMINING ATTORNEY

SN 79-021,579. SIRONA DENTAL SYSTEMS GMBH, FED REP GERMANY, FILED 11-10-2005.

CHAIRLINE

THE MARK CONSISTS OF STANDARD CHARACTERS WITHOUT CLAIM TO ANY PARTICULAR FONT, STYLE, SIZE, OR COLOR.

PRIORITY DATE OF 5-12-2005 IS CLAIMED.

OWNER OF INTERNATIONAL REGISTRATION 0878860 DATED 11-10-2005, EXPIRES 11-10-2015.

FOR MEDICAL AND DENTAL INSTRUMENTS, NAMELY DENTAL BURRS; DENTAL PICKS, DENTAL MIRRORS, DENTAL ULTRASONIC HANDPIECES AND TIPS THEREFOR, SPRAYERS FOR CLEANING GUMS AND TEETH, DENTAL DRILLS, CAVITY PREPARATION INSTRUMENTS, NAMELY, ORAL IRRIGATORS, DENTAL SCALPELS; X-RAY APPLIANCES FOR DENTAL AND MEDICAL USE, NAMELY, EXTRA-ORAL AND INTRA-ORAL LIGHTING DEVICES, NAMELY DENTAL LAMPS, INTRAMURAL ELECTROMAGNETIC MEDICAL DIAGNOSTIC IMAGING APPARATUS AND INTRA-ORAL DIGITAL SENSOR USED FOR TAKING DIGITAL DENTAL RADIOGRAPHS, REPLACEMENT PARTS OF ALL OF THE ABOVE INSTRUMENTS AND APPLIANCES; DENTAL PROPHYLACTIC INSTRUMENTS, NAMELY POLISHING INSTRUMENTS; SPECIAL FURNITURE FOR MEDICAL AND DENTAL USE, NAMELY DENTAL EXAMINATION CHAIRS, DENTAL PATIENT TREATMENT CHAIRS WITH OR WITHOUT BASINS FOR RINSING THE MOUTH, TREATMENT SITES FOR ORAL PROPHYLACTICS COMPRISING A DENTAL PATIENT EXAMINATION CHAIR AND DENTAL INSTRUMENTS, AS LISTED ABOVE IN THIS CLASS, CONNECTION CONSOLES FOR DENTAL HANDPIECES, INSTRUMENT CABINETS, DENTISTS' ELEMENTS, DENTAL ASSISTANT'S ELEMENTS, TREATMENT TABLES, FOOTRESTS, SINKS, CUSPIDORS, LAMPS, TROLLEYS; TREATMENT UNITS FOR ORAL PROPHYLACTICS COMPRISING A TREATMENT SEAT AND DENTAL INSTRUMENTS, DENTAL TREATMENT SEATS WITH OR WITHOUT BASINS (U.S. CLS. 26, 39 AND 44).

REBECCA GAN, EXAMINING ATTORNEY

CLASS 10—(Continued).

SN 79-027,977. ADVANCED MEDICAL OPTICS, INC, SANTA ANA, CA. FILED 8-1-2006.

OPTIBLUE

THE MARK CONSISTS OF STANDARD CHARACTERS WITHOUT CLAIM TO ANY PARTICULAR FONT, STYLE, SIZE, OR COLOR.

PRIORITY DATE OF 3-9-2006 IS CLAIMED.
OWNER OF INTERNATIONAL REGISTRATION 0896150 DATED 8-1-2006, EXPIRES 8-1-2016.

FOR INTRAOCULAR LENSES, PARTS AND FITTINGS FOR THE AFORESAID GOODS (U.S. CLS. 26, 39 AND 44).

GINA FINK, EXAMINING ATTORNEY

CLASS 10—(Continued).

SN 79-034,921. SORIN GROUP ITALIA S.R.L., ITALY, FILED 1-10-2007.



PRIORITY DATE OF 12-13-2006 IS CLAIMED.
OWNER OF INTERNATIONAL REGISTRATION 0914599 DATED 1-10-2007, EXPIRES 1-10-2017.

NO CLAIM IS MADE TO THE EXCLUSIVE RIGHT TO USE "KIDS", APART FROM THE MARK AS SHOWN.

THE COLOR(S) RED, BLUE, GREEN, YELLOW AND WHITE IS/ARE CLAIMED AS A FEATURE OF THE MARK. THE LETTER "K" APPEARS IN RED, THE TALLER FIGURE REPRESENTING THE LETTER "I" APPEARS IN BLUE, WHILE THE BOTTOM FIGURE APPEARS IN WHITE WITH A BLUE OUTLINE, THE LETTER "D" IS IN GREEN, AND THE LETTER "S" IS IN YELLOW, FOLLOWED BY A BLUE PERIOD.

FOR OXYGENATORS FOR NEONATES AND CHILDREN (U.S. CLS. 26, 39 AND 44).

NORA BUCHANAN WILL, EXAMINING ATTORNEY

CLASS 11—ENVIRONMENTAL CONTROL APPARATUS

SN 79-027,997. AMO UNITED KINGDOM LIMITED, UNITED KINGDOM, FILED 8-1-2006.

GET YOUR ZOOM BACK

THE MARK CONSISTS OF STANDARD CHARACTERS WITHOUT CLAIM TO ANY PARTICULAR FONT, STYLE, SIZE, OR COLOR.

PRIORITY DATE OF 7-27-2006 IS CLAIMED.
OWNER OF INTERNATIONAL REGISTRATION 0896195 DATED 8-1-2006, EXPIRES 8-1-2016.

FOR PHACOEMULSIFICATION MACHINES FOR USE DURING CATARACT SURGERY, REPLACEMENT AND STRUCTURAL PARTS THEREFOR; INTRAOCULAR LENS IMPLANTS AND DEVICES FOR INSERTING THEM; OCULAR IMPLANTS; SURGICAL SUTURES, KNIVES, BLADES, NEEDLES, ASPIRATION AND IRRIGATION TIPS AND TUBING; GLOVES AND MITTS FOR MEDICAL USE; OPHTHALMOLOGICAL SURGICAL APPARATUS AND INSTRUMENTS; REPLACEMENT AND STRUCTURAL PARTS THEREFOR; OPHTHALMOLOGICAL SURGERY SYSTEMS COMPRISED OF A LASER SOURCE AND OPTICS TO DELIVER LASER ENERGY TO THE EYE, REPLACEMENT AND STRUCTURAL PARTS THEREFOR; LASER REFRACTIVE SURGICAL SYSTEMS, COMPRISED OF A LASER SOURCE AND OPTICS TO DELIVER LASER ENERGY TO THE EYE, THAT CAN BE USED WITH OR THAT INCORPORATE WAVEFRONT MEASURING DEVICES (U.S. CLS. 26, 39 AND 44).

GINA FINK, EXAMINING ATTORNEY

SN 76-456,595. AIR QUALITY LABORATORIES CORP., SANTA MONICA, CA. FILED 10-8-2002.

ZEROWASTE

FOR WASTE WATER TREATMENT UNIT FOR USE IN CONNECTION WITH DRY CLEANING EQUIPMENT (U.S. CLS. 13, 21, 23, 31 AND 34).

FIRST USE 2-0-1991; IN COMMERCE 2-0-1991.

JANICE L. MCMORROW, EXAMINING ATTORNEY

SN 76-615,509. CONSEAL INTERNATIONAL INCORPORATED, NORWOOD, MA. FILED 10-12-2004.

CRISPAIR

THE MARK CONSISTS OF STANDARD CHARACTERS WITHOUT CLAIM TO ANY PARTICULAR FONT, STYLE, SIZE, OR COLOR.

FOR OZONE GENERATORS AND PARTS THEREOF (U.S. CLS. 13, 21, 23, 31 AND 34).

FIRST USE 0-0-1988; IN COMMERCE 0-0-1988.

RICHARD A. STRASER, EXAMINING ATTORNEY

CLASS 11—(Continued).

SN 76-663,417. ISLAND CLEAN AIR INC., VANCOUVER, BRITISH COLUMBIA, CANADA, FILED 7-21-2006.



PRIORITY CLAIMED UNDER SEC. 44(D) ON CANADA APPLICATION NO. 1,307,831, FILED 7-4-2006.

NO CLAIM IS MADE TO THE EXCLUSIVE RIGHT TO USE "GERM PRO", APART FROM THE MARK AS SHOWN. "THE MARK CONSISTS OF THE WORD "GERM" IN BETWEEN TWO SHADED SEMI-CIRCLES. THE WORD "PRO" APPEARS TO THE RIGHT OF THE WORD "GERM" OUTSIDE THE TWO SHADED SEMI-CIRCLES."

FOR AIR FILTRATION UNITS FOR COMMERCIAL AND RESIDENTIAL USE (U.S. CLS. 13, 21, 23, 31 AND 34).

SETH A. RAPPAPORT, EXAMINING ATTORNEY

SN 76-671,391. MIRAMA ENTERPRISES INC., SAN DIEGO, CA. FILED 1-16-2007.

TWISTY TREAT

THE MARK CONSISTS OF STANDARD CHARACTERS WITHOUT CLAIM TO ANY PARTICULAR FONT, STYLE, SIZE, OR COLOR.

NO CLAIM IS MADE TO THE EXCLUSIVE RIGHT TO USE "TREAT", APART FROM THE MARK AS SHOWN.

FOR ELECTRICAL APPLIANCES FOR DOMESTIC USE, NAMELY— ICE CREAM MAKER AND YOGURT MAKER (U.S. CLS. 13, 21, 23, 31 AND 34).

KIMBERLY PERRY, EXAMINING ATTORNEY

SN 76-674,409. HEMINGWAY, LTD., NEW YORK, NY. FILED 3-22-2007.

ERNEST HEMINGWAY

THE MARK CONSISTS OF STANDARD CHARACTERS WITHOUT CLAIM TO ANY PARTICULAR FONT, STYLE, SIZE, OR COLOR.

OWNER OF U.S. REG. NOS. 2,319,754, 2,832,793 AND OTHERS.

THE NAME 'ERNEST HEMINGWAY' DOES NOT IDENTIFY A LIVING INDIVIDUAL.

FOR ELECTRIC FANS, CEILING FANS, LAMPS FOR OUTDOOR USE, LAMP SHADES, LIGHTING FIXTURES, SCENCE LIGHTING FIXTURES, OUTDOOR LIGHTING FIXTURES (U.S. CLS. 13, 21, 23, 31 AND 34).

DAVID YONTEF, EXAMINING ATTORNEY

CLASS 11—(Continued).

SN 76-674,707. BALTIMORE AIRCOIL COMPANY, INC., JESSUP, MD. FILED 3-28-2007.

INTERLOK SYSTEM

THE MARK CONSISTS OF STANDARD CHARACTERS WITHOUT CLAIM TO ANY PARTICULAR FONT, STYLE, SIZE, OR COLOR.

NO CLAIM IS MADE TO THE EXCLUSIVE RIGHT TO USE "SYSTEM", APART FROM THE MARK AS SHOWN.

FOR JOINT SYSTEM COMPRISED OF FACING STRUCTURAL SECTIONS FOR USE IN JOINING ADJACENT UPPER AND LOWER MODULES OF COOLING TOWERS AND HEAT EXCHANGERS FOR COMMERCIAL BUILDINGS AND INDUSTRIAL APPLICATIONS (U.S. CLS. 13, 21, 23, 31 AND 34).

TRACY WHITTAKER-BROWN, EXAMINING ATTORNEY

SN 76-674,708. BALTIMORE AIRCOIL COMPANY, INC., JESSUP, MD. FILED 3-28-2007.

BRANCHLOK

THE MARK CONSISTS OF STANDARD CHARACTERS WITHOUT CLAIM TO ANY PARTICULAR FONT, STYLE, SIZE, OR COLOR.

FOR WATER DISTRIBUTION SYSTEMS COMPRISED OF PIPING CONNECTIONS USED IN COOLING TOWERS AND HEAT EXCHANGERS FOR COMMERCIAL BUILDINGS AND INDUSTRIAL APPLICATIONS (U.S. CLS. 13, 21, 23, 31 AND 34).

TRACY WHITTAKER-BROWN, EXAMINING ATTORNEY

SN 76-676,108. HAVIS SHIELDS EQUIPMENT CORPORATION, WARMINSTER, PA. FILED 4-27-2007.

COLLINS DYNAMICS

THE MARK CONSISTS OF STANDARD CHARACTERS WITHOUT CLAIM TO ANY PARTICULAR FONT, STYLE, SIZE, OR COLOR.

FOR ELECTRICAL LIGHTING FIXTURES AND PARTS THEREFOR (U.S. CLS. 13, 21, 23, 31 AND 34).

FIRST USE 0-0-1980; IN COMMERCE 0-0-1980. BENJAMIN OKEKE, EXAMINING ATTORNEY

CLASS 11—(Continued).

SN 77-026,916. PEGASUS ASSOCIATES, BEAVER FALLS, PA.
FILED 10-23-2006.



NO CLAIM IS MADE TO THE EXCLUSIVE RIGHT TO USE "LIGHTING", APART FROM THE MARK AS SHOWN. THE MARK CONSISTS OF AN OUTLINE OF PEGASUS (A WINGED HORSE) WITH STYLIZED TEXT OF THE WORDS, "PEGASUS LIGHTING".
FOR LIGHTING FIXTURES (U.S. CLS. 13, 21, 23, 31 AND 34).
CORY BOONE, EXAMINING ATTORNEY

SN 77-077,020. ERICKSON BEAMON, LTD., NEW YORK, NY. FILED 1-5-2007.

ERICKSON BEAMON

THE MARK CONSISTS OF STANDARD CHARACTERS WITHOUT CLAIM TO ANY PARTICULAR FONT, STYLE, SIZE, OR COLOR.
OWNER OF U.S. REG. NOS. 2,101,111, 2,101,112 AND 2,101,113.
THE NAME(S), PORTRAIT(S), AND/OR SIGNATURE(S) SHOWN IN THE MARK DOES NOT IDENTIFY A PARTICULAR LIVING INDIVIDUAL.
FOR CHANDELIERS (U.S. CLS. 13, 21, 23, 31 AND 34).
KATHERINE STOIDES, EXAMINING ATTORNEY

SN 77-082,650. HICKOK, RICHARD, FIFIELD, BUCHANAN, MI. FILED 1-14-2007.

Tile-A-Drain

THE MARK CONSISTS OF STANDARD CHARACTERS WITHOUT CLAIM TO ANY PARTICULAR FONT, STYLE, SIZE, OR COLOR.
FOR PLUMBING FIXTURES, NAMELY, SHOWER DRAIN HEIGHT EXTENSION AND FLOOR TILE ADAPTER (U.S. CLS. 13, 21, 23, 31 AND 34).
JOHN E. MICHOS, EXAMINING ATTORNEY

CLASS 11—(Continued).

SN 77-118,292. BIOCLIMATIC AIR SYSTEMS, LLC, DEL-RAN, NJ. FILED 2-28-2007.

BIOTRONIC

THE MARK CONSISTS OF STANDARD CHARACTERS WITHOUT CLAIM TO ANY PARTICULAR FONT, STYLE, SIZE, OR COLOR.
FOR AIR FILTERS FOR COMMERCIAL AND RESIDENTIAL USE (U.S. CLS. 13, 21, 23, 31 AND 34).
FIRST USE 2-26-2007; IN COMMERCE 2-26-2007.
DEIRDRE ROBERTSON, EXAMINING ATTORNEY

SN 77-120,403. TURBO TEK INTERNATIONAL, INC., LOS ANGELES, CA. FILED 3-1-2007.

PERFECT CHILL

THE MARK CONSISTS OF STANDARD CHARACTERS WITHOUT CLAIM TO ANY PARTICULAR FONT, STYLE, SIZE, OR COLOR.
NO CLAIM IS MADE TO THE EXCLUSIVE RIGHT TO USE "CHILL", APART FROM THE MARK AS SHOWN.
FOR REFRIGERATED BEER COOLER AND DISPENSERS; TEMPERATURE-CONTROLLED FOOD AND BEVERAGE DISPENSERS AND COMPONENTS THEREOF; ELECTRICAL ICE MAKERS, AND ELECTRIC REFRIGERATORS (U.S. CLS. 13, 21, 23, 31 AND 34).
CURTIS FRENCH, EXAMINING ATTORNEY

SN 77-120,509. THE BOC GROUP, INC., MURRAY HILL, NJ. FILED 3-2-2007.

MINISKID

THE MARK CONSISTS OF STANDARD CHARACTERS WITHOUT CLAIM TO ANY PARTICULAR FONT, STYLE, SIZE, OR COLOR.
FOR SEPARATORS FOR THE CLEANING AND PURIFICATION OF GASES, NAMELY, SEPARATORS COMPRISED OF FILTERS AND TANKS FOR PURIFYING AND PRESSURIZING GASES AND FOR DELIVERING SUCH GASES TO INDUSTRIAL FACILITIES AND SYSTEMS (U.S. CLS. 13, 21, 23, 31 AND 34).
FIRST USE 9-15-1999; IN COMMERCE 9-15-1999.
MARK T. MULLEN, EXAMINING ATTORNEY

CLASS 11—(Continued).

SN 77-122,120. GEANN INDUSTRIAL CO., LTD., CHANGHUA HSIEN, TAIWAN, FILED 3-5-2007.



THE MARK CONSISTS OF THE WORD "GEAR" WITH AN OPEN CIRCLE WITHIN THE "G" AND A CLOSED CIRCLE WITHIN THE "R".

FOR MANUALLY-OPERATED PLUMBING VALVES; PLUMBING FITTINGS, NAMELY, SHOWER CONTROL VALVES, TUB CONTROL VALVES AND VALVES; REGULATING ACCESSORIES FOR WATER SUPPLY, NAMELY, METERED VALVES; THERMOSTATIC VALVES; AND VALVES BEING PARTS OF SPRINKLER SYSTEMS (U.S. CLS. 13, 21, 23, 31 AND 34).

KELLY BOULTON, EXAMINING ATTORNEY

SN 77-122,355. SELUX CORPORATION, HIGHLAND, NY. FILED 3-5-2007.



NEO

THE MARK CONSISTS OF STANDARD CHARACTERS WITHOUT CLAIM TO ANY PARTICULAR FONT, STYLE, SIZE, OR COLOR.

FOR ELECTRIC LIGHTING FIXTURES (U.S. CLS. 13, 21, 23, 31 AND 34).

FIRST USE 1-1-2004; IN COMMERCE 1-1-2007.
GISELLE AGOSTO, EXAMINING ATTORNEY

SN 77-122,993. ENVIRONMENTAL LIGHTING CONCEPTS, INC., TAMPA, FL. FILED 3-6-2007.



TOTAL FLEX

THE MARK CONSISTS OF STANDARD CHARACTERS WITHOUT CLAIM TO ANY PARTICULAR FONT, STYLE, SIZE, OR COLOR.

FOR LIGHT BULBS; LIGHTING FIXTURES (U.S. CLS. 13, 21, 23, 31 AND 34).

REBECCA GAN, EXAMINING ATTORNEY

CLASS 11—(Continued).

SN 77-122,998. ENVIRONMENTAL LIGHTING CONCEPTS, INC., TAMPA, FL. FILED 3-6-2007.

SMART FLEX

THE MARK CONSISTS OF STANDARD CHARACTERS WITHOUT CLAIM TO ANY PARTICULAR FONT, STYLE, SIZE, OR COLOR.

FOR LIGHT BULBS; LIGHTING FIXTURES (U.S. CLS. 13, 21, 23, 31 AND 34).

REBECCA GAN, EXAMINING ATTORNEY

SN 77-123,335. AXIS WORLD ENTERPRISES CO., LTD, HONG KONG, HONG KONG, FILED 3-6-2007.



FLASH-TACS

THE MARK CONSISTS OF STANDARD CHARACTERS WITHOUT CLAIM TO ANY PARTICULAR FONT, STYLE, SIZE, OR COLOR.

FOR ADHESIVE LED LAMP (U.S. CLS. 13, 21, 23, 31 AND 34).

REBECCA GAN, EXAMINING ATTORNEY

SN 77-129,770. ENVIRONMENTAL LIGHTING CONCEPTS, INC., TAMPA, FL. FILED 3-13-2007.



IT'S LIKE NATURAL DAYLIGHT INDOORS

THE MARK CONSISTS OF STANDARD CHARACTERS WITHOUT CLAIM TO ANY PARTICULAR FONT, STYLE, SIZE, OR COLOR.

FOR LIGHT BULBS; LIGHTING FIXTURES (U.S. CLS. 13, 21, 23, 31 AND 34).

FIRST USE 7-31-2001; IN COMMERCE 7-31-2001.

REBECCA GAN, EXAMINING ATTORNEY

CLASS 11—(Continued).

SN 77-133,551. FLUIDMASTER, INC., SAN JUAN CAPISTRANO, CA. FILED 3-16-2007.

LEAK ALERT

THE MARK CONSISTS OF STANDARD CHARACTERS WITHOUT CLAIM TO ANY PARTICULAR FONT, STYLE, SIZE, OR COLOR.

NO CLAIM IS MADE TO THE EXCLUSIVE RIGHT TO USE "LEAK", APART FROM THE MARK AS SHOWN.

FOR PLUMBING FITTINGS, NAMELY, TOILET VALVES (U.S. CLS. 13, 21, 23, 31 AND 34).
TOBY BULLOFF, EXAMINING ATTORNEY

CLASS 11—(Continued).

SN 77-135,638. 998232 ALBERTA LTD, CALGARY, CANADA, FILED 3-20-2007.

QUIKSUN

THE MARK CONSISTS OF STANDARD CHARACTERS WITHOUT CLAIM TO ANY PARTICULAR FONT, STYLE, SIZE, OR COLOR.

FOR UV EMITTING LAMPS FOR THE PURPOSE OF COSMETIC INDOOR TANNING (U.S. CLS. 13, 21, 23, 31 AND 34).

TONI HICKEY, EXAMINING ATTORNEY

SN 77-134,046. BRENT CORNELISSEN, OAKVILLE, CANADA, FILED 3-19-2007.

Q-COIL

THE MARK CONSISTS OF STANDARD CHARACTERS WITHOUT CLAIM TO ANY PARTICULAR FONT, STYLE, SIZE, OR COLOR.

FOR DRAIN WATER HEAT EXCHANGER, CONTRA-FLOW HEAT EXCHANGER; DOMESTIC, INDUSTRIAL AND COMMERCIAL WATER HEATERS; HEAT RECLAIMERS, ENERGY SAVING DEVICE, NAMELY HEAT EXCHANGERS; DRAIN WATER HEAT RECOVERY SYSTEMS COMPRISED OF ONE OR MORE HEAT EXCHANGERS TO EXTRACT HEAT FROM WASTE WATER FOR USEFUL PURPOSES (U.S. CLS. 13, 21, 23, 31 AND 34).

SETH A. RAPPAPORT, EXAMINING ATTORNEY

SN 77-138,657. AMERICAN STANDARD INTERNATIONAL INC., NEW YORK, NY. FILED 3-23-2007.

AMERISTAR

THE MARK CONSISTS OF STANDARD CHARACTERS WITHOUT CLAIM TO ANY PARTICULAR FONT, STYLE, SIZE, OR COLOR.

FOR AIR CONDITIONERS, HEAT PUMPS, FURNACES AND AIR CONDITIONING AIR HANDLERS (U.S. CLS. 13, 21, 23, 31 AND 34).

FIRST USE 9-1-2004; IN COMMERCE 9-1-2004.

AISHA SALEM, EXAMINING ATTORNEY

SN 77-135,300. NOVA ELECTRONICS INC., COLCHESTER, CT. FILED 3-20-2007.

WHALE LED

THE MARK CONSISTS OF STANDARD CHARACTERS WITHOUT CLAIM TO ANY PARTICULAR FONT, STYLE, SIZE, OR COLOR.

NO CLAIM IS MADE TO THE EXCLUSIVE RIGHT TO USE "LED", APART FROM THE MARK AS SHOWN.

FOR LED UTILITY LIGHT INTENDED FOR MOUNTING ON A MOTOR VEHICLE (U.S. CLS. 13, 21, 23, 31 AND 34).

CORY BOONE, EXAMINING ATTORNEY

SN 77-138,904. GLEN ELECTRIC HOLDINGS GMBH, D-96515 SONNEBERG, FED REP GERMANY, FILED 3-23-2007.

POLYKOOL

THE MARK CONSISTS OF STANDARD CHARACTERS WITHOUT CLAIM TO ANY PARTICULAR FONT, STYLE, SIZE, OR COLOR.

OWNER OF U.S. REG. NOS. 1,462,679 AND 3,082,243.
FOR CLOSED LOOP INDUSTRIAL LIQUID COOLING UNITS, WATER CHILLERS AND HEAT EXCHANGERS (U.S. CLS. 13, 21, 23, 31 AND 34).

BRIAN PINO, EXAMINING ATTORNEY

CLASS 11—(Continued).

SN 77-138,925. GLEN ELECTRIC HOLDINGS GMBH, D-96515 SONNEBERG, FED REP GERMANY, FILED 3-23-2007.

MODUKOOL

THE MARK CONSISTS OF STANDARD CHARACTERS WITHOUT CLAIM TO ANY PARTICULAR FONT, STYLE, SIZE, OR COLOR.

OWNER OF U.S. REG. NOS. 1,462,679 AND 3,082,243.
FOR CLOSED LOOP INDUSTRIAL LIQUID COOLING UNITS, WATER CHILLERS AND HEAT EXCHANGERS (U.S. CLS. 13, 21, 23, 31 AND 34).
BRIAN PINO, EXAMINING ATTORNEY

CLASS 11—(Continued).

SN 77-138,981. GLEN ELECTRIC HOLDINGS GMBH, D-96515 SONNEBERG, FED REP GERMANY, FILED 3-23-2007.

TECHNOKOOL

THE MARK CONSISTS OF STANDARD CHARACTERS WITHOUT CLAIM TO ANY PARTICULAR FONT, STYLE, SIZE, OR COLOR.

OWNER OF U.S. REG. NOS. 1,462,679 AND 3,082,243.
FOR CLOSED LOOP INDUSTRIAL LIQUID COOLING UNITS, WATER CHILLERS AND HEAT EXCHANGERS (U.S. CLS. 13, 21, 23, 31 AND 34).
BRIAN PINO, EXAMINING ATTORNEY

SN 77-138,946. GLEN ELECTRIC HOLDINGS GMBH, D-96515 SONNEBERG, FED REP GERMANY, FILED 3-23-2007.

INDYKOOL

THE MARK CONSISTS OF STANDARD CHARACTERS WITHOUT CLAIM TO ANY PARTICULAR FONT, STYLE, SIZE, OR COLOR.

OWNER OF U.S. REG. NOS. 1,462,679 AND 3,082,243.
FOR CLOSED LOOP INDUSTRIAL LIQUID COOLING UNITS, WATER CHILLERS AND HEAT EXCHANGERS (U.S. CLS. 13, 21, 23, 31 AND 34).
BRIAN PINO, EXAMINING ATTORNEY

SN 77-139,658. PHOCATOX TECHNOLOGIES, LLC, INDIANAPOLIS, IN. FILED 3-25-2007.

PHOCATOX

THE MARK CONSISTS OF STANDARD CHARACTERS WITHOUT CLAIM TO ANY PARTICULAR FONT, STYLE, SIZE, OR COLOR.

FOR AIR CLEANING UNITS; AIR PURIFICATION UNITS (U.S. CLS. 13, 21, 23, 31 AND 34).
FIRST USE 2-16-2007; IN COMMERCE 2-16-2007.
CHRISTINA SOBRAL, EXAMINING ATTORNEY

SN 77-138,960. GLEN ELECTRIC HOLDINGS GMBH, D-96515 SONNEBERG, FED REP GERMANY, FILED 3-23-2007.

STERIKOOL

THE MARK CONSISTS OF STANDARD CHARACTERS WITHOUT CLAIM TO ANY PARTICULAR FONT, STYLE, SIZE, OR COLOR.

OWNER OF U.S. REG. NOS. 1,462,679 AND 3,082,243.
FOR CLOSED LOOP INDUSTRIAL LIQUID COOLING UNITS, WATER CHILLERS AND HEAT EXCHANGERS (U.S. CLS. 13, 21, 23, 31 AND 34).
BRIAN PINO, EXAMINING ATTORNEY

SN 77-139,663. PHOCATOX TECHNOLOGIES, LLC, INDIANAPOLIS, IN. FILED 3-25-2007.

BIOSWEEP

THE MARK CONSISTS OF STANDARD CHARACTERS WITHOUT CLAIM TO ANY PARTICULAR FONT, STYLE, SIZE, OR COLOR.

FOR AIR CLEANING UNITS; AIR PURIFICATION UNITS (U.S. CLS. 13, 21, 23, 31 AND 34).
FIRST USE 2-16-2007; IN COMMERCE 2-16-2007.
CHRISTINA SOBRAL, EXAMINING ATTORNEY

CLASS 11—(Continued).

SN 77-140,001. FULL SPECTRUM SOLUTIONS, INC., JACKSON, MI. FILED 3-26-2007.

EVERLAST

THE MARK CONSISTS OF STANDARD CHARACTERS WITHOUT CLAIM TO ANY PARTICULAR FONT, STYLE, SIZE, OR COLOR.

FOR LIGHTING FIXTURES THAT INTEGRATE NATURAL DAYLIGHT AND FLUORESCENT LIGHTING INTO THE FIXTURE (U.S. CLS. 13, 21, 23, 31 AND 34).

FIRST USE 3-25-2007; IN COMMERCE 3-25-2007.
JENNIFER MARTIN, EXAMINING ATTORNEY

CLASS 11—(Continued).

SN 77-140,743. DIMENSION ONE SPAS, INC., VISTA, CA. FILED 3-26-2007.

SofTouch

THE MARK CONSISTS OF STANDARD CHARACTERS WITHOUT CLAIM TO ANY PARTICULAR FONT, STYLE, SIZE, OR COLOR.

FOR BATH TUBS; FITTED LINERS FOR HOT TUBS OR SPAS; FITTED SPA COVERS; PORTABLE FOOT BATHS FOR USE IN PEDICURE SALONS AND DAY SPAS; SPA SURROUNDS; SPAS IN THE NATURE OF HEATED POOLS; WHIRLPOOL BATHS (U.S. CLS. 13, 21, 23, 31 AND 34).

TINA BROWN, EXAMINING ATTORNEY

SN 77-140,027. OZONICS, L.L.C., LAKE JACKSON, TX. FILED 3-26-2007.

OZONICS

THE MARK CONSISTS OF STANDARD CHARACTERS WITHOUT CLAIM TO ANY PARTICULAR FONT, STYLE, SIZE, OR COLOR.

FOR OZONE GENERATORS FOR PURIFYING AIR (U.S. CLS. 13, 21, 23, 31 AND 34).

AHSEN KHAN, EXAMINING ATTORNEY

SN 77-140,757. DIMENSION ONE SPAS, INC., VISTA, CA. FILED 3-26-2007.

Soft Touch

THE MARK CONSISTS OF STANDARD CHARACTERS WITHOUT CLAIM TO ANY PARTICULAR FONT, STYLE, SIZE, OR COLOR.

FOR BATH TUBS; FITTED LINERS FOR HOT TUBS OR SPAS; FITTED SPA COVERS; PORTABLE BATH SEAT; PORTABLE FOOT BATHS FOR USE IN PEDICURE SALONS AND DAY SPAS; SITZ BATHS; SPA SURROUNDS; SPAS IN THE NATURE OF HEATED POOLS; WHIRLPOOL BATHS (U.S. CLS. 13, 21, 23, 31 AND 34).

TINA BROWN, EXAMINING ATTORNEY

SN 77-140,030. OZONICS, L.L.C., LAKE JACKSON, TX. FILED 3-26-2007.

REVOLUTIONIZING SCENT CONTROL

THE MARK CONSISTS OF STANDARD CHARACTERS WITHOUT CLAIM TO ANY PARTICULAR FONT, STYLE, SIZE, OR COLOR.

NO CLAIM IS MADE TO THE EXCLUSIVE RIGHT TO USE "SCENT CONTROL", APART FROM THE MARK AS SHOWN.

FOR OZONE GENERATORS FOR PURIFYING AIR (U.S. CLS. 13, 21, 23, 31 AND 34).

AHSEN KHAN, EXAMINING ATTORNEY

SN 77-141,662. FULL SPECTRUM SOLUTIONS, INC., JACKSON, MI. FILED 3-27-2007.

ULTRALUX

THE MARK CONSISTS OF STANDARD CHARACTERS WITHOUT CLAIM TO ANY PARTICULAR FONT, STYLE, SIZE, OR COLOR.

FOR LIGHTING FIXTURES THAT INTEGRATE NATURAL DAYLIGHT AND FLUORESCENT LIGHTING INTO THE FIXTURE (U.S. CLS. 13, 21, 23, 31 AND 34).

FIRST USE 6-13-2001; IN COMMERCE 6-13-2001.
JENNIFER MARTIN, EXAMINING ATTORNEY

CLASS 11—(Continued).

SN 77-141,764. B2X CORPORATION, JERSEY CITY, NJ.
FILED 3-27-2007.

B2X

THE MARK CONSISTS OF STANDARD CHARACTERS WITHOUT CLAIM TO ANY PARTICULAR FONT, STYLE, SIZE, OR COLOR.

FOR BAKING OVEN, ELECTRIC TOASTER OVENS, MICROWAVE OVENS, ELECTRIC COOKTOPS, GAS COOKTOPS, ELECTRIC COFFEE MAKER, ELECTRIC ESPRESSO MAKER, CLOTHES DRYERS, HAIR DRYERS, REFRIGERATORS, AIR CONDITIONERS, HUMIDIFIERS, AIR PURIFIERS (U.S. CLS. 13, 21, 23, 31 AND 34).

THEODORE MCBRIDE, EXAMINING ATTORNEY

SN 77-142,387. FRYMASTER LLC, SHREVEPORT, LA.
FILED 3-28-2007.

SMART4U

THE MARK CONSISTS OF STANDARD CHARACTERS WITHOUT CLAIM TO ANY PARTICULAR FONT, STYLE, SIZE, OR COLOR.

FOR GAS AND ELECTRIC COMMERCIAL FRYERS, COMPONENTS FOR GAS AND ELECTRIC COMMERCIAL FRYERS, NAMELY, FILTER MODULES, SENSORS AND DEVICES FOR MONITORING OIL (U.S. CLS. 13, 21, 23, 31 AND 34).

JAMES A. RAUEN, EXAMINING ATTORNEY

SN 77-142,415. FRYMASTER LLC, SHREVEPORT, LA.
FILED 3-28-2007.

PROTECTOR

THE MARK CONSISTS OF STANDARD CHARACTERS WITHOUT CLAIM TO ANY PARTICULAR FONT, STYLE, SIZE, OR COLOR.

FOR GAS AND ELECTRIC COMMERCIAL FRYERS (U.S. CLS. 13, 21, 23, 31 AND 34).

JAMES A. RAUEN, EXAMINING ATTORNEY

CLASS 11—(Continued).

SN 77-142,622. FRYMASTER LLC, SHREVEPORT, LA.
FILED 3-28-2007.

FILTERLOGIC

THE MARK CONSISTS OF STANDARD CHARACTERS WITHOUT CLAIM TO ANY PARTICULAR FONT, STYLE, SIZE, OR COLOR.

FOR GAS AND ELECTRIC COMMERCIAL FRYERS, COMPONENTS FOR GAS AND ELECTRIC COMMERCIAL FRYERS, NAMELY, FILTER MODULES, SENSORS AND DEVICES FOR MONITORING OIL (U.S. CLS. 13, 21, 23, 31 AND 34).

JAMES A. RAUEN, EXAMINING ATTORNEY

SN 77-143,561. SPRAGUE, JOHN, ALISO VEIJO, CA. FILED
3-29-2007.

NEXT RO

THE MARK CONSISTS OF STANDARD CHARACTERS WITHOUT CLAIM TO ANY PARTICULAR FONT, STYLE, SIZE, OR COLOR.

NO CLAIM IS MADE TO THE EXCLUSIVE RIGHT TO USE RO, APART FROM THE MARK AS SHOWN.

FOR WATER PURIFICATION UNITS (U.S. CLS. 13, 21, 23, 31 AND 34).

FIRST USE 10-0-2004; IN COMMERCE 12-0-2004.

REBECCA SMITH, EXAMINING ATTORNEY

SN 77-144,181. PRASHANT SHEWA, YORBA LINDA, CA.
FILED 3-29-2007.

CYNERGY

THE MARK CONSISTS OF STANDARD CHARACTERS WITHOUT CLAIM TO ANY PARTICULAR FONT, STYLE, SIZE, OR COLOR.

FOR SOLAR LIGHT FIXTURES, NAMELY, INDOOR AND OUTDOOR SOLAR POWERED LIGHTING UNITS AND FIXTURES (U.S. CLS. 13, 21, 23, 31 AND 34).

DORITT L. CARROLL, EXAMINING ATTORNEY

CLASS 11—(Continued).

SN 77-158,047. KOHLER CO., KOHLER, WI. FILED 4-16-2007.

STARFLOWER

THE MARK CONSISTS OF STANDARD CHARACTERS WITHOUT CLAIM TO ANY PARTICULAR FONT, STYLE, SIZE, OR COLOR.

FOR PLUMBING PRODUCTS, NAMELY TOILET SEATS (U.S. CLS. 13, 21, 23, 31 AND 34).

ESTHER A. BORSUK, EXAMINING ATTORNEY



SN 77-158,049. KOHLER CO., KOHLER, WI. FILED 4-16-2007.

MOONDANCE

THE MARK CONSISTS OF STANDARD CHARACTERS WITHOUT CLAIM TO ANY PARTICULAR FONT, STYLE, SIZE, OR COLOR.

FOR PLUMBING PRODUCTS, NAMELY TOILET SEATS (U.S. CLS. 13, 21, 23, 31 AND 34).

ESTHER A. BORSUK, EXAMINING ATTORNEY



SN 77-181,849. FRYMASTER LLC, SHREVEPORT, LA. FILED 5-15-2007.

HOLDMASTER

THE MARK CONSISTS OF STANDARD CHARACTERS WITHOUT CLAIM TO ANY PARTICULAR FONT, STYLE, SIZE, OR COLOR.

FOR COMMERCIAL FOODSERVICE EQUIPMENT, NAMELY, ELECTRIC HEATED CABINETS USED TO HOLD COOKED FOODS AT CONTROLLED TEMPERATURES (U.S. CLS. 13, 21, 23, 31 AND 34).

JAMES A. RAUEN, EXAMINING ATTORNEY

CLASS 11—(Continued).

SN 77-198,755. BSH HOME APPLIANCES CORPORATION, HUNTINGTON BEACH, CA. FILED 6-6-2007.

POWERSTART

THE MARK CONSISTS OF STANDARD CHARACTERS WITHOUT CLAIM TO ANY PARTICULAR FONT, STYLE, SIZE, OR COLOR.

FOR HOUSEHOLD AND KITCHEN MACHINES AND EQUIPMENT, NAMELY, HEATING, STEAM PRODUCING, AND COOKING DEVICES, NAMELY, DOMESTIC COOKING OVENS, ELECTRIC AND GAS RANGES, COOKTOPS, WARMING DRAWERS SOLD AS PARTS OF OVENS, RANGES AND COOKTOPS, MICROWAVE APPLIANCES, NAMELY, MICROWAVE OVENS; AND STRUCTURAL PARTS OF ALL AFOREMENTIONED GOODS (U.S. CLS. 13, 21, 23, 31 AND 34).

MICHAEL SOUDERS, EXAMINING ATTORNEY



SN 78-678,252. KOHLER CO., KOHLER, WI. FILED 7-26-2005.

SYMBOL

THE MARK CONSISTS OF STANDARD CHARACTERS WITHOUT CLAIM TO ANY PARTICULAR FONT, STYLE, SIZE, OR COLOR.

FOR PLUMBING FIXTURES AND FITTINGS, NAMELY, TAPS FOR WATER FAUCETS, WATER CONTROL VALVES FOR FAUCETS, FAUCETS, HANDLES, DRAINS, PARTS AND FITTINGS THEREFOR (U.S. CLS. 13, 21, 23, 31 AND 34).

FIRST USE 1-31-2006; IN COMMERCE 1-31-2006.

ROBIN CHOSID, EXAMINING ATTORNEY



SN 78-685,997. KOHLER CO., KOHLER, WI. FILED 8-4-2005.

PRESSURE LITE

THE MARK CONSISTS OF STANDARD CHARACTERS WITHOUT CLAIM TO ANY PARTICULAR FONT, STYLE, SIZE, OR COLOR.

NO CLAIM IS MADE TO THE EXCLUSIVE RIGHT TO USE "PRESSURE", APART FROM THE MARK AS SHOWN.

FOR TOILET FLUSHING SYSTEMS CONSISTING OF PRESSURE VESSELS, TOILET TRIP LEVERS, TOILET TRIP ARMS, PLUNGERS, GASKETS, TOILET TANKS, TOILET BOWLS, TOILET TANK BOLT AND WASHERS (U.S. CLS. 13, 21, 23, 31 AND 34).

FIRST USE 2-28-1995; IN COMMERCE 2-28-1995.

VIVIAN MICZNIK FIRST, EXAMINING ATTORNEY

CLASS 11—(Continued).

SN 78-729,889. KOHLER CO., KOHLER, WI. FILED 10-10-2005.

KOHLER

THE MARK CONSISTS OF STANDARD CHARACTERS WITHOUT CLAIM TO ANY PARTICULAR FONT, STYLE, SIZE, OR COLOR.

SEC. 2(F).

FOR BATHTUBS; WHIRLPOOL BATHS; SHOWERS AND SHOWER INSTALLATIONS, NAMELY SHOWER RECEPTORS; SHOWER AND BATH CUBICLES; SHOWER HEADS; SHOWER DOORS; WATER DIVERTERS FOR SHOWERS AND BATHS; BATH SPOUTS; BIDETS; LAVATORIES; SINKS; PEDESTALS, NAMELY SINK PEDESTALS AND LAVATORY PEDESTALS; TOILETS; TOILET BOWLS; TOILET SEATS; WATER CISTERNS, NAMELY, TOILET TANKS; URINALS; TOUCHLESS FLUSHING APPARATUS, NAMELY, TOUCHLESS WATER CONTROL VALVE; LIGHTING FIXTURES; TAPS; FAUCETS; WATER CONTROL VALVES FOR FAUCETS; TOUCHLESS FAUCETS; STRAINERS FOR USE WITH PLUMBING FIXTURES, NAMELY SINKS AND URINALS; AND DRINKING FOUNTAINS (U.S. CLS. 13, 21, 23, 31 AND 34).

FIRST USE 1-1-1873; IN COMMERCE 1-1-1873.

SEAN CROWLEY, EXAMINING ATTORNEY

CLASS 11—(Continued).

SN 78-834,061. COLOR KINETICS INCORPORATED, BOSTON, MA. FILED 3-10-2006.

ESSENTIALWHITE

THE MARK CONSISTS OF STANDARD CHARACTERS WITHOUT CLAIM TO ANY PARTICULAR FONT, STYLE, SIZE, OR COLOR.

FOR LED ELECTRIC LIGHTING FIXTURES; ELECTRONIC DEVICES, NAMELY LEDS, SOLD AS INTEGRAL COMPONENTS OF LIGHTING FIXTURES; ALL OF THE FOREGOING SOLD TO INTERIOR DESIGNERS, LIGHTING DESIGNERS AND SPECIFIERS, ARCHITECTS, MANUFACTURERS AND ELECTRICIANS (U.S. CLS. 13, 21, 23, 31 AND 34).

HEATHER BIDDULPH, EXAMINING ATTORNEY

SN 78-910,749. HELMORE, IAN STEWART, HERTFORDSHIRE, UNITED KINGDOM, FILED 6-18-2006.

Steri-Spray

SN 78-760,674. EVAPCO, INC., WESTMINSTER, MD. FILED 11-23-2005.

ZM

THE MARK CONSISTS OF STANDARD CHARACTERS WITHOUT CLAIM TO ANY PARTICULAR FONT, STYLE, SIZE, OR COLOR.

FOR SPRAY NOZZLES FOR WATER DISTRIBUTION IN EVAPORATIVE CONDENSERS (U.S. CLS. 13, 21, 23, 31 AND 34).

FIRST USE 11-30-2003; IN COMMERCE 12-31-2003.

KATHLEEN M. VANSTON, EXAMINING ATTORNEY

THE MARK CONSISTS OF STANDARD CHARACTERS WITHOUT CLAIM TO ANY PARTICULAR FONT, STYLE, SIZE, OR COLOR.

OWNER OF UNITED KINGDOM REG. NO. 2408918, DATED 12-13-2005, EXPIRES 12-13-2015.

FOR FAUCET AERATORS; FAUCET SPRAYERS; FAUCETS; HAND HELD SHOWER HEADS; HAND SHOWERS; HAND-HELD SHOWERS; MIXER FAUCETS FOR WATER PIPES; PLUMBING FITTINGS, NAMELY, AERATORS FOR FAUCETS; PLUMBING FITTINGS, NAMELY, SHOWER CONTROL VALVES; PLUMBING FIXTURES, NAMELY, SHOWER SPRAYERS; SHOWER FAUCET EXTENSIONS; SHOWER HEAD SPRAYERS; SHOWER HEADS; SHOWERS; TAP WATER FAUCETS; WATER FAUCET SPOUT (U.S. CLS. 13, 21, 23, 31 AND 34).

GINA HAYES, EXAMINING ATTORNEY

CLASS 11—(Continued).

SN 78-938,009. ENERGY SAVING PRODUCTS CO., DIV. OF THOMAS J. FINNEGAN CO., VANDALIA, OH. FILED 7-26-2006.



NO CLAIM IS MADE TO THE EXCLUSIVE RIGHT TO USE "CELLAR SYSTEMS", APART FROM THE MARK AS SHOWN.

FOR WINE CELLAR CHILLING SYSTEM COMPRISED OF A SPLIT REFRIGERATION DEVICE, A CONDENSING UNIT, STAINLESS STEEL EVAPORATORS AND A DIGITAL TEMPERATURE AND HUMIDITY CONTROL (U.S. CLS. 13, 21, 23, 31 AND 34).
CHARLES L. JENKINS, EXAMINING ATTORNEY

CLASS 11—(Continued).

SN 78-943,572. GLOBAL EXPRESS MANUFACTURING LLC, ALBUQUERQUE, NM. FILED 8-2-2006.

Hydro Gem

THE MARK CONSISTS OF STANDARD CHARACTERS WITHOUT CLAIM TO ANY PARTICULAR FONT, STYLE, SIZE, OR COLOR.

FOR SPAS IN THE NATURE OF HEATED POOLS; WHIRLPOOLS; HOT TUBS; HOT TUB AND SPA ACCESSORIES, NAMELY, HOT TUB STEPS, FITTED HOT TUB COVERS; FITTED LINERS FOR HOT TUBS OR SPAS; BATH TUBS WHICH INCLUDE BATH JETS; BATH TUBS WHICH DO NOT INCLUDE BATH JETS; SAUNAS; ACRYLIC SHOWER WALL SURROUNDS; SHOWER ENCLOSURES; SHOWER DOORS; ACRYLIC SINKS; BATHROOM FIXTURES, NAMELY, FAUCETS AND SHOWER HEADS; DECORATIVE GARDEN WATER FOUNTAINS; GARDEN FISH POND KITS, CONSISTING OF A WATER FILTER, MOLDED OR UN-MOLDED LINER, WATER PUMP, WATER SKIMMER, TUBING, WITH OR WITHOUT WATERFALL KIT; PORTABLE HOT TUBS (U.S. CLS. 13, 21, 23, 31 AND 34).
ELLEN PERKINS, EXAMINING ATTORNEY

SN 78-943,094. SYSTEMS IV, INC., CHANDLER, AZ. FILED 8-2-2006.

SYSTEMS IV

THE MARK CONSISTS OF STANDARD CHARACTERS WITHOUT CLAIM TO ANY PARTICULAR FONT, STYLE, SIZE, OR COLOR.

NO CLAIM IS MADE TO THE EXCLUSIVE RIGHT TO USE "SYSTEMS", APART FROM THE MARK AS SHOWN.

FOR WATER TREATMENT UNITS, NAMELY WATER SOFTENING UNITS, WATER PURIFICATION UNITS, WATER CONDITIONING UNITS, AND WATER STERILIZATION UNITS FOR PREVENTING SCALE, ALL FOR DOMESTIC OR COMMERCIAL USE (U.S. CLS. 13, 21, 23, 31 AND 34).
FIRST USE 8-0-1974; IN COMMERCE 3-17-1976.
ELLEN PERKINS, EXAMINING ATTORNEY

SN 78-944,683. GLOBAL EXPRESS MANUFACTURING LLC, ALBUQUERQUE, NM. FILED 8-3-2006.



THE MARK CONSISTS OF A WAVE DESIGN WITH THE DRAWING OF A GEM DESIGN AND THE WORDING HYDRO GEM.

FOR SPAS IN THE NATURE OF HEATED POOLS; WHIRLPOOLS; HOT TUBS; HOT TUB AND SPA ACCESSORIES, NAMELY, HOT TUB STEPS, FITTED HOT TUB COVERS; FITTED LINERS FOR HOT TUBS OR SPAS; BATH TUBS WHICH INCLUDE BATH JETS; BATH TUBS WHICH DO NOT INCLUDE BATH JETS; SAUNAS; ACRYLIC SHOWER WALL SURROUNDS; SHOWER ENCLOSURES; SHOWER DOORS; ACRYLIC SINKS; BATHROOM FIXTURES, NAMELY, FAUCETS AND SHOWER HEADS; DECORATIVE GARDEN WATER FOUNTAINS; GARDEN FISH POND KITS, CONSISTING OF A WATER FILTER, MOLDED OR UN-MOLDED LINER, WATER PUMP, WATER SKIMMER, TUBING, WITH OR WITHOUT WATERFALL KIT; PORTABLE HOT TUBS (U.S. CLS. 13, 21, 23, 31 AND 34).
ELLEN PERKINS, EXAMINING ATTORNEY

CLASS 11—(Continued).

SN 78-949,578. JOHN ZINK COMPANY, LLC, TULSA, OK.
FILED 8-10-2006.

HALO

THE MARK CONSISTS OF STANDARD CHARACTERS WITHOUT CLAIM TO ANY PARTICULAR FONT, STYLE, SIZE, OR COLOR.

FOR COMBUSTION EQUIPMENT IN THE NATURE OF PROCESS BURNERS AND FLARE TIPS FOR USE IN INDUSTRIAL APPLICATIONS (U.S. CLS. 13, 21, 23, 31 AND 34).

ELLEN PERKINS, EXAMINING ATTORNEY

SN 78-954,390. NOVELAIRE TECHNOLOGIES, LLC, ALPHARETTA, GA. FILED 8-17-2006.

Creating the Great Indoors

THE MARK CONSISTS OF STANDARD CHARACTERS WITHOUT CLAIM TO ANY PARTICULAR FONT, STYLE, SIZE, OR COLOR.

FOR AIR CONDITIONING UNITS, NAMELY DEHUMIDIFIERS AND COMPONENT PARTS THEREOF (U.S. CLS. 13, 21, 23, 31 AND 34).

STEVEN PEREZ, EXAMINING ATTORNEY

SN 78-954,474. NOVELAIRE TECHNOLOGIES, LLC, ALPHARETTA, GA. FILED 8-17-2006.

NOVELAIRE

THE MARK CONSISTS OF STANDARD CHARACTERS WITHOUT CLAIM TO ANY PARTICULAR FONT, STYLE, SIZE, OR COLOR.

FOR AIR CONDITIONING UNITS, NAMELY DEHUMIDIFIERS AND COMPONENT PARTS THEREOF (U.S. CLS. 13, 21, 23, 31 AND 34).

STEVEN PEREZ, EXAMINING ATTORNEY

CLASS 11—(Continued).

SN 78-955,058. MOTION TECHNOLOGY, INC., MARLBORO, MA. FILED 8-18-2006.

MULTI-CHEF

THE MARK CONSISTS OF STANDARD CHARACTERS WITHOUT CLAIM TO ANY PARTICULAR FONT, STYLE, SIZE, OR COLOR.

FOR COOKING SYSTEM, NAMELY, A COOKING OVEN FOR COMMERCIAL USE (U.S. CLS. 13, 21, 23, 31 AND 34).

MARK SPARACINO, EXAMINING ATTORNEY

SN 78-959,311. ISLAND CLEAR AIR INC., VANCOUVER, CANADA, FILED 8-24-2006.



THE STIPPLING IS FOR SHADING PURPOSES ONLY. THE MARK CONSISTS OF THE LETTERS "ICA" WITH A CIRCLE DESIGN LOCATED INSIDE THE LETTER "C."

FOR AIR FILTERS FOR INDUSTRIAL INSTALLATIONS (U.S. CLS. 13, 21, 23, 31 AND 34).

FIRST USE 10-31-2004; IN COMMERCE 10-31-2004. CHRISTOPHER BUONGIORNO, EXAMINING ATTORNEY

SN 78-961,562. SUN WATER SYSTEMS, INC., FORT WORTH, TX. FILED 8-28-2006.

AQUASANA

THE MARK CONSISTS OF STANDARD CHARACTERS WITHOUT CLAIM TO ANY PARTICULAR FONT, STYLE, SIZE, OR COLOR.

OWNER OF U.S. REG. NO. 2,936,495. THE ENGLISH TRANSLATION OF THE LATIN TERM AQUASANA IS "WATER TO HEAL".

FOR WATER FILTERS, BATH AND SHOWER FAUCETS, WATER PURIFICATION UNITS, WATER DISPENSERS, WATER FOUNTAINS AND COOLERS, ALL FOR DOMESTIC USE THAT ARE SOLD OR DISTRIBUTED ONLINE VIA THE INTERNET (U.S. CLS. 13, 21, 23, 31 AND 34).

FIRST USE 7-15-2004; IN COMMERCE 7-15-2004. G. MAYERSCHOFF, EXAMINING ATTORNEY

CLASS 11—(Continued).

SN 78-963,496. SCENTAIR TECHNOLOGIES, CHARLOTTE, NC. FILED 8-30-2006.

ScentWave

THE MARK CONSISTS OF STANDARD CHARACTERS WITHOUT CLAIM TO ANY PARTICULAR FONT, STYLE, SIZE, OR COLOR.

FOR DISPENSING UNITS FOR AIR FRESHENERS; DISPENSING UNITS FOR ROOM DEODORANTS; ELECTRIC DISPENSER FOR AIR FRESHENER (U.S. CLS. 13, 21, 23, 31 AND 34).

FIRST USE 10-0-2003; IN COMMERCE 10-0-2003.
BRIDGETT SMITH, EXAMINING ATTORNEY

SN 78-964,715. SLOAN VALVE COMPANY, FRANKLIN AVENUE, IL. FILED 8-31-2006.



OWNER OF U.S. REG. NOS. 576,222, 620,217 AND OTHERS.

NO CLAIM IS MADE TO THE EXCLUSIVE RIGHT TO USE "100 YEARS 1906-2006", APART FROM THE MARK AS SHOWN.

FOR PLUMBING FIXTURES, NAMELY FLUSH VALVES, FLUSHOMETER BODIES, ACTIVATION HANDLES, CONTROL STOPS, VACUUM BREAKERS AND INTERNAL REPAIR PARTS THEREOF, QUIET FLUSH VALVE EQUIPMENT COMPRISED OF FLUSH VALVES ASSEMBLES (U.S. CLS. 13, 21, 23, 31 AND 34).

RONALD MCMORROW, EXAMINING ATTORNEY

SN 78-966,109. HEATWAVE PRODUCTS, LLC, CLEVELAND, OH. FILED 9-1-2006.

TOWEL SPA

THE MARK CONSISTS OF STANDARD CHARACTERS WITHOUT CLAIM TO ANY PARTICULAR FONT, STYLE, SIZE, OR COLOR.

NO CLAIM IS MADE TO THE EXCLUSIVE RIGHT TO USE "TOWEL", APART FROM THE MARK AS SHOWN.

FOR ELECTRIC DEVICES FOR WARMING VARIOUS ARTICLES IN THE NATURE OF ELECTRIC TOWEL WARMERS, ELECTRIC CLOTHING WARMERS, ELECTRIC SHEET WARMERS, ELECTRIC BLANKET WARMERS, AND ELECTRIC SHOE WARMERS (U.S. CLS. 13, 21, 23, 31 AND 34).

SCOTT SISUN, EXAMINING ATTORNEY

CLASS 11—(Continued).

SN 78-966,879. HEATWAVE, LLC, CLEVELAND, OH. FILED 9-5-2006.

The logo for towelspa features the word "towelspa" in a lowercase, sans-serif font. Above the "a" are three wavy lines representing steam. Below "towelspa" is the text "towel warmer" in a smaller, lowercase font.

NO CLAIM IS MADE TO THE EXCLUSIVE RIGHT TO USE "TOWEL WARMER", APART FROM THE MARK AS SHOWN.

FOR ELECTRIC DEVICES FOR WARMING VARIOUS ARTICLES IN THE NATURE OF ELECTRIC TOWEL WARMERS, ELECTRIC CLOTHING WARMERS, ELECTRIC SHEET WARMERS, ELECTRIC BLANKET WARMERS, AND ELECTRIC SHOE WARMERS (U.S. CLS. 13, 21, 23, 31 AND 34).

SCOTT SISUN, EXAMINING ATTORNEY

SN 79-029,334. JIEYANGSHI HUANENGDA; DIANQI YOUXIANGONGSI, CHINA, FILED 9-5-2006.



OWNER OF INTERNATIONAL REGISTRATION 0899558 DATED 9-5-2006, EXPIRES 9-5-2016.

THE FIRST TERM MEANS "HEALTH", THE SECOND TERM MEANS "GOOD MAN".

THE TRANSLITERATION OF THE NON-LATIN CHARACTERS IN THE MARK IS KANG FU.

FOR ELECTRICAL HAIR DRIER WITH A BLOWER FOR COMMERCIAL USE; HAIR DRIERS FOR HOUSEHOLD PURPOSES; STATIONARY HAIR DRIERS FOR COMMERCIAL USE AND DOMESTIC USE; AIR HUMIDIFIERS; LAMPS; PORTABLE ELECTRIC HEATERS; FUMIGATION APPARATUS, NOT FOR MEDICAL PURPOSES, NAMELY, ELECTRICAL DEVICES TO BE PLUGGED INTO WALL OUTLETS HAVING A HEATING ELEMENT AND WHICH DISPENSES INSECT AND RODENT FUMIGATING PREPARATIONS; ELECTRIC RADIATORS FOR HEATING BUILDINGS (U.S. CLS. 13, 21, 23, 31 AND 34).

MARY CRAWFORD, EXAMINING ATTORNEY

SN 79-034,339. LOLLI E MEMMOLI S.R.L., ITALY, FILED 12-12-2006.

LOLLI E MEMMOLI

THE MARK CONSISTS OF STANDARD CHARACTERS WITHOUT CLAIM TO ANY PARTICULAR FONT, STYLE, SIZE, OR COLOR.

PRIORITY DATE OF 10-10-2006 IS CLAIMED.

OWNER OF INTERNATIONAL REGISTRATION 0912758 DATED 12-12-2006, EXPIRES 12-12-2016.

THE FOREIGN WORDING IN THE MARK TRANSLATES INTO ENGLISH AS LOLLI AND MEMMOLI.

FOR INDOOR LIGHTING APPARATUS, NAMELY SWINGING LAMPS, BRACKET LAMPS, STANDING LAMPS, FLOOR LAMPS, TABLE LAMPS AND CEILING LAMPS (U.S. CLS. 13, 21, 23, 31 AND 34).

DANIEL BRODY, EXAMINING ATTORNEY

CLASS 12—VEHICLES

SN 76-673,916. RHINO MOTORCYCLES, INC., SUN VALLEY, CA. FILED 3-12-2007.

RHINO MOTORCYCLES

NO CLAIM IS MADE TO THE EXCLUSIVE RIGHT TO USE "MOTORCYCLES", APART FROM THE MARK AS SHOWN.

FOR MOTORCYCLES (U.S. CLS. 19, 21, 23, 31, 35 AND 44).

FIRST USE 6-1-2005; IN COMMERCE 6-1-2005.
RONALD AIKENS, EXAMINING ATTORNEY

SN 76-674,245. HUE CORPORATION, PINELLAS PARK, FL. FILED 3-19-2007.



HAMPTON UNIVERSAL ENTERPRISES

NO CLAIM IS MADE TO THE EXCLUSIVE RIGHT TO USE "ENTERPRISES", APART FROM THE MARK AS SHOWN.

THE STIPPLING IS FOR SHADING PURPOSES.

THE MARK CONSISTS OF HUE IN STYLIZED LETTERING CONTAINING A SPIRAL GALAXY SYSTEM ABOVE THE WORDS HAMPTON UNIVERSAL ENTERPRISES.

FOR COMPRESSED AIR-OPERATED MOTORS FOR USE IN AUTOMOBILES (U.S. CLS. 19, 21, 23, 31, 35 AND 44).

ELISSA GARBER KON, EXAMINING ATTORNEY

SN 76-674,490. ERWIN, MAY, NORTH TUSTIN, CA. FILED 3-23-2007.

LITTLE ONE SUNSHADE

THE MARK CONSISTS OF STANDARD CHARACTERS WITHOUT CLAIM TO ANY PARTICULAR FONT, STYLE, SIZE, OR COLOR.

NO CLAIM IS MADE TO THE EXCLUSIVE RIGHT TO USE "SUNSHADE", APART FROM THE MARK AS SHOWN. FOR COVERS AND SUNSHADES FOR BABY AND TODDLER CARRIAGES AND STROLLERS (U.S. CLS. 19, 21, 23, 31, 35 AND 44).

RENEE MCCRAY, EXAMINING ATTORNEY

CLASS 12—(Continued).

SN 76-674,966. RHINO MOTORCYCLES, INC., SUN VALLEY, CA. FILED 4-3-2007.

RHINO CHOPPERS

THE MARK CONSISTS OF STANDARD CHARACTERS WITHOUT CLAIM TO ANY PARTICULAR FONT, STYLE, SIZE, OR COLOR.

NO CLAIM IS MADE TO THE EXCLUSIVE RIGHT TO USE "CHOPPERS", APART FROM THE MARK AS SHOWN. FOR MOTORCYCLES (U.S. CLS. 19, 21, 23, 31, 35 AND 44).

FIRST USE 6-1-2005; IN COMMERCE 6-1-2005.
RONALD AIKENS, EXAMINING ATTORNEY

SN 76-674,975. RHINO MOTORCYCLES, INC., SUN VALLEY, CA. FILED 4-3-2007.

RHINO CUSTOMS

THE MARK CONSISTS OF STANDARD CHARACTERS WITHOUT CLAIM TO ANY PARTICULAR FONT, STYLE, SIZE, OR COLOR.

NO CLAIM IS MADE TO THE EXCLUSIVE RIGHT TO USE "CUSTOMS", APART FROM THE MARK AS SHOWN. FOR MOTORCYCLES (U.S. CLS. 19, 21, 23, 31, 35 AND 44).

FIRST USE 6-1-2005; IN COMMERCE 6-1-2005.
RONALD AIKENS, EXAMINING ATTORNEY

SN 77-002,318. STOLL, LOUISE F., BURLINGTON, VT. FILED 9-19-2006.

CARES

THE MARK CONSISTS OF STANDARD CHARACTERS WITHOUT CLAIM TO ANY PARTICULAR FONT, STYLE, SIZE, OR COLOR.

FOR CHILD RESTRAINT SYSTEM FOR AIRPLANE TRAVEL COMPRISING CHILD RESTRAINTS FOR AIRPLANE SEATS AND CARRYING BAGS FOR EASY TRANSPORT THEREFOR (U.S. CLS. 19, 21, 23, 31, 35 AND 44).

LINDSEY RUBIN, EXAMINING ATTORNEY

CLASS 12—(Continued).

SN 77-013,027. 630 ENTERPRISES, TORRANCE, CA. FILED 10-3-2006.

sixthreezero

THE MARK CONSISTS OF STANDARD CHARACTERS WITHOUT CLAIM TO ANY PARTICULAR FONT, STYLE, SIZE, OR COLOR.
FOR BICYCLES (U.S. CLS. 19, 21, 23, 31, 35 AND 44).
FIRST USE 4-25-2005; IN COMMERCE 5-25-2005.
KYLE PEETE, EXAMINING ATTORNEY

SN 77-026,303. WEBB WHEEL PRODUCTS, INC., CULLMAN, AL. FILED 10-20-2006.

2023

THE MARK CONSISTS OF STANDARD CHARACTERS WITHOUT CLAIM TO ANY PARTICULAR FONT, STYLE, SIZE, OR COLOR.
SEC. 2(F).
FOR BRAKE HUBS FOR TRUCKS AND PARTS AND ACCESSORIES THEREFOR (U.S. CLS. 19, 21, 23, 31, 35 AND 44).
FIRST USE 12-31-1990; IN COMMERCE 12-31-1990.
ALLISON HOLTZ, EXAMINING ATTORNEY

SN 77-039,734. TOYOTA JIDOSHA KABUSHIKI KAISHA, TA TOYOTA MOTOR CORPORATION, TOYOTA-SHI, JAPAN, FILED 11-8-2006.

IS-F

THE MARK CONSISTS OF STANDARD CHARACTERS WITHOUT CLAIM TO ANY PARTICULAR FONT, STYLE, SIZE, OR COLOR.
OWNER OF U.S. REG. NOS. 2,500,758, 3,127,959 AND OTHERS.
FOR AUTOMOBILES AND STRUCTURAL PARTS THEREOF (U.S. CLS. 19, 21, 23, 31, 35 AND 44).
NANCY CLARKE, EXAMINING ATTORNEY

CLASS 12—(Continued).

SN 77-041,491. KRUZ, INC., KNOX, IN. FILED 11-10-2006.

RAVENS BY KRUZ

THE MARK CONSISTS OF STANDARD CHARACTERS WITHOUT CLAIM TO ANY PARTICULAR FONT, STYLE, SIZE, OR COLOR.
FOR SEMI-TRACTOR TRAILERS, CAB GUARDS AND TRUCK BODIES (U.S. CLS. 19, 21, 23, 31, 35 AND 44).
SHANNON TWOHIG, EXAMINING ATTORNEY

SN 77-063,666. FEDERAL-MOGUL WORLD WIDE, INC., SOUTHFIELD, MI. FILED 12-13-2006.

ONESOURCE

THE MARK CONSISTS OF STANDARD CHARACTERS WITHOUT CLAIM TO ANY PARTICULAR FONT, STYLE, SIZE, OR COLOR.
FOR BRAKES, BRAKE PADS, BRAKE LININGS, BRAKE ROTORS FOR LAND VEHICLES; DRIVELINE PRODUCTS FOR LAND VEHICLES, NAMELY, UNIVERSAL JOINTS; CHASSIS PARTS FOR LAND VEHICLES, NAMELY, BUSHINGS, BALL JOINTS, BUMP STOPS, CENTER LINKS, CONTROL ARMS, DRAG LINKS, STEERING STABILIZERS, STRUT MOUNTS, SUSPENSION SPRINGS, SWAY BARS, TIE RODS, TORSION ARMS; WHEEL HUB ASSEMBLIES FOR LAND VEHICLES (U.S. CLS. 19, 21, 23, 31, 35 AND 44).
FRANK LATTUCA, EXAMINING ATTORNEY

SN 77-077,131. INDIANA MILLS & MANUFACTURING, INC., WESTFIELD, IN. FILED 1-5-2007.

SAFEGUARD TRANSPORT

THE MARK CONSISTS OF STANDARD CHARACTERS WITHOUT CLAIM TO ANY PARTICULAR FONT, STYLE, SIZE, OR COLOR.
OWNER OF U.S. REG. NOS. 2,711,608, 2,808,722 AND 2,990,622.
NO CLAIM IS MADE TO THE EXCLUSIVE RIGHT TO USE "TRANSPORT", APART FROM THE MARK AS SHOWN.
FOR VEHICLE CHILD RESTRAINTS FOR AMBULANCE COTS (U.S. CLS. 19, 21, 23, 31, 35 AND 44).
CHRISTOPHER BUONGIORNO, EXAMINING ATTORNEY

CLASS 12—(Continued).

SN 77-077,558. REMMLER, DARYL W, NORTH VANCOUVER, CANADA, FILED 1-7-2007.

Think Kayak

THE MARK CONSISTS OF STANDARD CHARACTERS WITHOUT CLAIM TO ANY PARTICULAR FONT, STYLE, SIZE, OR COLOR.

NO CLAIM IS MADE TO THE EXCLUSIVE RIGHT TO USE "KAYAK", APART FROM THE MARK AS SHOWN.

FOR CANOE PADDLES; CARTOP CANOE AND KAYAK CARRIER KITS; KAYAK EQUIPMENT, NAMELY, PADDLES; KAYAK-LIKE BOATS; KAYAKS; RECREATIONAL WATERCRAFT, NAMELY, PADDLE BOATS (U.S. CLS. 19, 21, 23, 31, 35 AND 44).

RICHARD WHITE, EXAMINING ATTORNEY

SN 77-081,961. TREK BICYCLE CORPORATION, WATERLOO, WI. FILED 1-12-2007.

Portland

THE MARK CONSISTS OF STANDARD CHARACTERS WITHOUT CLAIM TO ANY PARTICULAR FONT, STYLE, SIZE, OR COLOR.

FOR BICYCLES, BICYCLE FRAMES, AND BICYCLE STRUCTURAL PARTS THEREFOR (U.S. CLS. 19, 21, 23, 31, 35 AND 44).

FIRST USE 8-1-2005; IN COMMERCE 8-1-2005.

KATHRYN COWARD, EXAMINING ATTORNEY

SN 77-114,078. WEEKEND WARRIOR TRAILER, INC., PERRIS, CA. FILED 2-22-2007.

WEEKEND WARRIOR WIDE LITE

THE MARK CONSISTS OF STANDARD CHARACTERS WITHOUT CLAIM TO ANY PARTICULAR FONT, STYLE, SIZE, OR COLOR.

OWNER OF U.S. REG. NO. 2,567,154.

NO CLAIM IS MADE TO THE EXCLUSIVE RIGHT TO USE "WIDE LITE", APART FROM THE MARK AS SHOWN.

FOR RECREATIONAL VEHICLES, NAMELY, MOTORHOMES, TRAVEL TRAILERS, FIFTH-WHEEL TRAILERS, AND CARGO TRAILERS (U.S. CLS. 19, 21, 23, 31, 35 AND 44).

DAVID TOOLEY, EXAMINING ATTORNEY

CLASS 12—(Continued).

SN 77-117,350. KURYAKYN HOLDINGS, INC., SOMERSET, WI. FILED 2-27-2007.

Supersize your chrome

THE MARK CONSISTS OF STANDARD CHARACTERS WITHOUT CLAIM TO ANY PARTICULAR FONT, STYLE, SIZE, OR COLOR.

FOR MOTORCYCLE ACCESSORIES, STRUCTURAL PARTS AND DECORATIVE PARTS, NAMELY, ACCENT RINGS, BRAIDED LEVERS, SILHOUETTE LEVERS, CHROME RESERVOIR COVERS, BRAKE CONTROL DRESS-UP KITS COMPRISING CLUTCH HOUSING AND CLAMPS AND BRAKE RESERVOIR AND CLAMPS, BANJO BOLT COVERS, FENDER EXTENSIONS, FENDER TIPS, FENDER ORNAMENTS IN THE NATURE OF FIGURINES IN DIFFERENT ANIMAL SHAPES, AXLE NUT CAPS, AXLE CAPS, SPEEDO DRIVE COVERS, CHROME HEADLIGHT VISORS, TRANSMISSION SHROUDS, TAPPET COVERS, HEAD BOLT COVERS, BRAKE CYLINDER BASE COVERS, INNER PRIMARY COVERS, HORN COVERS, NECK COVERS, DASH PANEL INSERTS, FLUSH MOUNT GAS CAPS, FRAME COVERS, AXLE COVERS, HUB SPINNERS, LICENSE PLATE HOLDERS, TAILLIGHT COVERS, FRONT FENDER ACCENTS, DEBRIS MODULATORS, REAR FENDER TRIMS, BRAKE ROTOR AND PIVOT COVERS, TRIM RINGS, BANGO BOLT COVERS, BRAKE CALIPER COVERS, TRIPLE TREE COVERS, CHROME THROTTLE CABLE COVERS AND CLUTCH CABLE ADJUSTER CABLES, OIL PUMP COVERS, OIL FILTER AND MOUNT COVERS, FRONT MOTOR MOUNT COVERS, EXHAUST EXTENSIONS, CHROME ENGINE COVERS, AND ENGINE COVER INSERTS (U.S. CLS. 19, 21, 23, 31, 35 AND 44).

AMY HELLA, EXAMINING ATTORNEY

SN 77-119,846. LEISTNER AQUATIC SERVICES, INC., WHITELAND, IN. FILED 3-1-2007.



NO CLAIM IS MADE TO THE EXCLUSIVE RIGHT TO USE "LAKE MAINTENANCE VEHICLE", APART FROM THE MARK AS SHOWN.

FOR SPRAY BOATS FOR DELIVERING TREATMENT SOLUTIONS ONTO THE SURFACE OR WITHIN A BODY OF WATER TO MANAGE PROLIFERATION OF BIOLOGICAL ORGANISMS IN THE WATER (U.S. CLS. 19, 21, 23, 31, 35 AND 44).

FIRST USE 3-1-2007; IN COMMERCE 3-1-2007.

DAWN HAN, EXAMINING ATTORNEY

CLASS 12—(Continued).

SN 77-121,867. NETTLETON, RAYMOND J, KAYSVILLE, UT. FILED 3-4-2007.

FLATWERKS

THE MARK CONSISTS OF STANDARD CHARACTERS WITHOUT CLAIM TO ANY PARTICULAR FONT, STYLE, SIZE, OR COLOR.

FOR RECREATIONAL VEHICLES, NAMELY, CAMPERS; RECREATIONAL VEHICLES, NAMELY, TRUCK CAMPERS; TRUCK BED STORAGE ORGANIZERS; METAL LOCKING DEVICE FOR TRAILER HITCH COUPLERS; TRAILERS; TRAVEL TRAILERS (U.S. CLS. 19, 21, 23, 31, 35 AND 44).

DOMINIC FATHY, EXAMINING ATTORNEY

SN 77-132,599. STURMAN INDUSTRIES, INC., WOODLAND PARK, CO. FILED 3-15-2007.

Sturman Combustion Cycle

THE MARK CONSISTS OF STANDARD CHARACTERS WITHOUT CLAIM TO ANY PARTICULAR FONT, STYLE, SIZE, OR COLOR.

OWNER OF U.S. REG. NO. 2,455,567.

NO CLAIM IS MADE TO THE EXCLUSIVE RIGHT TO USE "COMBUSTION CYCLE", APART FROM THE MARK AS SHOWN.

FOR AUTOMOBILE ENGINES; DIESEL ENGINES FOR LAND VEHICLES; ENGINES FOR LAND VEHICLES; INTERNAL COMBUSTION ENGINES FOR LAND VEHICLES (U.S. CLS. 19, 21, 23, 31, 35 AND 44).

CORY BOONE, EXAMINING ATTORNEY

SN 77-132,604. STURMAN INDUSTRIES, INC., WOODLAND PARK, CO. FILED 3-15-2007.

Sturman Engine Cycle

THE MARK CONSISTS OF STANDARD CHARACTERS WITHOUT CLAIM TO ANY PARTICULAR FONT, STYLE, SIZE, OR COLOR.

OWNER OF U.S. REG. NO. 2,455,567.

NO CLAIM IS MADE TO THE EXCLUSIVE RIGHT TO USE "ENGINE CYCLE", APART FROM THE MARK AS SHOWN.

FOR DIESEL ENGINES FOR LAND VEHICLES; ENGINES FOR LAND VEHICLES; INTERNAL COMBUSTION ENGINES FOR LAND VEHICLES; AUTOMOBILE ENGINES (U.S. CLS. 19, 21, 23, 31, 35 AND 44).

CORY BOONE, EXAMINING ATTORNEY

CLASS 12—(Continued).

SN 77-132,608. STURMAN INDUSTRIES, INC., WOODLAND PARK, CO. FILED 3-15-2007.

Sturman Digital Engine

THE MARK CONSISTS OF STANDARD CHARACTERS WITHOUT CLAIM TO ANY PARTICULAR FONT, STYLE, SIZE, OR COLOR.

OWNER OF U.S. REG. NO. 2,455,567.

NO CLAIM IS MADE TO THE EXCLUSIVE RIGHT TO USE "DIGITAL ENGINE", APART FROM THE MARK AS SHOWN.

FOR AUTOMOBILE ENGINES; DIESEL ENGINES FOR LAND VEHICLES; ENGINES FOR LAND VEHICLES; INTERNAL COMBUSTION ENGINES FOR LAND VEHICLES (U.S. CLS. 19, 21, 23, 31, 35 AND 44).

CORY BOONE, EXAMINING ATTORNEY

SN 77-132,610. STURMAN INDUSTRIES, INC., WOODLAND PARK, CO. FILED 3-15-2007.

Sturman Digital Injector

THE MARK CONSISTS OF STANDARD CHARACTERS WITHOUT CLAIM TO ANY PARTICULAR FONT, STYLE, SIZE, OR COLOR.

OWNER OF U.S. REG. NO. 2,455,567.

NO CLAIM IS MADE TO THE EXCLUSIVE RIGHT TO USE "DIGITAL INJECTOR", APART FROM THE MARK AS SHOWN.

FOR AUTOMOBILE ENGINES; DIESEL ENGINES FOR LAND VEHICLES; ENGINES FOR LAND VEHICLES; INTERNAL COMBUSTION ENGINES FOR LAND VEHICLES (U.S. CLS. 19, 21, 23, 31, 35 AND 44).

CORY BOONE, EXAMINING ATTORNEY

SN 77-133,474. FORD MOTOR COMPANY, DEARBORN, MI. FILED 3-16-2007.

QCP - QUALITY CERTIFIED POWERTRAIN

THE MARK CONSISTS OF STANDARD CHARACTERS WITHOUT CLAIM TO ANY PARTICULAR FONT, STYLE, SIZE, OR COLOR.

NO CLAIM IS MADE TO THE EXCLUSIVE RIGHT TO USE "QUALITY CERTIFIED POWERTRAIN", APART FROM THE MARK AS SHOWN.

FOR REMANUFACTURED LAND MOTOR VEHICLE ENGINES AND TRANSMISSIONS (U.S. CLS. 19, 21, 23, 31, 35 AND 44).

KATHRYN COWARD, EXAMINING ATTORNEY

CLASS 12—(Continued).

SN 77-133,481. GRIFFIN, PERRY JEROME, WICHITA, KS. FILED 3-16-2007.



THE MARK CONSISTS OF STYLIZED LETTERS "S, H, U, E, Z" PLUS A FOOTPRINT WITH A CROWN ABOVE IT. FOR TIRES; TIRES FOR LAND VEHICLES (U.S. CLS. 19, 21, 23, 31, 35 AND 44).
DAVID H. STINE, EXAMINING ATTORNEY

CLASS 12—(Continued).

SN 77-138,700. STANDARD CAR TRUCK COMPANY, PARK RIDGE, IL. FILED 3-23-2007.

BARBER S2-86

THE MARK CONSISTS OF STANDARD CHARACTERS WITHOUT CLAIM TO ANY PARTICULAR FONT, STYLE, SIZE, OR COLOR. FOR MOUNTING ASSEMBLIES FOR RAILROAD CAR TRUCK AXLES, NAMELY, SHEAR PADS AND ADAPTORS (U.S. CLS. 19, 21, 23, 31, 35 AND 44).
C. DIONNE CLYBURN, EXAMINING ATTORNEY

SN 77-139,009. STRIDER SPORTS INTERNATIONAL, INC., RAPID CITY, SD. FILED 3-23-2007.

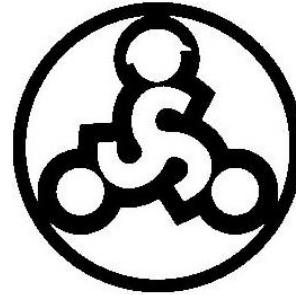

THE MARK CONSISTS OF A STYLIZED CHILD ON A BICYCLE. FOR BICYCLES (U.S. CLS. 19, 21, 23, 31, 35 AND 44). FIRST USE 3-14-2007; IN COMMERCE 3-14-2007.
REBECCA SMITH, EXAMINING ATTORNEY

SN 77-134,276. WYERS PRODUCTS GROUP, INC., CENTENNIAL, CO. FILED 3-19-2007.

THE WORLD'S TOUGHEST LOCKS

THE MARK CONSISTS OF STANDARD CHARACTERS WITHOUT CLAIM TO ANY PARTICULAR FONT, STYLE, SIZE, OR COLOR. FOR METAL LOCKS FOR VEHICLE HITCH RECEIVERS AND METAL CABLE LOCKS FOR USE WITH MOTORCYCLES, ALL-TERRAIN VEHICLES, SNOWMOBILES, RECREATIONAL JET BOATS AND SPARE TIRES FOR VEHICLES (U.S. CLS. 19, 21, 23, 31, 35 AND 44). FIRST USE 4-16-1999; IN COMMERCE 4-16-1999.
ANNE MADDEN, EXAMINING ATTORNEY

SN 77-134,751. ARMAND, ANTHONY E., BOULDER, CO. FILED 3-19-2007.

KICK N' GO

THE MARK CONSISTS OF STANDARD CHARACTERS WITHOUT CLAIM TO ANY PARTICULAR FONT, STYLE, SIZE, OR COLOR. FOR NON-MOTORIZED SCOOTERS (U.S. CLS. 19, 21, 23, 31, 35 AND 44).
APRIL ROACH, EXAMINING ATTORNEY

SN 77-139,097. BURNETT, DENIS, LAS VEGAS, NV. FILED 3-23-2007.

What's between your legs?

THE MARK CONSISTS OF STANDARD CHARACTERS WITHOUT CLAIM TO ANY PARTICULAR FONT, STYLE, SIZE, OR COLOR. FOR MOTORCYCLES (U.S. CLS. 19, 21, 23, 31, 35 AND 44).
DAVID YONTEF, EXAMINING ATTORNEY

CLASS 12—(Continued).

SN 77-139,934. SCOOTER WORKS USA, INC., CHICAGO, IL. FILED 3-26-2007.

RATTLER

THE MARK CONSISTS OF THE WORD "RATTLER" IN ALL CAPITAL LETTERS, IN A STYLIZED FONT, FOR MOTORIZED SCOOTERS (U.S. CLS. 19, 21, 23, 31, 35 AND 44).
FIRST USE 7-20-2006; IN COMMERCE 7-20-2006.
CURTIS FRENCH, EXAMINING ATTORNEY

SN 77-140,081. STEFFENS ENTERPRISES, INC., CALEDONIA, MI. FILED 3-26-2007.

G4

THE MARK CONSISTS OF STANDARD CHARACTERS WITHOUT CLAIM TO ANY PARTICULAR FONT, STYLE, SIZE, OR COLOR.
FOR TONNEAU COVERS FOR VEHICLES (U.S. CLS. 19, 21, 23, 31, 35 AND 44).
JORDAN BAKER, EXAMINING ATTORNEY

SN 77-140,101. STEFFENS ENTERPRISES, INC., CALEDONIA, MI. FILED 3-26-2007.

G4 ELITE

THE MARK CONSISTS OF STANDARD CHARACTERS WITHOUT CLAIM TO ANY PARTICULAR FONT, STYLE, SIZE, OR COLOR.
FOR TONNEAU COVERS FOR VEHICLES (U.S. CLS. 19, 21, 23, 31, 35 AND 44).
JORDAN BAKER, EXAMINING ATTORNEY

CLASS 12—(Continued).

SN 77-140,798. VIVIER, DONALD A, ORLANDO, FL. AND VALLI, ROBERT J, PHILIPSBURG, PA. FILED 3-26-2007.



THE MARK CONSISTS OF THE LETTERS FF IN STYLIZED FORM.
FOR AUTOMOBILE BODIES; AUTOMOBILE BUMPERS; AUTOMOBILE CHASSIS; AUTOMOBILE HOODS; AUTOMOBILE WINDSHIELDS; AUTOMOBILES; AUTOMOBILES AND STRUCTURAL PARTS THEREFOR; WHEEL RIMS; AUTOMOTIVE INTERIOR TRIM; BADGES FOR VEHICLES; INSIGNIA FOR VEHICLES; METAL PARTS FOR VEHICLES, NAMELY, AUTOMOTIVE EXTERIOR AND INTERIOR METAL DECORATIVE AND PROTECTIVE TRIM; PLASTIC PARTS FOR VEHICLES, NAMELY, AUTOMOTIVE EXTERIOR AND INTERIOR PLASTIC EXTRUDED DECORATIVE AND PROTECTIVE TRIM; SUSPENSION SYSTEMS FOR AUTOMOBILE; MOTORCYCLE TRIKE CONVERSION KITS FOR CONVERTING A TWO-WHEELED MOTORCYCLE INTO A THREE-WHEELED MOTORCYCLE; DOOR PANELS FOR LAND VEHICLES; ROOF PANELS FOR LAND VEHICLES; STRUCTURAL PARTS FOR AUTOMOBILES (U.S. CLS. 19, 21, 23, 31, 35 AND 44).
KAPIL BHANOT, EXAMINING ATTORNEY

SN 77-140,822. VIVIER, DONALD A, ORLANDO, FL. AND VALLI, ROBERT J, PHILIPSBURG, PA. FILED 3-26-2007.

FIBERFAB

THE MARK CONSISTS OF STANDARD CHARACTERS WITHOUT CLAIM TO ANY PARTICULAR FONT, STYLE, SIZE, OR COLOR.
FOR AUTOMOBILE BODIES; AUTOMOBILE CHASSIS; AUTOMOBILE ENGINES; AUTOMOBILE HOODS; AUTOMOBILE WINDSHIELDS; AUTOMOBILES; AUTOMOBILES AND STRUCTURAL PARTS THEREFOR; SUSPENSION SYSTEMS FOR AUTOMOBILE; WHEEL RIMS; MOTORCYCLE TRIKE CONVERSION KITS FOR CONVERTING A TWO-WHEELED MOTORCYCLE INTO A THREE-WHEELED MOTORCYCLE; MOTORS FOR AUTOMOBILES; REARVIEW MIRRORS; AUTOMOBILE BUMPERS; AUTOMOTIVE INTERIOR TRIM; BADGES FOR VEHICLES; INSIGNIA FOR VEHICLES; PLASTIC PARTS FOR VEHICLES, NAMELY, AUTOMOTIVE EXTERIOR AND INTERIOR PLASTIC EXTRUDED DECORATIVE AND PROTECTIVE TRIM; STRUCTURAL PARTS FOR AUTOMOBILES; AUTOMOBILE DOOR HANDLES; FITTED DASHBOARD COVERS FOR VEHICLES (U.S. CLS. 19, 21, 23, 31, 35 AND 44).
KAPIL BHANOT, EXAMINING ATTORNEY

CLASS 12—(Continued).

SN 77-141,215. BENNETT, MICHAEL J., ROANOKE, TX. FILED 3-27-2007.

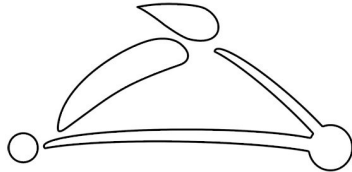

THE MARK CONSISTS OF ABSTRACT LINE DRAWING OF A PERSON ON A LAND-BASED SCOOTER.
FOR NON-MOTORIZED LAND-BASED SCOOTERS (U.S. CLS. 19, 21, 23, 31, 35 AND 44).
WILLIAM VERHOSEK, EXAMINING ATTORNEY

SN 77-141,253. BABY IS A STAR, INC., DULUTH, GA. FILED 3-27-2007.

NADA DING

THE MARK CONSISTS OF STANDARD CHARACTERS WITHOUT CLAIM TO ANY PARTICULAR FONT, STYLE, SIZE, OR COLOR.
THE ENGLISH TRANSLATION OF THE WORD "NADA" IN THE MARK IS "NOTHING."
FOR AUTOMOBILE PARTS, NAMELY, REMOVABLE PROTECTIVE DOOR BUMPERS WHICH EASILY ATTACH TO A VEHICLE'S DOOR TO PREVENT DINGS AND DENTS, IN THE NATURE OF A CUSHIONED, MOLDED FOAM (U.S. CLS. 19, 21, 23, 31, 35 AND 44).
CARYN GLASSER, EXAMINING ATTORNEY

SN 77-141,475. EAST MANUFACTURING CORPORATION, RANDOLPH, OH. FILED 3-27-2007.

GENESIS II

THE MARK CONSISTS OF STANDARD CHARACTERS WITHOUT CLAIM TO ANY PARTICULAR FONT, STYLE, SIZE, OR COLOR.
OWNER OF U.S. REG. NO. 2,930,020.
FOR TRUCK TRAILERS, SEMI-TRAILERS, DISCHARGE TRAILERS, CARGO TRAILERS, VEHICLE DUMP BODIES, DUMP TRAILERS, DUMP CHASSIS, GARBAGE TRUCKS, SCRAP TRUCKS, AND STRUCTURAL PARTS THEREOF (U.S. CLS. 19, 21, 23, 31, 35 AND 44).
FIRST USE 3-22-2007; IN COMMERCE 3-22-2007.
ERIN FALK, EXAMINING ATTORNEY

CLASS 12—(Continued).

SN 77-142,231. ALAN BUDHU, JERSEY CITY, NJ. FILED 3-28-2007.

Bumptronic

THE MARK CONSISTS OF STANDARD CHARACTERS WITHOUT CLAIM TO ANY PARTICULAR FONT, STYLE, SIZE, OR COLOR.
FOR METAL PARTS FOR VEHICLES, NAMELY, AUTOMOTIVE EXTERIOR AND INTERIOR METAL DECORATIVE AND PROTECTIVE TRIM (U.S. CLS. 19, 21, 23, 31, 35 AND 44).
HANNO RITTNER, EXAMINING ATTORNEY

SN 77-143,097. FREE FLIGHT ENTERPRISES, INC., WILDOMAR, CA. FILED 3-28-2007.

**FREE FLIGHT ENTERPRISES
INC.**

THE MARK CONSISTS OF STANDARD CHARACTERS WITHOUT CLAIM TO ANY PARTICULAR FONT, STYLE, SIZE, OR COLOR.
NO CLAIM IS MADE TO THE EXCLUSIVE RIGHT TO USE "ENTERPRISES INC.", APART FROM THE MARK AS SHOWN.
FOR PARACHUTES (U.S. CLS. 19, 21, 23, 31, 35 AND 44).
FIRST USE 0-0-1982; IN COMMERCE 0-0-1982.
ALICE BENMAMAN, EXAMINING ATTORNEY

SN 77-143,394. FUJI JUKOGYO KABUSHIKI KAISHA, DBA FUJI HEAVY INDUSTRIES LTD., SHINJUKU-KU, TOKYO, JAPAN, FILED 3-29-2007.

BLUEBOXER

THE MARK CONSISTS OF STANDARD CHARACTERS WITHOUT CLAIM TO ANY PARTICULAR FONT, STYLE, SIZE, OR COLOR.
FOR AUTOMOBILES; ENGINES FOR AUTOMOBILES (U.S. CLS. 19, 21, 23, 31, 35 AND 44).
SCOTT SISUN, EXAMINING ATTORNEY

CLASS 12—(Continued).

SN 77-143,705. ALL STAR TIRE CORPORATION, LONG BEACH, CA. FILED 3-29-2007.



THE MARK CONSISTS OF A WING WITH THE WORD RUSSTEC, WHERE THE R IS BACKWARDS.
FOR WHEEL RIMS FOR AUTOMOBILES (U.S. CLS. 19, 21, 23, 31, 35 AND 44).
FIRST USE 3-1-2007; IN COMMERCE 3-1-2007.
ALICE BENMAMAN, EXAMINING ATTORNEY

SN 77-144,312. FELT RACING, LLC, IRVINE, CA. FILED 3-29-2007.

VAULT

THE MARK CONSISTS OF STANDARD CHARACTERS WITHOUT CLAIM TO ANY PARTICULAR FONT, STYLE, SIZE, OR COLOR.
FOR BICYCLES AND BICYCLE STRUCTURAL PARTS (U.S. CLS. 19, 21, 23, 31, 35 AND 44).
LAURA KOVALSKY, EXAMINING ATTORNEY

SN 77-146,420. CHRISTOPHER ALESI, TINTON FALLS, NJ. FILED 4-2-2007.

WEE KICK

THE MARK CONSISTS OF STANDARD CHARACTERS WITHOUT CLAIM TO ANY PARTICULAR FONT, STYLE, SIZE, OR COLOR.
FOR MOTORIZED SCOOTERS; NON-MOTORIZED SCOOTERS (U.S. CLS. 19, 21, 23, 31, 35 AND 44).
WON TEAK OH, EXAMINING ATTORNEY

CLASS 12—(Continued).

SN 77-146,424. CHRISTOPHER ALESI, TINTON FALLS, NJ. FILED 4-2-2007.

I KICK

THE MARK CONSISTS OF STANDARD CHARACTERS WITHOUT CLAIM TO ANY PARTICULAR FONT, STYLE, SIZE, OR COLOR.
FOR MOTORIZED SCOOTERS; NON-MOTORIZED SCOOTERS (U.S. CLS. 19, 21, 23, 31, 35 AND 44).
WON TEAK OH, EXAMINING ATTORNEY

SN 77-149,495. NOVA ELECTRONICS INC., COLCHESTER, CT. FILED 4-5-2007.

TRAFFIC BOSS

THE MARK CONSISTS OF STANDARD CHARACTERS WITHOUT CLAIM TO ANY PARTICULAR FONT, STYLE, SIZE, OR COLOR.
NO CLAIM IS MADE TO THE EXCLUSIVE RIGHT TO USE "TRAFFIC", APART FROM THE MARK AS SHOWN.
FOR SIGNAL BAR FOR MOUNTING ON MOTOR VEHICLES SUCH AS POLICE CARS OR WRECKERS THAT USES SIGNAL LIGHTS TO DIRECT TRAFFIC (U.S. CLS. 19, 21, 23, 31, 35 AND 44).
CORY BOONE, EXAMINING ATTORNEY

SN 77-166,428. YAMAHA HATSUDOKI KABUSHIKI KAISHA, SHIZUOKA-KEN, JAPAN, FILED 4-26-2007.

YCC-T

THE MARK CONSISTS OF STANDARD CHARACTERS WITHOUT CLAIM TO ANY PARTICULAR FONT, STYLE, SIZE, OR COLOR.
FOR MOTORCYCLES, MOTORCYCLE ENGINES, AND STRUCTURAL PARTS THEREFOR (U.S. CLS. 19, 21, 23, 31, 35 AND 44).
HENRY S. ZAK, EXAMINING ATTORNEY

CLASS 12—(Continued).

SN 77-167,886. YAMAHA HATSUDOKI KABUSHIKI KAISHA, SHIZUOKA-KEN, JAPAN, FILED 4-27-2007.

YCC-S

THE MARK CONSISTS OF STANDARD CHARACTERS WITHOUT CLAIM TO ANY PARTICULAR FONT, STYLE, SIZE, OR COLOR.

FOR MOTORCYCLES, MOTORCYCLE ENGINES, AND STRUCTURAL PARTS THEREFOR (U.S. CLS. 19, 21, 23, 31, 35 AND 44).

HENRY S. ZAK, EXAMINING ATTORNEY

SN 77-168,180. YAMAHA HATSUDOKI KABUSHIKI KAISHA, SHIZUOKA-KEN, JAPAN, FILED 4-27-2007.

YCC-I

THE MARK CONSISTS OF STANDARD CHARACTERS WITHOUT CLAIM TO ANY PARTICULAR FONT, STYLE, SIZE, OR COLOR.

FOR MOTORCYCLES, MOTORCYCLE ENGINES, AND STRUCTURAL PARTS THEREFOR (U.S. CLS. 19, 21, 23, 31, 35 AND 44).

HENRY S. ZAK, EXAMINING ATTORNEY

SN 77-176,221. GULF STREAM COACH, INC., NAPPANEE, IN. FILED 5-9-2007.

OUTDOOR WORLD

THE MARK CONSISTS OF STANDARD CHARACTERS WITHOUT CLAIM TO ANY PARTICULAR FONT, STYLE, SIZE, OR COLOR.

FOR RECREATIONAL VEHICLES, NAMELY, MOTORHOMES, FIFTH WHEELS AND TRAVEL TRAILERS (U.S. CLS. 19, 21, 23, 31, 35 AND 44).

FIRST USE 3-1-2007; IN COMMERCE 3-1-2007.

JASON ROTH, EXAMINING ATTORNEY

SN 78-150,311. MERIDIAN MANAGEMENT CORPORATION, PONTE VEDRA BEACH, FL. FILED 8-2-2002.

FUSION

FOR AUTOMOTIVE WHEELS (U.S. CLS. 19, 21, 23, 31, 35 AND 44).

DAVID TAYLOR, EXAMINING ATTORNEY

CLASS 12—(Continued).

SN 78-388,685. EXCEL TIRE & WHEEL CORP., WALNUT, CA. FILED 3-22-2004.

MUD FLY

THE MARK CONSISTS OF STANDARD CHARACTERS WITHOUT CLAIM TO ANY PARTICULAR FONT, STYLE, SIZE, OR COLOR.

FOR TIRES (U.S. CLS. 19, 21, 23, 31, 35 AND 44).

GISELLE AGOSTO, EXAMINING ATTORNEY

SN 78-388,694. EXCEL TIRE & WHEEL CORP., WALNUT, CA. FILED 3-22-2004.

FREAK

THE MARK CONSISTS OF STANDARD CHARACTERS WITHOUT CLAIM TO ANY PARTICULAR FONT, STYLE, SIZE, OR COLOR.

FOR TIRES (U.S. CLS. 19, 21, 23, 31, 35 AND 44).

DEBRA LEE, EXAMINING ATTORNEY

CLASS 12—(Continued).

SN 78-388,696. EXCEL TIRE & WHEEL CORP., WALNUT, CA. FILED 3-22-2004.

CLASS 12—(Continued).

SN 78-388,708. EXCEL TIRE & WHEEL CORP., WALNUT, CA. FILED 3-22-2004.

SWAMP FOX

FOX A/T

THE MARK CONSISTS OF STANDARD CHARACTERS WITHOUT CLAIM TO ANY PARTICULAR FONT, STYLE, SIZE, OR COLOR.
OWNER OF U.S. REG. NO. 3,219,235.
FOR TIRES (U.S. CLS. 19, 21, 23, 31, 35 AND 44).
DEBRA LEE, EXAMINING ATTORNEY

THE MARK CONSISTS OF STANDARD CHARACTERS WITHOUT CLAIM TO ANY PARTICULAR FONT, STYLE, SIZE, OR COLOR.
OWNER OF U.S. REG. NO. 3,209,879.
NO CLAIM IS MADE TO THE EXCLUSIVE RIGHT TO USE "A/T", APART FROM THE MARK AS SHOWN.
FOR TIRES (U.S. CLS. 19, 21, 23, 31, 35 AND 44).
IRA J. GOODSaid, EXAMINING ATTORNEY

SN 78-538,058. FREEMAN, ANDREW CHARLES, NORTH-AMPTON, UNITED KINGDOM, FILED 12-23-2004.

SN 78-388,697. EXCEL TIRE & WHEEL CORP., WALNUT, CA. FILED 3-22-2004.

EBC

WHIPSNAKE

THE MARK CONSISTS OF STANDARD CHARACTERS WITHOUT CLAIM TO ANY PARTICULAR FONT, STYLE, SIZE, OR COLOR.
OWNER OF U.S. REG. NO. 1,845,542.
FOR AFTERMARKET REPLACEMENT DISK BRAKE PADS AND ROTORS FOR MOTORCYCLES SOLD IN AFTERMARKET MOTORCYCLE PART RETAIL STORES; AFTERMARKET REPLACEMENT DISK BRAKE PADS FOR BICYCLES SOLD IN AFTERMARKET BICYCLE PART RETAIL STORES (U.S. CLS. 19, 21, 23, 31, 35 AND 44).
FIRST USE 5-21-1986; IN COMMERCE 5-21-1986.
ZHALEH DELANEY, EXAMINING ATTORNEY

OWNER OF U.S. REG. NO. 3,223,592.
THE MARK CONSISTS OF WHIPSNAKE.
FOR TIRES (U.S. CLS. 19, 21, 23, 31, 35 AND 44).
DEBRA LEE, EXAMINING ATTORNEY

CLASS 12—(Continued).

SN 78-834,447. ENSI CONSULTING INC, STATEN ISLAND, NY. FILED 3-10-2006.

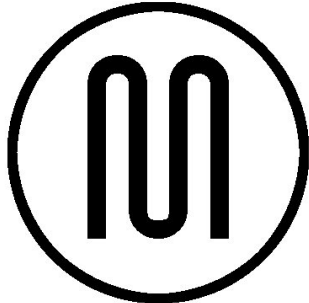

MIMOUSA

FOR AUTOMOTIVE PARTS AND ACCESSORIES, NAMELY DASH TRIM KITS (U.S. CLS. 19, 21, 23, 31, 35 AND 44).

FIRST USE 2-1-1999; IN COMMERCE 2-1-1999. SANJEEV VOHRA, EXAMINING ATTORNEY

SN 78-870,589. CALROD LLC, NEWBURY PARK, CA. FILED 4-26-2006.



NO CLAIM IS MADE TO THE EXCLUSIVE RIGHT TO USE "USA", APART FROM THE MARK AS SHOWN.

THE MARK CONSISTS OF STYLIZED WORDS, UNDERLINE UNDERNEATH "IMPUL".

FOR EXTERIOR AERODYNAMIC BODY PARTS FOR JAPANESE VEHICLES, NAMELY FRONT BUMPER, ROCKER PANELS, REAR BUMPER, REAR WING; PERFORMANCE SUSPENSION PARTS FOR JAPANESE VEHICLES, NAMELY BRAKE PADS, SHOCKS, SPRINGS, AND WHEELS (U.S. CLS. 19, 21, 23, 31, 35 AND 44).

RAUL CORDOVA, EXAMINING ATTORNEY

CLASS 12—(Continued).

SN 78-885,100. CALROD, LLC, NEWBURY PARK, CA. FILED 5-16-2006.



FOR BODY KITS FOR JAPANESE VEHICLES, NAMELY FRONT BUMPER, ROCK PANELS, SIDE SKIRTS, REAR BUMPER, REAR WING; PERFORMANCE SUSPENSION PARTS FOR JAPANESE VEHICLES, NAMELY BRAKE PADS, SHOCKS, SPRINGS, WHEELS (U.S. CLS. 19, 21, 23, 31, 35 AND 44).

RAUL CORDOVA, EXAMINING ATTORNEY

SN 78-935,010. REKLUSE MOTOR SPORTS, INC., BOISE, ID. FILED 7-21-2006.



THE MARK CONSISTS OF STANDARD CHARACTERS WITHOUT CLAIM TO ANY PARTICULAR FONT, STYLE, SIZE, OR COLOR.

FOR MOTORCYCLE AND ATV AFTERMARKET REPLACEMENT PARTS AND ACCESSORIES, NAMELY, CLUTCH PARTS AND ACCESSORIES, NAMELY CLUTCH COVERS AND LEVERS, HAND BRAKE COMPONENTS AND ACTUATORS, AUTOMATIC CLUTCH KITS COMPRISED OF MECHANICAL COMPONENTS THAT CONVERT MANUAL CLUTCHES TO AUTOMATIC CLUTCHES, ADJUSTABLE AXLES, BRAKE KITS COMPRISED OF HAND BRAKE MASTER CYLINDERS, BRAKE LINES, BRAKE LEVERS, AND FOOT MASTER CYLINDER CONVERSION PARTS, AND HOT START LEVERS (U.S. CLS. 19, 21, 23, 31, 35 AND 44).

FIRST USE 11-0-2002; IN COMMERCE 11-0-2002. ODESSA BIBBINS, EXAMINING ATTORNEY

SN 78-935,038. REKLUSE MOTOR SPORTS, INC., BOISE, ID. FILED 7-21-2006.



THE MARK CONSISTS OF STANDARD CHARACTERS WITHOUT CLAIM TO ANY PARTICULAR FONT, STYLE, SIZE, OR COLOR.

FOR MOTORCYCLE CLUTCHES, CLUTCH KITS COMPRISED OF MECHANICAL COMPONENTS THAT CONVERT MANUAL CLUTCHES TO AUTOMATIC CLUTCHES, AND CLUTCH ACCESSORIES, NAMELY CLUTCH COVERS AND LEVERS, LEFT HAND BRAKE COMPONENTS AND ACTUATORS (U.S. CLS. 19, 21, 23, 31, 35 AND 44).

FIRST USE 11-0-2002; IN COMMERCE 11-0-2002. ODESSA BIBBINS, EXAMINING ATTORNEY

CLASS 12—(Continued).

SN 78-935,789. EQUA-FLEX, INC., SYRACUSE, IN. FILED 7-24-2006.

EQUA-FLEX

THE MARK CONSISTS OF STANDARD CHARACTERS WITHOUT CLAIM TO ANY PARTICULAR FONT, STYLE, SIZE, OR COLOR.

FOR LAND VEHICLE SUSPENSION PARTS, NAMELY EQUALIZERS (U.S. CLS. 19, 21, 23, 31, 35 AND 44).

FIRST USE 11-15-2005; IN COMMERCE 11-30-2005.
DAWN HAN, EXAMINING ATTORNEY

CLASS 12—(Continued).

SN 78-939,048. STOLL, LOUISE F., BURLINGTON, VT. FILED 7-27-2006.



NO CLAIM IS MADE TO THE EXCLUSIVE RIGHT TO USE "KIDS FLY SAFE", APART FROM THE MARK AS SHOWN.

FOR CHILD RESTRAINT SYSTEM FOR AIRPLANE TRAVEL COMPRISING CHILD RESTRAINTS FOR AIRPLANE SEATS AND CARRYING BAGS FOR EASY TRANSPORT THEREFOR (U.S. CLS. 19, 21, 23, 31, 35 AND 44).

LINDSEY RUBIN, EXAMINING ATTORNEY

SN 78-939,192. NISSAN JIDOSHA KABUSHIKI KAISHA, ALSO TRADING AS NISSAN MOTOR CO., LTD., YOKOHAMA-SHI, JAPAN, FILED 7-27-2006.

PX35

THE MARK CONSISTS OF STANDARD CHARACTERS WITHOUT CLAIM TO ANY PARTICULAR FONT, STYLE, SIZE, OR COLOR.

PRIORITY CLAIMED UNDER SEC. 44(D) ON ERPN CMNTY TM OFC APPLICATION NO. 4931481, FILED 3-1-2006.

OWNER OF U.S. REG. NOS. 3,046,555 AND 3,080,055. FOR MOTOR VEHICLES, NAMELY AUTOMOBILES, TRUCKS, VANS, SPORT UTILITY VEHICLES AND STRUCTURAL PARTS THEREFOR (U.S. CLS. 19, 21, 23, 31, 35 AND 44).

JEAN IM, EXAMINING ATTORNEY

SN 78-937,492. AMERICA MITCHELL INTERNATIONAL BICYCLE LIMITED, TIANJIN,, CHINA, FILED 7-26-2006.



SN 78-945,886. MAS AUTOMOTIVE DISTRIBUTION INC., LAVAL, QUEBEC, CANADA, FILED 8-6-2006.

COLETECH CHASSIS PLUS

THE MARK CONSISTS OF STANDARD CHARACTERS WITHOUT CLAIM TO ANY PARTICULAR FONT, STYLE, SIZE, OR COLOR.

NO CLAIM IS MADE TO THE EXCLUSIVE RIGHT TO USE "CHASSIS", APART FROM THE MARK AS SHOWN.

FOR AUTOMOBILE PARTS, NAMELY, CHASSIS, SUSPENSION SYSTEMS FOR AUTOMOBILES AND STEERING UNITS FOR LAND VEHICLES AND PARTS THEREFOR (U.S. CLS. 19, 21, 23, 31, 35 AND 44).

FIRST USE 8-1-2006; IN COMMERCE 8-1-2006.
PAM WILLIS, EXAMINING ATTORNEY

"THE NON-LATIN CHARACTER(S) IN THE MARK TRANSLITERATES INTO "MIQIER," AND THIS MEANS "COOL" IN ENGLISH."

FOR BICYCLE BELLS, BICYCLE FRAMES, BICYCLE GEARS, BICYCLE HANDLEBAR GRIPS, BICYCLE PARTS, NAMELY, TUBES AND CONNECTORS FOR BICYCLE FRAMES, BICYCLE PARTS, NAMELY, FRONT FORK JOINTS, BICYCLE PARTS, NAMELY, SPROCKETS, BICYCLE SADDLE COVERS, BICYCLE WHEELS, BICYCLES (U.S. CLS. 19, 21, 23, 31, 35 AND 44).

GIANCARLO CASTRO, EXAMINING ATTORNEY

CLASS 12—(Continued).

SN 78-952,599. J & L'S CARGO EXPRESS, INC., BRISTOL, IN.
FILED 8-15-2006.

XL SERIES

THE MARK CONSISTS OF STANDARD CHARACTERS WITHOUT CLAIM TO ANY PARTICULAR FONT, STYLE, SIZE, OR COLOR.

NO CLAIM IS MADE TO THE EXCLUSIVE RIGHT TO USE "SERIES", APART FROM THE MARK AS SHOWN.

FOR CARGO TRAILERS (U.S. CLS. 19, 21, 23, 31, 35 AND 44).

FIRST USE 11-19-2004; IN COMMERCE 11-19-2004.
EUGENIA MARTIN, EXAMINING ATTORNEY

SN 78-952,659. WESTERN RECREATIONAL VEHICLES, INC., YAKIMA, WA. FILED 8-15-2006.

ALPENLITE DEFENDER

THE MARK CONSISTS OF STANDARD CHARACTERS WITHOUT CLAIM TO ANY PARTICULAR FONT, STYLE, SIZE, OR COLOR.

OWNER OF U.S. REG. NO. 1,885,958.

FOR RECREATIONAL VEHICLES; NAMELY, CAMPING TRAILERS, VACATION AND TRAVEL TRAILERS, FIFTH WHEEL TRAILERS, TRUCK CAMPERS, AND PICKUP TRUCK CANOPIES (U.S. CLS. 19, 21, 23, 31, 35 AND 44).

DEIRDRE ROBERTSON, EXAMINING ATTORNEY

SN 78-954,212. MINER ENTERPRISES, INC., GENEVA, IL.
FILED 8-17-2006.

AGGREGATE

THE MARK CONSISTS OF STANDARD CHARACTERS WITHOUT CLAIM TO ANY PARTICULAR FONT, STYLE, SIZE, OR COLOR.

FOR MECHANICAL DISCHARGE OUTLET CHUTES FOR RAILROAD HOPPER CARS (U.S. CLS. 19, 21, 23, 31, 35 AND 44).

FIRST USE 4-25-1984; IN COMMERCE 4-25-1984.
ANNE E. GUSTASON, EXAMINING ATTORNEY

CLASS 12—(Continued).

SN 78-966,976. BRITT, MARK STEVEN, ORMOND BEACH, FL. FILED 9-5-2006.

Cruising Canvas

THE MARK CONSISTS OF STANDARD CHARACTERS WITHOUT CLAIM TO ANY PARTICULAR FONT, STYLE, SIZE, OR COLOR.

NO CLAIM IS MADE TO THE EXCLUSIVE RIGHT TO USE "CANVAS", APART FROM THE MARK AS SHOWN.

FOR BOATS (U.S. CLS. 19, 21, 23, 31, 35 AND 44).

FIRST USE 2-1-2000; IN COMMERCE 2-1-2000.

TIMOTHY FINNEGAN, EXAMINING ATTORNEY

SN 78-972,384. MAZDA MOTOR CORPORATION, HIROSHIMA, JAPAN, FILED 9-12-2006.

MX-5

THE MARK CONSISTS OF STANDARD CHARACTERS WITHOUT CLAIM TO ANY PARTICULAR FONT, STYLE, SIZE, OR COLOR.

OWNER OF U.S. REG. NO. 1,738,207.

FOR AUTOMOBILES AND STRUCTURAL PARTS THEREOF, BUT EXCLUDING TIRES; ENGINES FOR AUTOMOBILES, BUT EXCLUDING THEIR PARTS; MOTORS AND ENGINES FOR LAND VEHICLES, BUT EXCLUDING THEIR PARTS; SUSPENSION SYSTEMS FOR AUTOMOBILES; SHOCK ABSORBERS AND SHOCK ABSORBING SPRINGS FOR LAND VEHICLE SUSPENSION SYSTEMS; DRIVE SHAFTS AND AXLES FOR LAND VEHICLES; WHEEL BEARINGS AND SHAFT COUPLINGS FOR LAND VEHICLES; TRANSMISSIONS FOR LAND VEHICLES; BRAKES FOR LAND VEHICLES; ANTI-THEFT ALARMS FOR VEHICLES (U.S. CLS. 19, 21, 23, 31, 35 AND 44).

LEIGH LOWRY, EXAMINING ATTORNEY

SN 79-023,385. AIRBUS SAS, FRANCE, FILED 2-23-2006.

A318

THE MARK CONSISTS OF STANDARD CHARACTERS WITHOUT CLAIM TO ANY PARTICULAR FONT, STYLE, SIZE, OR COLOR.

PRIORITY DATE OF 8-25-2005 IS CLAIMED.

OWNER OF INTERNATIONAL REGISTRATION 0883684 DATED 2-23-2006, EXPIRES 2-23-2016.

FOR AIRCRAFT AND STRUCTURAL PARTS THEREFOR (U.S. CLS. 19, 21, 23, 31, 35 AND 44).

ESTHER BELENKER, EXAMINING ATTORNEY

CLASS 12—(Continued).

SN 79-024,672. REVABILITY HOLDING B.V., NETHERLANDS, FILED 4-26-2006.

REVABILITY

THE MARK CONSISTS OF STANDARD CHARACTERS WITHOUT CLAIM TO ANY PARTICULAR FONT, STYLE, SIZE, OR COLOR.

PRIORITY DATE OF 10-28-2005 IS CLAIMED.
OWNER OF INTERNATIONAL REGISTRATION 0887044 DATED 4-26-2006, EXPIRES 4-26-2016.

FOR VEHICLES, NAMELY, LAND VEHICLES; WHEELCHAIRS; AND STRUCTURAL PARTS FOR THE AFOREMENTIONED GOODS (U.S. CLS. 19, 21, 23, 31, 35 AND 44).

LYDIA BELZER, EXAMINING ATTORNEY

SN 79-028,711. PNEUHAGE MANAGEMENT GMBH & CO. KG, FED REP GERMANY, FILED 6-21-2006.

PLATIN

OWNER OF INTERNATIONAL REGISTRATION 0692910 DATED 4-2-1998, EXPIRES 4-2-2008.

"THE FOREIGN WORDING IN THE MARK TRANSLATES INTO ENGLISH AS PLATINUM."

FOR LAND VEHICLES AND PARTS AND FITTINGS THEREFOR, NAMELY, TIRES, WHEELS, WHEEL RIMS; AIRCRAFT, AIRPLANES AND PARTS AND FITTINGS THEREFOR, NAMELY, TIRES, WHEELS, WHEEL RIMS. (U.S. CLS. 19, 21, 23, 31, 35 AND 44).

RONALD AIKENS, EXAMINING ATTORNEY

SN 79-034,353. TOYO TIRE & RUBBER CO., LTD., JAPAN, FILED 12-6-2006.



e-balance

PRIORITY DATE OF 10-31-2006 IS CLAIMED.
OWNER OF INTERNATIONAL REGISTRATION 0912782 DATED 12-6-2006, EXPIRES 12-6-2016.

FOR TIRES; INNER TUBES FOR AUTOMOBILE TIRES; WHEELS FOR AUTOMOBILES; AUTOMOBILES AND STRUCTURAL PARTS THEREFORE (U.S. CLS. 19, 21, 23, 31, 35 AND 44).

BERNICE MIDDLETON, EXAMINING ATTORNEY

CLASS 13—FIREARMS

SN 77-134,076. ASHBURY INTERNATIONAL GROUP INC., CHARLOTTESVILLE, VA. FILED 3-19-2007.

ASYMMETRIC WARRIOR

THE MARK CONSISTS OF STANDARD CHARACTERS WITHOUT CLAIM TO ANY PARTICULAR FONT, STYLE, SIZE, OR COLOR.

FOR COMPONENTS AND PARTS FOR RIFLES, NAMELY, PRECISION RIFLE SUITE (U.S. CLS. 2 AND 9).

EMILY CARLSEN, EXAMINING ATTORNEY

SN 77-141,005. ALLIANT TECHSYSTEMS INC., EDINA, MN. FILED 3-27-2007.

NITREX

THE MARK CONSISTS OF STANDARD CHARACTERS WITHOUT CLAIM TO ANY PARTICULAR FONT, STYLE, SIZE, OR COLOR.

OWNER OF U.S. REG. NO. 2,051,560.
FOR FIREARM SIGHTS (U.S. CLS. 2 AND 9).
LINDA M. KING, EXAMINING ATTORNEY

SN 77-142,365. ALLIANT TECHSYSTEMS INC., EDINA, MN. FILED 3-28-2007.

INTENSITY

THE MARK CONSISTS OF STANDARD CHARACTERS WITHOUT CLAIM TO ANY PARTICULAR FONT, STYLE, SIZE, OR COLOR.

FOR FIREARM SIGHTS (U.S. CLS. 2 AND 9).
LINDA M. KING, EXAMINING ATTORNEY

CLASS 13—(Continued).

SN 77-143,105. CALES, STEVEN A., MEADOW BRIDGE, WV.
FILED 3-28-2007.

CoyoteM1A

THE MARK CONSISTS OF STANDARD CHARACTERS WITHOUT CLAIM TO ANY PARTICULAR FONT, STYLE, SIZE, OR COLOR.

FOR RIFLE CHEEK REST (U.S. CLS. 2 AND 9).
FIRST USE 10-29-2006; IN COMMERCE 10-29-2006.
THEODORE MCBRIDE, EXAMINING ATTORNEY

CLASS 14—(Continued).

THE BOTTOM OF THE BUTTERFLY WINGS. THE COLOR GREEN APPEARS IN THE SHADING OF THE CHRYSALIS. THE COLOR YELLOW ALSO APPEARS IN THREE CIRCLES AND A CURVED LINE WITHIN THE CHRYSALIS. THE COLOR GRAY APPEARS AS SHADING LINES ON THE CHRYSALIS. THE COLOR WHITE LOCATED BEHIND THE LETTER AND DESIGN OF THE MARK IS NOT A FEATURE OF THE MARK, BUT REPRESENTS A TRANSPARENCY THROUGH TO THE BACKGROUND OF THE MARK."

THE MARK CONSISTS OF THE LETTERS "WW" IN STYLIZED FORMAT WITH THE LETTERS SEPARATED BY A CHRYSALIS AND COMPRISED OF BUTTERFLY WING DESIGN.

FOR JEWELRY (U.S. CLS. 2, 27, 28 AND 50).
MEGAN WHITNEY, EXAMINING ATTORNEY

SN 77-016,095. STRANDS OF COLOR, SOUTH JORDAN, UT.
FILED 10-6-2006.

CLASS 14—JEWELRY

SN 76-511,146. COLIBRI CORPORATION, PROVIDENCE, RI.
FILED 5-2-2003.

DARLING DIAMONDS

NO CLAIM IS MADE TO THE EXCLUSIVE RIGHT TO USE "DIAMONDS", APART FROM THE MARK AS SHOWN.
FOR JEWELRY FOR CHILDREN (U.S. CLS. 2, 27, 28 AND 50).

LEE-ANNE BERNS, EXAMINING ATTORNEY

PEARLS JUST FOR GIRLS

THE MARK CONSISTS OF STANDARD CHARACTERS WITHOUT CLAIM TO ANY PARTICULAR FONT, STYLE, SIZE, OR COLOR.

NO CLAIM IS MADE TO THE EXCLUSIVE RIGHT TO USE "PEARLS", APART FROM THE MARK AS SHOWN.

FOR BRACELETS (U.S. CLS. 2, 27, 28 AND 50).
FIRST USE 5-12-2006; IN COMMERCE 5-12-2006.
INGRID C. EULIN, EXAMINING ATTORNEY

SN 77-016,030. WINGS OF THE WOODLAND, KEEDYSVILLE, MD. FILED 10-6-2006.



THE COLOR(S) BLACK, GREEN, YELLOW, RED, BLUE, PURPLE, ORANGE, WHITE, AND GRAY IS/ARE CLAIMED AS A FEATURE OF THE MARK.

THE COLOR BLACK APPEARS IN THE OUTLINE OF THE BUTTERFLY WINGS, WITHIN THE BUTTERFLY WINGS DESIGN, IN THE OUTLINE OF THE CHRYSALIS, AND IN THE TWO LETTERS "W." THE COLORS GREEN, YELLOW, ORANGE, RED, BLUE, PURPLE, AND WHITE APPEAR IN A RAINBOW FASHION FROM THE TOP TO

SN 77-038,513. BULOVA CORPORATION, WOODSIDE, NY.
FILED 11-7-2006.

MIRADOR

THE MARK CONSISTS OF STANDARD CHARACTERS WITHOUT CLAIM TO ANY PARTICULAR FONT, STYLE, SIZE, OR COLOR.

THE SPANISH WORD MIRADOR TRANSLATES INTO ENGLISH AS "BAY WINDOW", "LOOKOUT", AND "SPECTATOR".

FOR WATCHES AND CLOCKS (U.S. CLS. 2, 27, 28 AND 50).

JESSICA FATHY, EXAMINING ATTORNEY

CLASS 14—(Continued).

SN 77-059,576. BURKE, TERENCE M., MONROE, NY. FILED 12-7-2006.



THE COLOR(S) RED, GREEN, YELLOW, BLACK, WHITE, GREY, LIGHT BLUE IS/ARE CLAIMED AS A FEATURE OF THE MARK.

THE MARK CONSISTS OF A CAPITAL RED LETTER Q WITH A WHITE INTERIOR IN THE FORM OF THREE INTERSECTING RECTANGLES THAT MAKE A MARK OFTEN ASSOCIATED WITH MEDICAL SYMBOLS. THIS WHITE MARK HAS A VERTICAL WHITE RECTANGLE IN THE CENTER WITH THE TWO OTHER WHITE RECTANGLES INTERSECTING IT AT EQUAL INTERVALS. INSIDE THIS WHITE INTERIOR IS A GREEN SNAKE WITH A RED TONGUE STICKING OUT ON THE LEFT SIDE OF HIS MOUTH (FROM THE VIEWER'S PERSPECTIVE). THE SNAKE IS WRAPPED AROUND A LIGHT BLUE POLE THAT COMES TO A POINT AT THE LOWER END. THIS POINT EXTENDS BELOW THE OUTLINE OF THE Q. THE POLE HAS A ROUNDED BULB ON THE TOP WITH A WHITE SPOT INDICATING A REFLECTIVE SHINE. THE SNAKE IS WRAPPED IN A GREY STRAIGHT JACKET. THE SNAKE'S LEFT EYE (VIEWER'S PERSPECTIVE) HAS A SWIRL THAT IS LIGHT RED. THE SNAKE HAS A YELLOW BELLY AND BLACK EYEBROWS THAT EXTEND OFF OF HIS BULBOUS EYES. AFTER THE Q THE LETTERS QUIRK APPEAR IN RED. ALL THESE RED LETTERS ARE OUTLINED IN BLACK. THE ENTIRE WORD QUIRK IS ENROBED IN YELLOW. BELOW IT IS THE WORD ALERT IN BLACK.

FOR COSTUME JEWELRY; IDENTIFICATION BRACELETS (U.S. CLS. 2, 27, 28 AND 50).

KIMBERLY FRYE, EXAMINING ATTORNEY

CLASS 14—(Continued).

SN 77-113,596. PROSPERITY AT ROYAL, INC., ST. FRANCISVILLE, LA. FILED 2-22-2007.

GRANDMOTHER'S BUTTONS

THE MARK CONSISTS OF STANDARD CHARACTERS WITHOUT CLAIM TO ANY PARTICULAR FONT, STYLE, SIZE, OR COLOR.

NO CLAIM IS MADE TO THE EXCLUSIVE RIGHT TO USE "BUTTONS", APART FROM THE MARK AS SHOWN.

FOR JEWELRY, NAMELY PINS, BROOCHES, WATCHES, EARRINGS, NECKLACES, BRACELETS, LOCKETS, CUFF LINKS, TIE TACKS, AND RINGS (U.S. CLS. 2, 27, 28 AND 50).

FIRST USE 1-0-1985; IN COMMERCE 5-8-1986.

C. DIONNE CLYBURN, EXAMINING ATTORNEY

SN 77-117,849. THE EXCELSIOR PLANET, LLC, PHILADELPHIA, PA. FILED 2-27-2007.

THE EXCELSIOR PLANET

THE MARK CONSISTS OF STANDARD CHARACTERS WITHOUT CLAIM TO ANY PARTICULAR FONT, STYLE, SIZE, OR COLOR.

FOR JEWELRY (U.S. CLS. 2, 27, 28 AND 50).

FIRST USE 2-1-2006; IN COMMERCE 2-1-2006.

COLLEEN KEARNEY, EXAMINING ATTORNEY

SN 77-104,589. THE TRACIAK COLLECTION, TECUMSEH, MI. FILED 2-11-2007.

THE TRACIAK COLLECTION

THE MARK CONSISTS OF STANDARD CHARACTERS WITHOUT CLAIM TO ANY PARTICULAR FONT, STYLE, SIZE, OR COLOR.

NO CLAIM IS MADE TO THE EXCLUSIVE RIGHT TO USE "COLLECTION", APART FROM THE MARK AS SHOWN.

FOR SCULPTURES MADE OF PRECIOUS METAL (U.S. CLS. 2, 27, 28 AND 50).

FIRST USE 11-5-2006; IN COMMERCE 11-5-2006.

DAWN FELDMAN, EXAMINING ATTORNEY

SN 77-120,919. SYL, LLC, WILMINGTON, DE. FILED 3-2-2007.

STANLEY B. BY STANLEY BLACKER

THE MARK CONSISTS OF STANDARD CHARACTERS WITHOUT CLAIM TO ANY PARTICULAR FONT, STYLE, SIZE, OR COLOR.

OWNER OF U.S. REG. NOS. 2,359,880, 2,862,769 AND OTHERS.

"THE NAME(S), PORTRAIT(S), AND/OR SIGNATURE(S) SHOWN IN THE MARK DOES NOT IDENTIFY A PARTICULAR LIVING INDIVIDUAL."

FOR WATCHES AND JEWELRY (U.S. CLS. 2, 27, 28 AND 50).

BRENDAN REGAN, EXAMINING ATTORNEY

CLASS 14—(Continued).

SN 77-135,267. MINNESOTA VIKINGS FOOTBALL, LLC,
EDEN PRAIRIE, MN. FILED 3-20-2007.



OWNER OF U.S. REG. NOS. 997,179 AND 2,876,746.
THE MARK CONSISTS OF DESIGN OF A VIKING HEAD.
FOR JEWELRY, WATCHES, CLOCKS, JEWELRY PINS,
EARRINGS, NECKLACES, BRACELETS, CHARMS, TIE
PINS, RINGS BEING JEWELRY, COLLECTIBLE OR
COMMEMORATIVE COINS MADE OF PRECIOUS METAL,
PENDANTS AND KEY CHAINS MADE OF PRE-
CIOUS METAL (U.S. CLS. 2, 27, 28 AND 50).

FIRST USE 9-0-1985; IN COMMERCE 9-0-1985.
MICHAEL TANNER, EXAMINING ATTORNEY

SN 77-135,283. MINNESOTA VIKINGS FOOTBALL, LLC.,
EDEN PRAIRIE, MN. FILED 3-20-2007.

MINNESOTA VIKINGS

THE MARK CONSISTS OF STANDARD CHARACTERS
WITHOUT CLAIM TO ANY PARTICULAR FONT, STYLE,
SIZE, OR COLOR.

OWNER OF U.S. REG. NOS. 997,182, 2,959,064 AND
OTHERS.

NO CLAIM IS MADE TO THE EXCLUSIVE RIGHT TO
USE "MINNESOTA", APART FROM THE MARK AS
SHOWN.

FOR JEWELRY, WATCHES, CLOCKS, JEWELRY PINS,
EARRINGS, NECKLACES, BRACELETS, CHARMS, TIE
PINS, RINGS BEING JEWELRY, COLLECTIBLE OR
COMMEMORATIVE COINS MADE OF PRECIOUS METAL,
PENDANTS AND KEY CHAINS MADE OF PRE-
CIOUS METAL (U.S. CLS. 2, 27, 28 AND 50).

FIRST USE 9-0-1983; IN COMMERCE 9-0-1983.
MICHAEL TANNER, EXAMINING ATTORNEY

CLASS 14—(Continued).

SN 77-137,606. EGM JEWELRY CORP., ARCADIA, CA.
FILED 3-22-2007.

Zaria Jewelry

THE MARK CONSISTS OF STANDARD CHARACTERS
WITHOUT CLAIM TO ANY PARTICULAR FONT, STYLE,
SIZE, OR COLOR.

NO CLAIM IS MADE TO THE EXCLUSIVE RIGHT TO
USE "JEWELRY", APART FROM THE MARK AS SHOWN.

FOR BEADS FOR USE IN THE MANUFACTURE OF
JEWELRY; BRACELETS; CHARMS; COSTUME JEW-
ELRY; JEWELRY (U.S. CLS. 2, 27, 28 AND 50).

DOMINICK J. SALEMI, EXAMINING ATTORNEY

SN 77-137,820. BABADJANIANS, EMIL, GLENDALE, CA.
FILED 3-22-2007.



NO CLAIM IS MADE TO THE EXCLUSIVE RIGHT TO
USE "CREATIONS", APART FROM THE MARK AS
SHOWN.

THE MARK CONSISTS OF A BIG CIRCLE OUTLINE
WITH THE STYLIZED LETTERS "FTW CREATIONS"
BORDERING THE INSIDE WITH TWO MALTESE CROSS
SPLITTING THE TWO WORDS AND A SMALL CIRCLE
OUTLINE INSIDE THE BIG CIRCLE WITH A CUSTOM-
IZED SPADE IN THE CENTER.

FOR ANKLE BRACELETS; BRACELETS; EARRINGS;
JEWELRY; JEWELRY CHAINS; NECK CHAINS; NECK-
LACES; PENDANTS; RINGS (U.S. CLS. 2, 27, 28 AND 50).

FIRST USE 12-20-2004; IN COMMERCE 2-1-2005.
DARRYL SPRULL, EXAMINING ATTORNEY

CLASS 14—(Continued).

SN 77-139,553. HOURCADE, ALLISON L, ASTORIA, NY. FILED 3-24-2007.

RockLove

THE MARK CONSISTS OF STANDARD CHARACTERS WITHOUT CLAIM TO ANY PARTICULAR FONT, STYLE, SIZE, OR COLOR.

FOR BRACELETS; BROOCHES; CHARMS; JEWELRY; JEWELRY FOR THE HEAD; JEWELRY, NAMELY, AMULETS; JEWELRY, NAMELY, CROSSES; LAPEL PINS; LEATHER JEWELRY AND ACCESSORY BOXES; PET JEWELRY; PINS BEING JEWELRY; RINGS BEING JEWELRY (U.S. CLS. 2, 27, 28 AND 50).

KAPIL BHANOT, EXAMINING ATTORNEY



SN 77-139,801. MIKI SIAMESE INTERNATIONAL CO., LTD., KHET PRAWES, BANGKOK, THAILAND, FILED 3-26-2007.



THE MARK CONSISTS OF A BLACK FLOWER WITH THE LETTERS MSI OUTLINED IN BLACK.

FOR JEWELRY (U.S. CLS. 2, 27, 28 AND 50). FIRST USE 3-0-2007; IN COMMERCE 3-0-2007.

IRA J. GOODSaid, EXAMINING ATTORNEY



SN 77-141,044. DEBIJOU, INC., NEW YORK, NY. FILED 3-27-2007.

MAGNIFICENT 145

THE MARK CONSISTS OF STANDARD CHARACTERS WITHOUT CLAIM TO ANY PARTICULAR FONT, STYLE, SIZE, OR COLOR.

FOR DIAMONDS (U.S. CLS. 2, 27, 28 AND 50). SALLY SHIH, EXAMINING ATTORNEY

CLASS 14—(Continued).

SN 77-141,705. SILVER SPOON JEWELRY, INC., LONG BEACH, CA. FILED 3-27-2007.



NO CLAIM IS MADE TO THE EXCLUSIVE RIGHT TO USE "JEWELRY", APART FROM THE MARK AS SHOWN.

FOR JEWELRY (U.S. CLS. 2, 27, 28 AND 50). FIRST USE 1-0-2003; IN COMMERCE 1-0-2003.

LINDSEY RUBIN, EXAMINING ATTORNEY



SN 77-141,872. UNITED FOOTBALL LEAGUE, LLC, SAN FRANCISCO, CA. FILED 3-27-2007.

UFL

THE MARK CONSISTS OF STANDARD CHARACTERS WITHOUT CLAIM TO ANY PARTICULAR FONT, STYLE, SIZE, OR COLOR.

FOR ALARM CLOCKS; APPARATUS FOR TIMING SPORTS EVENTS; CHARITY BRACELETS; CHARMS; CHRONOGRAPHS FOR USE AS WATCHES; CLOCKS; COLLECTIBLE COINS; COMMEMORATIVE COINS; COMMEMORATIVE STATUARY CUPS MADE OF PRECIOUS METAL; DESKTOP STATUARY MADE OF PRECIOUS METAL; HOLIDAY ORNAMENTS OF PRECIOUS METAL; IDENTIFICATION BRACELETS; JEWEL CHAINS; JEWEL PENDANTS; JEWELRY; JEWELRY CHAINS; JEWELRY FOR THE HEAD; JEWELRY PINS FOR USE ON HATS; JEWELRY WATCHES; KEY CHAINS OF PRECIOUS METAL; KEY HOLDERS OF PRECIOUS METALS; KEY RINGS OF PRECIOUS METAL; LAPEL PINS; MEDALLIONS; MEDALS; MONETARY COIN SETS FOR COLLECTING PURPOSES; NECK CHAINS; NECKLACES; NECKTIE FASTENERS; NON-MONETARY COINS; ORNAMENTAL LAPEL PINS; ORNAMENTAL PINS; ORNAMENTS OF PRECIOUS METAL; PENDANTS; PET JEWELRY; PRECIOUS METAL TROPHIES; PRECIOUS METAL TROPHY COLUMNS; RINGS; RINGS BEING JEWELRY; RUBBER OR SILICON WRISTBANDS IN THE NATURE OF A BRACELET; SHIRT STUDS; TABLE CLOCKS; TIE CLIPS; TIE FASTENERS; TIE PINS; TIE TACKS; WALL CLOCKS; WATCHES; WATCHES CONTAINING A GAME FUNCTION; WATCHES CONTAINING AN ELECTRONIC GAME FUNCTION; WRIST WATCHES (U.S. CLS. 2, 27, 28 AND 50).

JORDAN BAKER, EXAMINING ATTORNEY

CLASS 14—(Continued).

SN 77-143,114. PRIMA ROYAL ENTERPRISES, LTD., IRWINDALE, CA. FILED 3-28-2007.

BOBBI BLU

THE MARK CONSISTS OF STANDARD CHARACTERS WITHOUT CLAIM TO ANY PARTICULAR FONT, STYLE, SIZE, OR COLOR.

THE NAME SHOWN IN THE MARK DOES NOT IDENTIFY A PARTICULAR LIVING INDIVIDUAL.

FOR JEWELRY OF PRECIOUS AND NON-PRECIOUS METALS, NAMELY BRACELETS, NECKLACES, LAPEL PINS, BROOCHES, EARRINGS, ANKLE BRACELETS, CHARMS, PENDANTS, CHOKERS, TIE PINS, TIE BARS, RINGS, LAPEL PINS, NECKTIE FASTENERS, AND CUFF LINKS; WATCHES AND CLOCKS; CASES FOR WATCHES AND CLOCKS (U.S. CLS. 2, 27, 28 AND 50).
LINDA M. KING, EXAMINING ATTORNEY



SN 77-143,191. COLOR JEWELS, INC., NEW YORK, NY. FILED 3-28-2007.

RI

THE MARK CONSISTS OF STANDARD CHARACTERS WITHOUT CLAIM TO ANY PARTICULAR FONT, STYLE, SIZE, OR COLOR.

FOR JEWELRY (U.S. CLS. 2, 27, 28 AND 50).
FIRST USE 3-23-2007; IN COMMERCE 3-23-2007.
SIMON TENG, EXAMINING ATTORNEY



SN 77-149,654. AMERICAN MUSEUM OF NATURAL HISTORY, NEW YORK, NY. FILED 4-5-2007.

AMNH EXPEDITIONS

THE MARK CONSISTS OF STANDARD CHARACTERS WITHOUT CLAIM TO ANY PARTICULAR FONT, STYLE, SIZE, OR COLOR.

FOR RINGS; BRACELETS; CHARMS; BROOCHES; CUFF LINKS; EARRINGS AND PENDANTS; JEWELRY BOXES (U.S. CLS. 2, 27, 28 AND 50).
REBECCA SMITH, EXAMINING ATTORNEY

CLASS 14—(Continued).

SN 77-150,678. OLD BLUE LLC, LAKE GENEVA, WI. FILED 4-6-2007.

THE FEELGOOD T-SHIRT COMPANY

THE MARK CONSISTS OF STANDARD CHARACTERS WITHOUT CLAIM TO ANY PARTICULAR FONT, STYLE, SIZE, OR COLOR.

NO CLAIM IS MADE TO THE EXCLUSIVE RIGHT TO USE "COMPANY", APART FROM THE MARK AS SHOWN. FOR JEWELRY; WATCHES (U.S. CLS. 2, 27, 28 AND 50).
DAVID TAYLOR, EXAMINING ATTORNEY



SN 77-178,759. ABERCROMBIE & FITCH TRADING CO., NEW ALBANY, OH. FILED 5-11-2007.



THE MARK CONSISTS OF A MISCELLANEOUS DESIGN. FOR JEWELRY; WATCHES (U.S. CLS. 2, 27, 28 AND 50).
JOHN WILKE, EXAMINING ATTORNEY

CLASS 14—(Continued).

SN 77-178,773. ABERCROMBIE & FITCH TRADING CO., NEW ALBANY, OH. FILED 5-11-2007.



THE NAME(S), PORTRAIT(S), AND/OR SIGNATURE(S) SHOWN IN THE MARK DOES NOT IDENTIFY A PARTICULAR LIVING INDIVIDUAL.

THE MARK CONSISTS OF A MISCELLANEOUS DESIGN WITH THE TERM GILLY H.

FOR JEWELRY; WATCHES (U.S. CLS. 2, 27, 28 AND 50).

JOHN WILKE, EXAMINING ATTORNEY

CLASS 14—(Continued).

SN 78-345,066. AMERICA'S COLLECTIBLES NETWORK, INC., KNOXVILLE, TN. FILED 12-23-2003.



THE MARK CONSISTS OF STYLED WORD CHARIZMA WITH THE LETTERS C AND Z BEING A LARGER FONT SIZE THAN THE REMAINDER OF THE WORD.

FOR CUBIC ZIRCONIA JEWELRY (U.S. CLS. 2, 27, 28 AND 50).

FIRST USE 11-12-2003; IN COMMERCE 11-12-2003. RUDY R. SINGLETON, EXAMINING ATTORNEY

SN 78-488,391. RICHLINE GROUP, INC, NEW YORK, NY. FILED 9-23-2004.

HALOGEN

SN 77-178,782. ABERCROMBIE & FITCH TRADING CO., NEW ALBANY, OH. FILED 5-11-2007.



THE MARK CONSISTS OF STANDARD CHARACTERS WITHOUT CLAIM TO ANY PARTICULAR FONT, STYLE, SIZE, OR COLOR.

FOR JEWELRY (U.S. CLS. 2, 27, 28 AND 50). DOMINIC J. FERRAIUOLO, EXAMINING ATTORNEY

SN 78-747,194. THE GEMESIS CORPORATION, SARASOTA, FL. FILED 11-4-2005.

GEMESIS, THE CULTURED DIAMOND

THE NAME(S), PORTRAIT(S), AND/OR SIGNATURE(S) SHOWN IN THE MARK DOES NOT IDENTIFY A PARTICULAR LIVING INDIVIDUAL.

THE MARK CONSISTS OF A MISCELLANEOUS DESIGN WITH THE TERM GILLY H.

FOR JEWELRY; WATCHES (U.S. CLS. 2, 27, 28 AND 50).

JOHN WILKE, EXAMINING ATTORNEY

THE MARK CONSISTS OF STANDARD CHARACTERS WITHOUT CLAIM TO ANY PARTICULAR FONT, STYLE, SIZE, OR COLOR.

OWNER OF U.S. REG. NOS. 2,516,250 AND 2,662,799. SEC. 2(F) AS TO "CULTURED DIAMOND".

FOR SYNTHETIC DIAMONDS (U.S. CLS. 2, 27, 28 AND 50).

VIVIAN MICZNIK FIRST, EXAMINING ATTORNEY

CLASS 14—(Continued).

SN 78-919,511. MONTESINO INTERNATIONAL CORP.,
FORT LAUDERDALE, FL. FILED 6-29-2006.



OWNER OF U.S. REG. NOS. 2,819,144, 3,229,194 AND
3,233,443.

NO CLAIM IS MADE TO THE EXCLUSIVE RIGHT TO
USE "CARIBBEAN" AND "BRACELET COMPANY", APART
FROM THE MARK AS SHOWN.

SEC. 2(F).

FOR JEWELRY (U.S. CLS. 2, 27, 28 AND 50).

FIRST USE 5-1-2005; IN COMMERCE 5-1-2005.

GINA HAYES, EXAMINING ATTORNEY

SN 78-936,421. MISS BEVERLY HILLS INC., LOS ANGELES,
CA. FILED 7-24-2006.

MISS BEVERLY HILLS

THE MARK CONSISTS OF STANDARD CHARACTERS
WITHOUT CLAIM TO ANY PARTICULAR FONT, STYLE,
SIZE, OR COLOR.

NO CLAIM IS MADE TO THE EXCLUSIVE RIGHT TO
USE "BEVERLY HILLS", APART FROM THE MARK AS
SHOWN.

FOR JEWELRY (U.S. CLS. 2, 27, 28 AND 50).

KEVON CHISOLM, EXAMINING ATTORNEY

SN 78-954,109. L.C. LICENSING, INC., NEW YORK, NY.
FILED 8-17-2006.

RUSS

THE MARK CONSISTS OF STANDARD CHARACTERS
WITHOUT CLAIM TO ANY PARTICULAR FONT, STYLE,
SIZE, OR COLOR.

OWNER OF U.S. REG. NOS. 827,207, 2,084,412 AND
2,839,751.

FOR CLOCKS AND WATCHES; JEWELRY, NAMELY;
NECKLACES, BRACELETS, EARRINGS, JEWELRY
PINS, RINGS, ANKLETS, CUFFLINKS, PENDANTS;
PILLBOXES MADE OF PRECIOUS METAL (U.S. CLS. 2,
27, 28 AND 50).

REBECCA GAN, EXAMINING ATTORNEY

CLASS 14—(Continued).

SN 78-956,931. ZAPPOS.COM, INC., HENDERSON, NV.
FILED 8-21-2006.

BOUQUETS

THE MARK CONSISTS OF STANDARD CHARACTERS
WITHOUT CLAIM TO ANY PARTICULAR FONT, STYLE,
SIZE, OR COLOR.

OWNER OF U.S. REG. NO. 2,979,851.

FOR WATCHES, JEWELRY AND CLOCKS (U.S. CLS.
2, 27, 28 AND 50).

DOMINIC FATHY, EXAMINING ATTORNEY

SN 78-960,928. MICHELLE KAMINS, MARINA DEL REY,
CA. FILED 8-25-2006.

MICHELLE KAMINS

THE MARK CONSISTS OF STANDARD CHARACTERS
WITHOUT CLAIM TO ANY PARTICULAR FONT, STYLE,
SIZE, OR COLOR.

FOR BRACELETS; COSTUME JEWELRY; EAR CLIPS;
EAR STUDS; EARRINGS; JEWELRY; JEWELRY
CHAINS; NECK CHAINS; NECKLACES; PINS BEING
JEWELRY; RINGS BEING JEWELRY (U.S. CLS. 2, 27, 28
AND 50).

FIRST USE 3-31-2002; IN COMMERCE 3-31-2002.

ELLEN BURNS, EXAMINING ATTORNEY

SN 78-969,215. CRIPPLE CREEK HAT COMPANY, INC.,
BARRINGTON, IL. FILED 9-7-2006.

CRIPPLE CREEK

THE MARK CONSISTS OF STANDARD CHARACTERS
WITHOUT CLAIM TO ANY PARTICULAR FONT, STYLE,
SIZE, OR COLOR.

FOR JEWELRY, NAMELY, HAT PINS, EARRINGS,
BRACELETS, BELT BUCKLES OF PRECIOUS METAL,
AND ORNAMENTED LEATHER WRIST BANDS IN THE
NATURE OF A BRACELET (U.S. CLS. 2, 27, 28 AND 50).

ESTHER A. BORSUK, EXAMINING ATTORNEY

CLASS 14—(Continued).

SN 78-969,474. GORENSTEIN, ELINOR, NEW YORK, NY.
FILED 9-7-2006.

CURIOSITÉS

THE MARK CONSISTS OF STANDARD CHARACTERS WITHOUT CLAIM TO ANY PARTICULAR FONT, STYLE, SIZE, OR COLOR.

PRIORITY CLAIMED UNDER SEC. 44(D) ON FRANCE APPLICATION NO. 06/3416353, FILED 3-14-2006.

THE FOREIGN WORDING IN THE MARK TRANSLATES INTO ENGLISH AS OBJECTS OF CURIOSITY.

FOR PRECIOUS METALS, JEWELRY, JEWELS, NAMELY PRECIOUS STONES, CUSTOM JEWELRY, TIMEPIECES, WATCHES AND CHRONOMETER, COLLECTIBLE COINS, PENDANTS, RINGS, WATCH BANDS, EARRINGS, BRACELETS, BRACELET-WATCHES, WATCH STRAPS, BROOCHES, ORNAMENTAL PINS, JEWELRY CHAINS, NECKLACES, MEDALS, PARURES, NAMELY JEWELRY, DIAMONDS, JEWELRY BOXES OF PRECIOUS METAL, KEY HOLDERS AND CHARMS OF PRECIOUS METAL, SIGNS OF PRECIOUS METALS, STATUES IN PRECIOUS METAL, CUFFLINKS (U.S. CLS. 2, 27, 28 AND 50).

DOMINIC FATHY, EXAMINING ATTORNEY

SN 78-969,509. GORENSTEIN, ELINOR, NEW YORK, NY.
FILED 9-7-2006.



THE FOREIGN WORDING IN THE MARK TRANSLATES INTO ENGLISH AS OBJECTS OF CURIOSITY.

FOR PRECIOUS METALS, JEWELRY, JEWELS, NAMELY PRECIOUS STONES, CUSTOM JEWELRY, TIMEPIECES, WATCHES AND CHRONOMETER, COLLECTIBLE COINS, PENDANTS, RINGS, WATCH BANDS, EARRINGS, BRACELETS, BRACELET-WATCHES, WATCH STRAPS, BROOCHES, ORNAMENTAL PINS, JEWELRY CHAINS, NECKLACES, MEDALS, PARURES, NAMELY JEWELRY, DIAMONDS, JEWELRY BOXES OF PRECIOUS METAL, KEY HOLDERS AND CHARMS OF PRECIOUS METAL, SIGNS OF PRECIOUS METALS, STATUES IN PRECIOUS METAL, CUFFLINKS (U.S. CLS. 2, 27, 28 AND 50).

DOMINIC FATHY, EXAMINING ATTORNEY

CLASS 14—(Continued).

SN 79-019,752. PARMIGIANI FLEURIER S.A., SWITZERLAND, FILED 8-26-2005.



OWNER OF INTERNATIONAL REGISTRATION 0873651 DATED 8-26-2005, EXPIRES 8-26-2015.

FOR ALL WATCH AND CLOCK PRODUCTS, NAMELY WATCHES, WRISTWATCHES, WATCH STRAPS, WATCH CASES, WATCH GLASSES, WATCH WINDING KNOBS, WATCH MOVEMENTS, WRIST-WATCH BUCKLES, WATCH FACES, WATCH BEZELS; CHRONOMETERS, CHRONOGRAPHS FOR USE AS WATCHES; PENDULUM CLOCKS AND DIALS FOR PENDULUM CLOCKS, CLOCK AND WATCH MOVEMENTS ALSO FOR ACTUATING OBJECTS AND FIGURINES OF BRONZE OR PRECIOUS METALS (U.S. CLS. 2, 27, 28 AND 50).

MARLENE BELL, EXAMINING ATTORNEY

SN 79-029,512. GUANGZHOU YONGHONG WATCH; TECHNOLOGY DEVELOPMENT CO., LTD., CHINA, FILED 10-3-2006.

Eyki

OWNER OF INTERNATIONAL REGISTRATION 0864489 DATED 8-31-2005, EXPIRES 8-31-2015.

FOR PENDULUM CLOCKS; WATCHES; WATCH GLASSES; CASES FOR WATCHES; WATCH CASES; STRAPS FOR WRISTWATCHES; CLOCKS; CLOCKWORKS; MOVEMENTS FOR CLOCKS AND WATCHES; CLOCK HANDS FOR CLOCKS AND WATCH-MAKING (U.S. CLS. 2, 27, 28 AND 50).

LYDIA BELZER, EXAMINING ATTORNEY

CLASS 14—(Continued).

SN 79-030,465. LOVEKEY DIFFUSION SA, LA CHAUX-DE-FONDS, SWITZERLAND, FILED 9-25-2006.

LOVEKEY

THE MARK CONSISTS OF STANDARD CHARACTERS WITHOUT CLAIM TO ANY PARTICULAR FONT, STYLE, SIZE, OR COLOR.

OWNER OF INTERNATIONAL REGISTRATION 0902377 DATED 9-25-2006, EXPIRES 9-25-2016.
FOR JEWELLERY (U.S. CLS. 2, 27, 28 AND 50).
CHRISTOPHER OTT, EXAMINING ATTORNEY

SN 79-031,153. PHILIPPE DU BOIS ET FILS S.A., SWITZERLAND, FILED 8-17-2006.



PRIORITY DATE OF 2-25-2006 IS CLAIMED.
OWNER OF INTERNATIONAL REGISTRATION 0904086 DATED 8-17-2006, EXPIRES 8-17-2016.

NO CLAIM IS MADE TO THE EXCLUSIVE RIGHT TO USE "1785", APART FROM THE MARK AS SHOWN.

FOR JEWELLERY, PRECIOUS STONES; HOROLOGICAL AND CHRONOMETRIC INSTRUMENTS; SMALL WATCHES AND CLOCKS; WRIST-WATCHES; PARTS OF WATCHES AND CLOCKS; BANDS FOR WATCHES; WATCH FACES; WATCH AND CLOCK CASES; MOVEMENTS FOR WATCHES; HANDS FOR WATCHES AND CLOCKS (U.S. CLS. 2, 27, 28 AND 50).

TASHIA BUNCH, EXAMINING ATTORNEY

SN 79-037,349. LA MONTRE HERMES S.A., CH-2555 BRUGG, SWITZERLAND, FILED 3-21-2007.

ESPACE-TEMPS

THE MARK CONSISTS OF STANDARD CHARACTERS WITHOUT CLAIM TO ANY PARTICULAR FONT, STYLE, SIZE, OR COLOR.

PRIORITY DATE OF 11-14-2006 IS CLAIMED.
OWNER OF INTERNATIONAL REGISTRATION 0921092 DATED 3-21-2007, EXPIRES 3-21-2017.

THE ENGLISH TRANSLATION OF THE FOREIGN WORD(S) IN THE MARK IS: SPACE-TIME.

FOR TIMEPIECES AND CHRONOMETRIC INSTRUMENTS, WATCHES AND THEIR COMPONENTS, WATCH BANDS, WATCH CLASPS (U.S. CLS. 2, 27, 28 AND 50).

BERNICE MIDDLETON, EXAMINING ATTORNEY

CLASS 14—(Continued).

SN 79-038,627. FRANCK MULLER WATCHLAND SA, SWITZERLAND, FILED 2-14-2007.

SACRED HOURS

THE MARK CONSISTS OF STANDARD CHARACTERS WITHOUT CLAIM TO ANY PARTICULAR FONT, STYLE, SIZE, OR COLOR.

PRIORITY DATE OF 11-7-2006 IS CLAIMED.
OWNER OF INTERNATIONAL REGISTRATION 0924605 DATED 2-14-2007, EXPIRES 2-14-2017.

FOR PRECIOUS METALS AND THEIR ALLOYS SOLD IN BULK; JEWELLERY; PRECIOUS STONES; TIMEPIECES AND CHRONOMETRIC INSTRUMENTS, NAMELY WATCHES, WRIST-WATCHES, CHRONOMETERS, CLOCKS, TABLE CLOCKS (U.S. CLS. 2, 27, 28 AND 50).

JOSETTE BEVERLY, EXAMINING ATTORNEY

CLASS 15—MUSICAL INSTRUMENTS

SN 76-668,738. CUSANO, VINCENT, BRENTWOOD, TN. FILED 11-8-2006.

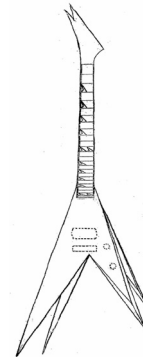

THE MARK CONSISTS OF AN ELECTRIC GUITAR BODY DESIGN IN THE SHAPE OF A "V" OVERLAPPING A SECONDARY "V" IN WHICH THE SECONDARY "V" IS OFFSET AT A RIGHT ANGLE BY 2 INCHES CREATING A 3 DIMENSIONAL DESIGN TO SUGGEST THE INITIALS OF VINNIE VINCENT. THE DESIGN IS POSITIONED ON A GUITAR. THE DOTTED OUTLINE OF THE HARDWARE OF GUITAR, I.E. PICKUP[S], KNOBS, TAILPIECE, ARE NOT PART OF THE MARK BUT MERELY INTEND TO SHOW THE POSITIONING OF THE HARDWARE WITHIN THE MARK.

SEC. 2(F).

FOR MUSICAL INSTRUMENTS, IN PARTICULAR ELECTRICAL AND ELECTRONIC MUSICAL INSTRUMENTS (U.S. CLS. 2, 21 AND 36).

FIRST USE 5-5-1985; IN COMMERCE 1-1-1986.

BRENDAN REGAN, EXAMINING ATTORNEY

CLASS 15—(Continued).

SN 77-062,380. PIRANHA, CAMARILLO, CA. FILED 12-12-2006.



THE COLOR(S) DARK GREY, LIGHT GREY, SILVER, BROWN, RED, TAN, BLACK, PINK, WHITE AND MAROON IS/ARE CLAIMED AS A FEATURE OF THE MARK.

THE COLORS DARK GREY, LIGHT GREY, SILVER, AND WHITE APPEAR IN THE FISH, THE COLORS PINK, AND BLACK APPEAR IN THE FISH EYE, THE COLORS RED AND TAN APPEAR IN THE GUITAR. THE COLOR TAN APPEARS ON THE FISH FIN, THE COLOR BLACK, GREY, WHITE AND MAROON APPEAR IN THE SKY, AND THE COLOR RED APPEARS IN THE WORD "PIRANHA". THE MARK CONSISTS OF A DARK GREY BACKGROUND HAVING A PIRANHA FISH WITH A LIGHT GREY BODY BITING A GUITAR WITH BROWN NECK AND RED BODY INTO PIECES AND THE TERM PIRANHA IN RED.

FOR MUSICAL INSTRUMENTS, NAMELY DRUMS, DRUM LUGS, DRUM FEET, DRUM HEADS, DRUM TOMS, DRUM BASSES, FLOOR TOMS, RACK TOMS, DRUM HOOPS, DRUM MOUNTS, DRUM STANDS, CYMBAL STANDS, BRASS CYMBALS, CYMBALS, DRUM STICKS, ELECTRIC DRUMS, ELECTRIC CYMBALS, PIANOS, ELECTRIC PIANOS, MUSIC EQUIPMENT STANDS, MUSIC INSTRUMENT CASES AND ENCLOSURES, DRUM CASES AND ENCLOSURES (U.S. CLS. 2, 21 AND 36).

FIRST USE 1-3-2004; IN COMMERCE 1-3-2004.

JOANNA DUKOVIC, EXAMINING ATTORNEY

CLASS 15—(Continued).

SN 77-149,599. AMERICAN MUSEUM OF NATURAL HISTORY, NEW YORK, NY. FILED 4-5-2007.

AMNH EXPEDITIONS

THE MARK CONSISTS OF STANDARD CHARACTERS WITHOUT CLAIM TO ANY PARTICULAR FONT, STYLE, SIZE, OR COLOR.

FOR PERCUSSION AND STRING INSTRUMENTS; GUITARS (U.S. CLS. 2, 21 AND 36).

REBECCA SMITH, EXAMINING ATTORNEY

SN 78-495,008. 9151-8886 QUÉBEC INC., BERTHIER-SUR-MER, CANADA, FILED 10-5-2004.

SPRUCE GOOSE

THE MARK CONSISTS OF STANDARD CHARACTERS WITHOUT CLAIM TO ANY PARTICULAR FONT, STYLE, SIZE, OR COLOR.

PRIORITY CLAIMED UNDER SEC. 44(D) ON CANADA APPLICATION NO. 1232322, FILED 10-1-2004, REG. NO. TMA676635, DATED 11-8-2006, EXPIRES 11-8-2021.

NO CLAIM IS MADE TO THE EXCLUSIVE RIGHT TO USE "SPRUCE", APART FROM THE MARK AS SHOWN.

FOR ACOUSTIC GUITARS (U.S. CLS. 2, 21 AND 36).

FIRST USE 7-31-2004; IN COMMERCE 7-31-2004.

TAMARA FRAZIER, EXAMINING ATTORNEY

SN 77-139,601. CAMPBELL, DOUGLAS J., PERRY, OH. FILED 3-24-2007.

BowMate

THE MARK CONSISTS OF STANDARD CHARACTERS WITHOUT CLAIM TO ANY PARTICULAR FONT, STYLE, SIZE, OR COLOR.

FOR BOWS FOR MUSICAL INSTRUMENTS (U.S. CLS. 2, 21 AND 36).

LINDSEY RUBIN, EXAMINING ATTORNEY

SN 78-846,996. ABBICK, MARION G., JUNCTION CITY, KS. FILED 3-27-2006.

SOFT LOCK

THE MARK CONSISTS OF STANDARD CHARACTERS WITHOUT CLAIM TO ANY PARTICULAR FONT, STYLE, SIZE, OR COLOR.

NO CLAIM IS MADE TO THE EXCLUSIVE RIGHT TO USE "LOCK", APART FROM THE MARK AS SHOWN.

FOR NON-METAL HARDWARE, NAMELY STRAPS AND CONNECTORS FOR RELEASABLY ATTACHING GUITAR (U.S. CLS. 2, 21 AND 36).

FIRST USE 1-1-2006; IN COMMERCE 1-1-2006.

DEZMONA MIZELLE, EXAMINING ATTORNEY

CLASS 15—(Continued).

SN 78-962,979. LEGENDARY GEAR, LLC, MEMPHIS, TN.
FILED 8-29-2006.

BLUESMASTER

THE MARK CONSISTS OF STANDARD CHARACTERS
WITHOUT CLAIM TO ANY PARTICULAR FONT, STYLE,
SIZE, OR COLOR.
FOR ELECTRIC GUITARS; GUITARS (U.S. CLS. 2, 21
AND 36).
FIRST USE 5-31-2001; IN COMMERCE 5-31-2001.
ALLISON SCHRODY, EXAMINING ATTORNEY

SN 79-029,171. GUSTAV PIRAZZI & COMP., FED REP
GERMANY, FILED 7-26-2006.

TONICA

OWNER OF INTERNATIONAL REGISTRATION 0646461
DATED 10-11-1995, EXPIRES 10-11-2015.
OWNER OF U.S. REG. NO. 1,993,323.
FOR STRINGS FOR MUSICAL INSTRUMENTS (U.S.
CLS. 2, 21 AND 36).
RAY THOMAS, EXAMINING ATTORNEY

**CLASS 16—PAPER GOODS AND PRINTED
MATTER**

SN 76-516,384. CRITICAL THINKING BOOKS & SOFT-
WARE, PACIFIC GROVE, CA. FILED 5-22-2003.



Bright Minds

THE STIPPLING IS A FEATURE OF THE MARK.
FOR HOME TEACHING AIDS, NAMELY, BOOKLETS
CONTAINING CROSSWORD PUZZLES AND GAMES TO
BE USED AS A TEACHING AID IN DEVELOPING
REASONING SKILLS AND FOR AMUSEMENT AND
RECREATION (U.S. CLS. 2, 5, 22, 23, 29, 37, 38 AND 50).
FIRST USE 4-3-2003; IN COMMERCE 4-11-2003.
CHARLES L. JENKINS, EXAMINING ATTORNEY

CLASS 16—(Continued).

SN 76-650,677. HOLMBERG, NANNETTE, SALT LAKE CITY,
UT. FILED 11-21-2005.

CHENILLE-IT

THE MARK CONSISTS OF STANDARD CHARACTERS
WITHOUT CLAIM TO ANY PARTICULAR FONT, STYLE,
SIZE, OR COLOR.
FOR SERIES OF BOOKS FEATURING PATTERNS
AND INSTRUCTIONS FOR SEWING CLOTHING;
PRINTED PATTERNS FOR SEWING CLOTHING (U.S.
CLS. 2, 5, 22, 23, 29, 37, 38 AND 50).
FIRST USE 2-25-2005; IN COMMERCE 2-25-2005.
BONNIE LUKEN, EXAMINING ATTORNEY

SN 76-661,521. SANDERS, ROBIN, ALTADENA, CA. FILED
S.R. 6-13-2006; AM. P.R. 8-21-2007.

**SHORT
MAGAZINE!**

NO CLAIM IS MADE TO THE EXCLUSIVE RIGHT TO
USE "MAGAZINE", APART FROM THE MARK AS SHOWN.
FOR MAGAZINES FEATURING ARTICLES OF IN-
TEREST FOR THE SHORT POPULATION (U.S. CLS. 2, 5,
22, 23, 29, 37, 38 AND 50).
FIRST USE 6-13-2006; IN COMMERCE 6-13-2006.
AISHA SALEM, EXAMINING ATTORNEY

SN 76-662,655. LEHMAN COMMUNICATIONS CORPORA-
TION, LONGMONT, CO. FILED 7-7-2006.

RH WEEKLY

THE MARK CONSISTS OF STANDARD CHARACTERS
WITHOUT CLAIM TO ANY PARTICULAR FONT, STYLE,
SIZE, OR COLOR.
OWNER OF U.S. REG. NO. 1,866,983.
NO CLAIM IS MADE TO THE EXCLUSIVE RIGHT TO
USE "WEEKLY", APART FROM THE MARK AS SHOWN.
FOR NEWSPAPERS (U.S. CLS. 2, 5, 22, 23, 29, 37, 38
AND 50).
FIRST USE 3-22-2006; IN COMMERCE 3-22-2006.
DEZMONA MIZELLE, EXAMINING ATTORNEY

CLASS 16—(Continued).

SN 76-666,115. ADVANCE MAGAZINE SERVICES INC.,
NEW YORK, NY. FILED 9-15-2006.

BRIDES NEW JERSEY

THE MARK CONSISTS OF STANDARD CHARACTERS
WITHOUT CLAIM TO ANY PARTICULAR FONT, STYLE,
SIZE, OR COLOR.

OWNER OF U.S. REG. NOS. 2,750,081, 2,752,664 AND
OTHERS.
SEC. 2(F).

FOR MAGAZINES FEATURING INFORMATION
CONCERNING WEDDINGS, FASHION, TRAVEL AND
ENTERTAINMENT (U.S. CLS. 2, 5, 22, 23, 29, 37, 38 AND
50).

FIRST USE 8-8-2006; IN COMMERCE 8-8-2006.
JILL C. ALT, EXAMINING ATTORNEY

SN 76-670,984. BLUE SKY PUBLICATIONS, LLC, BOERNE,
TX. FILED 1-3-2007.

Country Lifestyle

THE MARK CONSISTS OF STANDARD CHARACTERS
WITHOUT CLAIM TO ANY PARTICULAR FONT, STYLE,
SIZE, OR COLOR.

SEC. 2(F).

FOR MAGAZINE FEATURING INFORMATION ON
LIVING IN THE TEXAS HILL COUNTRY (U.S. CLS. 2, 5,
22, 23, 29, 37, 38 AND 50).

FIRST USE 11-1-1999; IN COMMERCE 11-1-1999.
MICHAEL GAFFAR, EXAMINING ATTORNEY

SN 76-672,973. FAN-FI INTERNATIONAL INC., MODESTO,
CA. FILED 2-21-2007.

ENERGY WISE

THE MARK CONSISTS OF STANDARD CHARACTERS
WITHOUT CLAIM TO ANY PARTICULAR FONT, STYLE,
SIZE, OR COLOR.

NO CLAIM IS MADE TO THE EXCLUSIVE RIGHT TO
USE ENERGY, APART FROM THE MARK AS SHOWN.

FOR PRINTED INSTRUCTION MATERIALS IN THE
FIELD OF ENERGY, THE ENVIRONMENT AND
WATER CONSERVATION (U.S. CLS. 2, 5, 22, 23, 29, 37,
38 AND 50).

FIRST USE 2-15-2004; IN COMMERCE 2-15-2004.
COLLEEN DOMBROW, EXAMINING ATTORNEY

CLASS 16—(Continued).

SN 76-674,573. PEACE STORE, INC., SANTA BARBARA, CA.
FILED 3-26-2007.

HAPPY IS HERE

THE MARK CONSISTS OF STANDARD CHARACTERS
WITHOUT CLAIM TO ANY PARTICULAR FONT, STYLE,
SIZE, OR COLOR.

FOR PRINTED MATTER, NAMELY POSTCARDS AND
STATIONERY; PENCIL POUCHES (U.S. CLS. 2, 5, 22, 23,
29, 37, 38 AND 50).

BARBARA RUTLAND, EXAMINING ATTORNEY

SN 77-001,688. BROADWATER & ASSOCIATES GROUP,
INC., NASHVILLE, TN. FILED 9-18-2006.

Celebrating A Wonderful Life

THE MARK CONSISTS OF THE WORDS "CELEBRATING
A WONDERFUL LIFE" IN A SCRIPTED FONT.

FOR SOUVENIR PROGRAMS CONCERNING FUN-
ERALS (U.S. CLS. 2, 5, 22, 23, 29, 37, 38 AND 50).

FIRST USE 6-1-2005; IN COMMERCE 6-1-2005.
SUSAN STIGLITZ, EXAMINING ATTORNEY

SN 77-014,290. CHULA MAGAZINE INC., WASHINGTON,
DC. FILED 10-5-2006.

CHULA MAGAZINE

THE MARK CONSISTS OF STANDARD CHARACTERS
WITHOUT CLAIM TO ANY PARTICULAR FONT, STYLE,
SIZE, OR COLOR.

NO CLAIM IS MADE TO THE EXCLUSIVE RIGHT TO
USE "MAGAZINE", APART FROM THE MARK AS SHOWN.

THE ENGLISH TRANSLATION OF THE WORD CHULA
IN THE MARK IS "PRETTY GIRL."

FOR MAGAZINE FEATURING LATINA WOMEN
AND LIFESTYLE TOPICS DIRECTED TO LATINA
WOMEN AGES 12-24 (U.S. CLS. 2, 5, 22, 23, 29, 37, 38
AND 50).

PETER B. BROMAGHIM, EXAMINING ATTORNEY

CLASS 16—(Continued).

SN 77-014,719. OSTERBERG, JAMES, LOS ANGELES, CA. FILED 10-5-2006.

IGGY POP

THE MARK CONSISTS OF STANDARD CHARACTERS WITHOUT CLAIM TO ANY PARTICULAR FONT, STYLE, SIZE, OR COLOR.

"IGGY POP" IDENTIFIES A LIVING INDIVIDUAL WHOSE CONSENT IS OF RECORD.

SEC. 2(F).

FOR PRINTED MATTER, PAPER AND STATIONERY PRODUCTS, NAMELY, POSTERS, CONCERT SOUVENIR PROGRAMS, STICKERS, BUMPER STICKERS, POSTCARDS, PICTURE POSTCARDS, PHOTOGRAPHS, CALENDARS, AND BOOKS IN THE FIELDS OF MUSIC, ENTERTAINMENT, ART AND/OR CULTURE (U.S. CLS. 2, 5, 22, 23, 29, 37, 38 AND 50).

FIRST USE 12-1-1979; IN COMMERCE 12-1-1979.

SCOTT SISUN, EXAMINING ATTORNEY

SN 77-021,696. SOUTHWELL, SIMONE, NEW YORK, NY. AND ROWLETT, BLAIR, NEWMARKET, NH. FILED 10-16-2006.



NO CLAIM IS MADE TO THE EXCLUSIVE RIGHT TO USE "MAGAZINE", APART FROM THE MARK AS SHOWN. THE COLOR(S) RED, ORANGE, YELLOW, GREEN, BLUE, BLACK AND PURPLE IS/ARE CLAIMED AS A FEATURE OF THE MARK.

THE COLORS RED, ORANGE, YELLOW, GREEN, BLUE, BLACK AND PURPLE APPEAR IN A STYLIZED "OUT" ABOVE THE WORDING "RAGEOUS MAGAZINE" IN BLACK.

FOR MAGAZINES FEATURING INFORMATION PERTAINING TO THE LESBIAN COMMUNITY, NAMELY, ENTERTAINMENT, FASHION, AND LIFESTYLE INFORMATION (U.S. CLS. 2, 5, 22, 23, 29, 37, 38 AND 50).

SCOTT SISUN, EXAMINING ATTORNEY

CLASS 16—(Continued).

SN 77-027,187. SOCIETE BIC, CLICHY, FRANCE, FILED 10-23-2006.



NO CLAIM IS MADE TO THE EXCLUSIVE RIGHT TO USE "DEFENDS AGAINST DRY OUT", APART FROM THE MARK AS SHOWN.

THE MARK CONSISTS OF A SHIELD WITH THE WORDS SEAL GUARD DEFENDS AGAINST DRY OUT WITHIN THE SHIELD.

FOR INTERNAL SEAL MADE OF FLEXIBLE PLASTIC THAT CLOSSES OVER THE TIP OF THE WRITING INSTRUMENT WHEN IT IS INSIDE THE INK TANK TO CREATE AN AIR TIGHT CHAMBER TO PROTECT THE TIP FROM DRYING OUT, SOLD AS AN INTEGRAL COMPONENT OF MARKERS AND HIGHLIGHTERS (U.S. CLS. 2, 5, 22, 23, 29, 37, 38 AND 50).

JILL C. ALT, EXAMINING ATTORNEY

SN 77-027,268. OTHER PRESS LLC, NEW YORK, NY. FILED 10-23-2006.

OTHER PRESS

THE MARK CONSISTS OF STANDARD CHARACTERS WITHOUT CLAIM TO ANY PARTICULAR FONT, STYLE, SIZE, OR COLOR.

OWNER OF U.S. REG. NO. 2,300,064.

NO CLAIM IS MADE TO THE EXCLUSIVE RIGHT TO USE "PRESS", APART FROM THE MARK AS SHOWN.

FOR SERIES OF FICTION BOOKS; BOOKS CONTAINING POETRY; AND SERIES OF NON-FICTION BOOKS ON CURRENT EVENTS, HISTORY, PSYCHOLOGY, PHILOSOPHY, MEMOIRS (U.S. CLS. 2, 5, 22, 23, 29, 37, 38 AND 50).

FIRST USE 6-1-1998; IN COMMERCE 6-1-1998.

MIDGE BUTLER, EXAMINING ATTORNEY

CLASS 16—(Continued).

SN 77-036,438. THE UPPER DECK COMPANY, NORTH LAS VEGAS, NV. FILED 11-3-2006.

WALLSTARS

THE MARK CONSISTS OF STANDARD CHARACTERS WITHOUT CLAIM TO ANY PARTICULAR FONT, STYLE, SIZE, OR COLOR.

FOR STICKERS; ALBUMS FOR STICKERS; BUMPER STICKERS; STICKER BOOKS; APPLIQUES IN THE FORM OF DECALS; ADHESIVE LABELS; PRINTED PAPER LABELS; PRINTED MATTER; NAMELY, MAGAZINES IN THE FIELD OF SPORTS OR ENTERTAINMENT; COMIC BOOKS; COMIC STRIPS; CARTOON PRINTS; NEWSPAPER CARTOONS; COLORING BOOKS; CHILDREN'S BOOKS; CHILDREN'S ACTIVITY BOOKS; NOTEBOOKS; COMPOSITION BOOKS; SCRAPBOOKS; PHOTO ALBUMS; BINDERS; STATIONERY; WRITING JOURNALS; POSTERS; PACKAGING; NAMELY, BLISTER CARDS; POSTCARDS; GREETING CARDS; BLANK CARDS; NOTE CARDS; GIFT CARDS; BUSINESS CARDS; OCCASION CARDS; DESK CALENDARS; DESK PADS AND DESK TOP ORGANIZERS; BOOKMARKS; CALENDARS; PEN CASES; PENCIL CASES; LUNCH BAGS; TEMPORARY BODY TATTOOS (U.S. CLS. 2, 5, 22, 23, 29, 37, 38 AND 50).

FIRST USE 8-1-2006; IN COMMERCE 8-1-2006. ANNE MADDEN, EXAMINING ATTORNEY

SN 77-066,168. BAYLISS CONSULTING SERVICES AND FLEXIBLE PACKAGING MANUFACTURING LLC, SCARSDALE, NY. FILED 12-18-2006.

Smartcube

THE MARK CONSISTS OF STANDARD CHARACTERS WITHOUT CLAIM TO ANY PARTICULAR FONT, STYLE, SIZE, OR COLOR.

FOR FLEXIBLE PACKAGING PLASTIC BAG THAT IS USED IN THE PACKAGING OF DRY AND LIQUID GOODS IN THE 0 - 55 GALLON RANGE (U.S. CLS. 2, 5, 22, 23, 29, 37, 38 AND 50).

FIRST USE 1-1-2006; IN COMMERCE 1-1-2006. ASMAT KHAN, EXAMINING ATTORNEY

CLASS 16—(Continued).

SN 77-067,830. JANOW, SUSAN BENAY, KAILUA, HI. FILED 12-19-2006.

The Colors of Hawaii

THE MARK CONSISTS OF STANDARD CHARACTERS WITHOUT CLAIM TO ANY PARTICULAR FONT, STYLE, SIZE, OR COLOR.

NO CLAIM IS MADE TO THE EXCLUSIVE RIGHT TO USE "HAWAII", APART FROM THE MARK AS SHOWN.

FOR FINE ART IMAGES, NAMELY, PHOTOGRAPHS, PRINTS, AND PAINTINGS (U.S. CLS. 2, 5, 22, 23, 29, 37, 38 AND 50).

FIRST USE 11-1-2003; IN COMMERCE 5-1-2004. WON TEAK OH, EXAMINING ATTORNEY

SN 77-074,692. NATASHA SPICKLER FENSTER, STAMFORD, CT. FILED 1-2-2007.



NO CLAIM IS MADE TO THE EXCLUSIVE RIGHT TO USE "PHOTO", APART FROM THE MARK AS SHOWN.

THE MARK CONSISTS OF STYLIZED WORDS FOTO FLOPPIES.

FOR MEMORY BOOKS (U.S. CLS. 2, 5, 22, 23, 29, 37, 38 AND 50).

MARCIE MILONE, EXAMINING ATTORNEY

SN 77-081,407. LATINO FUTURE VENTURES CORP., PHOENIX, AZ. FILED 1-11-2007.

LATINO FUTURE

THE MARK CONSISTS OF STANDARD CHARACTERS WITHOUT CLAIM TO ANY PARTICULAR FONT, STYLE, SIZE, OR COLOR.

NO CLAIM IS MADE TO THE EXCLUSIVE RIGHT TO USE "LATINO", APART FROM THE MARK AS SHOWN.

FOR MAGAZINES FEATURING LATIN AMERICAN GENERAL INTEREST AND CULTURAL ISSUES (U.S. CLS. 2, 5, 22, 23, 29, 37, 38 AND 50).

FIRST USE 1-17-2002; IN COMMERCE 1-17-2002. MARK SPARACINO, EXAMINING ATTORNEY

CLASS 16—(Continued).

SN 77-092,273. DRG TEXAS, LP, BERNE, IN. FILED 1-26-2007.

TOWN SQUARE

THE MARK CONSISTS OF STANDARD CHARACTERS WITHOUT CLAIM TO ANY PARTICULAR FONT, STYLE, SIZE, OR COLOR.

FOR GENERAL INTEREST PUBLICATIONS, NAMELY MAGAZINES FEATURING STORIES AND ARTICLES ABOUT THE SMALL TOWN LIFESTYLE (U.S. CLS. 2, 5, 22, 23, 29, 37, 38 AND 50).

FIRST USE 1-15-2007; IN COMMERCE 1-15-2007.
SETH A. RAPPAPORT, EXAMINING ATTORNEY

SN 77-095,354. DRG TEXAS, LP, BERNE, IN. FILED 1-31-2007.

GIFTMAKER

THE MARK CONSISTS OF STANDARD CHARACTERS WITHOUT CLAIM TO ANY PARTICULAR FONT, STYLE, SIZE, OR COLOR.

FOR MAGAZINES IN THE AREA OF PAPER CRAFTS AND CRAFTS THAT INCLUDE DIGITAL CRAFTING, STAMPING, EMBELLISHING, PAINTING, SEWING, KNITTING AND CROCHETING (U.S. CLS. 2, 5, 22, 23, 29, 37, 38 AND 50).

SETH A. RAPPAPORT, EXAMINING ATTORNEY

SN 77-097,430. SCHWEIZER, KENNETH R, NORWALK, CT. FILED 2-1-2007.

KENNY PENNY

THE MARK CONSISTS OF STANDARD CHARACTERS WITHOUT CLAIM TO ANY PARTICULAR FONT, STYLE, SIZE, OR COLOR.

FOR CHILDREN'S BOOKS (U.S. CLS. 2, 5, 22, 23, 29, 37, 38 AND 50).

FIRST USE 1-1-2007; IN COMMERCE 1-1-2007.
MICHELE SWAIN, EXAMINING ATTORNEY

CLASS 16—(Continued).

SN 77-101,593. THE MASTER-PLAYER LIBRARY, FLAG-STAFF, AZ. FILED 2-7-2007.

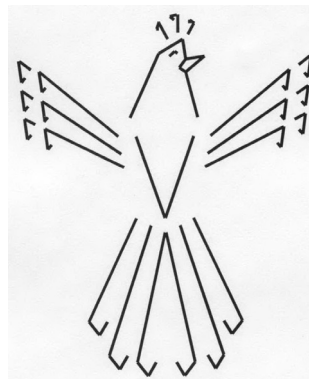

THE MARK CONSISTS OF A BIRD IN VERTICAL FLIGHT.

FOR SERIES OF FICTION AND NON-FICTION BOOKS ON A VARIETY OF TOPICS (U.S. CLS. 2, 5, 22, 23, 29, 37, 38 AND 50).

FIRST USE 2-7-2007; IN COMMERCE 2-7-2007.
MATTHEW MCDOWELL, EXAMINING ATTORNEY

SN 77-107,061. DND COMMUNICATIONS, LLC, ST. CHARLES, MO. FILED 2-14-2007.

Magazine
SAINT CHARLES
For Gracious Living in St. Charles County

OWNER OF U.S. REG. NOS. 2,429,918, 3,109,112 AND 3,204,737.

NO CLAIM IS MADE TO THE EXCLUSIVE RIGHT TO USE "MAGAZINE" AND "LIVING IN SAINT CHARLES COUNTY", APART FROM THE MARK AS SHOWN.

SEC. 2(F) AS TO SAINT CHARLES.

FOR GENERAL FEATURE MAGAZINES (U.S. CLS. 2, 5, 22, 23, 29, 37, 38 AND 50).

FIRST USE 2-0-2004; IN COMMERCE 2-0-2004.
TRACY WHITTAKER-BROWN, EXAMINING ATTORNEY

SN 77-112,330. RIBONS, ELIZABETH, CALABASAS, CA. FILED 2-21-2007.



Elizabeth Ribons

NO CLAIM IS MADE TO THE EXCLUSIVE RIGHT TO USE "DESIGN", APART FROM THE MARK AS SHOWN.

FOR BOOKS IN THE FIELD OF DIFFERENT AREAS OF DESIGN; MAGAZINE COLUMNS ABOUT DIFFERENT AREAS OF DESIGN; SYNDICATED NEWSPAPER COLUMNS DEALING WITH DIFFERENT AREAS OF DESIGN (U.S. CLS. 2, 5, 22, 23, 29, 37, 38 AND 50).

RONALD MCMORROW, EXAMINING ATTORNEY

CLASS 16—(Continued).

SN 77-113,155. FLYNT, DEBORAH A., DAVIE, FL. FILED 2-22-2007.

TUNE TOON

THE MARK CONSISTS OF STANDARD CHARACTERS WITHOUT CLAIM TO ANY PARTICULAR FONT, STYLE, SIZE, OR COLOR.

NO CLAIM IS MADE TO THE EXCLUSIVE RIGHT TO USE "TOON", APART FROM THE MARK AS SHOWN.

FOR NEWSPAPER CARTOONS (U.S. CLS. 2, 5, 22, 23, 29, 37, 38 AND 50).

FIRST USE 12-3-1997; IN COMMERCE 12-3-1997.
TRACY WHITTAKER-BROWN, EXAMINING ATTORNEY

SN 77-114,537. VICTORY, MARSHA, LIVERMORE, CA. FILED 2-23-2007.

LdyJessika

THE MARK CONSISTS OF STANDARD CHARACTERS WITHOUT CLAIM TO ANY PARTICULAR FONT, STYLE, SIZE, OR COLOR.

THE NAME LDYJESSIKA DOES NOT IDENTIFY A LIVING INDIVIDUAL.

FOR SERIES OF FICTION BOOKS (U.S. CLS. 2, 5, 22, 23, 29, 37, 38 AND 50).

FIRST USE 4-10-1995; IN COMMERCE 4-17-1995.
C. DIONNE CLYBURN, EXAMINING ATTORNEY

KAPIL BHANOT, EXAMINING ATTORNEY

CLASS 16—(Continued).

SN 77-116,404. NASHVILLE SOUNDS BASEBALL CLUB LIMITED PARTNERSHIP, NASHVILLE, TN. FILED 2-26-2007.



NO CLAIM IS MADE TO THE EXCLUSIVE RIGHT TO USE "NASHVILLE", APART FROM THE MARK AS SHOWN.

THE MARK CONSISTS OF THE DESIGN OF A SEAL CONTAINING THE WORD "NASHVILLE", THE SILHOUETTE OF A BASEBALL PLAYER WITH A BAT AND BALL, CITY SKYLINE, AND THE UNDERLINED WORD "SOUNDS".

FOR PAPER GOODS AND PRINTED MATTER; NAMELY DECALS, GAME PROGRAMS, MERCHANDISE BAGS, NEWSLETTERS OF INTEREST TO BASEBALL FANS, NOTE PADS, PAPER CONTAINERS, PAPER SCHEDULES, PENS, PENCILS, POSTCARDS, POSTERS, PRINTED AWARDS, COMMEMORATIVE GAME TICKETS, PRINTED GUIDES OF INTEREST TO BASEBALL FANS, REFERENCE BOOKS OF INTEREST TO BASEBALL FANS, SCORE BOOKS, SCORE CARDS, SCORE SHEETS, STATIONERY, STICKERS, AND TRADING CARDS (U.S. CLS. 2, 5, 22, 23, 29, 37, 38 AND 50).

FIRST USE 10-1-2005; IN COMMERCE 10-1-2005.
DAVID C. REIHNER, EXAMINING ATTORNEY

SN 77-122,644. PRIMO PRODUCTS INTERNATIONAL, INC., CARLSBAD, CA. FILED 3-5-2007.

FEELGOOD STORE

THE MARK CONSISTS OF STANDARD CHARACTERS WITHOUT CLAIM TO ANY PARTICULAR FONT, STYLE, SIZE, OR COLOR.

NO CLAIM IS MADE TO THE EXCLUSIVE RIGHT TO USE "STORE", APART FROM THE MARK AS SHOWN.

FOR MAIL ORDER CATALOGS, POSTCARDS AND BROCHURES FEATURING HEALTH CARE PRODUCTS (U.S. CLS. 2, 5, 22, 23, 29, 37, 38 AND 50).

FIRST USE 4-10-1995; IN COMMERCE 4-17-1995.
C. DIONNE CLYBURN, EXAMINING ATTORNEY

CLASS 16—(Continued).

SN 77-122,862. DISKUS YAYIN ORGANIZASYON VE TICARET LIMITED SIRKETI, AKATLAR BESIKTAS A-1, TURKEY, FILED 3-6-2007.

BESTTEEN

THE MARK CONSISTS OF STANDARD CHARACTERS WITHOUT CLAIM TO ANY PARTICULAR FONT, STYLE, SIZE, OR COLOR.

FOR DAILY NEWSPAPER; NEWSPAPER CARTOONS; NEWSPAPER COMIC STRIPS; NEWSPAPERS; NEWSPAPERS FOR GENERAL CIRCULATION; A SERIES OF BOOKS, WRITTEN ARTICLES, HANDOUTS AND WORKSHEETS IN THE FIELD OF HEALTH; SERIES OF BOOKS IN THE FIELD OF FICTION AND NONFICTION ON A VARIETY OF TOPICS; CHILDREN'S ACTIVITY BOOKS; CHILDREN'S BOOKS; CHILDREN'S INTERACTIVE EDUCATIONAL BOOKS; COLORING BOOKS; COMIC BOOKS; PICTURE BOOKS; RECIPE BOOKS; SCHOOL WRITING BOOKS; SERIES OF FICTION BOOKS; SERIES OF NON-FICTION BOOKS IN THE FIELD OF NON-FICTION ON A VARIETY OF TOPICS; STORY BOOKS; TALKING CHILDREN'S BOOKS; WIREBOUND BOOKS; GENERAL FEATURE MAGAZINES; INFLIGHT MAGAZINES; GENERAL INTEREST MAGAZINES; SYNDICATED GENERAL INTEREST MAGAZINE SECTIONS (U.S. CLS. 2, 5, 22, 23, 29, 37, 38 AND 50).

FRANK LATTUCA, EXAMINING ATTORNEY

CLASS 16—(Continued).

SN 77-122,864. DISKUS YAYIN ORGANIZASYON VE TICARET LIMITED SIRKETI, AKATLAR BESIKTAS A-1, TURKEY, FILED 3-6-2007.

BESTFAMILY

THE MARK CONSISTS OF STANDARD CHARACTERS WITHOUT CLAIM TO ANY PARTICULAR FONT, STYLE, SIZE, OR COLOR.

FOR DAILY NEWSPAPER; NEWSPAPER CARTOONS; NEWSPAPER COMIC STRIPS; NEWSPAPERS; NEWSPAPERS FOR GENERAL CIRCULATION; A SERIES OF BOOKS, WRITTEN ARTICLES, HANDOUTS AND WORKSHEETS IN THE FIELD OF HEALTH; SERIES OF BOOKS IN THE FIELD OF FICTION AND NONFICTION ON A VARIETY OF TOPICS; CHILDREN'S ACTIVITY BOOKS; CHILDREN'S BOOKS; CHILDREN'S INTERACTIVE EDUCATIONAL BOOKS; COLORING BOOKS; COMIC BOOKS; PICTURE BOOKS; RECIPE BOOKS; SCHOOL WRITING BOOKS; SERIES OF FICTION BOOKS; SERIES OF NON-FICTION BOOKS IN THE FIELD OF NON-FICTION ON A VARIETY OF TOPICS; STORY BOOKS; TALKING CHILDREN'S BOOKS; WIREBOUND BOOKS; GENERAL FEATURE MAGAZINES; INFLIGHT MAGAZINES; GENERAL INTEREST MAGAZINES; SYNDICATED GENERAL INTEREST MAGAZINE SECTIONS (U.S. CLS. 2, 5, 22, 23, 29, 37, 38 AND 50).

FRANK LATTUCA, EXAMINING ATTORNEY

SN 77-122,863. DISKUS YAYIN ORGANIZASYON VE TICARET LIMITED SIRKETI, AKATLAR BESIKTAS A-1, TURKEY, FILED 3-6-2007.

BESTKIDS

THE MARK CONSISTS OF STANDARD CHARACTERS WITHOUT CLAIM TO ANY PARTICULAR FONT, STYLE, SIZE, OR COLOR.

FOR DAILY NEWSPAPER; NEWSPAPER CARTOONS; NEWSPAPER COMIC STRIPS; NEWSPAPERS; NEWSPAPERS FOR GENERAL CIRCULATION; A SERIES OF BOOKS, WRITTEN ARTICLES, HANDOUTS AND WORKSHEETS IN THE FIELD OF HEALTH; SERIES OF BOOKS IN THE FIELD OF FICTION AND NONFICTION ON A VARIETY OF TOPICS; CHILDREN'S ACTIVITY BOOKS; CHILDREN'S BOOKS; CHILDREN'S INTERACTIVE EDUCATIONAL BOOKS; COLORING BOOKS; COMIC BOOKS; PICTURE BOOKS; RECIPE BOOKS; SCHOOL WRITING BOOKS; SERIES OF FICTION BOOKS; SERIES OF NON-FICTION BOOKS IN THE FIELD OF NON-FICTION ON A VARIETY OF TOPICS; STORY BOOKS; TALKING CHILDREN'S BOOKS; WIREBOUND BOOKS; GENERAL FEATURE MAGAZINES; INFLIGHT MAGAZINES; GENERAL INTEREST MAGAZINES; SYNDICATED GENERAL INTEREST MAGAZINE SECTIONS (U.S. CLS. 2, 5, 22, 23, 29, 37, 38 AND 50).

FRANK LATTUCA, EXAMINING ATTORNEY

SN 77-122,865. DISKUS YAYIN ORGANIZASYON VE TICARET LIMITED SIRKETI, AKATLAR BESIKTAS A-1, TURKEY, FILED 3-6-2007.

BESTWOMEN

THE MARK CONSISTS OF STANDARD CHARACTERS WITHOUT CLAIM TO ANY PARTICULAR FONT, STYLE, SIZE, OR COLOR.

FOR DAILY NEWSPAPER; NEWSPAPER CARTOONS; NEWSPAPER COMIC STRIPS; NEWSPAPERS; NEWSPAPERS FOR GENERAL CIRCULATION; A SERIES OF BOOKS, WRITTEN ARTICLES, HANDOUTS AND WORKSHEETS IN THE FIELD OF HEALTH; SERIES OF BOOKS IN THE FIELD OF FICTION AND NONFICTION ON A VARIETY OF TOPICS; CHILDREN'S ACTIVITY BOOKS; CHILDREN'S BOOKS; CHILDREN'S INTERACTIVE EDUCATIONAL BOOKS; COLORING BOOKS; COMIC BOOKS; PICTURE BOOKS; RECIPE BOOKS; SCHOOL WRITING BOOKS; SERIES OF FICTION BOOKS; SERIES OF NON-FICTION BOOKS IN THE FIELD OF NON-FICTION ON A VARIETY OF TOPICS; STORY BOOKS; TALKING CHILDREN'S BOOKS; WIREBOUND BOOKS; GENERAL FEATURE MAGAZINES; INFLIGHT MAGAZINES; GENERAL INTEREST MAGAZINES; SYNDICATED GENERAL INTEREST MAGAZINE SECTIONS (U.S. CLS. 2, 5, 22, 23, 29, 37, 38 AND 50).

FRANK LATTUCA, EXAMINING ATTORNEY

CLASS 16—(Continued).

SN 77-122,866. DISKUS YAYIN ORGANIZASYON VE TICARET LIMITED SIRKETI, AKATLAR BESIKTAS A-1, TURKEY, FILED 3-6-2007.

BESTGIRL

THE MARK CONSISTS OF STANDARD CHARACTERS WITHOUT CLAIM TO ANY PARTICULAR FONT, STYLE, SIZE, OR COLOR.

FOR DAILY NEWSPAPER; NEWSPAPER CARTOONS; NEWSPAPER COMIC STRIPS; NEWSPAPERS; NEWSPAPERS FOR GENERAL CIRCULATION; A SERIES OF BOOKS, WRITTEN ARTICLES, HANDOUTS AND WORKSHEETS IN THE FIELD OF HEALTH; SERIES OF BOOKS IN THE FIELD OF FICTION AND NONFICTION ON A VARIETY OF TOPICS; CHILDREN'S ACTIVITY BOOKS; CHILDREN'S BOOKS; CHILDREN'S INTERACTIVE EDUCATIONAL BOOKS; COLORING BOOKS; COMIC BOOKS; PICTURE BOOKS; RECIPE BOOKS; SCHOOL WRITING BOOKS; SERIES OF FICTION BOOKS; SERIES OF NON-FICTION BOOKS IN THE FIELD OF NON-FICTION ON A VARIETY OF TOPICS; STORY BOOKS; TALKING CHILDREN'S BOOKS; WIREBOUND BOOKS; GENERAL FEATURE MAGAZINES; INFLIGHT MAGAZINES; GENERAL INTEREST MAGAZINES; SYNDICATED GENERAL INTEREST MAGAZINE SECTIONS (U.S. CLS. 2, 5, 22, 23, 29, 37, 38 AND 50).

FRANK LATTUCA, EXAMINING ATTORNEY

CLASS 16—(Continued).

SN 77-124,027. DISKUS YAYIN ORGANIZASYON VE TICARET LIMITED SIRKETI, AKATLAR BESIKTAS A-1, TURKEY, FILED 3-7-2007.

BESTMEN

THE MARK CONSISTS OF STANDARD CHARACTERS WITHOUT CLAIM TO ANY PARTICULAR FONT, STYLE, SIZE, OR COLOR.

FOR DAILY NEWSPAPER; NEWSPAPER CARTOONS; NEWSPAPER COMIC STRIPS; NEWSPAPERS; NEWSPAPERS FOR GENERAL CIRCULATION; A SERIES OF BOOKS, WRITTEN ARTICLES, HANDOUTS AND WORKSHEETS IN THE FIELD OF HEALTH; SERIES OF BOOKS IN THE FIELD OF FICTION AND NONFICTION ON A VARIETY OF TOPICS; CHILDREN'S ACTIVITY BOOKS; CHILDREN'S BOOKS; CHILDREN'S INTERACTIVE EDUCATIONAL BOOKS; COLORING BOOKS; COMIC BOOKS; PICTURE BOOKS; RECIPE BOOKS; SCHOOL WRITING BOOKS; SERIES OF FICTION BOOKS; SERIES OF NON-FICTION BOOKS IN THE FIELD OF NON-FICTION ON A VARIETY OF TOPICS; STORY BOOKS; TALKING CHILDREN'S BOOKS; WIREBOUND BOOKS; GENERAL FEATURE MAGAZINES; INFLIGHT MAGAZINES; GENERAL INTEREST MAGAZINES; SYNDICATED GENERAL INTEREST MAGAZINE SECTIONS (U.S. CLS. 2, 5, 22, 23, 29, 37, 38 AND 50).

FRANK LATTUCA, EXAMINING ATTORNEY

SN 77-123,376. HIGHLIGHTS FOR CHILDREN, INC., COLUMBUS, OH. FILED 3-6-2007.

Highlights Puzzle Buzz

THE MARK CONSISTS OF STANDARD CHARACTERS WITHOUT CLAIM TO ANY PARTICULAR FONT, STYLE, SIZE, OR COLOR.

OWNER OF U.S. REG. NOS. 441,032, 2,219,711 AND OTHERS.

NO CLAIM IS MADE TO THE EXCLUSIVE RIGHT TO USE "PUZZLE", APART FROM THE MARK AS SHOWN.

FOR CHILDREN'S ACTIVITY BOOKS (U.S. CLS. 2, 5, 22, 23, 29, 37, 38 AND 50).

KIMBERLY FRYE, EXAMINING ATTORNEY

SN 77-125,534. THE WECK CORPORATION, NEW YORK, NY. FILED 3-8-2007.

GRACIOUS HOME

THE MARK CONSISTS OF STANDARD CHARACTERS WITHOUT CLAIM TO ANY PARTICULAR FONT, STYLE, SIZE, OR COLOR.

OWNER OF U.S. REG. NOS. 947,721 AND 2,284,659. FOR PAPER AND CARDBOARD GIFT BOXES (U.S. CLS. 2, 5, 22, 23, 29, 37, 38 AND 50).

FIRST USE 12-4-2000; IN COMMERCE 12-4-2000.

DAVID H. STINE, EXAMINING ATTORNEY

CLASS 16—(Continued).

SN 77-125,657. HARCOURT, INC., ORLANDO, FL. FILED 3-8-2007.

CALL TO CELEBRATE

THE MARK CONSISTS OF STANDARD CHARACTERS WITHOUT CLAIM TO ANY PARTICULAR FONT, STYLE, SIZE, OR COLOR.

FOR PRINTED INSTRUCTIONAL, EDUCATIONAL, AND TEACHING MATERIALS IN THE FIELD OF RELIGION, FOR USE DURING THE PROVISION OF RELIGIOUS INSTRUCTION (U.S. CLS. 2, 5, 22, 23, 29, 37, 38 AND 50).

FIRST USE 9-21-2005; IN COMMERCE 9-21-2005.
ELISSA GARBER KON, EXAMINING ATTORNEY

SN 77-127,693. RICHMOND, ELMORE, III, BROOKLYN, NY. FILED 3-10-2007.

Snob Magazine

THE MARK CONSISTS OF STANDARD CHARACTERS WITHOUT CLAIM TO ANY PARTICULAR FONT, STYLE, SIZE, OR COLOR.

NO CLAIM IS MADE TO THE EXCLUSIVE RIGHT TO USE "MAGAZINE", APART FROM THE MARK AS SHOWN.

FOR MAGAZINES FEATURING FASHION, ARTS, VINTAGE AND COLLECTORS' CLOTHING AND LIFESTYLE (U.S. CLS. 2, 5, 22, 23, 29, 37, 38 AND 50).

KEVON CHISOLM, EXAMINING ATTORNEY

SN 77-129,850. ALLEBEST, CHRISTIAAN, LAGUNA HILLS, CA. FILED 3-13-2007.

CAPTAIN ALMIGHTY

THE MARK CONSISTS OF STANDARD CHARACTERS WITHOUT CLAIM TO ANY PARTICULAR FONT, STYLE, SIZE, OR COLOR.

FOR COMIC BOOKS, POSTERS (U.S. CLS. 2, 5, 22, 23, 29, 37, 38 AND 50).

BARBARA A. GOLD, EXAMINING ATTORNEY

CLASS 16—(Continued).

SN 77-129,937. BEST COMMUNITY VALUES, INC., ALTA-MONTE SPRINGS, FL. FILED 3-13-2007.



NO CLAIM IS MADE TO THE EXCLUSIVE RIGHT TO USE "BEST", APART FROM THE MARK AS SHOWN.

THE COLOR(S) RED, BLACK, WHITE, GRAY AND ORANGE IS/ARE CLAIMED AS A FEATURE OF THE MARK.

THE MARK CONSISTS OF THE COLOR RED APPEARING IN THE WORDING "COMMUNITY"; THE COLOR BLACK APPEARS IN THE BOTTOM OF THE MISCELLANEOUS DESIGN BEHIND THE WORDING "VALUES" THE COLOR WHITE APPEARS IN THE UPPER BORDER OF THE MISCELLANEOUS DESIGN; THE COLOR GRAY APPEARS IN THE WORDING "BEST" & THE INNER BORDER OF THE MISCELLANEOUS DESIGN AND THE COLOR ORANGE APPEARS IN THE BACKGROUND OF THE WORDING "BEST".

FOR COUPON BOOKS (U.S. CLS. 2, 5, 22, 23, 29, 37, 38 AND 50).

REGINA DRUMMOND, EXAMINING ATTORNEY

SN 77-130,339. GHIA, "WALLY" FLAVIO, SARASOTA, FL. FILED 3-13-2007.

NECFASH

THE MARK CONSISTS OF STANDARD CHARACTERS WITHOUT CLAIM TO ANY PARTICULAR FONT, STYLE, SIZE, OR COLOR.

FOR EDUCATIONAL MATERIALS, NAMELY, PRINTED TEACHING MATERIALS FOR THE MEDICAL COMMUNITY IN THE FIELD OF AWARENESS AND RECOGNITION OF SYMPTOMS, TREATMENT OPTIONS, AND PREVENTIVE MEASURES RELATING TO THE DISEASE KNOWN AS NECROTIZING FASCIITIS (U.S. CLS. 2, 5, 22, 23, 29, 37, 38 AND 50).

KELLY BOULTON, EXAMINING ATTORNEY

CLASS 16—(Continued).

SN 77-131,081. WILLIAM E. RUSSELL, JR., ADDISON, TX.
FILED 3-14-2007.

INFORM - If you're not informed, it shows

THE MARK CONSISTS OF STANDARD CHARACTERS WITHOUT CLAIM TO ANY PARTICULAR FONT, STYLE, SIZE, OR COLOR.

FOR MAGAZINES FEATURING ARTICLES AND PROMOTIONAL MATERIAL RELATING TO HEALTH, COSMETIC SURGERY AND PERSONAL AESTHETICS TREATMENTS (U.S. CLS. 2, 5, 22, 23, 29, 37, 38 AND 50).

FIRST USE 3-1-2001; IN COMMERCE 3-1-2001.
BRIAN NEVILLE, EXAMINING ATTORNEY

SN 77-131,783. BUCKWELL, JEFFREY DAVID, HUNTINGTON BEACH, CA. FILED 3-15-2007.

My Top Ten Secrets

THE MARK CONSISTS OF STANDARD CHARACTERS WITHOUT CLAIM TO ANY PARTICULAR FONT, STYLE, SIZE, OR COLOR.

NO CLAIM IS MADE TO THE EXCLUSIVE RIGHT TO USE TOP TEN, APART FROM THE MARK AS SHOWN.

FOR A SERIES OF BOOKS, WRITTEN ARTICLES, HANDOUTS AND WORKSHEETS IN THE FIELD OF SELF HELP, CONSISTING OF THE TOP TEN SECRETS OR TIPS FROM PROFESSIONALS AND EXPERTS WITHIN THEIR FIELD OF EXPERTISE (U.S. CLS. 2, 5, 22, 23, 29, 37, 38 AND 50).

KAPIL BHANOT, EXAMINING ATTORNEY

SN 77-131,975. NEXT INNOVATIONS, LTD., WALKER, MN.
FILED 3-15-2007.

TruImage

THE MARK CONSISTS OF STANDARD CHARACTERS WITHOUT CLAIM TO ANY PARTICULAR FONT, STYLE, SIZE, OR COLOR.

FOR PRINT METAL SUBSTRATE, NAMELY, TRANSPARENT, OPAQUE, AND TRANSLUCENT FILMS CONTAINING DYE-SUBLIMATION INK APPLIED BY A HEAT TRANSFER PRESS (U.S. CLS. 2, 5, 22, 23, 29, 37, 38 AND 50).

FIRST USE 2-5-2007; IN COMMERCE 3-12-2007.
RONALD AIKENS, EXAMINING ATTORNEY

CLASS 16—(Continued).

SN 77-132,099. NEXT INNOVATIONS, LTD., WALKER, MN.
FILED 3-15-2007.

Truelmage

THE MARK CONSISTS OF STANDARD CHARACTERS WITHOUT CLAIM TO ANY PARTICULAR FONT, STYLE, SIZE, OR COLOR.

FOR PRINT METAL SUBSTRATE, NAMELY, TRANSPARENT, OPAQUE, AND TRANSLUCENT FILMS CONTAINING DYE-SUBLIMATION INK APPLIED BY A HEAT TRANSFER PRESS (U.S. CLS. 2, 5, 22, 23, 29, 37, 38 AND 50).

FIRST USE 2-5-2007; IN COMMERCE 3-12-2007.
RONALD AIKENS, EXAMINING ATTORNEY

SN 77-133,806. BING NOTE, INC., OAKLAND, CA. FILED 3-18-2007.

THAT'S BINGZY!

THE MARK CONSISTS OF STANDARD CHARACTERS WITHOUT CLAIM TO ANY PARTICULAR FONT, STYLE, SIZE, OR COLOR.

FOR A SERIES OF BOOKS, WRITTEN ARTICLES, HANDOUTS AND WORKSHEETS IN THE FIELD OF CHILDREN'S EDUCATION; BABY BOOKS; BOOK COVERS; BOOKS IN THE FIELD OF CHILDREN'S EDUCATION; CHILDREN'S ACTIVITY BOOKS; CHILDREN'S BOOKS; CHILDREN'S INTERACTIVE EDUCATIONAL BOOKS; COFFEE TABLE BOOKS FEATURING CHILDREN'S STORIES; COLORING BOOKS; COMIC BOOKS; DICTATION BOOKS; EDUCATIONAL BOOKS FEATURING CHILDREN'S STORIES; EDUCATIONAL PUBLICATIONS, NAMELY, EDUCATIONAL LEARNING CARDS, FLASH CARDS, ACTIVITY CARDS, WORKBOOKS, TEXTBOOKS, ACTIVITY BOOKS, STORY BOOKS, PUZZLE BOOKS, PUZZLES, TEACHER GUIDES, MANUALS, POSTERS, EDUCATIONAL CARD GAMES AND EDUCATIONAL BOOKLETS IN THE FIELD OF CHILDREN'S EDUCATION; EXERCISE BOOKS; NOTE BOOKS; PICTURE BOOKS; PRINTED MUSIC BOOKS; SCHOOL SUPPLY KITS CONTAINING VARIOUS COMBINATIONS OF SELECTED SCHOOL SUPPLIES, NAMELY, WRITING INSTRUMENTS, PENS, PENCILS, MECHANICAL PENCILS, ERASERS, MARKERS, CRAYONS, HIGHLIGHTERS, FOLDERS, NOTEBOOKS, PAPER, GRADUATED RULERS, PROTRACTORS, PAPER CLIPS, PENCIL SHARPENERS, WRITING GRIPS, GLUE AND BOOK MARKS; SCHOOL WRITING BOOKS; SERIES OF FICTION BOOKS; STORY BOOKS; TALKING CHILDREN'S BOOKS; WIREBOUND BOOKS (U.S. CLS. 2, 5, 22, 23, 29, 37, 38 AND 50).

B. PARADEWELAI, EXAMINING ATTORNEY

CLASS 16—(Continued).

SN 77-134,395. LINDA TYLER & ASSOCIATES, LLC, WILDWOOD, MO. FILED 3-19-2007.

poodletales

THE MARK CONSISTS OF STANDARD CHARACTERS WITHOUT CLAIM TO ANY PARTICULAR FONT, STYLE, SIZE, OR COLOR.

FOR AUTOGRAPH BOOKS; BIRTHDAY BOOKS; BLANK JOURNAL BOOKS; BRAG BOOKS; CHILDREN'S ACTIVITY BOOKS; CHILDREN'S BOOKS; CHILDREN'S INTERACTIVE EDUCATIONAL BOOKS; COLORING BOOKS; COMIC BOOKS; COMPOSITION BOOKS; COPY BOOKS; DATE BOOKS; MEMORY BOOKS; NOTE BOOKS; PICTURE BOOKS; POCKET MEMORANDUM BOOKS; PRINTED MUSIC BOOKS; SCHOOL SUPPLY KITS CONTAINING VARIOUS COMBINATIONS OF SELECTED SCHOOL SUPPLIES, NAMELY, WRITING INSTRUMENTS, PENS, PENCILS, MECHANICAL PENCILS, ERASERS, MARKERS, CRAYONS, HIGHLIGHTERS, FOLDERS, NOTEBOOKS, PAPER, GRADUATED RULERS, PROTRACTORS, PAPER CLIPS, PENCIL SHARPENERS, WRITING GRIPS, GLUE AND BOOK MARKS; SCHOOL WRITING BOOKS; SERIES OF FICTION BOOKS; SKETCH BOOKS; SONG BOOKS; STORY BOOKS; TALKING CHILDREN'S BOOKS; TELEPHONE NUMBER BOOKS (U.S. CLS. 2, 5, 22, 23, 29, 37, 38 AND 50).

KHANH LE, EXAMINING ATTORNEY

SN 77-134,459. ARCADE FIRE MUSIC LLC, LOS ANGELES, CA. FILED 3-19-2007.

THE ARCADE FIRE

THE MARK CONSISTS OF STANDARD CHARACTERS WITHOUT CLAIM TO ANY PARTICULAR FONT, STYLE, SIZE, OR COLOR.

FOR PRINTED MATTER, PAPER AND STATIONERY PRODUCTS, NAMELY, POSTERS, POSTER BOOKS, CALENDARS, CONCERT SOUVENIR PROGRAMS, STICKERS, BUMPER STICKERS, POSTCARDS, PICTURE POSTCARDS, GREETING CARDS, TRADING CARDS, STATIONERY, PENS, PENCILS, DECALS, PHOTOGRAPHS, SHEET MUSIC, AND BOOKS AND MAGAZINES IN THE FIELDS OF MUSIC, ENTERTAINMENT, ART AND/OR CULTURE (U.S. CLS. 2, 5, 22, 23, 29, 37, 38 AND 50).

LEIGH CAROLINE CASE, EXAMINING ATTORNEY

CLASS 16—(Continued).

SN 77-134,683. MRS. JOHN L. STRONG CO. INC., NEW YORK, NY. FILED 3-19-2007.

READY TO WRITE

THE MARK CONSISTS OF STANDARD CHARACTERS WITHOUT CLAIM TO ANY PARTICULAR FONT, STYLE, SIZE, OR COLOR.

FOR STATIONERY; BUSINESS CARDS; PAPER PRODUCTS, NAMELY, SOCIAL CALLING CARDS; SOCIAL NOTE CARDS; NOTE CARDS; NOTEPADS; CORRESPONDENCE CARDS; ENVELOPES; CORRESPONDENCE HOLDERS AND RACKS; LETTER OPENERS; WRITING PAPER; LETTER WRITING SHEETS; CALLIGRAPHY PAPER; INVITATIONS; ANNOUNCEMENT CARDS; CHANGE OF ADDRESS CARDS; MENU CARDS; PLACE CARDS; TABLE NUMBER CARDS; ADDRESS LABELS; PRINTED PAPER LABELS; PAPER GIFT LABELS; SEALING STAMPS; SEALING WAX; ADHESIVE GIFT SEALS; ADHESIVE GIFT SEALING WAFERS; BOOK PLATES; WRITING TABLETS; WRITING PADS; PAPER AND CARDBOARD GIFT BOXES; RECIPE CARDS; STATIONERY BOXES; COASTERS MADE OF PAPER; BOOKMARKS; PAPER GIFT TAGS, WITH AND WITHOUT RIBBONS; DRAWING RULERS; PAPER FOLDING APPARATUS, NAMELY, FOLDING BONES; PENCILS; PENS; HIGHLIGHTING PENS; INK PENS; FOUNTAIN PENS; PEN AND PENCIL CASES AND BOXES; PEN AND PENCIL TRAYS; DESK STAND HOLDERS FOR PENS, PENCILS AND INK; ERASERS; RUBBER STAMPS; SEALING STAMPS; STAMP PADS; SLEEVES FOR HOLDING AND PROTECTING STAMPS; STAMP CASES; STAMP INK; STAMP INK PADS; WRITING INKS; PEN INK REFILLS; STATIONERY CASES; CARRYING CASES MADE OF PAPER AND CARDBOARD; GREETING CARDS; HOLIDAY CARDS; BLANK WRITING JOURNALS; BLANK JOURNAL BOOKS; DAILY PLANNERS; DIARIES; AGENDAS; BOOK COVERS; CALENDARS; BLOTTERS; DESK PADS; ALBUMS FOR PHOTOGRAPHS; STATIONERY KITS COMPRISED OF STATIONERY, PENS, PENCILS AND CANDLES (U.S. CLS. 2, 5, 22, 23, 29, 37, 38 AND 50).

FIRST USE 10-3-2003; IN COMMERCE 10-3-2003.
KATHERINE CHANG, EXAMINING ATTORNEY

SN 77-134,719. SOMEDAY DESIGNS, LLC, SYOSSET, NY. FILED 3-19-2007.

SWEETSTRINGS

THE MARK CONSISTS OF STANDARD CHARACTERS WITHOUT CLAIM TO ANY PARTICULAR FONT, STYLE, SIZE, OR COLOR.

FOR GREETING CARDS SUPPLIED IN A CONTAINER AND CELEBRATORY PAPER BANNERS SUPPLIED IN A CONTAINER (U.S. CLS. 2, 5, 22, 23, 29, 37, 38 AND 50).

AMEETA JORDAN, EXAMINING ATTORNEY

CLASS 16—(Continued).

SN 77-135,113. BLANCHARD ENTERPRISES, INC., ROLLING MEADOWS, IL. FILED 3-20-2007.



THE MARK CONSISTS OF THE WORD HANDIRECORDS WITH DOTS ABOVE AND A PEN.

FOR CALENDAR REFILLS; CALENDAR-FINISHED PAPER; CALENDARS; POCKET CALENDARS; PRINTED CALENDARS; DAILY PLANNERS; DAY PLANNERS; DESKTOP PLANNERS; TIME PLANNERS; PRESCRIPTION REMINDER PADS; CHECKBOOK COVERS; CHECKBOOK HOLDERS; ADDRESS LISTS; PRINTED PRODUCTS, NAMELY, LISTS FEATURING SHOPPING NEEDS, MEDICATIONS, PHONE NUMBERS, CHARITABLE DONATIONS, WEBSITES AND PASSWORDS, EMERGENCY CONTACTS, MEDICAL HISTORIES; WRITING PADS; MEMO PADS; NOTE BOOKS; PAPER NOTE TABLETS (U.S. CLS. 2, 5, 22, 23, 29, 37, 38 AND 50).

FIRST USE 3-16-2007; IN COMMERCE 3-16-2007.

TAMARA FRAZIER, EXAMINING ATTORNEY

SN 77-135,353. GERALDINE ALEXIS, OMAHA, NE. FILED 3-20-2007.

GEORGIA PANTS

THE MARK CONSISTS OF STANDARD CHARACTERS WITHOUT CLAIM TO ANY PARTICULAR FONT, STYLE, SIZE, OR COLOR.

FOR BABIES' DIAPERS OF PAPER, DISPOSABLE DIAPERS, DISPOSABLE PADS FOR DIAPER CHANGING, PAPER DIAPERS, PAPER LINERS FOR DIAPERS, PAPER PADS FOR CHANGING DIAPERS, PLASTIC BAGS FOR DISPOSABLE DIAPERS, AND PLASTIC DISPOSABLE DIAPER BAGS (U.S. CLS. 2, 5, 22, 23, 29, 37, 38 AND 50).

DAVID TAYLOR, EXAMINING ATTORNEY

CLASS 16—(Continued).

SN 77-135,556. THE POPPI COMPANY, MILWAUKEE, WI. FILED 3-20-2007.

LAPOPI

THE MARK CONSISTS OF STANDARD CHARACTERS WITHOUT CLAIM TO ANY PARTICULAR FONT, STYLE, SIZE, OR COLOR.

FOR POSTCARDS; CARDBOARD PACKAGING; PACKAGING, NAMELY BLISTER CARDS; PAPER FOR WRAPPING AND PACKAGING (U.S. CLS. 2, 5, 22, 23, 29, 37, 38 AND 50).

ALYSSA PALADINO, EXAMINING ATTORNEY

SN 77-135,816. CUSTOM CREATION BY SHIRTTAIL L.L.C., MANASSAS, VA. FILED 3-20-2007.



THE MARK CONSISTS OF A STYLIZED LETTER C THAT IS USED TO COMPLETE THE WORDS 'CUSTOM' AND 'CREATION'.

FOR CALENDARS, BUSINESS CARDS, GREETING CARDS, POSTCARDS, TRADING CARDS, PRINTS OF PICTURES, MEMORY MATES, NAMELY, COLLAGES; MAGAZINE COVERS, GALLERY WRAPS, NAMELY, PICTURES MOUNTED ON CANVAS; PRINTED TICKETS, AND PICTURES MOUNTED ONTO SLATE (U.S. CLS. 2, 5, 22, 23, 29, 37, 38 AND 50).

ROBERT STRUCK, EXAMINING ATTORNEY

SN 77-136,129. GALAN, LLC, BRISTOW, VA. FILED 3-21-2007.

GALAN

THE FOREIGN WORDING IN THE MARK TRANSLATES INTO ENGLISH AS GALLANT.

FOR MAGAZINES FEATURING SUBJECTS OF INTEREST TO MEN, NAMELY, TRAVEL, SPORTS, ADVENTURE, HUMOR, HEALTH, WOMEN, MUSIC, FOOD, FILMS, FASHION, LIFESTYLE, CAREERS, AND ADULT ENTERTAINMENT (U.S. CLS. 2, 5, 22, 23, 29, 37, 38 AND 50).

KAREN SEVERSON, EXAMINING ATTORNEY

CLASS 16—(Continued).

SN 77-137,117. GRIPTION HOLDINGS, DRAPER, UT. FILED 3-21-2007.

JOT IT

THE MARK CONSISTS OF STANDARD CHARACTERS WITHOUT CLAIM TO ANY PARTICULAR FONT, STYLE, SIZE, OR COLOR.

FOR WRITING SURFACES, NAMELY DRY-ERASE WRITING SURFACES OR WRITING BOARDS, AND FRAMES OR BASES FOR HOLDING THE WRITING SURFACES (U.S. CLS. 2, 5, 22, 23, 29, 37, 38 AND 50).

BRIAN NEVILLE, EXAMINING ATTORNEY

SN 77-137,241. GALAN, LLC, BRISTOW, VA. FILED 3-21-2007.



THE FOREIGN WORDING IN THE MARK TRANSLATES INTO ENGLISH AS GALLANT.

FOR MAGAZINES FEATURING SUBJECTS OF INTEREST TO MEN, NAMELY, TRAVEL, SPORTS, ADVENTURE, HUMOR, HEALTH, WOMEN, MUSIC, FOOD, FILMS, FASHION, LIFESTYLE, CAREERS, AND ADULT ENTERTAINMENT (U.S. CLS. 2, 5, 22, 23, 29, 37, 38 AND 50).

KAREN SEVERSON, EXAMINING ATTORNEY

SN 77-137,613. BAKER, LORNA, TOPTON, PA. FILED 3-22-2007.

LORNOGRAPHY

THE MARK CONSISTS OF STANDARD CHARACTERS WITHOUT CLAIM TO ANY PARTICULAR FONT, STYLE, SIZE, OR COLOR.

FOR PHOTOGRAPHS; ART PRINTS (U.S. CLS. 2, 5, 22, 23, 29, 37, 38 AND 50).

DOMINICK J. SALEMI, EXAMINING ATTORNEY

CLASS 16—(Continued).

SN 77-137,616. SWIFT-WILKINSON, SHIRLEY, PEORIA, AZ. FILED 3-22-2007.

Vows of Oneness

THE MARK CONSISTS OF STANDARD CHARACTERS WITHOUT CLAIM TO ANY PARTICULAR FONT, STYLE, SIZE, OR COLOR.

FOR BOOKS IN THE FIELD OF SPIRITUALITY (U.S. CLS. 2, 5, 22, 23, 29, 37, 38 AND 50).

DOMINICK J. SALEMI, EXAMINING ATTORNEY

SN 77-137,722. NATIONAL FOUNDATION FOR ADVANCEMENT IN THE ARTS, INC., MIAMI, FL. FILED 3-22-2007.

YOUNGARTS

THE MARK CONSISTS OF STANDARD CHARACTERS WITHOUT CLAIM TO ANY PARTICULAR FONT, STYLE, SIZE, OR COLOR.

FOR PRINTED PERIODICAL IN THE FIELD OF ARTS AND YOUNG PEOPLE (U.S. CLS. 2, 5, 22, 23, 29, 37, 38 AND 50).

FIRST USE 9-1-2005; IN COMMERCE 9-1-2005.

LESLEY LAMOTHE, EXAMINING ATTORNEY

SN 77-137,927. CHARMA LLC, MAPLE GLEN, PA. FILED 3-22-2007.

BOW WOW BUNDLES

THE MARK CONSISTS OF STANDARD CHARACTERS WITHOUT CLAIM TO ANY PARTICULAR FONT, STYLE, SIZE, OR COLOR.

FOR FABRIC GIFT BAGS (U.S. CLS. 2, 5, 22, 23, 29, 37, 38 AND 50).

STANLEY I. OSBORNE, EXAMINING ATTORNEY

CLASS 16—(Continued).

SN 77-138,314. BRITT ALLCROFT PRODUCTIONS, LLC, SANTA MONICA, CA. FILED 3-22-2007.

CUBLEY

THE MARK CONSISTS OF STANDARD CHARACTERS WITHOUT CLAIM TO ANY PARTICULAR FONT, STYLE, SIZE, OR COLOR.

FOR PRINTED PUBLICATIONS, NAMELY, BOOKS, MAGAZINES, BROCHURES AND POSTERS IN THE FIELD OF ENTERTAINMENT (U.S. CLS. 2, 5, 22, 23, 29, 37, 38 AND 50).

CHARISMA HAMPTON, EXAMINING ATTORNEY



SN 77-138,319. BRITT ALLCROFT PRODUCTIONS, LLC, SANTA MONICA, CA. FILED 3-22-2007.

CUBLEY AND THE CITY KIDS

THE MARK CONSISTS OF STANDARD CHARACTERS WITHOUT CLAIM TO ANY PARTICULAR FONT, STYLE, SIZE, OR COLOR.

FOR PRINTED PUBLICATIONS, NAMELY, BOOKS, MAGAZINES, NEWSLETTERS, BROCHURES AND POSTERS IN THE FIELD OF ENTERTAINMENT (U.S. CLS. 2, 5, 22, 23, 29, 37, 38 AND 50).

CHARISMA HAMPTON, EXAMINING ATTORNEY



SN 77-138,376. DYRDAHL, LINKE, A, SEATTLE, WA. FILED 3-23-2007.

Animal Jack

THE MARK CONSISTS OF STANDARD CHARACTERS WITHOUT CLAIM TO ANY PARTICULAR FONT, STYLE, SIZE, OR COLOR.

FOR CHILDREN'S BOOKS (U.S. CLS. 2, 5, 22, 23, 29, 37, 38 AND 50).

JOHN GARTNER, EXAMINING ATTORNEY

CLASS 16—(Continued).

SN 77-138,453. THE SCENSIBLE SOURCE COMPANY LLC, PITTSFORD, NY. FILED 3-23-2007.

SecureFit360

THE MARK CONSISTS OF STANDARD CHARACTERS WITHOUT CLAIM TO ANY PARTICULAR FONT, STYLE, SIZE, OR COLOR.

FOR PLASTIC BAGS FOR LINING BATHROOM STALL MOUNTED WASTE RECEPTACLES FOR FEMINE HYGIENE PRODUCTS (U.S. CLS. 2, 5, 22, 23, 29, 37, 38 AND 50).

MARK SPARACINO, EXAMINING ATTORNEY



SN 77-138,878. MCNAUGHTON, DEBORAH L, PLACENTIA, CA. AND WEINSTEIN, MELINDA D, PLACENTIA, CA. FILED 3-23-2007.

Money Calorie Counter

THE MARK CONSISTS OF STANDARD CHARACTERS WITHOUT CLAIM TO ANY PARTICULAR FONT, STYLE, SIZE, OR COLOR.

NO CLAIM IS MADE TO THE EXCLUSIVE RIGHT TO USE "MONEY", APART FROM THE MARK AS SHOWN.

FOR BLANK JOURNAL BOOKS; CHARTS IN THE FIELD OF PERSONAL FINANCE; BOOKS IN THE FIELD OF PERSONAL FINANCE (U.S. CLS. 2, 5, 22, 23, 29, 37, 38 AND 50).

IRA J. GOODSID, EXAMINING ATTORNEY



SN 77-139,345. JODI RIVIERA, INC., MILL VALLEY, CA. FILED 3-23-2007.

DREAM CARDS

THE MARK CONSISTS OF STANDARD CHARACTERS WITHOUT CLAIM TO ANY PARTICULAR FONT, STYLE, SIZE, OR COLOR.

NO CLAIM IS MADE TO THE EXCLUSIVE RIGHT TO USE "CARDS", APART FROM THE MARK AS SHOWN.

FOR BOXED SET OF CARDS CONTAINING INSTRUCTIONAL AND/OR MOTIVATIONAL STATEMENTS (U.S. CLS. 2, 5, 22, 23, 29, 37, 38 AND 50).

CURTIS FRENCH, EXAMINING ATTORNEY

CLASS 16—(Continued).

SN 77-139,625. CELANO, KIMBERLY ANN, SAN DIEGO, CA.
FILED 3-24-2007.

The Law of InTrusting

THE MARK CONSISTS OF STANDARD CHARACTERS WITHOUT CLAIM TO ANY PARTICULAR FONT, STYLE, SIZE, OR COLOR.

FOR SERIES OF NON-FICTION BOOKS IN THE FIELD OF SELF-IMPROVEMENT, ETHNOGRAPHIES, SPIRITUALITY (U.S. CLS. 2, 5, 22, 23, 29, 37, 38 AND 50).
HENRY S. ZAK, EXAMINING ATTORNEY

SN 77-139,730. BUETTNER, HEATHER A., LOS ANGELES, CA. FILED 3-25-2007.

NomadChick

THE MARK CONSISTS OF STANDARD CHARACTERS WITHOUT CLAIM TO ANY PARTICULAR FONT, STYLE, SIZE, OR COLOR.

FOR GUIDE BOOKS FEATURING TRAVEL; MAGAZINES FEATURING TRAVEL; TRAVEL BOOKS; A SERIES OF BOOKS, WRITTEN ARTICLES, HANDOUTS AND WORKSHEETS IN THE FIELD OF TRAVEL (U.S. CLS. 2, 5, 22, 23, 29, 37, 38 AND 50).

REBECCA SMITH, EXAMINING ATTORNEY

SN 77-139,842. CAPLOON ENTERPRISES, LLC, MONTCCLAIR, NJ. FILED 3-26-2007.

SAYSO

THE MARK CONSISTS OF STANDARD CHARACTERS WITHOUT CLAIM TO ANY PARTICULAR FONT, STYLE, SIZE, OR COLOR.

FOR OFFICE SUPPLIES, NAMELY, BINDER CLIPS FEATURING AN AUDIO RECORDING AND PLAYBACK CAPABILITY (U.S. CLS. 2, 5, 22, 23, 29, 37, 38 AND 50).

FIRST USE 12-18-2006; IN COMMERCE 12-19-2006.
JORDAN BAKER, EXAMINING ATTORNEY

CLASS 16—(Continued).

SN 77-139,961. BINGHAM, MARK J., HONEYVILLE, UT.
FILED 3-26-2007.

WOOLIE

THE MARK CONSISTS OF STANDARD CHARACTERS WITHOUT CLAIM TO ANY PARTICULAR FONT, STYLE, SIZE, OR COLOR.

FOR A SERIES OF CHILDRENS BOOKS (U.S. CLS. 2, 5, 22, 23, 29, 37, 38 AND 50).

CURTIS FRENCH, EXAMINING ATTORNEY

SN 77-140,126. REINDL, STEVEN E., DALLAS, TX. FILED 3-26-2007.



THE MARK CONSISTS OF A STYLIZED GRAPHIC RENDITION OF THE HEAD OF A RHINOCEROS.

FOR MARKERS, NAMELY MARKING APPLICATORS CONTAINING DRY-ERASE INK FOR IMPRINTING PATTERNS ON DRY-WIPE PRESENTATION WHITEBOARDS (U.S. CLS. 2, 5, 22, 23, 29, 37, 38 AND 50).

THEODORE MCBRIDE, EXAMINING ATTORNEY

SN 77-140,145. CLEAR FOCUS IMAGING, INC., SANTA ROSA, CA. FILED 3-26-2007.

PAPERVUE

THE MARK CONSISTS OF STANDARD CHARACTERS WITHOUT CLAIM TO ANY PARTICULAR FONT, STYLE, SIZE, OR COLOR.

OWNER OF U.S. REG. NOS. 2,391,624, 2,754,383 AND OTHERS.

FOR PRINTABLE PERFORATED PAPER SOLD IN ROLL FORM FOR USE IN SUN SHADING AND DISPLAYING ADVERTISING, SIGNAGE, TEXT AND GRAPHICS ON GLASS WINDOWS AND DOORS (U.S. CLS. 2, 5, 22, 23, 29, 37, 38 AND 50).

MARK SPARACINO, EXAMINING ATTORNEY

CLASS 16—(Continued).

SN 77-140,155. CLEAR FOCUS IMAGING, INC., SANTA ROSA, CA. FILED 3-26-2007.

POSTERVUE

THE MARK CONSISTS OF STANDARD CHARACTERS WITHOUT CLAIM TO ANY PARTICULAR FONT, STYLE, SIZE, OR COLOR.

OWNER OF U.S. REG. NOS. 2,391,624, 2,754,383 AND OTHERS.

FOR PRINTABLE PERFORATED PAPER SOLD IN ROLL FORM FOR USE IN SUN SHADING AND DISPLAYING ADVERTISING, SIGNAGE, TEXT AND GRAPHICS ON GLASS WINDOWS AND DOORS (U.S. CLS. 2, 5, 22, 23, 29, 37, 38 AND 50).

MARK SPARACINO, EXAMINING ATTORNEY

SN 77-140,393. ZANER-BLOSER, INC., COLUMBUS, OH. FILED 3-26-2007.

ZB Spelling Connections

THE MARK CONSISTS OF STANDARD CHARACTERS WITHOUT CLAIM TO ANY PARTICULAR FONT, STYLE, SIZE, OR COLOR.

NO CLAIM IS MADE TO THE EXCLUSIVE RIGHT TO USE "SPELLING", APART FROM THE MARK AS SHOWN.

FOR EDUCATIONAL BOOKS FEATURING SPELLING INSTRUCTION (U.S. CLS. 2, 5, 22, 23, 29, 37, 38 AND 50).

FIRST USE 10-1-1995; IN COMMERCE 10-1-1995.
PAUL F. GAST, EXAMINING ATTORNEY

SN 77-140,773. JAKKS PACIFIC, INC., MALIBU, CA. FILED 3-26-2007.

RADIUS

THE MARK CONSISTS OF STANDARD CHARACTERS WITHOUT CLAIM TO ANY PARTICULAR FONT, STYLE, SIZE, OR COLOR.

FOR WRITING INSTRUMENTS (U.S. CLS. 2, 5, 22, 23, 29, 37, 38 AND 50).

DORITT L. CARROLL, EXAMINING ATTORNEY

CLASS 16—(Continued).

SN 77-140,803. JAKKS PACIFIC, INC., MALIBU, CA. FILED 3-26-2007.

TREATS

THE MARK CONSISTS OF STANDARD CHARACTERS WITHOUT CLAIM TO ANY PARTICULAR FONT, STYLE, SIZE, OR COLOR.

FOR WRITING INSTRUMENTS (U.S. CLS. 2, 5, 22, 23, 29, 37, 38 AND 50).

DORITT L. CARROLL, EXAMINING ATTORNEY

SN 77-140,899. PNS & WSS INC., THOROFARE, NJ. FILED 3-26-2007.

CARDIOLOGY TODAY

THE MARK CONSISTS OF STANDARD CHARACTERS WITHOUT CLAIM TO ANY PARTICULAR FONT, STYLE, SIZE, OR COLOR.

OWNER OF U.S. REG. NO. 2,652,788.

NO CLAIM IS MADE TO THE EXCLUSIVE RIGHT TO USE "CARDIOLOGY", APART FROM THE MARK AS SHOWN.

FOR MEDICAL NEWSPAPER (U.S. CLS. 2, 5, 22, 23, 29, 37, 38 AND 50).

KATHLEEN LORENZO, EXAMINING ATTORNEY

SN 77-141,410. THE FRAY LLC, THORNTON, CO. FILED 3-27-2007.

THE FRAY

THE MARK CONSISTS OF STANDARD CHARACTERS WITHOUT CLAIM TO ANY PARTICULAR FONT, STYLE, SIZE, OR COLOR.

FOR ADDRESS BOOKS; APPOINTMENT BOOKS; BLANK JOURNAL BOOKS; BOOK COVERS; BOOKS IN THE FIELD OF MUSIC AND ENTERTAINMENT; COFFEE TABLE BOOKS FEATURING MUSIC AND ENTERTAINMENT; COMPOSITION BOOKS; GIFT BOOKS FEATURING MUSIC AND ENTERTAINMENT; PICTURE BOOKS; RECIPE BOOKS; SERIES OF NON-FICTION BOOKS IN THE FIELD OF MUSIC AND ENTERTAINMENT; SONG BOOKS; SOUVENIR PROGRAMS CONCERNING A MUSICAL GROUP (U.S. CLS. 2, 5, 22, 23, 29, 37, 38 AND 50).

DAVID TOOLEY, EXAMINING ATTORNEY

CLASS 16—(Continued).

SN 77-141,566. ZANER-BLOSER, INC., COLUMBUS, OH. FILED 3-27-2007.

**Zaner-Bloser Handwriting
On the Road to Writing and
Reading for Prekindergarten**

THE MARK CONSISTS OF STANDARD CHARACTERS WITHOUT CLAIM TO ANY PARTICULAR FONT, STYLE, SIZE, OR COLOR.

OWNER OF U.S. REG. NO. 2,763,322.

NO CLAIM IS MADE TO THE EXCLUSIVE RIGHT TO USE "HANDWRITING" AND "WRITING AND READING FOR PREKINDERGARTEN", APART FROM THE MARK AS SHOWN.

FOR EDUCATIONAL BOOKS FEATURING MATERIALS GEARED TO PRE-KINDERGARTEN STUDENTS AND TEACHERS CONTAINING BEGINNING INSTRUCTION IN HANDWRITING (U.S. CLS. 2, 5, 22, 23, 29, 37, 38 AND 50).

PAUL F. GAST, EXAMINING ATTORNEY

CLASS 16—(Continued).

SN 77-141,627. FORBES LLC, NEW YORK, NY. FILED 3-27-2007.

FORBESLIFE EXECUTIVE WOMAN

SN 77-141,601. MCCARTHY, PATRICK J., WINNETKA, IL. FILED 3-27-2007.



THE MARK CONSISTS OF THE WORD TRIVIAL ON TOP OF THE WORD CONNECTION WITH THE "I" FROM TRIVIAL CONTINUING DOWN AND BECOMING THE "I" IN CONNECTION WITH AN ARROW AT THE BOTTOM OF THE "I".

FOR SYNDICATED NEWSPAPER COLUMNS DEALING WITH TRIVIA (U.S. CLS. 2, 5, 22, 23, 29, 37, 38 AND 50).

LINDA LAVACHE, EXAMINING ATTORNEY

SN 77-141,616. WILEY, SHANNON P, STUART, FL. FILED 3-27-2007.

**BOTTOM FEEDERS BOAT HULL
BOTTOM GRAPHICS**

THE MARK CONSISTS OF STANDARD CHARACTERS WITHOUT CLAIM TO ANY PARTICULAR FONT, STYLE, SIZE, OR COLOR.

NO CLAIM IS MADE TO THE EXCLUSIVE RIGHT TO USE "BOAT HULL BOTTOM GRAPHICS", APART FROM THE MARK AS SHOWN.

FOR APPLIQUES IN THE FORM OF DECALS; DECALS; STICKERS (U.S. CLS. 2, 5, 22, 23, 29, 37, 38 AND 50).

FIRST USE 3-1-2007; IN COMMERCE 3-1-2007.
HANNO RITTNER, EXAMINING ATTORNEY

THE MARK CONSISTS OF STANDARD CHARACTERS WITHOUT CLAIM TO ANY PARTICULAR FONT, STYLE, SIZE, OR COLOR.

OWNER OF U.S. REG. NOS. 1,141,299, 3,095,593 AND OTHERS.

NO CLAIM IS MADE TO THE EXCLUSIVE RIGHT TO USE "EXECUTIVE WOMAN", APART FROM THE MARK AS SHOWN.

FOR PRINT PUBLICATIONS, NAMELY, MAGAZINES, NEWSLETTERS, REPORTS, BROCHURES, REFERENCE GUIDES AND ARTICLES IN THE FIELDS OF INVESTING, SECURITIES, FINANCIAL PLANNING, PERSONAL FINANCE, CAREER PLANNING, COLLECTING, SHOPPING, TRAVEL AND LEISURE ACTIVITIES, HEALTH, BUSINESS AND ECONOMIC NEWS (U.S. CLS. 2, 5, 22, 23, 29, 37, 38 AND 50).

ANDREA K. NADELMAN, EXAMINING ATTORNEY

CLASS 16—(Continued).

SN 77-141,741. DEUTSCHE TELEKOM AG, BONN, FED REP GERMANY, FILED 3-27-2007.

Octopus Open

THE MARK CONSISTS OF STANDARD CHARACTERS WITHOUT CLAIM TO ANY PARTICULAR FONT, STYLE, SIZE, OR COLOR.

OWNER OF FED REP GERMANY REG. NO. 30620822, DATED 2-9-2007, EXPIRES 4-30-2016.

FOR PRINTED MATTER, NAMELY, TELEPHONE DIRECTORIES, SERIES OF BOOKS, NEWSLETTERS, PAMPHLETS, BROCHURES, MAGAZINES AND PAPERBACKS, ALL IN THE FIELD OF TELECOMMUNICATIONS; PRINTED AND STAMPED PLASTIC AND CARDBOARD GREETING, BLANK, NOTE, AND INDEX CARDS; NOTE PAPER AND ENVELOPES; NAMETAGS AND LABELS MADE FROM PAPER OR CARDBOARD; NOTEBOOKS; NOTE PADS; STATIONERY; PAPER, NAMELY, BOND PAPER AND ART PAPER; GIFT-WRAP PAPER; DIARIES; ADDRESS BOOKS; STUDENT CALENDARS; STAMP ALBUMS AND PHOTO-ALBUMS; FOLDERS FOR LETTERS AND LOOSE PAPERS; STATIONERY CLEAR HOLE TAB REINFORCEMENTS; RUBBER STAMPS AND IMPRESSION STAMPS; PAPER WEIGHTS; LETTER OPENERS; DRAWING AND UNGRADUATED RULERS; ERASERS; STAPLERS; PAPER CLIPS; BLOTTER PADS; DESK FILE TRAYS; DESK STANDS AND HOLDERS FOR HOLDING STATIONERY AND OFFICE IMPLEMENTS; PRINTED INSTRUCTIONAL AND TEACHING MATERIALS, ALL IN THE FIELDS OF TELECOMMUNICATIONS, INFORMATION TECHNOLOGY, SAFETY, NEWS, SPORTS, ENTERTAINMENT, CULTURE, BUSINESS AND FINANCE, WEATHER AND TRAVEL; BOOKMARKERS; STENCILS; SCRATCH PICTURES; PVC STICKERS; BLACKBOARDS; CHALK STICKS; ADHESIVES FOR STATIONERY OR HOUSEHOLD PURPOSES; DRAWING AND PAINTING MATERIALS, NAMELY, PENCILS, DRAWING PENCILS, PENS, DRAWING PENS, PAINT TRAYS, PAINTING SETS FOR ARTISTS, PAINTING SETS FOR CHILDREN, ARTS AND CRAFT PAINT KITS, AND PENCIL CASES; NON-MAGNETICALLY ENCODED PREPAID TELEPHONE CALLING CARDS (U.S. CLS. 2, 5, 22, 23, 29, 37, 38 AND 50).

LINDA ORNDORFF, EXAMINING ATTORNEY

SN 77-141,885. ALLEN, MICHAEL W., JERSEYVILLE, IL, FILED 3-27-2007.

Surgical Ink

THE MARK CONSISTS OF STANDARD CHARACTERS WITHOUT CLAIM TO ANY PARTICULAR FONT, STYLE, SIZE, OR COLOR.

FOR TEMPORARY TATTOOS (U.S. CLS. 2, 5, 22, 23, 29, 37, 38 AND 50).

MARGERY A. TIERNEY, EXAMINING ATTORNEY

CLASS 16—(Continued).

SN 77-141,897. UNITED FOOTBALL LEAGUE, LLC, SAN FRANCISCO, CA. FILED 3-27-2007.

UFL

THE MARK CONSISTS OF STANDARD CHARACTERS WITHOUT CLAIM TO ANY PARTICULAR FONT, STYLE, SIZE, OR COLOR.

FOR ADHESIVE NOTE PADS; ADVERTISING SIGNS OF PAPER OR CARDBOARD; ALBUMS FOR STICKERS; ALBUMS FOR SPORTS MEMORABILIA; ANNOUNCEMENT CARDS; BALL-POINT PENS; BASEBALL CARDS; BINDERS; BLANK JOURNAL BOOKS; BOOKLETS IN THE FIELD OF SPORTS; BOOKS IN THE FIELD OF SPORTS; BRAG BOOKS; BUMPER STICKERS; CALENDAR DESK PADS; CALENDAR DESK STANDS; CALENDAR REFILLS; CALENDAR STANDS; CALENDARS; CARDBOARD FLOOR DISPLAY UNITS FOR MERCHANDISING PRODUCTS; CARDS BEARING UNIVERSAL GREETINGS; CARDS, NAMELY, GREETING CARDS; CARTOON STRIPS; CASES FOR CHECKS; CATALOGS IN THE FIELD OF SPORTS AND SPORTS MEMORABILIA; CHECKBOOK AND PASSBOOK WALLETS; CHECKBOOK COVERS; CHECKBOOK HOLDERS; CHILDREN'S ACTIVITY BOOKS; CHILDREN'S BOOKS; CHILDREN'S INTERACTIVE EDUCATIONAL BOOKS; CHILDREN'S STORYBOOKS; CLIP BOARDS; COASTERS MADE OF PAPER; COFFEE TABLE BOOKS FEATURING; COIN ALBUMS; COIN HOLDERS; COIN MATS; COIN WRAPPERS; COLLECTOR'S PHOTOGRAPHS OF PLAYERS; COLOR PENCILS; COLORING BOOKS; COMIC BOOKS; COMIC STRIPS; COMIC STRIPS APPEARING IN MAGAZINES AND NEWSPAPERS; COMIC STRIPS' COMIC FEATURES; COMMEMORATIVE STAMP SHEETS; COMPOSITION BOOKS; COMPUTER GAME INSTRUCTION MANUALS; COMPUTER MANUALS FOR SPORTS PROGRAMS; CRAYONS; CREDIT CARDS WITHOUT MAGNETIC CODING; DAILY NEWSPAPER; DAILY PLANNERS; DATA BOOKS; DATE BOOKS; DATE INDICATORS; DATE STAMPS; DATE STAMPS; DAY PLANNERS; DEBIT CARDS WITHOUT MAGNETIC CODING; DECALCOMANIAS; DECALS; DECORATIVE STICKERS FOR HELMETS; DESK CALENDARS; DESKTOP STATIONERY CABINETS; DIARIES; DISPOSABLE HOUSEBREAKING PADS FOR PETS; DISPOSABLE HOUSEBREAKING PADS FOR USE IN TRAINING PUPPIES; DISPOSABLE SWIM PANTS FOR CHILDREN AND INFANTS; DOCUMENT COVERS; DOCUMENT FILES; DOCUMENT PORTFOLIOS; DOCUMENT STAMP RACKS; DRIVER'S LICENSE CASES; DRIVER'S LICENSE HOLDERS; EDUCATIONAL BOOKS FEATURING SPORTS; EDUCATIONAL PUBLICATIONS, NAMELY, EDUCATIONAL LEARNING CARDS, FLASH CARDS, ACTIVITY CARDS, WORKBOOKS, TEXTBOOKS, ACTIVITY BOOKS, STORY BOOKS, PUZZLE BOOKS, PUZZLES, TEACHER GUIDES, MANUALS, POSTERS, EDUCATIONAL CARD GAMES AND EDUCATIONAL BOOKLETS IN THE FIELD OF SPORTS; EDUCATIONAL PUBLICATIONS, NAMELY, TRAINING MANUALS IN THE FIELD OF SPORTS; ENTRY TICKETS; ENVELOPES; ENVELOPES FOR STATIONERY USE; EPHEMERA NAMELY, AUTOGRAPHS OF FAMOUS INDIVIDUALS; EVENT ALBUMS; EVENT PROGRAMS; EVENTS ALBUMS; EVENTS PROGRAMMES; EXERCISE BOOKS; EXERCISE-BOOK COVERS; FILE FOLDERS; FOLDERS; FOUNTAIN PENS; GENERAL FEATURE MAGAZINES; GIFT BOOKS FEATURING SPORTS; GIFT CARDS; GIFT WRAP PAPER; GIFT WRAPPING PAPER; GREETING CARDS; HANGING FOLDERS; HIGHLIGHTING MARKERS; HOLDERS SPECIALLY ADAPTED FOR HOLDING GREETING CARDS; HOLIDAY CARDS; INVITATION CARDS; JOURNALS CONCERNING SPORTS; LABEL PAPER; LEATHER APPOINTMENT BOOK COVERS; LEATHER BOOK COVERS; LETTER OPENERS; LOOSE LEAF BINDERS; LOOSE LEAF PAPER; LOOSE-LEAF PADS; LUNCH BAGS; LUNCH BAGS MADE OF TEXTILE; MAGAZINE COLUMNS ABOUT SPORTS; MAGAZINE DEPARTMENTS IN THE FIELD OF SPORTS; MAGA-

CLASS 16—(Continued).

ZINE PAPER; MAGAZINE SECTIONS IN THE FIELD OF SPORTS; MAGAZINE SUPPLEMENTS TO NEWSPAPERS IN THE FIELD OF SPORTS; MAGAZINES FEATURING SPORTS; MARKERS; MEMO PADS; MEMORANDUM BOOKS; MEMORY BOOKS; MERCHANDISE BAGS; METALLIC GIFT WRAP; METALLIC GIFT WRAPPING PAPER; METALLIC PAPER PARTY DECORATIONS; MONEY CLIPS; MOTIVATIONAL CARDS; MURALS; NEWS BULLETINS; NEWSLETTERS IN THE FIELD OF SPORTS; NEWSPAPER CARTOONS; NEWSPAPER COMIC STRIPS; NEWSPAPERS; NEWSPAPERS FOR GENERAL CIRCULATION; NEWSPAPERS IN THE FIELD OF SPORTS; NEWSPRINT PAPER; NON-MAGNETICALLY ENCODED FIDELITY CARDS; NON-MAGNETICALLY ENCODED PREPAID PURCHASE CARDS FOR ALLOWING USERS TO TRANSFER FINANCIAL VALUE ONLINE VIA RETAIL COMPUTER NETWORKS; NOTE BOOKS; NOTE CARDS; NOTE PAD HOLDERS; NOTE PADS; NOTE PAPER; NOTE PAPERS; NOTEBOARDS; NOTEBOOK DIVIDERS; NOTEBOOK PAPER; NOVELS; OFFICE BINDERS; OFFICE STATIONERY; PAPER; PAPER BADGES; PAPER BAGS AND SACKS; PAPER BANNERS; PAPER LABELS; PAPER NAPKINS; PAPER PARTY BAGS; PAPER PARTY DECORATIONS; PAPER PARTY FAVORS; PAPER PARTY HATS; PAPER PENNANTS; PAPER SHEETS FOR NOTE TAKING; PASSBOOK COVERS; PASSPORT COVERS; PASSPORT HOLDERS; PEN AND PENCIL CASES AND BOXES; PEN AND PENCIL TRAYS; PEN CASES; PENS; PERSONAL ORGANIZERS; PHOTO MATS; PHOTO MOUNTING CORNERS; PHOTO STORAGE BOXES; PHOTOCOPY PAPERS; PHOTOGRAPH ALBUM PAGES; PHOTOGRAPH ALBUMS; PHOTOGRAPH CORNERS; PHOTOGRAPH MOUNTS; PHOTOGRAPH STANDS; PHOTOGRAPHIC ALBUMS; PHOTOGRAPHIC PRINTS; PHOTOGRAPHS; PICTURE BOOKS; PICTURES; PLASTIC GIFT WRAP; POCKET CALENDARS; POCKET MEMORANDUM BOOKS; POSTCARDS; POSTER BOARD; POSTERS; PRE-PAID TELEPHONE CALLING CARDS, NOT MAGNETICALLY ENCODED; PRINTED HOLOGRAMS; PRINTED INSTRUCTIONAL MATERIAL ON TELECOMMUNICATIONS; PRINTED INSTRUCTIONAL, EDUCATIONAL, AND TEACHING MATERIALS IN THE FIELD OF SPORTS; PRINTED INVITATIONS; PRINTED PAPER LABELS; PRINTED PAPER SIGNS; PRINTED PAPER SIGNS, NAMELY TABLE TENTS; PRINTED PATTERNS; PRINTED PERIODICALS IN THE FIELD OF SPORTS; PRINTED SPORTS AND TOURNAMENT SCHEDULE CARDS IN CREDIT FORMAT WITH SPACE PROVIDED FOR RECORDING RESULTS; PRINTED TEACHING ACTIVITY GUIDES IN THE FIELD OF SPORTS; PRINTED TEACHING MATERIALS IN THE FIELD OF SPORTS; PRINTED TICKETS; PRINTS; PRINTS IN THE NATURE OF PHOTOGRAPHS, LITHOGRAPHS AND PICTURES; QUICK REFERENCE POCKET GUIDES IN THE FIELD OF SPORTS; ROLE PLAYING GAME EQUIPMENT IN THE NATURE OF GAME BOOK MANUALS; SCHOOL SUPPLY KITS CONTAINING VARIOUS COMBINATIONS OF SELECTED SCHOOL SUPPLIES, NAMELY, WRITING INSTRUMENTS, PENS, PENCILS, MECHANICAL PENCILS, ERASERS, MARKERS, CRAYONS, HIGHLIGHTERS, FOLDERS, NOTEBOOKS, PAPER, GRADUATED RULERS, PROTRACTORS, PAPER CLIPS, PENCIL SHARPENERS, WRITING GRIPS, GLUE AND BOOK MARKS; SCHOOL WRITING BOOKS; SCORE BOOKS; SCORE CARDS; SCORE CHARTS; SCORE PADS; SCORE SHEETS; SCORE-BOOKS; SCORE-CARDS; SCRAPBOOK ALBUMS; SCRAPBOOK PAGES; SCRAPBOOKS; SERIES OF FICTION BOOKS; SERIES OF NON-FICTION BOOKS IN THE FIELD OF SPORTS; SLEEVES FOR HOLDING AND PROTECTING STAMPS; SOUVENIR PROGRAMS CONCERNING SPORTS; SPORTS TRADING CARDS; STAMP ALBUMS; STAMP CASES; STAMP STANDS; STANDS FOR PEN AND PENCIL; STATIONERY; STATIONERY BOXES; STATIONERY CASES; STATIONERY FOLDERS; STATIONERY WRITING PAPER AND ENVELOPES; STATIONERY-TYPE PORTFOLIOS; STEEL PENS; STICKERS; STICKERS; STORIES IN ILLUSTRATED FORM; STORY BOOKS;

CLASS 16—(Continued).

SYNDICATED COLUMNS DEALING WITH SPORTS; SYNDICATED MAGAZINE SECTIONS DEALING WITH SPORTS; SYNDICATED NEWSPAPER COLUMNS DEALING WITH SPORTS; TABLE MATS OF PAPER; TABLE NAPKINS OF PAPER; TACKBOARDS; TALKING CHILDREN'S BOOKS; TELEPHONE CALLING CARDS, NOT MAGNETICALLY ENCODED; TEMPORARY TATTOOS; THREE-RING BINDERS; TIME PLANNERS; TRADING CARD DISCS OF PAPER OR CARDBOARD; TRADING CARDS; TRIVIA CARDS; UNMOUNTED POSTERS; WALL CALENDARS; WRITING PADS (U.S. CLS. 2, 5, 22, 23, 29, 37, 38 AND 50).

JORDAN BAKER, EXAMINING ATTORNEY

SN 77-141,899. ALLEN, MICHAEL W., JERSEYVILLE, IL. FILED 3-27-2007.

SurgInk

THE MARK CONSISTS OF STANDARD CHARACTERS WITHOUT CLAIM TO ANY PARTICULAR FONT, STYLE, SIZE, OR COLOR.

FOR TEMPORARY TATTOOS (U.S. CLS. 2, 5, 22, 23, 29, 37, 38 AND 50).

MARGERY A. TIERNEY, EXAMINING ATTORNEY

SN 77-141,963. JAKKS PACIFIC, INC., MALIBU, CA. FILED 3-27-2007.

STAT R7

THE MARK CONSISTS OF STANDARD CHARACTERS WITHOUT CLAIM TO ANY PARTICULAR FONT, STYLE, SIZE, OR COLOR.

FOR WRITING INSTRUMENTS (U.S. CLS. 2, 5, 22, 23, 29, 37, 38 AND 50).

DORITT L. CARROLL, EXAMINING ATTORNEY

SN 77-142,037. GINGLES, LISA A., MADISON, WI. FILED 3-27-2007.

Bizzles

THE MARK CONSISTS OF STANDARD CHARACTERS WITHOUT CLAIM TO ANY PARTICULAR FONT, STYLE, SIZE, OR COLOR.

FOR CROSSWORD PUZZLES (U.S. CLS. 2, 5, 22, 23, 29, 37, 38 AND 50).

RONALD MCMORROW, EXAMINING ATTORNEY

CLASS 16—(Continued).

SN 77-142,072. URCUTE ENTERTAINMENT, LLC, BRIDGEPORT, CT. FILED 3-27-2007.

URCUTE

THE MARK CONSISTS OF STANDARD CHARACTERS WITHOUT CLAIM TO ANY PARTICULAR FONT, STYLE, SIZE, OR COLOR.

FOR MAGAZINES RELATED TO STUDENT LIFE INCLUDING CAREER, HEALTH, FASHION, SPORTS, TRAVEL, AND ENTERTAINMENT (U.S. CLS. 2, 5, 22, 23, 29, 37, 38 AND 50).

FIRST USE 8-31-2004; IN COMMERCE 8-31-2004.
RENEE MCCRAY, EXAMINING ATTORNEY

SN 77-142,159. STERLING, TAYLOR JAMES, PASSIC, NJ. FILED 3-28-2007.

Red Arcis Inc.

THE MARK CONSISTS OF STANDARD CHARACTERS WITHOUT CLAIM TO ANY PARTICULAR FONT, STYLE, SIZE, OR COLOR.

NO CLAIM IS MADE TO THE EXCLUSIVE RIGHT TO USE "INC.", APART FROM THE MARK AS SHOWN.

FOR ORIGINAL ART COMIC BOOKS; ORIGINAL ART PRINTS; ORIGINAL ART PICTURES; ORIGINAL ART POSTERS; ORIGINAL ART SKETCH BOOKS (U.S. CLS. 2, 5, 22, 23, 29, 37, 38 AND 50).

CHRISTINE COOPER, EXAMINING ATTORNEY

SN 77-143,017. ENVENTYS, LLC, CHARLOTTE, NC. FILED 3-28-2007.

ENNOVATION

THE MARK CONSISTS OF STANDARD CHARACTERS WITHOUT CLAIM TO ANY PARTICULAR FONT, STYLE, SIZE, OR COLOR.

FOR BOOKS IN THE FIELD OF BUSINESS MANAGEMENT, FOCUSING ON ENTREPRENEURIAL CREATIVITY AND COLLABORATIVE USE OF EXTERNAL RESOURCES (U.S. CLS. 2, 5, 22, 23, 29, 37, 38 AND 50).

ALEX KEAM, EXAMINING ATTORNEY

CLASS 16—(Continued).

SN 77-143,407. BLACK, JONATHAN K., ALPINE, UT. FILED 3-29-2007.

POO-PA-PEE-DOO

THE MARK CONSISTS OF STANDARD CHARACTERS WITHOUT CLAIM TO ANY PARTICULAR FONT, STYLE, SIZE, OR COLOR.

FOR CHILDREN'S BOOKS (U.S. CLS. 2, 5, 22, 23, 29, 37, 38 AND 50).

JOHN HWANG, EXAMINING ATTORNEY

SN 77-143,517. CARTOON PIZZA, INC., NEW YORK, NY. FILED 3-29-2007.

MONSTER MONSTER TRUCKS

THE MARK CONSISTS OF STANDARD CHARACTERS WITHOUT CLAIM TO ANY PARTICULAR FONT, STYLE, SIZE, OR COLOR.

FOR SERIES OF FICTION BOOKS FOR CHILDREN; STATIONERY, GREETING CARDS, PEN AND PENCIL CASES, PENS, PENCILS, PENCIL SHARPENERS, MARKERS, DRAWING RULERS, WRITING PADS, NOTE-PADS, BOOKMARKS, RING BINDERS, FOLDERS, BOOK COVERS, PERSONAL ORGANIZERS, ADHESIVE TAPE DISPENSERS FOR HOUSEHOLD OR STATIONERY USE, GLUE STICKS FOR HOUSEHOLD OR STATIONERY USE, PHOTO ALBUMS, SCRAPBOOK ALBUMS, STICKER ALBUMS, STAMP ALBUMS; PAPER PARTY GOODS, NAMELY HATS, NAPKINS, PLACE MATS AND DECORATIONS; PAPER BAGS AND MERCHANDISE BAGS; GIFT WRAPPING MATERIALS, NAMELY GIFT WRAPPING PAPER, PAPER BOWS FOR GIFT WRAPPING, AND PAPER GIFT BAGS; POSTERS, STICKERS, TRADING CARDS, TELEPHONE CALLING CARDS NOT MAGNETICALLY ENCODED, ARTS AND CRAFTS PAINT KITS, CALENDARS; PAPER HOLIDAY DECORATIONS, NAMELY, PAPER CAKE DECORATIONS, PAPER BANNERS, AND PAPER PARTY DECORATIONS (U.S. CLS. 2, 5, 22, 23, 29, 37, 38 AND 50).

SCOTT SISUN, EXAMINING ATTORNEY

SN 77-143,688. JAKKS PACIFIC, INC., MALIBU, CA. FILED 3-29-2007.

TRI-TECH

THE MARK CONSISTS OF STANDARD CHARACTERS WITHOUT CLAIM TO ANY PARTICULAR FONT, STYLE, SIZE, OR COLOR.

OWNER OF U.S. REG. NO. 1,505,893.

FOR WRITING INSTRUMENTS (U.S. CLS. 2, 5, 22, 23, 29, 37, 38 AND 50).

DORITT L. CARROLL, EXAMINING ATTORNEY

CLASS 16—(Continued).

SN 77-143,886. JOSEPH J. MITCHELL, PORTLAND, OR.
FILED 3-29-2007.

REMEMBERING

THE MARK CONSISTS OF STANDARD CHARACTERS WITHOUT CLAIM TO ANY PARTICULAR FONT, STYLE, SIZE, OR COLOR.

FOR HAND HELD PRINTED CARDS INTENDED TO SUGGEST TRUTHS ABOUT HUMAN NATURE (U.S. CLS. 2, 5, 22, 23, 29, 37, 38 AND 50).

GEOFFREY FOSDICK, EXAMINING ATTORNEY

CLASS 16—(Continued).

SN 77-144,449. KRAUS, ERIC J., NEWARK, DE. FILED 3-30-2007.

THE FOUR COWGIRLS OF THE APOCALYPSE

THE MARK CONSISTS OF STANDARD CHARACTERS WITHOUT CLAIM TO ANY PARTICULAR FONT, STYLE, SIZE, OR COLOR.

FOR COMIC BOOKS; MAGAZINES FEATURING COMIC BOOK CHARACTERS; GRAPHIC NOVELS; BOOKS IN THE FIELD OF COMIC BOOK CHARACTERS; TRADING CARDS; ART PRINTS; POSTERS (U.S. CLS. 2, 5, 22, 23, 29, 37, 38 AND 50).

BARNEY CHARLON, EXAMINING ATTORNEY

SN 77-144,315. PRIMEWOMAN, MANALAPAN, NJ. FILED 3-29-2007.

Primewoman

THE MARK CONSISTS OF PRIMEWOMAN. FOR WOMEN'S LIFESTYLE MAGAZINES (U.S. CLS. 2, 5, 22, 23, 29, 37, 38 AND 50).

FIRST USE 6-10-2006; IN COMMERCE 7-1-2006.
LAURA KOVALSKY, EXAMINING ATTORNEY

SN 77-144,466. KRAUS, ERIC J., NEWARK, DE. FILED 3-30-2007.

SACRALITH

THE MARK CONSISTS OF STANDARD CHARACTERS WITHOUT CLAIM TO ANY PARTICULAR FONT, STYLE, SIZE, OR COLOR.

FOR COMIC BOOKS; MAGAZINES FEATURING COMIC BOOK CHARACTERS; GRAPHIC NOVELS; BOOKS IN THE FIELD OF COMIC BOOK CHARACTERS; TRADING CARDS; ART PRINTS; POSTERS (U.S. CLS. 2, 5, 22, 23, 29, 37, 38 AND 50).

BARNEY CHARLON, EXAMINING ATTORNEY

SN 77-144,334. SOWA, CATHERINE FRANCES, SCOTIA, NY.
FILED 3-29-2007.

Think-It Notes

THE MARK CONSISTS OF STANDARD CHARACTERS WITHOUT CLAIM TO ANY PARTICULAR FONT, STYLE, SIZE, OR COLOR.

NO CLAIM IS MADE TO THE EXCLUSIVE RIGHT TO USE NOTES, APART FROM THE MARK AS SHOWN.

FOR ADHESIVE NOTE PADS; ADHESIVE NOTE PAPER (U.S. CLS. 2, 5, 22, 23, 29, 37, 38 AND 50).

BILL DAWE, EXAMINING ATTORNEY

SN 77-144,538. JAKKS PACIFIC, INC., MALIBU, CA. FILED 3-30-2007.

MINIZ ESSENTIALS

THE MARK CONSISTS OF STANDARD CHARACTERS WITHOUT CLAIM TO ANY PARTICULAR FONT, STYLE, SIZE, OR COLOR.

OWNER OF U.S. REG. NOS. 3,178,646 AND 3,178,647.
FOR WRITING INSTRUMENTS (U.S. CLS. 2, 5, 22, 23, 29, 37, 38 AND 50).

DORITT L. CARROLL, EXAMINING ATTORNEY

CLASS 16—(Continued).

SN 77-146,190. BING NOTE, INC., OAKLAND, CA. FILED 4-2-2007.



THE MARK CONSISTS OF RECTANGULAR BODY WITH 2 ANTENNAS MUSICAL NOTES FOR THE ARMS AND LEGS THE BODY HAS STRIPES.

FOR A SERIES OF BOOKS, WRITTEN ARTICLES, HANDOUTS AND WORKSHEETS IN THE FIELD OF INSPIRING CHILDREN TO LEARN AND BELIEVE; BABY BOOKS; ADDRESS BOOKS; BIRTHDAY BOOKS; BOOK BINDINGS; BOOK COVERS; BOOK HOLDERS; BOOK-COVER PAPER; BOOKS IN THE FIELD OF CHILDREN'S EDUCATION; CHILDREN'S ACTIVITY BOOKS; CHILDREN'S BOOKS; CHILDREN'S INTERACTIVE EDUCATIONAL BOOKS; CHILDREN'S STORYBOOKS; COFFEE TABLE BOOKS FEATURING CHILDREN'S STORIES; COLORING BOOKS; COMIC BOOKS; COMPOSITION BOOKS; COOK BOOKS; COPY BOOKS; COUPON BOOKS; EDUCATIONAL BOOKS FEATURING CHILDREN'S EDUCATION; EDUCATIONAL PUBLICATIONS, NAMELY, EDUCATIONAL LEARNING CARDS, FLASH CARDS, ACTIVITY CARDS, WORKBOOKS, TEXTBOOKS, ACTIVITY BOOKS, STORY BOOKS, PUZZLE BOOKS, PUZZLES, TEACHER GUIDES, MANUALS, POSTERS, EDUCATIONAL CARD GAMES AND EDUCATIONAL BOOKLETS IN THE FIELD OF CHILDREN'S EDUCATION; EXERCISE BOOKS; FLIP BOOKS; GIFT BOOKS FEATURING CHILDREN'S EDUCATION; MODELING CLAY FOR CHILDREN; MODELING MATERIALS AND COMPOUNDS FOR USE BY CHILDREN; NOTE BOOKS; PAINTING SETS FOR CHILDREN; PICTURE BOOKS; PRINTED MUSIC BOOKS; PROTECTIVE COVERS FOR BOOKS; SCHOOL WRITING BOOKS; SERIES OF FICTION BOOKS; SONG BOOKS; STORY BOOKS; TALKING CHILDREN'S BOOKS (U.S. CLS. 2, 5, 22, 23, 29, 37, 38 AND 50).

B. PARADEWELAI, EXAMINING ATTORNEY

CLASS 16—(Continued).

SN 77-147,490. PUBLIX ASSET MANAGEMENT COMPANY, LAKELAND, FL. FILED 4-3-2007.



OWNER OF U.S. REG. NOS. 1,339,762, 1,824,506 AND OTHERS.

THE MARK CONSISTS OF A VERTICAL RECTANGLE, WITH A CIRCLE OVERLAPPING THE RECTANGLE AND EXTENDING HALFWAY INTO THE RECTANGLE. THE CIRCLE CONTAINS THE WORD PUBLIX, CENTERED HORIZONTALLY IN THE CIRCLE.

FOR PLASTIC FOOD STORAGE BAGS FOR HOUSEHOLD USE (U.S. CLS. 2, 5, 22, 23, 29, 37, 38 AND 50).

FIRST USE 10-15-2003; IN COMMERCE 8-15-2004.

NANCY CLARKE, EXAMINING ATTORNEY

SN 77-150,802. SOTELO, MANO G., TUCSON, AZ. FILED 4-6-2007.

THE COLLECTIVE TRUTH

THE MARK CONSISTS OF STANDARD CHARACTERS WITHOUT CLAIM TO ANY PARTICULAR FONT, STYLE, SIZE, OR COLOR.

FOR BOOKS IN THE FIELD OF SPIRITUALITY, SELF HELP, ENLIGHTENMENT, AND BODY, MIND AND SPIRIT (U.S. CLS. 2, 5, 22, 23, 29, 37, 38 AND 50).

PAUL E. FAHRENKOPF, EXAMINING ATTORNEY

SN 77-152,522. THORNBURY, DAVID, E., PHOENIXVILLE, PA. FILED 4-10-2007.

SALES SILVER BULLETS

THE MARK CONSISTS OF STANDARD CHARACTERS WITHOUT CLAIM TO ANY PARTICULAR FONT, STYLE, SIZE, OR COLOR.

NO CLAIM IS MADE TO THE EXCLUSIVE RIGHT TO USE "SALES", APART FROM THE MARK AS SHOWN.

FOR BOOKS IN THE FIELD OF SALES (U.S. CLS. 2, 5, 22, 23, 29, 37, 38 AND 50).

MIDGE BUTLER, EXAMINING ATTORNEY

CLASS 16—(Continued).

SN 77-158,352. STERLING PUBLISHING CO., INC., NEW YORK, NY. FILED 4-17-2007.



THE COLOR(S) BLACK, WHITE AND REDDISH-BROWN IS/ARE CLAIMED AS A FEATURE OF THE MARK.

THE MARK CONSISTS OF A WHITE AND REDDISH-BROWN COFFEE CUP AND SAUCER, OUTLINED IN BLACK, WITH BLACK COFFEE IN THE CUP AND THREE BLACK STEAM LINES ABOVE THE CUP.

FOR SERIES OF BOOKS FEATURING FICTIONAL INTERVIEWS WITH HISTORICAL FIGURES (U.S. CLS. 2, 5, 22, 23, 29, 37, 38 AND 50).

APRIL ROACH, EXAMINING ATTORNEY

CLASS 16—(Continued).

SN 77-159,386. MONSANTO TECHNOLOGY LLC, SAINT LOUIS, MO. FILED 4-18-2007.

PROTECTING TODAY'S
INVESTMENTS FOR TOMORROW'S
INNOVATIONS

THE MARK CONSISTS OF STANDARD CHARACTERS WITHOUT CLAIM TO ANY PARTICULAR FONT, STYLE, SIZE, OR COLOR.

FOR PRINTED PUBLICATIONS, NAMELY, PRINTED BROCHURES, PRINTED BOOKLETS, AND PRINTED TEACHING MATERIALS IN THE FIELD OF AGRICULTURE AND SEED STEWARDSHIP (U.S. CLS. 2, 5, 22, 23, 29, 37, 38 AND 50).

FIRST USE 5-31-2004; IN COMMERCE 5-31-2004.
PETER CHENG, EXAMINING ATTORNEY

SN 77-158,622. HISPANIC YELLOW PAGES OF AMERICA, INC., CHICAGO, IL. FILED 4-17-2007.



NO CLAIM IS MADE TO THE EXCLUSIVE RIGHT TO USE "LA GUIA", APART FROM THE MARK AS SHOWN.

THE ENGLISH TRANSLATION OF THE SPANISH WORDING LA GUIA DORADA DORADAS SON MEJORES QUE AMARILLAS IN THE MARK IS THE GOLDEN GUIDE GOLD IS BETTER THAN YELLOW.

FOR SPANISH LANGUAGE BUSINESS TELEPHONE DIRECTORIES (U.S. CLS. 2, 5, 22, 23, 29, 37, 38 AND 50).
FIRST USE 4-17-2007; IN COMMERCE 4-17-2007.

JENNIFER HETU, EXAMINING ATTORNEY

SN 77-160,869. NYT MANAGEMENT SERVICES, INC., TAMPA, FL. FILED 4-19-2007.



NO CLAIM IS MADE TO THE EXCLUSIVE RIGHT TO USE "FASHION BOSTON", APART FROM THE MARK AS SHOWN.

THE COLOR(S) BLACK, RED, AND GREY IS/ARE CLAIMED AS A FEATURE OF THE MARK.

THE MARK CONSISTS OF THE LOWERCASE LETTERS FB ABOVE THE WORDS FASHION BOSTON WITH THE LETTER "F" AND THE WORDS "FASHION BOSTON" IN BLACK AND THE LETTER "B" IN THE COLOR RED ABOVE A HORIZONTAL GREY LINE.

FOR GENERAL FEATURE MAGAZINES (U.S. CLS. 2, 5, 22, 23, 29, 37, 38 AND 50).

FIRST USE 5-0-2007; IN COMMERCE 5-0-2007.
KRISTIN DAHLING, EXAMINING ATTORNEY

CLASS 16—(Continued).

SN 77-165,809. HANSEN, JOHN, LAS VEGAS, NV. FILED 4-25-2007.

AD\$AVER MAGAZINE

THE MARK CONSISTS OF STANDARD CHARACTERS WITHOUT CLAIM TO ANY PARTICULAR FONT, STYLE, SIZE, OR COLOR.

NO CLAIM IS MADE TO THE EXCLUSIVE RIGHT TO USE "MAGAZINE", APART FROM THE MARK AS SHOWN, FOR DIRECT MAILED MAGAZINE CONSISTING OF COUPON ADS IN DIFFERENT SIZES (U.S. CLS. 2, 5, 22, 23, 29, 37, 38 AND 50).

FIRST USE 4-2-2007; IN COMMERCE 4-2-2007.
RONALD AIKENS, EXAMINING ATTORNEY

SN 77-172,568. RODRIGUEZ, SERGIO, BUFFALO, NY. FILED 5-3-2007.

LITTLE SANTA

THE MARK CONSISTS OF STANDARD CHARACTERS WITHOUT CLAIM TO ANY PARTICULAR FONT, STYLE, SIZE, OR COLOR.

FOR ART PRINTS; CHILDREN'S BOOKS; CHRISTMAS CARDS; POSTERS (U.S. CLS. 2, 5, 22, 23, 29, 37, 38 AND 50).

CHARLES L. JENKINS, EXAMINING ATTORNEY

SN 77-174,547. BLOOMSBURY PUBLISHING PLC, LONDON, UNITED KINGDOM, FILED 5-7-2007.



THE MARK CONSISTS OF A LION WITH A MANE MADE UP OF "W"'S.

FOR PUBLICATIONS, NAMELY, BOOKS, MAGAZINES, JOURNALS, BROCHURES, BOOKLETS, AND TEACHING MATERIALS ON A VARIETY OF TOPICS (U.S. CLS. 2, 5, 22, 23, 29, 37, 38 AND 50).

JOHN HWANG, EXAMINING ATTORNEY

CLASS 16—(Continued).

SN 77-174,595. WORLD WRESTLING ENTERTAINMENT, INC., STAMFORD, CT. FILED 5-7-2007.

WRESTLEMANIA

THE MARK CONSISTS OF STANDARD CHARACTERS WITHOUT CLAIM TO ANY PARTICULAR FONT, STYLE, SIZE, OR COLOR.

OWNER OF U.S. REG. NOS. 1,432,884, 2,625,125 AND OTHERS.

FOR PAPER HANGTAGS, CARDBOARD HANGTAGS; PACKAGING, NAMELY BLISTER CARDS, PAPER FOR WRAPPING AND PACKAGING, PAPER POUCHES FOR PACKAGING, PLASTIC BAGS FOR PACKAGING, PLASTIC BUBBLE PACKS FOR WRAPPING OR PACKAGING; COLLECTOR ALBUMS, NAMELY, FOR STICKER COLLECTABLE CARDS, PHOTO COLLECTABLES; LABELS, NAMELY, PRINTED PAPER LABELS, PRINTED SHIPPING LABELS; RETURN ADDRESS LABELS NOT OF TEXTILE; FOLDERS; PLASTIC BAGS FOR GENERAL USE; PAPER TABLEWARE, NAMELY, PAPER PLACE MATS, PAPER TABLE MATS, PAPER NAPKINS, PAPER TABLE LINENS, PAPER TABLECLOTHS; PAPER LUNCH BAGS; STICKERS; BUMPER STICKERS; WINDOW DECALS; PENS; PENCILS; PENCIL SHARPENERS; PENCIL CASES; CHALK; ERASERS, NAMELY, RUBBER ERASERS, CHALK ERASERS, BLACKBOARD ERASERS; POSTERS; NOTEBOOKS; TRADING CARDS; CALENDARS; PHOTOGRAPHS; FRAMED PICTURES; PHOTOGRAPHIC PRINTS; PICTURES; PHOTO ALBUMS; BROCHURES, NEWSLETTERS, MAGAZINES, AND NEWSPAPERS CONCERNING SPORTS ENTERTAINMENT; POSTCARDS; GREETING CARDS; DECALS; TEMPORARY TATTOO TRANSFERS; COLORING BOOKS; CHILDREN'S ACTIVITY BOOKS; SOUVENIR PROGRAMS CONCERNING SPORTS ENTERTAINMENT; BOOKS FEATURING PICTORIAL BIOGRAPHIES; AUTOGRAPH BOOKS; COMIC BOOKS; PICTURE BOOKS; STICKER ALBUMS; BOOK COVERS; PAPER BOOK MARKERS; BOOKPLATES; MEMO PADS; SCRIBBLE PADS; DATE BOOKS; ADDRESS BOOKS; AGENDA BOOKS; RUBBER STAMPS; STAMP PADS; COLLECTIBLE PREPAID TELEPHONE CARDS NOT MAGNETICALLY ENCODED; COLLECTOR STAMPS, NAMELY, COMMEMORATIVE STAMP SHEETS; CUSTOMIZED PERSONAL CHECKS; CHECKBOOK COVERS; PAPER BANNERS; PRINTED PAPER SIGNS FOR DOORS; DRAWING RULERS; LITHOGRAPHS; PAPER PARTY BAGS; PAPER PARTY FAVORS, NAMELY, PAPER HATS; STENCILS FOR TRACING DESIGNS ONTO PAPER; PAPER GIFT WRAP; PAPER CAKE DECORATIONS (U.S. CLS. 2, 5, 22, 23, 29, 37, 38 AND 50).

FIRST USE 3-15-1985; IN COMMERCE 3-15-1985.

THEODORE MCBRIDE, EXAMINING ATTORNEY

SN 77-177,319. CRAYOLA PROPERTIES, INC., EASTON, PA. FILED 5-10-2007.

RECOLORITZ

THE MARK CONSISTS OF STANDARD CHARACTERS WITHOUT CLAIM TO ANY PARTICULAR FONT, STYLE, SIZE, OR COLOR.

FOR MARKERS; PLASTIC SHEETS FOR WRITING, PRINTING, AND MARKING (U.S. CLS. 2, 5, 22, 23, 29, 37, 38 AND 50).

EMILY CHUO, EXAMINING ATTORNEY

CLASS 16—(Continued).

SN 77-178,315. USP COMMUNICATIONS, INC., SALT LAKE CITY, UT. FILED 5-10-2007.

USP Prepaid

THE MARK CONSISTS OF STANDARD CHARACTERS WITHOUT CLAIM TO ANY PARTICULAR FONT, STYLE, SIZE, OR COLOR.

NO CLAIM IS MADE TO THE EXCLUSIVE RIGHT TO USE "PREPAID", APART FROM THE MARK AS SHOWN.

FOR PRE-PAID TELEPHONE CALLING CARDS, NOT MAGNETICALLY ENCODED (U.S. CLS. 2, 5, 22, 23, 29, 37, 38 AND 50).

LINDA LAVACHE, EXAMINING ATTORNEY

CLASS 16—(Continued).

SN 77-196,710. HACHETTE BOOK GROUP USA, INC., NEW YORK, NY. FILED 6-4-2007.

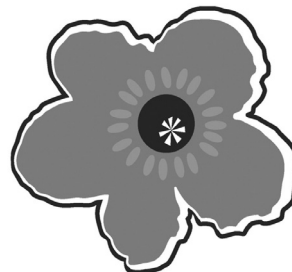

poppy

SN 77-178,954. FRESH EXPRESS INCORPORATED, SALINAS, CA. FILED 5-11-2007.

TEENS FOR GREENS

THE MARK CONSISTS OF STANDARD CHARACTERS WITHOUT CLAIM TO ANY PARTICULAR FONT, STYLE, SIZE, OR COLOR.

FOR RECIPE CARDS CONTAINING RECIPES (U.S. CLS. 2, 5, 22, 23, 29, 37, 38 AND 50).

FIRST USE 4-1-2006; IN COMMERCE 4-1-2006.

ANDREA K. NADELMAN, EXAMINING ATTORNEY

FOR TEEN BOOKS (U.S. CLS. 2, 5, 22, 23, 29, 37, 38 AND 50).

JENNIFER KRISP, EXAMINING ATTORNEY

SN 77-212,096. SEALED AIR CORPORATION (US), ELMWOOD PARK, NJ. FILED 6-21-2007.

TUFFGARD ROUNDTRIP

SN 77-187,911. COLUMBIA INSURANCE COMPANY, OMAHA, NE. FILED 5-23-2007.

LARSON-JUHL

THE MARK CONSISTS OF STANDARD CHARACTERS WITHOUT CLAIM TO ANY PARTICULAR FONT, STYLE, SIZE, OR COLOR.

OWNER OF U.S. REG. NO. 2,112,132.

FOR PRINTED ART REPRODUCTIONS (U.S. CLS. 2, 5, 22, 23, 29, 37, 38 AND 50).

IRA J. GOODSaid, EXAMINING ATTORNEY

THE MARK CONSISTS OF STANDARD CHARACTERS WITHOUT CLAIM TO ANY PARTICULAR FONT, STYLE, SIZE, OR COLOR.

OWNER OF U.S. REG. NO. 2,460,507.

FOR PACKAGING MATERIALS, NAMELY REINFORCED PAPER ENVELOPES, PAPER SHIPPING ENVELOPES WITH PAPER PADDING, PLASTIC PADDING, AIR CELLULAR PADDING AND/OR FOAM PADDING, PAPER CUSHIONING MATERIAL FOR USE AS PADDING DURING SHIPPING AND STORAGE, COMPOSITE PAPER AND CARDBOARD ENVELOPES FOR SHIPPING AND STORAGE, PROTECTIVE ENVELOPES COMPRISED OF PAPER OR PLASTIC WITH A PAPER, FOAM OR AIR CELLULAR LINING (U.S. CLS. 2, 5, 22, 23, 29, 37, 38 AND 50).

MICHELLE DUBOIS, EXAMINING ATTORNEY

CLASS 16—(Continued).

SN 78-706,854. ART ASIAPACIFIC PUBLISHING LLC, NEW YORK, NY. FILED 9-5-2005.

ArtAsiaPacific

TODAY'S ART FROM TOMORROW'S WORLD

FOR GENERAL FEATURE MAGAZINES; MAGAZINE COLUMNS ABOUT ART EVENTS, NEWS, PROFILES, FEATURES, REVIEWS, BOOK REVIEWS, AND DIRECTORIES OF ART GALLERIES AND FACILITIES; MAGAZINE DEPARTMENTS IN THE FIELD OF ART EVENTS, NEWS, PROFILES, FEATURES, REVIEWS, BOOK REVIEWS, AND DIRECTORIES OF ART GALLERIES AND FACILITIES; MAGAZINES FEATURING ART EVENTS, NEWS, PROFILES, FEATURES, REVIEWS, BOOK REVIEWS, AND DIRECTORIES OF ART GALLERIES AND FACILITIES (U.S. CLS. 2, 5, 22, 23, 29, 37, 38 AND 50).

FIRST USE 1-1-1993; IN COMMERCE 1-1-1993.
MARCIE MILONE, EXAMINING ATTORNEY

CLASS 16—(Continued).

SN 78-746,953. THE CALIFORNIA SPEEDWAY CORPORATION, DAYTONA BEACH, FL. FILED 11-4-2005.



FOR POSTERS, CALENDARS, STICKERS, BUMPER STICKERS, DECALS, TRADING CARDS, TRADING CARD ALBUMS, POSTCARDS, BOOK COVERS, POSTERS NOTEBOOKS, LOOSE LEAF BINDERS, AND MEMO PADS; PENS, PENCILS, AND ERASERS; PAPER NAPKINS AND PAPER PLACE MATS; AND CREDENTIAL HOLDERS (U.S. CLS. 2, 5, 22, 23, 29, 37, 38 AND 50).
BRIAN NEVILLE, EXAMINING ATTORNEY

SN 78-763,812. DISNEY ENTERPRISES, INC., BURBANK, CA. FILED 11-30-2005.

HAVERSHAM HALL

SN 78-723,791. CHILDREN'S PLUS, INC., SOUTH CHICAGO HEIGHTS, IL. FILED 9-29-2005.



NO CLAIM IS MADE TO THE EXCLUSIVE RIGHT TO USE "CHILDREN'S", APART FROM THE MARK AS SHOWN.

THE STIPPLING SHOWN IN THE DRAWING IS A FEATURE OF THE MARK.

FOR PRE-BOUND CHILDREN'S BOOKS AND CHILDREN'S BOOKS WITH SPECIALLY DESIGNED BINDINGS AND COVERS (U.S. CLS. 2, 5, 22, 23, 29, 37, 38 AND 50).

FIRST USE 2-2-1996; IN COMMERCE 2-2-1996.
CAROLYN GRAY, EXAMINING ATTORNEY

THE MARK CONSISTS OF STANDARD CHARACTERS WITHOUT CLAIM TO ANY PARTICULAR FONT, STYLE, SIZE, OR COLOR.

FOR ADDRESS BOOKS; ALMANACS; APPLIQUES IN THE FORM OF DECALS; APPOINTMENT BOOKS; ART PRINTS; ARTS AND CRAFT PAINT KITS; AUTOGRAPH BOOKS; BABY BOOKS; BALL POINT PENS; BASEBALL CARDS; BINDERS; BOOKENDS; BOOKMARKS; BOOKS, NAMELY A SERIES OF FICTION BOOKS; BUMPER STICKERS; CALENDARS; CARTOON STRIPS; CHRISTMAS CARDS; CHALK; CHILDREN'S ACTIVITY BOOKS; COASTERS MADE OF PAPER; COIN ALBUMS; COLORING BOOKS; COLOR PENCILS; COMIC BOOKS; COMIC STRIPS; COUPON BOOKS; DECALS; DECORATIVE PAPER CENTERPIECES; DIARIES; DISPOSABLE DIAPERS FOR BABIES; DRAWING RULERS; ENVELOPES; ERASERS; FELT PENS; FLASH CARDS; GIFT CARDS; GIFT WRAPPING PAPER; GLOBES; GREETING CARDS; GUEST BOOKS; MAGAZINES FEATURING FICTION, STORIES, GAMES AND ACTIVITIES FOR CHILDREN; MAPS; MEMO PADS; MODELING CLAY; NEWSLETTERS, FEATURING STORIES, GAMES AND ACTIVITIES FOR CHILDREN; NEWSPAPERS; NOTE PAPER; NOTEBOOKS; NOTEBOOK PAPER; PAINTINGS; PAPER FLAGS; PAPER PARTY FAVORS; PAPER PARTY HATS; PAPER CAKE DECORATIONS; PAPER PARTY DECORATIONS; PAPER NAPKINS; PAPER PARTY BAGS; PAPERWEIGHTS; PAPER GIFT WRAP BOWS; PAPER PENNANTS; PAPER PLACE MATS; PAPER TABLE CLOTHS; PEN OR PENCIL HOLDERS; PENCILS; PENCIL SHARPENERS; PEN AND PENCIL CASES AND BOXES; PENS; PRINTED PERIODICALS IN THE FIELD OF STORIES, GAMES AND ACTIVITIES FOR CHILDREN; PHOTOGRAPH ALBUMS; PHOTOGRAPHS; PHOTO-ENGRAVINGS; PICTORIAL PRINTS; PICTURE BOOKS; PORTRAITS; POSTCARDS; POSTERS; PRINTED AWARDS; PRINTED CERTIFICATES; PRINTED INVITATIONS; PRINTED MENUS; RECIPE BOOKS; RUBBER STAMPS; SCORE CARDS; STAMP ALBUMS; STATIONERY; STAPLERS; STICKERS; TRADING CARDS; UNGRADUATED RULERS; WRITING PAPER; WRITING IMPLEMENTS (U.S. CLS. 2, 5, 22, 23, 29, 37, 38 AND 50).
PAUL CROWLEY, EXAMINING ATTORNEY

CLASS 16—(Continued).

SN 78-771,407. THE JANE GOODALL INSTITUTE FOR WILDLIFE RESEARCH, EDUCATION AND CONSERVATION, ARLINGTON, VA. FILED 12-12-2005.

MR. H JUNIOR

THE MARK CONSISTS OF STANDARD CHARACTERS WITHOUT CLAIM TO ANY PARTICULAR FONT, STYLE, SIZE, OR COLOR.

THE NAME MR. H JUNIOR DOES NOT IDENTIFY A LIVING INDIVIDUAL.

FOR SERIES OF CHILDREN'S BOOKS; NON-FICTION BOOKS IN THE FIELDS OF COMMUNITY SERVICE, CIVIC AFFAIRS, LOCAL CULTURE, INTERCULTURAL HUMAN RELATIONS, NATURE, THE ENVIRONMENT, ANIMALS AND INTERSPECIES COMMUNICATIONS; NEWSPAPERS, NEWSLETTERS AND MAGAZINES IN THE FIELDS OF COMMUNITY SERVICE, CIVIC AFFAIRS, LOCAL CULTURE, INTERCULTURAL HUMAN RELATIONS, NATURE, THE ENVIRONMENT, ANIMALS AND INTERSPECIES COMMUNICATIONS; PRINTED INSTRUCTIONAL AND TEACHING MATERIALS IN THE FIELDS OF COMMUNITY SERVICE, CIVIC AFFAIRS, LOCAL CULTURE, INTERCULTURAL HUMAN RELATIONS, NATURE, THE ENVIRONMENT, ANIMALS AND INTERSPECIES COMMUNICATIONS; EDUCATIONAL BROCHURES IN THE FIELDS OF COMMUNITY SERVICE, CIVIC AFFAIRS, LOCAL CULTURE, INTERCULTURAL HUMAN RELATIONS, NATURE, THE ENVIRONMENT, ANIMALS AND INTERSPECIES COMMUNICATIONS; TEACHING GUIDES IN THE FIELDS OF COMMUNITY SERVICE, CIVIC AFFAIRS, LOCAL CULTURE, INTERCULTURAL HUMAN RELATIONS, NATURE, THE ENVIRONMENT, ANIMALS AND INTERSPECIES COMMUNICATIONS; TRAVEL GUIDES; POSTERS; COLORING BOOKS; AND FLIP BOOKS. (U.S. CLS. 2, 5, 22, 23, 29, 37, 38 AND 50).
LINDA POWELL, EXAMINING ATTORNEY

SN 78-784,836. BENNETT, DAWN J., CHEVY CHASE, MD. FILED 1-4-2006.

**DAWN J. BENNETT'S
FAIRYTALE FINANCES**

THE MARK CONSISTS OF STANDARD CHARACTERS WITHOUT CLAIM TO ANY PARTICULAR FONT, STYLE, SIZE, OR COLOR.

NO CLAIM IS MADE TO THE EXCLUSIVE RIGHT TO USE "FINANCES", APART FROM THE MARK AS SHOWN.

THE NAME DAWN J. BENNETT IDENTIFIES A LIVING INDIVIDUAL WHOSE CONSENT IS OF RECORD.

FOR SERIES OF NON-FICTIONAL BOOKS IN THE FIELDS OF BUSINESS AND FINANCE (U.S. CLS. 2, 5, 22, 23, 29, 37, 38 AND 50).

ASMAT KHAN, EXAMINING ATTORNEY

CLASS 16—(Continued).

SN 78-792,036. SEDONA SKIES GALLERY, INC, SEDONA, AZ. FILED 1-15-2006.



OWNER OF U.S. REG. NO. 3,013,116.

THE COLOR(S) WHITE, BLUE, GOLD, AND BLACK IS/ARE CLAIMED AS A FEATURE OF THE MARK.

THE MARK CONSISTS OF STYLIZED WORDING OF WORLDS IN AN ARABIC LIKE FONT IN GOLD WITH BLACK HIGHLIGHTS SET ABOVE THE WORDS WORLDS OF GOOD FORTUNE IN GOLD. THE CENTER OF THE STYLIZED O IN THE LARGER WORLDS FEATURES TWO SMALLER CIRCLES, A SMALLER ONE IN GOLD WITH BLACK HIGHLIGHTS SET ABOVE A LARGER ONE WHICH IS SHADOWED IN WHITE AND BLUE WITH BLACK HIGHLIGHTS.

FOR SERIES OF FICTIONAL BOOKS WITH MOTIVATIONAL THEMES; BLANK WRITING JOURNALS; NOTEBOOKS; SERIES OF DESIGNER GREETING CARDS WITH MOTIVATIONAL THEMES; SERIES OF TRADING CARDS WITH MOTIVATIONAL THEMES; SERIES OF MOTIVATIONAL GREETING CARDS; PAPER SCROLLS CONTAINING GRAPHIC DESIGNS AND INSPIRATIONAL MESSAGES (U.S. CLS. 2, 5, 22, 23, 29, 37, 38 AND 50).

FIRST USE 2-1-2005; IN COMMERCE 2-1-2005.

CHRISTOPHER OTT, EXAMINING ATTORNEY

SN 78-793,401. KATILLAC, KELEE, KANSAS CITY, MO. FILED 1-17-2006.

KIDS' SACRED PLACES

THE MARK CONSISTS OF STANDARD CHARACTERS WITHOUT CLAIM TO ANY PARTICULAR FONT, STYLE, SIZE, OR COLOR.

NO CLAIM IS MADE TO THE EXCLUSIVE RIGHT TO USE "KIDS'", APART FROM THE MARK AS SHOWN.

FOR BOOKS IN THE FIELD OF HOME DECORATING, SELF HELP AND CREATIVITY PROJECTS AND PRINTED INSTRUCTIONAL MATERIALS IN THE FIELD OF HOME DECORATING, SELF HELP AND CREATIVITY PROJECTS (U.S. CLS. 2, 5, 22, 23, 29, 37, 38 AND 50).

EVELYN BRADLEY, EXAMINING ATTORNEY

CLASS 16—(Continued).

SN 78-815,402. AMERICAN DIABETES ASSOCIATION, INC., ALEXANDRIA, VA. FILED 2-15-2006.



THE FOREIGN WORDING IN THE MARK TRANSLATES INTO ENGLISH AS "FOR YOUR FAMILY."

FOR PROMOTION INFORMATION AND MATERIALS, NAMELY, SAMPLE RECIPE CARDS, SAMPLE BOOKS AND SAMPLE RECIPE BROCHURES, HEALTH INFORMATION BROCHURES AND HEALTH FOCUSED BOOKS, ALL IN THE FIELD OF PROMOTING THE ADOPTION OF HEALTHIER LIFESTYLES TO VARIOUS LATINO POPULATIONS (U.S. CLS. 2, 5, 22, 23, 29, 37, 38 AND 50).

JAMES STEIN, EXAMINING ATTORNEY

CLASS 16—(Continued).

ING PENS, NOTE BOOKS, NOTE PAPER, NOTE CARDS, NOTE PADS, NOTE PAD HOLDERS, OFFICE PERFORMING MACHINES, OFFICE STATIONERY, OFFICE PAPER STATIONERY, OFFICE GLUES, PACKING PAPER, PAINT BRUSHES, PAPER AND CARDBOARD, PAPER, PAPER BAGS, PAPER BOARDS, PAPER BOXES, PAPER CUTTERS, PAPER FOLDERS, PAPER FOR PHOTOCOPIES, PAPER FOR PHOTOCOPYING, PAPER SHEETS FOR NOTE TAKING, PAPER SHREDDERS FOR OFFICE USE, PAPER STATIONERY, PAPER CLIPS, PAPERWEIGHTS, PEN AND PENCIL TRAYS, PENCIL BOXES, PENCIL CASES, PEN OR PENCIL HOLDERS, PENCILS FOR PAINTING AND DRAWING, PENCILS, PENHOLDERS, PENS, PEN CASES, PENS FOR MARKING, PHOTOCOPY PAPERS, POSTCARDS, PRINTING PAPERS, PUNCHES, SCHOOL WRITING BOOKS, STANDS FOR PEN AND PENCIL, STAPLES, NON-ELECTRIC STAPLING PRESSES, STATIONERY, STICKERS, T-SQUARES, WRITING INK, WRITING INSTRUMENTS, WRITING PAPER, WRITING PADS (U.S. CLS. 2, 5, 22, 23, 29, 37, 38 AND 50).

JASON BLAIR, EXAMINING ATTORNEY

SN 78-841,845. CONG TY CO PHAN VAN PHONG PHAM HONG HA (HONG HA STATIONERY JOINT STOCK COMPANY), HOAN KIEM, HA NOI, VIETNAM, FILED 3-20-2006.



OWNER OF VIETNAM REG. NO. 67392, DATED 10-20-2005, EXPIRES 4-9-2014.

NO CLAIM IS MADE TO THE EXCLUSIVE RIGHT TO USE "CTY VAN PHONG PHAM" AND "SINCE 1959", APART FROM THE MARK AS SHOWN.

THE COLOR(S) RED, DARK BLUE AND WHITE IS/ARE CLAIMED AS A FEATURE OF THE MARK.

THE COLOR BLUE APPEARS IN THE WORDING "CTY VAN PHONG PHAM" AND "SINCE 1959," THE COLOR WHITE APPEARS IN THE MIDDLE OF THE WORDING "HONG HA," IN THE CIRCLE AND IN BETWEEN THE WAVES. THE COLOR RED APPEARS IN THE OUTER PORTIONS OF THE WORDING "HONG HA," IN THE LETTERS "HH," IN THE WAVES, AND IN THE SQUARE.

THE ENGLISH TRANSLATION OF THE WORD HONG HA IN THE MARK IS RED RIVER.

FOR ADDRESS BOOKS, ADHESIVES FOR STATIONERY PURPOSES, ADHESIVE NOTE PADS, ADHESIVE NOTE PAPER, AGENDAS, ALBUMS FOR PHOTOGRAPHS, ALMANACS, ATLASES, BINDERS, BALL-POINT PENS, BABY BOOKS, BLACKBOARDS, BOOK-KEEPING BOOKS, BOOK-COVER PAPER, CHILDREN'S BOOKS, BOOKENDS, BOXES OF CARDBOARD OR PAPER, CALENDARS, CARBON PAPER, CARDBOARD, CARDBOARD BOXES, CELLOPHANE PAPER, CHALK, CHALK STICKS, CHARCOAL PENCILS, CLIP BOARDS, CLIPS FOR LETTERS, COLOURED PENS, COLOUR PENCILS, COMIC BOOKS, COLORING BOOKS, COPY BOOKS, COPY PAPER, COPIER PAPER, CORRECTING PENCILS, CRAYONS, DATE BOOKS, DESK CALENDARS, DIRECTORY PAPER, DOCUMENT FILES, DOCUMENT PORTFOLIOS, DRAWINGS, DRAWING BOARDS, DRAWING INSTRUMENTS, DRAWING PAPER, DRAWING PENCILS, DRAWING RULERS, DRAWING BRUSHES, DRAWING SQUARES, ENVELOPE PAPERS, ENVELOPES, ERASERS, FILLER PAPER, FOLDERS FOR LETTERS, FOLDERS, FOUNTAIN PENS, GLOBES, GIFT CARDS, GREETING CARDS, INK FOR WRITING INSTRUMENTS, INK STICKS, INK PENS, INKING PADS, INKING RIBBONS, INKWELLS, LETTER TRAYS, LETTER CLIPS, LETTER FILES, MAPS, MARK-

SN 78-878,906. SANDRA BOOKER, SHERMAN OAKS, CA. FILED 5-8-2006.

WHEN LOVE HAPPENS

THE MARK CONSISTS OF STANDARD CHARACTERS WITHOUT CLAIM TO ANY PARTICULAR FONT, STYLE, SIZE, OR COLOR.

FOR GREETING CARDS, POSTCARDS, PAPER COVERS FOR HARDBACK AND PAPERBACK BOOKS, PAPER COVERS FOR WRITING JOURNALS, BLANK WRITING JOURNALS (U.S. CLS. 2, 5, 22, 23, 29, 37, 38 AND 50).

KIMBERLY PERRY, EXAMINING ATTORNEY

CLASS 16—(Continued).

SN 78-905,861. MONMOUTH UNIVERSITY, WEST LONG BRANCH, NJ. FILED 6-12-2006.



NO CLAIM IS MADE TO THE EXCLUSIVE RIGHT TO USE "NEW JERSEY 1933", APART FROM THE MARK AS SHOWN.

FOR PAPER AND PAPER ARTICLES; NAMELY, STATIONERY, WRAPPING PAPER, PAPER GIFT WRAPPING RIBBON, GREETING CARDS, PAPER NAPKINS, CARDBOARD BOXES, PAPER BOXES, PENCIL BOXES, DECALS, STICKERS, AND OFFICE AND SCHOOL SUPPLIES; NAMELY, NOTEBOOKS, CALENDARS, BOOK COVERS, WRITING TABLETS, DESK FILE TRAYS AND DESK SETS; PEWTER AND GLASS PAPERWEIGHTS; LETTER OPENERS; PENS AND PENCILS; BINDERS; COIL BOUND NOTEBOOKS AND DIARIES; NOTEPADS; MEMO BOARDS; BULLETIN BOARDS; DATE BOOKS; WRITING PAPER AND ENVELOPES (U.S. CLS. 2, 5, 22, 23, 29, 37, 38 AND 50).

FIRST USE 3-24-1995; IN COMMERCE 3-24-1995.
MELISSA VALLILLO, EXAMINING ATTORNEY

SN 78-919,132. TWENTY AND SEVEN, LLC, NEW YORK, NY. FILED 6-28-2006.

KRISTINA WRENN

THE MARK CONSISTS OF STANDARD CHARACTERS WITHOUT CLAIM TO ANY PARTICULAR FONT, STYLE, SIZE, OR COLOR.

KRISTINA WRENN IDENTIFIES A LIVING INDIVIDUAL WHOSE CONSENT IS OF RECORD.

FOR STATIONERY MADE OF VARIOUS MATERIALS; PRINTED INVITATIONS; PRINTED INVITATIONS CONSISTING IN PART OF 3 DIMENSIONAL OBJECTS; PAPER BAGS FOR PACKAGING AND PLASTIC BAGS FOR PACKAGING; CORRESPONDENCE ENVELOPES; MAILING ENVELOPES; NOTE CARDS; HOLIDAY CARDS; PAPER LABELS; PAPER TAGS (U.S. CLS. 2, 5, 22, 23, 29, 37, 38 AND 50).

ANDREA BUTLER, EXAMINING ATTORNEY

CLASS 16—(Continued).

SN 78-930,669. REED ELSEVIER PROPERTIES INC., WILMINGTON, DE. FILED 7-17-2006.

VPAGE

THE MARK CONSISTS OF STANDARD CHARACTERS WITHOUT CLAIM TO ANY PARTICULAR FONT, STYLE, SIZE, OR COLOR.

FOR PRINTED PUBLICATIONS, NAMELY MAGAZINES AND MAGAZINE SECTIONS IN THE FIELD OF ENTERTAINMENT (U.S. CLS. 2, 5, 22, 23, 29, 37, 38 AND 50).

DARRYL SPRUILL, EXAMINING ATTORNEY

SN 78-933,706. BRV, INC. DBA REDDING RECORD SEARCHLIGHT, REDDING, CA. FILED 7-20-2006.

KEY BARGAINS

THE MARK CONSISTS OF STANDARD CHARACTERS WITHOUT CLAIM TO ANY PARTICULAR FONT, STYLE, SIZE, OR COLOR.

NO CLAIM IS MADE TO THE EXCLUSIVE RIGHT TO USE "BARGAINS", APART FROM THE MARK AS SHOWN.

FOR CLASSIFIED ADVERTISING MAGAZINE IN THE FIELD OF MOTOR VEHICLES AND MOTOR VEHICLE ACCESSORIES (U.S. CLS. 2, 5, 22, 23, 29, 37, 38 AND 50).

KELLY BOULTON, EXAMINING ATTORNEY

SN 78-934,585. MATTE INDUSTRIES, INC., GORMLEY, ONTARIO, CANADA, FILED 7-21-2006.

POLICEPRO

THE MARK CONSISTS OF STANDARD CHARACTERS WITHOUT CLAIM TO ANY PARTICULAR FONT, STYLE, SIZE, OR COLOR.

FOR WRITING INSTRUMENTS, NAMELY SPECIALTY BALL POINT PEN HAVING PRESSURIZED INK CARTRIDGE (U.S. CLS. 2, 5, 22, 23, 29, 37, 38 AND 50).

FIRST USE 7-15-1998; IN COMMERCE 7-15-1998.

TINA KUAN, EXAMINING ATTORNEY

CLASS 16—(Continued).

SN 78-938,423. HARRIS, JANET MARIE, GLENDALE, CA.
FILED 7-26-2006.

Simple Poetry

THE MARK CONSISTS OF STANDARD CHARACTERS WITHOUT CLAIM TO ANY PARTICULAR FONT, STYLE, SIZE, OR COLOR.

NO CLAIM IS MADE TO THE EXCLUSIVE RIGHT TO USE "POETRY", APART FROM THE MARK AS SHOWN.

FOR ANNOUNCEMENT CARDS; CARDS BEARING UNIVERSAL GREETINGS; CARDS, NAMELY, GREETING CARDS ; GREETING CARDS; HOLIDAY CARDS; INVITATION CARDS; MOTIVATIONAL CARDS; OCCASION CARDS; SOCIAL NOTE CARDS (U.S. CLS. 2, 5, 22, 23, 29, 37, 38 AND 50).

DOMINIC J. FERRAIUOLO, EXAMINING ATTORNEY

SN 78-938,432. HARRIS, JANET MARIE, GLENDALE, CA.
FILED 7-26-2006.

Jail Greeting Cards

THE MARK CONSISTS OF STANDARD CHARACTERS WITHOUT CLAIM TO ANY PARTICULAR FONT, STYLE, SIZE, OR COLOR.

NO CLAIM IS MADE TO THE EXCLUSIVE RIGHT TO USE "GREETING CARDS", APART FROM THE MARK AS SHOWN.

FOR CARDS, NAMELY, GREETING CARDS ; CHRISTMAS CARDS; GREETING CARDS; HOLIDAY CARDS; MOTIVATIONAL CARDS; OCCASION CARDS; SOCIAL NOTE CARDS (U.S. CLS. 2, 5, 22, 23, 29, 37, 38 AND 50).

DOMINIC J. FERRAIUOLO, EXAMINING ATTORNEY

SN 78-940,162. STAPLES THE OFFICE SUPERSTORE, LLC,
FRAMINGHAM, MA. FILED 7-28-2006.

FAST FLYER

THE MARK CONSISTS OF STANDARD CHARACTERS WITHOUT CLAIM TO ANY PARTICULAR FONT, STYLE, SIZE, OR COLOR.

NO CLAIM IS MADE TO THE EXCLUSIVE RIGHT TO USE "FLYER", APART FROM THE MARK AS SHOWN.

FOR PAPER (U.S. CLS. 2, 5, 22, 23, 29, 37, 38 AND 50).

MARK PILARO, EXAMINING ATTORNEY

CLASS 16—(Continued).

SN 78-942,137. NATIONAL ACADEMY OF RECORDING ARTS & SCIENCES, INC., SANTA MONICA, CA. FILED 8-1-2006.

MUSICARES

THE MARK CONSISTS OF STANDARD CHARACTERS WITHOUT CLAIM TO ANY PARTICULAR FONT, STYLE, SIZE, OR COLOR.

OWNER OF U.S. REG. NO. 1,665,539.

FOR PRINTED MATTER, NAMELY TICKETS, INVITATIONS, POSTERS, BOOKLETS, BROCHURES, BULLETINS, CIRCULARS, NEWSLETTERS, AND PAMPHLETS, ALL IN THE FIELDS OF SUBSTANCE ABUSE COUNSELING AND CHARITABLE SERVICES; STICKERS, DECALS, LITHOGRAPHS, PENS, PENCILS, NOTECARDS, POSTCARD, NOTEPADS, NOTEBOOKS, CALENDARS, EVENT PROGRAMS AND SOUVENIR PROGRAMS CONCERNING COUNSELING AND CHARITABLE SERVICES (U.S. CLS. 2, 5, 22, 23, 29, 37, 38 AND 50).

FLORENTINA BLANDU, EXAMINING ATTORNEY

SN 78-945,375. TORAIN, TROI, NEW YORK, NY. FILED 8-4-2006.

OBJECTIVE HATE

THE MARK CONSISTS OF STANDARD CHARACTERS WITHOUT CLAIM TO ANY PARTICULAR FONT, STYLE, SIZE, OR COLOR.

NO CLAIM IS MADE TO THE EXCLUSIVE RIGHT TO USE "HATE", APART FROM THE MARK AS SHOWN.

FOR COLUMNS ON THE SUBJECT OF ENTERTAINMENT, POPULAR CULTURE AND PHILOSOPHY; MAGAZINE COLUMNS ABOUT ENTERTAINMENT, POPULAR CULTURE AND PHILOSOPHY; MAGAZINE SECTIONS IN THE FIELD OF ENTERTAINMENT, POPULAR CULTURE AND PHILOSOPHY; MAGAZINES FEATURING ENTERTAINMENT, POPULAR CULTURE AND PHILOSOPHY; NEWSLETTERS IN THE FIELD OF ENTERTAINMENT, POPULAR CULTURE AND PHILOSOPHY; SERIES OF NON-FICTION BOOKS IN THE FIELD OF ENTERTAINMENT, POPULAR CULTURE AND PHILOSOPHY (U.S. CLS. 2, 5, 22, 23, 29, 37, 38 AND 50).

KATHLEEN LORENZO, EXAMINING ATTORNEY

CLASS 16—(Continued).

SN 78-945,571. GENUINE INDIAN RELIC SOCIETY, INC., KANSAS CITY, MO. FILED 8-4-2006.



NO CLAIM IS MADE TO THE EXCLUSIVE RIGHT TO USE "PREHISTORIC ARTIFACTS" AND "G.I.R.S. 1964", APART FROM THE MARK AS SHOWN.

FOR PRINTED PUBLICATIONS, NAMELY, MAGAZINES, BOOKS, JOURNALS AND PAMPHLETS IN THE FIELD OF ART AND ARTIFACTS (U.S. CLS. 2, 5, 22, 23, 29, 37, 38 AND 50).

FIRST USE 0-0-1964; IN COMMERCE 0-0-1964.
LOURDES AYALA, EXAMINING ATTORNEY

CLASS 16—(Continued).

SN 78-948,835. BICYCLE CITY, LLC, CINCINNATI, OH. FILED 8-9-2006.

BICYCLE CITY

THE MARK CONSISTS OF STANDARD CHARACTERS WITHOUT CLAIM TO ANY PARTICULAR FONT, STYLE, SIZE, OR COLOR.

FOR PUBLICATIONS, NAMELY, BOOKS, MAGAZINES, MANUALS, BOOKLETS, GUIDES AND PAMPHLETS IN THE FIELD OF ALTERNATIVE COMMUNITIES, NAMELY ENVIRONMENTALLY-FRIENDLY RESIDENTIAL AND COMMERCIAL PLANNED COMMUNITIES; POSTERS; DAILY PLANNERS; PERSONAL ORGANIZERS; CALENDARS; BINDERS; NOTEBOOKS; PENS; PENCILS; NOTE PADS (U.S. CLS. 2, 5, 22, 23, 29, 37, 38 AND 50).

DANIEL BRODY, EXAMINING ATTORNEY

SN 78-947,290. TARNISHED SILVER, INC., INDIANAPOLIS, IN. FILED 8-8-2006.

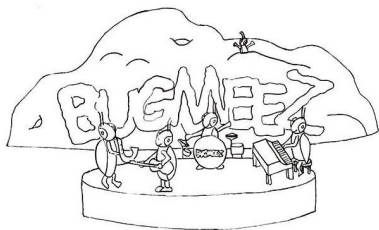

THE MARK CONSISTS OF A STAGE ON WHICH FOUR BUGS WITH SHELLS ARE PLAYING A SAXOPHONE, A GUITAR, DRUMS WITH THE WORD BUGMEEZ WRITTEN ACROSS THEM, AND A PIANO; BEHIND THE STAGE IS A PILE OF DIRT WITH THE WORD BUGMEEZ WRITTEN ACROSS IT.

FOR PAPER GOODS, NAMELY, TRADING CARDS, STICKERS, DECALS, POST CARDS, NOTE CARDS, MEMO PADS, NOTE PADS, BALL POINT PENS, PENCILS, SCRAP BOOKS, RUBBER STAMPS, PAPER BANNERS AND FLAGS, BOOKMARKS, 3-RING BINDERS, STATIONERY FOLDERS, WIREBOUND NOTEBOOKS, STATIONERY PORTFOLIO NOTEBOOKS, POSTERS, CALENDARS, BUMPER STICKERS, BOOK COVERS, WRAPPING PAPER, CHILDREN'S ACTIVITY BOOKS, CHILDREN'S COLORING BOOKS, COMIC BOOKS, PAPER PENNANTS, STATIONERY, STATIONERY-TYPE PORTFOLIOS, INVITATION CARDS, PRINTED CERTIFICATES, GREETING CARDS, CHRISTMAS CARDS AND HOLIDAY CARDS (U.S. CLS. 2, 5, 22, 23, 29, 37, 38 AND 50).

FIRST USE 7-17-2006; IN COMMERCE 7-17-2006.
CHRISIE B. KING, EXAMINING ATTORNEY

SN 78-948,871. BICYCLE CITY, LLC, CINCINNATI, OH. FILED 8-9-2006.

CIUDAD DE LA BICICLETA

THE MARK CONSISTS OF STANDARD CHARACTERS WITHOUT CLAIM TO ANY PARTICULAR FONT, STYLE, SIZE, OR COLOR.

"THE FOREIGN WORDING IN THE MARK TRANSLATES INTO ENGLISH AS BICYCLE CITY."

FOR PUBLICATIONS, NAMELY, BOOKS, MAGAZINES, MANUALS, BOOKLETS, GUIDES AND PAMPHLETS IN THE FIELD OF ALTERNATIVE COMMUNITIES, NAMELY ENVIRONMENTALLY-FRIENDLY RESIDENTIAL AND COMMERCIAL PLANNED COMMUNITIES; POSTERS; DAILY PLANNERS; PERSONAL ORGANIZERS; CALENDARS; BINDERS; NOTEBOOKS; PENS; PENCILS; NOTE PADS (U.S. CLS. 2, 5, 22, 23, 29, 37, 38 AND 50).

DANIEL BRODY, EXAMINING ATTORNEY

CLASS 16—(Continued).

SN 78-950,362. BARON, RICHARD L., SEATTLE, WA. FILED 8-11-2006.

POCKET PROMPTS

THE MARK CONSISTS OF STANDARD CHARACTERS WITHOUT CLAIM TO ANY PARTICULAR FONT, STYLE, SIZE, OR COLOR.

NO CLAIM IS MADE TO THE EXCLUSIVE RIGHT TO USE "POCKET", APART FROM THE MARK AS SHOWN.

FOR EDUCATIONAL PUBLICATIONS, NAMELY, TRAINING MANUALS IN THE FIELDS OF HUMAN RESOURCES AND BUSINESS MANAGEMENT; AND PRINTED SEMINAR NOTES (U.S. CLS. 2, 5, 22, 23, 29, 37, 38 AND 50).

FIRST USE 0-0-2005; IN COMMERCE 0-0-2005.

TRACY WHITTAKER-BROWN, EXAMINING ATTORNEY

SN 78-951,010. LAUFER, LIORA, CHARLOTTESVILLE, VA. FILED 8-13-2006.

Callirobics

THE MARK CONSISTS OF STANDARD CHARACTERS WITHOUT CLAIM TO ANY PARTICULAR FONT, STYLE, SIZE, OR COLOR.

FOR CHILDREN'S ACTIVITY BOOKS; CHILDREN'S INTERACTIVE EDUCATIONAL BOOKS; EDUCATIONAL BOOKS FEATURING HANDWRITING EXERCISES WHICH ARE PERFORMED TO MUSIC AND CONTAINING MUSICAL CDS AS A COMPONENT THEREOF; INSTRUCTIONAL BOOKS IN THE FIELD OF CALLIGRAPHY, NAMELY, BOOKS FEATURING DIRECTIONS FOR PERFORMING HANDWRITING EXERCISES TO MUSIC AND ASSOCIATED USER MANUALS FOR INSTRUCTORS OR TEACHERS (U.S. CLS. 2, 5, 22, 23, 29, 37, 38 AND 50).

FIRST USE 12-31-1990; IN COMMERCE 12-31-1990.

MATTHEW MCDOWELL, EXAMINING ATTORNEY

SN 78-951,194. FACTOR HEALTH MANAGEMENT, LLC, BOCA RATON, FL. FILED 8-14-2006.

MISDIAGNOSED DIANE

THE MARK CONSISTS OF STANDARD CHARACTERS WITHOUT CLAIM TO ANY PARTICULAR FONT, STYLE, SIZE, OR COLOR.

FOR BOOKS AND MAGAZINES REGARDING MEDICAL CONDITIONS (U.S. CLS. 2, 5, 22, 23, 29, 37, 38 AND 50).

BRENDAN REGAN, EXAMINING ATTORNEY

CLASS 16—(Continued).

SN 78-956,320. LAMBERTO ART & DESIGN, LLC, DBA SOLARE MEDIA, SOUTHLAKE, TX. FILED 8-21-2006.

LAMBERTO

THE MARK CONSISTS OF STANDARD CHARACTERS WITHOUT CLAIM TO ANY PARTICULAR FONT, STYLE, SIZE, OR COLOR.

FOR ARTWORK, NAMELY, PAINTINGS AND PICTURES (U.S. CLS. 2, 5, 22, 23, 29, 37, 38 AND 50).

FIRST USE 12-31-1983; IN COMMERCE 12-31-1983.

KRISTIN DAHLING, EXAMINING ATTORNEY

SN 78-961,655. ONE WEEK BATH, INC., TARZANA, CA. FILED 8-28-2006.

GRAMPA GREEN

THE MARK CONSISTS OF STANDARD CHARACTERS WITHOUT CLAIM TO ANY PARTICULAR FONT, STYLE, SIZE, OR COLOR.

FOR CHILDREN'S BOOKS, TALKING CHILDREN'S BOOKS, CHILDREN'S ACTIVITY BOOKS, CHILDREN'S INTERACTIVE EDUCATIONAL BOOKS, AND CHILDREN'S STORYBOOKS (U.S. CLS. 2, 5, 22, 23, 29, 37, 38 AND 50).

RONALD MCMORROW, EXAMINING ATTORNEY

SN 78-962,709. CONGREGATION AGUDAT ACHIM, NISKAYUNA, NY. FILED 8-29-2006.

Divine

THE MARK CONSISTS OF STANDARD CHARACTERS WITHOUT CLAIM TO ANY PARTICULAR FONT, STYLE, SIZE, OR COLOR.

FOR COOKBOOKS, KOSHER COOKBOOKS, JEWISH FOODS COOKBOOKS, RECIPE BOOKS, KOSHER RECIPE BOOKS, JEWISH RECIPE BOOKS, MENU BOOKS AND PRINTED GUIDES FOR PREPARING KOSHER FOODS AND PLANNING PARTIES WITH KOSHER FOODS, MENU BOOKS AND PRINTED GUIDES FOR PARTY PLANNING, KOSHER MENU BOOKS AND PRINTED GUIDES FOR PREPARING KOSHER FOODS AND PLANNING PARTIES WITH KOSHER FOODS, KOSHER MENU BOOKS AND PRINTED GUIDES FOR PARTY PLANNING, JEWISH MENU BOOKS AND PRINTED GUIDES FOR PREPARING KOSHER FOODS AND PLANNING PARTIES WITH KOSHER FOODS, JEWISH MENU BOOKS AND PRINTED GUIDES FOR PARTY PLANNING (U.S. CLS. 2, 5, 22, 23, 29, 37, 38 AND 50).

TONJA GASKINS, EXAMINING ATTORNEY

CLASS 16—(Continued).

SN 78-967,577. CLAY CREATIONS INC., CHICAGO, IL.
FILED 9-5-2006.

TAPE N SHAPE

THE MARK CONSISTS OF STANDARD CHARACTERS
WITHOUT CLAIM TO ANY PARTICULAR FONT, STYLE,
SIZE, OR COLOR.

FOR STENCILS; STICKERS (U.S. CLS. 2, 5, 22, 23, 29,
37, 38 AND 50).

JEFF DEFORD, EXAMINING ATTORNEY

SN 78-970,979. ROAD RUNNERS CLUB OF AMERICA,
COLUMBIA, MD. FILED 9-11-2006.

RRCA: KIDS RUN THE NATION

THE MARK CONSISTS OF STANDARD CHARACTERS
WITHOUT CLAIM TO ANY PARTICULAR FONT, STYLE,
SIZE, OR COLOR.

FOR PRINTED TEACHING ACTIVITY GUIDES IN
THE FIELD OF RUNNING, TO ENGAGE CHILDREN
OF ALL AGES IN THE SPORT OF RUNNING (U.S. CLS.
2, 5, 22, 23, 29, 37, 38 AND 50).

MORENO, PAUL, EXAMINING ATTORNEY

SN 78-973,638. CHICOPEE, INC., CHARLOTTE, NC. FILED 9-
13-2006.



FOR DISPOSABLE WIPES NOT IMPREGNATED WITH
CHEMICALS OR COMPOUNDS (U.S. CLS. 2, 5, 22, 23, 29,
37, 38 AND 50).

DOMINIC FATHY, EXAMINING ATTORNEY

CLASS 16—(Continued).

SN 79-031,057. EDDING AG, FED REP GERMANY, FILED 8-
29-2006.



OWNER OF INTERNATIONAL REGISTRATION 0903903
DATED 8-29-2006, EXPIRES 8-29-2016.

OWNER OF U.S. REG. NO. 1,217,506.

THE COLOR(S) RED, BLUE AND WHITE IS/ARE
CLAIMED AS A FEATURE OF THE MARK.

THE COLOR RED APPEARS IN THE BACKGROUND OF
THE RIGHT RECTANGLE BEHIND THE WORD "EDDING"
IN THE UPPER PORTION OF THE LEFT RECTANGLE,
AND IN THE THIRD DIAGONAL STRIPE, THE COLOR
BLUE APPEARS IN THE LOWER PORTION OF THE LEFT
RECTANGLE AND IN THE FIRST DIAGONAL STRIPE,
AND THE COLOR WHITE APPEARS IN THE CENTER
DIAGONAL STRIPE AND IN THE WORD "EDDING", AND
THE BACKGROUND OF THE MARK IS TRANSPARENT.

FOR WRITING INSTRUMENTS, NAMELY, FELT AND
FIBRE TIP PENS, MARKERS, PERMANENT AND PIG-
MENT MARKERS, FLIPCHART MARKERS, TEXT MAR-
KERS IN THE NATURE OF HIGHLIGHTERS, SPECIAL
MARKERS, FOUNTAIN PENS, BALL POINT PENS AND
ROLLERS, PROPELLING PENS, CORRECTION PENS,
BOARD MARKERS; OFFICE EQUIPMENT, NAMELY,
ERASERS, FASTENERS FOR BINDING FILES IN THE
NATURE OF PAPER FASTENERS AND PAPER CLIPS,
MATS FOR CUTTING PAPER, PAPER CUTTERS AND
SPARE BLADES FOR PAPER CUTTERS. (U.S. CLS. 2, 5,
22, 23, 29, 37, 38 AND 50).

CHARLOTTE CORWIN, EXAMINING ATTORNEY

SN 79-032,985. RICHEMONT ITALIA S.P.A., ITALY, FILED
6-13-2006.

ESPRESSIONE

THE MARK CONSISTS OF STANDARD CHARACTERS
WITHOUT CLAIM TO ANY PARTICULAR FONT, STYLE,
SIZE, OR COLOR.

PRIORITY DATE OF 12-15-2005 IS CLAIMED.

OWNER OF INTERNATIONAL REGISTRATION 0908747
DATED 6-13-2006, EXPIRES 6-13-2016.

THE FOREIGN WORDING IN THE MARK TRANSLATES
INTO ENGLISH AS EXPRESSION.

FOR WRITING INSTRUMENTS, NAMELY FOUNTAIN
PENS, BALLPOINT PENS, FELT-TIP PENS, ROLL-
ER BALL PENS, DOCUMENT MARKER PENS, PENCILS,
WRITING BRUSHES; VARIOUS PARTS OF THE AFORE-
MENTIONED WRITING INSTRUMENTS, NAMELY,
NIBS, PEN BODIES AND PEN CLIPS; WRITING INKS,
PEN INK REFILLS, AND PEN INK CARTRIDGES FOR
THE AFOREMENTIONED WRITING INSTRUMENTS;
POUCHES FOR WRITING INSTRUMENTS, GIFT CASES
FITTED FOR WRITING INSTRUMENTS; PEN AND
PENCIL HOLDERS (U.S. CLS. 2, 5, 22, 23, 29, 37, 38
AND 50).

DANIEL BRODY, EXAMINING ATTORNEY

CLASS 17—RUBBER GOODS

SN 77-052,977. OWENS-CORNING FIBERGLAS TECHNOLOGY INC., SUMMIT, IL. FILED 11-29-2006.

FLEXSMOOTH

THE MARK CONSISTS OF STANDARD CHARACTERS WITHOUT CLAIM TO ANY PARTICULAR FONT, STYLE, SIZE, OR COLOR.

FOR FIBERGLASS REINFORCED PLASTIC SHEETING FOR USE IN THE RECREATIONAL VEHICLE INDUSTRY (U.S. CLS. 1, 5, 12, 13, 35 AND 50).
ROBIN CHOSID, EXAMINING ATTORNEY

SN 77-052,986. OWENS-CORNING FIBERGLAS TECHNOLOGY INC., SUMMIT, IL. FILED 11-29-2006.

FLEXPEBBLE

THE MARK CONSISTS OF STANDARD CHARACTERS WITHOUT CLAIM TO ANY PARTICULAR FONT, STYLE, SIZE, OR COLOR.

FOR FIBERGLASS REINFORCED PLASTIC SHEETING FOR USE IN THE RECREATIONAL VEHICLE INDUSTRY (U.S. CLS. 1, 5, 12, 13, 35 AND 50).
ROBIN CHOSID, EXAMINING ATTORNEY

SN 77-097,584. TECTUM, INC., NEWARK, OH. FILED 2-2-2007.

FABRI-TEC

THE MARK CONSISTS OF STANDARD CHARACTERS WITHOUT CLAIM TO ANY PARTICULAR FONT, STYLE, SIZE, OR COLOR.

OWNER OF U.S. REG. NOS. 598,662, 1,508,153 AND 1,942,326.
FOR ABUSE-RESISTANT ACOUSTICAL PANELS (U.S. CLS. 1, 5, 12, 13, 35 AND 50).
FIRST USE 10-1-2006; IN COMMERCE 10-1-2006.
REBECCA GAN, EXAMINING ATTORNEY

CLASS 17—(Continued).

SN 77-119,386. INTEPLAST GROUP LTD., LIVINGSTON, NJ. FILED 3-1-2007.

Pelliko

THE MARK CONSISTS OF STANDARD CHARACTERS WITHOUT CLAIM TO ANY PARTICULAR FONT, STYLE, SIZE, OR COLOR.

FOR PLASTIC FILM FOR INDUSTRIAL AND COMMERCIAL PACKING USE (U.S. CLS. 1, 5, 12, 13, 35 AND 50).
BARBARA GAYNOR, EXAMINING ATTORNEY

SN 77-123,983. WENJOR CORPORATION, WINTER SPRINGS, FL. FILED 3-6-2007.

Bevona Wood

THE MARK CONSISTS OF STANDARD CHARACTERS WITHOUT CLAIM TO ANY PARTICULAR FONT, STYLE, SIZE, OR COLOR.

NO CLAIM IS MADE TO THE EXCLUSIVE RIGHT TO USE "WOOD", APART FROM THE MARK AS SHOWN.

FOR PLASTIC COMPOSITE MATERIAL RESEMBLING WOOD AND IN THE FORM OF PROFILES, BOARDS, SHEETS, BLOCKS AND RODS FOR USE IN MANUFACTURING (U.S. CLS. 1, 5, 12, 13, 35 AND 50).
FIRST USE 8-1-2001; IN COMMERCE 8-1-2001.
RAY THOMAS, EXAMINING ATTORNEY

SN 77-135,199. OWENS-CORNING FIBERGLAS TECHNOLOGY II, LLC, TOLEDO, OH. FILED 3-20-2007.

OCV

THE MARK CONSISTS OF STANDARD CHARACTERS WITHOUT CLAIM TO ANY PARTICULAR FONT, STYLE, SIZE, OR COLOR.

FOR GLASS WOOL FOR USE AS INSULATION IN INDUSTRIAL SILENCERS AND AUTOMOTIVE MUFFLERS; SEMI-FINISHED PRODUCTS IN THE FORM OF ROVING, FABRIC, SHEETS, PANELS, PLATES, GRANULATES AND COMPOSED OF COMMINGLED GLASS AND THERMOPLASTIC FILAMENTS FOR INSULATION PURPOSES; GLASS FIBERS STRANDS AND YARNS SPECIFICALLY DESIGNED FOR ELECTRICAL INSULATION; WEBS, MATS, SLUBS, TWINES, FABRICS, KNITTED FABRICS AND BANDS MADE OF GLASS STRAND AND YARN SPECIFICALLY DESIGNED FOR ELECTRIC INSULATION; CARBON FIBERS NOT FOR TEXTILE USE (U.S. CLS. 1, 5, 12, 13, 35 AND 50).
TASHIA BUNCH, EXAMINING ATTORNEY

CLASS 17—(Continued).

SN 77-141,574. POLYGUARD PRODUCTS, INC., ENNIS, TX. FILED 3-27-2007.

ALUMAGUARD

THE MARK CONSISTS OF STANDARD CHARACTERS WITHOUT CLAIM TO ANY PARTICULAR FONT, STYLE, SIZE, OR COLOR.

FOR SELF-ADHERING TAPES AND MEMBRANES WITH AN ALUMINUM FOIL FACING FOR VAPOR PROOFING, WEATHER SEALING, AND PROTECTING SUBSTRATES AND INSULATION PRODUCTS NOT FOR MARINE OR ROOFING USE (U.S. CLS. 1, 5, 12, 13, 35 AND 50).

FIRST USE 3-1-1998; IN COMMERCE 3-1-1998.
DAVID TOOLEY, EXAMINING ATTORNEY

SN 77-142,767. RAVNAAS, BRIAN E., FARGO, ND. FILED 3-28-2007.

Whisper Glue

THE MARK CONSISTS OF STANDARD CHARACTERS WITHOUT CLAIM TO ANY PARTICULAR FONT, STYLE, SIZE, OR COLOR.

NO CLAIM IS MADE TO THE EXCLUSIVE RIGHT TO USE "GLUE", APART FROM THE MARK AS SHOWN.

FOR SOUNDPROOFING MATERIALS FOR BUILDINGS (U.S. CLS. 1, 5, 12, 13, 35 AND 50).

MELVIN AXILBUND, EXAMINING ATTORNEY

SN 77-142,803. RAVNAAS, BRIAN E., FARGO, ND. FILED 3-28-2007.

whisper board

THE MARK CONSISTS OF STANDARD CHARACTERS WITHOUT CLAIM TO ANY PARTICULAR FONT, STYLE, SIZE, OR COLOR.

NO CLAIM IS MADE TO THE EXCLUSIVE RIGHT TO USE "BOARD", APART FROM THE MARK AS SHOWN.

FOR SOUNDPROOFING MATERIALS FOR BUILDINGS AND MACHINERY (U.S. CLS. 1, 5, 12, 13, 35 AND 50).

MELVIN AXILBUND, EXAMINING ATTORNEY

CLASS 17—(Continued).

SN 77-142,823. RAVNAAS, BRIAN E., FARGO, ND. FILED 3-28-2007.

whisper floor

THE MARK CONSISTS OF STANDARD CHARACTERS WITHOUT CLAIM TO ANY PARTICULAR FONT, STYLE, SIZE, OR COLOR.

NO CLAIM IS MADE TO THE EXCLUSIVE RIGHT TO USE "FLOOR", APART FROM THE MARK AS SHOWN.

FOR SOUNDPROOFING MATERIALS FOR BUILDINGS AND MACHINERY (U.S. CLS. 1, 5, 12, 13, 35 AND 50).

MELVIN AXILBUND, EXAMINING ATTORNEY

SN 77-142,830. RAVNAAS, BRIAN E., FARGO, ND. FILED 3-28-2007.

whisper rock

THE MARK CONSISTS OF STANDARD CHARACTERS WITHOUT CLAIM TO ANY PARTICULAR FONT, STYLE, SIZE, OR COLOR.

NO CLAIM IS MADE TO THE EXCLUSIVE RIGHT TO USE "ROCK", APART FROM THE MARK AS SHOWN.

FOR SOUNDPROOFING MATERIALS FOR BUILDINGS AND MACHINERY (U.S. CLS. 1, 5, 12, 13, 35 AND 50).

MELVIN AXILBUND, EXAMINING ATTORNEY

SN 77-164,464. WAMBOLD CORPORATION, WILMINGTON, DE. FILED 4-24-2007.

NST Non-Staining Technology

THE MARK CONSISTS OF STANDARD CHARACTERS WITHOUT CLAIM TO ANY PARTICULAR FONT, STYLE, SIZE, OR COLOR.

NO CLAIM IS MADE TO THE EXCLUSIVE RIGHT TO USE "NON-STAINING TECHNOLOGY", APART FROM THE MARK AS SHOWN.

FOR SILICONE SEALANTS USED IN BUILDING CONSTRUCTION, NAMELY SEALING EXPANSION AND CONTROL JOINTS IN PRECAST CONCRETE PANELS, ARCHITECTURAL STONES AND METAL CURTAINWALLS, AS WELL AS STRUCTURAL GLAZING, WEATHERPROOFING AND PERIMETER SEALING OF DOORS AND WINDOWS (U.S. CLS. 1, 5, 12, 13, 35 AND 50).

JOHN DWYER, EXAMINING ATTORNEY

CLASS 17—(Continued).

SN 77-169,689. SOLUTIA INC., ST. LOUIS, MO. FILED 5-1-2007.



OWNER OF U.S. REG. NO. 1,089,700.
FOR FILMS, PRINCIPALLY OF PLASTIC, FOR USE IN APPLICATION TO BUILDING WINDOWS OR VEHICULAR WINDOWS, FOR MINIMIZING ACOUSTIC TRANSMISSION THROUGH WINDOWS; FILMS, PRINCIPALLY OF PLASTIC, FOR USE IN APPLICATION TO BUILDING WINDOWS OR VEHICULAR WINDOWS, FOR MINIMIZING OR FILTERING ELECTROMAGNETIC TRANSMISSIONS THROUGH WINDOWS; FILMS, PRINCIPALLY OF PLASTIC, FOR USE IN APPLICATION TO BUILDING WINDOWS OR VEHICULAR WINDOWS FOR MINIMIZING OR FILTERING VISUAL TRANSMISSIONS THROUGH WINDOWS (U.S. CLS. 1, 5, 12, 13, 35 AND 50).

JENNIFER DIXON, EXAMINING ATTORNEY

CLASS 17—(Continued).

SN 78-772,128. APPLIED SEALS CO., LTD., CHANGHUA COUNTY, TAIWAN, FILED 12-13-2005.



THE COLOR(S) BLACK, RED AND YELLOW IS/ARE CLAIMED AS A FEATURE OF THE MARK.

THE COLOR BLACK APPEARS IN THE WORD "PERFREZ" AND THE TOP OF THE DESIGN TO THE RIGHT OF THE WORD IS YELLOW AND THE BOTTOM HALF IS RED.

FOR SEALING COMPONENTS MADE OF SYNTHETIC RUBBER, NAMELY, SEALS, RODS, TUBES, SHEETS, SLABS, O-RINGS, AND V-RINGS FOR USE IN MANUFACTURING AND SEMICONDUCTOR INDUSTRIES (U.S. CLS. 1, 5, 12, 13, 35 AND 50).

ALYSSA PALADINO, EXAMINING ATTORNEY

SN 78-722,401. PAK-LITE, INC., SUWANEE, GA. FILED 9-28-2005.



NO CLAIM IS MADE TO THE EXCLUSIVE RIGHT TO USE "LIP AND TAPE INCLUDED", APART FROM THE MARK AS SHOWN.

THE MARK CONSISTS OF A CIRCLE DEPICTING A ROLL OF TAPE WITH THE WORDS LIP AND TAPE INCLUDED IN A CIRCULAR PATTERN INSIDE THE CIRCLE AND THE BLOCK LETTERS LT IN THE CENTER OF THE CIRCLE.

FOR POLYETHYLENE AND FIBERPAD SOUND ABSORBING, INSULATING AND MOISTURE BARRIER PROTECTION FLOORING UNDERLAYMENT (U.S. CLS. 1, 5, 12, 13, 35 AND 50).

FIRST USE 7-1-2005; IN COMMERCE 7-1-2005.
LEIGH LOWRY, EXAMINING ATTORNEY

SN 78-772,129. APPLIED SEALS CO., LTD., CHANGHUA COUNTY, TAIWAN, FILED 12-13-2005.



THE COLOR(S) GREEN IS/ARE CLAIMED AS A FEATURE OF THE MARK.

THE COLOR GREEN APPEARS IN THE WORD "FLUORPAS" AND THE DESIGN TO THE RIGHT OF THE WORD.

FOR SEALING COMPONENTS MADE OF SYNTHETIC RUBBER, NAMELY, SEALS, RODS, TUBES, SHEETS, SLABS, O-RINGS, AND V-RINGS FOR USE IN MANUFACTURING AND SEMICONDUCTOR INDUSTRIES (U.S. CLS. 1, 5, 12, 13, 35 AND 50).

ALYSSA PALADINO, EXAMINING ATTORNEY

CLASS 17—(Continued).

SN 78-807,957. AT PLASTICS INC., BRAMPTON, ONTARIO, CANADA, FILED 2-6-2006.



PRIORITY CLAIMED UNDER SEC. 44(D) ON CANADA APPLICATION NO. 1287560, FILED 1-26-2006, REG. NO. TMA680254, DATED 1-24-2007, EXPIRES 1-24-2022.

OWNER OF U.S. REG. NOS. 1,407,699 AND 1,453,204.

NO CLAIM IS MADE TO THE EXCLUSIVE RIGHT TO USE "SUPER", APART FROM THE MARK AS SHOWN.

FOR POLYETHYLENE GREENHOUSE AND NURSERY FILM (U.S. CLS. 1, 5, 12, 13, 35 AND 50).

SARA THOMAS, EXAMINING ATTORNEY

CLASS 17—(Continued).

SN 78-921,299. R2 TAPE, INC., BENSALEM, PA. FILED 6-30-2006.

R2/BLU

THE MARK CONSISTS OF STANDARD CHARACTERS WITHOUT CLAIM TO ANY PARTICULAR FONT, STYLE, SIZE, OR COLOR.

FOR MASKING TAPE AND PROTECTIVE TAPE FOR PAINTING (U.S. CLS. 1, 5, 12, 13, 35 AND 50).

MARK SPARACINO, EXAMINING ATTORNEY

SN 78-936,639. THE LAMSON & SESSIONS CO., CLEVELAND, OH. FILED 7-25-2006.

WEATHER GARD

THE MARK CONSISTS OF STANDARD CHARACTERS WITHOUT CLAIM TO ANY PARTICULAR FONT, STYLE, SIZE, OR COLOR.

OWNER OF U.S. REG. NOS. 1,724,592, 1,829,251 AND 1,989,112.

FOR RUBBER PRODUCTS FOR ELECTRICAL PURPOSES, NAMELY RUBBER FILM FOR ELECTRICAL CONNECTIONS AND RUBBER FILM TO PROTECT AGAINST WATER (U.S. CLS. 1, 5, 12, 13, 35 AND 50).

MARY MUNSON, EXAMINING ATTORNEY

SN 78-829,977. INDUSTRIAS SALADILLO S.A., BUENOS AIRES, ARGENTINA, FILED 3-6-2006.



THE COLORS RED, BLUE, WHITE, GRAY AND BLACK ARE CLAIMED AS A FEATURE OF THE MARK.

THE MARK CONSISTS OF THE COLOR BLUE, WHICH APPEARS IN THE DOWNWARD-FACING DROP SHAPE. THE COLOR RED APPEARS IN THE UPWARD-FACING DROP SHAPE. THE COLOR GRAY APPEARS IN THE SHADING AND TOP PORTION OF THE OUTLINING OF THE WORDS IN THE MARK. THE COLOR WHITE APPEARS IN THE CENTER STRIPE ACROSS THE WORDS IN THE MARK AND AS SHADING IN THE BLUE AND RED DROP SHAPES. THE COLOR BLACK APPEARS IN THE BOTTOM PORTION OF THE OUTLINING OF THE WORDS IN THE MARK. THE MARK CONSISTS OF THE WORD "TOTAL" IN STYLIZED BLOCK LETTERING IN SHADES OF GRAY AND WITH BLACK OUTLINING; THE WORD IS FOLLOWED BY A BLUE DROP SHAPE COMING FROM THE TOP OF THE LETTERING AND FACING DOWNWARD, AND A RED DROP SHAPE COMING FROM THE BOTTOM OF THE LETTERING AND FACING UPWARD.

FOR PLASTIC TUBES AND PARTS THEREFORE FOR CARRYING HOT AND COLD WATER (U.S. CLS. 1, 5, 12, 13, 35 AND 50).

LOURDES AYALA, EXAMINING ATTORNEY

SN 79-023,759. ONESEAL A/S, DENMARK, FILED 8-29-2005.



PRIORITY DATE OF 3-7-2005 IS CLAIMED. OWNER OF INTERNATIONAL REGISTRATION 0884615 DATED 8-29-2005, EXPIRES 8-29-2015.

"THE STIPPLING IS FOR SHADING PURPOSES ONLY." FOR PACKING PADDING OF PLASTIC IN THE NATURE OF AIR CUSHIONS AND SACKS, NAMELY, AIR CUSHIONS AND SACKS FOR SECURING, PROTECTION AND FIXING OF CARGO (U.S. CLS. 1, 5, 12, 13, 35 AND 50).

COLLEEN KEARNEY, EXAMINING ATTORNEY

CLASS 18—LEATHER GOODS

SN 76-666,429. SAM DAE ENTERPRISES, INC., LOS ANGELES, CA. FILED 9-22-2006.



THE DESIGN CONSISTS IN PART OF FOUR PARTIAL OVALS FORMING HIGHLY STYLIZED LETTER "E'S" ARRANGED AS REVERSE IMAGES TO ONE ANOTHER.

FOR ATTACHE CASES, BACKPACKS, HANDBAGS, BILLFOLDS, BRIEFCASES, BUSINESS CASES, LUGGAGE, PURSES, FANNY PACKS, WAIST PACKS, POUCHES USED AS HANDBAGS; STRAPS FOR HANDBAGS; SUITCASES; TRAVEL BAGS; WALLETS (U.S. CLS. 1, 2, 3, 22 AND 41).

GENE MACIOL, EXAMINING ATTORNEY

SN 76-667,408. BICYCLE CITY, LLC, CINCINNATI, OH. FILED 10-12-2006.

BICYCLE CITY

THE MARK CONSISTS OF STANDARD CHARACTERS WITHOUT CLAIM TO ANY PARTICULAR FONT, STYLE, SIZE, OR COLOR.

FOR BAGS, NAMELY, BACKPACKS AND CANVAS GROCERY BAGS; TOTE BAGS; WALLETS; LUGGAGE; PURSES; UMBRELLAS (U.S. CLS. 1, 2, 3, 22 AND 41).

LINDA POWELL, EXAMINING ATTORNEY

SN 76-667,439. THECIRCLE.ORG, LLC, CINCINNATI, OH. FILED 10-12-2006.

MI CÍRCULO

THE MARK CONSISTS OF STANDARD CHARACTERS WITHOUT CLAIM TO ANY PARTICULAR FONT, STYLE, SIZE, OR COLOR.

THE FOREIGN WORDING IN THE MARK TRANSLATES INTO ENGLISH AS MY CIRCLE.

FOR BAGS, NAMELY, BACKPACKS AND CANVAS SHOPPING BAGS; TOTE BAGS; WALLETS; LUGGAGE; PURSES; UMBRELLAS (U.S. CLS. 1, 2, 3, 22 AND 41).

LAURA HAMMEL, EXAMINING ATTORNEY

CLASS 18—(Continued).

SN 76-667,443. THECIRCLE.ORG, LLC, CINCINNATI, OH. FILED 10-12-2006.

EL CÍRCULO

THE MARK CONSISTS OF STANDARD CHARACTERS WITHOUT CLAIM TO ANY PARTICULAR FONT, STYLE, SIZE, OR COLOR.

THE FOREIGN WORDING IN THE MARK TRANSLATES INTO ENGLISH AS THE CIRCLE.

FOR BAGS, NAMELY, BACKPACKS AND CANVAS SHOPPING BAGS; TOTE BAGS; WALLETS; LUGGAGE; PURSES; UMBRELLAS (U.S. CLS. 1, 2, 3, 22 AND 41).

LAURA HAMMEL, EXAMINING ATTORNEY

SN 76-667,449. THECIRCLE.ORG, LLC, CINCINNATI, OH. FILED 10-12-2006.

MY CIRCLE

THE MARK CONSISTS OF STANDARD CHARACTERS WITHOUT CLAIM TO ANY PARTICULAR FONT, STYLE, SIZE, OR COLOR.

FOR BAGS, NAMELY, BACKPACKS AND CANVAS SHOPPING BAGS; TOTE BAGS; WALLETS; LUGGAGE; PURSES; UMBRELLAS (U.S. CLS. 1, 2, 3, 22 AND 41).

LAURA HAMMEL, EXAMINING ATTORNEY

SN 76-674,492. CONDOM KEYCHAIN, ROME, PA. FILED 3-23-2007.

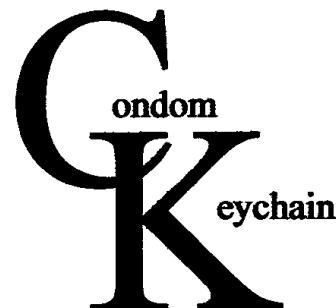

NO CLAIM IS MADE TO THE EXCLUSIVE RIGHT TO USE "CONDOM KEYCHAIN", APART FROM THE MARK AS SHOWN.

FOR POCKET KEYCHAIN, MEASURING 2.5" BY 3.0", MADE OF LEATHER AND IMITATIONS OF LEATHER MATERIALS, THAT STORES PREPACKAGED CONDOM (U.S. CLS. 1, 2, 3, 22 AND 41).

FIRST USE 1-1-2007; IN COMMERCE 1-1-2007.

ZACHARY BELLO, EXAMINING ATTORNEY

CLASS 18—(Continued).

SN 76-674,571. PEACE STORE, INC., SANTA BARBARA, CA.
FILED 3-26-2007.

HAPPY IS HERE

THE MARK CONSISTS OF STANDARD CHARACTERS WITHOUT CLAIM TO ANY PARTICULAR FONT, STYLE, SIZE, OR COLOR.

FOR BAGS, NAMELY BACKPACKS, TOTE BAGS, AND VINYL CARRYING BAGS (U.S. CLS. 1, 2, 3, 22 AND 41).

BARBARA RUTLAND, EXAMINING ATTORNEY

SN 77-002,085. L.C. LICENSING, INC., NEW YORK, NY.
FILED 9-19-2006.

DANA BUCHMAN

THE MARK CONSISTS OF STANDARD CHARACTERS WITHOUT CLAIM TO ANY PARTICULAR FONT, STYLE, SIZE, OR COLOR.

OWNER OF U.S. REG. NOS. 1,493,081, 1,884,379 AND OTHERS.

THE NAME DANA BUCHMAN IDENTIFIES A LIVING INDIVIDUAL WHOSE CONSENT IS OF RECORD.

FOR HANDBAGS, WALLETS AND CHANGE PURSES (U.S. CLS. 1, 2, 3, 22 AND 41).

REBECCA GAN, EXAMINING ATTORNEY

SN 77-009,527. L.C. LICENSING, INC., NEW YORK, NY.
FILED 9-28-2006.

DIVA BY DANA BUCHMAN

THE MARK CONSISTS OF STANDARD CHARACTERS WITHOUT CLAIM TO ANY PARTICULAR FONT, STYLE, SIZE, OR COLOR.

OWNER OF U.S. REG. NOS. 1,493,081, 1,884,379 AND OTHERS.

THE NAME DANA BUCHMAN IDENTIFIES A LIVING INDIVIDUAL WHOSE CONSENT IS OF RECORD.

FOR HANDBAGS (U.S. CLS. 1, 2, 3, 22 AND 41).
FIRST USE 9-23-2006; IN COMMERCE 9-23-2006.

REBECCA GAN, EXAMINING ATTORNEY

CLASS 18—(Continued).

SN 77-048,528. GALVAN, ROY JOSEPH BOYCE, STA. CRUZ DE BEZANA, SPAIN, FILED 11-21-2006.



OWNER OF ERPN CMNTY TM OFC REG. NO. 3995941, DATED 11-7-2005, EXPIRES 8-25-2014.

THE COLOR(S) DARK GREEN, WHITE AND RED IS/ARE CLAIMED AS A FEATURE OF THE MARK.

THE MARK CONSISTS OF THE COLOR DARK GREEN AS A THIN, OUTER CIRCLE, AND THE WORD BENZI TO THE RIGHT OF THE CIRCLE. THE COLOR WHITE IS SHOWN AS A THIN CIRCLE INSIDE THE DARK GREEN CIRCLE. THE COLOR RED IS SHOWN AS A SOLID CIRCLE INSIDE THE WHITE CIRCLE WITH A STYLIZED LETTER B SHOWN IN WHITE INSIDE THE RED CIRCLE.

FOR BAGS, NAMELY, BOOK BAGS, HANDBAGS, TRAVELING BAGS, TRUNKS, LEATHER AND IMITATIONS OF LEATHER, AND GOODS MADE OF THESE MATERIALS, NOT INCLUDED IN OTHER CLASSES, NAMELY, BRIEFCASES; ANIMAL SKINS, HIDES; UMBRELLAS, PARASOLS AND WALKING STICKS, WHIPS, HARNESS AND SADDLERY; CREDIT CARD HOLDER, WAIST BAG, SHOULDER BAG, BACKPACK, CAMPING RUCK SACK, WHEELED BACKPACK, CHILD BACKPACK, BEACH BAG, SPORT BAG (U.S. CLS. 1, 2, 3, 22 AND 41).

ROBIN CHOSID, EXAMINING ATTORNEY

SN 77-071,134. TRAN, BEN K., HONOLULU, HI. AND LEE, TINA, HONOLULU, HI. AND TRAN, ELISE, HONOLULU, HI. FILED 12-26-2006.

Elise Tran

THE MARK CONSISTS OF STANDARD CHARACTERS WITHOUT CLAIM TO ANY PARTICULAR FONT, STYLE, SIZE, OR COLOR.

THE NAME "ELISE TRAN" IDENTIFIES A LIVING INDIVIDUAL WHOSE CONSENT IS OF RECORD.

FOR EVENING HANDBAGS; FLEXIBLE BAGS FOR GARMENTS; GARMENT BAGS FOR TRAVEL; HANDBAGS; HANDBAGS FOR MEN; LEATHER BAGS, SUITCASES AND WALLETS; LEATHER FOR SHOES; LEATHER HANDBAGS; LUGGAGE; LUGGAGE TAGS; OVERNIGHT SUITCASES; SMALL SUITCASES; SUITCASES; TRUNKS (U.S. CLS. 1, 2, 3, 22 AND 41).
FIRST USE 3-14-1984; IN COMMERCE 1-1-1996.

GEOFFREY FOSDICK, EXAMINING ATTORNEY

CLASS 18—(Continued).

SN 77-083,786. J2 PRODUCTIONS, LLC, CHICAGO, IL. FILED 1-16-2007.

MOJUBA

THE MARK CONSISTS OF STANDARD CHARACTERS WITHOUT CLAIM TO ANY PARTICULAR FONT, STYLE, SIZE, OR COLOR.
THE ENGLISH TRANSLATION OF THE LUKIMI WORD MOJUBA IN THE MARK IS I SALUTE YOU.
FOR KIT BAGS (U.S. CLS. 1, 2, 3, 22 AND 41).
GIANCARLO CASTRO, EXAMINING ATTORNEY

SN 77-120,148. LACKOVICH, JOEL KRISTIN, SAN DIEGO, CA. FILED 3-1-2007.

GIRL POWDER

THE MARK CONSISTS OF STANDARD CHARACTERS WITHOUT CLAIM TO ANY PARTICULAR FONT, STYLE, SIZE, OR COLOR.
OWNER OF U.S. REG. NO. 3,093,954.
NO CLAIM IS MADE TO THE EXCLUSIVE RIGHT TO USE "GIRL", APART FROM THE MARK AS SHOWN.
FOR SPORTS BAGS, TOTE BAGS, ALL PURPOSE CARRY BAGS, BACKPACKS, LUGGAGE, FANNY PACKS, MAKE-UP BAGS SOLD EMPTY, PURSES, AND WALLETS (U.S. CLS. 1, 2, 3, 22 AND 41).
CURTIS FRENCH, EXAMINING ATTORNEY

SN 77-120,927. SYL, LLC, WILMINGTON, DE. FILED 3-2-2007.

STANLEY B. BY STANLEY BLACKER

THE MARK CONSISTS OF STANDARD CHARACTERS WITHOUT CLAIM TO ANY PARTICULAR FONT, STYLE, SIZE, OR COLOR.
OWNER OF U.S. REG. NOS. 2,359,880, 2,862,769 AND OTHERS.
"THE NAME(S), PORTRAIT(S), AND/OR SIGNATURE(S) SHOWN IN THE MARK DOES NOT IDENTIFY A PARTICULAR LIVING INDIVIDUAL."
FOR LEATHER GOODS, NAMELY, WALLETS, BRIEF-CASE-TYPE PORTFOLIOS, LEATHER ACCESSORIES, NAMELY, KEY CHAINS, UMBRELLAS, TOTE BAGS (U.S. CLS. 1, 2, 3, 22 AND 41).
BRENDAN REGAN, EXAMINING ATTORNEY

CLASS 18—(Continued).

SN 77-121,179. LMH, INC., WILMINGTON, DE. FILED 3-2-2007.

LITTLE ME

THE MARK CONSISTS OF STANDARD CHARACTERS WITHOUT CLAIM TO ANY PARTICULAR FONT, STYLE, SIZE, OR COLOR.
OWNER OF U.S. REG. NOS. 938,132, 2,112,460 AND OTHERS.
FOR ALL-PURPOSE CARRYING BAGS, DIAPER BAGS, TOTE BAGS (U.S. CLS. 1, 2, 3, 22 AND 41).
GRETTA YAO, EXAMINING ATTORNEY

SN 77-121,203. LMH, INC., WILMINGTON, DE. FILED 3-2-2007.



OWNER OF U.S. REG. NOS. 938,132, 2,112,460 AND OTHERS.
FOR ALL PURPOSE CARRYING BAGS, DIAPER BAGS, TOTE BAGS (U.S. CLS. 1, 2, 3, 22 AND 41).
GRETTA YAO, EXAMINING ATTORNEY

SN 77-134,146. KEMPT DESIGN LLC, BROOKLYN, NY. FILED 3-19-2007.



THE MARK CONSISTS OF A SQUARE WITH A FOUR FLOWER PETALS CUT OUT OF THE CENTER. NEXT TO THIS IN UPPERCASE LETTERS IS THE WORD KEMPT.
FOR EVENING HANDBAGS; HANDBAGS; PURSES; TRAVEL BAGS; WALLETS (U.S. CLS. 1, 2, 3, 22 AND 41).
FIRST USE 7-1-2006; IN COMMERCE 7-1-2006.
PAULA MAHONEY, EXAMINING ATTORNEY

CLASS 18—(Continued).

SN 77-138,616. WEIZHI INC., BERKELEY, CA. FILED 3-23-2007.

WEIZHI

THE MARK CONSISTS OF STANDARD CHARACTERS WITHOUT CLAIM TO ANY PARTICULAR FONT, STYLE, SIZE, OR COLOR.

THE FOREIGN WORDING IN THE MARK TRANSLATES INTO ENGLISH AS POSITION.

FOR PET COLLARS AND LEASHES (U.S. CLS. 1, 2, 3, 22 AND 41).

STEVEN R. FINE, EXAMINING ATTORNEY

SN 77-138,894. MASCOTTE HOLDINGS, INC., NEW YORK, NY. FILED 3-23-2007.

THE PAST TELLS EVERYTHING

THE MARK CONSISTS OF STANDARD CHARACTERS WITHOUT CLAIM TO ANY PARTICULAR FONT, STYLE, SIZE, OR COLOR.

FOR ALL-PURPOSE SPORTS AND ATHLETIC BAGS; BEACH, BOOK, CARRY-ON, DUFFEL, DIAPER, GYM, LEATHER SHOPPING, SHOULDER, TOTE AND TRAVEL BAGS; FANNY PACKS AND WAIST PACKS; BACKPACKS; KNAPSACKS; PURSES; GARMENT BAGS FOR TRAVEL; SATCHELS; LUGGAGE; LUGGAGE TAGS; TRUNKS; SUITCASES; HAT BOXES FOR TRAVEL NOT OF PAPER OR CARDBOARD; COSMETIC CASES AND BAGS SOLD EMPTY; TOILETRY AND VANITY CASES SOLD EMPTY; TOOL BAGS SOLD EMPTY; ATTACHE CASES; BRIEFCASES; BRIEFCASE-TYPE PORTFOLIOS; DOCUMENT CASES; MEN'S CLUTCHES; BUSINESS CASES; BUSINESS CARD CASES; CALLING AND CREDIT CARD CASES; KEY CASES; LEATHER KEY CHAINS; WALLETS; BANKNOTE HOLDERS; BILLFOLDS; UMBRELLAS; PARASOLS; WALKING STICKS (U.S. CLS. 1, 2, 3, 22 AND 41).

CHRISTOPHER OTT, EXAMINING ATTORNEY

CLASS 18—(Continued).

SN 77-140,858. M & M ADVENTURES LLC, MINNEAPOLIS, MN. FILED 3-26-2007.



THE MARK CONSISTS OF A "G" INTERSECTING WITH AN "O". THE "G" BREAKS INTO THE "O" OVERLAPPING IT. THE "O" CONTAINS A SIMPLE LINE DRAWING OF A GLOBE WITHIN THE "O".

FOR DUFFEL BAGS FOR TRAVEL; GARMENT BAGS FOR TRAVEL; HAT BOXES FOR TRAVEL NOT OF PAPER OR CARDBOARD; SHOE BAGS FOR TRAVEL; TRAVEL BAGS; TRAVELING BAGS; TRAVELLING BAGS; TRAVELLING CASES OF LEATHER (U.S. CLS. 1, 2, 3, 22 AND 41).

REBECCA SMITH, EXAMINING ATTORNEY

SN 77-143,820. NVIZION CORP., CITY OF INDUSTRY, CA. FILED 3-29-2007.

MONEY MOVES

THE MARK CONSISTS OF STANDARD CHARACTERS WITHOUT CLAIM TO ANY PARTICULAR FONT, STYLE, SIZE, OR COLOR.

FOR CARRYING CASES; BACKPACKS; BAGS, NAMELY, ALL PURPOSE SPORTS BAGS, ATHLETIC BAGS, DUFFEL BAGS, GYM BAGS, MESSENGER BAGS, SCHOOL BAGS, SHOULDER BAGS, SLING BAGS, SMALL BAGS FOR MEN (U.S. CLS. 1, 2, 3, 22 AND 41).

EDWARD NELSON, EXAMINING ATTORNEY

SN 77-143,836. NVIZION CORP., CITY OF INDUSTRY, CA. FILED 3-29-2007.

I GET POOR SLEEP, BUT I GOT RICH DREAMS

THE MARK CONSISTS OF STANDARD CHARACTERS WITHOUT CLAIM TO ANY PARTICULAR FONT, STYLE, SIZE, OR COLOR.

FOR CARRYING CASES; BACKPACKS; BAGS, NAMELY, ALL PURPOSE SPORTS BAGS, ATHLETIC BAGS, DUFFEL BAGS, GYM BAGS, MESSENGER BAGS, SCHOOL BAGS, SHOULDER BAGS, SLING BAGS, SMALL BAGS FOR MEN (U.S. CLS. 1, 2, 3, 22 AND 41).

EDWARD NELSON, EXAMINING ATTORNEY

CLASS 18—(Continued).

SN 77-150,684. OLD BLUE LLC, LAKE GENEVA, WI. FILED 4-6-2007.

**THE FEELGOOD T-SHIRT
COMPANY**

THE MARK CONSISTS OF STANDARD CHARACTERS WITHOUT CLAIM TO ANY PARTICULAR FONT, STYLE, SIZE, OR COLOR.

NO CLAIM IS MADE TO THE EXCLUSIVE RIGHT TO USE "COMPANY", APART FROM THE MARK AS SHOWN. FOR BACKPACKS; HANDBAGS; LUGGAGE; WALLETS (U.S. CLS. 1, 2, 3, 22 AND 41).

DAVID TAYLOR, EXAMINING ATTORNEY

CLASS 18—(Continued).

SN 78-795,223. XMA, L.L.C., MIDWEST CITY, OK. FILED 1-19-2006.

XMA

THE MARK CONSISTS OF STANDARD CHARACTERS WITHOUT CLAIM TO ANY PARTICULAR FONT, STYLE, SIZE, OR COLOR.

FOR LEATHER PRODUCTS, NAMELY, ALL PURPOSE ATHLETIC BAGS, ALL-PURPOSE CARRYING BAGS, ATTACHE CASES, BACKPACKS, BRIEFCASES, BUSINESS CARD CASES, CREDIT CARD CASES, PURSES, KEY CHAINS, TRAVELING BAGS, TRAVELING CASES OF LEATHER; LUGGAGE; BAGS, NAMELY, ALL-PURPOSE CARRYING BAGS, BACKPACKS, BAGS FOR SPORTS, BOOK BAGS, BRIEFCASES, CARRYING CASES FOR DOCUMENTS, CHANGE PURSES, DRAW-STRING POUCHES, DUFFLE BAGS, FLEXIBLE BAGS FOR GARMENTS, GARMENT BAGS FOR TRAVEL, GYM BAGS, MESSENGER BAGS, HANDBAGS FOR MEN, OVERNIGHT BAGS, SHOULDER BAGS, TOTE BAGS, WAIST BAGS, WASH BAGS FOR CARRYING TOILETRIES; SMALL LEATHER GOODS, NAMELY, KEY CASES, KEY WALLETS, PURSES, NAME-CARD CASES; WALLETS (U.S. CLS. 1, 2, 3, 22 AND 41).

JENNY PARK, EXAMINING ATTORNEY

SN 78-326,247. LATINA MEDIA VENTURES LLC, NEW YORK, NY. FILED 11-11-2003.



IN ITS ENGLISH TRANSLATION THE TERM "LATINA" RELATES TO WOMEN OF HISPANIC ORIGIN.

FOR HANDBAGS; SMALL LEATHER GOODS, NAMELY, HANDBAGS, CASES, NAMELY BUSINESS CARD CASES, CALLING CARD CASES, CREDIT CARD CASES, KEY CASES, AND NAME CARD CASES, AND WALLETS; FASHION ACCESSORIES, NAMELY, HANDBAGS AND BACKPACKS (U.S. CLS. 1, 2, 3, 22 AND 41).

NAKIA HENRY, EXAMINING ATTORNEY

SN 78-795,408. STRNAD, CARLA G., WASHINGTON, MO. FILED 1-19-2006.



NO CLAIM IS MADE TO THE EXCLUSIVE RIGHT TO USE "WASHINGTON, MO", APART FROM THE MARK AS SHOWN.

FOR TOTE BAGS DEPICTING VARIOUS TOWNS' LANDMARKS (U.S. CLS. 1, 2, 3, 22 AND 41).

FIRST USE 11-15-2005; IN COMMERCE 11-23-2005.

DEBRA LEE, EXAMINING ATTORNEY

CLASS 18—(Continued).

SN 78-828,918. NUNI LLC, NEW YORK, NY. FILED 3-3-2006.

Skelly Case

THE MARK CONSISTS OF STANDARD CHARACTERS WITHOUT CLAIM TO ANY PARTICULAR FONT, STYLE, SIZE, OR COLOR.

NO CLAIM IS MADE TO THE EXCLUSIVE RIGHT TO USE "CASE", APART FROM THE MARK AS SHOWN.

FOR ALL PURPOSE CARRYING BAGS MADE OF SYNTHETIC OR NATURAL MATERIALS (U.S. CLS. 1, 2, 3, 22 AND 41).

MARIAM MAHMOUDI, EXAMINING ATTORNEY

CLASS 18—(Continued).

SN 78-949,911. SPROUT POUCH INC., MISSOULA, MT. FILED 8-11-2006.

sprout pouch

THE MARK CONSISTS OF STANDARD CHARACTERS WITHOUT CLAIM TO ANY PARTICULAR FONT, STYLE, SIZE, OR COLOR.

NO CLAIM IS MADE TO THE EXCLUSIVE RIGHT TO USE "POUCH", APART FROM THE MARK AS SHOWN.

FOR BABY CARRIERS WORN ON THE BODY; BAGS FOR CARRYING BABIES' ACCESSORIES; DIAPER BAGS; INFANT CARRIERS WORN ON THE BODY; MESSENGER BAGS; MULTI-PURPOSE PURSES; SHOULDER BAGS (U.S. CLS. 1, 2, 3, 22 AND 41).

FIRST USE 2-1-2005; IN COMMERCE 3-1-2005.
ALICE BENMAMAN, EXAMINING ATTORNEY

SN 78-917,588. BUILDING E DESIGN, INC., EAGAN, MN. FILED 6-27-2006.

VIA PENDIO

THE MARK CONSISTS OF STANDARD CHARACTERS WITHOUT CLAIM TO ANY PARTICULAR FONT, STYLE, SIZE, OR COLOR.

THE ENGLISH TRANSLATION OF THE MARK IS "STREET OR WAY OF THE HILLSIDE."

FOR WORK BAGS SOLD EMPTY FOR PERSONAL ITEMS, HANDBAGS, PURSES AND TOTE BAGS (U.S. CLS. 1, 2, 3, 22 AND 41).

FIRST USE 10-0-2006; IN COMMERCE 10-0-2006.
MATTHEW PAPPAS, EXAMINING ATTORNEY

SN 78-953,703. UNIVERSAL MODELS LIMITED, NEW TERRITORIES, HONG KONG, FILED 8-16-2006.



THE MARK CONSISTS OF THE WORDS COOKIE ALAMO SURROUNDED BY THE SHAPE OF A DOG BONE, WITH THE OUTLINE BROKEN INTERMITTENTLY.

FOR CLOTHING FOR DOMESTIC PETS; COLLARS FOR PETS; LEATHER CHEWS AND BITS FOR PETS; ANIMAL LEASHES; DOG COLLARS; RAWHIDE CHEWS FOR PETS; HARNESSES FOR PETS; ANIMAL COLLARS, NAMELY, LEADS FOR PETS; PET CARRIER BAGS (U.S. CLS. 1, 2, 3, 22 AND 41).

DOMINIC FATHY, EXAMINING ATTORNEY

SN 78-928,341. CATFIGHT GEAR, LLC, BERKELEY, CA. FILED 7-12-2006.

CATFIGHTGEAR

THE MARK CONSISTS OF STANDARD CHARACTERS WITHOUT CLAIM TO ANY PARTICULAR FONT, STYLE, SIZE, OR COLOR.

FOR ATHLETIC BAGS, GYM BAGS AND WORKOUT WAIST POUCHES (U.S. CLS. 1, 2, 3, 22 AND 41).

ANGELA M. MICHELI, EXAMINING ATTORNEY

SN 78-957,988. GALLAGHER, SHANE P., SANTA CRUZ, CA. FILED 8-22-2006.

ON THE EDGE

THE MARK CONSISTS OF STANDARD CHARACTERS WITHOUT CLAIM TO ANY PARTICULAR FONT, STYLE, SIZE, OR COLOR.

FOR CLUTCHES, SHOULDER BAGS, COSMETIC BAGS SOLD EMPTY, TOTE BAGS, SADDLE BAGS, BACKPACKS, GYM BAGS, DUFFLE BAGS, TRAVEL BAGS, ROLL BAGS, SLING BAGS, GROOMING KITS SOLD EMPTY FOR CARRYING PERSONAL HYGIENE ITEMS, SUIT BAGS, TIE CASES, SATCHELS, GARMENT BAGS FOR TRAVEL, COIN PURSES, DRAWSTRING POUCHES, OVERNIGHT BAGS, WALLETS, LUGGAGE AND KEY CASES (U.S. CLS. 1, 2, 3, 22 AND 41).

JERI J. FICKES, EXAMINING ATTORNEY

CLASS 18—(Continued).

SN 78-958,379. L.C. LICENSING, INC., NEW YORK, NY.
FILED 8-23-2006.

LIZ CLAIBORNE WALLPAPER

THE MARK CONSISTS OF STANDARD CHARACTERS WITHOUT CLAIM TO ANY PARTICULAR FONT, STYLE, SIZE, OR COLOR.

OWNER OF U.S. REG. NOS. 2,885,141, 2,916,333 AND OTHERS.

"THE NAME(S), PORTRAIT(S), AND/OR SIGNATURE(S) SHOWN IN THE MARK DOES NOT IDENTIFY A PARTICULAR LIVING INDIVIDUAL."

FOR HANDBAGS, PURSES, WALLETS, KEY CASES, CREDIT CARD CASES, COSMETIC CASES SOLD EMPTY, BACKPACKS, SPORT BAGS, BRIEFCASES, LUGGAGE, UMBRELLAS (U.S. CLS. 1, 2, 3, 22 AND 41).
REBECCA GAN, EXAMINING ATTORNEY

SN 78-962,050. LEISURE ARTS, INC., LITTLE ROCK, AR.
FILED 8-28-2006.

CREATE AND UNWIND

THE MARK CONSISTS OF STANDARD CHARACTERS WITHOUT CLAIM TO ANY PARTICULAR FONT, STYLE, SIZE, OR COLOR.

FOR KNITTING AND CROCHET BAGS (U.S. CLS. 1, 2, 3, 22 AND 41).

ELLEN PERKINS, EXAMINING ATTORNEY

SN 78-971,091. L. C. LICENSING, INC., NEW YORK, NY.
FILED 9-11-2006.

CONCEPTS BY CLAIBORNE

THE MARK CONSISTS OF STANDARD CHARACTERS WITHOUT CLAIM TO ANY PARTICULAR FONT, STYLE, SIZE, OR COLOR.

OWNER OF U.S. REG. NOS. 1,554,507, 1,630,447 AND OTHERS.

FOR LEATHER AND IMITATION LEATHER BAGS, SMALL LEATHER GOODS, NAMELY, PURSES, HANDBAGS, CLUTCHES, KEY CASES, CREDIT CARD CASES, AND WALLETS. (U.S. CLS. 1, 2, 3, 22 AND 41).
REBECCA GAN, EXAMINING ATTORNEY

CLASS 18—(Continued).

SN 79-023,963. DAIWA SEIKO, INC., JAPAN, FILED 3-31-2006.

TEAM DAIWA

THE MARK CONSISTS OF STANDARD CHARACTERS WITHOUT CLAIM TO ANY PARTICULAR FONT, STYLE, SIZE, OR COLOR.

PRIORITY DATE OF 3-27-2006 IS CLAIMED.

OWNER OF INTERNATIONAL REGISTRATION 0885171 DATED 3-31-2006, EXPIRES 3-31-2016.

OWNER OF U.S. REG. NOS. 808,820, 3,082,385 AND OTHERS.

THE ENGLISH TRANSLATION OF THE WORD DAIWA IN THE MARK IS "GREAT PEACE."

FOR RUCKSACKS, SHOULDER BAGS, BOSTON BAGS, CARRY-ON BAGS, BAGS FOR PACKING IN THE NATURE OF WATERPROOF NYLON BAGS FOR FISHING THAT ARE NOT FITTED TO ANY PARTICULAR FISHING APPARATUS, PURSES NOT OF PRECIOUS METAL (U.S. CLS. 1, 2, 3, 22 AND 41).

DANIEL BRODY, EXAMINING ATTORNEY

SN 79-023,966. DAIWA SEIKO, INC., JAPAN, FILED 3-31-2006.



PRIORITY DATE OF 3-27-2006 IS CLAIMED.

OWNER OF INTERNATIONAL REGISTRATION 0885179 DATED 3-31-2006, EXPIRES 3-31-2016.

OWNER OF U.S. REG. NOS. 80,820, 3,082,385 AND OTHERS.

THE ENGLISH TRANSLATION OF THE WORD DAIWA IN THE MARK IS "GREAT PEACE."

FOR RUCKSACKS, SHOULDER BAGS, BOSTON BAGS, CARRY-ON BAGS, BAGS FOR PACKING IN THE NATURE OF WATERPROOF NYLON BAGS FOR FISHING THAT ARE NOT FITTED TO ANY PARTICULAR FISHING APPARATUS, PURSES NOT OF PRECIOUS METAL (U.S. CLS. 1, 2, 3, 22 AND 41).

DANIEL BRODY, EXAMINING ATTORNEY

CLASS 18—(Continued).

SN 79-026,167. CONVERSE TRADING LTD, UNITED KINGDOM, FILED 7-5-2006.

TRUCCO

OWNER OF INTERNATIONAL REGISTRATION 0891185 DATED 7-5-2006, EXPIRES 7-5-2016.

FOR LEATHER AND IMITATION LEATHER, GOODS MADE OF THESE MATERIALS, NAMELY, HARNESES, TRAVELING BAGS, HANDBAGS OF LEATHER AND IMITATION LEATHER, BAGS OF LEATHER AND IMITATION LEATHER, BRIEFCASES OF LEATHER AND IMITATION LEATHER, PURSES OF LEATHER AND IMITATION LEATHER, RUCKSACKS OF LEATHER AND IMITATION LEATHER, KEY CASES OF LEATHER AND IMITATION LEATHER, ANIMAL SKINS AND HIDES; TRUNKS; UMBRELLAS, PARASOLS AND WALKING STICKS; WHIPS AND SADDLERY (U.S. CLS. 1, 2, 3, 22 AND 41).

ANDREA K. NADELMAN, EXAMINING ATTORNEY

SN 79-029,565. ZHEJIANG BUBULE BAGS & CASES CO., LTD., CHINA, FILED 7-26-2006.

bubule

OWNER OF INTERNATIONAL REGISTRATION 0900907 DATED 7-26-2006, EXPIRES 7-26-2016.

FOR PURSES; VALISES; BRIEFCASES; IMITATION LEATHER CASES; VANITY CASES SOLD EMPTY; CASES, OF LEATHER OR LEATHERBOARD; IMITATION LEATHER; FUR; UMBRELLAS; LEATHER THONGS (U.S. CLS. 1, 2, 3, 22 AND 41).

MELISSA VALLILLO, EXAMINING ATTORNEY

SN 79-031,938. PER UNA GROUP LIMITED, UNITED KINGDOM, FILED 8-8-2006.

PER UNA

THE MARK CONSISTS OF STANDARD CHARACTERS WITHOUT CLAIM TO ANY PARTICULAR FONT, STYLE, SIZE, OR COLOR.

OWNER OF INTERNATIONAL REGISTRATION 0876856 DATED 12-6-2005, EXPIRES 12-6-2015.

OWNER OF U.S. REG. NOS. 3,147,506 AND 3,152,453. THE ENGLISH TRANSLATION OF "PER UNA" IS "FOR ONE".

FOR LEATHER AND IMITATIONS OF LEATHER AND GOODS MADE OF THESE MATERIALS, NAMELY, BAGS, WALLETS, PURSES, SHOPPING BAGS, BRIEFCASES, KEY BAGS, COSMETIC BAGS SOLD EMPTY, BAGS FOR TOILETRIES SOLD EMPTY, BUMBAGS, SUITCASES AND PASSPORT COVERS (U.S. CLS. 1, 2, 3, 22 AND 41).

STANLEY I. OSBORNE, EXAMINING ATTORNEY

CLASS 19—NON-METALLIC BUILDING MATERIALS

SN 76-670,072. BASEMENT TECHNOLOGIES, INC., NEEDHAM, MA. FILED 12-7-2006.

LAWN MAGNUM

THE MARK CONSISTS OF STANDARD CHARACTERS WITHOUT CLAIM TO ANY PARTICULAR FONT, STYLE, SIZE, OR COLOR.

NO CLAIM IS MADE TO THE EXCLUSIVE RIGHT TO USE "LAWN", APART FROM THE MARK AS SHOWN.

FOR UNDERGROUND CONCRETE WATER DISPERSAL AND DRAINAGE SYSTEM CONTAINING ACTIVATED CHARCOAL FOR HANDLING WATER EMANATING FROM BUILDING GUTTERS OR SUMP PUMP DISCHARGES (U.S. CLS. 1, 12, 33 AND 50).

FIRST USE 5-0-2007; IN COMMERCE 5-0-2007.

ALYSSA PALADINO, EXAMINING ATTORNEY

SN 77-002,686. VINTAGE HARDWOODS, LLC, SCOTTSDALE, AZ. FILED 9-19-2006.

Revival Old Wood, New Life

THE MARK CONSISTS OF STANDARD CHARACTERS WITHOUT CLAIM TO ANY PARTICULAR FONT, STYLE, SIZE, OR COLOR.

FOR FLOOR BOARDS (U.S. CLS. 1, 12, 33 AND 50).

FIRST USE 9-15-2006; IN COMMERCE 9-15-2006.

ZACHARY BELLO, EXAMINING ATTORNEY

SN 77-057,990. ARCHITECTURAL SYSTEMS, INC., NEW YORK, NY. FILED 12-6-2006.

ECOLINEA

THE MARK CONSISTS OF STANDARD CHARACTERS WITHOUT CLAIM TO ANY PARTICULAR FONT, STYLE, SIZE, OR COLOR.

THE ENGLISH TRANSLATION OF ECOLINEA IS ECHOLINE OR ECOLINE.

FOR WOOD PANELLING; WOOD TILE FLOORS (U.S. CLS. 1, 12, 33 AND 50).

REBECCA POVARCHUK, EXAMINING ATTORNEY

CLASS 19—(Continued).

SN 77-068,130. FIBREBOND CORPORATION, MINDEN, LA. FILED 12-20-2006.

Phoenix Systems-Built Homes

THE MARK CONSISTS OF STANDARD CHARACTERS WITHOUT CLAIM TO ANY PARTICULAR FONT, STYLE, SIZE, OR COLOR.

NO CLAIM IS MADE TO THE EXCLUSIVE RIGHT TO USE "SYSTEMS-BUILT HOMES", APART FROM THE MARK AS SHOWN.

FOR PREFABRICATED NON-METAL BUILDINGS (U.S. CLS. 1, 12, 33 AND 50).

NAAKWAMA ANKRAH, EXAMINING ATTORNEY

CLASS 19—(Continued).

SN 77-108,827. WINDSOR HOLDING COMPANY, COTATI, CA. FILED 2-15-2007.



THE MARK CONSISTS OF BOLDED DOUBLE DIAMOND DESIGN (ONE DIAMOND WITHIN ANOTHER DIAMOND) WITH ONE BANNER CENTRALLY PLACED ACROSS BOTH DIAMONDS CONTAINING THE MARK WINDSOR-ONE.

FOR LUMBER, WOOD SIDING, WOOD TRIM, WOOD MOLDINGS (U.S. CLS. 1, 12, 33 AND 50).

FIRST USE 1-15-1998; IN COMMERCE 1-15-1998.

CIMMERIAN COLEMAN, EXAMINING ATTORNEY

SN 77-068,167. FIBREBOND CORPORATION, MINDEN, LA. FILED 12-20-2006.

Phoenix Systems-Built Classrooms

THE MARK CONSISTS OF STANDARD CHARACTERS WITHOUT CLAIM TO ANY PARTICULAR FONT, STYLE, SIZE, OR COLOR.

NO CLAIM IS MADE TO THE EXCLUSIVE RIGHT TO USE "SYSTEMS-BUILT CLASSROOMS", APART FROM THE MARK AS SHOWN.

FOR PREFABRICATED NON-METAL BUILDINGS (U.S. CLS. 1, 12, 33 AND 50).

NAAKWAMA ANKRAH, EXAMINING ATTORNEY

SN 77-126,042. ELDORADO STONE OPERATIONS LLC, SOUTH JORDAN, UT. FILED 3-8-2007.

ELDORADO ADOBE

SN 77-069,070. OWENS-CORNING FIBERGLAS TECHNOLOGY INC., SUMMIT, IL. FILED 12-21-2006.

1-800-GET-PINK

THE MARK CONSISTS OF STANDARD CHARACTERS WITHOUT CLAIM TO ANY PARTICULAR FONT, STYLE, SIZE, OR COLOR.

FOR NON-METAL ROOFING SHINGLES; NON-METAL SIDING; ASPHALT; NON-METAL ATTIC RAFTER VENTS; MANUFACTURED STONE AND BRICK VENEER (U.S. CLS. 1, 12, 33 AND 50).

ROBIN CHOSID, EXAMINING ATTORNEY

THE MARK CONSISTS OF STANDARD CHARACTERS WITHOUT CLAIM TO ANY PARTICULAR FONT, STYLE, SIZE, OR COLOR.

OWNER OF U.S. REG. NOS. 1,182,120, 2,901,565 AND OTHERS.

NO CLAIM IS MADE TO THE EXCLUSIVE RIGHT TO USE "ADOBE", APART FROM THE MARK AS SHOWN.

FOR BUILDING MATERIALS, NAMELY MANUFACTURED BRICK VENEER PRODUCTS FOR USE ON INTERIOR AND EXTERIOR WALLS, FLOORS AND SURFACES, PATIOS, POOLSIDES AND DRIVEWAYS (U.S. CLS. 1, 12, 33 AND 50).

JILL PRATER, EXAMINING ATTORNEY

CLASS 19—(Continued).

SN 77-129,658. READING ROCK INCORPORATED, CINCINNATI, OH. FILED 3-13-2007.

THE SMART CHOICE

THE MARK CONSISTS OF STANDARD CHARACTERS WITHOUT CLAIM TO ANY PARTICULAR FONT, STYLE, SIZE, OR COLOR.

FOR MASONRY VENEER PRODUCTS, NAMELY BLOCKS, BRICKS AND STONES (U.S. CLS. 1, 12, 33 AND 50).

FIRST USE 12-31-1999; IN COMMERCE 12-31-1999.
RUDY R. SINGLETON, EXAMINING ATTORNEY

SN 77-135,213. OWENS-CORNING FIBERGLAS TECHNOLOGY II, LLC, TOLEDO, OH. FILED 3-20-2007.

OCV

THE MARK CONSISTS OF STANDARD CHARACTERS WITHOUT CLAIM TO ANY PARTICULAR FONT, STYLE, SIZE, OR COLOR.

FOR MIXED MORTARS, MORTARS, MICRO-CONCRETE, CONCRETE; BUILDING GLASS (U.S. CLS. 1, 12, 33 AND 50).

TASHIA BUNCH, EXAMINING ATTORNEY

SN 77-136,379. WILREP LTD., MISSISSAUGA, CANADA, FILED 3-21-2007.

ACOUSTIFLOAT

THE MARK CONSISTS OF STANDARD CHARACTERS WITHOUT CLAIM TO ANY PARTICULAR FONT, STYLE, SIZE, OR COLOR.

PRIORITY CLAIMED UNDER SEC. 44(D) ON CANADA APPLICATION NO. 1337521, FILED 3-1-2007.

OWNER OF U.S. REG. NO. 1,296,185.
FOR SUB-FLOOR PANELS (U.S. CLS. 1, 12, 33 AND 50).

FIRST USE 2-4-2005; IN COMMERCE 3-12-2007.
TINA L. SNAPP, EXAMINING ATTORNEY

CLASS 19—(Continued).

SN 77-140,740. BRADBURY, DAVID, KIHEI, HI. FILED 3-26-2007.



NO CLAIM IS MADE TO THE EXCLUSIVE RIGHT TO USE "STONE", APART FROM THE MARK AS SHOWN.

THE MARK CONSISTS OF THE STYLIZED WORDS ELEMENTAL STONE, WITH A STYLIZED CURLING WAVE ABOVE.

FOR STONE TILES, CERAMIC TILES, GLASS TILES, GYPSUM TILES, STUCCO TILES, PAVING TILES, PLASTIC TILES, PLAYGROUND TILES, STONE ROOFING TILES, WOOD TILE FLOORS, WALL TILES, EARTH-WARE TILES, CLAY ROOFING TILES, CERAMIC ENAMEL TILES, CEMENT MORTAR ROOFING TILES, GLASS ROOFING TILES (U.S. CLS. 1, 12, 33 AND 50).

STEPHEN AQUILA, EXAMINING ATTORNEY

SN 77-141,324. DANIELS, WILLIAM, SAMMAMISH, WA. FILED 3-27-2007.

DOORFX

THE MARK CONSISTS OF STANDARD CHARACTERS WITHOUT CLAIM TO ANY PARTICULAR FONT, STYLE, SIZE, OR COLOR.

FOR DECORATIVE FIRE-RATED NON-METAL DOORS (U.S. CLS. 1, 12, 33 AND 50).

LINDA E. BLOHM, EXAMINING ATTORNEY

SN 77-142,347. WOLFE, ALBERT, III, AUSTIN, TX. FILED 3-28-2007.

Magnaplank

THE MARK CONSISTS OF STANDARD CHARACTERS WITHOUT CLAIM TO ANY PARTICULAR FONT, STYLE, SIZE, OR COLOR.

FOR NON-METAL SCAFFOLDING, NAMELY, HARDWOOD PLANKS USED AS FLOORING FOR SCAFFOLDS (U.S. CLS. 1, 12, 33 AND 50).

KRISTIN DAHLING, EXAMINING ATTORNEY

CLASS 19—(Continued).

SN 77-142,786. IPA - INDUSTRIA DE PISOS DA AMAZONIA, AMAZONAS, BRAZIL, FILED 3-28-2007.

IPANEMA

THE MARK CONSISTS OF STANDARD CHARACTERS WITHOUT CLAIM TO ANY PARTICULAR FONT, STYLE, SIZE, OR COLOR.

FOR HARDWOOD FLOORS (U.S. CLS. 1, 12, 33 AND 50).

DAWN FELDMAN, EXAMINING ATTORNEY

SN 77-142,804. EPOCH COMPOSITE PRODUCTS, INC., JOPLIN, MO. FILED 3-28-2007.

Lamarite EstateSlate

THE MARK CONSISTS OF STANDARD CHARACTERS WITHOUT CLAIM TO ANY PARTICULAR FONT, STYLE, SIZE, OR COLOR.

OWNER OF U.S. REG. NO. 2,809,190.

FOR NONMETAL BUILDING MATERIALS, NAMELY, NONMETAL COMPOSITE ROOFING MATERIALS, NAMELY, SIMULATED ROOFING SHINGLES, ROOFING SLATE, ROOFING WOOD SHAKES, ROOFING TILES, SOLD AS A UNIT TOGETHER WITH COMPOSITE ROOFING MATERIALS SUITABLE FOR ROOF HIP AND RIDGE APPLICATIONS WITH EACH TYPE OF MATERIAL (U.S. CLS. 1, 12, 33 AND 50).

CHRISTINA SOBRAL, EXAMINING ATTORNEY

SN 77-143,148. WARINER, WADE, WASILLA, AK. FILED 3-28-2007.

POCKETKNOCKER

THE MARK CONSISTS OF STANDARD CHARACTERS WITHOUT CLAIM TO ANY PARTICULAR FONT, STYLE, SIZE, OR COLOR.

FOR PIECE OF WOOD, APPROX:2-1/2"X1-1/2"X1/2" THAT ATTACHES TO A KEY RING/CHAIN (U.S. CLS. 1, 12, 33 AND 50).

FIRST USE 6-0-1996; IN COMMERCE 4-0-2002.

C. DIONNE CLYBURN, EXAMINING ATTORNEY

CLASS 19—(Continued).

SN 77-143,724. ALABAMA METAL INDUSTRIES CORPORATION, BIRMINGHAM, AL. FILED 3-29-2007.

ANC

THE MARK CONSISTS OF STANDARD CHARACTERS WITHOUT CLAIM TO ANY PARTICULAR FONT, STYLE, SIZE, OR COLOR.

FOR NON-METAL FENCING AND ACCESSORIES THEREFOR, NAMELY, PANELS, POSTS, FITTINGS AND FASTENERS (U.S. CLS. 1, 12, 33 AND 50).

FIRST USE 10-0-2005; IN COMMERCE 10-0-2005.
PATRICIA EVANKO, EXAMINING ATTORNEY

SN 77-151,636. COLUMBIA INSURANCE COMPANY, OMAHA, NE. FILED 4-9-2007.

SINGLE ACTION

THE MARK CONSISTS OF STANDARD CHARACTERS WITHOUT CLAIM TO ANY PARTICULAR FONT, STYLE, SIZE, OR COLOR.

FOR HARDWOOD, LAMINATE AND ENGINEERED WOOD FLOORING (U.S. CLS. 1, 12, 33 AND 50).

IRA J. GOODSID, EXAMINING ATTORNEY

SN 77-156,684. ACF ENVIRONMENTAL, RICHMOND, VA. FILED 4-13-2007.

GRATEGATOR

THE MARK CONSISTS OF STANDARD CHARACTERS WITHOUT CLAIM TO ANY PARTICULAR FONT, STYLE, SIZE, OR COLOR.

OWNER OF U.S. REG. NOS. 3,103,944 AND 3,103,948.

FOR STORM WATER AND INLET PROTECTION FILTERS, NAMELY, NON-METAL FILTERS FOR STORM DRAINS AND GUTTERS (U.S. CLS. 1, 12, 33 AND 50).

FIRST USE 3-31-2006; IN COMMERCE 3-31-2006.

GENE MACIOL, EXAMINING ATTORNEY

CLASS 19—(Continued).

SN 77-172,144. TIN INC., AUSTIN, TX. FILED 5-3-2007.

GreenGlass DuraDeck

THE MARK CONSISTS OF STANDARD CHARACTERS WITHOUT CLAIM TO ANY PARTICULAR FONT, STYLE, SIZE, OR COLOR.

NO CLAIM IS MADE TO THE EXCLUSIVE RIGHT TO USE "GREENGLASS", APART FROM THE MARK AS SHOWN.

FOR GYPSUM; NON-METAL FIRE-RESISTANT BOARDS AND PANELS FOR CONSTRUCTION; NON-METAL ROOF COVERINGS; NON-METAL ROOFING; NON-METAL ROOFING PANELS; ROOFING UNDERLAYMENT; BUILDING MATERIALS, NAMELY, GYPSUM FIBERGLASS DECKING BOARDS (U.S. CLS. 1, 12, 33 AND 50).

FRANK LATTUCA, EXAMINING ATTORNEY

SN 77-180,361. COLUMBIA INSURANCE COMPANY, OMAHA, NE. FILED 5-14-2007.

SOUND SUPPRESSOR 3 IN 1

THE MARK CONSISTS OF STANDARD CHARACTERS WITHOUT CLAIM TO ANY PARTICULAR FONT, STYLE, SIZE, OR COLOR.

NO CLAIM IS MADE TO THE EXCLUSIVE RIGHT TO USE "SOUND SUPPRESSOR", APART FROM THE MARK AS SHOWN.

FOR FLOORING UNDERLAYMENTS (U.S. CLS. 1, 12, 33 AND 50).

IRA J. GOODSaid, EXAMINING ATTORNEY

SN 78-737,516. ROGERS, ANDREW, TOORAK, AUSTRALIA, FILED 10-20-2005.

ART FROM THE AIR

THE MARK CONSISTS OF STANDARD CHARACTERS WITHOUT CLAIM TO ANY PARTICULAR FONT, STYLE, SIZE, OR COLOR.

PRIORITY CLAIMED UNDER SEC. 44(D) ON AUSTRALIA APPLICATION NO. 1081134, FILED 10-19-2005, REG. NO. 1081134, DATED 10-19-2005, EXPIRES 10-19-2015.

NO CLAIM IS MADE TO THE EXCLUSIVE RIGHT TO USE "ART", APART FROM THE MARK AS SHOWN.

FOR WORKS OF ART, NAMELY, SCULPTURES, STATUES, FIGURES, FIGURINES, MODELS, CARVINGS, CASTS, AND GEOGLYPHS MADE FROM MARBLE, STONE, CONCRETE, EARTH, AND ROCKS (U.S. CLS. 1, 12, 33 AND 50).

JERI J. FICKES, EXAMINING ATTORNEY

CLASS 19—(Continued).

SN 78-777,346. ILLINOIS ENERGY WINDOWS & SIDING, INC., LOMBARD, IL. FILED 12-20-2005.

WORTHINGTON WINDOWS

THE MARK CONSISTS OF STANDARD CHARACTERS WITHOUT CLAIM TO ANY PARTICULAR FONT, STYLE, SIZE, OR COLOR.

NO CLAIM IS MADE TO THE EXCLUSIVE RIGHT TO USE "WINDOWS", APART FROM THE MARK AS SHOWN. SEC. 2(F).

FOR VINYL WINDOWS (U.S. CLS. 1, 12, 33 AND 50).

FIRST USE 3-1-1993; IN COMMERCE 3-1-1993.

DOMINIC FATHY, EXAMINING ATTORNEY

SN 78-882,226. MAGNUM BUILDING PRODUCTS LLC, WELLESLEY ISLAND, NY. FILED 5-12-2006.

The logo for 'MAGNUM BOARD' features the word 'MAGNUM' in a large, bold, blue, sans-serif font. Below it, the word 'BOARD' is written in a smaller, bold, green, sans-serif font. The letters in 'BOARD' are spaced out and have a slight shadow effect.

NO CLAIM IS MADE TO THE EXCLUSIVE RIGHT TO USE "BOARD", APART FROM THE MARK AS SHOWN.

THE COLOR(S) BLUE COLOR FOR WORD MAGNUM AND GREEN COLOR FOR WORD BOARD IS/ARE CLAIMED AS A FEATURE OF THE MARK.

THE MARK CONSISTS OF BLUE FOR WORD MAGNUM AND GREEN FOR THE WORD BOARD.

FOR MAGNESIUM OXIDE BASED SHEET BOARD FOR BUILDING PURPOSES (U.S. CLS. 1, 12, 33 AND 50).

HENRY S. ZAK, EXAMINING ATTORNEY

SN 78-952,531. CALUCEM GMBH, MANNHEIM, FED REP GERMANY, FILED 8-15-2006.

Calucem

THE MARK CONSISTS OF STANDARD CHARACTERS WITHOUT CLAIM TO ANY PARTICULAR FONT, STYLE, SIZE, OR COLOR.

PRIORITY CLAIMED UNDER SEC. 44(D) ON FED REP GERMANY APPLICATION NO. 30648865.9/1, FILED 8-8-2006.

FOR CEMENT, NAMELY, FILLING CEMENT, MAGNESIA CEMENT, PORTLAND CEMENT, ROOFING CEMENT, AND ALUMINA CEMENT; CEMENT MIXES; CONCRETE (U.S. CLS. 1, 12, 33 AND 50).

FIRST USE 1-0-2007; IN COMMERCE 1-0-2007.

CARYN GLASSER, EXAMINING ATTORNEY

CLASS 19—(Continued).

SN 78-972,182. KEYSTONE RETAINING WALL SYSTEMS, INC., MINNEAPOLIS, MN. FILED 9-12-2006.

POTENZO STONE

THE MARK CONSISTS OF STANDARD CHARACTERS WITHOUT CLAIM TO ANY PARTICULAR FONT, STYLE, SIZE, OR COLOR.

NO CLAIM IS MADE TO THE EXCLUSIVE RIGHT TO USE "STONE", APART FROM THE MARK AS SHOWN.

FOR MODULAR CONCRETE BLOCKS USED TO CONSTRUCT EARTH RETAINING WALLS; MODULAR CONCRETE BLOCKS USED IN LANDSCAPING APPLICATIONS (U.S. CLS. 1, 12, 33 AND 50).

DANNEAN HETZEL, EXAMINING ATTORNEY

SN 78-973,101. OUTDOOR TECHNOLOGIES INC., MACON, MS. FILED 9-13-2006.

GET IN THE ZONE

THE MARK CONSISTS OF STANDARD CHARACTERS WITHOUT CLAIM TO ANY PARTICULAR FONT, STYLE, SIZE, OR COLOR.

FOR VINYL FENCING, VINYL FENCE POST PROFILES, AND VINYL FENCE RAILING PROFILES (U.S. CLS. 1, 12, 33 AND 50).

FIRST USE 1-5-2006; IN COMMERCE 1-5-2006.

LANA PHAM, EXAMINING ATTORNEY

SN 79-026,700. SOCIETE EUROPEENNE DES PRODUITS REFRACTAIRES, F-92400 COURBEVOIE, FRANCE, FILED 6-29-2006.

ADVANCAL

THE MARK CONSISTS OF STANDARD CHARACTERS WITHOUT CLAIM TO ANY PARTICULAR FONT, STYLE, SIZE, OR COLOR.

PRIORITY DATE OF 1-19-2006 IS CLAIMED.

OWNER OF INTERNATIONAL REGISTRATION 0892800 DATED 6-29-2006, EXPIRES 6-29-2016.

FOR FIRED REFRACTORY MATERIALS, REFRACTORY BRICKS, REFRACTORY SLABS USED FOR ALL TYPES OF INDUSTRIAL FURNACES (U.S. CLS. 1, 12, 33 AND 50).

VERNA BETH RIRIE, EXAMINING ATTORNEY

CLASS 19—(Continued).

SN 79-028,748. DR. STEPHAN HAUSER, FED REP GERMANY, AND PHILIPP HOFMANN, FED REP GERMANY, FILED 7-17-2006.

DucoStone

THE MARK CONSISTS OF STANDARD CHARACTERS WITHOUT CLAIM TO ANY PARTICULAR FONT, STYLE, SIZE, OR COLOR.

PRIORITY DATE OF 1-20-2006 IS CLAIMED.

OWNER OF INTERNATIONAL REGISTRATION 0898113 DATED 7-17-2006, EXPIRES 7-17-2016.

FOR NON-METALLIC BUILDING MATERIALS, NAMELY CONCRETE SLABS COVERED WITH STONE SLABS; CONCRETE, ESPECIALLY FIBER MAT-CONCRETE, AND PREFABRICATED CONCRETE BLOCKS; NON-METALLIC REINFORCEMENTS FOR BUILDING PURPOSES, NAMELY CONCRETE SLABS COVERED WITH STONE SLABS; ASBESTOS MORTAR; ASBESTOS CEMENT; NON-METAL SHUTTERS FOR BUILDING PURPOSES; MORTAR; PLASTER; NON-METALLIC SUPPORTS FOR CONSTRUCTION PURPOSES (U.S. CLS. 1, 12, 33 AND 50).

KHANH LE, EXAMINING ATTORNEY

SN 79-034,439. BALESTRA RENATO, ITALY, FILED 11-23-2006.

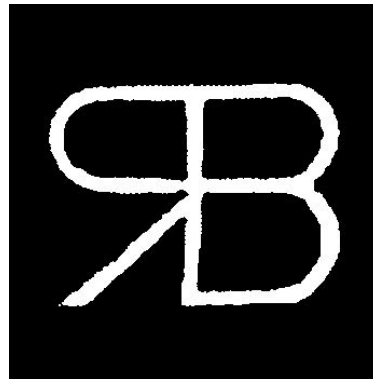

OWNER OF INTERNATIONAL REGISTRATION 0913030 DATED 11-23-2006, EXPIRES 11-23-2016.

FOR NON-METAL TILES (U.S. CLS. 1, 12, 33 AND 50).

ELI HELLMAN, EXAMINING ATTORNEY

CLASS 19—(Continued).

SN 79-036,787. JIANGXI KANGDA ZHUZHIPIN; JITUAN
YOUXIAN GONGSI, CHINA, FILED 3-26-2007.



OWNER OF INTERNATIONAL REGISTRATION 0919757
DATED 3-26-2007, EXPIRES 3-26-2017.

THE WORDS CONTAINED IN THE MARK HAVE NO
MEANING.

THE TRANSLITERATION OF THE NON-LATIN CHAR-
ACTERS IN THE MARK IS: TONG GUI.

FOR NON-METAL FLOORS (U.S. CLS. 1, 12, 33 AND
50).

GINA FINK, EXAMINING ATTORNEY

CLASS 20—(Continued).

SN 76-670,275. RISLEY, AMELIA M., ROCHESTER, NY.
FILED 12-8-2006.

Your Winning Hand

THE MARK CONSISTS OF STANDARD CHARACTERS
WITHOUT CLAIM TO ANY PARTICULAR FONT, STYLE,
SIZE, OR COLOR.

FOR NON-METAL HOOKS FOR SECURING HAND-
BAG STRAPS TO STRUCTURAL ITEMS, NAMELY,
ARTICLES OF FURNITURE AND MACHINES (U.S.
CLS. 2, 13, 22, 25, 32 AND 50).

FIRST USE 4-14-2004; IN COMMERCE 4-14-2004.

JANICE KIM, EXAMINING ATTORNEY

SN 76-673,499. KROLL ENTERPRISES, LLC, OMAHA, NE.
FILED 3-2-2007.

HATNOODLE

THE MARK CONSISTS OF STANDARD CHARACTERS
WITHOUT CLAIM TO ANY PARTICULAR FONT, STYLE,
SIZE, OR COLOR.

FOR HAT SHAPING DEVICE, NAMELY, NONMETAL
DEVICE TO HOLD, RETAIN, AND RESTORE THE
SHAPE OF SPORTS CAPS (U.S. CLS. 2, 13, 22, 25, 32
AND 50).

MARGARET POWER, EXAMINING ATTORNEY

CLASS 20—FURNITURE AND ARTICLES NOT OTHERWISE CLASSIFIED

SN 76-601,869. STUDIO RTA, INC., PICO RIVERA, CA.
FILED 7-12-2004.

MILAN

THE MARK CONSISTS OF STANDARD CHARACTERS
WITHOUT CLAIM TO ANY PARTICULAR FONT, STYLE,
SIZE, OR COLOR.

FOR READY-TO-ASSEMBLE COMPUTER DESKS/
CARTS AND ENTERTAINMENT CENTERS (U.S. CLS.
2, 13, 22, 25, 32 AND 50).

JOHN DALIER, EXAMINING ATTORNEY

SN 76-673,533. KROLL ENTERPRISES, LLC, OMAHA, NE.
FILED 3-2-2007.



THE MARK CONSISTS OF A MAN WITH HIS ARMS
CROSSED AND A LOWER BODY PORTION IN THE FORM
OF NOODLES.

FOR HAT SHAPING DEVICE, NAMELY, NONMETAL
DEVICE TO HOLD, RETAIN, AND RESTORE THE
SHAPE OF SPORTS CAPS (U.S. CLS. 2, 13, 22, 25, 32
AND 50).

MARGARET POWER, EXAMINING ATTORNEY

CLASS 20—(Continued).

SN 76-674,639. PLASTIPAK PACKAGING, INC., PLYMOUTH, MI. FILED 3-27-2007.

THE ART OF PACKAGING

THE MARK CONSISTS OF STANDARD CHARACTERS WITHOUT CLAIM TO ANY PARTICULAR FONT, STYLE, SIZE, OR COLOR.
FOR PLASTIC CONTAINERS FOR COMMERCIAL USE (U.S. CLS. 2, 13, 22, 25, 32 AND 50).
CAROLINE WOOD, EXAMINING ATTORNEY

CLASS 20—(Continued).

SN 77-022,935. KARI ROUNDY, LLC, BOCA RATON, FL. FILED 10-17-2006.

VitaBox

SN 77-012,775. TRADE GUYS INTERNATIONAL PTY LTD, QUEENSLAND, AUSTRALIA, FILED 10-3-2006.

BATWING

THE MARK CONSISTS OF STANDARD CHARACTERS WITHOUT CLAIM TO ANY PARTICULAR FONT, STYLE, SIZE, OR COLOR.
PRIORITY CLAIMED UNDER SEC. 44(D) ON AUSTRALIA APPLICATION NO. 1,137,685, FILED 9-26-2006, REG. NO. 1137685, DATED 6-7-2007, EXPIRES 9-26-2016.
FOR PLASTIC LOCKS FOR USE WITH RECORDED MEDIA PRODUCTS; PLASTIC LOCKS FOR LOCKING DVD'S AND CD'S WITHIN A STORAGE CASE; PLASTIC HUB LOCKS FOR LOCKING DVD'S AND CD'S TO AN INNER WALL OF A MEDIA STORAGE CASE (U.S. CLS. 2, 13, 22, 25, 32 AND 50).
LINDA MICKLEBURGH, EXAMINING ATTORNEY

THE MARK CONSISTS OF STANDARD CHARACTERS WITHOUT CLAIM TO ANY PARTICULAR FONT, STYLE, SIZE, OR COLOR.
FOR WOOD AND PLASTIC COMPARTMENTALIZED BOXES FOR DISPENSING VITAMINS FOR HOME OR TRAVEL USE, SOLD EMPTY (U.S. CLS. 2, 13, 22, 25, 32 AND 50).
RAMONA ORTIGA, EXAMINING ATTORNEY

SN 77-039,752. DISNEY ENTERPRISES, INC., BURBANK, CA. FILED 11-8-2006.

KINGDOM COUTURE

SN 77-017,098. OWENS-ILLINOIS CLOSURE INC., PERRYSBURG, OH. FILED 10-9-2006.

FreshSeal

THE MARK CONSISTS OF STANDARD CHARACTERS WITHOUT CLAIM TO ANY PARTICULAR FONT, STYLE, SIZE, OR COLOR.
FOR MOLDED-IN BARRIER LINERS MARKETED TO PACKAGERS FOR HOT FILL, ASEPTIC FILL AND RETORT CLOSURE APPLICATIONS (U.S. CLS. 2, 13, 22, 25, 32 AND 50).
FIRST USE 5-2-2005; IN COMMERCE 5-2-2005.
JOANNA DUKOVIC, EXAMINING ATTORNEY

THE MARK CONSISTS OF STANDARD CHARACTERS WITHOUT CLAIM TO ANY PARTICULAR FONT, STYLE, SIZE, OR COLOR.
FOR FURNITURE, MIRRORS BEING FURNITURE, HAND MIRRORS, JEWELRY BOXES NOT OF METAL, PICTURE FRAMES, PLASTIC FIGURINES, PLASTIC NAME BADGES, PLASTIC SCULPTURES, PLASTIC PARTY ORNAMENTS, PILLOWS, SLEEPING BAGS, PLASTIC BOXES AND PLASTIC CRATES, PLASTIC CAKE DECORATIONS, CLOTHES HANGERS, WIND CHIMES, DRINKING STRAWS, FIGURINES AND STATUES MADE OF BONE, IVORY, PLASTER, PLASTIC, WAX AND WOOD, PLASTIC KEY CHAINS AND PLASTIC KEY CHAIN TAGS, AND DECORATIVE GLITTER (U.S. CLS. 2, 13, 22, 25, 32 AND 50).
TRACY WHITTAKER-BROWN, EXAMINING ATTORNEY

CLASS 20—(Continued).

SN 77-042,899. TIME INC., NEW YORK, NY. FILED 11-13-2006.

REAL SIMPLE

THE MARK CONSISTS OF STANDARD CHARACTERS WITHOUT CLAIM TO ANY PARTICULAR FONT, STYLE, SIZE, OR COLOR.

OWNER OF U.S. REG. NOS. 2,470,211, 2,953,267 AND 3,098,845.

FOR OUTDOOR FURNITURE, FURNITURE CUSHIONS AND LAWN ORNAMENTS OF POLYRESIN, PLASTIC, PLASTER AND WOOD; CLOSET ACCESSORIES, NAMELY, CLOSET AND STORAGE SYSTEMS AND ORGANIZATIONAL UNITS COMPRISED OF COMBINATIONS OF SHELVES, CABINETS, DRAWERS, TIE RACKS, BELT RACKS, WIRE BASKETS OR RODS, SOLD AS A UNIT; HOME OFFICE SYSTEMS COMPRISED OF COMBINATIONS OF SHELVES, CABINETS OR TABLES SOLD INDIVIDUALLY AND AS A UNIT; AND GARAGE, LAUNDRY AND PANTRY SYSTEMS AND ORGANIZATIONAL UNITS COMPRISED OF COMBINATIONS OF CABINETS, SHELVES, DRAWERS OR RACKS SOLD INDIVIDUALLY AND AS A UNIT (U.S. CLS. 2, 13, 22, 25, 32 AND 50).

DAWN FELDMAN, EXAMINING ATTORNEY

SN 77-043,378. GENIE LENS TECHNOLOGIES, LLC, GOLDEN, CO. FILED 11-14-2006.

G WRAP

THE MARK CONSISTS OF STANDARD CHARACTERS WITHOUT CLAIM TO ANY PARTICULAR FONT, STYLE, SIZE, OR COLOR.

NO CLAIM IS MADE TO THE EXCLUSIVE RIGHT TO USE "WRAP", APART FROM THE MARK AS SHOWN.

FOR PRINTED LABELS, NAMELY PLASTIC LABELS WITH LENSES FOCUSING ON IMAGES FOR USE IN DISPLAYS AND IN PACKAGING, NAMELY LABELING BOTTLES AND OTHER CONTAINERS (U.S. CLS. 2, 13, 22, 25, 32 AND 50).

STEVEN R. FINE, EXAMINING ATTORNEY

CLASS 20—(Continued).

SN 77-063,047. M BRASIL ARTES OBJETOS LTDA, UBERLANDIA-MG, BRAZIL, FILED 12-13-2006.



NO CLAIM IS MADE TO THE EXCLUSIVE RIGHT TO USE "BRASIL", APART FROM THE MARK AS SHOWN.

THE MARK CONSISTS OF A STYLIZED "M" PLUS THE CHARACTERS "M. BRASIL" CONTAINED IN BOXES.

FOR FURNITURE (U.S. CLS. 2, 13, 22, 25, 32 AND 50). FIRST USE 10-7-2004; IN COMMERCE 10-7-2004.

STEPHEN AQUILA, EXAMINING ATTORNEY

SN 77-079,890. FOAMFANATICS LLC, SEATTLE, WA. FILED 1-10-2007.

4 IN 1 TOPPERS

THE MARK CONSISTS OF STANDARD CHARACTERS WITHOUT CLAIM TO ANY PARTICULAR FONT, STYLE, SIZE, OR COLOR.

NO CLAIM IS MADE TO THE EXCLUSIVE RIGHT TO USE "4 IN 1", APART FROM THE MARK AS SHOWN.

FOR NON-METAL KEY CHAINS; NON-METAL KEY FOBS (U.S. CLS. 2, 13, 22, 25, 32 AND 50).

FIRST USE 4-18-2007; IN COMMERCE 4-18-2007.

KAREN K. BUSH, EXAMINING ATTORNEY

SN 77-082,845. DRAPER, INC., SPICELAND, IN. FILED 1-15-2007.

DRAPER

THE MARK CONSISTS OF STANDARD CHARACTERS WITHOUT CLAIM TO ANY PARTICULAR FONT, STYLE, SIZE, OR COLOR.

SEC. 2(F).

FOR WINDOW SHADES (U.S. CLS. 2, 13, 22, 25, 32 AND 50).

FIRST USE 0-0-1902; IN COMMERCE 0-0-1902.

RICHARD WHITE, EXAMINING ATTORNEY

CLASS 20—(Continued).

SN 77-091,492. RESPONSIBLE GAMBLING COUNCIL (ONTARIO), TORONTO, CANADA, FILED 1-25-2007.

**RESPONSIBLE GAMBLING
COUNCIL**

THE MARK CONSISTS OF STANDARD CHARACTERS WITHOUT CLAIM TO ANY PARTICULAR FONT, STYLE, SIZE, OR COLOR.

FOR PICTURE FRAMES (U.S. CLS. 2, 13, 22, 25, 32 AND 50).

NATALIE POLZER, EXAMINING ATTORNEY

CLASS 20—(Continued).

SN 77-106,103. PHILIPPE LANGDON FURNITURE, INC., BELL GARDENS, CA. FILED 2-13-2007.

Philippe Langdon

THE MARK CONSISTS OF STANDARD CHARACTERS WITHOUT CLAIM TO ANY PARTICULAR FONT, STYLE, SIZE, OR COLOR.

THE NAME(S), PORTRAIT(S), AND/OR SIGNATURE(S) SHOWN IN THE MARK DOES NOT IDENTIFY A PARTICULAR LIVING INDIVIDUAL.

FOR FURNITURE (U.S. CLS. 2, 13, 22, 25, 32 AND 50). FIRST USE 11-28-2003; IN COMMERCE 11-28-2003. GENE MACIOL, EXAMINING ATTORNEY

SN 77-098,919. DREAMLINE MANUFACTURING, INC., CABOT, AR. FILED 2-5-2007.

THERM-O-PEDIC

THE MARK CONSISTS OF STANDARD CHARACTERS WITHOUT CLAIM TO ANY PARTICULAR FONT, STYLE, SIZE, OR COLOR.

FOR SLEEP PRODUCTS, NAMELY, MATTRESSES, SPRING MATTRESSES, BOX SPRINGS AND MATTRESS FOUNDATIONS (U.S. CLS. 2, 13, 22, 25, 32 AND 50).

FIRST USE 1-1-2002; IN COMMERCE 1-1-2002. SANI KHOURI, EXAMINING ATTORNEY

SN 77-113,353. TESLER, JUSTIN, QUAKER HILL, CT. FILED 2-22-2007.

Coastal Crete Design

THE MARK CONSISTS OF STANDARD CHARACTERS WITHOUT CLAIM TO ANY PARTICULAR FONT, STYLE, SIZE, OR COLOR.

NO CLAIM IS MADE TO THE EXCLUSIVE RIGHT TO USE "DESIGN", APART FROM THE MARK AS SHOWN.

FOR BATHROOM VANITIES; FURNITURE; FURNITURE PARTS, NAMELY, COUNTERTOPS (U.S. CLS. 2, 13, 22, 25, 32 AND 50).

SCOTT BALDWIN, EXAMINING ATTORNEY

SN 77-103,581. DOWNEAST OUTFITTERS, INC., OREM, UT. FILED 2-9-2007.

Downeast Home

THE MARK CONSISTS OF STANDARD CHARACTERS WITHOUT CLAIM TO ANY PARTICULAR FONT, STYLE, SIZE, OR COLOR.

NO CLAIM IS MADE TO THE EXCLUSIVE RIGHT TO USE "HOME", APART FROM THE MARK AS SHOWN.

FOR FURNITURE FOR HOUSE, OFFICE AND GARDEN (U.S. CLS. 2, 13, 22, 25, 32 AND 50).

FIRST USE 11-1-1996; IN COMMERCE 11-1-1996. CHRIS DONINGER, EXAMINING ATTORNEY

SN 77-119,888. GLIDE N' GUARD FLOOR PROTECTION LTD., SASKATOON, CANADA, FILED 3-1-2007.

GLIDE N' GUARD

THE MARK CONSISTS OF STANDARD CHARACTERS WITHOUT CLAIM TO ANY PARTICULAR FONT, STYLE, SIZE, OR COLOR.

FOR PLASTIC STRIPS USED UNDER APPLIANCES TO PROTECT FLOORS (U.S. CLS. 2, 13, 22, 25, 32 AND 50).

FIRST USE 11-30-1993; IN COMMERCE 11-30-1993. CHARLES L. JENKINS, EXAMINING ATTORNEY

CLASS 20—(Continued).

SN 77-120,588. WP IP LLC, NEW YORK, NY. FILED 3-2-2007.



NO CLAIM IS MADE TO THE EXCLUSIVE RIGHT TO USE "HOME", APART FROM THE MARK AS SHOWN.

THE MARK CONSISTS OF A BOX WITH THE STYLIZED WORDS "WP HOME" INSIDE.

FOR PILLOWS (U.S. CLS. 2, 13, 22, 25, 32 AND 50).
FRANK LATTUCA, EXAMINING ATTORNEY

CLASS 20—(Continued).

SN 77-122,058. RTC INDUSTRIES, INC., ROLLING MEADOWS, IL. FILED 3-5-2007.

SHELFLEX

THE MARK CONSISTS OF STANDARD CHARACTERS WITHOUT CLAIM TO ANY PARTICULAR FONT, STYLE, SIZE, OR COLOR.

FOR SELECTIVELY ADJUSTABLE ORGANIZER SYSTEMS FOR HOLDING AND POSITIONING GOODS THAT ARE TO BE DISPLAYED AND SUPPORTED UPON A SUPPORT SHELF, SAID SYSTEM COMPRISING A MASTER CHANNEL, SHELF DIVIDERS ADAPTED FOR CONNECTION TO THE MASTER CHANNEL, OPTIONAL CROSSBRACES FOR INTERCONNECTING PAIRS OF SHELF DIVIDERS, AND OPTIONAL RETAINER STRIPS FOR CONNECTION TO THE MASTER CHANNEL (U.S. CLS. 2, 13, 22, 25, 32 AND 50).

FIRST USE 5-12-1985; IN COMMERCE 5-12-1985.
DOMINIC J. FERRAIUOLO, EXAMINING ATTORNEY

SN 77-122,429. DACS, INC., PORTSMOUTH, VA. FILED 3-5-2007.

FLUEKEEPER

THE MARK CONSISTS OF STANDARD CHARACTERS WITHOUT CLAIM TO ANY PARTICULAR FONT, STYLE, SIZE, OR COLOR.

FOR STORAGE SPACING DEVICE, NAMELY METAL STORAGE RACKS, FOR USE IN STORAGE FACILITIES (U.S. CLS. 2, 13, 22, 25, 32 AND 50).

FRANK LATTUCA, EXAMINING ATTORNEY

SN 77-122,048. RTC INDUSTRIES, INC., ROLLING MEADOWS, IL. FILED 3-5-2007.

RTC

SN 77-122,441. EQUITY EARNINGS CORPORATION, SCOTTSDALE, AZ. FILED 3-5-2007.

MED-ALERT

THE MARK CONSISTS OF STANDARD CHARACTERS WITHOUT CLAIM TO ANY PARTICULAR FONT, STYLE, SIZE, OR COLOR.

FOR PRODUCT DISPLAY SHELVING, RACKS, BINS AND CONTAINERS, CONSTRUCTED AT LEAST IN PART FROM MOLDED PLASTIC (U.S. CLS. 2, 13, 22, 25, 32 AND 50).

FIRST USE 7-0-1971; IN COMMERCE 7-0-1971.
DOMINIC J. FERRAIUOLO, EXAMINING ATTORNEY

THE MARK CONSISTS OF STANDARD CHARACTERS WITHOUT CLAIM TO ANY PARTICULAR FONT, STYLE, SIZE, OR COLOR.

FOR PLASTIC MEDICATION CASES SOLD EMPTY CONTAINING A VIBRATING ALARM AS A REMINDER TO TAKE MEDICATION (U.S. CLS. 2, 13, 22, 25, 32 AND 50).

FIRST USE 2-16-2007; IN COMMERCE 2-20-2007.
KEVON CHISOLM, EXAMINING ATTORNEY

CLASS 20—(Continued).

SN 77-124,600. CLIMACOVER, MILTON, WA. FILED 3-7-2007.



FOR A FLUID-FILLED VINYL BLADDER AND RUBBER BLADDERS USED TO HOLD DOWN TARPS AND OTHER TYPES OF COVERS (U.S. CLS. 2, 13, 22, 25, 32 AND 50).

BRIDGETT SMITH, EXAMINING ATTORNEY



SN 77-125,575. THE WECK CORPORATION, NEW YORK, NY. FILED 3-8-2007.

GRACIOUS HOME

THE MARK CONSISTS OF STANDARD CHARACTERS WITHOUT CLAIM TO ANY PARTICULAR FONT, STYLE, SIZE, OR COLOR.

OWNER OF U.S. REG. NOS. 947,721 AND 2,284,659. FOR FRAMED DECORATIVE MIRRORS (U.S. CLS. 2, 13, 22, 25, 32 AND 50). FIRST USE 9-5-2005; IN COMMERCE 9-5-2005. DAVID H. STINE, EXAMINING ATTORNEY



SN 77-125,945. SELECT COMFORT CORPORATION, PLYMOUTH, MN. FILED 3-8-2007.

SEAT NUMBER

THE MARK CONSISTS OF STANDARD CHARACTERS WITHOUT CLAIM TO ANY PARTICULAR FONT, STYLE, SIZE, OR COLOR.

OWNER OF U.S. REG. NOS. 2,618,999, 2,913,779 AND OTHERS. FOR FURNITURE (U.S. CLS. 2, 13, 22, 25, 32 AND 50). COLLEEN DOMBROW, EXAMINING ATTORNEY

CLASS 20—(Continued).

SN 77-126,382. JAMISON BEDDING, INC., NASHVILLE, TN. FILED 3-9-2007.

MORRIS KELLY COLLECTION

THE MARK CONSISTS OF STANDARD CHARACTERS WITHOUT CLAIM TO ANY PARTICULAR FONT, STYLE, SIZE, OR COLOR.

NO CLAIM IS MADE TO THE EXCLUSIVE RIGHT TO USE "COLLECTION", APART FROM THE MARK AS SHOWN.

THE NAME(S), PORTRAIT(S), AND/OR SIGNATURE(S) SHOWN IN THE MARK DOES NOT IDENTIFY A PARTICULAR LIVING INDIVIDUAL.

FOR BEDDING, NAMELY MATTRESSES AND BOX SPRINGS (U.S. CLS. 2, 13, 22, 25, 32 AND 50). FIRST USE 2-9-2007; IN COMMERCE 2-9-2007. CURTIS FRENCH, EXAMINING ATTORNEY



SN 77-129,013. HYLOFT, INC., LAS VEGAS, NV. FILED 3-12-2007.

MASTER RAIL

THE MARK CONSISTS OF STANDARD CHARACTERS WITHOUT CLAIM TO ANY PARTICULAR FONT, STYLE, SIZE, OR COLOR.

NO CLAIM IS MADE TO THE EXCLUSIVE RIGHT TO USE "RAIL", APART FROM THE MARK AS SHOWN.

FOR SHELVES; SHELVING; SHELVING AND COMPONENT PARTS THEREOF, NAMELY SHELVES AND BRACKETS SOLD AS A UNIT; STORAGE RACKS (U.S. CLS. 2, 13, 22, 25, 32 AND 50). KIMBERLY FRYE, EXAMINING ATTORNEY



SN 77-129,701. MINIMUM, INC., SEATTLE, WA. FILED 3-13-2007.

BIG SHRIMPY

THE MARK CONSISTS OF STANDARD CHARACTERS WITHOUT CLAIM TO ANY PARTICULAR FONT, STYLE, SIZE, OR COLOR.

FOR PET BEDS (U.S. CLS. 2, 13, 22, 25, 32 AND 50). FIRST USE 10-23-2003; IN COMMERCE 10-23-2003. MARGARET POWER, EXAMINING ATTORNEY

CLASS 20—(Continued).

SN 77-131,652. ORGANIZERS DIRECT, L.L.C., SCOTTSDALE, AZ. FILED 3-15-2007.



OWNER OF U.S. REG. NOS. 2,075,179, 2,094,240 AND OTHERS.

NO CLAIM IS MADE TO THE EXCLUSIVE RIGHT TO USE "ORGANIZERS", APART FROM THE MARK AS SHOWN.

THE MARK CONSISTS OF THE WORDS "ORGANIZERS DIRECT" AND A CIRCLE AND HALF SPHERE.

FOR STORAGE SYSTEMS FOR HOME OR OFFICE USE, COMPRISING, NON-METAL RACKS, SHELVES, DRAWERS, DIVIDERS, RODS, BASKETS, HANGERS AND INSTALLATION VIDEO CASSETTES DISTRIBUTED THEREWITH (U.S. CLS. 2, 13, 22, 25, 32 AND 50).

FIRST USE 1-6-2007; IN COMMERCE 1-13-2007.
KHANH LE, EXAMINING ATTORNEY

SN 77-134,308. BEAUTY PLUS TRADING CO., INC., MOONACHIE, NJ. FILED 3-19-2007.

Dura Mannequin

THE MARK CONSISTS OF STANDARD CHARACTERS WITHOUT CLAIM TO ANY PARTICULAR FONT, STYLE, SIZE, OR COLOR.

NO CLAIM IS MADE TO THE EXCLUSIVE RIGHT TO USE "MANNEQUIN", APART FROM THE MARK AS SHOWN.

FOR MANNEQUINS (U.S. CLS. 2, 13, 22, 25, 32 AND 50).

ELIZABETH BEYER, EXAMINING ATTORNEY

SN 77-137,460. CARMEL GLASS AND MIRROR, INC., INDIANAPOLIS, IN. FILED 3-22-2007.

CORKY'S BETTER BUTTONS

THE MARK CONSISTS OF STANDARD CHARACTERS WITHOUT CLAIM TO ANY PARTICULAR FONT, STYLE, SIZE, OR COLOR.

NO CLAIM IS MADE TO THE EXCLUSIVE RIGHT TO USE "BETTER BUTTONS", APART FROM THE MARK AS SHOWN.

FOR POLYURETHANE SPACERS FOR GLASS (U.S. CLS. 2, 13, 22, 25, 32 AND 50).

FIRST USE 7-1-2007; IN COMMERCE 7-1-2007.
DAVID TAYLOR, EXAMINING ATTORNEY

CLASS 20—(Continued).

SN 77-138,888. MORRIS, DAVID, TAMPA, FL. AND MORGAN, ADRIAN, TAMPA, FL. FILED 3-23-2007.

GROUND LOUNGE

THE MARK CONSISTS OF STANDARD CHARACTERS WITHOUT CLAIM TO ANY PARTICULAR FONT, STYLE, SIZE, OR COLOR.

FOR OUTDOOR SEATS COMPOSED OF A PVC OR ALUMINUM FRAME WITH A SLING TYPE SEAT THAT LEANS AGAINST THE BASE OF A TREE FOR USE IN HUNTING, CAMPING, FISHING (U.S. CLS. 2, 13, 22, 25, 32 AND 50).

FIRST USE 2-0-2002; IN COMMERCE 3-24-2002.
SARA THOMAS, EXAMINING ATTORNEY

SN 77-138,957. NEW HAVEN MOVING EQUIPMENT CORP., EAST HAVEN, CT. FILED 3-23-2007.



NO CLAIM IS MADE TO THE EXCLUSIVE RIGHT TO USE "NEW HAVEN MOVING EQUIPMENT", APART FROM THE MARK AS SHOWN.

THE MARK CONSISTS OF THE WORDS "NEW" AND "HAVEN" WITH A BATTLESHIP HAVING ITS BOW PROJECTING BETWEEN THE WORDS AND BEING PARTIALLY OBSCURED BY "HAVEN", WITH "MOVING EQUIPMENT" BELOW "NEW HAVEN".

FOR FURNITURE PADS (U.S. CLS. 2, 13, 22, 25, 32 AND 50).

FIRST USE 1-1-1911; IN COMMERCE 1-1-1911.
HOWARD FRIEDMAN, EXAMINING ATTORNEY

SN 77-139,058. CASCADE CREEK COMPANY, HUNTINGTON, NY. FILED 3-23-2007.

YAKCLIPS

THE MARK CONSISTS OF STANDARD CHARACTERS WITHOUT CLAIM TO ANY PARTICULAR FONT, STYLE, SIZE, OR COLOR.

OWNER OF U.S. REG. NO. 2,814,734.
FOR NON-METAL CLIPS FOR USE IN HOLDING PADDLES ONTO SMALL HUMAN POWERED WATERCRAFT, WHICH CLIPS CAN BE ADJUSTED AND REMOVED WITHOUT TOOLS (U.S. CLS. 2, 13, 22, 25, 32 AND 50).

FIRST USE 3-23-2007; IN COMMERCE 3-23-2007.
MICHAEL GAFFAR, EXAMINING ATTORNEY

CLASS 20—(Continued).

SN 77-139,088. MCKINNEY, LAWRENCE, HAMILTON SQUARE, NJ. FILED 3-23-2007.

THE DOORMANAGER

THE MARK CONSISTS OF STANDARD CHARACTERS WITHOUT CLAIM TO ANY PARTICULAR FONT, STYLE, SIZE, OR COLOR.

FOR SOFT DOOR STOPS MADE FROM VINYL BALLS TO BE USED IN HOME OR OFFICE (U.S. CLS. 2, 13, 22, 25, 32 AND 50).

PATRICIA EVANKO, EXAMINING ATTORNEY

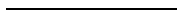

SN 77-139,430. WARFORD, MICHELLE R., DBA TIRESWING VENTURES, LLC, BURLINGAME, CA. FILED 3-23-2007.

UBrand

THE MARK CONSISTS OF STANDARD CHARACTERS WITHOUT CLAIM TO ANY PARTICULAR FONT, STYLE, SIZE, OR COLOR.

FOR POLYMER BASED LABELS, NAMELY PLASTIC, PVC AND RUBBER LABELS, FOR IDENTIFICATION AND PERSONALIZATION OF LUGGAGE, BAGS, BACK-PACKS, SHOES, OUTDOOR CLOTHING AND EQUIPMENT, SPORTING GOODS, AND OTHER PERSONAL ITEMS (U.S. CLS. 2, 13, 22, 25, 32 AND 50).

LINDA POWELL, EXAMINING ATTORNEY



SN 77-141,782. B2X CORPORATION, JERSEY CITY, NJ. FILED 3-27-2007.

B2X

THE MARK CONSISTS OF STANDARD CHARACTERS WITHOUT CLAIM TO ANY PARTICULAR FONT, STYLE, SIZE, OR COLOR.

FOR FURNITURE (U.S. CLS. 2, 13, 22, 25, 32 AND 50). THEODORE MCBRIDE, EXAMINING ATTORNEY

CLASS 20—(Continued).

SN 77-141,798. COLORGUARD, ATLANTA, GA. FILED 3-27-2007.

COLORGUARD

THE MARK CONSISTS OF STANDARD CHARACTERS WITHOUT CLAIM TO ANY PARTICULAR FONT, STYLE, SIZE, OR COLOR.

FOR INTERIOR WINDOW BLINDS (U.S. CLS. 2, 13, 22, 25, 32 AND 50).

CHRISTINE COOPER, EXAMINING ATTORNEY



SN 77-141,840. CYPRESS ENTERPRISES, INC., DBA OASIS CONCEPTS, TRABUCO CANYON, CA. FILED 3-27-2007.

OASIS ISLAND

THE MARK CONSISTS OF STANDARD CHARACTERS WITHOUT CLAIM TO ANY PARTICULAR FONT, STYLE, SIZE, OR COLOR.

FOR FURNITURE FOR THE HOME, NAMELY, FOLDING KITCHEN TABLES AND CARTS (U.S. CLS. 2, 13, 22, 25, 32 AND 50).

FIRST USE 3-31-2004; IN COMMERCE 3-31-2004. MARY CRAWFORD, EXAMINING ATTORNEY

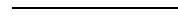

SN 77-141,924. UNITED FOOTBALL LEAGUE, LLC, SAN FRANCISCO, CA. FILED 3-27-2007.

UFL

THE MARK CONSISTS OF STANDARD CHARACTERS WITHOUT CLAIM TO ANY PARTICULAR FONT, STYLE, SIZE, OR COLOR.

FOR BABY BOLSTERS; BABY BOUNCERS; BABY WALKERS; BENCHES FOR SPORTS FIELDS; BOOSTER SEATS; CABINETS; CHAIRS; CLEAR PLASTIC HOLDERS FOR BADGES; CLOTHES HANGERS; COMMERCIAL WORK STATIONS INCLUDING ACCESSORIES AND COMPONENTS THEREFOR; COMPUTER FURNITURE; COMPUTER KEYBOARD TRAYS; COUCHES; CRADLES; DECK CHAIRS; DESKS; DOG BEDS; EASY-CHAIRS; EXTENDIBLE SOFAS; FITTED FABRIC FURNITURE COVERS; FLAGPOLES; FOOTSTOOLS; FURNITURE FOR CAMPING; FURNITURE FOR HOUSE, OFFICE AND GARDEN; HIGH CHAIRS; INFLATABLE MATTRESSES FOR USE WHEN CAMPING; INFLATABLE NECK SUPPORT CUSHIONS; INFLATABLE PILLOWS; INFLATABLE PLASTIC SIGNS; INFLATABLE PUBLICITY OBJECTS; LIVING ROOM FURNITURE; LOUNGE CHAIRS; LOVE SEATS; NON-

CLASS 20—(Continued).

METAL HOLDERS FOR SIGNS; NONMETAL TAPS FOR KEYS; NON-ELECTRIC, PLASTIC SCOREBOARDS FOR SPORTS; NON-ELECTRIC, PLASTIC SPORTS SCORING DEVICE USING MANUAL DIALS THAT ALLOW SPECTATORS TO KEEP TRACK OF SCORES AND OTHER DATA AT SPORTS EVENTS; NON-METAL KEY HOLDERS; NON-METAL KEY RINGS; NON-METAL TENT PEGS; NON-METAL TOOL BOXES; NON-METAL TRAIN AND BUS TICKET HOLDERS; NON-METAL TROPHIES; NON-METAL TROPHY COLUMNS; NON-METALLIC BOTTLE CAPS; NON-METALLIC BOTTLE STOPPERS; OFFICE FURNITURE; PLASTIC CAKE DECORATIONS; PLASTIC FLAGS; PLASTIC KEY CHAIN TAGS; PLASTIC KEY RINGS; PLASTIC KEY TAGS; PORTABLE BABY BATH SEATS FOR USE IN BATH TUBS; PORTABLE BACK SUPPORT FOR USE WITH CHAIRS; PORTABLE BEDS FOR PETS; RECLINING CHAIRS; SLEEPING BAGS; SLEEPING BAGS; STADIUM CUSHIONS; STATUES OF PLASTER, PLASTIC, WAX AND WOOD; STATUETTES OF PLASTER, PLASTIC, WAX AND WOOD (U.S. CLS. 2, 13, 22, 25, 32 AND 50).
JORDAN BAKER, EXAMINING ATTORNEY

SN 77-143,266. ZINUS INC., PLEASANTON, CA. FILED 3-29-2007.

Slumber One

THE MARK CONSISTS OF STANDARD CHARACTERS WITHOUT CLAIM TO ANY PARTICULAR FONT, STYLE, SIZE, OR COLOR.

NO CLAIM IS MADE TO THE EXCLUSIVE RIGHT TO USE "SLUMBER", APART FROM THE MARK AS SHOWN. FOR SLEEP PRODUCTS, NAMELY, MATTRESSES, SPRING MATTRESSES, BOX SPRINGS AND MATTRESS FOUNDATIONS (U.S. CLS. 2, 13, 22, 25, 32 AND 50).
BERNICE MIDDLETON, EXAMINING ATTORNEY

SN 77-143,827. HARTSON-KENNEDY CABINET TOP CO. INC., MARION, IN. FILED 3-29-2007.

AMORE'

THE MARK CONSISTS OF STANDARD CHARACTERS WITHOUT CLAIM TO ANY PARTICULAR FONT, STYLE, SIZE, OR COLOR.

THE ENGLISH TRANSLATION OF THE WORD AMORE IN THE MARK IS LOVE.

FOR CUSTOM KITCHEN COUNTERTOPS AND BAR COUNTERTOPS (U.S. CLS. 2, 13, 22, 25, 32 AND 50).
BARBARA GAYNOR, EXAMINING ATTORNEY

CLASS 20—(Continued).

SN 77-149,174. SCHERING CORPORATION, KENILWORTH, NJ. FILED 4-5-2007.

CLARITIN

THE MARK CONSISTS OF STANDARD CHARACTERS WITHOUT CLAIM TO ANY PARTICULAR FONT, STYLE, SIZE, OR COLOR.

OWNER OF U.S. REG. NOS. 1,498,292, 3,140,850 AND OTHERS.

FOR PLASTIC PILL BOXES SOLD EMPTY (U.S. CLS. 2, 13, 22, 25, 32 AND 50).

ANGELA GAW, EXAMINING ATTORNEY

SN 77-149,181. SCHERING CORPORATION, KENILWORTH, NJ. FILED 4-5-2007.

LIVE CLARITIN CLEAR

THE MARK CONSISTS OF STANDARD CHARACTERS WITHOUT CLAIM TO ANY PARTICULAR FONT, STYLE, SIZE, OR COLOR.

OWNER OF U.S. REG. NOS. 1,498,292, 3,140,850 AND OTHERS.

FOR PLASTIC PILL BOXES SOLD EMPTY (U.S. CLS. 2, 13, 22, 25, 32 AND 50).

ANGELA GAW, EXAMINING ATTORNEY

SN 77-165,677. CHAN, KING YIU. BEAVERTON, OR. AND DU, SI MING, BEAVERTON, OR. FILED 4-25-2007.

TravelMate

THE MARK CONSISTS OF STANDARD CHARACTERS WITHOUT CLAIM TO ANY PARTICULAR FONT, STYLE, SIZE, OR COLOR.

FOR NECK-SUPPORTING PILLOWS (U.S. CLS. 2, 13, 22, 25, 32 AND 50).

FIRST USE 3-28-2007; IN COMMERCE 3-28-2007.

IRA J. GOODSaid, EXAMINING ATTORNEY

CLASS 20—(Continued).

SN 77-174,571. LOUISVILLE BEDDING COMPANY, LOUISVILLE, KY. FILED 5-7-2007.

CLASS 20—(Continued).

SN 77-196,656. ZINUS INC., PLEASANTON, CA. FILED 6-4-2007.

BRIDAL BEGINNINGS

THE MARK CONSISTS OF STANDARD CHARACTERS WITHOUT CLAIM TO ANY PARTICULAR FONT, STYLE, SIZE, OR COLOR.
OWNER OF U.S. REG. NO. 2,408,994.
FOR PILLOWS; BED PILLOWS (U.S. CLS. 2, 13, 22, 25, 32 AND 50).
JAMES LOVELACE, EXAMINING ATTORNEY

Priage

THE MARK CONSISTS OF STANDARD CHARACTERS WITHOUT CLAIM TO ANY PARTICULAR FONT, STYLE, SIZE, OR COLOR.
FOR SLEEP PRODUCTS, NAMELY, MATTRESSES, SPRING MATTRESSES, BOX SPRINGS AND MATTRESS FOUNDATIONS (U.S. CLS. 2, 13, 22, 25, 32 AND 50).
DAVID MURRAY, EXAMINING ATTORNEY

SN 77-174,727. C. J. LEACHCO, INC., ADA, OK. FILED 5-7-2007.

IN THE BUFF

THE MARK CONSISTS OF STANDARD CHARACTERS WITHOUT CLAIM TO ANY PARTICULAR FONT, STYLE, SIZE, OR COLOR.
FOR PILLOWS, MATERNITY PILLOWS, NURSING PILLOWS, BODY PILLOWS, INFANT SUPPORT PILLOWS (U.S. CLS. 2, 13, 22, 25, 32 AND 50).
KATHRYN COWARD, EXAMINING ATTORNEY

SN 78-367,181. HILL-ROM SERVICES, INC., BATESVILLE, IN. FILED 2-12-2004.

ARTISAN

THE MARK CONSISTS OF STANDARD CHARACTERS WITHOUT CLAIM TO ANY PARTICULAR FONT, STYLE, SIZE, OR COLOR.
FOR FURNITURE FOR USE IN MEDICAL FACILITIES (U.S. CLS. 2, 13, 22, 25, 32 AND 50).
FIRST USE 10-0-2004; IN COMMERCE 10-0-2004.
KATHRYN COWARD, EXAMINING ATTORNEY

SN 77-190,026. ZINUS, INC., PLEASANTON, CA. FILED 5-24-2007.

MOTIVA

THE MARK CONSISTS OF STANDARD CHARACTERS WITHOUT CLAIM TO ANY PARTICULAR FONT, STYLE, SIZE, OR COLOR.
FOR SLEEP PRODUCTS, NAMELY, MATTRESSES, SPRING MATTRESSES, BOX SPRINGS AND MATTRESS FOUNDATIONS (U.S. CLS. 2, 13, 22, 25, 32 AND 50).
DAVID MURRAY, EXAMINING ATTORNEY

SN 78-603,277. WESTMINSTER, INC., ATLANTA, GA. FILED 4-6-2005.



NO CLAIM IS MADE TO THE EXCLUSIVE RIGHT TO USE "CUSHY", APART FROM THE MARK AS SHOWN.
FOR SOFT PILLOWS (U.S. CLS. 2, 13, 22, 25, 32 AND 50).
FIRST USE 3-1-2004; IN COMMERCE 3-1-2004.
TIMOTHY FINNEGAN, EXAMINING ATTORNEY

CLASS 20—(Continued).

SN 78-689,531. NORCRAFT COMPANIES, L.P., DBA THE ULTRACRAFT COMPANY, LIBERTY, NC. FILED 8-10-2005.

DESTINY

THE MARK CONSISTS OF STANDARD CHARACTERS WITHOUT CLAIM TO ANY PARTICULAR FONT, STYLE, SIZE, OR COLOR.
FOR CABINETS (U.S. CLS. 2, 13, 22, 25, 32 AND 50).
WON TEAK OH, EXAMINING ATTORNEY

SN 78-759,674. CHESNEY, KENNY, ATLANTA, GA. FILED 11-22-2005.

OL' BLUE CHAIR

THE MARK CONSISTS OF STANDARD CHARACTERS WITHOUT CLAIM TO ANY PARTICULAR FONT, STYLE, SIZE, OR COLOR.
NO CLAIM IS MADE TO THE EXCLUSIVE RIGHT TO USE "BLUE CHAIR", APART FROM THE MARK AS SHOWN.
FOR FURNITURE (U.S. CLS. 2, 13, 22, 25, 32 AND 50).
SHARON MEIER, EXAMINING ATTORNEY

SN 78-775,328. KAYFOAM WOOLFSON, DUBLIN, IRELAND, FILED 12-16-2005.



OWNER OF U.S. REG. NO. 2,737,405.
NO CLAIM IS MADE TO THE EXCLUSIVE RIGHT TO USE "VISCO", APART FROM THE MARK AS SHOWN.
THE COLOR(S) BLUE, GREEN AND WHITE IS/ARE CLAIMED AS A FEATURE OF THE MARK.
THE MARK CONSISTS OF A GREEN OVAL CONTAINING THE IMAGE OF A WHITE PERSON SLEEPING WITH THE WORDING KAYMED WRITTEN IN BLUE AND THE WORDING VISCO AIRLAYER WRITTEN IN GREEN IMMEDIATELY BENEATH THE LOGO.
FOR MATTRESSES, PILLOWS, CUSHIONS ALL MADE OF CELLULAR AND POLYURETHANE FOAM (U.S. CLS. 2, 13, 22, 25, 32 AND 50).
COLLEEN DOMBROW, EXAMINING ATTORNEY

CLASS 20—(Continued).

SN 78-791,431. SCANDINAVIAN CHILD, INC., RALEIGH, NC. FILED 1-13-2006.

MONARCH

THE COLOR(S) BLACK IS/ARE CLAIMED AS A FEATURE OF THE MARK.
THE MARK APPEARS IN THE COLOR BLACK.
FOR UPHOLSTERED CHAIR (U.S. CLS. 2, 13, 22, 25, 32 AND 50).
ARETHA SOMERVILLE, EXAMINING ATTORNEY

SN 78-838,833. INSCAPE CORPORATION, HOLLAND LANDING, CANADA, FILED 3-16-2006.

FREEFORM

THE MARK CONSISTS OF STANDARD CHARACTERS WITHOUT CLAIM TO ANY PARTICULAR FONT, STYLE, SIZE, OR COLOR.
PRIORITY CLAIMED UNDER SEC. 44(D) ON CANADA APPLICATION NO. 1293702, FILED 3-14-2006, REG. NO. TMA689807, DATED 6-14-2007, EXPIRES 6-14-2022.
FOR OFFICE FURNITURE, OFFICE EQUIPMENT AND FURNISHINGS, NAMELY, DESKS, TABLES, TABLETOPS, COUNTERTOPS, CREDENZAS, SHELVING, MAGAZINE RACKS, ROOM SPACE DIVIDERS, PARTITIONS, MOVABLE PRIVACY PANELS AND MODULAR MOVABLE PARTITIONS AND ASSOCIATED COMPONENTS THEREFOR (U.S. CLS. 2, 13, 22, 25, 32 AND 50).
REBECCA POVARCHUK, EXAMINING ATTORNEY

SN 78-842,909. NATIONAL TOILET PARTITIONS, LLC, COLUMBIA, SC. FILED 3-22-2006.



NO CLAIM IS MADE TO THE EXCLUSIVE RIGHT TO USE "TOILET PARTITIONS, LLC", APART FROM THE MARK AS SHOWN.
FOR FURNITURE PARTITIONS (U.S. CLS. 2, 13, 22, 25, 32 AND 50).
FIRST USE 10-1-2004; IN COMMERCE 10-1-2004.
MELISSA VALLILLO, EXAMINING ATTORNEY

CLASS 20—(Continued).

SN 78-900,050. ZHEJIANG ZHENGTE GROUP CO., LTD., LINHAI, CHINA, FILED 6-4-2006.



OWNER OF CHINA REG. NO. 3449066, DATED 11-7-2004, EXPIRES 11-6-2014.

THE FOREIGN WORDING IN THE MARK TRANSLATES INTO ENGLISH AS FAIRNESS AND CREATIVITY.
FOR LAWN FURNITURE; OUTDOOR FURNITURE; PLASTIC FURNITURE FOR GARDENS (U.S. CLS. 2, 13, 22, 25, 32 AND 50).

JAMES MACFARLANE, EXAMINING ATTORNEY

SN 78-923,600. EVENT HORIZON PVDC, INC., SAN DIEGO, CA. FILED 7-6-2006.

EVENT HORIZON

THE MARK CONSISTS OF STANDARD CHARACTERS WITHOUT CLAIM TO ANY PARTICULAR FONT, STYLE, SIZE, OR COLOR.

FOR COMPUTER FURNITURE; DRAFTING TABLES; FURNITURE FOR HOUSE, OFFICE AND GARDEN; FURNITURE MADE FROM STEEL TUBING; OFFICE FURNITURE; SEATING FURNITURE; SEATS; TABLES (U.S. CLS. 2, 13, 22, 25, 32 AND 50).

KATHLEEN M. VANSTON, EXAMINING ATTORNEY

SN 78-936,689. HARDWOOD HIDEAWAY, BELLEVUE, WA. FILED 7-25-2006.

HARDWOOD HIDEAWAY

THE MARK CONSISTS OF STANDARD CHARACTERS WITHOUT CLAIM TO ANY PARTICULAR FONT, STYLE, SIZE, OR COLOR.

NO CLAIM IS MADE TO THE EXCLUSIVE RIGHT TO USE "HARDWOOD", APART FROM THE MARK AS SHOWN.

FOR PET CRATES (U.S. CLS. 2, 13, 22, 25, 32 AND 50).
FIRST USE 6-1-2005; IN COMMERCE 1-1-2006.
DORITT L. CARROLL, EXAMINING ATTORNEY

CLASS 20—(Continued).

SN 78-939,107. ENCOMPASS GROUP LLC, MCDONOUGH, GA. FILED 7-27-2006.

BRILLIANCE

THE MARK CONSISTS OF STANDARD CHARACTERS WITHOUT CLAIM TO ANY PARTICULAR FONT, STYLE, SIZE, OR COLOR.

FOR PILLOWS, NAMELY BED PILLOWS (U.S. CLS. 2, 13, 22, 25, 32 AND 50).

ALYSSA PALADINO, EXAMINING ATTORNEY

SN 78-941,739. WAL-MART STORES, INC., BENTONVILLE, AR. FILED 7-31-2006.

FAIR PARK

THE MARK CONSISTS OF STANDARD CHARACTERS WITHOUT CLAIM TO ANY PARTICULAR FONT, STYLE, SIZE, OR COLOR.

FOR FURNITURE; INDOOR AND OUTDOOR FURNITURE (U.S. CLS. 2, 13, 22, 25, 32 AND 50).

LINDA LAVACHE, EXAMINING ATTORNEY

SN 78-944,435. AMAZON TECHNOLOGIES, INC., RENO, NV. FILED 8-3-2006.

DENALI

THE MARK CONSISTS OF STANDARD CHARACTERS WITHOUT CLAIM TO ANY PARTICULAR FONT, STYLE, SIZE, OR COLOR.

FOR NON-METAL TOOLBOXES; WALL MOUNTED TOOL RACKS; NON-METAL BINS; FURNITURE, NAMELY, CABINETS; FURNITURE PARTS, NAMELY, COUNTERTOPS; WOOD KNOBS FOR CABINETS; PLASTIC KNOBS; AND NON-METAL DECORATIVE HARDWARE, NAMELY, GATE LATCHES; DRAPERY HARDWARE, NAMELY TRAVERSE RODS, POLES, CURTAIN HOOKS, CURTAIN RODS AND FINIALS; BATHROOM VANITIES; BATHROOM AND SHAVING MIRRORS; MEDICINE CABINETS; LETTER BOXES NOT OF METAL; NON-METAL HOUSE NUMBERS (U.S. CLS. 2, 13, 22, 25, 32 AND 50).

ATTIYA MALIK, EXAMINING ATTORNEY

CLASS 20—(Continued).

SN 78-944,464. THE COCA-COLA COMPANY, ATLANTA, GA. FILED 8-3-2006.

R-PET

THE MARK CONSISTS OF STANDARD CHARACTERS WITHOUT CLAIM TO ANY PARTICULAR FONT, STYLE, SIZE, OR COLOR.
FOR PILLOWS (U.S. CLS. 2, 13, 22, 25, 32 AND 50).
SUNG IN, EXAMINING ATTORNEY

SN 78-947,087. GLAXO GROUP LIMITED, GREENFORD, MIDDLESEX, ENGLAND, FILED 8-8-2006.

CLEAN LOK

THE MARK CONSISTS OF STANDARD CHARACTERS WITHOUT CLAIM TO ANY PARTICULAR FONT, STYLE, SIZE, OR COLOR.
FOR NON-METAL CAPS FOR TUBES CONTAINING ANTIBIOTIC PREPARATIONS (U.S. CLS. 2, 13, 22, 25, 32 AND 50).
STEVEN R. FINE, EXAMINING ATTORNEY

SN 78-950,249. WINNOVATION, LLC, MILL CREEK, WA. FILED 8-11-2006.

FreshCap

THE MARK CONSISTS OF STANDARD CHARACTERS WITHOUT CLAIM TO ANY PARTICULAR FONT, STYLE, SIZE, OR COLOR.
FOR NON-METAL BOTTLE CAPS; NON-METALLIC BOTTLE CAPS; PLASTIC CAPS (U.S. CLS. 2, 13, 22, 25, 32 AND 50).
CHRISIE B. KING, EXAMINING ATTORNEY

CLASS 20—(Continued).

SN 78-952,971. HEINLE, KEN, W, SNOHOMISH, WA. FILED 8-16-2006.

The Edge

THE MARK CONSISTS OF STANDARD CHARACTERS WITHOUT CLAIM TO ANY PARTICULAR FONT, STYLE, SIZE, OR COLOR.
FOR NON-METAL LAWN EDGING; PLASTIC LAWN EDGING (U.S. CLS. 2, 13, 22, 25, 32 AND 50).
FIRST USE 1-10-2005; IN COMMERCE 7-12-2005.
BERYL GARDNER, EXAMINING ATTORNEY

SN 79-031,783. HANGZHOU HAILONG; FURNITURE CORPORATION, CHINA, FILED 6-13-2006.



OWNER OF INTERNATIONAL REGISTRATION 0905802 DATED 6-13-2006, EXPIRES 6-13-2016.
FOR FURNITURE, SOFAS, TEA TABLE, COAT STANDS; MATTRESS, CUSHIONS; BAMBOO WOODWORKING ART IN THE NATURE OF SCULPTURES, STATUES, STATUETTES, CABINETS, MIRROR FRAMES, PICTURE FRAMES, FURNITURE FRAMES, AND BED FRAMES; WICKERWORK FURNITURE, WICKERWORK FURNITURE FRAMES, WICKERWORK BED FRAMES; WORKS OF ART OF WOOD, WAX, PLASTER OR PLASTIC IN THE NATURE OF SCULPTURES, STATUES, STATUETTES, CABINETS, MIRROR FRAMES, PICTURE FRAMES, FURNITURE FRAMES, AND BED FRAMES, VINE WEAVE GOODS, NAMELY VINE WEAVED FURNITURE, VINE WEAVED FURNITURE FRAMES, AND VINE WEAVED BED FRAMES. (U.S. CLS. 2, 13, 22, 25, 32 AND 50).
MICHAEL LEWIS, EXAMINING ATTORNEY

SN 79-034,892. WILKHahn WILKENING + HAHNE GMBH + CO., FED REP GERMANY, FILED 12-22-2006.

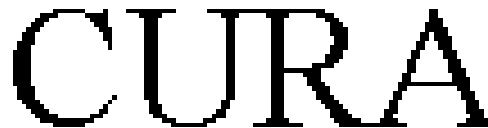

THE MARK CONSISTS OF STANDARD CHARACTERS WITHOUT CLAIM TO ANY PARTICULAR FONT, STYLE, SIZE, OR COLOR.
PRIORITY DATE OF 7-3-2006 IS CLAIMED.
OWNER OF INTERNATIONAL REGISTRATION 0914543 DATED 12-22-2006, EXPIRES 12-22-2016.
THE ENGLISH TRANSLATION OF CURA IN THE MARK IS "CURE".
FOR FURNITURE (U.S. CLS. 2, 13, 22, 25, 32 AND 50).
JAMES STEIN, EXAMINING ATTORNEY

CLASS 21—HOUSEWARES AND GLASS

SN 76-674,576. PEACE STORE, INC., SANTA BARBARA, CA.
FILED 3-26-2007.

HAPPY IS HERE

THE MARK CONSISTS OF STANDARD CHARACTERS
WITHOUT CLAIM TO ANY PARTICULAR FONT, STYLE,
SIZE, OR COLOR.
FOR HOUSEWARES, NAMELY CHINA DINNER-
WARE (U.S. CLS. 2, 13, 23, 29, 30, 33, 40 AND 50).
BARBARA RUTLAND, EXAMINING ATTORNEY

CLASS 21—(Continued).

SN 77-023,699. WHITNEY DESIGN, INC., BRIDGETON, MO.
FILED 10-18-2006.

STOWAWAY

SN 77-001,687. WHITMIRE MICRO-GEN RESEARCH LA-
BORATORIES, INC., ST. LOUIS, MO. FILED 9-18-2006.

ULTRALIGHT

THE MARK CONSISTS OF STANDARD CHARACTERS
WITHOUT CLAIM TO ANY PARTICULAR FONT, STYLE,
SIZE, OR COLOR.
FOR INSECT TRAPS (U.S. CLS. 2, 13, 23, 29, 30, 33, 40
AND 50).
TASHIA BUNCH, EXAMINING ATTORNEY

THE MARK CONSISTS OF STANDARD CHARACTERS
WITHOUT CLAIM TO ANY PARTICULAR FONT, STYLE,
SIZE, OR COLOR.
FOR IRONING BOARDS WITH CABINET ENSEM-
BLES (U.S. CLS. 2, 13, 23, 29, 30, 33, 40 AND 50).
MARTHA FROMM, EXAMINING ATTORNEY

SN 77-023,716. WHITNEY DESIGN, INC., BRIDGETON, MO.
FILED 10-18-2006.

SN 77-003,989. MIKASA INTERNATIONAL CORPORATION,
SECAUCUS, NJ. FILED 9-21-2006.

**PS PANTRY SOLUTIONS BY
MIKASA**

THE MARK CONSISTS OF STANDARD CHARACTERS
WITHOUT CLAIM TO ANY PARTICULAR FONT, STYLE,
SIZE, OR COLOR.
OWNER OF U.S. REG. NOS. 681,148, 1,620,866 AND
OTHERS.
FOR DINNERWARE, NAMELY, PLATES, BOWLS,
CUPS, MUGS, SAUCERS, SERVING BOWLS AND PLAT-
TER; BEVERAGE GLASSWARE (U.S. CLS. 2, 13, 23, 29,
30, 33, 40 AND 50).
DEIRDRE ROBERTSON, EXAMINING ATTORNEY



THE MARK CONSISTS OF THE WORD "STOWAWAY"
WITH A DRAWING OF THE TOP OF AN IRONING BOARD.
FOR IRONING BOARDS WITH CABINET ENSEM-
BLES (U.S. CLS. 2, 13, 23, 29, 30, 33, 40 AND 50).
MARTHA FROMM, EXAMINING ATTORNEY

CLASS 21—(Continued).

SN 77-037,647. DEERE & COMPANY, MOLINE, IL. FILED 11-6-2006.



OWNER OF U.S. REG. NOS. 2,580,000, 2,729,766 AND OTHERS.

THE MARK CONSISTS OF A LEAPING DEER INSIDE OF A SINGLE CLOSED BORDER.

FOR BUCKETS, GLASS BEVERAGEWARE, CUPS, MUGS, HOUSEHOLD UTENSILS, NAMELY POTS AND PANS, THERMAL INSULATED SLEEVE HOLDERS FOR BEVERAGE CANS, PEPPER GRINDERS, SALT AND PEPPER SHAKERS, VACUUM BOTTLES, THERMAL INSULATED CONTAINERS FOR FOOD OR BEVERAGE, AND BARBECUE GRILL ACCESSORIES, NAMELY SPATULAS, TONGS, COOKING FORKS; BATH ACCESSORIES, NAMELY, TUMBLERS IN THE NATURE OF DRINKING VESSELS, TOOTHBRUSH HOLDERS, SOAP DISHES, WASTEPAPER BASKETS, LOTION DISPENSERS WITH PUMPS (U.S. CLS. 2, 13, 23, 29, 30, 33, 40 AND 50).

FIRST USE 12-1-2000; IN COMMERCE 12-1-2000.
FRED CARL, EXAMINING ATTORNEY

SN 77-085,196. BEE HOUSE CO., LTD., SAN FRANCISCO, CA. FILED 1-17-2007.

ZERO JAPAN

THE MARK CONSISTS OF STANDARD CHARACTERS WITHOUT CLAIM TO ANY PARTICULAR FONT, STYLE, SIZE, OR COLOR.

NO CLAIM IS MADE TO THE EXCLUSIVE RIGHT TO USE "JAPAN", APART FROM THE MARK AS SHOWN.

FOR BUTTER DISHES; CERAMIC SCULPTURES, VASES, VESSELS, BOWLS, PLATES AND POTS; CUPS; HOUSEHOLD CONTAINERS FOR FOODS; MUGS; SUGAR BOWLS; SYRUP JUGS; TEA CANISTERS; TEA POTS NOT OF PRECIOUS METAL (U.S. CLS. 2, 13, 23, 29, 30, 33, 40 AND 50).

FIRST USE 1-2-2007; IN COMMERCE 1-2-2007.
VERNA BETH RIRIE, EXAMINING ATTORNEY

CLASS 21—(Continued).

SN 77-087,917. ON TAP LLC, CLEVELAND HEIGHTS, OH. FILED 1-22-2007.

FRIDGE TAP

THE MARK CONSISTS OF STANDARD CHARACTERS WITHOUT CLAIM TO ANY PARTICULAR FONT, STYLE, SIZE, OR COLOR.

NO CLAIM IS MADE TO THE EXCLUSIVE RIGHT TO USE "FRIDGE", APART FROM THE MARK AS SHOWN.

FOR PORTABLE BEVERAGE DISPENSERS (U.S. CLS. 2, 13, 23, 29, 30, 33, 40 AND 50).

SHAUNIA CARLYLE, EXAMINING ATTORNEY

SN 77-115,060. PLACONTROL, INC., SAN DIEGO, CA. FILED 2-23-2007.

B-TWEENERS

THE MARK CONSISTS OF STANDARD CHARACTERS WITHOUT CLAIM TO ANY PARTICULAR FONT, STYLE, SIZE, OR COLOR.

FOR ORAL CARE DEVICES, NAMELY, INTERDENTAL BRUSHES, DENTAL FLOSS, DENTAL FLOSS HOLDERS AND PICKS. (U.S. CLS. 2, 13, 23, 29, 30, 33, 40 AND 50).

ANNE MADDEN, EXAMINING ATTORNEY

SN 77-118,381. VIATEL CHINA (HK) LIMITED, WAN CHAI, HONG KONG, FILED 2-28-2007.

SNAPPIES

THE MARK CONSISTS OF STANDARD CHARACTERS WITHOUT CLAIM TO ANY PARTICULAR FONT, STYLE, SIZE, OR COLOR.

FOR TRIVETS; INSULATED AND UNINSULATED FITTED DECORATIVE CLOTH WRAPS FOR HOUSEHOLD SERVING DISHES AND CONTAINERS (U.S. CLS. 2, 13, 23, 29, 30, 33, 40 AND 50).

SUNG IN, EXAMINING ATTORNEY

CLASS 21—(Continued).

SN 77-119,280. VIATEL CHINA (HK) LIMITED, WAN CHAI, HONG KONG, FILED 3-1-2007.

FIS B

THE MARK CONSISTS OF STANDARD CHARACTERS WITHOUT CLAIM TO ANY PARTICULAR FONT, STYLE, SIZE, OR COLOR.

FOR TRIVETS; INSULATED AND UNINSULATED FITTED DECORATIVE CLOTH WRAPS FOR HOUSEHOLD SERVING DISHES AND CONTAINERS (U.S. CLS. 2, 13, 23, 29, 30, 33, 40 AND 50).

SUNG IN, EXAMINING ATTORNEY

SN 77-120,599. WP IP LLC, NEW YORK, NY. FILED 3-2-2007.



NO CLAIM IS MADE TO THE EXCLUSIVE RIGHT TO USE "HOME", APART FROM THE MARK AS SHOWN.

THE MARK CONSISTS OF A BOX WITH THE STYLIZED WORDS "WP HOME" INSIDE.

FOR TUMBLERS, SOAP DISHES, SOAP DISPENSERS, TOOTHBRUSH HOLDERS AND WASTEBASKETS (U.S. CLS. 2, 13, 23, 29, 30, 33, 40 AND 50).

FRANK LATTUCA, EXAMINING ATTORNEY

CLASS 21—(Continued).

SN 77-121,261. GAIA HERBS, INC., BREVARD, NC. FILED 3-2-2007.

EARTH RENEWABLE TECHNOLOGIES

THE MARK CONSISTS OF STANDARD CHARACTERS WITHOUT CLAIM TO ANY PARTICULAR FONT, STYLE, SIZE, OR COLOR.

NO CLAIM IS MADE TO THE EXCLUSIVE RIGHT TO USE "RENEWABLE TECHNOLOGIES", APART FROM THE MARK AS SHOWN.

FOR BIODEGRADABLE BOTTLES FOR PHARMACEUTICALS, SOLD EMPTY; BIODEGRADABLE BOTTLES, SOLD EMPTY; BIODEGRADABLE EMPTY SPRAY BOTTLES; BIODEGRADABLE PLASTIC WATER BOTTLES, SOLD EMPTY; BIODEGRADABLE SPORTS BOTTLES, SOLD EMPTY; BIODEGRADABLE VACUUM BOTTLES, SOLD EMPTY (U.S. CLS. 2, 13, 23, 29, 30, 33, 40 AND 50).

ERIN FALK, EXAMINING ATTORNEY

SN 77-121,273. GAIA HERBS, INC., BREVARD, NC. FILED 3-2-2007.

EARTH BOTTLE

THE MARK CONSISTS OF STANDARD CHARACTERS WITHOUT CLAIM TO ANY PARTICULAR FONT, STYLE, SIZE, OR COLOR.

NO CLAIM IS MADE TO THE EXCLUSIVE RIGHT TO USE "BOTTLE", APART FROM THE MARK AS SHOWN.

FOR BIODEGRADABLE BOTTLES FOR PHARMACEUTICALS, SOLD EMPTY; BIODEGRADABLE BOTTLES, SOLD EMPTY; BIODEGRADABLE EMPTY SPRAY BOTTLES; BIODEGRADABLE PLASTIC WATER BOTTLES, SOLD EMPTY; BIODEGRADABLE SPORTS BOTTLES, SOLD EMPTY; BIODEGRADABLE VACUUM BOTTLES, SOLD EMPTY (U.S. CLS. 2, 13, 23, 29, 30, 33, 40 AND 50).

ERIN FALK, EXAMINING ATTORNEY

CLASS 21—(Continued).

SN 77-121,285. GAIA HERBS, INC., BREVARD, NC. FILED 3-2-2007.

EARTH BOTTLES

THE MARK CONSISTS OF STANDARD CHARACTERS WITHOUT CLAIM TO ANY PARTICULAR FONT, STYLE, SIZE, OR COLOR.

NO CLAIM IS MADE TO THE EXCLUSIVE RIGHT TO USE "BOTTLES", APART FROM THE MARK AS SHOWN.

FOR BIODEGRADABLE BOTTLES FOR PHARMACEUTICALS, SOLD EMPTY; BIODEGRADABLE BOTTLES, SOLD EMPTY; BIODEGRADABLE EMPTY SPRAY BOTTLES; BIODEGRADABLE PLASTIC WATER BOTTLES, SOLD EMPTY; BIODEGRADABLE SPORTS BOTTLES, SOLD EMPTY; BIODEGRADABLE VACUUM BOTTLES, SOLD EMPTY (U.S. CLS. 2, 13, 23, 29, 30, 33, 40 AND 50).

ERIN FALK, EXAMINING ATTORNEY

SN 77-121,756. HAN LIEN INTERNATIONAL CORPORATION, TAIPEI, TAIWAN, FILED 3-4-2007.

LIT'L BIT

THE MARK CONSISTS OF STANDARD CHARACTERS WITHOUT CLAIM TO ANY PARTICULAR FONT, STYLE, SIZE, OR COLOR.

FOR HORSE BRUSHES (U.S. CLS. 2, 13, 23, 29, 30, 33, 40 AND 50).

ANDREA BUTLER, EXAMINING ATTORNEY

SN 77-124,407. MEYER MANUFACTURING COMPANY LIMITED, KOWLOON, HONGKONG, CHINA, FILED 3-7-2007.

**INFINITE
CIRCULON**

OWNER OF U.S. REG. NOS. 2,874,836, 2,895,675 AND OTHERS.

THE MARK CONSISTS OF EACH OF THE LETTERS COMPRISING THE "CIRCULON" IN "INFINITE CIRCULON" IS FASHIONED FROM THREE PARALLEL LINES.

FOR COOKWARE, NAMELY POTS AND PANS; COOKWARE, NAMELY, ROASTING PANS; COOKWARE, NAMELY, STEAMERS (U.S. CLS. 2, 13, 23, 29, 30, 33, 40 AND 50).

FIRST USE 6-1-2006; IN COMMERCE 11-1-2006.

CHRISTINA SOBRAL, EXAMINING ATTORNEY

CLASS 21—(Continued).

SN 77-125,622. THE SHERWIN-WILLIAMS COMPANY, CLEVELAND, OH. FILED 3-8-2007.

EZ TOUCH 360°

THE MARK CONSISTS OF STANDARD CHARACTERS WITHOUT CLAIM TO ANY PARTICULAR FONT, STYLE, SIZE, OR COLOR.

NO CLAIM IS MADE TO THE EXCLUSIVE RIGHT TO USE 360°, APART FROM THE MARK AS SHOWN.

FOR PLASTIC NOZZLES FOR METAL CANS (U.S. CLS. 2, 13, 23, 29, 30, 33, 40 AND 50).

JOHN WILKE, EXAMINING ATTORNEY

SN 77-125,915. CASTILLO, SOCORRO, HAVERHILL, MA. FILED 3-8-2007.

SERENA'S PARTY BOUTIQUE

THE MARK CONSISTS OF STANDARD CHARACTERS WITHOUT CLAIM TO ANY PARTICULAR FONT, STYLE, SIZE, OR COLOR.

NO CLAIM IS MADE TO THE EXCLUSIVE RIGHT TO USE "PARTY BOUTIQUE", APART FROM THE MARK AS SHOWN.

FOR PARTY FAVORS COMPRISED OF CERAMIC FIGURINES, RIBBONS AND FABRICS, FOR WEDDINGS, BRIDAL SHOWERS AND BABY SHOWERS (U.S. CLS. 2, 13, 23, 29, 30, 33, 40 AND 50).

CHARLOTTE CORWIN, EXAMINING ATTORNEY

SN 77-134,230. PUPMAID CORPORATION, OVERLAND PARK, KS. FILED 3-19-2007.



NO CLAIM IS MADE TO THE EXCLUSIVE RIGHT TO USE "PUPPY", APART FROM THE MARK AS SHOWN.

THE COLOR(S) BLACK, WHITE, BROWN AND GREEN IS/ARE CLAIMED AS A FEATURE OF THE MARK.

THE DOG APPEARS IN THE COLORS BROWN AND WHITE WITH A BLACK BOW ON ITS HEAD. THE FEATHER DUSTER APPEARS IN BROWN AND BLACK. THE GRASS APPEARS IN GREEN WITH A BROWN FOUNDATION. THE WORDING PUPPY MAID.COM APPEARS IN BLACK.

FOR WASTE CONTAINERS, NAMELY, PET WASTE RECEPTACLES AND CONTAINERS (U.S. CLS. 2, 13, 23, 29, 30, 33, 40 AND 50).

TAMARA FRAZIER, EXAMINING ATTORNEY

CLASS 21—(Continued).

SN 77-134,586. NATURE IN GLASS LTD., EAST ROCK-AWAY, NY. FILED 3-19-2007.

AS CARE FREE AS A PET CAN
BE

THE MARK CONSISTS OF STANDARD CHARACTERS WITHOUT CLAIM TO ANY PARTICULAR FONT, STYLE, SIZE, OR COLOR.

FOR AQUARIUMS (U.S. CLS. 2, 13, 23, 29, 30, 33, 40 AND 50).

TINA BROWN, EXAMINING ATTORNEY

SN 77-136,419. VARSITY BABY, INC., INDIANAPOLIS, IN. FILED 3-21-2007.

Flush and Cheer Potty

THE MARK CONSISTS OF STANDARD CHARACTERS WITHOUT CLAIM TO ANY PARTICULAR FONT, STYLE, SIZE, OR COLOR.

NO CLAIM IS MADE TO THE EXCLUSIVE RIGHT TO USE "FLUSH" AND "POTTY", APART FROM THE MARK AS SHOWN.

FOR POTTIES FOR CHILDREN (U.S. CLS. 2, 13, 23, 29, 30, 33, 40 AND 50).

LAURA HAMMEL, EXAMINING ATTORNEY

SN 77-136,470. OLD BLUE LLC, LAKE GENEVA, WI. FILED 3-21-2007.

THE FEELGOOD T-SHIRT
COMPANY

THE MARK CONSISTS OF STANDARD CHARACTERS WITHOUT CLAIM TO ANY PARTICULAR FONT, STYLE, SIZE, OR COLOR.

NO CLAIM IS MADE TO THE EXCLUSIVE RIGHT TO USE "COMPANY", APART FROM THE MARK AS SHOWN.

FOR BAKEWARE; BEVERAGE GLASSWARE; COOKWARE, NAMELY POTS AND PANS; DINNERWARE; MUGS; SOAP DISHES; SOAP DISPENSERS; TRAYS; VASES; HOUSEHOLD UTENSILS, NAMELY SCRAPERS, ROLLING PINS, SPATULAS, STRAINERS AND WHISKS; SERVING SPOONS; SERVING LADLES; CANISTER SETS; SPICE RACKS (U.S. CLS. 2, 13, 23, 29, 30, 33, 40 AND 50).

DAVID TAYLOR, EXAMINING ATTORNEY

CLASS 21—(Continued).

SN 77-137,151. OFF CENTER LINE LLC, SCOTTSDALE, AZ. FILED 3-21-2007.



NO CLAIM IS MADE TO THE EXCLUSIVE RIGHT TO USE "BROOM", APART FROM THE MARK AS SHOWN.

THE MARK CONSISTS OF AN OPEN HORIZONTAL SCROLL WITH THE WORD DINUBA INSIDE. THE WORD BROOM IS LOCATED BENEATH THE OPEN SCROLL. AN IMAGE OF SORGHUM GRAIN APPEARS IN THE LOWER RIGHT QUADRANT OF THE LOGO AT THE OPEN SCROLL.

FOR BROOMS; FEATHER BROOMS; HARD BROOMS; ROUGH BROOMS; DUST PANS; DUST-PANS (U.S. CLS. 2, 13, 23, 29, 30, 33, 40 AND 50).

FIRST USE 3-1-2007; IN COMMERCE 3-20-2007.

MARILYN IZZI, EXAMINING ATTORNEY

SN 77-139,073. BEST BUYS DIRECT, INC., WAYNE, NJ. FILED 3-23-2007.

COOL WAVES

THE MARK CONSISTS OF STANDARD CHARACTERS WITHOUT CLAIM TO ANY PARTICULAR FONT, STYLE, SIZE, OR COLOR.

FOR INSULATED COOLER WITH A BUILT-IN RADIO (U.S. CLS. 2, 13, 23, 29, 30, 33, 40 AND 50).

FIRST USE 2-16-2007; IN COMMERCE 2-16-2007.

JOHN GARTNER, EXAMINING ATTORNEY

SN 77-139,936. SPICESTACK, INC., ARLINGTON HEIGHTS, IL. FILED 3-26-2007.

SPICE STACK

THE MARK CONSISTS OF STANDARD CHARACTERS WITHOUT CLAIM TO ANY PARTICULAR FONT, STYLE, SIZE, OR COLOR.

NO CLAIM IS MADE TO THE EXCLUSIVE RIGHT TO USE "SPICE", APART FROM THE MARK AS SHOWN.

FOR CONTAINERS FOR HOUSEHOLD OR KITCHEN USE NOT OF PRECIOUS METAL; PORTABLE CONTAINERS FOR STORING HOUSEHOLD AND KITCHEN GOODS; SPICE RACKS (U.S. CLS. 2, 13, 23, 29, 30, 33, 40 AND 50).

FIRST USE 12-26-2006; IN COMMERCE 12-26-2006.

LINDA POWELL, EXAMINING ATTORNEY

CLASS 21—(Continued).

SN 77-140,229. THE ZEROLL COMPANY, FT. PIERCE, FL. FILED 3-26-2007.

ZELATO

THE MARK CONSISTS OF STANDARD CHARACTERS WITHOUT CLAIM TO ANY PARTICULAR FONT, STYLE, SIZE, OR COLOR.

FOR ICE CREAM SPADES (U.S. CLS. 2, 13, 23, 29, 30, 33, 40 AND 50).

PATRICIA EVANKO, EXAMINING ATTORNEY

CLASS 21—(Continued).

SN 77-141,751. KOHL'S ILLINOIS, INC., AURORA, IL. FILED 3-27-2007.

FIRST MOMENTS

THE MARK CONSISTS OF STANDARD CHARACTERS WITHOUT CLAIM TO ANY PARTICULAR FONT, STYLE, SIZE, OR COLOR.

OWNER OF U.S. REG. NO. 2,448,165.

FOR GIFT SETS COMPRISING PRIMARILY OF BABY GROOMING ACCESSORIES, NAMELY, HAIR BRUSHES AND COMBS (U.S. CLS. 2, 13, 23, 29, 30, 33, 40 AND 50).

WON TEAK OH, EXAMINING ATTORNEY

SN 77-141,000. MELIN LLC, BELLEVUE, WA. FILED 3-27-2007.

machFLOSS

THE MARK CONSISTS OF STANDARD CHARACTERS WITHOUT CLAIM TO ANY PARTICULAR FONT, STYLE, SIZE, OR COLOR.

FOR DENTAL FLOSS; DENTAL FLOSS DISPENSERS; DENTAL TAPE (U.S. CLS. 2, 13, 23, 29, 30, 33, 40 AND 50).

ESTHER A. BORSUK, EXAMINING ATTORNEY

SN 77-141,802. B2X CORPORATION, JERSEY CITY, NJ. FILED 3-27-2007.

B2X

SN 77-141,282. FLANNERY, NEIL M., BANGOR, PA. FILED 3-27-2007.



THE COLOR(S) GREEN, BLACK, WHITE, AND YELLOW IS/ARE CLAIMED AS A FEATURE OF THE MARK.

THE MARK CONSISTS OF A CARICATURE OF THREE DRINKING GLASSES. THE CARICATURES ARE OUTLINED IN BLACK; THE COLORS YELLOW AND GREEN APPEAR IN THE FACIAL FEATURES OF THE GLASSES; AND THE COLOR WHITE APPEARS IN TEETH AND EYES OF THE FACES ON THE GLASSES AND AS A BACKGROUND COLOR FOR THE UNFILLED PORTION OF THE GLASSES.

FOR BEVERAGE TRAY NOT MADE OF PRECIOUS METAL FOR HOLDING OR CONTAINING DRINKING VESSELS, DRINKING CUPS, DRINKING GLASSES AND BEVERAGE GLASSWARE WHILE IN USE; DRINKING VESSELS, DRINKING CUPS NOT OF PRECIOUS METAL, DRINKING GLASSES, AND BEVERAGE GLASSWARE (U.S. CLS. 2, 13, 23, 29, 30, 33, 40 AND 50).

JORDAN BAKER, EXAMINING ATTORNEY

THE MARK CONSISTS OF STANDARD CHARACTERS WITHOUT CLAIM TO ANY PARTICULAR FONT, STYLE, SIZE, OR COLOR.

FOR NON-ELECTRONIC COFFEE MAKERS, NON-ELECTRIC JUICERS, HAND OPERATED GRINDERS (U.S. CLS. 2, 13, 23, 29, 30, 33, 40 AND 50).

THEODORE MCBRIDE, EXAMINING ATTORNEY

CLASS 21—(Continued).

SN 77-141,955. UNITED FOOTBALL LEAGUE, LLC, SAN FRANCISCO, CA. FILED 3-27-2007.

UFL

THE MARK CONSISTS OF STANDARD CHARACTERS WITHOUT CLAIM TO ANY PARTICULAR FONT, STYLE, SIZE, OR COLOR.

FOR BACK SCRATCHERS; BASKETS FOR WASTE PAPER LITTERING; BATH ACCESSORIES, NAMELY, CUP HOLDERS; BEER JUGS; BEER MUGS; BEVERAGE GLASSWARE; BOTTLE OPENERS; BOTTLE SQUEEGEES; BOWLS; COCKTAIL PICKS; COCKTAIL SHAKERS; COFFEE CUPS; COMMEMORATIVE PLATES; CORK SCREWS; CUPS; DISHES; DISHES AND PLATES; DRINKING CUPS; DRINKING FLASKS; DRINKING FLASKS; DRINKING GLASSES; DRINKING HORNS; DRINKING STEINS; DRINKING VESSELS; FOAM DRINK HOLDERS; GARBAGE CANS; GLASS BEVERAGEWARE; GLASS DISHES; GLASS MUGS; GLASS STORAGE JARS; GOBLETS; LEATHER COASTERS; LUNCH BOXES; LUNCH PAILS; MANUAL TOOTHBRUSHES; MUGS; NON-METAL PIGGY BANKS; PAPER CUPS; PAPER PLATES; PIGGY BANKS; PIGGY BANKS MADE OF PRECIOUS METAL; PILSNER DRINKING GLASSES; PITCHERS; PLASTIC COASTERS; PLASTIC PLATES; PLASTIC WATER BOTTLES SOLD EMPTY; PLATES; PORCELAIN MUGS; PORTABLE BEVERAGE COOLERS; PORTABLE BEVERAGE DISPENSERS; PORTABLE COLDBOXES; PORTABLE COOKING KITS FOR OUTDOOR USE; PORTABLE COOLERS; PORTABLE ICE CHESTS FOR FOOD AND BEVERAGES; SALT AND PEPPER SHAKERS; SHOT GLASSES; SOAP DISHES; SOAP DISPENSERS; SOAP HOLDERS; SOAP HOLDERS AND BOXES; SOUVENIR PLATES; SPORTS BOTTLES SOLD EMPTY; SQUEEZE BOTTLE SOLD EMPTY; SUN CATCHERS; TABLE PLACE CARD HOLDERS NOT OF PRECIOUS METAL; TOOTHBRUSH CASES; TOOTHBRUSH HOLDERS; TOOTHBRUSHES; TOOTHBRUSHES; TOOTHBRUSHES; TRASH CANS; TRASH CONTAINERS FOR HOUSEHOLD USE; UTENSILS FOR BARBECUES, NAMELY, FORKS, TONGS, TURNERS; WASTE BASKETS; WASTEPAPER BASKETS; CANDY AND SERVING DISHES (U.S. CLS. 2, 13, 23, 29, 30, 33, 40 AND 50).

JORDAN BAKER, EXAMINING ATTORNEY

CLASS 21—(Continued).

SN 77-142,045. COOKEVER, INC., FULLERTON, CA. FILED 3-27-2007.

COOKEVER

THE MARK CONSISTS OF STANDARD CHARACTERS WITHOUT CLAIM TO ANY PARTICULAR FONT, STYLE, SIZE, OR COLOR.

FOR PANS; POT LIDS; POTS; BOWLS; SERVING DISHES; METAL COOKING PANS; ROASTING DISHES (U.S. CLS. 2, 13, 23, 29, 30, 33, 40 AND 50).

FIRST USE 3-11-2007; IN COMMERCE 3-11-2007.

RONALD MCMORROW, EXAMINING ATTORNEY

SN 77-142,085. THE PAWPLUNGER, LLC, NEW YORK, NY. FILED 3-28-2007.

CLEANLINESS IS NEXT TO DOGLINESS

THE MARK CONSISTS OF STANDARD CHARACTERS WITHOUT CLAIM TO ANY PARTICULAR FONT, STYLE, SIZE, OR COLOR.

FOR PET GROOMING DEVICE COMPRISING A SMALL ENCLOSED BATH WITH A FITTED OPENING TO CLEAN PETS' PAWS (U.S. CLS. 2, 13, 23, 29, 30, 33, 40 AND 50).

BARNEY CHARLON, EXAMINING ATTORNEY

SN 77-142,016. LEXICON MARKETING OPERATING LUXEMBOURG S.A.R.L., LUXEMBOURG, LUXEMBOURG, FILED 3-27-2007.



THE MARK CONSISTS OF A FANCIFUL GRAPHIC CONTAINING A CIRCLE AND SPIRALS IN PROXIMITY TO THE LITERAL ELEMENT OF THE MARK.

FOR COOKWARE, NAMELY POTS AND PANS (U.S. CLS. 2, 13, 23, 29, 30, 33, 40 AND 50).

EDWARD NELSON, EXAMINING ATTORNEY

SN 77-142,144. ALDRIDGE III, JAMES K, DBA SUPERBOWL FEEDERS, LA GRANGE, NC. FILED 3-28-2007.

Superbowl

THE MARK CONSISTS OF STANDARD CHARACTERS WITHOUT CLAIM TO ANY PARTICULAR FONT, STYLE, SIZE, OR COLOR.

FOR PLASTIC POULTRY FEEDERS (U.S. CLS. 2, 13, 23, 29, 30, 33, 40 AND 50).

FIRST USE 5-0-1996; IN COMMERCE 5-0-1996.

DAVID MURRAY, EXAMINING ATTORNEY

CLASS 21—(Continued).

SN 77-142,156. THE PROCTER & GAMBLE COMPANY, CINCINNATI, OH. FILED 3-28-2007.

CLASS 21—(Continued).

SN 77-144,972. FOH, INC., MIAMI SHORES, FL. FILED 3-30-2007.

MR. CLEAN

THE MARK CONSISTS OF STANDARD CHARACTERS WITHOUT CLAIM TO ANY PARTICULAR FONT, STYLE, SIZE, OR COLOR.

FOR REUSABLE WIPING CLOTHS (U.S. CLS. 2, 13, 23, 29, 30, 33, 40 AND 50).

FIRST USE 9-30-2002; IN COMMERCE 9-30-2002.
GEOFFREY FOSDICK, EXAMINING ATTORNEY

MOD

SN 77-143,880. HARPER BRUSH WORKS, INC., FAIRFIELD, IA. FILED 3-29-2007.

CLEAN RINSE

THE MARK CONSISTS OF STANDARD CHARACTERS WITHOUT CLAIM TO ANY PARTICULAR FONT, STYLE, SIZE, OR COLOR.

FOR BUCKETS (U.S. CLS. 2, 13, 23, 29, 30, 33, 40 AND 50).

GEOFFREY FOSDICK, EXAMINING ATTORNEY

THE MARK CONSISTS OF STANDARD CHARACTERS WITHOUT CLAIM TO ANY PARTICULAR FONT, STYLE, SIZE, OR COLOR.

FOR CERAMIC SCULPTURES, VASES, VESSELS, BOWLS, PLATES AND POTS; DECORATIVE PLATES; DINNERWARE, NAMELY, PLATES, BOWLS, PLATTERS, SERVERS, POTS, CREAMERS, CUPS, SAUCERS, MUGS, TEAPOTS; DISHES AND PLATES; PLATES; PLATES FOR HORS D'OEUVRE; BOWLS; FINGER BOWLS; FRUIT BOWLS; JAPANESE RICE BOWLS (CHAWAN); JAPANESE RICE BOWLS NOT OF PRECIOUS METAL (CHAWAN); JAPANESE STYLE SOUP SERVING BOWLS (WAN); PEPPER POTS, SUGAR BOWLS AND SALT SHAKERS; SALAD BOWLS; SALAD BOWLS; SERVING BOWLS (HACHI); SHALLOW BOWLS; SUGAR BOWLS; SERVING PLATTERS; SERVING PLATTERS NOT OF PRECIOUS METAL; CAKE SERVERS; COFFEE SERVERS; NON-ELECTRIC COFFEE SERVERS NOT OF PRECIOUS METAL; PIE SERVERS; COFFEE POTS; COFFEE POTS NOT OF PRECIOUS METAL; COOKING POTS; COOKING POTS AND PANS; COOKWARE, NAMELY POTS AND PANS; JAPANESE STYLE TEA-SERVING POTS (KYUSU); MUSTARD POTS; NON-ELECTRIC COFFEE POTS; NON-ELECTRIC COFFEE POTS NOT OF PRECIOUS METAL; POT LIDS; POT STANDS; POTS; RICE COOKING POTS; TEA POTS; TEA POTS NOT OF PRECIOUS METAL; CREAMER PITCHERS; COFFEE CUPS; CUPS; DRINKING CUPS; EGG CUPS; EGG CUPS; MIXING CUPS; SAKE CUPS; SAUCERS; SAUCERS NOT OF PRECIOUS METALS; MUGS; PORCELAIN MUGS; HOT POTS. (U.S. CLS. 2, 13, 23, 29, 30, 33, 40 AND 50).

FIRST USE 11-1-2001; IN COMMERCE 11-1-2001.
JAMES GRIFFIN, EXAMINING ATTORNEY

CLASS 21—(Continued).

SN 77-146,631. FOH, INC., MIAMI SHORES, FL. FILED 4-2-2007.

SPIRAL

THE MARK CONSISTS OF STANDARD CHARACTERS WITHOUT CLAIM TO ANY PARTICULAR FONT, STYLE, SIZE, OR COLOR.

FOR BOWLS; CERAMIC SCULPTURES, VASES, VESSELS, BOWLS, PLATES AND POTS; FINGER BOWLS; FLOWER BOWLS; FLOWER VASES AND BOWLS; FRUIT BOWLS; JAPANESE RICE BOWLS (CHAWAN); JAPANESE RICE BOWLS NOT OF PRECIOUS METAL (CHAWAN); JAPANESE STYLE SOUP SERVING BOWLS (WAN); PEPPER POTS, SUGAR BOWLS AND SALT SHAKERS; SALAD BOWLS; SALAD BOWLS; SERVING BOWLS (HACHI); SHALLOW BOWLS; SUGAR BOWLS; DECORATIVE PLATES; DINNERWARE, NAMELY, BOWLS, PLATES, SOUPBOWLS, COFFEE POTS, TEAPOTS, CUPS, CREAMERS, SAUCERS, VASES, SAUCE BOATS, DISHES, SWEETENER PACKET HOLDERS, AND SALT AND PEPPER SETS.; DISHES AND PLATES; PLATES; PLATES FOR HORS D'OEUVRE; BUTTER DISHES; BUTTER-DISH AND CHEESE-DISH COVERS; DISHES; POTPOURRI DISHES; SERVING DISHES; FLOWER VASES; VASES; COFFEE CUPS; COFFEE POTS; COFFEE POTS NOT OF PRECIOUS METAL; COFFEE SERVERS; JAPANESE STYLE TEA-SERVING POTS (KYUSU); NON-ELECTRIC COFFEE POTS; NON-ELECTRIC COFFEE SERVERS NOT OF PRECIOUS METAL; POT LIDS; POTS; TEA POTS; TEA POTS NOT OF PRECIOUS METAL; CUPS; DRINKING CUPS; EGG CUPS; MIXING CUPS; SAKE CUPS; CREAMER PITCHERS; SAUCERS; SAUCERS NOT OF PRECIOUS METALS; SAUCEBOATS NOT OF PRECIOUS METALS; MENU CARD HOLDERS; HAND-OPERATED COFFEE GRINDERS AND PEPPER MILLS; PEPPER GRINDERS; PEPPER MILLS; PEPPER MILLS; SALT AND PEPPER MILLS; SALT AND PEPPER SHAKERS; SALT SHAKERS; CAKE SERVERS; PIE SERVERS (U.S. CLS. 2, 13, 23, 29, 30, 33, 40 AND 50).

FIRST USE 11-1-2001; IN COMMERCE 11-1-2001.
JAMES GRIFFIN, EXAMINING ATTORNEY

SN 77-171,193. BATH & BODY WORKS BRAND MANAGEMENT, INC., REYNOLDSBURG, OH. FILED 5-2-2007.

RUB-A-DUB-SCRUBS

THE MARK CONSISTS OF STANDARD CHARACTERS WITHOUT CLAIM TO ANY PARTICULAR FONT, STYLE, SIZE, OR COLOR.

FOR BATH SPONGES (U.S. CLS. 2, 13, 23, 29, 30, 33, 40 AND 50).

SUNG IN, EXAMINING ATTORNEY

CLASS 21—(Continued).

SN 77-174,237. NEVAREZ, MICHAEL, BATTLE CREEK, MI. FILED 5-7-2007.



THE MARK CONSISTS OF AN ABSTRACT DESIGN OF A CAVEWOMAN WITH THOUGHT BUBBLES, AND THE WORDING "NEANDER THOUGHTS."

FOR MUGS (U.S. CLS. 2, 13, 23, 29, 30, 33, 40 AND 50).
TEJBIR SINGH, EXAMINING ATTORNEY

SN 77-176,120. COLUMBIAN HOME PRODUCTS, LLC, TERRE HAUTE, IN. FILED 5-9-2007.

GRANDE EPICURE

THE MARK CONSISTS OF STANDARD CHARACTERS WITHOUT CLAIM TO ANY PARTICULAR FONT, STYLE, SIZE, OR COLOR.

FOR CUTTING BOARDS (U.S. CLS. 2, 13, 23, 29, 30, 33, 40 AND 50).

FIRST USE 1-9-1993; IN COMMERCE 1-9-1993.
WENDY JUN, EXAMINING ATTORNEY

SN 77-176,123. COLUMBIAN HOME PRODUCTS, LLC, TERRE HAUTE, IN. FILED 5-9-2007.



THE MARK CONSISTS OF GRANDE EPICURE IN DOUBLE-LINED BOX WITH THE LETTERS G AND E IN SCRIPT.

FOR CUTTING BOARDS (U.S. CLS. 2, 13, 23, 29, 30, 33, 40 AND 50).

FIRST USE 4-6-2007; IN COMMERCE 4-6-2007.
WENDY JUN, EXAMINING ATTORNEY

CLASS 21—(Continued).

SN 78-306,599. S. C. JOHNSON & SON, INC., RACINE, WI.
FILED 9-29-2003.

FRESH BRUSH

OWNER OF U.S. REG. NO. 2,543,416.
NO CLAIM IS MADE TO THE EXCLUSIVE RIGHT TO
USE "BRUSH", APART FROM THE MARK AS SHOWN.
FOR SCRUBBING BRUSHES FOR HOUSEHOLD
CLEANING (U.S. CLS. 2, 13, 23, 29, 30, 33, 40 AND 50).
ZHALEH DELANEY, EXAMINING ATTORNEY

SN 78-712,029. THE LIBMAN COMPANY, ARCOLA, IL.
FILED 9-13-2005.

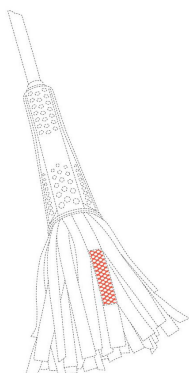

THE COLOR(S) RED AND WHITE IS/ARE CLAIMED AS
A FEATURE OF THE MARK.

THE MARK CONSISTS OF A MOP IN WHICH WHITE
POLKA DOTS ON A RED BACKGROUND ARE FEATURED
ON THE MOP HEAD. THE OUTLINE OF THE MOP IS
SHOWN IN DOTTED LINES TO INDICATE THE PLACE-
MENT OF THE MARK ON THE GOODS.

SEC. 2(F).

FOR MOPS (U.S. CLS. 2, 13, 23, 29, 30, 33, 40 AND 50).
FIRST USE 12-0-1989; IN COMMERCE 12-0-1989.
KRISTIN DAHLING, EXAMINING ATTORNEY

SN 78-929,769. BRITVISION MEDIA, LLC, SANTA BAR-
BARA, CA. FILED 7-14-2006.

CAFÉ CANVAS

THE MARK CONSISTS OF STANDARD CHARACTERS
WITHOUT CLAIM TO ANY PARTICULAR FONT, STYLE,
SIZE, OR COLOR.

FOR INSULATING SLEEVE HOLDERS FOR BEVER-
AGE CUPS (U.S. CLS. 2, 13, 23, 29, 30, 33, 40 AND 50).
FIRST USE 4-10-2006; IN COMMERCE 4-10-2006.
JUSTINE D. PARKER, EXAMINING ATTORNEY

CLASS 21—(Continued).

SN 78-934,870. BEACHTECH CORPORATION, HONOLULU,
HI. FILED S.R. 7-21-2006; AM. P.R. 7-26-2007.

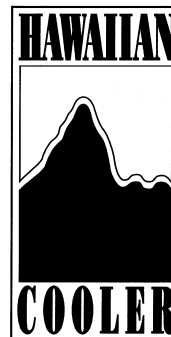

NO CLAIM IS MADE TO THE EXCLUSIVE RIGHT TO
USE "HAWAIIAN COOLER", APART FROM THE MARK AS
SHOWN.

FOR SOFT SIDED AND HARD-SIDED INSULATED
PORTABLE COOLERS ALL IN THE FORMS OF BACK-
PACKS, CAN-WRAPS, LUNCH BAGS, BOTTLE SACKS,
COLLAPSIBLE COOLERS AND ICE PACKS (U.S. CLS. 2,
13, 23, 29, 30, 33, 40 AND 50).

FIRST USE 7-15-1989; IN COMMERCE 7-15-1989.
BERYL GARDNER, EXAMINING ATTORNEY

SN 78-960,840. HEB GROCERY COMPANY, LP, SAN ANTO-
NIO, TX. FILED 8-25-2006.

COCINAWARE

THE MARK CONSISTS OF STANDARD CHARACTERS
WITHOUT CLAIM TO ANY PARTICULAR FONT, STYLE,
SIZE, OR COLOR.

THE TRANSLATION OF THE WORD COCINA IN THE
MARK IS "KITCHEN."

FOR DINNERWARE (U.S. CLS. 2, 13, 23, 29, 30, 33, 40
AND 50).
ZACHARY BELLO, EXAMINING ATTORNEY

CLASS 21—(Continued).

SN 78-967,890. ALTERNATIVE DESIGN MANUFACTURING AND SUPPLY, INC., SILOAM SPRINGS, AR. FILED 9-6-2006.



FOR ANIMAL CAGES WHICH ARE USED FOR HOLDING MULTIPLE NUMBERS OF POULTRY, RODENTS AND OTHER SMALL ANIMALS IN SEPARATE COMPARTMENTS FOR PURPOSES OF TESTING, BREEDING, ISOLATION AND GENERAL HOUSING AND WHICH INCORPORATE AN ELECTRONIC VENTILATION AND AIR FILTRATION SYSTEM (U.S. CLS. 2, 13, 23, 29, 30, 33, 40 AND 50).

ZACHARY BELLO, EXAMINING ATTORNEY

CLASS 21—(Continued).

SN 79-034,047. CHAOZHOU LIANYUAN CERAMICS MAKING CO., LTD., CHAOZHOU, GUANGDONG 521000, CHINA, FILED 10-19-2006.

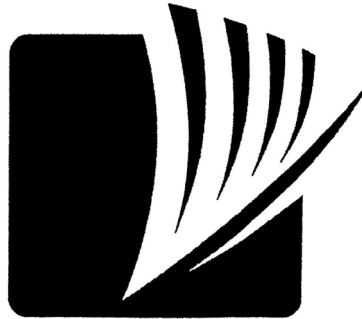

OWNER OF INTERNATIONAL REGISTRATION 0911828 DATED 10-19-2006, EXPIRES 10-19-2016.

FOR CERAMICS FOR HOUSEHOLD PURPOSES, NAMELY, CERAMIC FIGURINES; CERAMIC SCULPTURES, VASES, VESSELS, BOWLS, PLATES AND POTS; CERAMIC TISSUE BOX COVERS; DECORATIVE CERAMIC TILES NOT FOR USE AS BUILDING MATERIALS; GLASS AND CERAMIC BEADS THAT ARE NOT USED IN THE MANUFACTURE OF JEWELRY; HOLIDAY ORNAMENTS OF CERAMIC, NOT TREE ORNAMENTS; WORKS OF ART, PORCELAIN IMITATION, POTTERY IMITATION, POTTERY, PORCELAIN, ACID-AND ALKALI-RESISTANT CERAMIC ARTICLES, NAMELY, BUSTS OF CRYSTAL, BUSTS OF CHINA, BUSTS OF EARTHENWARE, BUSTS OF GLASS, BUSTS OF PORCELAIN; DESKTOP STATUARY MADE OF CHINA, DESKTOP STATUARY MADE OF CRYSTAL, DESKTOP STATUARY MADE OF EARTHENWARE, DESKTOP STATUARY MADE OF GLASS, DESKTOP STATUARY MADE OF PORCELAIN; FIGURES OF CHINA, FIGURES OF CRYSTAL, FIGURES OF EARTHENWARE, FIGURES OF GLASS, FIGURES OF PORCELAIN; FIGURINES OF CHINA, FIGURINES OF CRYSTAL, FIGURINES OF EARTHENWARE, FIGURINES OF GLASS, FIGURINES OF PORCELAIN, FIGURINES OF TERRACOTTA; SCULPTURES OF CHINA, SCULPTURES OF CRYSTAL, SCULPTURES OF EARTHENWARE, SCULPTURES OF GLASS, SCULPTURES OF PORCELAIN; STATUES OF CHINA, STATUES OF CRYSTAL, STATUES OF EARTHENWARE, STATUES OF PORCELAIN, STATUETTES OF CHINA, STATUETTES OF CRYSTAL, STATUETTES OF EARTHENWARE, STATUETTES OF GLASS, STATUETTES OF PORCELAIN; CHINA ORNAMENTS; POTTERY FOR EVERYDAY USE, NAMELY, BASINS, BOWLS, PLATES, JARS FOR COOKIES, GLASS STORAGE JARS; FOOD PRESERVING JARS OF GLASS, INSULATING JARS, JUGS, POTS, MARMITE POTS, KETTLES; CERAMIC AND PORCELAIN TABLEWARE, NAMELY, CERAMIC AND PORCELAIN PLATES, CERAMIC AND PORCELAIN BOWLS, PORCELAIN MIXING SPOONS, PORCELAIN SERVING SPOONS, PORCELAIN BASTING SPOONS; PORCELAIN FOR EVERYDAY USE, NAMELY, BASINS, BOWLS, PLATES, KETTLES, JAR FOR COOKIES, GLASS STORAGE JARS, FOOD PRESERVING JARS OF GLASS, INSULATING JARS, JUG AND POTS (U.S. CLS. 2, 13, 23, 29, 30, 33, 40 AND 50).

LOURDES AYALA, EXAMINING ATTORNEY

SN 78-977,899. LARRY H. MILLER BASEBALL, INC., SANDY, UT. FILED 10-26-2005.



THE MARK CONSISTS OF BEES LOGO. FOR BASEBALL FAN BEVERAGE CONTAINERS, NAMELY DRINKING GLASSES, CUPS AND MUGS, SOLD EXCLUSIVELY THROUGH APPLICANT'S BASEBALL STADIUM, BASEBALL TEAM WEBSITE, AND SPECIALTY RETAIL OUTLETS FEATURING SPORTS FAN PRODUCTS (U.S. CLS. 2, 13, 23, 29, 30, 33, 40 AND 50).

CAROLYN CATALDO, EXAMINING ATTORNEY

CLASS 21—(Continued).

SN 79-034,605. SAM KWANG GLASS IND. CO., LTD., REPUBLIC OF KOREA, FILED 8-21-2006.

GlassLock

OWNER OF INTERNATIONAL REGISTRATION 0913604 DATED 8-21-2006, EXPIRES 8-21-2016.

FOR CONTAINERS FOR FOODSTUFFS; CHANHAP, NAMELY KOREAN NESTS OF BOXES FOR STORING AND CARRYING FOODS; MESS-TINS; CONTAINERS FOR KIMCHI; GLASS BOWLS; CUPS OF GLASS; CRUETS, NOT OF PRECIOUS METAL; DRINKING TROUGHS; THERMOBOTTLES FOR COLD WATER; HEATPROOF EARTHENWARE AND GLASS PANS; SPICE SETS (U.S. CLS. 2, 13, 23, 29, 30, 33, 40 AND 50).
KARANENDRA S. CHHINA, EXAMINING ATTORNEY

CLASS 22—CORDAGE AND FIBERS

SN 76-674,756. ANCHOR INDUSTRIES INC., EVANSVILLE, IN. FILED 3-28-2007.

PERFECTSHADE

THE MARK CONSISTS OF STANDARD CHARACTERS WITHOUT CLAIM TO ANY PARTICULAR FONT, STYLE, SIZE, OR COLOR.

FOR FREE STANDING TENT-LIKE SUN SHELTERS WITH MESH-TYPE FABRIC CANOPY AND STEEL FRAME, SOLD AS A UNIT; MESH-TYPE FABRIC CANOPIES (U.S. CLS. 1, 2, 7, 19, 22, 42 AND 50).

FIRST USE 10-20-1998; IN COMMERCE 10-20-1998.
BILL DAWE, EXAMINING ATTORNEY

SN 77-037,738. SHAW INDUSTRIES GROUP, INC., DALTON, GA. FILED 11-6-2006.

**GREEN BY NATURE
FASHIONABLE BY DESIGN**

THE MARK CONSISTS OF STANDARD CHARACTERS WITHOUT CLAIM TO ANY PARTICULAR FONT, STYLE, SIZE, OR COLOR.

FOR SYNTHETIC FIBERS AND FILAMENTS FOR USE IN THE MANUFACTURE OF FABRICS, TEXTILES, YARNS, AND CARPETS (U.S. CLS. 1, 2, 7, 19, 22, 42 AND 50).

VERNA BETH RIRIE, EXAMINING ATTORNEY

CLASS 22—(Continued).

SN 77-041,239. TAMA PLASTIC INDUSTRY, 19236, ISRAEL, FILED 11-10-2006.

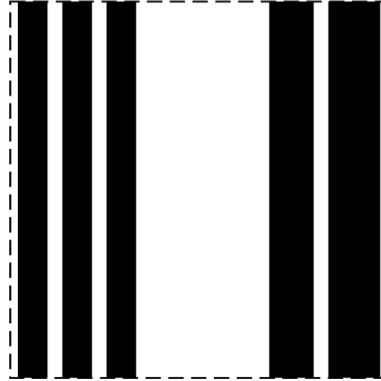

"THE MARK CONSISTS OF A PATTERN OF FIVE ASYMMETRICALLY ARRAYED VERTICAL STRIPES OF VARYING WIDTHS APPLIED CONTINUOUSLY TO THE ENTIRE SURFACE OF THE GOODS. THE SUBJECT MARK IS ALWAYS APPLIED TO THE GOODS IN THE SAME MANNER. THE BROKEN LINES SHOW PLACEMENT OF THE MARK ON THE GOODS AND ARE NOT PART OF THE MARK."

SEC. 2(F).
FOR BALE WRAP NETTING (U.S. CLS. 1, 2, 7, 19, 22, 42 AND 50).

FIRST USE 0-0-2000; IN COMMERCE 0-0-2000.
SUSAN STIGLITZ, EXAMINING ATTORNEY

SN 77-041,261. TAMA PLASTIC INDUSTRY, 19236, ISRAEL, FILED 11-10-2006.

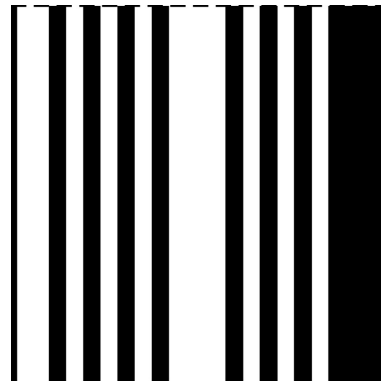

"THE MARK CONSISTS OF A PATTERN OF NINE ASYMMETRICALLY ARRAYED VERTICAL STRIPES OF VARYING WIDTHS APPLIED CONTINUOUSLY TO THE ENTIRE SURFACE OF THE GOODS. THE SUBJECT MARK IS ALWAYS APPLIED TO THE GOODS IN THE SAME MANNER. THE BROKEN LINES SHOW PLACEMENT OF THE MARK ON THE GOODS AND ARE NOT PART OF THE MARK."

SEC. 2(F).
FOR BALE WRAP NETTING (U.S. CLS. 1, 2, 7, 19, 22, 42 AND 50).

FIRST USE 0-0-1998; IN COMMERCE 0-0-1998.
SUSAN STIGLITZ, EXAMINING ATTORNEY

CLASS 22—(Continued).

SN 77-063,163. GREYHAME INC, BAIE D'URFE, CANADA,
FILED 12-13-2006.

CordoClip

THE MARK CONSISTS OF STANDARD CHARACTERS
WITHOUT CLAIM TO ANY PARTICULAR FONT, STYLE,
SIZE, OR COLOR.

PRIORITY CLAIMED UNDER SEC. 44(D) ON CANADA
APPLICATION NO. 1320741, FILED 10-19-2006.
FOR CLOTHESLINE (U.S. CLS. 1, 2, 7, 19, 22, 42 AND
50).

SARA THOMAS, EXAMINING ATTORNEY

CLASS 22—(Continued).

SN 77-129,903. MINIMUM, INC., SEATTLE, WA. FILED 3-13-
2007.

SMARTFILL

THE MARK CONSISTS OF STANDARD CHARACTERS
WITHOUT CLAIM TO ANY PARTICULAR FONT, STYLE,
SIZE, OR COLOR.

FOR PADDING AND STUFFING MATERIALS NOT
OF RUBBER, PAPER OR PLASTIC (U.S. CLS. 1, 2, 7, 19,
22, 42 AND 50).

MARGARET POWER, EXAMINING ATTORNEY

SN 77-078,694. UNIVERSAL COOPERATIVES, INC., EAGAN,
MN. FILED 1-9-2007.

HARVEST GREEN

THE MARK CONSISTS OF STANDARD CHARACTERS
WITHOUT CLAIM TO ANY PARTICULAR FONT, STYLE,
SIZE, OR COLOR.

NO CLAIM IS MADE TO THE EXCLUSIVE RIGHT TO
USE GREEN, APART FROM THE MARK AS SHOWN.

FOR TWINE, BALING TWINE, TYING TWINE, BALER
AND BINDER TWINE, AND STRING (U.S. CLS. 1, 2, 7,
19, 22, 42 AND 50).

FIRST USE 4-0-1992; IN COMMERCE 4-0-1992.

CHARISMA HAMPTON, EXAMINING ATTORNEY

SN 77-177,770. WAY SAFE FLORIDA, INC., CLEARWATER,
FL. FILED 5-10-2007.



THE COLOR(S) BLUE IS/ARE CLAIMED AS A FEATURE
OF THE MARK.

THE MARK CONSISTS, IN PART, OF AQUATIC WAVES
IN THE LETTER "O". THE MARK IS IN VARIOUS SHADES
OF BLUE.

FOR UNFITTED PLASTIC LINERS AND PLASTIC
BLADDERS FOR FLUID STORAGE (U.S. CLS. 1, 2, 7,
19, 22, 42 AND 50).

KIM SAITO, EXAMINING ATTORNEY

SN 77-078,718. UNIVERSAL COOPERATIVES, INC., EAGAN,
MN. FILED 1-9-2007.

HARVEST GOLD

THE MARK CONSISTS OF STANDARD CHARACTERS
WITHOUT CLAIM TO ANY PARTICULAR FONT, STYLE,
SIZE, OR COLOR.

NO CLAIM IS MADE TO THE EXCLUSIVE RIGHT TO
USE GOLD, APART FROM THE MARK AS SHOWN.

FOR TWINE, BALING TWINE, TYING TWINE, BALER
AND BINDER TWINE, AND STRING (U.S. CLS. 1, 2, 7,
19, 22, 42 AND 50).

CHARISMA HAMPTON, EXAMINING ATTORNEY

SN 78-936,062. TAMA PLASTIC INDUSTRY, 19236, ISRAEL,
FILED 7-24-2006.

ZEBRA

THE MARK CONSISTS OF STANDARD CHARACTERS
WITHOUT CLAIM TO ANY PARTICULAR FONT, STYLE,
SIZE, OR COLOR.

PRIORITY CLAIMED UNDER SEC. 44(D) ON ERP
CMNTY TM OFC APPLICATION NO. 5170543, FILED 6-29-
2006.

FOR BALE WRAP NETTING (U.S. CLS. 1, 2, 7, 19, 22,
42 AND 50).

FIRST USE 12-0-1998; IN COMMERCE 12-0-1998.

SUSAN STIGLITZ, EXAMINING ATTORNEY

CLASS 22—(Continued).

SN 78-947,414. MASTER LOCK COMPANY LLC, OAK CREEK, WI. FILED 8-8-2006.

STEELCOR

THE MARK CONSISTS OF STANDARD CHARACTERS WITHOUT CLAIM TO ANY PARTICULAR FONT, STYLE, SIZE, OR COLOR.

FOR CARGO SECURING AND CARGO CARRYING PRODUCTS, NAMELY, BUNGEE CORDS (U.S. CLS. 1, 2, 7, 19, 22, 42 AND 50).

FIRST USE 9-0-2004; IN COMMERCE 9-0-2004.

KATHERINE CONNOLLY, EXAMINING ATTORNEY

SN 79-033,821. SOYANG TECHNOLOGIES CO., LTD., CHINA, FILED 3-8-2006.



PRIORITY DATE OF 9-19-2005 IS CLAIMED.
OWNER OF INTERNATIONAL REGISTRATION 0911110 DATED 3-8-2006, EXPIRES 3-8-2016.

"THE COLOR(S) RED, ORANGE AND BLACK IS/ARE CLAIMED AS A FEATURE OF THE MARK."

THE MARK CONSISTS OF THE COLOURS RED AND ORANGE APPEAR IN THE TOP AND BOTTOM PARTS RESPECTIVELY OF THE STYLIZED DESIGN OF THE LETTER 'S' AND THE WORDING 'SOYANG' APPEARS IN THE COLOR BLACK.

FOR AWNINGS; CANVAS SACKS FOR STORAGE OF MATERIALS IN BULK; CANVAS TARPULINS; CHEMICAL FIBER NETTINGS; COMMERCIAL NETS; DISPOSABLE BULK CONTAINER LINERS USED AS DISPOSABLE COVERS FOR BULK CONTAINERS; FABRIC AND POLYESTER MESH NET USED FOR STORING TOYS AND OTHER HOUSEHOLD ITEMS; TARPULINS NOT FOR SHIPS; TENTS NOT FOR CAMPING; UNFITTED LINERS OF FLEXIBLE VINYL FOR HOT TUBS, SWIMMING POOLS, PONDS, SPAS AND INDUSTRIAL TANKS; UNFITTED SWIMMING POOL COVERS; AND UNFITTED VEHICLE COVERS (U.S. CLS. 1, 2, 7, 19, 22, 42 AND 50).

VERNA BETH RIRIE, EXAMINING ATTORNEY

CLASS 23—YARNS AND THREADS

SN 77-089,591. J. & P. COATS, LIMITED, GLASGOW G2 5PA, SCOTLAND, FILED 1-24-2007.

SPARKLE SOFT

THE MARK CONSISTS OF STANDARD CHARACTERS WITHOUT CLAIM TO ANY PARTICULAR FONT, STYLE, SIZE, OR COLOR.

NO CLAIM IS MADE TO THE EXCLUSIVE RIGHT TO USE "SOFT", APART FROM THE MARK AS SHOWN.

FOR HANDKNITTING YARNS (U.S. CL. 43).

TONI HICKEY, EXAMINING ATTORNEY

SN 77-102,207. J. & P. COATS, LIMITED, GLASGOW G2 5PA, SCOTLAND, FILED 2-8-2007.

JULIA

THE MARK CONSISTS OF STANDARD CHARACTERS WITHOUT CLAIM TO ANY PARTICULAR FONT, STYLE, SIZE, OR COLOR.

"THE NAME(S), PORTRAIT(S), AND/OR SIGNATURE(S) SHOWN IN THE MARK DOES NOT IDENTIFY A PARTICULAR LIVING INDIVIDUAL."

FOR HANDKNITTING YARNS (U.S. CL. 43).

FIRST USE 10-18-2005; IN COMMERCE 10-18-2005.

TONI HICKEY, EXAMINING ATTORNEY

SN 78-941,816. SPOTLIGHT PTY LTD., SOUTH MELBOURNE, AUSTRALIA, FILED 7-31-2006.



PRIORITY CLAIMED UNDER SEC. 44(D) ON AUSTRALIA APPLICATION NO. 1115982, FILED 5-26-2006, REG. NO. 1115982, DATED 5-26-2006, EXPIRES 5-26-2017.

OWNER OF U.S. REG. NO. 3,164,574.

FOR YARNS AND THREADS, FOR TEXTILE USE (U.S. CL. 43).

DAVID COLLIER, EXAMINING ATTORNEY

CLASS 23—(Continued).

SN 78-964,617. J. & P. COATS, LIMITED, GLASGOW, SCOTLAND, FILED 8-31-2006.

ORACOLO

THE MARK CONSISTS OF STANDARD CHARACTERS WITHOUT CLAIM TO ANY PARTICULAR FONT, STYLE, SIZE, OR COLOR.

THE FOREIGN WORDING IN THE MARK TRANSLATES INTO ENGLISH AS "ORACLE."

FOR HANDKNITTING YARNS (U.S. CL. 43).
FIRST USE 5-22-2006; IN COMMERCE 5-22-2006.
KRISTIN DAHLING, EXAMINING ATTORNEY

SN 79-035,607. FISTAS FANTAZI IPLIK; SANAYI VE TICARET ANONIM SIRKETI, TURKEY, FILED 1-31-2007.

NAZLI GELİN

OWNER OF INTERNATIONAL REGISTRATION 0916586 DATED 1-31-2007, EXPIRES 1-31-2017.

THE NAME NAZLI GELİN DOES NOT IDENTIFY A LIVING INDIVIDUAL.

THE ENGLISH TRANSLATION OF THE TURKISH WORD "NAZLI" IS "COY" AND THE TURKISH "GELİN" IS "BRIDE".

FOR THREADS AND YARNS FOR TEXTILE USE, SEWING THREADS AND YARNS, EMBROIDERY AND DARNING YARDS, ELASTIC YARNS (U.S. CL. 43).
REBECCA GAN, EXAMINING ATTORNEY

CLASS 24—FABRICS

SN 76-674,572. PEACE STORE, INC., SANTA BARBARA, CA. FILED 3-26-2007.

HAPPY IS HERE

THE MARK CONSISTS OF STANDARD CHARACTERS WITHOUT CLAIM TO ANY PARTICULAR FONT, STYLE, SIZE, OR COLOR.

FOR TOWELS (U.S. CLS. 42 AND 50).
BARBARA RUTLAND, EXAMINING ATTORNEY

CLASS 24—(Continued).

SN 77-014,572. MCARTHUR TOWEL AND SPORTS I, LLC, BARABOO, WI. FILED 10-5-2006.

UGLY TOWEL

THE MARK CONSISTS OF STANDARD CHARACTERS WITHOUT CLAIM TO ANY PARTICULAR FONT, STYLE, SIZE, OR COLOR.

NO CLAIM IS MADE TO THE EXCLUSIVE RIGHT TO USE "TOWEL", APART FROM THE MARK AS SHOWN.

FOR TOWELS (U.S. CLS. 42 AND 50).
ANDREA HACK, EXAMINING ATTORNEY

SN 77-037,752. DEERE & COMPANY, MOLINE, IL. FILED 11-6-2006.

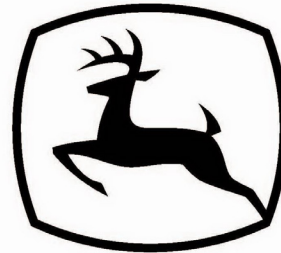

OWNER OF U.S. REG. NOS. 2,580,000, 2,729,766 AND OTHERS.

THE MARK CONSISTS OF A LEAPING DEER INSIDE OF A SINGLE CLOSED BORDER.

FOR BED BLANKETS, BLANKET THROWS, TOWELS, PILLOW CASES, COMFORTERS, BED SKIRTS, CURTAINS AND SHOWER CURTAINS (U.S. CLS. 42 AND 50).

FIRST USE 12-1-2000; IN COMMERCE 12-1-2000.
FRED CARL, EXAMINING ATTORNEY

SN 77-040,242. STEEL GUARD SAFETY CORP., TERRE HAUTE, IN. FILED 11-9-2006.

Flo-Tex Mesh Curtain Doors

THE MARK CONSISTS OF STANDARD CHARACTERS WITHOUT CLAIM TO ANY PARTICULAR FONT, STYLE, SIZE, OR COLOR.

NO CLAIM IS MADE TO THE EXCLUSIVE RIGHT TO USE "MESH CURTAIN DOORS", APART FROM THE MARK AS SHOWN.

FOR VINYL AND CLOTH TEXTILES FOR USE IN THE MANUFACTURE OF CURTAINS (U.S. CLS. 42 AND 50).

REBECCA SMITH, EXAMINING ATTORNEY

CLASS 24—(Continued).

SN 77-049,138. ROCKY SHOES & BOOTS, INC., NELSONVILLE, OH. FILED 11-21-2006.

MICRO5

THE MARK CONSISTS OF STANDARD CHARACTERS WITHOUT CLAIM TO ANY PARTICULAR FONT, STYLE, SIZE, OR COLOR.

FOR HYDROPHOBIC FABRIC USED IN THE MANUFACTURE OF SHOES AND BOOTS (U.S. CLS. 42 AND 50).

FIRST USE 1-31-1995; IN COMMERCE 1-31-1995.
ADA HAN, EXAMINING ATTORNEY

SN 77-104,858. OFFICIAL PILLOWTEX LLC, COLUMBUS, OH. FILED 2-12-2007.

SURESOFT

THE MARK CONSISTS OF STANDARD CHARACTERS WITHOUT CLAIM TO ANY PARTICULAR FONT, STYLE, SIZE, OR COLOR.

FOR TEXTILE TABLECLOTHS, PLACEMATS AND NAPKINS; BATH, HAND AND FACE TOWELS; TEXTILE FABRICS OF COTTON, WOOL, RAYON AND SYNTHETIC MATERIALS AND MIXTURES OF THE SAME; FITTED CLOTH TOILET SEAT COVERS; WASH CLOTHS, POT HOLDERS; BEDDING, NAMELY, BLANKETS, SHEETS, PILLOW CASES, PILLOW COVERS, MATTRESS PADS, MATTRESS COVERS, FEATHERBEDS, PILLOWS, DUST RUFFLES, DUVET COVERS, BEDSPREADS, COVERLETS AND THROWS, COMFORTERS; FABRIC WINDOW COVERINGS AND TREATMENTS, NAMELY, DRAPERIES, CURTAINS AND VALANCES (U.S. CLS. 42 AND 50).

H. M. FISHER, EXAMINING ATTORNEY

CLASS 24—(Continued).

SN 77-120,651. WP IP LLC, NEW YORK, NY. FILED 3-2-2007.



NO CLAIM IS MADE TO THE EXCLUSIVE RIGHT TO USE "HOME", APART FROM THE MARK AS SHOWN.

THE MARK CONSISTS OF A BOX WITH THE STYLIZED WORDS "WP HOME" INSIDE.

FOR BED SHEETS, PILLOW CASES, COMFORTERS, BEDSPREADS, QUILTS, PILLOW SHAMS, BED DUST RUFFLES, BED SKIRTS, DUVET COVERS, COMFORTER COVERS, MATTRESS PADS, BED BLANKETS, TOWELS, WASH CLOTHS, FABRIC SHOWER CURTAINS; FITTED TOILET LID AND TANK COVERS, CURTAINS, DRAPERIES, FABRIC VALANCES, FABRIC PUFFS, PUFFS AND SWAGS; TEXTILE WALL HANGINGS, TABLECLOTHS, NAPKINS, PLACEMATS, TABLE RUNNERS, OVEN MITTS AND POT HOLDERS, ALL MADE OF TEXTILE MATERIALS; BED CANOPIES, CRIB BUMPERS, CRIB CANOPIES, CRIB SHEETS, CRIB COMFORTERS, FABRIC DIAPER STACKERS, CRIB DUST RUFFLES, CRIB BLANKETS, AND HANDKERCHIEFS (U.S. CLS. 42 AND 50).

FRANK LATTUCA, EXAMINING ATTORNEY

SN 77-135,183. LINDA FERRINI D/B/A VINEYARD CLOTHS, EDGARTOWN, MA. FILED 3-20-2007.

APPMAT

THE MARK CONSISTS OF STANDARD CHARACTERS WITHOUT CLAIM TO ANY PARTICULAR FONT, STYLE, SIZE, OR COLOR.

FOR CANVAS TABLE MATS (U.S. CLS. 42 AND 50).

FIRST USE 6-15-2003; IN COMMERCE 6-15-2003.

CHARISMA HAMPTON, EXAMINING ATTORNEY

CLASS 24—(Continued).

SN 77-136,474. OLD BLUE LLC, LAKE GENEVA, WI. FILED 3-21-2007.

THE FEELGOOD T-SHIRT COMPANY

THE MARK CONSISTS OF STANDARD CHARACTERS WITHOUT CLAIM TO ANY PARTICULAR FONT, STYLE, SIZE, OR COLOR.

NO CLAIM IS MADE TO THE EXCLUSIVE RIGHT TO USE "COMPANY", APART FROM THE MARK AS SHOWN.

FOR TOWELS; BED SHEETS; COMFORTERS; QUILTS; BED SPREADS; FABRIC WINDOW COVERINGS AND TREATMENTS, NAMELY CURTAINS, DRAPERIES, SHEERS, SWAGS AND VALANCES; KITCHEN LINENS; SHOWER CURTAINS (U.S. CLS. 42 AND 50).

DAVID TAYLOR, EXAMINING ATTORNEY

SN 77-136,875. LOUISVILLE BEDDING COMPANY, LOUISVILLE, KY. FILED 3-21-2007.

BEST GRIP

THE MARK CONSISTS OF STANDARD CHARACTERS WITHOUT CLAIM TO ANY PARTICULAR FONT, STYLE, SIZE, OR COLOR.

OWNER OF U.S. REG. NOS. 1,649,144, 3,143,028 AND OTHERS.

NO CLAIM IS MADE TO THE EXCLUSIVE RIGHT TO USE "BEST", APART FROM THE MARK AS SHOWN.

FOR BED SHEETS; MATTRESS PADS (U.S. CLS. 42 AND 50).

JAMES LOVELACE, EXAMINING ATTORNEY

SN 77-139,608. LDI CORPORATION, PORTSMOUTH, NH. FILED 3-24-2007.

NatureEarth

THE MARK CONSISTS OF STANDARD CHARACTERS WITHOUT CLAIM TO ANY PARTICULAR FONT, STYLE, SIZE, OR COLOR.

FOR UPHOLSTERY FABRICS (U.S. CLS. 42 AND 50).

FIRST USE 2-27-2007; IN COMMERCE 2-27-2007.

LINDA ORNDORFF, EXAMINING ATTORNEY

CLASS 24—(Continued).

SN 77-139,854. STRETCHLINE HOLDINGS LIMITED, KOWLOON, HONG KONG, FILED 3-26-2007.

ECOLASTIC

THE MARK CONSISTS OF STANDARD CHARACTERS WITHOUT CLAIM TO ANY PARTICULAR FONT, STYLE, SIZE, OR COLOR.

FOR ELASTIC FABRICS FOR CLOTHING (U.S. CLS. 42 AND 50).

MARTHA FROMM, EXAMINING ATTORNEY

SN 77-141,539. SHAUGHNA ROWSON GIRACCA, UPTON, MA. FILED 3-27-2007.

Susie's  *swaddlers*

THE MARK CONSISTS OF THE WORD "SUSIE'S" FOLLOWED BY THE SKETCH OF THE FLOWER FOLLOWED BY THE WORD "SWADDLERS".

FOR (BASED ON INTENT TO USE) CHILDREN'S BLANKETS; CRIB BUMPERS; (BASED ON USE IN COMMERCE) RECEIVING BLANKETS (U.S. CLS. 42 AND 50).

FIRST USE 10-1-2006; IN COMMERCE 10-1-2006.

G. MAYERSCHOFF, EXAMINING ATTORNEY

SN 77-142,180. VIACOM INTERNATIONAL INC., NEW YORK, NY. FILED 3-28-2007.

DORA BEBE

THE MARK CONSISTS OF STANDARD CHARACTERS WITHOUT CLAIM TO ANY PARTICULAR FONT, STYLE, SIZE, OR COLOR.

NO CLAIM IS MADE TO THE EXCLUSIVE RIGHT TO USE "BEBE", APART FROM THE MARK AS SHOWN.

THE ENGLISH TRANSLATION OF THE WORD BEBE IN THE MARK IS BABY.

FOR BED SHEETS, BED BLANKETS, RECEIVING BLANKETS, WASH CLOTHS, CRIB BUMPER PADS, CRIB BUMPERS, CRIB CANOPIES (U.S. CLS. 42 AND 50).

B. PARADEWELAI, EXAMINING ATTORNEY

CLASS 24—(Continued).

SN 77-142,805. LANG, MICHELLE, LOS ANGELES, CA. FILED 3-28-2007.

mimosa

THE MARK CONSISTS OF STANDARD CHARACTERS WITHOUT CLAIM TO ANY PARTICULAR FONT, STYLE, SIZE, OR COLOR.

FOR (BASED ON USE IN COMMERCE) CHILDREN'S BLANKETS; QUILTS; RECEIVING BLANKETS; (BASED ON INTENT TO USE) BED BLANKETS; BED LINEN; BED SHEETS; BED SKIRTS; BED SPREADS; BLANKET THROWS; CASHMERE BLANKETS; COVERLETS; CRIB BUMPERS; DUVET COVERS; DUVETS; PILLOW CASES; PILLOW COVERS; QUILTS OF TEXTILE; SILK BED BLANKETS; SILK BLANKETS; THROWS (U.S. CLS. 42 AND 50).

FIRST USE 10-16-2006; IN COMMERCE 10-16-2006.
MELISSA VALLILLO, EXAMINING ATTORNEY

SN 77-149,918. DISNEY ENTERPRISES, INC., BURBANK, CA. FILED 4-5-2007.

WHERE IMAGINATION BEGINS

THE MARK CONSISTS OF STANDARD CHARACTERS WITHOUT CLAIM TO ANY PARTICULAR FONT, STYLE, SIZE, OR COLOR.

FOR AFGHANS; BARBECUE MITTS; BATH LINEN; BATH TOWELS; BED BLANKETS; BED CANOPIES; BED LINEN; BED SHEETS; BED SKIRTS; BED SPREADS; BLANKET THROWS; CALICO; CHILDREN'S BLANKETS; CLOTH COASTERS; CLOTH DOILIES; CLOTH FLAGS; CLOTH PENNANTS; COMFORTERS; CRIB BUMPERS; CURTAINS; FABRIC FLAGS; FELT PENNANTS; GOLF TOWELS; HAND TOWELS; HANDKERCHIEFS; HOODED TOWELS; HOUSEHOLD LINEN; KITCHEN TOWELS; OVEN MITTS; PILLOW CASES; PILLOW COVERS; POT HOLDERS; QUILTS; RECEIVING BLANKETS; SILK BLANKETS; TABLE LINEN; TEXTILE NAPKINS; TEXTILE PLACE MATS; TEXTILE TABLECLOTHS; THROWS; TOWELS; WASHCLOTHS; WOOLLEN BLANKETS (U.S. CLS. 42 AND 50).

BRIDGETT SMITH, EXAMINING ATTORNEY

SN 77-174,582. LOUISVILLE BEDDING COMPANY, LOUISVILLE, KY. FILED 5-7-2007.

BRIDAL BEGINNINGS

THE MARK CONSISTS OF STANDARD CHARACTERS WITHOUT CLAIM TO ANY PARTICULAR FONT, STYLE, SIZE, OR COLOR.

OWNER OF U.S. REG. NO. 2,408,994.
FOR MATTRESS PADS (U.S. CLS. 42 AND 50).
JAMES LOVELACE, EXAMINING ATTORNEY

CLASS 24—(Continued).

SN 77-180,949. BOBBIN, INC., FRAMINGHAM, MA. FILED 5-15-2007.

EMBROIDER THIS!

THE MARK CONSISTS OF STANDARD CHARACTERS WITHOUT CLAIM TO ANY PARTICULAR FONT, STYLE, SIZE, OR COLOR.

NO CLAIM IS MADE TO THE EXCLUSIVE RIGHT TO USE EMBROIDER, APART FROM THE MARK AS SHOWN.
FOR BURP CLOTHS; CLOTH COASTERS; HANDKERCHIEFS; TABLE LINEN; BATH LINEN; PILLOW COVERS; TOWELS (U.S. CLS. 42 AND 50).

FIRST USE 2-16-2000; IN COMMERCE 2-16-2000.
DAVID TOOLEY, EXAMINING ATTORNEY

SN 77-182,713. AMERICAN TEXTILE COMPANY, DUESNE, PA. FILED 5-16-2007.

ALLER-CHECK

THE MARK CONSISTS OF STANDARD CHARACTERS WITHOUT CLAIM TO ANY PARTICULAR FONT, STYLE, SIZE, OR COLOR.

FOR PILLOW COVERS AND MATTRESS COVERS (U.S. CLS. 42 AND 50).

HANNO RITTNER, EXAMINING ATTORNEY

SN 77-200,021. AMERICAN TEXTILE COMPANY, DUESNE, PA. FILED 6-7-2007.

HEALTHY SKIN

THE MARK CONSISTS OF STANDARD CHARACTERS WITHOUT CLAIM TO ANY PARTICULAR FONT, STYLE, SIZE, OR COLOR.

FOR PILLOWCASES AND PILLOW COVERS (U.S. CLS. 42 AND 50).
HANNO RITTNER, EXAMINING ATTORNEY

CLASS 24—(Continued).

SN 78-778,549. MICROTHIN.COM, INC., ADDISON, IL. FILED 12-21-2005.

TAILGATE PAD

THE MARK CONSISTS OF STANDARD CHARACTERS WITHOUT CLAIM TO ANY PARTICULAR FONT, STYLE, SIZE, OR COLOR.
NO CLAIM IS MADE TO THE EXCLUSIVE RIGHT TO USE "PAD", APART FROM THE MARK AS SHOWN.
FOR PLACEMATS NOT OF PAPER (U.S. CLS. 42 AND 50).
FIRST USE 3-10-2006; IN COMMERCE 3-10-2006.
ESTHER A. BORSUK, EXAMINING ATTORNEY

SN 78-783,480. WESTLAND INDUSTRIES INC., PHOENIX, AZ. FILED 12-31-2005.

Sharkskin

THE MARK CONSISTS OF STANDARD CHARACTERS WITHOUT CLAIM TO ANY PARTICULAR FONT, STYLE, SIZE, OR COLOR.
FOR WATER RESISTANT FABRIC FOR USE IN THE MANUFACTURE OF BOAT COVERS AND VARIOUS MARINE ACCESSORIES, NAMELY, BIMINI TOPS, BOAT TRAILER WHEEL COVERS AND SEAT COVERS FOR BOATS (U.S. CLS. 42 AND 50).
FIRST USE 8-1-1997; IN COMMERCE 8-1-1997.
JOANNA DUKOVIC, EXAMINING ATTORNEY

CLASS 25—CLOTHING

SN 76-423,158. WOOLWORTHS PLC, LONDON NW1 6JL, UNITED KINGDOM, FILED 6-19-2002.

LADYBIRD

OWNER OF ERPN CMNTY TM OFC REG. NO. 1925171, DATED 12-4-2001, EXPIRES 10-27-2010.
FOR CLOTHING FOR MEN, WOMEN AND CHILDREN, NAMELY COATS, RAINCOATS, ANORAKS, PARKAS, BLAZERS, JACKETS, CARDIGANS, BOLEROS, SPORT COATS, WIND RESISTANT JACKETS, SUITS, TUXEDOS, VESTS, FUR STOLEES, DRESSES, EVENING GOWNS, JUMPERS, SKIRTS, KILTS, PANTS, SLACKS, TROUSERS, JEANS, DUNGAREES, BOTTOMS, JUMPSUITS, OVERALLS, COVERALLS, LEGGINGS, GYM SUITS, JOGGING SUITS, SWEAT PANTS, THERMAL UNDERWEAR, SHORTS, SKIRTS, ROMPERS, CULOTTES, SHORTALLS, SHIRTS, SWEATERS, JERSEYS, BLOUSES, TUNICS, SWEATSHIRTS, T-SHIRTS, HALTER TOPS, TANK TOPS, BODYSUITS, UNITARDS, CAMISOLES, CHEMISES, UNDERSHIRTS, SLIPS, FOUNDATION GARMENTS, BODYSHAPERS, CORSETS, BRASSIERES, BUSTIERS, GARTER BELTS, BRIEFS, BOXER SHORTS, BLOOMERS, UNDERPANTS, PANTIES LINGERIE, LOUNGEWEAR, NIGHTGOWNS, NIGHT SHIRTS, NEGLIGEEES, ROBES, PAJAMAS, DUSTERS, APRONS, NECKTIES, BOW TIES, ASCOTS, POCKET SQUARES, SCARVES, SHAWLS, NECKERCHIEFS, GLOVES, MITTENS, BELTS, SASHES, CUMMERBUNDS, SWIMWEAR, BATHING SUITS, BATHING TRUNKS, BEACHWEAR, BEACH COVER-UPS, SARONGS, SKI WEAR, SKI SUITS, SKI BIBS, SKI PANTS, SKI GLOVES, SOCKS, SLIPPER SOCKS, THERMAL SOCKS, HOSEY, SLIPPERS, TENNIS WEAR, INFANT WEAR, CREEPERS, SNOW SUITS, BABY BIBS NOT OF PAPER, BIB OVERALLS, BOOTIES, BABY BUNTINGS, PINAFORES, PLAYSUITS, HEADWEAR, AND FOOTWEAR (U.S. CLS. 22 AND 39).
MICHAEL ENGEL, EXAMINING ATTORNEY

SN 76-622,320. GREENE, TROY A., DBA T2GREENE, EFFINGHAM, IL. AND GREENE, PATRICIA M., DBA T2GREENE, EFFINGHAM, IL. FILED 11-26-2004.

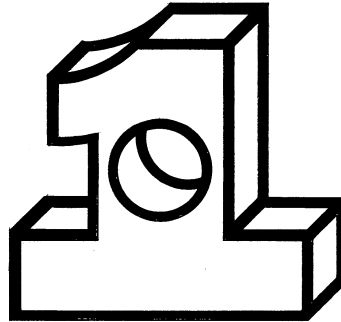

FOR MEN'S, WOMEN'S, CHILDREN'S AND INFANT'S SPORTSWEAR, NAMELY, SHIRTS, SHORTS, PANTS, SOCKS, CAPS AND HATS (U.S. CLS. 22 AND 39).
EUGENIA MARTIN, EXAMINING ATTORNEY

CLASS 25—(Continued).

SN 76-625,908. KMART OF MICHIGAN, INC., HOFFMAN ESTATES, IL. FILED 12-21-2004.

BASIC EDITIONS

THE MARK CONSISTS OF STANDARD CHARACTERS WITHOUT CLAIM TO ANY PARTICULAR FONT, STYLE, SIZE, OR COLOR.

FOR WOMEN'S, GIRLS', MEN'S AND BOYS' APPAREL— NAMELY, PANTS, SHORTS, TOPS, SHIRTS, DRESSES, SWEATERS, JACKETS, GLOVES, HATS, SCARVES, SOCKS, PANTYHOSE AND SHOES (U.S. CLS. 22 AND 39).

FIRST USE 12-1-1992; IN COMMERCE 12-1-1992.
RUDY R. SINGLETON, EXAMINING ATTORNEY

SN 76-664,122. ROGERS, KATHERINE S., HOUSTON, TX. FILED 8-4-2006.

Attitude Beyond Compliance...The New ABC's of HSE

THE MARK CONSISTS OF STANDARD CHARACTERS WITHOUT CLAIM TO ANY PARTICULAR FONT, STYLE, SIZE, OR COLOR.

FOR MEN'S, WOMEN'S AND CHILDREN'S CLOTHING, NAMELY, SWEATSHIRTS, SHIRTS, JEANS, JUMPSUITS, JACKETS, COATS, SWEATPANTS, SLACKS, SUITS, HATS, HEADBANDS, VISORS, CAPS, DRESSES, SHOES, SNEAKERS, BOOTS, WRISTBANDS, SOCKS, T-SHIRTS, BELTS, NECKTIES, DRESS SHIRTS, COLARED SHIRTS, RUGBY SHIRTS, KNIT SHIRTS, SHORTS AND SANDALS (U.S. CLS. 22 AND 39).

CIMMERIAN COLEMAN, EXAMINING ATTORNEY

SN 76-664,331. GREEN, JENNIE C., COVINA, CA. FILED 8-9-2006.



THE MARK CONSISTS OF A STYLIZED DEPICTION OF A BIRD'S HEAD.
FOR CLOTHING, NAMELY, SHIRTS, PANTS, HATS, JACKETS, SHOES (U.S. CLS. 22 AND 39).

AMOS T. MATTHEWS, JR., EXAMINING ATTORNEY

CLASS 25—(Continued).

SN 76-664,332. GREEN, JENNIE C., COVINA, CA. FILED 8-9-2006.

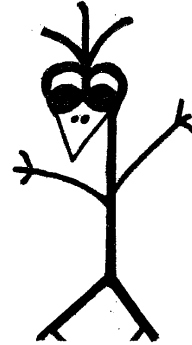

THE MARK CONSISTS OF A STICK MAN FIGURE WITH A STYLIZED DEPICTION OF A BIRD'S HEAD.

FOR CLOTHING, NAMELY, SHIRTS, PANTS, HATS, JACKETS, SHOES (U.S. CLS. 22 AND 39).

AMOS T. MATTHEWS, JR., EXAMINING ATTORNEY

SN 76-665,001. PETTWAY, DESHAWNTA, LOS ANGELES, CA. FILED 8-23-2006.

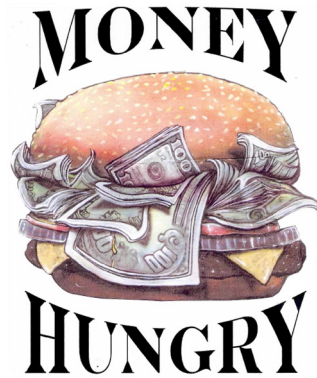

THE COLOR(S) BLACK, WHITE, GREY, BROWN, GREEN, PURPLE, RED, GOLD IS/ARE CLAIMED AS A FEATURE OF THE MARK.

THE WORDING IN THE MARK IS BLACK. THE BUN IS BROWN WITH WHITE SESAME SEEDS. THE LETTUCE/MONEY IS GREEN, GRAY AND WHITE. THE TOMATO SLICE IS RED. THE ONION IS PURPLE AND GRAY. THE CHEESE IS GOLD. THE MEAT PATTY IS DARK BROWN. THE BOTTOM BUN IS BROWN. THE BOTTOM WORDING IS BLACK.

FOR CLOTHING, NAMELY T-SHIRTS, BASEBALL CAPS, AND JACKETS (U.S. CLS. 22 AND 39).

FIRST USE 7-22-2002; IN COMMERCE 12-17-2005.
STEVEN PEREZ, EXAMINING ATTORNEY

CLASS 25—(Continued).

SN 76-666,478. CMI ENTERPRISES, LLC, SANTA MONICA, CA. FILED 9-22-2006.

HIPS AND CURVES

THE MARK CONSISTS OF STANDARD CHARACTERS WITHOUT CLAIM TO ANY PARTICULAR FONT, STYLE, SIZE, OR COLOR.

OWNER OF U.S. REG. NO. 2,693,220.
FOR CLOTHING, NAMELY, WOMEN'S AND MEN'S CLOTHING, UNDERWEAR AND SHOES, NAMELY, BABYDOLL PAJAMAS, BIKINIS, BODYSTOCKINGS, BOOTS, BRAS, BRIDAL LINGERIE, BUSTIERS, CAMISOLES, CAT SUITS, CHEMISES, CORSETS, DRESSES, FEATHER BOAS, FISHNET STOCKINGS, G-STRINGS, GARTER BELTS, GLOVES, HATS, HOSIERY, LINGERIE, SKIRTS, NIGHTGOWNS, NIGHTIES, PANTIES, PANTY-HOSE, PEIGNOIRS, PUMPS, WOMEN'S ROBES, SHOES, STOCKINGS, TEDDIES, TEDDIETTES, WOMEN'S UNDERWEAR, WOMEN'S THONG BIKINIS, THONG PANTIES, BLINDFOLDS, MEN'S THONGS, BUN-HUGGER BRIEFS, CAMOUFLAGE BRIEFS, BOXER SHORTS, MEN'S ROBES, MEN'S UNDERWEAR, T-SHIRTS, HATS, AND ADULT COSTUMES, NAMELY, NURSE, SCHOOL GIRL AND FRENCH MAID COSTUMES (U.S. CLS. 22 AND 39).

FIRST USE 8-1-2000; IN COMMERCE 8-1-2000.
KAPIL BHANOT, EXAMINING ATTORNEY

SN 76-666,576. PODGUR, JULIE, MARBLEHEAD, MA. FILED 9-25-2006.



FOR PANTS, SHIRTS, JACKETS, BELTS, SHOES (U.S. CLS. 22 AND 39).
FIRST USE 1-0-2006; IN COMMERCE 1-0-2006.
CAROLYN CATALDO, EXAMINING ATTORNEY

CLASS 25—(Continued).

SN 76-667,407. BICYCLE CITY, LLC, CINCINNATI, OH. FILED 10-12-2006.

BICYCLE CITY

THE MARK CONSISTS OF STANDARD CHARACTERS WITHOUT CLAIM TO ANY PARTICULAR FONT, STYLE, SIZE, OR COLOR.

FOR CLOTHING, NAMELY, T-SHIRTS, POLO SHIRTS, SHORTS, SWEATERS, SWEAT SHIRTS, SWEAT PANTS, JACKETS AND SOCKS; HEADWEAR (U.S. CLS. 22 AND 39).
LINDA POWELL, EXAMINING ATTORNEY

SN 76-672,193. ROBINSON, RHASIAH J., CINCINNATI, OH. FILED 2-2-2007.

FLY NY

THE MARK CONSISTS OF STANDARD CHARACTERS WITHOUT CLAIM TO ANY PARTICULAR FONT, STYLE, SIZE, OR COLOR.

OWNER OF U.S. REG. NOS. 2,876,188 AND 2,969,178.
NO CLAIM IS MADE TO THE EXCLUSIVE RIGHT TO USE "NY", APART FROM THE MARK AS SHOWN.
FOR CLOTHING, NAMELY, T-SHIRTS, SHIRTS AND JEANS; HEADGEAR, NAMELY, BASEBALL CAPS; AND FOOTWEAR (U.S. CLS. 22 AND 39).
CAROLYN CATALDO, EXAMINING ATTORNEY

SN 76-673,260. BOOT ROYALTY COMPANY, L.P., FORT WORTH, TX. FILED 2-27-2007.

JUSTIN STABILIZATION TECHNOLOGY

THE MARK CONSISTS OF STANDARD CHARACTERS WITHOUT CLAIM TO ANY PARTICULAR FONT, STYLE, SIZE, OR COLOR.

OWNER OF U.S. REG. NOS. 1,101,091, 2,712,065 AND OTHERS.
NO CLAIM IS MADE TO THE EXCLUSIVE RIGHT TO USE "STABILIZATION TECHNOLOGY", APART FROM THE MARK AS SHOWN.
FOR FOOTWEAR, NAMELY SHOES, BOOTS, AND FOOTWEAR OF LEATHER (U.S. CLS. 22 AND 39).
TANYA AMOS, EXAMINING ATTORNEY

CLASS 25—(Continued).

SN 76-673,763. WHACK, JOSEPH, DBA URBAN ENTERPRISES, PHILADELPHIA, PA. FILED 3-8-2007.



THE MARK CONSISTS OF A DESIGN OF A FLAME WITH A SKATEBOARD IN THE MIDDLE AND THE LETTERS US TO THE RIGHT OF THE DESIGN.

FOR APPAREL, NAMELY, SHIRTS, TEE-SHIRTS, JACKETS, COATS, GLOVES, VESTS, SWEAT SHIRTS, PANTS, SHORTS, SHOES, SOCKS, HATS, VISORS AND UNDERWEAR (U.S. CLS. 22 AND 39).

MICHAEL LITZAU, EXAMINING ATTORNEY

SN 76-674,577. PEACE STORE, INC., SANTA BARBARA, CA. FILED 3-26-2007.

HAPPY IS HERE

THE MARK CONSISTS OF STANDARD CHARACTERS WITHOUT CLAIM TO ANY PARTICULAR FONT, STYLE, SIZE, OR COLOR.

FOR CLOTHING, NAMELY T-SHIRTS, SWEATSHIRTS, SWEATPANTS, UNDERWEAR, FOOTWEAR, HEADWEAR AND JACKETS (U.S. CLS. 22 AND 39).

BARBARA RUTLAND, EXAMINING ATTORNEY

SN 76-674,764. THE GEORGE B. PATTERSON GROUP, INC., SEWICKLEY, PA. FILED 3-29-2007.

FROGDOG INTERNATIONAL

THE MARK CONSISTS OF STANDARD CHARACTERS WITHOUT CLAIM TO ANY PARTICULAR FONT, STYLE, SIZE, OR COLOR.

NO CLAIM IS MADE TO THE EXCLUSIVE RIGHT TO USE "INTERNATIONAL", APART FROM THE MARK AS SHOWN.

FOR CLOTHING, NAMELY, SHIRTS, SHORTS, PANTS, SWEATSHIRTS, SWEATPANTS, HATS, JACKETS, BELTS, BANDANAS (U.S. CLS. 22 AND 39).

MICHAEL TANNER, EXAMINING ATTORNEY

CLASS 25—(Continued).

SN 76-674,804. MICHAEL T. DOUGHER, QUEENSBURY, NY. FILED 3-29-2007.



FOR CLOTHING, NAMELY, SHIRTS, HATS; CLOTHING, NAMELY, T-SHIRT, BASEBALL CAPS (U.S. CLS. 22 AND 39).

ROBERT STRUCK, EXAMINING ATTORNEY

SN 76-675,070. ROPA SIETE LEGUAS S.A. DE C.V., LERDO, DURANGO, MEXICO, FILED 4-5-2007.

HABANA BLUE

THE MARK CONSISTS OF STANDARD CHARACTERS WITHOUT CLAIM TO ANY PARTICULAR FONT, STYLE, SIZE, OR COLOR.

THE ENGLISH TRANSLATION OF HABANA IS HAVANA.

FOR MEN'S, WOMEN'S AND CHILDREN'S CLOTHING, NAMELY, PANTS, JEANS, SHORTS, SKIRTS, JACKETS, CAPRIS, DRESSES, TOPS, T-SHIRTS, SWEATERS, HATS, BELTS, BLOUSES, AND SHOES; WOMEN'S AND MEN'S OUTERWEAR, UNDERWEAR AND NIGHTWEAR, NAMELY, LINGERIE, ROBES, CAF-TANS, KIMONOS, BOXER SHORTS, AND PAJAMAS (U.S. CLS. 22 AND 39).

ESTHER BELENKER, EXAMINING ATTORNEY

SN 76-675,071. ROPA SIETE LEGUAS S.A. DE C.V., LERDO, DURANGO, MEXICO, FILED 4-5-2007.

YELLOW BANANA

THE MARK CONSISTS OF STANDARD CHARACTERS WITHOUT CLAIM TO ANY PARTICULAR FONT, STYLE, SIZE, OR COLOR.

FOR MEN'S, WOMEN'S AND CHILDREN'S CLOTHING, NAMELY, PANTS, JEANS, SHORTS, SKIRTS, JACKETS, CAPRIS, DRESSES, TOPS, T-SHIRTS, SWEATERS, HATS, BELTS, BLOUSES, AND SHOES; WOMEN'S AND MEN'S OUTERWEAR, UNDERWEAR AND NIGHTWEAR, NAMELY, LINGERIE, ROBES, CAF-TANS, KIMONOS, BOXER SHORTS, AND PAJAMAS (U.S. CLS. 22 AND 39).

ESTHER BELENKER, EXAMINING ATTORNEY

CLASS 25—(Continued).

SN 76-676,043. HAVIS SHIELDS EQUIPMENT CORPORATION, WARMINSTER, PA. FILED 4-26-2007.



DYLANO

FOR CLOTHING, NAMELY, JACKETS, TROUSERS AND HATS (U.S. CLS. 22 AND 39).
FIRST USE 5-31-2006; IN COMMERCE 5-31-2006.
BENJAMIN OKEKE, EXAMINING ATTORNEY

SN 76-676,474. OWENS, RICHARD R., LANTANA, FL. FILED 5-7-2007.

GET OVER IT

THE MARK CONSISTS OF STANDARD CHARACTERS WITHOUT CLAIM TO ANY PARTICULAR FONT, STYLE, SIZE, OR COLOR.
FOR CLOTHING, NAMELY, T-SHIRTS AND HATS (U.S. CLS. 22 AND 39).
WILLIAM P. SHANAHAN, EXAMINING ATTORNEY

SN 77-001,579. JOHNSON, CHERYL L. SAN MARCOS, CA. FILED S.R. 9-18-2006; AM. P.R. 8-20-2007.

U Deserve Beautiful

THE MARK CONSISTS OF STANDARD CHARACTERS WITHOUT CLAIM TO ANY PARTICULAR FONT, STYLE, SIZE, OR COLOR.
FOR CLOTHING, NAMELY, T-SHIRTS, SWEAT-SHIRTS, TANK TOPS, SWEATERS, JACKETS, CAPS, VISORS, SOCKS, SWEATPANTS, SKIRTS, SKORTS, SHORTS, AND PANTS (U.S. CLS. 22 AND 39).
BRENDAN MCCAULEY, EXAMINING ATTORNEY

CLASS 25—(Continued).

SN 77-005,530. VIVAHORA, LLC, MIAMI BEACH, FL. FILED 9-22-2006.

VIVAHORA

THE MARK CONSISTS OF STANDARD CHARACTERS WITHOUT CLAIM TO ANY PARTICULAR FONT, STYLE, SIZE, OR COLOR.
"THE FOREIGN WORDING IN THE MARK TRANSLATES INTO ENGLISH AS HOORAY NOW."
FOR SPORTSWEAR, NAMELY, T-SHIRTS (U.S. CLS. 22 AND 39).
NATALIE POLZER, EXAMINING ATTORNEY

SN 77-014,747. OSTERBERG, JAMES, LOS ANGELES, CA. FILED 10-5-2006.

IGGY POP

THE MARK CONSISTS OF STANDARD CHARACTERS WITHOUT CLAIM TO ANY PARTICULAR FONT, STYLE, SIZE, OR COLOR.
"IGGY POP" IDENTIFIES A LIVING INDIVIDUAL WHOSE CONSENT IS OF RECORD.
SEC. 2(F).
FOR CLOTHING, NAMELY, SHIRTS, T-SHIRTS, SWEAT SHIRTS, JACKETS, CAPS, SKIRTS, PANTS AND JEANS (U.S. CLS. 22 AND 39).
FIRST USE 12-1-1979; IN COMMERCE 12-1-1979.
SCOTT SISUN, EXAMINING ATTORNEY

SN 77-020,923. ROBLES, JOSE L., LONG BEACH, CA. FILED 10-13-2006.

KINGLY

THE MARK CONSISTS OF STANDARD CHARACTERS WITHOUT CLAIM TO ANY PARTICULAR FONT, STYLE, SIZE, OR COLOR.
FOR BRIEFS; DISPOSABLE UNDERWEAR; KNITTED UNDERWEAR; THERMAL UNDERWEAR; UNDERWEAR; WOVEN OR KNITTED UNDERWEAR (U.S. CLS. 22 AND 39).
FIRST USE 1-10-2006; IN COMMERCE 1-10-2006.
GISELLE AGOSTO, EXAMINING ATTORNEY

CLASS 25—(Continued).

SN 77-023,123. ZICHERMAN, ZVIKA, SUNNY ISLES BEACH, FL. FILED 10-17-2006.

Likerr

THE MARK CONSISTS OF STANDARD CHARACTERS WITHOUT CLAIM TO ANY PARTICULAR FONT, STYLE, SIZE, OR COLOR.

FOR CLOTHING, NAMELY, T-SHIRTS, SWEATSHIRTS, TANK-TOPS, JERSEYS, CAPS, HATS, SHORTS, BOXER SHORTS, SOCKS, SKIRTS, SUNDRESSES, SWEATPANTS, PANTS, WARM-UP SUITS, BRAS, UNDERWEAR, HEADBANDS, SCARVES, JACKETS (U.S. CLS. 22 AND 39).

FIRST USE 12-10-2006; IN COMMERCE 12-10-2006.
SUSAN RICHARDS, EXAMINING ATTORNEY

CLASS 25—(Continued).

SN 77-033,972. DAWSON INTERNATIONAL HOLDINGS (UK) LIMITED, KINROSS KY13 8GL, UNITED KINGDOM, FILED 11-1-2006.



Mac Alan

FOR KNITWEAR, NAMELY, SWEATERS, HATS, SCARVES AND GLOVES (BASED ON USE— DATE OF FIRST USE OF THE MARK IN COMMERCE— MAY 31, 2006; DATE OF FIRST USE OF THE MARK ANYWHERE— MAY 31, 2006); CLOTHING, NAMELY, SHIRTS, SKIRTS, DRESSES, TROUSERS, JACKETS, STOCKINGS, SOCKS, UNDERGARMENTS, TIES AND FOOTWEAR (BASED ON INTENT-TO-USE) (U.S. CLS. 22 AND 39).

FIRST USE 5-31-2006; IN COMMERCE 5-31-2006.
ALICE BENMAMAN, EXAMINING ATTORNEY

SN 77-032,126. L.C. LICENSING, INC., NEW YORK, NY. FILED 10-30-2006.



Juicy Couture

OWNER OF U.S. REG. NOS. 2,978,046, 3,194,741 AND OTHERS.

NO CLAIM IS MADE TO THE EXCLUSIVE RIGHT TO USE "COUTURE", APART FROM THE MARK AS SHOWN. "THE MARK CONSISTS OF TWO HERALDIC LIONS HOLDING A SHIELD WITH "JM" AND A BAR DESIGN. ABOVE THE SHIELD IS A CROWN. BELOW THE SHIELD IS A BANNER AND PLANT DESIGN."

FOR MEN'S APPAREL, NAMELY, SHIRTS, PANTS, JEANS, SWEATERS, AND JACKETS (U.S. CLS. 22 AND 39).

REBECCA GAN, EXAMINING ATTORNEY

SN 77-034,298. SAULTER, COREY ALLAN, BLOOMFIELD, CT. FILED 11-1-2006.



THE COLOR(S) GREEN, BROWN, BEIGE, AND BLACK AND GREY IS/ARE CLAIMED AS A FEATURE OF THE MARK.

THE MARK CONSISTS OF THE COLOR BEIGE APPEARS IN THE DESIGN OF THE LEFT MOST LEAF, THE COLOR BROWN APPEARS IN THE LEAF IN THE CENTER OF THE DESIGN, THE COLOR GREEN APPEARS IN THE LEAF ON THE RIGHT, THE COLOR BLACK APPEARS IN THE WOODEN TWIG AND THE COLOR GREY APPEARS IN THE BACKGROUND FOR THE MARK.

FOR CLOTHING, NAMELY, JEANS, JACKETS, T-SHIRTS, LONG SLEEVE SHIRTS, SWEATSHIRTS, BOOTS, HATS, CAPS, UNDERWEAR (U.S. CLS. 22 AND 39).

SUSAN RICHARDS, EXAMINING ATTORNEY

CLASS 25—(Continued).

SN 77-034,832. JOHN CROWE, LLC, TAMARAC, FL. FILED 11-2-2006.

JOHN CROWE

THE MARK CONSISTS OF STANDARD CHARACTERS WITHOUT CLAIM TO ANY PARTICULAR FONT, STYLE, SIZE, OR COLOR.

"THE NAME(S), PORTRAIT(S), AND/OR SIGNATURE(S) SHOWN IN THE MARK DOES NOT IDENTIFY A PARTICULAR LIVING INDIVIDUAL."

FOR MEN'S, WOMEN'S, AND CHILDREN'S CLOTHING, NAMELY, T-SHIRTS, POLO SHIRTS, HATS AND CAPS (U.S. CLS. 22 AND 39).

FIRST USE 9-25-2006; IN COMMERCE 9-25-2006.

JEAN IM, EXAMINING ATTORNEY

SN 77-035,602. ANAUVE, S.L., MADRID, SPAIN, FILED 11-2-2006.

ANAUVE

PRIORITY CLAIMED UNDER SEC. 44(D) ON SPAIN APPLICATION NO. 2.736.769, FILED 10-25-2006, REG. NO. 2.736.769, DATED 4-12-2007, EXPIRES 10-25-2016.

FOR ALL TYPES OF CLOTHING, FOR MEN, WOMEN AND CHILDREN, NAMELY, SHIRTS, T-SHIRTS, TROUSERS, SHORTS, SKIRTS, PULLOVERS, SWEATERS, CARDIGANS, JACKETS, SWIMWEAR, COATS, ANORAKS, BELTS, TIES, WRISTBANDS, GLOVES, SOCKS, STOCKINGS, UNDERWEAR; HEADGEAR, NAMELY, HATS, CAPS, HEADBANDS; FOOTWEAR, NAMELY, SHOES, BOOTS, SLIPPERS, SANDALS AND ATHLETIC SHOES (U.S. CLS. 22 AND 39).

SOPHIA S. KIM, EXAMINING ATTORNEY

CLASS 25—(Continued).

SN 77-038,857. SKY DESIGN, INC., WEST LINN, OR. FILED 11-7-2006.

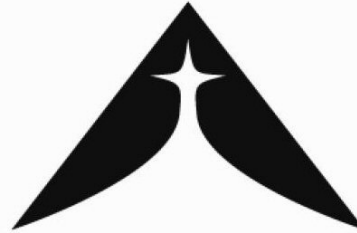

THE MARK CONSISTS OF STYLIZED LETTER A.

FOR CLOTHING, NAMELY, CHEMISETTES, CHILDREN'S AND INFANTS' CLOTH BIBS, CHILDREN'S CLOTH EATING BIBS, NECK TUBES, WRAP-AROUNDS, COATS, CORSETS, CRAVATS, CROP TOPS, CUMMERBUNDS, DANCE COSTUMES, DOWN JACKETS, DRESS SHIELDS, DRESS SHIRTS, DUNGAREES, EVENING GOWNS, FLEECE PULLOVERS, FROCKS, FULL-LENGTH KIMONOS (NAGAGI), FUR CLOAKS, GLOVES, GOLF TROUSERS, GOWNS, HALTER TOPS, HAT BANDS, HATS, HEAD SCARVES, HEAD WEAR, HEADBANDS, HOODS, HOUSECOATS, INFANT AND TODDLER ONE PIECE CLOTHING, JACKET LINERS, JAPANESE STYLE SOCKS (TABI), JERKINS, JERSEYS, JODHPURS, JOGGING PANTS, JOGGING SUITS, KERICHS, KILTS, KNEE HIGHS, KNEE-HIGH STOCKINGS, KNICKERS, LAB COATS, LADIES' SUITS, LAYETTES, LEATHER BELTS, LEATHER HEADWEAR, LEATHER SLIPPERS, LEG SHAPERS, LIGHT-REFLECTING JACKETS, LINGERIE, MARTIAL ARTS UNIFORMS, MEN'S SOCKS, MEN'S SUITS, WOMEN'S SUITS, MUFFLERS, MUU MUUS, NURSE PANTS, OVERSHOES, OVER-TROUSERS, PANTYHOSE, PLASTIC BABY BIBS, PLEATED SKIRTS FOR FORMAL KIMONOS (HAKAMA), PULLOVERS, PUTTEES AND GAITERS, PAJAMAS, QUILTED VESTS, RAIN JACKETS, RAIN SLICKERS, RAINPROOF JACKETS, RIDING GLOVES, ROBES, RUBBER SOLES FOR JIKATABI, RUBBERS, SCARVES, SCRUBS NOT FOR MEDICAL PURPOSES, SERAPES, SHAMPOO CAPES, SHAWLS, SHOE PEGS, SHOES, SHORT OVERCOAT FOR KIMONO (HAORI), SHORT PETTICOATS, SHORT SETS, SHORTS, SINGLET, SKI AND SNOWBOARD SHOES AND PARTS THEREOF, SKI BIBS, SKI BOOTS, SKI JACKETS, SKI MASKS, SKI PANTS, SKI SUITS, SKI SUITS FOR COMPETITION, SKI WEAR, SKIING SHOES, SKIRTS, SKIRTS AND DRESSES, SKIWEAR, SKORTS, SKULL CAPS, SKULLIES, SLACKS, SLEEP SHIRTS, SLEEPING GARMENTS, SLEEPWEAR, SLIDING SHORTS, SLIPPERS, SMOCKS, SNOW SUITS, SNOWBOARD PANTS, SOCK SUSPENDERS, SOCKS, SOLES FOR JAPANESE STYLE SANDALS, SPORT COATS, SPORTS BRA, SPORTS JACKETS, STOCKINGS, STOLE, STUFF JACKETS, SUITS, SUITS OF LEATHER, SUN VISORS, SUN-SUITS, SURF WEAR, SUSPENDER BELTS FOR MEN, SUSPENDER BELTS FOR WOMEN, SUSPENDERS, SWADDLING CLOTHES, SWEAT PANTS, SWEAT SHIRTS, SWIM CAPS, SWIM WEAR, SWIMMING CAPS, TANK-TOPS, TAP PANTS, TEDDIES, TOBOGGAN HATS, PANTS AND CAPS, TOE STRAPS FOR JAPANESE STYLE SANDALS ZORI, TOGAS, TOPS, TRACK PANTS, TRACK SUITS, TROUSERS, TUNICS, TUQUES, TURTLENECKS, TUXEDO BELTS, TUXEDOS, UNDER GARMENTS, UNDERGARMENTS, UNDERWEAR, UNITARDS, UPPERS FOR JAPANESE STYLE SANDALS, VESTED SUITS, VESTS, WARM UP SUITS, WATER SOCKS, WATERPROOF JACKETS AND PANTS, WET SUIT GLOVES, WET SUITS, WOODEN MAIN BODIES OF JAPANESE STYLE WOODEN CLOGS, WOODEN SUPPORTS OF JAPANESE STYLE WOODEN CLOGS, WORKING OVERALLS; FOOTWEAR (U.S. CLS. 22 AND 39).

SALLY SHIH, EXAMINING ATTORNEY

CLASS 25—(Continued).

SN 77-038,860. SKY DESIGN, INC., WEST LINN, OR. FILED 11-7-2006.

AKLESIA

THE MARK CONSISTS OF STANDARD CHARACTERS WITHOUT CLAIM TO ANY PARTICULAR FONT, STYLE, SIZE, OR COLOR.

FOR CLOTHING, NAMELY, CHEMISETTES, CHILDREN'S AND INFANTS' CLOTH BIBS, CHILDREN'S CLOTH EATING BIBS, NECK TUBES, WRAP-AROUNDS, COATS, CORSETS, CRAVATS, CROP TOPS, CUMMERBUNDS, DANCE COSTUMES, DOWN JACKETS, DRESS SHIELDS, DRESS SHIRTS, DUNGAREES, EVENING GOWNS, FLEECE PULLOVERS, FROCKS, FULL-LENGTH KIMONOS (NAGAGI), FUR CLOAKS, GLOVES, GOLF TROUSERS, GOWNS, HALTER TOPS, HAT BANDS, HATS, HEAD SCARVES, HEAD WEAR, HEADBANDS, HOODS, HOUSECOATS, INFANT AND TODDLER ONE PIECE CLOTHING, JACKET LINERS, JAPANESE STYLE SOCKS (TABI), JERKINS, JERSEYS, JODHPURS, JOGGING PANTS, JOGGING SUITS, KERCHEIFS, KILTS, KNEE HIGHS, KNEE-HIGH STOCKINGS, KNICKERS, LAB COATS, LADIES' SUITS, LAYETTES, LEATHER BELTS, LEATHER HEADWEAR, LEATHER SLIPPERS, LEG SHAPERS, LIGHT-REFLECTING JACKETS, LINGERIE, MARTIAL ARTS UNIFORMS, MEN'S SOCKS, MEN'S SUITS, WOMEN'S SUITS, MUFFLERS, MUU MUUS, NURSE PANTS, OVERSHOES, OVER-TROUSERS, PANTYHOSE, PLASTIC BABY BIBS, PLEATED SKIRTS FOR FORMAL KIMONOS (HAKAMA), PULLOVERS, PUTTEES AND GAITERS, PAJAMAS, QUILTED VESTS, RAIN JACKETS, RAIN SLICKERS, RAINPROOF JACKETS, RIDING GLOVES, ROBES, RUBBER SOLES FOR JIKATABI, RUBBERS, SCARVES, SCRUBS NOT FOR MEDICAL PURPOSES, SERAPES, SHAMPOO CAPES, SHAWLS, SHOE PEGS, SHOES, SHORT OVERCOAT FOR KIMONO (HAORI), SHORT PETTICOATS, SHORT SETS, SHORTS, SINGLET, SKI AND SNOWBOARD SHOES AND PARTS THEREOF, SKI BIBS, SKI BOOTS, SKI JACKETS, SKI MASKS, SKI PANTS, SKI SUITS, SKI SUITS FOR COMPETITION, SKI WEAR, SKIING SHOES, SKIRTS, SKIRTS AND DRESSES, SKIWEAR, SKORTS, SKULL CAPS, SKULLIES, SLACKS, SLEEP SHIRTS, SLEEPING GARMENTS, SLEEPWEAR, SLIDING SHORTS, SLIPPERS, SMOCKS, SNOW SUITS, SNOWBOARD PANTS, SOCK SUSPENDERS, SOCKS, SOLES FOR JAPANESE STYLE SANDALS, SPORT COATS, SPORTS BRA, SPORTS JACKETS, STOCKINGS, STOLE, STUFF JACKETS, SUITS, SUITS OF LEATHER, SUN VISORS, SUNSUITS, SURF WEAR, SUSPENDER BELTS FOR MEN, SUSPENDER BELTS FOR WOMEN, SUSPENDERS, SWADDLING CLOTHES, SWEAT PANTS, SWEAT SHIRTS, SWIM CAPS, SWIM WEAR, SWIMMING CAPS, TANK-TOPS, TAP PANTS, TEDDIES, TOBOGGAN HATS, PANTS AND CAPS, TOE STRAPS FOR JAPANESE STYLE SANDALS ZORI, TOGAS, TOPS, TRACK PANTS, TRACK SUITS, TROUSERS, TUNICS, TUQUES, TURTLENECKS, TUXEDO BELTS, TUXEDOS, UNDER GARMENTS, UNDER GARMENTS, UNDERWEAR, UNITARDS, UPPERS FOR JAPANESE STYLE SANDALS, VESTED SUITS, VESTS, WARM UP SUITS, WATER SOCKS, WATERPROOF JACKETS AND PANTS, WET SUIT GLOVES, WET SUITS, WOODEN MAIN BODIES OF JAPANESE STYLE WOODEN CLOGS, WOODEN SUPPORTS OF JAPANESE STYLE WOODEN CLOGS, WORKING OVERALLS; FOOTWEAR (U.S. CLS. 22 AND 39).

SALLY SHIH, EXAMINING ATTORNEY

CLASS 25—(Continued).

SN 77-042,844. RISE SURF LLC, TEXAS CITY, TX. FILED 11-13-2006.

RISE SURF

THE MARK CONSISTS OF STANDARD CHARACTERS WITHOUT CLAIM TO ANY PARTICULAR FONT, STYLE, SIZE, OR COLOR.

FOR T-SHIRTS (U.S. CLS. 22 AND 39).
FIRST USE 7-2-2002; IN COMMERCE 9-1-2006.
HEATHER BIDDULPH, EXAMINING ATTORNEY

SN 77-042,948. SATORI MOVEMENT, SAN FRANCISCO, CA. FILED S.R. 11-13-2006; AM. P.R. 4-4-2007.

SATORI MOVEMENT

THE MARK CONSISTS OF STANDARD CHARACTERS WITHOUT CLAIM TO ANY PARTICULAR FONT, STYLE, SIZE, OR COLOR.

THE ENGLISH TRANSLATION OF THE WORD "SATORI" IN THE MARK IS "ENLIGHTENMENT".

FOR MEN'S, WOMEN'S, AND CHILDREN'S CLOTHING, NAMELY, TANK TOPS, SHIRTS, SKIRTS, PANTS, DRESSES, SHORTS, JUMPERS, CAPRIS, LEGGINGS, PAJAMAS, ROBES, JERSEYS, SWIMWEAR, WETSUITS, BATHING SUITS, BIKINIS, COVER-UPS, UNDERWEAR, SOCKS, GLOVES, BELTS, TIES, VESTS, AND JACKETS; NATURAL FIBER CLOTHING, NAMELY, CLOTHING FEATURING HEMP, BAMBOO, AND ORGANIC CONTENT, NAMELY, TANK TOPS, SHIRTS, SKIRTS, PANTS, DRESSES, SHORTS, JUMPERS, CAPRIS, LEGGINGS, PAJAMAS, ROBES, JERSEYS, SWIMWEAR, BATHING SUITS, BIKINIS, COVER-UPS, UNDERWEAR, SOCKS, GLOVES, BELTS, TIES, VESTS, JACKETS; HEADWEAR, NAMELY, CAPS AND VISORS; FOOTWEAR, NAMELY, SANDALS, SLIPPERS, BOOTS, AND ATHLETIC SHOES; AND WRISTBANDS (U.S. CLS. 22 AND 39).

FIRST USE 8-1-1998; IN COMMERCE 8-1-1998.
TIMOTHY FINNEGAN, EXAMINING ATTORNEY

CLASS 25—(Continued).

SN 77-049,652. EDUCATION EXPERIENCES INC., LOS ANGELES, CA. FILED 11-22-2006.

DEVELOPMENTOR

THE MARK CONSISTS OF STANDARD CHARACTERS WITHOUT CLAIM TO ANY PARTICULAR FONT, STYLE, SIZE, OR COLOR.

OWNER OF U.S. REG. NOS. 2,269,017, 2,396,301 AND OTHERS.

FOR CAPS; CAPS WITH VISORS; HATS; SHORT-SLEEVED OR LONG-SLEEVED T-SHIRTS; T-SHIRTS (U.S. CLS. 22 AND 39).

FIRST USE 4-1-1994; IN COMMERCE 4-1-1994.
KAELE KUNG, EXAMINING ATTORNEY

CLASS 25—(Continued).

SN 77-055,806. SIGHT UNSEEN, PINEY POINT, MD. FILED 12-1-2006.

SIGHT UNSEEN

THE MARK CONSISTS OF TEXT WITH LINES ABOVE AND BELOW.

FOR T-SHIRTS, HOODED SWEATSHIRTS, SWEATERS, HATS, JACKETS AND JERSEYS (U.S. CLS. 22 AND 39).

JANICE L. MCMORROW, EXAMINING ATTORNEY

SN 77-061,036. VALUE CITY OF MICHIGAN, INC., WESTLAND, MI. FILED 12-11-2006.

SN 77-050,406. MARTINEZ, DEBBIE J., CRYSTAL LAKE, IL. FILED 11-24-2006.

THE MARK CONSISTS OF THE WORDS IN A STYLIZED WITH A LARGE STYLIZED D AND M THEREOVER. FOR CLOTHING IN THE NATURE OF CAPS, SHIRTS OF ALL KINDS AND JACKETS (U.S. CLS. 22 AND 39).

JAMES A. RAUEN, EXAMINING ATTORNEY

MAZZONI

THE MARK CONSISTS OF STANDARD CHARACTERS WITHOUT CLAIM TO ANY PARTICULAR FONT, STYLE, SIZE, OR COLOR.

OWNER OF U.S. REG. NOS. 2,263,818 AND 3,069,906. SEC. 2(F).

FOR DRESS SHIRTS, KNIT SPORT SHIRTS, SWEATERS, TIES (U.S. CLS. 22 AND 39).

FIRST USE 3-15-2006; IN COMMERCE 3-15-2006.
KATHY DE JONGE, EXAMINING ATTORNEY

SN 77-053,550. KENPO INC., LOS ANGELES, CA. FILED 11-29-2006.

CREATIVE MINDS

THE MARK CONSISTS OF STANDARD CHARACTERS WITHOUT CLAIM TO ANY PARTICULAR FONT, STYLE, SIZE, OR COLOR.

FOR CLOTHING, NAMELY JEANS, PANTS, SHIRTS, T-SHIRTS, SWEATSHIRTS, UNDERSHIRTS, UNDERWEAR, AND HATS (U.S. CLS. 22 AND 39).

FIRST USE 8-1-2006; IN COMMERCE 8-1-2006.
JULIE WATSON, EXAMINING ATTORNEY

SN 77-062,386. TOPSEVEN, INC. DBA BEROTEX, WOODLAND HILLS, CA. FILED 12-12-2006.

DIANA ONIHARA

THE MARK CONSISTS OF STANDARD CHARACTERS WITHOUT CLAIM TO ANY PARTICULAR FONT, STYLE, SIZE, OR COLOR.

"THE NAME(S), PORTRAIT(S), AND/OR SIGNATURE(S) SHOWN IN THE MARK DOES NOT IDENTIFY A PARTICULAR LIVING INDIVIDUAL."

FOR CLOTHING, NAMELY, SHIRTS, PANTS, T-SHIRTS, FOOTWEAR, SHORTS, SWIMWEAR, LINGERIE, UNDERWEAR, JACKETS, DRESSES AND SKIRTS; BELTS; SCARVES; GLOVES (U.S. CLS. 22 AND 39).

ANNE E. GUSTASON, EXAMINING ATTORNEY

CLASS 25—(Continued).

SN 77-063,078. GROSZ, SHANI SUSAN, NEW YORK, NY. FILED 12-13-2006.

SHANI

THE MARK CONSISTS OF STANDARD CHARACTERS WITHOUT CLAIM TO ANY PARTICULAR FONT, STYLE, SIZE, OR COLOR.

OWNER OF U.S. REG. NO. 3,243,498.
FOR CLOTHING, NAMELY, SHIRTS, BLOUSES, SWEATERS, PANTS, SKIRTS, DRESSES, JACKETS, SUITS, SHOES, HATS, OVERCOATS, EVENING DRESSES, EVENING GOWNS AND EVENING JACKETS (U.S. CLS. 22 AND 39).

FIRST USE 6-30-2001; IN COMMERCE 6-30-2001.
THEODORE MCBRIDE, EXAMINING ATTORNEY

CLASS 25—(Continued).

SN 77-073,722. KAROL, CHRISTOPHER H., ASPEN, CO. FILED 12-29-2006.

SHREDABLES

THE MARK CONSISTS OF STANDARD CHARACTERS WITHOUT CLAIM TO ANY PARTICULAR FONT, STYLE, SIZE, OR COLOR.

FOR SHIRTS, PANTS, JACKETS, ONE-PIECE SUITS, UNDERWEAR, HATS, GLOVES, SOCKS, BATHING SUITS, PAJAMAS, SHOES, BOOTS, SLIPPERS, SANDALS (U.S. CLS. 22 AND 39).

ALICE SUE CARRUTHERS, EXAMINING ATTORNEY

SN 77-066,904. SIMMONS, SHERRIN E, LAS VEGAS, NV. FILED 12-18-2006.

I am inspired by

THE MARK CONSISTS OF STANDARD CHARACTERS WITHOUT CLAIM TO ANY PARTICULAR FONT, STYLE, SIZE, OR COLOR.

FOR T-SHIRTS (U.S. CLS. 22 AND 39).
FIRST USE 12-21-2004; IN COMMERCE 12-21-2004.
HEATHER THOMPSON, EXAMINING ATTORNEY

SN 77-078,295. PRIMALWEAR, INC., DENVER, CO. FILED 1-8-2007.



OWNER OF U.S. REG. NOS. 2,875,532 AND 3,213,870.
NO CLAIM IS MADE TO THE EXCLUSIVE RIGHT TO USE "WEAR", APART FROM THE MARK AS SHOWN.

FOR CLOTHING, HEADWEAR, AND SPORTSWEAR, NAMELY, SHORTS, TIGHTS, SHIRTS, JERSEYS, HEADBANDS, AND HATS (U.S. CLS. 22 AND 39).
FIRST USE 8-1-1992; IN COMMERCE 8-1-1992.
MIDGE BUTLER, EXAMINING ATTORNEY

SN 77-073,177. NTA ENTERPRISES, INC, PITTSBURGH, PA. FILED 12-29-2006.

HUNTWORTH

THE MARK CONSISTS OF STANDARD CHARACTERS WITHOUT CLAIM TO ANY PARTICULAR FONT, STYLE, SIZE, OR COLOR.

SEC. 2(F).
FOR BIB OVERALLS; EAR MUFFS; GLOVES; HATS; HUNTING VESTS; JACKETS; MUFFS; OVERALLS; PANTS; SCARVES; SOCKS; VESTS (U.S. CLS. 22 AND 39).
FIRST USE 10-1-2000; IN COMMERCE 10-1-2000.
KELLY BOULTON, EXAMINING ATTORNEY

SN 77-079,307. HARMONY, LLP, MINNEAPOLIS, MN. FILED 1-9-2007.

Peace Baby

THE MARK CONSISTS OF STANDARD CHARACTERS WITHOUT CLAIM TO ANY PARTICULAR FONT, STYLE, SIZE, OR COLOR.

NO CLAIM IS MADE TO THE EXCLUSIVE RIGHT TO USE "BABY", APART FROM THE MARK AS SHOWN.
FOR CLOTHING NAMELY, SHIRTS, PANTS, HATS, SKIRTS, DRESSES, SLEEPWEAR AND OUTERWEAR, NAMELY, COATS, JACKETS AND PARKAS (U.S. CLS. 22 AND 39).

WOODROW HARTZOG, EXAMINING ATTORNEY

CLASS 25—(Continued).

SN 77-081,131. K & S SPORTSWEAR, INC., SOUTH HACKENSACK, NJ. FILED 1-11-2007.

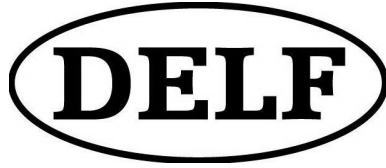

FOR CLOTHING, NAMELY, SHIRTS, PANTS, JACKETS, HATS, T-SHIRTS, SHORT, AND SWEATERS (U.S. CLS. 22 AND 39).
 FIRST USE 9-28-1999; IN COMMERCE 9-28-1999.
 ALICIA COLLINS, EXAMINING ATTORNEY

SN 77-090,560. ROSSON, CAROL L., LAKEWOOD, CA. FILED 1-24-2007.

...LEE ROY...

THE MARK CONSISTS OF STANDARD CHARACTERS WITHOUT CLAIM TO ANY PARTICULAR FONT, STYLE, SIZE, OR COLOR.
 FOR CLOTHING AND APPAREL, NAMELY SHIRTS, T-SHIRTS AND JACKETS (U.S. CLS. 22 AND 39).
 FIRST USE 1-1-2007; IN COMMERCE 1-1-2007.
 JOHN DWYER, EXAMINING ATTORNEY

SN 77-091,139. SUTTON CREATIONS INC., NEW YORK, NY. FILED 1-25-2007.

WATERBURY CLASSICS

THE MARK CONSISTS OF STANDARD CHARACTERS WITHOUT CLAIM TO ANY PARTICULAR FONT, STYLE, SIZE, OR COLOR.
 NO CLAIM IS MADE TO THE EXCLUSIVE RIGHT TO USE "CLASSICS", APART FROM THE MARK AS SHOWN.
 FOR KNIT SHIRTS; SHORTS; SPORT COATS; SPORT SHIRTS; SPORTS JACKETS; SPORTS SHIRTS; SWEATERS; TOPS (U.S. CLS. 22 AND 39).
 AMY ALFIERI, EXAMINING ATTORNEY

CLASS 25—(Continued).

SN 77-094,384. ARIZONA SUPER BOWL HOST COMMITTEE, PHOENIX, AZ. FILED 1-30-2007.

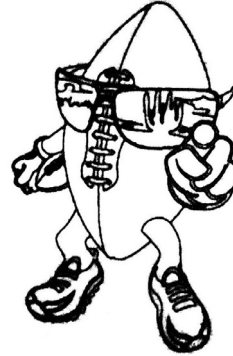

THE MARK CONSISTS OF A DESIGN OF A PERSONIFIED FOOTBALL WEARING SUNGLASSES AND SNEAKERS; AND HOLDING A SMALLER FOOTBALL.
 FOR MEN'S, WOMEN'S AND CHILDREN'S CLOTHING, NAMELY, JERSEYS, CAPS, SHIRTS, HATS, T-SHIRTS, SWEATSHIRTS, SHIRTS, GOLF SHIRTS (U.S. CLS. 22 AND 39).
 BERNICE MIDDLETON, EXAMINING ATTORNEY

SN 77-097,173. IKIZ, CENK, NEW YORK, NY. FILED 2-1-2007.

NEVER NAKED

THE MARK CONSISTS OF STANDARD CHARACTERS WITHOUT CLAIM TO ANY PARTICULAR FONT, STYLE, SIZE, OR COLOR.
 FOR CLOTHING, NAMELY, SHIRTS, PANTS AND UNDERWEAR FOR MEN, WOMEN, BOYS AND GIRLS (U.S. CLS. 22 AND 39).
 FIRST USE 1-1-2007; IN COMMERCE 1-1-2007.
 KHANH LE, EXAMINING ATTORNEY

SN 77-099,756. SAN MAR CORPORATION, PRESTON, WA. FILED 2-5-2007.

TEKLON

THE MARK CONSISTS OF STANDARD CHARACTERS WITHOUT CLAIM TO ANY PARTICULAR FONT, STYLE, SIZE, OR COLOR.
 FOR NYLON FABRIC SOLD AS AN INTEGRAL COMPONENT OF CLOTHING, NAMELY, JACKETS AND COATS (U.S. CLS. 22 AND 39).
 FIRST USE 4-21-2000; IN COMMERCE 4-21-2000.
 CHRISTOPHER BUONGIORNO, EXAMINING ATTORNEY

CLASS 25—(Continued).

SN 77-102,729. TIMOTHY D. HUDDLESTON, LLC., HIGH SPRINGS, FL. FILED 2-8-2007.

GOT SWAGGER

THE MARK CONSISTS OF STANDARD CHARACTERS WITHOUT CLAIM TO ANY PARTICULAR FONT, STYLE, SIZE, OR COLOR.

FOR BERMUDA SHORTS; BOARD SHORTS; BOXER SHORTS; BUTTON-FRONT ALOHA SHIRTS; CAMP SHIRTS; CAPRI PANTS; CARGO PANTS; DENIMS; DRESS SHIRTS; FLEECE SHORTS; GOLF SHIRTS; GYM SHORTS; HAT BANDS; HATS; JOGGING PANTS; KNIT SHIRTS; NIGHT SHIRTS; NON-DISPOSABLE CLOTH TRAINING PANTS; NURSE PANTS; OPEN-NECKED SHIRTS; PANTIES, SHORTS AND BRIEFS; PANTS; PIQUE SHIRTS; POLO SHIRTS; RUGBY SHORTS; SHIRT FRONTS; SHIRT YOKES; SHIRTS; SHIRTS FOR SUITS; SHORT OVERCOAT FOR KIMONO (HAORI); SHORT SETS; SHORT TROUSERS; SHORT-SLEEVED OR LONG-SLEEVED T-SHIRTS; SHORT-SLEEVED SHIRTS; SHORTS; SKI PANTS; SLEEP SHIRTS; SLIDING SHORTS; SMALL HATS; SNOW PANTS; SNOWBOARD PANTS; SPORT SHIRTS; SPORTS SHIRTS; SPORTS SHIRTS WITH SHORT SLEEVES; SWEAT PANTS; SWEAT SHIRTS; SWEAT SHORTS; T-SHIRTS; TAP PANTS; TOBOGGAN HATS, PANTS AND CAPS; TRACK PANTS; WALKING SHORTS; WATER-PROOF JACKETS AND PANTS; WIND SHIRTS (U.S. CLS. 22 AND 39).

FIRST USE 2-1-2007; IN COMMERCE 4-12-2007.
TRACY CROSS, EXAMINING ATTORNEY

SN 77-108,348. BLIND MELON, NEW YORK, NY. FILED 2-15-2007.

BLIND MELON

THE MARK CONSISTS OF STANDARD CHARACTERS WITHOUT CLAIM TO ANY PARTICULAR FONT, STYLE, SIZE, OR COLOR.

SEC. 2(F).

FOR CLOTHING FOR MEN, WOMEN AND CHILDREN, NAMELY, SHIRTS, T-SHIRTS, SWEATSHIRTS, BLOUSES, PULLOVERS, TANK TOPS, JACKETS, PARKAS, COATS, SWEATERS, VESTS, PANTS, SWEAT-PANTS, SHORTS, BOTTOMS, SKIRTS, DRESSES; FASHION ACCESSORIES, NAMELY, HATS, CAPS, VISORS, HEADBANDS, WRISTBANDS, HOODS, SCARVES, BANDANAS, MUFFLERS AND BELTS; UNDERWEAR, NAMELY, BOXER SHORTS, UNDERSHORTS, UNDER-PANTS, BRAS, SOCKS, HOSIERY; SWIM WEAR; BEACHWEAR (U.S. CLS. 22 AND 39).

FIRST USE 1-15-1992; IN COMMERCE 1-15-1992.
GIANCARLO CASTRO, EXAMINING ATTORNEY

CLASS 25—(Continued).

SN 77-112,804. GURU DENIM INC., VERNON, CA. FILED 2-21-2007.



OWNER OF U.S. REG. NO. 3,147,244.

THE MARK CONSISTS OF A STYLIZED REPRESENTATION OF THE LETTER "U".

FOR APPAREL, NAMELY JEANS, PANTS, SKIRTS, SHORTS, OVERALLS, DRESSES, JACKETS, COATS, SWEATERS, SHIRTS, T-SHIRTS, TOPS, HATS, FOOTWEAR, SWIMWEAR (U.S. CLS. 22 AND 39).

LINDA M. KING, EXAMINING ATTORNEY

SN 77-112,885. GURU DENIM INC., VERNON, CA. FILED 2-21-2007.

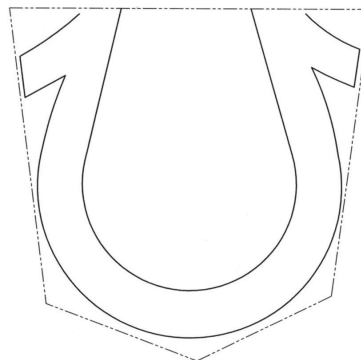

OWNER OF U.S. REG. NO. 3,147,244.

THE MARK CONSISTS OF A STITCHING DESIGN ON THE POCKET OF A GARMENT WHICH INCLUDES A STYLIZED REPRESENTATION OF THE LETTER "U." THE BROKEN LINES ARE USED TO INDICATE THE POSITIONING OF THE MARK ON THE GOODS AND ARE NOT A FEATURE OF THE MARK.

FOR APPAREL, NAMELY JEANS, PANTS, SKIRTS, SHORTS, JACKETS, COATS, SWEATERS, SHIRTS, TOPS (U.S. CLS. 22 AND 39).

LINDA M. KING, EXAMINING ATTORNEY

CLASS 25—(Continued).

SN 77-113,531. MARGO J. CICCI, FINLEYVILLE, PA. FILED 2-22-2007.

THE SUIT CHICK

THE MARK CONSISTS OF STANDARD CHARACTERS WITHOUT CLAIM TO ANY PARTICULAR FONT, STYLE, SIZE, OR COLOR.

NO CLAIM IS MADE TO THE EXCLUSIVE RIGHT TO USE "SUIT", APART FROM THE MARK AS SHOWN.

FOR CLOTHING, NAMELY, T-SHIRTS, BODYBUILDING COMPETITION BIKINIS, FIGURE COMPETITION BIKINIS, FITNESS COMPETITION BIKINIS AND ONE-PIECE COMPETITION SUITS (U.S. CLS. 22 AND 39).

DAVID TAYLOR, EXAMINING ATTORNEY

CLASS 25—(Continued).

SN 77-114,126. GURU DENIM INC., VERNON, CA. FILED 2-22-2007.

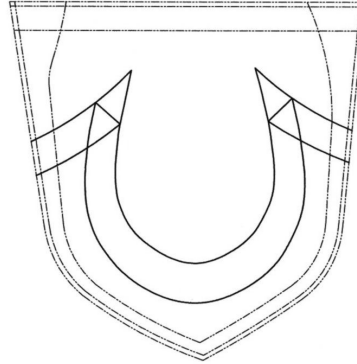

OWNER OF U.S. REG. NO. 3,147,244.

THE MARK CONSISTS OF A POCKET STITCHING DESIGN ON A GARMENT WHICH IS A STYLIZED REPRESENTATION OF THE LETTER "U." THE BROKEN LINES ARE USED TO INDICATE THE POSITIONING OF THE MARK ON THE GOODS AND ARE NOT A FEATURE OF THE MARK.

FOR APPAREL, NAMELY JEANS, PANTS, SKIRTS, SHORTS, JACKETS, COATS, SWEATERS, SHIRTS, TOPS (U.S. CLS. 22 AND 39).

LINDA M. KING, EXAMINING ATTORNEY

SN 77-113,843. GURU DENIM INC., VERNON, CA. FILED 2-22-2007.

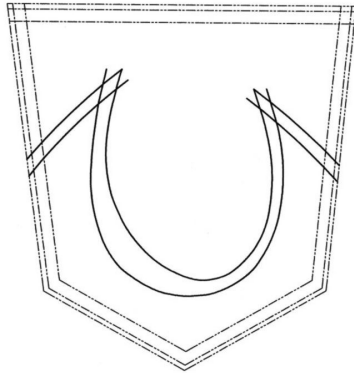

SN 77-114,467. DOWNEAST OUTFITTERS, INC., SALT LAKE CITY, UT. FILED 2-23-2007.

Downeast Basics

OWNER OF U.S. REG. NO. 3,147,244.

THE MARK CONSISTS OF A POCKET STITCHING DESIGN ON A GARMENT WHICH IS A STYLIZED REPRESENTATION OF THE LETTER "U." THE BROKEN LINES ARE USED TO INDICATE THE POSITIONING OF THE MARK ON THE GOODS AND ARE NOT A FEATURE OF THE MARK.

FOR APPAREL, NAMELY JEANS, PANTS, TROUSERS, SKIRTS, SHORTS, OVERALLS, JACKETS, SHIRTS (U.S. CLS. 22 AND 39).

LINDA M. KING, EXAMINING ATTORNEY

THE MARK CONSISTS OF STANDARD CHARACTERS WITHOUT CLAIM TO ANY PARTICULAR FONT, STYLE, SIZE, OR COLOR.

NO CLAIM IS MADE TO THE EXCLUSIVE RIGHT TO USE "BASICS", APART FROM THE MARK AS SHOWN.

FOR CAMISOLES; SHIRTS (U.S. CLS. 22 AND 39). FIRST USE 4-1-2005; IN COMMERCE 4-1-2005.

CHRIS DONINGER, EXAMINING ATTORNEY

CLASS 25—(Continued).

SN 77-114,558. RINGER ATHLETIC APPAREL, PHILADELPHIA, PA. FILED 2-23-2007.



NO CLAIM IS MADE TO THE EXCLUSIVE RIGHT TO USE ATHLETIC, APART FROM THE MARK AS SHOWN.
FOR HATS; JACKETS; SHIRTS; SWEAT SHIRTS; T-SHIRTS (U.S. CLS. 22 AND 39).
FIRST USE 12-1-2005; IN COMMERCE 11-29-2006.
JORDAN BAKER, EXAMINING ATTORNEY

SN 77-115,540. SPERBER, JOSHUA D, BERKELEY, CA. AND MANDEL, LEV L, BERKELEY, CA. FILED 2-24-2007.

YABASTA

THE MARK CONSISTS OF STANDARD CHARACTERS WITHOUT CLAIM TO ANY PARTICULAR FONT, STYLE, SIZE, OR COLOR.
THE ENGLISH TRANSLATION OF YABASTA IS "ENOUGH ALREADY" OR "ENOUGH IS ENOUGH".
FOR HEADWEAR (U.S. CLS. 22 AND 39).
FIRST USE 8-6-2005; IN COMMERCE 11-10-2006.
PAUL CROWLEY, EXAMINING ATTORNEY

CLASS 25—(Continued).

SN 77-115,997. SHERMAN, NEIL, STONY POINT, NY. FILED 2-26-2007.



THE MARK CONSISTS OF THE WORDING WASTED TALENT IN STYLIZED TEXT.
FOR BELTS; BLOUSES; DRESSES; HATS; JACKETS; PANTS; PULLOVERS; SHIRTS; SHOES; SOCKS; SWEAT SHIRTS; SWEATERS; TANK TOPS; UNDERGARMENTS; UNDERWEAR (U.S. CLS. 22 AND 39).
TIMOTHY FINNEGAN, EXAMINING ATTORNEY

SN 77-116,412. NASHVILLE SOUNDS BASEBALL CLUB LIMITED PARTNERSHIP, NASHVILLE, TN. FILED 2-26-2007.



NO CLAIM IS MADE TO THE EXCLUSIVE RIGHT TO USE "NASHVILLE", APART FROM THE MARK AS SHOWN.

THE MARK CONSISTS OF THE DESIGN OF A SEAL CONTAINING THE WORD "NASHVILLE", THE SILHOUETTE OF A BASEBALL PLAYER WITH A BAT AND BALL, CITY SKYLINE, AND THE UNDERLINED WORD "SOUNDS".

FOR CLOTHING; NAMELY, SHIRTS, SHORTS, T-SHIRTS, POLO SHIRTS, GOLF SHIRTS, TANK TOPS, SOCKS, JACKETS, SWEATERS, VESTS, VISORS, HATS, CAPS, SWEATSHIRTS, WRIST BANDS, WIND RESISTANT JACKETS, SWEATPANTS, GYM SUITS, HEADWEAR, JERSEYS, PULLOVERS, V-NECK SWEATERS AND KNIT SHIRTS (U.S. CLS. 22 AND 39).
FIRST USE 10-1-2005; IN COMMERCE 10-1-2005.
DAVID C. REIHNER, EXAMINING ATTORNEY

CLASS 25—(Continued).

SN 77-116,587. GURU DENIM INC., VERNON, CA. FILED 2-26-2007.

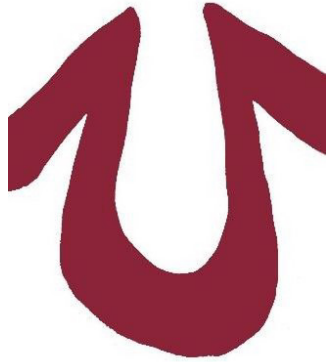

OWNER OF U.S. REG. NO. 3,127,244.
THE COLOR(S) RED IS/ARE CLAIMED AS A FEATURE OF THE MARK.

THE MARK CONSISTS OF A STYLIZED REPRESENTATION OF THE LETTER "U" IN THE COLOR RED.

FOR APPAREL, NAMELY JEANS, PANTS, TROUSERS, SKIRTS, SHORTS, DRESSES, JACKETS, COATS, SWEATERS, SHIRTS, T-SHIRTS, TOPS, HATS, FOOTWEAR, SWIMWEAR (U.S. CLS. 22 AND 39).

LINDA M. KING, EXAMINING ATTORNEY

SN 77-116,790. GORDON, JUDY C., DULUTH, MN. FILED 2-27-2007.

MINNESOTA NICE

THE MARK CONSISTS OF STANDARD CHARACTERS WITHOUT CLAIM TO ANY PARTICULAR FONT, STYLE, SIZE, OR COLOR.

NO CLAIM IS MADE TO THE EXCLUSIVE RIGHT TO USE "MINNESOTA", APART FROM THE MARK AS SHOWN.

FOR CLOTHING, NAMELY, BANDANAS, BASEBALL CAPS, BEACH COVERUPS, BOXER SHORTS, CAPS, CARDIGANS, DENIM JACKETS, FLEECE PULLOVERS, NIGHT GOWNS, GYM SHORTS, HATS, HEADBANDS, PAJAMAS, POLO SHIRTS, PONCHOS, SCARVES, SHAWLS, SHIRTS, SHORTS, SLEEP SHIRTS, SLEEPWEAR, SOCKS, SUN VISORS, SWEATBANDS, SWEAT PANTS, SWEAT SHIRTS, SWEAT SHORTS, SWEAT SUITS, SWEATERS, TANK TOPS, TOPS, TURTLENECKS, VISORS, EAR MUFFS, JACKETS, T-SHIRTS, BLOUSES, PANTS (U.S. CLS. 22 AND 39).

MORENO, PAUL, EXAMINING ATTORNEY

CLASS 25—(Continued).

SN 77-120,936. SYL, LLC, WILMINGTON, DE. FILED 3-2-2007.

**STANLEY B. BY STANLEY
BLACKER**

THE MARK CONSISTS OF STANDARD CHARACTERS WITHOUT CLAIM TO ANY PARTICULAR FONT, STYLE, SIZE, OR COLOR.

OWNER OF U.S. REG. NOS. 2,359,880, 2,862,769 AND OTHERS.

"THE NAME(S), PORTRAIT(S), AND/OR SIGNATURE(S) SHOWN IN THE MARK DOES NOT IDENTIFY A PARTICULAR LIVING INDIVIDUAL."

FOR WEARING APPAREL FOR MEN, LADIES, BOYS AND GIRLS, NAMELY, TIES, RAINWEAR, SHORTS, SKIRTS, PANTS, HOSIERY, JEANS, ROBES, SHOES, COATS, JACKETS, SWEATERS, SUITS, SLACKS, BLOUSES AND DRESSES (U.S. CLS. 22 AND 39).

BRENDAN REGAN, EXAMINING ATTORNEY

SN 77-121,599. JR, RIVERA, JUAN, R, READING, PA. FILED 3-2-2007.



D'Corá Wear

NO CLAIM IS MADE TO THE EXCLUSIVE RIGHT TO USE "WEAR", APART FROM THE MARK AS SHOWN.

THE MARK CONSISTS OF STYLIZED D WITH AN W INSIDE OF IT ARE IN BLACK AND WHITE .

"THE FOREIGN WORDING IN THE MARK TRANSLATES INTO ENGLISH AS THE WORD D'CORÁ DOES NOT HAVE ANY IDENTIFIABLE MEANING OF ITS OWN AND IS NOT A WORD AS RECOGNIZED BY THE ROYAL ACADEMY OF THE SPANISH LANGUAGE (RAE). THE CONCEPTUAL MEANING OF THE WORD IN SPANISH IS ALONG THE LINES OF "HIP URBAN LATIN ORIENTED LIFESTYLE BASED AROUND LATINOS AND REGGAE-TON (LATIN HIP HOP) MUSIC". D'CORÁ IS AN IDIOMATIC EXPRESSION WHICH HAS NOT TRUE TRANSLATION INTO ENGLISH.."

FOR CAPS; CHILDREN'S HEADWEAR; COATS FOR MEN AND WOMEN; FOOTWEAR FOR MEN; FOOTWEAR FOR MEN AND WOMEN; HEADWEAR; HEAVY JACKETS; INFANTS' SHOES AND BOOTS; JACKETS; JEANS; MEN'S AND WOMEN'S JACKETS, COATS, TROUSERS, VESTS; PANTS; SHOES; T-SHIRTS; TANK TOPS; WOMEN'S SHOES (U.S. CLS. 22 AND 39).

ROBIN CHOSID, EXAMINING ATTORNEY

CLASS 25—(Continued).

SN 77-123,183. OVERSEAS DEVELOPMENT CORP, SAN DIEGO, CA. FILED 3-6-2007.

Cuddle Me Fleece

NO CLAIM IS MADE TO THE EXCLUSIVE RIGHT TO USE "FLEECE", APART FROM THE MARK AS SHOWN.
THE MARK CONSISTS OF THE FONT KRISTEN ITC., FOR LOUNGEWEAR; PAJAMAS; ROBES (U.S. CLS. 22 AND 39).
FIRST USE 2-5-2007; IN COMMERCE 2-5-2007.
REBECCA HAN, EXAMINING ATTORNEY

SN 77-123,665. JOHNSON, KILO M., OCEANSIDE, CA. FILED 3-6-2007.

Cellar Door Clothing

THE MARK CONSISTS OF STANDARD CHARACTERS WITHOUT CLAIM TO ANY PARTICULAR FONT, STYLE, SIZE, OR COLOR.
NO CLAIM IS MADE TO THE EXCLUSIVE RIGHT TO USE CLOTHING, APART FROM THE MARK AS SHOWN.
FOR JACKETS; SHIRTS; PANTS (U.S. CLS. 22 AND 39).
CHARLOTTE CORWIN, EXAMINING ATTORNEY

SN 77-124,985. STRATEGIC CONSULTING NETWORK, LLC, DBA, JASSIN-O'ROURKE, NEW YORK, NY. FILED 3-7-2007.

FIVE EASY PIECES

THE MARK CONSISTS OF STANDARD CHARACTERS WITHOUT CLAIM TO ANY PARTICULAR FONT, STYLE, SIZE, OR COLOR.
FOR CLOTHING FOR BOTH MEN AND WOMEN, NAMELY, SWIMWEAR, LINGERIE, FOOTWEAR, OUTERWEAR AND UNDERWEAR FOR WOMEN, MEN, AND CHILDREN, NAMELY, SUITS, DRESSES, TROUSERS, JEANS, SKIRTS, BLOUSES, COATS, OVERCOATS, RAINCOATS, PARKAS, JACKETS, VESTS; KNITWEAR, NAMELY, PULLOVERS, JERSEYS, JUMPERS, SWEATERS, OVERALLS, PANTS, HOSIERY, SOCKS AND STOCKINGS; DRESSING GOWNS; PAJAMAS; BATHING SUITS, BATHING CAPS; ROBES; CLOTHING ACCESSORIES, NAMELY, NECKTIES, SUSPENDERS, BELTS, HATS AND CAPS, SCARVES, SHAWLS, GLOVES, MUFFS; FOOTWEAR, NAMELY SHOES, BOOTS, SANDALS, AND SLIPPERS (U.S. CLS. 22 AND 39).
FRANK LATTUCA, EXAMINING ATTORNEY

CLASS 25—(Continued).

SN 77-125,892. PETTI, LIANNA, DUMONT, NJ. FILED 3-8-2007.

MAMMASAN

THE MARK CONSISTS OF STANDARD CHARACTERS WITHOUT CLAIM TO ANY PARTICULAR FONT, STYLE, SIZE, OR COLOR.
FOR NURSING APPAREL, NAMELY, A NURSING COVER (U.S. CLS. 22 AND 39).
SHANNON TWOHIG, EXAMINING ATTORNEY

SN 77-126,024. PERALES, NANCY J., GLENDORA, CA. FILED 3-8-2007.

Bright Light Girls

THE MARK CONSISTS OF STANDARD CHARACTERS WITHOUT CLAIM TO ANY PARTICULAR FONT, STYLE, SIZE, OR COLOR.
NO CLAIM IS MADE TO THE EXCLUSIVE RIGHT TO USE "GIRLS", APART FROM THE MARK AS SHOWN.
FOR CLOTHING, NAMELY, T-SHIRTS, JEANS AND JACKETS (U.S. CLS. 22 AND 39).
SHANNON TWOHIG, EXAMINING ATTORNEY

SN 77-128,359. CMRG APPAREL, LLC, CANTON, MA. FILED 3-12-2007.

OAKHILL
Established 1972

NO CLAIM IS MADE TO THE EXCLUSIVE RIGHT TO USE "ESTABLISHED 1972", APART FROM THE MARK AS SHOWN.
FOR SHIRTS, SWEATERS, VESTS, BLAZERS, PANTS, JEANS, SHORTS, SOCKS, JACKETS, COATS, JOGGING SUITS, SWEATSHIRTS, SWEATPANTS, PULLOVERS, TOPS, SWIMWEAR, PAJAMAS, ROBES, UNDERWEAR, HEADWEAR, HATS, CAPS, BELTS, TIES, AND FOOTWEAR (U.S. CLS. 22 AND 39).
FIRST USE 2-1-2007; IN COMMERCE 2-1-2007.
COLLEEN DOMBROW, EXAMINING ATTORNEY

CLASS 25—(Continued).

SN 77-129,736. OLAES ENTERPRISES, INC., DBA ODM, POWAY, CA. FILED 3-13-2007.

MUSIC IS MY RELIGION

THE MARK CONSISTS OF STANDARD CHARACTERS WITHOUT CLAIM TO ANY PARTICULAR FONT, STYLE, SIZE, OR COLOR.

FOR CLOTHING APPAREL, NAMELY, SHIRTS, TANK TOPS, JERSEYS, SWEATSHIRTS, SWEAT PANTS, LOUNGE PANTS, BOXER SHORTS, DENIM JEANS, JACKETS, HEADWEAR, NAMELY, HATS, CAPS AND BEANIES (U.S. CLS. 22 AND 39).

SEAN CROWLEY, EXAMINING ATTORNEY

SN 77-131,446. SALTWATER SISTERS, LLC, OSTEEN, FL. FILED 3-14-2007.



NO CLAIM IS MADE TO THE EXCLUSIVE RIGHT TO USE ".COM", APART FROM THE MARK AS SHOWN.

THE COLOR(S) BLUE, GREEN, YELLOW, RED, BLACK AND WHITE IS/ARE CLAIMED AS A FEATURE OF THE MARK.

THE MARK CONSISTS OF THE COLOR BLUE WHICH APPEARS IN THE DESIGN OF THE FISH FINS, IN SPOTS ON THE FISH, IN THE FLOWERS AND WAVES AND AS BACKGROUND IN THE OVAL DESIGN. THE COLOR GREEN APPEARS IN THE BODY OF THE FISH. THE COLOR YELLOW APPEARS IN THE BODY OF THE FISH. THE COLOR RED APPEARS IN THE LIPS OF THE FISH. THE COLOR BLACK APPEARS IN THE WORDING "SALT-WATER SISTERS FOR REEL WOMEN BY REEL WOMEN," IN THE EYE OF THE FISH, IN THE PERIOD AND AS A BORDER TO THE OVAL DESIGN. THE COLOR WHITE APPEARS IN THE WORDING ".COM", IN THE OUTLINES OF THE WORDING "SALTWATER SISTERS FOR REEL WOMEN BY REEL WOMEN," IN PARTS OF THE FLOWERS AND AS A RECTANGULAR BACKGROUND TO THE MARK.

FOR SHIRTS; HATS; SHORTS; PANTS; JACKETS; VISORS (U.S. CLS. 22 AND 39).

NATALIE POLZER, EXAMINING ATTORNEY

CLASS 25—(Continued).

SN 77-131,903. L.C. LICENSING, INC., NEW YORK, NY. FILED 3-15-2007.



OWNER OF U.S. REG. NOS. 2,093,751, 2,351,411 AND 3,143,636.

THE MARK CONSISTS OF OF INTERLOCKING E'S WITH STYLIZED ENYCE.

FOR SHOES (U.S. CLS. 22 AND 39).

CHARLES L. JENKINS, EXAMINING ATTORNEY

SN 77-132,155. ALBEMARLE ASSOCIATES, LLC., NEW YORK, NY. FILED 3-15-2007.



NO CLAIM IS MADE TO THE EXCLUSIVE RIGHT TO USE "LONDON", APART FROM THE MARK AS SHOWN.

THE NAME "RUFUS ALBEMARLE" IDENTIFIES A LIVING INDIVIDUAL WHOSE CONSENT IS OF RECORD.

THE MARK CONSISTS OF A BLACK AND WHITE PROFILE IMAGE OF A STYLIZED SWAN RESTING ON TOP OF A FRONTAL IMAGE OF A STYLIZED CROWN. BENEATH THE CROWN, THE IMAGE OF THE WORD "ALBEMARLE" APPEARS IN STYLIZED FORM. BENEATH THE WORD "ALBEMARLE" IS THE WORD "LONDON".

FOR MEN'S SHIRTS, TOPS, SWEATERS, JACKETS, PANTS, SUITS, BOTTOMS, SOCKS, HATS AND CAPS; SHOES; SHORTS, COATS, NECKTIES, UNDERWEAR, VESTS, ROBES, LOUNGEWEAR, RAINWEAR, TROUSERS, ASCOTS, TIES, OUTER SHIRTS INCLUDING EVENING, DRESS, POLO AND SPORTS SHIRTS, COLLARS, PAJAMAS, ROBES, SMOKING JACKETS, DRESSING GOWNS, MUFFLERS, GLOVES, HOSE, BELTS, SUSPENDERS, GARTERS, BOOTS, SLIPPERS, SHOES, OVERSHOES, BEACH WEAR, SWIMWEAR, AND FORMAL WEAR, NAMELY, JACKETS, PANTS, SUITS, SHIRTS, SHOES, CUMMERBUNDS, TIES, SUSPENDERS AND GOWNS (U.S. CLS. 22 AND 39).

FIRST USE 2-28-2007; IN COMMERCE 2-28-2007.

KATHERINE STOIDES, EXAMINING ATTORNEY

CLASS 25—(Continued).

SN 77-133,631. CHESTNUT, ROBERT, SANTA CLARITA, CA.
FILED 3-16-2007.

RACEGIRL

THE MARK CONSISTS OF STANDARD CHARACTERS WITHOUT CLAIM TO ANY PARTICULAR FONT, STYLE, SIZE, OR COLOR.

OWNER OF U.S. REG. NOS. 2,585,810, 2,721,684 AND 2,988,926.

FOR CAPS; JERSEYS; LEATHER BELTS; SHORT SETS; TOPS; SHIRTS; SHORTS; JACKETS; BLOUSES; CAPS WITH VISORS; CROP TOPS; HAT BANDS; HATS; KNITTED CAPS; SWEAT BANDS; SWEAT PANTS; TANK TOPS; VISORS (U.S. CLS. 22 AND 39).

FIRST USE 5-28-1996; IN COMMERCE 5-28-1996.
B. PARADEWELAI, EXAMINING ATTORNEY

SN 77-134,217. ZONA ENTERPRISES INC., DANIA BEACH, FL. FILED 3-19-2007.



THE MARK CONSISTS OF THE STYLIZED TERMS OFFICIAL ZONKERS AND PARTIAL IMAGES OF SEVERAL GAME BALLS WITHIN A CREST OR SHIELD.

FOR HEADGEAR, NAMELY, CAPS, HATS; FOOTWEAR; JACKETS; PAJAMAS; PANTS; SHIRTS; SOCKS; T-SHIRTS (U.S. CLS. 22 AND 39).

WARREN L. OLANDRIA, EXAMINING ATTORNEY

CLASS 25—(Continued).

SN 77-134,448. ARCADE FIRE MUSIC LLC, LOS ANGELES, CA. FILED 3-19-2007.

THE ARCADE FIRE

THE MARK CONSISTS OF STANDARD CHARACTERS WITHOUT CLAIM TO ANY PARTICULAR FONT, STYLE, SIZE, OR COLOR.

FOR CLOTHING, NAMELY, SHIRTS, UNDER SHIRTS, NIGHT SHIRTS, RUGBY SHIRTS, POLO SHIRTS, T-SHIRTS, COORDINATED SHIRTS AND PANTS, JERSEYS, UNIFORMS, ATHLETIC UNIFORMS, PANTS, TROUSERS, SLACKS, JEANS, DENIM JEANS, OVERALLS, COVERALLS, JUMPERS, JUMP SUITS, SHORTS, BOXER SHORTS, TOPS, CROP TOPS, TANK TOPS, HALTER TOPS, SWEAT SHIRTS, SWEAT SHORTS, SWEAT PANTS, WRAPS, WARM-UP SUITS, JOGGING SUITS, BLOUSES, SKIRTS, DRESSES, SWEATERS, VESTS, FLEECE VESTS, PULLOVERS, FLEECE PULLOVERS, SNOW SUITS, PARKAS, ANORAKS, PONCHOS, JACKETS, DINNER JACKETS, SPORTS JACKETS, GOLF AND SKI JACKETS, REVERSIBLE JACKETS, COATS, BLAZERS, SUITS, TURTLENECKS, SWIMWEAR, BEACHWEAR, CAPS, BERETS, HATS, HEADBANDS, WRISTBANDS, SWEAT BANDS, HEADWEAR, EAR MUFFS, APRONS, SCARVES, BANDANAS, BELTS, SUSPENDERS, NECKWEAR, NECKTIES, TIES, UNDERWEAR, BRIEFS, TRUNKS, BRAS, SPORTS BRAS, SINGLET, SOCKS, LOUNGEWEAR, ROBES, BATHROBES, UNDERCLOTHES, PAJAMAS, THERMAL UNDERWEAR, SLEEPWEAR, NIGHT GOWNS, LINGERIE, CAMISOLES, HOSIERY, SLIPS, LEG WARMERS, BODY-SUITS, LEGGINGS, TIGHTS, LEOTARDS, UNITARDS, GLOVES, MITTENS, FOOTWEAR, SHOES, TENNIS SHOES, SNEAKERS, BOOTS, GALOSHES, SANDALS, ZORI, SLIPPERS AND RAINWEAR (U.S. CLS. 22 AND 39).

LEIGH CAROLINE CASE, EXAMINING ATTORNEY

SN 77-134,710. SEENO, JACQUELINE MICHELLE, OAKLAND, CA. FILED 3-19-2007.

RUACH UNLIMITED

THE MARK CONSISTS OF STANDARD CHARACTERS WITHOUT CLAIM TO ANY PARTICULAR FONT, STYLE, SIZE, OR COLOR.

"RUACH" IS A HEBREW WORD MEANING "SPIRIT" OR "BREATH".

FOR JACKETS; PARKAS; PONCHOS; BLAZERS; DRESS SUITS; COATS; OVERALLS; SWEAT SUITS; SHORTS; BATHING SUITS; COVERUPS; SLEEPING GARMENTS; ROBES; UNDERSHIRTS; BRAS; PANTIES; WOMEN'S UNDERWEAR; SHIRTS; T-SHIRTS; SWEAT SHIRTS; TANK TOPS; SWEATERS; TUNICS; TOPS; BLOUSES; SKIRTS; DRESSES; BELTS; GLOVES; MITTENS; BEANIES; CAPS; HATS; SCARVES; SASHES; HEADBANDS; BANDANAS; SHAWLS; PANTS; TROUSERS; JEANS; CAPRI PANTS; SLACKS; SHOES; SANDALS; FOOTWEAR, NAMELY, PUMPS; THONGS; INFANT AND TODDLER ONE PIECE CLOTHING (U.S. CLS. 22 AND 39).

SONYA STEPHENS, EXAMINING ATTORNEY

CLASS 25—(Continued).

SN 77-135,104. SPAGNUOLO, TAMMY L., PALM BEACH GARDENS, FL. FILED 3-20-2007.

POCKET OF KISSES

THE MARK CONSISTS OF STANDARD CHARACTERS WITHOUT CLAIM TO ANY PARTICULAR FONT, STYLE, SIZE, OR COLOR.

FOR CAPRI PANTS; DENIMS; PANTS; BLOUSES; CROP TOPS; HALTER TOPS; TANK TOPS; TOPS; SHIRTS; T-SHIRTS (U.S. CLS. 22 AND 39).

CARYN GLASSER, EXAMINING ATTORNEY

SN 77-135,211. MINNESOTA VIKINGS FOOTBALL, LLC, EDEN PRAIRIE, MN. FILED 3-20-2007.

VIKINGS

THE MARK CONSISTS OF STANDARD CHARACTERS WITHOUT CLAIM TO ANY PARTICULAR FONT, STYLE, SIZE, OR COLOR.

OWNER OF U.S. REG. NOS. 997,180, 1,878,590 AND OTHERS.

FOR MEN'S, WOMEN'S AND CHILDREN'S CLOTHING, NAMELY, FLEECE TOPS AND BOTTOMS, HEADWEAR, CAPS, KNIT HATS, T-SHIRTS, SWEATSHIRTS, SHORTS, TANK TOPS, SWEATERS, PANTS, JACKETS, GOLF SHIRTS, KNIT SHIRTS, JERSEYS, WRISTBANDS, WARM-UP SUITS, TIES, SLEEPWEAR, NAMELY, PAJAMAS, HEADBANDS AND UNDERWEAR (U.S. CLS. 22 AND 39).

FIRST USE 9-0-1981; IN COMMERCE 9-0-1981.

MICHAEL TANNER, EXAMINING ATTORNEY

SN 77-135,794. JEWELL, MICHAEL, ZURICH, SWITZERLAND, FILED 3-20-2007.

UNMANIPULATED

THE MARK CONSISTS OF STANDARD CHARACTERS WITHOUT CLAIM TO ANY PARTICULAR FONT, STYLE, SIZE, OR COLOR.

FOR CLOTHING, NAMELY T-SHIRTS, HATS, JACKETS, PANTS, SWEATSHIRTS, AND SHORTS (U.S. CLS. 22 AND 39).

WILLIAM BRECKENFELD, EXAMINING ATTORNEY

CLASS 25—(Continued).

SN 77-135,985. OLAES ENTERPRISES, INC., DBA ODM, POWAY, CA. FILED 3-20-2007.

MUSIC IS MY NATURE

THE MARK CONSISTS OF STANDARD CHARACTERS WITHOUT CLAIM TO ANY PARTICULAR FONT, STYLE, SIZE, OR COLOR.

FOR CLOTHING APPAREL, NAMELY SHIRTS (U.S. CLS. 22 AND 39).

FIRST USE 10-31-2006; IN COMMERCE 10-31-2006.

SEAN CROWLEY, EXAMINING ATTORNEY

SN 77-136,132. DONALD SEUNG-YEUP RHEE, PARAMOUNT, CA. FILED 3-21-2007.

FLIP-POPS

THE MARK CONSISTS OF STANDARD CHARACTERS WITHOUT CLAIM TO ANY PARTICULAR FONT, STYLE, SIZE, OR COLOR.

FOR SANDALS AND SHOES (U.S. CLS. 22 AND 39).

TASHIA BUNCH, EXAMINING ATTORNEY

SN 77-137,316. SKATERHEAD, LLC, FARMINGTON HILLS, MI. FILED 3-22-2007.

SKATERHEAD

THE MARK CONSISTS OF STANDARD CHARACTERS WITHOUT CLAIM TO ANY PARTICULAR FONT, STYLE, SIZE, OR COLOR.

FOR CLOTHING, FOOTWEAR AND HEADGEAR, NAMELY, SHIRTS, SWEATSHIRTS, JACKETS, SWEATPANTS, SHORTS, SHOES AND HATS (U.S. CLS. 22 AND 39).

KATHLEEN LORENZO, EXAMINING ATTORNEY

CLASS 25—(Continued).

SN 77-138,102. ROYAL HAWAIIAN SURF ACADEMY LIMITED, LAHAINA, HI. FILED 3-22-2007.

ROYAL HAWAIIAN SURF ACADEMY

THE MARK CONSISTS OF STANDARD CHARACTERS WITHOUT CLAIM TO ANY PARTICULAR FONT, STYLE, SIZE, OR COLOR.

NO CLAIM IS MADE TO THE EXCLUSIVE RIGHT TO USE "HAWAIIAN", APART FROM THE MARK AS SHOWN. FOR T-SHIRTS; HATS (U.S. CLS. 22 AND 39). FIRST USE 1-13-2000; IN COMMERCE 9-1-2005. ALLISON SCHRODY, EXAMINING ATTORNEY

SN 77-138,153. ROYAL HAWAIIAN SURF ACADEMY LIMITED, LAHAINA, HI. FILED 3-22-2007.

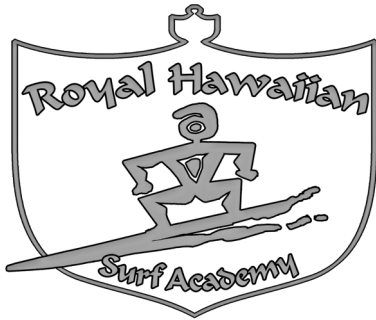

NO CLAIM IS MADE TO THE EXCLUSIVE RIGHT TO USE "HAWAIIAN", APART FROM THE MARK AS SHOWN.

THE MARK CONSISTS OF A CARTOONISH IMAGE OF A PERSON ON A SURFBOARD SURFING ON A WAVE, WITH THE WORDS "ROYAL HAWAIIAN" ABOVE THE PERSON AND THE WORDS "SURF ACADEMY" BELOW THE PERSON, ALL OF WHICH (EXCEPT FOR THE FRONT TIP OF THE SURFBOARD) IS INSIDE AN ESCUTCHEON.

FOR T-SHIRTS; HATS (U.S. CLS. 22 AND 39). FIRST USE 1-13-2000; IN COMMERCE 9-1-2005. ALLISON SCHRODY, EXAMINING ATTORNEY

CLASS 25—(Continued).

SN 77-138,328. BRITT ALLCROFT PRODUCTIONS, LLC, SANTA MONICA, CA. FILED 3-22-2007.

CUBLEY AND THE CITY KIDS

THE MARK CONSISTS OF STANDARD CHARACTERS WITHOUT CLAIM TO ANY PARTICULAR FONT, STYLE, SIZE, OR COLOR.

FOR APPAREL, NAMELY, HEADWEAR, FOOTWEAR, RAINWEAR, LOUNGEWEAR, TOPS AND BOTTOMS, TANK TOPS, CROP-TOPS, T-SHIRTS, SHIRTS, NECKTIES, ASCOTS, SWEATSHIRTS, SWEAT PANTS, SWEAT SUITS, CARDIGANS, SWEATERS, JACKETS, COATS, BLAZERS, SPORT COATS, SLACKS, BLOUSES, JERSEYS, TIES, VESTS, PULLOVERS, PANTS, WORKOUT SUITS, UNDERSHIRTS, JEANS, LEGGINGS, THERMAL UNDERWEAR, SKORTS, SHORTS, SLEEP SHORTS, ROMPERS, TROUSERS, JUMPSUITS, OVERALLS, SKIRTS, DRESSES, JUMPERS, SWIMWEAR, UNITARDS, LEOTARDS, TIGHTS, SLEEPWEAR, PAJAMAS, NIGHTSHIRTS, ROBES, BATH ROBES, NIGHTGOWNS, PONCHOS, SLIPPERS, SLIPPER SOCKS, SOCKS, HOSIERY, BANDANAS, SCARVES, SHAWLS, NECKERCHIEFS, SUSPENDERS, DRESSING GOWNS, APRONS, MUFFLERS, HATS, CAPS, VISORS, HEADBANDS, GLOVES, BELTS, LINGERIE; WOMEN'S UNDERWEAR, NAMELY, BRAS, PANTIES AND THONGS; MEN'S UNDERWEAR, NAMELY, BOXER SHORTS AND BRIEFS; CLOTH BIBS; MASQUERADE COSTUMES AND MASKS SOLD IN CONNECTION THEREWITH (U.S. CLS. 22 AND 39).

CHARISMA HAMPTON, EXAMINING ATTORNEY

SN 77-138,330. BRITT ALLCROFT PRODUCTIONS, LLC, SANTA MONICA, CA. FILED 3-22-2007.

CUBLEY

THE MARK CONSISTS OF STANDARD CHARACTERS WITHOUT CLAIM TO ANY PARTICULAR FONT, STYLE, SIZE, OR COLOR.

FOR APPAREL, NAMELY, HEADWEAR, FOOTWEAR, RAINWEAR, LOUNGEWEAR, TOPS AND BOTTOMS, TANK TOPS, CROP-TOPS, T-SHIRTS, SHIRTS, NECKTIES, ASCOTS, SWEATSHIRTS, SWEAT PANTS, SWEAT SUITS, CARDIGANS, SWEATERS, JACKETS, COATS, BLAZERS, SPORT COATS, SLACKS, BLOUSES, JERSEYS, TIES, VESTS, PULLOVERS, PANTS, WORKOUT SUITS, UNDERSHIRTS, JEANS, LEGGINGS, THERMAL UNDERWEAR, SKORTS, SHORTS, SLEEP SHORTS, ROMPERS, TROUSERS, JUMPSUITS, OVERALLS, SKIRTS, DRESSES, JUMPERS, SWIMWEAR, UNITARDS, LEOTARDS, TIGHTS, SLEEPWEAR, PAJAMAS, NIGHTSHIRTS, ROBES, BATH ROBES, NIGHTGOWNS, PONCHOS, SLIPPERS, SLIPPER SOCKS, SOCKS, HOSIERY, BANDANAS, SCARVES, SHAWLS, NECKERCHIEFS, SUSPENDERS, DRESSING GOWNS, APRONS, MUFFLERS, HATS, CAPS, VISORS, HEADBANDS, GLOVES, BELTS, LINGERIE; WOMEN'S UNDERWEAR, NAMELY, BRAS, PANTIES AND THONGS; MEN'S UNDERWEAR, NAMELY, BOXER SHORTS AND BRIEFS; CLOTH BIBS; MASQUERADE COSTUMES AND MASKS SOLD IN CONNECTION THEREWITH (U.S. CLS. 22 AND 39).

CHARISMA HAMPTON, EXAMINING ATTORNEY

CLASS 25—(Continued).

SN 77-138,359. ROCK MAFIA, LLC, SANTA MONICA, CA.
FILED 3-23-2007.

Rock Mafia

THE MARK CONSISTS OF STANDARD CHARACTERS WITHOUT CLAIM TO ANY PARTICULAR FONT, STYLE, SIZE, OR COLOR.

FOR SHORT-SLEEVED OR LONG-SLEEVED T-SHIRTS; T-SHIRTS; SHORT-SLEEVED SHIRTS; SHORTS; PANTS; HATS (U.S. CLS. 22 AND 39).
PAUL E. FAHRENKOPF, EXAMINING ATTORNEY

SN 77-138,408. PENGUIN GROUP (USA) INC., NEW YORK, NY. FILED 3-23-2007.

THE LITTLE ENGINE THAT COULD

THE MARK CONSISTS OF STANDARD CHARACTERS WITHOUT CLAIM TO ANY PARTICULAR FONT, STYLE, SIZE, OR COLOR.

OWNER OF U.S. REG. NOS. 2,747,009, 3,169,278 AND OTHERS.
FOR CLOTHING, NAMELY, T-SHIRTS AND HATS (U.S. CLS. 22 AND 39).
FIRST USE 5-1-2005; IN COMMERCE 5-1-2005.
C. DIONNE CLYBURN, EXAMINING ATTORNEY

SN 77-138,430. JOHNSON TECHNOLOGIES CORPORATION, NASHVILLE, TN. FILED 3-23-2007.

APPLYING THE SCIENCE OF ERGONOMICS TO FOOTWEAR

THE MARK CONSISTS OF STANDARD CHARACTERS WITHOUT CLAIM TO ANY PARTICULAR FONT, STYLE, SIZE, OR COLOR.

FOR FOOTWEAR; SHOES; SOCKS; SHOE INSERTS FOR PRIMARILY NON-ORTHOPEDIC PURPOSES; INSOLES FOR SHOES AND BOOTS; SHOE SOLES; AND SHOE SOLES FOR REPAIR (U.S. CLS. 22 AND 39).
CHRISTOPHER BUONGIORNO, EXAMINING ATTORNEY

CLASS 25—(Continued).

SN 77-138,434. PENGUIN GROUP (USA) INC., NEW YORK, NY. FILED 3-23-2007.

I THINK I CAN

THE MARK CONSISTS OF STANDARD CHARACTERS WITHOUT CLAIM TO ANY PARTICULAR FONT, STYLE, SIZE, OR COLOR.

OWNER OF U.S. REG. NOS. 2,904,156 AND 2,915,530.
FOR CLOTHING, NAMELY, T-SHIRTS AND HATS (U.S. CLS. 22 AND 39).
FIRST USE 5-1-2005; IN COMMERCE 5-1-2005.
C. DIONNE CLYBURN, EXAMINING ATTORNEY

SN 77-138,486. YOUNG, DENA, SAN JUAN CAPISTRANO, CA. FILED 3-23-2007.

Little Darling Maternity

THE MARK CONSISTS OF STANDARD CHARACTERS WITHOUT CLAIM TO ANY PARTICULAR FONT, STYLE, SIZE, OR COLOR.

NO CLAIM IS MADE TO THE EXCLUSIVE RIGHT TO USE "MATERNITY", APART FROM THE MARK AS SHOWN.
FOR MATERNITY SLEEPWEAR, MATERNITY LINGERIE, SHIRTS, PANTS, JACKETS, SHORTS (U.S. CLS. 22 AND 39).
FRANK LATTUCA, EXAMINING ATTORNEY

SN 77-138,607. FIDO DIDO, INC., CHATHAM, NY. FILED 3-23-2007.



OWNER OF U.S. REG. NOS. 1,433,859, 1,492,151 AND OTHERS.

THE MARK CONSISTS OF A STYLIZED REPRESENTATION OF A HEAD WITH A FACE ABOVE THE WORDS FIDO DIDO.

FOR T-SHIRTS, SWEATSHIRTS, PANT, SOCKS AND HATS (U.S. CLS. 22 AND 39).
DAVID C. REIHNER, EXAMINING ATTORNEY

CLASS 25—(Continued).

SN 77-138,649. ZIERK, MARIA, CHICAGO, IL. FILED 3-23-2007.

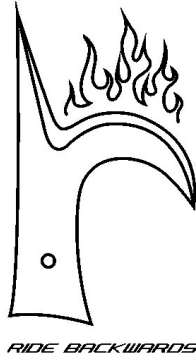

THE MARK CONSISTS OF FLAMING PIKE POLE WITH STYLIZED TEXT.
FOR CAPS; HOODS; SHIRTS; SHORTS; SOCKS; SWEAT PANTS; SWEAT SHIRTS (U.S. CLS. 22 AND 39).
LESLIE RICHARDS, EXAMINING ATTORNEY

SN 77-138,663. ABECASSIS, SERGE, BOCA RATON, FL. FILED 3-23-2007.

SILVER DAGGER

THE MARK CONSISTS OF STANDARD CHARACTERS WITHOUT CLAIM TO ANY PARTICULAR FONT, STYLE, SIZE, OR COLOR.
FOR WRAPS; VISORS; VESTS; UNDER GARMENTS; T-SHIRTS; TUXEDOS; TURTLENECKS; TUNICS; TROUSERS; TOPS; TOPCOATS; TIGHTS; TANK TOPS; SWIM WEAR FOR GENTLEMEN AND LADIES; SWEATERS; SWEAT SUITS; SWEAT PANTS; SWEAT BANDS; SUSPENDERS; SUITS; LADIES' SUITS; SPORT COATS; SOCKS; SNEAKERS; SLIPPERS; SKIRTS; SHORTS; SHOES; SHIRTS; SHAWLS; SCARVES; RAINCOATS; PULLOVERS; POLO SHIRTS; PANTS; PAJAMAS; OVERALLS; NIGHTWEAR; NECKTIES; MEN'S SUITS; MEN'S SOCKS; MEN AND WOMEN JACKETS, COATS, TROUSERS, VESTS; LINGERIE; LEGGINGS; LEATHER JACKETS; LEATHER SHOES; LEATHER SLIPPERS; JEANS; JACKETS; HOSIERY; HEADBANDS; HATS; GOLF SHIRTS; FOOTWEAR FOR MEN AND WOMEN; DRESS SHIRTS; DRESSES; DENIM JACKETS; DENIMS; CORSETS; COATS; CARDIGANS; CAPS; CAPRIS; BLOUSES; BLAZERS; BELTS; BEACHWEAR; BATHROBES; BATHING TRUNKS; BATHING SUITS; BATH SLIPPERS; BASEBALL CAPS; BANDANAS; ATHLETIC FOOTWEAR; SLEEPWEAR (U.S. CLS. 22 AND 39).
PETER CHENG, EXAMINING ATTORNEY

CLASS 25—(Continued).

SN 77-138,697. KULOCO CLOTHING LLC, BERLIN, MD. FILED 3-23-2007.

KULOCO

THE MARK CONSISTS OF STANDARD CHARACTERS WITHOUT CLAIM TO ANY PARTICULAR FONT, STYLE, SIZE, OR COLOR.
FOR BELTS; BLOUSES; BOARD SHORTS; DRESSES; HATS; JEANS; PANTS; SHIRTS; SHOES; SHORTS; SOCKS; SWEAT SHIRTS; TANK TOPS; UNDERWEAR (U.S. CLS. 22 AND 39).
JACQUELINE A. LAVINE, EXAMINING ATTORNEY

SN 77-138,718. ABECASSIS, SERGE, BOCA RATON, FL. FILED 3-23-2007.



THE MARK CONSISTS OF A DAGGER POINTING DOWNWARD IN BETWEEN THE WORDS "SILVER" AND "DAGGER".
FOR ATHLETIC FOOTWEAR; BANDANAS; BASEBALL CAPS; BATH SLIPPERS; BATHING SUITS; BATHING TRUNKS; BATHROBES; BEACHWEAR; BELTS; BLAZERS; BLOUSES; CAPRIS; CAPS; CARDIGANS; COATS; CORSETS; DENIM JACKETS; DENIMS; DRESS SHIRTS; DRESSES; FOOTWEAR FOR MEN AND WOMEN; GOLF SHIRTS; HATS; HEADBANDS; HOSIERY; JACKETS; JEANS; LADIES' SUITS; LEATHER JACKETS; LEATHER SHOES; LEATHER SLIPPERS; LEGGINGS; LINGERIE; MEN AND WOMEN JACKETS, COATS, TROUSERS, VESTS; MEN'S SOCKS; MEN'S SUITS; NECKTIES; NIGHTWEAR; OVERALLS; PAJAMAS; PANTS; POLO SHIRTS; PULLOVERS; RAINCOATS; SCARVES; SHAWLS; SHIRTS; SHOES; SHORTS; SKIRTS; SLEEPWEAR; SLIPPERS; SNEAKERS; SOCKS; SPORT COATS; SUITS; SUSPENDERS; SWEAT BANDS; SWEAT PANTS; SWEAT SUITS; SWEATERS; SWIM WEAR FOR GENTLEMEN AND LADIES; TANK TOPS; TIGHTS; TOPCOATS; TOPS; TROUSERS; TUNICS; TURTLENECKS; TUXEDOS; T-SHIRTS; UNDER GARMENTS; VESTS; VISORS; WRAPS (U.S. CLS. 22 AND 39).
PETER CHENG, EXAMINING ATTORNEY

CLASS 25—(Continued).

SN 77-138,792. ASIAMA-KISIEDU, STEPHEN, RIVERSIDE, CA. FILED 3-23-2007.

FORCE FOR GOOD

THE MARK CONSISTS OF STANDARD CHARACTERS WITHOUT CLAIM TO ANY PARTICULAR FONT, STYLE, SIZE, OR COLOR.

FOR ATHLETIC SHOES; BANDANAS; BEANIES; BLOUSES; BOOTS; BOXER BRIEFS; BOXER SHORTS; CAPRIS; CAPS; COATS; DRESSES; FOOTWEAR; GLOVES; GOLF SHIRTS; HALTER TOPS; HATS; HEADWEAR; JACKETS; JEANS; JERSEYS; JUMPERS; OVERALLS; PAJAMAS; PANTS; ROBES; SANDALS; SHIRTS; SHOES; SHORTS; SKIRTS; SLACKS; SLIPPERS; SOCKS; SPORT COATS; SWEAT PANTS; SWEAT SHIRTS; SWEATBANDS; SWEATERS; SWIM WEAR; T-SHIRTS; TANK TOPS; TIES; TROUSERS; UNDERWEAR; VESTS; VISORS (U.S. CLS. 22 AND 39).

FIRST USE 9-20-2006; IN COMMERCE 9-20-2006.
ANDREA K. NADELMAN, EXAMINING ATTORNEY

SN 77-138,796. BOLING, STEWART, B, NORTH ARLINGTON, NJ. FILED 3-23-2007.

VOJ

THE MARK CONSISTS OF STANDARD CHARACTERS WITHOUT CLAIM TO ANY PARTICULAR FONT, STYLE, SIZE, OR COLOR.

FOR CLOTHING FOR WOMEN, MEN AND CHILDREN, NAMELY BELTS, COATS, RAINCOATS, WAISTCOATS, BLOUSES AND PULLOVERS, JACKETS, TROUSERS, SKIRTS, DRESSES, SUITS, SHIRTS AND CHEMISES, T-SHIRTS, JEANS, SWEATERS, UNDERWEAR, SOCKS AND STOCKINGS, GLOVES, TIES, SCARVES, HATS AND CAPS, BOOTS, SHOES AND SLIPPERS (U.S. CLS. 22 AND 39).

MICHAEL SOUDERS, EXAMINING ATTORNEY

SN 77-138,841. VIBRAM FIVEFINGERS, LLC, CONCORD, MA. FILED 3-23-2007.

DISCOVER THE ALTERNATIVE

THE MARK CONSISTS OF STANDARD CHARACTERS WITHOUT CLAIM TO ANY PARTICULAR FONT, STYLE, SIZE, OR COLOR.

FOR FOOTWEAR; HEADWEAR, NAMELY, HATS, CAPS, VISORS; CLOTHING, NAMELY, T-SHIRTS, SWEATSHIRTS, SHIRTS, SWEATPANTS, SHORTS, SOCKS (U.S. CLS. 22 AND 39).

MICHAEL KEATING, EXAMINING ATTORNEY

CLASS 25—(Continued).

SN 77-139,233. PERSON, AARON K., BELLEVILLE, MI. FILED 3-23-2007.

MENES ONU One United

THE MARK CONSISTS OF STANDARD CHARACTERS WITHOUT CLAIM TO ANY PARTICULAR FONT, STYLE, SIZE, OR COLOR.

FOR CLOTHING NAMELY, SHIRTS, PANTS, T-SHIRTS, CAPS, HATS, JERSEYS, SWEATERS, SWEAT SHIRTS, SWEATPANTS, JOGGING SUITS, JEANS, JACKETS, COATS, PARKAS, SHOES, SOCKS, PAJAMAS, DRESS SUITS, SKIRTS, DRESSES, BLOUSES, BLAZERS, UNDERWEAR, BEACHWEAR, SWIM WEAR, SLEEPWEAR, RAINWEAR, BELTS, OVERALLS, SLACKS, BOXER SHORTS, SKI WEAR, AND FOOTWEAR (U.S. CLS. 22 AND 39).

MICHAEL SOUDERS, EXAMINING ATTORNEY

SN 77-139,286. COLBERT, NICHOLAS, COSTA MESA, CA. FILED 3-23-2007.

45 cali

THE MARK CONSISTS OF STANDARD CHARACTERS WITHOUT CLAIM TO ANY PARTICULAR FONT, STYLE, SIZE, OR COLOR.

FOR HATS; JACKETS; SWEAT SHIRTS; T-SHIRTS (U.S. CLS. 22 AND 39).

ZACHARY BELLO, EXAMINING ATTORNEY

SN 77-139,294. HARD LUCK CHOPPER SHOP, CULVER CITY, CA. FILED 3-23-2007.



FOR SHORT-SLEEVED OR LONG-SLEEVED T-SHIRTS (U.S. CLS. 22 AND 39).

STACY WAHLBERG, EXAMINING ATTORNEY

CLASS 25—(Continued).

SN 77-139,412. COWBOY BETTY, LLC, LOS ANGELES, CA.
FILED 3-23-2007.

LOST SOULS

THE MARK CONSISTS OF STANDARD CHARACTERS WITHOUT CLAIM TO ANY PARTICULAR FONT, STYLE, SIZE, OR COLOR.

FOR T-SHIRTS; JACKETS; HATS; PANTS; TANK-TOPS (U.S. CLS. 22 AND 39).

MICHAEL LEWIS, EXAMINING ATTORNEY

SN 77-139,472. MAGDALENO, BEN, FRESNO, CA. FILED 3-23-2007.

ALL AMERICAN SPORTS USA

THE MARK CONSISTS OF STANDARD CHARACTERS WITHOUT CLAIM TO ANY PARTICULAR FONT, STYLE, SIZE, OR COLOR.

NO CLAIM IS MADE TO THE EXCLUSIVE RIGHT TO USE "SPORTS USA", APART FROM THE MARK AS SHOWN.

FOR CLOTHING, NAMELY T-SHIRTS, SHIRTS, SWEATSHIRTS, JACKETS, SWEATERS, PANTS, SWEAT-PANTS, SHORTS, SPORTS JERSEYS, SOCKS, SHOES, HATS AND GLOVES (U.S. CLS. 22 AND 39).

MICHAEL GAAFAR, EXAMINING ATTORNEY

SN 77-139,478. MAGDALENO, BEN, FRESNO, CA. FILED 3-23-2007.

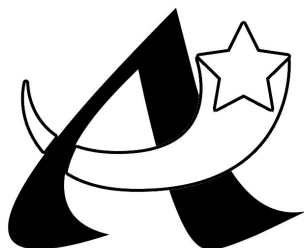

THE MARK CONSISTS OF A STYLIZED LETTER "A" WITH A SHOOTING STAR PASSING THROUGH AND COMPRISING PART OF THE "A".

FOR CLOTHING, NAMELY T-SHIRTS, SHIRTS, SWEATSHIRTS, JACKETS, SWEATERS, PANTS, SWEAT-PANTS, SHORTS, SPORTS JERSEYS, SOCKS, SHOES, HATS AND GLOVES (U.S. CLS. 22 AND 39).

MICHAEL GAAFAR, EXAMINING ATTORNEY

CLASS 25—(Continued).

SN 77-139,635. MEALIFFE, DIANE R, SCOTTS VALLEY, CA.
FILED 3-24-2007.



NO CLAIM IS MADE TO THE EXCLUSIVE RIGHT TO USE RAINWEAR, APART FROM THE MARK AS SHOWN. THE COLOR(S) BLACK, WHITE, AND LAVENDER IS/ARE CLAIMED AS A FEATURE OF THE MARK.

THE MARK CONSISTS OF WHITE BACKGROUND, LAVENDER UMBRELLA, BLACK DLL RAINWEAR LETTERING.

FOR RAINWEAR (U.S. CLS. 22 AND 39).
FIRST USE 7-24-2006; IN COMMERCE 7-24-2006.
REBECCA SMITH, EXAMINING ATTORNEY

SN 77-139,637. MEALIFFE, DIANE R, SCOTTS VALLEY, CA.
FILED 3-24-2007.

“Puddle Stomp in Style”

THE MARK CONSISTS OF STANDARD CHARACTERS WITHOUT CLAIM TO ANY PARTICULAR FONT, STYLE, SIZE, OR COLOR.

FOR RAINWEAR; RAIN BOOTS; RAIN COATS (U.S. CLS. 22 AND 39).

FIRST USE 8-16-2006; IN COMMERCE 8-16-2006.
REBECCA SMITH, EXAMINING ATTORNEY

CLASS 25—(Continued).

SN 77-139,649. WEISNER, ANDREA PADILLA, CARLSBAD, CA. FILED 3-25-2007.



NO CLAIM IS MADE TO THE EXCLUSIVE RIGHT TO USE SOLES, APART FROM THE MARK AS SHOWN. THE COLOR(S) PEACH, LAVENDER, WHITE, AND BLACK IS/ARE CLAIMED AS A FEATURE OF THE MARK. THE MARK CONSISTS OF AN OVAL IN WHICH APPEARS A PAIR OF FEET IN SHOES DECORATED WITH BOWS ABOVE THE STYLIZED WORDS SPARE SOLES; THE STYLIZED WORDS STYLISH COMFORT FOR YOUR FEET APPEARS BELOW SPARE SOLES; THE COLOR PEACH APPEARS ON THE FEET; THE COLOR LAVENDER APPEARS IN THE BACKGROUND OF THE OVAL; THE COLOR WHITE APPEARS ON THE BOWS; THE COLOR BLACK APPEARS IN THE OUTLINE OF THE OVAL, ON THE SHOES, AND IN THE TEXT FOR SHOES (U.S. CLS. 22 AND 39). FIRST USE 3-1-2007; IN COMMERCE 3-1-2007. DAVID TOOLEY, EXAMINING ATTORNEY

SN 77-139,715. KEVIN M. FOSNOCHT, MERION STATION, PA. FILED 3-25-2007.

Live life like a girl

THE MARK CONSISTS OF STANDARD CHARACTERS WITHOUT CLAIM TO ANY PARTICULAR FONT, STYLE, SIZE, OR COLOR. FOR SPORTS BRA; SPORTS JERSEYS; CAPS; HEAD WEAR; SKI WEAR; SPORTS JACKETS; SPORTS JERSEYS AND BREECHES FOR SPORTS; SPORTS OVER-UNIFORMS; SPORTS SHIRTS; SPORTS SHIRTS WITH SHORT SLEEVES; SWIM WEAR; TENNIS WEAR; SURF WEAR; INFANT AND TODDLER ONE PIECE CLOTHING; JERSEYS; TOPS; HEADGEAR, NAMELY, CAPS; SHORT-SLEEVED SHIRTS; SWEAT SHIRTS; T-SHIRTS; YOGA SHIRTS; HEADBANDS AGAINST SWEATING; SWEAT BANDS; SWEAT PANTS; SWEAT SHORTS; SWEAT SUITS (U.S. CLS. 22 AND 39). PAUL E. FAHRENKOPF, EXAMINING ATTORNEY

CLASS 25—(Continued).

SN 77-139,720. KEAVNEY, MARTHA, JERSEY CITY, NJ. FILED 3-25-2007.

This is ridiculous! It's impossible to express anything important with the language available to us. Don't you feel like something is wrong, something's missing, and has been missing so long that we only vaguely sense that there are other ways to speak and think?

THE MARK CONSISTS OF STANDARD CHARACTERS WITHOUT CLAIM TO ANY PARTICULAR FONT, STYLE, SIZE, OR COLOR. FOR T-SHIRTS (U.S. CLS. 22 AND 39). SHAUNIA CARLYLE, EXAMINING ATTORNEY

SN 77-139,733. MORIA R. MILLER, WEST CHESTER, PA. FILED 3-25-2007.

SKOAT

THE MARK CONSISTS OF STANDARD CHARACTERS WITHOUT CLAIM TO ANY PARTICULAR FONT, STYLE, SIZE, OR COLOR. FOR COATS; SKIRTS; SKIRTS AND DRESSES; WIND COATS; COATS MADE OF COTTON; COATS OF DENIM; LIGHT-REFLECTING COATS; RAIN COATS (U.S. CLS. 22 AND 39). TARAH HARDY, EXAMINING ATTORNEY

SN 77-139,896. PAN MELLOTEX LLC, NEW YORK, NY. FILED 3-26-2007.

SCOTT LANGTON

THE MARK CONSISTS OF STANDARD CHARACTERS WITHOUT CLAIM TO ANY PARTICULAR FONT, STYLE, SIZE, OR COLOR. THE NAME(S), PORTRAIT(S), AND/OR SIGNATURE(S) SHOWN IN THE MARK IDENTIFIES SCOTT LANGTON, WHOSE CONSENT(S) TO REGISTER IS MADE OF RECORD. FOR SHIRTS; PANTS; JEANS; SKIRTS; JACKETS; COATS; VESTS; SUITS; ASCOTS; SCARVES; NECKTIES; BELTS; GLOVES; HEADWEAR; CAPS; HATS; FOOTWEAR; DRESSES; SHORTS; PAJAMAS; UNDERGARMENTS; ROBES; TOPS; BLOUSES (U.S. CLS. 22 AND 39). MATTHEW PAPPAS, EXAMINING ATTORNEY

CLASS 25—(Continued).

SN 77-139,921. COMEDY PARTNERS, NEW YORK, NY.
FILED 3-26-2007.

DOWNTOWN BODY & CUSTOMS

THE MARK CONSISTS OF STANDARD CHARACTERS WITHOUT CLAIM TO ANY PARTICULAR FONT, STYLE, SIZE, OR COLOR.

FOR CLOTHING, NAMELY, BATHING SUITS, BELTS, COATS, SOCKS, FOOTWEAR, BANDANNAS, DRESSES, GLOVES, GYM SHORTS, NECK WEAR, JACKETS, PAJAMAS, PANTS, SHIRTS, SHORTS, SUN VISORS, SWEATERS, TURTLENECKS, UNDERCLOTHES, VESTS, WARM-UP SUITS, HEADWEAR, BATHROBES, BEACHWEAR (U.S. CLS. 22 AND 39).

BRIAN CALLAGHAN, EXAMINING ATTORNEY

SN 77-140,015. RISQUE APPAREL, HILTON HEAD, SC.
FILED 3-26-2007.



**RISQUE
BITCH**

THE MARK CONSISTS OF A WOMAN IN A BIKINI WITH HER HAND ON HER HEAD ABOVE STYLIZED TEXT.

FOR HATS; PANTS; SHORTS; T-SHIRTS; TANK TOPS; UNDERWEAR (U.S. CLS. 22 AND 39).

FRANK LATTUCA, EXAMINING ATTORNEY

SN 77-140,016. A WISH COME TRUE, LP, BRISTOL, PA.
FILED 3-26-2007.

A WISH COME TRUE

THE MARK CONSISTS OF STANDARD CHARACTERS WITHOUT CLAIM TO ANY PARTICULAR FONT, STYLE, SIZE, OR COLOR.

OWNER OF U.S. REG. NO. 1,737,667.

FOR DANCE COSTUMES, FANTASY DRESS COSTUMES, AND MARCHING BAND AND COLOR GUARD UNIFORMS (U.S. CLS. 22 AND 39).

FIRST USE 7-9-1990; IN COMMERCE 7-9-1990.
FRANK LATTUCA, EXAMINING ATTORNEY

CLASS 25—(Continued).

SN 77-140,195. TEFRON LTD., BNEI-BRAK 51371, ISRAEL,
FILED 3-26-2007.

EFP

THE MARK CONSISTS OF STANDARD CHARACTERS WITHOUT CLAIM TO ANY PARTICULAR FONT, STYLE, SIZE, OR COLOR.

FOR MEN'S AND BOYS' ACTIVEWEAR, NAMELY, BODY SUITS, SOCKS, LEGGINGS, T-SHIRTS, UNDERWEAR, TANK TOPS, SHORTS, PANTS, SHIRTS, JACKETS, SUITS, SLEEP WEAR AND SWIM WEAR (U.S. CLS. 22 AND 39).

ODESSA BIBBINS, EXAMINING ATTORNEY

SN 77-140,279. CITY SPORTS, INC., WILMINGTON, MA.
FILED 3-26-2007.

1983

THE MARK CONSISTS OF THE NUMBERS 1, 9, 8 AND 3 STYLIZED WITH A RETRO FONT.

FOR SHIRTS; T-SHIRTS; SWEAT SHIRTS (U.S. CLS. 22 AND 39).

MICHAEL KAZAZIAN, EXAMINING ATTORNEY

SN 77-140,301. A & H SPORTSWEAR CO., INC., STOCKERTOWN, PA. FILED 3-26-2007.

XFIN

THE MARK CONSISTS OF STANDARD CHARACTERS WITHOUT CLAIM TO ANY PARTICULAR FONT, STYLE, SIZE, OR COLOR.

FOR SWIM WEAR (U.S. CLS. 22 AND 39).
SALLY SHIH, EXAMINING ATTORNEY

CLASS 25—(Continued).

SN 77-140,316. A & H SPORTSWEAR CO., INC., STOCKERTOWN, PA. FILED 3-26-2007.

SWIMPROVISE

THE MARK CONSISTS OF STANDARD CHARACTERS WITHOUT CLAIM TO ANY PARTICULAR FONT, STYLE, SIZE, OR COLOR.
FOR SWIM WEAR (U.S. CLS. 22 AND 39).
SALLY SHIH, EXAMINING ATTORNEY

SN 77-140,330. FALCONER, ASTRA, NORTH PALM BEACH, FL. AND FALCONER, HUGH, NORTH PALM BEACH, FL. FILED 3-26-2007.

THUG SQUAD

THE MARK CONSISTS OF STANDARD CHARACTERS WITHOUT CLAIM TO ANY PARTICULAR FONT, STYLE, SIZE, OR COLOR.
FOR CAPS; HATS; JEANS; PANTS; T-SHIRTS; UNDERWEAR (U.S. CLS. 22 AND 39).
VERNA BETH RIRIE, EXAMINING ATTORNEY

SN 77-140,347. PLANET GOLD CLOTHING CO., INC., NEW YORK, NY. FILED 3-26-2007.



FOR CLOTHING, NAMELY, SHIRTS, TANK TOPS, PANTS, BELTS, SOCKS, JACKETS, VESTS, SUITS, DRESSES, SHORTS, SKIRTS, SWEATERS, KNIT TOPS, SHORTALLS, OVERALLS, CAPRIS, HATS AND SHOES (U.S. CLS. 22 AND 39).
BRIAN PINO, EXAMINING ATTORNEY

CLASS 25—(Continued).

SN 77-140,399. JMI (USA), LTD., MERRILL, WI. FILED 3-26-2007.

LASERVENT

THE MARK CONSISTS OF STANDARD CHARACTERS WITHOUT CLAIM TO ANY PARTICULAR FONT, STYLE, SIZE, OR COLOR.
FOR GLOVES HAVING VENTILATED THERMOPLASTIC PALM SECTIONS (U.S. CLS. 22 AND 39).
COLLEEN DOMBROW, EXAMINING ATTORNEY

SN 77-140,587. BALTIC RISE, LLC, NEW YORK, NY. FILED 3-26-2007.



THE MARK CONSISTS OF A CARTOON CHARACTER HEAD WITH FLAMES IN ITS HAIR. THE HEAD IS FLANKED BY THE WORD "WONDER" ON ITS LEFT AND "WARMERS" ON ITS RIGHT. THE WORDS "WONDER" AND "WARMERS" ARE COMPRISED OF STYLIZED CAPITAL LETTERS. "WWW.WONDERWARMERS.COM" APPEARS BELOW "WARMERS".

FOR CLOTHING, NAMELY T-SHIRTS, POLO SHIRTS, RUGBY SHIRTS, GOLF SHIRTS, TANK TOPS, JERSEYS, TIGHTS, SHORTS, PANTS, STOCKINGS, LEOTARDS, UNITARDS, BODY SUITS, LEG WARMERS, LEGGINGS, SOCKS, GLOVES, ATHLETIC UNIFORMS, JACKETS, PARKAS, PONCHOS, SWIMWEAR, SWEATERS, FLEECE PULLOVERS, SWEAT SUITS, JOGGING SUITS, RAIN SUITS, BOOTS, SLIPPERS, SANDALS, ATHLETIC FOOTWEAR, HATS, CAPS, VISORS, HEAD BANDS, EARMUFFS, WRIST BANDS, SKI WEAR, NECK WARMERS, SCARVES, BANDANAS, SHAWLS, ROBES, SLEEPWEAR, LOUNGEWEAR, TIES, VESTS, UNDERGARMENTS AND ALL PURPOSE FOOTWEAR EXCLUDING ORTHOPEDIC FOOTWEAR (U.S. CLS. 22 AND 39).

FIRST USE 8-0-2005; IN COMMERCE 9-12-2005.
GEOFFREY FOSDICK, EXAMINING ATTORNEY

SN 77-140,590. LUMINARY VENTURES, INC., TARPON SPRINGS, FL. FILED 3-26-2007.

Stunt Academy

THE MARK CONSISTS OF STANDARD CHARACTERS WITHOUT CLAIM TO ANY PARTICULAR FONT, STYLE, SIZE, OR COLOR.
FOR CLOTHING, NAMELY, SWEATSHIRTS AND CAPS (U.S. CLS. 22 AND 39).
SALLY SHIH, EXAMINING ATTORNEY

CLASS 25—(Continued).

SN 77-140,596. PROM QUEEN-II, LLC, PENSACOLA BEACH, FL. FILED 3-26-2007.

GRAND MARLIN

THE MARK CONSISTS OF STANDARD CHARACTERS WITHOUT CLAIM TO ANY PARTICULAR FONT, STYLE, SIZE, OR COLOR.

FOR MEN'S, WOMEN'S AND CHILDREN'S CLOTHING, NAMELY, SHIRTS, T-SHIRTS, BATHING SUITS, SPORT SHIRTS, DRESS SHIRTS, SWEATSHIRTS, JACKETS, COATS, OUTERWEAR, NAMELY, RAINCOATS, WIND RESISTANT JACKETS AND CARCOATS, SUITS, SWEATERS, PANTS, SHORTS, CAPS, HATS, FOOTWEAR, SOCKS, HOSIERY, UNDERWEAR, BLOUSES, DRESSES, SKIRTS, JEANS, VESTS, BELTS, TIES, SLEEPWEAR, GLOVES, SCARVES, AND BATHROBES (U.S. CLS. 22 AND 39).

ROBIN CHOSID, EXAMINING ATTORNEY

CLASS 25—(Continued).

SN 77-140,865. SHAFER BOWERS CORPORATION, VERNON, CA. FILED 3-26-2007.



OWNER OF U.S. REG. NO. 2,502,605.

THE MARK CONSISTS OF THREE FOUR POINT STARS SURROUNDING A CHEVRON.

FOR CLOTHING, NAMELY, JACKETS, SHIRTS, PANTS, JEANS, SHORTS, HEADWEAR, AND COVERALLS (U.S. CLS. 22 AND 39).

REBECCA SMITH, EXAMINING ATTORNEY

SN 77-140,762. DR.'S OWN, INC., SAN DIEGO, CA. FILED 3-26-2007.

INSERT COMFORT HERE!

THE MARK CONSISTS OF STANDARD CHARACTERS WITHOUT CLAIM TO ANY PARTICULAR FONT, STYLE, SIZE, OR COLOR.

FOR T-SHIRTS, SHIRTS, SWEATSHIRTS, SWEAT PANTS, BELTS, SOCKS, HOSIERY, FOOTWEAR, SLIPPERS, HATS, CAPS, VISORS, INSOLES, HEEL CUSHIONS, HEEL LINERS, AND HEEL RESTS IN THE NATURE OF HEEL INSERTS (U.S. CLS. 22 AND 39).

ADA HAN, EXAMINING ATTORNEY

SN 77-140,872. MANN, KIRAN, SACRAMENTO, CA. AND BAINS, LAKH S., SACRAMENTO, CA. FILED 3-26-2007.

WHAT'S YOUR SIN?

THE MARK CONSISTS OF STANDARD CHARACTERS WITHOUT CLAIM TO ANY PARTICULAR FONT, STYLE, SIZE, OR COLOR.

FOR BELTS; BOXER BRIEFS; BOXER SHORTS; HATS; CAPS; PANTS; SHIRTS; SHORT-SLEEVED OR LONG-SLEEVED T-SHIRTS; SWEAT PANTS; SWEAT SHIRTS; SWEATERS; TANK-TOPS; UNDERWEAR (U.S. CLS. 22 AND 39).

Laurie Mayes, EXAMINING ATTORNEY

SN 77-140,859. LEAR, RACHAEL E., WILMINGTON, NC. FILED 3-26-2007.

Derby Darlins

THE MARK CONSISTS OF STANDARD CHARACTERS WITHOUT CLAIM TO ANY PARTICULAR FONT, STYLE, SIZE, OR COLOR.

FOR SHIRTS; SHORT-SLEEVED OR LONG-SLEEVED T-SHIRTS; SHORT-SLEEVED SHIRTS; SWEAT SHIRTS; T-SHIRTS; GYM SHORTS; PANTIES, SHORTS AND BRIEFS; SHORTS; SWEAT SHORTS; WALKING SHORTS; BELTS; BELTS MADE OF LEATHER; BELTS OF TEXTILE; WAIST BELTS; SOCKS; SOCKS AND STOCKINGS (U.S. CLS. 22 AND 39).

KATHLEEN LORENZO, EXAMINING ATTORNEY

SN 77-140,887. KAREN THOMPSON, LLC, LAHASKA, PA. FILED 3-26-2007.

WISH ... DREAM ... REALIZE

THE MARK CONSISTS OF STANDARD CHARACTERS WITHOUT CLAIM TO ANY PARTICULAR FONT, STYLE, SIZE, OR COLOR.

FOR CLOTHING, NAMELY SLEEP WEAR AND LOUNGE WEAR (U.S. CLS. 22 AND 39).

C. DIONNE CLYBURN, EXAMINING ATTORNEY

CLASS 25—(Continued).

SN 77-140,889. PAWLUK, GEORGE, D., S.EL MONTE, CA. FILED 3-26-2007.

PLOSION

THE MARK CONSISTS OF STANDARD CHARACTERS WITHOUT CLAIM TO ANY PARTICULAR FONT, STYLE, SIZE, OR COLOR.

FOR ATHLETIC FOOTWEAR; BEACH FOOTWEAR; FOOTWEAR FOR MEN AND WOMEN; SNEAKERS; SHIRTS; SHORT-SLEEVED OR LONG-SLEEVED T-SHIRTS; BANDANAS; JACKETS; UNDERWEAR; HATS (U.S. CLS. 22 AND 39).

JOHN WILKE, EXAMINING ATTORNEY

CLASS 25—(Continued).

SN 77-140,900. SHAFER BOWERS CORPORATION, VERNON, CA. FILED 3-26-2007.

LOUD, FAST & OUTTA' CONTROL

THE MARK CONSISTS OF STANDARD CHARACTERS WITHOUT CLAIM TO ANY PARTICULAR FONT, STYLE, SIZE, OR COLOR.

FOR CLOTHING, NAMELY, JACKETS, SHIRTS, PANTS, JEANS, SHORTS, HEADWEAR, AND COVERALLS (U.S. CLS. 22 AND 39).

REBECCA SMITH, EXAMINING ATTORNEY

SN 77-140,895. KAREN THOMPSON, LLC, LAHASKA, PA. FILED 3-26-2007.

WISH POCKET

THE MARK CONSISTS OF STANDARD CHARACTERS WITHOUT CLAIM TO ANY PARTICULAR FONT, STYLE, SIZE, OR COLOR.

FOR CLOTHING, NAMELY SLEEP WEAR AND LOUNGE WEAR (U.S. CLS. 22 AND 39).

C. DIONNE CLYBURN, EXAMINING ATTORNEY

SN 77-140,918. KONG, JOYCE J., SPRINGFIELD, VA. AND HALE, BRYAN A., SPRINGFIELD, VA. FILED 3-27-2007.

The7Angels

THE MARK CONSISTS OF STANDARD CHARACTERS WITHOUT CLAIM TO ANY PARTICULAR FONT, STYLE, SIZE, OR COLOR.

FOR COATS FOR MEN AND WOMEN; HOODS; JERSEYS; MEN'S AND WOMEN'S JACKETS, COATS, TROUSERS, VESTS; SHORT SETS; TOPS; SHOULDER WRAPS; WRAPS; CLOTHING, NAMELY, WRAP-AROUNDS; SWEAT SUITS; TRACK PANTS; TRACK SUITS; KNIT SHIRTS; POLO SHIRTS; SHIRTS; SHORT-SLEEVED OR LONG-SLEEVED T-SHIRTS; SHORT-SLEEVED SHIRTS; SPORT SHIRTS; SWEAT PANTS; SWEAT SHIRTS; SWEAT SHORTS; T-SHIRTS; YOGA SHIRTS (U.S. CLS. 22 AND 39).

ALICE BENMAMAN, EXAMINING ATTORNEY

SN 77-140,897. CHRISTOPHER KOCH, PHILADELPHIA, PA. FILED 3-26-2007.

U-GNIT

THE MARK CONSISTS OF STANDARD CHARACTERS WITHOUT CLAIM TO ANY PARTICULAR FONT, STYLE, SIZE, OR COLOR.

FOR SHIRTS (U.S. CLS. 22 AND 39).

TASNEEM HUSSAIN, EXAMINING ATTORNEY

SN 77-140,989. LAZAR, LANCMAN MARK, NEW YORK, NY. FILED 3-27-2007.

Wrap-Jack

THE MARK CONSISTS OF STANDARD CHARACTERS WITHOUT CLAIM TO ANY PARTICULAR FONT, STYLE, SIZE, OR COLOR.

FOR HEAD SCARVES; LONG SLEEVED VESTS; MEN AND WOMEN JACKETS, COATS, TROUSERS, VESTS; QUILTED VESTS; SCARVES; SHOULDER SCARVES; SILK SCARVES; VESTS (U.S. CLS. 22 AND 39).

ESTHER A. BORSUK, EXAMINING ATTORNEY

CLASS 25—(Continued).

SN 77-141,024. TEFRON LTD., BNEI-BRAK 51371, ISRAEL,
FILED 3-27-2007.

ENGINEERED FOR PERFORMANCE
BY TEFRON

THE MARK CONSISTS OF STANDARD CHARACTERS
WITHOUT CLAIM TO ANY PARTICULAR FONT, STYLE,
SIZE, OR COLOR.

FOR MEN'S AND BOYS' ACTIVEWEAR, NAMELY,
BODY SUITS, SOCKS, LEGGINGS, T-SHIRTS, UNDER-
WEAR, TANK TOPS, SHORTS, PANTS, SHIRTS, JACK-
ETS, SUITS, SLEEPWEAR AND SWIMWEAR (U.S. CLS.
22 AND 39).

ODESSA BIBBINS, EXAMINING ATTORNEY

SN 77-141,060. MITCHELL, THOMAS, MASCOUTAH, IL.
FILED 3-27-2007.

NAWIS

THE MARK CONSISTS OF STANDARD CHARACTERS
WITHOUT CLAIM TO ANY PARTICULAR FONT, STYLE,
SIZE, OR COLOR.

FOR T-SHIRTS; TANK TOPS; BLOUSES; JERSEYS;
SWEATERS; PANTS; SKIRTS; DRESSES; SHORTS;
OVERALLS; SWEAT SUITS; UNDERWEAR; SOCKS;
SHOES; SANDALS; JACKETS; SPORT COATS; COATS;
SCARVES; GLOVES (U.S. CLS. 22 AND 39).

FIRST USE 2-1-2006; IN COMMERCE 2-1-2006.
CURTIS FRENCH, EXAMINING ATTORNEY

SN 77-141,339. VAGABOND PUNCH, INC., WEST HARRI-
SON, NY. FILED 3-27-2007.

HAN MIDEUM

THE MARK CONSISTS OF STANDARD CHARACTERS
WITHOUT CLAIM TO ANY PARTICULAR FONT, STYLE,
SIZE, OR COLOR.

THE FOREIGN WORDING IN THE MARK TRANSLATES
INTO ENGLISH AS "ONE BELIEF" FROM KOREAN.

FOR CLOTHING, NAMELY, T-SHIRTS, HOODED
SWEATSHIRTS, CAPS, HATS, SOCKS, PANTS, SHORTS,
OVERALLS, SWEATSHIRTS, TOPS, BLOUSES, SWEA-
TERS, PAJAMAS, JACKETS, SCARVES, GLOVES, MIT-
TENS, DRESSES AND SKIRTS (U.S. CLS. 22 AND 39).

MICHAEL GAAFAR, EXAMINING ATTORNEY

CLASS 25—(Continued).

SN 77-141,439. KAREN THOMPSON, LLC, LAHASKA, PA.
FILED 3-27-2007.

KAREN THOMPSON

THE MARK CONSISTS OF STANDARD CHARACTERS
WITHOUT CLAIM TO ANY PARTICULAR FONT, STYLE,
SIZE, OR COLOR.

THE NAME(S), PORTRAIT(S), AND/OR SIGNATURE(S)
SHOWN IN THE MARK IDENTIFIES KAREN THOMPSON,
WHOSE CONSENT(S) TO REGISTER IS MADE OF RE-
CORD.

FOR CLOTHING, NAMELY SLEEP WEAR AND
LOUNGE WEAR (U.S. CLS. 22 AND 39).

C. DIONNE CLYBURN, EXAMINING ATTORNEY

SN 77-141,455. GEORGEANN HUSZAR, BIRMINGHAM, MI.
FILED 3-27-2007.

THE LITTLE THINGS IN LIFE

THE MARK CONSISTS OF STANDARD CHARACTERS
WITHOUT CLAIM TO ANY PARTICULAR FONT, STYLE,
SIZE, OR COLOR.

FOR CLOTHING, NAMELY, SHIRTS AND UNDER-
WEAR (U.S. CLS. 22 AND 39).

KAPIL BHANOT, EXAMINING ATTORNEY

SN 77-141,563. PEARCE, ROBERT, SAN FRANCISCO, CA.
FILED 3-27-2007.

KILLERBOB
GRAPHICS



NO CLAIM IS MADE TO THE EXCLUSIVE RIGHT TO
USE "GRAPHICS", APART FROM THE MARK AS SHOWN.

THE MARK CONSISTS OF KILLERBOB WITH THE "I" AS
A SMALL DAGGER AND THE "O" AS A GRAPHIC
RENDITION OF MY FACE, WITH GRAPHICS UNDER-
NEATH.

FOR BASEBALL CAPS; SKULL CAPS; SWEAT SHIRTS;
T-SHIRTS (U.S. CLS. 22 AND 39).

FIRST USE 2-10-2005; IN COMMERCE 3-1-2005.

LOURDES AYALA, EXAMINING ATTORNEY

CLASS 25—(Continued).

SN 77-141,793. STAVROU, MARITA, MIAMI BEACH, FL. FILED 3-27-2007.

MARITA STAVROU

THE MARK CONSISTS OF STANDARD CHARACTERS WITHOUT CLAIM TO ANY PARTICULAR FONT, STYLE, SIZE, OR COLOR.

THE NAME IN THE MARK IDENTIFIES A LIVING INDIVIDUAL WHOSE CONSENT IS OF RECORD.

FOR DRESSES; SHIRTS; PANTS (U.S. CLS. 22 AND 39). AMY HELLA, EXAMINING ATTORNEY

SN 77-141,939. SIXTH ALICE LLC, KESWICK, VA. FILED 3-27-2007.

Sixth Alice

THE MARK CONSISTS OF STANDARD CHARACTERS WITHOUT CLAIM TO ANY PARTICULAR FONT, STYLE, SIZE, OR COLOR.

FOR DRESSES; PANTS; SHIRTS; SKIRTS (U.S. CLS. 22 AND 39).

FIRST USE 2-1-2005; IN COMMERCE 2-1-2005. MARGERY A. TIERNEY, EXAMINING ATTORNEY

SN 77-141,979. KID DANGEROUS LLC, LOS ANGELES, CA. FILED 3-27-2007.

LA
DON'T
♥ U

FOR JACKETS; POLO SHIRTS; SWEAT SHIRTS; T-SHIRTS (U.S. CLS. 22 AND 39). CAROLINE WOOD, EXAMINING ATTORNEY

CLASS 25—(Continued).

SN 77-142,025. MCNARY, JR, DERICK WILLIAM, EUCLID, OH. FILED 3-27-2007.

Neral

FOR MEN'S SOCKS; ATHLETIC SHOES; BLOUSES; BOXER BRIEFS; BOXER SHORTS; COATS FOR MEN AND WOMEN; DRESSES; HEADGEAR, NAMELY, HATS, CAPS; JACKETS; JEANS; JERSEYS; LEATHER BELTS; SKIRTS; SWEAT BANDS; SWEATERS; JOGGING PANTS; POLO SHIRTS; SHORT-SLEEVED OR LONG-SLEEVED T-SHIRTS (U.S. CLS. 22 AND 39). RONALD MCMORROW, EXAMINING ATTORNEY

SN 77-142,044. CLANCY-GARVEY, KELLY, LONG BEACH, CA. FILED 3-27-2007.

CyclingDiva

THE MARK CONSISTS OF STANDARD CHARACTERS WITHOUT CLAIM TO ANY PARTICULAR FONT, STYLE, SIZE, OR COLOR.

FOR SHORT-SLEEVED OR LONG-SLEEVED T-SHIRTS; SPORTS SHIRTS; HEADGEAR, NAMELY, RUNNING CAPS AND VISORS; CAMISOLES; SHORTS (U.S. CLS. 22 AND 39).

RONALD MCMORROW, EXAMINING ATTORNEY

SN 77-142,047. STEVEN MORENO, LOS ANGELES, CA. FILED 3-27-2007.

MELEE

THE MARK CONSISTS OF STANDARD CHARACTERS WITHOUT CLAIM TO ANY PARTICULAR FONT, STYLE, SIZE, OR COLOR.

FOR CLOTHING, NAMELY, SHIRTS, T-SHIRTS, TANK TOPS, JERSEYS, RASH GUARDS, HATS, BEANIES, SWEAT-SHIRTS, HOODED SWEAT-SHIRTS, SWEAT-PANTS, JACKETS, PANTS, JEANS, UNDERWEAR, SOCKS, WRISTBANDS, TRUNKS, SHORTS, AND FOOTWEAR (U.S. CLS. 22 AND 39).

RONALD MCMORROW, EXAMINING ATTORNEY

CLASS 25—(Continued).

SN 77-142,048. CLANCY-GARVEY, KELLY, LONG BEACH, CA. FILED 3-27-2007.

SwimDiva

THE MARK CONSISTS OF STANDARD CHARACTERS WITHOUT CLAIM TO ANY PARTICULAR FONT, STYLE, SIZE, OR COLOR.

FOR SHORT-SLEEVED OR LONG-SLEEVED T-SHIRTS; SPORTS SHIRTS; HEADGEAR, NAMELY, RUNNING CAPS AND VISORS; CAMISOLES; SHORTS; BATHING SUITS (U.S. CLS. 22 AND 39).

RONALD MCMORROW, EXAMINING ATTORNEY

SN 77-142,097. 3SOM DESIGNZ LLC, LAS VEGAS, NV. FILED 3-28-2007.

3SOM

THE MARK CONSISTS OF STANDARD CHARACTERS WITHOUT CLAIM TO ANY PARTICULAR FONT, STYLE, SIZE, OR COLOR.

FOR BELTS; CAPS; JERSEYS; LEATHER BELTS; TOPS; PANTS; SKI PANTS; SNOW PANTS; SNOWBOARD PANTS; SWEAT PANTS; POLO SHIRTS; SHIRTS; SHORT-SLEEVED OR LONG-SLEEVED T-SHIRTS; SWEAT SHIRTS; T-SHIRTS; SHOES; SOCKS; JACKETS; BANDANAS; HATS; PANTIES; BRAS; GLOVES; SCARVES; SHORTS; BATHING SUITS; BOARD SHORTS; SNOW BOARDING SUITS; SURF WEAR; SLEEPWEAR; GYM SUITS; JOGGING SUITS; BOXER BRIEFS; BOXER SHORTS (U.S. CLS. 22 AND 39).

REBECCA EISINGER, EXAMINING ATTORNEY

CLASS 25—(Continued).

SN 77-142,118. UNITED FOOTBALL LEAGUE, LLC, SAN FRANCISCO, CA. FILED 3-28-2007.

UFL

THE MARK CONSISTS OF STANDARD CHARACTERS WITHOUT CLAIM TO ANY PARTICULAR FONT, STYLE, SIZE, OR COLOR.

FOR ANKLE SOCKS; ANTI-PERSPIRANT SOCKS; APRONS; ATHLETIC FOOTWEAR; ATHLETIC SHOES; ATHLETIC UNIFORMS; BANDANAS; BASEBALL CAPS; BASKETBALL SNEAKERS; BATH SLIPPERS; BATHING SUITS; BATHING TRUNKS; BATHROBES; BEACH FOOTWEAR; BEACHWEAR; BELTS; BERMUDA SHORTS; BICYCLE GLOVES; BLAZERS; BOARD SHORTS; BOOTIES; BOOTS; BOTTOMS; BOXER BRIEFS; BOXER SHORTS; CAPS; CHILDREN'S AND INFANTS' CLOTH BIBS; CHILDREN'S HEADWEAR; CLOTH DIAPERS; COATS; COATS MADE OF COTTON; COATS OF DENIM; CUMMERBUNDS; DENIM JACKETS; DO RAGS; DOWN JACKETS; DRESS SHIRTS; DRESSES; DUNGAREES; EAR MUFFS; FISHING VESTS; FLEECE PULLOVERS; FLEECE SHORTS; FLIP FLOPS; FOOTBALL BOOTS AND STUDS THEREFOR; FOOTBALL SHOES; FOOTWEAR; FOOTWEAR FOR MEN AND WOMEN; GLOVES; GOLF CAPS; GOLF SHIRTS; GYM SHORTS; HALLOWEEN COSTUMES; HATS; HEAD SWEATBANDS; HEADBANDS; HEADWEAR; HEAVY JACKETS; INFANT AND TODDLER ONE PIECE CLOTHING; INFANT CLOTH DIAPERS; INFANT SLEEPERS; INFANTS' TROUSERS; INFANTWEAR; JACKETS; JEANS; JERSEYS; JOGGING OUTFITS; JOGGING PANTS; JOGGING SUITS; KNIT SHIRTS; KNITTED CAPS; KNITTED UNDERWEAR; LEATHER COATS; LEATHER HEADWEAR; LEATHER JACKETS; MEN AND WOMEN JACKETS, COATS, TROUSERS, VESTS; MEN'S SOCKS; MITTENS; MOCK TURTLE-NECK SWEATERS; NECKTIES; NIGHT SHIRTS; OVERALLS; PAJAMAS; PANTS; PARKAS; PIQUE SHIRTS; POCKET KERCHIEFS; POCKET SQUARES; POLO SHIRTS; PONCHOS; RAIN SLICKERS; RUGBY TOPS; RUNNING SHOES; SANDALS; SHIRTS; SHIRTS FOR SUITS; SHORT-SLEEVED OR LONG-SLEEVED T-SHIRTS; SHORT-SLEEVED SHIRTS; SHORTS; SKI GLOVES; SKI JACKETS; SKI MASKS; SKI WEAR; SKULL CAPS; SLEEP SHIRTS; SLEEVED OR SLEEVELESS JACKETS; SLEEVELESS JERSEYS; SNEAKERS; SOCKS; SPORT SHIRTS; SPORTS BRA; SPORTS JERSEYS; SPORTS SHIRTS WITH SHORT SLEEVES; SUEDE JACKETS; SURF WEAR; SUSPENDERS; SWEAT BANDS; SWEAT PANTS; SWEAT SHIRTS; SWEAT SHORTS; SWEAT SUITS; SWEATBANDS; SWEATERS; SWEATSOCKS; TANK TOPS; TENNIS SHOES; TENNIS WEAR; THONGS; TIES; TRACK PANTS; TRACK SUITS; TROUSERS FOR SWEATING; TURTLENECK SWEATERS; UNIFORMS; T-SHIRTS (U.S. CLS. 22 AND 39).

JORDAN BAKER, EXAMINING ATTORNEY

CLASS 25—(Continued).

SN 77-142,182. VIACOM INTERNATIONAL INC., NEW YORK, NY. FILED 3-28-2007.

DORA BEBE

THE MARK CONSISTS OF STANDARD CHARACTERS WITHOUT CLAIM TO ANY PARTICULAR FONT, STYLE, SIZE, OR COLOR.

NO CLAIM IS MADE TO THE EXCLUSIVE RIGHT TO USE "BEBE", APART FROM THE MARK AS SHOWN.

THE ENGLISH TRANSLATION OF THE WORD BEBE IN THE MARK IS BABY.

FOR CHILDREN'S CLOTHING, NAMELY, BATHING SUITS, HALLOWEEN COSTUMES, COATS, SOCKS, FOOTWEAR, DRESSES, GLOVES, JACKETS, PAJAMAS, PANTS, SHIRTS, SHORTS, SLACKS, SUN VISORS, SWEATERS, TURTLENECKS, UNDERCLOTHES, WARM-UP SUITS, HEADWEAR, BATHROBES, BEACHWEAR (U.S. CLS. 22 AND 39).

B. PARADEWELAI, EXAMINING ATTORNEY

SN 77-142,479. GENERAL, MCKINNEY, TX. FILED 3-28-2007.

Pink Axle

THE MARK CONSISTS OF STANDARD CHARACTERS WITHOUT CLAIM TO ANY PARTICULAR FONT, STYLE, SIZE, OR COLOR.

FOR HATS (U.S. CLS. 22 AND 39).

DOMINICK J. SALEMI, EXAMINING ATTORNEY

SN 77-142,533. FORBESS, WILLIAM, LAFAYETTE, CA. FILED 3-28-2007.

FEARLESS POKER

THE MARK CONSISTS OF STANDARD CHARACTERS WITHOUT CLAIM TO ANY PARTICULAR FONT, STYLE, SIZE, OR COLOR.

FOR HATS; SWEAT SHIRTS; T-SHIRTS (U.S. CLS. 22 AND 39).

REBECCA GAN, EXAMINING ATTORNEY

CLASS 25—(Continued).

SN 77-143,004. SAWHORSE BUSINESS SERVICES LLC, ATLANTA, GA. FILED 3-28-2007.

SAWHORSE

THE MARK CONSISTS OF STANDARD CHARACTERS WITHOUT CLAIM TO ANY PARTICULAR FONT, STYLE, SIZE, OR COLOR.

OWNER OF U.S. REG. NO. 2,272,029.

FOR CLOTHING, NAMELY, T-SHIRTS, POLO SHIRTS, CAPS, JEANS, SHORTS, SHORT-SLEEVED SHIRTS (U.S. CLS. 22 AND 39).

FIRST USE 6-22-2006; IN COMMERCE 6-22-2006.

ALEX KEAM, EXAMINING ATTORNEY

SN 77-143,036. IAMEDIA, INC., MISSOULA, MT. FILED 3-28-2007.

ATOM & ETHER

THE MARK CONSISTS OF STANDARD CHARACTERS WITHOUT CLAIM TO ANY PARTICULAR FONT, STYLE, SIZE, OR COLOR.

FOR SHORT-SLEEVED OR LONG-SLEEVED T-SHIRTS; HATS; CAPS; APRONS; TANK TOPS; INFANT AND TODDLER ONE-PIECE CLOTHING; BIBS NOT OF CLOTH OR PAPER; CLOTH BIBS; SWEAT PANTS; SWEATSHIRTS; SWEAT SUITS; SCARVES; UNDERWEAR; SLIPPERS; BELTS (U.S. CLS. 22 AND 39).

ALICE SUE CARRUTHERS, EXAMINING ATTORNEY

SN 77-143,136. MATHEW, MATHEW A., OAKBROOK TERRACE, IL. FILED 3-28-2007.

Mathew & Mathew

THE MARK CONSISTS OF STANDARD CHARACTERS WITHOUT CLAIM TO ANY PARTICULAR FONT, STYLE, SIZE, OR COLOR.

FOR SHIRTS; NECKTIES; POCKET SQUARES (U.S. CLS. 22 AND 39).

FIRST USE 9-28-2006; IN COMMERCE 9-28-2006.

LAURIE MAYES, EXAMINING ATTORNEY

CLASS 25—(Continued).

SN 77-143,195. MUSTBETHEGENES, HOUSTON, TX. FILED 3-28-2007.

mustbethegenes

THE MARK CONSISTS OF STANDARD CHARACTERS WITHOUT CLAIM TO ANY PARTICULAR FONT, STYLE, SIZE, OR COLOR.

FOR HATS; JACKETS; PANTS; SHIRTS; SHORTS (U.S. CLS. 22 AND 39).

LINDSEY RUBIN, EXAMINING ATTORNEY

SN 77-143,320. GRANADA SALES CORPORATION, NEW YORK, NY. FILED 3-29-2007.

GRANADA

THE MARK CONSISTS OF STANDARD CHARACTERS WITHOUT CLAIM TO ANY PARTICULAR FONT, STYLE, SIZE, OR COLOR.

FOR SLEEPWEAR; NIGHT GOWNS; ROBES; CHEMISES; PAJAMAS; HOUSECOATS; LOUNGEWEAR; DRESSES; SWIM WEAR (U.S. CLS. 22 AND 39).

FIRST USE 0-0-1959; IN COMMERCE 0-0-1959.
JAMES LOVELACE, EXAMINING ATTORNEY

SN 77-143,548. ELLIE SHOES, INC. ORANGE, CA. FILED 3-29-2007.

1031

THE MARK CONSISTS OF STANDARD CHARACTERS WITHOUT CLAIM TO ANY PARTICULAR FONT, STYLE, SIZE, OR COLOR.

FOR WOMEN'S SHOES, NAMELY HIGH FASHION AND EXOTIC PUMPS, SANDALS, STILETTOS, PLATFORMS AND BOOTS (U.S. CLS. 22 AND 39).

TARAH HARDY, EXAMINING ATTORNEY

CLASS 25—(Continued).

SN 77-143,828. H&H ENTERTAINMENT CORP., ROSEDALE, NY. FILED 3-29-2007.



THE MARK CONSISTS OF THE STYLIZED WORDS H&H ENTERTAINMENT ENCIRCLED IN A THREE-BANDED OVAL.

FOR SHIRTS (U.S. CLS. 22 AND 39).

AMEETA JORDAN, EXAMINING ATTORNEY

SN 77-143,834. SHANTOU SAYONA FOOTWEAR CO., LTD., SHANTOU, CHINA. FILED 3-29-2007.

SAYONA

THE MARK CONSISTS OF STANDARD CHARACTERS WITHOUT CLAIM TO ANY PARTICULAR FONT, STYLE, SIZE, OR COLOR.

FOR FOOTWEAR; FOOTWEAR FOR MEN; FOOTWEAR FOR MEN AND WOMEN; FOOTWEAR FOR WOMEN; FOOTWEAR NOT FOR SPORTS; THONGS; BEACH FOOTWEAR; FLIP FLOPS; FOOTWEAR (U.S. CLS. 22 AND 39).

REBECCA EISINGER, EXAMINING ATTORNEY

SN 77-143,978. MAJESTIC INDUSTRIES (CANADA) LIMITED, MONTREAL, CANADA, FILED 3-29-2007.

SEA SCAPES

THE MARK CONSISTS OF STANDARD CHARACTERS WITHOUT CLAIM TO ANY PARTICULAR FONT, STYLE, SIZE, OR COLOR.

FOR CLOTHING, NAMELY, SWIMWEAR (U.S. CLS. 22 AND 39).

FIRST USE 7-23-2007; IN COMMERCE 7-23-2007.

CYNTHIA SLOAN, EXAMINING ATTORNEY

CLASS 25—(Continued).

SN 77-144,169. CROCS, INC., NIWOT, CO. FILED 3-29-2007.

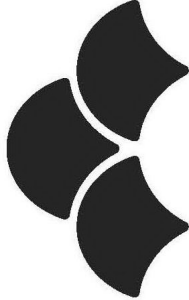

FOR CLOTHING, NAMELY, SHIRTS, SWEATERS, PANTS, SHORTS, SKIRTS, DRESSES, SOCKS, HATS; OUTERWEAR FOR MEN, WOMEN, CHILDREN, YOUTH AND TODDLERS, NAMELY, COATS, JACKETS, ANORAKS, PARKAS, VESTS, PULLOVER JACKETS, BOTH INSULATED AND NON-INSULATED, RAIN WEAR, PONCHOS, CAPES, SHAWLS, SWEATERS, WATERPROOF AND WIND-RESISTANT JACKETS, PULLOVERS, VESTS, AND PANTS; FOOTWEAR (U.S. CLS. 22 AND 39).

LINDSEY RUBIN, EXAMINING ATTORNEY

CLASS 25—(Continued).

SN 77-144,369. SHAMILLE A. WENER, DBA SIDITY CO., EAST HIGHLAND, CA. FILED 3-29-2007.



SN 77-144,325. KENCHI, YUNUSA, NEW YORK, NY. FILED 3-29-2007.

Yunusa Kenchi

THE MARK CONSISTS OF STANDARD CHARACTERS WITHOUT CLAIM TO ANY PARTICULAR FONT, STYLE, SIZE, OR COLOR.

FOR BELTS; FOOTWEAR; HATS; JACKETS; JEANS; LEATHER JACKETS; PANTS; SCARVES; SHIRTS; SOCKS; SWEATERS; T-SHIRTS; UNDERWEAR (U.S. CLS. 22 AND 39).

SCOTT SISUN, EXAMINING ATTORNEY

SN 77-144,326. VARTANIAN, ALEN, RESEDA, CA. FILED 3-29-2007.

Freedom Summer

THE MARK CONSISTS OF STANDARD CHARACTERS WITHOUT CLAIM TO ANY PARTICULAR FONT, STYLE, SIZE, OR COLOR.

FOR HATS; JACKETS; PANTS; SHIRTS (U.S. CLS. 22 AND 39).

LINDA E. BLOHM, EXAMINING ATTORNEY

THE MARK CONSISTS OF A STYLIZED FORM OF THE WORD SIDITY.

FOR ANKLE SOCKS; BABY BIBS NOT OF PAPER; BASEBALL CAPS; BATH SLIPPERS; BEANIES; BLOUSES; BOOTIES; BOXER SHORTS; CAP VISORS; CAPS; CHILDREN'S AND INFANTS' CLOTH BIBS; CHILDREN'S CLOTH EATING BIBS; CHILDREN'S HEADWEAR; CLOTH BIBS; DRESSES; FLIP FLOPS; GYM SHORTS; HALTER TOPS; HATS; HEAD SCARVES; HEAD WEAR; HEADBANDS; HEADWEAR; INFANT AND TODDLER ONE PIECE CLOTHING; INFANT SLEEPERS; INFANTS' SHOES AND BOOTS; INFANTS' TROUSERS; INFANTWEAR; JOGGING OUTFITS; JOGGING PANTS; JOGGING SUITS; JUMPERS; JUMPSUITS; LONG JACKETS; LOUNGEWEAR; MATERNITY SLEEPWEAR; MUSCLE TOPS; NIGHT SHIRTS; NIGHTIES; NIGHTWEAR; ONE PIECE GARMENT FOR INFANTS AND TODDLERS; OPEN-NECKED SHIRTS; PAJAMAS; PANTIES, SHORTS AND BRIEFS; PANTS; PANTSUITS; PLAY SUITS; POLO SHIRTS; PULLOVERS; SHIRTS; SHORT-SLEEVED OR LONG-SLEEVED T-SHIRTS; SHORT-SLEEVED SHIRTS; SHOULDER WRAPS; SKIRTS; SKIRTS AND DRESSES; SKULL CAPS; SKULLIES; SLEEP SHIRTS; SLEEPING GARMENTS; SLEEPWEAR; SLEEVED OR SLEEVELESS JACKETS; SLIPPERS; SMALL HATS; SOCKS; SUN VISORS; SWEAT PANTS; SWEAT SHIRTS; SWEAT SHORTS; SWEAT SUITS; SWEATERS; T-SHIRTS; TANK TOPS; THERMAL UNDERWEAR; THONGS; TUBE TOPS; TURTLENECK SWEATERS; UNDERGARMENTS; UNDERSHIRTS; V-NECK SWEATERS; VESTS; VISORS; WARM UP SUITS; WRAPS; YOGA PANTS; YOGA SHIRTS; TOPS; SHORTS; CROP TOPS; FLEECE PULLOVERS; FLEECE SHORTS; LAYETTES (U.S. CLS. 22 AND 39).

FIRST USE 1-1-2007; IN COMMERCE 1-1-2007.

IRA J. GOODSaid, EXAMINING ATTORNEY

CLASS 25—(Continued).

SN 77-144,370. MOTORCYCLES OF BEND, INC, BEND, OR. FILED 3-29-2007.



NO CLAIM IS MADE TO THE EXCLUSIVE RIGHT TO USE "BEND" OR "INC", APART FROM THE MARK AS SHOWN.

THE MARK CONSISTS OF STYLIZED LETTERS M, O, B, I, N, AND C.

FOR DRESS SHIRTS; HATS; KNIT SHIRTS; POLO SHIRTS; SHIRTS; SHORT-SLEEVED OR LONG-SLEEVED T-SHIRTS; SHORT-SLEEVED SHIRTS; SPORT SHIRTS; SWEAT SHIRTS; T-SHIRTS (U.S. CLS. 22 AND 39).

FIRST USE 3-15-2007; IN COMMERCE 3-15-2007. IRA J. GOODSaid, EXAMINING ATTORNEY

SN 77-144,381. TRIPLEX INVESTMENTS, L.L.C., IRVING, TX. FILED 3-29-2007.

Shoebacca

THE MARK CONSISTS OF STANDARD CHARACTERS WITHOUT CLAIM TO ANY PARTICULAR FONT, STYLE, SIZE, OR COLOR.

FOR SHOES (U.S. CLS. 22 AND 39). TEJBIR SINGH, EXAMINING ATTORNEY

CLASS 25—(Continued).

SN 77-146,388. CROCS, INC., NIWOT, CO. FILED 4-2-2007.

CROSLITE RT

THE MARK CONSISTS OF STANDARD CHARACTERS WITHOUT CLAIM TO ANY PARTICULAR FONT, STYLE, SIZE, OR COLOR.

FOR CLOTHING, NAMELY, SHIRTS, SHORTS, PANTS; SWIM WEAR, NAMELY, SHORTS, RASH GUARDS AND SWIM SUITS; OUTERWEAR FOR MEN, WOMEN, CHILDREN, YOUTH AND TODDLERS, NAMELY, COATS, JACKETS, ANORAKS, PARKAS, VESTS, PULLOVER JACKETS, BOTH INSULATED AND NON-INSULATED, RAIN WEAR, PONCHOS, CAPES, SHAWLS, SWEATERS, WATERPROOF AND WIND-RESISTANT JACKETS, PULLOVERS, VESTS, AND PANTS; HOODED SWEATSHIRTS; LOUNGE WEAR; SOCKS; ACTIVEWEAR FOR MEN, WOMEN, CHILDREN, YOUTH AND TODDLERS, NAMELY, SHIRTS, SWEATSHIRTS, JERSEYS, GOLF SHIRTS, SPORT SHIRTS, SEAMLESS KNIT SHIRTS, SWEATER KNITS, COLLARED SHIRTS, SLEEVELESS SHIRTS, SPORT SHIRTS, AND BOTTOMS; HATS AND HEADWEAR; ATHLETIC PERFORMANCE WEAR, NAMELY, TOPS, SHIRTS, BOTTOMS, PANTS, SHORTS, HOSIERY, UNDERWEAR, ATHLETIC UNIFORMS, ATHLETIC UNIFORM TOPS, ATHLETIC UNIFORM BOTTOMS (U.S. CLS. 22 AND 39). LINDSEY RUBIN, EXAMINING ATTORNEY

SN 77-146,410. CROCS, INC., NIWOT, CO. FILED 4-2-2007.



FOR CLOTHING, NAMELY, SHIRTS, SHORTS, PANTS; SWIM WEAR, NAMELY, SHORTS, RASH GUARDS AND SWIM SUITS; OUTERWEAR FOR MEN, WOMEN, CHILDREN, YOUTH AND TODDLERS, NAMELY, COATS, JACKETS, ANORAKS, PARKAS, VESTS; PULLOVER JACKETS, BOTH INSULATED AND NON-INSULATED; RAIN WEAR, PONCHOS, CAPES, SHAWLS, SWEATERS, WATERPROOF AND WIND-RESISTANT JACKETS, PULLOVERS, VESTS, AND PANTS; HOODED SWEATSHIRTS; LOUNGE WEAR, SOCKS, ACTIVEWEAR FOR MEN, WOMEN, CHILDREN, YOUTH AND TODDLERS, NAMELY, SHIRTS, SWEATSHIRTS, JERSEYS, GOLF SHIRTS, SPORT SHIRTS, SEAMLESS KNIT SHIRTS, SWEATER KNITS, COLLARED SHIRTS, SLEEVELESS SHIRTS, SPORT SHIRTS, SLEEVELESS SHIRTS, AND BOTTOMS; HATS AND HEADWEAR; ATHLETIC PERFORMANCE WEAR, NAMELY, TOPS, SHIRTS, BOTTOMS, PANTS, SHORTS, HOSIERY, UNDERWEAR, ATHLETIC UNIFORMS, ATHLETIC UNIFORMS TOPS, ATHLETIC UNIFORMS BOTTOMS (U.S. CLS. 22 AND 39). LINDSEY RUBIN, EXAMINING ATTORNEY

CLASS 25—(Continued).

SN 77-147,780. URGENT GEAR, INC., LOS ANGELES, CA. FILED 4-3-2007.

MAUI SANDS

THE MARK CONSISTS OF STANDARD CHARACTERS WITHOUT CLAIM TO ANY PARTICULAR FONT, STYLE, SIZE, OR COLOR.

FOR CLOTHING, NAMELY MEN'S AND BOY'S SHIRTS, T-SHIRTS, PANTS, SHORTS AND FOOTWEAR (U.S. CLS. 22 AND 39).

MARGARET POWER, EXAMINING ATTORNEY



SN 77-148,951. L.A. GEAR, INC., LOS ANGELES, CA. FILED 4-4-2007.



OWNER OF U.S. REG. NOS. 1,768,103 AND 1,792,665. THE MARK CONSISTS OF BROAD FLASH DESIGN. FOR FOOTWEAR (U.S. CLS. 22 AND 39). G. MAYERSCHOFF, EXAMINING ATTORNEY



SN 77-148,952. L.A. GEAR, INC., LOS ANGELES, CA. FILED 4-4-2007.



OWNER OF U.S. REG. NOS. 1,768,103 AND 1,792,665. THE MARK CONSISTS OF NARROW FLASH DESIGN. FOR FOOTWEAR (U.S. CLS. 22 AND 39). G. MAYERSCHOFF, EXAMINING ATTORNEY

CLASS 25—(Continued).

SN 77-149,192. MULITEX LIMITED, KOWLOON, HONG KONG, FILED 4-5-2007.

MOLECULE

THE MARK CONSISTS OF STANDARD CHARACTERS WITHOUT CLAIM TO ANY PARTICULAR FONT, STYLE, SIZE, OR COLOR.

FOR CLOTHING, NAMELY, T-SHIRTS, BLOUSES, UNDERWEAR, SHIRTS, PANTS, LADIES' VESTS, SHORTS, SLIPPERS, SHOES, SOCKS, SWEATERS, SWEATSHIRTS, JACKETS AND CHILDREN'S CLOTHING, NAMELY, T-SHIRTS, UNDERWEAR, SHIRTS, PANTS, SHORTS, BOOTS, SLIPPERS, SHOES, SOCKS, SWEATERS, SWEATSHIRTS, JACKETS (U.S. CLS. 22 AND 39).

ALYSSA PALADINO, EXAMINING ATTORNEY



SN 77-149,550. PLANET GOLD CLOTHING CO., INC., NEW YORK, NY. FILED 4-5-2007.

FUDGE-O-LICIOUS

THE MARK CONSISTS OF STANDARD CHARACTERS WITHOUT CLAIM TO ANY PARTICULAR FONT, STYLE, SIZE, OR COLOR.

FOR CLOTHING, NAMELY, SHIRTS, PANTS, BELTS, SOCKS, JACKETS, VESTS, SUITS, DRESSES, SHORTS, SKIRTS, SWEATERS, KNIT TOPS, SHORTALLS, OVERALLS AND CAPRIS (U.S. CLS. 22 AND 39).

BRIAN PINO, EXAMINING ATTORNEY



SN 77-151,881. COLUMBIA INSURANCE COMPANY, OMAHA, NE. FILED 4-9-2007.

TRODDEN

THE MARK CONSISTS OF STANDARD CHARACTERS WITHOUT CLAIM TO ANY PARTICULAR FONT, STYLE, SIZE, OR COLOR.

FOR FOOTWEAR (U.S. CLS. 22 AND 39). IRA J. GOODSaid, EXAMINING ATTORNEY

CLASS 25—(Continued).

SN 77-152,426. MAGDALENO, BEN, FRESNO, CA. FILED 4-9-2007.

ARE YOU ALL AMERICAN?

THE MARK CONSISTS OF STANDARD CHARACTERS WITHOUT CLAIM TO ANY PARTICULAR FONT, STYLE, SIZE, OR COLOR.

FOR CLOTHING, NAMELY T-SHIRTS, SHIRTS, SWEATSHIRTS, JACKETS, SWEATERS, PANTS, SWEAT-PANTS, SHORTS, SPORTS JERSEYS, SOCKS, SHOES, HATS AND GLOVES (U.S. CLS. 22 AND 39).

MICHAEL GAAFAR, EXAMINING ATTORNEY

SN 77-154,286. PHI KAPPA SIGMA FRATERNITY, INC., CHESTER SPRINGS, PA. FILED 4-11-2007.

ΦΚΣ

OWNER OF U.S. REG. NOS. 2,515,036 AND 2,529,663.
THE MARK CONSISTS OF THE GREEK LETTERS "PHI," "KAPPA" AND "SIGMA".
SEC. 2(F).

FOR SHIRTS; SWEAT PANTS; SWEAT SHIRTS; HATS; JACKETS (U.S. CLS. 22 AND 39).

FIRST USE 0-0-1991; IN COMMERCE 0-0-1991.

KAREN BRACEY, EXAMINING ATTORNEY

SN 77-154,378. PHI KAPPA SIGMA FRATERNITY, INC., CHESTER SPRINGS, PA. FILED 4-11-2007.

PHI KAPPA SIGMA

THE MARK CONSISTS OF STANDARD CHARACTERS WITHOUT CLAIM TO ANY PARTICULAR FONT, STYLE, SIZE, OR COLOR.

OWNER OF U.S. REG. NO. 2,529,662.
SEC. 2(F).
FOR HATS; JACKETS; SHIRTS; SWEAT PANTS; SWEAT SHIRTS (U.S. CLS. 22 AND 39).

FIRST USE 0-0-1991; IN COMMERCE 0-0-1991.

KAREN BRACEY, EXAMINING ATTORNEY

CLASS 25—(Continued).

SN 77-155,428. DAX CONSULTING, LLC, DBA D MO BABY, SAN MARCOS, CA. FILED 4-12-2007.



NO CLAIM IS MADE TO THE EXCLUSIVE RIGHT TO USE "BABY", APART FROM THE MARK AS SHOWN.

THE MARK CONSISTS OF A "D" IN A BOX AND THE "MO" IS ALSO IN A BOX. THERE ARE SEVEN STRIPES IN BETWEEN THE "D" AND THE "MO". THE WORD "BABY" IS IN A SCRIPT FONT UNDER AND RIGHT OF THE "MO" AND IS ANGLED UP.

FOR JACKETS; SHIRTS (U.S. CLS. 22 AND 39).

FIRST USE 7-1-2007; IN COMMERCE 7-1-2007.

PAMELA HIRSCHMAN, EXAMINING ATTORNEY

SN 77-159,125. SEUNG-YEUP RHEE, DONALD, LOS ANGELES, CA. FILED 4-18-2007.

POPITS

THE MARK CONSISTS OF STANDARD CHARACTERS WITHOUT CLAIM TO ANY PARTICULAR FONT, STYLE, SIZE, OR COLOR.

OWNER OF U.S. REG. NOS. 3,013,708 AND 3,064,202.
FOR CLOTHING, NAMELY, T-SHIRTS, SWEATSHIRTS, SWEATPANTS, JEANS, SANDALS, SOCKS, VISORS, TANK TOPS, SWIMWEAR, BRAS, THONGS, BIKINIS, BEANIES, HATS, CAPS, FLIP-FLOPS, WRISTBANDS, HEADBANDS, SHOES (U.S. CLS. 22 AND 39).
TASHIA BUNCH, EXAMINING ATTORNEY

SN 77-159,265. COLUMBIA INSURANCE COMPANY, OMAHA, NE. FILED 4-18-2007.

DEXTAIR

THE MARK CONSISTS OF STANDARD CHARACTERS WITHOUT CLAIM TO ANY PARTICULAR FONT, STYLE, SIZE, OR COLOR.

OWNER OF U.S. REG. NOS. 1,137,437, 3,002,801 AND OTHERS.

FOR FOOTWEAR (U.S. CLS. 22 AND 39).

IRA J. GOODSaid, EXAMINING ATTORNEY

CLASS 25—(Continued).

SN 77-162,209. JEWELL, MICHAEL, ZURICH, SWITZERLAND, FILED 4-20-2007.

MO OS

THE MARK CONSISTS OF STANDARD CHARACTERS WITHOUT CLAIM TO ANY PARTICULAR FONT, STYLE, SIZE, OR COLOR.

FOR CLOTHING, NAMELY T-SHIRTS, HATS, JACKETS, PANTS, SWEATSHIRTS AND SHORTS (U.S. CLS. 22 AND 39).

WILLIAM BRECKENFELD, EXAMINING ATTORNEY

CLASS 25—(Continued).

SN 77-173,094. JOHNSON TECHNOLOGIES CORPORATION, NASHVILLE, TN. FILED 5-4-2007.

THERAPY PLATFORMS

THE MARK CONSISTS OF STANDARD CHARACTERS WITHOUT CLAIM TO ANY PARTICULAR FONT, STYLE, SIZE, OR COLOR.

FOR INSOLES; SHOE INSERTS FOR PRIMARILY NON-ORTHOPEDIC PURPOSES (U.S. CLS. 22 AND 39).

FIRST USE 2-19-2007; IN COMMERCE 2-19-2007. CHRISTOPHER BUONGIORNO, EXAMINING ATTORNEY

SN 77-169,978. DEAN ALLEN PAGE, NAMPA, ID. FILED 5-1-2007.

True Biker

THE MARK CONSISTS OF STANDARD CHARACTERS WITHOUT CLAIM TO ANY PARTICULAR FONT, STYLE, SIZE, OR COLOR.

NO CLAIM IS MADE TO THE EXCLUSIVE RIGHT TO USE "BIKER", APART FROM THE MARK AS SHOWN.

FOR T-SHIRTS; THONGS; SWEAT SHIRTS; TANK-TOPS; JACKETS; VESTS; HATS; BEANIES; BOOTS; BANDANAS; SKULL CAPS; DO RAGS; CAPS (U.S. CLS. 22 AND 39).

FIRST USE 2-1-2004; IN COMMERCE 2-1-2004. MARGERY A. TIERNEY, EXAMINING ATTORNEY

SN 77-173,245. COLUMBIA INSURANCE COMPANY, OMAHA, NE. FILED 5-4-2007.

DEXTECH

THE MARK CONSISTS OF STANDARD CHARACTERS WITHOUT CLAIM TO ANY PARTICULAR FONT, STYLE, SIZE, OR COLOR.

OWNER OF U.S. REG. NOS. 1,137,437, 2,434,595 AND OTHERS.

FOR FOOTWEAR (U.S. CLS. 22 AND 39). IRA J. GOODSaid, EXAMINING ATTORNEY

SN 77-173,277. COLUMBIA INSURANCE COMPANY, OMAHA, NE. FILED 5-4-2007.

DEXTEX

SN 77-170,230. JIM CRANE, FARMINGTON, IL. FILED 5-1-2007.

POWERBARK

FOR SHIRTS, SHOES, SOCKS, PANTS, HATS, VESTS AND SHORTS (U.S. CLS. 22 AND 39).

COLLEEN KEARNEY, EXAMINING ATTORNEY

THE MARK CONSISTS OF STANDARD CHARACTERS WITHOUT CLAIM TO ANY PARTICULAR FONT, STYLE, SIZE, OR COLOR.

OWNER OF U.S. REG. NOS. 1,137,437, 2,434,595 AND OTHERS.

FOR FOOTWEAR (U.S. CLS. 22 AND 39). IRA J. GOODSaid, EXAMINING ATTORNEY

CLASS 25—(Continued).

SN 77-173,532. GURU DENIM INC., VERNON, CA. FILED 5-4-2007.

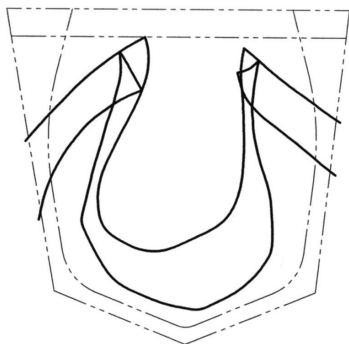

OWNER OF U.S. REG. NO. 3,147,244.

THE MARK CONSISTS OF A STITCHING DESIGN ON THE POCKET OF A GARMENT WHICH INCLUDES A STYLIZED REPRESENTATION OF THE LETTER "U". THE BROKEN LINES IN THE DRAWING ARE USED TO INDICATE THE POSITION OF THE MARK ON THE GOODS AND ARE NOT A FEATURE OF THE MARK.

FOR APPAREL, NAMELY JEANS, PANTS, SKIRTS, SHORTS, JACKETS, COATS, SWEATERS, SHIRTS, TOPS (U.S. CLS. 22 AND 39).

LINDA M. KING, EXAMINING ATTORNEY

SN 77-174,580. WORLD WRESTLING ENTERTAINMENT, INC., STAMFORD, CT. FILED 5-7-2007.

WRESTLEMANIA

THE MARK CONSISTS OF STANDARD CHARACTERS WITHOUT CLAIM TO ANY PARTICULAR FONT, STYLE, SIZE, OR COLOR.

OWNER OF U.S. REG. NOS. 1,432,884, 2,625,125 AND OTHERS.

FOR CLOTHING, NAMELY, TANK TOPS, T-SHIRTS, SHIRTS, SPORT SHIRTS, DRESS SHIRTS, POLO SHIRTS, UNDERSHIRTS, SWEATSHIRTS, SWEATERS, PULL-OVERS, BLOUSES, JACKETS, RAINCOATS, OVERCOATS, TOPCOATS, TROUSERS, PANTS, JEAN PANTS, JOGGING SUITS, EXERCISE PANTS, EXERCISE SUITS, SWEATPANTS, SHORTS, UNDERWEAR, BOXER SHORTS, SOCKS, CLOTHING TIES, PAJAMAS, BELTS, GLOVES, HALLOWEEN AND MASQUERADE COSTUMES, WRIST BANDS, BANDANNAS; FOOTWEAR, NAMELY, SHOES, SNEAKERS, BOOTS, SLIPPERS; HEADWEAR, NAMELY, HATS, CAPS (U.S. CLS. 22 AND 39).

FIRST USE 3-15-1985; IN COMMERCE 3-15-1985.

THEODORE MCBRIDE, EXAMINING ATTORNEY

CLASS 25—(Continued).

SN 77-178,744. ABERCROMBIE & FITCH TRADING CO., NEW ALBANY, OH. FILED 5-11-2007.

CEDRIC

THE MARK CONSISTS OF STANDARD CHARACTERS WITHOUT CLAIM TO ANY PARTICULAR FONT, STYLE, SIZE, OR COLOR.

THE NAME(S), PORTRAIT(S), AND/OR SIGNATURE(S) SHOWN IN THE MARK DOES NOT IDENTIFY A PARTICULAR LIVING INDIVIDUAL.

FOR BATHROBES; BEACH COVERUPS; BEACHWEAR; BELTS; BODY SHAPERS; BODY SUITS; BOXER SHORTS; BUSTIERS; BRAS; CAMISOLES; CAPS; CORSETS; FOOTWEAR; FOUNDATION GARMENTS; GARTER BELTS; GIRDLES; HALTER TOPS; HATS; HEADBANDS; HOSIERY; JEANS; JOGGING SUITS; KNEE HIGHS; KNIT SHIRTS; LEOTARDS; LINGERIE; LOUNGEWEAR; NEGLIGEEES; NIGHT GOWNS; NIGHT SHIRTS; PAJAMAS; PANTIES; PANTS; PANTYHOSE; ROBES; SARONGS; SCARVES; SHIRTS; SHORTS; SKIRTS; SLACKS; SLEEPWEAR; SLIPS; SOCKS; STOCKINGS; SUITS; SWEAT PANTS; SWEAT SHIRTS; SWEAT SHORTS; SWEAT SUITS; SWEATERS; SWIM WEAR; T-SHIRTS; TANK TOPS; TEDDIES; TIES; TIGHTS; TOPS; UNDERPANTS; UNDERSHIRTS; UNDERWEAR; TRACK SUITS; WARM UP SUITS; YOGA PANTS; YOGA SHIRTS (U.S. CLS. 22 AND 39).

JOHN WILKE, EXAMINING ATTORNEY

SN 77-180,937. BOBBIN, INC., FRAMINGHAM, MA. FILED 5-15-2007.

EMBROIDER THIS!

THE MARK CONSISTS OF STANDARD CHARACTERS WITHOUT CLAIM TO ANY PARTICULAR FONT, STYLE, SIZE, OR COLOR.

NO CLAIM IS MADE TO THE EXCLUSIVE RIGHT TO USE EMBROIDER, APART FROM THE MARK AS SHOWN. FOR APRONS; CLOTH BIBS; SCARVES; HATS; UNDERWEAR (U.S. CLS. 22 AND 39).

FIRST USE 2-16-2000; IN COMMERCE 2-16-2000.

DAVID TOOLEY, EXAMINING ATTORNEY

CLASS 25—(Continued).

SN 77-183,479. WRANGLER APPAREL CORP., WILMINGTON, DE. FILED 5-17-2007.

WORK WEAR BY WRANGLER

THE MARK CONSISTS OF STANDARD CHARACTERS WITHOUT CLAIM TO ANY PARTICULAR FONT, STYLE, SIZE, OR COLOR.

OWNER OF U.S. REG. NOS. 849,477, 2,998,129 AND OTHERS.

NO CLAIM IS MADE TO THE EXCLUSIVE RIGHT TO USE "WORK WEAR", APART FROM THE MARK AS SHOWN.

FOR FOOTWEAR (U.S. CLS. 22 AND 39).
FIRST USE 8-26-1998; IN COMMERCE 8-26-1998.
SCOTT SISUN, EXAMINING ATTORNEY

SN 77-183,539. LILY MCNEAL, LLC, LOS ANGELES, CA. FILED 5-17-2007.

~~dear pruit~~

THE MARK CONSISTS OF A STYLIZED TWO WORDS "DEAR PRUITT" WITH A STRIKETHROUGH LINE SEPARATING THE TOP AND BOTTOM HALVES OF THE LOGO.

FOR SWEATERS; COATS; DRESSES; JACKETS; SCARVES; GLOVES (U.S. CLS. 22 AND 39).
FIRST USE 4-1-2007; IN COMMERCE 4-1-2007.
ALICE BENMAMAN, EXAMINING ATTORNEY

SN 77-183,604. LILY MCNEAL, LLC, LOS ANGELES, CA. FILED 5-17-2007.

l i t t l e m c n e a l

THE MARK CONSISTS OF STYLIZED LETTERING, EACH LETTER EQUALLY SPACED.

FOR SWEATERS; COATS; JACKETS; PANTS; HATS; CAPS; SOCKS; SHORTS (U.S. CLS. 22 AND 39).
FIRST USE 9-1-2006; IN COMMERCE 10-1-2006.
ALICE BENMAMAN, EXAMINING ATTORNEY

CLASS 25—(Continued).

SN 77-187,857. SCHERING-PLOUGH HEALTHCARE PRODUCTS, INC., MEMPHIS, TN. FILED 5-23-2007.

TUFF-STEP

THE MARK CONSISTS OF STANDARD CHARACTERS WITHOUT CLAIM TO ANY PARTICULAR FONT, STYLE, SIZE, OR COLOR.

FOR HOSE, SOCKS, STOCKINGS, AND TIGHTS (U.S. CLS. 22 AND 39).

PRISCILLA MILTON, EXAMINING ATTORNEY

SN 77-188,661. HARRAH'S LICENSE COMPANY, LLC, LAS VEGAS, NV. FILED 5-23-2007.

WSOP

THE MARK CONSISTS OF STANDARD CHARACTERS WITHOUT CLAIM TO ANY PARTICULAR FONT, STYLE, SIZE, OR COLOR.

FOR CLOTHING, NAMELY, T-SHIRTS AND CAPS (U.S. CLS. 22 AND 39).

FIRST USE 3-5-2007; IN COMMERCE 3-5-2007.
JULIE THOMAS, EXAMINING ATTORNEY

SN 77-193,907. CBS STUDIOS INC., NEW YORK, NY. FILED 5-31-2007.



OWNER OF U.S. REG. NOS. 1,266,611, 1,362,556 AND 1,674,277.

THE MARK CONSISTS OF THE WORD CHEERS IN A STYLIZED FONT.

FOR APPAREL, NAMELY SHIRTS, JACKETS, SHORTS, PANTS, PAJAMAS, INFANT AND TODDLER ONE PIECE CLOTHING, AND HATS (U.S. CLS. 22 AND 39).

FIRST USE 2-1-1991; IN COMMERCE 2-1-1991.
CYNTHIA SLOAN, EXAMINING ATTORNEY

CLASS 25—(Continued).

SN 77-195,145. HBI BRANDED APPAREL LIMITED, INC., WINSTON-SALEM, NC. FILED 6-1-2007.

COMFORTSOFT

THE MARK CONSISTS OF STANDARD CHARACTERS WITHOUT CLAIM TO ANY PARTICULAR FONT, STYLE, SIZE, OR COLOR.

OWNER OF U.S. REG. NOS. 1,833,894, 3,110,247 AND OTHERS.

FOR SOCKS; PANTS (U.S. CLS. 22 AND 39).
LEE-ANNE BERNS, EXAMINING ATTORNEY

SN 77-195,152. HBI BRANDED APPAREL LIMITED, INC., WINSTON-SALEM, NC. FILED 6-1-2007.

COMFORTSOFT

THE MARK CONSISTS OF STANDARD CHARACTERS WITHOUT CLAIM TO ANY PARTICULAR FONT, STYLE, SIZE, OR COLOR.

OWNER OF U.S. REG. NOS. 1,833,894, 3,110,247 AND OTHERS.

FOR FABRIC SOLD AS A COMPONENT OF PANTS AND SOCKS (U.S. CLS. 22 AND 39).

LEE-ANNE BERNS, EXAMINING ATTORNEY

SN 78-469,318. ORIGINAL BUFF, S.L., IGUALADA (BARCELONA) 08700, SPAIN, FILED 8-18-2004.



PRIORITY CLAIMED UNDER SEC. 44(D) ON SPAIN APPLICATION NO. 2608022, FILED 7-23-2004, REG. NO. 2608022, DATED 4-18-2007, EXPIRES 7-23-2022.

OWNER OF U.S. REG. NO. 2,197,157.

NO CLAIM IS MADE TO THE EXCLUSIVE RIGHT TO USE VISOR, APART FROM THE MARK AS SHOWN.

THE COLOR(S) BLACK, WHITE, ORANGE AND LIGHT ORANGE IS/ARE CLAIMED AS A FEATURE OF THE MARK.

THE MARK CONSISTS OF THE STYLIZED TERM VISOR IN BLACK TO THE LEFT OF THE STYLIZED TERM BUFF THE TERM BUFF IS IN AN ORANGE CIRCLE WITH BLACK ARROWS POINTING CLOCKWISE; THE INTERIOR OF THE LETTER B IS WHITE; THE ENTIRE MARK IS ON A LIGHT ORANGE BACKGROUND.

FOR ARTICLES OF CLOTHING FOR WOMEN, MEN AND CHILDREN, NAMELY, MULTIPURPOSE WRAPS MADE OF TEXTILES FOR USE AS DECORATIVE HEAD-WEAR, HEAD BANDS, ARM BANDS, WRIST BANDS AND LEG BANDS (U.S. CLS. 22 AND 39).

KEVIN DINALLO, EXAMINING ATTORNEY

CLASS 25—(Continued).

SN 78-480,544. JONES, KAREN E, VERO BEACH, FL. FILED 9-8-2004.

Bubbles

THE MARK CONSISTS OF STANDARD CHARACTERS WITHOUT CLAIM TO ANY PARTICULAR FONT, STYLE, SIZE, OR COLOR.

FOR BODY SHAPE ENHANCING CLOTHING, NAMELY HOSIERY, SHAPEWEAR IN THE NATURE OF GIRDLES, BODY-ENHANCING HOSIERY, TIGHTS, ALL OF WHICH INCLUDE AN ELASTICIZED BAND THAT WHEN SITUATED ON THE UPPER LEG JUST BELOW THE BUTTOKS, OPERATE TO PUSH-UP THE BUTTOKS, SUCH PRODUCTS BEING SOLD THROUGH THE INTERNET AND THROUGH BOUTIQUE STORES SPECIALIZING IN UNDERGARMENTS (U.S. CLS. 22 AND 39).

FIRST USE 7-23-2004; IN COMMERCE 7-23-2004.
IRENE D. WILLIAMS, EXAMINING ATTORNEY

SN 78-528,261. OUTHERE SMARTWEAR INC., LAKE WORTH, FL. FILED 12-7-2004.

SMART-TEX

THE MARK CONSISTS OF STANDARD CHARACTERS WITHOUT CLAIM TO ANY PARTICULAR FONT, STYLE, SIZE, OR COLOR.

FOR CLOTHING FOR HUNTING AND RECREATIONAL USE, NAMELY WIND AND WATER RESISTANT JACKETS, COATS, AND PANTS. (U.S. CLS. 22 AND 39).

ANDREA SAUNDERS, EXAMINING ATTORNEY

CLASS 25—(Continued).

SN 78-542,460. THE TIMBERLAND COMPANY, STRATHAM, NH. FILED 1-5-2005.

SMART COMFORT

THE MARK CONSISTS OF STANDARD CHARACTERS WITHOUT CLAIM TO ANY PARTICULAR FONT, STYLE, SIZE, OR COLOR.

NO CLAIM IS MADE TO THE EXCLUSIVE RIGHT TO USE "COMFORT", APART FROM THE MARK AS SHOWN.

FOR SHIRTS, SWEATERS, SWEATSHIRTS, T-SHIRTS, JERSEYS, VESTS, RAINWEAR, JACKETS, COATS, PANTS, SHORTS, COVERALLS, SOCKS, GLOVES, CAPS, HATS, BELTS, SCARVES, BABY BUNTINGS, CYCLISTS' CLOTHING, NAMELY, PANTS, SHORTS, SHIRTS, JACKETS, CAPS, AND GLOVES; SPORTING ANORAKS, LONG COATS, SHORT COATS, BLOUSONS, SUITS, SKIRTS, SLACKS, NON-SPORTING ANORAKS, TROUSERS, OVERALLS, OVERCOATS, ONE-PIECE DRESSES, LAYETTES, WORKING CLOTHES, NAMELY, PANTS, SHIRTS, GLOVES, AND SHOES; JUMPERS, JEAN PANTS, TOPCOATS, TWO-PIECE DRESSES, PARKAS, DRESSING GOWNS, BATH ROBES, UNDERWEAR, UNDERSHIRTS, BATHING SUITS, BATHING TRUNKS, CHEMISE, SWEAT PANTS, DRESS SHIRTS, SLEEPING GARMENTS, CARDIGANS, COMBINATION UNDERWEAR, TANK TOPS, TRACK SUITS, PAJAMAS, POLO SHIRTS, PULL-OVER T-SHIRTS, NECKTIES, SWEAT-ABSORBENT STOCKINGS, LEGWARMERS, LEGGINGS, MITTENS, WATERPROOF CLOTHING, NAMELY, PANTS AND JACKETS; SUSPENDERS FOR CLOTHING, AND HOODED SLEEPING GARMENTS FOR INFANTS (U.S. CLS. 22 AND 39).

JOHN SCHUYLER YARD, EXAMINING ATTORNEY

SN 78-563,173. AMERICAN GIRL, LLC, EL SEGUNDO, CA. FILED 2-8-2005.

FOLLOW YOUR INNER STAR

THE MARK CONSISTS OF STANDARD CHARACTERS WITHOUT CLAIM TO ANY PARTICULAR FONT, STYLE, SIZE, OR COLOR.

FOR GIRL'S CLOTHING, FOOTWEAR AND HEADGEAR, NAMELY, SWEATSHIRTS, SWEATERS, V-NECK SWEATERS, CARDIGANS, BANDANNAS, BASEBALL CAPS, GLOVES, MITTENS, PANTS, CROPPED PANTS, SLACKS, HALLOWEEN COSTUMES AND MASKS, KERICHS, PARKAS, SUN VISORS, SOCKS, PAJAMAS, SWIM WEAR, BATHING SUITS, BATHING SUIT COVER-UPS, NIGHT GOWNS, NIGHT SHIRTS, SLEEP SHIRTS, NIGHTCAPS, SHORTS, SHIRTS, SKORTS, SKIRTS, JACKETS, HATS, CAMISOLES, CAPS, T-SHIRTS, BELTS, COATS, DRESSES, SLIP DRESSES, ROBES, BATHROBES, SPA ROBES; HOSIERY, NAMELY, TIGHTS (U.S. CLS. 22 AND 39).

JILL PRATER, EXAMINING ATTORNEY

CLASS 25—(Continued).

SN 78-575,379. MYERS, ANDY, CHANDLER, AZ. FILED 2-25-2005.



THE COLOR(S) BLACK, WHITE AND RED IS/ARE CLAIMED AS A FEATURE OF THE MARK.

THE MARK CONSISTS OF BLACK BACKGROUND WITH WORDING "NEVERSTOPRIDING" IN WHITE AND RED OCTAGON OUTLINE OVERLYING THE WORDING.

FOR HATS, T-SHIRTS, SWEATSHIRTS, SOCKS, GLOVES, JACKETS, RAINWEAR, PANTS, THERMALS, NAMELY THERMAL SOCKS AND THERMAL UNDERWEAR; NECKWEAR, NECK BANDS, BALACLAVAS, UNDERWEAR, BRAS, HEADWEAR; AND LONGSLEEVE SHIRTS SOLD THROUGH ONLINE WEBSITES, MAGAZINES AND TRADESHOWS (U.S. CLS. 22 AND 39).

FIRST USE 2-1-2005; IN COMMERCE 2-1-2005.

SCOTT SISUN, EXAMINING ATTORNEY

SN 78-614,620. JORDAN, BRIAN O., ATLANTA, GA. FILED 4-22-2005.

GAME FACE

THE MARK CONSISTS OF STANDARD CHARACTERS WITHOUT CLAIM TO ANY PARTICULAR FONT, STYLE, SIZE, OR COLOR.

FOR CLOTHING, NAMELY, T-SHIRTS, POLO SHIRTS, TANK TOPS, SWEAT SHIRTS, SWEAT PANTS, SHORTS, SOCKS, CAPS, HATS, AND JACKETS (U.S. CLS. 22 AND 39).

FIRST USE 8-31-1995; IN COMMERCE 8-31-1995.

GISELLE AGOSTO, EXAMINING ATTORNEY

SN 78-711,492. GUMBOOT ENTERPRISES, INC., LA HABRA, CA. FILED 9-13-2005.

NVR 2 OLD

THE MARK CONSISTS OF STANDARD CHARACTERS WITHOUT CLAIM TO ANY PARTICULAR FONT, STYLE, SIZE, OR COLOR.

FOR KNIT SHIRTS, NIGHT SHIRTS, OPEN-NECKED SHIRTS, SHIRT FRONTS, SHIRTS, SHORT-SLEEVED OR LONG-SLEEVED T-SHIRTS, SHORT-SLEEVED SHIRTS, SLEEP SHIRTS, SPORT SHIRTS, SPORTS SHIRTS, SPORTS SHIRTS WITH SHORT SLEEVES, T-SHIRTS (U.S. CLS. 22 AND 39).

FIRST USE 3-9-2005; IN COMMERCE 6-10-2005.

TONJA GASKINS, EXAMINING ATTORNEY

CLASS 25—(Continued).

SN 78-738,970. COLE, PATRICIA A., DENVER, IN. FILED 10-24-2005.

CLASS 25—(Continued).

SN 78-776,382. BENNETT, DUANE, WILBRAHAM, MA. FILED 12-19-2005.

SHOWCASE

THE MOST SENSUAL GIFT IN THE WORLD

THE MARK CONSISTS OF STANDARD CHARACTERS WITHOUT CLAIM TO ANY PARTICULAR FONT, STYLE, SIZE, OR COLOR.

FOR CUSTOM-MADE APPAREL FOR MEN, WOMEN AND CHILDREN, NAMELY, BLOUSES, SHIRTS, JACKETS, PANTS, COATS, VESTS, DRESSES AND SKIRTS (U.S. CLS. 22 AND 39).

KATHRYN COWARD, EXAMINING ATTORNEY

THE MARK CONSISTS OF STANDARD CHARACTERS WITHOUT CLAIM TO ANY PARTICULAR FONT, STYLE, SIZE, OR COLOR.

NO CLAIM IS MADE TO THE EXCLUSIVE RIGHT TO USE "GIFT", APART FROM THE MARK AS SHOWN.

FOR PANTIES, SHORTS AND BRIEFS; PANTS; SHIRTS; SHORTS; SKIRTS AND DRESSES; T-SHIRTS; THONGS ; UNDERGARMENTS; UNDERGARMENTS WITH ANIMAL TAILS ATTACHED TO THE BACK (U.S. CLS. 22 AND 39).

TIMOTHY FINNEGAN, EXAMINING ATTORNEY

SN 78-758,372. OFFICE OF THE COMMISSIONER OF BASEBALL, NEW YORK, NY. FILED 11-21-2005.

SN 78-777,309. NEW ERA CAP COMPANY, INC., DERBY, NY. FILED 12-20-2005.



FIT FOR THE STREETS TOUR

OWNER OF U.S. REG. NO. 1,357,826 AND OTHERS. SEC. 2(F).

FOR CLOTHING, NAMELY, CAPS, HATS, SHIRTS, T-SHIRTS, TANK TOPS, TURTLENECKS, PULLOVERS, SHORTS, PANTS, BASEBALL UNIFORMS, JERSEYS, WARM-UP SUITS, JOGGING SUITS, SWEATSHIRTS, SWEATPANTS, JACKETS (U.S. CLS. 22 AND 39).

FIRST USE 10-10-1995; IN COMMERCE 10-10-1995.

MICHAEL KEATING, EXAMINING ATTORNEY

THE MARK CONSISTS OF STANDARD CHARACTERS WITHOUT CLAIM TO ANY PARTICULAR FONT, STYLE, SIZE, OR COLOR.

FOR CLOTHING FOR MEN, WOMEN AND CHILDREN, NAMELY T-SHIRTS, SWEATSHIRTS, SWEATSUITS, OUTERWEAR, NAMELY, TRENCH COATS, PARKAS AND WIND RESISTANT JACKETS, BASEBALL JACKETS, CAPS, HATS COATS, PANTS, SHORTS, JEANS, SHIRTS, BOXER BRIEFS, THERMAL UNDERGARMENTS, AND SOCKS; FOOTWEAR FOR MEN, WOMEN AND CHILDREN (U.S. CLS. 22 AND 39).

JENNIFER KRISP, EXAMINING ATTORNEY

CLASS 25—(Continued).

SN 78-788,286. WILLISON, JANET, VAN NUYS, CA. FILED 1-10-2006.

DRAMA PRINCESS

THE MARK CONSISTS OF STANDARD CHARACTERS WITHOUT CLAIM TO ANY PARTICULAR FONT, STYLE, SIZE, OR COLOR.

FOR CLOTHING FOR INFANTS, CHILDREN AND ADULTS, NAMELY, T-SHIRTS, POLO SHIRTS, SHIRTS, SWEATSHIRTS, SWEATPANTS, PANTS, SLACKS, TANK TOPS, JERSEYS, JERSEY DRESSES, SHORTS, PAJAMAS, SPORT SHIRTS, RUGBY SHIRTS, SWEATERS, BELTS, TIES, NIGHTSHIRTS, HATS, CAPS, VISORS, WARM-UP SUITS, WARM-UP PANTS, WARM-UP TOPS, JACKETS, BABY BIBS NOT OF PAPER, BABY ONE PIECES, LAYETTE SETS COMPRISING SHORT ALLS AND TOPS, LAYETTE SETS COMPRISING TOPS AND PANTS, LAYETTE SETS COMPRISING GOWNS AND CAPS, LAYETTE SETS COMPRISING OVERALLS AND TOPS, LAYETTE SETS COMPRISING CARDIGANS AND PANTS, LAYETTE SETS COMPRISING CREEPERS AND PANTS, LAYETTE SETS COMPRISING CARDIGANS, TOPS, AND PANTS, LAYETTES, OVERALL SETS COMPRISING OVERALLS AND TOPS, OVERALLS, BODY SUITS, BONNETS, BOOTIES, BOTTOMS, CARDIGANS, COATS, COORDINATING SETS COMPRISING TOPS AND BOTTOMS, COVERALLS, CREEPERS, DRESSES, JEANS, JOGGING SUITS, JUMPERS, JUMPSUITS, PANTS, PONCHOS, ROMPERS, SHOES, SHORT SETS, SHORT ALL SETS COMPRISING SHORT ALLS AND TOPS, SHORT ALLS, SKIRTS, SLEEPWEAR, SOCKS, HEAD BANDS, WRIST BANDS, UNDERGARMENTS, UNDERWEAR, BOXER SHORTS, EAR MUFFS, GLOVES, MITTENS, SCARVES, AND WOVEN AND KNIT SHIRTS (U.S. CLS. 22 AND 39).

GISELLE AGOSTO, EXAMINING ATTORNEY

SN 78-797,075. MIZSU CORPORATION, CORPUS CHRISTI, TX. FILED 1-23-2006.

CRAWDADDY'S

THE MARK CONSISTS OF STANDARD CHARACTERS WITHOUT CLAIM TO ANY PARTICULAR FONT, STYLE, SIZE, OR COLOR.

FOR CLOTHING, NAMELY, CAPS AND T-SHIRTS (U.S. CLS. 22 AND 39).
FIRST USE 2-6-1993; IN COMMERCE 2-6-1993.
KELLY CHOE, EXAMINING ATTORNEY

CLASS 25—(Continued).

SN 78-809,060. SAUCONY, INC., PEABODY, MA. FILED 2-7-2006.

HIDDEN REFLECTIVITY

THE MARK CONSISTS OF STANDARD CHARACTERS WITHOUT CLAIM TO ANY PARTICULAR FONT, STYLE, SIZE, OR COLOR.

FOR CLOTHING, NAMELY, ATHLETIC CLOTHING, SHORTS, SHIRTS, TANKS, SOCKS, HATS, GLOVES, MITTENS, PANTS, JACKETS, SWIMWEAR, SWIM CAPS, SWEATBANDS, LEGWARMERS, ARM WARMERS, CYCLE BOOTIES, TOE COVERS, HEADBANDS, VESTS, SINGLET, TIGHTS, ATHLETIC BRASSIERES, AND FOOTWEAR (U.S. CLS. 22 AND 39).

TRACY WHITTAKER-BROWN, EXAMINING ATTORNEY

SN 78-816,546. OFFICIAL BUGLE BOY, LLC, COLUMBUS, OH. FILED 2-16-2006.

7M21

THE MARK CONSISTS OF STANDARD CHARACTERS WITHOUT CLAIM TO ANY PARTICULAR FONT, STYLE, SIZE, OR COLOR.

FOR CLOTHING, NAMELY, PANTS AND SHORTS (U.S. CLS. 22 AND 39).

SHARON MEIER, EXAMINING ATTORNEY

SN 78-816,553. OFFICIAL BUGLE BOY, LLC, COLUMBUS, OH. FILED 2-16-2006.

BODYBLAST

THE MARK CONSISTS OF STANDARD CHARACTERS WITHOUT CLAIM TO ANY PARTICULAR FONT, STYLE, SIZE, OR COLOR.

FOR CLOTHING, NAMELY, JEANS AND SHORTS (U.S. CLS. 22 AND 39).

SHARON MEIER, EXAMINING ATTORNEY

CLASS 25—(Continued).

SN 78-819,168. NIFTY AFTER FIFTY, GARDEN GROVE, CA. FILED 2-20-2006.

NIFTY AFTER FIFTY

THE MARK CONSISTS OF STANDARD CHARACTERS WITHOUT CLAIM TO ANY PARTICULAR FONT, STYLE, SIZE, OR COLOR.

FOR CLOTHING, NAMELY SHIRTS, T-SHIRTS, SWEATSHIRTS, SWEATPANTS, POLO SHIRTS, JACKETS, WIND RESISTANT JACKETS, PANTS, SHORTS, SWIMWEAR, AND SOCKS; FOOTWEAR AND HEADWEAR (U.S. CLS. 22 AND 39).

ALICIA COLLINS, EXAMINING ATTORNEY

CLASS 25—(Continued).

SN 78-868,493. HERNANDEZ, ROGER, SAN DIEGO, CA. FILED 4-24-2006.

HARD NINETY

THE MARK CONSISTS OF STANDARD CHARACTERS WITHOUT CLAIM TO ANY PARTICULAR FONT, STYLE, SIZE, OR COLOR.

FOR SPORTS APPAREL AND GARMENTS NAMELY T-SHIRTS, SWEATSHIRTS, TANK TOPS, SWEAT PANTS AND HATS (U.S. CLS. 22 AND 39).

JOHN HWANG, EXAMINING ATTORNEY

SN 78-831,991. HELLEMS, ROMAN D. SR., DES MOINES, IA. FILED 3-8-2006.

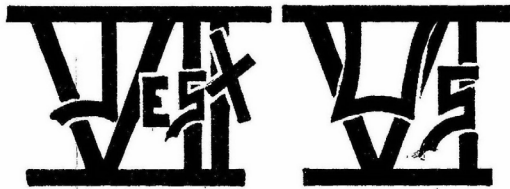

THE MARK CONSISTS OF A STYLIZED ROMAN NUMERAL VII, COMBINED WITH THE STYLIZED WORD "JEST" AND A STYLIZED ROMAN NUMERAL VI, COMBINED WITH THE STYLIZED WORD "US".

FOR CLOTHING, NAMELY, HATS, SHIRTS, JACKETS AND PANTS (U.S. CLS. 22 AND 39).

LOURDES AYALA, EXAMINING ATTORNEY

SN 78-890,194. SCHOTT BROS. INC., ELIZABETH, NJ. FILED 5-23-2006.

CROWN BY SCHOTT N.Y.C.

THE MARK CONSISTS OF STANDARD CHARACTERS WITHOUT CLAIM TO ANY PARTICULAR FONT, STYLE, SIZE, OR COLOR.

OWNER OF U.S. REG. NOS. 1,167,412 AND 2,786,813. NO CLAIM IS MADE TO THE EXCLUSIVE RIGHT TO USE "N.Y.C.", APART FROM THE MARK AS SHOWN.

FOR CLOTHING, NAMELY, COATS, JACKETS, PARKAS, VESTS, T-SHIRTS, SINGLET, TURTLE NECKS, POLO SHIRTS, SHIRTS, SWEATSHIRTS, JEANS, HATS, CAPS, VISORS; SCARVES, NIGHT SHIRTS, RUGBY SHIRTS, POLO SHIRTS, CARDIGANS, JERSEYS, UNIFORMS, PANTS, TROUSERS, SLACKS, JEANS, DENIM JEANS, OVERALLS, COVERALLS, JUMPERS, JUMP SUITS, SHORTS, BOXER SHORTS, TOPS, CROP TOPS, TANK TOPS, HALTER TOPS, SWEAT SHIRTS, SWEAT SHORTS, SWEAT PANTS, WRAPS, WARM-UP SUITS, JOGGING SUITS, TRACK SUITS, BLOUSES, SKIRTS, DRESSES, GOWNS, SWEATERS, FLEECE VESTS, PULL-OVERS, SNOW SUITS, CAPES, ANORAKS PONCHOS, REVERSIBLE JACKETS, BLAZERS, SUITS, CLOTH SKI BIBS, SWIMWEAR, BEACHWEAR, TENNIS WEAR, SURF WEAR, SKI WEAR, HEADBANDS, EAR MUFFS, APRONS, BANDANAS, BELTS, SUSPENDERS, NECKWEAR, TIES, NECKERCHIEFS, ASCOTS, SWIM AND BATHING TRUNKS, SOCKS, LOUNGEWEAR, ROBES, PAJAMAS, SLEEPWEAR, NIGHT GOWNS, SARONGS, LEG WARMERS, PANTYHOSE, BODY STOCKING, KNEE HIGHS, LEGGINGS, TIGHTS, LEOTARDS, BODY SUITS, UNITARDS, BODY SHAPERS, GLOVES, MITTEN, FOOTWEAR, RAINWEAR, AND HOSIERY (U.S. CLS. 22 AND 39).

JOHN GARTNER, EXAMINING ATTORNEY

SN 78-843,708. MOTO 1, DENVER, CO. FILED 3-22-2006.



THE MARK CONSISTS OF THE LETTER M OVER THE NUMBER 1.

FOR HATS; SHIRTS (U.S. CLS. 22 AND 39).

FIRST USE 12-12-2004; IN COMMERCE 12-12-2004. CHARLOTTE CORWIN, EXAMINING ATTORNEY

CLASS 25—(Continued).

SN 78-902,837. BEAZLEY, DAVID, ASHLAND CITY, TN. FILED 6-7-2006.



THE MARK CONSISTS OF AN ANCHOR WITH THE STYLIZED TEXT BEARING SEA CRABBERS INSIDE OF IT. FOR CAPS ; GOLF SHIRTS; T-SHIRTS (U.S. CLS. 22 AND 39).
FIRST USE 3-0-2006; IN COMMERCE 3-0-2006.
JILL C. ALT, EXAMINING ATTORNEY

SN 78-903,267. ARISTOCRACY, INC., LOS ANGELES, CA. FILED 6-7-2006.



THE MARK CONSISTS OF A CROWN WITH TWO WINGED HORSES, ONE ON THE LEFT AND THE OTHER ON THE RIGHT, AND A BIRD SITTING ON THE CROWN WITH WINGS SPREAD OPEN, UNDERNEATH THE CROWN IS THE WORD ARISTOCRACY IN STYLIZED FONT.
FOR BLAZERS; MEN AND WOMEN JACKETS, COATS, TROUSERS, VESTS; MEN'S SUITS; MEN'S SUITS, WOMEN'S SUITS; PANTS; SHIRTS; T-SHIRTS (U.S. CLS. 22 AND 39).
FIRST USE 8-1-2005; IN COMMERCE 8-1-2005.
JOHN HWANG, EXAMINING ATTORNEY

CLASS 25—(Continued).

SN 78-906,149. FOCUS PULL S.P.A., I-40124 BOLOGNA, ITALY, FILED 6-12-2006.

FAIRLY

THE MARK CONSISTS OF STANDARD CHARACTERS WITHOUT CLAIM TO ANY PARTICULAR FONT, STYLE, SIZE, OR COLOR.
OWNER OF ITALY REG. NO. 572552, DATED 7-14-1992, EXPIRES 11-29-2011.
FOR CLOTHING, NAMELY, PULLOVERS, VESTS, SKIRTS, BLOUSES, JACKETS, OVERCOATS, RAINCOATS, TROUSERS, SCARVES, FOULARDS, HATS, TIES, STOCKINGS, GLOVES, DRESSES AND PANTS (U.S. CLS. 22 AND 39).
KEVIN DINALLO, EXAMINING ATTORNEY

SN 78-916,209. DERIC WHATLEY, TUSCALOOSA, AL. FILED 6-24-2006.



THE COLOR(S) BLACK AND RED IS/ARE CLAIMED AS A FEATURE OF THE MARK.
"THE MARK CONSISTS OF A TREE WITH LEAVES BLOWING AWAY FROM IT, POSITIONED ADJACENT TO THE WORDS "FIRETREE RECORDS". THE COLOR BLACK APPEARS IN THE WORDING AND THE TREE; THE COLOR RED APPEARS IN THE LEAVES."
FOR CLOTHING FOR MEN, WOMEN AND CHILDREN, NAMELY, SHIRTS, T-SHIRTS, TANK TOPS, JACKETS, SWEATSHIRTS, CAPS AND HATS (U.S. CLS. 22 AND 39).
STEVEN R. FINE, EXAMINING ATTORNEY

SN 78-918,889. NEGRON, VINCENT L., HUDSON, NH. FILED 6-28-2006.

SoulPowerful

THE MARK CONSISTS OF STANDARD CHARACTERS WITHOUT CLAIM TO ANY PARTICULAR FONT, STYLE, SIZE, OR COLOR.
FOR T-SHIRTS, SOCKS, SCARVES, MITTENS (U.S. CLS. 22 AND 39).
AMY BROZENIC, EXAMINING ATTORNEY

CLASS 25—(Continued).

SN 78-923,437. LUCKY BRAND DUNGAREES, INC., VERNON, CA. FILED 7-6-2006.

LUCKY KID

THE MARK CONSISTS OF STANDARD CHARACTERS WITHOUT CLAIM TO ANY PARTICULAR FONT, STYLE, SIZE, OR COLOR.

OWNER OF U.S. REG. NOS. 1,646,123, 2,381,638 AND 2,903,532.

FOR CLOTHING NAMELY, CHILDREN'S APPAREL, NAMELY SHIRTS, PANTS, SWEATERS, COATS, JEANS, T-SHIRTS AND INFANT AND TODDLER ONE-PIECE CLOTHING. (U.S. CLS. 22 AND 39).

FIRST USE 2-22-2006; IN COMMERCE 2-22-2006.

DAYNA BROWNE, EXAMINING ATTORNEY

SN 78-926,455. PASQUALE & DELICIA, CRANSTON, RI. FILED 7-11-2006.

DIRTY BEATS

THE MARK CONSISTS OF STANDARD CHARACTERS WITHOUT CLAIM TO ANY PARTICULAR FONT, STYLE, SIZE, OR COLOR.

FOR CLOTHING, NAMELY, TEE-SHIRTS, TANK TOPS, HOODED SWEATSHIRTS, AND SWEAT PANTS (U.S. CLS. 22 AND 39).

FIRST USE 3-21-2007; IN COMMERCE 3-21-2007.

GEORGIA CARTY, EXAMINING ATTORNEY

SN 78-935,300. BRADFORD D. STONE, MANHATTAN BEACH, CA. FILED 7-21-2006.

STONE AGE

THE MARK CONSISTS OF STANDARD CHARACTERS WITHOUT CLAIM TO ANY PARTICULAR FONT, STYLE, SIZE, OR COLOR.

FOR CLOTHING, NAMELY, T-SHIRTS, LEGGINGS, HEADBANDS, INFANT AND TODDLER T-SHIRTS. (U.S. CLS. 22 AND 39).

BARBARA A. GOLD, EXAMINING ATTORNEY

CLASS 25—(Continued).

SN 78-937,234. GSM (OPERATIONS) PTY LTD, BURLEIGH HEADS, AUSTRALIA, FILED 7-25-2006.

HYBRID ZIP SYSTEM

THE MARK CONSISTS OF STANDARD CHARACTERS WITHOUT CLAIM TO ANY PARTICULAR FONT, STYLE, SIZE, OR COLOR.

PRIORITY CLAIMED UNDER SEC. 44(D) ON AUSTRALIA APPLICATION NO. 1123845, FILED 7-14-2006, REG. NO. 1123845, DATED 7-14-2006, EXPIRES 7-14-2016.

NO CLAIM IS MADE TO THE EXCLUSIVE RIGHT TO USE "ZIP SYSTEM", APART FROM THE MARK AS SHOWN.

FOR SWIMWEAR; WETSUITS, NON-FLOTATION VESTS TO BE USED IN CONNECTION WITH WETSUITS, BOOTS, GLOVES AND HOODS, WETSUIT SHORTS AND TOPS AND RASH GUARDS (U.S. CLS. 22 AND 39).

CARRIE GENOVESE, EXAMINING ATTORNEY

SN 78-938,587. BOSH, JOEL A., DORAL, FL. FILED 7-27-2006.

YO SOY BORICUA PA' QUE TU LO SEPAS!

THE MARK CONSISTS OF STANDARD CHARACTERS WITHOUT CLAIM TO ANY PARTICULAR FONT, STYLE, SIZE, OR COLOR.

THE ENGLISH TRANSLATION OF "YO SOY BORICUA PA' QUE TU LO SEPAS!" IS "I'M PUERTO RICAN, JUST SO YOU KNOW IT!"

FOR CLOTHING, NAMELY, APRONS, ASCOTS, BABY BIBS NOT OF PAPER, BABY BUNTING, BANDANAS, BATHING CAPS, BATHING SUITS, BATHROBES, BEACH COVERUPS, BEACHWEAR, BEANIES, BELTS, BIB OVERALLS, BIKINIS, BLAZERS, BLOOMERS, BLOUSES, BODY SUITS, BONNETS, BOOTS, BOW TIES, BRAS, BRASSIERES, BRIEFS, BUSTIERS, CAMISOLES, CAPRIS, CAPS, CARDIGANS, CHAPS, CLOAKS, COATS, COLLARS, CORSELETS, COVERALLS, CLOTH DIAPERS, DRESSES, DUNGAREES, FLIP FLOPS, FOOTWEAR, ANKLE GARTERS, GLOVES, GOWNS, HATS, HEAD WEAR, HOSIERY, JACKETS, JEANS, JUMPSUITS, LAB COATS, LEOTARDS, LINGERIE, LOUNGEWEAR, MINISKIRTS, MITTENS, MONEY BELTS, MUFFLERS, NECKTIES, NIGHTWEAR, OVERALLS, OVERCOATS, PAJAMAS, PANTIES, PANTS, PANTSUITS, PANTYHOSE, PETTICOATS, POLO SHIRTS, PONCHOS, PULLOVERS, RAINCOATS, RAINWEAR, ROBES, ROMPERS, SANDALS, SARIS, SARONGS, SASHES, SCARVES, SHIRTS, SHOES, SHORTS, SHOULDER WRAPS, SHOWER CAPS, SILK SCARVES, SKI WEAR, SKIRTS, SKORTS, SLACKS, SLEEPWEAR, SLIPPERS, SLIPS, SMOCKS, SNEAKERS, SOCKS, STOCKINGS, SUIT COATS, SUITS, SUN VISORS, SUNSUITS, SUSPENDERS, SWEAT PANTS, SWEAT SHIRTS, SWEAT SHORTS, SWEAT SUITS, SWEATBANDS, SWEATERS, SWEATSOCKS, SWIM WEAR, SWIMSUITS, TANK-TOPS, TEDDIES, THONGS, TIES, TIGHTS, TOPCOATS, TRENCH COATS, TROUSERS, TRUNKS, T-SHIRTS, TUXEDOS, UNDER GARMENTS, UNDERPANTS, UNDERSHIRTS, UNDERSKIRTS, UNDERWEAR, UNIFORMS, VEILS, VESTS, VISORS, WAIST BELTS, WRAP-AROUNDS, WRAPS, WRISTBANDS (U.S. CLS. 22 AND 39).

SUSAN RICHARDS, EXAMINING ATTORNEY

CLASS 25—(Continued).

SN 78-939,411. JENNY YOO COLLECTION, INC., NEW YORK, NY. FILED 7-27-2006.

REDEFINING BRIDESMAIDS

THE MARK CONSISTS OF STANDARD CHARACTERS WITHOUT CLAIM TO ANY PARTICULAR FONT, STYLE, SIZE, OR COLOR.

NO CLAIM IS MADE TO THE EXCLUSIVE RIGHT TO USE "BRIDESMAIDS", APART FROM THE MARK AS SHOWN.

FOR DRESSES AND GOWNS FOR WOMEN AND GIRLS; TIES (U.S. CLS. 22 AND 39).

FIRST USE 1-0-2003; IN COMMERCE 1-0-2003.

KRISTIN DAHLING, EXAMINING ATTORNEY

SN 78-939,412. THE CORE APPAREL GROUP, LLC, IRVINE, CA. FILED 7-27-2006.



THE MARK CONSISTS OF THE WORDS "THE CORE" IN LOWER CASE LETTERS, ALL POSITIONED WITHIN A CIRCLE.

FOR SHIRTS, PANTS, HATS, SOCKS, UNDERWEAR, JACKETS, SWEATERS, SHORTS (U.S. CLS. 22 AND 39).

BENJAMIN OKEKE, EXAMINING ATTORNEY

SN 78-940,402. RICH & SKINNY, INC., SANTA MONICA, CA. FILED 7-28-2006.

Rich and Skinny

THE MARK CONSISTS OF STANDARD CHARACTERS WITHOUT CLAIM TO ANY PARTICULAR FONT, STYLE, SIZE, OR COLOR.

FOR CLOTHING, NAMELY JEANS AND T-SHIRTS (U.S. CLS. 22 AND 39).

MARK PILARO, EXAMINING ATTORNEY

CLASS 25—(Continued).

SN 78-943,238. AFTERMATH HOLDING COMPANY LLC, IRVINE, CA. FILED 8-2-2006.

AFTERMATH SURFBOARDS

THE MARK CONSISTS OF STANDARD CHARACTERS WITHOUT CLAIM TO ANY PARTICULAR FONT, STYLE, SIZE, OR COLOR.

FOR HATS; PANTS; SHIRTS; SHORTS; SURF WEAR; SWIM WEAR (U.S. CLS. 22 AND 39).

PAUL CROWLEY, EXAMINING ATTORNEY

SN 78-943,881. IL PONTE FINANZIARIA S.P.A., SCANDICCI, FLORENCE, ITALY, FILED 8-3-2006.

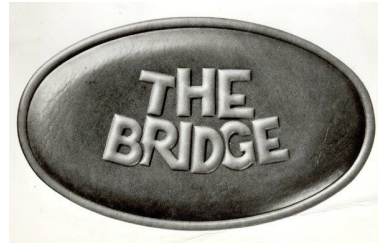

OWNER OF ITALY REG. NO. 633349, DATED 10-3-1994, EXPIRES 6-22-2014.

OWNER OF U.S. REG. NOS. 2,363,664, 2,873,121 AND OTHERS.

FOR SKIRTS, TROUSERS, SHORTS, COATS, JACKETS, HATS, CAPS, GLOVES, NECKTIES, BELTS, VESTS, SOCKS, SHOES, BOOTS, SANDALS, SLIPPERS (U.S. CLS. 22 AND 39).

DEZMONA MIZELLE, EXAMINING ATTORNEY

SN 78-944,032. HARDNETT A. FITZGERALD, OXON HILL, MD. FILED 8-3-2006.

REAL EYES-REALIZE-REAL LIES

THE MARK CONSISTS OF STANDARD CHARACTERS WITHOUT CLAIM TO ANY PARTICULAR FONT, STYLE, SIZE, OR COLOR.

FOR MEN'S AND WOMEN'S JACKETS, COATS, TROUSERS, VESTS (U.S. CLS. 22 AND 39).

FIRST USE 5-10-2004; IN COMMERCE 8-24-2005.

LINDA MICKLEBURGH, EXAMINING ATTORNEY

CLASS 25—(Continued).

SN 78-947,806. KATHRYN M. RHODES, SAINT LOUIS, MO.
FILED 8-8-2006.

PINK MONKEY

THE MARK CONSISTS OF STANDARD CHARACTERS WITHOUT CLAIM TO ANY PARTICULAR FONT, STYLE, SIZE, OR COLOR.

FOR CLOTHING, NAMELY, SHIRTS, PANTS, SKIRTS, SHORTS, SWEATERS, COATS, DRESSES, HOSIERY AND SHOES. (U.S. CLS. 22 AND 39).

LAURA HAMMEL, EXAMINING ATTORNEY

SN 78-947,819. KATHRYN M. RHODES, SAINT LOUIS, MO.
FILED 8-8-2006.



THE MARK CONSISTS OF THE WORDS PINK MONKEY IN SCRIPTS WITH A MONKEY IN BETWEEN THE WORDS. FOR CLOTHING, NAMELY, SHIRTS, PANTS, SKIRTS, SHORTS, SWEATERS, COATS, DRESSES, HOSIERY AND SHOES. (U.S. CLS. 22 AND 39).

LAURA HAMMEL, EXAMINING ATTORNEY

SN 78-947,963. SMITH, CHARLES C. JR., LONGWOOD, FL.
FILED 8-8-2006.

**EDISTO MARINA SOUTH
CAROLINA GOVERNOR'S CUP
BILLFISHING TOURNAMENT**

THE MARK CONSISTS OF STANDARD CHARACTERS WITHOUT CLAIM TO ANY PARTICULAR FONT, STYLE, SIZE, OR COLOR.

FOR CLOTHING, NAMELY SHIRTS; T-SHIRTS, SHORT-SLEEVED OR LONG-SLEEVED T-SHIRTS; CAMP SHIRTS; GOLF SHIRTS; POLO SHIRTS; SPORTS SHIRTS; KNIT SHIRTS; CROP TOPS; SWEATSHIRTS; SWEATERS; JACKETS; PANTS; SHORTS; SKIRTS; HATS; NECKWEAR AND SHOES (U.S. CLS. 22 AND 39).

FIRST USE 12-31-1991; IN COMMERCE 12-31-1991.

CAROL SPILS, EXAMINING ATTORNEY

CLASS 25—(Continued).

SN 78-951,394. SCHAFFER, ROBIN, EAST BRUNSWICK, NJ.
FILED 8-14-2006.

MASTERFUL KIDS

THE MARK CONSISTS OF STANDARD CHARACTERS WITHOUT CLAIM TO ANY PARTICULAR FONT, STYLE, SIZE, OR COLOR.

NO CLAIM IS MADE TO THE EXCLUSIVE RIGHT TO USE "KIDS", APART FROM THE MARK AS SHOWN.

FOR APPAREL, NAMELY, SHIRTS AND HATS (U.S. CLS. 22 AND 39).

BRENDAN REGAN, EXAMINING ATTORNEY

SN 78-952,788. WALESIEWICZ, ADAM C., RESTON, VA.
FILED 8-15-2006.

BALLISTO

THE MARK CONSISTS OF STANDARD CHARACTERS WITHOUT CLAIM TO ANY PARTICULAR FONT, STYLE, SIZE, OR COLOR.

FOR ATHLETIC SHOES, PANTS, SHIRTS, JERSEYS, SOCKS, AND OTHER APPAREL, NAMELY, T-SHIRTS, SWEATSHIRTS, SWEATPANTS, HEADBANDS, AND WRISTBANDS. (U.S. CLS. 22 AND 39).

STEVEN JACKSON, EXAMINING ATTORNEY

SN 78-953,984. GIFFORD, KEITH A., REDWAY, CA. FILED
8-17-2006.



NO CLAIM IS MADE TO THE EXCLUSIVE RIGHT TO USE "BEACH AND SURF GEAR", APART FROM THE MARK AS SHOWN.

THE COLOR(S) BLACK, YELLOW AND RED IS/ARE CLAIMED AS A FEATURE OF THE MARK.

THE COLOR BLACK APPEARS AS BACKGROUND; THE COLOR YELLOW APPEARS IN THE LETTERS "H" AND "T," IN THE WORDING "BEACH 'N' SURF GEAR," IN A NARROW INSET BORDER, AND IN THE CENTER OF THE SUN DESIGN; THE COLOR RED APPEARS IN THE RAYS OF THE SUN DESIGN.

FOR SURF WEAR (U.S. CLS. 22 AND 39).

FIRST USE 1-15-2003; IN COMMERCE 1-15-2003.

AISHA SALEM, EXAMINING ATTORNEY

CLASS 25—(Continued).

SN 78-957,780. LINDA NGUYEN, FOUNTAIN VALLEY, CA.
FILED 8-22-2006.

LOVEMADE

THE MARK CONSISTS OF STANDARD CHARACTERS WITHOUT CLAIM TO ANY PARTICULAR FONT, STYLE, SIZE, OR COLOR.

FOR CLOTHING, NAMELY, SHIRTS, PANTS, JACKETS, SWEATERS, DRESSES, FOOTWEAR, HEADWEAR (U.S. CLS. 22 AND 39).

MELISSA VALLILLO, EXAMINING ATTORNEY

CLASS 25—(Continued).

SN 78-962,205. LEGENDARY GEAR, LLC, MEMPHIS, TN.
FILED 8-28-2006.



SN 78-957,970. GALLAGHER, SHANE P., SANTA CRUZ, CA.
FILED 8-22-2006.

ON THE EDGE

THE MARK CONSISTS OF STANDARD CHARACTERS WITHOUT CLAIM TO ANY PARTICULAR FONT, STYLE, SIZE, OR COLOR.

FOR CLOTHING, NAMELY, T-SHIRTS, SPORT SHIRTS, LONG-SLEEVED T-SHIRTS, SWEAT SHIRTS, CAPS, SOCKS, SHORTS, BOARD SHORTS, PANTS, JEANS, DENIM JEANS, AND SWEAT PANTS (U.S. CLS. 22 AND 39).

JERI J. FICKES, EXAMINING ATTORNEY

NO CLAIM IS MADE TO THE EXCLUSIVE RIGHT TO USE "MEMPHIS, TN", APART FROM THE MARK AS SHOWN.

FOR HATS, CAPS, JACKETS, SHIRTS, TANK TOPS, JERSEYS, CHILDREN'S CLOTH BIBS, CHILDREN'S CLOTHING, NAMELY, PANTS AND SHIRTS (U.S. CLS. 22 AND 39).

FIRST USE 12-31-2005; IN COMMERCE 12-31-2005.

ALLISON SCHRODY, EXAMINING ATTORNEY

SN 78-958,393. L. C. LICENSING, INC., NEW YORK, NY.
FILED 8-23-2006.

LIZ CLAIBORNE WALLPAPER

THE MARK CONSISTS OF STANDARD CHARACTERS WITHOUT CLAIM TO ANY PARTICULAR FONT, STYLE, SIZE, OR COLOR.

OWNER OF U.S. REG. NOS. 2,885,141, 2,916,333 AND OTHERS.

"THE NAME(S), PORTRAIT(S), AND/OR SIGNATURE(S) SHOWN IN THE MARK DOES NOT IDENTIFY A PARTICULAR LIVING INDIVIDUAL."

FOR CLOTHING, NAMELY, SHIRTS, PANTS, SWEATERS, SKIRTS, DRESSES, COATS, SUITS, NECKTIES, BELTS, SWIMWEAR, RAINWEAR, SLEEPWEAR, NAMELY, NIGHTGOWNS, PAJAMAS AND ROBES, LINGERIE, UNDERWEAR, BRAS, SOCKS, HOSIERY, GLOVES, MITTENS AND SCARVES; FOOTWEAR; HEADWEAR (U.S. CLS. 22 AND 39).

REBECCA GAN, EXAMINING ATTORNEY

SN 78-967,347. FOXWORTHY, JEFF, SHERMAN OAKS, CA.
FILED 9-5-2006.

FOXWORTHY OUTDOORS

THE MARK CONSISTS OF STANDARD CHARACTERS WITHOUT CLAIM TO ANY PARTICULAR FONT, STYLE, SIZE, OR COLOR.

OWNER OF U.S. REG. NOS. 2,953,800, 2,956,789 AND OTHERS.

NO CLAIM IS MADE TO THE EXCLUSIVE RIGHT TO USE "OUTDOORS", APART FROM THE MARK AS SHOWN. SEC. 2(F).

FOR HEADWEAR; SWEATSHIRTS, T-SHIRTS, PANTS, SHORTS, AND SWIMWEAR (U.S. CLS. 22 AND 39).

FIRST USE 6-30-2006; IN COMMERCE 6-30-2006.

MATTHEW PAPPAS, EXAMINING ATTORNEY

CLASS 25—(Continued).

SN 78-968,385. PATRICK SANDOVAL, BOULDER, CO.
FILED 9-6-2006.

Primal Future

THE MARK CONSISTS OF STANDARD CHARACTERS WITHOUT CLAIM TO ANY PARTICULAR FONT, STYLE, SIZE, OR COLOR.

FOR (BASED ON USE IN COMMERCE) MUSCLE TOPS; SHIRTS; SHORT-SLEEVED OR LONG-SLEEVED T-SHIRTS; SHORT-SLEEVED SHIRTS; SILK SCARVES; SPORT SHIRTS; SPORTS SHIRTS; SPORTS SHIRTS WITH SHORT SLEEVES; T-SHIRTS; (BASED ON INTENT TO USE) BALLOON PANTS; BOARD SHORTS; BOXER BRIEFS; CAMP SHIRTS; CAPRI PANTS; CARGO PANTS; DRESS SHIRTS; GOLF SHIRTS; GYM SHORTS; HATS; JOGGING PANTS; KNIT SHIRTS; NECKWEAR; PANTIES, SHORTS AND BRIEFS; PANTS; POLO SHIRTS; SCARVES; SHOULDER SCARVES; SKIRTS; SWEAT PANTS; SWEAT SHORTS; TAP PANTS; UNDERGARMENTS; WRISTBANDS (U.S. CLS. 22 AND 39).

FIRST USE 7-25-2002; IN COMMERCE 12-10-2004.
KIMBERLY PERRY, EXAMINING ATTORNEY

SN 78-969,181. UTEX CORPORATION, MONT-ROYAL; PQ,
CANADA, FILED 9-7-2006.

Antonio Treviso

THE MARK CONSISTS OF STANDARD CHARACTERS WITHOUT CLAIM TO ANY PARTICULAR FONT, STYLE, SIZE, OR COLOR.

THE NAME ANTONIO TREVISO DOES NOT IDENTIFY A LIVING INDIVIDUAL.

FOR MEN'S CLOTHING, NAMELY, SUITS, SPORTS JACKETS AND BLAZERS (U.S. CLS. 22 AND 39).

BRENDAN REGAN, EXAMINING ATTORNEY

SN 78-974,703. CARMELA DECRISTOFORO, HAYDEN, ID.
FILED 9-14-2006.

SURF KID

THE MARK CONSISTS OF STANDARD CHARACTERS WITHOUT CLAIM TO ANY PARTICULAR FONT, STYLE, SIZE, OR COLOR.

NO CLAIM IS MADE TO THE EXCLUSIVE RIGHT TO USE "KID", APART FROM THE MARK AS SHOWN.

FOR CLOTHING, NAMELY T-SHIRTS, SWEAT-SHIRTS, TANK TOPS, HATS, BEANIES, SHORTS, ROMPERS, BIBS NOT MADE OF PAPER, AND DRESSES (U.S. CLS. 22 AND 39).

BARBARA A. GOLD, EXAMINING ATTORNEY

CLASS 25—(Continued).

SN 78-978,723. DOUECK, STEVE, BROOKLYN, NY. FILED 4-24-2006.

JERSEY SHORE FILM FESTIVAL

THE MARK CONSISTS OF STANDARD CHARACTERS WITHOUT CLAIM TO ANY PARTICULAR FONT, STYLE, SIZE, OR COLOR.

FOR CLOTHING, NAMELY, T-SHIRTS, HATS AND JACKETS (U.S. CLS. 22 AND 39).

FIRST USE 3-13-2007; IN COMMERCE 3-13-2007.

LYDIA BELZER, EXAMINING ATTORNEY

SN 79-027,127. AFOI THEOCHARI O.E., GR-112 54 ATHENS,
GREECE, FILED 6-26-2006.

PARANOÏA

THE MARK CONSISTS OF STANDARD CHARACTERS WITHOUT CLAIM TO ANY PARTICULAR FONT, STYLE, SIZE, OR COLOR.

OWNER OF INTERNATIONAL REGISTRATION 0893955 DATED 6-26-2006, EXPIRES 6-26-2016.

FOR CLOTHING, NAMELY, T-SHIRTS, SHIRTS, DRESSES, SKIRTS, TROUSERS, SHORTS, PANTS, BLAZERS, COATS, OVERCOATS, KNITTED TOPS, JEANS, JACKETS, SHOES, SNEAKERS, UNDERWEAR, CLOTHING BELTS (U.S. CLS. 22 AND 39).

KATHERINE CHANG, EXAMINING ATTORNEY

SN 79-027,512. ZANONE - S.R.L., ITALY, FILED 6-1-2006.

ZANONE FLEXWOOL

THE MARK CONSISTS OF STANDARD CHARACTERS WITHOUT CLAIM TO ANY PARTICULAR FONT, STYLE, SIZE, OR COLOR.

PRIORITY DATE OF 3-10-2006 IS CLAIMED.

OWNER OF INTERNATIONAL REGISTRATION 0894996 DATED 6-1-2006, EXPIRES 6-1-2016.

OWNER OF U.S. REG. NO. 2,221,283.

NO CLAIM IS MADE TO THE EXCLUSIVE RIGHT TO USE "FLEXWOOL", APART FROM THE MARK AS SHOWN.

FOR SINGLET, PULLOVERS, GLOVES AND MUFFS FOR CLOTHING, CARDIGANS, JERSEYS, NECKTIES, SCARVES, SWEATERS, SKIRTS, JACKETS, JERKINS, SHIRTS, VESTS, WAISTCOATS, JUMPERS, T-SHIRTS, SUITS AND DRESSES, OVERCOATS, COATS, SASHES FOR WEAR, BELTS FOR CLOTHING, HATS, BERETS, KNITTED SHIRTS, POLO SHIRTS, ALL MADE WHOLLY OR SIGNIFICANTLY IN PART OF WOOL (U.S. CLS. 22 AND 39).

HOWARD SMIGA, EXAMINING ATTORNEY

CLASS 25—(Continued).

SN 79-027,557. MUSTO LIMITED, ESSEX SS15 6TR, UNITED KINGDOM, FILED 5-12-2006.

SPORTING LADIES

THE MARK CONSISTS OF STANDARD CHARACTERS WITHOUT CLAIM TO ANY PARTICULAR FONT, STYLE, SIZE, OR COLOR.

PRIORITY DATE OF 12-23-2005 IS CLAIMED. OWNER OF INTERNATIONAL REGISTRATION 0895005 DATED 5-12-2006, EXPIRES 5-12-2016.

FOR WOMEN'S CLOTHING, NAMELY, SHIRTS, T-SHIRTS, POLO SHIRTS, TURTLENECKS, SWEATSHIRTS, SMOCKS, GILETS, SHORTS, SKIRTS, PANTS, TROUSERS, OVER-TROUSERS, BREEKS, WAISTCOATS, JACKETS, SMOCKS, ONE-PIECE SUITS, SALOPETTES, COATS, JERSEYS, WATERPROOF JACKETS, VESTS, BLOUSONS, GLOVES; HEADWEAR AND FOOTWEAR FOR CASUAL WEAR (U.S. CLS. 22 AND 39).

ALICE SUE CARRUTHERS, EXAMINING ATTORNEY

CLASS 25—(Continued).

SN 79-036,259. SCORE RETAIL NEDERLAND BV, NETHERLANDS, FILED 1-15-2007.



PRIORITY DATE OF 12-7-2006 IS CLAIMED. OWNER OF INTERNATIONAL REGISTRATION 0918161 DATED 1-15-2007, EXPIRES 1-15-2017.

FOR CLOTHING, NAMELY, JEANS, NON-DENIM PANTS AND SHORTS, T-SHIRTS, SHIRTS, SKIRTS, SWEATERS, VESTS, JACKETS, BLAZERS, SWIMWEAR, BLOUSES, UNDERWEAR, BELTS, CAPS, SCARVES AND TIES (U.S. CLS. 22 AND 39).

JOHN E. MICHOS, EXAMINING ATTORNEY

SN 79-028,486. NATASHA STONE, AUSTRALIA, FILED 8-23-2006.

Rockstars & ANGELS

OWNER OF INTERNATIONAL REGISTRATION 0897446 DATED 8-23-2006, EXPIRES 8-23-2016.

FOR CLOTHING FOR MEN, LADIES, BOYS, GIRLS, CHILDREN AND BABIES, NAMELY, JACKETS, JERSEYS, SHIRTS, PANTS AND HATS; CASUAL CLOTHING, NAMELY, DENIM JACKETS AND PANTS; FASHION CLOTHING, NAMELY, DRESSES; BEACHWEAR; KNITWEAR, NAMELY, KNIT SHIRTS, KNITTED CAPS AND KNITTED UNDERWEAR (U.S. CLS. 22 AND 39).

NELSON SNYDER, EXAMINING ATTORNEY

SN 79-036,416. DAZAWA SHOES CO., LTD, WENZHOU; 325006 ZHEJIANG, CHINA, FILED 3-21-2007.

SN 79-030,557. ALBERTO GMBH & CO. KG, FED REP GERMANY, FILED 9-27-2006.

ALBERTO



DAZAWA

THE MARK CONSISTS OF STANDARD CHARACTERS WITHOUT CLAIM TO ANY PARTICULAR FONT, STYLE, SIZE, OR COLOR.

PRIORITY DATE OF 6-8-2006 IS CLAIMED. OWNER OF INTERNATIONAL REGISTRATION 0902609 DATED 9-27-2006, EXPIRES 9-27-2016.

OWNER OF U.S. REG. NO. 2,820,901. FOR MEN'S CLOTHING, NAMELY, TROUSERS, SHIRTS, POLO-SHIRTS, WAISTCOATS, BELTS, BRACES; WOMEN'S CLOTHING, NAMELY, TROUSERS, CULOTTES, SKIRTS, BLOUSES, POLO-SHIRTS, WAISTCOATS, BELTS (U.S. CLS. 22 AND 39).

MARK PILARO, EXAMINING ATTORNEY

OWNER OF INTERNATIONAL REGISTRATION 0918540 DATED 3-21-2007, EXPIRES 3-21-2017.

THE MARK CONSISTS OF A DESIGN OF A FOOTPRINT ON A DOTTED BACKGROUND WITH FOUR CIRCLES TO THE LEFT OF THE FOOTPRINT. TO THE RIGHT OF THE FOOTPRINT IS THE WORDING DAZAWA IN STYLIZED LETTERS.

FOR SHOES (U.S. CLS. 22 AND 39). MARILYN IZZI, EXAMINING ATTORNEY

CLASS 26—FANCY GOODS

SN 77-112,348. KRAVET, INC., SOUTH BETHPAGE, NY.
FILED 2-21-2007.

GROUNDWORKS

THE MARK CONSISTS OF STANDARD CHARACTERS WITHOUT CLAIM TO ANY PARTICULAR FONT, STYLE, SIZE, OR COLOR.

OWNER OF U.S. REG. NO. 1,215,911.
FOR FABRIC AND FURNISHING TRIMMINGS, NAMELY, ORNAMENTAL RIBBONS MADE OF TEXTILES, LACE, TRIMMING, TASSELS, BRAIDS, DECORATIVE CORDS, FRINGES (U.S. CLS. 37, 39, 40, 42 AND 50).

FIRST USE 1-26-2007; IN COMMERCE 1-26-2007.
VIVIAN MICZNIK FIRST, EXAMINING ATTORNEY

SN 77-132,352. ROOTPHI, LLC, ALLENTOWN, PA. FILED 3-15-2007.

GOLACES

THE MARK CONSISTS OF STANDARD CHARACTERS WITHOUT CLAIM TO ANY PARTICULAR FONT, STYLE, SIZE, OR COLOR.

FOR SHOE LACES (U.S. CLS. 37, 39, 40, 42 AND 50).
CURTIS FRENCH, EXAMINING ATTORNEY

SN 77-137,466. ROLSTON, STACY LEE, SALMON ARM, CANADA, FILED 3-22-2007.

Zippitz

THE MARK CONSISTS OF STANDARD CHARACTERS WITHOUT CLAIM TO ANY PARTICULAR FONT, STYLE, SIZE, OR COLOR.

FOR ZIPPER PULLS (U.S. CLS. 37, 39, 40, 42 AND 50).
FIRST USE 1-2-2007; IN COMMERCE 1-2-2007.
ANDREA HACK, EXAMINING ATTORNEY

CLASS 26—(Continued).

SN 77-138,963. MASCOTTE HOLDINGS, INC., NEW YORK, NY. FILED 3-23-2007.

THE PAST TELLS EVERYTHING

THE MARK CONSISTS OF STANDARD CHARACTERS WITHOUT CLAIM TO ANY PARTICULAR FONT, STYLE, SIZE, OR COLOR.

FOR ORNAMENTAL NOVELTY BUTTONS, PRESS BUTTONS, RIVET BUTTONS, AND CAMPAIGN BUTTONS; ORNAMENTAL NOVELTY PINS; HAT PINS; HAT ORNAMENTS NOT OF PRECIOUS METAL; ORNAMENTAL BOWS OF TEXTILE FOR DECORATION; SAFETY PINS; RIBBONS; ORNAMENTAL RIBBONS MADE OF TEXTILES; RIBBONS FOR WRAPPING AND GIFT WRAPPING; ELASTIC RIBBONS; SEWING BOXES; CLOTHING AND SHIRT BUTTONS; EMBROIDERED PATCHES FOR CLOTHING; CLOTH PATCHES FOR CLOTHING; ORNAMENTAL CLOTH PATCHES; EMBROIDERED EMBLEMS; BELT BUCKLES NOT OF PRECIOUS METAL; CLOTHING BUCKLES; BELT CLASPS; ZIPPERS AND ZIPPER PULLS; SNAP FASTENERS; CLASPS FOR CLOTHING; HAIR ACCESSORIES, NAMELY, HAIR TIES, HAIR ORNAMENTS, HAIR PINS, BARRETTES, HAIR BANDS, HAIR RIBBONS, HAIR BOWS, PONYTAIL HOLDERS, HAIR BOWS WITH CLIPS, HAIR CLIPS, HAIR FASTENERS, HAIR PINS AND GRIPS, ORIENTAL HAIR PINS, HAIR BUCKLES, CLAM CLIPS FOR HAIR, CLAW CLIPS, TWISTERS, HAIR SCRUNCHIES, SNAP CLIPS, ORNAMENTAL COMBS WORN ON HAIR; HAIR ROLLER CLIPS AND PINS, BOBBY PINS, CURLING PINS, WAVING PINS FOR THE HAIR, HAIR NETS, HAIR WRAPS, HAIR CURL CLIPS, SLEEP CLIPS, SALON CLIPS, HAIR FROSTING CAPS, NON-ELECTRIC HAIR CURLERS AND ROLLERS, BRAIDS, AND BRAIDING PINS (U.S. CLS. 37, 39, 40, 42 AND 50).

CHRISTOPHER OTT, EXAMINING ATTORNEY

SN 77-141,507. SC LICENSING CORP, WEST BRIDGEWATER, MA. FILED 3-27-2007.

hair DIVAS

NO CLAIM IS MADE TO THE EXCLUSIVE RIGHT TO USE "HAIR", APART FROM THE MARK AS SHOWN.

THE MARK CONSISTS OF THE WORDING "HAIR" IN BOLD LOWER CASE LETTERS AND DIVAS IN UPPER CASE LETTERS.

FOR WIGS (U.S. CLS. 37, 39, 40, 42 AND 50).
EMILY CHUO, EXAMINING ATTORNEY

CLASS 26—(Continued).

SN 77-143,749. SHAKE-N-GO FASHION, INC., PORT WASHINGTON, NY. FILED 3-29-2007.

SHAKE-N-GO

THE MARK CONSISTS OF STANDARD CHARACTERS WITHOUT CLAIM TO ANY PARTICULAR FONT, STYLE, SIZE, OR COLOR.

OWNER OF U.S. REG. NOS. 1,821,473, 1,829,485 AND 2,894,668.

FOR HAIR PRODUCTS, NAMELY HAIR EXTENSIONS, WIGS AND PONYTAILS (U.S. CLS. 37, 39, 40, 42 AND 50).

FIRST USE 7-1-1992; IN COMMERCE 7-1-1992.

STANLEY I. OSBORNE, EXAMINING ATTORNEY

SN 77-159,395. SHAKE-N-GO FASHION, INC., PORT WASHINGTON, NY. FILED 4-18-2007.

EQUAL

THE MARK CONSISTS OF STANDARD CHARACTERS WITHOUT CLAIM TO ANY PARTICULAR FONT, STYLE, SIZE, OR COLOR.

FOR HAIR PRODUCTS, NAMELY HAIR EXTENSIONS, WIGS, HAIR PIECES, AND PONYTAILS (U.S. CLS. 37, 39, 40, 42 AND 50).

STANLEY I. OSBORNE, EXAMINING ATTORNEY

SN 77-183,359. BEAUTY PLUS TRADING CO., INC., MOONACHIE, NJ. FILED 5-17-2007.

EZ Weave

THE MARK CONSISTS OF STANDARD CHARACTERS WITHOUT CLAIM TO ANY PARTICULAR FONT, STYLE, SIZE, OR COLOR.

NO CLAIM IS MADE TO THE EXCLUSIVE RIGHT TO USE "WEAVE", APART FROM THE MARK AS SHOWN.

FOR HAIR EXTENSIONS (U.S. CLS. 37, 39, 40, 42 AND 50).

ELIZABETH BEYER, EXAMINING ATTORNEY

CLASS 26—(Continued).

SN 78-941,818. SPOTLIGHT PTY LTD., SOUTH MELBOURNE, AUSTRALIA, FILED 7-31-2006.



The Creatives

PRIORITY CLAIMED UNDER SEC. 44(D) ON AUSTRALIA APPLICATION NO. 1115982, FILED 5-26-2006, REG. NO. 1115982, DATED 5-26-2006, EXPIRES 5-26-2017.

OWNER OF U.S. REG. NO. 3,164,574.

FOR LACES AND EMBROIDERY; RIBBONS AND BRAID; BUTTONS FOR CLOTHING; HOOKS AND EYES; SEWING, KNITTING AND QUILTING PINS AND NEEDLES; AND ARTIFICIAL FLOWERS (U.S. CLS. 37, 39, 40, 42 AND 50).

LINDA ESTRADA, EXAMINING ATTORNEY

SN 78-951,432. HAMMAD, IYAD, PARKLAND, UNITED STATES, FILED 8-14-2006.

Hush Collection

THE MARK CONSISTS OF STANDARD CHARACTERS WITHOUT CLAIM TO ANY PARTICULAR FONT, STYLE, SIZE, OR COLOR.

NO CLAIM IS MADE TO THE EXCLUSIVE RIGHT TO USE "COLLECTION", APART FROM THE MARK AS SHOWN.

FOR NATURAL HUMAN HAIR FOR USE IN CONSTRUCTING, WIGS, HAIRPIECES, HAIR EXTENSIONS, AND ADD-IN AND ADD-ON HAIR ACCESSORIES. (U.S. CLS. 37, 39, 40, 42 AND 50).

FIRST USE 6-1-1999; IN COMMERCE 6-1-1999.

RUSS HERMAN, EXAMINING ATTORNEY

SN 78-951,479. HAMMAD, IYAD, PARKLAND, FL. FILED 8-14-2006.

Beauty Tress

THE MARK CONSISTS OF STANDARD CHARACTERS WITHOUT CLAIM TO ANY PARTICULAR FONT, STYLE, SIZE, OR COLOR.

NO CLAIM IS MADE TO THE EXCLUSIVE RIGHT TO USE "TRESS", APART FROM THE MARK AS SHOWN.

FOR NATURAL HUMAN HAIR SOLD AS: HAIRPIECES; HAIR EXTENSIONS; ADD-IN HAIR ACCESSORIES; AND ADD-ON HAIR ACCESSORIES (U.S. CLS. 37, 39, 40, 42 AND 50).

FIRST USE 8-1-2004; IN COMMERCE 8-1-2004.

RUSS HERMAN, EXAMINING ATTORNEY

CLASS 27—FLOOR COVERINGS

SN 76-674,832. SCHOONER PRINTS INC., LARGO, FL. FILED 3-29-2007.

EVERGREEN

THE MARK CONSISTS OF STANDARD CHARACTERS WITHOUT CLAIM TO ANY PARTICULAR FONT, STYLE, SIZE, OR COLOR.

FOR WALLCOVERINGS (U.S. CLS. 19, 20, 37, 42 AND 50).

ELISSA GARBER KON, EXAMINING ATTORNEY

SN 77-058,899. CARPETS FOR KIDS, ETC...INC., PORTLAND, OR. FILED 12-7-2006.

**GIVE THE PLANET A HUG!
RECYCLE YOUR RUG!**

THE MARK CONSISTS OF STANDARD CHARACTERS WITHOUT CLAIM TO ANY PARTICULAR FONT, STYLE, SIZE, OR COLOR.

FOR FLOOR COVERING PRODUCTS, NAMELY, CARPETS AND RUGS (U.S. CLS. 19, 20, 37, 42 AND 50).

FIRST USE 11-1-2006; IN COMMERCE 11-1-2006.
DANNEAN HETZEL, EXAMINING ATTORNEY

SN 77-120,676. WP IP LLC, NEW YORK, NY. FILED 3-2-2007.



NO CLAIM IS MADE TO THE EXCLUSIVE RIGHT TO USE "HOME", APART FROM THE MARK AS SHOWN.

THE MARK CONSISTS OF A BOX WITH THE STYLIZED WORDS "WP HOME" INSIDE.

FOR BATH RUGS, WALLPAPERS BORDERS AND FABRIC BATH MATS (U.S. CLS. 19, 20, 37, 42 AND 50).
FRANK LATTUCA, EXAMINING ATTORNEY

CLASS 27—(Continued).

SN 77-138,910. TRADE AM INTERNATIONAL, INC., NORCROSS, GA. FILED 3-23-2007.

Minas Clay

THE MARK CONSISTS OF STANDARD CHARACTERS WITHOUT CLAIM TO ANY PARTICULAR FONT, STYLE, SIZE, OR COLOR.

FOR RUGS (U.S. CLS. 19, 20, 37, 42 AND 50).

TINA KUAN, EXAMINING ATTORNEY

SN 78-938,572. U.S. RUG CO., INC., TROY, NC. FILED 7-27-2006.

U.S. RUG CO.

THE MARK CONSISTS OF STANDARD CHARACTERS WITHOUT CLAIM TO ANY PARTICULAR FONT, STYLE, SIZE, OR COLOR.

NO CLAIM IS MADE TO THE EXCLUSIVE RIGHT TO USE "RUG CO.", APART FROM THE MARK AS SHOWN.

FOR RUGS (U.S. CLS. 19, 20, 37, 42 AND 50).

FIRST USE 11-21-1994; IN COMMERCE 11-21-1994.

ESTHER BELENKER, EXAMINING ATTORNEY

CLASS 28—TOYS AND SPORTING GOODS

SN 75-783,121. WORKMAN PUBLISHING CO., INC, NEW YORK, NY. FILED 8-23-1999.

WORKMAN

OWNER OF U.S. REG. NOS. 2,467,122, 2,479,099 AND 2,528,926.

FOR TOY COMPUTER; CARD GAMES; BOARD GAMES; JUMP ROPES; TOY JACKS; MARBLES; CHESS SETS; TOY DIORAMAS; PUPPETS; BASEBALLS; TOY SKELETONS; YO-YOS; TOY SAND PAILS; TOY ANIMAL FIGURINES; SOCCER BALLS; PAPER AIRPLANES; FISHING TACKLE BOXES; HOBBY CRAFT TOY IN THE NATURE OF A BUG COLLECTION BOTTLE; HOBBY CRAFT TOY IN THE NATURE OF A TADPOLE COLLECTION TANK; LEAF COLLECTION HOBBY CRAFT KITS CONSISTING OF A COLLECTING ENVELOPE, A COLLECTING ALBUM, AND AN ILLUSTRATED GUIDE BOOK; WILD FLOWER COLLECTION HOBBY CRAFT KITS CONSISTING OF A CUSTOM-DESIGNED PLASTIC PRESS, SHEETS OF BLOTTING PAPER, CORRUGATED SPACERS, AND AN ILLUSTRATED GUIDE BOOK; TOY GREENHOUSES; COSTUME MASKS; TOY HOUSES, TOY BUILDINGS AND TOY THREE DIMENSIONAL STRUCTURES, WHICH OPEN UP INTO SECTIONS CONTAINING PRINTED STORIES (U.S. CLS. 22, 23, 38 AND 50).

FIRST USE 12-1-1985; IN COMMERCE 12-1-1985.

YONG KIM, EXAMINING ATTORNEY

CLASS 28—(Continued).

SN 76-600,817. GREENHOUSE INTERNATIONAL LLC, NEWARK, DE. FILED 7-6-2004.

THE BEAN

THE MARK CONSISTS OF STANDARD CHARACTERS WITHOUT CLAIM TO ANY PARTICULAR FONT, STYLE, SIZE, OR COLOR.

PRIORITY CLAIMED UNDER SEC. 44(D) ON SOUTH AFRICA APPLICATION NO. 2004/11217, FILED 7-6-2004.

FOR PERSONAL INFLATABLE EXERCISE PLATFORM FOR TRAINING AND CONDITIONING (U.S. CLS. 22, 23, 38 AND 50).

FIRST USE 10-0-2004; IN COMMERCE 10-0-2004.
KATHERINE STOIDES, EXAMINING ATTORNEY

SN 76-604,504. RAWLINGS SPORTING GOODS COMPANY, INC., ST. LOUIS, MO. FILED 7-28-2004.

GAIT BY DEBEER

THE MARK CONSISTS OF STANDARD CHARACTERS WITHOUT CLAIM TO ANY PARTICULAR FONT, STYLE, SIZE, OR COLOR.

FOR LACROSSE EQUIPMENT, NAMELY LACROSSE STICK HEADS, LACROSSE STICKS, LACROSSE GLOVES, LACROSSE BALLS, LACROSSE STICK HANDLES, POCKETS FOR LACROSSE STICKS, SPORTS BAGS FOR HOLDING LACROSSE STICKS (U.S. CLS. 22, 23, 38 AND 50).

FIRST USE 6-1-2003; IN COMMERCE 6-1-2003.
ELLEN PERKINS, EXAMINING ATTORNEY

SN 76-642,066. ANDERSON, JOSEPH M., SANBORN, NY. FILED 7-1-2005.

KING KYLE'S TOYS

THE MARK CONSISTS OF STANDARD CHARACTERS WITHOUT CLAIM TO ANY PARTICULAR FONT, STYLE, SIZE, OR COLOR.

NO CLAIM IS MADE TO THE EXCLUSIVE RIGHT TO USE "TOYS", APART FROM THE MARK AS SHOWN.

THE NAME KYLE IDENTIFIES A LIVING INDIVIDUAL WHOSE CONSENT IS OF RECORD.

FOR TOYS GAMES AND PLAY THINGS, NAMELY STUFFED ANIMALS, DOLLS, TOY VEHICLES, ACTION FIGURES, BALLS, NAMELY BASEBALLS, BASKETBALLS, PLAYGROUND BALLS, SOCCER BALLS, LACROSSE BALLS, SQUASH BALLS, SPORT BALLS AND RUBBER BALLS, LACROSSE STICKS AND PLAYGROUND EQUIPMENT, NAMELY SWING SETS, SLIDES AND CLIMBING UNITS (U.S. CLS. 22, 23, 38 AND 50).

KATHLEEN M. VANSTON, EXAMINING ATTORNEY

CLASS 28—(Continued).

SN 76-665,197. MAY CHEONG TOY PRODUCTS FACTORY LIMITED, KOWLOON, HONG KONG, FILED 8-28-2006.

Fresh Metal

THE MARK CONSISTS OF STANDARD CHARACTERS WITHOUT CLAIM TO ANY PARTICULAR FONT, STYLE, SIZE, OR COLOR.

NO CLAIM IS MADE TO THE EXCLUSIVE RIGHT TO USE "METAL", APART FROM THE MARK AS SHOWN.

FOR TOYS AND PLAYTHINGS, NAMELY, DIE CAST TOY VEHICLES AND THEIR ACCESSORIES; PLASTIC TOY VEHICLES AND THEIR ACCESSORIES; RADIO CONTROLLED TOY VEHICLES; ELECTRONICALLY AND/OR ELECTRICALLY OPERATED TOY VEHICLES AND LOCOMOTIVES; PLASTIC AND/OR DIE-CAST MODEL KITS, NAMELY TOY MODEL HOBBY CRAFT KITS FOR BUILDING TOY VEHICLES AND LOCOMOTIVES; TOY SCALE MODEL VEHICLES; TOY MODEL TRAINS; SCALE MODEL CARS, SCALE MODEL MOTORCYCLES, SCALE MODEL AIRCRAFTS; TOY SCALE SIZE COLLECTOR MODEL VEHICLES AND MINIATURE TOY MODEL VEHICLES; TOY CARS AND LOCOMOTIVES, TOY AIRCRAFT, TOY WATERCRAFT, TOY SPACECRAFT, TOY BICYCLES, TOY MOTORCYCLES, TOY TRAINS, TOY TRUCKS AND TOY CONSTRUCTION CARS; CHRISTMAS ACTION TOYS; TOY ROBOTS; ACTION FIGURES; TOY VINYL FIGURES (U.S. CLS. 22, 23, 38 AND 50).

MORENO, PAUL, EXAMINING ATTORNEY

SN 76-673,400. HASBRO, INC., PAWTUCKET, RI. FILED 3-1-2007.

BUSY BALL POPPER

THE MARK CONSISTS OF STANDARD CHARACTERS WITHOUT CLAIM TO ANY PARTICULAR FONT, STYLE, SIZE, OR COLOR.

OWNER OF U.S. REG. NO. 2,935,968 AND OTHERS.

NO CLAIM IS MADE TO THE EXCLUSIVE RIGHT TO USE "BALL POPPER", APART FROM THE MARK AS SHOWN.

FOR CHILDREN'S MULTIPLE ACTIVITY TOYS (U.S. CLS. 22, 23, 38 AND 50).

FIRST USE 12-1-2002; IN COMMERCE 12-1-2002.
DORITT L. CARROLL, EXAMINING ATTORNEY

CLASS 28—(Continued).

SN 76-673,454. HASBRO, INC., PAWTUCKET, RI. FILED 3-2-2007.

BUSY ACTIVITY BLOCKS

THE MARK CONSISTS OF STANDARD CHARACTERS WITHOUT CLAIM TO ANY PARTICULAR FONT, STYLE, SIZE, OR COLOR.

OWNER OF U.S. REG. NO. 2,935,968 AND OTHERS.

NO CLAIM IS MADE TO THE EXCLUSIVE RIGHT TO USE ACTIVITY BLOCKS, APART FROM THE MARK AS SHOWN.

FOR CHILDREN'S MULTIPLE ACTIVITY TOYS (U.S. CLS. 22, 23, 38 AND 50).

DORITT L. CARROLL, EXAMINING ATTORNEY

SN 76-676,774. HASBRO, INC., PAWTUCKET, RI. FILED 5-14-2007.

MIO PUP

THE MARK CONSISTS OF STANDARD CHARACTERS WITHOUT CLAIM TO ANY PARTICULAR FONT, STYLE, SIZE, OR COLOR.

NO CLAIM IS MADE TO THE EXCLUSIVE RIGHT TO USE "PUP", APART FROM THE MARK AS SHOWN.

THE ENGLISH TRANSLATION OF THE WORD "MIO" IS "MY".

FOR TOY ROBOTIC ANIMALS (U.S. CLS. 22, 23, 38 AND 50).

REBECCA POVARCHUK, EXAMINING ATTORNEY

SN 77-002,563. MGA ENTERTAINMENT, INC., VAN NUYS, CA. FILED 9-19-2006.

XO

THE MARK CONSISTS OF STANDARD CHARACTERS WITHOUT CLAIM TO ANY PARTICULAR FONT, STYLE, SIZE, OR COLOR.

FOR HAND HELD UNIT FOR PLAYING ELECTRONIC GAMES (U.S. CLS. 22, 23, 38 AND 50).

JESSICA A. POWERS, EXAMINING ATTORNEY

CLASS 28—(Continued).

SN 77-002,569. MGA ENTERTAINMENT, INC., VAN NUYS, CA. FILED 9-19-2006.

XOXO

THE MARK CONSISTS OF STANDARD CHARACTERS WITHOUT CLAIM TO ANY PARTICULAR FONT, STYLE, SIZE, OR COLOR.

FOR HAND HELD UNIT FOR PLAYING ELECTRONIC GAMES (U.S. CLS. 22, 23, 38 AND 50).

JESSICA A. POWERS, EXAMINING ATTORNEY

SN 77-004,862. GO R DESIGN, LLC, NEW EGYPT, NJ. FILED 9-21-2006.

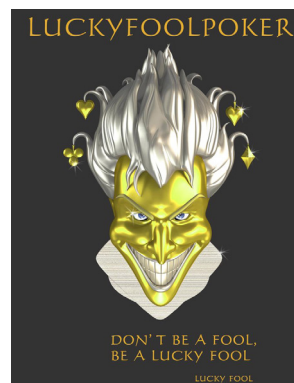

THE COLOR(S) GOLD, SILVER, BLUE, ORANGE, AND WHITE IS/ARE CLAIMED AS A FEATURE OF THE MARK.

THE MARK CONSISTS OF HEAD AND FACE OF A PERSON IN GOLD WITH THE TEXT LUCKYFOOLPOKER ABOVE THE HEAD IN ORANGE. THE HAIR IS SILVER WITH THE FOUR CARD SUITS HANGING FROM THE HAIR IN GOLD (ONE OF EACH: CLUB, DIAMOND, HEART AND SPADE), THE EYES ARE BLUE WITH A WHITE BACKGROUND, THE NOSE IS GOLD, AND THE TEETH ARE SILVER. THE WORDING DON'T BE A FOOL, BE A LUCKY FOOL IS BELOW THE HEAD AND NECK IN ORANGE. THE AREA AROUND THE NECK IS WHITE.

FOR GIFTS AND ACCESSORIES RELATED TO POKER AND CARD GAMES, NAMELY POKER CHIPS AND PLAYING CARD CASES (U.S. CLS. 22, 23, 38 AND 50).

FIRST USE 9-4-2006; IN COMMERCE 9-21-2006.

KENNETH E. SHARPERSON, EXAMINING ATTORNEY

CLASS 28—(Continued).

SN 77-004,875. R&R MARKETING, LLC, GLEN ALLEN, VA. FILED 9-21-2006.

AEROSPORT FITNESS

THE MARK CONSISTS OF STANDARD CHARACTERS WITHOUT CLAIM TO ANY PARTICULAR FONT, STYLE, SIZE, OR COLOR.

NO CLAIM IS MADE TO THE EXCLUSIVE RIGHT TO USE "FITNESS", APART FROM THE MARK AS SHOWN.

FOR EXERCISE EQUIPMENT, NAMELY, JUMP ROPES, JUMP ROPE IN THE NATURE OF SPEED ROPES AND DOUBLE DUTCH ROPES, SKIPPING ROPE, RESISTANCE BANDS, PILATES EXERCISE BALLS, WEIGHT LIFTING GLOVES, ANKLE WEIGHTS, POWER EXERCISE BANDS, CHIN UP BARS, SIT UP BARS, STABILITY BALL, WEIGHT VEST, WRIST SUPPORTS, YOGA MATS, PERSONAL EXERCISE MATS, WEIGHT TRAINING BELT, BOXING GLOVES, MINI STEPPER, SPEED BAG (U.S. CLS. 22, 23, 38 AND 50).

SUE LAWRENCE, EXAMINING ATTORNEY

CLASS 28—(Continued).

SN 77-008,699. NOMACO, INC., ZEBULON, NC. FILED 9-27-2006.

BIG DIPPER

THE MARK CONSISTS OF STANDARD CHARACTERS WITHOUT CLAIM TO ANY PARTICULAR FONT, STYLE, SIZE, OR COLOR.

FOR TOYS IN THE NATURE OF FLEXIBLE FOAM RODS FOR RECREATIONAL USE, FLEXIBLE FOAM FLOATATION TOYS CONTAINING CONNECTORS SPECIFICALLY DESIGNS FOR JOINING FOAM TOY RODS, SOLD AS A UNIT, FLEXIBLE FOAM CONSTRUCTION TOYS, AND FLEXIBLE FOAM FLOATATION TOYS (U.S. CLS. 22, 23, 38 AND 50).

CHRISTINA SOBRAL, EXAMINING ATTORNEY

SN 77-008,666. NOMACO, INC., ZEBULON, NC. FILED 9-27-2006.

DIPPER

THE MARK CONSISTS OF STANDARD CHARACTERS WITHOUT CLAIM TO ANY PARTICULAR FONT, STYLE, SIZE, OR COLOR.

FOR TOYS IN THE NATURE OF FLEXIBLE FOAM RODS FOR RECREATIONAL USE, FLEXIBLE FOAM FLOATATION TOYS CONTAINING CONNECTORS SPECIFICALLY DESIGNS FOR JOINING FOAM TOY RODS, SOLD AS A UNIT, FLEXIBLE FOAM CONSTRUCTION TOYS, AND FLEXIBLE FOAM FLOATATION TOYS (U.S. CLS. 22, 23, 38 AND 50).

CHRISTINA SOBRAL, EXAMINING ATTORNEY

SN 77-024,685. WRIGHT & MCGILL CO., DENVER, CO. FILED 10-19-2006.

SALTWATER SALSA

THE MARK CONSISTS OF STANDARD CHARACTERS WITHOUT CLAIM TO ANY PARTICULAR FONT, STYLE, SIZE, OR COLOR.

FOR FISH ATTRACTANTS (U.S. CLS. 22, 23, 38 AND 50).

DAVID C. REIHNER, EXAMINING ATTORNEY

SN 77-008,685. NOMACO, INC., ZEBULON, NC. FILED 9-27-2006.

LITTLE DIPPER

THE MARK CONSISTS OF STANDARD CHARACTERS WITHOUT CLAIM TO ANY PARTICULAR FONT, STYLE, SIZE, OR COLOR.

FOR TOYS IN THE NATURE OF FLEXIBLE FOAM RODS FOR RECREATIONAL USE, FLEXIBLE FOAM FLOATATION TOYS CONTAINING CONNECTORS SPECIFICALLY DESIGNS FOR JOINING FOAM TOY RODS, SOLD AS A UNIT, FLEXIBLE FOAM CONSTRUCTION TOYS, AND FLEXIBLE FOAM FLOATATION TOYS (U.S. CLS. 22, 23, 38 AND 50).

CHRISTINA SOBRAL, EXAMINING ATTORNEY

SN 77-029,174. WYNN RESORTS HOLDINGS, LLC, LAS VEGAS, NV. FILED 10-25-2006.

DOUBLE FORTUNE BACCARAT

THE MARK CONSISTS OF STANDARD CHARACTERS WITHOUT CLAIM TO ANY PARTICULAR FONT, STYLE, SIZE, OR COLOR.

NO CLAIM IS MADE TO THE EXCLUSIVE RIGHT TO USE "BACCARAT", APART FROM THE MARK AS SHOWN. FOR CARD GAMES (U.S. CLS. 22, 23, 38 AND 50).

ROSELLE HERRERA, EXAMINING ATTORNEY

CLASS 28—(Continued).

SN 77-034,786. HANIMEX MFG. CORPORATION, TAIPEI CITY, TAIWAN, FILED 11-1-2006.



THE MARK CONSISTS OF THE WORD HANIMEX CONTAINING A STYLIZED LETTER M.

FOR GOLF CLUBS, GOLF BALLS, GOLF BAGS, NON-MOTORIZED GOLF CARTS, GOLF CLUB HEAD COVERS, GOLF BALL RETRIEVERS, NETS FOR BALL GAMES, NAMELY, GOLF PRACTICING NETS AND GOLF CHIPPING PRACTICE NETS; PUTTING PRACTICE MATS (U.S. CLS. 22, 23, 38 AND 50).

FIRST USE 6-20-1995; IN COMMERCE 6-20-1995.
KATHERINE E. HALMEN, EXAMINING ATTORNEY

SN 77-046,011. MIZUNO USA, INC., NORCROSS, GA. FILED 11-16-2006.



THE MARK CONSISTS OF STANDARD CHARACTERS WITHOUT CLAIM TO ANY PARTICULAR FONT, STYLE, SIZE, OR COLOR.

FOR BASEBALL BATS, BASEBALL BATting GLOVES, BASEBALL GLOVES, CATCHERS' MASKS, ELBOW PADS FOR ATHLETIC USE, GOLF BALL RETRIEVERS, GOLF BAGS, GOLF GLOVES; GOLF CLUBS, GOLF CLUB COVERS, KNEE PADS FOR ATHLETIC USE, SHIN PADS FOR ATHLETIC USE, SOFTBALL GLOVES, SOFTBALL BATS, UMPIRE PROTECTION EQUIPMENT, BASEBALL CHEST PROTECTORS NOT FOR USE FOR HUNTING OR FISHING (U.S. CLS. 22, 23, 38 AND 50).

JERI J. FICKES, EXAMINING ATTORNEY

SN 77-054,069. MATTEL, INC., EL SEGUNDO, CA. FILED 11-30-2006.



THE MARK CONSISTS OF STANDARD CHARACTERS WITHOUT CLAIM TO ANY PARTICULAR FONT, STYLE, SIZE, OR COLOR.

FOR TOYS, GAMES AND PLAYTHINGS, NAMELY, TOY VEHICLES, TOY VEHICLE PLAYSETS, TOY VEHICLE TRACK SETS, AND ACCESSORIES FOR ALL OF THE FOREGOING (U.S. CLS. 22, 23, 38 AND 50).

JUDITH HELFMAN, EXAMINING ATTORNEY

CLASS 28—(Continued).

SN 77-057,721. WARNER BROS. ENTERTAINMENT INC., BURBANK, CA. FILED 12-5-2006.



THE MARK CONSISTS OF THE WORDS HAPPY FEET. FOR TOYS AND SPORTING GOODS, INCLUDING GAMES AND PLAYTHINGS - NAMELY, PLUSH TOYS; BALLOONS; EQUIPMENT SOLD AS A UNIT FOR PLAYING CARD GAMES; DOLLS; GAME EQUIPMENT SOLD AS A UNIT FOR PLAYING A BOARD GAME, A CARD GAME, A MANIPULATIVE GAME, AND A PARLOR GAME; JIGSAW AND MANIPULATIVE PUZZLES; BALLS - NAMELY, PLAYGROUND BALLS; AND CHRISTMAS TREE ORNAMENTS ALL FEATURING THE ADVENTURES OF A FUN-LOVING EMPEROR PENGUIN WITH SUPERIOR DANCING SKILLS (U.S. CLS. 22, 23, 38 AND 50).

FIRST USE 8-15-2006; IN COMMERCE 8-15-2006.
MICHELLE DUBOIS, EXAMINING ATTORNEY

SN 77-059,617. MATTEL, INC., EL SEGUNDO, CA. FILED 12-7-2006.



THE MARK CONSISTS OF STANDARD CHARACTERS WITHOUT CLAIM TO ANY PARTICULAR FONT, STYLE, SIZE, OR COLOR.

FOR TOYS, GAMES AND PLAYTHINGS, NAMELY, TOY VEHICLE PLAYSETS AND ACCESSORIES THEREFOR (U.S. CLS. 22, 23, 38 AND 50).

KATHLEEN M. VANSTON, EXAMINING ATTORNEY

SN 77-059,620. MATTEL, INC., EL SEGUNDO, CA. FILED 12-7-2006.



THE MARK CONSISTS OF STANDARD CHARACTERS WITHOUT CLAIM TO ANY PARTICULAR FONT, STYLE, SIZE, OR COLOR.

FOR TOYS, GAMES AND PLAYTHINGS, NAMELY, DOLLS, DOLL CLOTHING AND DOLL ACCESSORIES, DOLL PLAYSETS, TOY FIGURES, AND ACCESSORIES FOR ALL OF THE FOREGOING (U.S. CLS. 22, 23, 38 AND 50).

KATHLEEN M. VANSTON, EXAMINING ATTORNEY

CLASS 28—(Continued).

SN 77-062,489. ADLER, MITCHELL L., SARASOTA, FL. FILED 12-12-2006.

PERFECTOUT

THE MARK CONSISTS OF STANDARD CHARACTERS WITHOUT CLAIM TO ANY PARTICULAR FONT, STYLE, SIZE, OR COLOR.

FOR EDUCATIONAL AND MOTIVATIONAL GAMES IN THE FIELDS OF MATH, SCIENCE, FOREIGN LANGUAGES, GENERALIZED TEST-TAKING TECHNIQUES FOR STANDARDIZED MULTIPLE CHOICE AND STUDENT-PRODUCED RESPONSE QUESTION EXAMINATIONS, READING, PROBLEM SOLVING, MEMORY DEVELOPMENT, AND SOCIAL STUDIES WITH ASSOCIATED STUDY MATERIALS (U.S. CLS. 22, 23, 38 AND 50).

TASHIA BUNCH, EXAMINING ATTORNEY

SN 77-065,118. MATTEL, INC., EL SEGUNDO, CA. FILED 12-15-2006.

I KNOW YOU

THE MARK CONSISTS OF STANDARD CHARACTERS WITHOUT CLAIM TO ANY PARTICULAR FONT, STYLE, SIZE, OR COLOR.

FOR ELECTRONIC TOY TELEPHONES AND ASSOCIATED COMPUTER SOFTWARE; ELECTRONIC TOY COMPUTERS AND ASSOCIATED COMPUTER SOFTWARE (U.S. CLS. 22, 23, 38 AND 50).

KATHLEEN M. VANSTON, EXAMINING ATTORNEY

SN 77-073,821. ORBIT INDUSTRIES NJ ,LLC, MARLBORO, NJ. FILED 12-30-2006.

Tidbit

THE MARK CONSISTS OF STANDARD CHARACTERS WITHOUT CLAIM TO ANY PARTICULAR FONT, STYLE, SIZE, OR COLOR.

FOR PLUSH TOYS; STUFFED TOY ANIMALS; STUFFED TOY BEARS; STUFFED TOYS (U.S. CLS. 22, 23, 38 AND 50).

FIRST USE 7-7-2006; IN COMMERCE 9-25-2006.

AHSEN KHAN, EXAMINING ATTORNEY

CLASS 28—(Continued).

SN 77-082,857. DRAPER, INC., SPICELAND, IN. FILED 1-15-2007.

DRAPER

THE MARK CONSISTS OF STANDARD CHARACTERS WITHOUT CLAIM TO ANY PARTICULAR FONT, STYLE, SIZE, OR COLOR.

SEC. 2(F).

FOR GYM EQUIPMENT, NAMELY, MULTI-SPORT PRACTICE CAGES, CLIMBING ROPES, STALL BARS AND CHINNING BARS, CLIMBING LADDERS; VOLLEYBALL AND BADMINTON NETS, POLES AND ACCESSORIES, NAMELY, PADS, FLOOR PLATES, FLOOR SLEEVES, FLOOR SLEEVE ADAPTORS, TRANSPORTERS; BASKETBALL EQUIPMENT, NAMELY, GOALS, BACKSTOPS, BACKBOARDS AND GOAL POSTS; SAFETY PADDING FOR GYMNASIUM WALLS (U.S. CLS. 22, 23, 38 AND 50).

FIRST USE 0-0-1994; IN COMMERCE 0-0-1994.

RICHARD WHITE, EXAMINING ATTORNEY

SN 77-083,272. PETERKIN UK LTD, LEICESTER, UNITED KINGDOM, FILED 1-15-2007.

DOLLS WORLD

THE MARK CONSISTS OF STANDARD CHARACTERS WITHOUT CLAIM TO ANY PARTICULAR FONT, STYLE, SIZE, OR COLOR.

OWNER OF UNITED KINGDOM REG. NO. 2336488, DATED 4-30-2004, EXPIRES 7-2-2013.

NO CLAIM IS MADE TO THE EXCLUSIVE RIGHT TO USE "DOLLS", APART FROM THE MARK AS SHOWN.

FOR TOYS, GAMES AND PLAYTHINGS, NAMELY, DOLLS, ACTION FIGURES, POSABLE FIGURES, PLAY SETS ADAPTED FOR USE WITH ACTION FIGURES, TOY VEHICLES FOR USE WITH DOLLS AND ACTION FIGURES, DOLLS HOUSES, ACCESSORIES FOR DOLLS HOUSES, ARTICLES OF CLOTHING ADAPTED FOR DOLLS AND ACTION FIGURES, ACCESSORIES FOR ACTION FIGURES (U.S. CLS. 22, 23, 38 AND 50).

CYNTHIA SLOAN, EXAMINING ATTORNEY

CLASS 28—(Continued).

SN 77-090,843. PEARISON, INC. D/B/A BAND SHOPPE, CYNTHIANA, IN. FILED 1-25-2007.

AIR BLADE

THE MARK CONSISTS OF STANDARD CHARACTERS WITHOUT CLAIM TO ANY PARTICULAR FONT, STYLE, SIZE, OR COLOR.

FOR MARCHING BAND ACCESSORY, NAMELY A TWIRLING PROP, NAMELY A RIFLE-LIKE PROP FOR USE BY MARCHING BANDS (U.S. CLS. 22, 23, 38 AND 50).

CHRISTINA SOBRAL, EXAMINING ATTORNEY

SN 77-094,388. ARIZONA SUPER BOWL HOST COMMITTEE, PHOENIX, AZ. FILED 1-30-2007.

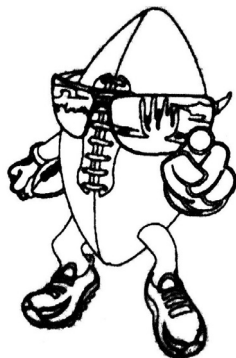

THE MARK CONSISTS OF A DESIGN OF A PERSONIFIED FOOTBALL WEARING SUNGLASSES AND SNEAKERS; AND HOLDING A SMALLER FOOTBALL.

FOR TOYS AND SPORTING GOODS, NAMELY, PLUSH TOYS, STUFFED TOY ANIMALS, PLAY FIGURES, BALLOONS, FOOTBALLS, AND CHRISTMAS TREE ORNAMENTS (U.S. CLS. 22, 23, 38 AND 50).

BERNICE MIDDLETON, EXAMINING ATTORNEY

SN 77-100,657. ROCKET USA, INC., FOREST PARK, IL. FILED 2-6-2007.

BOOGILY HEADS

THE MARK CONSISTS OF STANDARD CHARACTERS WITHOUT CLAIM TO ANY PARTICULAR FONT, STYLE, SIZE, OR COLOR.

NO CLAIM IS MADE TO THE EXCLUSIVE RIGHT TO USE "HEADS", APART FROM THE MARK AS SHOWN.

FOR BOBBLE HEAD TOYS AND PLUSH BEAN BAG FIGURES (U.S. CLS. 22, 23, 38 AND 50).

JUSTINE D. PARKER, EXAMINING ATTORNEY

CLASS 28—(Continued).

SN 77-102,017. MARCHESANI, NICK, DBA NEW FUN ENTERPRISES, BRIGATINE, NJ. FILED 2-7-2007.

DI GAO

THE MARK CONSISTS OF STANDARD CHARACTERS WITHOUT CLAIM TO ANY PARTICULAR FONT, STYLE, SIZE, OR COLOR.

FOR EQUIPMENT FOR PLAYING A CASINO CARD GAME, NAMELY, CARDS AND ASSOCIATED GAMING TABLE (U.S. CLS. 22, 23, 38 AND 50).

BRIAN CALLAGHAN, EXAMINING ATTORNEY

SN 77-105,363. WILDLIFE RESEARCH CENTER, INC., RAMSEY, MN. FILED 2-12-2007.



FOR PRODUCTS ALL SPECIFICALLY DESIGNED FOR USE IN HUNTING BIG GAME, NAMELY, HUNTERS' SCENT LURE FOR USE AS A BIG GAME ANIMAL ATTRACTANT AND DISPENSERS THEREFORE, AND HUNTER'S SCENT CAMOUFLAGE PRODUCTS FOR MASKING OR ELIMINATING HUMAN SCENT, NAMELY, BODY SOAPS, HAIR AND SKIN CONDITIONERS, ANTIPERSPIRANTS, LAUNDRY DETERGENT, AND APPAREL AND BODY LIQUID SPRAY (U.S. CLS. 22, 23, 38 AND 50).

MARCIE MILONE, EXAMINING ATTORNEY

SN 77-106,110. BODY-SOLID, INC., FOREST PARK, IL. FILED 2-13-2007.



THE MARK CONSISTS OF A QUADRILLATERAL WITH CONVEX SIDES WITH THE LETTERS P AND D ABOVE THE WORDING PRO DUAL.

FOR EXERCISE EQUIPMENT, NAMELY, EXERCISE MACHINES FOR WEIGHT LIFTING EXERCISES (U.S. CLS. 22, 23, 38 AND 50).

BERNICE MIDDLETON, EXAMINING ATTORNEY

CLASS 28—(Continued).

SN 77-106,277. BODY-SOLID, INC., FOREST PARK, IL.
FILED 2-13-2007.

PRO·DUAL

FOR EXERCISE EQUIPMENT, NAMELY, EXERCISE
MACHINES FOR WEIGHT LIFTING EXERCISES (U.S.
CLS. 22, 23, 38 AND 50).

BERNICE MIDDLETON, EXAMINING ATTORNEY

CLASS 28—(Continued).

SN 77-116,833. SPORTS TUTOR, INC., BURBANK, CA.
FILED 2-27-2007.

SPORTS TUTOR

THE MARK CONSISTS OF STANDARD CHARACTERS
WITHOUT CLAIM TO ANY PARTICULAR FONT, STYLE,
SIZE, OR COLOR.

OWNER OF U.S. REG. NO. 2,437,181.

NO CLAIM IS MADE TO THE EXCLUSIVE RIGHT TO
USE "SPORTS", APART FROM THE MARK AS SHOWN.

FOR TENNIS BALL PRACTICE MACHINES; BASE-
BALL PRACTICE MACHINES; VOLLEYBALL PRACTICE
MACHINES; AND SOCCER BALL PRACTICE
MACHINES (U.S. CLS. 22, 23, 38 AND 50).

FIRST USE 6-0-1991; IN COMMERCE 6-0-1991.

SOPHIA S. KIM, EXAMINING ATTORNEY

SN 77-120,175. LACKOVICH, JOEL KRISTIN, SAN DIEGO,
CA. FILED 3-1-2007.

GIRL POWDER

THE MARK CONSISTS OF STANDARD CHARACTERS
WITHOUT CLAIM TO ANY PARTICULAR FONT, STYLE,
SIZE, OR COLOR.

OWNER OF U.S. REG. NO. 3,093,954.

NO CLAIM IS MADE TO THE EXCLUSIVE RIGHT TO
USE "GIRL", APART FROM THE MARK AS SHOWN.

FOR SPORTS GOODS, NAMELY STORAGE RACKS
FOR SNOWBOARDS, SKIS AND SPORTS EQUIPMENT;
SNOWBOARD DECKS, SNOWBOARD BINDINGS AND
LEASHES, SNOW SKI RACKS, SNOW SKIS, SKI BIND-
INGS, SKI POLES, SNOW BOARD BOOTS, SKI BAGS,
SKI SCRAPERS, SKI CARRIERS, SNOW BOARD BAGS,
SKI BAGS, SNOW BOARD BOOT BAGS, SKI BOOT BAGS
(U.S. CLS. 22, 23, 38 AND 50).

CURTIS FRENCH, EXAMINING ATTORNEY

SN 77-121,138. LMH, INC., WILMINGTON, DE. FILED 3-2-
2007.

LITTLE ME

THE MARK CONSISTS OF STANDARD CHARACTERS
WITHOUT CLAIM TO ANY PARTICULAR FONT, STYLE,
SIZE, OR COLOR.

OWNER OF U.S. REG. NOS. 938,132, 2,112,460 AND
OTHERS.

FOR CRIB TOYS; STUFFED TOYS (U.S. CLS. 22, 23, 38
AND 50).

GRETTA YAO, EXAMINING ATTORNEY

SN 77-115,404. KEARNS CAPITAL INVESTMENT GROUP,
PARKVILLE, MO. FILED 2-24-2007.



NO CLAIM IS MADE TO THE EXCLUSIVE RIGHT TO
USE "CHUM", APART FROM THE MARK AS SHOWN.

THE MARK CONSISTS OF THE WORDS CHUM FACTOR
WRITTEN ON THE INSIDE OF A CIRCLE AND SUR-
ROUNDED BY ANOTHER CIRCLE. THE TOP AND BOT-
TOM OF THE OUTER CIRCLE ARE SHADOWED BY A
DARK BAR. IN THE CENTER OF THE CIRCLE AND
WRITING IS A GRAPHIC OF EXPLODING CHUM. THE
LETTER "O" IN FACTOR IS MADE UP OF CHUM.

FOR ARTIFICIAL FISHING BAIT; ARTIFICIAL FISH-
ING LURES; ARTIFICIAL FISHING WORMS; FISH
ATTRACTANTS; FISHING LURES; FISHING TACKLE;
LURES FOR FISHING; SCENT LURES FOR HUNTING
OR FISHING (U.S. CLS. 22, 23, 38 AND 50).

ALYSSA PALADINO, EXAMINING ATTORNEY

CLASS 28—(Continued).

SN 77-121,159. LMH, INC., WILMINGTON, DE. FILED 3-2-2007.



OWNER OF U.S. REG. NOS. 938,132, 2,112,460 AND OTHERS.

THE MARK CONSISTS OF A CIRCLE WITH THE WORDS LITTLE ME INSIDE ANOTHER CIRCLE. THE DOT IN THE I IN LITTLE IS A STAR.

FOR CRIB TOYS; STUFFED TOYS (U.S. CLS. 22, 23, 38 AND 50).

GRETTA YAO, EXAMINING ATTORNEY

SN 77-122,529. HACKETT, DAVID, ENCINITAS, CA. AND HACKETT, ZANNAH, ENCINITAS, CA. FILED 3-5-2007.

MALIBU SURFSKATES

THE MARK CONSISTS OF STANDARD CHARACTERS WITHOUT CLAIM TO ANY PARTICULAR FONT, STYLE, SIZE, OR COLOR.

NO CLAIM IS MADE TO THE EXCLUSIVE RIGHT TO USE SURFSKATES, APART FROM THE MARK AS SHOWN.

FOR SPORTING GOODS, NAMELY SKATEBOARDS AND SKATEBOARDING ACCESSORIES, NAMELY, DECKS, WHEELS, BUSHINGS, BOLTS, LOCK NUTS, BALL BEARINGS, SKATEBOARD RAILS, SKATEBOARD RISERS, SKATEBOARD TRUCKS, SKATEBOARD WHEELS, SKATEBOARD WAX, SKATEBOARD SHOCK PADS; TOYS, GAMES, PLAYTHINGS, NAMELY DOLLS, PLUSH TOYS, ACTION FIGURES AND ACCESSORIES THEREFOR; ACTION TOYS; COLLECTIBLE TOY FIGURINES, CARD GAMES; BOARD GAMES; AND TRADING CARDS GAMES (U.S. CLS. 22, 23, 38 AND 50).

FIRST USE 6-1-2005; IN COMMERCE 6-1-2005.

KEVIN DINALLO, EXAMINING ATTORNEY

CLASS 28—(Continued).

SN 77-128,798. KABUSHIKI KAISHA MIKI, DBA MIKI CO., LTD. CORPORATION, GUNMA-KEN, JAPAN, FILED 3-12-2007.

AIRDRIVE

THE MARK CONSISTS OF STANDARD CHARACTERS WITHOUT CLAIM TO ANY PARTICULAR FONT, STYLE, SIZE, OR COLOR.

FOR POOL CUES AND BILLIARD GAME PLAYING EQUIPMENT (U.S. CLS. 22, 23, 38 AND 50).

SAIMA MAKHDOOM, EXAMINING ATTORNEY

SN 77-130,621. WARRIOR CUSTOM GOLF, INC, IRVINE, CA. FILED 3-14-2007.

Extreme Weighting

THE MARK CONSISTS OF STANDARD CHARACTERS WITHOUT CLAIM TO ANY PARTICULAR FONT, STYLE, SIZE, OR COLOR.

NO CLAIM IS MADE TO THE EXCLUSIVE RIGHT TO USE "WEIGHTING", APART FROM THE MARK AS SHOWN.

FOR GOLF CLUBS (U.S. CLS. 22, 23, 38 AND 50).

FIRST USE 4-1-2006; IN COMMERCE 5-15-2006.

TINA L. SNAPP, EXAMINING ATTORNEY

SN 77-131,700. DIAMOND AIDS, INC., TOLEDO, OH. FILED 3-15-2007.

CATCH CLEAN

THE MARK CONSISTS OF THE WORDING CATCH CLEAN, WITH THE A IN EACH WORD STYLIZED TO FORM A PENTAGON SHAPE RESEMBLING HOME PLATE.

FOR BASEBALL GLOVE ACCESSORY, NAMELY, A PLASTIC STRIP FOR ATTACHMENT TO BASEBALL GLOVES THAT IS DESIGNED TO RESTRICT GLOVE MOBILITY FOR THE PURPOSE OF IMPROVING CATCHING SKILLS (U.S. CLS. 22, 23, 38 AND 50).

FIRST USE 1-2-2007; IN COMMERCE 1-2-2007.

LYDIA BELZER, EXAMINING ATTORNEY

CLASS 28—(Continued).

SN 77-132,351. HARDFIST PRODUCTS LLC, SPRING GROVE, PA. FILED 3-15-2007.

HARDFIST

THE MARK CONSISTS OF STANDARD CHARACTERS WITHOUT CLAIM TO ANY PARTICULAR FONT, STYLE, SIZE, OR COLOR.

FOR PUNCHING TARGET MADE PRIMARILY FROM HARD PLASTIC AND USED BY MARTIAL ARTISTS TO TOUGHEN SKIN AND KNUCKLES ON HANDS (U.S. CLS. 22, 23, 38 AND 50).

KAPIL BHANOT, EXAMINING ATTORNEY

CLASS 28—(Continued).

SN 77-134,106. FREESTYLE SLIDES, INC., ST. PETERSBURG, FL. FILED 3-19-2007.

THE HIPPO

THE MARK CONSISTS OF STANDARD CHARACTERS WITHOUT CLAIM TO ANY PARTICULAR FONT, STYLE, SIZE, OR COLOR.

FOR INFLATABLE SLIDES FOR RECREATIONAL USE (U.S. CLS. 22, 23, 38 AND 50).

FIRST USE 3-1-2004; IN COMMERCE 5-1-2004.

TINA L. SNAPP, EXAMINING ATTORNEY

SN 77-132,824. CALLAWAY GOLF COMPANY, CARLSBAD, CA. FILED 3-16-2007.

SQUAREWAY WOODS

THE MARK CONSISTS OF STANDARD CHARACTERS WITHOUT CLAIM TO ANY PARTICULAR FONT, STYLE, SIZE, OR COLOR.

NO CLAIM IS MADE TO THE EXCLUSIVE RIGHT TO USE "WOODS", APART FROM THE MARK AS SHOWN.

FOR GOLF CLUBS (U.S. CLS. 22, 23, 38 AND 50).

SAMUEL E. SHARPER JR., EXAMINING ATTORNEY

SN 77-135,395. UCHINO, STEPHEN PEPPER, CORAL GABLES, FL. AND UCHINO, JOHN TAKESHI, MIAMI, FL. FILED 3-20-2007.

STRA-TEE-GERY

THE MARK CONSISTS OF STANDARD CHARACTERS WITHOUT CLAIM TO ANY PARTICULAR FONT, STYLE, SIZE, OR COLOR.

FOR BOARD GAME FEATURING TRIVIA AND PRE-IDENTENTIAL POLITICS (U.S. CLS. 22, 23, 38 AND 50).

LINDA M. KING, EXAMINING ATTORNEY

SN 77-132,937. PRETTY UGLY LLC, EDISON, NJ. AND DAVID HORVATH, EDISON, NJ. AND SUN-MIN KIM, EDISON, NJ. FILED 3-16-2007.

DEER UGLY

THE MARK CONSISTS OF STANDARD CHARACTERS WITHOUT CLAIM TO ANY PARTICULAR FONT, STYLE, SIZE, OR COLOR.

OWNER OF U.S. REG. NO. 3,136,659.

NO CLAIM IS MADE TO THE EXCLUSIVE RIGHT TO USE "DEER", APART FROM THE MARK AS SHOWN.

FOR STUFFED TOYS (U.S. CLS. 22, 23, 38 AND 50).

BARNEY CHARLON, EXAMINING ATTORNEY

SN 77-135,800. FUNK'D GOLF LTD., PRESTON, LANCA-SHIRE, UNITED KINGDOM, FILED 3-20-2007.

FUNKY GOLF GRIPS

THE MARK CONSISTS OF STANDARD CHARACTERS WITHOUT CLAIM TO ANY PARTICULAR FONT, STYLE, SIZE, OR COLOR.

NO CLAIM IS MADE TO THE EXCLUSIVE RIGHT TO USE "GOLF GRIPS", APART FROM THE MARK AS SHOWN.

FOR GOLF CLUB GRIPS (U.S. CLS. 22, 23, 38 AND 50).

FIRST USE 8-8-2006; IN COMMERCE 9-17-2006.

CURTIS FRENCH, EXAMINING ATTORNEY

CLASS 28—(Continued).

SN 77-137,213. JOHNSON, GARRETT T., VIRGINIA BEACH, VA. FILED 3-21-2007.



THE MARK CONSISTS OF THE WORDS WAVE RACER ON WATER WITH A CRESTING WAVE IN BETWEEN THE WORDS.

FOR AMUSEMENT PARK RIDES, WATER PARK RIDES AND OCEAN SIMULATORS FOR USE IN WATER RIDES (U.S. CLS. 22, 23, 38 AND 50).

LEIGH CAROLINE CASE, EXAMINING ATTORNEY

SN 77-137,344. REACTION INNOVATIONS, LLC, ALABAMA, AL. FILED 3-22-2007.

REACTION INNOVATIONS

THE MARK CONSISTS OF STANDARD CHARACTERS WITHOUT CLAIM TO ANY PARTICULAR FONT, STYLE, SIZE, OR COLOR.

FOR ARTIFICIAL FISHING LURES (U.S. CLS. 22, 23, 38 AND 50).

FIRST USE 11-30-2002; IN COMMERCE 11-30-2002.

DAVID TOOLEY, EXAMINING ATTORNEY

SN 77-138,316. BRITT ALLCROFT PRODUCTIONS, LLC, SANTA MONICA, CA. FILED 3-22-2007.

CUBLEY

THE MARK CONSISTS OF STANDARD CHARACTERS WITHOUT CLAIM TO ANY PARTICULAR FONT, STYLE, SIZE, OR COLOR.

FOR PLUSH TOYS (U.S. CLS. 22, 23, 38 AND 50).

CHARISMA HAMPTON, EXAMINING ATTORNEY

CLASS 28—(Continued).

SN 77-138,321. BRITT ALLCROFT PRODUCTIONS, LLC, SANTA MONICA, CA. FILED 3-22-2007.

CUBLEY AND THE CITY KIDS

THE MARK CONSISTS OF STANDARD CHARACTERS WITHOUT CLAIM TO ANY PARTICULAR FONT, STYLE, SIZE, OR COLOR.

FOR PLUSH TOYS (U.S. CLS. 22, 23, 38 AND 50).

CHARISMA HAMPTON, EXAMINING ATTORNEY

SN 77-138,950. TALON INDUSTRIES, LLC, BANGOR, ME. FILED 3-23-2007.

TANGLER

THE MARK CONSISTS OF STANDARD CHARACTERS WITHOUT CLAIM TO ANY PARTICULAR FONT, STYLE, SIZE, OR COLOR.

FOR ARCHERY EQUIPMENT, NAMELY ARROW AND GAME RETRIEVAL DEVICES (U.S. CLS. 22, 23, 38 AND 50).

G. MAYERSCHOFF, EXAMINING ATTORNEY

SN 77-139,323. PURE FISHING, INC., SPIRIT LAKE, IA. FILED 3-23-2007.

OUT LASTS LIVE!

THE MARK CONSISTS OF STANDARD CHARACTERS WITHOUT CLAIM TO ANY PARTICULAR FONT, STYLE, SIZE, OR COLOR.

OWNER OF U.S. REG. NO. 3,022,276.

FOR ARTIFICIAL FISHING BAIT (U.S. CLS. 22, 23, 38 AND 50).

ELISSA GARBER KON, EXAMINING ATTORNEY

CLASS 28—(Continued).

SN 77-139,538. TONER PLASTICS INC., AGAWAM, MA.
FILED 3-24-2007.

Fun Wire

THE MARK CONSISTS OF STANDARD CHARACTERS WITHOUT CLAIM TO ANY PARTICULAR FONT, STYLE, SIZE, OR COLOR.

NO CLAIM IS MADE TO THE EXCLUSIVE RIGHT TO USE "WIRE", APART FROM THE MARK AS SHOWN.

FOR HOBBY CRAFT KITS COMPRISING CHILDREN'S WIRE CONSTRUCTION AND ART ACTIVITY TOYS USED TO MAKE BRACELETS, BOOKMARKS, HAIR BERETS, KEY CHAINS, EYEGLOSS CASES, EARRINGS, ZIPPER ATTACHMENTS, AND NOVELTY ITEMS THAT SPIN IN THE WIND (U.S. CLS. 22, 23, 38 AND 50).

FIRST USE 2-1-1989; IN COMMERCE 2-1-1989.
AHSEN KHAN, EXAMINING ATTORNEY

SN 77-139,644. PARNUPOL THONGKUM, BANGPOON,-
MUANG, THAILAND, FILED 3-25-2007.

SUPERIO

THE MARK CONSISTS OF STANDARD CHARACTERS WITHOUT CLAIM TO ANY PARTICULAR FONT, STYLE, SIZE, OR COLOR.

FOR GOLF EQUIPMENT, NAMELY, GOLF BAGS; GOLF BALLS; GOLF CLUB HEADS; GOLF CLUB INSERTS; GOLF CLUB SHAFTS; GOLF CLUBS; GRIP TAPES FOR GOLF CLUBS; HAND GRIPS FOR GOLF CLUBS; GOLF GLOVES; GOLF ACCESSORY POUCHES; GOLF BAG COVERS; GOLF BAG TAGS; GOLF BALL MARKERS; GOLF IRONS; GOLF PUTTER COVERS; GOLF PUTTERS; GOLF TEE MARKERS; GOLF TEES (U.S. CLS. 22, 23, 38 AND 50).

KAPIL BHANOT, EXAMINING ATTORNEY

SN 77-139,685. ALVAREZ, ANDRES O, WEST PALM BEACH,
FL. FILED 3-25-2007.

XGENERATION RODS

THE MARK CONSISTS OF STANDARD CHARACTERS WITHOUT CLAIM TO ANY PARTICULAR FONT, STYLE, SIZE, OR COLOR.

NO CLAIM IS MADE TO THE EXCLUSIVE RIGHT TO USE "RODS", APART FROM THE MARK AS SHOWN.

FOR FISHING RODS (U.S. CLS. 22, 23, 38 AND 50).
ALEX KEAM, EXAMINING ATTORNEY

CLASS 28—(Continued).

SN 77-139,745. COOKE, JOHN B., SUN LAKES, AZ. FILED 3-
25-2007.

SPONGE PAL

THE MARK CONSISTS OF STANDARD CHARACTERS WITHOUT CLAIM TO ANY PARTICULAR FONT, STYLE, SIZE, OR COLOR.

NO CLAIM IS MADE TO THE EXCLUSIVE RIGHT TO USE "SPONGE", APART FROM THE MARK AS SHOWN.

FOR SQUEEZE TOYS (U.S. CLS. 22, 23, 38 AND 50).
FIRST USE 3-8-1976; IN COMMERCE 3-16-1976.
MARTHA FROMM, EXAMINING ATTORNEY

SN 77-139,807. PACIFIC TOYS, INC., COMMERCE, CA.
FILED 3-26-2007.

2CUTE

THE MARK CONSISTS OF STANDARD CHARACTERS WITHOUT CLAIM TO ANY PARTICULAR FONT, STYLE, SIZE, OR COLOR.

FOR PLUSH TOYS; RUBBER CHARACTER TOYS; SOFT SCULPTURE PLUSH TOYS; SOFT SCULPTURE TOYS; SQUEEZABLE SQUEAKING TOYS; SQUEEZE TOYS; STUFFED TOYS; TALKING TOYS; TOY FIGURES; STUFFED DOLLS AND ANIMALS; STUFFED PUPPETS; STUFFED TOY ANIMALS; TOY ANIMALS AND ACCESSORIES THEREFORE (U.S. CLS. 22, 23, 38 AND 50).

FIRST USE 8-0-2006; IN COMMERCE 8-0-2006.
JENNIFER HETU, EXAMINING ATTORNEY

SN 77-139,815. PACIFIC TOYS, INC., COMMERCE, CA.
FILED 3-26-2007.

L.A.M.O! LOOK AT ME ONLY!

THE MARK CONSISTS OF STANDARD CHARACTERS WITHOUT CLAIM TO ANY PARTICULAR FONT, STYLE, SIZE, OR COLOR.

FOR TOY ANIMALS AND ACCESSORIES THEREFORE; TOY FIGURES; RUBBER CHARACTER TOYS; SOFT SCULPTURE DOLLS; SOFT SCULPTURE PLUSH TOYS; SOFT SCULPTURE TOYS; SQUEEZABLE SQUEAKING TOYS; SQUEEZE TOYS; STUFFED DOLLS AND ANIMALS; STUFFED PUPPETS; STUFFED TOY ANIMALS; STUFFED TOYS; TALKING TOYS; PLUSH TOYS (U.S. CLS. 22, 23, 38 AND 50).

FIRST USE 8-0-2006; IN COMMERCE 8-0-2006.
JENNIFER HETU, EXAMINING ATTORNEY

CLASS 28—(Continued).

SN 77-140,064. BRUSSO INCORPORATED, NEW YORK, NY.
FILED 3-26-2007.

GRAVITRAC

THE MARK CONSISTS OF STANDARD CHARACTERS
WITHOUT CLAIM TO ANY PARTICULAR FONT, STYLE,
SIZE, OR COLOR.

FOR TOY TRACK SET COMPRISING RAILS, BASES,
RODS AND BALLS (U.S. CLS. 22, 23, 38 AND 50).
THEODORE MCBRIDE, EXAMINING ATTORNEY

SN 77-140,425. OUT O' SITE, LLC, SPRINGFIELD, MO.
FILED 3-26-2007.

MAGNE-TECH

THE MARK CONSISTS OF STANDARD CHARACTERS
WITHOUT CLAIM TO ANY PARTICULAR FONT, STYLE,
SIZE, OR COLOR.

FOR TREE STANDS FOR HUNTING (U.S. CLS. 22, 23,
38 AND 50).
NANCY CLARKE, EXAMINING ATTORNEY

SN 77-140,885. CHU, BRUCE L.K., HONOLULU, HI. FILED 3-
26-2007.

Pocket Predictions

THE MARK CONSISTS OF STANDARD CHARACTERS
WITHOUT CLAIM TO ANY PARTICULAR FONT, STYLE,
SIZE, OR COLOR.

NO CLAIM IS MADE TO THE EXCLUSIVE RIGHT TO
USE "PREDICTIONS", APART FROM THE MARK AS
SHOWN.

FOR PSYCHIC PREDICTION GAME WITH CHART
AND DICE (U.S. CLS. 22, 23, 38 AND 50).
JOHN WILKE, EXAMINING ATTORNEY

CLASS 28—(Continued).

SN 77-140,999. ALLIANT TECHSYSTEMS INC., EDINA, MN.
FILED 3-27-2007.

NITREX

THE MARK CONSISTS OF STANDARD CHARACTERS
WITHOUT CLAIM TO ANY PARTICULAR FONT, STYLE,
SIZE, OR COLOR.

OWNER OF U.S. REG. NO. 2,051,560.
FOR ARCHERYBOW SIGHTS (U.S. CLS. 22, 23, 38 AND
50).

LINDA M. KING, EXAMINING ATTORNEY

SN 77-141,119. MARKOWITZ, MICHAEL, NEW YORK, NY.
FILED 3-27-2007.

Cinema of Fear

THE MARK CONSISTS OF STANDARD CHARACTERS
WITHOUT CLAIM TO ANY PARTICULAR FONT, STYLE,
SIZE, OR COLOR.

FOR TOYS, GAMES AND PLAYTHINGS, NAMELY,
DOLLS, ARTICULATED AND INARTICULATED AC-
TION FIGURES, PLUSH TOYS, TOY FIGURES, TOY
ACTION FIGURES AND ACCESSORIES THEREFOR,
AND PLAYSETS FOR ACTION FIGURES (U.S. CLS. 22,
23, 38 AND 50).

FIRST USE 10-2-2002; IN COMMERCE 1-15-2003.
BARBARA GAYNOR, EXAMINING ATTORNEY

SN 77-141,230. THOMAS, TORRIS G, BIRMINGHAM, AL.
FILED 3-27-2007.



THE MARK CONSISTS OF A STYLIZED NUMBER 2
CONSISTING OF TWO TWISTED, ROUND, THICK LINES
IN ALTERNATING COLOR PRECEDING THE WORD
"TAIL". THE DOTTED PORTION OF THE LETTER I IN
THE WORD "TAIL" IS OF CONTRASTING COLOR TO THE
WORD ITSELF AND MATCHES THE SECONDARY COLOR
OF THE STYLIZED NUMBER 2.

FOR PLUSH TOYS; STUFFED TOY ANIMALS;
STUFFED TOYS (U.S. CLS. 22, 23, 38 AND 50).
LOURDES AYALA, EXAMINING ATTORNEY

CLASS 28—(Continued).

SN 77-141,560. WIRCHAK, MICHAEL J., HESPERIA, CA. FILED 3-27-2007.

FLOATASSAGE

THE MARK CONSISTS OF STANDARD CHARACTERS WITHOUT CLAIM TO ANY PARTICULAR FONT, STYLE, SIZE, OR COLOR.

FOR FLOATING RECREATIONAL LOUNGES CAPABLE OF PROVIDING HYDRO MASSAGE (U.S. CLS. 22, 23, 38 AND 50).
TEJBIR SINGH, EXAMINING ATTORNEY

CLASS 28—(Continued).

SN 77-142,213. DREAM INTERNATIONAL USA, INC. DBA CALTOY, BUENA PARK, CA. FILED 3-28-2007.

DUSTY MY BUDDY

THE MARK CONSISTS OF STANDARD CHARACTERS WITHOUT CLAIM TO ANY PARTICULAR FONT, STYLE, SIZE, OR COLOR.

FOR STUFFED TOY ANIMALS (U.S. CLS. 22, 23, 38 AND 50).
TEJBIR SINGH, EXAMINING ATTORNEY

SN 77-141,854. B2X CORPORATION, JERSEY CITY, NJ. FILED 3-27-2007.

B2X

THE MARK CONSISTS OF STANDARD CHARACTERS WITHOUT CLAIM TO ANY PARTICULAR FONT, STYLE, SIZE, OR COLOR.

FOR PLUSH TOYS AND BOARD GAMES (U.S. CLS. 22, 23, 38 AND 50).
THEODORE MCBRIDE, EXAMINING ATTORNEY

SN 77-142,295. THE HARTZ MOUNTAIN CORPORATION, SECAUCUS, NJ. FILED 3-28-2007.

ZYGON

THE MARK CONSISTS OF STANDARD CHARACTERS WITHOUT CLAIM TO ANY PARTICULAR FONT, STYLE, SIZE, OR COLOR.

FOR PET TOYS (U.S. CLS. 22, 23, 38 AND 50).
WON TEAK OH, EXAMINING ATTORNEY

SN 77-142,189. VIACOM INTERNATIONAL INC., NEW YORK, NY. FILED 3-28-2007.

DORA BEBE

THE MARK CONSISTS OF STANDARD CHARACTERS WITHOUT CLAIM TO ANY PARTICULAR FONT, STYLE, SIZE, OR COLOR.

NO CLAIM IS MADE TO THE EXCLUSIVE RIGHT TO USE "BEBE", APART FROM THE MARK AS SHOWN.
THE ENGLISH TRANSLATION OF THE WORD BEBE IN THE MARK IS BABY.

FOR INFANT TOYS, NAMELY, DEVELOPMENT TOYS, CRIB TOYS, MOBILES, RATTLES, BATH TOYS; INFANT EXERCISE SEATS, NAMELY, JUMPERS, SAUCERS AND SWINGS (U.S. CLS. 22, 23, 38 AND 50).
B. PARADEWELAI, EXAMINING ATTORNEY

SN 77-142,319. THE HARTZ MOUNTAIN CORPORATION, SECAUCUS, NJ. FILED 3-28-2007.

ZORCH

THE MARK CONSISTS OF STANDARD CHARACTERS WITHOUT CLAIM TO ANY PARTICULAR FONT, STYLE, SIZE, OR COLOR.

FOR PET TOYS (U.S. CLS. 22, 23, 38 AND 50).
WON TEAK OH, EXAMINING ATTORNEY

CLASS 28—(Continued).

SN 77-142,356. T.I.G. SPEC. INC., SAN CLEMENTE, CA.
FILED 3-28-2007.

SURFWORKS

THE MARK CONSISTS OF STANDARD CHARACTERS
WITHOUT CLAIM TO ANY PARTICULAR FONT, STYLE,
SIZE, OR COLOR.

FOR SURFBOARD STORAGE RACK (U.S. CLS. 22, 23,
38 AND 50).

FIRST USE 7-1-1997; IN COMMERCE 7-1-1997.
LINDA E. BLOHM, EXAMINING ATTORNEY

SN 77-142,366. ALLIANT TECHSYSTEMS INC., EDINA, MN.
FILED 3-28-2007.

INTENSITY

THE MARK CONSISTS OF STANDARD CHARACTERS
WITHOUT CLAIM TO ANY PARTICULAR FONT, STYLE,
SIZE, OR COLOR.

FOR ARCHERY BOW SIGHTS (U.S. CLS. 22, 23, 38 AND
50).

LINDA M. KING, EXAMINING ATTORNEY

SN 77-142,658. JOYCEE KENNEDY, DENVER, CO. FILED 3-
28-2007.

**FLOSSY THE FEEL BETTER
BUNNY**

THE MARK CONSISTS OF STANDARD CHARACTERS
WITHOUT CLAIM TO ANY PARTICULAR FONT, STYLE,
SIZE, OR COLOR.

FOR STUFFED DOLLS AND ANIMALS (U.S. CLS. 22,
23, 38 AND 50).

FIRST USE 2-23-2006; IN COMMERCE 2-23-2006.
ANDREA HACK, EXAMINING ATTORNEY

CLASS 28—(Continued).

SN 77-142,722. THE HARTZ MOUNTAIN CORPORATION,
SECAUCUS, NJ. FILED 3-28-2007.

THE JULI ADAMS COLLECTION

THE MARK CONSISTS OF STANDARD CHARACTERS
WITHOUT CLAIM TO ANY PARTICULAR FONT, STYLE,
SIZE, OR COLOR.

NO CLAIM IS MADE TO THE EXCLUSIVE RIGHT TO
USE "COLLECTION", APART FROM THE MARK AS
SHOWN.

"THE NAME(S), PORTRAIT(S), AND/OR SIGNATURE(S)
SHOWN IN THE MARK IDENTIFIES JULI ADAMS ,
WHOSE CONSENT(S) TO REGISTER IS SUBMITTED."

FOR PET TOYS (U.S. CLS. 22, 23, 38 AND 50).
WON TEAK OH, EXAMINING ATTORNEY

SN 77-142,855. THE HARTZ MOUNTAIN CORPORATION,
SECAUCUS, NJ. FILED 3-28-2007.

MUNSUN DRAGON

THE MARK CONSISTS OF STANDARD CHARACTERS
WITHOUT CLAIM TO ANY PARTICULAR FONT, STYLE,
SIZE, OR COLOR.

NO CLAIM IS MADE TO THE EXCLUSIVE RIGHT TO
USE "DRAGON", APART FROM THE MARK AS SHOWN.

FOR PET TOYS (U.S. CLS. 22, 23, 38 AND 50).
WON TEAK OH, EXAMINING ATTORNEY

SN 77-143,043. UNITED FOOTBALL LEAGUE, LLC, SAN
FRANCISCO, CA. FILED 3-28-2007.

UFL

THE MARK CONSISTS OF STANDARD CHARACTERS
WITHOUT CLAIM TO ANY PARTICULAR FONT, STYLE,
SIZE, OR COLOR.

FOR ACTION FIGURES; ACTION SKILL GAMES;
ACTION-TYPE TARGET GAMES; AIR MATTRESSES
FOR RECREATIONAL USE; ANIMAL ATTRACTANT
SCENTS; ANKLE AND WRIST WEIGHTS FOR EXER-
CISE; ARCADE GAMES; ARCADE-TYPE ELECTRONIC
VIDEO GAMES; ARCHERY ARM GUARDS; ARCHERY
ARROW FLETCHING DEVICES; BABY SWINGS; BACK-
BOARDS FOR BASKETBALL; BACKGAMMON GAME
SETS; BADMINTON GAME PLAYING EQUIPMENT;
BALL BEARINGS FOR IN-LINE SKATES; BALLS OF
ALL KINDS; BAR-BELLS; BARBELLS; BATTERY OPER-
ATED ACTION TOYS; BATTING GLOVES; BEACH
BALLS; BEAN BAGS; BENDABLE TOYS; BILLIARD
BRIDGES; BILLIARD BUMPERS; BILLIARD CUES; BIL-
LIARD CUSHIONS; BILLIARD GAME PLAYING EQUIP-
MENT; BILLIARD TABLES; BINDINGS FOR
SNOWBOARDS; BOARD GAMES; BOBSLEDS; BODY
BOARDS; BOWLING BALL COVERS; CAMOUFLAGE

CLASS 28—(Continued).

SCREENS; CASES FOR ACTION FIGURES; CASES FOR TENNIS BALLS; CATCHERS' MITTS; CHEERLEADING POM-POMS; CHESS SETS; CHEST EXPANDERS; CHEST PROTECTORS; CHRISTMAS TREE ORNAMENTS; CHRISTMAS TREE ORNAMENTS INCORPORATING A FIRE ALARM FUNCTION; CHRISTMAS TREE ORNAMENTS WITH A MUSIC FEATURE; CHRISTMAS TREE ORNAMENTS, NAMELY, BELLS; COLLECTABLE TOY FIGURES; CONFETTI; CONSTRUCTION TOYS; CRAFT SETS FOR DECORATING BALLOONS; CRICKET BALLS; CRICKET BATS; DART CARRYING CASES; DART FLIGHTS; DART POINT SHARPENERS; DART POINTS; DEER LURES; DISCUSES; DISCUSES; DOG TOYS; DOLL CASES; DOLL FURNITURE; DOLL HOUSE FURNISHINGS; DOLLS AND PLAYSETS THEREFOR; DUCK BLINDS; FLIES FOR USE IN FISHING; FLOOR-STANDING UNITS FOR PLAYING ELECTRONIC GAMES OTHER THAN IN CONJUNCTION WITH A TELEVISION OR COMPUTER; FOILS; FOOTBALL BODY PROTECTORS; FOOTBALL GIRDLES; FOOTBALL KNEE PADS; FOOTBALL LEG PADS; FOOTBALL OR SOCCER GOALS; FOOTBALL SHOULDER PADS; FURNITURE FOR DOLL'S HOUSES; FURNITURE FOR DOLLS' HOUSES; GAME TABLES; GAMING TABLES; GOLF BAG PEGS; GOLF BAG TAGS; GOLF BALL MARKERS; GOLF BALL RETRIEVERS; GOLF CLUB BAGS; GOLF CLUB COVERS; GOLF CLUB GRIPS; GOLF CLUB HEADS; GOLF PUTTER COVERS; GOLF PUTTING AIDS, NAMELY AIDS TO PRACTICE PUTTING GOLF BALLS; GRIP TAPES FOR GOLF CLUBS; HAND PADS FOR ATHLETIC USE; HAND PUPPETS; HANDBALLS; HOBBY CRAFT KIT COMPRISING SPORTING GOODS AND SPORTS MEMORABILIA; HUNTERS' SCENT LURE; INFANT EXERCISE SEATS, NAMELY, JUMPERS AND INFANT SAUCERS; INFLATABLE BATH TOYS; INFLATABLE BOP BAGS; INFLATABLE INNER TUBES FOR AQUATIC RECREATIONAL USE; INFLATABLE POOLS FOR RECREATIONAL USE; INFLATABLE TOYS; IN-LINE SKATES; KITE HANDLES; KITS FOR BUILDING SURFBOARDS; LEG GUARDS FOR ATHLETIC USE; LURES FOR FISHING; MECHANICAL ACTION TOYS; MODEL CARS; MODEL TOY STEAM ENGINES; MODEL TOY STEAM OPERATED TRACTION ENGINES; MOLDED TOY FIGURES; NET BALLS; PARTY FAVORS IN THE NATURE OF SMALL TOYS; PARTY GAMES; PERSONAL EXERCISE MATS; PET TOYS; PET TOYS CONTAINING CATNIP; PET TOYS MADE OF ROPE; PINBALL-TYPE GAMES; PITCHERS' PLATES; PLASTIC CHARACTER TOYS; PLATFORM TENNIS NETS; PLAY MATS CONTAINING INFANT TOYS; PLAY TENTS; PLAYGROUND EQUIPMENT, NAMELY, PLAY STRUCTURES, AND BALANCING, JUMPING AND CLIMBING UNITS; PLAYSETS FOR DOLLS, ACTION FIGURES AND CONSTRUCTION TOYS; POMMEL HORSES; PUNCHING BALLS; PUSH TOYS; PUZZLES; QUILTS; RACKET BALLS; RADIO TRANSMITTERS FOR USE WITH RADIO-CONTROLLED TOYS; RAG DOLLS; RING GAMES; SCENT LURES FOR HUNTING OR FISHING; SHUTTLECOCKS FOR HAGOITA-PLAY; SKI BAGS; SNOW SAUCERS; SNOW SHOES; SNOWBOARD DECKS; SOFT SCULPTURE TOYS; SOFT TENNIS BALLS; SPORTSMAN'S FISHING BAGS; STARTING BLOCKS; STARTING BLOCKS; STATIONARY EXERCISE BICYCLES; STUFFED PUPPETS; STUFFED TOY ANIMALS; STUFFED TOY BEARS; STUFFED TOYS; SURF BOARDS; SURF FINS; SWIM FLOATS FOR RECREATIONAL USE; SWIMMING BOARDS; TABLE TENNIS RACKETS; TARGET LAUNCHERS FOR TOYS AND SPORTING GOODS; TENNIS BALL RETRIEVERS; TOY AIRPLANES; TOY ANIMALS AND ACCESSORIES THEREFOR; TOY ARMOR; TOY ARTIFICIAL FINGERNAILS; TOY BUILDING BLOCKS CAPABLE OF INTERCONNECTION; TOY CONSTRUCTION SETS; TOY MODEL KIT CARS; TOY MODEL TRAIN SETS; TOY MODEL VEHICLES AND RELATED ACCESSORIES SOLD AS UNITS; TOY MODELING DOUGH; TOY

CLASS 28—(Continued).

MUSIC BOXES; TOY NOISEMAKERS; TOY PIANOS; TOY PIANOS, SOLD AS AS A UNIT WITH PRINTED BOOKS IN THE FIELD OF MUSIC EDUCATION; TOY PISTOLS; TOY ROBOTS; TOY SNOW GLOBES; TOY SWORDS; TOYS, NAMELY, A DISK TO TOSS IN PLAYING A GAME WHEREIN OTHER DISKS ARE FLIPPED AND COLLECTED; TRADING CARD GAMES; TRAIN SET ACCESSORIES, NAMELY, ARTIFICIAL TREES, TURF, FOLIAGE, BALLAST, LICHEN & GRASS; TRANSFORMING ROBOTIC TOYS; WATER SKIS; WEIGHT LIFTING BENCHES AND BENCH ACCESSORIES; WIND-UP TOYS (U.S. CLS. 22, 23, 38 AND 50).
JORDAN BAKER, EXAMINING ATTORNEY

SN 77-143,177. SWAMP FRIENDS, FRANKFORD, DE. FILED 3-28-2007.

SWAMP FRIENDS

THE MARK CONSISTS OF STANDARD CHARACTERS WITHOUT CLAIM TO ANY PARTICULAR FONT, STYLE, SIZE, OR COLOR.

FOR DOLLS (U.S. CLS. 22, 23, 38 AND 50).
FIRST USE 9-30-2006; IN COMMERCE 9-30-2006.
TEJBIR SINGH, EXAMINING ATTORNEY

SN 77-143,229. XLNT VETERINARY CARE, INC., LOS GATOS, CA. FILED 3-28-2007.

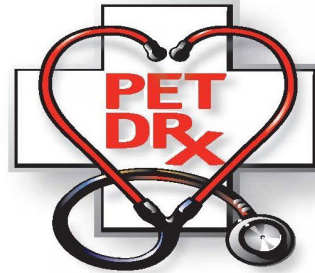

NO CLAIM IS MADE TO THE EXCLUSIVE RIGHT TO USE "PET", APART FROM THE MARK AS SHOWN.

THE COLOR(S) BLACK, GRAY, WHITE AND RED IS/ ARE CLAIMED AS A FEATURE OF THE MARK.

THE COLOR RED APPEARS IN THE WORDING "PET DRX". THE EARPIECES OF THE STETHOSCOPE FORMING A HEART, AND SHADING, REFLECTIONS, AND TONALITIES ALONG A SPECTRUM FROM RED TO BLACK IN THE SINGLE LUMEN TUBING OF THE STETHOSCOPE; THE COLOR BLACK APPEARS IN THE EARPIECE, TUBING AND OUTLINE OF THE STETHOSCOPE, AND, THE OUTLINE OF THE CROSS; THE COLOR GRAY APPEARS IN THE SHADING OF THE STETHOSCOPE CHESTPIECE AND SHADOWS ON AND AROUND THE CROSS; THE COLOR WHITE APPEARS IN THE CROSS AND AS HIGHLIGHTS ON THE STETHOSCOPE.

FOR PET TOYS (U.S. CLS. 22, 23, 38 AND 50).
HANNO RITTNER, EXAMINING ATTORNEY

CLASS 28—(Continued).

SN 77-143,299. DER MARDEROSIAN, MARK, NEWTONVILLE, MA. FILED 3-29-2007.

HEAVEN IN SMALL HANDS

THE MARK CONSISTS OF STANDARD CHARACTERS WITHOUT CLAIM TO ANY PARTICULAR FONT, STYLE, SIZE, OR COLOR.

FOR ACTION FIGURES; ACTION FIGURES AND ACCESSORIES THEREFOR; BABY MULTIPLE ACTIVITY TOYS; BABY RATTLES; BABY RATTLES INCORPORATING TEETHING RINGS; BALLOONS; BALLS FOR GAMES; BATH TOYS; BATHTUB TOYS; BATTERY OPERATED ACTION TOYS; BEACH BALLS; BEAN BAG DOLLS; BEAN BAGS; BENDABLE TOYS; BOARD GAMES; CASES FOR ACTION FIGURES; CASES FOR PLAY ACCESSORIES; CASES FOR TENNIS BALLS; CASES FOR TOY STRUCTURES; CHILDREN'S MULTIPLE ACTIVITY TOYS; CHILDREN'S MULTIPLE ACTIVITY TOYS SOLD AS A UNIT WITH PRINTED BOOKS; CHILDREN'S PLAY COSMETICS; CHRISTMAS TREE DECORATIONS; CHRISTMAS TREE ORNAMENTS; CHRISTMAS TREE ORNAMENTS OF BRONZE; CHRISTMAS TREE ORNAMENTS WITH A MUSIC FEATURE; CHRISTMAS TREE ORNAMENTS, NAMELY, BELLS; COLLECTABLE TOY FIGURES; CRIB MOBILES; CRIB TOYS; DECORATIVE WIND SOCKS; DOLL ACCESSORIES; DOLL CASES; DOLL CLOTHING; DOLL COSTUMES; DOLL FURNITURE; DOLL HOUSE FURNISHINGS; DOLL HOUSES; DOLLS; DOLLS AND ACCESSORIES THEREFOR; DOLLS AND PLAYSETS THEREFOR; DOLLS FOR PLAYING; DOMINOES; DRAWING TOYS; ELECTRIC ACTION TOYS; ELECTRONIC LEARNING TOYS; FANTASY CHARACTER TOYS; FURNITURE FOR DOLL'S HOUSES; FURNITURE FOR DOLLS' HOUSES; HAND PUPPETS; INFANT ACTION CRIB TOYS; INFANT DEVELOPMENT TOYS; INFANT TOYS; INFANT'S RATTLES; INFLATABLE BATH TOYS; INFLATABLE BOP BAGS; INFLATABLE TOYS; INFLATABLE TOYS SHOWING DECORATIVE PICTURES; JACK-IN-THE-BOXES; JIGSAW PUZZLES; KITES; MANIPULATIVE GAMES; MANIPULATIVE PUZZLES; MARIONETTE PUPPETS; MECHANICAL ACTION TOYS; MECHANICAL TOYS; MOBILES FOR CHILDREN; MODELED PLASTIC TOY FIGURINES; MUSIC BOX TOYS; MUSICAL TOYS; PAPER DOLLS; PARTY FAVORS IN THE NATURE OF SMALL TOYS; PARTY GAMES; PINATAS; PLASTIC CHARACTER TOYS; PLAY FIGURES; PLAY HOUSES; PLAYGROUND BALLS; PLUSH TOYS; PULL TOYS; PUPPETS; PUSH TOYS; PUZZLES; RAG DOLLS; ROCKING HORSES; SAND TOYS; SANDBOX TOYS; SOFT SCULPTURE PLUSH TOYS; SOFT SCULPTURE TOYS; SQUEEZABLE SQUEAKING TOYS; SQUEEZE TOYS; STACKING TOYS; STUFFED DOLLS AND ANIMALS; STUFFED PUPPETS; STUFFED TOY ANIMALS; STUFFED TOY BEARS; STUFFED TOYS; TALKING TOYS; TEDDY BEARS; TOY ACTION FIGURES; TOY ACTION FIGURES AND ACCESSORIES THEREFOR; TOY ANIMALS AND ACCESSORIES THEREFOR; TOY FIGURES; TOY WIND SOCKS; WIND-UP TOYS; WIND-UP WALKING TOYS; YO-YOS (U.S. CLS. 22, 23, 38 AND 50).

ELISSA GARBER KON, EXAMINING ATTORNEY

CLASS 28—(Continued).

SN 77-143,300. DER MARDEROSIAN, MARK, NEWTONVILLE, MA. FILED 3-29-2007.

ANGELS FROM THE ATTIC

THE MARK CONSISTS OF STANDARD CHARACTERS WITHOUT CLAIM TO ANY PARTICULAR FONT, STYLE, SIZE, OR COLOR.

FOR ACTION FIGURES; ACTION FIGURES AND ACCESSORIES THEREFOR; BABY MULTIPLE ACTIVITY TOYS; BABY RATTLES; BABY RATTLES INCORPORATING TEETHING RINGS; BALLOONS; BALLS FOR GAMES; BATH TOYS; BATHTUB TOYS; BATTERY OPERATED ACTION TOYS; BEACH BALLS; BEAN BAG DOLLS; BEAN BAGS; BENDABLE TOYS; BOARD GAMES; BUBBLE MAKING WAND AND SOLUTION SETS; CARD GAMES; CASES FOR ACTION FIGURES; CASES FOR PLAY ACCESSORIES; CASES FOR TOY STRUCTURES; CHILDREN'S MULTIPLE ACTIVITY TOYS; CHILDREN'S MULTIPLE ACTIVITY TOYS SOLD AS A UNIT WITH PRINTED BOOKS; CHILDREN'S PLAY COSMETICS; CHRISTMAS STOCKINGS; CHRISTMAS TREE DECORATIONS; CHRISTMAS TREE ORNAMENTS; CHRISTMAS TREE ORNAMENTS OF BRONZE; CHRISTMAS TREE ORNAMENTS WITH A MUSIC FEATURE; CHRISTMAS TREE ORNAMENTS, NAMELY, BELLS; COLLECTABLE TOY FIGURES; CRIB MOBILES; CRIB TOYS; DECORATIVE WIND SOCKS; DICE GAMES; DOLL ACCESSORIES; DOLL CASES; DOLL CLOTHING; DOLL COSTUMES; DOLL FURNITURE; DOLL HOUSE FURNISHINGS; DOLL HOUSES; DOLLS; DOLLS AND ACCESSORIES THEREFOR; DOLLS AND PLAYSETS THEREFOR; DOLLS FOR PLAYING; DOLLS IN SITTING POSTURE (OSUWARI DOLLS); DOMINOES; DRAWING TOYS; ELECTRONIC EDUCATIONAL GAME MACHINES FOR CHILDREN; ELECTRONIC LEARNING TOYS; EQUIPMENT SOLD AS A UNIT FOR PLAYING A MEMORY GAME; EQUIPMENT SOLD AS A UNIT FOR PLAYING BOARD GAMES; EQUIPMENT SOLD AS A UNIT FOR PLAYING CARD GAMES; FANTASY CHARACTER TOYS; FLYING DISCS; FURNITURE FOR DOLL'S HOUSES; FURNITURE FOR DOLLS' HOUSES; HAND PUPPETS; HEADGEAR FOR DOLLS; INFANT ACTION CRIB TOYS; INFANT DEVELOPMENT TOYS; INFANT TOYS; INFANT'S RATTLES; INFLATABLE BATH TOYS; INFLATABLE BOP BAGS; INFLATABLE TOYS; JACK-IN-THE-BOXES; JIGSAW PUZZLES; KITES; MANIPULATIVE GAMES; MANIPULATIVE PUZZLES; MARIONETTE PUPPETS; MECHANICAL ACTION TOYS; MECHANICAL TOYS; MOBILES FOR CHILDREN; MUSIC BOX TOYS; MUSICAL TOYS; PAPER DOLLS; PARTY FAVORS IN THE NATURE OF SMALL TOYS; PARTY GAMES; PINATAS; PLASTIC CHARACTER TOYS; PLAY FIGURES; PLAY HOUSES; PLAYSETS FOR DOLLS; PLUSH TOYS; POP UP TOYS; POSITIONABLE TOY FIGURES; PULL TOYS; PUPPETS; PUSH TOYS; PUZZLES; RAG DOLLS; ROCKING HORSES; RUBBER ACTION BALLS; RUBBER BALLS; RUBBER CHARACTER TOYS; SANDBOX TOYS; SHOES FOR DOLLS; SOFT SCULPTURE PLUSH TOYS; SOFT SCULPTURE TOYS; SQUEEZABLE SQUEAKING TOYS; SQUEEZE TOYS; STACKING TOYS; STUFFED DOLLS AND ANIMALS; STUFFED PUPPETS; STUFFED TOY ANIMALS; STUFFED TOY BEARS; STUFFED TOYS; TEDDY BEARS; TOY ACTION FIGURES; TOY ACTION FIGURES AND ACCESSORIES THEREFOR; TOY ANIMALS AND ACCESSORIES THEREFOR; TOY FIGURES; TOY MUSIC BOXES; YO-YOS (U.S. CLS. 22, 23, 38 AND 50).

ELISSA GARBER KON, EXAMINING ATTORNEY

CLASS 28—(Continued).

SN 77-143,730. OUTRAGEOUS, INC., VOORHEES, NJ. FILED 3-29-2007.

BOUNCEABLES

THE MARK CONSISTS OF STANDARD CHARACTERS WITHOUT CLAIM TO ANY PARTICULAR FONT, STYLE, SIZE, OR COLOR.
FOR PLUSH TOYS (U.S. CLS. 22, 23, 38 AND 50).
PAUL F. GAST, EXAMINING ATTORNEY

SN 77-143,787. THE HARTZ MOUNTAIN CORPORATION, SECAUCUS, NJ. FILED 3-29-2007.

FLIP 'N FUN

THE MARK CONSISTS OF STANDARD CHARACTERS WITHOUT CLAIM TO ANY PARTICULAR FONT, STYLE, SIZE, OR COLOR.
FOR PET TOYS (U.S. CLS. 22, 23, 38 AND 50).
FIRST USE 9-0-2005; IN COMMERCE 9-0-2005.
STEVEN R. FOSTER, EXAMINING ATTORNEY

SN 77-146,189. MIZUNO CORPORATION, OSAKA, JAPAN, FILED 4-2-2007.

PhD

THE MARK CONSISTS OF STANDARD CHARACTERS WITHOUT CLAIM TO ANY PARTICULAR FONT, STYLE, SIZE, OR COLOR.
FOR GOLF BALLS (U.S. CLS. 22, 23, 38 AND 50).
TARAH HARDY, EXAMINING ATTORNEY

SN 77-147,125. CALLAWAY GOLF COMPANY, CARLSBAD, CA. FILED 4-3-2007.

Hyper Face

THE MARK CONSISTS OF STANDARD CHARACTERS WITHOUT CLAIM TO ANY PARTICULAR FONT, STYLE, SIZE, OR COLOR.
FOR GOLF CLUBS (U.S. CLS. 22, 23, 38 AND 50).
SAMUEL E. SHARPER JR., EXAMINING ATTORNEY

CLASS 28—(Continued).

SN 77-147,170. CALLAWAY GOLF COMPANY, CARLSBAD, CA. FILED 4-3-2007.

Square Way

THE MARK CONSISTS OF STANDARD CHARACTERS WITHOUT CLAIM TO ANY PARTICULAR FONT, STYLE, SIZE, OR COLOR.
FOR GOLF CLUBS; FITTED HEAD COVERS FOR GOLF CLUBS (U.S. CLS. 22, 23, 38 AND 50).
SAMUEL E. SHARPER JR., EXAMINING ATTORNEY

SN 77-148,799. LUCKY CRAFT CO., LTD., OYABE-SHI, JAPAN, FILED 4-4-2007.

BIG DADDY STRIKE

THE MARK CONSISTS OF STANDARD CHARACTERS WITHOUT CLAIM TO ANY PARTICULAR FONT, STYLE, SIZE, OR COLOR.
FOR FISHING EQUIPMENT NAMELY FISHING LURES, FISHING RODS, FISHING LINES AND FISHING REELS (U.S. CLS. 22, 23, 38 AND 50).
LESLIE RICHARDS, EXAMINING ATTORNEY

SN 77-148,830. LUCKY CRAFT CO., LTD., OYABE-SHI TOYAMA, JAPAN, FILED 4-4-2007.

MAJESTY

THE MARK CONSISTS OF STANDARD CHARACTERS WITHOUT CLAIM TO ANY PARTICULAR FONT, STYLE, SIZE, OR COLOR.
FOR FISHING EQUIPMENT NAMELY FISHING LURES, FISHING RODS, FISHING LINES AND FISHING REELS (U.S. CLS. 22, 23, 38 AND 50).
LESLIE RICHARDS, EXAMINING ATTORNEY

CLASS 28—(Continued).

SN 77-149,377. AEROPOSTALE WEST, INC., WAYNE, NJ. FILED 4-5-2007.

AEROPOSTALE

THE MARK CONSISTS OF STANDARD CHARACTERS WITHOUT CLAIM TO ANY PARTICULAR FONT, STYLE, SIZE, OR COLOR.

OWNER OF U.S. REG. NOS. 1,485,368, 1,548,372 AND OTHERS.

THE FOREIGN WORDING IN THE MARK TRANSLATES INTO ENGLISH AS AIR MAIL.

FOR SURFBOARDS, SKATEBOARDS, SNOWBOARDS, BODYBOARDS, ROLLER SKATES, INLINE SKATES, WAKE BOARDS, BALLS, NAMELY BEACH BALLS, RUBBER BALLS; SPORTS BAGS, NAMELY, SURFBOARD BAGS, SKATEBOARD BAGS, SNOWBOARD BAGS (U.S. CLS. 22, 23, 38 AND 50).

ELIZABETH BEYER, EXAMINING ATTORNEY

CLASS 28—(Continued).

SN 77-157,109. SHAW, MICKI L., BLACKLICK, OH. FILED 4-15-2007.



NO CLAIM IS MADE TO THE EXCLUSIVE RIGHT TO USE "THE FOTO GAME", APART FROM THE MARK AS SHOWN.

FOR BOARD GAMES THAT ALLOW USERS TO PERSONALIZE THE GAME BY INSERTING FAMILY PHOTOS AND DECORATING THE BOARD (U.S. CLS. 22, 23, 38 AND 50).

BRIDGETT SMITH, EXAMINING ATTORNEY

SN 77-151,556. ENOR CORPORATION, NORTHVALE, NJ. FILED 4-9-2007.

FAT BAT

THE MARK CONSISTS OF STANDARD CHARACTERS WITHOUT CLAIM TO ANY PARTICULAR FONT, STYLE, SIZE, OR COLOR.

FOR BASEBALL BATS (U.S. CLS. 22, 23, 38 AND 50).

FIRST USE 10-1-2005; IN COMMERCE 10-1-2005.

HOWARD B. LEVINE, EXAMINING ATTORNEY

SN 77-165,114. HD DESIGN CENTER, LLC, NEW PORT RICHEY, FL. FILED 4-25-2007.



THE MARK CONSISTS OF HD AND HDDDESIGNCENTER.COM "WE CAN MAKE YOU BOBBLE".

FOR BOBBLE HEAD DOLLS; PLUSH TOYS (U.S. CLS. 22, 23, 38 AND 50).

FIRST USE 12-1-2006; IN COMMERCE 12-1-2006.

RAUL CORDOVA, EXAMINING ATTORNEY

SN 77-151,888. PENGUIN GROUP (USA) INC., NEW YORK, NY. FILED 4-9-2007.

**THE LITTLE ENGINE THAT
COULD**

THE MARK CONSISTS OF STANDARD CHARACTERS WITHOUT CLAIM TO ANY PARTICULAR FONT, STYLE, SIZE, OR COLOR.

OWNER OF U.S. REG. NOS. 2,747,009, 3,169,278 AND OTHERS.

FOR PLUSH TOYS (U.S. CLS. 22, 23, 38 AND 50).

FIRST USE 3-1-2006; IN COMMERCE 3-1-2006.

C. DIONNE CLYBURN, EXAMINING ATTORNEY

SN 77-165,701. CALLAWAY GOLF COMPANY, CARLSBAD, CA. FILED 4-25-2007.

Top Loader

THE MARK CONSISTS OF STANDARD CHARACTERS WITHOUT CLAIM TO ANY PARTICULAR FONT, STYLE, SIZE, OR COLOR.

FOR GOLF CLUBS (U.S. CLS. 22, 23, 38 AND 50).

SAMUEL E. SHARPER JR., EXAMINING ATTORNEY

CLASS 28—(Continued).

SN 77-168,711. OUT O' SITE, LLC, SPRINGFIELD, MO. FILED 4-30-2007.

ULTRA-STEEL

THE MARK CONSISTS OF STANDARD CHARACTERS WITHOUT CLAIM TO ANY PARTICULAR FONT, STYLE, SIZE, OR COLOR.
FOR TREESTANDS FOR HUNTING (U.S. CLS. 22, 23, 38 AND 50).
NANCY CLARKE, EXAMINING ATTORNEY

CLASS 28—(Continued).

SN 77-174,568. MISSION ITECH HOCKEY, INC., IRVINE, CA. FILED 5-7-2007.

I AM A GOALIE

THE MARK CONSISTS OF STANDARD CHARACTERS WITHOUT CLAIM TO ANY PARTICULAR FONT, STYLE, SIZE, OR COLOR.
NO CLAIM IS MADE TO THE EXCLUSIVE RIGHT TO USE "GOALIE", APART FROM THE MARK AS SHOWN.
FOR HOCKEY GOALTENDING EQUIPMENT, NAMELY, LEG, SHOULDER, KNEE, SHIN, HAND, CHEST OR ELBOW PADS, NECK GUARDS, FACE MASKS, BLOCKER PADS, GLOVES, HOCKEY SKATES AND HOCKEY STICKS (U.S. CLS. 22, 23, 38 AND 50).
TEJBIR SINGH, EXAMINING ATTORNEY

SN 77-172,126. HORIZON HOBBY, INC., CHAMPAIGN, IL. FILED 5-3-2007.

LOSI

THE MARK CONSISTS OF STANDARD CHARACTERS WITHOUT CLAIM TO ANY PARTICULAR FONT, STYLE, SIZE, OR COLOR.
OWNER OF U.S. REG. NO. 1,528,416.
FOR REMOTE CONTROLLED HOBBY MODEL LAND VEHICLES AND PARTS AND ACCESSORIES THEREFOR (U.S. CLS. 22, 23, 38 AND 50).
DANNEAN HETZEL, EXAMINING ATTORNEY

SN 77-176,098. IRON PEANUT PRODUCTIONS, LLC, RO-
SLYN HEIGHTS, NY. FILED 5-9-2007.

Flat City

THE MARK CONSISTS OF STANDARD CHARACTERS WITHOUT CLAIM TO ANY PARTICULAR FONT, STYLE, SIZE, OR COLOR.
FOR PLAYING CARDS; TOY ACTION FIGURES AND ACCESSORIES THEREFORE (U.S. CLS. 22, 23, 38 AND 50).
INGA ERVIN, EXAMINING ATTORNEY

SN 77-173,081. ALEXANDER DOLL COMPANY, INC., NEW YORK, NY. FILED 5-4-2007.

FAVORITE FRIENDS

THE MARK CONSISTS OF STANDARD CHARACTERS WITHOUT CLAIM TO ANY PARTICULAR FONT, STYLE, SIZE, OR COLOR.
FOR DOLLS, DOLL CLOTHING AND DOLL ACCESSORIES (U.S. CLS. 22, 23, 38 AND 50).
KATHERINE M. DUBRAY, EXAMINING ATTORNEY

SN 78-499,707. LITTLE KIDS PREFERRED, LLC, DAYTON, NJ. FILED 10-14-2004.

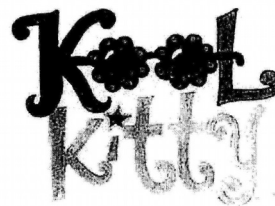

NO CLAIM IS MADE TO THE EXCLUSIVE RIGHT TO USE "KITTY", APART FROM THE MARK AS SHOWN.
THE MARK CONSISTS OF THE WORDS "KOOL KITTY" WITH THE DOUBLE "OO" OF 'KOOL' IN THE SHAPE OF FLOWERED SUNGLASS LENSES, LINKED TO THE OTHER LETTERS OF THE WORD VIA THE FRAMES OF THE SUNGLASSES.
FOR PLUSH TOYS FOR INFANTS AND TODDLERS (U.S. CLS. 22, 23, 38 AND 50).
CAROLYN GRAY, EXAMINING ATTORNEY

CLASS 28—(Continued).

SN 78-503,332. BONOCORE, MARK J., ALDAN, PA. FILED 10-21-2004.

Teddy Babes

THE MARK CONSISTS OF STANDARD CHARACTERS WITHOUT CLAIM TO ANY PARTICULAR FONT, STYLE, SIZE, OR COLOR.

NO CLAIM IS MADE TO THE EXCLUSIVE RIGHT TO USE "TEDDY", APART FROM THE MARK AS SHOWN. FOR PLUSH TOYS (U.S. CLS. 22, 23, 38 AND 50).
TONI HICKEY, EXAMINING ATTORNEY

SN 78-515,789. SRI SPORTS LIMITED, HYOGO, JAPAN, FILED 11-12-2004.

AD Hybrid

NO CLAIM IS MADE TO THE EXCLUSIVE RIGHT TO USE HYBRID, APART FROM THE MARK AS SHOWN. FOR GOLF CLUBS (U.S. CLS. 22, 23, 38 AND 50).
LINDA ESTRADA, EXAMINING ATTORNEY

CLASS 28—(Continued).

SN 78-641,261. PIRANHA VOLLEYBALL, SAN ANTONIO, TX. FILED 6-1-2005.

PIRANHA VOLLEYBALL

THE MARK CONSISTS OF STANDARD CHARACTERS WITHOUT CLAIM TO ANY PARTICULAR FONT, STYLE, SIZE, OR COLOR.

NO CLAIM IS MADE TO THE EXCLUSIVE RIGHT TO USE "VOLLEYBALL", APART FROM THE MARK AS SHOWN.

FOR VOLLEYBALL EQUIPMENT FOR LEARNING TO PLAY VOLLEYBALL, NAMELY, A PASS CATCHER FOR TEACHING THE BASICS OF HAND AND ARM POSITIONING FOR RETURNING A VOLLEYBALL SERVE CONSISTING OF WIRED COVERED IN A PLASTIC TUBE STRUNG ON A BAG WITH A RUBBER HANDLE, A BLOCKER WHICH TEACHES HOW TO HIT AROUND OUTSTRETCHED HANDS OF A DEFENSIVE PLAYERS AND FOR DEFENSIVE PLAYERS TO GET IN POSITION TO SEE THE VOLLEYBALL AND MAKE A POSSIBLE RETURN OF THE VOLLEYBALL WITH A HIT OR SPIKE CONSISTING OF A RECTANGULAR BOARD WITH HAND GRIPS, A GUIDE LINE STRAP TO TEACH VOLLEYBALL PLAYERS WHERE A SERVED VOLLEYBALL IS MOST LIKELY TO APPEAR OVER THE NET WHICH ALSO GIVES THE SERVER A TARGET AREA TO AIM FOR WHEN SERVING CONSISTING OF ELASTIC HELD TOGETHER BY ADHESIVE FASTENERS WHICH ARE ATTACHED TO THE ANTENNAS AFFIXED AT EACH END OF THE NET, AND A HEAD SETTER FOR TEACHING SETTERS A POINT ON THE HEAD TO AIM AT FOR SETTING AND JUMP SETTING THE VOLLEYBALL CONSISTING OF A TIE ON HEADBAND WITH ADHESIVE FASTENERS IN THE CENTER FOR ATTACHING THE VOLLEYBALL WHICH ALSO HELPS WITH PROPER PLACEMENT OF HANDS WITH RESPECT TO THE HEAD WHEN SETTING THE BALL (U.S. CLS. 22, 23, 38 AND 50).

BRENDAN MCCAULEY, EXAMINING ATTORNEY

SN 78-654,154. OUR NATION'S BEST SPORTS, FORT WORTH, TX. FILED 6-20-2005.

PRO SPORT

THE MARK CONSISTS OF STANDARD CHARACTERS WITHOUT CLAIM TO ANY PARTICULAR FONT, STYLE, SIZE, OR COLOR.

NO CLAIM IS MADE TO THE EXCLUSIVE RIGHT TO USE "SPORT", APART FROM THE MARK AS SHOWN.

FOR SPORTS EQUIPMENT, NAMELY, BASEBALLS, SOFTBALLS, BASEBALL GLOVES, BASEBALL BATTING TEES, BASEBALL BASES, BASEBALL BAT CASES, BASEBALL PITCHING SCREENS; FOOTBALLS; PROTECTIVE PADDING FOR USE IN SPORTS ACTIVITIES, NAMELY, SHOULDER, HIP AND THIGH PADS FOR USE IN FOOTBALL (U.S. CLS. 22, 23, 38 AND 50).

MICHAEL LEWIS, EXAMINING ATTORNEY

CLASS 28—(Continued).

SN 78-735,343. KAIYODO CO., LTD., OSAKA, JAPAN, FILED 10-18-2005.

REVOLVER JOINT

THE MARK CONSISTS OF STANDARD CHARACTERS WITHOUT CLAIM TO ANY PARTICULAR FONT, STYLE, SIZE, OR COLOR.

NO CLAIM IS MADE TO THE EXCLUSIVE RIGHT TO USE "REVOLVER", APART FROM THE MARK AS SHOWN.

FOR TOY FIGURES, TOY ACTION FIGURES, DOLLS, COLLECTIBLE TOY MINIATURE FIGURES, TOY FIGURINES OF MODELED PLASTIC, TOY FIGURINES OF MODELED RESIN, TOY FIGURINES OF MODELED RUBBER, TOY FIGURINES OF COMMON METAL, TOY FIGURE PLAYSETS, AND ACCESSORIES THEREFOR (U.S. CLS. 22, 23, 38 AND 50).

GEORGIA CARTY, EXAMINING ATTORNEY

CLASS 28—(Continued).

SN 78-805,408. HEALTHY HEROES, LLC, CHICAGO, IL, FILED 2-2-2006.

SHAKTI

SN 78-745,363. AMERICAN GIRL, LLC, EL SEGUNDO, CA, FILED 11-2-2005.

EMILY

THE MARK CONSISTS OF STANDARD CHARACTERS WITHOUT CLAIM TO ANY PARTICULAR FONT, STYLE, SIZE, OR COLOR.

FOR TOYS, GAMES AND PLAYTHINGS, NAMELY, DOLLS, DOLL CLOTHING AND DOLL ACCESSORIES (U.S. CLS. 22, 23, 38 AND 50).

IRENE D. WILLIAMS, EXAMINING ATTORNEY

SN 78-784,164. HANAYAMA CO., LTD., CHIBA, JAPAN, FILED 1-3-2006.



NO CLAIM IS MADE TO THE EXCLUSIVE RIGHT TO USE "CAST PUZZLE", APART FROM THE MARK AS SHOWN.

FOR PUZZLES; PUZZLE TOYS, NAMELY, PUZZLES (U.S. CLS. 22, 23, 38 AND 50).

FIRST USE 1-3-2006; IN COMMERCE 1-3-2006.

MAUREEN DALL, EXAMINING ATTORNEY

THE MARK CONSISTS OF STANDARD CHARACTERS WITHOUT CLAIM TO ANY PARTICULAR FONT, STYLE, SIZE, OR COLOR.

THE FOREIGN WORDING IN THE MARK TRANSLATES INTO ENGLISH AS POWER.

FOR TOYS, GAMES AND PLAYTHINGS, NAMELY, TOY ACTION FIGURES AND ACCESSORIES THEREFOR, MECHANICAL ACTION TOYS; RIDE ON TOYS; TALKING ACTION FIGURES; ACTION FIGURE PLAYSETS; BATTERY OPERATED ACTION TOYS; RADIO-CONTROLLED ACTION FIGURES, MODEL CARS AND VEHICLES, RADIO-CONTROLLED TOY VEHICLES, BATTERY OPERATED TOY VEHICLES, TOY VEHICLES; DIE-CAST TOY FIGURES, ACTION PLAYSETS SOLD AS A UNIT FOR MAKE-BELIEVE PLAY BATTLE OR ADVENTURE ACTIVITIES, TOY DRESS-UP SETS FOR CHILDREN AND ACCESSORIES THEREFOR, TOY NOVELTY JEWELRY FOR CHILDREN, TOY ENVIRONMENTS FOR USE WITH ACTION FIGURES, TOY RACE CARS, TOY ROAD RACE SETS, BOARD GAMES WITH AND WITHOUT ELECTRONIC FEATURES, INTERACTIVE ARCADE TYPE GAMES, PLUSH TOY FIGURES, ELECTRONIC HAND-HELD GAME UNITS, SOFT SCULPTURE TOY FIGURES, DOLLS, ACCESSORIES FOR DOLLS, BATTERY-OPERATED DOLLS AND TOY ANIMAL FIGURES, PLUSH DOLLS, STUFFED TOY ANIMALS, BENDABLE TOY FIGURINES, PUPPETS, BALLOONS, WATER PLAY TOYS, CHESS SETS, BOARD GAMES, CARD GAMES, BEAN BAGS, COLLECTIBLE CARD GAMES AND TRADING CARDS, JIGSAW PUZZLES, KITES, YO-YOS, TOY WEAPONS, TOY WATCHES, TOY CALCULATORS, TOY MODEL HOBBY-CRAFT KITS, HAND HELD UNITS FOR PLAYING ELECTRONIC GAMES, COIN OPERATED ARCADE GAMES; ROLLER SKATES, IN-LINE SKATES, SKATEBOARDS, ELBOW PADS AND KNEE PADS FOR ATHLETIC USE; SNOW BOARDS, SNOW SLEDS FOR RECREATIONAL USE; SURFBOARDS; SWIMBOARDS AND FLOATS FOR RECREATIONAL USE NAMELY SWIM FLOATS AND ARM FLOATS; CHRISTMAS TREE ORNAMENTS, BALLS NAMELY, PLAYGROUND BALLS; SOCCER BALLS, BASEBALLS, AND BASKETBALLS; BASEBALL GLOVES (U.S. CLS. 22, 23, 38 AND 50).

ELLEN PERKINS, EXAMINING ATTORNEY

CLASS 28—(Continued).

SN 78-807,052. MICROSOFT CORPORATION, REDMOND, WA. FILED 2-3-2006.

NINETY-NINE NIGHTS

THE MARK CONSISTS OF STANDARD CHARACTERS WITHOUT CLAIM TO ANY PARTICULAR FONT, STYLE, SIZE, OR COLOR.

FOR TOYS AND GAMES, NAMELY, ACTION FIGURES AND ACCESSORIES THEREFOR; BALLOONS; BATHTUB TOYS; TOY BUILDING BLOCKS; DOLLS AND ACCESSORIES THEREFOR; DOLL CLOTHING; BOARD GAMES; CARD GAMES; PLAY COSMETICS FOR CHILDREN; COSTUME MASKS; TOY AIRPLANES AND HELICOPTERS; FLYING DISCS; INFLATABLE TOY VINYL FIGURES; JIGSAW PUZZLES; KITES; MARBLES; INDOOR SLUMBER PLAY TENTS; PLUSH TOYS FEATURING VIDEO GAME CHARACTERS UNRELATED TO AUTO RACING; HAND-HELD PUPPETS; SIT-IN AND RIDE-ON TOY VEHICLES; TRAIN TOY MODEL SETS; PLAY SHAVING KITS; SKATEBOARDS; ROLLER SKATES; TOY BANKS; WATER SQUIRTING TOYS; TOY PISTOLS; CHRISTMAS TREE ORNAMENTS; PINBALL AND ARCADE GAME MACHINES; HAND-HELD UNITS FOR PLAYING ELECTRONIC GAMES; MODEL CRAFT KITS OF TOY FIGURES; PLAYGROUND BALLS; SPORT BALLS; BASKETBALLS; GOLF BALLS; GOLF BALL MARKERS; TENNIS BALLS; BASEBALLS; RUBBER ACTION BALLS; RUBBER SPORTS BALLS; RUBBER PLAYING BALLS; SQUEEZABLE BALLS USED TO RELIEVE STRESS; BAGS FITTED FOR CARRYING GOLF EQUIPMENT; BAGS FITTED FOR CARRYING BASKETBALL EQUIPMENT; BAGS FITTED FOR CARRYING BASEBALL EQUIPMENT; BAGS FITTED FOR CARRYING TENNIS EQUIPMENT; MANIPULATIVE PUZZLES AND CONSTRUCTION TOYS; CRIB MOBILES; MOBILES FOR CHILDREN; TARGET SETS CONSISTING OF A TARGET, RUBBER SUCTION DARTS AND TOY DART GUN; AND PLAYING CARDS, ALL FOR PROMOTING AN EPIC FANTASY-ACTION VIDEO GAME UNRELATED TO AUTO RACING (U.S. CLS. 22, 23, 38 AND 50).
KELLY CHOE, EXAMINING ATTORNEY

CLASS 28—(Continued).

SN 78-824,189. AFNA, LLC, VERONA, VA. FILED 2-27-2006.

INFUZE

THE MARK CONSISTS OF STANDARD CHARACTERS WITHOUT CLAIM TO ANY PARTICULAR FONT, STYLE, SIZE, OR COLOR.

FOR EXERCISE EQUIPMENT, NAMELY WEIGHT LIFTING MACHINES, TREADMILLS, EXERCISE WEIGHTS, BARBELLS, AND DUMBBELLS; YOGA MATS; STATIONARY EXERCISE BICYCLES; WEIGHT LIFTING BENCHES AND BENCH ACCESSORIES; EXERCISE EQUIPMENT NAMELY, SLANT BOARDS; EXERCISE PLATFORMS; EXERCISE MACHINES; EXERCISE BENCHES; JUMP ROPES; WRIST AND ANKLE WEIGHTS FOR EXERCISE; AEROBIC STEPS; EXERCISE TRAMPOLINES; HAND GRIP EXERCISERS; RESISTANCE BANDS FOR EXERCISE; MACHINES AND EQUIPMENT FOR PHYSICAL AND GYMNASIAC/SPORTS EXERCISES, FOR MUSCLE TRAINING AND REHABILITATION AND FOR AEROBIC AND CARDIOVASCULAR EXERCISE, NAMELY, STEP SIMULATORS, ROWING MACHINES AND CYCLE SIMULATORS; MANUALLY OPERATED ATHLETIC EXERCISE EQUIPMENT FOR USE IN THE FIELDS OF FOOTBALL, BASEBALL, SOFTBALL, BASKETBALL, SOCCER, RUNNING AND VOLLEYBALL TO FACILITATE TRAINING FOR SPEED, STRENGTH, AGILITY AND QUICKNESS (U.S. CLS. 22, 23, 38 AND 50).

THEODORE MCBRIDE, EXAMINING ATTORNEY

SN 78-833,751. MATTEL, INC., EL SEGUNDO, CA. FILED 3-9-2006.

EXTREME RAPPEL

THE MARK CONSISTS OF STANDARD CHARACTERS WITHOUT CLAIM TO ANY PARTICULAR FONT, STYLE, SIZE, OR COLOR.

NO CLAIM IS MADE TO THE EXCLUSIVE RIGHT TO USE "RAPPEL", APART FROM THE MARK AS SHOWN.

FOR TOYS, GAMES AND PLAYTHINGS, NAMELY, TOY ACTION FIGURES, TOY FIGURES, AND ACCESSORIES FOR ALL OF THE FOREGOING (U.S. CLS. 22, 23, 38 AND 50).

FIRST USE 6-29-2006; IN COMMERCE 6-29-2006.
KATHLEEN LORENZO, EXAMINING ATTORNEY

CLASS 28—(Continued).

SN 78-839,428. TAPOUT, INC., RANCHO CUCAMONGA, CA. FILED 3-16-2006.



OWNER OF U.S. REG. NO. 2,346,533.
FOR TOY FIGURES; PLAYSETS FOR USE WITH TOY FIGURES; BOARD GAMES, HAND-HELD UNITS FOR PLAYING ELECTRONIC GAMES; SPORTS EQUIPMENT AND APPARATUS, NAMELY, EAR AND EYEBROW PROTECTORS AND FACE MASKS FOR WRESTLERS, BOXERS, AND OTHER SPORTS FIGHTERS, STRIKING BAGS, STRIKING-BAG PLATFORMS, WEIGHTS FOR EXERCISE AND FOR LIFTING, WEIGHT LIFTING BELTS, MANUALLY OPERATED EXERCISE EQUIPMENT, NAMELY, SPRING EXERCISERS, GRIP DEVELOPERS, MEDICINE BALLS; PUNCHING BAGS, STRIKING BAGS FOR TRAINING IN WRESTLING, BOXING AND OTHER FIGHTING SPORTS; SKIPPING ROPES, ATHLETIC EQUIPMENT, NAMELY, MOUTH GUARDS, ATHLETIC SUPPORTERS, ATHLETIC EQUIPMENT, NAMELY, SHOE GUARDS, BOXING, WRESTLING AND MIXED MARTIAL ARTS RINGS, SPORTS BALLS OF ALL TYPES, WEIGHTLIFTING BENCHES, AEROBIC STEP MACHINES, AND BAGS SPECIALLY ADAPTED FOR SPORTS EQUIPMENT (U.S. CLS. 22, 23, 38 AND 50).

ELISSA GARBER KON, EXAMINING ATTORNEY

SN 78-926,076. SPORTADE CORPORATION EHF., REYKJAVIK, ICELAND, FILED 7-10-2006.

SOCCERADE

THE MARK CONSISTS OF STANDARD CHARACTERS WITHOUT CLAIM TO ANY PARTICULAR FONT, STYLE, SIZE, OR COLOR.

FOR SPORTING EQUIPMENT, NAMELY, GOLF TEES, GOLF BALLS, BASKETBALLS, SOCCER BALLS, BASEBALLS, FOOTBALLS, TENNIS BALLS AND TENNIS RACKETS, BATS AND BASKETBALL BACKBOARDS, TOYS, NAMELY DOLLS, PUZZLES, DART BOARDS, YO-YO'S, AND BALLS FOR RECREATIONAL USE, NAMELY, RUBBER BALLS, STUFFED TOY ANIMALS AND CHRISTMAS TREE ORNAMENTS AND DECORATIONS. (U.S. CLS. 22, 23, 38 AND 50).

GEORGIA CARTY, EXAMINING ATTORNEY

CLASS 28—(Continued).

SN 78-926,108. PIXEL PLANET, INC., CHICAGO, IL. FILED 7-10-2006.

WINSTON

THE MARK CONSISTS OF STANDARD CHARACTERS WITHOUT CLAIM TO ANY PARTICULAR FONT, STYLE, SIZE, OR COLOR.

FOR PLUSH TOY INCORPORATING A DEVICE FOR RECORDING THE USER'S MESSAGE AND PLAYING IT BACK IN AN ARTIFICIALLY MODIFIED SPEECH PATTERN (U.S. CLS. 22, 23, 38 AND 50).

FIRST USE 0-0-2005; IN COMMERCE 0-0-2005.

AMY MCMENAMIN, EXAMINING ATTORNEY

SN 78-929,158. BORG UNLIMITED INC., MONTEREY PARK, CA. FILED 7-13-2006.

TORSO BAG

THE MARK CONSISTS OF STANDARD CHARACTERS WITHOUT CLAIM TO ANY PARTICULAR FONT, STYLE, SIZE, OR COLOR.

NO CLAIM IS MADE TO THE EXCLUSIVE RIGHT TO USE "TORSO", APART FROM THE MARK AS SHOWN.

FOR FOOTBALL BLOCKING/TACKLING SLEDS AND PADDING THEREFOR (U.S. CLS. 22, 23, 38 AND 50).

DEZMONA MIZELLE, EXAMINING ATTORNEY

SN 78-931,769. FUNRISE TOYS LTD., KOWLOON, HONG KONG, FILED 7-18-2006.



OWNER OF U.S. REG. NOS. 1,547,521 AND 1,604,826.
THE MARK CONSISTS OF THE WORDS FUNRISE IN A STYLIZED FORMAT WITH A DESIGN OF A SHOOTING STAR DOTTING THE I.

FOR A HOUSEMARK FOR A LINE OF TOYS (U.S. CLS. 22, 23, 38 AND 50).

FIRST USE 1-0-2006; IN COMMERCE 1-0-2006.

THOMAS MANOR, EXAMINING ATTORNEY

CLASS 28—(Continued).

SN 78-932,947. BRAINSTORMPRODUCTS, LLC, ESCONDI-
DO, CA. FILED 7-19-2006.

BrainStormProducts, LLC

THE MARK CONSISTS OF STANDARD CHARACTERS
WITHOUT CLAIM TO ANY PARTICULAR FONT, STYLE,
SIZE, OR COLOR.

NO CLAIM IS MADE TO THE EXCLUSIVE RIGHT TO
USE "LLC", APART FROM THE MARK AS SHOWN.

FOR KITES AND TOY GLIDERS (U.S. CLS. 22, 23, 38
AND 50).

MORGAN WYNNE, EXAMINING ATTORNEY

CLASS 28—(Continued).

SN 78-946,297. MATTEL, INC., EL SEGUNDO, CA. FILED 8-
7-2006.

ROCK 'N GO

THE MARK CONSISTS OF STANDARD CHARACTERS
WITHOUT CLAIM TO ANY PARTICULAR FONT, STYLE,
SIZE, OR COLOR.

FOR TOYS, GAMES AND PLAYTHINGS, NAMELY,
DOLLS, DOLL CLOTHING AND DOLL ACCESSORIES,
TOY FIGURES AND ACCESSORIES THEREFOR (U.S.
CLS. 22, 23, 38 AND 50).

FIRST USE 2-6-2007; IN COMMERCE 2-6-2007.

ALYSSA PALADINO, EXAMINING ATTORNEY

SN 78-937,046. IOMIC CO., OSAKA, JAPAN, FILED 7-25-2006.



FOR GOLF SPORTING EQUIPMENT; NAMELY, GOLF
BAGS, GOLF BALLS, GOLF CLUB GRIPS, GOLF CLUB
HEADS, GOLF CLUBS, GOLF PUTTERS, GOLF TEES,
HEAD COVERS FOR GOLF CLUBS, GOLF BALL PITCH-
ING MACHINES AND GOLF GLOVES (U.S. CLS. 22, 23,
38 AND 50).

ELI HELLMAN, EXAMINING ATTORNEY

SN 78-949,832. MARTIN YAFFE INTERNATIONAL LIM-
ITED, ROCHDALE, OL11 2QN, UNITED KINGDOM,
FILED 8-10-2006.



NO CLAIM IS MADE TO THE EXCLUSIVE RIGHT TO
USE "TRACKS", APART FROM THE MARK AS SHOWN.

THE COLOR(S) YELLOW, LIGHT BLUE, BLUE, RED IS/
ARE CLAIMED AS A FEATURE OF THE MARK.

THE MARK CONSISTS OF THE LETTERS "SNAP TRAX"
IN YELLOW, A LIGHT BLUE TOP SEMI-OVAL PORTION
AND A RED BOTTOM SEMI-OVAL PORTION AROUND
THE LETTERING AND BLUE IRREGULAR SHAPED SEC-
TIONS BETWEEN THE LETTERING.

FOR TOYS, GAMES, PLAYTHINGS NAMELY, RE-
MOTE CONTROL TOY VEHICLES AND TRACKS FOR
TOY VEHICLES (U.S. CLS. 22, 23, 38 AND 50).

RICHARD WHITE, EXAMINING ATTORNEY

SN 78-939,569. MASCOLO, KYARA, CARROLLTON, TX.
FILED 7-27-2006.



THE MARK CONSISTS OF A CIRCLE CONTAINING THE
WORD I AND THE DESIGN ELEMENT (HEART SYMBOL)
AND THE WORDS BED HEAD.

FOR PET TOYS (U.S. CLS. 22, 23, 38 AND 50).

HOWARD B. LEVINE, EXAMINING ATTORNEY

SN 78-950,120. ZUNKER, INC., CLEARWATER, FL. FILED 8-
11-2006.

ZUNKER

THE MARK CONSISTS OF STANDARD CHARACTERS
WITHOUT CLAIM TO ANY PARTICULAR FONT, STYLE,
SIZE, OR COLOR.

FOR PARTY GAMES, DICE GAMES, BOARD GAMES
(U.S. CLS. 22, 23, 38 AND 50).

MICHAEL TANNER, EXAMINING ATTORNEY

CLASS 28—(Continued).

SN 78-950,748. MATTEL, INC., EL SEGUNDO, CA. FILED 8-11-2006.

HEFTY

THE MARK CONSISTS OF STANDARD CHARACTERS WITHOUT CLAIM TO ANY PARTICULAR FONT, STYLE, SIZE, OR COLOR.

FOR TOYS, GAMES AND PLAYTHINGS, NAMELY, TOY VEHICLES AND ACCESSORIES THEREFOR (U.S. CLS. 22, 23, 38 AND 50).

JUDITH HELFMAN, EXAMINING ATTORNEY

CLASS 28—(Continued).

SN 78-952,232. TIPPMANN SPORTS, LLC, FORT WAYNE, IN. FILED 8-15-2006.

X-7

THE MARK CONSISTS OF STANDARD CHARACTERS WITHOUT CLAIM TO ANY PARTICULAR FONT, STYLE, SIZE, OR COLOR.

FOR PAINTBALL MARKERS; PARTS AND ACCESSORIES THEREFOR, NAMELY, HOPPERS, TRIGGERS, BARRELS, STOCKS, MAGAZINES, SHROUDS, GRIPS, CARRY HANDLES AND SIGHTS. (U.S. CLS. 22, 23, 38 AND 50).

BRENDAN REGAN, EXAMINING ATTORNEY

SN 78-950,749. MATTEL, INC., EL SEGUNDO, CA. FILED 8-11-2006.

VICTOR

THE MARK CONSISTS OF STANDARD CHARACTERS WITHOUT CLAIM TO ANY PARTICULAR FONT, STYLE, SIZE, OR COLOR.

FOR TOYS, GAMES AND PLAYTHINGS, NAMELY, TOY FIGURES AND ACCESSORIES THEREFOR (U.S. CLS. 22, 23, 38 AND 50).

JUDITH HELFMAN, EXAMINING ATTORNEY

SN 78-954,447. MIRACLE RECREATION EQUIPMENT COMPANY, MONETT, MO. FILED 8-17-2006.

BUG BITES

THE MARK CONSISTS OF STANDARD CHARACTERS WITHOUT CLAIM TO ANY PARTICULAR FONT, STYLE, SIZE, OR COLOR.

FOR COMMERCIAL PLAYGROUND EQUIPMENT, NAMELY, SPRING RIDERS (U.S. CLS. 22, 23, 38 AND 50).

IRENE D. WILLIAMS, EXAMINING ATTORNEY

SN 78-950,752. MATTEL, INC., EL SEGUNDO, CA. FILED 8-11-2006.

SIR JOHN

THE MARK CONSISTS OF STANDARD CHARACTERS WITHOUT CLAIM TO ANY PARTICULAR FONT, STYLE, SIZE, OR COLOR.

FOR TOYS, GAMES AND PLAYTHINGS, NAMELY, TOY VEHICLES AND ACCESSORIES THEREFOR (U.S. CLS. 22, 23, 38 AND 50).

JUDITH HELFMAN, EXAMINING ATTORNEY

SN 78-957,100. POPPO BRANDS LLC, BEVERLY, MA. FILED 8-21-2006.

PLAY FOR LIFE

THE MARK CONSISTS OF STANDARD CHARACTERS WITHOUT CLAIM TO ANY PARTICULAR FONT, STYLE, SIZE, OR COLOR.

FOR GAMES, NAMELY, CARD GAMES AND BOARD GAMES; EQUIPMENT SOLD AS A UNIT FOR PLAYING A BOARD GAME; BOARD GAME ACCESSORIES, NAMELY, QUESTION CARD SETS FOR USE IN PLAYING A BOARD GAME; EQUIPMENT SOLD AS A UNIT FOR PLAYING A BOARD GAME, NAMELY, BOARD GAMES FEATURING TOYS, SOLD AS A UNIT (U.S. CLS. 22, 23, 38 AND 50).

SETH A. RAPPAPORT, EXAMINING ATTORNEY

CLASS 28—(Continued).

SN 78-958,110. MATTEL, INC., EL SEGUNDO, CA. FILED 8-22-2006.

WEEKEND WARRIOR

THE MARK CONSISTS OF STANDARD CHARACTERS WITHOUT CLAIM TO ANY PARTICULAR FONT, STYLE, SIZE, OR COLOR.

FOR TOYS, GAMES AND PLAYTHINGS, NAMELY, TOY VEHICLES AND ACCESSORIES THEREFOR (U.S. CLS. 22, 23, 38 AND 50).

RON FAIRBANKS, EXAMINING ATTORNEY

CLASS 28—(Continued).

SN 78-958,131. MATTEL, INC., EL SEGUNDO, CA. FILED 8-22-2006.

SUPDOGG

THE MARK CONSISTS OF STANDARD CHARACTERS WITHOUT CLAIM TO ANY PARTICULAR FONT, STYLE, SIZE, OR COLOR.

FOR TOYS, GAMES AND PLAYTHINGS, NAMELY, TOY VEHICLES AND ACCESSORIES THEREFOR (U.S. CLS. 22, 23, 38 AND 50).

KATHLEEN M. VANSTON, EXAMINING ATTORNEY

SN 78-958,118. MATTEL, INC., EL SEGUNDO, CA. FILED 8-22-2006.

RADIO ACTIVE X-RAYCERS

THE MARK CONSISTS OF STANDARD CHARACTERS WITHOUT CLAIM TO ANY PARTICULAR FONT, STYLE, SIZE, OR COLOR.

OWNER OF U.S. REG. NO. 3,151,837.
FOR TOYS, GAMES AND PLAYTHINGS, NAMELY, TOY VEHICLES AND ACCESSORIES THEREFOR (U.S. CLS. 22, 23, 38 AND 50).

KATHLEEN M. VANSTON, EXAMINING ATTORNEY

SN 78-960,511. MATTEL, INC., EL SEGUNDO, CA. FILED 8-25-2006.

THREE KINGS

THE MARK CONSISTS OF STANDARD CHARACTERS WITHOUT CLAIM TO ANY PARTICULAR FONT, STYLE, SIZE, OR COLOR.

FOR TOYS, GAMES AND PLAYTHINGS, NAMELY, TOY VEHICLES AND ACCESSORIES THEREFOR (U.S. CLS. 22, 23, 38 AND 50).

KATHLEEN M. VANSTON, EXAMINING ATTORNEY

SN 78-958,127. MATTEL, INC., EL SEGUNDO, CA. FILED 8-22-2006.

PAW POINTS

THE MARK CONSISTS OF STANDARD CHARACTERS WITHOUT CLAIM TO ANY PARTICULAR FONT, STYLE, SIZE, OR COLOR.

FOR TOYS, GAMES AND PLAYTHINGS, NAMELY, TOY FIGURES, TOY FIGURES SOLD TOGETHER WITH AN ELECTRONIC GAME UNIT (U.S. CLS. 22, 23, 38 AND 50).

KATHLEEN M. VANSTON, EXAMINING ATTORNEY

SN 78-960,517. MATTEL, INC., EL SEGUNDO, CA. FILED 8-25-2006.

MAGNA STUNT

THE MARK CONSISTS OF STANDARD CHARACTERS WITHOUT CLAIM TO ANY PARTICULAR FONT, STYLE, SIZE, OR COLOR.

OWNER OF U.S. REG. NOS. 3,150,680, 3,174,119 AND OTHERS.

FOR TOYS, GAMES AND PLAYTHINGS, NAMELY, TOY VEHICLES, TOY FIGURES, TOY VEHICLE PLAYSETS, TOY FIGURE PLAYSETS, AND ACCESSORIES FOR ALL OF THE FOREGOING (U.S. CLS. 22, 23, 38 AND 50).

FIRST USE 3-21-2007; IN COMMERCE 3-21-2007.

WARREN L. OLANDRIA, EXAMINING ATTORNEY

CLASS 28—(Continued).

SN 78-965,446. WILD PLANET ENTERTAINMENT, INC., SAN FRANCISCO, CA. FILED 8-31-2006.

MIGHTY PENS

THE MARK CONSISTS OF STANDARD CHARACTERS WITHOUT CLAIM TO ANY PARTICULAR FONT, STYLE, SIZE, OR COLOR.

NO CLAIM IS MADE TO THE EXCLUSIVE RIGHT TO USE "PENS", APART FROM THE MARK AS SHOWN.

FOR ACTION TOYS CONVERTIBLE INTO WRITING PENS (U.S. CLS. 22, 23, 38 AND 50).

SALLY SHIH, EXAMINING ATTORNEY

CLASS 28—(Continued).

SN 78-974,314. MATTEL, INC., EL SEGUNDO, CA. FILED 9-14-2006.

JUAN EIGHTY

THE MARK CONSISTS OF STANDARD CHARACTERS WITHOUT CLAIM TO ANY PARTICULAR FONT, STYLE, SIZE, OR COLOR.

THE NAME(S), PORTRAIT(S), AND/OR SIGNATURE(S) SHOWN IN THE MARK DOES NOT IDENTIFY A PARTICULAR LIVING INDIVIDUAL.

FOR TOYS, GAMES AND PLAYTHINGS, NAMELY, TOY FIGURES AND ACCESSORIES THEREFOR (U.S. CLS. 22, 23, 38 AND 50).

FIRST USE 3-21-2007; IN COMMERCE 3-21-2007.
KATHY DE JONGE, EXAMINING ATTORNEY

SN 78-965,548. MICHAEL CASEY, PALM SPRINGS, CA. FILED 8-31-2006.

BUN & THIGH WAVE

THE MARK CONSISTS OF STANDARD CHARACTERS WITHOUT CLAIM TO ANY PARTICULAR FONT, STYLE, SIZE, OR COLOR.

NO CLAIM IS MADE TO THE EXCLUSIVE RIGHT TO USE "BUN & THIGH", APART FROM THE MARK AS SHOWN.

FOR MANUALLY-OPERATED EXERCISE EQUIPMENT (U.S. CLS. 22, 23, 38 AND 50).

ROBERT LAVACHE, EXAMINING ATTORNEY

SN 78-974,317. MATTEL, INC., EL SEGUNDO, CA. FILED 9-14-2006.

MO'HAWK

THE MARK CONSISTS OF STANDARD CHARACTERS WITHOUT CLAIM TO ANY PARTICULAR FONT, STYLE, SIZE, OR COLOR.

FOR TOYS, GAMES AND PLAYTHINGS, NAMELY, TOY FIGURES AND ACCESSORIES THEREFOR (U.S. CLS. 22, 23, 38 AND 50).

FIRST USE 7-25-2007; IN COMMERCE 7-25-2007.
KATHY DE JONGE, EXAMINING ATTORNEY

SN 78-974,310. MATTEL, INC., EL SEGUNDO, CA. FILED 9-14-2006.

CIRCUIT CRASHERS

THE MARK CONSISTS OF STANDARD CHARACTERS WITHOUT CLAIM TO ANY PARTICULAR FONT, STYLE, SIZE, OR COLOR.

FOR TOYS, GAMES AND PLAYTHINGS, NAMELY, TOY VEHICLES AND ACCESSORIES THEREFOR (U.S. CLS. 22, 23, 38 AND 50).

FIRST USE 7-30-2007; IN COMMERCE 7-30-2007.
KATHY DE JONGE, EXAMINING ATTORNEY

SN 78-974,325. MATTEL, INC., EL SEGUNDO, CA. FILED 9-14-2006.

POP-UP CRAZY CRASHERS

THE MARK CONSISTS OF STANDARD CHARACTERS WITHOUT CLAIM TO ANY PARTICULAR FONT, STYLE, SIZE, OR COLOR.

NO CLAIM IS MADE TO THE EXCLUSIVE RIGHT TO USE "POP-UP", APART FROM THE MARK AS SHOWN.

FOR TOYS, GAMES AND PLAYTHINGS, NAMELY, TOY VEHICLES AND ACCESSORIES THEREFOR (U.S. CLS. 22, 23, 38 AND 50).

FIRST USE 6-20-2007; IN COMMERCE 6-20-2007.
KATHY DE JONGE, EXAMINING ATTORNEY

CLASS 28—(Continued).

SN 78-974,328. MATTEL, INC., EL SEGUNDO, CA. FILED 9-14-2006.

POPPIN' RAIL GRIND

THE MARK CONSISTS OF STANDARD CHARACTERS WITHOUT CLAIM TO ANY PARTICULAR FONT, STYLE, SIZE, OR COLOR.

NO CLAIM IS MADE TO THE EXCLUSIVE RIGHT TO USE "RAIL GRIND", APART FROM THE MARK AS SHOWN.

FOR TOYS, GAMES AND PLAYTHINGS, NAMELY, TOY FIGURES, TOY FIGURE PLAYSETS, AND ACCESSORIES FOR ALL OF THE FOREGOING (U.S. CLS. 22, 23, 38 AND 50).

FIRST USE 2-27-2007; IN COMMERCE 2-27-2007.
KATHY DE JONGE, EXAMINING ATTORNEY

SN 78-974,331. MATTEL, INC., EL SEGUNDO, CA. FILED 9-14-2006.

STREET PACK

THE MARK CONSISTS OF STANDARD CHARACTERS WITHOUT CLAIM TO ANY PARTICULAR FONT, STYLE, SIZE, OR COLOR.

FOR TOYS, GAMES AND PLAYTHINGS, NAMELY, TOY FIGURES AND ACCESSORIES THEREFOR (U.S. CLS. 22, 23, 38 AND 50).

FIRST USE 3-21-2007; IN COMMERCE 3-21-2007.
KATHY DE JONGE, EXAMINING ATTORNEY

SN 78-974,449. SUNSHINE CITY, LLC, LOS ANGELES, CA. FILED 9-14-2006.

GHETTO UNIVERSITY

THE MARK CONSISTS OF STANDARD CHARACTERS WITHOUT CLAIM TO ANY PARTICULAR FONT, STYLE, SIZE, OR COLOR.

FOR BALLOONS; BASKETBALL BACKBOARDS; CHRISTMAS STOCKINGS; CHRISTMAS TREE ORNAMENTS; GOLF CLUB COVERS; SPORT BALLS; STUFFED TOY ANIMALS; THROWING DISCS (U.S. CLS. 22, 23, 38 AND 50).

DANIEL CAPSHAW, EXAMINING ATTORNEY

CLASS 28—(Continued).

SN 79-038,045. DIFFUSION LANSA SARL, F-01172 GEX CEDEX, FRANCE, FILED 3-27-2007.

SPYK-TEE

PRIORITY DATE OF 3-14-2007 IS CLAIMED.
OWNER OF INTERNATIONAL REGISTRATION 0922897 DATED 3-27-2007, EXPIRES 3-27-2017.

FOR GOLF BALLS, GOLF TEES, GOLF CLUBS (U.S. CLS. 22, 23, 38 AND 50).

INGA ERVIN, EXAMINING ATTORNEY

SN 79-038,231. AV EDITIONS, FRANCE, FILED 3-27-2007.

IN LOVE

THE MARK CONSISTS OF STANDARD CHARACTERS WITHOUT CLAIM TO ANY PARTICULAR FONT, STYLE, SIZE, OR COLOR.

OWNER OF INTERNATIONAL REGISTRATION 0923448 DATED 3-27-2007, EXPIRES 3-27-2017.

FOR BOARD GAMES, PLAYING CARDS, DICE (U.S. CLS. 22, 23, 38 AND 50).

TEJBIR SINGH, EXAMINING ATTORNEY

CLASS 29—MEATS AND PROCESSED FOODS

SN 75-103,788. TRADEMARK MANAGEMENT COMPANY, BOISE, ID. FILED 5-14-1996.

QUESO SHRIMP POPPERS

OWNER OF U.S. REG. NO. 1,922,249.
NO CLAIM IS MADE TO THE EXCLUSIVE RIGHT TO USE "QUESO SHRIMP", APART FROM THE MARK AS SHOWN.

THE ENGLISH TRANSLATION OF "QUESO" IS "CHEESE."

FOR FROZEN APPETIZERS, NAMELY, JALAPENO PEPPERS STUFFED WITH MEATS, CHEESES AND OR CHOPPED VEGETABLES (U.S. CL. 46).

GEOFFREY FOSDICK, EXAMINING ATTORNEY

CLASS 29—(Continued).

SN 75-799,618. TRADEMARK MANAGEMENT COMPANY, BOISE, OH. FILED 9-15-1999.

MINI POPPERS

OWNER OF U.S. REG. NOS. 1,788,303, 1,922,249 AND OTHERS.

NO CLAIM IS MADE TO THE EXCLUSIVE RIGHT TO USE "MINI", APART FROM THE MARK AS SHOWN.

FOR APPETIZERS, NAMELY BREADED AND COATED VEGETABLE, PROCESSED FRUIT, AND CHEESE PIECES (U.S. CL. 46).

GEOFFREY FOSDICK, EXAMINING ATTORNEY

CLASS 29—(Continued).

SN 76-646,607. SAFEWAY INC., PLEASANTON, CA. FILED 9-12-2005.

2 HOUR TURKEY

THE MARK CONSISTS OF STANDARD CHARACTERS WITHOUT CLAIM TO ANY PARTICULAR FONT, STYLE, SIZE, OR COLOR.

NO CLAIM IS MADE TO THE EXCLUSIVE RIGHT TO USE "TURKEY", APART FROM THE MARK AS SHOWN.

FOR TURKEY (U.S. CL. 46).

FIRST USE 10-26-2005; IN COMMERCE 10-26-2005.

ROBERT C. CLARK JR., EXAMINING ATTORNEY

SN 76-549,070. AGROPUR COOPERATIVE, GRANBY, QUEBEC, J2G 7G2, CANADA, FILED 10-6-2003.



OWNER OF CANADA REG. NO. TMA689,269, DATED 6-7-2007, EXPIRES 6-7-2022.

OWNER OF U.S. REG. NOS. 2,497,535, 2,675,777 AND OTHERS.

NO CLAIM IS MADE TO THE EXCLUSIVE RIGHT TO USE FINE FILTERED MILK, APART FROM THE MARK AS SHOWN.

COLOR IS NOT CLAIMED AS A FEATURE OF THE MARK.

FOR DAIRY BEVERAGES, NAMELY FLAVORED MILK, FORTIFIED MILK, LACTOSE SERUM BEVERAGES, NAMELY, ENRICHED MILK, LACTOSE-REDUCED MILK, FLUID MILK, FILTERED MILK (U.S. CL. 46).

NANCY CLARKE, EXAMINING ATTORNEY

SN 76-673,327. ATLANTA DAIRIES, INC., ATLANTA, GA. FILED 2-28-2007.



THE MARK CONSISTS OF A DESIGN OF A COW'S FACE WITH A BOW ON ITS HEAD. THE WORD "KATIE" APPEARS TO THE RIGHT OF THE DESIGN.

FOR MILK, CHOCOLATE MILK, FLAVORED MILKS, CREAM, AND EGG NOG (U.S. CL. 46).

FIRST USE 0-0-1903; IN COMMERCE 0-0-1903.

BERNICE MIDDLETON, EXAMINING ATTORNEY

SN 76-642,740. JAC'S HANDY MEALS, INC., PLAINVIEW, NY. FILED 7-13-2005.

SIMPLICITY IS SENSATIONAL

THE MARK CONSISTS OF STANDARD CHARACTERS WITHOUT CLAIM TO ANY PARTICULAR FONT, STYLE, SIZE, OR COLOR.

FOR FROZEN FOOD PRODUCTS, NAMELY, BITE-SIZED SPINACH-BASED SNACK FOODS (U.S. CL. 46).

ALLISON HOLTZ, EXAMINING ATTORNEY

SN 76-674,750. MOONSHINE FARMS, INC., BRONX, NY. FILED 3-28-2007.

MOONSHINE FARMS

THE MARK CONSISTS OF STANDARD CHARACTERS WITHOUT CLAIM TO ANY PARTICULAR FONT, STYLE, SIZE, OR COLOR.

NO CLAIM IS MADE TO THE EXCLUSIVE RIGHT TO USE "FARMS", APART FROM THE MARK AS SHOWN.

FOR PREPARED MEAT, NAMELY, POULTRY, PORK, AND BEEF (U.S. CL. 46).

JORDAN BAKER, EXAMINING ATTORNEY

CLASS 29—(Continued).

SN 77-010,675. SWIFT BRANDS COMPANY, GREELEY, CO.
FILED 9-29-2006.

**ROCKY MOUNTAIN RESERVE
PREMIUM BLACK ANGUS**

THE MARK CONSISTS OF STANDARD CHARACTERS WITHOUT CLAIM TO ANY PARTICULAR FONT, STYLE, SIZE, OR COLOR.

NO CLAIM IS MADE TO THE EXCLUSIVE RIGHT TO USE "RESERVE PREMIUM BLACK ANGUS", APART FROM THE MARK AS SHOWN.

FOR MEAT, NAMELY BLACK ANGUS BEEF (U.S. CL. 46).

EMILY CHUO, EXAMINING ATTORNEY

SN 77-020,100. NORTH DAKOTA NATURAL BEEF, LLC,
DENVER, CO. FILED 10-12-2006.



NO CLAIM IS MADE TO THE EXCLUSIVE RIGHT TO USE "DAKOTA FARMS", APART FROM THE MARK AS SHOWN.

THE MARK CONSISTS OF A MOUNTAIN RANGE BEHIND THE STYLIZED WORDS DAKOTA FARMS.

FOR ALL-NATURAL, ANTIBIOTIC AND HORMONE FREE BEEF. (U.S. CL. 46).

MICHAEL GAAFAR, EXAMINING ATTORNEY

SN 77-049,693. HIGH LINER FOODS INCORPORATED,
LUNENBURG, NS, CANADA, FILED 11-22-2006.

CAPTAIN HIGH LINER

THE MARK CONSISTS OF STANDARD CHARACTERS WITHOUT CLAIM TO ANY PARTICULAR FONT, STYLE, SIZE, OR COLOR.

OWNER OF CANADA REG. NO. TMA251581, DATED 10-10-1980, EXPIRES 10-10-2010.

OWNER OF U.S. REG. NOS. 722,334 AND 3,135,355.

FOR FISH, FISH PRODUCTS NAMELY FISH CAKES, FISH STICKS AND FISH FILETS; FISH AND CHIPS, FRENCH FRIED POTATOES, FROZEN VEGETABLES AND FROZEN FISH PORTIONS (U.S. CL. 46).

JOANNA DUKOVIC, EXAMINING ATTORNEY

CLASS 29—(Continued).

SN 77-070,148. NUT HOUSE LLC, BINH DUONG, VIETNAM,
FILED 12-22-2006.



NO CLAIM IS MADE TO THE EXCLUSIVE RIGHT TO USE THE PICTORIAL REPRESENTATION OF CASHEWS, APART FROM THE MARK AS SHOWN.

THE COLOR(S) TAN, RED, ORANGE, GOLD, BLACK, WHITE, LIGHT BLUE, DARK BLUE, AND LIGHT PINK IS/ARE CLAIMED AS A FEATURE OF THE MARK.

THE COLOR TAN APPEARS IN THE DESIGN OF THE CASHEWS, AND THE LINE UNDERNEATH THE RECTANGLE CONTAINING THE WORDING "CASHEWS"; RED APPEARS IN THE BACKGROUND BENEATH THE TOP LINE OF CASHEWS AND BEHIND THE "NUT HOUSE" AND "NH" WORDING; ORANGE APPEARS IN THE BAND AND SEAL AROUND THE CUP HOLDING THE CASHEWS; GOLD APPEARS IN THE "NH" ACRONYM AND THE CUP HOLDING THE CASHEWS; BLACK APPEARS IN THE SUNGLASSES OF THE MAN, HIS TIE, HIS HAIR, THE RECTANGLE BEHIND THE WORDING "CASHEWS", IN THE WORDING "NUT HOUSE" BELOW THE "NH", AND THE OUTLINE OF THE LETTERING "NUT HOUSE", THE CUP, THE MAN AND HIS ACCESSORIES; WHITE APPEARS IN THE WORDING "NUT HOUSE," "CASHEWS," AND THE APRON; LIGHT BLUE APPEARS IN THE BACKGROUND IN THE LOWER THIRD OF THE MARK; DARK BLUE APPEARS IN THE SHIRT OF THE MAN AND THE SHADING BEHIND THE MOUND OF CASHEWS IN THE CUP AND TO THE LEFT OF THE BLACK RECTANGLE; LIGHT PINK APPEARS IN THE FLESH OF THE MAN.

FOR ROASTED CASHEW NUTS (U.S. CL. 46).

REBECCA POVARCHUK, EXAMINING ATTORNEY

SN 77-072,065. GOLDMAN, RYAN, NEW YORK, NY. FILED
12-27-2006.

happy ending jerky

THE MARK CONSISTS OF STANDARD CHARACTERS WITHOUT CLAIM TO ANY PARTICULAR FONT, STYLE, SIZE, OR COLOR.

NO CLAIM IS MADE TO THE EXCLUSIVE RIGHT TO USE "JERKY", APART FROM THE MARK AS SHOWN.

FOR DRIED MEAT; JERKY (U.S. CL. 46).

MICHAEL KEATING, EXAMINING ATTORNEY

CLASS 29—(Continued).

SN 77-082,976. SECRETARIA DE DESARROLLO ECONOMICO DE SINALOA, CULIACAN, MEXICO, FILED 1-15-2007.



the mexican shrimp!

NO CLAIM IS MADE TO THE EXCLUSIVE RIGHT TO USE "OCEAN WILD THE MEXICAN SHRIMP", APART FROM THE MARK AS SHOWN.

THE MARK CONSISTS OF A CIRCLE WITHIN A CIRCLE WITH THE WORDS SINALOA WRITTEN IN THE UPPER BORDER AND THE WORDS OCEAN WILD WRITTEN IN THE LOWER BORDER. A SHRIMP AT THE CENTER OF THE INNER CIRCLE AND THE WORDS THE MEXICAN SHRIMP! IN STYLIZED LETTERS UNDERNEATH THE CIRCLES. THE MARK IS NOT IN COLOR.

FOR SHRIMP (U.S. CL. 46).

LAURA KOVALSKY, EXAMINING ATTORNEY

SN 77-093,249. KLONDIKE CHEESE CO., MONROE, WI. FILED 1-29-2007.

ARGOS

THE MARK CONSISTS OF STANDARD CHARACTERS WITHOUT CLAIM TO ANY PARTICULAR FONT, STYLE, SIZE, OR COLOR.

FOR CHEESE (U.S. CL. 46).

PAUL CROWLEY, EXAMINING ATTORNEY

SN 77-113,083. WESTWOOD DELI & CATERING, LLC, TAMPA, FL. FILED 2-22-2007.



THE MARK CONSISTS OF AN OVAL CONTAINING TWO STYLIZED "WS" WITH THE WORD "WESTWOOD'S" UNDERNEATH.

FOR DIPS AND OLIVE OIL; CUSTOM FLAVORED SAUCES, NAMELY, BASIL, OREGANO, JALAPENO, GARLIC, LEMON, ORANGE AND CITRUS INFUSED OLIVE OIL (U.S. CL. 46).

DOMINIC J. FERRAIUOLO, EXAMINING ATTORNEY

CLASS 29—(Continued).

SN 77-116,734. EL ENCANTO, INC., ALBUQUERQUE, NM. FILED 2-26-2007.

BUENO

THE MARK CONSISTS OF STANDARD CHARACTERS WITHOUT CLAIM TO ANY PARTICULAR FONT, STYLE, SIZE, OR COLOR.

OWNER OF U.S. REG. NOS. 1,538,311, 2,370,165 AND OTHERS.

THE FOREIGN WORDING IN THE MARK TRANSLATES INTO ENGLISH AS GOOD, KIND, FINE, OKAY, ALL RIGHT.

SEC. 2(F) AS TO BUENO.

FOR PREPARED FOOD PRODUCTS, NAMELY, PROCESSED VEGETABLES IN THE NATURE OF CUT CHILE PEPPERS FOR SALE AND USE IN THE RESTAURANT SETTING (U.S. CL. 46).

FIRST USE 12-31-1986; IN COMMERCE 12-31-1986.

ANDREA K. NADELMAN, EXAMINING ATTORNEY

SN 77-119,766. DEL MONTE CORPORATION, SAN FRANCISCO, CA. FILED 3-1-2007.

TUNA CREATIONS LUNCH TO-GO

THE MARK CONSISTS OF STANDARD CHARACTERS WITHOUT CLAIM TO ANY PARTICULAR FONT, STYLE, SIZE, OR COLOR.

OWNER OF U.S. REG. NOS. 2,309,921, 2,831,857 AND 3,015,191.

NO CLAIM IS MADE TO THE EXCLUSIVE RIGHT TO USE "TUNA" AND "LUNCH TO-GO", APART FROM THE MARK AS SHOWN.

FOR PACKAGED READY TO EAT MEAL CONSISTING PRIMARILY OF TUNA, MAYONNAISE AND CRACKERS (U.S. CL. 46).

ANDREA HACK, EXAMINING ATTORNEY

SN 77-122,128. RED'S BEST, LLC, BOSTON, MA. FILED 3-5-2007.

Red's Best

THE MARK CONSISTS OF STANDARD CHARACTERS WITHOUT CLAIM TO ANY PARTICULAR FONT, STYLE, SIZE, OR COLOR.

NO CLAIM IS MADE TO THE EXCLUSIVE RIGHT TO USE "BEST", APART FROM THE MARK AS SHOWN.

FOR PRE-PACKAGED DINNERS CONSISTING OF SEAFOOD; SEAFOOD; SEAFOOD, NAMELY, WILD ALASKAN SEAFOOD (U.S. CL. 46).

GRETTA YAO, EXAMINING ATTORNEY

CLASS 29—(Continued).

SN 77-127,697. MARIN GUZMAN, JORGE ENRIQUE,
NORTH PLAINFIELD, NJ. FILED 3-10-2007.



NO CLAIM IS MADE TO THE EXCLUSIVE RIGHT TO USE "QUESO" AND "CREMA SOFT CURD CHEESE ECUADOREAN BRAND", APART FROM THE MARK AS SHOWN.

THE MARK CONSISTS OF THE DESIGN OF A COW IN A FIELD WITH A WINDMILL IN THE BACKGROUND. THE WORDS QUESO PURA CREMA APPEAR AT THE TOP WITH THE WORDS SOFT CURD CHEESE UNDERNEATH. GONZALEZ APPEARS BELOW THE DESIGN ELEMENT AND BELOW THIS APPEARS ECUADOREAN BRAND.

THE ENGLISH TRANSLATION OF THE WORD QUESO PURA CREMA IN THE MARK IS PURE CREAM CHEESE. FOR CHEESE (U.S. CL. 46).

FIRST USE 0-0-1995; IN COMMERCE 0-0-1995.
KEVON CHISOLM, EXAMINING ATTORNEY

SN 77-131,722. MAPLE LEAF TECHNOLOGIES, INC., WILMINGTON, DE. FILED 3-15-2007.

FULLY COOKED FOR PEACE OF
MIND

THE MARK CONSISTS OF STANDARD CHARACTERS WITHOUT CLAIM TO ANY PARTICULAR FONT, STYLE, SIZE, OR COLOR.

NO CLAIM IS MADE TO THE EXCLUSIVE RIGHT TO USE "FULLY COOKED", APART FROM THE MARK AS SHOWN.

FOR FOOD PRODUCTS, NAMELY A PREPARED ENTREE DISH CONSISTING PRIMARILY OF CHICKEN (U.S. CL. 46).

JANICE L. MCMORROW, EXAMINING ATTORNEY

CLASS 29—(Continued).

SN 77-137,599. TROPICAL NUT & FRUIT CO., CHARLOTTE, NC. FILED 3-22-2007.

WE PUT A KICK IN THE NUTS

THE MARK CONSISTS OF STANDARD CHARACTERS WITHOUT CLAIM TO ANY PARTICULAR FONT, STYLE, SIZE, OR COLOR.

FOR PROCESSED NUTS (U.S. CL. 46).

FIRST USE 2-1-2007; IN COMMERCE 2-1-2007.

DOMINICK J. SALEMI, EXAMINING ATTORNEY

SN 77-138,413. CONAGRA FOODS PACKAGED FOODS, LLC, OMAHA, NE. FILED 3-23-2007.

PAM PROFESSIONAL

THE MARK CONSISTS OF STANDARD CHARACTERS WITHOUT CLAIM TO ANY PARTICULAR FONT, STYLE, SIZE, OR COLOR.

OWNER OF U.S. REG. NO. 817,496.

FOR COOKING OIL SPRAY (U.S. CL. 46).

CURTIS FRENCH, EXAMINING ATTORNEY

SN 77-138,454. RANIERI FINE FOODS, INC., BROOKLYN, NY. FILED 3-23-2007.

MADRE SICILIA

THE MARK CONSISTS OF STANDARD CHARACTERS WITHOUT CLAIM TO ANY PARTICULAR FONT, STYLE, SIZE, OR COLOR.

OWNER OF U.S. REG. NO. 2,327,416.

THE FOREIGN WORDING IN THE MARK TRANSLATES INTO ENGLISH AS MOTHER SICILY.

SEC. 2(F).

FOR OLIVE OIL (U.S. CL. 46).

FIRST USE 1-0-1996; IN COMMERCE 1-0-1996.

MARK SPARACINO, EXAMINING ATTORNEY

CLASS 29—(Continued).

SN 77-138,741. SAVE-A-LOT FOOD STORES, LTD., EARTH CITY, MO. FILED 3-23-2007.

HOME CHURNED

THE MARK CONSISTS OF STANDARD CHARACTERS WITHOUT CLAIM TO ANY PARTICULAR FONT, STYLE, SIZE, OR COLOR.
OWNER OF U.S. REG. NO. 2,333,847.
FOR BUTTER, MARGARINE AND VEGETABLE OIL SPREAD (U.S. CL. 46).
NAAKWAMA ANKRAH, EXAMINING ATTORNEY

SN 77-138,923. TOWNSENDS, INC., WILMINGTON, DE. FILED 3-23-2007.

Townsend CLEAR

THE MARK CONSISTS OF STANDARD CHARACTERS WITHOUT CLAIM TO ANY PARTICULAR FONT, STYLE, SIZE, OR COLOR.
OWNER OF U.S. REG. NO. 1,681,331.
FOR FRESH CHICKENS RAISED WITHOUT THE USE OF ANTIBIOTICS; FROZEN, PREPARED AND PACKAGED CHICKEN ENTREES AND MEALS MADE FROM CHICKENS RAISED WITHOUT THE USE OF ANTIBIOTICS (U.S. CL. 46).
TINA KUAN, EXAMINING ATTORNEY

SN 77-139,639. COSTELLO, RACHEL S., NANUET, NY. FILED 3-24-2007.

VINCENT VAN GOGH PREMIUM YOGURT

THE MARK CONSISTS OF STANDARD CHARACTERS WITHOUT CLAIM TO ANY PARTICULAR FONT, STYLE, SIZE, OR COLOR.
NO CLAIM IS MADE TO THE EXCLUSIVE RIGHT TO USE "PREMIUM YOGURT", APART FROM THE MARK AS SHOWN.
FOR DAIRY PRODUCTS EXCLUDING ICE CREAM, ICE MILK AND FROZEN YOGURT; DAIRY-BASED SNACK FOODS EXCLUDING ICE CREAM, ICE MILK AND FROZEN YOGURT; DRINKING YOGURTS; MILK PRODUCTS EXCLUDING ICE CREAM, ICE MILK AND FROZEN YOGURT; YOGURT; YOGURT-BASED BEVERAGES (U.S. CL. 46).
PAUL F. GAST, EXAMINING ATTORNEY

CLASS 29—(Continued).

SN 77-140,122. CHEESYGIRL CHEESE CO., LLC, SEALY, TX. FILED 3-26-2007.

SOPHISTICATED LADY

THE MARK CONSISTS OF STANDARD CHARACTERS WITHOUT CLAIM TO ANY PARTICULAR FONT, STYLE, SIZE, OR COLOR.
FOR CHEESE, NAMELY, GOAT CHEESE (U.S. CL. 46).
STEVEN PEREZ, EXAMINING ATTORNEY

SN 77-140,134. CHEESYGIRL CHEESE CO., LLC, SEALY, TX. FILED 3-26-2007.

BELLA RAGAZZA

THE MARK CONSISTS OF STANDARD CHARACTERS WITHOUT CLAIM TO ANY PARTICULAR FONT, STYLE, SIZE, OR COLOR.
THE ENGLISH TRANSLATION OF "BELLA RAGAZZA" IS "BEAUTIFUL WOMAN".
FOR CHEESE, NAMELY, GOAT CHEESE (U.S. CL. 46).
STEVEN PEREZ, EXAMINING ATTORNEY

SN 77-140,151. CHEESYGIRL CHEESE CO., LLC, SEALY, TX. FILED 3-26-2007.

SATIN DOLL

THE MARK CONSISTS OF STANDARD CHARACTERS WITHOUT CLAIM TO ANY PARTICULAR FONT, STYLE, SIZE, OR COLOR.
FOR CHEESE, NAMELY, GOAT CHEESE (U.S. CL. 46).
STEVEN PEREZ, EXAMINING ATTORNEY

SN 77-140,162. CHEESYGIRL CHEESE CO., LLC, SEALY, TX. FILED 3-26-2007.

PLAIN JANE

THE MARK CONSISTS OF STANDARD CHARACTERS WITHOUT CLAIM TO ANY PARTICULAR FONT, STYLE, SIZE, OR COLOR.
FOR CHEESE, NAMELY, GOAT CHEESE (U.S. CL. 46).
STEVEN PEREZ, EXAMINING ATTORNEY

CLASS 29—(Continued).

SN 77-140,198. CHEESYGIRL CHEESE CO., LLC, SEALY, TX.
FILED 3-26-2007.

FEMME FATALE

THE MARK CONSISTS OF STANDARD CHARACTERS WITHOUT CLAIM TO ANY PARTICULAR FONT, STYLE, SIZE, OR COLOR.

THE ENGLISH TRANSLATION OF "FEMME FATALE" IS "DEADLY WOMEN".

FOR CHEESE, NAMELY, GOAT CHEESE (U.S. CL. 46).
STEVEN PEREZ, EXAMINING ATTORNEY

CLASS 29—(Continued).

SN 77-143,118. BANGKAL DISTRIBUTORS, LLC, EDISON, NJ. FILED 3-28-2007.

AquaFour

THE MARK CONSISTS OF STANDARD CHARACTERS WITHOUT CLAIM TO ANY PARTICULAR FONT, STYLE, SIZE, OR COLOR.

FOR MARINATED SEAFOOD; PRE-PACKAGED DINERS CONSISTING OF SEAFOOD; SEAFOOD (U.S. CL. 46).

FIRST USE 3-2-2006; IN COMMERCE 3-2-2006.
COLLEEN KEARNEY, EXAMINING ATTORNEY

SN 77-140,546. BEEF INTERNATIONAL CORP., MEDIA, PA.
FILED 3-26-2007.

MI MERCEDITA

THE MARK CONSISTS OF STANDARD CHARACTERS WITHOUT CLAIM TO ANY PARTICULAR FONT, STYLE, SIZE, OR COLOR.

THE FOREIGN WORDING IN THE MARK TRANSLATES INTO ENGLISH AS MY LITTLE GIFT.

FOR MEAT (U.S. CL. 46).
JEFF DEFORD, EXAMINING ATTORNEY

SN 77-144,020. BINCO, LLC, CHICAGO, IL. FILED 3-29-2007.

DEMILL

THE MARK CONSISTS OF STANDARD CHARACTERS WITHOUT CLAIM TO ANY PARTICULAR FONT, STYLE, SIZE, OR COLOR.

FOR CHEESE (U.S. CL. 46).

FIRST USE 10-28-1943; IN COMMERCE 10-28-1943.
AMY BROZENIC, EXAMINING ATTORNEY

SN 77-141,881. GODFREY'S TCB, LLC, MURRIETA, CA.
FILED 3-27-2007.

Sun Crunchers

THE MARK CONSISTS OF STANDARD CHARACTERS WITHOUT CLAIM TO ANY PARTICULAR FONT, STYLE, SIZE, OR COLOR.

FOR SEED BASED FOOD BAR (U.S. CL. 46).
FIRST USE 3-19-2007; IN COMMERCE 3-19-2007.
MELISSA VALLILLO, EXAMINING ATTORNEY

SN 77-152,212. TRUE WORLD FOODS INTERNATIONAL, INC., SUMNER, WA. FILED 4-9-2007.

Crab Smart Dippers

THE MARK CONSISTS OF STANDARD CHARACTERS WITHOUT CLAIM TO ANY PARTICULAR FONT, STYLE, SIZE, OR COLOR.

NO CLAIM IS MADE TO THE EXCLUSIVE RIGHT TO USE "CRAB", APART FROM THE MARK AS SHOWN.

FOR IMITATION CRAB MEAT STICKS SOLD WITH SAUCE FOR DIPPING (U.S. CL. 46).

FIRST USE 11-4-2005; IN COMMERCE 11-4-2005.
DAWN FELDMAN, EXAMINING ATTORNEY

CLASS 29—(Continued).

SN 77-152,245. TRUE WORLD FOODS INTERNATIONAL, INC., SUMNER, WA. FILED 4-9-2007.

Crab Smart Toppers

THE MARK CONSISTS OF STANDARD CHARACTERS WITHOUT CLAIM TO ANY PARTICULAR FONT, STYLE, SIZE, OR COLOR.

NO CLAIM IS MADE TO THE EXCLUSIVE RIGHT TO USE "CRAB", APART FROM THE MARK AS SHOWN.

FOR IMITATION CRAB MEAT SALAD TOPPING (U.S. CL. 46).

FIRST USE 5-1-2005; IN COMMERCE 5-1-2005.
DAWN FELDMAN, EXAMINING ATTORNEY

SN 77-166,971. RYC ALIMENTOS, S.A. DE C.V., PUEBLA, MEXICO, FILED 4-26-2007.

MEXICO MAGICO

THE MARK CONSISTS OF STANDARD CHARACTERS WITHOUT CLAIM TO ANY PARTICULAR FONT, STYLE, SIZE, OR COLOR.

OWNER OF MEXICO REG. NO. 963430, DATED 11-7-2006, EXPIRES 11-6-2016.

NO CLAIM IS MADE TO THE EXCLUSIVE RIGHT TO USE "MEXICO", APART FROM THE MARK AS SHOWN.

THE FOREIGN WORDING IN THE MARK TRANSLATES INTO ENGLISH AS MEXICO MAGIC.

FOR BOTTLED COOKED MEAT; CANNED COOKED MEAT; CANNED FISH; DRIED MEAT; FISH; FISH CAKES; FISH CROQUETTES; FISH FILLETS; FISH MOUSSE; FISH SAUSAGES; FISH STOCK; FOOD PACKAGE COMBINATIONS CONSISTING PRIMARILY OF CHEESE, MEAT AND/OR PROCESSED FRUIT; FORMED TEXTURED VEGETABLE PROTEIN FOR USE AS A MEAT EXTENDER OR MEAT SUBSTITUTE; FORMED TEXTURED VEGETABLE PROTEIN TO BE USED AS AN EXTENDER OR MEAT SUBSTITUTE; FRANKFURTERS; FRIED MEAT; HAMBURGER; HOT DOGS; LUNCHEON MEATS; MARINATED MEAT, SEAFOOD, FISH, POULTRY, AND VEGETABLES; MEAT; MEAT EXTRACT; MEAT JELLIES; MEAT JUICES; MEAT PASTE; MEAT SUBSTITUTES; MEAT, FROZEN; MEAT-BASED MOUSSE; MEAT-BASED SPREADS; NUT MEATS; PICKLED FISH; POULTRY; POULTRY SUBSTITUTES; POULTRY, NAMELY, CHICKEN, TURKEY; PRE-PACKAGED DINNERS CONSISTING PRIMARILY OF MEAT, POULTRY, FISH; PREPARED MEAT; PROCESSED FISH ROE; PROCESSED MEAT; PROCESSED MEAT, NAMELY, KIDNEYS; PROCESSED MEAT, NAMELY, HAM, TURKEY, CHICKEN, AND SAUSAGES; SEASONED MEAT, FISH, POULTRY, VEGETABLES; SMOKED FISH; TEXTURED VEGETABLE PROTEIN FOR USE AS A MEAT EXTENDER; TUNA FISH; UNFORMED TEXTURED VEGETABLE PROTEIN FOR USE AS A MEAT EXTENDER; FROZEN, PREPARED AND PACKAGED ENTREES CONSISTING PRIMARILY OF MEAT, FISH, POULTRY OR VEGETABLES; FROZEN, PREPARED AND PACKAGED MEALS CONSISTING PRIMARILY OF MEAT, FISH, POULTRY OR VEGETABLES; MEAT, FISH, POULTRY, AND VEGETABLE CROQUETTES; MEAT, FISH, POULTRY AND VEGETABLE SOUFFLES; DAIRY PRODUCTS EXCLUDING ICE CREAM, ICE MILK AND FROZEN YOGURT;

CLASS 29—(Continued).

EDIBLE OIL; OIL, NAMELY, EDIBLE OIL; EDIBLE FATS; DRIED EGGS; DUCK EGGS; EGG NOG; EGG NOG MIXES; EGG PRODUCT; EGG SUBSTITUTE; EGGS; FROZEN EGGS; HEN EGGS; QUAIL EGGS; GAME; CANDIED FRUIT; CANDIED FRUIT SNACKS; CANNED FRUITS; CANNED OR BOTTLED FRUITS; CRYSTALLIZED FRUIT; CUT FRUITS; DEHYDRATED FRUIT SNACKS; DRIED BEANS; DRIED BEEF; DRIED EDIBLE ALGAE; DRIED FIGS; DRIED FRUIT MIXES; DRIED FRUITS; DRIED SOYBEANS; DRIED VEGETABLES; DRY OR AROMATIZED FRUIT; FOOD GLAZING PREPARATIONS COMPRISED PRIMARILY OF FRUIT AND/OR FRUIT PECTIC FOR USE IN COOKING AND BAKING; FRUIT CONSERVES; FRUIT PRESERVES; FRUIT-BASED SPREADS; PICKLED FRUITS; PROCESSED FRUITS; PROCESSED VEGETABLES AND FRUITS; PROCESSED, CANNED, DRIED, AND PRESERVED FRUITS; MILK BASED BEVERAGES CONTAINING FRUIT JUICE; MILK BEVERAGES CONTAINING FRUITS; MILK DRINKS CONTAINING FRUITS (U.S. CL. 46).

DAVID MILLER, EXAMINING ATTORNEY

SN 77-174,797. SAN-RALLO PASTA COMPANY, DOVER, NJ. FILED 5-7-2007.



FOR EGGPLANT CUTLETS, EGGPLANT ROLLETES AND ITALIAN ENTREES (U.S. CL. 46).

FIRST USE 3-0-1993; IN COMMERCE 3-0-1993.
PAUL F. GAST, EXAMINING ATTORNEY

SN 77-175,468. SMALL FRY, INC., MIDDLETOWN, VA. FILED 5-8-2007.

UNHURRIED POTATOES

THE MARK CONSISTS OF STANDARD CHARACTERS WITHOUT CLAIM TO ANY PARTICULAR FONT, STYLE, SIZE, OR COLOR.

NO CLAIM IS MADE TO THE EXCLUSIVE RIGHT TO USE "POTATOES", APART FROM THE MARK AS SHOWN.

FOR POTATO CHIPS; POTATO-BASED SNACK FOODS (U.S. CL. 46).

JOHN SCHUYLER YARD, EXAMINING ATTORNEY

CLASS 29—(Continued).

SN 77-181,189. WAKEFERN FOOD CORP., ELIZABETH, NJ.
FILED 5-15-2007.

READINGTON FARMS

THE MARK CONSISTS OF STANDARD CHARACTERS
WITHOUT CLAIM TO ANY PARTICULAR FONT, STYLE,
SIZE, OR COLOR.

OWNER OF U.S. REG. NOS. 1,685,818 AND 2,413,191.
NO CLAIM IS MADE TO THE EXCLUSIVE RIGHT TO
USE "FARMS", APART FROM THE MARK AS SHOWN.
FOR MILK (U.S. CL. 46).
ODESSA BIBBINS, EXAMINING ATTORNEY

SN 77-189,877. WAKEFERN FOOD CORP., ELIZABETH, NJ.
FILED 5-24-2007.

STEAK RITE

THE MARK CONSISTS OF STANDARD CHARACTERS
WITHOUT CLAIM TO ANY PARTICULAR FONT, STYLE,
SIZE, OR COLOR.

NO CLAIM IS MADE TO THE EXCLUSIVE RIGHT TO
USE "STEAK", APART FROM THE MARK AS SHOWN.
FOR MEAT (U.S. CL. 46).
ODESSA BIBBINS, EXAMINING ATTORNEY

SN 77-193,762. WARNER BROS. ENTERTAINMENT INC.,
BURBANK, CA. FILED 5-30-2007.

**THE WIZARDING WORLD OF
HARRY POTTER**

THE MARK CONSISTS OF STANDARD CHARACTERS
WITHOUT CLAIM TO ANY PARTICULAR FONT, STYLE,
SIZE, OR COLOR.

OWNER OF U.S. REG. NOS. 2,450,788, 2,525,908 AND
OTHERS.

FOR PROCESSED AND DRIED VEGETABLES; PRO-
CESSED AND DRIED FRUITS; PROCESSED GINSENG
FOR USE AS A VEGETABLE; RAISINS, FRUIT SALADS,
MARMALADE; PRESERVED ONIONS, PRESERVED OL-
IVES; CRYSTALLIZED FRUITS; VEGETABLE JUICES
FOR COOKING; JAMS, CHOCOLATE NUT BUTTER,
COCOA BUTTER FOR FOOD PURPOSES AND PEANUT
BUTTER; CANNED FRUITS AND VEGETABLES;
PICKLES; SOYBEAN-BASED FOOD BEVERAGE USED
AS A MILK SUBSTITUTE; FROZEN FRUITS AND
VEGETABLES; POTATO CHIPS; PROCESSED AND
DRIED MEAT; MEAT; MILK; SEAFOOD; AND MAR-
GARINE (U.S. CL. 46).
DORITT L. CARROLL, EXAMINING ATTORNEY

CLASS 29—(Continued).

SN 78-612,743. BACALAO LISTO CO., INC., VALLEY
STREAM, NY. FILED 4-20-2005.

BACALAO LISTO

THE MARK CONSISTS OF STANDARD CHARACTERS
WITHOUT CLAIM TO ANY PARTICULAR FONT, STYLE,
SIZE, OR COLOR.

NO CLAIM IS MADE TO THE EXCLUSIVE RIGHT TO
USE "BACALAO", APART FROM THE MARK AS SHOWN.
THE FOREIGN WORDING IN THE MARK TRANSLATES
INTO ENGLISH AS CLEVER CODFISH.
FOR SEAFOOD, NAMELY, PROCESSED CODFISH
(U.S. CL. 46).
RONALD R. SUSSMAN, EXAMINING ATTORNEY

SN 78-620,486. WANG, ROGER H., MD, SANTA ANA, CA.
FILED 5-1-2005.

POLY FRUITS

THE MARK CONSISTS OF STANDARD CHARACTERS
WITHOUT CLAIM TO ANY PARTICULAR FONT, STYLE,
SIZE, OR COLOR.

NO CLAIM IS MADE TO THE EXCLUSIVE RIGHT TO
USE FRUITS, APART FROM THE MARK AS SHOWN.
FOR PROCESSED FOOD PRODUCTS, NAMELY,
FRUITS (U.S. CL. 46).
MARY ROSSMAN, EXAMINING ATTORNEY

SN 78-620,487. WANG, ROGER H., MD, SANTA ANA, CA.
FILED 5-1-2005.

POLY VEGGIES

THE MARK CONSISTS OF STANDARD CHARACTERS
WITHOUT CLAIM TO ANY PARTICULAR FONT, STYLE,
SIZE, OR COLOR.

NO CLAIM IS MADE TO THE EXCLUSIVE RIGHT TO
USE "VEGGIES", APART FROM THE MARK AS SHOWN.
FOR PROCESSED FOOD PRODUCTS, NAMELY, VE-
GETABLES (U.S. CL. 46).
MARY ROSSMAN, EXAMINING ATTORNEY

CLASS 29—(Continued).

SN 78-754,545. FOSTER POULTRY FARMS, DBA FOSTER FARMS, LIVINGSTON, CA. FILED 11-15-2005.

**WE KNOW WHAT THE WEST
HUNGERS FOR**

THE MARK CONSISTS OF STANDARD CHARACTERS WITHOUT CLAIM TO ANY PARTICULAR FONT, STYLE, SIZE, OR COLOR.
FOR POULTRY PRODUCTS, NAMELY PREPARED CHICKEN AND TURKEY PRODUCTS (U.S. CL. 46).
KELLY MCCOY, EXAMINING ATTORNEY

SN 78-754,584. FOSTER POULTRY FARMS, DBA FOSTER FARMS, LIVINGSTON, CA. FILED 11-15-2005.

STICK WITH QUALITY

THE MARK CONSISTS OF STANDARD CHARACTERS WITHOUT CLAIM TO ANY PARTICULAR FONT, STYLE, SIZE, OR COLOR.
FOR REFRIGERATED, FROZEN OR SHELF-STABLE, MICROWAVEABLE OR READY TO HEAT, POULTRY, PORK, BEEF, FISH, VEGETABLE OR CHEESE PRODUCTS, ALL ON A STICK (U.S. CL. 46).
KELLY MCCOY, EXAMINING ATTORNEY

SN 78-781,426. MANTEQUERIAS ARIAS, MADRID, SPAIN, FILED 12-28-2005.

SAN MILLAN

THE MARK CONSISTS OF STANDARD CHARACTERS WITHOUT CLAIM TO ANY PARTICULAR FONT, STYLE, SIZE, OR COLOR.
FOR MILK, DAIRY PRODUCTS EXCLUDING ICE CREAM, ICE MILK AND FROZEN YOGURT; EDIBLE OILS AND FATS (U.S. CL. 46).
RICHARD WHITE, EXAMINING ATTORNEY

CLASS 29—(Continued).

SN 78-841,872. JAMSHID, ASHOURIAN, DEERFIELD, IL. FILED 3-21-2006.

Free Chicken Nuggets

THE MARK CONSISTS OF STANDARD CHARACTERS WITHOUT CLAIM TO ANY PARTICULAR FONT, STYLE, SIZE, OR COLOR.
NO CLAIM IS MADE TO THE EXCLUSIVE RIGHT TO USE "CHICKEN NUGGETS", APART FROM THE MARK AS SHOWN.
FOR COOKED POULTRY AND GAME; COOKED GROUND POULTRY AND GAME; COOKED PATTIES MADE ENTIRELY OR PRIMARILY WITH VEGETABLES, FRUITS AND/OR NUTS (U.S. CL. 46).
DANIEL CAPSHAW, EXAMINING ATTORNEY

SN 78-841,874. JAMSHID, ASHOURIAN, DEERFIELD, IL. FILED 3-21-2006.

Free Filet of Fish

THE MARK CONSISTS OF STANDARD CHARACTERS WITHOUT CLAIM TO ANY PARTICULAR FONT, STYLE, SIZE, OR COLOR.
NO CLAIM IS MADE TO THE EXCLUSIVE RIGHT TO USE "FILET OF FISH", APART FROM THE MARK AS SHOWN.
FOR COOKED FISH; COOKED PATTIES MADE ENTIRELY OR PRIMARILY FROM FISH; COOKED PATTIES MADE ENTIRELY OR PRIMARILY FROM VEGETABLES, FRUITS AND/OR NUTS (U.S. CL. 46).
DANIEL CAPSHAW, EXAMINING ATTORNEY

SN 78-841,876. JAMSHID, ASHOURIAN, DEERFIELD, IL. FILED 3-21-2006.

Free Burger

THE MARK CONSISTS OF STANDARD CHARACTERS WITHOUT CLAIM TO ANY PARTICULAR FONT, STYLE, SIZE, OR COLOR.
NO CLAIM IS MADE TO THE EXCLUSIVE RIGHT TO USE "BURGER", APART FROM THE MARK AS SHOWN.
FOR COOKED MEAT, FISH, POULTRY, AND GAME; COOKED PATTIES MADE ENTIRELY OR PRIMARILY WITH MEAT, FISH, POULTRY, AND/OR GAME; COOKED PATTIES MADE ENTIRELY OR PRIMARILY WITH VEGETABLES, FRUITS AND/OR NUTS (U.S. CL. 46).
DANIEL CAPSHAW, EXAMINING ATTORNEY

CLASS 29—(Continued).

SN 78-904,382. SCHENK PACKING CO., INC., STANWOOD, WA. FILED 6-8-2006.

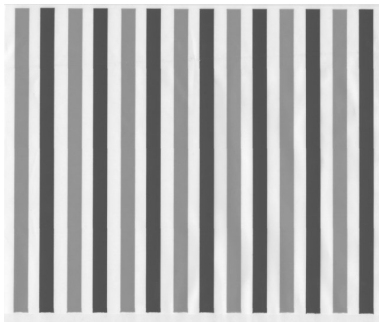

THE MARK CONSISTS OF A PLURALITY OF STRIPES REPRESENTED BY THE JUXTAPOSITION OF ALTERNATING LIGHTNESS AND DARKNESS .

SEC. 2(F).
FOR MEATS, NAMELY, GROUND MEAT PATTIES AND PACKAGED PRODUCTS CONSISTING PRIMARILY OF GROUND MEAT PRODUCTS (U.S. CL. 46).
FIRST USE 8-1-1994; IN COMMERCE 8-1-1994.
BRENDAN REGAN, EXAMINING ATTORNEY

CLASS 29—(Continued).

SN 78-921,728. GUANGZHOU LUYE FISHERIES CO., LTD, GUANGDONG PROVINCE, CHINA, FILED 7-2-2006.



NO CLAIM IS MADE TO THE EXCLUSIVE RIGHT TO USE "FISHERIES", APART FROM THE MARK AS SHOWN. THE COLOR(S) BLACK AND GREY IS/ARE CLAIMED AS A FEATURE OF THE MARK.

THE MARK CONSISTS OF A STYLIZED FISH AND MAN IN A TEARDROP SHAPE, WITH THE COLOR BLACK APPEARING AS THE COLOR OF ALL WORDING AND AS THE COLOR OF THE MAIN BODY OF THE STYLIZED FISH. THE COLOR BLACK TRANSITIONS INTO THE COLOR GRAY AT THE BEGINNING OF THE FISH TAIL WITH THE COLOR GRAY APPEARING AS THE COLOR OF THE HUMAN HEAD AND SHOULDERS ON THE TOP OF THE FISH TAIL.

FOR DRIED FISH FLOSS FOR HUMAN CONSUMPTION; CANNED FISH; PROCESSED ANCHOVIES; CAVIAR; CRUSTACEANS NOT LIVE; CRAYFISH NOT LIVE; FISH FILLETS; FISH NOT LIVE; HERRINGS NOT LIVE; LOBSTERS NOT LIVE FOR HUMAN CONSUMPTION; OYSTERS NOT LIVE; SHELLFISH IN GENERAL; BLUE MUSSELS NOT LIVE; SARDINES; SALMON FOR FOOD PURPOSES; TUNA FISH; PREPARED MEALS CONSISTING PRIMARILY OF MEAT, FISH, POULTRY OR VEGETABLES; CLAMS NOT LIVE; PRAWNS NOT LIVE FOR HUMAN CONSUMPTION; PICKLED FISH; SHRIMP NOT LIVE FOR HUMAN CONSUMPTION; FISHMEAL FOR HUMAN CONSUMPTION; SALTED FISH; FLAKES OF DRIED FISH MEAT; SQUIDS NOT LIVE; DRIED SHRIMPS; JELLYFISH SKIN FOR HUMAN CONSUMPTION; DRIED SCALLOPS; SHRIMP PASTE; FOOD PRODUCTS MADE FROM FISH, NAMELY, FISH FILLETS, FISH CAKES; FISH BLADDERS FOR HUMAN CONSUMPTION; SHARKS' FINS FOR HUMAN CONSUMPTION (U.S. CL. 46).

JEFF DEFORD, EXAMINING ATTORNEY

SN 78-948,817. PEDERSON'S NATURAL FARMS, INC., HAMILTON, TX. FILED 8-9-2006.

PEDERSON'S

THE MARK CONSISTS OF STANDARD CHARACTERS WITHOUT CLAIM TO ANY PARTICULAR FONT, STYLE, SIZE, OR COLOR.

SEC. 2(F).
FOR NATURAL PORK (U.S. CL. 46).
FIRST USE 12-31-1995; IN COMMERCE 12-31-1995.
JOHN KELLY, EXAMINING ATTORNEY

CLASS 29—(Continued).

SN 78-948,931. TREE TOP, INC., SELAH, WA. FILED 8-9-2006.



THE MARK CONSISTS OF A CANOPY OF LEAVES WHEREIN THE BROKEN LINES REPRESENT MATTER NOT CLAIMED AS A FEATURE OF THE MARK.
 FOR PROCESSED FRUIT; DRIED FRUIT; FRUIT FLAKE POWDERS; APPLE FIBER; FROZEN FRUIT; FRESH APPLE SLICES; FRUIT-BASED SNACK FOODS; FRUIT LEATHER; AND APPLSAUCE (U.S. CL. 46).
 ROBERT LAVACHE, EXAMINING ATTORNEY

SN 78-957,771. PENNFIELD CORPORATION, LANCASTER, PA. FILED 8-22-2006.



NO CLAIM IS MADE TO THE EXCLUSIVE RIGHT TO USE "FARMS" AND "KEEP REFRIGERATED", APART FROM THE MARK AS SHOWN.
 THE COLOR(S) ORANGE, WHITE AND PURPLE IS/ARE CLAIMED AS A FEATURE OF THE MARK.
 THE COLOR PURPLE APPEARS IN THE WORDING "PENNFIELD FARMS", "KEEP REFRIGERATED", AND "WWW.PENNFIELDFARMS.COM". THE COLOR PURPLE ALSO APPEARS IN THE DESIGN IN THE TOP HALF CIRCLE, IN THE FLOWER DESIGNS, IN THE STAR DESIGNS, IN THE CIRCULAR OUTLINE AND IN THE BIRDS. THE COLOR ORANGE APPEARS IN THE BOTTOM HALF CIRCLE, IN THE RECTANGULAR DESIGN CONTAINING THE WORDS "PENNFIELD FARMS", IN THE FLOWER DESIGNS, IN THE STAR DESIGNS AND IN THE BIRD DESIGNS. THE COLOR WHITE APPEARS IN THE FLOWER DESIGN IN THE RECTANGLE CONTAINING THE WORDS "PENNFIELD FARMS".
 FOR PROCESSED MEAT, POULTRY AND VEGETABLES (U.S. CL. 46).
 ROSELLE HERRERA, EXAMINING ATTORNEY

CLASS 29—(Continued).

SN 78-961,902. J&B WHOLESALE DISTRIBUTING, INC., ST. MICHAEL, MN. FILED 8-28-2006.



NO CLAIM IS MADE TO THE EXCLUSIVE RIGHT TO USE "SEAFOOD COMPANY", APART FROM THE MARK AS SHOWN.
 THE COLOR(S) BLUE, WHITE, BLACK AND GREEN IS/ARE CLAIMED AS A FEATURE OF THE MARK.
 THE MARK CONSISTS OF THE TERM BLUEWAVE, SHOWN IN THE COLOR BLUE, ABOVE A WAVY BLUE LINE, AND THE WORDS SEAFOOD COMPANY, SHOWN IN THE COLOR GREEN, AND A PICTURE OF AN ANCHOR, SHOWN IN THE COLOR BLACK, ALL SET AGAINST A WHITE BACKGROUND.
 FOR FISH AND SEAFOOD (U.S. CL. 46).
 FIRST USE 11-1-2005; IN COMMERCE 11-1-2005.
 LINDA POWELL, EXAMINING ATTORNEY

SN 78-970,013. WALTER R. BENNETT III, LAWRENCEVILLE, GA. FILED 9-8-2006.

SAUSAGE THANG

THE MARK CONSISTS OF STANDARD CHARACTERS WITHOUT CLAIM TO ANY PARTICULAR FONT, STYLE, SIZE, OR COLOR.
 NO CLAIM IS MADE TO THE EXCLUSIVE RIGHT TO USE "SAUSAGE", APART FROM THE MARK AS SHOWN.
 FOR PRE-PACKAGE DINNERS CONSISTING OF SAUSAGE, PEPPERS, RICE, AND SPICES (U.S. CL. 46).
 SALLY SHIH, EXAMINING ATTORNEY

CLASS 29—(Continued).

SN 79-032,172. CONSORZIO PER LA TUTELA DELL'OLIO EXTRA VERGINE DI OLIVA D.O.P. "TERRE DI SIENA", I-53100 SIENA, ITALY, FILED 9-29-2006.



OWNER OF INTERNATIONAL REGISTRATION 0906687 DATED 9-29-2006, EXPIRES 9-29-2016.

NO CLAIM IS MADE TO THE EXCLUSIVE RIGHT TO USE "DOP TERRE DI SIENA", APART FROM THE MARK AS SHOWN.

THE TRADEMARK CONSISTS OF THE WORDING DOP TERRE DI SIENA AND DEVICE; THE WORD DOP IS REPRESENTED ON THE CENTER OF THE MARK INSIDE THE DESIGN OF AN OLIVE; ABOVE THE OLIVE IS PLACED THE LOGO OF A CROWN AND BELOW THE OLIVE IS REPORTED THE WORDING TERRE DI SIENA INSIDE A RIBBON.

THE FOREIGN WORDING IN THE MARK TRANSLATES INTO ENGLISH AS LANDS OF SIENA.

FOR EDIBLE OLIVE OIL (U.S. CL. 46).
DANIEL BRODY, EXAMINING ATTORNEY

SN 79-034,359. LACTALIS MCLELLAND LTD, UNITED KINGDOM, FILED 12-5-2006.

SERIOUSLY

OWNER OF INTERNATIONAL REGISTRATION 0912807 DATED 12-5-2006, EXPIRES 12-5-2016.

OWNER OF U.S. REG. NO. 2,181,726.

FOR MILK, BUTTER, CREAM, YOGHURTS, PROCESSED CHEESE, CHEDDAR CHEESE AND OTHER DAIRY GOODS, NAMELY, CHEESE, CHEESE POWDER, CHEESE SPREADS, COTTAGE CHEESE, CREAM CHEESE, DAIRY-BASED DIPS; EDIBLE OILS AND FATS (U.S. CL. 46).

GILBERT SWIFT, EXAMINING ATTORNEY

SN 79-038,704. LACTEAS GARCIA-BAQUERO, S.A., SPAIN, FILED 3-16-2007.

VILLACENTENO

THE MARK CONSISTS OF STANDARD CHARACTERS WITHOUT CLAIM TO ANY PARTICULAR FONT, STYLE, SIZE, OR COLOR.

OWNER OF INTERNATIONAL REGISTRATION 0924779 DATED 3-16-2007, EXPIRES 3-16-2017.

FOR CHEESES (U.S. CL. 46).
KRISTINA MORRIS, EXAMINING ATTORNEY

CLASS 30—STAPLE FOODS

SN 76-659,500. GLUTEN FREE FABULOUS, LLC., SCOTTSDALE, AZ. FILED 4-27-2006.

KAREN'S GLUTEN FREE PRODUCTS

THE MARK CONSISTS OF STANDARD CHARACTERS WITHOUT CLAIM TO ANY PARTICULAR FONT, STYLE, SIZE, OR COLOR.

FOR GLUTEN-FREE FLOUR; GLUTEN-FREE FOOD PRODUCTS, NAMELY, COOKIES, CRACKER MAC AND CHEESE (U.S. CL. 46).

FIRST USE 10-0-2005; IN COMMERCE 10-0-2005.
SUZANNE BLANE, EXAMINING ATTORNEY

SN 76-672,730. NORTHERN VALLEY BAKING CO., LLC, DUMONT, NJ. FILED 2-15-2007.

GANACHAROONS

THE MARK CONSISTS OF STANDARD CHARACTERS WITHOUT CLAIM TO ANY PARTICULAR FONT, STYLE, SIZE, OR COLOR.

FOR COOKIES, PASTRIES, AND BAKERY GOODS (U.S. CL. 46).

MICHAEL SOUDERS, EXAMINING ATTORNEY

SN 76-672,731. NORTHERN VALLEY BAKING CO., LLC, DUMONT, NJ. FILED 2-15-2007.

RASPBEROONS

THE MARK CONSISTS OF STANDARD CHARACTERS WITHOUT CLAIM TO ANY PARTICULAR FONT, STYLE, SIZE, OR COLOR.

FOR COOKIES, PASTRIES, AND BAKERY GOODS (U.S. CL. 46).

MICHAEL SOUDERS, EXAMINING ATTORNEY

SN 76-672,733. NORTHERN VALLEY BAKING CO., LLC, DUMONT, NJ. FILED 2-15-2007.

VANILLAROONS

THE MARK CONSISTS OF STANDARD CHARACTERS WITHOUT CLAIM TO ANY PARTICULAR FONT, STYLE, SIZE, OR COLOR.

FOR COOKIES, PASTRIES AND BAKERY GOODS (U.S. CL. 46).

MICHAEL SOUDERS, EXAMINING ATTORNEY

CLASS 30—(Continued).

SN 77-000,368. MURRY'S INC., UPPER MARLBORO, MD. FILED 9-15-2006.

CINNAMON BLAST

THE MARK CONSISTS OF STANDARD CHARACTERS WITHOUT CLAIM TO ANY PARTICULAR FONT, STYLE, SIZE, OR COLOR.

NO CLAIM IS MADE TO THE EXCLUSIVE RIGHT TO USE "CINNAMON", APART FROM THE MARK AS SHOWN.

FOR FROZEN BREAKFAST FOODS, NAMELY, FRENCH TOAST (U.S. CL. 46).

JANICE L. MCMORROW, EXAMINING ATTORNEY

SN 77-004,578. WM. WRIGLEY JR. COMPANY, CHICAGO, IL. FILED 9-21-2006.

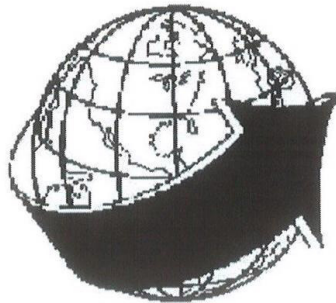

THE MARK CONSISTS OF A GLOBE IN THE SHAPE OF A SPHERE WITH AN ARROW CROSSING THE GLOBE FROM LEFT TO RIGHT.

FOR CONFECTIONERY, NAMELY, CHEWING GUM, BUBBLE GUM, CANDY, AND CANDY MINTS (U.S. CL. 46).

JORDAN BAKER, EXAMINING ATTORNEY

CLASS 30—(Continued).

SN 77-006,800. NORTHERN FOOD INC., HICKSVILLE, NY. FILED 9-25-2006.



NO CLAIM IS MADE TO THE EXCLUSIVE RIGHT TO USE "MOON CAKE" AND THE NON-LATIN CHARACTERS THAT MEAN "HONG KONG" APART FROM THE MARK AS SHOWN, APART FROM THE MARK AS SHOWN.

THE COLOR(S) RED, BLUE, GREEN, PURPLE, YELLOW, PINK, BLACK, WHITE, SILVER AND GOLD IS/ARE CLAIMED AS A FEATURE OF THE MARK.

THE MARK CONSISTS OF FOUR MULTIPLE-COLORED TRADITIONAL WOMEN PORTRAITS IN PINK, BLACK, RED, WHITE, GREEN, YELLOW, BLUE, AND PURPLE ON A RED BACKGROUND AND A TRADITIONAL PAVILION IN SILVER IN THE LOWER PORTION, AND THE WORDS "MOON CAKE" IN SILVER BELOW SILVER CHINESE CHARACTERS. GOLD CHINESE CHARACTERS APPEAR IN THE TOP RIGHT OF THE DRAWING.

THE NON-LATIN CHARACTERS IN THE BOTTOM RIGHT OF THE MARK TRANSLITERATE TO "JING ZHUANG YUE BING" AND THIS MEANS "HARDCOVER MOON CAKES". THE NON-LATIN CHARACTERS IN THE UPPER RIGHT OF THE MARK TRANSLITERATE TO "SHIANG GONG" AND THIS MEANS "HONG KONG".

FOR CAKE MIXES (U.S. CL. 46).
FIRST USE 1-1-2002; IN COMMERCE 6-1-2002.
JAMES STEIN, EXAMINING ATTORNEY

SN 77-019,000. CHERRYDALE MANUFACTURING, L.L.C., ALLENTOWN, PA. FILED 10-11-2006.

BARTONS DREAM

THE MARK CONSISTS OF STANDARD CHARACTERS WITHOUT CLAIM TO ANY PARTICULAR FONT, STYLE, SIZE, OR COLOR.

OWNER OF U.S. REG. NOS. 669,032, 2,923,935 AND OTHERS.

FOR CHOCOLATE (U.S. CL. 46).
HANNO RITTNER, EXAMINING ATTORNEY

CLASS 30—(Continued).

SN 77-019,003. CHERRYDALE MANUFACTURING, L.L.C., ALLENTOWN, PA. FILED 10-11-2006.

CLASS 30—(Continued).

SN 77-021,656. FIRST WATCH RESTAURANTS, INC., BRADENTON, FL. FILED 10-16-2006.

BARTONS DREAM BITES

THE MARK CONSISTS OF STANDARD CHARACTERS WITHOUT CLAIM TO ANY PARTICULAR FONT, STYLE, SIZE, OR COLOR.

OWNER OF U.S. REG. NOS. 669,032, 2,923,935 AND OTHERS.

NO CLAIM IS MADE TO THE EXCLUSIVE RIGHT TO USE "BITES", APART FROM THE MARK AS SHOWN.

FOR CHOCOLATE (U.S. CL. 46).

HANNO RITTNER, EXAMINING ATTORNEY

TRI-FECTA

THE MARK CONSISTS OF STANDARD CHARACTERS WITHOUT CLAIM TO ANY PARTICULAR FONT, STYLE, SIZE, OR COLOR.

SEC. 2(F).

FOR PREPARED BREAKFAST COMBINATION MEALS FEATURING A WAFFLE FOR CONSUMPTION ON OR OFF THE PREMISES (U.S. CL. 46).

FIRST USE 1-31-1998; IN COMMERCE 1-31-1998.

JEFF DEFORD, EXAMINING ATTORNEY

SN 77-021,313. KELLOGG NORTH AMERICA COMPANY, BATTLE CREEK, MI. FILED 10-14-2006.



OWNER OF U.S. REG. NO. 1,468,538.

NO CLAIM IS MADE TO THE EXCLUSIVE RIGHT TO USE "CRUNCHY NUT", APART FROM THE MARK AS SHOWN.

THE MARK CONSISTS OF THE STYLIZED WORDS CRUNCHY NUT WITH THE LETTER "C" ON THE WORD CRUNCHY SHOWING THE FOLLOWING LETTER "R" BEING CRUNCHED.

FOR GRANOLA-BASED SNACK BARS (U.S. CL. 46).

BARBARA GAYNOR, EXAMINING ATTORNEY

SN 77-023,695. WM. WRIGLEY JR. COMPANY, CHICAGO, IL. FILED 10-18-2006.

SN 77-021,634. FIRST WATCH RESTAURANTS, INC., BRADENTON, FL. FILED 10-16-2006.

SIESTA KEY COCKTAIL**RAIN**

THE MARK CONSISTS OF STANDARD CHARACTERS WITHOUT CLAIM TO ANY PARTICULAR FONT, STYLE, SIZE, OR COLOR.

NO CLAIM IS MADE TO THE EXCLUSIVE RIGHT TO USE "COCKTAIL", APART FROM THE MARK AS SHOWN.

SEC. 2(F).

FOR PARFAITS FOR CONSUMPTION ON OR OFF THE PREMISES (U.S. CL. 46).

FIRST USE 2-28-1987; IN COMMERCE 2-28-1987.

JEFF DEFORD, EXAMINING ATTORNEY

THE MARK CONSISTS OF STANDARD CHARACTERS WITHOUT CLAIM TO ANY PARTICULAR FONT, STYLE, SIZE, OR COLOR.

FOR CONFECTIONERY, NAMELY, CHEWING GUM, BUBBLE GUM, CANDY AND MINTS (U.S. CL. 46).

KAREN SEVERSON, EXAMINING ATTORNEY

CLASS 30—(Continued).

SN 77-031,926. TEN REN TEA CO., LTD., TAIPEI, TAIWAN, FILED 10-30-2006.



OWNER OF U.S. REG. NOS. 2,555,651, 2,555,832 AND OTHERS.

NO CLAIM IS MADE TO THE EXCLUSIVE RIGHT TO USE "THE CHINESE CHARACTER WHICH TRANSLITERATES TO "CHA" AND TRANSLATES TO "TEA", APART FROM THE MARK AS SHOWN.

THE MARK CONSISTS OF TWO CHINESE CHARACTERS.

THE NON-LATIN CHARACTER(S) IN THE MARK TRANSLITERATE INTO CHA WON, AND THIS MEANS TEA KING IN ENGLISH.

FOR TEA; TEA BAGS; TEA POWDER; TEA EXTRACT; CAKES; TEA-BASED FILLINGS FOR CAKES AND PIES IN THE NATURE OF FLAVORINGS OF TEA; NON-ALCOHOLIC TEA-BASED BEVERAGES; COCOA; COFFEE; CANDIES; COOKIES (U.S. CL. 46).

FIRST USE 6-6-2004; IN COMMERCE 1-31-2005.
KELLY BOULTON, EXAMINING ATTORNEY

CLASS 30—(Continued).

SN 77-036,361. FIORI NATURALI COMERCIO DE SORVETES LTDA., SAO PAULO, BRAZIL, FILED 11-3-2006.



NO CLAIM IS MADE TO THE EXCLUSIVE RIGHT TO USE "IL BUON GELATO ARTIGIANALE, GELATERIA, GELATO Y DOLCI", APART FROM THE MARK AS SHOWN.

THE MARK CONSISTS, IN PART, OF AN STYLIZED ICE CREAM IN A CUP AND A SMALL WAFER ON THE TOP.

"THE FOREIGN WORDING IN THE MARK TRANSLATES INTO ENGLISH AS VERY COLD, ICE CREAM PARLOR, AND ICE CREAM AND SWEETS, AND THE GOOD HANDMADE GELATO"

FOR CANDIES; ICE CREAM (U.S. CL. 46).
FIRST USE 3-10-2007; IN COMMERCE 3-10-2007.
JOHN E. MICHOS, EXAMINING ATTORNEY

SN 77-033,308. SCHADE, KATHERINE A, VICTOR, ID. FILED 10-31-2006.



NO CLAIM IS MADE TO THE EXCLUSIVE RIGHT TO USE "BAR", APART FROM THE MARK AS SHOWN.

THE MARK CONSISTS OF AERIAL TRAM. FOR GRAIN-BASED FOOD BARS ALSO CONTAINING SEEDS, CHOCOLATE, HONEY, NUT BUTTERS, DRIED FRUITS, SALT, SPICES (U.S. CL. 46).

FIRST USE 9-0-2004; IN COMMERCE 1-0-2006.
BILL DAWE, EXAMINING ATTORNEY

SN 77-038,178. DEERE & COMPANY, MOLINE, IL. FILED 11-7-2006.

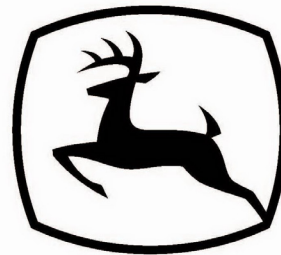

OWNER OF U.S. REG. NOS. 2,580,000, 2,729,766 AND OTHERS.

THE MARK CONSISTS OF A LEAPING DEER INSIDE OF A SINGLE CLOSED BORDER.

FOR COFFEE; CONFECTIONARY, NAMELY, GUM AND LOLLIPOPS (U.S. CL. 46).

FIRST USE 12-1-2000; IN COMMERCE 12-1-2000.
FRED CARL, EXAMINING ATTORNEY

CLASS 30—(Continued).

SN 77-053,756. WM. WRIGLEY JR. COMPANY, CHICAGO, IL. FILED 11-30-2006.

MEGA ROLL

THE MARK CONSISTS OF STANDARD CHARACTERS WITHOUT CLAIM TO ANY PARTICULAR FONT, STYLE, SIZE, OR COLOR.

FOR CONFECTIONERY, NAMELY, CHEWING GUM, BUBBLE GUM, CANDY AND MINTS (U.S. CL. 46).
KAREN SEVERSON, EXAMINING ATTORNEY

CLASS 30—(Continued).

SN 77-101,898. PINNACLE RESTAURANT GROUP, INC., BOULDER, CO. FILED 2-7-2007.



NO CLAIM IS MADE TO THE EXCLUSIVE RIGHT TO USE "DELI", APART FROM THE MARK AS SHOWN.
FOR SALAD DRESSING (U.S. CL. 46).
FIRST USE 6-4-2003; IN COMMERCE 6-4-2003.
ELIZABETH BEYER, EXAMINING ATTORNEY

SN 77-075,740. SILVER SPRING GARDENS, INC., EAU CLAIRE, WI. FILED 1-4-2007.

BELLA MIGLIORE

THE MARK CONSISTS OF STANDARD CHARACTERS WITHOUT CLAIM TO ANY PARTICULAR FONT, STYLE, SIZE, OR COLOR.

OWNER OF U.S. REG. NO. 2,673,145.
"THE FOREIGN WORDING IN THE MARK TRANSLATES INTO ENGLISH AS THE MOST BEAUTIFUL."
FOR MINCED GARLIC (U.S. CL. 46).
FIRST USE 12-26-2006; IN COMMERCE 12-26-2006.
LANA PHAM, EXAMINING ATTORNEY

SN 77-108,206. MEIJI SEIKA KAISHA, LTD., CHUO-KU, TOKYO, JAPAN, FILED 2-15-2007.

CHOCOROOMS

THE MARK CONSISTS OF STANDARD CHARACTERS WITHOUT CLAIM TO ANY PARTICULAR FONT, STYLE, SIZE, OR COLOR.

FOR SNACK FOOD, NAMELY, A CRACKER WITH A CHOCOLATE COVERED TOP; BISCUITS; CHOCOLATE; CRACKERS (U.S. CL. 46).
JENNIFER HETU, EXAMINING ATTORNEY

SN 77-086,981. LISELLE VINTAGE CARAMELS, RANCHO SANTA MARGARITA, CA. FILED 1-19-2007.

Liselle Vintage Caramels

THE MARK CONSISTS OF STANDARD CHARACTERS WITHOUT CLAIM TO ANY PARTICULAR FONT, STYLE, SIZE, OR COLOR.

FOR CANDY WITH CARAMEL; CARAMELS; SUGAR-COATED HARD CARAMELS (U.S. CL. 46).
WON TEAK OH, EXAMINING ATTORNEY

SN 77-113,676. HOT STUFF FOODS, LLC, SIOUX FALLS, SD. FILED 2-22-2007.

JR. BITES

THE MARK CONSISTS OF STANDARD CHARACTERS WITHOUT CLAIM TO ANY PARTICULAR FONT, STYLE, SIZE, OR COLOR.

NO CLAIM IS MADE TO THE EXCLUSIVE RIGHT TO USE "BITES", APART FROM THE MARK AS SHOWN.

FOR FOOD ITEM CONSISTING OF BREAD WITH A FILLING CONSISTING PRIMARILY OF ONE OR MORE OF MEATS, CHEESES, SAUCES, VEGETABLES, CONDIMENTS, GRAINS, DAIRY PRODUCTS AND FLAVORINGS; BREADSTICKS STUFFED WITH ONE OR MORE OF MEATS, CHEESES, SAUCES, VEGETABLES, CONDIMENTS, GRAINS, DAIRY PRODUCTS AND FLAVORINGS (U.S. CL. 46).

RONALD MCMORROW, EXAMINING ATTORNEY

CLASS 30—(Continued).

SN 77-118,007. COHEN, ANDREW I., NEW YORK, NY.
FILED 2-28-2007.

American Homeland Dressing

THE MARK CONSISTS OF STANDARD CHARACTERS WITHOUT CLAIM TO ANY PARTICULAR FONT, STYLE, SIZE, OR COLOR.

NO CLAIM IS MADE TO THE EXCLUSIVE RIGHT TO USE "AMERICAN" AND "DRESSING", APART FROM THE MARK AS SHOWN.

FOR SALAD DRESSINGS (U.S. CL. 46).
MARK SPARACINO, EXAMINING ATTORNEY

SN 77-119,082. FOOD (THAT IS) FAST, FRESH & DELICIOUS, INC., NEW YORK, NY. FILED 2-28-2007.



THE COLOR(S) BROWN, GREEN AND ORANGE IS/ARE CLAIMED AS A FEATURE OF THE MARK.

THE COLOR GREEN APPEARS IN THE DESIGN OF THE LEAF, AND THE COLOR ORANGE APPEARS IN THE WORDING "WH LE BURGER," AND THE COLOR BROWN APPEARS IN THE LETTER "O," WHICH REPRESENT A BURGER PATTY.

FOR HAMBURGER SANDWICHES; SANDWICHES, NAMELY, BEEF BURGER, LAMBURGER, PORKBURGER, FISHBURGER, VEGGIEBURGER, SOYBURGER, GRAINBURGER, TURKEYBURGER, CHICKENBURGER (U.S. CL. 46).

DAYNA BROWNE, EXAMINING ATTORNEY

SN 77-122,204. D.F. STAUFFER BISCUIT CO., INC., YORK, PA. FILED 3-5-2007.

STAUFFER'S

THE MARK CONSISTS OF STANDARD CHARACTERS WITHOUT CLAIM TO ANY PARTICULAR FONT, STYLE, SIZE, OR COLOR.

OWNER OF U.S. REG. NOS. 793,744 AND 3,124,711.
SEC. 2(F).

FOR COOKIES AND CRACKERS (U.S. CL. 46).
FIRST USE 12-31-1913; IN COMMERCE 12-31-1913.

JANICE L. MCMORROW, EXAMINING ATTORNEY

CLASS 30—(Continued).

SN 77-122,217. GRUMA CORPORATION, IRVING, TX.
FILED 3-5-2007.



OWNER OF U.S. REG. NOS. 1,705,245, 2,872,656 AND OTHERS.

NO CLAIM IS MADE TO THE EXCLUSIVE RIGHT TO USE "LAS TORTILLERIAS", APART FROM THE MARK AS SHOWN.

THE COLOR(S) RED, GREEN, WHITE IS/ARE CLAIMED AS A FEATURE OF THE MARK.

THE MARK CONSISTS OF THE WORDS FROM THE MAKERS OF GUERRERO DE LAS TORTILLERIAS DE IN A SEAL DESIGN; THE OUTER CIRCULAR PORTION OF THE MARK WHICH IS LIKE A SEAL IS GREEN; THE BAND IN THE UPPER HALF OF THE INNER CIRCLE IS RED AND THE WORDS FROM THE MAKERS OF ARE WHITE; THE BAND IN THE LOWER HALF OF THE INNER CIRCLE IS RED AND THE WORDS DE LAS TORTILLERIAS DE ARE WHITE; THE SMALL HALF CIRCLES IN THE UPPER AND LOWER PORTIONS OF THE INNER CIRCLE ARE OUTLINED IN GREEN; THE WORD GUERRERO IS GREEN.

THE ENGLISH TRANSLATION OF GUERRERO AND DE LAS TORTILLERIAS DE IS "WARRIOR" AND "FROM THE TORTILLA FACTORIES OF".

FOR TORTILLAS (U.S. CL. 46).

FIRST USE 6-0-2003; IN COMMERCE 6-0-2003.

HOWARD B. LEVINE, EXAMINING ATTORNEY

SN 77-124,826. TRAVIS RYAN MARKS, PASO ROBLES, CA.
FILED 3-7-2007.



NO CLAIM IS MADE TO THE EXCLUSIVE RIGHT TO USE "FROZEN YOGURT", APART FROM THE MARK AS SHOWN.

THE COLOR(S) BLUE, GREEN, YELLOW, ORANGE, RED, PURPLE, PINK AND BLACK IS/ARE CLAIMED AS A FEATURE OF THE MARK.

THE MARK CONSISTS OF A SURFBOARD STYLIZED HORIZONTALLY ADJUSTED OVAL SHAPE COMPLETELY FILLED IN WITH A PHOTOGRAPHIC REPRESENTATION OF A "BIRD OF PARADISE" FLOWER. BLOCK STYLE LETTERING ON THE UPPER-HALF AND LOWER-HALF OF THE SURFBOARD OVAL IS FILLED IN WITH THE COLORS BLUE, GREEN, YELLOW, ORANGE, RED, PURPLE, PINK AND BLACK. THE LETTERING IS OUTLINED IN BLACK. THE UPPER-HALF LETTERING IS CURVED TO FOLLOW THE UPPER SHAPE OF THE OVAL AND READS, "TJ'S PARADISE ISLE". THE LOWER-HALF LETTERING IS CURVED TO FOLLOW THE LOWER SHAPE OF THE OVAL AND READS, "FROZEN YOGURT".

FOR FROZEN YOGURT (U.S. CL. 46).

WOODROW HARTZOG, EXAMINING ATTORNEY

CLASS 30—(Continued).

SN 77-126,174. PACIFIC GIANT, INC., LOS ANGELES, CA.
FILED 3-8-2007.

아차가바

THE NON-LATIN CHARACTERS TRANSLITERATES TO "AH CHAD GA MBA" AND THERE IS NO MEANING IN ENGLISH.

FOR FRUIT ICE BAR; ICE CREAM BAR; FLAVORED ICE BAR; ICE CREAM (U.S. CL. 46).

KEVON CHISOLM, EXAMINING ATTORNEY

SN 77-126,718. BERNSTEIN, ROBERT, SAN MARCOS, CA.
FILED 3-9-2007.

Dad's Popcorn

THE MARK CONSISTS OF STANDARD CHARACTERS WITHOUT CLAIM TO ANY PARTICULAR FONT, STYLE, SIZE, OR COLOR.

NO CLAIM IS MADE TO THE EXCLUSIVE RIGHT TO USE "POPCORN", APART FROM THE MARK AS SHOWN.

FOR CANDY COATED POPCORN; CARAMEL POPCORN; CEREAL BASED SNACK FOOD; CEREAL-BASED SNACK FOODS; CHEESE FLAVORED PUFFED CORN SNACKS; CORN-BASED SNACK FOODS; GLAZED POPCORN; MICROWAVE POPCORN; POPCORN; POPPED POPCORN; PROCESSED POPCORN; PROCESSED UNPOPPED POPCORN; PUFFED CORN SNACKS; SNACK MIX CONSISTING PRIMARILY OF CRACKERS, PRETZELS, CANDIED NUTS AND/OR POPPED POPCORN; UNPOPPED POPCORN (U.S. CL. 46).

DAVID H. STINE, EXAMINING ATTORNEY

SN 77-128,395. ROBINSON, CHRIS, BALTIMORE, MD.
FILED 3-12-2007.

MS C & D'S SAUCE

THE MARK CONSISTS OF STANDARD CHARACTERS WITHOUT CLAIM TO ANY PARTICULAR FONT, STYLE, SIZE, OR COLOR.

NO CLAIM IS MADE TO THE EXCLUSIVE RIGHT TO USE "SAUCE", APART FROM THE MARK AS SHOWN.

FOR SALAD DRESSINGS; DIPPING SAUCES (U.S. CL. 46).

JILL PRATER, EXAMINING ATTORNEY

CLASS 30—(Continued).

SN 77-129,028. CHARLES T. ROMANUS, SANTA BARBARA, CA. FILED 3-12-2007.



NO CLAIM IS MADE TO THE EXCLUSIVE RIGHT TO USE GRUB, APART FROM THE MARK AS SHOWN.

THE MARK CONSISTS OF A DESIGN OF A FIST HOLDING A CARROT, WITH THE WORDING "THE ANGRY VEGAN" ABOVE THE DESIGN AND THE WORDING "CRUELTY-FREE GRUB," FOLLOWED BY A HEART SHAPE, BELOW THE DESIGN; AND A SQUARE SHAPE IN THE BACKGROUND FRAMING THE FIST.

FOR VEGAN FOOD PRODUCTS, NAMELY, BAKERY GOODS, SAUCES AND PASTA SAUCE (U.S. CL. 46).

NICHOLAS ALTREE, EXAMINING ATTORNEY

SN 77-130,368. MOGGIO HOLGUIN, CATHERINE, BOGOTA, D.C., COLOMBIA, AND GROSSMAN CHABERMAN, SAMUEL, BOGOTA, D.C., COLOMBIA, FILED 3-14-2007.

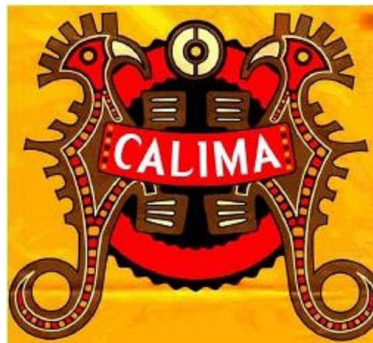

THE COLOR(S) ORANGE, BROWN, WHITE, RED, AND BLACK IS/ARE CLAIMED AS A FEATURE OF THE MARK.

THE MARK CONSISTS OF A RING WITH A CIRCLE AT THE TOP OF THE RING COMPRISED OF TWO FACING SEMI-CIRCLES, WITHIN THE RING ARE TWO VERTICAL BANNERS WITH HORIZONTAL LINES, ON EACH SIDE OF THE RING ARE TWO BIRD-LIKE FIGURES FACING EACH OTHER WHICH ARE JOINED BY A HORIZONTAL BANNER BEARING THE NAME "CALIMA" AND HAVING A SERIES OF CIRCLES AT EACH END OF THE BANNER, ALL OF WHICH IS SUPERIMPOSED OVER A SQUARE BACKGROUND. THE COLOR ORANGE APPEARS IN THE SQUARE BACKGROUND, IN THE BIRDS AND IN THE CIRCLES AT THE ENDS OF THE HORIZONTAL BANNER; THE COLOR YELLOW APPEARS IN THE SEMI-CIRCLES, AND IN THE BEAKS OF THE BIRDS; THE COLOR BROWN APPEARS IN THE BIRDS, IN THE TWO VERTICAL BANNERS AND IN THE BORDERS OF THE SEMI-CIRCLES; THE COLOR WHITE APPEARS IN THE HORIZON-

CLASS 30—(Continued).

TAL LINES IN THE TWO VERTICAL BANNERS, IN THE BIRDS AND IN THE WORDING, "CALIMA"; THE COLOR RED APPEARS IN THE RING, IN THE BIRDS AND IN THE HORIZONTAL BANNER; AND THE COLOR BLACK APPEARS INSIDE THE RING, IN THE OUTER BORDER OF THE RING, IN THE BIRDS, IN THE OUTER BORDER OF THE SEMI-CIRCLES, IN THE BORDERS OF THE COLOR WHITE AS IT APPEARS IN THE HORIZONTAL LINES IN THE TWO VERTICAL BANNERS, AND IN THE CIRCLES AT THE ENDS OF THE HORIZONTAL BANNER.

THE FOREIGN WORDING IN THE MARK TRANSLATES INTO ENGLISH AS MIST OR SMOG.

FOR COFFEE (U.S. CL. 46).

PAUL CROWLEY, EXAMINING ATTORNEY

SN 77-130,573. WAGNER, ALYSSA KALANIT, ENCINITAS, CA. AND WAND, JOSH S. ENCINITAS, CA. FILED 3-14-2007.

BuddhaBites

THE MARK CONSISTS OF STANDARD CHARACTERS WITHOUT CLAIM TO ANY PARTICULAR FONT, STYLE, SIZE, OR COLOR.

FOR ICE CREAM; BEVERAGES MADE OF TEA; BLACK TEA; FLAVOURINGS OF TEA; FRUIT TEAS; GREEN TEA; HERB TEA; HERBAL TEA; ICED TEA; JAPANESE GREEN TEA; MIXES IN THE NATURE OF CONCENTRATES, SYRUPS OR POWDERS USED IN THE PREPARATION OF TEA BASED BEVERAGES; OOLONG TEA; SAGE TEA; TEA; TEA FOR INFUSIONS; TEA-BASED BEVERAGES WITH FRUIT FLAVORING; BASES FOR MAKING MILK SHAKES; MILK SHAKES; BAKERY DESSERTS; FLAVORED, SWEETENED GELATIN DESSERTS (U.S. CL. 46).

MELVIN AXILBUND, EXAMINING ATTORNEY

SN 77-130,775. GRUMA CORPORATION, IRVING, TX. FILED 3-14-2007.



OWNER OF U.S. REG. NOS. 2,587,997, 2,591,165 AND 2,656,947.

NO CLAIM IS MADE TO THE EXCLUSIVE RIGHT TO USE "TORTILLAS", APART FROM THE MARK AS SHOWN.

THE COLOR(S) RED, YELLOW, LIGHT BROWN, BLACK, WHITE IS/ARE CLAIMED AS A FEATURE OF THE MARK.

THE MARK CONSISTS OF A SEMI CIRCLE CONTAINING THE WORDS FROM THE MAKERS OF, THE WORDS FROM THE MAKERS OF ARE IN WHITE; ACROSS THE TOP OF THE SEMI CIRCLE IS A YELLOW BAND AND A

CLASS 30—(Continued).

BLACK BAND; THE BELL TOWER IS YELLOW OUTLINED IN LIGHT BROWN; THE OPENING IN THE BELL TOWER CONTAINING THE BELL IS OUTLINED IN LIGHT BROWN AND HAS A WHITE INTERIOR OUTLINED IN BLACK; THE BELL IS RED WITH BLACK AND YELLOW HIGHLIGHTING; THE ARM HOLDING THE BELL IS BLACK; THE TWO FLOWER DESIGNS ON EITHER SIDE OF THE OPENING IN THE BELL TOWER ARE LIGHT BROWN; THE RECTANGLE CONTAINING THE WORD MISSION IS RED WITH YELLOW AND BLACK OUTLINES; THE WORD MISSION IS WHITE; THE RIBBON DESIGN CONTAINING THE WORD TORTILLAS IS RED WITH A YELLOW BAND ACROSS THE TOP AND THE BOTTOM OF THE RIBBON; THE RIBBON IS OUTLINED IN BLACK; THE WORD TORTILLAS IN THE RIBBON IS WHITE.

FOR TORTILLAS (U.S. CL. 46).

FIRST USE 3-0-2004; IN COMMERCE 3-0-2004.

HOWARD B. LEVINE, EXAMINING ATTORNEY

SN 77-132,912. RANDY LECKEY/ JASMINE INFANTE PARTNERSHIP, THE, BRONX, NY. FILED 3-16-2007.

cremaze

THE MARK CONSISTS OF STANDARD CHARACTERS WITHOUT CLAIM TO ANY PARTICULAR FONT, STYLE, SIZE, OR COLOR.

FOR ICE CREAM (U.S. CL. 46).

JILL C. ALT, EXAMINING ATTORNEY

SN 77-134,720. GONZALEZ-TORRES, ABRAHAM MARCELLO, CD. INDUSTRIAL TIZAUCA, MEXICO, FILED 3-19-2007.

QUE TOTIS

THE MARK CONSISTS OF STANDARD CHARACTERS WITHOUT CLAIM TO ANY PARTICULAR FONT, STYLE, SIZE, OR COLOR.

OWNER OF U.S. REG. NOS. 2,931,058, 7,890,632 AND OTHERS.

THE FOREIGN WORDING IN THE MARK TRANSLATES INTO ENGLISH AS QUE MEANING WHAT AND TOTIS AS HAVING NO MEANING.

FOR PROCESSED POPCORN; CORN-BASED SNACK FOODS; WHEAT-BASED SNACK FOODS (U.S. CL. 46).

SONYA STEPHENS, EXAMINING ATTORNEY

CLASS 30—(Continued).

SN 77-134,746. GONZALEZ-TORRES, ABRAHAM MARCELO, TIZAYUCA, MEXICO, FILED 3-19-2007.

TOTIS TOP-TOP'S

THE MARK CONSISTS OF STANDARD CHARACTERS WITHOUT CLAIM TO ANY PARTICULAR FONT, STYLE, SIZE, OR COLOR.

OWNER OF U.S. REG. NOS. 2,931,058, 7,890,632 AND OTHERS.

FOR CORN-BASED SNACK FOODS; WHEAT-BASED SNACK FOODS (U.S. CL. 46).
SONYA STEPHENS, EXAMINING ATTORNEY

SN 77-136,687. THE PILLSBURY COMPANY, MINNEAPOLIS, MN. FILED 3-21-2007.

¡SÓLO COLOQUE Y HORNEE!

THE MARK CONSISTS OF STANDARD CHARACTERS WITHOUT CLAIM TO ANY PARTICULAR FONT, STYLE, SIZE, OR COLOR.

OWNER OF U.S. REG. NOS. 2,794,544, 2,968,032 AND 2,991,576.

THE FOREIGN WORDING IN THE MARK TRANSLATES INTO ENGLISH AS JUST PLACE & BAKE!

FOR DOUGH (U.S. CL. 46).
FIRST USE 2-26-2006; IN COMMERCE 2-26-2006.
SHARON MEIER, EXAMINING ATTORNEY

SN 77-137,361. BAY STATE MILLING COMPANY, QUINCY, MA. FILED 3-22-2007.

BakingEssentials

THE MARK CONSISTS OF STANDARD CHARACTERS WITHOUT CLAIM TO ANY PARTICULAR FONT, STYLE, SIZE, OR COLOR.

FOR FLOUR (U.S. CL. 46).
PAULA MAHONEY, EXAMINING ATTORNEY

CLASS 30—(Continued).

SN 77-137,387. BAY STATE MILLING COMPANY, QUINCY, MA. FILED 3-22-2007.

EthnicEssentials

THE MARK CONSISTS OF STANDARD CHARACTERS WITHOUT CLAIM TO ANY PARTICULAR FONT, STYLE, SIZE, OR COLOR.

FOR FLOUR (U.S. CL. 46).
PAULA MAHONEY, EXAMINING ATTORNEY

SN 77-138,255. CHON, RAY, MURRIETA, CA. FILED 3-22-2007.

koolbliss

THE MARK CONSISTS OF STANDARD CHARACTERS WITHOUT CLAIM TO ANY PARTICULAR FONT, STYLE, SIZE, OR COLOR.

FOR FROZEN YOGHURT; FROZEN YOGURT; FROZEN YOGURT MIXES (U.S. CL. 46).

GENE MACIOL, EXAMINING ATTORNEY

SN 77-138,509. NEW WORLD PASTA COMPANY, HARRISBURG, PA. FILED 3-23-2007.

SMART TASTE

THE MARK CONSISTS OF STANDARD CHARACTERS WITHOUT CLAIM TO ANY PARTICULAR FONT, STYLE, SIZE, OR COLOR.

FOR PASTA, SAUCE, PREPARED OR PACKAGED MEALS CONSISTING PRIMARILY OF PASTA AND CONTAINING SAUCE (U.S. CL. 46).

LEIGH CAROLINE CASE, EXAMINING ATTORNEY

CLASS 30—(Continued).

SN 77-138,623. CLOVER FARMS DAIRY COMPANY, READING, PA. FILED 3-23-2007.

OWNER OF U.S. REG. NO. 1,956,990.
THE MARK CONSISTS OF THE WORD FARMERS' IN STYLIZED FORM.
FOR ICED TEA (U.S. CL. 46).
FIRST USE 4-0-1937; IN COMMERCE 4-0-1937.
ANDREA K. NADELMAN, EXAMINING ATTORNEY

SN 77-139,200. ORIGINAL V LLC, BELLEVILLE, WI. FILED 3-23-2007.

THE MARK CONSISTS OF STANDARD CHARACTERS WITHOUT CLAIM TO ANY PARTICULAR FONT, STYLE, SIZE, OR COLOR.
FOR WHOLE BEAN COFFEE, GROUND COFFEE, BREWED COFFEE, INSTANT COFFEE, READY TO DRINK COFFEE, BREWED ESPRESSO, CAPPUCCINO AND COFFEE BASED BEVERAGES CONTAINING MILK, NAMELY, LATTE; COFFEE AND TEA IN FILTER PODS; TEA, TEA BEVERAGES, BEVERAGES MADE OF TEA, NAMELY, CHAI TEA; FLAVORING SYRUPS FOR HOT AND COLD BEVERAGES (U.S. CL. 46).
MICHAEL GAAFAR, EXAMINING ATTORNEY

SN 77-139,253. HEY SUGAR!, INC., NEW YORK, NY. FILED 3-23-2007.

THE MARK CONSISTS OF STANDARD CHARACTERS WITHOUT CLAIM TO ANY PARTICULAR FONT, STYLE, SIZE, OR COLOR.
FOR ICE CREAM; COOKIES; BAKERY PRODUCTS, NAMELY SWEET BAKERY GOODS; ICE CREAM SANDWICHES; ICE-CREAM CAKES; FROZEN CONFECTIONS; BAKERY DESSERTS; BAKERY GOODS; BAKERY PRODUCTS (U.S. CL. 46).
FIRST USE 2-1-2007; IN COMMERCE 2-15-2007.
BRIAN PINO, EXAMINING ATTORNEY

CLASS 30—(Continued).

SN 77-139,545. COSTELLO, RACHEL S., NANUET, NY. FILED 3-24-2007.

THE MARK CONSISTS OF STANDARD CHARACTERS WITHOUT CLAIM TO ANY PARTICULAR FONT, STYLE, SIZE, OR COLOR.

NO CLAIM IS MADE TO THE EXCLUSIVE RIGHT TO USE "PREMIUM COFFEE", APART FROM THE MARK AS SHOWN.

FOR BEVERAGES MADE OF COFFEE; CAFFEINE-FREE COFFEE; CHICORY BASED COFFEE SUBSTITUTE; COFFEE; COFFEE; COFFEE BEANS; COFFEE FLAVORED SYRUP USED IN MAKING FOOD BEVERAGES; COFFEE PODS; COFFEE SUBSTITUTES; COFFEE SUBSTITUTES; COFFEE-BASED BEVERAGE CONTAINING MILK; GROUND COFFEE BEANS; INSTANT COFFEE; PREPARED COFFEE AND COFFEE-BASED BEVERAGES; ROASTED COFFEE BEANS; SUGAR-COATED COFFEE BEANS (U.S. CL. 46).
PAUL F. GAST, EXAMINING ATTORNEY

SN 77-139,954. MOORE, PATTY, MIDDLETOWN, NJ. FILED 3-26-2007.

THE MARK CONSISTS OF STANDARD CHARACTERS WITHOUT CLAIM TO ANY PARTICULAR FONT, STYLE, SIZE, OR COLOR.

FOR COOKIES (U.S. CL. 46).
FIRST USE 1-15-2007; IN COMMERCE 1-15-2007.
JILL C. ALT, EXAMINING ATTORNEY

SN 77-140,618. LALLEMAND USA, INC., MONTREAL, CANADA, FILED 3-26-2007.

THE MARK CONSISTS OF STANDARD CHARACTERS WITHOUT CLAIM TO ANY PARTICULAR FONT, STYLE, SIZE, OR COLOR.

OWNER OF U.S. REG. NOS. 1,714,567, 1,954,397 AND OTHERS.
FOR YEAST (U.S. CL. 46).
THEODORE MCBRIDE, EXAMINING ATTORNEY

CLASS 30—(Continued).

SN 77-140,647. EARTHSPACE LLC, NEW YORK, NY. FILED 3-26-2007.

EARTHKIDS

THE MARK CONSISTS OF STANDARD CHARACTERS WITHOUT CLAIM TO ANY PARTICULAR FONT, STYLE, SIZE, OR COLOR.

FOR CANDY, CANDY BARS, CHEWING AND BUBBLE GUM, CARAMELS, CHOCOLATE, CHOCOLATE TRUFFLES, CHOCOLATE COVERED NUTS, CHOCOLATE POWDER, HOT CHOCOLATE, CHOCOLATE CHIPS, PEANUT BUTTER CONFECTIONERY CHIPS, PIES, CAKES, CAKE AND FROSTING MIXES, ICING AND ICING MIXES, EDIBLE CAKE DECORATIONS, CHOCOLATE-BASED AND CUSTARD-BASED FILLINGS FOR CAKES AND PIES, MIXES FOR BAKERY GOODS, PANCAKE MIXES, PASTRIES, BAKERY GOODS AND BAKERY PRODUCTS, PUDDINGS, MARSHMALLOWS AND MARSHMALLOW TOPPING, WAFFLES, COOKIES, CRACKERS, GRANOLA-BASED SNACK BARS, CEREAL-BASED SNACK FOODS, RICE-BASED SNACK FOODS, FLOUR-BASED CHIPS, GRAIN-BASED CHIPS, WHEAT-BASED SNACK FOODS, PROCESSED CEREALS AND BREAKFAST CEREALS, OAT-MEAL, GRITS, PROCESSED POPCORN, TORTILLA CHIPS AND TORTILLA SHELLS, TACO CHIPS, TORTILLAS, PRETZELS, CORN CHIPS, CORN CURLS, PUFFED CORN SNACKS, CHEESE FLAVORED SNACKS IN THE NATURE OF CHEESE CURLS AND CHEESE BALLS, TOASTED CORN KERNELS, CORN FLAKES, CORN MEAL, FLOUR, PROCESSED OATS AND SEMOLINA, RICE, BREAD, BREAD STICKS, BREAD CRUMBS, CROUTONS, PASTA, SEASONINGS, VEGETABLE CONCENTRATES USED FOR SEASONING, SPICES, PROCESSED HERBS, MARINADES, FOOD STARCH, NATURAL SWEETENER, EXTRACTS USED AS FLAVORING, FLAVORING ADDITIVES FOR NON-NUTRITIONAL PURPOSES AND FOOD FLAVORINGS; FOOD ADDITIVES FOR NON-NUTRITIONAL PURPOSES FOR USE AS A FLAVORING, INGREDIENT OR FILLER; FLAVORED AND SWEETENED GELATINES; FLAVORED, SWEETENED GELATIN DESSERTS; GRAVY MIXES, MEAT PIES, MEAT TENDERIZERS AND SWEETMEATS; CORN, MAPLE, CHOCOLATE, PANCAKE, TOPPING, TABLE AND FLAVORING SYRUPS; SUGAR, SALT, PEPPER, KETCHUP, MUSTARD, MAYONNAISE, SALAD DRESSINGS, VINEGAR, SAUCES AND SALSA; CHOCOLATE FOOD BEVERAGES NOT BEING DAIRY-BASED OR VEGETABLE-BASED; TEA-BASED BEVERAGES WITH FRUIT FLAVORING; HERBAL FOOD BEVERAGES; GRAIN-BASED BEVERAGES AND GRAIN-BASED FOOD BEVERAGES; COFFEE, COFFEE BEANS, COFFEE SUBSTITUTES, TEA, COCOA AND COCOA MIXES; SNACK MIX CONSISTING PRIMARILY OF CRACKERS, PRETZELS, CANDIED NUTS AND/OR POPPED POPCORN; FOOD PACKAGE COMBINATIONS CONSISTING PRIMARILY OF BREAD, CRACKERS AND/OR COOKIES; CRACKER AND CHEESE COMBINATIONS; FLAVORED ICES, FROZEN YOGURT, FROZEN CONFECTIONS, ICE CREAM AND ICE MILK; ICE CREAM DRINKS, ICE CREAM SUBSTITUTE, SHAKES, CUSTARDS AND CONES FOR ICE CREAM; SANDWICHES, PIZZA AND DOUGH; PASTA, MACARONI AND RICE SALADS (U.S. CL. 46).

GRETTA YAO, EXAMINING ATTORNEY

CLASS 30—(Continued).

SN 77-140,860. WEISZ, JORDAN M., ASTORIA, NY. FILED 3-26-2007.

"FLAVORS ARE GUARANTEED TO SATISFY"

THE MARK CONSISTS OF STANDARD CHARACTERS WITHOUT CLAIM TO ANY PARTICULAR FONT, STYLE, SIZE, OR COLOR.

FOR CANDY CONTAINING ALCOHOLIC BEVERAGE CONTENT AND FLAVOR; EXTRACTS USED AS FLAVORING; FLAVOR ENHANCERS USED IN FOOD AND BEVERAGE PRODUCTS; FLAVORED AND SWEETENED GELATINS; FLAVORED ICES; FLAVORED, SWEETENED GELATIN DESSERTS; FLAVORING ADDITIVES FOR NON-NUTRITIONAL PURPOSES; FLAVORING SYRUP; FLAVORINGS FOR BEVERAGES; FOOD ADDITIVES FOR NON-NUTRITIONAL PURPOSES FOR USE AS A FLAVORING, INGREDIENT OR FILLER; FOOD FLAVORINGS; MALT EXTRACTS USED AS FLAVORING (U.S. CL. 46).

IRENE D. WILLIAMS, EXAMINING ATTORNEY

SN 77-140,881. THE CABRON FAMILY HOLDINGS, INC., LOS ANGELES, CA. FILED 3-26-2007.

CABRON HOT SAUCE

THE MARK CONSISTS OF STANDARD CHARACTERS WITHOUT CLAIM TO ANY PARTICULAR FONT, STYLE, SIZE, OR COLOR.

NO CLAIM IS MADE TO THE EXCLUSIVE RIGHT TO USE "HOT SAUCE", APART FROM THE MARK AS SHOWN.

THE FOREIGN WORDING IN THE MARK TRANSLATES INTO ENGLISH AS GOAT.

FOR HOT SAUCE; SALSA; BARBECUE SAUCE; CHICKEN WING SAUCE; SAUCES; SAUCE MIXES; SAUCES FOR BARBECUED MEAT; CHEESE SAUCE; CHEESE FLAVORED SNACKS, NAMELY, CHEESE CURLS, CHEESE PUFFS, CHEESE BALLS; TORTILLA CHIPS; SNACK MIX CONSISTING PRIMARILY OF CRACKERS, PRETZELS, CANDIED NUTS AND/OR POPPED POPCORN; PRETZELS; TOASTED CORN KERNELS; BURRITOS; ENCHILADAS; FAJITAS; NACHOS; TAMALES; TOSTADAS; TACO SEASONING (U.S. CL. 46).

JOHN WILKE, EXAMINING ATTORNEY

CLASS 30—(Continued).

SN 77-140,920. BELLA PITA, INC., SANTA MONICA, CA. FILED 3-27-2007.

Wowshi

THE MARK CONSISTS OF STANDARD CHARACTERS WITHOUT CLAIM TO ANY PARTICULAR FONT, STYLE, SIZE, OR COLOR.
FOR SANDWICHES (U.S. CL. 46).
FIRST USE 3-15-2007; IN COMMERCE 3-15-2007.
ALICE BENMAMAN, EXAMINING ATTORNEY

SN 77-141,334. MARS, INCORPORATED, MCLEAN, VA. FILED 3-27-2007.

CHOCOLATE LUXURY WITH NO STRINGS ATTACHED

THE MARK CONSISTS OF STANDARD CHARACTERS WITHOUT CLAIM TO ANY PARTICULAR FONT, STYLE, SIZE, OR COLOR.
NO CLAIM IS MADE TO THE EXCLUSIVE RIGHT TO USE "CHOCOLATE", APART FROM THE MARK AS SHOWN.
FOR CONFECTIONERY, NAMELY, CANDY (U.S. CL. 46).
LYDIA BELZER, EXAMINING ATTORNEY

SN 77-141,340. MARS, INCORPORATED, MCLEAN, VA. FILED 3-27-2007.

CHOCOLATE WITH NO STRINGS ATTACHED

THE MARK CONSISTS OF STANDARD CHARACTERS WITHOUT CLAIM TO ANY PARTICULAR FONT, STYLE, SIZE, OR COLOR.
NO CLAIM IS MADE TO THE EXCLUSIVE RIGHT TO USE "CHOCOLATE", APART FROM THE MARK AS SHOWN.
FOR CONFECTIONERY, NAMELY, CANDY (U.S. CL. 46).
LYDIA BELZER, EXAMINING ATTORNEY

CLASS 30—(Continued).

SN 77-141,397. MR. EGGS, INC., LOS ANGELES, CA. FILED 3-27-2007.

MR. EGG'S

THE MARK CONSISTS OF STANDARD CHARACTERS WITHOUT CLAIM TO ANY PARTICULAR FONT, STYLE, SIZE, OR COLOR.
THE NAME(S), PORTRAIT(S), AND/OR SIGNATURE(S) SHOWN IN THE MARK DOES NOT IDENTIFY A PARTICULAR LIVING INDIVIDUAL.
FOR FOOD SEASONINGS AND SPICES; MARINADES (U.S. CL. 46).
CURTIS FRENCH, EXAMINING ATTORNEY

SN 77-141,559. BELL FLOUR, LLC, PHILADELPHIA, PA. FILED 3-27-2007.

PhilaDing

THE MARK CONSISTS OF STANDARD CHARACTERS WITHOUT CLAIM TO ANY PARTICULAR FONT, STYLE, SIZE, OR COLOR.
FOR COOKIES (U.S. CL. 46).
WON TEAK OH, EXAMINING ATTORNEY

SN 77-141,954. DELISH FOODS INTERNATIONAL, AGOURA, CA. FILED 3-27-2007.

Svegliati!

THE MARK CONSISTS OF STANDARD CHARACTERS WITHOUT CLAIM TO ANY PARTICULAR FONT, STYLE, SIZE, OR COLOR.
THE FOREIGN WORDING IN THE MARK TRANSLATES INTO ENGLISH AS "WAKE UP!"
FOR FRUIT JELLIES (U.S. CL. 46).
PATRICIA EVANKO, EXAMINING ATTORNEY

CLASS 30—(Continued).

SN 77-142,082. EMPACADOS, S.A. DE C.V., MONTERREY, MEXICO, FILED 3-28-2007.

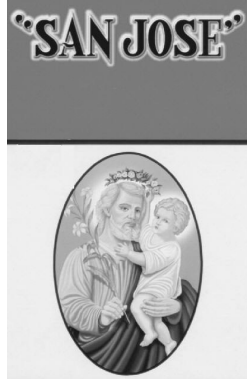

FOR RICE (U.S. CL. 46).
LINDA ORNDORFF, EXAMINING ATTORNEY

SN 77-142,256. THE ZIEGENFELDER COMPANY, INC., WHEELING, WV. FILED 3-28-2007.

SUMMER BLAST

THE MARK CONSISTS OF STANDARD CHARACTERS WITHOUT CLAIM TO ANY PARTICULAR FONT, STYLE, SIZE, OR COLOR.

FOR FROZEN CONFECTIONS (U.S. CL. 46).
FIRST USE 3-16-2007; IN COMMERCE 3-16-2007.
FRANK LATTUCA, EXAMINING ATTORNEY

SN 77-142,379. AMERICAN MUSEUM OF NATURAL HISTORY, NEW YORK, NY. FILED 3-28-2007.

AMNH EXPEDITIONS

THE MARK CONSISTS OF STANDARD CHARACTERS WITHOUT CLAIM TO ANY PARTICULAR FONT, STYLE, SIZE, OR COLOR.

FOR BEVERAGES MADE OF COFFEE; BEVERAGES MADE OF TEA (U.S. CL. 46).
REBECCA SMITH, EXAMINING ATTORNEY

CLASS 30—(Continued).

SN 77-143,103. GOYA FOODS, INC., SECAUCUS, NJ. FILED 3-28-2007.

MY TIME, TEA TIME

THE MARK CONSISTS OF STANDARD CHARACTERS WITHOUT CLAIM TO ANY PARTICULAR FONT, STYLE, SIZE, OR COLOR.

NO CLAIM IS MADE TO THE EXCLUSIVE RIGHT TO USE "TEA", APART FROM THE MARK AS SHOWN.

FOR TEA; HERBAL TEA (U.S. CL. 46).

FIRST USE 12-16-2006; IN COMMERCE 12-16-2006.
THEODORE MCBRIDE, EXAMINING ATTORNEY

SN 77-143,169. MACHAT, MICHAEL, BEVERLY HILLS, CA. FILED 3-28-2007.

VAMPIRE

THE MARK CONSISTS OF STANDARD CHARACTERS WITHOUT CLAIM TO ANY PARTICULAR FONT, STYLE, SIZE, OR COLOR.

OWNER OF U.S. REG. NOS. 2,263,907, 3,196,399 AND OTHERS.

FOR CHOCOLATE; COCOA; COFFEE; SPICES; TEA; HERB TEA; GROUND COFFEE BEANS; HOT CHOCOLATE; CHOCOLATE SYRUP; COFFEE BEANS (U.S. CL. 46).

JUDITH HELFMAN, EXAMINING ATTORNEY

SN 77-143,745. HOKULANI BAKERY, INC., HONOLULU, HI. FILED 3-29-2007.

Indulge Intelligently

THE MARK CONSISTS OF STANDARD CHARACTERS WITHOUT CLAIM TO ANY PARTICULAR FONT, STYLE, SIZE, OR COLOR.

FOR COOKIE MIXES; COOKIES; CAKE DOUGHS; CAKE MIXES; CAKES; CHOCOLATE-BASED FILLINGS FOR CAKES AND PIES; CUP CAKES; ICED CAKES; FRUIT PIES; PIES; BROWNIES (U.S. CL. 46).

ANDREA SAUNDERS, EXAMINING ATTORNEY

CLASS 30—(Continued).

SN 77-144,121. THE REAL CHOCOLATE COMPANY, LLC, CROZIER, VA. FILED 3-29-2007.

Affordable Indulgence

THE MARK CONSISTS OF STANDARD CHARACTERS WITHOUT CLAIM TO ANY PARTICULAR FONT, STYLE, SIZE, OR COLOR.

NO CLAIM IS MADE TO THE EXCLUSIVE RIGHT TO USE "AFFORDABLE", APART FROM THE MARK AS SHOWN.

FOR COOKIES AND CHOCOLATE (U.S. CL. 46).
ANDREA K. NADELMAN, EXAMINING ATTORNEY

SN 77-144,178. MANDISA, INC. DOING BUSINESS AS MANDISA L.A. INC., ONTARIO, CA. FILED 3-29-2007.



NO CLAIM IS MADE TO THE EXCLUSIVE RIGHT TO USE "KITCHEN" OR "TASTE OF ASIA", APART FROM THE MARK AS SHOWN.

THE NAME LOO LOO DOES NOT IDENTIFY A LIVING INDIVIDUAL.

THE MARK CONSISTS OF THE WORDS "LOO LOO KITCHEN TASTE OF ASIA." AND A DISTINCTIVE LOGO SHOWING A HOUSE CONTAINING A STYLIZED CARICATURE SUGGESTING THE CHINESE CHARACTER "LU." (IT IS NOTED THAT THIS IS MERELY A CARICATURE AS THE CHARACTER "LU" IS NOT WRITTEN THIS WAY IN CHINESE).

FOR NOODLES, INSTANT NOODLES, SAUCES (U.S. CL. 46).

LINDSEY RUBIN, EXAMINING ATTORNEY

SN 77-145,074. HOTEL VILLA MOZART, INC., SHORT HILLS, NY. FILED 3-30-2007.

MARIA PIA

THE MARK CONSISTS OF STANDARD CHARACTERS WITHOUT CLAIM TO ANY PARTICULAR FONT, STYLE, SIZE, OR COLOR.

OWNER OF U.S. REG. NO. 2,917,607.

THE NAME MARIA PIA IDENTIFIES A LIVING INDIVIDUAL WHOSE CONSENT IS OF RECORD.

SEC. 2(F).

FOR BREAD STICKS (U.S. CL. 46).

FIRST USE 1-1-2003; IN COMMERCE 4-1-2004.

SUE LAWRENCE, EXAMINING ATTORNEY

CLASS 30—(Continued).

SN 77-145,697. COSTELLO, RACHEL S., NANUET, NY. FILED 4-1-2007.

VINCENT VAN GOGH

THE MARK CONSISTS OF STANDARD CHARACTERS WITHOUT CLAIM TO ANY PARTICULAR FONT, STYLE, SIZE, OR COLOR.

FOR CANDIES; CANDY; CANDY BARS; CANDY CAKE DECORATIONS; CANDY COATED APPLES; CANDY COATED POPCORN; CANDY CONTAINING ALCOHOLIC BEVERAGE CONTENT AND FLAVOR; CANDY DECORATIONS FOR CAKES; CANDY MINTS; CANDY WITH CARAMEL; CANDY WITH COCOA; CHOCOLATE CANDIES; GIFT BASKETS CONTAINING CANDY; GUMMY CANDIES; ICE CANDIES; PEPPERMINT CANDY; SNACK MIX CONSISTING PRIMARILY OF CRACKERS, PRETZELS, CANDIED NUTS AND/OR POPPED POPCORN; STARCH-BASED CANDIES (AME); SUGARLESS CANDIES; CHOCOLATE; CHOCOLATE BARS; CHOCOLATE CHIPS; CHOCOLATE COVERED NUTS; CHOCOLATE COVERED RAISINS; CHOCOLATE FONDUE; CHOCOLATE FOOD BEVERAGES NOT BEING DAIRY-BASED OR VEGETABLE BASED; CHOCOLATE MOUSSE; CHOCOLATE PASTES; CHOCOLATE POWDER; CHOCOLATE SYRUP; CHOCOLATE TOPPING; CHOCOLATE TRUFFLES; CHOCOLATE-BASED FILLINGS FOR CAKES AND PIES; CHOCOLATE-BASED READY-TO-EAT FOOD BARS; CHOCOLATE-COVERED POTATO CHIPS; FILLED CHOCOLATE; HOT CHOCOLATE; MILK CHOCOLATE; SPREAD CONTAINING CHOCOLATE AND NUTS (U.S. CL. 46).

PAUL F. GAST, EXAMINING ATTORNEY

SN 77-147,151. NATRA ZAHOR S.A.U., OÑATE - GUIPUZCOA, SPAIN, FILED 4-3-2007.

BELGIDOR

THE MARK CONSISTS OF STANDARD CHARACTERS WITHOUT CLAIM TO ANY PARTICULAR FONT, STYLE, SIZE, OR COLOR.

FOR CHOCOLATE; CHOCOLATE BARS; CHOCOLATE CANDIES; CHOCOLATE CHIPS; CHOCOLATE COVERED NUTS; CHOCOLATE COVERED RAISINS; CHOCOLATE FONDUE; CHOCOLATE MOUSSE; CHOCOLATE PASTES; CHOCOLATE POWDER; CHOCOLATE SYRUP; CHOCOLATE TOPPING; CHOCOLATE TRUFFLES; CHOCOLATE-BASED FILLINGS FOR CAKES AND PIES; CHOCOLATE-BASED READY-TO-EAT FOOD BARS; CHOCOLATE-COVERED POTATO CHIPS; FILLED CHOCOLATE; HOT CHOCOLATE; MILK CHOCOLATE; SPREAD CONTAINING CHOCOLATE AND NUTS (U.S. CL. 46).

EDWARD NELSON, EXAMINING ATTORNEY

CLASS 30—(Continued).

SN 77-155,177. NEW WORLD PASTA COMPANY, HARRISBURG, PA. FILED 4-12-2007.

RONZONI BISTRO

THE MARK CONSISTS OF STANDARD CHARACTERS WITHOUT CLAIM TO ANY PARTICULAR FONT, STYLE, SIZE, OR COLOR.

OWNER OF U.S. REG. NOS. 518,709, 2,022,974 AND OTHERS.

FOR PASTA; PREPARED OR PACKAGED MEALS CONSISTING PRIMARILY OF RICE OR PASTA AND CONTAINING SAUCE, MEAT AND/OR VEGETABLES (U.S. CL. 46).

LEIGH CAROLINE CASE, EXAMINING ATTORNEY

CLASS 30—(Continued).

SN 77-159,971. ANHING CORPORATION, LOS ANGELES, CA. FILED 4-18-2007.



THE MARK CONSISTS OF A WINKING BOY IN SHORTS. FOR RICE CRACKERS (U.S. CL. 46).
ROBERT C. CLARK JR., EXAMINING ATTORNEY

SN 77-156,242. CADBURY ADAMS USA LLC, PARSIPPANY, NJ. FILED 4-13-2007.

SOUR MANIA

THE MARK CONSISTS OF STANDARD CHARACTERS WITHOUT CLAIM TO ANY PARTICULAR FONT, STYLE, SIZE, OR COLOR.

NO CLAIM IS MADE TO THE EXCLUSIVE RIGHT TO USE "SOUR", APART FROM THE MARK AS SHOWN.

FOR CONFECTIONERY, NAMELY CHEWING GUM (U.S. CL. 46).

G. MAYERSCHOFF, EXAMINING ATTORNEY

SN 77-166,070. ORION CORPORATION, SEOUL, REPUBLIC OF KOREA, FILED 4-26-2007.

Choco·Pie

SN 77-156,741. COLTON PARTNERS LLC, EL SEGUNDO, CA. FILED 4-13-2007.

TRULY FRUIT

THE MARK CONSISTS OF STANDARD CHARACTERS WITHOUT CLAIM TO ANY PARTICULAR FONT, STYLE, SIZE, OR COLOR.

NO CLAIM IS MADE TO THE EXCLUSIVE RIGHT TO USE "FRUIT", APART FROM THE MARK AS SHOWN.

FOR CANDY (U.S. CL. 46).

GENE MACIOL, EXAMINING ATTORNEY

FOR CHOCOLATES, BISCUITS, COOKIES, CRACKERS, WAFERS, COCOA-BASED INGREDIENT IN CONFECTIONERY PRODUCTS, CONFECTIONERY CHIPS FOR BAKING, CONFECTIONERY, NAMELY, PASTILLES, CRYSTAL SUGAR PIECES, PEANUT BUTTER CONFECTIONERY CHIPS, PEPPERMINT FOR CONFECTIONERY, CORN CHIPS, BREAD, PASTRIES, CAKES, PIES, PUDDINGS, SHERBETS, ICE CREAMS, CANDY, CARAMELS, CHEWING GUM NOT FOR MEDICAL PURPOSES (U.S. CL. 46).

FIRST USE 4-1-1974; IN COMMERCE 1-1-1992.

CHARLES L. JENKINS, EXAMINING ATTORNEY

CLASS 30—(Continued).

SN 77-166,955. MONTEREY GOURMET FOODS, INC., SALINAS, CA. FILED 4-26-2007.

LA BELLA VITA ITALIAN CLASSICS

THE MARK CONSISTS OF STANDARD CHARACTERS WITHOUT CLAIM TO ANY PARTICULAR FONT, STYLE, SIZE, OR COLOR.

NO CLAIM IS MADE TO THE EXCLUSIVE RIGHT TO USE "ITALIAN CLASSICS", APART FROM THE MARK AS SHOWN.

THE FOREIGN WORDING IN THE MARK TRANSLATES INTO ENGLISH AS THE BEAUTIFUL LIFE.

FOR RAVIOLI; FRESH PASTA; PASTA; PREPARED PASTA; FROZEN, PREPARED, OR PACKAGED EN- TREES CONSISTING PRIMARILY OF PASTA OR RICE (U.S. CL. 46).

RONALD AIKENS, EXAMINING ATTORNEY

CLASS 30—(Continued).

SN 77-173,571. DISHAKA GOURMET IMPORTS, L.L.C., HOUSTON, TX. FILED 5-4-2007.



THE COLOR(S) PINK, YELLOW, BLUE, PURPLE, RED, BLACK, AND WHITE IS/ARE CLAIMED AS A FEATURE OF THE MARK.

THE MARK CONSISTS OF A STYLIZED DEPICTION OF A PIG IN THE COLOR PINK AND OUTLINED IN BLACK WITH GLASSES IN THE COLOR PURPLE, WHITE AND BLACK, AND HAVING WHITE TEETH, AND WEARING A YELLOW SHIRT WITH A BLUE COLLAR AND THE TERM "PIJ" IN THE COLOR RED AND THE TERM "PIJ" IN THE COLOR RED BELOW.

FOR SNACK FOODS, NAMELY, CORN-BASED SNACK FOODS, WHEAT-BASED SNACK FOODS (U.S. CL. 46).

NAAKWAMA ANKRAH, EXAMINING ATTORNEY

SN 77-173,213. 621284 N.B. INC., FREDERICTON, CANADA, FILED 5-4-2007.

BRANNIE

THE MARK CONSISTS OF STANDARD CHARACTERS WITHOUT CLAIM TO ANY PARTICULAR FONT, STYLE, SIZE, OR COLOR.

FOR BAKERY PRODUCTS (U.S. CL. 46).

COLLEEN KEARNEY, EXAMINING ATTORNEY

SN 77-174,262. GOLDING FARMS FOODS, INC., WINSTON- SALEM, NC. FILED 5-7-2007.

MR. HONEY BEAR'S

THE MARK CONSISTS OF STANDARD CHARACTERS WITHOUT CLAIM TO ANY PARTICULAR FONT, STYLE, SIZE, OR COLOR.

OWNER OF U.S. REG. NO. 2,459,535.

FOR HONEY SYRUP (U.S. CL. 46).

FIRST USE 2-28-2003; IN COMMERCE 2-28-2003.

STEVEN R. FOSTER, EXAMINING ATTORNEY

CLASS 30—(Continued).

SN 77-174,803. SAN-RALLO PASTA COMPANY, DOVER, NJ.
FILED 5-7-2007.



NO CLAIM IS MADE TO THE EXCLUSIVE RIGHT TO USE "PASTA PRODUCTS" AND THE MAP OF ITALY, APART FROM THE MARK AS SHOWN.

FOR ITALIAN STYLE FOODS, NAMELY, FROZEN PASTA, FILLED FROZEN PASTA AND LASAGNA (U.S. CL. 46).

FIRST USE 3-0-1993; IN COMMERCE 3-0-1993.
PAUL F. GAST, EXAMINING ATTORNEY

SN 77-181,202. WAKEFERN FOOD CORP., ELIZABETH, NJ.
FILED 5-15-2007.

READINGTON FARMS

THE MARK CONSISTS OF STANDARD CHARACTERS WITHOUT CLAIM TO ANY PARTICULAR FONT, STYLE, SIZE, OR COLOR.

OWNER OF U.S. REG. NOS. 1,685,818 AND 2,413,191.
NO CLAIM IS MADE TO THE EXCLUSIVE RIGHT TO USE "FARMS", APART FROM THE MARK AS SHOWN.

FOR ICED TEA (U.S. CL. 46).
ODESSA BIBBINS, EXAMINING ATTORNEY

SN 77-186,306. TIMES GRILL RESTAURANT GROUP, LLC,
JACKSONVILLE, FL. FILED 5-21-2007.

ROCKIN' USA BURGER

THE MARK CONSISTS OF STANDARD CHARACTERS WITHOUT CLAIM TO ANY PARTICULAR FONT, STYLE, SIZE, OR COLOR.

NO CLAIM IS MADE TO THE EXCLUSIVE RIGHT TO USE "USA BURGER", APART FROM THE MARK AS SHOWN.

FOR SANDWICHES (U.S. CL. 46).
BRIDGETT SMITH, EXAMINING ATTORNEY

CLASS 30—(Continued).

SN 77-186,326. TIMES GRILL RESTAURANT GROUP, LLC,
JACKSONVILLE, FL. FILED 5-21-2007.

TIMES TWO WITH CHEESE

THE MARK CONSISTS OF STANDARD CHARACTERS WITHOUT CLAIM TO ANY PARTICULAR FONT, STYLE, SIZE, OR COLOR.

OWNER OF U.S. REG. NO. 3,144,659.

NO CLAIM IS MADE TO THE EXCLUSIVE RIGHT TO USE "WITH CHEESE", APART FROM THE MARK AS SHOWN.

FOR SANDWICHES (U.S. CL. 46).
BRIDGETT SMITH, EXAMINING ATTORNEY

SN 78-182,192. HEB GROCERY COMPANY, LP, SAN ANTONIO, TX. FILED 11-6-2002.

DIPPERS

FOR CORN-BASED SNACK FOODS, NAMELY, CORN CHIPS (U.S. CL. 46).

KELLY BOULTON, EXAMINING ATTORNEY

SN 78-235,878. BETTER BAKED FOODS, INC., NORTH EAST, PA. FILED 4-9-2003.



NO CLAIM IS MADE TO THE EXCLUSIVE RIGHT TO USE "CLASSICS", APART FROM THE MARK AS SHOWN.

THE MARK CONSISTS OF A YELLOW CIRCLE WITH SUN RAYS ON THE TOP PORTION. THE CIRCLE IS BISECTED WITH A RED BANNER CONTAINING THE WORDS DAYBREAK CLASSICS IN YELLOW WITH A BLACK OUTLINE. THE BOTTOM HALF OF THE CIRCLE CAN ALSO APPEAR CLEAR WHEN PRINTED ON THE PRODUCT PACKAGING.

FOR BREAD OR OTHER BAKERY GOODS TOPPED WITH EGGS AND/OR CHEESE AND/OR MEAT AND/OR FRUIT (U.S. CL. 46).

ANNE MADDEN, EXAMINING ATTORNEY

CLASS 30—(Continued).

SN 78-483,239. LA BONNE BOUCHEE DE SAINT LOUIS, INC., SAINT LOUIS, MO. FILED 9-14-2004.

La Bonne Bouchee

THE MARK CONSISTS OF STANDARD CHARACTERS WITHOUT CLAIM TO ANY PARTICULAR FONT, STYLE, SIZE, OR COLOR.

THE FOREIGN WORDING IN THE MARK TRANSLATES INTO ENGLISH AS THE GOOD MOUTHFUL.

FOR BAKERY GOODS, BAKERY PRODUCTS, BAKERY DESSERTS, CAKES, PASTRIES (U.S. CL. 46).

FIRST USE 0-0-1991; IN COMMERCE 0-0-1991.

STEVEN PEREZ, EXAMINING ATTORNEY

CLASS 30—(Continued).

SN 78-671,319. TEJEDA, FRANCISCO R., MCALLEN, TX. FILED 7-15-2005.

FLANtastico

THE MARK CONSISTS OF STANDARD CHARACTERS WITHOUT CLAIM TO ANY PARTICULAR FONT, STYLE, SIZE, OR COLOR.

FOR CUSTARD, SPANISH FLAN (U.S. CL. 46).

LANA PHAM, EXAMINING ATTORNEY

SN 78-565,989. SOCIETE DES PRODUITS NESTLE, S.A., 1800 VEVEY, SWITZERLAND, FILED 2-11-2005.



NO CLAIM IS MADE TO THE EXCLUSIVE RIGHT TO USE "RICH & CREAMY", APART FROM THE MARK AS SHOWN.

FOR ICE CREAM (U.S. CL. 46).

ADA HAN, EXAMINING ATTORNEY

SN 78-730,956. MARS, INCORPORATED, MCLEAN, VA. FILED 10-11-2005.

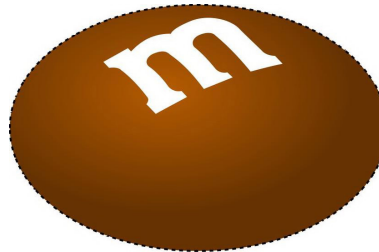

SN 78-607,168. RIKKI USA, INC., REDMOND, WA. FILED 4-12-2005.

MASA'S

THE MARK CONSISTS OF STANDARD CHARACTERS WITHOUT CLAIM TO ANY PARTICULAR FONT, STYLE, SIZE, OR COLOR.

THE NAME SHOWN IN THE MARK IDENTIFIES MASA-HIRO TERADA, WHOSE CONSENT IS OF RECORD.

FOR READY-MADE SAUCES; SALAD DRESSINGS; MARINADES; SOY SAUCE (U.S. CL. 46).

FIRST USE 5-20-2002; IN COMMERCE 5-20-2002.

HENRY S. ZAK, EXAMINING ATTORNEY

OWNER OF U.S. REG. NOS. 418,332 AND 2,923,541.

NO CLAIM IS MADE TO THE EXCLUSIVE RIGHT TO USE A ROUND SHAPE FOR CANDY PIECES, APART FROM THE MARK AS SHOWN.

THE COLOR(S) BROWN AND WHITE IS/ARE CLAIMED AS A FEATURE OF THE MARK.

THE MARK CONSISTS OF THE COLOR BROWN APPLIED TO THE SURFACE OF A CANDY PIECE WITH A WHITE STYLIZED LETTER "M" DEPICTED IN THE CENTER.

FOR CONFECTIONERY, NAMELY, CANDY (U.S. CL. 46).

FIRST USE 0-0-1941; IN COMMERCE 0-0-1941.

RON FAIRBANKS, EXAMINING ATTORNEY

CLASS 30—(Continued).

SN 78-731,048. MARS, INCORPORATED, MCLEAN, VA. FILED 10-11-2005.



OWNER OF U.S. REG. NOS. 418,332 AND 2,923,541.
NO CLAIM IS MADE TO THE EXCLUSIVE RIGHT TO USE A ROUND SHAPE FOR CANDY PIECES, APART FROM THE MARK AS SHOWN.

THE COLOR(S) GREEN AND WHITE IS/ARE CLAIMED AS A FEATURE OF THE MARK.

THE MARK CONSISTS OF THE COLOR GREEN APPLIED TO THE SURFACE OF A CANDY PIECE WITH A WHITE STYLIZED LETTER "M" DEPICTED IN THE CENTER.

FOR CONFECTIONERY, NAMELY, CANDY (U.S. CL. 46).

FIRST USE 0-0-1941; IN COMMERCE 0-0-1941.
RON FAIRBANKS, EXAMINING ATTORNEY

CLASS 30—(Continued).

SN 78-737,104. D.LAZZARONI & C S.P.A., 21047 SARONNO(VA), ITALY, FILED 10-20-2005.

AMARETTINI DI SARONNO

THE MARK CONSISTS OF STANDARD CHARACTERS WITHOUT CLAIM TO ANY PARTICULAR FONT, STYLE, SIZE, OR COLOR.

OWNER OF U.S. REG. NO. 1,869,811.

NO CLAIM IS MADE TO THE EXCLUSIVE RIGHT TO USE "AMARETTINI", APART FROM THE MARK AS SHOWN.

THE FOREIGN WORDING IN THE MARK TRANSLATES INTO ENGLISH AS MINI-MACAROONS FROM SARONNO. SEC. 2(F).

FOR COOKIES (U.S. CL. 46).

FIRST USE 12-31-1969; IN COMMERCE 12-31-1969.
KATHRYN COWARD, EXAMINING ATTORNEY

SN 78-731,565. BEST BRANDS CORP., ST. PAUL, MN. FILED 10-12-2005.



Best Brands Corp.

NO CLAIM IS MADE TO THE EXCLUSIVE RIGHT TO USE "BRANDS CORP.", APART FROM THE MARK AS SHOWN.

SEC. 2(F) BEST BRANDS CORP.

FOR BAKERY PRODUCTS; MIXES FOR BAKERY GOODS; FROZEN COOKIE DOUGH; RAW BAKERY GOODS, NAMELY, DOUGH FOR BAKERY GOODS (U.S. CL. 46).

FIRST USE 10-0-2001; IN COMMERCE 10-0-2001.
CHRISIE B. KING, EXAMINING ATTORNEY

SN 78-751,496. MCKEE FOODS KINGMAN, INC., KINGMAN, AZ. FILED 11-10-2005.

COSMIC

THE MARK CONSISTS OF STANDARD CHARACTERS WITHOUT CLAIM TO ANY PARTICULAR FONT, STYLE, SIZE, OR COLOR.

OWNER OF U.S. REG. NO. 3,047,312.

FOR COOKIES (U.S. CL. 46).

FIRST USE 11-5-1996; IN COMMERCE 11-5-1996.
MICHAEL KAZAZIAN, EXAMINING ATTORNEY

CLASS 30—(Continued).

SN 78-780,367. KUDO BEANS LLC, FORT LEE, NJ. FILED 12-23-2005.



NO CLAIM IS MADE TO THE EXCLUSIVE RIGHT TO USE "LEAVES", APART FROM THE MARK AS SHOWN.

THE MARK CONSISTS OF A BRANCH OF A TREE WITH LEAVES AND THE WORDS KUDO LEAVES ARE SUPERIMPOSED ON IT.

FOR TEA, TEA BAGS, AND TEA LEAVES, NAMELY BLEND TEAS, FLAVORED TEAS, BLACK TEA, GREEN TEA, WHITE TEA, OOLONG TEA, FRUIT TEA, HERBAL TEA FOR FOOD PURPOSES, LOOSE-LEAF TEA, AND OTHER TEA-BASED BEVERAGES, NAMELY TEA FLAVORED WITH FRUIT JUICE, LIME TEAS, SAGE TEA, ICED TEAS, AND CHOCOLATE FOOD BEVERAGES NOT BEING DAIRY-BASED OR VEGETABLE BASED, NAMELY CHOCOLATE-FLAVORED TEAS (U.S. CL. 46).

FIRST USE 8-1-2002; IN COMMERCE 8-1-2002.
JUSTINE D. PARKER, EXAMINING ATTORNEY

SN 78-780,374. KUDO BEANS LLC, FORT LEE, NJ. FILED 12-23-2005.

KUDO LEAVES

THE MARK CONSISTS OF STANDARD CHARACTERS WITHOUT CLAIM TO ANY PARTICULAR FONT, STYLE, SIZE, OR COLOR.

NO CLAIM IS MADE TO THE EXCLUSIVE RIGHT TO USE "LEAVES", APART FROM THE MARK AS SHOWN.

FOR TEA, TEA BAGS, AND TEA LEAVES, NAMELY BLEND TEAS, FLAVORED TEAS, BLACK TEA, GREEN TEA, WHITE TEA, OOLONG TEA, FRUIT TEA, HERBAL TEA FOR FOOD PURPOSES, LOOSE-LEAF TEA, AND OTHER TEA-BASED BEVERAGES, NAMELY TEA FLAVORED WITH FRUIT JUICE, LIME TEAS, SAGE TEA, ICED TEAS, AND CHOCOLATE FOOD BEVERAGES NOT BEING DAIRY-BASED OR VEGETABLE BASED, NAMELY CHOCOLATE-FLAVORED TEAS (U.S. CL. 46).

FIRST USE 8-1-2002; IN COMMERCE 8-1-2002.
JUSTINE D. PARKER, EXAMINING ATTORNEY

CLASS 30—(Continued).

SN 78-798,372. SIGMA ALIMENTOS, S.A. DE C.V., SAN PEDRO GARZA GARCIA, NUEVO LEON, MEXICO, FILED 1-24-2006.

HORNO DE PIEDRA

THE MARK CONSISTS OF STANDARD CHARACTERS WITHOUT CLAIM TO ANY PARTICULAR FONT, STYLE, SIZE, OR COLOR.

OWNER OF MEXICO REG. NO. 836377, DATED 6-7-2004, EXPIRES 4-22-2014.

THE FOREIGN WORDING IN THE MARK TRANSLATES INTO ENGLISH AS STONE OVEN.

FOR FROZEN ENTREES CONSISTING PRIMARILY OF LASAGNA, PIZZA, TACOS, TAMALES, AND WAFLES (U.S. CL. 46).

REBECCA HAN, EXAMINING ATTORNEY

SN 78-799,481. COLD STONE CREAMERY, INC., SCOTTSDALE, AZ. FILED 1-25-2006.

MINE

THE MARK CONSISTS OF STANDARD CHARACTERS WITHOUT CLAIM TO ANY PARTICULAR FONT, STYLE, SIZE, OR COLOR.

FOR ICE CREAM; FROZEN YOGURT; SORBETS; FROZEN CONFECTIONS, NAMELY, ICE CREAM, FROZEN YOGURT, AND SORBETS CUSTOM-BLENDED WITH MIX-INS SUCH AS CANDY, FRUITS, AND NUTS (U.S. CL. 46).

FIRST USE 12-0-2005; IN COMMERCE 12-0-2005.
WILLIAM BRECKENFELD, EXAMINING ATTORNEY

SN 78-799,509. COLD STONE CREAMERY, INC., SCOTTSDALE, AZ. FILED 1-25-2006.

OURS

THE MARK CONSISTS OF STANDARD CHARACTERS WITHOUT CLAIM TO ANY PARTICULAR FONT, STYLE, SIZE, OR COLOR.

FOR ICE CREAM; FROZEN YOGURT; SORBETS; FROZEN CONFECTIONS, NAMELY, ICE CREAM, FROZEN YOGURT, AND SORBETS CUSTOM-BLENDED WITH MIX-INS SUCH AS CANDY, FRUITS, AND NUTS (U.S. CL. 46).

FIRST USE 12-0-2005; IN COMMERCE 12-0-2005.
WILLIAM BRECKENFELD, EXAMINING ATTORNEY

CLASS 30—(Continued).

SN 78-814,709. CASTALDO, RICHARD, GROVE, OK. FILED 2-14-2006.



NO CLAIM IS MADE TO THE EXCLUSIVE RIGHT TO USE BRAND, APART FROM THE MARK AS SHOWN. "THE STIPPLING IS A FEATURE OF THE MARK." THE MARK CONSISTS OF CASTALDO CASTLE BRAND AND DESIGN OF A CASTLE FROM OUR CASTLE TO YOUR. FOR READY-MADE SAUCES (U.S. CL. 46). REBECCA SMITH, EXAMINING ATTORNEY

SN 78-816,645. PRODUCTOS INDY SA DE CV, SANTA CATARINA, NUEVO LEON, MEXICO, FILED 2-16-2006.



FOR CONFECTIONS, NAMELY, CANDY, CHILE PEPPER-BASED CANDY, CANDY INCLUDING EITHER SPICY, BITTER OR SOUR FLAVORINGS OR A COMBINATION THEREOF, INDIVIDUALLY WRAPPED CANDY, HARD CANDY, TAFFY, CARAMEL, CANDY SWEETS, SWEETENED SPREADS, NAMELY, A SUGAR BASED SPREAD THAT ALSO CONTAINS CHILE FLAVORING; CHEWING GUMS; AND SWEETENED GELATINS (U.S. CL. 46). FIRST USE 8-1-1991; IN COMMERCE 1-1-1993. JENNIFER VASQUEZ, EXAMINING ATTORNEY

CLASS 30—(Continued).

SN 78-819,758. PATTIES FOODS LTD., VICTORIA, AUSTRALIA, FILED 2-21-2006.



FOR PASTRY PRODUCTS, NAMELY, QUICHES; PASTRIES; PIES; PARTY PIES; PASTIES; MEAT, VEGETABLE, FRUIT AND SWEET PIES; MEAT, VEGETABLE, FRUIT AND SWEET PASTRIES; VEGETABLE, FRUIT AND SWEET PARTY PIES; POT PIES; SAUSAGE ROLLS; MEAT, CHEESE AND VEGETABLE PARTY ROLLS; SAVOURY ROLLS; COCKTAIL ROLLS; MEAT AND VEGETABLE PASTIES; PIZZA; PIZZA PIES; SAVOURIES; NAMELY, FILLED BREAD PRODUCTS, NAMELY JAFFLES; BISCUITS, CAKES, DESSERTS, NAMELY, STRUDELS AND LAMINGTONS, WAFFLES, PANCAKES, DOUGHNUTS, DANISH PASTRIES; PUDDINGS; SPONGE CAKES; SHORTBREADS; ICES AND ICE-CREAM; CHEESECAKES; CUSTARD PIES; FRUIT CRUMBLE CAKES; FROZEN FRUIT BASED DESSERTS, NAMELY, FROZEN YOGHURTS (U.S. CL. 46). STEVEN JACKSON, EXAMINING ATTORNEY

SN 78-819,765. PATTIES FOODS LTD., VICTORIA, AUSTRALIA, FILED 2-21-2006.

HERBERT ADAMS

THE MARK CONSISTS OF STANDARD CHARACTERS WITHOUT CLAIM TO ANY PARTICULAR FONT, STYLE, SIZE, OR COLOR. THE NAME(S), PORTRAIT(S), AND/OR SIGNATURE(S) SHOWN IN THE MARK DOES NOT IDENTIFY A PARTICULAR LIVING INDIVIDUAL. FOR PASTRY PRODUCTS, NAMELY, QUICHES; PASTRIES; PIES; PARTY PIES; PASTIES; MEAT, VEGETABLE, FRUIT AND SWEET PIES; MEAT, VEGETABLE, FRUIT AND SWEET PASTRIES; MEAT, VEGETABLE, FRUIT AND SWEET PARTY PIES; POT PIES; SAUSAGE ROLLS; MEAT, CHEESE AND VEGETABLE PARTY ROLLS; SAVOURY ROLLS; COCKTAIL ROLLS; MEAT AND VEGETABLE PASTIES; PIZZAS; PIZZA PIES; SAVOURIES; NAMELY, FILLED BREAD PRODUCTS, NAMELY, JAFFLES; BISCUITS, CAKES, DESSERTS, NAMELY, STRUDELS AND LAMINGTONS, WAFFLES, PANCAKES, DOUGHNUTS, DANISH PASTRIES; PUDDINGS; SPONGE CAKES; SHORTBREADS; ICES AND ICE CREAM; CHEESECAKES; CUSTARD PIES; FRUIT CRUMBLE CAKES; FROZEN FRUIT BASED DESSERTS, NAMELY, FROZEN YOGHURTS (U.S. CL. 46). STEVEN JACKSON, EXAMINING ATTORNEY

CLASS 30—(Continued).

SN 78-819,772. PATTIES FOODS LTD., VICTORIA, AUSTRALIA, FILED 2-21-2006.



NO CLAIM IS MADE TO THE EXCLUSIVE RIGHT TO USE "SINCE 1909", APART FROM THE MARK AS SHOWN. THE NAME(S), PORTRAIT(S), AND/OR SIGNATURE(S) SHOWN IN THE MARK DOES NOT IDENTIFY A PARTICULAR LIVING INDIVIDUAL.

FOR PASTRY PRODUCTS, NAMELY, QUICHES; PIES, PASTIES, SAUSAGE ROLLS, PARTY ROLLS AND COCKTAIL ROLLS; POT PIES, VEGETABLE PASTIES, CHEESE AND VEGETABLE SAVOURY ROLLS; CAKES; BISCUITS; DONUTS; PUDDINGS; SPONGE CAKES; SHORTBREADS; SAVOURIES, NAMELY FILLED BREAD PRODUCTS, NAMELY JAFFLES (U.S. CL. 46). STEVEN JACKSON, EXAMINING ATTORNEY

CLASS 30—(Continued).

CRUSTS; FROZEN YOGHURT ; FRUIT CAKES; FRUIT ICE; FRUIT ICE BAR; FRUIT ICES; GROUND COFFEE BEANS; HOT CHOCOLATE; ICE; ICE BLOCKS; ICE CANDIES; ICE CREAM; ICE CREAM DRINKS; ICE CREAM MIXES; ICE CREAM POWDER; ICE CREAM SUBSTITUTE; ICE CUBES; ICE MILK; ICE MILK BARS; ICE-CREAM CAKES; ICED CAKES; ICED TEA; ICING; ICING MIXES; INSTANT COFFEE; JAPANESE STYLE STEAMED CAKES (MUSHI-GASHI); MILK CHOCOLATE; MIXES FOR BAKERY GOODS; PASTRIES; PASTRY SHELLS FOR MONAKA; POUNDED RICE CAKES (MOCHI); PREPARED COFFEE AND COFFEE-BASED BEVERAGES; RICE CAKES; ROASTED COFFEE BEANS; SOFT PIN-ROLLED CAKES OF POUNDED RICE (GYUHI); SOY-BASED ICE CREAM SUBSTITUTE; SPONGE CAKES; SPREAD CONTAINING CHOCOLATE AND NUTS; STARCH-BASED BINDING AGENTS FOR ICE CREAM; STARCH-BASED THICKENERS FOR WHIPPED CREAM; SUGAR-COATED COFFEE BEANS; SWEET POUNDED RICE CAKES (MOCHI-GASHI); TARTS (U.S. CL. 46).

JORDAN BAKER, EXAMINING ATTORNEY

SN 78-856,949. NOBLE GRACE LLC, NEW YORK, NY. FILED 4-7-2006.

SN 78-863,019. PATTIES FOODS LTD., VICTORIA, AUSTRALIA, FILED 4-17-2006.

Horoscope

THE MARK CONSISTS OF STANDARD CHARACTERS WITHOUT CLAIM TO ANY PARTICULAR FONT, STYLE, SIZE, OR COLOR.

FOR ALMOND CAKE; BAKERY DESSERTS; BAKERY GOODS; BAKERY PRODUCTS; BAKERY PRODUCTS, NAMELY SWEET BAKERY GOODS; BEVERAGES MADE OF COFFEE; CAFFEINE-FREE COFFEE; CAKE DOUGHS; CAKE MIXES; CAKES; CAKES OF SUGAR-BOUNDED MILLET OR POPPED RICE (OKOSHI); CANDY CAKE DECORATIONS; CANDY DECORATIONS FOR CAKES; CHICORY BASED COFFEE SUBSTITUTE; CHOCOLATE; CHOCOLATE BARS; CHOCOLATE CANDIES; CHOCOLATE CHIPS; CHOCOLATE COVERED NUTS; CHOCOLATE FONDUE; CHOCOLATE FOOD BEVERAGES NOT BEING DAIRY-BASED OR VEGETABLE BASED; CHOCOLATE MOUSSE; CHOCOLATE PASTES; CHOCOLATE POWDER; CHOCOLATE SYRUP; CHOCOLATE TOPPING; CHOCOLATE TRUFFLES; CHOCOLATE-BASED FILLINGS FOR CAKES AND PIES; CHOCOLATE-BASED READY-TO-EAT FOOD BARS; COFFEE; COFFEE; COFFEE BEANS; COFFEE FLAVORED SYRUP USED IN MAKING FOOD BEVERAGES; COFFEE PODS; COFFEE SUBSTITUTES; COFFEE SUBSTITUTES; COFFEE-BASED BEVERAGE CONTAINING MILK; CONES FOR ICE CREAM; COOKIE MIXES; COOKIES; CREAM BUNS; CREAM PUFFS; CUSTARD-BASED FILLINGS FOR CAKES AND PIES; DANISH PASTRIES; DRIED SUGARED CAKES OF RICE FLOUR (RAKUGAN); EDIBLE CAKE DECORATIONS; EDIBLE DECORATIONS FOR CAKES; EDIBLE FRUIT ICES; FILLED CHOCOLATE; FLAVORED ICES; FLAVOURINGS FOR CAKES OTHER THAN ESSENTIAL OILS; FOOD PACKAGE COMBINATIONS CONSISTING PRIMARILY OF BREAD, CRACKERS AND/OR COOKIES; FRIED DOUGH COOKIES (KARINTOH); FROZEN PIE

FOUR'N TWENTY THE GREAT AUSTRALIAN TASTE

THE MARK CONSISTS OF STANDARD CHARACTERS WITHOUT CLAIM TO ANY PARTICULAR FONT, STYLE, SIZE, OR COLOR.

NO CLAIM IS MADE TO THE EXCLUSIVE RIGHT TO USE "GREAT AUSTRALIAN TASTE", APART FROM THE MARK AS SHOWN.

FOR PASTRY PRODUCTS, NAMELY, QUICHES; PASTRIES; PIES; PARTY PIES; PASTIES; MEAT, VEGETABLE, FRUIT AND SWEET PIES; MEAT, VEGETABLE, FRUIT AND SWEET PASTRIES; VEGETABLE, FRUIT AND SWEET PARTY PIES; POT PIES; SAUSAGE ROLLS; MEAT, CHEESE AND VEGETABLE PARTY ROLLS; SAVOURY ROLLS; COCKTAIL ROLLS; MEAT AND VEGETABLE PASTIES; PIZZA; PIZZA PIES; SAVOURIES; NAMELY, FILLED BREAD PRODUCTS, NAMELY JAFFLES; BISCUITS, CAKES, DESSERTS, NAMELY, STRUDELS AND LAMINGTONS, WAFFLES, PANCAKES, DOUGHNUTS, DANISH PASTRIES; PUDDINGS; SPONGE CAKES; SHORTBREADS; ICE AND ICE-CREAM; CHEESECAKES; CUSTARD PIES; FRUIT CRUMBLE CAKES; FROZEN FRUIT BASED DESSERTS, NAMELY FROZEN YOGHURTS (U.S. CL. 46).

STEVEN JACKSON, EXAMINING ATTORNEY

CLASS 30—(Continued).

SN 78-886,995. GRUPO BIMBO, S.A. B. DE C.V., MEXICO CITY, MEXICO, FILED 5-18-2006.



FOR CHOCOLATE COVERED MARSHMALLOWS (U.S. CL. 46).
FIRST USE 7-28-2005; IN COMMERCE 7-28-2005.
BENJAMIN OKEKE, EXAMINING ATTORNEY

CLASS 30—(Continued).

SN 78-942,132. NUTRATERRA, LLC, BERWYN, PA. FILED 8-1-2006.

CAFFE ACAPELLA

THE MARK CONSISTS OF STANDARD CHARACTERS WITHOUT CLAIM TO ANY PARTICULAR FONT, STYLE, SIZE, OR COLOR.

NO CLAIM IS MADE TO THE EXCLUSIVE RIGHT TO USE "CAFFE", APART FROM THE MARK AS SHOWN.

THE FOREIGN WORDING IN THE MARK TRANSLATES INTO ENGLISH AS COFFEE.

FOR COFFEE CONFECTIONERY PRODUCTS, NAMELY, COFFEE CONFECTIONERY BARS, COATINGS FOR ICE CREAM, CANDY DROPS, CHIPS, CHUNKS, NAMELY, FOR COATINGS FOR ICE CREAM, PASTRIES, AND CAKES, BAKING COFFEE CONFECTIONERY, COFFEE CONFECTIONERY MIXES FOR COOKIES, CAKE, MUFFINS AND BREAD, COFFEE CONFECTIONERY COATED ICE CREAM, BAKED GOODS, NAMELY, PASTRIES, CAKES, COOKIES, AND MUFFINS, AND COFFEE-BASED FILLINGS FOR CANDY; COFFEE CONFECTIONERY SPREADS AND ICINGS; AND COFFEE (U.S. CL. 46).

DAYNA BROWNE, EXAMINING ATTORNEY

SN 78-942,218. NUTRATERRA, LLC, BERWYN, PA. FILED 8-1-2006.

SN 78-922,948. THE COCA-COLA COMPANY, ATLANTA, GA. FILED 7-5-2006.



ART HAUS

NO CLAIM IS MADE TO THE EXCLUSIVE RIGHT TO USE "CAFFE", APART FROM THE MARK AS SHOWN.

THE FOREIGN WORDING IN THE MARK TRANSLATES INTO ENGLISH AS COFFEE.

FOR COFFEE CONFECTIONERY PRODUCTS, NAMELY, COFFEE CONFECTIONERY BARS, COATINGS FOR ICE CREAM, CANDY DROPS, CHIPS, CHUNKS, NAMELY, FOR COATINGS FOR ICE CREAM, PASTRIES, AND CAKES, BAKING COFFEE CONFECTIONERY, COFFEE CONFECTIONERY MIXES FOR COOKIES, CAKE, MUFFINS AND BREAD, COFFEE CONFECTIONERY COATED ICE CREAM, BAKED GOODS, NAMELY, PASTRIES, CAKES, COOKIES, AND MUFFINS, AND COFFEE-BASED FILLINGS FOR CANDY; COFFEE CONFECTIONERY SPREADS AND ICINGS; AND COFFEE (U.S. CL. 46).

BARNEY CHARLON, EXAMINING ATTORNEY

THE MARK CONSISTS OF STANDARD CHARACTERS WITHOUT CLAIM TO ANY PARTICULAR FONT, STYLE, SIZE, OR COLOR.

THE FOREIGN WORDING IN THE MARK TRANSLATES INTO ENGLISH AS HOUSE.

FOR COFFEE; COFFEE ESSENCES, NOT FOR ESSENTIAL OILS; COFFEE EXTRACTS; DECAFFEINATED COFFEE; COFFEE SUBSTITUTES; ARTIFICIAL COFFEE; COFFEE FLAVORINGS (U.S. CL. 46).

CAROLYN CATALDO, EXAMINING ATTORNEY

CLASS 30—(Continued).

SN 78-948,503. WM. WRIGLEY JR. COMPANY, CHICAGO, IL. FILED 8-9-2006.

HUBBA BUBBA GUMMI TAPE

THE MARK CONSISTS OF STANDARD CHARACTERS WITHOUT CLAIM TO ANY PARTICULAR FONT, STYLE, SIZE, OR COLOR.

OWNER OF U.S. REG. NO. 2,579,033.

NO CLAIM IS MADE TO THE EXCLUSIVE RIGHT TO USE "GUMMI", APART FROM THE MARK AS SHOWN, FOR CONFECTIONERY, NAMELY CANDY (U.S. CL. 46).

KIMBERLY FRYE, EXAMINING ATTORNEY

CLASS 30—(Continued).

SN 78-954,005. ALIMENTOS NUTRABIEN S.A., SANTIAGO, CHILE. FILED 8-17-2006.



THE PORTRAIT(S) SHOWN IN THE MARK IDENTIFIES ISABELLA JARAS AND PATRICIO JARAS, WHOSE CONSENT(S) TO REGISTER IS SUBMITTED.

THE MARK CONSISTS OF THE WORDING NUTRA BIEN! WITHIN A BANNER SUPERIMPOSED OVER A STYLIZED DEPICTION OF TWO CHEFS WHO ARE THEMSELVES SUPERIMPOSED OVER A DIAMOND SHAPE.

THE FOREIGN WORDING IN THE MARK TRANSLATES INTO ENGLISH AS WELL.

FOR COOKIES, PASTRY, AND CEREAL-BASED SNACK FOOD (U.S. CL. 46).

DAVID MURRAY, EXAMINING ATTORNEY

SN 78-948,676. MARS, INCORPORATED, MCLEAN, VA. FILED 8-9-2006.



OWNER OF U.S. REG. NOS. 2,926,792, 3,051,283 AND 3,139,417.

NO CLAIM IS MADE TO THE EXCLUSIVE RIGHT TO USE "USA", APART FROM THE MARK AS SHOWN.

FOR BAKED GOODS, NAMELY, COOKIES (U.S. CL. 46).

FIRST USE 5-0-2005; IN COMMERCE 5-0-2005.
JOHN WILKE, EXAMINING ATTORNEY

SN 78-954,774. R & A PREMIUM FOODS LLC, CARNATION, WA. FILED 8-17-2006.

KONA UKULELE BLEND

SN 78-952,045. THE GIFT OF GAB, LLC, NEW YORK, NY. FILED 8-15-2006.

The Gift of Gab

THE MARK CONSISTS OF STANDARD CHARACTERS WITHOUT CLAIM TO ANY PARTICULAR FONT, STYLE, SIZE, OR COLOR.

FOR PACKAGED GRANOLA FOR USE AS A CEREAL, SNACK FOOD AND/OR DESSERT (U.S. CL. 46).

FIRST USE 9-23-2004; IN COMMERCE 6-10-2005.
LYDIA BELZER, EXAMINING ATTORNEY

THE MARK CONSISTS OF STANDARD CHARACTERS WITHOUT CLAIM TO ANY PARTICULAR FONT, STYLE, SIZE, OR COLOR.

NO CLAIM IS MADE TO THE EXCLUSIVE RIGHT TO USE "KONA" AND "BLEND", APART FROM THE MARK AS SHOWN.

FOR COFFEE (U.S. CL. 46).

FIRST USE 6-9-2006; IN COMMERCE 6-9-2006.
G. MAYERSCHOFF, EXAMINING ATTORNEY

CLASS 30—(Continued).

SN 78-957,088. MADE IN NATURE, LLC, FRESNO, CA. FILED 8-21-2006.



OWNER OF U.S. REG. NOS. 1,798,053 AND 2,215,887.
 NO CLAIM IS MADE TO THE EXCLUSIVE RIGHT TO USE "CERTIFIED ORGANIC", APART FROM THE MARK AS SHOWN.
 "THE STIPPLING IS FOR SHADING PURPOSES ONLY."
 THE MARK CONSISTS OF AN ORANGE AND A PEAR SURROUNDED BY TWO CONCENTRIC CIRCLES WHICH CONTAIN THE WORDS MADE IN NATURE THAT ARE TOTALLY OR PARTIALLY SHADED AND AN OBLONG CARRIER FOR THE WORDS CERTIFIED ORGANIC.
 FOR FRESH OR FROZEN PIZZA, PASTA, FLAT-BREADS AND CALZONES (U.S. CL. 46).
 DAYNA BROWNE, EXAMINING ATTORNEY

SN 78-958,690. WM. WRIGLEY JR. COMPANY, CHICAGO, IL. FILED 8-23-2006.



OWNER OF U.S. REG. NO. 970,276.
 FOR CONFECTIONERY, NAMELY, CHEWING GUM, BUBBLE GUM, CANDY AND MINTS (U.S. CL. 46).
 CHRISTOPHER OTT, EXAMINING ATTORNEY

SN 78-959,715. WM. WRIGLEY JR. COMPANY, CHICAGO, IL. FILED 8-24-2006.

SOUR GUMMI TAPE

THE MARK CONSISTS OF STANDARD CHARACTERS WITHOUT CLAIM TO ANY PARTICULAR FONT, STYLE, SIZE, OR COLOR.
 NO CLAIM IS MADE TO THE EXCLUSIVE RIGHT TO USE "SOUR GUMMI", APART FROM THE MARK AS SHOWN.
 FOR CONFECTIONERY, NAMELY, CANDY (U.S. CL. 46).
 KIMBERLY FRYE, EXAMINING ATTORNEY

CLASS 30—(Continued).

SN 78-963,961. AMAY'S BAKERY & NOODLE CO. INC., LOS ANGELES, CA. FILED 8-30-2006.



OWNER OF U.S. REG. NOS. 2,203,783 AND 3,196,478.
 THE TRANSLITERATION OF THE FOREIGN LETTERING IS AMAY'S.
 FOR COOKIES, ALMOND COOKIES, FORTUNE COOKIES, CHOCOLATE FORTUNE COOKIES, CHOCOLATE-DIPPED FORTUNE COOKIES, GIANT FORTUNE COOKIE, LEMON COOKIES, PECAN COOKIES, CRISPY NOODLES, FRIED NOODLES, CRISPY WONTON STRIPS, CRISPY WONTON CHIPS, NOODLES, FRESH NOODLES, FRESH EGG NOODLES, DUMPLING SKIN WRAPS, WONTON WRAPPERS, WONTON SKINS, EGG ROLL WRAPPERS, EGG ROLL SKINS, SUEY GOW WRAPPERS, SUEY GOW SKINS, POTSTICKER WRAPPERS, POTSTICKER SKINS, SPRING ROLL WRAPPERS, SPRING ROLL SKINS, PASTA, AND BAKERY PRODUCTS (U.S. CL. 46).
 FIRST USE 1-1-1969; IN COMMERCE 1-1-1969.
 AMY HELLA, EXAMINING ATTORNEY

SN 79-024,524. DORSET CEREALS LTD, UNITED KINGDOM, FILED 3-22-2006.



PRIORITY DATE OF 2-21-2006 IS CLAIMED.
 OWNER OF INTERNATIONAL REGISTRATION 0886646 DATED 3-22-2006, EXPIRES 3-22-2016.
 FOR BREAKFAST CEREALS; PROCESSED CEREALS; PREPARATIONS MADE FROM CEREALS, NAMELY, MUESLI AND BAKERY GOODS CONTAINING CEREAL (U.S. CL. 46).
 MICHAEL GAAFAR, EXAMINING ATTORNEY

CLASS 30—(Continued).

SN 79-029,924. NEROMODENA UK LTD., UNITED KINGDOM, FILED 8-2-2006.



OWNER OF INTERNATIONAL REGISTRATION 0901065 DATED 8-2-2006, EXPIRES 8-2-2016.

NO CLAIM IS MADE TO THE EXCLUSIVE RIGHT TO USE "ACETO BALSAMICO DI MODENA", APART FROM THE MARK AS SHOWN.

THE MARK CONSISTS OF THE WORDING "BALZEBU" EXTENDING HORIZONTALLY AND A DESIGN ELEMENT IN THE NATURE OF A RECTANGULAR SHAPE WHICH EXTENDS UPWARDLY ABOVE BALZEBU, AND THE WORDING "ACETO BALSAMICO DI MODENA" ON THE LEFT EXTENDING VERTICALLY.

THE FOREIGN WORDING IN THE MARK TRANSLATES INTO ENGLISH AS BALSAMIC VINEGAR OF MODENA.

FOR VINEGAR, SAUCES AND SPICES (U.S. CL. 46).
AMY ALFIERI, EXAMINING ATTORNEY

CLASS 30—(Continued).

SN 79-034,435. INDIAN S.R.L., ITALY, FILED 12-12-2006.



PRIORITY DATE OF 10-2-2006 IS CLAIMED.

OWNER OF INTERNATIONAL REGISTRATION 0913017 DATED 12-12-2006, EXPIRES 12-12-2016.

NO CLAIM IS MADE TO THE EXCLUSIVE RIGHT TO USE GELATO D'ITALIA, APART FROM THE MARK AS SHOWN.

THE MARK PRESENTS A COMPLEX TEXT COMPRISING SEVERAL GRAPHIC AND TEXT ELEMENTS; IN PARTICULAR THE MARK COMPRISES THE PORTRAIT OF A YOUNG MAN RIDING AN ICE-CREAM SELLER'S TRICYCLE; THIS PORTRAIT IS OVERPRINTED WITH THE TEXT "GELATO D'ITALIA" IN SPECIAL FONT ARRANGED ON TWO LINES.

THE ENGLISH TRANSLATION OF GELATO D'ITALIA IS ITALIAN ICE CREAM.

FOR ICES, NAMELY, FRUIT ICES, FLAVORED ICES; BINDERS FOR ICES, NAMELY STARCH-BASED BINDING AGENTS FOR ICE CREAM; ICE CREAM CONES; FRUIT-FLAVORED ICES; SORBETS, FROZEN YOGHURT; FROZEN CONFECTIONS; PREPARATIONS FOR MAKING ICES, NAMELY, SUGAR; PRODUCTS AND PREPARATIONS FOR MAKING ICES, NAMELY, ALMOND PASTE, CHOCOLATE PASTES, FRUIT PASTE FOR FLAVORING OF FOOD; ICE CREAM POWDER; INSTANT PREPARATIONS FOR MAKING ICES, NAMELY, SUGAR; CAKE DOUGHS; PASTA; SWEETS, NAMELY, CANDY; COFFEE; TEA; COCOA; SUGAR; RICE; TAPIOCA; ARTIFICIAL COFFEE; FLOUR; CEREAL PREPARATIONS, NAMELY, CEREAL BASED SNACK FOODS, READY TO EAT, CEREAL DERIVED FOOD BARS; BREAD; BISCUITS; TARTS, PASTRY; CONFECTIONERY CHIPS FOR BAKING; CANDIES, NAMELY, DRAGEES; HONEY; TOPPING SYRUP; PEPPER; VINEGAR; SAUCES, SPICES, ICE FOR REFRESHMENT; BEVERAGES MADE WITH COFFEE, COCOA OR CHOCOLATE (U.S. CL. 46).

GILBERT SWIFT, EXAMINING ATTORNEY

SN 79-032,002. JIANGSU DAYWELL FOODS CO., LTD, LIYANG CITY, JIANGSU PROVINCE, CHINA, FILED 6-6-2006.



PRIORITY DATE OF 1-9-2006 IS CLAIMED.

OWNER OF INTERNATIONAL REGISTRATION 0906222 DATED 6-6-2006, EXPIRES 6-6-2016.

FOR COFFEE; TEA; CONFECTIONERY IN THE NATURE OF PASTILLES; NURTURE NOT USED FOR MEDICAL PURPOSES, NAMELY ROYAL JELLY FOR FOOD PURPOSES; PASTRIES; CEREAL BASED SNACK FOOD; FOOD LEAVENING AGENTS; PUFFED CANDY FRUIT SLICES AND PUFFED CANDY GREENSTUFF SLICES; CONDIMENTS IN THE NATURE OF PEPPER SAUCE AND PIMENTO; FLAVOURINGS FOR FOODSTUFFS EXCEPT ETHERIC ESSENCES AND ESSENTIAL OIL (U.S. CL. 46).

RAMONA ORTIGA, EXAMINING ATTORNEY

CLASS 30—(Continued).

SN 79-038,699. SURGITAL S.P.A., ITALY, FILED 11-27-2006.



PRIORITY DATE OF 8-11-2006 IS CLAIMED.
OWNER OF INTERNATIONAL REGISTRATION 0924772 DATED 11-27-2006, EXPIRES 11-27-2016.

THE MARK CONSISTS OF A SIGN DEPICTING THE WORDING SUGOSI IN SHADED FANCY CHARACTERS, A STYLIZED LEAF DIVIDED INTO TWO PORTIONS BEING OVER THE LETTER O, ALL BEING INCLUDED IN A LABEL DEFINED BY A SUBSTANTIALLY IRREGULAR ELLIPTICAL FRAME, THE LEAF, THE INITIAL LETTER S AND THE LETTER I BEING PARTIALLY OVERLAPPING THAT FRAME.

FOR SAUCES; TOMATO SAUCES; TOMATO AND BASIL SAUCE; SPAGHETTI SAUCE; PIZZA SAUCE; FOUR CHEESE SAUCE; BOLOGNESE MEAT SAUCE; SALMON AND SWORDFISH SAUCE; FISH SAUCE; GENOVESE PESTO SAUCE; MUSHROOMS SAUCE; SPECK, BEING SMOKED HAM SAUCE; HAM SAUCE; ARTICHOKE SAUCE; SEASONINGS; BARBECUE SAUCE; CHILI SAUCE; HOT SAUCE; SOY SAUCE; TARTAR SAUCE; SPINACH SAUCE; VEGETABLE SAUCE; PINE-SEED AND WALNUT SAUCE; CARBONARA SAUCE; AMATRICIANA SAUCE; ARRABBIATA SAUCE; PROCESSED ALIMENTARY PASTA WITH VEGETABLE BASED SAUCE; PROCESSED ALIMENTARY PASTA WITH CHEESE BASED SAUCE; PROCESSED ALIMENTARY PASTA WITH FISH BASED SAUCE; PROCESSED ALIMENTARY PASTA WITH MEAT BASED SAUCE; PROCESSED ALIMENTARY PASTA WITH VEGETABLES AND CHEESE, NAMELY CANNELLONI AND LASAGNE; PROCESSED ALIMENTARY STUFFED PASTA, NAMELY RAVIOLI; PROCESSED RICE WITH VEGETABLE BASED SAUCE; PROCESSED RICE WITH CHEESE BASED SAUCE; PROCESSED RICE WITH FISH BASED SAUCE; PROCESSED RICE WITH MEAT BASED SAUCE; PROCESSED RICE WITH VEGETABLES; PROCESSED RICE WITH CHEESE (U.S. CL. 46).

NAAKWAMA ANKRAH, EXAMINING ATTORNEY

CLASS 31—NATURAL AGRICULTURAL PRODUCTS

SN 77-024,629. COMMERCIAL BUSINESS SERVICES LLC, WAYCROSS, GA. FILED 10-19-2006.

THE ORIGINAL 93 OCTANE FEED BOOSTER!

THE MARK CONSISTS OF STANDARD CHARACTERS WITHOUT CLAIM TO ANY PARTICULAR FONT, STYLE, SIZE, OR COLOR.

NO CLAIM IS MADE TO THE EXCLUSIVE RIGHT TO USE "ORIGINAL" AND "FEED BOOSTER", APART FROM THE MARK AS SHOWN.

FOR FOOD FOR ANIMALS; NON-MEDICATED ADDITIVES FOR ANIMAL FEED (U.S. CLS. 1 AND 46).

FIRST USE 9-0-2006; IN COMMERCE 9-0-2006.
JESSICA FATHY, EXAMINING ATTORNEY

CLASS 31—(Continued).

SN 77-052,785. MERRICK PET CARE, LTD., AMARILLO, TX. FILED 11-29-2006.

THANKSGIVING DAY DINNER

THE MARK CONSISTS OF STANDARD CHARACTERS WITHOUT CLAIM TO ANY PARTICULAR FONT, STYLE, SIZE, OR COLOR.

NO CLAIM IS MADE TO THE EXCLUSIVE RIGHT TO USE DINNER, APART FROM THE MARK AS SHOWN.

FOR PET FOOD (U.S. CLS. 1 AND 46).
FIRST USE 12-16-2003; IN COMMERCE 1-2-2004.
JOHN KELLY, EXAMINING ATTORNEY

SN 77-081,392. ARCADIA BIOSCIENCES, INC., DAVIS, CA. FILED 1-11-2007.



OWNER OF U.S. REG. NO. 3,216,702.
NO CLAIM IS MADE TO THE EXCLUSIVE RIGHT TO USE "BIOSCIENCES", APART FROM THE MARK AS SHOWN.

THE MARK CONSISTS OF THE STYLIZED WORDS ARCADIA BIOSCIENCES WITH A LEAF DESIGN.

FOR SEEDS AND LIVE PLANTS FOR AGRICULTURAL USE (U.S. CLS. 1 AND 46).

CURTIS FRENCH, EXAMINING ATTORNEY

SN 77-124,969. SDR FRUIT, LLC, BOULDER, CO. FILED 3-7-2007.

MONSTER COT

THE MARK CONSISTS OF STANDARD CHARACTERS WITHOUT CLAIM TO ANY PARTICULAR FONT, STYLE, SIZE, OR COLOR.

NO CLAIM IS MADE TO THE EXCLUSIVE RIGHT TO USE "COT", APART FROM THE MARK AS SHOWN.

FOR LIVE APRICOT TREES, AND FRESH APRICOTS (U.S. CLS. 1 AND 46).

NELSON SNYDER, EXAMINING ATTORNEY

CLASS 31—(Continued).

SN 77-124,987. SDR FRUIT, LLC, BOULDER, CO. FILED 3-7-2007.

SOL COT

THE MARK CONSISTS OF STANDARD CHARACTERS WITHOUT CLAIM TO ANY PARTICULAR FONT, STYLE, SIZE, OR COLOR.
NO CLAIM IS MADE TO THE EXCLUSIVE RIGHT TO USE "COT", APART FROM THE MARK AS SHOWN.
FOR LIVE APRICOT TREES, AND FRESH APRICOTS (U.S. CLS. 1 AND 46).
NELSON SNYDER, EXAMINING ATTORNEY

SN 77-128,571. BALL HORTICULTURAL COMPANY, WEST CHICAGO, IL. FILED 3-12-2007.

FastFlowers

THE MARK CONSISTS OF STANDARD CHARACTERS WITHOUT CLAIM TO ANY PARTICULAR FONT, STYLE, SIZE, OR COLOR.
FOR LIVE PLANTS AND PLANT SEEDS (U.S. CLS. 1 AND 46).
SHANNON TWOHIG, EXAMINING ATTORNEY

SN 77-129,430. RADER, NED D., AMANDA, OH. FILED 3-13-2007.

LEMON PFIZZ

THE MARK CONSISTS OF STANDARD CHARACTERS WITHOUT CLAIM TO ANY PARTICULAR FONT, STYLE, SIZE, OR COLOR.
NO CLAIM IS MADE TO THE EXCLUSIVE RIGHT TO USE "LEMON", APART FROM THE MARK AS SHOWN.
FOR LIVE PLANTS, NAMELY JUNIPERS (U.S. CLS. 1 AND 46).
ZACHARY BELLO, EXAMINING ATTORNEY

CLASS 31—(Continued).

SN 77-137,389. FETCH INC., ENGLEWOOD CLIFFS, NJ. FILED 3-22-2007.



FOR PET BEVERAGES (U.S. CLS. 1 AND 46).
JERI J. FICKES, EXAMINING ATTORNEY

SN 77-138,515. HUSTON, JAMES, BIRMINGHAM, MI. FILED 3-23-2007.

ESTA

THE MARK CONSISTS OF STANDARD CHARACTERS WITHOUT CLAIM TO ANY PARTICULAR FONT, STYLE, SIZE, OR COLOR.
FOR FRESH ONIONS (U.S. CLS. 1 AND 46).
STEVEN R. FOSTER, EXAMINING ATTORNEY

SN 77-139,757. VIECELI, MARK J, GREENWOOD, SC. FILED 3-25-2007.

Dogevity

THE MARK CONSISTS OF STANDARD CHARACTERS WITHOUT CLAIM TO ANY PARTICULAR FONT, STYLE, SIZE, OR COLOR.
FOR DOG BISCUITS; DOG FOOD; DOG TREATS (U.S. CLS. 1 AND 46).
MARTHA FROMM, EXAMINING ATTORNEY

CLASS 31—(Continued).

SN 77-140,020. FORMAN, DAVID, NEW YORK, NY. AND FORMAN, STACIE, NEW YORK, NY. FILED 3-26-2007.

REX AND THE KITTY

THE MARK CONSISTS OF STANDARD CHARACTERS WITHOUT CLAIM TO ANY PARTICULAR FONT, STYLE, SIZE, OR COLOR.
FOR PET FOOD (U.S. CLS. 1 AND 46).
FRANK LATTUCA, EXAMINING ATTORNEY

CLASS 31—(Continued).

SN 77-142,734. GELSON'S MARKETS, ENCINO, CA. FILED 3-28-2007.



NO CLAIM IS MADE TO THE EXCLUSIVE RIGHT TO USE "ORGANIC", APART FROM THE MARK AS SHOWN.
THE COLOR(S) GREEN, GOLD, ORANGE, AND WHITE IS/ARE CLAIMED AS A FEATURE OF THE MARK.
THE MARK CONSISTS OF A DESIGN CONSISTING OF A CIRCLE CONTAINING TWO BROAD GREEN LEAVES IN THE LOWER PORTION, AN IMAGE OF A GOLD RISING SUN IN THE CENTER, AND THE WORD "ORGANIC" IN THE UPPER PORTION. THE SKY ABOVE THE RISING SUN IS ORANGE AND THE WORD "ORGANIC" IS GREEN; THE COLOR WHITE APPEARS IN THE DRAWING IN THE CIRCLE AS AN OUTLINE BETWEEN THE INNER SUN AND LEAF DESIGN AND AN OUTER GREEN BORDER.
FOR FRESH VEGETABLES, FRESH FRUITS, FRESH NUTS; FRESH HERBS; PET FOOD (U.S. CLS. 1 AND 46).
FIRST USE 6-5-2006; IN COMMERCE 6-27-2006.
JORDAN BAKER, EXAMINING ATTORNEY

SN 77-141,213. A. PERRI FARMS INC., RONKONKOMA, NY. FILED 3-27-2007.

Sun Touched Collection

THE MARK CONSISTS OF STANDARD CHARACTERS WITHOUT CLAIM TO ANY PARTICULAR FONT, STYLE, SIZE, OR COLOR.
NO CLAIM IS MADE TO THE EXCLUSIVE RIGHT TO USE "COLLECTION", APART FROM THE MARK AS SHOWN.
FOR LIVE FLOWERS (U.S. CLS. 1 AND 46).
FIRST USE 1-1-2007; IN COMMERCE 1-1-2007.
MICHAEL WEBSTER, EXAMINING ATTORNEY

SN 77-143,217. XLNT VETERINARY CARE, INC., LOS GATOS, CA. FILED 3-28-2007.



NO CLAIM IS MADE TO THE EXCLUSIVE RIGHT TO USE "PET", APART FROM THE MARK AS SHOWN.
THE COLOR(S) BLACK, GRAY, WHITE AND RED IS/ARE CLAIMED AS A FEATURE OF THE MARK.
THE COLOR RED APPEARS IN THE WORDING "PET DRX". THE EARPIECES OF THE STETHOSCOPE FORMING A HEART, AND SHADING, REFLECTIONS, AND TONALITIES ALONG A SPECTRUM FROM RED TO BLACK IN THE SINGLE LUMEN TUBING OF THE STETHOSCOPE; THE COLOR BLACK APPEARS IN THE EARPIECE, TUBING AND OUTLINE OF THE STETHOSCOPE, AND, THE OUTLINE OF THE CROSS; THE COLOR GRAY APPEARS IN THE SHADING OF THE STETHOSCOPE CHESTPIECE AND SHADOWS ON AND AROUND THE CROSS; THE COLOR WHITE APPEARS IN THE CROSS AND AS HIGHLIGHTS ON THE STETHOSCOPE.
FOR PET FOODS AND TREATS (U.S. CLS. 1 AND 46).
HANNO RITTNER, EXAMINING ATTORNEY

CLASS 31—(Continued).

SN 77-143,597. PHILLIPS SEAFOODS, INC., SEATTLE, WA. FILED 3-29-2007.

WILDSIDESALMON

THE MARK CONSISTS OF STANDARD CHARACTERS WITHOUT CLAIM TO ANY PARTICULAR FONT, STYLE, SIZE, OR COLOR.
FOR PET FOOD; PET TREATS (U.S. CLS. 1 AND 46).
FIRST USE 2-24-2000; IN COMMERCE 2-24-2000.
TARAH HARDY, EXAMINING ATTORNEY

SN 77-150,316. J. POUW BEHEER B.V., BOSKOOP, NETHERLANDS, FILED 4-6-2007.

True

THE MARK CONSISTS OF STANDARD CHARACTERS WITHOUT CLAIM TO ANY PARTICULAR FONT, STYLE, SIZE, OR COLOR.
FOR LIVE FLOWERS, SPECIFICALLY ROSES (U.S. CLS. 1 AND 46).
MAUREEN DALL, EXAMINING ATTORNEY

SN 77-151,218. J. POUW BEHEER B.V., BOSKOOP, NETHERLANDS, FILED 4-7-2007.

True.

THE MARK CONSISTS OF STANDARD CHARACTERS WITHOUT CLAIM TO ANY PARTICULAR FONT, STYLE, SIZE, OR COLOR.
FOR LIVE FLOWERS, SPECIFICALLY ROSES (U.S. CLS. 1 AND 46).
MAUREEN DALL, EXAMINING ATTORNEY

CLASS 31—(Continued).

SN 77-156,749. RUSSELL III, MILAS, YUMA, AZ. FILED 4-13-2007.

Savor Fresh

THE MARK CONSISTS OF STANDARD CHARACTERS WITHOUT CLAIM TO ANY PARTICULAR FONT, STYLE, SIZE, OR COLOR.
NO CLAIM IS MADE TO THE EXCLUSIVE RIGHT TO USE "FRESH", APART FROM THE MARK AS SHOWN.
FOR FRESH FRUITS; FRESH VEGETABLES (U.S. CLS. 1 AND 46).
GENE MACIOL, EXAMINING ATTORNEY

SN 78-124,012. PURINA MILLS LLC, ARDEN HILLS, MN. FILED 4-25-2002.

FELINE MEDLEY

NO CLAIM IS MADE TO THE EXCLUSIVE RIGHT TO USE "FELINE", APART FROM THE MARK AS SHOWN.
FOR CAT FOOD AND CAT TREATS (U.S. CLS. 1 AND 46).
LAURA KOVALSKY, EXAMINING ATTORNEY

SN 78-551,172. THOMPSON HOLDINGS, L.P., NEW YORK, NY. FILED 1-20-2005.



THE MARK CONSISTS OF THE CONFIGURATION OF A PIECE OF PET FOOD IN THE SHAPE OF A PRETZEL KNOT.
SEC. 2(F).
FOR PET FOOD (U.S. CLS. 1 AND 46).
FIRST USE 0-0-1995; IN COMMERCE 0-0-1995.
DOMINIC J. FERRAIUOLO, EXAMINING ATTORNEY

CLASS 31—(Continued).

SN 78-735,732. PLANT DEVELOPMENT SERVICES INC., LOXLEY, AL. FILED 10-18-2005.

EMILY ANN

THE MARK CONSISTS OF STANDARD CHARACTERS WITHOUT CLAIM TO ANY PARTICULAR FONT, STYLE, SIZE, OR COLOR.

FOR LIVE FLOWERING PLANTS; LIVING FRUIT PLANTS; LIVING PLANTS; PLANT SEEDS (U.S. CLS. 1 AND 46).

FIRST USE 4-1-2005; IN COMMERCE 4-1-2005.
JOHN GARTNER, EXAMINING ATTORNEY

SN 78-754,631. HINES NURSERIES, INC., IRVINE, CA. FILED 11-15-2005.

CHERRY BON BON

THE MARK CONSISTS OF STANDARD CHARACTERS WITHOUT CLAIM TO ANY PARTICULAR FONT, STYLE, SIZE, OR COLOR.

NO CLAIM IS MADE TO THE EXCLUSIVE RIGHT TO USE "CHERRY", APART FROM THE MARK AS SHOWN. FOR LIVE FLOWERING PLANTS (U.S. CLS. 1 AND 46).

FIRST USE 2-1-2006; IN COMMERCE 2-1-2006.
MYRIAH HABEEB, EXAMINING ATTORNEY

SN 78-775,840. HEART OF FLORIDA GREENHOUSES, INC., ZOLFO SPRINGS, FL. FILED 12-19-2005.

HEARTS  *DESIRE*

NO CLAIM IS MADE TO THE EXCLUSIVE RIGHT TO USE "HEARTS DESIRE", APART FROM THE MARK AS SHOWN.

THE MARK CONSISTS OF THE WORDING HEARTS DESIRE WITH A HEART DESIGN BETWEEN THE TWO WORDS.

FOR LIVE FLOWERING PLANTS, LIVING PLANTS, PLANT SEEDS, LIVE FLOWERS, FLOWER SEEDS, NATURAL FLOWERS AND CUT FLOWERS, EXCLUDING ROSES (U.S. CLS. 1 AND 46).

FIRST USE 8-1-2005; IN COMMERCE 8-1-2005.
NELSON SNYDER, EXAMINING ATTORNEY

CLASS 31—(Continued).

SN 78-885,287. HAWKINS, CYNTHIA K., DBA REDBONES DOG BAKERY, FERNANDINA BEACH, FL. FILED 5-17-2006.

REDBONES

THE MARK CONSISTS OF STANDARD CHARACTERS WITHOUT CLAIM TO ANY PARTICULAR FONT, STYLE, SIZE, OR COLOR.

FOR DOG TREATS (U.S. CLS. 1 AND 46).
FIRST USE 10-1-2004; IN COMMERCE 10-1-2004.
JENNY PARK, EXAMINING ATTORNEY

SN 78-897,550. FRESH ASPARAGUS E.I.R.L. DE PERU, MIAMI, FL. FILED 5-31-2006.



OWNER OF PERU REG. NO. 012513, DATED 10-29-2003, EXPIRES 10-29-2013.

NO CLAIM IS MADE TO THE EXCLUSIVE RIGHT TO USE "FRESH ASPARAGUS", APART FROM THE MARK AS SHOWN.

THE COLOR(S) GREEN, YELLOW AND BLACK IS/ARE CLAIMED AS A FEATURE OF THE MARK.

THE COLOR YELLOW APPEARS IN THE WORDS MAMITA'S AND FRESH ASPARAGUS, THE DRESS, SHOES, AND THE MOUTH; THE STYLIZED FIGURE AND THE OUTLINE OF THE LETTERS IN THE WORD MAMITA'S ARE IN GREEN; THE EYES OF THE FIGURE ARE IN BLACK AND YELLOW.

"THE FOREIGN WORDING IN THE MARK TRANSLATES INTO ENGLISH AS LITTLE MOTHER."

SEC. 2(F).
FOR FRESH ASPARAGUS FOR THE WHOLESALE MARKET (U.S. CLS. 1 AND 46).

JOHN E. MICHOS, EXAMINING ATTORNEY

CLASS 31—(Continued).

SN 78-958,639. EAGLE AQUACULTURE, INC., AUBURN, AL. FILED 8-23-2006.



OWNER OF U.S. REG. NO. 3,196,189.
NO CLAIM IS MADE TO THE EXCLUSIVE RIGHT TO USE "AQUACULTURE, INC.", APART FROM THE MARK AS SHOWN.

"THE COLOR(S) BLUE IS/ARE CLAIMED AS A FEATURE OF THE MARK."

"THE MARK CONSISTS OF THE WORDS EAGLE AQUACULTURE, INC., A CIRCLE WITH A DRAWING OF A FISH INSIDE, AND WAVY LINES. THE COLOR BLUE APPEARS IN THE WORDING, THE LINES, THE CIRCLE, AND THE OUTLINE OF THE FISH; THE COLOR WHITE INSIDE THE CIRCLE AND BEHIND THE FISH SIMPLY CONSTITUTES BACKGROUND OR TRANSPARENT AREAS AND IS NOT PART OF THE MARK."

FOR LIVE FISH FOR FOOD PURPOSES (U.S. CLS. 1 AND 46).

FIRST USE 2-7-2005; IN COMMERCE 8-5-2005.
MARTHA FROMM, EXAMINING ATTORNEY

CLASS 32—LIGHT BEVERAGES

SN 76-659,067. SAFEWAY INC., PLEASANTON, CA. FILED 4-24-2006.



NO CLAIM IS MADE TO THE EXCLUSIVE RIGHT TO USE "COLA", APART FROM THE MARK AS SHOWN.

FOR SODA POPS (U.S. CLS. 45, 46 AND 48).

FIRST USE 7-1-2006; IN COMMERCE 7-1-2006.

DEZMONA MIZELLE, EXAMINING ATTORNEY

CLASS 32—(Continued).

SN 76-674,483. TROPICAL PARADISE, INC., BEDFORD, MA. FILED 3-23-2007.

BE COOL @ SCHOOL

THE MARK CONSISTS OF STANDARD CHARACTERS WITHOUT CLAIM TO ANY PARTICULAR FONT, STYLE, SIZE, OR COLOR.

FOR NON-ALCOHOLIC FRUIT JUICES (U.S. CLS. 45, 46 AND 48).

FIRST USE 7-1-2004; IN COMMERCE 7-1-2004.

DAVID TOOLEY, EXAMINING ATTORNEY

SN 76-676,517. TROPICAL PARADISE, INC., BEDFORD, MA. FILED 5-7-2007.

500% COOL

THE MARK CONSISTS OF STANDARD CHARACTERS WITHOUT CLAIM TO ANY PARTICULAR FONT, STYLE, SIZE, OR COLOR.

FOR NON-ALCOHOLIC FRUIT JUICES (U.S. CLS. 45, 46 AND 48).

FIRST USE 7-1-2004; IN COMMERCE 7-1-2004.

DAVID TOOLEY, EXAMINING ATTORNEY

SN 77-049,653. CLIF BAR & CO., BERKELEY, CA. FILED 11-22-2006.

LUNA ELIXIR

THE MARK CONSISTS OF STANDARD CHARACTERS WITHOUT CLAIM TO ANY PARTICULAR FONT, STYLE, SIZE, OR COLOR.

THE FOREIGN WORDING IN THE MARK TRANSLATES INTO ENGLISH AS MOON.

FOR FORTIFIED DRY BEVERAGE MIX FOR MAKING FRUIT-FLAVORED SOFT DRINKS (U.S. CLS. 45, 46 AND 48).

FIRST USE 10-5-2006; IN COMMERCE 10-5-2006.

PAMELA HIRSCHMAN, EXAMINING ATTORNEY

CLASS 32—(Continued).

SN 77-073,655. KAGOME CO., LTD., NAGOYA, JAPAN,
FILED 12-29-2006.

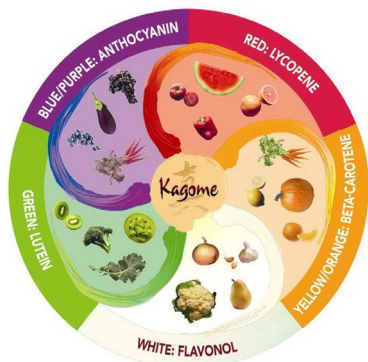

OWNER OF U.S. REG. NOS. 1,589,138, 2,315,177 AND
3,152,823.

NO CLAIM IS MADE TO THE EXCLUSIVE RIGHT TO USE "BLUE/PURPLE ANTHOCYANIN, RED: LYCOPENE, YELLOW/ORANGE BETA-CAROTENE, WHITE: FLAVONOL, GREEN LUTEIN," AS WELL AS THE REPRESENTATIONS OF THE FRUITS AND VEGETABLES DEPICTED IN THE MARK, NAMELY, GRAPES, EGGPLANT, BEETS, PEPPERS, TOMATOES, WATERMELON, GRAPEFRUIT, CARROTS, ORANGES, PUMPKIN, LEMONS, ONIONS, PEARS, CAULIFLOWER, GARLIC, KIWI, BROCCOLI, GREEN LEAF AND BERRIES, APART FROM THE MARK AS SHOWN.

THE APPLICANT CLAIMS COLOR AS A FEATURE OF THE MARK, NAMELY, WHITE, BLUE, PURPLE, RED, ORANGE, YELLOW, GREEN, PEACH, AND BROWN.

THE MARK CONSISTS OF THE DESIGN OF A WHEEL OR DISC DIVIDED INTO SECTIONS SHOWING A BLUE AND PURPLE SECTION AT TOP LEFT; A RED AND ORANGE SECTION AT TOP RIGHT; AN ORANGE AND YELLOW SECTION AT RIGHT; A WHITE SECTION AT THE BOTTOM; A GREEN SECTION AT LEFT; AND A PEACH-COLORED SECTION IN THE CENTER WITH THE WORD KAGOME IN PURPLE AND THE KANJI CHARACTER MAKOTO IN BROWN. THE MARK CONSISTS OF THE FOLLOWING WORDINGS: BLUE/PURPLE: ANTHOCYANIN IN THE COLOR WHITE ON A PURPLE BACKGROUND, RED: LYCOPENE IN THE COLOR WHITE ON A REDDISH ORANGE BACKGROUND, YELLOW/ORANGE: BETA-CAROTENE IN THE COLOR WHITE ON AN ORANGE BACKGROUND, WHITE: FLAVONOL IN THE COLOR DARK BROWN ON AN IVORY BACKGROUND, GREEN: LUTEIN IN THE COLOR WHITE ON A GREEN BACKGROUND.

THE ENGLISH TRANSLATION OF THE WORD KAGOME IN THE MARK IS "WOVEN BAMBOO PATTERNS".

THE KANJI CHARACTER IN THE MARK TRANSLITERATES TO "MAKOTO" AND THIS TRANSLATES TO "TRUE" IN ENGLISH.

FOR BLENDED JUICES OF VEGETABLES AND FRUITS (U.S. CLS. 45, 46 AND 48).

MATTHEW EINSTEIN, EXAMINING ATTORNEY

CLASS 32—(Continued).

SN 77-093,738. ABITA BREWING CO., L.L.C., ABITA
SPRINGS, LA. FILED 1-29-2007.

RESTORATION ALE

THE MARK CONSISTS OF STANDARD CHARACTERS WITHOUT CLAIM TO ANY PARTICULAR FONT, STYLE, SIZE, OR COLOR.

NO CLAIM IS MADE TO THE EXCLUSIVE RIGHT TO USE "ALE", APART FROM THE MARK AS SHOWN.

FOR BEER, ALE, MALT LIQUOR AND LAGER (U.S. CLS. 45, 46 AND 48).

ANNE FARRELL, EXAMINING ATTORNEY

SN 77-093,810. ABITA BREWING CO., L.L.C., ABITA
SPRINGS, LA. FILED 1-29-2007.

LOUISIANA TRUE

THE MARK CONSISTS OF STANDARD CHARACTERS WITHOUT CLAIM TO ANY PARTICULAR FONT, STYLE, SIZE, OR COLOR.

NO CLAIM IS MADE TO THE EXCLUSIVE RIGHT TO USE "LOUISIANA", APART FROM THE MARK AS SHOWN.

FOR BEER, ALE, MALT LIQUOR AND LAGER (U.S. CLS. 45, 46 AND 48).

BERYL GARDNER, EXAMINING ATTORNEY

SN 77-102,983. ABITA BREWING CO., L.L.C., ABITA
SPRINGS, LA. FILED 2-8-2007.

JOCKAMO IPA

THE MARK CONSISTS OF STANDARD CHARACTERS WITHOUT CLAIM TO ANY PARTICULAR FONT, STYLE, SIZE, OR COLOR.

NO CLAIM IS MADE TO THE EXCLUSIVE RIGHT TO USE "IPA", APART FROM THE MARK AS SHOWN.

FOR BEER, ALE, MALT LIQUOR AND LAGER (U.S. CLS. 45, 46 AND 48).

BERYL GARDNER, EXAMINING ATTORNEY

CLASS 32—(Continued).

SN 77-117,205. DECOPAC, INC., ANOKA, MN. FILED 2-27-2007.

PARTY FIZZ

THE MARK CONSISTS OF STANDARD CHARACTERS WITHOUT CLAIM TO ANY PARTICULAR FONT, STYLE, SIZE, OR COLOR.

NO CLAIM IS MADE TO THE EXCLUSIVE RIGHT TO USE "FIZZ", APART FROM THE MARK AS SHOWN, FOR CARBONATED FRUIT BEVERAGES (U.S. CLS. 45, 46 AND 48).

MARCIE MILONE, EXAMINING ATTORNEY

CLASS 32—(Continued).

SN 77-124,768. KATHLEEN M DAVIDSON, MEDFIELD, MA. FILED 3-7-2007.

Rugby Lite Beer

THE MARK CONSISTS OF STANDARD CHARACTERS WITHOUT CLAIM TO ANY PARTICULAR FONT, STYLE, SIZE, OR COLOR.

NO CLAIM IS MADE TO THE EXCLUSIVE RIGHT TO USE "LITE BEER", APART FROM THE MARK AS SHOWN, FOR BEER; MALT LIQUOR; BREWED MALT-BASED BEVERAGE IN THE NATURE OF A BEER (U.S. CLS. 45, 46 AND 48).

DANIEL CAPSHAW, EXAMINING ATTORNEY

SN 77-123,141. COMPANIA CERVECERA DEL TROPICO, S.A. DE C.V., TUXTEPEC, OAX. 68365, MEXICO, FILED 3-6-2007.



OWNER OF MEXICO REG. NO. 942795, DATED 7-10-2006, EXPIRES 7-10-2016.

NO CLAIM IS MADE TO THE EXCLUSIVE RIGHT TO USE "CERVEZA CLARA," "COMPANIA CERVECERA," AND "DESDE 1900", APART FROM THE MARK AS SHOWN.

THE MARK CONSISTS OF A MISCELLANEOUS OVAL DESIGN ON A BACKGROUND WITH THE WORDS CERVEZA CLARA APPEARING AT THE TOP OF THE OVAL, AND COMPANIA CERVECERA DEL TROPICO, S.A. DE C.V. APPEARING AT THE BOTTOM OF THE OVAL. WITHIN THE OVAL THE STYLIZED LETTER M IS ENTWINED WITH A DESIGN OF GRIFFINS ON EITHER SIDE ON A BACKGROUND. THE WORD MONTEJO APPEARS IN LARGE STYLIZED LETTERS WITH SHADOWS ON A BACKGROUND WITH THE WORDS DESDE 1900 BELOW IN A RECTANGULAR BORDER CONTAINING A LEAF DESIGN ON EITHER SIDE.

THE FOREIGN WORDING IN THE MARK CERVEZA CLARA TRANSLATES INTO ENGLISH AS LAGER BEER. THE FOREIGN WORDING COMPANIA CERVECERA DEL TROPICO TRANSLATES INTO ENGLISH AS TROPICAL BEER COMPANY. THE FOREIGN WORDING DESDE 1900 TRANSLATES INTO ENGLISH AS SINCE 1900.

FOR ALCOHOLIC BEVERAGES, NAMELY BEER (U.S. CLS. 45, 46 AND 48).

HEATHER SAPP, EXAMINING ATTORNEY

SN 77-124,951. BOILINGFROGS, L.L.C., SCOTTSDALE, AZ. FILED 3-7-2007.

BOILINGFROG

THE MARK CONSISTS OF STANDARD CHARACTERS WITHOUT CLAIM TO ANY PARTICULAR FONT, STYLE, SIZE, OR COLOR.

FOR BEER; ALE (U.S. CLS. 45, 46 AND 48).

HEATHER SAPP, EXAMINING ATTORNEY

SN 77-124,954. BOILINGFROGS, L.L.C., SCOTTSDALE, AZ. FILED 3-7-2007.

BOILED FROG

THE MARK CONSISTS OF STANDARD CHARACTERS WITHOUT CLAIM TO ANY PARTICULAR FONT, STYLE, SIZE, OR COLOR.

FOR BEER; ALE (U.S. CLS. 45, 46 AND 48).

HEATHER SAPP, EXAMINING ATTORNEY

CLASS 32—(Continued).

SN 77-129,488. SOCIETE DES PRODUITS NESTLE S.A., 1800 VEVEY, SWITZERLAND, FILED 3-13-2007.

PURE LIFE

THE MARK CONSISTS OF STANDARD CHARACTERS WITHOUT CLAIM TO ANY PARTICULAR FONT, STYLE, SIZE, OR COLOR.

OWNER OF U.S. REG. NOS. 2,856,193 AND 2,936,486. NO CLAIM IS MADE TO THE EXCLUSIVE RIGHT TO USE "PURE", APART FROM THE MARK AS SHOWN. FOR FLAVORED WATERS (U.S. CLS. 45, 46 AND 48). FIRST USE 1-31-2005; IN COMMERCE 1-31-2005. MICHAEL WEBSTER, EXAMINING ATTORNEY

SN 77-133,098. NATIONAL DAIRY HOLDINGS, LP, DALLAS, TX. FILED 3-16-2007.

BERMUDA BLAST

THE MARK CONSISTS OF STANDARD CHARACTERS WITHOUT CLAIM TO ANY PARTICULAR FONT, STYLE, SIZE, OR COLOR.

FOR FRUIT DRINKS; FRUIT JUICES (U.S. CLS. 45, 46 AND 48).

FIRST USE 5-1-2003; IN COMMERCE 3-1-2005. SUSAN RICHARDS, EXAMINING ATTORNEY

SN 77-134,978. OTRO MUNDO BREWING COMPANY S.A., BUENOS AIRES, ARGENTINA, FILED 3-20-2007.

OTRO MUNDO

THE MARK CONSISTS OF STANDARD CHARACTERS WITHOUT CLAIM TO ANY PARTICULAR FONT, STYLE, SIZE, OR COLOR.

THE FOREIGN WORDING IN THE MARK TRANSLATES INTO ENGLISH AS ANOTHER WORLD. FOR BEER (U.S. CLS. 45, 46 AND 48). THEODORE MCBRIDE, EXAMINING ATTORNEY

CLASS 32—(Continued).

SN 77-135,044. EUROBUBBLIES, INC., ASHLAND, MA. FILED 3-20-2007.

European RENDEZ VOUS

THE MARK CONSISTS OF STANDARD CHARACTERS WITHOUT CLAIM TO ANY PARTICULAR FONT, STYLE, SIZE, OR COLOR.

FOR LEMONADE (U.S. CLS. 45, 46 AND 48). REGINA DRUMMOND, EXAMINING ATTORNEY

SN 77-136,084. PETER STROMBERG, CITRUS HEIGHTS, CA. AND TED LEE, ORANGEVALE, CA. FILED 3-20-2007.

Silver Fork Brewing Company

THE MARK CONSISTS OF STANDARD CHARACTERS WITHOUT CLAIM TO ANY PARTICULAR FONT, STYLE, SIZE, OR COLOR.

NO CLAIM IS MADE TO THE EXCLUSIVE RIGHT TO USE "BREWING COMPANY", APART FROM THE MARK AS SHOWN.

FOR BREWED MALT-BASED ALCOHOLIC BEVERAGE IN THE NATURE OF A BEER (U.S. CLS. 45, 46 AND 48).

SANJEEV VOHRA, EXAMINING ATTORNEY

SN 77-136,788. NEW DUTCH WATER CORP., OLD BETHPAGE, NY. FILED 3-21-2007.



THE MARK CONSISTS OF AN ORNAMENTAL WAVE AND PARTIAL STARBURST WITHIN A CIRCLE. FOR DRINKING WATER (U.S. CLS. 45, 46 AND 48). MARCIE MILONE, EXAMINING ATTORNEY

CLASS 32—(Continued).

SN 77-138,286. TOTALLY ORGANICA, LLC, LAS VEGAS, NV. FILED 3-22-2007.



NO CLAIM IS MADE TO THE EXCLUSIVE RIGHT TO USE "ORGANICA", APART FROM THE MARK AS SHOWN. THE COLOR(S) GREEN IS/ARE CLAIMED AS A FEATURE OF THE MARK. THE COLOR GREEN APPEARS IN THE WORDING TOTALLY ORGANICA. THE ENGLISH TRANSLATION OF ORGANICA IS ORGANIC. FOR FLAVORED WATERS (U.S. CLS. 45, 46 AND 48). GENE MACIOL, EXAMINING ATTORNEY

SN 77-138,620. EDDIE H. GREEN, KANSAS CITY, MO. AND CECILIA J. GREEN, KANSAS CITY, MO. FILED 3-23-2007.

Mogul Beer

THE MARK CONSISTS OF STANDARD CHARACTERS WITHOUT CLAIM TO ANY PARTICULAR FONT, STYLE, SIZE, OR COLOR. NO CLAIM IS MADE TO THE EXCLUSIVE RIGHT TO USE "BEER", APART FROM THE MARK AS SHOWN. FOR BEER (U.S. CLS. 45, 46 AND 48). FIRST USE 3-22-2007; IN COMMERCE 3-22-2007. ANDREA K. NADELMAN, EXAMINING ATTORNEY

SN 77-140,004. TROPICANA PRODUCTS, INC., BRADENTON, FL. FILED 3-26-2007.

TROPICANA PURE PREMIUM

THE MARK CONSISTS OF STANDARD CHARACTERS WITHOUT CLAIM TO ANY PARTICULAR FONT, STYLE, SIZE, OR COLOR. OWNER OF U.S. REG. NOS. 1,468,582, 2,229,933 AND OTHERS. SEC. 2(F) AS TO "PURE PREMIUM". FOR FRUIT JUICES AND FRUIT JUICE DRINKS (U.S. CLS. 45, 46 AND 48). FIRST USE 10-29-1982; IN COMMERCE 10-29-1982. LAURA KOVALSKY, EXAMINING ATTORNEY

CLASS 32—(Continued).

SN 77-140,065. KARMAQUENCH, LLC, RHINEBECK, NY. FILED 3-26-2007.

KarmaQuench

THE MARK CONSISTS OF STANDARD CHARACTERS WITHOUT CLAIM TO ANY PARTICULAR FONT, STYLE, SIZE, OR COLOR. FOR BOTTLED WATER (U.S. CLS. 45, 46 AND 48). FIRST USE 3-20-2007; IN COMMERCE 3-22-2007. THEODORE MCBRIDE, EXAMINING ATTORNEY

SN 77-140,593. SHORTROUND CORPORATION, SEATTLE, WA. FILED 3-26-2007.



OWNER OF U.S. REG. NO. 3,042,389. NO CLAIM IS MADE TO THE EXCLUSIVE RIGHT TO USE "UNFILTERED DRAFT BEER" AND "RED ALE" AND "SEATTLE" AND "BREWING CO.", APART FROM THE MARK AS SHOWN. FOR BEER (U.S. CLS. 45, 46 AND 48). FIRST USE 6-17-2006; IN COMMERCE 6-17-2006. ANDREA HACK, EXAMINING ATTORNEY

SN 77-142,272. DALY, CAROLE T., MIDDLEBURG, VA. FILED 3-28-2007.

SHIRLEY IN A BOTTLE

THE MARK CONSISTS OF STANDARD CHARACTERS WITHOUT CLAIM TO ANY PARTICULAR FONT, STYLE, SIZE, OR COLOR. FOR NON-ALCOHOLIC SOFT DRINKS (U.S. CLS. 45, 46 AND 48). SANI KHOURI, EXAMINING ATTORNEY

CLASS 32—(Continued).

SN 77-142,290. DALY, CAROLE T., MIDDLEBURG, VA. FILED 3-28-2007.

ROY IN A BOTTLE

THE MARK CONSISTS OF STANDARD CHARACTERS WITHOUT CLAIM TO ANY PARTICULAR FONT, STYLE, SIZE, OR COLOR.

FOR NON-ALCOHOLIC SOFT DRINKS (U.S. CLS. 45, 46 AND 48).

SANI KHOURI, EXAMINING ATTORNEY

SN 77-144,037. WEINER, RUSSELL G., LAS VEGAS, NV. FILED 3-29-2007.

RED POWER

THE MARK CONSISTS OF STANDARD CHARACTERS WITHOUT CLAIM TO ANY PARTICULAR FONT, STYLE, SIZE, OR COLOR.

FOR SPORTS DRINKS, NAMELY, ENERGY DRINKS (U.S. CLS. 45, 46 AND 48).

SALLY SHIH, EXAMINING ATTORNEY

SN 77-147,330. TROPICANA PRODUCTS, INC., BRADENTON, FL. FILED 4-3-2007.

TROPICANA GO-J

THE MARK CONSISTS OF STANDARD CHARACTERS WITHOUT CLAIM TO ANY PARTICULAR FONT, STYLE, SIZE, OR COLOR.

OWNER OF U.S. REG. NOS. 1,468,582, 2,949,352 AND OTHERS.

FOR FRUIT JUICES AND FRUIT JUICE DRINKS (U.S. CLS. 45, 46 AND 48).

LAURA KOVALSKY, EXAMINING ATTORNEY

SN 77-148,244. JONES, JEFF, FRANKLIN, TN. FILED 4-4-2007.

SONGWRITERS STOUT

THE MARK CONSISTS OF STANDARD CHARACTERS WITHOUT CLAIM TO ANY PARTICULAR FONT, STYLE, SIZE, OR COLOR.

NO CLAIM IS MADE TO THE EXCLUSIVE RIGHT TO USE "STOUT", APART FROM THE MARK AS SHOWN.

FOR BEER (U.S. CLS. 45, 46 AND 48).

LEIGH CAROLINE CASE, EXAMINING ATTORNEY

CLASS 32—(Continued).

SN 77-151,534. PUBLIX ASSET MANAGEMENT COMPANY, LAKELAND, FL. FILED 4-9-2007.



OWNER OF U.S. REG. NOS. 1,339,762, 1,824,506 AND OTHERS.

THE MARK CONSISTS OF A VERTICAL RECTANGLE, WITH A CIRCLE OVERLAPPING THE RECTANGLE AND EXTENDING HALFWAY INTO THE RECTANGLE. THE CIRCLE CONTAINS THE WORD PUBLIX, CENTERED HORIZONTALLY IN THE CIRCLE.

FOR CHILLED FRUIT JUICES (U.S. CLS. 45, 46 AND 48).

FIRST USE 11-21-2003; IN COMMERCE 1-1-2004.

NANCY CLARKE, EXAMINING ATTORNEY

SN 77-158,171. TROPICANA PRODUCTS, INC., BRADENTON, FL. FILED 4-17-2007.

TROPICANA BLISS

THE MARK CONSISTS OF STANDARD CHARACTERS WITHOUT CLAIM TO ANY PARTICULAR FONT, STYLE, SIZE, OR COLOR.

OWNER OF U.S. REG. NOS. 630,572, 1,303,002 AND OTHERS.

FOR FRUIT JUICES AND FRUIT JUICE DRINKS (U.S. CLS. 45, 46 AND 48).

LAURA KOVALSKY, EXAMINING ATTORNEY

SN 77-159,614. CHOXOTICA, INC., TAMPA, FL. FILED 4-18-2007.

CACAOLA

THE MARK CONSISTS OF STANDARD CHARACTERS WITHOUT CLAIM TO ANY PARTICULAR FONT, STYLE, SIZE, OR COLOR.

FOR NUTRITIONAL SOFT DRINKS (U.S. CLS. 45, 46 AND 48).

WON TEAK OH, EXAMINING ATTORNEY

CLASS 32—(Continued).

SN 77-172,956. TROPICANA PRODUCTS, INC., BRADENTON, FL. FILED 5-4-2007.

TROPICANA TRUE NATURE

THE MARK CONSISTS OF STANDARD CHARACTERS WITHOUT CLAIM TO ANY PARTICULAR FONT, STYLE, SIZE, OR COLOR.

OWNER OF U.S. REG. NOS. 630,572, 1,303,002 AND OTHERS.

FOR FRUIT JUICES AND FRUIT JUICE DRINKS (U.S. CLS. 45, 46 AND 48).

LAURA KOVALSKY, EXAMINING ATTORNEY

CLASS 32—(Continued).

SN 77-187,021. WEINER, RUSSELL G., LAS VEGAS, NV. FILED 5-22-2007.

ROASTED

THE MARK CONSISTS OF STANDARD CHARACTERS WITHOUT CLAIM TO ANY PARTICULAR FONT, STYLE, SIZE, OR COLOR.

FOR ENERGY DRINKS (U.S. CLS. 45, 46 AND 48).
SALLY SHIH, EXAMINING ATTORNEY

SN 77-181,215. WAKEFERN FOOD CORP., ELIZABETH, NJ. FILED 5-15-2007.

READINGTON FARMS

THE MARK CONSISTS OF STANDARD CHARACTERS WITHOUT CLAIM TO ANY PARTICULAR FONT, STYLE, SIZE, OR COLOR.

OWNER OF U.S. REG. NOS. 1,685,818 AND 2,413,191. NO CLAIM IS MADE TO THE EXCLUSIVE RIGHT TO USE "FARMS", APART FROM THE MARK AS SHOWN.

FOR FRUIT JUICES; SPRING WATER (U.S. CLS. 45, 46 AND 48).

ODESSA BIBBINS, EXAMINING ATTORNEY

SN 78-427,217. STEAM WHISTLE BREWING INC., TORONTO, ONTARIO, CANADA, FILED 5-28-2004.



SN 77-187,005. WEINER, RUSSELL G., LAS VEGAS, NV. FILED 5-22-2007.

ROCKSTAR ROASTED

THE MARK CONSISTS OF STANDARD CHARACTERS WITHOUT CLAIM TO ANY PARTICULAR FONT, STYLE, SIZE, OR COLOR.

OWNER OF U.S. REG. NOS. 2,545,247, 2,784,403 AND OTHERS.

FOR ENERGY DRINKS (U.S. CLS. 45, 46 AND 48).
SALLY SHIH, EXAMINING ATTORNEY

OWNER OF CANADA REG. NO. TMA576334, DATED 2-25-2003, EXPIRES 2-25-2018.

FOR ALCOHOLIC BEVERAGES, NAMELY, BEER (U.S. CLS. 45, 46 AND 48).

CAROLYN CATALDO, EXAMINING ATTORNEY

CLASS 32—(Continued).

SN 78-508,581. NORTHWEST NATURALS, LLC, BOTHELL, WA. FILED 10-29-2004.

FRUTEX

THE MARK CONSISTS OF STANDARD CHARACTERS WITHOUT CLAIM TO ANY PARTICULAR FONT, STYLE, SIZE, OR COLOR.

FOR FRUIT JUICE CONCENTRATES (U.S. CLS. 45, 46 AND 48).

FIRST USE 12-0-2000; IN COMMERCE 12-0-2000.
MELVIN AXILBUND, EXAMINING ATTORNEY

SN 78-544,760. SUMOL-GESTAO DE MARCAS, S.A., 2795-854 CARNAXIDE, PORTUGAL, FILED 1-10-2005.

GUD

THE MARK CONSISTS OF STANDARD CHARACTERS WITHOUT CLAIM TO ANY PARTICULAR FONT, STYLE, SIZE, OR COLOR.

PRIORITY CLAIMED UNDER SEC. 44(D) ON ERPNCMNTY TM OFC APPLICATION NO. 4128476, FILED 11-22-2004, REG. NO. 004128476, DATED 2-14-2007, EXPIRES 11-22-2014.

FOR BEVERAGES, NAMELY, DRINKING WATER, FLAVORED WATER, MINERAL AND AERATED WATERS, ENERGY DRINKS, SPORTS DRINKS, SOFT DRINKS, FRUIT DRINKS, AERATED DRINKS MADE FROM FRUIT JUICES, VEGETABLE JUICES, FRUIT JUICES, SOFT DRINKS MADE FROM PLANT EXTRACTS AND JUICES; PREPARATIONS FOR THE FOREGOING IN THE NATURE OF SYRUPS, CONCENTRATES, AND POWDERS (U.S. CLS. 45, 46 AND 48).

CHRISTOPHER BUONGIORNO, EXAMINING ATTORNEY

CLASS 32—(Continued).

SN 78-703,532. CORR, ROBERT J., BLUE ISLAND, IL. FILED 8-30-2005.

RUSHADE

THE MARK CONSISTS OF STANDARD CHARACTERS WITHOUT CLAIM TO ANY PARTICULAR FONT, STYLE, SIZE, OR COLOR.

FOR FRUIT JUICE BASED CARBONATED DRINKS (U.S. CLS. 45, 46 AND 48).

VERNA BETH RIRIE, EXAMINING ATTORNEY

SN 78-811,009. BLHUE, INC., BOULDER, CO. FILED 2-9-2006.

PICKUP

THE MARK CONSISTS OF STANDARD CHARACTERS WITHOUT CLAIM TO ANY PARTICULAR FONT, STYLE, SIZE, OR COLOR.

FOR CONCENTRATES, SYRUPS OR POWDERS USED IN THE PREPARATION OF SOFT DRINKS; ENERGY DRINKS; FLAVORED WATERS; FRUIT DRINKS; FRUIT JUICE CONCENTRATES; FRUIT-FLAVORED BEVERAGES; NON-ALCOHOLIC BEVERAGES CONTAINING FRUIT JUICES; NON-ALCOHOLIC BEVERAGES, NAMELY, CARBONATED BEVERAGES; NON-ALCOHOLIC COCKTAIL MIXES; NON-ALCOHOLIC FRUIT EXTRACTS USED IN THE PREPARATION OF BEVERAGES; NON-ALCOHOLIC FRUIT JUICE BEVERAGES; NON-ALCOHOLIC MALT BEVERAGE; NON-ALCOHOLIC MALT COOLERS; NON-ALCOHOLIZED WINES; PREPARATIONS FOR MAKING ENERGY DRINKS, FLAVORED WATERS, SOFT DRINKS, AND SPORTS DRINKS; SOFT DRINKS; SPORTS DRINKS; SYRUPS FOR MAKING ENERGY DRINKS, FLAVORED WATERS, SOFT DRINKS, AND SPORTS DRINKS (U.S. CLS. 45, 46 AND 48).

KIMBERLY FRYE, EXAMINING ATTORNEY

SN 78-811,921. WAL-MART STORES, INC., BENTONVILLE, AR. FILED 2-10-2006.

ESSENTIALS BY CLEAR AMERICAN

THE MARK CONSISTS OF STANDARD CHARACTERS WITHOUT CLAIM TO ANY PARTICULAR FONT, STYLE, SIZE, OR COLOR.

OWNER OF U.S. REG. NO. 2,304,923.

FOR CARBONATED AND NON-CARBONATED BEVERAGES, NAMELY, SOFT DRINKS, FRUIT-FLAVORED DRINKS, AND SPARKLING WATERS (U.S. CLS. 45, 46 AND 48).

SHANNON TWOHIG, EXAMINING ATTORNEY

CLASS 32—(Continued).

SN 78-835,391. ARABICA FUNDING, INC., MELVILLE, NY.
FILED 3-13-2006.

SNOWDRIFT

THE MARK CONSISTS OF STANDARD CHARACTERS WITHOUT CLAIM TO ANY PARTICULAR FONT, STYLE, SIZE, OR COLOR.

FOR BEVERAGE SMOOTHIES (U.S. CLS. 45, 46 AND 48).

FIRST USE 12-1-2004; IN COMMERCE 12-1-2004.
DEZMONA MIZELLE, EXAMINING ATTORNEY

SN 78-949,684. TREE TOP, INC., SELAH, WA. FILED 8-10-2006.

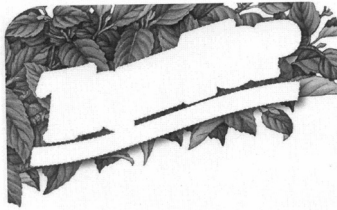

THE MARK CONSISTS OF A CANOPY OF LEAVES WHEREIN THE BROKEN LINES REPRESENT MATTER NOT CLAIMED AS A FEATURE OF THE MARK.

FOR APPLE JUICE AND SWEET CIDER; FRUIT JUICES; FRUIT JUICE BEVERAGES; FRUIT JUICE AND FRUIT DRINK CONCENTRATES; FROZEN CONCENTRATED FRUIT JUICE (U.S. CLS. 45, 46 AND 48).

FIRST USE 1-0-2006; IN COMMERCE 1-0-2006.
ROBERT LAVACHE, EXAMINING ATTORNEY

SN 78-953,853. RG GLOBAL LIFESTYLES INC, RANCHO SANTA MARGARITA, CA. FILED 8-16-2006.

OC ENERGY

THE MARK CONSISTS OF STANDARD CHARACTERS WITHOUT CLAIM TO ANY PARTICULAR FONT, STYLE, SIZE, OR COLOR.

NO CLAIM IS MADE TO THE EXCLUSIVE RIGHT TO USE "ENERGY", APART FROM THE MARK AS SHOWN.

FOR ENERGY DRINKS (U.S. CLS. 45, 46 AND 48).
ANNE E. GUSTASON, EXAMINING ATTORNEY

CLASS 32—(Continued).

SN 78-959,870. BRANDS AND BEVERAGES INTERNATIONAL LIMITED, CHARLESTOWN, ST.CHRIST-NEVIS, FILED 8-24-2006.

CHUMMY

THE MARK CONSISTS OF STANDARD CHARACTERS WITHOUT CLAIM TO ANY PARTICULAR FONT, STYLE, SIZE, OR COLOR.

OWNER OF U.S. REG. NO. 2,656,131.

FOR SOFT DRINKS, FRUIT JUICES, BOTTLED DRINKING WATER, SYRUPS AND CONCENTRATES FOR MAKING FRUIT DRINKS AND SOFT DRINKS, AND NON-ALCOHOLIC CARBONATED FRUIT JUICE DRINKS (U.S. CLS. 45, 46 AND 48).

BRENDAN REGAN, EXAMINING ATTORNEY

SN 78-959,961. BRANDS AND BEVERAGES INTERNATIONAL LIMITED, CHARLESTOWN, ST.CHRIST-NEVIS, FILED 8-24-2006.

CHUBBY

THE MARK CONSISTS OF STANDARD CHARACTERS WITHOUT CLAIM TO ANY PARTICULAR FONT, STYLE, SIZE, OR COLOR.

OWNER OF U.S. REG. NO. 2,656,131.

FOR SOFT DRINKS, FRUIT JUICES, BOTTLED DRINKING WATER, SYRUPS AND CONCENTRATES FOR MAKING FRUIT DRINKS AND SOFT DRINKS, AND NON-ALCOHOLIC CARBONATED FRUIT JUICE DRINKS (U.S. CLS. 45, 46 AND 48).

BRENDAN REGAN, EXAMINING ATTORNEY

CLASS 33—WINES AND SPIRITS

SN 76-476,137. PASTERNAK WINE IMPORTS, GREENWICH, CT. FILED 11-27-2002.

TERRA AUSTRALIS

FOR WINES (U.S. CLS. 47 AND 49).

ELIZABETH HUGHITT, EXAMINING ATTORNEY

CLASS 33—(Continued).

SN 76-674,272. NEW MEXICO WINERIES, INC., DEMING, NM. FILED 3-19-2007.

WINE-A-RITA

THE MARK CONSISTS OF STANDARD CHARACTERS WITHOUT CLAIM TO ANY PARTICULAR FONT, STYLE, SIZE, OR COLOR.

FOR WINE (U.S. CLS. 47 AND 49).
FIRST USE 9-8-2004; IN COMMERCE 9-8-2004.
PAM WILLIS, EXAMINING ATTORNEY

SN 76-674,482. STORYCO, LLC, ST. HELENA, CA. FILED 3-23-2007.

SÉDUIRE

THE MARK CONSISTS OF STANDARD CHARACTERS WITHOUT CLAIM TO ANY PARTICULAR FONT, STYLE, SIZE, OR COLOR.

THE ENGLISH TRANSLATION OF THE MARK IS "TO SEDUCE".

FOR WINE (U.S. CLS. 47 AND 49).
FIRST USE 2-28-2007; IN COMMERCE 6-26-2007.
TARAH HARDY, EXAMINING ATTORNEY

SN 77-000,266. VINA CALITERRA S.A., SANTIAGO, CHILE, FILED 9-15-2006.

CALITERRA CENIT

THE MARK CONSISTS OF STANDARD CHARACTERS WITHOUT CLAIM TO ANY PARTICULAR FONT, STYLE, SIZE, OR COLOR.

OWNER OF U.S. REG. NOS. 2,754,775, 2,962,090 AND OTHERS.

THE FOREIGN WORDING IN THE MARK TRANSLATES INTO ENGLISH AS ZENITH.

FOR WINES (U.S. CLS. 47 AND 49).
JEFFERY COWARD, EXAMINING ATTORNEY

CLASS 33—(Continued).

SN 77-010,038. THE WINE GROUP LLC, TRACY, CA. FILED 9-28-2006.

ENOTECA DI MASSIMO

THE MARK CONSISTS OF STANDARD CHARACTERS WITHOUT CLAIM TO ANY PARTICULAR FONT, STYLE, SIZE, OR COLOR.

NO CLAIM IS MADE TO THE EXCLUSIVE RIGHT TO USE ENOTECA, APART FROM THE MARK AS SHOWN.

THE FOREIGN WORDING IN THE MARK TRANSLATES INTO ENGLISH AS MAXIMUM WINE CELLAR.

FOR WINES (U.S. CLS. 47 AND 49).
ASMAT KHAN, EXAMINING ATTORNEY

SN 77-010,390. BEDELL NORTH FORK, LLC, CUTCHOGUE, NY. FILED 9-29-2006.



NO CLAIM IS MADE TO THE EXCLUSIVE RIGHT TO USE "2005", APART FROM THE MARK AS SHOWN.

THE COLOR(S) BLACK, WHITE, BLUE, AND SLATE GREY IS/ARE CLAIMED AS A FEATURE OF THE MARK.

THE MARK CONSISTS OF A WHITE BACKGROUND WITH A BLACK OUTLINE, THE WORDS AND NUMBERS "2005 BEDELL" APPEAR IN SLATE GREY CENTERED ABOVE A BLACK RECTANGLE WITH A BLUE AND WHITE SHADED ABSTRACT BIRD DESIGN CENTERED IN THE RECTANGLE, AND THE WORD "GALLERY" IN SLATE GREY CENTERED BELOW THE RECTANGLE.

FOR WINE (U.S. CLS. 47 AND 49).
HEATHER BIDDULPH, EXAMINING ATTORNEY

CLASS 33—(Continued).

SN 77-025,477. MACHAT, MICHAEL, BEVERLY HILLS, CA. FILED 10-19-2006.

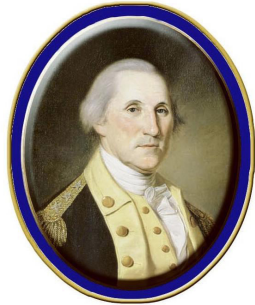

GORGEOUS GEORGE

THE COLOR(S) DARK BLUE, ROYAL BLUE, YELLOW, GOLD, GRAY, PINK, FLESH, TAN, AND WHITE IS/ARE CLAIMED AS A FEATURE OF THE MARK.

THE COLOR DARK BLUE APPEARS IN THE CLOTHING WORN BY THE IMAGE OF GEORGE WASHINGTON AND IN THE WORDING GORGEOUS GEORGE. THE COLOR YELLOW APPEARS IN THE CLOTHING WORN BY THE IMAGE OF GEORGE WASHINGTON. THE COLOR GOLD APPEARS IN THE ACCENTS ON THE CLOTHING WORN BY THE IMAGE OF GEORGE WASHINGTON AND IN THE OVAL SURROUNDING THE PORTRAIT OF GEORGE WASHINGTON. THE COLOR ROYAL BLUE APPEARS IN THE OVAL SURROUNDING THE PORTRAIT. THE COLOR GRAY APPEARS IN THE BACKGROUND OF THE PORTRAIT AND IN GEORGE WASHINGTON'S HAIR. THE COLOR PINK APPEARS ON THE CHEEKS AND LIPS OF THE PORTRAIT. THE COLOR FLESH APPEARS IN THE SKIN OF PORTRAIT. THE COLOR TAN APPEARS IN THE BACKGROUND OF THE PORTRAIT. THE COLOR WHITE APPEARS IN THE CLOTHING WORN BY GEORGE WASHINGTON AND IN THE TOP PORTION OF THE SURROUNDING OVAL.

FOR WINE (U.S. CLS. 47 AND 49).
COLLEEN KEARNEY, EXAMINING ATTORNEY

SN 77-058,386. MCILHENNY COMPANY, AVERY ISLAND, LA. FILED 12-6-2006.

TABASCO

THE MARK CONSISTS OF STANDARD CHARACTERS WITHOUT CLAIM TO ANY PARTICULAR FONT, STYLE, SIZE, OR COLOR.

FOR ALCOHOLIC BEVERAGES, NAMELY TEQUILA (U.S. CLS. 47 AND 49).
WANDA KAY PRICE, EXAMINING ATTORNEY

CLASS 33—(Continued).

SN 77-069,319. SIDEJOB CELLARS LLC, NOVATO, CA. FILED 12-21-2006.

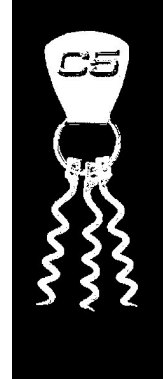

THE MARK CONSISTS OF STYLIZED TEXT AND A KEY CHAIN WITH THREE CORKSCREW PRONGS HANGING FROM IT.

FOR WINE (U.S. CLS. 47 AND 49).
FIRST USE 1-15-2006; IN COMMERCE 12-12-2006.
DAVID COLLIER, EXAMINING ATTORNEY

SN 77-091,273. E. & J. GALLO WINERY, MODESTO, CA. FILED 1-25-2007.

DMG 1884

THE MARK CONSISTS OF STANDARD CHARACTERS WITHOUT CLAIM TO ANY PARTICULAR FONT, STYLE, SIZE, OR COLOR.

NO CLAIM IS MADE TO THE EXCLUSIVE RIGHT TO USE "1884", APART FROM THE MARK AS SHOWN.

FOR WINES (U.S. CLS. 47 AND 49).
PAM WILLIS, EXAMINING ATTORNEY

SN 77-092,659. OLE IMPORTS, LLC, NEW ROCHELLE, NY. FILED 1-26-2007.

Puntazo

THE MARK CONSISTS OF STANDARD CHARACTERS WITHOUT CLAIM TO ANY PARTICULAR FONT, STYLE, SIZE, OR COLOR.

THE ENGLISH TRANSLATION OF THE WORD PUNTAZO IN THE MARK IS WITTY.

FOR WINE (U.S. CLS. 47 AND 49).
ODESSA BIBBINS, EXAMINING ATTORNEY

CLASS 33—(Continued).

SN 77-092,711. OLE IMPORTS, LLC, NEW ROCHELLE, NY.
FILED 1-26-2007.

DACU

THE MARK CONSISTS OF STANDARD CHARACTERS WITHOUT CLAIM TO ANY PARTICULAR FONT, STYLE, SIZE, OR COLOR.
FOR WINE (U.S. CLS. 47 AND 49).
ODESSA BIBBINS, EXAMINING ATTORNEY

SN 77-092,713. OLE IMPORTS, LLC, NEW ROCHELLE, NY.
FILED 1-26-2007.

Calma

THE MARK CONSISTS OF STANDARD CHARACTERS WITHOUT CLAIM TO ANY PARTICULAR FONT, STYLE, SIZE, OR COLOR.
THE FOREIGN WORDING, CALMA IN THE MARK TRANSLATES INTO ENGLISH AS CALM.
FOR WINE (U.S. CLS. 47 AND 49).
ODESSA BIBBINS, EXAMINING ATTORNEY

SN 77-092,719. OLE IMPORTS, LLC, NEW ROCHELLE, NY.
FILED 1-26-2007.

Compania Mata

THE MARK CONSISTS OF STANDARD CHARACTERS WITHOUT CLAIM TO ANY PARTICULAR FONT, STYLE, SIZE, OR COLOR.
NO CLAIM IS MADE TO THE EXCLUSIVE RIGHT TO USE COMPANIA, APART FROM THE MARK AS SHOWN.
THE FOREIGN WORDING COMPANIA MATA IN THE MARK TRANSLATES INTO ENGLISH AS MATA COMPANY.
FOR WINE (U.S. CLS. 47 AND 49).
ODESSA BIBBINS, EXAMINING ATTORNEY

CLASS 33—(Continued).

SN 77-092,725. OLE IMPORTS, LLC, NEW ROCHELLE, NY.
FILED 1-26-2007.

Flaco

THE MARK CONSISTS OF STANDARD CHARACTERS WITHOUT CLAIM TO ANY PARTICULAR FONT, STYLE, SIZE, OR COLOR.
THE FOREIGN WORDING FLACO IN THE MARK TRANSLATES INTO ENGLISH AS THIN.
FOR WINE (U.S. CLS. 47 AND 49).
ODESSA BIBBINS, EXAMINING ATTORNEY

SN 77-092,748. OLE IMPORTS, LLC, NEW ROCHELLE, NY.
FILED 1-26-2007.

Liquid Geography

THE MARK CONSISTS OF STANDARD CHARACTERS WITHOUT CLAIM TO ANY PARTICULAR FONT, STYLE, SIZE, OR COLOR.
NO CLAIM IS MADE TO THE EXCLUSIVE RIGHT TO USE LIQUID, APART FROM THE MARK AS SHOWN.
FOR WINE (U.S. CLS. 47 AND 49).
ODESSA BIBBINS, EXAMINING ATTORNEY

SN 77-109,564. HAKUTSURU SAKE BREWING CO., LTD.,
KOBE, JAPAN, FILED 2-16-2007.

淡麗純米

NO CLAIM IS MADE TO THE EXCLUSIVE RIGHT TO USE THE NON-LATIN CHARACTERS THAT MEAN "PURE RICE" APART FROM THE MARK AS SHOWN., APART FROM THE MARK AS SHOWN.
THE MARK CONSISTS OF JAPANESE CHARACTERS.
THE NON-LATIN CHARACTERS IN THE MARK TRANSLITERATE TO TANREI JUNMAI AND THIS MEANS "PURE RICE" FOR THE WORD JUNMAI. TANREI HAS NO TRANSLATION. IN ENGLISH.
FOR SAKE (U.S. CLS. 47 AND 49).
FIRST USE 9-30-1993; IN COMMERCE 1-31-2004.
HENRY S. ZAK, EXAMINING ATTORNEY

CLASS 33—(Continued).

SN 77-114,544. ST. CLAIR WINES LLC, NAPA, CA. FILED 2-23-2007.

ELAINE ST. CLAIR WINES

THE MARK CONSISTS OF STANDARD CHARACTERS WITHOUT CLAIM TO ANY PARTICULAR FONT, STYLE, SIZE, OR COLOR.

NO CLAIM IS MADE TO THE EXCLUSIVE RIGHT TO USE "WINES", APART FROM THE MARK AS SHOWN.

THE NAME "ELAINE ST. CLAIR WINES" IDENTIFIES A LIVING INDIVIDUAL WHOSE CONSENT IS OF RECORD.

FOR WINE (U.S. CLS. 47 AND 49).
SHARON MEIER, EXAMINING ATTORNEY

SN 77-118,338. DITTA SILVIO MELETTI SRL, ASCOLI PICENO, ITALY, FILED 2-28-2007.



NO CLAIM IS MADE TO THE EXCLUSIVE RIGHT TO USE "ANISETTA", "ESPORTAZIONE", "PRODUCT OF ITALY", "ASCOLI PICENO", "PRODUCED AND BOTTLED BY DITTA SILVIO MELETTI S.R.L.", "OSTENDA 1900 MED ORO", "NAPOLI 1900 MED D'ARGENTO", "OMBERTO I RED D'ITALIA", "TORINO 1900 MED D'ARGENTO", "PARIGI 1900 MED ORO", "OSTENDA 1901 CROCE AL MERITO", AND "L'ANISETTA MELETTI È PRODOTTO OTTENUTO DALL'AROMATIZZAZIONE DI SPIRITO CON SEMI DI ANICE DI PREFERENZA COLTIVATI NELLE VICINANZE DI ASCOLI PICENO (CASTIGNANO). È LIQUORE GRATO AL PALATO OPPORTUNISSIMO PER DESSERT. CON VANTAGGIO ADOPERARSI PER PUNCH E PRESO CON ACQUA O SELTZ RIESCE NA BIBITA GRADITISSIMA E DISSETANTE", APART FROM THE MARK AS SHOWN.

THE NAME(S), PORTRAIT(S), AND/OR SIGNATURE(S) SHOWN IN THE MARK DOES NOT IDENTIFY A PARTICULAR LIVING INDIVIDUAL.

THE MARK CONSISTS OF A RECTANGULAR DESIGN WITH A SHADED BORDER, INCLUDING THE WORDING "MELETTI" ON A SHADED RECTANGULAR BACKGROUND AT THE TOP, A CREST WITH THE WORDING "DEPOSITATA - PER ASPERA AD ASTRA" AND THE LETTERS "SM," ON THE LEFT BELOW THE M IN MELETTI; AN ARCULATE BANNER CONTAINING THE WORDS "ANISETTA MELETTI" EXTENDING FROM THE LEFT CENTER OF THE MARK UPWARD AND TO THE RIGHT; A COLLECTION OF TWELVE AWARD MEDALS, ARRANGED RANDOMLY ON THE LEFT OF THE MARK, BELOW AND BEHIND THE CREST AND THE BANNER AND HAVING THE WORDING "OSTENDA 1900 MED ORO", "NAPOLI 1900 MED D'ARGENTO", "OMBERTO I RED D'ITALIA", "TORINO 1900 MED D'ARGENTO", "PARIGI 1900 MED ORO" AND "OSTENDA 1901 CROCE AL MERITO", EACH IN A CIRCULAR ORIENTATION AROUND THE MEDALS; THE WORDS "SPECIALITÀ SILVIO MELETTI" APPEAR BELOW THE BANNER; A RECTANGULAR TEXT BOX BELOW "SILVIO MELETTI"

CLASS 33—(Continued).

HAS A FANCY BORDER ON ITS LEFT AND BOTTOM SIDES; WITHIN THE TEXT BOX IS THE BACKGROUND TEXT "L'ANISETTA MELETTI È PRODOTTO OTTENUTO DALL'AROMATIZZAZIONE DI SPIRITO CON SEMI DI ANICE DI PREFERENZA COLTIVATI NELLE VICINANZE DI ASCOLI PICENO (CASTIGNANO). È LIQUORE GRATO AL PALATO OPPORTUNISSIMO PER DESSERT. CON VANTAGGIO ADOPERARSI PER PUNCH E PRESO CON ACQUA O SELTZ RIESCE NA BIBITA GRADITISSIMA E DISSETANTE"; THE FACSIMILE SIGNATURE OF SILVIO MELETTI IS SUPERIMPOSED ON THE BACKGROUND TEXT; BELOW THE LEGEND ARE THE WORDS "ESPORTAZIONE" AND "PRODUCT OF ITALY"; BELOW THESE WORDS, THE WORDS "ASCOLI-PICENO" APPEAR ON A SHADED BACKGROUND, IN FRONT OF A SPRIG. THE WORDING "PRODUCED AND BOTTLED BY DITTA SILVIO MELETTI S.R.L. - ASCOLI PICENO" IS CENTERED AT THE BOTTOM OF THE MARK.

THE ENGLISH TRANSLATION OF THE WORD "ANISETTA" IN THE MARK IS "ANISETTE". THE ENGLISH TRANSLATION OF THE WORD "SPECIALITÀ" IN THE MARK IS "SPECIALTY". THE ENGLISH TRANSLATION OF THE WORDING "PER ASPERA AD ASTRA" IN THE MARK IS "THROUGH ADVERSITY TO THE STARS". THE ENGLISH TRANSLATION OF THE WORD "ESPORTAZIONE" IN THE MARK IS "EXPORT". THE ENGLISH TRANSLATION OF THE WORDING "ESIGERE SULL'ETICHETTA LA MARCA DI FABBRICA E LA FIRMA DEL FABBRICANTE" IS "ON THE LABEL MUST BE THE TRADEMARK AND THE SIGNATURE OF THE PRODUCER". THE ENGLISH TRANSLATION OF THE WORDING "OSTENDA 1900 MED ORO" IN THE MARK IS "OSTEND 1900 GOLD MEDAL". THE ENGLISH TRANSLATION OF THE WORDING "NAPOLI 1900 MED D'ARGENTO" IN THE MARK IS "NAPLES 1900 SILVER MEDAL". THE ENGLISH TRANSLATION OF THE WORDING "OMBERTO I RE D'ITALIA" IN THE MARK IS "UMBERTO I KING OF ITALY". THE ENGLISH TRANSLATION OF THE WORDING "TORINO 1900 MED D'ARGENTO" IN THE MARK IS "TURIN 1900 SILVER MEDAL". THE ENGLISH TRANSLATION OF THE WORDING "PARIGI 1900 MED ORO" IN THE MARK IS "PARIS 1900 GOLD MEDAL". THE ENGLISH TRANSLATION OF THE WORDING "OSTENDA 1901 CROCE AL MERITO" IN THE MARK IS "OSTEND 1901 CROSS OF MERIT". THE ENGLISH TRANSLATION OF THE FOLLOWING WORDING: "L'ANISETTA MELETTI È PRODOTTO OTTENUTO DALL'AROMATIZZAZIONE DI SPIRITO CON SEMI DI ANICE DI PREFERENZA COLTIVATI NELLE VICINANZE DI ASCOLI PICENO (CASTIGNANO). È LIQUORE GRATO AL PALATO OPPORTUNISSIMO PER DESSERT. CON VANTAGGIO ADOPERARSI PER PUNCH E PRESO CON ACQUA O SELTZ RIESCE NA BIBITA GRADITISSIMA E DISSETANTE" IS THE FOLLOWING: "ANISETTA MELETTI IS THE RESULT OF AN ACCURATE DISTILLATION OF ANISES EXPRESSLY GROWN NEAR ASCOLI PICENO (CASTIGNANO). IT IS A LIQUOR THAT DELIGHTS THE PALATE, PARTICULARLY INDICATED WITH DESSERT. IT CAN BE USED FOR PUNCH AND ENJOYED WITH WATER OR SELTZER. IT IS A REFRESHING AND APPRECIATED DRINK".

FOR ANISETTE (U.S. CLS. 47 AND 49).
FIRST USE 7-26-1961; IN COMMERCE 7-26-1961.
JAY BESCH, EXAMINING ATTORNEY

CLASS 33—(Continued).

SN 77-126,074. THE GRANDE DALLES LLC, PORTLAND, OR. FILED 3-8-2007.

The Grande Dalles

THE MARK CONSISTS OF STANDARD CHARACTERS WITHOUT CLAIM TO ANY PARTICULAR FONT, STYLE, SIZE, OR COLOR.

THE ENGLISH TRANSLATION OF GRANDE DALLES IS LARGE FLAGSTONE.

FOR WINES (U.S. CLS. 47 AND 49).

MICHAEL LITZAU, EXAMINING ATTORNEY

SN 77-132,326. DANA ESTATES, INC., RUTHERFORD, CA. FILED 3-15-2007.

ONDA D'ORO

THE MARK CONSISTS OF STANDARD CHARACTERS WITHOUT CLAIM TO ANY PARTICULAR FONT, STYLE, SIZE, OR COLOR.

THE FOREIGN WORDING IN THE MARK TRANSLATES INTO ENGLISH AS GOLDEN WAVE.

FOR WINE (U.S. CLS. 47 AND 49).

CURTIS FRENCH, EXAMINING ATTORNEY

SN 77-133,612. ICARIA CREEK WINERY, INC., CLOVERDALE, CA. FILED 3-16-2007.

PROTEGE

THE MARK CONSISTS OF STANDARD CHARACTERS WITHOUT CLAIM TO ANY PARTICULAR FONT, STYLE, SIZE, OR COLOR.

FOR WINES (U.S. CLS. 47 AND 49).

B. PARADEWELAI, EXAMINING ATTORNEY

CLASS 33—(Continued).

SN 77-136,091. YANTAI WEILONG GRAPE WINE CO.,LTD., LONGKOU CITY, CHINA, FILED 3-20-2007.



THE MARK CONSISTS OF LITERAL ELEMENT "GRAND DRAGON" AND GRAPE SHAPE WITHIN THE LETTER D OF DRAGON.

FOR ALCOHOLIC FRUIT EXTRACTS; HARD CIDER; WINES; KIRSCH; LIQUEURS; BRANDY; WHISKEY; ALCOHOLIC BEVERAGES OF FRUIT; ALCOHOLIC BEVERAGES, NAMELY, ALCOHOLIC COFFEE-BASED BEVERAGE, ALCOHOLIC TEA-BASED BEVERAGE AND ALCOHOLIC BEVERAGE MADE FROM PEARS (U.S. CLS. 47 AND 49).

FIRST USE 2-10-2005; IN COMMERCE 2-10-2005.

BENJAMIN OKEKE, EXAMINING ATTORNEY

SN 77-136,113. YANTAI WEILONG GRAPE WINE CO.,LTD., LONGKOU CITY, CHINA, FILED 3-21-2007.



THE MARK CONSISTS OF CHINESE CHARACTERS AND A DESIGN.

THE FOREIGN WORDING IN THE MARK TRANSLATES INTO ENGLISH AS GRAND DRAGON.

THE NON-LATIN CHARACTER(S) IN THE MARK TRANSLITERATE INTO WEI LONG, AND THIS MEANS GRAND DRAGON IN ENGLISH.

FOR ALCOHOLIC FRUIT EXTRACTS; HARD CIDER; WINES; KIRSCH; LIQUEURS; BRANDY; WHISKEY; ALCOHOLIC BEVERAGES OF FRUIT; ALCOHOLIC BEVERAGES, NAMELY, ALCOHOLIC COFFEE-BASED BEVERAGE, ALCOHOLIC TEA-BASED BEVERAGE AND ALCOHOLIC BEVERAGE MADE FROM PEARS (U.S. CLS. 47 AND 49).

FIRST USE 4-20-1995; IN COMMERCE 4-22-1995.

BENJAMIN OKEKE, EXAMINING ATTORNEY

CLASS 33—(Continued).

SN 77-137,531. GRAVES, DOUGLAS, SEATTLE, WA. FILED 3-22-2007.

CLASS 33—(Continued).

SN 77-138,849. BURLWOOD GROUP, INC., PORT HUENEME, CA. FILED 3-23-2007.

GRAVES CELLARS

THE MARK CONSISTS OF STANDARD CHARACTERS WITHOUT CLAIM TO ANY PARTICULAR FONT, STYLE, SIZE, OR COLOR.
NO CLAIM IS MADE TO THE EXCLUSIVE RIGHT TO USE "CELLARS", APART FROM THE MARK AS SHOWN.
FOR TABLE WINES (U.S. CLS. 47 AND 49).
FIRST USE 7-20-2006; IN COMMERCE 7-20-2006.
ANNE MADDEN, EXAMINING ATTORNEY

BLACK PEARL

THE MARK CONSISTS OF STANDARD CHARACTERS WITHOUT CLAIM TO ANY PARTICULAR FONT, STYLE, SIZE, OR COLOR.
FOR RUM (U.S. CLS. 47 AND 49).
RICHARD A. STRASER, EXAMINING ATTORNEY

SN 77-138,599. MANIFESTO!, LLC, NAPA, CA. FILED 3-23-2007.

SN 77-139,371. CHAMPAGNE INDAGE LIMITED, WORLI, MUMBAI-400 018, INDIA, FILED 3-23-2007.

SIMPLE WINE FOR A COMPLEX WORLD

THE MARK CONSISTS OF STANDARD CHARACTERS WITHOUT CLAIM TO ANY PARTICULAR FONT, STYLE, SIZE, OR COLOR.
FOR WINE (U.S. CLS. 47 AND 49).
FIRST USE 3-21-2007; IN COMMERCE 3-21-2007.
AHSEN KHAN, EXAMINING ATTORNEY

Tiger Hill

THE MARK CONSISTS OF STANDARD CHARACTERS WITHOUT CLAIM TO ANY PARTICULAR FONT, STYLE, SIZE, OR COLOR.
FOR WINE (U.S. CLS. 47 AND 49).
ANDREA K. NADELMAN, EXAMINING ATTORNEY

SN 77-138,781. C&N COPORATION, DBA DOOR PENINSULA WINERY, STURGEON BAY, WI. FILED 3-23-2007.

SN 77-139,519. WOMEN OF THE VINE CELLARS, LLC, TAPPAN, NY. FILED 3-24-2007.

CRANBENET

THE MARK CONSISTS OF STANDARD CHARACTERS WITHOUT CLAIM TO ANY PARTICULAR FONT, STYLE, SIZE, OR COLOR.
FOR WINE (U.S. CLS. 47 AND 49).
FIRST USE 7-26-2001; IN COMMERCE 7-26-2001.
ELISSA GARBER KON, EXAMINING ATTORNEY

COUNTRY ROADS

THE MARK CONSISTS OF STANDARD CHARACTERS WITHOUT CLAIM TO ANY PARTICULAR FONT, STYLE, SIZE, OR COLOR.
FOR WINES (U.S. CLS. 47 AND 49).
KIMBERLY FRYE, EXAMINING ATTORNEY

CLASS 33—(Continued).

SN 77-139,726. THOMAS R. SIMONEAU, HEALDSBURG, CA. FILED 3-25-2007.



NO CLAIM IS MADE TO THE EXCLUSIVE RIGHT TO USE "VINEYARDS", APART FROM THE MARK AS SHOWN.

THE MARK CONSISTS OF A STYLIZED "S" WRITTEN ABOVE THE WORDS SIMONEAU VINEYARDS. FOR WINES (U.S. CLS. 47 AND 49).
REBECCA SMITH, EXAMINING ATTORNEY

SN 77-139,728. KATHERINE ANNE GOLD, SAINT HELENA, CA. FILED 3-25-2007.

Reckless

THE MARK CONSISTS OF STANDARD CHARACTERS WITHOUT CLAIM TO ANY PARTICULAR FONT, STYLE, SIZE, OR COLOR.

FOR APERITIF WINES; COOKING WINE; FRUIT WINE; GRAPE WINE; KITS FOR MAKING WINE; NATURAL SPARKLING WINES; PORT WINES; PREPARED WINE COCKTAILS; RED WINE; SPARKLING FRUIT WINE; SPARKLING GRAPE WINE; SPARKLING WINE; STRAWBERRY WINE; SWEET WINES; TABLE WINES; TONIC SWEET GRAPE WINE CONTAINING EXTRACTS FROM GINSENG AND CONCHONA BARK (NINJIN-KINATETSU WINE); WHITE WINE; WINE; WINE COOLERS; WINE PUNCH; WINE PUNCHES; WINES (U.S. CLS. 47 AND 49).

RICHARD A. STRASER, EXAMINING ATTORNEY

SN 77-140,245. LONG TAIL LIBATIONS INCORPORATED, ST. LOUIS, MO. FILED 3-26-2007.

ZOLANCO

THE MARK CONSISTS OF STANDARD CHARACTERS WITHOUT CLAIM TO ANY PARTICULAR FONT, STYLE, SIZE, OR COLOR.

FOR TEQUILA (U.S. CLS. 47 AND 49).
SALLY SHIH, EXAMINING ATTORNEY

CLASS 33—(Continued).

SN 77-140,248. LONG TAIL LIBATIONS INCORPORATED, ST. LOUIS, MO. FILED 3-26-2007.

PURUS

THE MARK CONSISTS OF STANDARD CHARACTERS WITHOUT CLAIM TO ANY PARTICULAR FONT, STYLE, SIZE, OR COLOR.

FOR VODKA (U.S. CLS. 47 AND 49).
SALLY SHIH, EXAMINING ATTORNEY

SN 77-140,597. PROM QUEEN-II, LLC, PENSACOLA BEACH, FL. FILED 3-26-2007.

GRAND MARLIN

THE MARK CONSISTS OF STANDARD CHARACTERS WITHOUT CLAIM TO ANY PARTICULAR FONT, STYLE, SIZE, OR COLOR.

FOR PREPARED ALCOHOLIC COCKTAILS (U.S. CLS. 47 AND 49).
ROBIN CHOSID, EXAMINING ATTORNEY

SN 77-140,753. THOMAS C. HOFFMAN, VICTOR, CA. FILED 3-26-2007.

ZINFIDELITY

THE MARK CONSISTS OF STANDARD CHARACTERS WITHOUT CLAIM TO ANY PARTICULAR FONT, STYLE, SIZE, OR COLOR.

FOR WINES (U.S. CLS. 47 AND 49).
TEJBIR SINGH, EXAMINING ATTORNEY

SN 77-140,779. VAN RUITEN FAMILY WINERY, LLC., LODI, CA. FILED 3-26-2007.

SCREW-PULOUS

THE MARK CONSISTS OF STANDARD CHARACTERS WITHOUT CLAIM TO ANY PARTICULAR FONT, STYLE, SIZE, OR COLOR.

FOR WINES (U.S. CLS. 47 AND 49).
AMY BROZENIC, EXAMINING ATTORNEY

CLASS 33—(Continued).

SN 77-140,793. CHARLES, WILLIAM, BOONVILLE, CA. AND CHARLES, NANCY, BOONVILLE, CA. FILED 3-26-2007.

CLASS 33—(Continued).

SN 77-142,582. INTWINE MARKETING LLC, SAN FRANCISCO, CA. FILED 3-28-2007.

FOURSIGHT

WINE SPOTS

THE MARK CONSISTS OF STANDARD CHARACTERS WITHOUT CLAIM TO ANY PARTICULAR FONT, STYLE, SIZE, OR COLOR.
FOR WINES (U.S. CLS. 47 AND 49).
LINDA E. BLOHM, EXAMINING ATTORNEY

THE MARK CONSISTS OF STANDARD CHARACTERS WITHOUT CLAIM TO ANY PARTICULAR FONT, STYLE, SIZE, OR COLOR.
NO CLAIM IS MADE TO THE EXCLUSIVE RIGHT TO USE "WINE", APART FROM THE MARK AS SHOWN.
FOR WINE (U.S. CLS. 47 AND 49).
RAY THOMAS, EXAMINING ATTORNEY

SN 77-140,863. OAKVILLE TRANSFER LLC, NAPA, CA. FILED 3-26-2007.

SN 77-142,723. ANDERSON & MIDDLETON COMPANY, HOQUIAM, WA. FILED 3-28-2007.

OAKVILLE TERRACES

ADOBE WHITE

THE MARK CONSISTS OF STANDARD CHARACTERS WITHOUT CLAIM TO ANY PARTICULAR FONT, STYLE, SIZE, OR COLOR.
NO CLAIM IS MADE TO THE EXCLUSIVE RIGHT TO USE "OAKVILLE", APART FROM THE MARK AS SHOWN.
FOR WINES (U.S. CLS. 47 AND 49).
COLLEEN DOMBROW, EXAMINING ATTORNEY

THE MARK CONSISTS OF STANDARD CHARACTERS WITHOUT CLAIM TO ANY PARTICULAR FONT, STYLE, SIZE, OR COLOR.
NO CLAIM IS MADE TO THE EXCLUSIVE RIGHT TO USE "WHITE", APART FROM THE MARK AS SHOWN.
FOR WINE (U.S. CLS. 47 AND 49).
BRIAN CALLAGHAN, EXAMINING ATTORNEY

SN 77-141,813. SOLOROSA, SAINT HELENA, CA. FILED 3-27-2007.

SN 77-142,812. THE WINE GROUP LLC, TRACY, CA. FILED 3-28-2007.

ZMOR

TREASURE HUNTER

THE MARK CONSISTS OF STANDARD CHARACTERS WITHOUT CLAIM TO ANY PARTICULAR FONT, STYLE, SIZE, OR COLOR.
FOR WINE (U.S. CLS. 47 AND 49).
FIRST USE 9-1-2006; IN COMMERCE 9-1-2006.
THEODORE MCBRIDE, EXAMINING ATTORNEY

THE MARK CONSISTS OF STANDARD CHARACTERS WITHOUT CLAIM TO ANY PARTICULAR FONT, STYLE, SIZE, OR COLOR.
FOR WINES (U.S. CLS. 47 AND 49).
TEJBIR SINGH, EXAMINING ATTORNEY

CLASS 33—(Continued).

SN 77-143,326. PHILIP STEVENS, PASO ROBLES, CA. FILED 3-29-2007.

DelReal

THE MARK CONSISTS OF STANDARD CHARACTERS WITHOUT CLAIM TO ANY PARTICULAR FONT, STYLE, SIZE, OR COLOR.
FOR GRAPE WINE; RED WINE; TABLE WINES; WHITE WINE; WINE; WINES (U.S. CLS. 47 AND 49).
THEODORE MCBRIDE, EXAMINING ATTORNEY

SN 77-143,573. SARL JEAN MARC BROCARD, PREHY, FRANCE, FILED 3-29-2007.

AZO

THE MARK CONSISTS OF STANDARD CHARACTERS WITHOUT CLAIM TO ANY PARTICULAR FONT, STYLE, SIZE, OR COLOR.
FOR WINES OF CHABLIS A FRENCH CONTROLLED APPELLATION OF ORIGIN (U.S. CLS. 47 AND 49).
FIRST USE 7-1-1987; IN COMMERCE 7-1-1987.
MICHAEL KAZAZIAN, EXAMINING ATTORNEY

SN 77-155,194. INTWINE MARKETING LLC, SAN FRANCISCO, CA. FILED 4-12-2007.

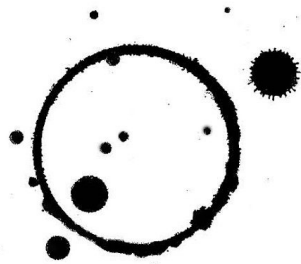

Wine Spots

NO CLAIM IS MADE TO THE EXCLUSIVE RIGHT TO USE "WINE", APART FROM THE MARK AS SHOWN.
THE STIPPLING IS A FEATURE OF THE MARK.
THE MARK CONSISTS OF AN OUTLINE OF A LARGE CIRCLE WITH VARIOUS-SIZED SMALLER CIRCLES AND SPECKS LOCATED INSIDE AND OUTSIDE THE LARGE CIRCLE WITH THE WORDS WINE SPOTS BELOW.
FOR WINE (U.S. CLS. 47 AND 49).
RAY THOMAS, EXAMINING ATTORNEY

CLASS 33—(Continued).

SN 77-163,443. THE WINE GROUP LLC, TRACY, CA. FILED 4-23-2007.

RUSTLING FALLS

THE MARK CONSISTS OF STANDARD CHARACTERS WITHOUT CLAIM TO ANY PARTICULAR FONT, STYLE, SIZE, OR COLOR.
FOR WINES (U.S. CLS. 47 AND 49).
TEJBIR SINGH, EXAMINING ATTORNEY

SN 77-163,445. THE WINE GROUP LLC, TRACY, CA. FILED 4-23-2007.

HUNTER THOMAS

THE MARK CONSISTS OF STANDARD CHARACTERS WITHOUT CLAIM TO ANY PARTICULAR FONT, STYLE, SIZE, OR COLOR.
THE NAME(S), PORTRAIT(S), AND/OR SIGNATURE(S) SHOWN IN THE MARK DOES NOT IDENTIFY A PARTICULAR LIVING INDIVIDUAL.
FOR WINES (U.S. CLS. 47 AND 49).
TEJBIR SINGH, EXAMINING ATTORNEY

SN 77-163,628. THE WINE GROUP LLC, TRACY, CA. FILED 4-23-2007.

ROBINS CREEK

THE MARK CONSISTS OF STANDARD CHARACTERS WITHOUT CLAIM TO ANY PARTICULAR FONT, STYLE, SIZE, OR COLOR.
FOR WINES (U.S. CLS. 47 AND 49).
TEJBIR SINGH, EXAMINING ATTORNEY

CLASS 33—(Continued).

SN 77-172,227. HEAVEN HILL DISTILLERIES, INC., BARDS-TOWN, KY. FILED 5-3-2007.

CHASKA

THE MARK CONSISTS OF STANDARD CHARACTERS WITHOUT CLAIM TO ANY PARTICULAR FONT, STYLE, SIZE, OR COLOR.
FOR DISTILLED SPIRITS (U.S. CLS. 47 AND 49).
FIRST USE 1-1-1980; IN COMMERCE 1-1-1980.
LANA PHAM, EXAMINING ATTORNEY

CLASS 33—(Continued).

SN 78-695,158. LA-HEM AB, 542 95 MARIESTAD, SWEDEN, FILED 8-18-2005.

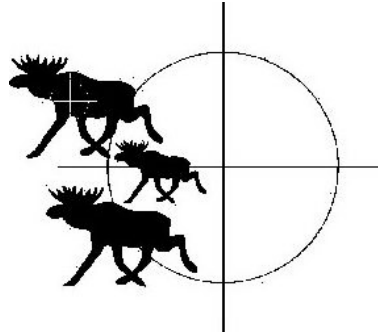

SN 77-189,790. NEAL FAMILY VINEYARDS LLC, ST. HELENA, CA. FILED 5-24-2007.

FIFTEEN FORTY

THE MARK CONSISTS OF STANDARD CHARACTERS WITHOUT CLAIM TO ANY PARTICULAR FONT, STYLE, SIZE, OR COLOR.
FOR WINE (U.S. CLS. 47 AND 49).
FIRST USE 3-2-2005; IN COMMERCE 3-2-2005.
LESLEY LAMOTHE, EXAMINING ATTORNEY

PRIORITY CLAIMED UNDER SEC. 44(D) ON ERPN CMNTY TM OFC APPLICATION NO. 004308235, FILED 2-24-2005, REG. NO. 004308235, DATED 4-4-2006, EXPIRES 2-24-2015.

THE MARK CONSISTS OF A PICTURE OF THREE ELK, TWO CIRCLES AND TWO SETS OF CROSSED LINES.
FOR ALCOHOLIC BEVERAGES, NAMELY, SCHNAPPS (U.S. CLS. 47 AND 49).
MARIA-VICTORIA SUAREZ, EXAMINING ATTORNEY

SN 78-703,112. ELSA'S MEXICAN ENTERPRISES, INC., DAYTON, OH. FILED 8-30-2005.

BAD JUAN

SN 78-427,801. BANISH, THOMAS C. DBA BLACK HAND CELLARS, SAN MIGUEL, CA. AND BANISH, TERRI A. DBA BLACK HAND CELLARS, SAN MIGUEL, CA. FILED 6-1-2004.

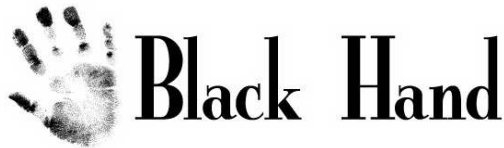

THE MARK CONSISTS OF A BLACK HAND PRINT AND THE WORDS BLACK HAND IN STYLIZED LETTERS.
FOR WINE (U.S. CLS. 47 AND 49).
FIRST USE 5-16-2004; IN COMMERCE 5-16-2004.
HOWARD B. LEVINE, EXAMINING ATTORNEY

THE MARK CONSISTS OF STANDARD CHARACTERS WITHOUT CLAIM TO ANY PARTICULAR FONT, STYLE, SIZE, OR COLOR.

THE NAME(S), PORTRAIT(S), AND/OR SIGNATURE(S) SHOWN IN THE MARK DOES NOT IDENTIFY A PARTICULAR LIVING INDIVIDUAL.

FOR PREPARED ALCOHOLIC COCKTAIL (U.S. CLS. 47 AND 49).
FIRST USE 7-0-1980; IN COMMERCE 7-0-1980.
MATTHEW PAPPAS, EXAMINING ATTORNEY

CLASS 33—(Continued).

SN 78-714,934. KIUCHI BREWERY GOSHIKAISHA, NAKASHI, JAPAN, FILED 9-16-2005.

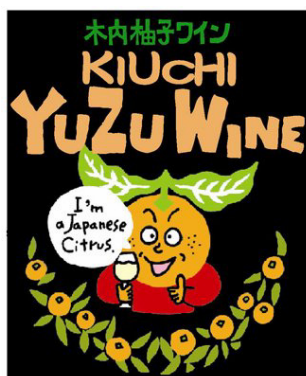

NO CLAIM IS MADE TO THE EXCLUSIVE RIGHT TO USE "YUZU WINE", APART FROM THE MARK AS SHOWN.

"THE COLOR(S) GREEN, ORANGE, RED, PINK, YELLOW, BLACK AND WHITE IS/ARE CLAIMED AS A FEATURE OF THE MARK."

THE MARK CONSISTS OF JAPANESE CHARACTERS ARE GREEN; THE WORDS "KIUCHI YUZU WINE" ARE ORANGE; TOP OF HEAD ARE GREEN WITH WHITE VEINS; THE HEAD AND HANDS ARE ORANGE; THE EYE BROWS, NOSE, OUTLINE OF THE HANDS, MOUTH AND EYES ARE BLACK; CHEEK LINES AND FRECKLES ARE BLACK; THE EYES ARE WHITE WITH BLACK PUPILS; THE INSIDE OF THE MOUTH IS PINK; THE WINE GLASS IS YELLOW WITH WHITE ON TOP; THE SWEATER IS RED; THE SPEECH BUBBLE IS WHITE WITH THE WORDS "I'M A JAPANESE CITRUS." WHICH ARE BLACK; ORANGES ON THE BOTTOM ARE ORANGE WITH A GREEN DOT ON EACH; THE LEAVES AROUND THE ORANGES ARE GREEN; ALL OF WHICH IS ON A BLACK BACKGROUND.

"THE NON-LATIN CHARACTER(S) IN THE MARK TRANSLITERATES INTO KIUCHI YUZU WAIN, AND THIS MEANS KIUCHI YUZU WINE IN ENGLISH."

FOR WINE (U.S. CLS. 47 AND 49).

FIRST USE 5-1-2005; IN COMMERCE 5-1-2005.

IRENE D. WILLIAMS, EXAMINING ATTORNEY

CLASS 33—(Continued).

SN 78-721,082. SCA SAINTE-COLOMBE, SAINT-MAGNE DE CASTILLON, FRANCE, FILED 9-27-2005.

Château
Clos l'Eglise

Grand Vin de Bordeaux
Produced in France

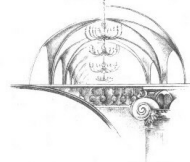

Côtes de Castillon

NO CLAIM IS MADE TO THE EXCLUSIVE RIGHT TO USE "CHATEAU" AND "GRAND VIN DE BORDEAUX PRODUCE OF FRANCE COTES DE CASTILLON", APART FROM THE MARK AS SHOWN.

THE MARK CONSISTS OF THE WORDS CHATEAU CLOS L'EGLISE IN SPECIAL FORM, THE WORDS GRAND VIN DE BORDEAUX PRODUCT OF FRANCE APPEARING UNDERNEATH AND A DESIGN REPRESENTATIVE OF A WINE OR SPIRIT STORE AND THE WORDS COTES DE CASTILLON IN SPECIAL FORM APPEARING UNDERNEATH.

THE ENGLISH TRANSLATION OF THE WORDS "CHATEAU CLOS L'EGLISE GRAND VIN DE BORDEAUX" IN THE MARK IS "CASTLE CHURCH'S VINEYARD OF THE GREAT BORDEAUX WINE".

FOR RED WINE PRODUCED NEAR DE CASTILLON (U.S. CLS. 47 AND 49).

NAKIA HENRY, EXAMINING ATTORNEY

SN 78-741,770. ELVIS PRESLEY ENTERPRISES, INC., MEMPHIS, TN. FILED 10-27-2005.

JAILHOUSE RED

THE MARK CONSISTS OF STANDARD CHARACTERS WITHOUT CLAIM TO ANY PARTICULAR FONT, STYLE, SIZE, OR COLOR.

NO CLAIM IS MADE TO THE EXCLUSIVE RIGHT TO USE "RED", APART FROM THE MARK AS SHOWN.

FOR WINE (U.S. CLS. 47 AND 49).

FIRST USE 2-24-2004; IN COMMERCE 2-24-2004.

STEVEN JACKSON, EXAMINING ATTORNEY

CLASS 33—(Continued).

SN 78-814,875. BOOMERANG VODKA PTY LTD., MELBOURNE, AUSTRALIA, FILED 2-14-2006.

BOOMERANG VODKA

THE MARK CONSISTS OF STANDARD CHARACTERS WITHOUT CLAIM TO ANY PARTICULAR FONT, STYLE, SIZE, OR COLOR.

PRIORITY CLAIMED UNDER SEC. 44(D) ON AUSTRALIA APPLICATION NO. 1086185, FILED 11-16-2005, REG. NO. 1086185, DATED 11-16-2005, EXPIRES 11-16-2015.

NO CLAIM IS MADE TO THE EXCLUSIVE RIGHT TO USE "VODKA", APART FROM THE MARK AS SHOWN.

FOR ALCOHOLIC BEVERAGES, NAMELY DISTILLED SPIRITS (U.S. CLS. 47 AND 49).

DAHLIA GEORGE, EXAMINING ATTORNEY

SN 78-901,229. ANDREW EDWARD GUNN, GRABOUW, SOUTH AFRICA, FILED 6-6-2006.



THE MARK CONSISTS OF A VIKING SHIP, THE WORD-ING IONA WITH A WAVE UNDERLINE.

FOR APERITIF WINES; APERITIFS WITH A WINE BASE; COOKING WINE; FRUIT WINE; GRAPE WINE; KITS FOR MAKING WINE; NATURAL SPARKLING WINES; PORT WINES; PREPARED WINE COCKTAILS; RED WINE; SPARKLING FRUIT WINE; SPARKLING GRAPE WINE; SPARKLING WINE; STRAWBERRY WINE; SWEET WINES; TABLE WINES; TONIC SWEET GRAPE WINE CONTAINING EXTRACTS FROM GINSENG AND CONCHONA BARK (NINJIN-KINATETSU WINE); WHITE WINE; WINE; WINE COOLERS ; WINE PUNCH; WINE PUNCHES; WINES (U.S. CLS. 47 AND 49).

FIRST USE 7-1-2001; IN COMMERCE 7-1-2001.
LINDA ESTRADA, EXAMINING ATTORNEY

CLASS 33—(Continued).

SN 78-915,437. DISTRIBUIDORA CANDELARIA S.A., CORDOBA, ARGENTINA, FILED 6-23-2006.



NO CLAIM IS MADE TO THE EXCLUSIVE RIGHT TO USE "VP", APART FROM THE MARK AS SHOWN.

THE MARK CONSISTS OF A RECTANGLE WITH A DECORATIVE BORDER IN THE BACKGROUND; AND THE WORDS VASIJA PRIVADA, LOCATED ON TOP, AND THE LETTERS VP WITHIN A SMALLER RECTANGLE, LOCATED IN THE MIDDLE, IN THE FOREGROUND.

THE FOREIGN WORDING IN THE MARK TRANSLATES INTO ENGLISH AS PRIVATE VESSEL.

FOR WINES, EXCLUDING GINGER WINES (U.S. CLS. 47 AND 49).

KATHERINE STOIDES, EXAMINING ATTORNEY

SN 78-943,994. JUDD, JAMES, PALM DESERT, CA. FILED 8-3-2006.

EL GIGANTE ROJO

THE MARK CONSISTS OF STANDARD CHARACTERS WITHOUT CLAIM TO ANY PARTICULAR FONT, STYLE, SIZE, OR COLOR.

NO CLAIM IS MADE TO THE EXCLUSIVE RIGHT TO USE "ROJO", APART FROM THE MARK AS SHOWN.

THE FOREIGN WORDING IN THE MARK TRANSLATES INTO ENGLISH AS THE RED GIANT.

FOR WINE (U.S. CLS. 47 AND 49).

SETH A. RAPPAPORT, EXAMINING ATTORNEY

CLASS 33—(Continued).

SN 78-948,086. VINA VENTISQUERO LIMITADA, RANCA-GUA, CHILE, FILED 8-9-2006.

ORIUNDO

THE MARK CONSISTS OF STANDARD CHARACTERS WITHOUT CLAIM TO ANY PARTICULAR FONT, STYLE, SIZE, OR COLOR.

PRIORITY CLAIMED UNDER SEC. 44(D) ON CHILE APPLICATION NO. 736762, FILED 7-18-2006, REG. NO. 779254, DATED 2-5-2007, EXPIRES 2-5-2017.

THE ENGLISH TRANSLATION OF THE SPANISH WORD ORIUNDO IN THE MARK IS: "NATIVE" OR "ORIGINATING."

FOR WINES AND ALCOHOLIC BEVERAGES, NAMELY, GIN, VODKA, AND BRANDY SPIRITS (U.S. CLS. 47 AND 49).

THOMAS MANOR, EXAMINING ATTORNEY

SN 78-952,733. DICKERSON VINEYARD LLC, PORTOLA VALLEY, CA. FILED 8-15-2006.

DICKERSON VINEYARD

THE MARK CONSISTS OF STANDARD CHARACTERS WITHOUT CLAIM TO ANY PARTICULAR FONT, STYLE, SIZE, OR COLOR.

NO CLAIM IS MADE TO THE EXCLUSIVE RIGHT TO USE "VINEYARD", APART FROM THE MARK AS SHOWN. SEC. 2(F).

FOR WINE (U.S. CLS. 47 AND 49).
FIRST USE 0-0-1986; IN COMMERCE 0-0-1986.
ANNE E. GUSTASON, EXAMINING ATTORNEY

SN 78-968,929. BAILEY FAMILY VINEYARDS, LLC, BOSTON, MA. FILED 9-7-2006.

KNIGHTS BRIDGE

THE MARK CONSISTS OF STANDARD CHARACTERS WITHOUT CLAIM TO ANY PARTICULAR FONT, STYLE, SIZE, OR COLOR.

FOR WINE (U.S. CLS. 47 AND 49).
SUSAN STIGLITZ, EXAMINING ATTORNEY

CLASS 33—(Continued).

SN 79-016,857. "MARAN" LTD, ARMENIA, FILED 10-14-2004.



OWNER OF INTERNATIONAL REGISTRATION 0866300 DATED 10-14-2004, EXPIRES 10-14-2014.

NO CLAIM IS MADE TO THE EXCLUSIVE RIGHT TO USE "ARENI", APART FROM THE MARK AS SHOWN.

THE COLOR(S) WHITE, RED, WINE-COLORED, BLACK, GREY, GREEN, BLUE, GOLD, AND LIGHT BROWN IS/ARE CLAIMED AS A FEATURE OF THE MARK.

THE BACKGROUND OF THE MARK IS WHITE. IN THE CENTER OF THE FRAGMENT, THERE IS THE GROOM SITTING ON A THRONE. HE IS WEARING A LONG RED GARMENT, WITH BLUE EDGES AND APRON AND A BLUE CAP TOPPED WITH RED. THE BLUE OF THE EDGING OF THE GROOM'S GARMENT, THE APRON AND THE CAP HAVE BLACK STRIPES. THE THRONE IS OF GOLDEN COLOR. A SMALL TABLE TO THE RIGHT OF THE GROOM IS ALSO GOLD, WITH THREE RED GOBLET ON IT. TO THE RIGHT FROM THE GROOM THERE ARE TWO FIGURES. THE FIRST OF THESE TWO IS WEARING A GREEN LONG GARMENT WITH BLACK STRIPES AND LIGHT BROWN EDGING AND SLEEVES. HE IS HOLDING A RED JAR FROM WHICH HE IS POURING RED WINE INTO THE MIDDLE GOBLET ON THE TABLE. THE SECOND FIGURE IS CLAD IN A LONG RED GARMENT WITH BLACK EDGING. THESE TWO FIGURES ARE WEARING RED SHOES AND HAVE GOLDEN HALOS ABOVE THEIR HEADS. TO THE LEFT FROM THE GROOM THE CHRIST IS SITTING ON A THRONE OF GOLD. HE IS WEARING LIGHT BROWN GARMENT WITH DARK GREEN EDGING AND SLEEVES. THE EDGING AND THE SLEEVES HAVE BLACK STRIPES, AND THE RIMS OF THE LIGHT BROWN ARE HIGHLIGHTED IN DARK BROWN. HE HAS A GOLDEN HALO ABOVE HIS HEAD. TO THE LEFT OF THE CHRIST THERE ARE TWO DISCIPLES. THE FIRST IS WEARING A LONG GREEN ROBE WITH BLACK STRIPES AND RED FOLDS. THE SECOND ONE IS WEARING A RED GARMENT WITH GREEN STRIPED SLEEVES AND EDGING. THE DISCIPLES ARE WEARING RED SHOES AND HAVE GOLDEN HALOS ABOVE THEIR HEADS. BELOW THESE SIX FIGURES, THERE IS A ROW OF SIX VESSELS OR JARS. THE FIRST AND THE FOURTH FROM THE LEFT ARE DARK GREEN AND ARE COVERED WITH BLACK STRIPES, THE SECOND AND THE FIFTH ARE DARK BLUE AND ALSO HAVE BLACK STRIPES, AND THE THIRD AND THE LAST ONE ARE RED. BELOW THESE JARS THERE IS ARMENIAN WORDING IN PURPLE.

THE ARMENIAN CAPITAL CHARACTERS ABOVE THE RECORD ARENI OF MARAN ARE TRANSLITERATED AS ARENI MARANI. ARENI IS A TYPE OF GRAPE. THE NON-LATIN CHARACTERS ABOVE THE DEPICTED FIGURES ARE TRANSLITERATED INTO "YIS QS, ASHAKER, PE-SAYN, JOKHOVURDQN", AND THESE MEAN "DISCIPLES, JESUS CHRIST, GROOM, PEOPLE" IN ENGLISH. ABOVE THE JARS, THE NON-LATIN INSCRIPTION IS TRANSLITERATED INTO "KTCHEAYQ VETS EST SRBOU TEAN HREAYITS" AND THIS TRANSLATES AS "SIX VESSELS ACCORDING TO JEWISH SANCTUARIES" IN ENGLISH.

FOR WINE MADE OF GRAPES OF "ARENI" TYPE (U.S. CLS. 47 AND 49).
MICHAEL WEBSTER, EXAMINING ATTORNEY

CLASS 33—(Continued).

SN 79-019,283. LATVIJAS BALZAMS, A/S, LV-1012 RIGA, LATVIA, FILED 12-9-2005.



PRIORITY DATE OF 10-28-2005 IS CLAIMED.
OWNER OF INTERNATIONAL REGISTRATION 0872390
DATED 12-9-2005, EXPIRES 12-9-2015.

OWNER OF U.S. REG. NO. 2,890,819.

NO CLAIM IS MADE TO THE EXCLUSIVE RIGHT TO USE "RIGA" AND "HERBAL BITTER" AND "PRODUCT OF LATVIA" AND "BLACK BALSAM" AND "SINCE 1752" AND "RIGAS" AND "MELNAIS" AND "BALZAMS" AND "RAZOSANU PARRAUGA "SPI GROUP"" AND "RAZOTS UN PILDITS LATVIJA" AND "PRODUCED FOR S.P.I. GROUP" AND "PRODUCED & BOTTLED IN LATVIA" AND "ALK. 45% TILP." AND "TILP. 0,04L", APART FROM THE MARK AS SHOWN.

THE COLOR(S) BLACK, BRONZE, GOLD, AND WHITE IS/ARE CLAIMED AS A FEATURE OF THE MARK.

THE MARK CONSISTS OF A DESIGN AGAINST A BLACK BACKGROUND. THE WORDS RIGA AND BALZAMS APPEAR AT THE TOP AND BOTTOM PORTION OF THE DESIGN IN GOLD LETTERS OUTLINED IN WHITE. THERE IS A DESIGN OF A CASTLE AT THE TOP OF THE DESIGN WITH TWO BANNERS SPREADING OUT ON EITHER SIDE. THE BANNER ON THE LEFT CONTAINS THE WORDS "HERBAL BITTER" AND THE BANNER ON THE RIGHT CONTAINS THE WORDS "PRODUCT OF LATVIA." THE BANNERS ARE OUTLINED IN GOLD AGAINST A BLACK BACKGROUND, THE CASTLE IS IN GOLD, AND THE WORDS, HERBAL BITTER AND PRODUCT OF LATVIA, ARE IN GOLD LETTERS OUTLINED IN WHITE. ABOVE THE CASTLE ARE TWO GOLD KEYS THAT OVERLAP AND ABOVE THE KEYS IS A GOLD CROSS. AROUND THE TOP AND EDGES OF THE DESIGN ARE ELABORATE SWIRLS, LEAF-TYPE OBJECTS, AND FLOWER GARLANDS, ALL IN GOLD. IN THE CENTER OF THE DESIGN IS A GOLD-TRIMMED SECTION THAT IS FILLED WITH THE COLOR BRONZE. THE WORDS BLACK, BALSAM AND SINCE 1752 ARE ENCLOSED WITHIN THIS SECTION, IN BLACK LETTERS WITH GOLD TRIM. TO THE LEFT OF THE WORDS SINCE 1752 IS THE WORD RIGAS IN GOLD LETTERS OUTLINED IN WHITE AND TO THE RIGHT THE WORD MELNAIS IN GOLD LETTERS OUTLINED IN WHITE. BELOW THE WORD BALZAMS IS A SERIES OF OVAL AND CIRCULAR SHAPED MEDALLION-LIKE OBJECTS WITH WRITING AND DRAWINGS CONTAINED THEREIN, ALL IN BRONZE AGAINST A BLACK BACKGROUND. THE GOLD WRITING BELOW THESE MEDALLION-LIKE OBJECTS CONSISTS OF INFORMATION FOR THE LABEL ONLY AND IS NOT PART OF THE DESIGN.

THE FOREIGN WORDING IN THE MARK TRANSLATES INTO ENGLISH AS RIGA, BLACK, BALSAM, PRODUCTION OVERSEEN, AND PRODUCED AND BOTTLED IN LATVIA.

FOR ALCOHOLIC BEVERAGES, NAMELY HERBAL BITTER LIQUEURS (U.S. CLS. 47 AND 49).

PAMELA HIRSCHMAN, EXAMINING ATTORNEY

CLASS 33—(Continued).

SN 79-029,388. SCI DES BROIX, FRANCE, FILED 9-6-2006.

VIEILLE VILLE

THE MARK CONSISTS OF STANDARD CHARACTERS WITHOUT CLAIM TO ANY PARTICULAR FONT, STYLE, SIZE, OR COLOR.

PRIORITY DATE OF 3-21-2006 IS CLAIMED.

OWNER OF INTERNATIONAL REGISTRATION 0899688
DATED 9-6-2006, EXPIRES 9-6-2016.

THE ENGLISH TRANSLATION OF THE FOREIGN WORD(S) IN THE MARK IS: OLD TOWN.

FOR ALCOHOLIC BEVERAGES, NAMELY, VODKA, BRANDY, COGNAC, AND LIQUEUR (U.S. CLS. 47 AND 49).

CHRISTOPHER BUONGIORNO, EXAMINING ATTORNEY

SN 79-030,250. LES PROVINS, FRANCE, FILED 7-18-2006.

GRAND EMPEREUR NAPOLEON

OWNER OF INTERNATIONAL REGISTRATION 0151487
DATED 1-29-1951, EXPIRES 1-29-2011.

THE NAME NAPOLEON DOES NOT IDENTIFY A LIVING INDIVIDUAL.

THE ENGLISH TRANSLATION OF THE FOREIGN WORD(S) IN THE MARK IS: GRAND EMPEROR NAPOLEON.

FOR EAU DE VIE, LIQUEURS AND DISTILLED SPIRITS (U.S. CLS. 47 AND 49).

JENNIFER VASQUEZ, EXAMINING ATTORNEY

SN 79-030,323. SCI DES BROIX, FRANCE, FILED 9-27-2006.

OLD TOWN

THE MARK CONSISTS OF STANDARD CHARACTERS WITHOUT CLAIM TO ANY PARTICULAR FONT, STYLE, SIZE, OR COLOR.

PRIORITY DATE OF 4-6-2006 IS CLAIMED.

OWNER OF INTERNATIONAL REGISTRATION 0901991
DATED 9-27-2006, EXPIRES 9-27-2016.

FOR ALCOHOLIC BEVERAGES, NAMELY, VODKA, BRANDY, COGNAC, AND LIQUEUR (U.S. CLS. 47 AND 49).

CHRISTOPHER BUONGIORNO, EXAMINING ATTORNEY

CLASS 33—(Continued).

SN 79-033,262. SCI DES BROIX, FRANCE, FILED 10-11-2006.

DOMAINE DE BROIX

THE MARK CONSISTS OF STANDARD CHARACTERS WITHOUT CLAIM TO ANY PARTICULAR FONT, STYLE, SIZE, OR COLOR.

OWNER OF INTERNATIONAL REGISTRATION 0909497 DATED 10-11-2006, EXPIRES 10-11-2016.

THE FOREIGN WORDING IN THE MARK TRANSLATES INTO ENGLISH AS BROIX ESTATE.

FOR ALCOHOLIC BEVERAGES NAMELY VODKA, BRANDY, COGNAC AND LIQUEUR (U.S. CLS. 47 AND 49).

CHRISTOPHER BUONGIORNO, EXAMINING ATTORNEY

SN 79-034,428. TORREVILLA VITICOLTORI ASSOCIATI -; SOC. COOP. AGRICOLA, ITALY, FILED 11-27-2006.

TORREVILLA

THE MARK CONSISTS OF STANDARD CHARACTERS WITHOUT CLAIM TO ANY PARTICULAR FONT, STYLE, SIZE, OR COLOR.

OWNER OF INTERNATIONAL REGISTRATION 0912979 DATED 11-27-2006, EXPIRES 11-27-2016.

THE ENGLISH TRANSLATION OF THE WORD "TORRE" IN THE MARK IS "TOWER".

FOR WINES; SPARKLING WINES; WINE BASED APERITIFS, APERITIFS WITH A DISTILLED ALCOHOLIC LIQUOR BASE; LIQUEURS; BRANDY; GRAPPA (U.S. CLS. 47 AND 49).

BARBARA A. GOLD, EXAMINING ATTORNEY

SN 79-038,437. MICHELE CHIARLO S.R.L.; AZIENDA VITIVINICOLA, ITALY, FILED 3-23-2007.

LE ORME

THE MARK CONSISTS OF STANDARD CHARACTERS WITHOUT CLAIM TO ANY PARTICULAR FONT, STYLE, SIZE, OR COLOR.

OWNER OF INTERNATIONAL REGISTRATION 0924026 DATED 3-23-2007, EXPIRES 3-23-2017.

THE ENGLISH TRANSLATION OF THE FOREIGN WORD(S) "LE ORME" IN THE MARK IS "THE FOOTPRINTS" OR "THE TRACES".

FOR WINES (U.S. CLS. 47 AND 49).

ROBIN CHOSID, EXAMINING ATTORNEY

CLASS 34—SMOKERS' ARTICLES

SN 77-020,912. A-Z CORPORATION INTERNATIONAL SAL, BEIRUT, LEBANON, FILED 10-13-2006.

AFTERS

OWNER OF LEBANON REG. NO. 107916, DATED 9-5-2006, EXPIRES 9-5-2021.

THE MARK CONSISTS OF THE WORD AFTERS WITH AN ARBITRARY DESIGN.

FOR CIGARETTES, CIGARS, ASHTRAYS, LIGHTERS, CIGARETTE PAPERS (U.S. CLS. 2, 8, 9 AND 17).

RICHARD WHITE, EXAMINING ATTORNEY

SN 77-051,320. TIDELINE INTERNATIONAL COMPANY, PORTLAND, OR. FILED 11-27-2006.

WESTBURY

THE MARK CONSISTS OF STANDARD CHARACTERS WITHOUT CLAIM TO ANY PARTICULAR FONT, STYLE, SIZE, OR COLOR.

FOR TOBACCO; CIGARETTES; CIGARS; SMOKELESS TOBACCO; LOOSE TOBACCO; AND SMOKERS' ARTICLES, NAMELY, MATCHES AND CIGARETTE LIGHTERS (U.S. CLS. 2, 8, 9 AND 17).

ALEXANDER L. POWERS, EXAMINING ATTORNEY

CLASS 34—(Continued).

SN 77-127,507. SASA GROUP LLC, SAN DIEGO, CA. FILED 3-9-2007.



THE MARK CONSISTS OF FLAME SYMBOL. FOR SMOKING TOBACCO; TOBACCO; TOBACCO POUCHES (U.S. CLS. 2, 8, 9 AND 17). FIRST USE 1-1-2006; IN COMMERCE 1-1-2007. KATHERINE CHANG, EXAMINING ATTORNEY

SN 77-130,803. FILLIGENT LIMITED, CENTRAL, HONG KONG, FILED 3-14-2007.

CHARCOAL +

THE MARK CONSISTS OF STANDARD CHARACTERS WITHOUT CLAIM TO ANY PARTICULAR FONT, STYLE, SIZE, OR COLOR. NO CLAIM IS MADE TO THE EXCLUSIVE RIGHT TO USE CHARCOAL, APART FROM THE MARK AS SHOWN. FOR COMPONENTS FOR INCORPORATION INTO CIGARETTES, CIGARS, CIGARILLOS, NAMELY, CELLULOSE PAPER AND TOBACCO SMOKE FILTERS (U.S. CLS. 2, 8, 9 AND 17). DOMINICK J. SALEMI, EXAMINING ATTORNEY

SN 77-130,820. FILLIGENT LIMITED, CENTRAL, HONG KONG, FILED 3-14-2007.

CHARCOAL PLUS

THE MARK CONSISTS OF STANDARD CHARACTERS WITHOUT CLAIM TO ANY PARTICULAR FONT, STYLE, SIZE, OR COLOR. NO CLAIM IS MADE TO THE EXCLUSIVE RIGHT TO USE CHARCOAL, APART FROM THE MARK AS SHOWN. FOR COMPONENTS FOR INCORPORATION INTO CIGARETTES, CIGARS, CIGARILLOS, NAMELY, CELLULOSE PAPER AND TOBACCO SMOKE FILTERS (U.S. CLS. 2, 8, 9 AND 17). DOMINICK J. SALEMI, EXAMINING ATTORNEY

CLASS 34—(Continued).

SN 77-130,826. FILLIGENT LIMITED, CENTRAL, HONG KONG, FILED 3-14-2007.

CARBON +

THE MARK CONSISTS OF STANDARD CHARACTERS WITHOUT CLAIM TO ANY PARTICULAR FONT, STYLE, SIZE, OR COLOR. NO CLAIM IS MADE TO THE EXCLUSIVE RIGHT TO USE CARBON, APART FROM THE MARK AS SHOWN. FOR COMPONENTS FOR INCORPORATION INTO CIGARETTES, CIGARS, CIGARILLOS, NAMELY, CELLULOSE PAPER AND TOBACCO SMOKE FILTERS (U.S. CLS. 2, 8, 9 AND 17). DOMINICK J. SALEMI, EXAMINING ATTORNEY

SN 77-130,844. FILLIGENT LIMITED, CENTRAL, HONG KONG, FILED 3-14-2007.

CARBON PLUS

THE MARK CONSISTS OF STANDARD CHARACTERS WITHOUT CLAIM TO ANY PARTICULAR FONT, STYLE, SIZE, OR COLOR. NO CLAIM IS MADE TO THE EXCLUSIVE RIGHT TO USE "CARBON", APART FROM THE MARK AS SHOWN. FOR COMPONENTS FOR INCORPORATION INTO CIGARETTES, CIGARS, CIGARILLOS, NAMELY, CELLULOSE PAPER AND TOBACCO SMOKE FILTERS (U.S. CLS. 2, 8, 9 AND 17). DOMINICK J. SALEMI, EXAMINING ATTORNEY

SN 77-136,693. NATIONAL TOBACCO COMPANY, L.P., LOUISVILLE, KY. FILED 3-21-2007.

QUALITY MADE IT FAMOUS

THE MARK CONSISTS OF STANDARD CHARACTERS WITHOUT CLAIM TO ANY PARTICULAR FONT, STYLE, SIZE, OR COLOR. SEC. 2(F). FOR TOBACCO, NAMELY, SMOKELESS TOBACCO, SNUFF AND CHEWING TOBACCO (U.S. CLS. 2, 8, 9 AND 17). FIRST USE 12-31-1939; IN COMMERCE 12-31-1939. MARGERY A. TIERNEY, EXAMINING ATTORNEY

CLASS 34—(Continued).

SN 77-142,997. SKOOKUM CREEK TOBACCO, SHELTON, WA. FILED 3-28-2007.

Traditions

THE MARK CONSISTS OF STANDARD CHARACTERS WITHOUT CLAIM TO ANY PARTICULAR FONT, STYLE, SIZE, OR COLOR.

FOR CIGARETTES (U.S. CLS. 2, 8, 9 AND 17).
PAM WILLIS, EXAMINING ATTORNEY

SN 77-144,689. CAO INTERNATIONAL, INC., NASHVILLE, TN. FILED 3-30-2007.

DAGGERS

THE MARK CONSISTS OF STANDARD CHARACTERS WITHOUT CLAIM TO ANY PARTICULAR FONT, STYLE, SIZE, OR COLOR.

FOR CIGARS (U.S. CLS. 2, 8, 9 AND 17).
EMILY CHUO, EXAMINING ATTORNEY

SN 77-153,349. BLUNT WRAP U.S.A., INC., MANDEVILLE, LA. FILED 4-10-2007.

C-THRU

THE MARK CONSISTS OF STANDARD CHARACTERS WITHOUT CLAIM TO ANY PARTICULAR FONT, STYLE, SIZE, OR COLOR.

FOR TOBACCO PRODUCTS, ACCESSORIES, AND SMOKING ARTICLES, NAMELY, CIGARETTES, CIGARS, ROLLING PAPERS MADE OUT OF PAPER, TOBACCO, CELLULOSE, AND OTHER MATERIALS FOR CIGARETTES AND CIGARS, AND ROLLING TOBACCO FOR CIGARETTES AND CIGARS, PRE-ROLLED TOBACCO SHELLS, TOBACCO SHEETS, CHEWING TOBACCO, SNUFF, PIPE TOBACCO, ROLL YOUR OWN TOBACCO, AND CIGARETTE PAPERS (U.S. CLS. 2, 8, 9 AND 17).
CURTIS FRENCH, EXAMINING ATTORNEY

CLASS 34—(Continued).

SN 77-204,126. CIGARS INTERNATIONAL, INC., BATH, PA. FILED 6-12-2007.

BANDIDOS

THE MARK CONSISTS OF STANDARD CHARACTERS WITHOUT CLAIM TO ANY PARTICULAR FONT, STYLE, SIZE, OR COLOR.

THE ENGLISH TRANSLATION OF THE WORD BANDIDOS IN THE MARK IS BANDITS.

FOR CIGARS (U.S. CLS. 2, 8, 9 AND 17).
FIRST USE 10-20-2004; IN COMMERCE 10-20-2004.
THEODORE MCBRIDE, EXAMINING ATTORNEY

SN 78-938,630. JOH. WILH. VON EICKEN GMBH, 23556 LÜBECK, FED REP GERMANY, FILED 7-27-2006.

DIMITRINO

THE MARK CONSISTS OF STANDARD CHARACTERS WITHOUT CLAIM TO ANY PARTICULAR FONT, STYLE, SIZE, OR COLOR.

FOR CIGARETTES, SMOKING TOBACCO, ASHTRAYS, AND LIGHTERS NOT OF PRECIOUS METAL (U.S. CLS. 2, 8, 9 AND 17).
YONG KIM, EXAMINING ATTORNEY

SN 78-952,693. JONATHAN DREW, INC. D/B/A DREW ESTATE, MIAMI, FL. FILED 8-15-2006.

HOME GROWN

THE MARK CONSISTS OF STANDARD CHARACTERS WITHOUT CLAIM TO ANY PARTICULAR FONT, STYLE, SIZE, OR COLOR.

FOR CIGARS, CIGARETTES, BLUNT WRAP, NAMELY, ROLLING PAPERS FOR CIGARS AND CIGARETTES, TOBACCO, AND RELATED PRODUCTS, NAMELY CIGAR BOXES, CIGAR AND CIGARETTE LIGHTERS NOT FOR LAND VEHICLES, CIGARETTE HOLDERS, ASHTRAYS, CIGAR BANDS, CIGAR CUTTERS, HUMIDORS, AND CIGAR TUBES (U.S. CLS. 2, 8, 9 AND 17).
MATTHEW MCDOWELL, EXAMINING ATTORNEY

CLASS 34—(Continued).

SN 78-956,731. KING MOUNTAIN TOBACCO COMPANY, INC., WHITE SWAN, WA. FILED 8-21-2006.

King Mountain

THE MARK CONSISTS OF STANDARD CHARACTERS WITHOUT CLAIM TO ANY PARTICULAR FONT, STYLE, SIZE, OR COLOR.

FOR CIGARETTES (U.S. CLS. 2, 8, 9 AND 17).
FIRST USE 1-1-2006; IN COMMERCE 1-1-2006.
MARY CRAWFORD, EXAMINING ATTORNEY

SN 79-028,076. GIZEH RAUCHERBEDARF GMBH, FED REP GERMANY, FILED 7-27-2006.



PRIORITY DATE OF 2-21-2006 IS CLAIMED.
OWNER OF INTERNATIONAL REGISTRATION 0896416 DATED 7-27-2006, EXPIRES 7-27-2016.
OWNER OF U.S. REG. NOS. 1,877,884, 2,205,181 AND 3,136,077.

FOR CIGARETTE PAPER, CIGARETTE PAPER SHEETS, BOOKS FOR CIGARETTE PAPER, CIGARETTE TUBES, IN PARTICULAR FILTER CIGARETTE TUBES; SMOKERS' ARTICLES, NAMELY, APPARATUS FOR MAKING CIGARETTES, IN PARTICULAR FOR ROLLING AND FILLING, TOBACCO SMOKE FILTERS, ABSORBENT PAPER FOR TOBACCO SMOKE, PAPER TOBACCO FILTERS, TOBACCO PIPES, SMOKING PIPE CLEANERS, TOBACCO PIPE CLEANERS, TOOLS FOR SMOKING PIPES, NAMELY, PIPE TAMPERS, TOBACCO TINS, CIGARETTE HOLDERS CIGAR CUTTERS, LIGHTERS, ALL THE AFORESAID GOODS NOT MADE OF PRECIOUS METALS AND THEIR ALLOYS, OR COATED THEREWITH; TOBACCO, IN PARTICULAR SMOKING TOBACCO, CIGARETTES, FILTER CIGARETTES, CIGARETTES MADE FROM TOBACCO SUBSTITUTES, NOT FOR MEDICAL PURPOSES, CIGARILLOS, CIGARS (U.S. CLS. 2, 8, 9 AND 17).
JOANNA DUKOVIC, EXAMINING ATTORNEY

CLASS 35—(Continued).**SERVICE MARKS****CLASS 35—ADVERTISING AND BUSINESS**

SN 76-372,742. BROADCAST ARCHITECTURE, INC., PRINCETON, NJ. FILED 2-20-2002.

SMOOTH JAZZ NETWORK

NO CLAIM IS MADE TO THE EXCLUSIVE RIGHT TO USE "NETWORK", APART FROM THE MARK AS SHOWN. FOR BUSINESS CONSULTATION IN THE FIELDS OF SALES, RESEARCH, MARKETING, FORMATTING AND PROGRAMMING FOR RADIO STATION BROADCASTING (U.S. CLS. 100, 101 AND 102).

FIRST USE 11-9-1993; IN COMMERCE 1-1-1994.
TRACY WHITTAKER-BROWN, EXAMINING ATTORNEY

SN 76-496,303. BEHR GMBH & CO., D-70469 STUTTGART, FED REP GERMANY, FILED 3-11-2003.

HOUSE OF RELIABILITY

OWNER OF ERPN CMNTY TM OFC REG. NO. 003074358, DATED 9-21-2006, EXPIRES 2-27-2013.

FOR BUSINESS CONSULTING, MANAGEMENT CONSULTING, BUSINESS ADMINISTRATION, BUSINESS MANAGEMENT (U.S. CLS. 100, 101 AND 102).
ANNE MADDEN, EXAMINING ATTORNEY

SN 76-641,566. DESIGN ROOM, INC., CLEVELAND, OH. FILED 6-24-2005.

DR. C

THE MARK CONSISTS OF STANDARD CHARACTERS WITHOUT CLAIM TO ANY PARTICULAR FONT, STYLE, SIZE, OR COLOR.

FOR ADVERTISING SERVICES, NAMELY PREPARATION OF ADVERTISEMENTS AND BUSINESS PROMOTION MATERIALS FOR OTHERS FOR USE IN PRINT ADVERTISING, INTERNET ADVERTISING, TRADE SHOW ADVERTISING AND OTHER ELECTRONIC ADVERTISING (U.S. CLS. 100, 101 AND 102).

FIRST USE 1-1-2004; IN COMMERCE 1-1-2004.
JENNIFER DIXON, EXAMINING ATTORNEY

CLASS 35—(Continued).

SN 76-650,864. CHERRY BEKAERT & HOLLAND, L.L.P., RICHMOND, VA. FILED 11-25-2005.

RADAR

THE MARK CONSISTS OF STANDARD CHARACTERS WITHOUT CLAIM TO ANY PARTICULAR FONT, STYLE, SIZE, OR COLOR.

FOR BUSINESS CONSULTING SERVICES IN THE FIELD OF DETECTION, EXAMINATION AND EVALUATION OF ORGANIZATIONAL AND INTERNAL BUSINESS RISKS AND INTERNAL BUSINESS CONTROLS (U.S. CLS. 100, 101 AND 102).

FIRST USE 6-15-2004; IN COMMERCE 6-15-2004.
LOURDES AYALA, EXAMINING ATTORNEY

SN 76-650,869. CHERRY BEKAERT & HOLLAND, L.L.P., RICHMOND, VA. FILED 11-25-2005.



FOR BUSINESS CONSULTING SERVICES IN THE FIELD OF DETECTION, EXAMINATION AND EVALUATION OF ORGANIZATIONAL AND INTERNAL BUSINESS RISKS AND INTERNAL BUSINESS CONTROLS (U.S. CLS. 100, 101 AND 102).

FIRST USE 5-7-2006; IN COMMERCE 5-7-2006.
LOURDES AYALA, EXAMINING ATTORNEY

SN 76-660,941. METRO ONE TELECOMMUNICATIONS, INC., BEAVERTON, OR. FILED 6-1-2006.

M1 DATA & ANALYTICS

THE MARK CONSISTS OF STANDARD CHARACTERS WITHOUT CLAIM TO ANY PARTICULAR FONT, STYLE, SIZE, OR COLOR.

NO CLAIM IS MADE TO THE EXCLUSIVE RIGHT TO USE "DATA & ANALYTICS", APART FROM THE MARK AS SHOWN.

FOR PROVIDING INFORMATION AND BUSINESS CONSULTING ANALYSIS PERTAINING THERETO, IN THE FIELD OF DATABASE SERVICES, NAMELY, PROVIDING CURRENT AND HISTORICAL TELEPHONE DIRECTORY ASSISTANCE LISTINGS FROM A COMPUTERIZED DATABASE OF STORED INFORMATION VIA A GLOBAL COMPUTER NETWORK OR BY OTHER ELECTRONIC TRANSMISSION METHODS WHEREIN SUCH LISTINGS OF THE DATABASE RECORDS HAVE BEEN ANALYZED TO IDENTIFY THE ACCURACY OR USABILITY OF THE INFORMATION (U.S. CLS. 100, 101 AND 102).

FIRST USE 5-17-2006; IN COMMERCE 5-17-2006.
THOMAS MANOR, EXAMINING ATTORNEY

CLASS 35—(Continued).

SN 76-661,658. BEST CELLARS INC., NEW YORK, NY. FILED 6-14-2006.



FOR RETAIL STORE SERVICES FEATURING ALCOHOLIC BEVERAGES AND ACCESSORIES USED IN THE STORAGE AND CONSUMPTION OF ALCOHOLIC BEVERAGES (U.S. CLS. 100, 101 AND 102).

FIRST USE 12-31-1998; IN COMMERCE 12-31-1998.
MORENO, PAUL, EXAMINING ATTORNEY

SN 76-667,406. BICYCLE CITY, LLC, CINCINNATI, OH. FILED 10-12-2006.

BICYCLE CITY

THE MARK CONSISTS OF STANDARD CHARACTERS WITHOUT CLAIM TO ANY PARTICULAR FONT, STYLE, SIZE, OR COLOR.

FOR PROMOTING BUSINESS AND TOURISM IN ALTERNATIVE COMMUNITIES, NAMELY ENVIRONMENTALLY-FRIENDLY RESIDENTIAL AND COMMERCIAL PLANNED COMMUNITIES (U.S. CLS. 100, 101 AND 102).

LINDA POWELL, EXAMINING ATTORNEY

SN 76-667,453. BICYCLE CITY, LLC, CINCINNATI, OH. FILED 10-12-2006.

CIUDAD DE LA BICICLETA

THE MARK CONSISTS OF STANDARD CHARACTERS WITHOUT CLAIM TO ANY PARTICULAR FONT, STYLE, SIZE, OR COLOR.

"THE FOREIGN WORDING IN THE MARK TRANSLATES INTO ENGLISH AS BICYCLE CITY."

FOR PROMOTING BUSINESS AND TOURISM IN ALTERNATIVE COMMUNITIES, NAMELY ENVIRONMENTALLY-FRIENDLY RESIDENTIAL AND COMMERCIAL PLANNED COMMUNITIES (U.S. CLS. 100, 101 AND 102).

DANIEL BRODY, EXAMINING ATTORNEY

CLASS 35—(Continued).

SN 76-667,899. LOGITIN, LLC, JACKSON, TN. FILED 10-23-2006.

Logitin

THE MARK CONSISTS OF STANDARD CHARACTERS WITHOUT CLAIM TO ANY PARTICULAR FONT, STYLE, SIZE, OR COLOR.

FOR OPERATING ON-LINE MARKET PLACE FOR INVENTORS OF ORIGINAL GOODS AND SERVICES TO ADVERTISE, MARKET, AND OFFER FOR SALE ORIGINAL PRODUCT DESIGNS, CONCEPTS AND IDEAS (U.S. CLS. 100, 101 AND 102).

FIRST USE 2-11-2006; IN COMMERCE 2-11-2006.
MICHAEL TANNER, EXAMINING ATTORNEY

CLASS 35—(Continued).

SN 76-672,435. PRECIMA, INC., WILMINGTON, DE. FILED 2-8-2007.

PRECIMA

FOR BUSINESS MANAGEMENT CONSULTATION; INFORMATION AND DATA COMPILING AND ANALYZING RELATING TO BUSINESS MANAGEMENT, NAMELY, COMPILING AND ANALYZING INFORMATION AND DATA ABOUT CUSTOMER TRANSACTIONS, CONSUMER PURCHASE BEHAVIOR AND CUSTOMER PROFILES; BUSINESS MANAGEMENT CONSULTING WITH RELATION TO STRATEGY, MARKETING, PRODUCTION, PERSONNEL AND RETAIL SALES MATTERS. (U.S. CLS. 100, 101 AND 102).

LINDA M. KING, EXAMINING ATTORNEY

SN 76-674,046. ALPINE ACCESS, INC., GOLDEN, CO. FILED 3-14-2007.

ALPINE ACCESS

THE MARK CONSISTS OF STANDARD CHARACTERS WITHOUT CLAIM TO ANY PARTICULAR FONT, STYLE, SIZE, OR COLOR.

FOR BUSINESS CONSULTATION IN THE CALL CENTER AND CUSTOMER CARE INDUSTRY, NAMELY, CALL CENTER SERVICES FOR OTHERS; AND CUSTOMER CARE SERVICES IN THE FIELD OF TELEPHONY AND INFORMATION TECHNOLOGIES PROVIDED VIA TELECOMMUNICATION, INTERNET AND MULTIMEDIA (U.S. CLS. 100, 101 AND 102).

FIRST USE 9-30-1998; IN COMMERCE 9-30-1998.
MARILYN IZZI, EXAMINING ATTORNEY

SN 76-670,290. BLUE HERON BEACH RESORT DEVELOPER, LLC, DESTIN, FL. FILED 12-13-2006.



SN 76-674,047. ALPINE ACCESS, INC., GOLDEN, CO. FILED 3-14-2007.

ADVANTAGE, YOURS.

NO CLAIM IS MADE TO THE EXCLUSIVE RIGHT TO USE "BEACH RESORT" AND "ORLANDO, FLORIDA", APART FROM THE MARK AS SHOWN.

THE COLOR(S) BLUE, PINK, YELLOW AND BLACK IS/ ARE CLAIMED AS A FEATURE OF THE MARK.

THE COLOR BLUE IS ON THE HERON, AND IN THE LETTERS BLUE HERON; THE COLOR PINK IS IN THE FLOWERS, THE COLOR YELLOW IS IN THE CENTER OF THE FLOWER AND THE COLOR WHITE IS ON THE FLOWER PETALS. THE COLOR YELLOW ALSO OUTLINES THE BLUE LETTERS BLUE HERON.

FOR BUSINESS MANAGEMENT FOR RESORT DEVELOPERS (U.S. CLS. 100, 101 AND 102).

FIRST USE 8-13-2003; IN COMMERCE 8-13-2003.
BERYL GARDNER, EXAMINING ATTORNEY

THE MARK CONSISTS OF STANDARD CHARACTERS WITHOUT CLAIM TO ANY PARTICULAR FONT, STYLE, SIZE, OR COLOR.

FOR BUSINESS CONSULTATION IN THE CALL CENTER AND CUSTOMER CARE INDUSTRY, NAMELY, CALL CENTER SERVICES FOR OTHERS; AND CUSTOMER CARE SERVICES IN THE FIELD OF TELEPHONY AND INFORMATION TECHNOLOGIES PROVIDED VIA TELECOMMUNICATION, INTERNET AND MULTIMEDIA (U.S. CLS. 100, 101 AND 102).

FIRST USE 2-14-2007; IN COMMERCE 2-14-2007.
MARILYN IZZI, EXAMINING ATTORNEY

CLASS 35—(Continued).

SN 76-674,286. MEMPHIS CITY SCHOOLS, MEMPHIS, TN.
FILED 3-19-2007.

Every Child. Every Day. College Bound.

FOR PROMOTING THE PUBLIC AWARENESS OF
THE NEED FOR SUPPORT FOR PUBLIC EDUCATION
(U.S. CLS. 100, 101 AND 102).

MARGERLY A. TIERNEY, EXAMINING ATTORNEY

SN 76-674,299. COMMON KNOWLEDGE, INC., DALLAS,
TX. FILED 3-20-2007.

TECHKNOWLEDGE OPINION PANEL

THE MARK CONSISTS OF STANDARD CHARACTERS
WITHOUT CLAIM TO ANY PARTICULAR FONT, STYLE,
SIZE, OR COLOR.

NO CLAIM IS MADE TO THE EXCLUSIVE RIGHT TO
USE OPINION PANEL, APART FROM THE MARK AS
SHOWN.

FOR MARKET RESEARCH SERVICES (U.S. CLS. 100,
101 AND 102).

MARGERLY A. TIERNEY, EXAMINING ATTORNEY

SN 76-674,318. BARNETT CONSULTING GROUP LLC,
CEDAR HILL, TX. FILED 3-20-2007.

SERVICEKEY

THE MARK CONSISTS OF STANDARD CHARACTERS
WITHOUT CLAIM TO ANY PARTICULAR FONT, STYLE,
SIZE, OR COLOR.

FOR CONSULTING SERVICES, NAMELY CONDUCT-
ING BEHAVIORAL ASSESSMENT OF PERSONNEL FOR
HIRING IN SALES POSITIONS, SALES MANAGERS,
CUSTOMER SERVICE AND MANAGEMENT POSITIONS
(U.S. CLS. 100, 101 AND 102).

FIRST USE 1-3-2007; IN COMMERCE 1-3-2007.

AMOS T. MATTHEWS, JR., EXAMINING ATTORNEY

SN 76-674,348. WHIMSEY, BELLINGHAM, WA. FILED 3-21-
2007.

whimsey

FOR RETAIL JEWELRY STORES AND ART GAL-
LERIES (U.S. CLS. 100, 101 AND 102).

FIRST USE 5-0-2003; IN COMMERCE 5-0-2003.

ELISSA GARBER KON, EXAMINING ATTORNEY

CLASS 35—(Continued).

SN 76-674,500. TRUSTIN TECHNOLOGY, LLC, IRVINE, CA.
FILED 3-23-2007.

weirdware

THE MARK CONSISTS OF STANDARD CHARACTERS
WITHOUT CLAIM TO ANY PARTICULAR FONT, STYLE,
SIZE, OR COLOR.

FOR PROCUREMENT SERVICES FOR OTHERS,
NAMELY THE PURCHASING AND RESALE OF COM-
PUTER AND ELECTRONIC HARDWARE, COMPUTER
SOFTWARE AND RELATED PERIPHERALS (U.S. CLS.
100, 101 AND 102).

FIRST USE 6-1-2005; IN COMMERCE 10-1-2005.

PRISCILLA MILTON, EXAMINING ATTORNEY

SN 76-674,522. COLLEGE PRO PAINTERS (U.S.) LTD.,
WALTHAM, MA. FILED 3-26-2007.

THE LEADERSHIP ADVANTAGE

THE MARK CONSISTS OF STANDARD CHARACTERS
WITHOUT CLAIM TO ANY PARTICULAR FONT, STYLE,
SIZE, OR COLOR.

FOR RENDERING TECHNICAL ASSISTANCE IN THE
ESTABLISHMENT AND OPERATION OF PAINTING
BUSINESSES (U.S. CLS. 100, 101 AND 102).

KIMBERLY PERRY, EXAMINING ATTORNEY

SN 76-674,585. WALGREEN CO., DEERFIELD, IL. FILED 3-
26-2007.

**PREMIUM EUROPEAN QUALITY
WITHOUT THE PREMIUM PRICE**

THE MARK CONSISTS OF STANDARD CHARACTERS
WITHOUT CLAIM TO ANY PARTICULAR FONT, STYLE,
SIZE, OR COLOR.

FOR RETAIL STORE SERVICES FEATURING
BEAUTY CARE PRODUCTS (U.S. CLS. 100, 101 AND
102).

MICHAEL ENGEL, EXAMINING ATTORNEY

SN 76-674,808. CIGNA INTELLECTUAL PROPERTY, INC.,
CLAYMONT, DE. FILED 3-29-2007.

CIGNAPLUS SAVINGS

THE MARK CONSISTS OF STANDARD CHARACTERS
WITHOUT CLAIM TO ANY PARTICULAR FONT, STYLE,
SIZE, OR COLOR.

FOR ADMINISTRATION OF A DISCOUNT PROGRAM
FOR ENABLING PARTICIPANTS TO OBTAIN DIS-
COUNTS ON DENTAL SERVICES WITH PARTICIPAT-
ING NETWORK DENTISTS THROUGH USE OF AN ID
CARD (U.S. CLS. 100, 101 AND 102).

FIRST USE 10-6-2004; IN COMMERCE 10-6-2004.

JAMES A. RAUEN, EXAMINING ATTORNEY

CLASS 35—(Continued).

SN 76-674,954. CFC ENTERTAINMENT, INC., DBA CTIY-FAME.COM, PORTER RANCH, CA. FILED 4-3-2007.



NO CLAIM IS MADE TO THE EXCLUSIVE RIGHT TO USE DESCRIPTIVE DESIGN OF THE WALKING FINGERS, APART FROM THE MARK AS SHOWN.

FOR PROVIDING AN ONLINE DIRECTORY AND INFORMATION SERVICE ON THE INTERNET FEATURING INFORMATION REGARDING BUSINESS LISTINGS AND ADVERTISEMENTS IN THE NATURE OF STREAMING VIDEO ADS, TEXT ADS, PHOTO ADS, COUPON ADS, BANNER ADS AND HYPERLINKS TO OTHER WEBSITES (U.S. CLS. 100, 101 AND 102).

PAUL F. GAST, EXAMINING ATTORNEY

CLASS 35—(Continued).

SN 77-003,403. VALPAK DIRECT MARKETING SYSTEMS, INC., LARGO, FL. FILED 9-20-2006.

MY MAIL ZONE

THE MARK CONSISTS OF STANDARD CHARACTERS WITHOUT CLAIM TO ANY PARTICULAR FONT, STYLE, SIZE, OR COLOR.

NO CLAIM IS MADE TO THE EXCLUSIVE RIGHT TO USE "MAIL", APART FROM THE MARK AS SHOWN.

FOR PROVIDING GEO-DEMOGRAPHIC AREA INFORMATION TO CLIENTS FOR DESIGNING AND DISTRIBUTING THE ADVERTISING MATERIALS OF OTHERS; PROVIDING GEO-DEMOGRAPHIC AREA INFORMATION TO CLIENTS FOR DESIGNING AND DISTRIBUTING THE ADVERTISING MATERIALS OF OTHERS VIA A GLOBAL COMPUTER NETWORK (U.S. CLS. 100, 101 AND 102).

FIRST USE 9-6-2006; IN COMMERCE 9-6-2006.
DAVID TAYLOR, EXAMINING ATTORNEY

SN 76-674,960. CIGNA INTELLECTUAL PROPERTY, INC., CLAYMONT, DE. FILED 4-3-2007.

CIGNA BRIDGE

THE MARK CONSISTS OF STANDARD CHARACTERS WITHOUT CLAIM TO ANY PARTICULAR FONT, STYLE, SIZE, OR COLOR.

FOR ADMINISTRATION OF A DISCOUNT PROGRAM FOR ENABLING PARTICIPANTS TO OBTAIN DISCOUNTS ON OUTPATIENT AND INPATIENT HEALTH CARE SERVICES THROUGH USE OF AN ID CARD (U.S. CLS. 100, 101 AND 102).

FIRST USE 12-15-2006; IN COMMERCE 12-15-2006.
JAMES A. RAUEN, EXAMINING ATTORNEY

SN 77-010,279. PIANO BENCH.COM, INC., CINCINNATI, OH. FILED 9-29-2006.



NO CLAIM IS MADE TO THE EXCLUSIVE RIGHT TO USE "PIANO BENCH.COM", APART FROM THE MARK AS SHOWN.

THE MARK CONSISTS OF THE WORDS "PIANO BENCH.COM" STYLIZED WITH THE LETTER "B" IN BENCH BEING A MUSICAL NOTE, PLUS A PIANO BENCH DESIGN.

FOR (BASED ON USE IN COMMERCE) ELECTRONIC RETAIL STORE SERVICES OVER THE INTERNET IN THE FIELD OF PIANO BENCHES; PIANO LAMPS AND REPLACEMENT LAMP BULBS; PIANO MOVING DOLLIES AND MOVERS; PIANO COVERS; PIANO BENCH CUSHIONS; MUSIC STANDS; STORAGE CABINETS FOR STORING MUSIC BOOKS, SHEET MUSIC AND ELECTRONIC MEDIA MUSIC; CLEANING, MAINTENANCE AND CARE PRODUCTS FOR PIANOS, PIANO BENCHES, MUSIC STANDS, AND MUSIC STORAGE CABINETS, INCLUDING CLEANING CLOTHS, DUSTING CLOTHS, POLISHING CLOTHS, COMBINATION DUSTING AND POLISHING CLOTHS, SHEEPSKIN MITTS FOR DUSTING AND/OR POLISHING, FURNITURE POLISH, KEYBOARD POLISH, AND KITS CONTAINING TWO OR MORE OF THE FOREGOING PIANO CLEANING, MAINTENANCE AND CARE PRODUCTS; KEYBOARD LOCKS; CASTER CUPS; TOUCH-UP MARKERS FOR SEALING, STAINING AND FINISHING SCRATCHES ON WOOD PIANOS, BENCHES, AND CABINETS; PIANO AND FURNITURE MOVING PROTECTIVE PADS; AND GIFT CERTIFICATES FOR THE PURCHASE OF THE FOREGOING GOODS; (BASED ON

SN 77-002,126. CARTE, DANIEL, HERNDON, VA. FILED 9-19-2006.

Live Free Listing Program

THE MARK CONSISTS OF STANDARD CHARACTERS WITHOUT CLAIM TO ANY PARTICULAR FONT, STYLE, SIZE, OR COLOR.

NO CLAIM IS MADE TO THE EXCLUSIVE RIGHT TO USE "LISTING PROGRAM", APART FROM THE MARK AS SHOWN.

FOR REAL ESTATE ADVERTISING SERVICES (U.S. CLS. 100, 101 AND 102).

CHARLOTTE CORWIN, EXAMINING ATTORNEY

CLASS 35—(Continued).

INTENT TO USE) ELECTRONIC RETAIL STORE SERVICES OVER THE INTERNET IN THE FIELD OF MUSIC-ORIENTED GIFT ACCESSORIES, INCLUDING JEWELRY, DECORATIVE PILLOWS, AFGHANS, SCULPTURES, PHOTOGRAPHS, PRINTS, POSTERS, PICTURE FRAMES, GAMES, TOYS, PLUSH TOY ANIMALS, BACKPACKS, PURSES, TOTE BAGS, PERSONAL PLANNERS, BOOKMARKS, CALENDARS, DECALS, LOOSE-LEAF BINDERS, NOTEPADS, CHECK BOOK COVERS, STICKERS, WRITING PAPER, NOTE CARDS, ENVELOPES, IMPRINTED PAPER NAPKINS, ADDRESS BOOKS, PHOTO ALBUMS, PENS AND PENCILS, LETTER OPENERS, ASHTRAYS, MUGS, BEVERAGeware, WATER BOTTLES SOLD EMPTY, THERMALLY INSULATED TUMBLERS, POT HOLDERS, GUEST TOWELS, SHORTS, SCARVES, NECKTIES, JACKETS, SHIRTS, SUN VISORS, HATS, SOCKS, CHRISTMAS TREE ORNAMENTS, LICENSE PLATE FRAMES, REFRIGERATOR MAGNETS, PLAYING CARDS, MOUSE PADS, UMBRELLAS, LUGGAGE TAGS; AND GIFT CERTIFICATES FOR THE PURCHASE OF THE FOREGOING GOODS (U.S. CLS. 100, 101 AND 102).

FIRST USE 7-28-2006; IN COMMERCE 7-28-2006.
ELISSA GARBER KON, EXAMINING ATTORNEY

SN 77-023,898. KAUFMAN, DAVID I., LOS ALTOS, CA.
FILED 10-18-2006.

YouDerm

THE MARK CONSISTS OF STANDARD CHARACTERS WITHOUT CLAIM TO ANY PARTICULAR FONT, STYLE, SIZE, OR COLOR.

FOR COMPUTERIZED ON-LINE RETAIL STORE SERVICES IN THE FIELD OF COSMETICS AND LUXURY GOODS; ON-LINE RETAIL STORE SERVICES FEATURING COSMETICS AND LUXURY GOODS (U.S. CLS. 100, 101 AND 102).

ANDREA BUTLER, EXAMINING ATTORNEY

SN 77-026,011. BEN E. KEITH COMPANY, FORT WORTH, TX. FILED 10-20-2006.



NO CLAIM IS MADE TO THE EXCLUSIVE RIGHT TO USE "DELIVERING QUALITY SINCE 1906" AND "CO.", APART FROM THE MARK AS SHOWN.

THE NAME "BEN E. KEITH" DOES NOT IDENTIFY A LIVING INDIVIDUAL.

FOR DISTRIBUTORSHIP SERVICES FOR FOOD AND BEVERAGE PRODUCTS (U.S. CLS. 100, 101 AND 102).

FIRST USE 5-1-2006; IN COMMERCE 5-1-2006.
REBECCA EISINGER, EXAMINING ATTORNEY

CLASS 35—(Continued).

SN 77-026,457. ADVERTAS, LLC, KATY, TX. FILED 10-20-2006.

Advertas

THE MARK CONSISTS OF STANDARD CHARACTERS WITHOUT CLAIM TO ANY PARTICULAR FONT, STYLE, SIZE, OR COLOR.

FOR ADVERTISING AND MARKETING; ADVERTISING AND PROMOTION SERVICES AND RELATED CONSULTING; ADVERTISING AND PUBLICITY SERVICES; ADVERTISING AND PUBLICITY SERVICES, NAMELY, PROMOTING THE GOODS, SERVICES, BRAND IDENTITY AND COMMERCIAL INFORMATION AND NEWS OF THIRD PARTIES THROUGH PRINT, AUDIO, VIDEO, DIGITAL AND ON-LINE MEDIUM; ADVERTISING BY TRANSMISSION OF ON-LINE PUBLICITY FOR THIRD PARTIES THROUGH ELECTRONIC COMMUNICATIONS NETWORKS; ADVERTISING, MARKETING AND PROMOTION SERVICES; ADVICE IN THE FIELD OF BUSINESS MANAGEMENT AND MARKETING; ADVICE RELATING TO THE ORGANISATION AND MANAGEMENT OF BUSINESS; ADVISORY SERVICES RELATING TO BUSINESS MANAGEMENT AND BUSINESS OPERATIONS; ARRANGING AND CONDUCTING MARKETING PROMOTIONAL EVENTS FOR OTHERS; BUSINESS ADVICE AND ANALYSIS OF MARKETS; BUSINESS CONSULTATION AND MANAGEMENT REGARDING MARKETING ACTIVITIES AND LAUNCHING OF NEW PRODUCTS; BUSINESS MARKETING CONSULTING SERVICES; BUSINESS MARKETING SERVICES; CONDUCTING BUSINESS AND MARKET RESEARCH SURVEYS; CONDUCTING MARKETING STUDIES; CREATION OF MARKETING TOOLS DESIGNED TO INCREASE A CLIENT COMPANY'S KNOWLEDGE OF CUSTOMER NEEDS, AND ITS COMPETITORS' PRODUCTS AND SERVICES, PRICING, ADVERTISING STRATEGY AND SALES STRATEGY; DEVELOPMENT OF MARKETING STRATEGIES AND CONCEPTS; INFORMATION AND EXPERT OPINIONS RELATING TO COMPANIES AND BUSINESS; MARKET ANALYSIS; MARKET REPORTS AND STUDIES; MARKET RESEARCH; MARKET RESEARCH SERVICES; MARKET RESEARCH STUDIES; MARKET SEGMENTATION CONSULTATION; MARKETING CONSULTING; MARKETING PLAN DEVELOPMENT; MEDIA PLANNING, NAMELY, ADVISING THE CLIENT ON THE CORRECT TIMES AND STATIONS TO ADVERTISE BASED ON MEDIA ANALYSIS OF THE MARKET FOR THAT MEDIA; OUTSOURCING IN THE FIELD OF SALES AND MARKETING OF COMPUTER SOFTWARE; PROMOTING, ADVERTISING AND MARKETING OF THE ON-LINE WEBSITES OF OTHERS; PROMOTION AND MARKETING SERVICES AND RELATED CONSULTING; PROMOTION, ADVERTISING AND MARKETING OF ON-LINE WEBSITES; PROVIDING MARKETING AND PROMOTION OF SPECIAL EVENTS; PUBLIC RELATIONS; STATISTICAL EVALUATIONS OF MARKETING DATA (U.S. CLS. 100, 101 AND 102).

FIRST USE 4-1-2006; IN COMMERCE 4-1-2006.
TIMOTHY FINNEGAN, EXAMINING ATTORNEY

CLASS 35—(Continued).

SN 77-028,314. LEAPCARD, LLC, HENDERSON, NV. FILED 10-24-2006.



THE COLOR(S) GREEN AND BLACK IS/ARE CLAIMED AS A FEATURE OF THE MARK.

THE COLOR GREEN APPEARS IN THE WORDING OF THE WORDMARK "LE AP" AND THE COLOR BLACK APPEARS IN THE WORDING "CARD". THE WORDMARK APPEARS AS "LEAPCARD" LOWERCASE AND CENTERED BELOW A GREEN JUMPING FROG.

FOR PROMOTING THE GOODS AND SERVICES OF OTHERS THROUGH THE DISTRIBUTION OF DISCOUNT CARDS (U.S. CLS. 100, 101 AND 102).

FIRST USE 3-18-2006; IN COMMERCE 8-18-2006.
DAVID TAYLOR, EXAMINING ATTORNEY

SN 77-028,415. PULSE 360, INC., NEW YORK, NY. FILED 10-24-2006.

PULSE360 ADS

THE MARK CONSISTS OF STANDARD CHARACTERS WITHOUT CLAIM TO ANY PARTICULAR FONT, STYLE, SIZE, OR COLOR.

NO CLAIM IS MADE TO THE EXCLUSIVE RIGHT TO USE "ADS", APART FROM THE MARK AS SHOWN.

FOR DISSEMINATION OF ADVERTISING FOR OTHERS VIA THE INTERNET; ONLINE ADVERTISING SERVICES FOR OTHERS, NAMELY, PROVIDING ADVERTISING SPACE ON INTERNET WEB SITES (U.S. CLS. 100, 101 AND 102).

JERI J. FICKES, EXAMINING ATTORNEY

SN 77-036,048. MING, JAMES, NEW YORK, NY. FILED 11-3-2006.

♣️ **prospace**

FOR PROMOTING, ADVERTISING AND MARKETING OF THE ON-LINE WEBSITES OF OTHERS (U.S. CLS. 100, 101 AND 102).

CARRIE GENOVESE, EXAMINING ATTORNEY

CLASS 35—(Continued).

SN 77-038,909. CRAFT WHOLESALERS, INC., REYNOLDSBURG, OH. FILED 11-7-2006.

KRUENPEEPER CREEK GIFTS

THE MARK CONSISTS OF STANDARD CHARACTERS WITHOUT CLAIM TO ANY PARTICULAR FONT, STYLE, SIZE, OR COLOR.

NO CLAIM IS MADE TO THE EXCLUSIVE RIGHT TO USE "GIFTS", APART FROM THE MARK AS SHOWN.

FOR MAIL ORDER SERVICES AND CATALOG ORDERING SERVICES FEATURING GIFT AND HOME DÉCOR MERCHANDISE; ON-LINE RETAIL STORE SERVICES FEATURING GIFT AND HOME DÉCOR MERCHANDISE (U.S. CLS. 100, 101 AND 102).

FIRST USE 3-31-2002; IN COMMERCE 3-31-2002.
ESTHER A. BORSUK, EXAMINING ATTORNEY

SN 77-038,984. CRAFT WHOLESALERS, INC., REYNOLDSBURG, OH. FILED 11-7-2006.

SCRAPPER'S ALLEY

THE MARK CONSISTS OF STANDARD CHARACTERS WITHOUT CLAIM TO ANY PARTICULAR FONT, STYLE, SIZE, OR COLOR.

NO CLAIM IS MADE TO THE EXCLUSIVE RIGHT TO USE "SCRAPPER'S", APART FROM THE MARK AS SHOWN.

FOR MAIL ORDER SERVICES AND CATALOG ORDERING SERVICES FEATURING SCRAPBOOKING SUPPLIES AND MATERIALS; ON-LINE RETAIL STORE SERVICES FEATURING SCRAPBOOKING SUPPLIES AND MATERIALS (U.S. CLS. 100, 101 AND 102).

FIRST USE 1-31-1999; IN COMMERCE 1-31-1999.
ESTHER A. BORSUK, EXAMINING ATTORNEY

SN 77-039,279. ATM CASH KING, INC., WEBSTER, NY. FILED 11-8-2006.

ATM CASH KING

THE MARK CONSISTS OF STANDARD CHARACTERS WITHOUT CLAIM TO ANY PARTICULAR FONT, STYLE, SIZE, OR COLOR.

NO CLAIM IS MADE TO THE EXCLUSIVE RIGHT TO USE "ATM CASH", APART FROM THE MARK AS SHOWN.

FOR BUSINESS SERVICES, NAMELY, PLACEMENT OF AUTOMATED TELLER MACHINE SERVICES FOR OTHERS (U.S. CLS. 100, 101 AND 102).

ARETHA SOMERVILLE, EXAMINING ATTORNEY

CLASS 35—(Continued).

SN 77-039,298. CRAFT WHOLESALERS, INC., REYNOLDSBURG, OH. FILED 11-8-2006.

CLASS 35—(Continued).

SN 77-040,212. RIGHT PATH MARKETING LLC, HOUSTON, TX. FILED 11-9-2006.

CWI GIFTS

Outsource The Marketing Discipline for Success

THE MARK CONSISTS OF STANDARD CHARACTERS WITHOUT CLAIM TO ANY PARTICULAR FONT, STYLE, SIZE, OR COLOR.

NO CLAIM IS MADE TO THE EXCLUSIVE RIGHT TO USE "GIFTS", APART FROM THE MARK AS SHOWN.

FOR WHOLESALE ORDERING SERVICES, MAIL ORDER SERVICES AND CATALOG ORDERING SERVICES, WHOLESALE ORDERING SERVICES VIA THE INTERNET, AND WHOLESALE STORES, ALL FEATURING GIFT AND HOME DECOR MERCHANDISE, ARTS AND CRAFTS AND SCRAPBOOKING SUPPLIES AND MATERIALS, AND DECORATIVE PAINTING SUPPLIES AND MATERIALS (U.S. CLS. 100, 101 AND 102).

FIRST USE 3-31-2000; IN COMMERCE 3-31-2000.
ESTHER A. BORSUK, EXAMINING ATTORNEY

THE MARK CONSISTS OF STANDARD CHARACTERS WITHOUT CLAIM TO ANY PARTICULAR FONT, STYLE, SIZE, OR COLOR.

FOR PROVIDING ADVICE AND CONSULTATION SERVICES IN THE FIELDS OF MARKETING AND SALES PROMOTION SERVICES (U.S. CLS. 100, 101 AND 102).

FIRST USE 9-15-2006; IN COMMERCE 9-15-2006.
JENNIFER VASQUEZ, EXAMINING ATTORNEY

SN 77-040,114. THIRD HORIZON CONSULTING PARTNERS PTY LTD, NORTH SYDNEY, AUSTRALIA, FILED 11-9-2006.

SN 77-040,337. NATIONAL BARCODE, INC, MERTZTOWN, PA. FILED 11-9-2006.

THIRD HORIZON



THE MARK CONSISTS OF STANDARD CHARACTERS WITHOUT CLAIM TO ANY PARTICULAR FONT, STYLE, SIZE, OR COLOR.

PRIORITY CLAIMED UNDER SEC. 44(D) ON AUSTRALIA APPLICATION NO. 1142575, FILED 10-24-2006, REG. NO. 1142575, DATED 10-24-2006, EXPIRES 10-24-2016.

FOR BUSINESS CONSULTANCY AND ADVISORY SERVICES; STRATEGIC BUSINESS PLANNING SERVICES; BUSINESS MERGER SERVICES; BUSINESS DEVELOPMENT AND MANAGEMENT SERVICES; BUSINESS PROJECT MANAGEMENT; BUSINESS ADMINISTRATION SERVICES; TAX ADVICE AND CONSULTANCY; ACCOUNTING SERVICES; PROVISION OF INFORMATION, ADVICE AND CONSULTANCY SERVICES IN RELATION TO THE AFOREMENTIONED SERVICES (U.S. CLS. 100, 101 AND 102).

JENNIFER KRISP, EXAMINING ATTORNEY

NO CLAIM IS MADE TO THE EXCLUSIVE RIGHT TO USE "NATIONAL BARCODE" OR THE PICTORIAL REPRESENTATION OF A BARCODE, APART FROM THE MARK AS SHOWN.

FOR WHOLESALE DISTRIBUTORSHIPS FEATURING BARCODE AND POINT-OF-SALE EQUIPMENT (U.S. CLS. 100, 101 AND 102).

FIRST USE 2-22-2002; IN COMMERCE 2-22-2002.
CHARLOTTE CORWIN, EXAMINING ATTORNEY

CLASS 35—(Continued).

SN 77-043,533. THE KROGER CO. OF MICHIGAN, LIVONIA, MI. FILED 11-14-2006.



THE COLOR(S) RED, WHITE AND BLUE IS/ARE CLAIMED AS A FEATURE OF THE MARK.

THE COLOR BLUE APPEARS IN THE WORDING "PRODUCTS I WANT, PLUS A LITTLE" AND IN THE DESIGN AS THE BACKGROUND OF THE INNER SHADED CIRCLE. THE COLOR WHITE APPEARS IN THE DESIGN AS THE COLOR OF THE MILK CARTON, BANANAS, EGGS, AND THE "+" SIGN. THE COLOR RED APPEARS IN THE DESIGN AS THE COLOR OF THE OUTER CONCENTRIC CIRCLE.

FOR GROCERY STORE SERVICES (U.S. CLS. 100, 101 AND 102).

BENJAMIN ALLEN, EXAMINING ATTORNEY

CLASS 35—(Continued).

SN 77-051,382. AEROTEK, INC., HANOVER, MD. FILED 11-27-2006.



Career Placement Specialists

OWNER OF U.S. REG. NOS. 1,557,200, 1,595,657 AND 2,524,549.

NO CLAIM IS MADE TO THE EXCLUSIVE RIGHT TO USE "AUTOMOTIVE AND CAREER PLACEMENT SPECIALISTS", APART FROM THE MARK AS SHOWN.

"THE MARK CONSISTS OF THE DESIGN OF A TRIANGLE MADE OF HORIZONTAL BARS AND THE WORDS AEROTEK, AUTOMOTIVE, AND CAREER PLACEMENT SPECIALISTS."

FOR EMPLOYMENT AGENCIES; EMPLOYMENT HIRING, RECRUITING, PLACEMENT, STAFFING AND CAREER NETWORKING SERVICES; TEMPORARY EMPLOYMENT AGENCIES (U.S. CLS. 100, 101 AND 102).

MARTHA FROMM, EXAMINING ATTORNEY

SN 77-051,886. 9011-0172 QUEBEC INC. DOING BUSINESS AS COTE COMMUNICATION CONSEIL, QUEBEC, CANADA, FILED 11-28-2006.

SN 77-047,015. KEENE PROMOTIONS, INC., AUBURN-DALE, MA. FILED 11-17-2006.

RELATIVE HAPPINESS INDEX (RHI)

YOUR LOGO AT WORK

THE MARK CONSISTS OF STANDARD CHARACTERS WITHOUT CLAIM TO ANY PARTICULAR FONT, STYLE, SIZE, OR COLOR.

NO CLAIM IS MADE TO THE EXCLUSIVE RIGHT TO USE "INDEX", APART FROM THE MARK AS SHOWN.

FOR CONDUCTING PUBLIC OPINION SURVEYS; COMPILING, ANALYZING, AND REPORTING PUBLIC OPINION SURVEY RESULTS; PROVIDING INFORMATION ABOUT PUBLIC OPINION SURVEYS VIA THE INTERNET AND OTHER ELECTRONIC NETWORKS; PROVIDING A WEBSITE FEATURING RESULTS OF PUBLIC OPINION SURVEYS (U.S. CLS. 100, 101 AND 102).

JASON LOTT, EXAMINING ATTORNEY

THE MARK CONSISTS OF STANDARD CHARACTERS WITHOUT CLAIM TO ANY PARTICULAR FONT, STYLE, SIZE, OR COLOR.

FOR WHOLESALE DISTRIBUTORSHIP IN THE FIELD OF PROMOTIONAL PRODUCTS (U.S. CLS. 100, 101 AND 102).

FIRST USE 3-0-2005; IN COMMERCE 3-0-2005. JENNY PARK, EXAMINING ATTORNEY

CLASS 35—(Continued).

SN 77-052,596. DIANA LIN DESIGN, BOULDER, CO. FILED 11-29-2006.

CLASS 35—(Continued).

SN 77-054,816. CONTRAIL, INC. D/B/A VALUEMAGS, CHICAGO, IL. FILED 12-1-2006.

VALUEMAGS

THE MARK CONSISTS OF STANDARD CHARACTERS WITHOUT CLAIM TO ANY PARTICULAR FONT, STYLE, SIZE, OR COLOR.

FOR BUSINESS CONSULTATION SERVICES IN THE FIELD OF MAGAZINE SUBSCRIPTIONS AND BUSINESS MARKETING SERVICES, NAMELY ASSISTING MAGAZINE PUBLISHERS TO INCREASE CIRCULATION THROUGH FACILITATING RELATIONSHIPS WITH AND AMONG BUSINESS PARTNERS; BUSINESS MARKETING SERVICES IN THE NATURE OF ON-DEMAND SINGLE ISSUE AND SUBSCRIPTION SPONSORED ORDERING SERVICES, NAMELY BROKERING RELATIONSHIPS WITH AND BETWEEN AND AMONG BUSINESS PARTNERS TO ASSIST IN HAVING SPONSORS PAY FOR MAGAZINES FOR THE SPONSOR'S CUSTOMER; PROVIDING PROMOTIONAL MARKETING SERVICES IN THE MEDIA INDUSTRY, NAMELY ASSISTING PUBLISHERS TO FULFILL PROMOTIONAL OFFERS AND PROMOTIONAL CONTESTS FOR CUSTOMERS; PROMOTING SALE OF GOODS AND SERVICES OF OTHERS, NAMELY DEVELOPING PROGRAMS FOR NEWSPAPERS TO OFFER THEIR CUSTOMERS MAGAZINE SUBSCRIPTIONS INCLUDED WITH A CUSTOMER'S PURCHASES OR TO RENEW THEIR NEWSPAPER SUBSCRIPTIONS; ON-LINE BUSINESS MARKETING SERVICES, NAMELY ASSISTING BUSINESS PARTNERS TO UP-SELL MAGAZINES AND SELLING OF FIXED TERM SUBSCRIPTIONS WITHIN THE PARTNER'S E-COMMERCE ENVIRONMENT (U.S. CLS. 100, 101 AND 102).

FIRST USE 4-15-1999; IN COMMERCE 4-15-1999.
JAY BESCH, EXAMINING ATTORNEY



SN 77-056,991. COLUMBIA INSURANCE COMPANY, OMAHA, NE. FILED 12-5-2006.

THE LEADER IN PAINT & COLOR

NO CLAIM IS MADE TO THE EXCLUSIVE RIGHT TO USE "DESIGN LLC", APART FROM THE MARK AS SHOWN.

THE NAME(S), PORTRAIT(S), AND/OR SIGNATURE(S) SHOWN IN THE MARK IDENTIFIES DIANA LIN, WHOSE CONSENT(S) TO REGISTER IS SUBMITTED.

THE COLOR(S) RED AND BLACK IS/ARE CLAIMED AS A FEATURE OF THE MARK.

THE MARK CONSISTS OF AN ABSTRACTION OF THE LETTER D. THE LETTER D IS RED AND THE TEXT DIANA LIN DESIGN, LLC IS BLACK.

FOR RETAIL STORE SERVICES IN THE FIELD OF LIGHTING, FURNITURE, STATIONERY, DECORATING ACCESSORIES AND PILLOW (U.S. CLS. 100, 101 AND 102).

KIM SAITO, EXAMINING ATTORNEY

THE MARK CONSISTS OF STANDARD CHARACTERS WITHOUT CLAIM TO ANY PARTICULAR FONT, STYLE, SIZE, OR COLOR.

NO CLAIM IS MADE TO THE EXCLUSIVE RIGHT TO USE "PAINT & COLOR", APART FROM THE MARK AS SHOWN.

FOR RETAIL STORE SERVICES FEATURING PAINT (U.S. CLS. 100, 101 AND 102).

FIRST USE 5-31-2002; IN COMMERCE 5-31-2002.
SETH A. RAPPAPORT, EXAMINING ATTORNEY

CLASS 35—(Continued).

SN 77-060,341. TELEQUITY LLC, HONOLULU, HI. FILED 12-8-2006.

HOME BUSINESS COOKBOOK

THE MARK CONSISTS OF STANDARD CHARACTERS WITHOUT CLAIM TO ANY PARTICULAR FONT, STYLE, SIZE, OR COLOR.

NO CLAIM IS MADE TO THE EXCLUSIVE RIGHT TO USE "HOME BUSINESS", APART FROM THE MARK AS SHOWN.

FOR BUSINESS SERVICES, NAMELY, PROVIDING ONLINE INFORMATION IN THE FIELD OF BUSINESS START-UP, BUSINESS PLANNING AND DEVELOPMENT, AND START-UP SUPPORT FOR BUSINESSES OF OTHERS AND THE SELF-EMPLOYED; BUSINESS INFORMATION SERVICES IN THE FIELD OF RECENT BUSINESS DEVELOPMENTS IN MARKETING, INFORMATION TECHNOLOGY, OFFICE EQUIPMENT, WEBSITE DESIGN AND HOSTING, BUSINESS FINANCE, ELECTRONIC COMMERCE, ELECTRONIC COMMUNICATIONS AND DIGITAL TECHNOLOGIES, CONSUMER ELECTRONICS PRODUCTS, COMPUTING, AND CORPORATE ORGANIZATION, MANAGEMENT, ACCOUNTING AND HUMAN RESOURCES; PROVIDING INFORMATIONAL WEB SITES FOR ADVERTISING THE GOODS AND SERVICES OF OTHERS; PROVIDING INFORMATIONAL WEB SITES THAT ARE DESIGNED TO GENERATE SALES TRAFFIC VIA HYPERLINKS TO OTHER WEB SITES VIA A GLOBAL COMPUTER NETWORK; PROVIDING INFORMATIONAL WEB SITES IN THE FIELD OF BUSINESS; AND PROVIDING SPACE AT A WEBSITE FOR THE ADVERTISEMENT OF THE GOODS AND SERVICES OF OTHERS (U.S. CLS. 100, 101 AND 102).

BARNEY CHARLON, EXAMINING ATTORNEY

SN 77-060,667. TELEQUITY LLC, HONOLULU, HI. FILED 12-8-2006.

TELEQUITY

THE MARK CONSISTS OF STANDARD CHARACTERS WITHOUT CLAIM TO ANY PARTICULAR FONT, STYLE, SIZE, OR COLOR.

FOR PROVIDING INFORMATIONAL WEB SITES THAT INCLUDE ADVERTISEMENTS FOR THE GOODS AND SERVICES OF OTHERS; PROVIDING INFORMATIONAL WEB SITES THAT ARE DESIGNED TO GENERATE SALES TRAFFIC VIA HYPERLINKS TO OTHER WEB SITES VIA A GLOBAL COMPUTER NETWORK; PROVIDING INFORMATIONAL WEB SITES IN THE FIELD OF BUSINESS; AND PROVIDING SPACE AT A WEBSITE FOR THE ADVERTISEMENT OF THE GOODS AND SERVICES OF OTHERS (U.S. CLS. 100, 101 AND 102).

DAVID COLLIER, EXAMINING ATTORNEY

CLASS 35—(Continued).

SN 77-060,687. TELEQUITY LLC, HONOLULU, HI. FILED 12-9-2006.

HOME BUSINESS KITCHEN

THE MARK CONSISTS OF STANDARD CHARACTERS WITHOUT CLAIM TO ANY PARTICULAR FONT, STYLE, SIZE, OR COLOR.

NO CLAIM IS MADE TO THE EXCLUSIVE RIGHT TO USE "HOME BUSINESS", APART FROM THE MARK AS SHOWN.

FOR BUSINESS SERVICES, NAMELY, PROVIDING INFORMATION AND START-UP SUPPORT FOR BUSINESSES OF OTHERS AND THE SELF-EMPLOYED, BUSINESS PLANNING AND DEVELOPMENT, BUSINESS NETWORKING, AND BUSINESS RESEARCH; PROVIDING INFORMATION IN THE FIELDS OF BUSINESS, BUSINESS DEVELOPMENT, MARKETING, BUSINESS FINANCE, SMALL BUSINESS AND HOME BUSINESS, FOR INDIVIDUALS IN THE FIELDS CONCERNING STARTING, OWNING AND OPERATING BUSINESSES, AND THE SELF-EMPLOYED, ALL BY MEANS OF ELECTRONIC COMMUNICATIONS NETWORKS; BUSINESS INFORMATION SERVICES IN THE FIELD OF RECENT BUSINESS DEVELOPMENTS IN MARKETING, INFORMATION TECHNOLOGY, OFFICE EQUIPMENT, WEBSITE DESIGN AND HOSTING, BUSINESS FINANCE, ELECTRONIC COMMERCE, ELECTRONIC COMMUNICATIONS AND DIGITAL TECHNOLOGIES, CONSUMER ELECTRONICS PRODUCTS, COMPUTING, AND CORPORATE ORGANIZATION, MANAGEMENT, ACCOUNTING AND HUMAN RESOURCES; PROVIDING INFORMATIONAL WEB SITES FOR ADVERTISING THE GOODS AND SERVICES OF OTHERS; PROVIDING INFORMATIONAL WEB SITES THAT ARE DESIGNED TO GENERATE SALES TRAFFIC VIA HYPERLINKS TO OTHER WEB SITES VIA A GLOBAL COMPUTER NETWORK; PROVIDING INFORMATIONAL WEB SITES IN THE FIELD OF BUSINESS; AND PROVIDING SPACE AT A WEBSITE FOR THE ADVERTISEMENT OF THE GOODS AND SERVICES OF OTHERS; PROVIDING A WEB SITE WHERE USERS CAN POST REVIEWS, COMMENTS AND RECOMMENDATIONS ON PRODUCTS AND SERVICES (U.S. CLS. 100, 101 AND 102).

LINDA ESTRADA, EXAMINING ATTORNEY

SN 77-061,012. ALLEGIS GROUP, INC., HANOVER, MD. FILED 12-11-2006.

ALLEGIS GROUP SERVICES

THE MARK CONSISTS OF STANDARD CHARACTERS WITHOUT CLAIM TO ANY PARTICULAR FONT, STYLE, SIZE, OR COLOR.

OWNER OF U.S. REG. NOS. 2,516,311 AND 2,888,615. NO CLAIM IS MADE TO THE EXCLUSIVE RIGHT TO USE "GROUP SERVICES", APART FROM THE MARK AS SHOWN.

FOR BUSINESS MANAGEMENT AND CONSULTATION; EMPLOYMENT HIRING, RECRUITING, PLACEMENT, STAFFING AND CAREER NETWORKING SERVICES; HUMAN CAPITAL MANAGEMENT OUTSOURCING SERVICES; TEMPORARY EMPLOYMENT AGENCIES (U.S. CLS. 100, 101 AND 102).

FIRST USE 1-23-2003; IN COMMERCE 1-23-2003.

ODESSA BIBBINS, EXAMINING ATTORNEY

CLASS 35—(Continued).

SN 77-061,035. CTAM: CABLE & TELECOMMUNICATIONS ASSOCIATION FOR MARKETING, ALEXANDRIA, VA. FILED 12-11-2006.

THIS IS CABLE

THE MARK CONSISTS OF STANDARD CHARACTERS WITHOUT CLAIM TO ANY PARTICULAR FONT, STYLE, SIZE, OR COLOR.

NO CLAIM IS MADE TO THE EXCLUSIVE RIGHT TO USE "CABLE", APART FROM THE MARK AS SHOWN.

FOR ASSOCIATION SERVICES, NAMELY, PROMOTING THE INTERESTS OF THE CABLE TELEVISION INDUSTRY (U.S. CLS. 100, 101 AND 102).

FIRST USE 10-0-2005; IN COMMERCE 10-0-2005.
RICHARD A. STRASER, EXAMINING ATTORNEY

SN 77-064,895. TELEMANAGER TECHNOLOGIES, INC., NEWARK, NJ. FILED 12-15-2006.

TELEMANAGER

THE MARK CONSISTS OF STANDARD CHARACTERS WITHOUT CLAIM TO ANY PARTICULAR FONT, STYLE, SIZE, OR COLOR.

FOR INTERACTIVE VOICE RESPONSE PRESCRIPTION REFILL ORDERING SERVICES (U.S. CLS. 100, 101 AND 102).

FIRST USE 8-12-1997; IN COMMERCE 8-12-1997.
JENNIFER VASQUEZ, EXAMINING ATTORNEY

SN 77-064,902. TELEMANAGER TECHNOLOGIES, INC., NEWARK, NJ. FILED 12-15-2006.

TELEMANAGER

THE MARK CONSISTS OF STANDARD CHARACTERS WITHOUT CLAIM TO ANY PARTICULAR FONT, STYLE, SIZE, OR COLOR.

FOR AUTOMATED TELEPHONE PRESCRIPTION REFILL ORDERING SERVICES (U.S. CLS. 100, 101 AND 102).

FIRST USE 8-12-1997; IN COMMERCE 8-12-1997.
JENNIFER VASQUEZ, EXAMINING ATTORNEY

CLASS 35—(Continued).

SN 77-065,652. GIFTLIT LLC, SAN FRANCISCO, CA. FILED 12-15-2006.



THE MARK CONSISTS OF THE WORD GIFTLIT PLUS AN IMAGE OF AN OPEN BOOK.

FOR ONLINE RETAIL STORE SERVICES AND MAIL ORDER SERVICES IN THE FIELDS OF GIFTWARE, BOOKS, AUDIO BOOKS, VIDEOS, DVDS, AND MUSIC (U.S. CLS. 100, 101 AND 102).

ADA HAN, EXAMINING ATTORNEY

SN 77-066,772. PYRAMIND LLC, FALLS CHURCH, VA. FILED 12-18-2006.

OWNER OF U.S. REG. NO. 2,663,784.

THE MARK CONSISTS OF THE WORD PYRAMIND WITH A TRIANGLE OVER THE LETTER I.

FOR EMPLOYMENT SERVICES, NAMELY EMPLOYMENT AGENCY SERVICES, EMPLOYMENT COUNSELING SERVICES, EMPLOYMENT RECRUITING SERVICES, AND EMPLOYMENT OUTPLACEMENT SERVICES (U.S. CLS. 100, 101 AND 102).

FIRST USE 7-29-2005; IN COMMERCE 7-29-2005.
SCOTT BIBB, EXAMINING ATTORNEY

SN 77-067,618. CBS RADIO STATIONS INC., NEW YORK, NY. FILED 12-19-2006.

MEALS & STEALS

THE MARK CONSISTS OF STANDARD CHARACTERS WITHOUT CLAIM TO ANY PARTICULAR FONT, STYLE, SIZE, OR COLOR.

FOR PROMOTING THE SALE OF GOODS AND SERVICES OF OTHERS BY OFFERING PROMOTIONAL DISCOUNT COUPONS VIA RADIO (U.S. CLS. 100, 101 AND 102).

FIRST USE 5-22-2006; IN COMMERCE 5-22-2006.
SCOTT SISUN, EXAMINING ATTORNEY

CLASS 35—(Continued).

SN 77-069,851. DEUTSCHE TELEKOM AG, BONN, FED REP GERMANY, FILED 12-21-2006.

qiro

THE MARK CONSISTS OF STANDARD CHARACTERS WITHOUT CLAIM TO ANY PARTICULAR FONT, STYLE, SIZE, OR COLOR.

PRIORITY CLAIMED UNDER SEC. 44(D) ON FED REP GERMANY APPLICATION NO. 30639011638, FILED 6-22-2006, REG. NO. 30639011, DATED 6-22-2006, EXPIRES 6-30-2016.

FOR TELEPHONE DIRECTORY ASSISTANCE SERVICES; ADVERTISING SERVICES, NAMELY, PREPARING AND PLACING ADVERTISEMENTS FOR OTHERS PROMOTING THE GOODS AND SERVICES OF OTHERS THROUGH PRINTED ADVERTISING, PRINTED DIRECTORIES, THROUGH ENCODED MEDIA, THROUGH THE DISSEMINATION OF PROMOTIONAL MATERIALS, THROUGH DIRECT MAIL ADVERTISING, THROUGH ELECTRONIC BILLBOARD ADVERTISING, PREPARING AUDIO-VISUAL PRESENTATIONS FOR USE IN ADVERTISING; BUSINESS MANAGEMENT SERVICES, NAMELY, BUSINESS APPRAISALS, BUSINESS AUDITING, PROVIDING BUSINESS INFORMATION, NAMELY, PREPARING BUSINESS REPORTS AND CONDUCTING BUSINESS RESEARCH, ANALYSIS AND SURVEYS, BUSINESS MANAGEMENT PLANNING, BUSINESS MANAGEMENT CONSULTATION, BUSINESS MANAGEMENT SUPERVISION, CONDUCTING BUSINESS NETWORKING FOR OTHERS; BUSINESS MANAGEMENT AND CONSULTING SERVICES, EXCLUDING AGRICULTURAL BUSINESS MANAGEMENT AND CONSULTING SERVICES; PROVIDING INFORMATION VIA THE TELEPHONE AND THE GLOBAL COMMUNICATION NETWORKS IN THE FIELD OF ADVERTISING AND BUSINESS MARKETING; PROFESSIONAL CONSULTANCY IN THE FIELD OF DATA PROCESSING; RENTAL OF AUTOMATIC VENDING MACHINES; RENTAL OF DATA PROCESSING EQUIPMENT; ORGANIZING JOB FAIRS (U.S. CLS. 100, 101 AND 102).

CARRIE GENOVESE, EXAMINING ATTORNEY

CLASS 35—(Continued).

SN 77-069,930. CRAFT WHOLESALERS, INC., REYNOLDSBURG, OH. FILED 12-21-2006.



NO CLAIM IS MADE TO THE EXCLUSIVE RIGHT TO USE "GIFTS & CRAFTS", APART FROM THE MARK AS SHOWN.

"THE STIPLING IS FOR SHADING PURPOSES ONLY."

THE MARK CONSISTS OF A THREE-DIMENSIONAL-APPEARING IMAGE OF A FIVE POINTED STAR, WITH THE WORDS "CWI GIFTS" AND THE AMPERSAND GENERALLY CONTAINED WITHIN THE BODY OF THE STAR, WITH THE WORD "CRAFTS" UNDERNEATH, WHICH WORD EXTENDS HORIZONTALLY SOMEWHAT BEYOND THE BORDERS OF THE STAR.

FOR WHOLESALE ORDERING SERVICES, MAIL ORDER SERVICES AND CATALOG ORDERING SERVICES, WHOLESALE ORDERING SERVICES VIA THE INTERNET, AND WHOLESALE STORES, ALL FEATURING GIFT AND HOME DECOR MERCHANDISE, ARTS AND CRAFTS AND SCRAPBOOKING SUPPLIES AND MATERIALS, AND DECORATIVE PAINTING SUPPLIES AND MATERIALS (U.S. CLS. 100, 101 AND 102).

FIRST USE 3-31-2000; IN COMMERCE 3-31-2000.

ESTHER A. BORSUK, EXAMINING ATTORNEY

SN 77-073,042. PROJECT SIMPLIFY, NEVADA CITY, CA. FILED 12-28-2006.

Project Simplify

THE MARK CONSISTS OF STANDARD CHARACTERS WITHOUT CLAIM TO ANY PARTICULAR FONT, STYLE, SIZE, OR COLOR.

NO CLAIM IS MADE TO THE EXCLUSIVE RIGHT TO USE "PROJECT", APART FROM THE MARK AS SHOWN.

FOR MANAGEMENT AND BUSINESS CONSULTING SERVICES IN THE FIELD OF MANAGING WORK FLOW, WORK SPACE, WORK TIME, BUSINESS INFORMATION, AND OFFICE CLUTTER (U.S. CLS. 100, 101 AND 102).

FIRST USE 8-30-2004; IN COMMERCE 8-30-2004.

SUE LAWRENCE, EXAMINING ATTORNEY

CLASS 35—(Continued).

SN 77-079,883. SITE4HIRE.COM, INC., BOCA RATON, FL.
FILED 1-10-2007.



FOR ORDER FULFILLMENT SERVICES (U.S. CLS. 100, 101 AND 102).
FIRST USE 6-15-2006; IN COMMERCE 6-15-2006.
BARNEY CHARLON, EXAMINING ATTORNEY

CLASS 35—(Continued).

SN 77-082,835. BUTCHER & PACKER SUPPLY COMPANY,
DETROIT, MI. FILED 1-15-2007.

BUTCHER & PACKER

THE MARK CONSISTS OF STANDARD CHARACTERS WITHOUT CLAIM TO ANY PARTICULAR FONT, STYLE, SIZE, OR COLOR.

SEC. 2(F).

FOR RETAIL STORE SERVICES, ON-LINE RETAIL STORE SERVICES, MAIL ORDER RETAIL STORE SERVICES, WHOLESALE STORE SERVICES, ON-LINE WHOLESALE STORE SERVICES, AND MAIL ORDER WHOLESALE SERVICES IN THE FIELDS OF FOOD PROCESSING EQUIPMENT, FOOD PREPARATION EQUIPMENT, FOOD ADDITIVES, MARINADES, SPICES AND CLOTHING (U.S. CLS. 100, 101 AND 102).

FIRST USE 7-23-1997; IN COMMERCE 7-23-1997.
MARTHA FROMM, EXAMINING ATTORNEY

SN 77-081,344. JUGGERNAUTS MOTORCYCLE CLUB,
FORT CAMPBELL, TN. FILED 1-11-2007.



SN 77-083,045. INQUEST MARKETING, L.L.C., LEAWOOD,
KS. FILED 1-15-2007.

Don't Push _Connect

NO CLAIM IS MADE TO THE EXCLUSIVE RIGHT TO USE "M.C. EST. 2006 CLARKSVILLE, TN", APART FROM THE MARK AS SHOWN.

THE MARK CONSISTS OF THE CENTER OF INSIGNIA IS A MOTORCYCLE. ABOVE THE MOTORCYCLE IS THE WORD "JUGGERNAUTS"; ON THE LEFT OF THE MOTORCYCLE IS THE LETTER "M."; ON THE RIGHT OF THE MOTORCYCLE IS THE LETTER "C"; UNDERNEATH THE MOTORCYCLE IS "EST. 2006"; BELOW THAT IS "CLARKSVILLE, TN".

FOR ASSOCIATION SERVICES, NAMELY, PROMOTING THE INTERESTS OF MOTORCYCLISTS (U.S. CLS. 100, 101 AND 102).

FIRST USE 8-12-2006; IN COMMERCE 8-12-2006.
ESTHER A. BORSUK, EXAMINING ATTORNEY

THE MARK CONSISTS OF STANDARD CHARACTERS WITHOUT CLAIM TO ANY PARTICULAR FONT, STYLE, SIZE, OR COLOR.

FOR ADVERTISING AND MARKETING (U.S. CLS. 100, 101 AND 102).

FIRST USE 10-1-2006; IN COMMERCE 10-1-2006.
GENE MACIOL, EXAMINING ATTORNEY

CLASS 35—(Continued).

SN 77-084,747. NEW SOUTH CONSTRUCTION SUPPLY, LLC, COLUMBIA, SC. FILED 1-17-2007.



OWNER OF U.S. REG. NO. 2,695,173.
NO CLAIM IS MADE TO THE EXCLUSIVE RIGHT TO USE CONSTRUCTION SUPPLY, APART FROM THE MARK AS SHOWN.

THE MARK CONSISTS OF A STYLIZED IMAGE OF A BEAR WEARING A CAP IN A CIRCLE AND THE WORDING NEW SOUTH CONSTRUCTION SUPPLY

FOR WHOLESALE DISTRIBUTORSHIP SERVICES FOR BUILDING MATERIALS, NAMELY INSULATION PRODUCTS, DRAINS, VAPOR BARRIERS, FIREPROOFING PRODUCTS, GEOTEXTILE FABRICS, WATER-PROOFING PRODUCTS, NAMELY SEALANTS, COATINGS, EPOXIES, MOISTURE BARRIERS, AND WATER REPELLANTS, MOISTURE CURING PRODUCTS, ROOFING PRODUCTS, EXPANSION JOINTS FOR CONCRETE AND MASONRY, SPECIALTY FLOORING PRODUCTS NAMELY DECORATIVE QUARTZ, TROWEL SAND, AND VINYL COLOR CHIPS, FORMING ACCESSORIES, NAMELY WIRE MESH, REBAR, COLUMN FORMS, STRAIGHT EDGE AND CURVE FORMS; HAND TOOLS USED IN MASONRY AND CONCRETE INSTALLATION; MASONRY ACCESSORIES NAMELY LADDER AND TRUSS WALL REINFORCING, VENEER TIES, CONTROL JOINTS, FLASHINGS, AND LOOSE FILL; AND TOOLS AND ACCESSORIES USED IN CONCRETE AND MASONRY INSTALLATION (U.S. CLS. 100, 101 AND 102).

EMILY CHUO, EXAMINING ATTORNEY

CLASS 35—(Continued).

SN 77-087,187. JULIE QUIGLEY, WEED, CA. FILED 1-19-2007.



THE COLOR(S) RED, BLACK, WHITE, YELLOW, TAN, AND GRAY IS/ARE CLAIMED AS A FEATURE OF THE MARK.

THE MARK CONSISTS OF THE WORDS "FIRE DAWG" IN RED FLAMES WITH BLACK LINES, A WHITE ANTHROPOMORPHIC BULL DOG WITH FOLDED ARMS FEATURING TAN FINGERNAILS, GRAY JOWLS, TAN UPPER LIP AND EYES, AND BLACK NOSE AND FEATURES, A RED FIREMAN'S HAT WITH A YELLOW AND WHITE STRIPED PLATE FEATURING THE BLACK NUMBERS 343, RED SUSPENDERS, AND A BLACK PAW PRINT AND A RED PAW PRINT.

FOR CLERICAL AND ADMINISTRATIVE SUPPORT SERVICES, NAMELY, PROVIDING OFFICE SUPPORT STAFFING SERVICES, RENTAL OF OFFICE MACHINERY AND EQUIPMENT, AND MANAGEMENT AND BUSINESS CONSULTING SERVICES IN THE FIELD OF DISASTER AND EMERGENCY RESPONSE (U.S. CLS. 100, 101 AND 102).

FIRST USE 12-18-2005; IN COMMERCE 1-30-2006.
DAVID C. REIHNER, EXAMINING ATTORNEY

SN 77-089,825. SPONSORED WHIPS LLC, WILMINGTON, DE. FILED 1-24-2007.

SPONSOREDWHIPS.COM

THE MARK CONSISTS OF STANDARD CHARACTERS WITHOUT CLAIM TO ANY PARTICULAR FONT, STYLE, SIZE, OR COLOR.

FOR PROMOTING THE GOODS AND SERVICES OF OTHERS BY ARRANGING FOR SPONSORS TO AFFILIATE THEIR GOODS AND SERVICES WITH AUTO RACING (U.S. CLS. 100, 101 AND 102).

FIRST USE 6-4-2006; IN COMMERCE 6-4-2006.
SEAN CROWLEY, EXAMINING ATTORNEY

SN 77-090,570. ACCESS NURSES, INC., SAN DIEGO, CA. FILED 1-24-2007.



OWNER OF U.S. REG. NOS. 3,229,311 AND 3,255,217.
NO CLAIM IS MADE TO THE EXCLUSIVE RIGHT TO USE "ALLIED", APART FROM THE MARK AS SHOWN.

"THE COLOR(S) ORANGE, WHITE AND GREY IS/ARE CLAIMED AS A FEATURE OF THE MARK."

THE MARK CONSISTS OF THE STYLIZED LETTER "A" IN WHITE FORMED WITH TWO UPWARD SLASHES WITH A DOT IN THE MIDDLE IN WHITE ENCLOSED IN AN ORANGE GEOMETRIC SQUARE SHAPE PLACE IN FRONT OF THE WORDS "ACCESS ALLIED" IN GREY TEXT.

FOR STAFFING SERVICES, NAMELY HIRING, RECRUITING, PLACEMENT, STAFFING AND CAREER NETWORKING SERVICES FOR TRAVELING AND NON-TRAVELING ALLIED HEALTHCARE PROFESSIONALS (U.S. CLS. 100, 101 AND 102).

FIRST USE 12-4-2004; IN COMMERCE 12-4-2004.
SEAN CROWLEY, EXAMINING ATTORNEY

CLASS 35—(Continued).

SN 77-092,479. THE FLAGPOLE CO, BROOKLYN, MI. FILED 1-26-2007.

FLAGPOLES ETC.

THE MARK CONSISTS OF STANDARD CHARACTERS WITHOUT CLAIM TO ANY PARTICULAR FONT, STYLE, SIZE, OR COLOR.

NO CLAIM IS MADE TO THE EXCLUSIVE RIGHT TO USE "FLAGPOLES", APART FROM THE MARK AS SHOWN.

FOR RETAIL AND ONLINE STORE SERVICES FEATURING FLAGPOLES, FLAGS AND ACCESSORIES (U.S. CLS. 100, 101 AND 102).

FIRST USE 2-18-2002; IN COMMERCE 2-18-2002.
JOHN WILKE, EXAMINING ATTORNEY

SN 77-094,392. ARIZONA SUPER BOWL HOST COMMITTEE, PHOENIX, AZ. FILED 1-30-2007.

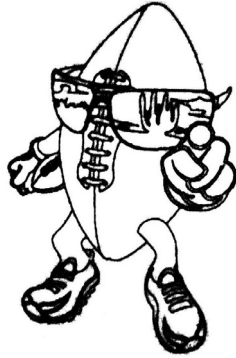

THE MARK CONSISTS OF A DESIGN OF A PERSONIFIED FOOTBALL WEARING SUNGLASSES AND SNEAKERS; AND HOLDING A SMALLER FOOTBALL.

FOR PROMOTING SPORTS COMPETITIONS AND EVENTS OF OTHERS; PROMOTING ECONOMIC DEVELOPMENT IN THE STATE OF ARIZONA; PROMOTING THE GOODS AND SERVICES OF OTHERS BY ARRANGING FOR SPONSORS TO AFFILIATE THEIR GOODS AND SERVICES WITH A SPORTS COMPETITION; PROMOTING THE PRODUCTS OF OTHERS BY DISTRIBUTING ADVERTISING MATERIALS FOR OTHERS THROUGH A VARIETY OF METHODS (U.S. CLS. 100, 101 AND 102).

BERNICE MIDDLETON, EXAMINING ATTORNEY

SN 77-094,451. YOU WISH NO MORE, INC., ST. CHARLES, MO. FILED 1-30-2007.

YOU WISH NO MORE

THE MARK CONSISTS OF STANDARD CHARACTERS WITHOUT CLAIM TO ANY PARTICULAR FONT, STYLE, SIZE, OR COLOR.

FOR RETAIL STORE SERVICES AND ON-LINE RETAIL STORE SERVICES FEATURING GIFT BASKETS (U.S. CLS. 100, 101 AND 102).

DAVID I, EXAMINING ATTORNEY

CLASS 35—(Continued).

SN 77-100,110. BRAIN WAREHOUSE LLC, SAN DIEGO, CA. FILED 2-6-2007.

HEALTHINSURANCEFINDER

THE MARK CONSISTS OF STANDARD CHARACTERS WITHOUT CLAIM TO ANY PARTICULAR FONT, STYLE, SIZE, OR COLOR.

SEC. 2(F).
FOR ADVERTISING, MARKETING AND PROMOTION SERVICES; DISSEMINATION OF ADVERTISING FOR OTHERS VIA THE INTERNET; INSURANCE LEAD COLLECTION AND MATCHING SERVICES, NAMELY, MATCHING CONSUMER REQUESTS FOR INSURANCE POLICY QUOTES COLLECTED OVER THE INTERNET TO PRE-QUALIFIED INSURANCE BROKERS, AGENTS AND AGENCIES INTERESTED IN THOSE REQUESTS; PROMOTING THE GOODS AND SERVICES OF OTHERS THROUGH SEARCH ENGINE REFERRAL TRAFFIC ANALYSIS AND REPORTING; PROMOTION OF FINANCIAL AND INSURANCE SERVICES, ON BEHALF OF THIRD PARTIES; PROVIDING INSURANCE AGENT REFERRALS; REFERRALS IN THE FIELD OF INSURANCE (U.S. CLS. 100, 101 AND 102).

FIRST USE 2-0-1997; IN COMMERCE 2-0-1997.
SCOTT BIBB, EXAMINING ATTORNEY

SN 77-100,300. RAMOS, LUIS MANUEL JR., CORAL SPRINGS, FL. FILED 2-6-2007.

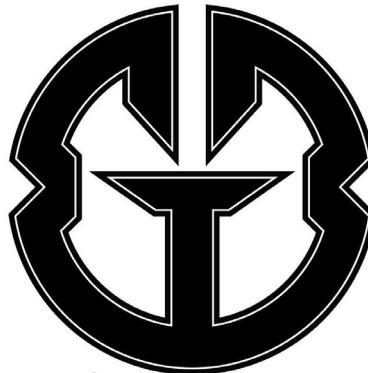

THE MARK CONSISTS OF THE MARK IS A G AND A B COMBINED TO CREATE A DOG.

FOR RETAIL APPAREL STORES (U.S. CLS. 100, 101 AND 102).

RONALD AIKENS, EXAMINING ATTORNEY

CLASS 35—(Continued).

SN 77-102,202. BRENNER, TOMAS, ZOFINGEN, SWITZERLAND, FILED 2-8-2007.

VentureLeap

THE MARK CONSISTS OF STANDARD CHARACTERS WITHOUT CLAIM TO ANY PARTICULAR FONT, STYLE, SIZE, OR COLOR.

PRIORITY CLAIMED UNDER SEC. 44(D) ON SWITZERLAND APPLICATION NO. 51488/2007, FILED 2-8-2007.

FOR BUSINESS SERVICES, NAMELY, CONSULTING, MANAGEMENT AND ADVISORY SERVICES TO BUSINESS STARTUPS AND MATCHING INVESTORS WITH SUCH BUSINESS STARTUPS IN NEED OF FUNDING (U.S. CLS. 100, 101 AND 102).

FIRST USE 2-22-2004; IN COMMERCE 3-28-2004.
MARY CRAWFORD, EXAMINING ATTORNEY

SN 77-102,325. ACCESS INTELLIGENCE, LLC, ROCKVILLE, MD. FILED 2-8-2007.

THE LDC FORUM

THE MARK CONSISTS OF STANDARD CHARACTERS WITHOUT CLAIM TO ANY PARTICULAR FONT, STYLE, SIZE, OR COLOR.

SEC. 2(F).

FOR ARRANGING AND CONDUCTING BUSINESS CONFERENCES; BUSINESS NETWORKING (U.S. CLS. 100, 101 AND 102).

FIRST USE 9-1-1995; IN COMMERCE 9-1-1995.
SALLY SHIH, EXAMINING ATTORNEY

SN 77-102,743. TSETSOKHA, VLADIMIR, SAN FRANCISCO, CA. AND REYFER, YELENA, SAN FRANCISCO, CA. FILED 2-8-2007.



THE COLOR(S) GREEN AND BLACK IS/ARE CLAIMED AS A FEATURE OF THE MARK.

THE MARK CONSISTS OF THE LETTERING LORMANDI.COM. ALL OF THE LETTERING IN THE MARK IS IN GREEN WITH BLACK HIGHLIGHTING AT THE BOTTOM AND RIGHT OF EACH LETTER.

FOR ONLINE RETAIL STORE SERVICES FEATURING ELECTRONICS, FURNITURE, HEALTH AND PERSONAL CARE ITEMS, HOME DECOR, HOUSEWARES, KITCHEN PRODUCTS, OUTDOOR PRODUCTS, PET SUPPLIES, SOFTWARE, SPORTS PRODUCTS, CHILDREN'S PRODUCTS, BEAUTY PRODUCTS, HEALTH AND FITNESS PRODUCTS, TOOLS, HARDWARE, TOYS AND GAMES (U.S. CLS. 100, 101 AND 102).

FIRST USE 8-10-2006; IN COMMERCE 8-10-2006.
MARY CRAWFORD, EXAMINING ATTORNEY

CLASS 35—(Continued).

SN 77-106,237. DIGITAL CITIZEN, L.L.C., BROOKLYN, NY. FILED 2-13-2007.

DIGITAL CITIZEN

THE MARK CONSISTS OF STANDARD CHARACTERS WITHOUT CLAIM TO ANY PARTICULAR FONT, STYLE, SIZE, OR COLOR.

NO CLAIM IS MADE TO THE EXCLUSIVE RIGHT TO USE "DIGITAL", APART FROM THE MARK AS SHOWN.

FOR PROVIDING ONLINE RETAIL STORES FEATURING PRERECORDED AUDIO AND AUDIOVISUAL WORKS (U.S. CLS. 100, 101 AND 102).

VIVIAN MICZNIK FIRST, EXAMINING ATTORNEY

SN 77-107,547. CVS PHARMACY, INC., WOONSOCKET, RI. FILED 2-14-2007.



NO CLAIM IS MADE TO THE EXCLUSIVE RIGHT TO USE "HEALTHY SKINCARE CENTER", APART FROM THE MARK AS SHOWN.

THE MARK CONSISTS OF THE WORDS HEALTHY SKINCARE CENTER WITH A PARTIAL CROSS.

FOR RETAIL-STORE SERVICES FEATURING HEALTH AND BEAUTY PRODUCTS; RETAIL PHARMACY SERVICES; RETAIL DRUG STORE SERVICES AND RETAIL STORE SERVICES FEATURING GENERAL CONSUMER MERCHANDISE, PROVIDED VIA RETAIL STORES AND VIA THE INTERNET (U.S. CLS. 100, 101 AND 102).

FIRST USE 3-1-2003; IN COMMERCE 3-1-2003.
MICHELE SWAIN, EXAMINING ATTORNEY

CLASS 35—(Continued).

SN 77-108,305. MEDIA WEST - GSI, INC., RENO, NV. FILED 2-15-2007.

USA TODAY TRAVEL ZONE

THE MARK CONSISTS OF STANDARD CHARACTERS WITHOUT CLAIM TO ANY PARTICULAR FONT, STYLE, SIZE, OR COLOR.

NO CLAIM IS MADE TO THE EXCLUSIVE RIGHT TO USE "TRAVEL", APART FROM THE MARK AS SHOWN. FOR RETAIL NEWSSTANDS, BOOKSTORES, AND GIFT STORE SERVICES; RETAIL STORE SERVICES FEATURING CONVENIENCE STORE ITEMS AND A WIDE VARIETY OF CONSUMER GOODS OF OTHERS (U.S. CLS. 100, 101 AND 102).

TIMOTHY FINNEGAN, EXAMINING ATTORNEY

SN 77-108,501. INDEPENDENT WASTE CONSULTANTS INC., ALTAMONTE SPRINGS, FL. FILED 2-15-2007.

waste professionals

THE MARK CONSISTS OF STANDARD CHARACTERS WITHOUT CLAIM TO ANY PARTICULAR FONT, STYLE, SIZE, OR COLOR.

SEC. 2(F).

FOR ADVISORY SERVICES RELATING TO BUSINESS MANAGEMENT AND BUSINESS OPERATIONS; ASSISTANCE IN MANAGEMENT OF BUSINESS ACTIVITIES; BUSINESS CONSULTATION; BUSINESS CONSULTATION SERVICES (U.S. CLS. 100, 101 AND 102).

FIRST USE 0-0-1999; IN COMMERCE 0-0-1999.

JENNIFER VASQUEZ, EXAMINING ATTORNEY

SN 77-108,511. TDR MANAGEMENT, INC., DAL-WORTHINGTON GARDENS, TX. FILED 2-15-2007.

SHOES ON A SHOESTRING

THE MARK CONSISTS OF STANDARD CHARACTERS WITHOUT CLAIM TO ANY PARTICULAR FONT, STYLE, SIZE, OR COLOR.

NO CLAIM IS MADE TO THE EXCLUSIVE RIGHT TO USE "SHOES", APART FROM THE MARK AS SHOWN.

FOR ON-LINE RETAIL STORE SERVICES FEATURING FOOT APPAREL; RETAIL SHOPS FEATURING FOOT APPAREL (U.S. CLS. 100, 101 AND 102).

FIRST USE 12-31-1990; IN COMMERCE 12-31-1990.

LAURIE MAYES, EXAMINING ATTORNEY

CLASS 35—(Continued).

SN 77-110,051. BANTIS RESOURCES LLC, OVERLAND PARK, KS. FILED 2-16-2007.

BANTIS

THE MARK CONSISTS OF STANDARD CHARACTERS WITHOUT CLAIM TO ANY PARTICULAR FONT, STYLE, SIZE, OR COLOR.

FOR EMPLOYMENT HIRING, RECRUITING, PLACEMENT, STAFFING AND CAREER NETWORKING SERVICES (U.S. CLS. 100, 101 AND 102).

FIRST USE 6-7-2006; IN COMMERCE 6-7-2006.

WON TEAK OH, EXAMINING ATTORNEY

SN 77-110,150. GREENPLANET.ORG, INC., FOUNTAIN HILLS, AZ. FILED 2-17-2007.



NO CLAIM IS MADE TO THE EXCLUSIVE RIGHT TO USE "CERTIFIED", APART FROM THE MARK AS SHOWN.

THE COLOR(S) YELLOW, LIGHT GREEN, DARK GREEN AND GRAY IS/ARE CLAIMED AS A FEATURE OF THE MARK.

THE COLOR YELLOW APPEARS IN THE CENTER OF THE GLOBE FORMING THE CENTER OF AN OPEN FLOWER WITHIN THE GLOBE. THE COLOR LIGHT GREEN APPEARS IN THE MIDDLE PART OF THE GLOBE FORMING THE LEAVES OF AN OPEN FLOWER WITHIN THE GLOBE. THE COLOR DARK GREEN APPEARS IN THE OUTERMOST PART OF THE GLOBE FORMING THE LEAVES OF AN OPEN FLOWER WITHIN THE GLOBE. THE COLOR DARK GREEN ALSO APPEARS IN THE LETTERING GREEN PLANET CERTIFIED THAT ENCIRCLES THE GLOBE. THE COLOR GRAY APPEARS IN THE SINGLE LINE CIRCLE THAT ENCOMPASSES THE LETTERING AND THE GLOBE.

FOR CHARITABLE SERVICES, NAMELY ORGANIZING AND CONDUCTING VOLUNTEER PROGRAMS AND COMMUNITY SERVICE PROJECTS (U.S. CLS. 100, 101 AND 102).

DANIEL RUSSELL, EXAMINING ATTORNEY

CLASS 35—(Continued).

SN 77-110,367. FATWALLET, INC., MACHESNEY PARK, IL. FILED 2-18-2007.



FOR PROMOTING THE GOODS AND SERVICES OF OTHERS THROUGH THE DISTRIBUTION OF DISCOUNT OFFERS AND COUPONS (U.S. CLS. 100, 101 AND 102).
FRED CARL, EXAMINING ATTORNEY

CLASS 35—(Continued).

SN 77-113,238. LEIGH CODY VARONA, HUNGTINGTON BEACH, CA. FILED 2-22-2007.

CONGREGATION OF THE FORGOTTEN SAINTS

THE MARK CONSISTS OF STANDARD CHARACTERS WITHOUT CLAIM TO ANY PARTICULAR FONT, STYLE, SIZE, OR COLOR.
FOR RETAIL STORE SERVICES FEATURING CLOTHING AND ACCESSORIES; WHOLESALE STORES FEATURING CLOTHING AND ACCESSORIES (U.S. CLS. 100, 101 AND 102).
CHERYL CLAYTON, EXAMINING ATTORNEY

SN 77-110,789. BRAINERD LAKES AREA CHAMBERS OF COMMERCE, BRAINERD, MN. FILED 2-19-2007.

Connect. Lead. Grow.

THE MARK CONSISTS OF STANDARD CHARACTERS WITHOUT CLAIM TO ANY PARTICULAR FONT, STYLE, SIZE, OR COLOR.
FOR CHAMBER OF COMMERCE SERVICES, NAMELY, PROMOTING BUSINESS AND TOURISM IN THE BRAINERD LAKES AREA (U.S. CLS. 100, 101 AND 102).
JEFFERY COWARD, EXAMINING ATTORNEY

SN 77-113,769. MORGAN STANLEY, NEW YORK, NY. FILED 2-22-2007.

STYLESELECT

THE MARK CONSISTS OF STANDARD CHARACTERS WITHOUT CLAIM TO ANY PARTICULAR FONT, STYLE, SIZE, OR COLOR.
FOR PROVIDING A FINANCIAL INDEX IN THE NATURE OF QUANTITATIVE MEASUREMENTS FOR ANALYZING INVESTOR PREFERENCES, NAMELY, APPLYING RULES TO GROUPS OF STOCKS FOR USE IN CREATING FINANCIAL RESEARCH, FINANCIAL INDICES AND INVESTMENT SECURITIES (U.S. CLS. 100, 101 AND 102).
SCOTT BIBB, EXAMINING ATTORNEY

SN 77-111,647. WAL-MART STORES, INC., BENTONVILLE, AR. FILED 2-20-2007.

SHOP SMART. LIVE BETTER.

THE MARK CONSISTS OF STANDARD CHARACTERS WITHOUT CLAIM TO ANY PARTICULAR FONT, STYLE, SIZE, OR COLOR.
FOR ONLINE RETAIL DEPARTMENT STORE SERVICES; RETAIL DEPARTMENT STORE SERVICES (U.S. CLS. 100, 101 AND 102).
STEVEN R. FINE, EXAMINING ATTORNEY

SN 77-115,607. AMBROSE, STEPHEN D, RICHMOND, VA. FILED 2-25-2007.

Compensatory Invoicing

THE MARK CONSISTS OF STANDARD CHARACTERS WITHOUT CLAIM TO ANY PARTICULAR FONT, STYLE, SIZE, OR COLOR.
NO CLAIM IS MADE TO THE EXCLUSIVE RIGHT TO USE "INVOICING", APART FROM THE MARK AS SHOWN.
FOR DATA MANAGEMENT SERVICES FOR USE IN DEBT COLLECTION, NAMELY, ELECTRONIC DATA COLLECTION AND ONLINE CLAIMS MANAGEMENT; INVOICING SERVICES (U.S. CLS. 100, 101 AND 102).
RAUL CORDOVA, EXAMINING ATTORNEY

CLASS 35—(Continued).

SN 77-115,628. JOHNSTON, SHANNON A., ATLANTA, GA.
FILED 2-25-2007.

WELL HUNG

THE MARK CONSISTS OF STANDARD CHARACTERS WITHOUT CLAIM TO ANY PARTICULAR FONT, STYLE, SIZE, OR COLOR.

FOR ART GALLERIES (U.S. CLS. 100, 101 AND 102).
FIRST USE 12-20-2004; IN COMMERCE 12-20-2004.
ANDREA HACK, EXAMINING ATTORNEY

SN 77-116,346. MARTIN, HEATHER, JERSEY CITY, NJ.
FILED 2-26-2007.

CRUSH THE BOX

THE MARK CONSISTS OF STANDARD CHARACTERS WITHOUT CLAIM TO ANY PARTICULAR FONT, STYLE, SIZE, OR COLOR.

FOR ADVERTISING AND ADVERTISEMENT SERVICES; ADVERTISING AND MARKETING; ADVERTISING SERVICES; ADVICE IN THE FIELD OF BUSINESS MANAGEMENT AND MARKETING; BUSINESS ADVICE AND INFORMATION; BUSINESS ADVICE, INQUIRIES OR INFORMATION; BUSINESS ADVISORY SERVICES, CONSULTANCY AND INFORMATION; BUSINESS CONSULTATION; BUSINESS CONSULTATION SERVICES; BUSINESS CONSULTING AND INFORMATION SERVICES; BUSINESS CONSULTING, INQUIRIES OR INFORMATION (U.S. CLS. 100, 101 AND 102).

FRED CARL, EXAMINING ATTORNEY

SN 77-116,396. CLASSY CASUALS, INC., NAMPA, ID. FILED
2-26-2007.

CLASSY CASUALS

THE MARK CONSISTS OF STANDARD CHARACTERS WITHOUT CLAIM TO ANY PARTICULAR FONT, STYLE, SIZE, OR COLOR.

NO CLAIM IS MADE TO THE EXCLUSIVE RIGHT TO USE "CASUALS", APART FROM THE MARK AS SHOWN.

FOR RETAIL APPAREL STORE (U.S. CLS. 100, 101 AND 102).

ANNE MADDEN, EXAMINING ATTORNEY

CLASS 35—(Continued).

SN 77-116,846. RXINSIDER, LTD, WEST WARWICK, RI.
FILED 2-27-2007.

The logo for RNINSIDER.COM features the letters "RN" in a bold, blue, stylized font. To the right of "RN" is the word "INSIDER" in a white, sans-serif font, and ".COM" in a smaller white, sans-serif font. The entire text is set against a red, rounded rectangular background with a white border.

THE COLOR(S) BLUE, ORANGE, AND WHITE IS/ARE CLAIMED AS A FEATURE OF THE MARK.

THE MARK CONSISTS OF ONE LINE OF TEXT BEGINNING WITH BLUE STYLIZED LETTERS "R" AND "N", FOLLOWED BY WHITE STYLIZED WORD "INSIDER", FOLLOWED BY SMALL WHITE SQUARE, FOLLOWED BY WHITE STYLIZED LETTERS "C", "O", AND "M". THE FIRST LETTER OF THE WORD "INSIDER" IS PARTIALLY SUPERIMPOSED ON THE BLUE "N". EXCEPT FOR THE PARTIALLY SUPERIMPOSED WHITE "I", THE WORD "INSIDER", THE SMALL WHITE SQUARE, AND THE WHITE LETTERS "C", "O" AND "M" ARE ENCAPSULATED IN AN ORANGE BACKGROUND. THE ENTIRE MARK IS OUTLINED IN BLUE.

FOR ON-LINE ADVERTISING AND MARKETING SERVICES FOR THE NURSING PROFESSION PROVIDING AN ON-LINE SEARCHABLE DATABASE FEATURING EMPLOYMENT OPPORTUNITIES (U.S. CLS. 100, 101 AND 102).

FIRST USE 3-1-2003; IN COMMERCE 3-1-2003.
DAVID I, EXAMINING ATTORNEY

SN 77-116,976. RXINSIDER, LTD, WEST WARWICK, RI.
FILED 2-27-2007.

The logo for RXINSIDER.COM features the letters "RX" in a bold, blue, stylized font. To the right of "RX" is the word "INSIDER" in a white, sans-serif font, and ".COM" in a smaller white, sans-serif font. The entire text is set against a green, rounded rectangular background with a white border.

THE COLOR(S) BLUE, GREEN, AND WHITE IS/ARE CLAIMED AS A FEATURE OF THE MARK.

THE MARK CONSISTS OF ONE LINE OF TEXT BEGINNING WITH BLUE STYLIZED LETTERS "R" AND "X", FOLLOWED BY WHITE STYLIZED WORD "INSIDER", FOLLOWED BY SMALL WHITE CIRCLE, FOLLOWED BY WHITE STYLIZED LETTERS "C", "O", AND "M". THE LETTER "I" AND HALF OF THE LETTER "N" ARE SUPERIMPOSED ON BLUE "X". EXCEPT FOR THE PRECEDING, THE REMAINING HALF OF THE LETTER "N" AND THE WHITE LETTERS "S", "I", "D", "E", AND "R", AND THE SMALL WHITE CIRCLE, AND THE WHITE LETTERS "C", "O" AND "M" ARE ENCAPSULATED IN A GREEN BACKGROUND. THE ENTIRE MARK IS OUTLINED IN BLUE.

FOR ON-LINE ADVERTISING AND MARKETING SERVICES FOR PHARMACISTS PROVIDING AN ON-LINE SEARCHABLE DATABASE FEATURING EMPLOYMENT OPPORTUNITIES (U.S. CLS. 100, 101 AND 102).

FIRST USE 3-1-2003; IN COMMERCE 3-1-2003.
DAVID I, EXAMINING ATTORNEY

CLASS 35—(Continued).

SN 77-117,010. ROBOT TRACTOR, LLC, DRIPPING SPRINGS, TX. FILED 2-27-2007.



THE MARK CONSISTS OF THE ARCHED PATH OF A BOUNCING BALL OVER THE PHRASE "SMILES INCLUDED" WITH THE BALL COMING TO REST ABOVE THE LETTER "I" IN THE WORD "INCLUDED" AND THE WORD "SMILES" BEING IN THE SHAPE OF A SMILE .

FOR PROVIDING A WEBSITE FEATURING PRODUCT RATINGS OF THE CONSUMER GOODS OF OTHERS IN THE FIELD OF PRODUCTS FOR CHILDREN AND YOUNG ADULTS (U.S. CLS. 100, 101 AND 102).

FIRST USE 2-0-2007; IN COMMERCE 2-0-2007.
KIMBERLY PERRY, EXAMINING ATTORNEY

SN 77-117,728. CINEMASaurus INC., SAN FRANCISCO, CA. FILED 2-27-2007.

CINEMASaurus

THE MARK CONSISTS OF STANDARD CHARACTERS WITHOUT CLAIM TO ANY PARTICULAR FONT, STYLE, SIZE, OR COLOR.

FOR RETAIL STORE SERVICES AND COMPUTERIZED ON-LINE RETAIL STORE SERVICES FEATURING PRE-RECORDED MUSIC, PRE-RECORDED VIDEOS, MUSICAL RECORDINGS, COMPUTER GAMES AND BOOKS (U.S. CLS. 100, 101 AND 102).

GIANCARLO CASTRO, EXAMINING ATTORNEY

SN 77-119,218. MIAN, MICHAEL, LIVERMORE, CA. FILED 3-1-2007.

googerang

THE MARK CONSISTS OF STANDARD CHARACTERS WITHOUT CLAIM TO ANY PARTICULAR FONT, STYLE, SIZE, OR COLOR.

FOR PROVIDING AN ONLINE DIRECTORY INFORMATION SERVICE FEATURING PERSONAL AND CONTACT INFORMATION OF SUBSCRIBERS (U.S. CLS. 100, 101 AND 102).

THOMAS MANOR, EXAMINING ATTORNEY

CLASS 35—(Continued).

SN 77-120,223. LACKOVICH, JOEL KRISTIN, SAN DIEGO, CA. FILED 3-1-2007.

GIRL POWDER

THE MARK CONSISTS OF STANDARD CHARACTERS WITHOUT CLAIM TO ANY PARTICULAR FONT, STYLE, SIZE, OR COLOR.

OWNER OF U.S. REG. NO. 3,093,954.

NO CLAIM IS MADE TO THE EXCLUSIVE RIGHT TO USE "GIRL", APART FROM THE MARK AS SHOWN.

FOR ON-LINE RETAIL STORE SERVICES AND MAIL-ORDER SERVICES FEATURING WOMEN'S SNOWBOARDING AND SKIING, CLOTHING, SPORTING GOODS, LUGGAGE AND SPORTS BAGS, AND MUSIC (U.S. CLS. 100, 101 AND 102).

FIRST USE 4-30-2004; IN COMMERCE 4-30-2004.
CURTIS FRENCH, EXAMINING ATTORNEY

SN 77-120,940. SYL, LLC, WILMINGTON, DE. FILED 3-2-2007.

STANLEY B. BY STANLEY BLACKER

THE MARK CONSISTS OF STANDARD CHARACTERS WITHOUT CLAIM TO ANY PARTICULAR FONT, STYLE, SIZE, OR COLOR.

OWNER OF U.S. REG. NOS. 2,359,880, 2,862,769 AND OTHERS.

"THE NAME(S), PORTRAIT(S), AND/OR SIGNATURE(S) SHOWN IN THE MARK DOES NOT IDENTIFY A PARTICULAR LIVING INDIVIDUAL."

FOR RETAIL CLOTHING STORE SERVICES (U.S. CLS. 100, 101 AND 102).

BRENDAN REGAN, EXAMINING ATTORNEY

SN 77-121,651. REHAB LICENSE NETWORK, LLC, DENVER, CO. FILED 3-3-2007.



NO CLAIM IS MADE TO THE EXCLUSIVE RIGHT TO USE "REHAB LICENSE NETWORK", APART FROM THE MARK AS SHOWN.

THE COLOR(S) RED, WHITE, BLUE IS/ARE CLAIMED AS A FEATURE OF THE MARK.

THE MARK CONSISTS OF THREE BLUE STYLIZED

CLASS 35—(Continued).

CURVED LINES GROUPED TOGETHER WITH A RED CIRCLE TO THE RIGHT OF THE GROUPING. BELOW IS THE WORD "REHAB" IN RED WITH THE "R" LARGER THAN THE REST OF THE WORD. BELOW IS A BLUE BLOCK THE SAME WIDTH AS THE WORD "REHAB" WITH THE WORDS "LICENSE NETWORK" IN WHITE. THE WORDS "LICENSE NETWORK" ARE SMALLER THAN THE WORD "REHAB." THE WORD "REHAB" AND THE CIRCLE ON THE RIGHT OF THE THREE BLUE STYLIZED BLUE CURVED LINES ARE THE SAME COLOR RED. THE BLUE BLOCK AND THE STYLIZED CURVED LINES ARE THE SAME COLOR BLUE.

FOR MARKETING SERVICES, NAMELY PROVIDING INFORMATIONAL WEB PAGES DESIGNED TO GENERATE SALES TRAFFIC VIA HYPERLINKS TO OTHER WEB SITES; PROVIDING AN ON-LINE COMPUTER DATABASE FEATURING TRADE INFORMATION IN THE FIELD OF ALLIED HEALTH; PROVIDING AN ONLINE DIRECTORY INFORMATION SERVICE FEATURING INFORMATION REGARDING, STATE LICENSURE REQUIREMENTS, EDUCATIONAL INSTITUTIONS, PROFESSIONAL ASSOCIATIONS; PROVIDING CAREER INFORMATION VIA INTERNET GLOBAL COMPUTER NETWORK; PROVIDING ON-LINE DIRECTORY INFORMATION SERVICES ALSO FEATURING HYPERLINKS TO OTHER WEB SITES; PROVIDING AN ON-LINE SEARCHABLE DATABASE FEATURING CLASSIFIED AD LISTINGS AND EMPLOYMENT OPPORTUNITIES; ADVERTISING VIA ELECTRONIC MEDIA AND SPECIFICALLY THE INTERNET (U.S. CLS. 100, 101 AND 102).

MICHELLE DUBOIS, EXAMINING ATTORNEY

SN 77-122,069. WORLDWAYS, INC., GREENWOOD VILLAGE, CO. FILED 3-5-2007.



OWNER OF U.S. REG. NO. 2,522,336.

NO CLAIM IS MADE TO THE EXCLUSIVE RIGHT TO USE "SOCIAL MARKETING", APART FROM THE MARK AS SHOWN.

THE COLOR(S) BLUE AND GREEN IS/ARE CLAIMED AS A FEATURE OF THE MARK.

THE MARK CONSISTS OF A TWO TALKING BUBBLES ABOVE THE BLUE WORDING WORLDWAYS SOCIAL MARKETING. THE COLOR BLUE APPEARS ON THE FIRST TALKING BUBBLE AND THE COLOR GREEN APPEARS ON THE SECOND TALKING BUBBLE.

FOR DEVELOPMENT OF MARKETING STRATEGIES AND CONCEPTS; ADVERTISING AND MARKETING; BUSINESS MARKETING CONSULTING SERVICES; BUSINESS MARKETING SERVICES (U.S. CLS. 100, 101 AND 102).

FIRST USE 3-15-2007; IN COMMERCE 3-15-2007.

DOMINIC J. FERRAIUOLO, EXAMINING ATTORNEY

CLASS 35—(Continued).

SN 77-122,178. KLIGMAN, RICHARD, PASSAIC, NJ. FILED 3-5-2007.

QOOF

THE MARK CONSISTS OF STANDARD CHARACTERS WITHOUT CLAIM TO ANY PARTICULAR FONT, STYLE, SIZE, OR COLOR.

FOR ON-LINE ADVERTISING AND PUBLICITY SERVICES, NAMELY, PROMOTING THE GOODS, SERVICES, BRAND IDENTITY AND COMMERCIAL INFORMATION OF THIRD PARTIES THROUGH ON-LINE MEDIUMS FEATURING VIDEO ADVERTISEMENTS; ON-LINE MARKETING SERVICES, NAMELY, PROMOTION RELATING TO THE SALE OF ARTICLES AND SERVICES FOR THIRD PARTIES BY THE TRANSMISSION OF VIDEO ADVERTISING MATERIAL AND THE DISSEMINATION OF VIDEO ADVERTISING MESSAGES ON COMPUTER NETWORKS. (U.S. CLS. 100, 101 AND 102).

DANIEL BRODY, EXAMINING ATTORNEY

SN 77-122,191. KLIGMAN, RICHARD, PASSAIC, NJ. FILED 3-5-2007.

Usermercial

THE MARK CONSISTS OF STANDARD CHARACTERS WITHOUT CLAIM TO ANY PARTICULAR FONT, STYLE, SIZE, OR COLOR.

FOR ON-LINE ADVERTISING AND PUBLICITY SERVICES, NAMELY, PROMOTING THE GOODS, SERVICES, BRAND IDENTITY AND COMMERCIAL INFORMATION OF THIRD PARTIES THROUGH ON-LINE MEDIUMS FEATURING VIDEO ADVERTISEMENTS; ON-LINE MARKETING SERVICES, NAMELY, PROMOTION RELATING TO THE SALE OF ARTICLES AND SERVICES FOR THIRD PARTIES BY THE TRANSMISSION OF VIDEO ADVERTISING MATERIAL AND THE DISSEMINATION OF VIDEO ADVERTISING MESSAGES ON COMPUTER NETWORKS. (U.S. CLS. 100, 101 AND 102).

DANIEL BRODY, EXAMINING ATTORNEY

CLASS 35—(Continued).

SN 77-122,203. KLIGMAN, RICHARD, PASSAIC, NJ. FILED 3-5-2007.



THE MARK CONSISTS OF A SOLID BLACK CIRCLE WITH A WHITE LETTER Q IN THE MIDDLE, ALONG WITH THE WORD QOOF, IN BLACK, LOCATED BELOW THE CIRCLE.

FOR ON-LINE ADVERTISING AND PUBLICITY SERVICES, NAMELY, PROMOTING THE GOODS, SERVICES, BRAND IDENTITY AND COMMERCIAL INFORMATION OF THIRD PARTIES THROUGH ON-LINE MEDIUMS FEATURING VIDEO ADVERTISEMENTS; ON-LINE MARKETING SERVICES, NAMELY, PROMOTION RELATING TO THE SALE OF ARTICLES AND SERVICES FOR THIRD PARTIES BY THE TRANSMISSION OF VIDEO ADVERTISING MATERIAL AND THE DISSEMINATION OF VIDEO ADVERTISING MESSAGES ON COMPUTER NETWORKS. (U.S. CLS. 100, 101 AND 102).

DANIEL BRODY, EXAMINING ATTORNEY

CLASS 35—(Continued).

SN 77-123,080. GRAND BAHAMA ISLAND TOURISM BOARD, CORAL SPRINGS, FL. FILED 3-6-2007.



NO CLAIM IS MADE TO THE EXCLUSIVE RIGHT TO USE "GRAND BAHAMA ISLAND", APART FROM THE MARK AS SHOWN.

THE COLOR(S) ORANGE AND GRAY IS/ARE CLAIMED AS A FEATURE OF THE MARK.

THE MARK CONSISTS OF FIRST THREE WORDS CONTAIN LETTERS IN ORANGE AND AND THE SECOND FOUR WORDS CONTAIN LETTERS IN GRAY, THE CHAIN OF ISLANDS DRAWING IS IN GRAY EXCEPT FOR ONE CIRCULAR ISLAND DRAWING IN THE UPPER LEFT CORNER WHICH IS ORANGE.

FOR PROMOTING TOURISM IN THE GRAND BAHAMA ISLAND AREA (U.S. CLS. 100, 101 AND 102).

JOHN DWYER, EXAMINING ATTORNEY

SN 77-123,074. GRAND BAHAMA ISLAND TOURISM BOARD, CORAL SPRINGS, FL. FILED 3-6-2007.



NO CLAIM IS MADE TO THE EXCLUSIVE RIGHT TO USE "GRAND BAHAMA ISLAND", APART FROM THE MARK AS SHOWN.

THE COLOR(S) ORANGE AND GRAY IS/ARE CLAIMED AS A FEATURE OF THE MARK.

THE MARK CONSISTS OF FIRST THREE WORDS CONTAIN LETTERS IN ORANGE AND AND THE SECOND THREE WORDS CONTAIN LETTERS IN GRAY, THERE IS A CHAIN OF ISLANDS DRAWING THAT IS IN GRAY EXCEPT FOR ONE CIRCULAR ISLAND DRAWING IN THE UPPER LEFT CORNER WHICH IS ORANGE.

FOR PROMOTING TOURISM IN THE GRAND BAHAMA ISLAND AREA (U.S. CLS. 100, 101 AND 102).

JOHN DWYER, EXAMINING ATTORNEY

SN 77-123,218. BOTTOM LINE RESULTS, LLC, MIDLOTHIAN, VA. FILED 3-6-2007.



THE COLOR(S) BLACK, WHITE, AND YELLOW IS/ARE CLAIMED AS A FEATURE OF THE MARK.

THE MARK CONSISTS OF THE LETTERS BLR RENDERED ON A BLACK SQUARE WITH A YELLOW OUTLINE, THE LETTERS B AND L ARE RENDERED IN WHITE, AND THE LETTER R IS RENDERED IN YELLOW.

FOR BUSINESS CONSULTING SERVICES IN THE FIELD OF TEXTILES (U.S. CLS. 100, 101 AND 102).

REBECCA GAN, EXAMINING ATTORNEY

CLASS 35—(Continued).

SN 77-123,228. AUTOMOTIVE RENTALS, INC., MOUNT LAUREL, NJ. FILED 3-6-2007.

ARIFLEET.COM

THE MARK CONSISTS OF STANDARD CHARACTERS WITHOUT CLAIM TO ANY PARTICULAR FONT, STYLE, SIZE, OR COLOR.

OWNER OF U.S. REG. NOS. 1,705,456, 3,223,846 AND OTHERS.

FOR ADVICE AND INFORMATION ABOUT CUSTOMER SERVICES AND VEHICLE FLEET MANAGEMENT AND PRICES FOR FLEET VEHICLES AND PARTS ON INTERNET SITES IN CONNECTION WITH PURCHASES MADE OVER THE INTERNET; VEHICLE FLEET ADMINISTRATION AND MANAGEMENT; BUSINESS INFORMATION MANAGEMENT IN THE AREA OF VEHICLE FLEETS; CARRYING OUT TASKS NECESSARY FOR THE SMOOTH CONDUCT OF USED VEHICLE SALES BY AUCTION; AUCTIONING, LIQUIDATING AND REMARKETING VEHICLES OF OTHERS; STATE VEHICULAR REGISTRATION AND TITLE TRANSFER (U.S. CLS. 100, 101 AND 102).

FIRST USE 1-2-1996; IN COMMERCE 1-2-1996.

ANDREW RHIM, EXAMINING ATTORNEY

CLASS 35—(Continued).

SN 77-124,672. MLA MULTIBRAND HOLDINGS, INC., VERNON, CA. FILED 3-7-2007.

PARALLEL UNIVERSE

THE MARK CONSISTS OF STANDARD CHARACTERS WITHOUT CLAIM TO ANY PARTICULAR FONT, STYLE, SIZE, OR COLOR.

OWNER OF U.S. REG. NO. 1,747,190.

FOR RETAIL STORES FEATURING MEN'S, WOMEN'S, AND CHILDREN'S CLOTHING, FOOTWEAR, EYEWEAR, BELTS, BAGS, WALLETS, NOTEBOOKS, COSTUME JEWELRY, AND ACCESSORIES (U.S. CLS. 100, 101 AND 102).

INGRID C. EULIN, EXAMINING ATTORNEY

SN 77-124,198. PEA SOUP, INC., DEERFIELD, IL. FILED 3-7-2007.



SN 77-126,362. SHYMATTA, DAVID R., CHUBBUCK, ID. FILED 3-9-2007.

CELL JUNKIE

NO CLAIM IS MADE TO THE EXCLUSIVE RIGHT TO USE ACCESSORIES FOR KIDS, APART FROM THE MARK AS SHOWN.

THE COLOR(S) GREEN, PINK, PEACH AND WHITE IS/ARE CLAIMED AS A FEATURE OF THE MARK.

THE STYLIZED WORDING "PEA SOUP" IN PEACH THAT FADES TO PINK WITH A WHITE OUTLINE AND THEN A GREEN OUTLINE SURROUNDING THE LETTERS. THE STYLIZED WORDING "ACCESSORIES FOR KIDS" IS IN GREEN UNDERNEATH THE WORDING "PEA SOUP." THREE GREEN PEAS ARE IN FRONT OF THE WORD "PEA" AND ONE GREEN PEA IS AFTER THE WORD "KIDS."

FOR RETAIL STORES FEATURING CHILDREN'S CLOTHING AND ACCESSORIES (U.S. CLS. 100, 101 AND 102).

FIRST USE 10-1-2006; IN COMMERCE 10-1-2006.

TASHIA BUNCH, EXAMINING ATTORNEY

THE MARK CONSISTS OF STANDARD CHARACTERS WITHOUT CLAIM TO ANY PARTICULAR FONT, STYLE, SIZE, OR COLOR.

NO CLAIM IS MADE TO THE EXCLUSIVE RIGHT TO USE "CELL", APART FROM THE MARK AS SHOWN.

FOR RETAIL STORE SERVICES FEATURING CELL PHONE ACCESSORIES (U.S. CLS. 100, 101 AND 102).

FIRST USE 2-13-2006; IN COMMERCE 2-13-2006.

RAY THOMAS, EXAMINING ATTORNEY

CLASS 35—(Continued).

SN 77-126,373. FIRST ADVANTAGE CORPORATION, ST. PETERSBURG, FL. FILED 3-9-2007.



THE MARK CONSISTS OF THE STYLIZED LETTERS RM WITHIN A CIRCLE.

FOR PROVIDING AN ON-LINE COMPUTER DATABASE FEATURING INFORMATION USED BY COMPANIES TO OVERSEE, MANAGE, AND MITIGATE BUSINESS RISKS ASSOCIATED WITH INSURANCE CLAIMS, ACCIDENTS, PERSONNEL, AND INVESTMENTS (U.S. CLS. 100, 101 AND 102).

TANYA AMOS, EXAMINING ATTORNEY

CLASS 35—(Continued).

SN 77-127,062. MAKEMESUSTAINABLE, CAMBRIDGE, MA. FILED 3-9-2007.



THE COLOR(S) GREEN AND WHITE IS/ARE CLAIMED AS A FEATURE OF THE MARK.

THE MARK CONSISTS OF A GREEN THUMBPRINT, WITH A WHITE TREE OUTLINED IN THE CENTER. WHITE MARKS ARE USED TO ACCENTUATE THE THUMBPRINT..

FOR ENERGY USAGE MANAGEMENT INFORMATION SERVICES (U.S. CLS. 100, 101 AND 102).

FIRST USE 11-1-2006; IN COMMERCE 1-1-2007.

WILLIAM P. SHANAHAN, EXAMINING ATTORNEY

SN 77-126,428. BELIZE TOURISM BOARD, BELIZE CITY, BELIZE, FILED 3-9-2007.



NO CLAIM IS MADE TO THE EXCLUSIVE RIGHT TO USE "BELIZE", APART FROM THE MARK AS SHOWN.

THE COLOR(S) BLUE, GREEN, YELLOW, RED, BLACK IS/ARE CLAIMED AS A FEATURE OF THE MARK.

THE MARK CONSISTS OF A YELLOW CIRCLE, A BIRD WITH A YELLOW THROAT, BLACK AND RED BODY, RED, GREEN AND YELLOW BEAK. THE WORD BELIZE WHERE THE LETTERS BELI ARE TWO DIFFERENT SHADES OF BLUE AND THE LETTERS ZE ARE GREEN AND THE WORDS MOTHER NATURE'S BEST KEPT SECRET ARE BLACK.

FOR TRAVEL AND TOURISM SERVICES, NAMELY, PROMOTING TOURISM IN BELIZE (U.S. CLS. 100, 101 AND 102).

FIRST USE 2-0-1999; IN COMMERCE 2-0-1999.
AMEETA JORDAN, EXAMINING ATTORNEY

SN 77-127,065. THE ALLEGHENY COUNTY BAR ASSOCIATION, PITTSBURGH, PA. FILED 3-9-2007.

Raising the Bar on Legal and Community Service

THE MARK CONSISTS OF STANDARD CHARACTERS WITHOUT CLAIM TO ANY PARTICULAR FONT, STYLE, SIZE, OR COLOR.

FOR ASSOCIATION SERVICES, NAMELY, PROMOTING THE INTERESTS OF THE LEGAL PROFESSION AND BAR ASSOCIATION MEMBERS (U.S. CLS. 100, 101 AND 102).

FIRST USE 8-8-2003; IN COMMERCE 8-8-2003.

CIMMERIAN COLEMAN, EXAMINING ATTORNEY

CLASS 35—(Continued).

SN 77-127,109. EXPONATION, L.L.C., ROSWELL, GA. FILED 3-9-2007.



NO CLAIM IS MADE TO THE EXCLUSIVE RIGHT TO USE "EXPO", "DIGITAL SIGNAGE", "RETAIL", "HOSPITALITY", "FINANCIAL", AND "PUBLIC SPACES", APART FROM THE MARK AS SHOWN.

THE MARK CONSISTS OF THE WORDS "DIGITAL SIGNAGE" WITH THE WORD "EXPO" SUPERIMPOSED ON A STYLIZED GLOBE SHOWING ONLY MERIDIAN AND PARALLEL LINES.

FOR ARRANGING AND CONDUCTING TRADE SHOW EXHIBITIONS IN THE FIELD OF DIGITAL SIGNAGE FOR VARIOUS INDUSTRIES, INCLUDING RETAIL, HOSPITALITY, FINANCIAL, AND PUBLIC SPACES (U.S. CLS. 100, 101 AND 102).

FIRST USE 2-1-2007; IN COMMERCE 2-1-2007.

JANICE L. MCMORROW, EXAMINING ATTORNEY

CLASS 35—(Continued).

SN 77-128,721. BROWN, SARAH L., NAPLES, FL. FILED 3-12-2007.



THE COLOR(S) BLACK, BROWN, AND GREEN IS/ARE CLAIMED AS A FEATURE OF THE MARK.

THE MARK CONSISTS OF A STYLIZED DEPICTION OF THE WORD "BANYANBROWN" WITH A FLOATING TREETOP ABOVE THE LETTER "Y". THE COLOR BLACK APPEARS IN THE LETTERS "B", "A", "N", "A", "N", "B", "R", "O", "W", AND "N". THE COLOR GREEN APPEARS IN THE FLOATING TREETOP. THE COLOR BROWN APPEARS IN THE LETTER "Y".

FOR EMPLOYMENT AGENCIES; EMPLOYMENT COUNSELING AND RECRUITING; EMPLOYMENT HIRING, RECRUITING, PLACEMENT, STAFFING AND CAREER NETWORKING SERVICES; EMPLOYMENT OUTPLACEMENT SERVICES; EMPLOYMENT VERIFICATION; PROVIDING AN ON-LINE SEARCHABLE DATABASE FEATURING CLASSIFIED AD LISTINGS AND EMPLOYMENT OPPORTUNITIES; TEMPORARY EMPLOYMENT AGENCIES; TESTING TO DETERMINE EMPLOYMENT SKILLS; ADMINISTRATION OF BUSINESS PAYROLL FOR OTHERS; PAYROLL PREPARATION; WAGE PAYROLL PREPARATION (U.S. CLS. 100, 101 AND 102).

FIRST USE 2-1-2007; IN COMMERCE 2-1-2007.

JOHN DWYER, EXAMINING ATTORNEY

SN 77-127,510. BURKHARD, VICKI, LAKE FOREST, CA. FILED 3-9-2007.



THE COLOR(S) BLACK, RED, BLUE AND YELLOW IS/ ARE CLAIMED AS A FEATURE OF THE MARK.

THE MARK CONSISTS OF ART-FASCI-NATION WITH A BLACK LINE ABOVE THE LETTERS AND THE COLORS RED, BLUE AND YELLOW IN THE DESIGN BEHIND.

FOR ADVERTISING OF FINE ARTS, NAMELY PAINTINGS, SCULPTURES, BOOKS AND THE LIKE (U.S. CLS. 100, 101 AND 102).

KATHY DE JONGE, EXAMINING ATTORNEY

SN 77-128,915. KIM, PAUL K., BEVERLY HILLS, CA. FILED 3-12-2007.

Location Swatchbook

THE MARK CONSISTS OF STANDARD CHARACTERS WITHOUT CLAIM TO ANY PARTICULAR FONT, STYLE, SIZE, OR COLOR.

NO CLAIM IS MADE TO THE EXCLUSIVE RIGHT TO USE LOCATION, APART FROM THE MARK AS SHOWN.

FOR PROVIDING CONSUMER INFORMATION SERVICES AND MAKING REFERRALS IN THE FIELD OF ENTERTAINMENT SERVICES FOR PRODUCTS, SERVICES, EVENTS, ACTIVITIES, FACILITIES AND LOCATIONS (U.S. CLS. 100, 101 AND 102).

AMEETA JORDAN, EXAMINING ATTORNEY

CLASS 35—(Continued).

SN 77-128,983. THE PERSONNEL OFFICE, INC., FALLS CHURCH, VA. FILED 3-12-2007.

MAKING HR A DRIVER OF RESULTS

THE MARK CONSISTS OF STANDARD CHARACTERS WITHOUT CLAIM TO ANY PARTICULAR FONT, STYLE, SIZE, OR COLOR.

FOR PERSONNEL MANAGEMENT CONSULTATION; HUMAN RESOURCES CONSULTATION; HUMAN RESOURCES MANAGEMENT; OUTSOURCING IN THE FIELD OF HUMAN RESOURCE MANAGEMENT; BUSINESS CONSULTATION; BUSINESS MANAGEMENT CONSULTANCY AND ADVISORY SERVICES; BUSINESS ADMINISTRATION AND MANAGEMENT (U.S. CLS. 100, 101 AND 102).

FIRST USE 3-27-2006; IN COMMERCE 3-27-2006.
ERIN FALK, EXAMINING ATTORNEY

CLASS 35—(Continued).

SN 77-129,187. VERTIGO TATTOO AND BODY PIERCING, INC., MANN'S HARBOR, NC. FILED 3-13-2007.



NO CLAIM IS MADE TO THE EXCLUSIVE RIGHT TO USE "OUTER BANKS BIKE RALLY", APART FROM THE MARK AS SHOWN.

THE MARK CONSISTS OF A CREATURE STANDING ON A MOTORCYCLE UNDER THE STYLIZED WORDS OUTER BANKS BIKE RALLY.

FOR ARRANGING AND CONDUCTING TRADE SHOWS IN THE FIELD OF MOTORCYCLES (U.S. CLS. 100, 101 AND 102).

FIRST USE 2-0-2007; IN COMMERCE 2-0-2007.
SHARON MEIER, EXAMINING ATTORNEY

SN 77-128,997. SAN FRANCHISECO, INC., SAN FRANCISCO, CA. FILED 3-12-2007.



SAN FRANCHISECO INC.
MULTI-UNIT. MULTI-BRAND.

NO CLAIM IS MADE TO THE EXCLUSIVE RIGHT TO USE "INC.", APART FROM THE MARK AS SHOWN.

THE COLOR(S) RED, GRAY IS/ARE CLAIMED AS A FEATURE OF THE MARK.

THE MARK CONSISTS OF A RED STYLIZED REPRESENTATION OF THE GOLDEN GATE BRIDGE, WITH THE WORDINGS MULTI-UNIT. AND MULTI-BRAND. IN RED, AND THE WORDING SAN FRANCHISECO INC. IN GRAY.

FOR BUSINESS DEVELOPMENT SERVICES, NAMELY, PROVIDING START-UP SUPPORT FOR BUSINESSES OF OTHERS (U.S. CLS. 100, 101 AND 102).

ALICE BENMAMAN, EXAMINING ATTORNEY

SN 77-130,273. D.C. JACOBSON & ASSOCIATES LLC, SISTERS, OR. FILED 3-13-2007.

YOUR WORDS ARE IMPORTANT

THE MARK CONSISTS OF STANDARD CHARACTERS WITHOUT CLAIM TO ANY PARTICULAR FONT, STYLE, SIZE, OR COLOR.

FOR LITERARY AGENCY SERVICES (U.S. CLS. 100, 101 AND 102).

JULIE GUTTADAURO, EXAMINING ATTORNEY

CLASS 35—(Continued).

SN 77-130,648. PRIME REALTY USA, LLC, CLIFTON, NJ. FILED 3-14-2007.



Prime
Realty *USA*

NO CLAIM IS MADE TO THE EXCLUSIVE RIGHT TO USE REALTY USA, APART FROM THE MARK AS SHOWN. THE MARK CONSISTS OF THE WORDS "PRIME REALTY" IN INITIAL CAP LETTERING, THE WORD PRIME IS DIRECTLY ABOVE THE WORD "REALTY". THE LETTER "Y" HAS A LINE EXTENDING FROM THE BOTTOM OF THE "Y" TO THE RIGHT. IMMEDIATELY ABOVE THE EXTENDING LINE ARE THE LETTERS USA IN ALL CAPS.

FOR FRANCHISING, NAMELY, OFFERING TECHNICAL ASSISTANCE IN THE ESTABLISHMENT AND/OR OPERATION OF REAL ESTATE AGENCIES (U.S. CLS. 100, 101 AND 102).

FIRST USE 9-1-2004; IN COMMERCE 9-1-2006.

CHARLOTTE CORWIN, EXAMINING ATTORNEY

CLASS 35—(Continued).

SN 77-131,326. METARIZON LLC, CHARLESTON, SC. FILED 3-14-2007.



metarizon

THE COLOR(S) BLUE AND BLACK IS/ARE CLAIMED AS A FEATURE OF THE MARK.

THE MARK CONSISTS OF THE LITERAL ELEMENT "METARIZON" IN STYLIZED LETTERING AND APPEARING IN BLACK AND THE DESIGN ELEMENT OF ANGULAR SHAPES ABOVE THE LITERAL ELEMENT APPEARING IN BLUE. NO BACKGROUND COLOR IS CLAIMED.

FOR BUSINESS CONSULTING AND INFORMATION SERVICES (U.S. CLS. 100, 101 AND 102).

FIRST USE 5-1-2004; IN COMMERCE 5-1-2004.

JUDITH HELFMAN, EXAMINING ATTORNEY

SN 77-131,263. PATRICIA I SUE, EMERYVILLE, CA. FILED 3-14-2007.



ICECOLDsake

THE MARK CONSISTS OF THE WORDING "ICECOLD-SAKE" AND A JAPANESE SYMBOL WITHIN A SQUARE. THE NON-LATIN CHARACTERS IN THE MARK TRANSLITERATE TO "SAKE" AND THIS MEANS "SAKE" IN ENGLISH.

FOR COMPUTERIZED ON-LINE RETAIL STORE SERVICES IN THE FIELD OF CLOTHING (U.S. CLS. 100, 101 AND 102).

FIRST USE 7-26-2006; IN COMMERCE 7-28-2006.

DAVID H. STINE, EXAMINING ATTORNEY

SN 77-131,400. THE POWER BEHIND THE PASSION, LLC, MIAMI, FL. FILED 3-14-2007.



THE COLOR(S) RED, WHITE, AND BLACK IS/ARE CLAIMED AS A FEATURE OF THE MARK.

THE MARK CONSISTS OF A RED BUTTERFLY SET INSIDE A BLACK CIRCLE SURROUNDED BY A RED CIRCLE CONTAINING WHITE LETTERING AND WHITE DECORATIVE ELEMENTS.

FOR BUSINESS MARKETING CONSULTING SERVICES (U.S. CLS. 100, 101 AND 102).

SETH A. RAPPAPORT, EXAMINING ATTORNEY

CLASS 35—(Continued).

SN 77-131,565. TELUS CORPORATION, EDMONTON, CANADA, FILED 3-15-2007.



THE MARK CONSISTS OF THE LETTER "T" WRITTEN IN A DISTINCTIVE SCRIPT.

FOR HUMAN CAPITAL MANAGEMENT OUTSOURCING SERVICES; OUTSOURCING SERVICES; BUSINESS OUTSOURCING SERVICES IN THE FIELD OF OPERATING, MAINTAINING, AND PROVIDING TELECOMMUNICATIONS INFRASTRUCTURE AND TELECOMMUNICATIONS APPLICATIONS FOR TELECOMMUNICATIONS COMPANIES; PROVIDING OUTSOURCED BUSINESS SERVICES TO OTHER COMPANIES, NAMELY PROVIDING OUTSOURCING IN THE FIELD OF CONTACT CENTER OPERATIONS, CUSTOMER CARE SOLUTIONS, CUSTOMER MEDIATION SERVICES, BILLING SERVICES, HUMAN RESOURCES OPERATIONS, GEOMATICS SERVICES, WIRELESS FIELD DEPLOYMENT SERVICES, INFORMATION TECHNOLOGY SERVICES, DATA AND APPLICATION BACKUP AND DISASTER RECOVERY SERVICES, AND COMPUTER APPLICATION SERVICES (U.S. CLS. 100, 101 AND 102).

KAPIL BHANOT, EXAMINING ATTORNEY

CLASS 35—(Continued).

SN 77-131,757. TEAM DOUBLE-CLICK, INC., LODI, WI. FILED 3-15-2007.

TEAM DOUBLE-CLICK

THE MARK CONSISTS OF STANDARD CHARACTERS WITHOUT CLAIM TO ANY PARTICULAR FONT, STYLE, SIZE, OR COLOR.

NO CLAIM IS MADE TO THE EXCLUSIVE RIGHT TO USE "TEAM", APART FROM THE MARK AS SHOWN.

FOR PROVIDING BUSINESS ADMINISTRATION, BUSINESS MANAGEMENT, OFFICE SUPPORT STAFF, SECRETARIAL, AND CLERICAL SERVICES FOR OTHERS; BUSINESS ADMINISTRATION, BUSINESS MANAGEMENT, OFFICE SUPPORT STAFF, SECRETARIAL, AND CLERICAL SERVICES RENDERED VIA INTERNET, EMAIL, AND TELEPHONIC COMMUNICATIONS (U.S. CLS. 100, 101 AND 102).

FIRST USE 10-0-2004; IN COMMERCE 10-0-2004.
LINDA LAVACHE, EXAMINING ATTORNEY

SN 77-131,824. TEAM DOUBLE-CLICK, INC., LODI, WI. FILED 3-15-2007.

SN 77-131,684. NETWORKS MARKETING GROUP, INC., CONCORD, NC. FILED 3-15-2007.



Team Double-Click



THE STIPPLING IS FOR SHADING PURPOSES ONLY.
FOR INTERNET MARKETING SERVICES, NAMELY, PROMOTING THE GOODS AND SERVICES OF OTHERS BY PROVIDING HYPERTEXT LINKS TO WEBSITES OF OTHERS AND THROUGH SEARCH ENGINE REFERRAL TRAFFIC ANALYSIS AND REPORTING (U.S. CLS. 100, 101 AND 102).

FIRST USE 1-1-2003; IN COMMERCE 1-1-2003.
LINDA ORNDORFF, EXAMINING ATTORNEY

NO CLAIM IS MADE TO THE EXCLUSIVE RIGHT TO USE "TEAM", APART FROM THE MARK AS SHOWN.

THE MARK CONSISTS OF THE DESIGN OF A PARTIAL GLOBE INCORPORATING FACIAL SILHOUETTES WITH THE WORDING PROVIDING THE PEOPLE . . . VIRTUALLY! AROUND THE LEFT SIDE OF THE DESIGN AND THE UNDERLINED WORDS TEAM DOUBLE-CLICK TO THE RIGHT OF THE DESIGN.

FOR PROVIDING BUSINESS ADMINISTRATION, BUSINESS MANAGEMENT, OFFICE SUPPORT STAFF, SECRETARIAL, AND CLERICAL SERVICES FOR OTHERS; BUSINESS ADMINISTRATION, BUSINESS MANAGEMENT, OFFICE SUPPORT STAFF, SECRETARIAL, AND CLERICAL SERVICES RENDERED VIA INTERNET, EMAIL, AND TELEPHONIC COMMUNICATIONS (U.S. CLS. 100, 101 AND 102).

FIRST USE 12-0-2006; IN COMMERCE 12-0-2006.
LINDA LAVACHE, EXAMINING ATTORNEY

CLASS 35—(Continued).

SN 77-131,829. NGN NEW GENERATION NETWORK GMBH, BERLIN, FED REP GERMANY, FILED 3-15-2007.

ATTENTION NGN

THE MARK CONSISTS OF STANDARD CHARACTERS WITHOUT CLAIM TO ANY PARTICULAR FONT, STYLE, SIZE, OR COLOR.

FOR BUSINESS SERVICES, NAMELY MATCHING CONSUMERS WITH PROFESSIONALS IN THE FIELD OF TRADE SHOWS (U.S. CLS. 100, 101 AND 102).

FIRST USE 10-0-2006; IN COMMERCE 10-0-2006.
RAMONA ORTIGA, EXAMINING ATTORNEY

SN 77-132,350. HOMES.ORG LLC, FT. LAUDERDALE, FL. FILED 3-15-2007.

We Lower Your Cost of Living!

THE MARK CONSISTS OF STANDARD CHARACTERS WITHOUT CLAIM TO ANY PARTICULAR FONT, STYLE, SIZE, OR COLOR.

FOR WEB, TELEPHONE AND DIRECT MAIL ADVERTISING TO CONSUMERS OF CONSUMER HOUSEHOLD PRODUCTS AND SERVICES FOR CONSUMERS RELOCATING TO SINGLE FAMILY RESIDENCES (U.S. CLS. 100, 101 AND 102).

FIRST USE 10-16-2006; IN COMMERCE 10-16-2006.
HOWARD SMIGA, EXAMINING ATTORNEY

SN 77-132,382. HOMES.ORG LLC, FT. LAUDERDALE, FL. FILED 3-15-2007.

One Destination, Unlimited Possibilities

THE MARK CONSISTS OF STANDARD CHARACTERS WITHOUT CLAIM TO ANY PARTICULAR FONT, STYLE, SIZE, OR COLOR.

FOR WEB AND DIRECT MAIL ADVERTISING OF CONSUMER HOUSEHOLD SERVICES FOR CONSUMERS RELOCATING TO SINGLE FAMILY HOMES THROUGHOUT THE CONTINENTAL UNITED STATES (U.S. CLS. 100, 101 AND 102).

FIRST USE 10-16-2006; IN COMMERCE 10-16-2006.
HOWARD SMIGA, EXAMINING ATTORNEY

CLASS 35—(Continued).

SN 77-132,389. CHARLES AND MARIE, INC., SAN CARLOS, CA. FILED 3-15-2007.

MARIE'S CLOSET

THE MARK CONSISTS OF STANDARD CHARACTERS WITHOUT CLAIM TO ANY PARTICULAR FONT, STYLE, SIZE, OR COLOR.

OWNER OF U.S. REG. NO. 3,157,731.

FOR ON-LINE RETAIL STORE SERVICES FEATURING WOMEN'S FASHION AND ACCESSORIES, GIFTS, JEWELRY, AND COSMETICS (U.S. CLS. 100, 101 AND 102).

JOHN SCHUYLER YARD, EXAMINING ATTORNEY

SN 77-132,491. TOP TEN FUND RAISERS, INC., SUNNYVALE, TX. FILED 3-15-2007.



NO CLAIM IS MADE TO THE EXCLUSIVE RIGHT TO USE "DESKTOP SCHOOL SUPPLIES", APART FROM THE MARK AS SHOWN.

THE MARK CONSISTS OF A STACKED PRESENTATION OF THE WORD DESKTOP ENCLOSED BY A SOLID BORDER LINE THAT GENERALLY FOLLOWS THE CONTOUR OF THE LETTERS ALONG THE SIDES AND TOP, TOGETHER WITH THE WORDS SCHOOL SUPPLIES ENCLOSED BY A SOLID BORDER LINE THAT FOLLOWS LEFT AND RIGHT CURVED SIDE PORTIONS, A STRAIGHT-LINE BOTTOM PORTION JOINING THE CURVED PORTIONS AND A STRAIGHT-LINE TOP PORTION EXTENDING IN PARALLEL WITH THE STRAIGHT-LINE BOTTOM PORTION.

FOR PACKAGING OF BACK-TO-SCHOOL SUPPLY KITS, INTENDED FOR USE BY ELEMENTARY SCHOOL CHILDREN, THAT CONTAIN VARIOUS COMBINATIONS OF SCHOOL SUPPLY ITEMS SELECTED FROM THE GROUP COMPRISING PENS, PENCILS, PAPER, NOTEBOOKS, GLUE, RULERS, FOLDERS, SCISSORS, ERASERS AND CRAYONS, ACCORDING TO THE ORDER AND SPECIFICATION OF OTHERS; AND ON-LINE RETAIL STORE SERVICES FEATURING STANDARD AND CUSTOM BACK-TO-SCHOOL PRE-PACKAGED SUPPLY KITS, INTENDED FOR USE BY ELEMENTARY SCHOOL CHILDREN, THAT CONTAIN VARIOUS COMBINATIONS OF SCHOOL SUPPLY ITEMS SELECTED FROM THE GROUP COMPRISING PENS, PENCILS, PAPER, NOTEBOOKS, GLUE, RULERS, FOLDERS, SCISSORS, ERASERS AND CRAYONS (U.S. CLS. 100, 101 AND 102).

FIRST USE 11-0-2004; IN COMMERCE 11-0-2004.
NICHOLAS ALTREE, EXAMINING ATTORNEY

CLASS 35—(Continued).

SN 77-133,305. CEXCHANGE, LLC, CARSON CITY, NV.
FILED 3-16-2007.

CEXCHANGE

THE MARK CONSISTS OF STANDARD CHARACTERS WITHOUT CLAIM TO ANY PARTICULAR FONT, STYLE, SIZE, OR COLOR.

FOR ELECTRONICS RESELLER SERVICES, NAMELY, PROVIDING AN ONLINE TRADE-IN PROGRAM FOR THE TRADE OF USED CONSUMER ELECTRONICS EQUIPMENT FOR COUPONS, GIFT CARDS, OR GIFT CERTIFICATES REDEEMABLE FOR MERCHANDISE OR SERVICES (U.S. CLS. 100, 101 AND 102).

EMILY CARLSEN, EXAMINING ATTORNEY

SN 77-133,724. MINDFIRE INTERNET SOLUTIONS, INC.,
IRVINE, CA. FILED 3-17-2007.

DIRECT MAIL'S MISSING LINK.

THE MARK CONSISTS OF STANDARD CHARACTERS WITHOUT CLAIM TO ANY PARTICULAR FONT, STYLE, SIZE, OR COLOR.

NO CLAIM IS MADE TO THE EXCLUSIVE RIGHT TO USE "DIRECT MAIL'S", APART FROM THE MARK AS SHOWN.

FOR ADVERTISING AND MARKETING (U.S. CLS. 100, 101 AND 102).

FIRST USE 6-1-2005; IN COMMERCE 6-1-2005.
LINDSEY RUBIN, EXAMINING ATTORNEY

SN 77-134,018. REED EXPOSITIONS FRANCE, LEVALLOIS-
PERRET CEDEX, FRANCE, FILED 3-19-2007.

EQUIP'BAIE

THE MARK CONSISTS OF STANDARD CHARACTERS WITHOUT CLAIM TO ANY PARTICULAR FONT, STYLE, SIZE, OR COLOR.

FOR ARRANGING AND PROMOTING OF TRADE SHOWS, EXHIBITIONS AND BUSINESS CONFERENCES SERVING THE WINDOW, DOOR, SHUTTER AND SOLAR PROTECTION INDUSTRY (U.S. CLS. 100, 101 AND 102).

FIRST USE 12-1-1993; IN COMMERCE 12-1-1993.
SETH A. RAPPAPORT, EXAMINING ATTORNEY

CLASS 35—(Continued).

SN 77-134,213. THEMBID.COM, INC., RIVERSIDE, CA.
FILED 3-19-2007.



THE COLOR(S) RED, BLACK AND GOLD IS/ARE CLAIMED AS A FEATURE OF THE MARK.

THE MARK CONSISTS OF THEMBID- IS IN ALL CAPS, RED WITH A BLACK OUTLINE. .COM - IS IN ALL CAPS, SMALLER FONT THAN THE THEMBID, SET BACK IN A FADED RED WITH A FADED BLACK OUTLINE THERE ARE TWO INTERLOCKING RINGS BEHIND THE THEM IN THEMBID. THE SECOND RING IS SLIGHTLY LOWER AND TO THE RIGHT OF THE FIRST RING. THE RINGS ARE PRIMARILY GOLD WITH RED HIGHLIGHTS. THE ENTIRE MARK HAS AN EXTREMELY FADED MIRROR IMAGE OF ITSELF IN THE FRONT LEANING TOWARD THE RIGHT.

FOR ONLINE AUCTION SERVICES (U.S. CLS. 100, 101 AND 102).

MEGAN WHITNEY, EXAMINING ATTORNEY

SN 77-134,280. BEST COMMUNITY VALUES, INC., ALTA-
MONTE SPRINGS, FL. FILED 3-19-2007.



NO CLAIM IS MADE TO THE EXCLUSIVE RIGHT TO USE "BEST", APART FROM THE MARK AS SHOWN.

THE COLOR(S) RED, BLACK, WHITE, GRAY AND ORANGE IS/ARE CLAIMED AS A FEATURE OF THE MARK.

THE MARK CONSISTS OF THE COLOR RED APPEARING IN THE WORDING "COMMUNITY"; THE COLOR BLACK APPEARS IN THE BOTTOM OF THE MISCELLANEOUS DESIGN BEHIND THE WORDING "VALUES" THE COLOR WHITE APPEARS IN THE UPPER BORDER OF THE MISCELLANEOUS DESIGN; THE COLOR GRAY APPEARS IN THE WORDING "BEST" & THE INNER BORDER OF THE MISCELLANEOUS DESIGN AND THE COLOR ORANGE APPEARS IN THE BACKGROUND OF THE WORDING "BEST".

FOR DIRECT MAIL ADVERTISING (U.S. CLS. 100, 101 AND 102).

REGINA DRUMMOND, EXAMINING ATTORNEY

CLASS 35—(Continued).

SN 77-134,317. ONLINE INDICATOR CORP., WESTON, FL. FILED 3-19-2007.

GASTROMETRIX.COM

THE MARK CONSISTS OF STANDARD CHARACTERS WITHOUT CLAIM TO ANY PARTICULAR FONT, STYLE, SIZE, OR COLOR.

FOR CONSULTING SERVICES IN THE FIELD OF RESTAURANT MANAGEMENT; INFORMATION AND DATA COMPILING AND ANALYZING RELATING TO RESTAURANT MANAGEMENT (U.S. CLS. 100, 101 AND 102).

WILLIAM BRECKENFELD, EXAMINING ATTORNEY

CLASS 35—(Continued).

SN 77-134,892. PROMISED LAND DEVELOPMENT AUTHORITY, INC, MADISON, GA. FILED 3-19-2007.

Promised Land Plantation

THE MARK CONSISTS OF STANDARD CHARACTERS WITHOUT CLAIM TO ANY PARTICULAR FONT, STYLE, SIZE, OR COLOR.

FOR LOBBYING SERVICES, NAMELY, PROMOTING THE INTERESTS OF INTERNATIONAL, REAL ESTATE AND NONPROFIT COMPANIES IN THE FIELDS OF POLITICS, LEGISLATION, AND REGULATION; MATCHING CONSUMERS WITH REAL ESTATE PROFESSIONALS IN THE FIELD OF REAL ESTATE SERVICES VIA COMPUTER NETWORK; PROMOTING THE GOODS OF OTHERS BY MEANS OF ON-LINE REAL TIME PRESENTATION FOR INSPECTION, VIEWING OR SHOWING OF HOMES, LAND AND OTHER REAL PROPERTY; PROVIDING INTERACTIVE SALES ASSESSMENT SERVICES VIA THE TELEPHONE FOR MEASURING THE SKILLS AND KNOWLEDGE OF FIELD SALES FORCES IN REAL WORLD SELLING SITUATIONS; PROVIDING REAL ESTATE LEADS FOR PROSPECTIVE PURCHASERS; REAL ESTATE ADVERTISING SERVICES; REAL ESTATE AUCTIONS; REAL ESTATE MARKETING SERVICES IN THE FIELD OF REAL PROPERTY IN GENERAL; REAL ESTATE MARKETING SERVICES, NAMELY, ON-LINE SERVICES FEATURING TOURS OF RESIDENTIAL AND COMMERCIAL REAL ESTATE; REAL ESTATE SALES MANAGEMENT (U.S. CLS. 100, 101 AND 102).

FIRST USE 1-17-2006; IN COMMERCE 2-28-2007.

JAMES MACFARLANE, EXAMINING ATTORNEY

SN 77-134,561. SARIS TECHNOLOGIES, INC., ORLANDO, FL. FILED 3-19-2007.

LIST'D

THE MARK CONSISTS OF STANDARD CHARACTERS WITHOUT CLAIM TO ANY PARTICULAR FONT, STYLE, SIZE, OR COLOR.

FOR AUCTION MANAGEMENT SERVICES PROVIDED TO OTHERS OVER AN ON-LINE WEB SITE ACCESSED THROUGH A GLOBAL COMPUTER NETWORK (U.S. CLS. 100, 101 AND 102).

FIRST USE 7-23-2006; IN COMMERCE 7-23-2006.

DANIEL CAPSHAW, EXAMINING ATTORNEY

SN 77-135,038. S J M & L, INC., AUSTIN, TX. FILED 3-20-2007.

 The logo for 'ibacks' features a stylized lowercase letter 'i' in blue, followed by the lowercase letters 'b', 'a', 'c', 'k', and 's' in red. The letters are bold and sans-serif.

THE COLOR(S) RED AND BLUE IS/ARE CLAIMED AS A FEATURE OF THE MARK.

THE MARK CONSISTS OF THE STYLIZED LETTER I IN BLUE FOLLOWED BY THE STYLIZED LETTERS B A C K S IN RED.

FOR RETAIL AND ONLINE STORES FEATURING FURNITURE, NAMELY CHAIRS, RECLINERS, ROCKERS, PORTABLE SEATS, SLANTED DESK TOPS, OFFICE SEATS, PILLOWS, SOFAS, TABLES, COMMERCIAL WORKSTATIONS, DESKS USED WHILE STANDING, AND BEDS SPECIFICALLY DESIGNED TO TREAT BACK CONDITIONS (U.S. CLS. 100, 101 AND 102).

FIRST USE 10-24-2004; IN COMMERCE 10-24-2004.

ELISSA GARBER KON, EXAMINING ATTORNEY

CLASS 35—(Continued).

SN 77-135,433. LIEBERMAN RESEARCH WORLDWIDE, INC., LOS ANGELES, CA. FILED 3-20-2007.

EVOLUTION

THE MARK CONSISTS OF STANDARD CHARACTERS WITHOUT CLAIM TO ANY PARTICULAR FONT, STYLE, SIZE, OR COLOR.

FOR MANAGEMENT AND BUSINESS CONSULTING SERVICES IN THE FIELD OF MARKET RESEARCH (U.S. CLS. 100, 101 AND 102).

FIRST USE 2-1-1997; IN COMMERCE 2-1-1997.
TONI HICKEY, EXAMINING ATTORNEY

SN 77-135,478. CHEAURE, PATRICIA A., CARY, NC. FILED 3-20-2007.

Web-Salon

THE MARK CONSISTS OF STANDARD CHARACTERS WITHOUT CLAIM TO ANY PARTICULAR FONT, STYLE, SIZE, OR COLOR.

FOR RETAIL STORE SERVICES, AVAILABLE THROUGH COMPUTER COMMUNICATIONS AND INTERACTIVE TELEVISION, FEATURING CLOTHING, BEAUTY AIDES, HAIR PRODUCTS, WIG PRODUCTS, HATS, SCRAVES, BEAUTY LOTIONS, BEAUTY OILS, ART WORK, BED JACKETS, HEAD BANDS, EYELASHES, EYEBROWS, ASCOTS, COSTMETICS, BATH SOAPS, BATH SALTS, BATH SLIPPERS, BATHING SUITES FOR WOMEN AND MEN, BATH GELS, HAIR SAMPOOS, WIG SAMPOOS, BOOKS, PUBLICATIONS, ELECTRONIC PHOTO ALBUMS, ELECTRONIC PHOTO FRAMES, SOCKS, SLIPPERS, PURSES, SMOCKS, T-SHIRTS, NIGHT SHIRTS, DRESSING GOWNS, PAJAMAS, NIGHT GOWNS, HEAD CAPS, NOTE CARDS, JEWELRY, PERFUMES, FRAGRANCES, PANTS, JACKETS, CAPES, TOPS, BLOUSES, FACIAL MAKE-UP, MANICURE PRODUCTS, GIFT CARDS, BODY MAKE-UP, SKIRTS, SHIRTS, CHILDREN CAPS, CHILDREN GLOVES, ADULT GLOVES, CHILDREN SOCKS, SKIN CARE TRETMENT FOR CANCER PATIENTS, SCALP TREATMENTS FOR CANCER PATIENTS, PARTIAL WIGS, WIGS, PHOTOS, ART WORK, CANCER RIBBON PINS, JEWELRY PINS, JEWELRY EARRINGS, BEACH CLOTHING FOR MEN AND WOMEN BATH ROBES, LADIES UNDERWEAR, CHILDREN'S UNDERWEAR, FLOWER PINS, HAIR BANDS, HAIR PIECES, HAIR TIE PINS, GIFT ITEMS, NOVELTY GIFTS, LEISURE WARE, THERAPY STONES AND ROCKS, GREETING CARDS, WIG BRUSHES, CALANDERS, FIGUREINES, PILLOWS, MAGAZINES, STUFFED ANIMALS AND DOLLS, SUNGLASSES, READING GLASSES, RIBBONS, DECALS, LICENSE PLATES, DISHES, BREAST ENHANCERS, MEN'S HATS, MEN'S SKIN LOTIONS, MEN'S PAJAMA'S, MEN'S SWEATERS, CAPS, DRAWLINERS, BAGS, BLANKETS, SHAWLS, ARTIFICIAL FLOWERS, VISORS, WIG STANDS (U.S. CLS. 100, 101 AND 102).

JILL PRATER, EXAMINING ATTORNEY

CLASS 35—(Continued).

SN 77-135,606. JANINE'S 3-D STICKY BOWS, INC., SAN ANTONIO, TX. FILED 3-20-2007.

JANINE'S 3-D STICKY BOWS

THE MARK CONSISTS OF STANDARD CHARACTERS WITHOUT CLAIM TO ANY PARTICULAR FONT, STYLE, SIZE, OR COLOR.

NO CLAIM IS MADE TO THE EXCLUSIVE RIGHT TO USE "3-D STICKY BOWS", APART FROM THE MARK AS SHOWN.

FOR ON-LINE RETAIL STORE SERVICES FEATURING LENTICULAR PRINTS AND LENTICULAR CARDS; MAIL ORDER SERVICES FEATURING LENTICULAR PRINTS AND LENTICULAR CARDS; TELEPHONE ORDER SERVICES FEATURING LENTICULAR PRINTS AND LENTICULAR CARDS (U.S. CLS. 100, 101 AND 102).

HOWARD B. LEVINE, EXAMINING ATTORNEY

SN 77-136,061. EXCELLIGENCE LEARNING CORPORATION, MONTEREY, CA. FILED 3-20-2007.



THE COLOR(S) GREEN, BLUE, YELLOW, WHITE IS/ARE CLAIMED AS A FEATURE OF THE MARK.

THE MARK CONSISTS OF A GREEN CHILD, WHICH IS OUTLINED IN WHITE; THE CHILD IS REACHING FOR A YELLOW SUN, WHICH IS OUTLINED IN BLUE; THE SUN IS RISING OVER A BLUE GLOBE, WHICH IS OUTLINED IN WHITE AS WELL AS THE MERIDIANS AND PARALLELS.

FOR CATALOG ORDERING SERVICE FEATURING EDUCATIONAL AND ART SUPPLIES AND CURRICULUM MATERIALS (U.S. CLS. 100, 101 AND 102).

FIRST USE 1-2-2007; IN COMMERCE 1-2-2007.
NAKIA HENRY, EXAMINING ATTORNEY

CLASS 35—(Continued).

SN 77-136,066. TRI-STATE DATING.COM INCORPORATED, HOWARD BEACH, NY. FILED 3-20-2007.

CLASS 35—(Continued).

SN 77-136,347. BRUNSWICK CORPORATION, LAKE FOREST, IL. FILED 3-21-2007.

Promote Yourself

MARINE PERFORMANCE PLUS

THE MARK CONSISTS OF STANDARD CHARACTERS WITHOUT CLAIM TO ANY PARTICULAR FONT, STYLE, SIZE, OR COLOR.

FOR PROVIDING AN ONLINE SEARCHABLE DATABASE FEATURING YELLOW PAGES BUSINESS PROFILE LISTINGS AND WHITE PAGES INDIVIDUAL PROFILE LISTINGS (U.S. CLS. 100, 101 AND 102).

MARGERY A. TIERNEY, EXAMINING ATTORNEY

THE MARK CONSISTS OF STANDARD CHARACTERS WITHOUT CLAIM TO ANY PARTICULAR FONT, STYLE, SIZE, OR COLOR.

NO CLAIM IS MADE TO THE EXCLUSIVE RIGHT TO USE "MARINE PERFORMANCE", APART FROM THE MARK AS SHOWN.

FOR CONDUCTING A MARINE DEALER AND MARINE RETAILER INCENTIVE AWARD PROGRAM TO PROMOTE SALES PRODUCTIVITY IN THE FIELD OF MARINE ENGINES, MARINE ENGINE PARTS AND MARINE ENGINE ACCESSORIES (U.S. CLS. 100, 101 AND 102).

SONYA STEPHENS, EXAMINING ATTORNEY

SN 77-136,118. COCCO, WILFREDO, WESTON, FL. FILED 3-21-2007.

NetScale

THE FEELGOOD T-SHIRT COMPANY

THE MARK CONSISTS OF STANDARD CHARACTERS WITHOUT CLAIM TO ANY PARTICULAR FONT, STYLE, SIZE, OR COLOR.

FOR BUSINESS CONSULTING AND INFORMATION SERVICES; BUSINESS DEVELOPMENT SERVICES, NAMELY, PROVIDING START-UP SUPPORT FOR BUSINESSES OF OTHERS; BUSINESS INFORMATION SERVICES AND APPRAISALS; BUSINESS MANAGEMENT SERVICES, NAMELY, MANAGING LOGISTICS, REVERSE LOGISTICS, SUPPLY CHAIN SERVICES, SUPPLY CHAIN VISIBILITY AND SYNCHRONIZATION, SUPPLY AND DEMAND FORECASTING AND PRODUCT DISTRIBUTION PROCESSES FOR OTHERS; BUSINESS MARKETING AND DIRECT MAIL CONSULTING SERVICES; BUSINESS MARKETING SERVICES; BUSINESS PROCESS RE-ENGINEERING SERVICES; BUSINESS SERVICES, NAMELY, FACILITIES MANAGEMENT OF TECHNICAL OPERATIONS; COMPUTERIZED ACCOUNTING SERVICES; CONSULTING SERVICES IN THE AREA OF SUSTAINABLE BUSINESS SOLUTIONS; CREATION OF MARKETING TOOLS DESIGNED TO INCREASE A CLIENT COMPANY'S KNOWLEDGE OF CUSTOMER NEEDS, AND ITS COMPETITORS' PRODUCTS AND SERVICES, PRICING, ADVERTISING STRATEGY AND SALES STRATEGY; DATA PROCESSING SERVICES; ELECTRONIC COMMERCE SERVICES, NAMELY PROVIDING INFORMATION ABOUT PRODUCTS VIA TELECOMMUNICATION NETWORKS FOR ADVERTISING AND SALES PURPOSES; DEVELOPMENT OF MARKETING STRATEGIES AND CONCEPTS; BUSINESS OPERATION, BUSINESS ADMINISTRATION AND OFFICE FUNCTIONS; MANAGEMENT AND OPERATION ASSISTANCE TO COMMERCIAL BUSINESSES (U.S. CLS. 100, 101 AND 102).

CAROLINE WOOD, EXAMINING ATTORNEY

SN 77-136,435. OLD BLUE LLC, LAKE GENEVA, WI. FILED 3-21-2007.

THE MARK CONSISTS OF STANDARD CHARACTERS WITHOUT CLAIM TO ANY PARTICULAR FONT, STYLE, SIZE, OR COLOR.

NO CLAIM IS MADE TO THE EXCLUSIVE RIGHT TO USE "T-SHIRT COMPANY", APART FROM THE MARK AS SHOWN.

FOR ON-LINE RETAIL STORE SERVICES FEATURING DECORATIVE HOME FURNISHINGS, CLOTHING AND RELATED ACCESSORIES, BED, BATH, AND KITCHEN PRODUCTS, FURNITURE, AND HARDWARE; RETAIL STORE SERVICES FEATURING DECORATIVE HOME FURNISHINGS, CLOTHING AND RELATED ACCESSORIES, BED, BATH, AND KITCHEN PRODUCTS, FURNITURE, AND HARDWARE (U.S. CLS. 100, 101 AND 102).

DAVID TAYLOR, EXAMINING ATTORNEY

CLASS 35—(Continued).

SN 77-136,453. URBAN FOREST HOME, OAKLAND, CA.
FILED 3-21-2007.



NO CLAIM IS MADE TO THE EXCLUSIVE RIGHT TO USE "HOME", APART FROM THE MARK AS SHOWN.

THE MARK CONSISTS OF THE WORDS URBAN FOREST HOME SURROUNDED BY A GRAPHIC DESIGN THAT BLENDS A CITYSCAPE SKYLINE AND BLADES OF GRASS.

FOR RETAIL STORES FEATURING LIVING, REPLICATED AND PRESERVED FLOWERS, PLANTS AND TREES; RETAIL STORES FEATURING VASES AND PLANT CONTAINERS; RETAIL STORES FEATURING HOME ACCESSORIES AND FURNISHINGS MADE WITH RECYCLED AND REUSED ITEMS; RETAIL STORES FEATURING DECORATIVE AND BOTANICAL HOME ITEMS MADE OF NATURAL OBJECTS (U.S. CLS. 100, 101 AND 102).

FIRST USE 7-1-2006; IN COMMERCE 11-22-2006.
MICHAEL LITZAU, EXAMINING ATTORNEY

SN 77-136,729. LNR ENTERPRISES, INC., NEW YORK, NY.
FILED 3-21-2007.

ESERVEWEB

THE MARK CONSISTS OF STANDARD CHARACTERS WITHOUT CLAIM TO ANY PARTICULAR FONT, STYLE, SIZE, OR COLOR.

FOR BUSINESS PROCESS OUTSOURCING SERVICES FOR OTHERS, NAMELY, PERFORMING FOOD AND GIFT EXPENSE REPORTING, FOOD AND GIFT ORDERING, BILLING AND EXPENSE REIMBURSEMENT SERVICES VIA AN INTERNET PORTAL; ONLINE FOOD AND GIFT ORDERING AND FULFILLMENT SERVICES; BUSINESS ADVISORY SERVICES, CONSULTANCY AND INFORMATION (U.S. CLS. 100, 101 AND 102).

JENNIFER VASQUEZ, EXAMINING ATTORNEY

CLASS 35—(Continued).

SN 77-136,813. DEPARTMENT OF DEFENSE, ARLINGTON, VA. FILED 3-21-2007.



THE MARK CONSISTS OF THE LETTERS "ESGR" WHERE THE LETTER E IS FORMED FROM A STYLIZED VARIATION OF THE U.S. FLAG DESIGN.

FOR PROVIDING EMPLOYMENT INFORMATION TO EMPLOYERS REGARDING THE RIGHTS, RESPONSIBILITIES, AND BENEFITS OF EMPLOYING A MEMBER OF THE U S MILITARY RESERVES OR NATIONAL GUARDS (U.S. CLS. 100, 101 AND 102).

FIRST USE 11-1-2001; IN COMMERCE 4-0-2003.
ALICIA COLLINS, EXAMINING ATTORNEY

SN 77-137,338. BOBBIN, INC., FRAMINGHAM, MA. FILED 3-22-2007.

EMBROIDER THIS!

THE MARK CONSISTS OF STANDARD CHARACTERS WITHOUT CLAIM TO ANY PARTICULAR FONT, STYLE, SIZE, OR COLOR.

NO CLAIM IS MADE TO THE EXCLUSIVE RIGHT TO USE "EMBROIDER", APART FROM THE MARK AS SHOWN.

FOR ONLINE STORE SERVICES FEATURING EMBROIDERY SUPPLIES, EMBROIDERY DESIGNS, EMBROIDERY NOTIONS, EMBROIDERED CLOTHING AND GIFTS, THREADS, SCISSORS, HANDKERCHIEFS, TOWELS, LINENS, BIBS, UNDERWEAR, PILLOWS, PILLOW COVERS, COASTERS, HATS, APRONS, BONNETS, NAPKINS, PLACEMATS, COASTERS, BOOK COVERS, TOTE BAGS, LINGERIE BAGS, LAUNDRY BAGS, BOOKS, NEEDLES, INFANTWEAR, BEVERAGE HOLDERS, GIFT BOXES (U.S. CLS. 100, 101 AND 102).

FIRST USE 2-16-2000; IN COMMERCE 2-16-2000.
DAVID TOOLEY, EXAMINING ATTORNEY

SN 77-137,384. ARIZONA MAIL ORDER COMPANY, INC., TUCSON, AZ. FILED 3-22-2007.

SHOETRADER

THE MARK CONSISTS OF STANDARD CHARACTERS WITHOUT CLAIM TO ANY PARTICULAR FONT, STYLE, SIZE, OR COLOR.

FOR ONLINE RETAIL STORE SERVICES FEATURING FOOTWEAR, FOOTWEAR RELATED PRODUCTS AND ACCESSORIES (U.S. CLS. 100, 101 AND 102).

SHANNON TWOHIG, EXAMINING ATTORNEY

CLASS 35—(Continued).

SN 77-137,412. WAKEFERN FOOD CORP., ELIZABETH, NJ.
FILED 3-22-2007.

SHOP RITE

THE MARK CONSISTS OF STANDARD CHARACTERS WITHOUT CLAIM TO ANY PARTICULAR FONT, STYLE, SIZE, OR COLOR.

OWNER OF U.S. REG. NOS. 2,465,289, 2,467,334 AND 2,938,720.

FOR RETAIL GASOLINE SUPPLY SERVICES (U.S. CLS. 100, 101 AND 102).

FIRST USE 1-19-2007; IN COMMERCE 1-19-2007.

ODESSA BIBBINS, EXAMINING ATTORNEY

CLASS 35—(Continued).

SN 77-138,423. ARABICA FUNDING, INC., MELVILLE, NY.
FILED 3-23-2007.

CARIBREW CLUB

THE MARK CONSISTS OF STANDARD CHARACTERS WITHOUT CLAIM TO ANY PARTICULAR FONT, STYLE, SIZE, OR COLOR.

NO CLAIM IS MADE TO THE EXCLUSIVE RIGHT TO USE "CLUB", APART FROM THE MARK AS SHOWN.

FOR RETAIL STORE SERVICES IN THE FIELD OF COFFEE, TEA, COFFEE AND TEA BREWING ACCESSORIES, FOOD, CANDY, AND BEVERAGWARE FEATURING A BONUS INCENTIVE PROGRAM FOR CUSTOMERS (U.S. CLS. 100, 101 AND 102).

DOMINICK J. SALEMI, EXAMINING ATTORNEY

SN 77-137,994. THE SWEET SHOP, LTD., AUCKLAND, NEW ZEALAND, FILED 3-22-2007.

THE RUMPUS ROOM

THE MARK CONSISTS OF STANDARD CHARACTERS WITHOUT CLAIM TO ANY PARTICULAR FONT, STYLE, SIZE, OR COLOR.

FOR ADVERTISING AND ADVERTISEMENT SERVICES (U.S. CLS. 100, 101 AND 102).

JAY FLOWERS, EXAMINING ATTORNEY

SN 77-138,435. SKOLLAR, GREG, ATLANTA, GA. FILED 3-23-2007.

BOZANG.COM

THE MARK CONSISTS OF STANDARD CHARACTERS WITHOUT CLAIM TO ANY PARTICULAR FONT, STYLE, SIZE, OR COLOR.

FOR PROVIDING AN ON-LINE SEARCHABLE DATABASE FEATURING CLASSIFIED AD LISTINGS AND EMPLOYMENT OPPORTUNITIES (U.S. CLS. 100, 101 AND 102).

TONJA GASKINS, EXAMINING ATTORNEY

SN 77-138,416. GORRA,JANE, MANLIUS, NY. FILED 3-23-2007.

LuLo

THE MARK CONSISTS OF STANDARD CHARACTERS WITHOUT CLAIM TO ANY PARTICULAR FONT, STYLE, SIZE, OR COLOR.

FOR ON-LINE RETAIL STORE SERVICES FEATURING DOG TOILETRIES, INCLUDING PERFUME, SHAMPOO, PAW CREAM, AND SPRITZERS (U.S. CLS. 100, 101 AND 102).

CURTIS FRENCH, EXAMINING ATTORNEY

SN 77-138,450. PERCEPTION, INC., GAITHERSBURG, MD.
FILED 3-23-2007.

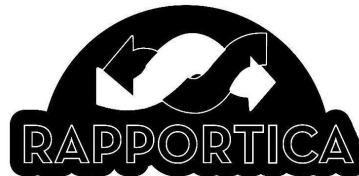

FOR ONLINE BUSINESS NETWORKING SERVICES (U.S. CLS. 100, 101 AND 102).

FIRST USE 3-1-2007; IN COMMERCE 3-1-2007.

MARK SPACINO, EXAMINING ATTORNEY

CLASS 35—(Continued).

SN 77-138,479. EXI INTERNATIONAL CORP., DBA FAMOUS DISCOVERIES, ST. PETERSBURG, FL. FILED 3-23-2007.

FAMOUS DISCOVERIES

THE MARK CONSISTS OF STANDARD CHARACTERS WITHOUT CLAIM TO ANY PARTICULAR FONT, STYLE, SIZE, OR COLOR.

FOR ON-LINE RETAIL STORE SERVICES FEATURING A WIDE VARIETY OF CONSUMER PRODUCTS; RETAIL STORES FEATURING A WIDE VARIETY OF CONSUMER PRODUCTS (U.S. CLS. 100, 101 AND 102).

FIRST USE 12-0-2004; IN COMMERCE 12-0-2004.
FRANK LATTUCA, EXAMINING ATTORNEY

SN 77-138,569. BRIGGS, ELLEN DOBBS, BOCA RATON, FL. FILED 3-23-2007.

Million Moms

THE MARK CONSISTS OF STANDARD CHARACTERS WITHOUT CLAIM TO ANY PARTICULAR FONT, STYLE, SIZE, OR COLOR.

FOR COST MANAGEMENT FOR THE HEALTH BENEFIT PLANS OF OTHERS; COST MANAGEMENT FOR THE HEALTH CARE BENEFIT PLANS OF OTHERS; HEALTH CARE COST CONTAINMENT; HEALTH CARE COST REVIEW; HEALTH CARE UTILIZATION AND REVIEW SERVICES; MANAGED CARE SERVICES, NAMELY, ELECTRONIC PROCESSING OF HEALTH CARE INFORMATION; MANAGEMENT OF HEALTH CARE CLINICS FOR OTHERS; REQUESTING HEALTH CARE PROVIDER PRIVILEGES FROM HEALTH CARE INSTITUTIONS ON BEHALF OF PHYSICIANS AND HEALTH CARE PROVIDERS; SUPPLYING PRESCRIPTION DRUGS TO HEALTH PLAN PARTICIPANTS FOR THE FUNDING ORGANIZATIONS (U.S. CLS. 100, 101 AND 102).

CHARLOTTE CORWIN, EXAMINING ATTORNEY

SN 77-138,615. WAHINE'S, INC., SAN DIEGO, CA. FILED 3-23-2007.

Sending Aloha Around the World

THE MARK CONSISTS OF STANDARD CHARACTERS WITHOUT CLAIM TO ANY PARTICULAR FONT, STYLE, SIZE, OR COLOR.

FOR ON-LINE RETAIL STORE SERVICES FEATURING A WIDE VARIETY OF CONSUMERS GOODS OF OTHERS FROM THE HAWAIIAN ISLANDS AND OTHER TROPICAL ISLANDS (U.S. CLS. 100, 101 AND 102).

FIRST USE 3-16-2007; IN COMMERCE 3-17-2007.
ANDREA K. NADELMAN, EXAMINING ATTORNEY

CLASS 35—(Continued).

SN 77-138,671. PAYNE, KRISTINA, EUGENE, OR. AND PAYNE, TODD, EUGENE, OR. FILED 3-23-2007.

THE SPORTSCHICK

THE MARK CONSISTS OF STANDARD CHARACTERS WITHOUT CLAIM TO ANY PARTICULAR FONT, STYLE, SIZE, OR COLOR.

FOR RETAIL STORES FEATURING ATHLETIC CLOTHING, FOOTWEAR AND ACCESSORIES FOR WOMEN (U.S. CLS. 100, 101 AND 102).

JACQUELINE A. LAVINE, EXAMINING ATTORNEY

SN 77-138,698. GUERON, MARC, MIAMI, FL. FILED 3-23-2007.

LINKXPRESS

THE MARK CONSISTS OF STANDARD CHARACTERS WITHOUT CLAIM TO ANY PARTICULAR FONT, STYLE, SIZE, OR COLOR.

FOR PROVIDING AN ON-LINE DIRECTORY INFORMATION SERVICES ALSO FEATURING HYPERLINKS TO OTHER WEB SITES; MARKETING SERVICES, NAMELY PROVIDING INFORMATIONAL WEB PAGES DESIGNED TO GENERATE SALES TRAFFIC VIA HYPERLINKS TO OTHER WEB SITES; ONLINE INFORMATION SEARCH AND REFERRAL SYSTEM WHICH PROVIDES READERS OF PRINT MAGAZINES AND PRINT NEWSLETTERS EASY ONLINE HYPERLINKS TO OTHER WEB SITES, TO ADVERTISERS AND VENDORS, AND TO BUYERS AND SELLERS, OR BETWEEN ANY OTHER PARTIES (U.S. CLS. 100, 101 AND 102).

FIRST USE 1-15-2007; IN COMMERCE 1-15-2007.
NAAKWAMA ANKRAH, EXAMINING ATTORNEY

CLASS 35—(Continued).

SN 77-138,705. LUCKY DISTRIBUTING, INC., DBA HEARTH PRODUCTS GROUP, PORTLAND, OR. FILED 3-23-2007.



FOR DISTRIBUTORSHIPS FEATURING HEATING STOVES, PELLET STOVES, WOOD STOVES, BIOMASS STOVES AND GAS STOVES, AND ACCESSORIES THEREFOR (U.S. CLS. 100, 101 AND 102).
MELVIN AXILBUND, EXAMINING ATTORNEY

SN 77-138,763. COCO DE MER, LTD., SANTA BARBARA, CA. FILED 3-23-2007.

EROTIC LUXURY

THE MARK CONSISTS OF STANDARD CHARACTERS WITHOUT CLAIM TO ANY PARTICULAR FONT, STYLE, SIZE, OR COLOR.

NO CLAIM IS MADE TO THE EXCLUSIVE RIGHT TO USE EROTIC, APART FROM THE MARK AS SHOWN.

FOR RETAIL STORE SERVICES AND ON-LINE RETAIL STORE SERVICES IN THE FIELD OF EROTIC PRODUCTS, ADULT SEXUAL AIDS, AND PERSONAL LUBRICANTS (U.S. CLS. 100, 101 AND 102).

FIRST USE 3-20-2005; IN COMMERCE 8-31-2006.
BRIAN PINO, EXAMINING ATTORNEY

CLASS 35—(Continued).

SN 77-138,775. ZERIVITZ, MICHAEL, DELTONA, FL. FILED 3-23-2007.



THE COLOR(S) MAROON, GOLD AND WHITE IS/ARE CLAIMED AS A FEATURE OF THE MARK.

THE WORDS "HAND-OFF.NET" APPEAR IN MAROON LETTERS ABOVE A DESIGN OF TWO HANDS WHICH ARE OUTLINED IN GOLD AND HAVE A WHITE PIECE OF PAPER OUTLINED IN MAROON IN BETWEEN THEM. ON THE RIGHT SIDE OF THE MARK, THE WORDS "NEVER LOSE ANOTHER REFERRAL!" ARE IN MAROON LETTERS AND THE WORD "NEVER" IS UNDERLINED WITH A THICK GOLD LINE. A FLOWING GOLD LINE RUNS ALONG THE BOTTOM OF THE ENTIRE MARK, GETTING THICKER TOWARDS THE RIGHT SIDE OF THE MARK.

FOR ONLINE REFERRAL SERVICES, NAMELY, PROVIDING PATIENT REFERRALS FROM GENERAL DENTISTS TO SPECIALIZED DENTISTS (U.S. CLS. 100, 101 AND 102).

PATRICIA EVANKO, EXAMINING ATTORNEY

SN 77-138,798. PALAMAR, GEORGE, GREENSBORO, NC. FILED 3-23-2007.

FIND FRESH HERE

THE MARK CONSISTS OF STANDARD CHARACTERS WITHOUT CLAIM TO ANY PARTICULAR FONT, STYLE, SIZE, OR COLOR.

FOR RETAIL GROCERY STORES (U.S. CLS. 100, 101 AND 102).

KATHRYN COWARD, EXAMINING ATTORNEY

SN 77-138,881. PUMP 'EM UP, ODESSA, FL. FILED 3-23-2007.

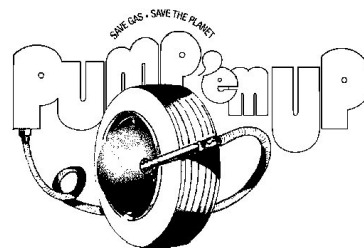

NO CLAIM IS MADE TO THE EXCLUSIVE RIGHT TO USE "SAVE GAS - SAVE THE PLANET", APART FROM THE MARK AS SHOWN.

THE MARK CONSISTS OF SAVE GAS SAVE THE PLANET, PUMP 'EM UP.

FOR PROMOTING PUBLIC AWARENESS OF THE NEED FOR SAVING GAS TO SAVE THE PLANET (U.S. CLS. 100, 101 AND 102).

FIRST USE 4-22-2001; IN COMMERCE 4-22-2001.
IRA J. GOODSaid, EXAMINING ATTORNEY

CLASS 35—(Continued).

SN 77-138,899. J. T. STRICKLAND ASSOCIATES, L.L.C., ST. PETERSBURG, FL. FILED 3-23-2007.

SIGNATURE SOURCE

THE MARK CONSISTS OF STANDARD CHARACTERS WITHOUT CLAIM TO ANY PARTICULAR FONT, STYLE, SIZE, OR COLOR.

FOR BUSINESS RELOCATION CONSULTING; BUSINESS RELOCATION; MOVING AND RELOCATION SERVICES, NAMELY PLANNING AND IMPLEMENTING MOVES OF HOMES AND OFFICES; PERSONNEL RELOCATION (U.S. CLS. 100, 101 AND 102).

KATHRYN COWARD, EXAMINING ATTORNEY

SN 77-138,994. MASCOTTE HOLDINGS, INC., NEW YORK, NY. FILED 3-23-2007.

THE PAST TELLS EVERYTHING

THE MARK CONSISTS OF STANDARD CHARACTERS WITHOUT CLAIM TO ANY PARTICULAR FONT, STYLE, SIZE, OR COLOR.

FOR RETAIL STORES, WHOLESALE STORES, MAIL ORDER SERVICES, ON-LINE ORDERING SERVICES AND ON-LINE RETAIL STORE SERVICES, ELECTRONIC RETAILING SERVICES VIA COMPUTERS, AND RETAIL STORE SERVICES AVAILABLE THROUGH COMPUTER COMMUNICATIONS AND INTERACTIVE TELEVISION, ALL OF THE AFORESAID FEATURING COSMETICS, FRAGRANCES, HAIR, NAIL, BATH AND BODY PRODUCTS, RECORDED PRODUCT, MUSIC RELATED ITEMS, PROMOTIONAL ITEMS SUCH AS MOUSE PADS, MAGNETS, PAPER WEIGHTS, TRANSPORT AND STORAGE CASES, MUGS, GLASSES AND COASTERS, COMPUTER GOODS, SOFTWARE, GAMES, TOYS AND PLAYTHINGS, PLUSH TOYS, TEDDY BEARS AND ACCESSORIES THEREFOR, DOLLS AND ACCESSORIES THEREFOR, SPORTING GOODS AND EQUIPMENT, BAGS AND ACCESSORIES THEREFOR, CLOTHING AND ACCESSORIES THEREFOR, FOOTWEAR, HEADWEAR, EYEWEAR AND ACCESSORIES THEREFOR, JEWELRY AND WATCHES AND ACCESSORIES THEREFOR, ITEMS OF PRECIOUS METAL, CLOCKS, PRINTED PROMOTIONAL MATTER SUCH AS POSTERS, CALENDARS, STICKERS, STATIONERY AND RELATED MATTER, BOOKS AND PUBLICATIONS, NOVELTY ITEMS AND ORNAMENTS, HAIR ACCESSORIES, PICTURE FRAMES, HOUSEHOLD ITEMS, FURNITURE AND HOME FURNISHINGS, BEDDING AND LINENS; PUBLIC RELATIONS; PUBLICITY AGENTS; MANAGEMENT OF PERFORMING ARTISTS AND PROFESSIONAL ATHLETES; TALENT AGENCIES; ADVERTISING, PROMOTIONAL, MARKETING, MERCHANDISING AND BRANDING SERVICES; PRODUCT MERCHANDISING; PROMOTING THE GOODS AND SERVICES OF OTHERS THROUGH ISSUANCE OF PRODUCT AND/OR SERVICE ENDORSEMENTS, AND THROUGH APPEARANCES FOR PRODUCT AND/OR SERVICE ADVERTISING; PROVIDING A WEB SITE WHICH FEATURES ADVERTISEMENTS FOR THE GOODS AND SERVICES OF OTHERS ON A GLOBAL COMPUTER NETWORK; PROVIDING SPACE AT A WEB SITE FOR THE ADVERTISEMENT OF THE GOODS AND SERVICES OF OTHERS; PROVIDING A WEB SITE AT WHICH USERS CAN OFFER GOODS FOR SALE AND BUY GOODS OFFERED BY OTHERS; PROMOTING THE GOODS AND SERVICES OF OTHERS BY PROVIDING

CLASS 35—(Continued).

HYPertext LINKS TO THE WEB SITES OF OTHERS; PROMOTING THE GOODS AND SERVICES OF OTHERS BY PROVIDING A WEB SITE AT WHICH USERS CAN LINK TO MUSIC, ENTERTAINMENT, TELEVISION, FILM, FASHION, BEAUTY, LIFESTYLES, HOME FURNISHINGS, GAMES, AND THE ARTS; PROVIDING ON-LINE DIRECTORY INFORMATION SERVICES ALSO FEATURING HYPERLINKS TO OTHER WEB SITES; PROVIDING INFORMATION ABOUT THE GOODS AND SERVICES OF OTHERS VIA THE GLOBAL COMPUTER NETWORK; PROMOTING THE GOODS AND SERVICES OF OTHERS BY MEANS OF OPERATING AN ON-LINE SHOPPING MALL WITH LINKS TO THE RETAIL WEB SITES OF OTHERS; PROMOTING THE GOODS AND SERVICES OF OTHERS THROUGH ON-LINE ORDERING AND CATALOGING OF THOSE GOODS AND SERVICES; PROVIDING AN ON-LINE SHOWROOM FOR THE GOODS OF OTHERS IN THE FIELDS OF MUSIC, ENTERTAINMENT, TELEVISION, FILM, FASHION, BEAUTY, LIFESTYLES, HOME FURNISHINGS, GAMES, AND THE ARTS; PROMOTING THE GOODS AND SERVICES OF OTHERS BY PREPARING AND PLACING ADVERTISEMENTS IN AN ELECTRONIC MAGAZINE ACCESSED THROUGH A GLOBAL COMPUTER NETWORK; PROMOTING AND CONDUCTING TRADE SHOWS IN THE FIELDS OF MUSIC, ENTERTAINMENT, TELEVISION, FILM, FASHION, BEAUTY, LIFESTYLES, HOME FURNISHINGS, GAMES, AND THE ARTS; CONDUCTING AN ON-LINE TRADE SHOW EXHIBITION, IN THE FIELDS OF MUSIC, ENTERTAINMENT, TELEVISION, FILM, FASHION, BEAUTY, LIFESTYLES, HOME FURNISHINGS, GAMES, AND THE ARTS; PROMOTING THE CONCERTS OF OTHERS; PROMOTING THE GOODS AND SERVICES OF OTHERS BY ARRANGING FOR SPONSORS TO AFFILIATE THEIR GOODS AND SERVICES WITH MUSIC, CULTURAL AND ENTERTAINMENT EVENTS (U.S. CLS. 100, 101 AND 102).

CHRISTOPHER OTT, EXAMINING ATTORNEY

SN 77-139,069. YARNTOPIA, LLC, KATY, TX. FILED 3-23-2007.

YARNTOPIA

THE MARK CONSISTS OF STANDARD CHARACTERS WITHOUT CLAIM TO ANY PARTICULAR FONT, STYLE, SIZE, OR COLOR.

FOR RETAIL AND ONLINE RETAIL STORE SERVICES FEATURING YARN (U.S. CLS. 100, 101 AND 102). FIRST USE 9-15-2005; IN COMMERCE 1-9-2006. JOHN GARTNER, EXAMINING ATTORNEY

CLASS 35—(Continued).

SN 77-139,163. ROBERT A LOVINGOOD, INC., VICTORVILLE, CA. FILED 3-23-2007.



THE MARK CONSISTS OF THE STYLIZED LETTERS DJ, THE D HAS A DOT IN IT REPRESENTING THE EYE THE J FORMS THE NOSE, WITH A MOUTH BELOW AND 3 STRANDS OF HAIR ABOVE.

FOR PROVIDING AN ON-LINE COMPUTER DATABASE IN THE FIELD OF EMPLOYMENT FEATURING JOB PLACEMENT AND EMPLOYEE RECRUITMENT INFORMATION (U.S. CLS. 100, 101 AND 102).
CORY BOONE, EXAMINING ATTORNEY

SN 77-139,225. JACKTHAT LLC, HENDERSON, NV. FILED 3-23-2007.

JACKTHAT

THE MARK CONSISTS OF STANDARD CHARACTERS WITHOUT CLAIM TO ANY PARTICULAR FONT, STYLE, SIZE, OR COLOR.

FOR ON-LINE RETAIL STORE SERVICES FEATURING ASSORTED MERCHANDISE, NAMELY, SUNGLASSES, APPAREL ACCESSORIES, JEWELRY AND ELECTRONICS (U.S. CLS. 100, 101 AND 102).
BRIAN PINO, EXAMINING ATTORNEY

CLASS 35—(Continued).

SN 77-139,229. AMERICAN INDUSTRIAL HYGIENE ASSOCIATION, FAIRFAX, VA. FILED 3-23-2007.

AIHA

THE MARK CONSISTS OF STANDARD CHARACTERS WITHOUT CLAIM TO ANY PARTICULAR FONT, STYLE, SIZE, OR COLOR.

OWNER OF U.S. REG. NOS. 1,722,588 AND 1,722,863.
FOR ASSOCIATION SERVICES, NAMELY PROMOTING THE INTERESTS OF OCCUPATIONAL AND ENVIRONMENTAL HEALTH PROFESSIONALS AND THE PRACTICE OF INDUSTRIAL HYGIENE (U.S. CLS. 100, 101 AND 102).

FIRST USE 7-0-1944; IN COMMERCE 7-0-1944.
MICHAEL LITZAU, EXAMINING ATTORNEY

SN 77-139,251. AMERICAN INDUSTRIAL HYGIENE ASSOCIATION, FAIRFAX, VA. FILED 3-23-2007.



OWNER OF U.S. REG. NOS. 1,722,588 AND 1,722,863.
THE MARK CONSISTS OF THE LETTERS AIHA AND TO THE LEFT OF WHICH IS A STYLIZED DESIGN OF A HAND AND A SMALL CIRCLE.

FOR ASSOCIATION SERVICES, NAMELY PROMOTING THE INTERESTS OF OCCUPATIONAL AND ENVIRONMENTAL HEALTH PROFESSIONALS AND THE PRACTICE OF INDUSTRIAL HYGIENE (U.S. CLS. 100, 101 AND 102).
MICHAEL LITZAU, EXAMINING ATTORNEY

SN 77-139,272. T.S. OUTFITTERS INCORPORATED, ATLANTA, GA. FILED 3-23-2007.



NO CLAIM IS MADE TO THE EXCLUSIVE RIGHT TO USE "OUTFITTERS", APART FROM THE MARK AS SHOWN.

THE COLOR(S) GREEN AND WHITE IS/ARE CLAIMED AS A FEATURE OF THE MARK.

THE MARK CONSISTS OF THE WHITE LETTERS "T"

CLASS 35—(Continued).

AND "S", OUTLINED IN GREEN, ENCIRCLED BY A GREEN RING, WITH THE LETTER T BEING SITUATED TO THE UPPER LEFT OF THE CIRCLE AND THE LETTER S SITUATED TO THE LOWER RIGHT OF THE CIRCLE, AND WITH THE WHITE WORD "OUTFITTERS", SITUATED TO THE RIGHT OF THE ENCIRCLED LETTERS TS AND SET AGAINST A GREEN BAR DESIGN WITH ROUNDED EDGES ON THE RIGHT HAND SIDE WITH THE WHITE HORIZONTAL STRIPE ON THE RIGHT HAND SIDE OF THE BAR.

FOR CATALOG ORDERING SERVICE FEATURING APPAREL, AFGHANS, THROWS, BLANKETS, BACKPACKS, UMBRELLAS, BEVERAGE CONTAINERS, STADIUM CHAIRS, SEAT CUSHIONS, POM-POMS, HELMETS, BRACELETS, DOGS TAGS, RINGS, LANYARDS, TATTOOS, EYE BLACKS, CAR DECALS, EMBROIDERY, PRINTED DESIGNS, AND SCREEN PRINTS; ELECTRONIC CATALOG SERVICES FEATURING APPAREL, AFGHANS, THROWS, BLANKETS, BACKPACKS, UMBRELLAS, BEVERAGE CONTAINERS, STADIUM CHAIRS, SEAT CUSHIONS, POM-POMS, HELMETS, BRACELETS, DOGS TAGS, RINGS, LANYARDS, TATTOOS, EYE BLACKS, CAR DECALS, EMBROIDERY, PRINTED DESIGNS, AND SCREEN PRINTS; MAIL ORDER CATALOG SERVICES FEATURING APPAREL, AFGHANS, THROWS, BLANKETS, BACKPACKS, UMBRELLAS, BEVERAGE CONTAINERS, STADIUM CHAIRS, SEAT CUSHIONS, POM-POMS, HELMETS, BRACELETS, DOGS TAGS, RINGS, LANYARDS, TATTOOS, EYE BLACKS, CAR DECALS, EMBROIDERY, PRINTED DESIGNS, AND SCREEN PRINTS; PROMOTING THE GOODS AND SERVICES OF OTHERS THROUGH ON-LINE ORDERING AND CATALOGING OF THOSE GOODS AND SERVICES; COMPUTERIZED ON-LINE RETAIL STORE SERVICES IN THE FIELD OF APPAREL, AFGHANS, THROWS, BLANKETS, BACKPACKS, UMBRELLAS, BEVERAGE CONTAINERS, STADIUM CHAIRS, SEAT CUSHIONS, POM-POMS, HELMETS, BRACELETS, DOGS TAGS, RINGS, LANYARDS, TATTOOS, EYE BLACKS, CAR DECALS, EMBROIDERY, PRINTED DESIGNS, AND SCREEN PRINTS; ON-LINE ORDERING SERVICES FEATURING APPAREL, AFGHANS, THROWS, BLANKETS, BACKPACKS, UMBRELLAS, BEVERAGE CONTAINERS, STADIUM CHAIRS, SEAT CUSHIONS, POM-POMS, HELMETS, BRACELETS, DOGS TAGS, RINGS, LANYARDS, TATTOOS, EYE BLACKS, CAR DECALS, EMBROIDERY, PRINTED DESIGNS, AND SCREEN PRINTS; ON-LINE RETAIL STORE SERVICES FEATURING APPAREL, AFGHANS, THROWS, BLANKETS, BACKPACKS, UMBRELLAS, BEVERAGE CONTAINERS, STADIUM CHAIRS, SEAT CUSHIONS, POM-POMS, HELMETS, BRACELETS, DOGS TAGS, RINGS, LANYARDS, TATTOOS, EYE BLACKS, CAR DECALS, EMBROIDERY, PRINTED DESIGNS, AND SCREEN PRINTS; COMPUTERIZED ON-LINE ORDERING SERVICES IN THE FIELD OF APPAREL, AFGHANS, THROWS, BLANKETS, BACKPACKS, UMBRELLAS, BEVERAGE CONTAINERS, STADIUM CHAIRS, SEAT CUSHIONS, POM-POMS, HELMETS, BRACELETS, DOGS TAGS, RINGS, LANYARDS, TATTOOS, EYE BLACKS, CAR DECALS, EMBROIDERY, PRINTED DESIGNS, AND SCREEN PRINTS (U.S. CLS. 100, 101 AND 102).

FIRST USE 6-1-2000; IN COMMERCE 6-1-2000.
BRIAN PINO, EXAMINING ATTORNEY

CLASS 35—(Continued).

SN 77-139,287. THE ORDER OF THE DAUGHTERS OF THE KING, WOODSTOCK, GA. FILED 3-23-2007.

The Order Of The Daughters Of The King

THE MARK CONSISTS OF STANDARD CHARACTERS WITHOUT CLAIM TO ANY PARTICULAR FONT, STYLE, SIZE, OR COLOR.

NO CLAIM IS MADE TO THE EXCLUSIVE RIGHT TO USE "ORDER", APART FROM THE MARK AS SHOWN.

FOR RELIGIOUS ASSOCIATION SERVICES, NAMELY, PROMOTING THE INTERESTS OF A RELIGIOUS ORDER FOR WOMEN COMMUNICANTS OF THE EPISCOPAL CHURCH, OF CHURCHES IN COMMUNION WITH IT OR OF CHURCHES WITH THE HISTORIC EPISCOPATE BUT NOT IN COMMUNION WITH IT (U.S. CLS. 100, 101 AND 102).

FIRST USE 4-4-1885; IN COMMERCE 4-4-1885.
DANNEAN HETZEL, EXAMINING ATTORNEY

SN 77-139,296. DOSSIA CONSORTIUM, HILLSBORO, OR. FILED 3-23-2007.

DOSSIA

THE MARK CONSISTS OF STANDARD CHARACTERS WITHOUT CLAIM TO ANY PARTICULAR FONT, STYLE, SIZE, OR COLOR.

FOR PROVIDING HEALTH INFORMATION VIA GLOBAL COMPUTER NETWORKS IN THE NATURE OF MAINTAINING, AUTHENTICATING AND INTEGRATING PERSONAL HEALTH RECORDS AND PERSONAL MEDICAL INFORMATION (U.S. CLS. 100, 101 AND 102).
ELLEN B. AWRICH, EXAMINING ATTORNEY

SN 77-139,426. V3 UNLIMITED, VIRGINIA BEACH, VA. FILED 3-23-2007.

V3 Unlimited

THE MARK CONSISTS OF STANDARD CHARACTERS WITHOUT CLAIM TO ANY PARTICULAR FONT, STYLE, SIZE, OR COLOR.

FOR RETAIL STORE SERVICES FEATURING WIRELESS COMMUNICATION PRODUCTS (U.S. CLS. 100, 101 AND 102).

FIRST USE 11-1-2006; IN COMMERCE 11-1-2006.
LINDA POWELL, EXAMINING ATTORNEY

CLASS 35—(Continued).

SN 77-139,522. WOMEN OF THE VINE CELLARS, LLC, TAPPAN, NY. FILED 3-24-2007.

COUNTRY ROADS

THE MARK CONSISTS OF STANDARD CHARACTERS WITHOUT CLAIM TO ANY PARTICULAR FONT, STYLE, SIZE, OR COLOR.

FOR RETAIL STORE SERVICES FEATURING WINES, WINE ACCESSORIES AND BOOKS AND MAGAZINES ON WINES (U.S. CLS. 100, 101 AND 102).

KIMBERLY FRYE, EXAMINING ATTORNEY

SN 77-139,698. PAWSITIVELY PAMPERED INC., OSWEGO, IL. FILED 3-25-2007.

PAWSITIVELY PAMPERED

THE MARK CONSISTS OF STANDARD CHARACTERS WITHOUT CLAIM TO ANY PARTICULAR FONT, STYLE, SIZE, OR COLOR.

FOR ON-LINE RETAIL STORE SERVICES FEATURING FOOD, SUPPLIES AND OTHER PRODUCTS FOR DOGS; RETAIL OUTLETS FEATURING FOOD, SUPPLIES AND OTHER PRODUCTS FOR DOGS; RETAIL PET STORES (U.S. CLS. 100, 101 AND 102).

ALEX KEAM, EXAMINING ATTORNEY

SN 77-139,802. GELSON'S MARKETS, ENCINO, CA. FILED 3-26-2007.



NO CLAIM IS MADE TO THE EXCLUSIVE RIGHT TO USE "ORGANIC", APART FROM THE MARK AS SHOWN.

THE COLOR(S) GREEN, GOLD, ORANGE, TAN, BROWN, AND WHITE IS/ARE CLAIMED AS A FEATURE OF THE MARK.

THE MARK CONSISTS OF A RECTANGLE DESIGN WITH A GREEN BORDER, WHITE INNER OUTLINE, AND TAN BACKGROUND; ON THE LEFT SIDE OF THE RECTANGLE IS THE WORDING "GOOD LIVING" IN

CLASS 35—(Continued).

BROWN; ON THE RIGHT SIDE OF THE RECTANGLE IS A DESIGN CONSISTING OF A CIRCLE CONTAINING TWO BROAD GREEN LEAVES IN THE LOWER PORTION, AN IMAGE OF A GOLD RISING SUN IN THE CENTER, AND THE WORD "ORGANIC" IN THE UPPER PORTION. THE SKY ABOVE THE RISING SUN IS ORANGE AND THE WORD "ORGANIC" IS GREEN; THE COLOR WHITE APPEARS IN THE DRAWING IN THE CIRCLE AS AN OUTLINE BETWEEN THE INNER SUN AND LEAF DESIGN AND AN OUTER GREEN BORDER.

FOR RETAIL GROCERY STORES (U.S. CLS. 100, 101 AND 102).

FIRST USE 6-5-2006; IN COMMERCE 6-5-2006.

JORDAN BAKER, EXAMINING ATTORNEY

SN 77-140,185. AMERICAN PROMOTIONAL EVENTS, INC., FLORENCE, AL. FILED 3-26-2007.

FIRST ON THE FOURTH

THE MARK CONSISTS OF STANDARD CHARACTERS WITHOUT CLAIM TO ANY PARTICULAR FONT, STYLE, SIZE, OR COLOR.

FOR ADVERTISING AND MARKETING (U.S. CLS. 100, 101 AND 102).

ALICE BENMAMAN, EXAMINING ATTORNEY

SN 77-140,299. HALO BRANDED SOLUTIONS, INC., STERLING, IL. FILED 3-26-2007.

BRIGHT IDEAS. BRILLIANT RESULTS.

THE MARK CONSISTS OF STANDARD CHARACTERS WITHOUT CLAIM TO ANY PARTICULAR FONT, STYLE, SIZE, OR COLOR.

FOR SPECIALTY AND PREMIUM ADVERTISING SERVICES, NAMELY, PREPARING ADVERTISING AND PROMOTIONAL PROGRAMS AND EVENTS FOR OTHERS AND ADMINISTRATION OF CORPORATE PROMOTIONAL AND FULFILLMENT PROGRAMS (U.S. CLS. 100, 101 AND 102).

FIRST USE 11-1-2006; IN COMMERCE 11-1-2006.

MARTHA FROMM, EXAMINING ATTORNEY

CLASS 35—(Continued).

SN 77-140,334. HENDERSON JR. , CHARLES E., MARINA, CA. FILED 3-26-2007.

My Bag Tagg

THE MARK CONSISTS OF STANDARD CHARACTERS WITHOUT CLAIM TO ANY PARTICULAR FONT, STYLE, SIZE, OR COLOR.
FOR ADVERTISING AND MARKETING (U.S. CLS. 100, 101 AND 102).
LAURIE MAYES, EXAMINING ATTORNEY

SN 77-140,394. PARKER, DAVID A, PALM SPRINGS, CA. FILED 3-26-2007.

ECODRIVE

THE MARK CONSISTS OF STANDARD CHARACTERS WITHOUT CLAIM TO ANY PARTICULAR FONT, STYLE, SIZE, OR COLOR.
FOR ADVERTISING SERVICES, NAMELY, PROMOTING AND MARKETING THE GOODS AND SERVICES OF OTHERS THROUGH ALL PUBLIC COMMUNICATION MEANS (U.S. CLS. 100, 101 AND 102).
KATHLEEN LORENZO, EXAMINING ATTORNEY

SN 77-140,573. IDEAS THAT DELIVER, INC., NEENAH, WI. FILED 3-26-2007.

INSIGHTS THAT DELIVER

THE MARK CONSISTS OF STANDARD CHARACTERS WITHOUT CLAIM TO ANY PARTICULAR FONT, STYLE, SIZE, OR COLOR.
FOR BUSINESS MARKETING CONSULTING SERVICES; BUSINESS MARKETING SERVICES (U.S. CLS. 100, 101 AND 102).
SHAUNIA CARLYLE, EXAMINING ATTORNEY

CLASS 35—(Continued).

SN 77-140,827. BIEGEL, DAVID, BOZEMAN, MT. FILED 3-26-2007.

EMERGENCYSMART

THE MARK CONSISTS OF STANDARD CHARACTERS WITHOUT CLAIM TO ANY PARTICULAR FONT, STYLE, SIZE, OR COLOR.
FOR ON-LINE RETAIL STORE SERVICES FEATURING EMERGENCY FLASHLIGHTS AND EMERGENCY RADIOS (U.S. CLS. 100, 101 AND 102).
FIRST USE 1-10-2006; IN COMMERCE 1-10-2006.
DANIEL CAPSHAW, EXAMINING ATTORNEY

SN 77-140,836. UNLOCKED RECORDINGS, INC., MANHATTAN BEACH, CA. FILED 3-26-2007.

UNLOCKED RECORDINGS

THE MARK CONSISTS OF STANDARD CHARACTERS WITHOUT CLAIM TO ANY PARTICULAR FONT, STYLE, SIZE, OR COLOR.
NO CLAIM IS MADE TO THE EXCLUSIVE RIGHT TO USE "RECORDINGS", APART FROM THE MARK AS SHOWN.
FOR ADVERTISING SERVICES, NAMELY, PROMOTION OF PRODUCTS AND SERVICES OF THIRD PARTIES THROUGH SPONSORING ARRANGEMENTS AND PROMOTION RELATING TO THE SALE OF ARTICLES AND SERVICES FOR THIRD PARTIES BY THE TRANSMISSION OF ADVERTISING MATERIAL AND THE DISSEMINATION OF ADVERTISING MESSAGES IN CONNECTION WITH MUSIC ON VARIOUS FORMS OF DIGITAL MEDIA (U.S. CLS. 100, 101 AND 102).
FIRST USE 10-31-2005; IN COMMERCE 10-31-2005.
TASNEEM HUSSAIN, EXAMINING ATTORNEY

SN 77-140,901. O' NEILL, ROBERT S., CREAM RIDGE, NJ. FILED 3-26-2007.

DreamStone Consulting

THE MARK CONSISTS OF STANDARD CHARACTERS WITHOUT CLAIM TO ANY PARTICULAR FONT, STYLE, SIZE, OR COLOR.
NO CLAIM IS MADE TO THE EXCLUSIVE RIGHT TO USE "CONSULTING", APART FROM THE MARK AS SHOWN.
FOR BUSINESS CONSULTATION SERVICES (U.S. CLS. 100, 101 AND 102).
PAMELA HIRSCHMAN, EXAMINING ATTORNEY

CLASS 35—(Continued).

SN 77-140,926. RHEINLANDER BAKERY, ARVADA, CO.
FILED 3-27-2007.

MOONGRAIN

THE MARK CONSISTS OF STANDARD CHARACTERS WITHOUT CLAIM TO ANY PARTICULAR FONT, STYLE, SIZE, OR COLOR.

FOR RETAIL BAKERY SHOPS AND RETAIL GROCERY STORES, SPECIALIZING IN SELLING GLUTEN FREE, SUGAR FREE AND ALLERGEN FREE PRODUCTS (U.S. CLS. 100, 101 AND 102).

JASON BLAIR, EXAMINING ATTORNEY

SN 77-140,978. J&W MEDICAL LLC, WESTPORT, CT. FILED
3-27-2007.

iOrtho

THE MARK CONSISTS OF STANDARD CHARACTERS WITHOUT CLAIM TO ANY PARTICULAR FONT, STYLE, SIZE, OR COLOR.

FOR SERVICES CONSISTING OF THE REGISTRATION, COLLECTION, TRANSCRIPTION, COMPILATION AND SYSTEMIZATION OF WRITTEN COMMUNICATIONS AND DATA FOR THE MEDICAL COMMUNITY; CONSULTING SERVICES IN BUSINESS ORGANIZATION AND MANAGEMENT OF MEDICAL OFFICES; TRACKING AND MONITORING CLINICAL TEST COMPLIANCE; ANALYZING, COMPILING, AND RECORD-KEEPING SERVICES OF PATIENT DATA FOR USE IN RISK MANAGEMENT AND REGULATORY COMPLIANCE BY PROFESSIONALS AND INSURERS IN THE MEDICAL FIELD; MEDICAL BILLING SERVICES (U.S. CLS. 100, 101 AND 102).

DORITT L. CARROLL, EXAMINING ATTORNEY

SN 77-140,980. DP PROFESSIONALS, INC., COLUMBIA, SC.
FILED 3-27-2007.

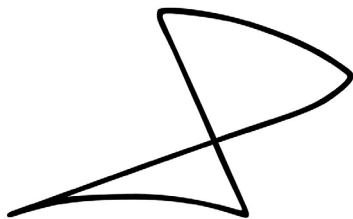

THE MARK CONSISTS OF A STYLIZED FIGURE 8. FOR EMPLOYMENT HIRING, RECRUITING, PLACEMENT, STAFFING AND CAREER NETWORKING SERVICES (U.S. CLS. 100, 101 AND 102).

FIRST USE 9-1-2006; IN COMMERCE 9-1-2006.

ELISSA GARBER KON, EXAMINING ATTORNEY

CLASS 35—(Continued).

SN 77-141,069. MCCLURE, KEVIN, SNOHOMISH, WA.
FILED 3-27-2007.

LIVE IT GOOD

THE MARK CONSISTS OF STANDARD CHARACTERS WITHOUT CLAIM TO ANY PARTICULAR FONT, STYLE, SIZE, OR COLOR.

FOR RETAIL STORE SERVICES FEATURING CLOTHING; ON-LINE RETAIL STORE SERVICES FEATURING CLOTHING (U.S. CLS. 100, 101 AND 102).

GEORGIA CARTY, EXAMINING ATTORNEY

SN 77-141,085. DALY, THOMAS F., MARIETTA, GA. FILED
3-27-2007.

GROUP1201

THE MARK CONSISTS OF STANDARD CHARACTERS WITHOUT CLAIM TO ANY PARTICULAR FONT, STYLE, SIZE, OR COLOR.

FOR ADVERTISING AGENCY SERVICES, NAMELY PROMOTING THE GOODS AND SERVICES OF OTHERS (U.S. CLS. 100, 101 AND 102).

FIRST USE 3-21-2007; IN COMMERCE 3-21-2007.

ANDREA HACK, EXAMINING ATTORNEY

SN 77-141,210. ENERGY CAREERS INC., HOUSTON, TX.
FILED 3-27-2007.

Energy Careers

THE MARK CONSISTS OF STANDARD CHARACTERS WITHOUT CLAIM TO ANY PARTICULAR FONT, STYLE, SIZE, OR COLOR.

OWNER OF U.S. REG. NO. 2,554,281.

SEC. 2(F).

FOR CONFIDENTIAL ON LINE RECRUITING AND PLACEMENT SERVICES NAMELY, REGISTERING JOB SEEKERS VIA A GLOBAL COMPUTER NETWORK, POSTING RECRUITING ADVERTISEMENTS REGARDING OPEN POSITIONS VIA A GLOBAL COMPUTER NETWORK, AUTOMATICALLY MATCHING REGISTERED JOB SEEKERS TO OPEN POSITIONS, NOTIFYING MATCHED JOB SEEKERS VIA A GLOBAL COMPUTER NETWORK AND SENDING AUTHORIZED JOB SEEKER INFORMATION TO PROSPECTIVE EMPLOYERS VIA A GLOBAL COMPUTER NETWORK, ALL FOR THE ENERGY INDUSTRY (U.S. CLS. 100, 101 AND 102).

FIRST USE 11-1-1999; IN COMMERCE 11-1-1999.

MICHAEL WEBSTER, EXAMINING ATTORNEY

CLASS 35—(Continued).

SN 77-141,303. 45FIX, LLC, CHARLOTTESVILLE, VA. FILED 3-27-2007.

45FIX

THE MARK CONSISTS OF STANDARD CHARACTERS WITHOUT CLAIM TO ANY PARTICULAR FONT, STYLE, SIZE, OR COLOR.

FOR BUSINESS MANAGEMENT AND MARKETING SERVICES, NAMELY, PROVIDING LEAD GENERATION, SCHEDULING, PROPOSAL GENERATION, CUSTOMER SERVICES, AND COLLECTIONS SERVICES TO CONTRACTS IN THE REAL ESTATE IMPROVEMENT, HOME IMPROVEMENT, CONSTRUCTION, HANDYMAN AND HOME MAINTENANCE AND REPAIR INDUSTRIES; PROVIDING CONSUMER INFORMATION SERVICES AND PROVIDING REFERRALS IN THE FIELD OF REAL ESTATE IMPROVEMENT, HOME IMPROVEMENT, CONSTRUCTION, HANDYMAN, REPAIR AND HOME MAINTENANCE (U.S. CLS. 100, 101 AND 102).

DAVID H. STINE, EXAMINING ATTORNEY

SN 77-141,361. BLUE 2, LLC, ST. LOUIS, MO. FILED 3-27-2007.

BLUE 2

THE MARK CONSISTS OF STANDARD CHARACTERS WITHOUT CLAIM TO ANY PARTICULAR FONT, STYLE, SIZE, OR COLOR.

FOR PROMOTION AND MARKETING SERVICES AND RELATED CONSULTING (U.S. CLS. 100, 101 AND 102).

JAY BESCH, EXAMINING ATTORNEY

CLASS 35—(Continued).

SN 77-141,384. CLAYTON, DANIEL, UNDERHILL CENTER, VT. FILED 3-27-2007.

digmyloot.com

THE MARK CONSISTS OF STANDARD CHARACTERS WITHOUT CLAIM TO ANY PARTICULAR FONT, STYLE, SIZE, OR COLOR.

FOR COMPUTERIZED ON-LINE RETAIL STORE SERVICES IN THE FIELD OF NAMELY SPORTING GOODS; MAIL ORDER CATALOG SERVICES FEATURING NAMELY SPORTING GOODS; ON-LINE RETAIL STORE SERVICES FEATURING NAMELY SPORTING GOODS; PROVIDING A WEB SITE AT WHICH USERS CAN OFFER GOODS FOR SALE AND BUY GOODS OFFERED BY OTHERS; COMPUTERIZED ON-LINE ORDERING FEATURING GENERAL MERCHANDISE AND GENERAL CONSUMER GOODS; ON-LINE CONSIGNMENT SERVICES WHEREBY GOODS ARE RECEIVED ON CONSIGNMENT FOR AUCTION ON AN ONLINE AUCTION SITE (U.S. CLS. 100, 101 AND 102).

JENNIFER HETU, EXAMINING ATTORNEY

SN 77-141,469. I9 ADVANTAGE LLC, DUBLIN, OH. FILED 3-27-2007.

i9 Advantage

NO CLAIM IS MADE TO THE EXCLUSIVE RIGHT TO USE "I9", APART FROM THE MARK AS SHOWN.

FOR EMPLOYMENT VERIFICATION, NAMELY, PROVIDING A SERVICE FOR USE IN ENABLING EMPLOYERS TO VERIFY THE EMPLOYMENT ELIGIBILITY STATUS OF NEWLY-HIRED EMPLOYEES (U.S. CLS. 100, 101 AND 102).

LEE-ANNE BERNIS, EXAMINING ATTORNEY

SN 77-141,481. KHALIL, MOHAMMED ALI, BROOKLYN, NY. FILED 3-27-2007.

Buy Smarter

THE MARK CONSISTS OF STANDARD CHARACTERS WITHOUT CLAIM TO ANY PARTICULAR FONT, STYLE, SIZE, OR COLOR.

FOR PROVIDING CONSUMER INFORMATION IN THE AUTOMOTIVE FIELD VIA A GLOBAL COMPUTER NETWORK RELATING TO VEHICLES FOR SALE, VALUATION OF VEHICLES, AVAILABILITY OF VEHICLE PARTS AND ACCESSORIES, DEALERS, MANUFACTURERS, AUTOMOTIVE SERVICES AND SERVICE PROVIDERS, AS WELL AS TRADE INFORMATION CONCERNING THE AUTOMOBILE INDUSTRY (U.S. CLS. 100, 101 AND 102).

FIRST USE 1-1-2005; IN COMMERCE 1-1-2007.

AHSEN KHAN, EXAMINING ATTORNEY

CLASS 35—(Continued).

SN 77-141,576. BOESEN MILWAUKEE, LLC, MILWAUKEE, WI. FILED 3-27-2007.

LOCKER'S

THE MARK CONSISTS OF STANDARD CHARACTERS WITHOUT CLAIM TO ANY PARTICULAR FONT, STYLE, SIZE, OR COLOR.

FOR RETAIL FLORIST SHOPS (U.S. CLS. 100, 101 AND 102).

FIRST USE 12-31-1911; IN COMMERCE 12-31-1911.
DAVID TOOLEY, EXAMINING ATTORNEY

SN 77-141,639. DALE & THOMAS POPCORN, LLC, ENGLEWOOD, NJ. FILED 3-27-2007.

POPSTOP

THE MARK CONSISTS OF STANDARD CHARACTERS WITHOUT CLAIM TO ANY PARTICULAR FONT, STYLE, SIZE, OR COLOR.

FOR RETAIL STORE SERVICES, MAIL ORDER CATALOG, AND INTERNET STORE SERVICES ALL FEATURING POPCORN PRODUCTS, CLOTHING AND GIFTS (U.S. CLS. 100, 101 AND 102).

LINDSEY RUBIN, EXAMINING ATTORNEY

SN 77-141,725. TRÜF, LLC, SANTA MONICA, CA. FILED 3-27-2007.

CLÜ

THE MARK CONSISTS OF STANDARD CHARACTERS WITHOUT CLAIM TO ANY PARTICULAR FONT, STYLE, SIZE, OR COLOR.

FOR MARKETING CONSULTING SERVICES IN ALL FIELDS OF MEDIA CONTENT (U.S. CLS. 100, 101 AND 102).

ANDREA K. NADELMAN, EXAMINING ATTORNEY

CLASS 35—(Continued).

SN 77-141,971. SALGUERO, MICHAEL A., WILLIAMSBURG, MA. FILED 3-27-2007.

The Junto Group

THE MARK CONSISTS OF STANDARD CHARACTERS WITHOUT CLAIM TO ANY PARTICULAR FONT, STYLE, SIZE, OR COLOR.

NO CLAIM IS MADE TO THE EXCLUSIVE RIGHT TO USE "GROUP", APART FROM THE MARK AS SHOWN.

FOR CHARITABLE SERVICES, NAMELY ORGANIZING AND CONDUCTING VOLUNTEER PROGRAMS AND COMMUNITY SERVICE PROJECTS; BUSINESS NETWORKING (U.S. CLS. 100, 101 AND 102).

FIRST USE 1-1-2006; IN COMMERCE 1-1-2006.
ANDREW RHIM, EXAMINING ATTORNEY

SN 77-141,973. STRAIGHT, AARON M., BELLINGHAM, WA. FILED 3-27-2007.

Relief Marketing

THE MARK CONSISTS OF STANDARD CHARACTERS WITHOUT CLAIM TO ANY PARTICULAR FONT, STYLE, SIZE, OR COLOR.

NO CLAIM IS MADE TO THE EXCLUSIVE RIGHT TO USE "MARKETING", APART FROM THE MARK AS SHOWN.

FOR ADVERTISING SERVICES, NAMELY, PROMOTING AND MARKETING THE GOODS AND SERVICES OF OTHERS THROUGH ALL PUBLIC COMMUNICATION MEANS; ADVERTISING, MARKETING AND PROMOTION SERVICES; ADVICE IN THE FIELD OF BUSINESS MANAGEMENT AND MARKETING; ARRANGING AND CONDUCTING MARKETING PROMOTIONAL EVENTS FOR OTHERS; BUSINESS CONSULTATION AND MANAGEMENT REGARDING MARKETING ACTIVITIES AND LAUNCHING OF NEW PRODUCTS; BUSINESS MANAGEMENT CONSULTING WITH RELATION TO STRATEGY, MARKETING, PRODUCTION, PERSONNEL AND RETAIL SALE MATTERS; BUSINESS MARKETING CONSULTING SERVICES; CO-OPERATIVE ADVERTISING AND MARKETING (U.S. CLS. 100, 101 AND 102).

ANDREW RHIM, EXAMINING ATTORNEY

CLASS 35—(Continued).

SN 77-142,064. STEEL HORSES M.C. LLC, BROOKLYN, NY. FILED 3-27-2007.

EAST COAST MEETS WEST COAST

THE MARK CONSISTS OF STANDARD CHARACTERS WITHOUT CLAIM TO ANY PARTICULAR FONT, STYLE, SIZE, OR COLOR.

FOR PROMOTING PUBLIC AWARENESS OF MOTORCYCLES, MOTORCYCLE SAFETY AND MOTORCYCLE CLUB ORGANIZATIONS (U.S. CLS. 100, 101 AND 102).
FIRST USE 9-0-2006; IN COMMERCE 9-0-2006.
LESLEY LAMOTHE, EXAMINING ATTORNEY

CLASS 35—(Continued).

SN 77-142,251. THE ZUCCONI IDEA AGENCY INC, MARLTON, NJ. FILED 3-28-2007.

promotizing

THE MARK CONSISTS OF STANDARD CHARACTERS WITHOUT CLAIM TO ANY PARTICULAR FONT, STYLE, SIZE, OR COLOR.

FOR ADVERTISING AGENCIES, NAMELY, PROMOTING THE GOODS AND SERVICES OF OTHERS (U.S. CLS. 100, 101 AND 102).
FRANK LATTUCA, EXAMINING ATTORNEY

SN 77-142,194. REALTECHNETWORK CORPORATION, CONGERS, NY. FILED 3-28-2007.

YOUR REVENUE SYNCHRONIZED

THE MARK CONSISTS OF STANDARD CHARACTERS WITHOUT CLAIM TO ANY PARTICULAR FONT, STYLE, SIZE, OR COLOR.

FOR ON-LINE ADVERTISING AND MARKETING SERVICES (U.S. CLS. 100, 101 AND 102).
FIRST USE 11-0-2006; IN COMMERCE 11-0-2006.
ZACHARY BELLO, EXAMINING ATTORNEY

SN 77-142,275. RAGGED ASS, LLC, ST JAMES CITY, FL. FILED 3-28-2007.

RAGGED ASS

SN 77-142,221. CRESCENT ELECTRIC SUPPLY COMPANY, EAST DUBUQUE, IL. FILED 3-28-2007.

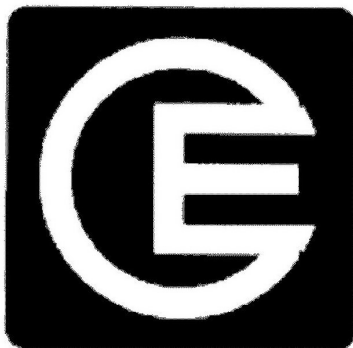

THE MARK CONSISTS OF A STYLIZED CE IN A PARTIALLY SHADED SQUARE.

FOR DISTRIBUTORSHIPS IN THE FIELD OF ELECTRICAL PRODUCTS AND SUPPLIES (U.S. CLS. 100, 101 AND 102).
FIRST USE 12-31-1960; IN COMMERCE 12-31-1960.
TANYA AMOS, EXAMINING ATTORNEY

THE MARK CONSISTS OF STANDARD CHARACTERS WITHOUT CLAIM TO ANY PARTICULAR FONT, STYLE, SIZE, OR COLOR.

FOR RETAIL OUTLETS FEATURING CLOTHING, HOT SAUCE, BOTTLE SUITS, AND LICENSE PLATES; ON-LINE RETAIL STORE SERVICES FEATURING CLOTHING, HOT SAUCE, BOTTLE SUITS, AND LICENSE PLATES (U.S. CLS. 100, 101 AND 102).
FIRST USE 11-1-2002; IN COMMERCE 11-1-2002.
JANICE L. MCMORROW, EXAMINING ATTORNEY

CLASS 35—(Continued).

SN 77-142,532. GELSON'S MARKETS, ENCINO, CA. FILED 3-28-2007.



NO CLAIM IS MADE TO THE EXCLUSIVE RIGHT TO USE "ORGANIC", APART FROM THE MARK AS SHOWN. THE COLOR(S) GREEN, GOLD, ORANGE, AND WHITE IS/ARE CLAIMED AS A FEATURE OF THE MARK.

THE MARK CONSISTS OF A DESIGN CONSISTING OF A CIRCLE CONTAINING TWO BROAD GREEN LEAVES IN THE LOWER PORTION, AN IMAGE OF A GOLD RISING SUN IN THE CENTER, AND THE WORD "ORGANIC" IN THE UPPER PORTION. THE SKY ABOVE THE RISING SUN IS ORANGE AND THE WORD "ORGANIC" IS GREEN; THE COLOR WHITE APPEARS IN THE DRAWING IN THE CIRCLE AS AN OUTLINE BETWEEN THE INNER SUN AND LEAF DESIGN AND AN OUTER GREEN BORDER.

FOR RETAIL GROCERY STORES (U.S. CLS. 100, 101 AND 102).

FIRST USE 6-5-2006; IN COMMERCE 6-5-2006.
JORDAN BAKER, EXAMINING ATTORNEY

SN 77-142,602. SAHARA STRATEGIES, INC., PALO ALTO, CA. FILED 3-28-2007.

Sahara

THE MARK CONSISTS OF STANDARD CHARACTERS WITHOUT CLAIM TO ANY PARTICULAR FONT, STYLE, SIZE, OR COLOR.

FOR ONLINE TRADING SERVICES TO FACILITATE THE SALE OF GOODS BY OTHERS VIA A COMPUTER NETWORK, INCLUDING THE PRESENTATION OF VIDEO AND IMAGES OF PRODUCTS AND THEIR SELLERS, AND PROVIDING EVALUATIVE FEEDBACK AND RATINGS OF SELLERS' GOODS AND SERVICES, THE VALUE AND PRICES OF SELLERS' GOODS, BUYERS' AND SELLERS' PERFORMANCE, DELIVERY, AND OVERALL TRADING EXPERIENCE IN CONNECTION THEREWITH (U.S. CLS. 100, 101 AND 102).

NATALIE POLZER, EXAMINING ATTORNEY

CLASS 35—(Continued).

SN 77-142,732. KATZ, ANDREA, NEW YORK, NY. FILED 3-28-2007.

IDEON

THE MARK CONSISTS OF STANDARD CHARACTERS WITHOUT CLAIM TO ANY PARTICULAR FONT, STYLE, SIZE, OR COLOR.

FOR STRATEGIC MARKETING SERVICES (U.S. CLS. 100, 101 AND 102).

MATTHEW PAPPAS, EXAMINING ATTORNEY

SN 77-142,822. JOHNNY ADVERTISING MANAGEMENT, INC., GRAND HAVEN, MI. FILED 3-28-2007.



NO CLAIM IS MADE TO THE EXCLUSIVE RIGHT TO USE "ADVERTISING", APART FROM THE MARK AS SHOWN.

THE MARK CONSISTS OF THE WORDS JOHNNY ADVERTISING.

FOR PROVIDING BILLBOARD ADVERTISING FOR OTHERS TO BE PLACED IN RESTAURANTS, BARS, CLUBS, COLLEGES AND UNIVERSITIES, MARINAS, ARENAS, STADIUMS, THEATERS AND BUSINESS OFFICES (U.S. CLS. 100, 101 AND 102).

FIRST USE 11-30-1995; IN COMMERCE 11-30-1996.
MICHAEL WEBSTER, EXAMINING ATTORNEY

SN 77-142,981. MOUSER ELECTRONICS, INC., MANSFIELD, TX. FILED 3-28-2007.

MOUSER

THE MARK CONSISTS OF STANDARD CHARACTERS WITHOUT CLAIM TO ANY PARTICULAR FONT, STYLE, SIZE, OR COLOR.

OWNER OF U.S. REG. NOS. 2,207,030 AND 2,210,703.

FOR CATALOG ORDERING SERVICE FEATURING SEMICONDUCTOR ELECTRONIC COMPONENTS; ELECTRONIC CATALOG SERVICES FEATURING SEMICONDUCTOR ELECTRONIC COMPONENTS; MAIL ORDER CATALOG SERVICES FEATURING SEMICONDUCTOR ELECTRONIC COMPONENTS; ELECTRONIC COMMERCE SERVICES, NAMELY PROVIDING INFORMATION ABOUT PRODUCTS VIA TELECOMMUNICATION NETWORKS FOR ADVERTISING AND SALES PURPOSES (U.S. CLS. 100, 101 AND 102).

FIRST USE 4-23-1973; IN COMMERCE 4-27-1973.
BILL DAWE, EXAMINING ATTORNEY

CLASS 35—(Continued).

SN 77-143,064. RLR MARKETING, FLOWER MOUND, TX. FILED 3-28-2007.

KRITTERS IN THE MAILBOX

THE MARK CONSISTS OF STANDARD CHARACTERS WITHOUT CLAIM TO ANY PARTICULAR FONT, STYLE, SIZE, OR COLOR.

FOR ON-LINE RETAIL STORE SERVICES FEATURING GIFTS WITH AN ANIMAL THEME (U.S. CLS. 100, 101 AND 102).

FIRST USE 10-0-1998; IN COMMERCE 10-0-1998.
ROSELLE HERRERA, EXAMINING ATTORNEY

SN 77-143,123. THE FRANK LLOYD WRIGHT FOUNDATION, SCOTTSDALE, AZ. FILED 3-28-2007.

TALIESIN DESIGN

THE MARK CONSISTS OF STANDARD CHARACTERS WITHOUT CLAIM TO ANY PARTICULAR FONT, STYLE, SIZE, OR COLOR.

OWNER OF U.S. REG. NOS. 853,377, 1,932,276 AND OTHERS.

NO CLAIM IS MADE TO THE EXCLUSIVE RIGHT TO USE "DESIGN", APART FROM THE MARK AS SHOWN.

FOR ON-LINE RETAIL STORE SERVICES, RETAIL STORE SERVICES, AND MAIL, TELEPHONE AND FACSIMILE ORDER CATALOG SERVICES IN THE FIELD OF ADDRESS BOOKS, AFGHANS, THROWS, ARCHITECTURAL HARDWARE, ARCHITECTURAL KITS, ARCHITECTURAL METALWORK, ARCHITECTURAL MOLDINGS, ARCHITECTURAL TOYS, ART GLASS PANELS, ART GLASS WINDOWS, ART PRINTS, ATRIUMS, BATH ACCESSORIES, BATH MATS, BED LINENS, BED RUNNERS, BEDS, BENCHES, BIRD BATHS, BIRD HOUSES, BLACK AND LIGHT PHOTOGRAPHY, BOOK STANDS, BOOKENDS, BOOKMARKS, BOOKPLATES, SERIES OF BOOKS, BRACELETS, BUFFETS/CHINA CABINETS, BUSINESS CARD CASES, CALENDARS, CANDLE ACCESSORIES, CANDLE HOLDERS, CANDLES, CANDLESTICKS, CAPS, CARPETS, CD HOLDERS, CDS, CERAMICS, CHAIRS, CHARMS, CHECKBOOK COVERS, CHESTS OF DRAWERS, CHILDREN'S BLOCKS, CLOCKS, CLOTHING, COASTERS, COFFEE MUGS, COMFORTERS, COMPUTER ACCESSORIES, COMPUTER SOFTWARE, COSMETIC BAGS, COVERLETS, CRYSTAL, CUFF LINKS, DECANTERS, DECORATIVE ART GLASS, DECORATIVE BOWLS, DECORATIVE BOXES, DECORATIVE FABRICS, DECORATIVE METALWORK, DECORATIVE PILLOWS, DECORATIVE PLATTERS, DECORATIVE TILE, DESK ACCESSORIES, DESK CALENDARS, DESKS, DINING ROOM TABLES, DINNERWARE, DOOR SYSTEMS, DOORMATS, DOORS, DUVET COVERS, DVDS, EARRINGS, EDUCATIONAL BLOCKS, EDUCATIONAL CARDS, ENCLOSURE CARDS, END TABLES, ENGAGEMENT BOOKS, EYEGLASS CASES, FABRIC, FACIA, FIREPLACE SCREENS, FIREPLACE TOOL SETS, FOUNTAINS, FURNITURE, GAMES, GARDEN ACCESSORIES, GAZEBOS, GIFT BAGS, GIFT WRAP, GIFT WRAP PAPER, GLASS ARCHITECTURAL ELEMENTS, GLASS PANELS FOR CABINETS, GLASSES, GLASSWARE, GREEN HOUSES, GREETING CARDS, GUEST BOOKS, HASSOCKS, HATS, HOLIDAY CARDS, HOUSE LETTERS, HOUSE NUMBERS, ICE BUCKETS, INVITATIONS, JEWELRY, JOURNAL COVERS, JOUR-

CLASS 35—(Continued).

NALS/DIARIES, KEY CHAINS, KEY TAGS, LAMP SHADES, LAMPS, LANTERNS, LETTER OPENERS, LIGHTING FIXTURES, LINENS, LUMINARIES, MAGAZINE RACKS, MAGNETS, MAGNIFYING GLASSES, MECHANICAL PENCILS, METAL AND WOOD FRAMED ART GLASS PANELS, METAL VASES, METAL WALL ART, METAL WRAPPED CANDLES, METAL WRAPPED VOTIVES, MINIATURE BUILDINGS, MINIATURE CHAIRS, MIRRORS, MOBILES, MONEY CLIPS, MUFFLERS, NECKLACES, NECKTIES, NEEDLEPOINT KITS, NIGHT LIGHTS, NOTE CADDY, NOTE PADS, NOTECARDS, OBJECTS OF INTERIOR DESIGN, ORNAMENTS, OTTOMANS, PAINT, PAINTED CANVAS NEEDLEWORK KITS, PAPER NAPKINS, PAPER WEIGHTS, PAPERCLIP BOXES, PAVERS, PEN AND PENCIL BOXES, PEN AND PENCIL CUPS, PENCILS, PENDANTS, PENS, PERSONAL ACCESSORIES, PET BOWLS, PET HOUSES, PHOTO ALBUMS, PIANOS, PICTURE FRAMES, PILL BOXES, PILLOWS, PINS, PLACEMATS, PLACQUES, PLANT STANDS, PLANTERS, PLAYING CARDS, PLUMBING FIXTURES, POCKET KNIVES, POLO SHIRTS, POSTCARD BOOKS, POSTCARDS, POSTERS, POUFS, PRE-RECORDED VIDEOTAPES, PRINTS, PURSES, PUZZLES, RIBBONS, RINGS, ROMPERS, RUBBER STAMP SETS, RUBBER STAMPS, RUGS, SALT AND PEPPER SETS, SCARVES, SCREENSAVERS, SCULPTURES, SHAWLS, SHOWER CURTAINS, SKETCH BOOKS, SOFAS, STAMP KITS, STATIONERY, STENCILS, STEPPING STONES, STITCHERY KITS, SUGAR AND CREAMER SETS, SWEATSHIRTS, SWITCH PLATES, T SHIRTS, TABLE RUNNERS, TABLES, TEAPOTS, THERMOMETERS, TIE CLIPS, TIE TACS, TOTE BAGS, TOYS, TRADING CARDS, TRELLISES, TRIVETS, TYPE FONTS, UMBRELLAS, URNS, VASES, VOTIVES, WALL ART, WALL COVERINGS, WALL MIRRORS, WALL PANELS, WALL PLACQUES, WALL SCONCES, WALL SHELVES, WALLETS, WASTEBASKETS, WATCHES, WIND CHIMES, WINDOW SHADES, WINE RACKS, WOOD SCREENS, AND WOODEN ARCHITECTURAL ELEMENTS (U.S. CLS. 100, 101 AND 102).

MICHAEL ENGEL, EXAMINING ATTORNEY

SN 77-143,181. STRINGER, CHRISTOPHER, SANTA ANA, CA. AND BOWES, GRAHAM, SANTA ANA, CA. FILED 3-28-2007.

Not A Robot

THE MARK CONSISTS OF THE WORDS "NOT A ROBOT" WHERE THE "T" IN THE WORD "ROBOT" IS CROSSED TWICE TO RESEMBLE AN ANTENNAE AND IS ALSO BENT SLIGHTLY TO THE RIGHT.

FOR ON-LINE RETAIL STORE SERVICES FEATURING CLOTHING, TOYS, STICKERS, PATCHES, ART; RETAIL STORE SERVICES FEATURING CLOTHING, TOYS, STICKERS, PATCHES, ART (U.S. CLS. 100, 101 AND 102).

SANI KHOURI, EXAMINING ATTORNEY

CLASS 35—(Continued).

SN 77-143,186. SPANISH HILLS REALTY INC., LAS VEGAS, NV. FILED 3-28-2007.

Six Star Living

THE MARK CONSISTS OF STANDARD CHARACTERS WITHOUT CLAIM TO ANY PARTICULAR FONT, STYLE, SIZE, OR COLOR.

FOR CUSTOMER SERVICE IN THE FIELD OF HOTEL/RESORT LIFESTYLE (U.S. CLS. 100, 101 AND 102).
PAUL F. GAST, EXAMINING ATTORNEY

SN 77-143,188. SPANISH HILLS REALTY INC., LAS VEGAS, NV. FILED 3-28-2007.

Six Star Lifestyle

THE MARK CONSISTS OF STANDARD CHARACTERS WITHOUT CLAIM TO ANY PARTICULAR FONT, STYLE, SIZE, OR COLOR.

NO CLAIM IS MADE TO THE EXCLUSIVE RIGHT TO USE "LIFESTYLE", APART FROM THE MARK AS SHOWN.
FOR CUSTOMER SERVICE IN THE FIELD OF HOTEL/RESORT LIFESTYLE (U.S. CLS. 100, 101 AND 102).
PAUL F. GAST, EXAMINING ATTORNEY

SN 77-143,211. AUTOMOTIVE RENTALS, INC., MOUNT LAUREL, NJ. FILED 3-28-2007.

ENVIROFLEET

THE MARK CONSISTS OF STANDARD CHARACTERS WITHOUT CLAIM TO ANY PARTICULAR FONT, STYLE, SIZE, OR COLOR.

FOR RATING FLEET VEHICLES FOR CARBON EMISSIONS LEVELS. FOR USE IN AIDING CONSUMER PURCHASING DECISIONS (U.S. CLS. 100, 101 AND 102).
FIRST USE 3-5-2007; IN COMMERCE 3-5-2007.
ANDREW RHIM, EXAMINING ATTORNEY

CLASS 35—(Continued).

SN 77-143,260. GALLEGOS, JESUS, GUADALAJARA, MEXICO, FILED 3-29-2007.

ELEMENTS RESORTS & SPA

THE MARK CONSISTS OF STANDARD CHARACTERS WITHOUT CLAIM TO ANY PARTICULAR FONT, STYLE, SIZE, OR COLOR.

NO CLAIM IS MADE TO THE EXCLUSIVE RIGHT TO USE "RESORTS & SPA", APART FROM THE MARK AS SHOWN.

FOR REAL ESTATE ADVERTISING SERVICES; REAL ESTATE MARKETING SERVICES IN THE FIELD OF CONDOMINIUMS, APARTMENTS, LUXURY APARTMENTS, HOMES; REAL ESTATE MARKETING SERVICES, NAMELY, ON-LINE SERVICES FEATURING TOURS OF RESIDENTIAL AND COMMERCIAL REAL ESTATE; REAL ESTATE SALES MANAGEMENT (U.S. CLS. 100, 101 AND 102).

MICHAEL KAZAZIAN, EXAMINING ATTORNEY

SN 77-143,395. ECOLAVATION, LLC, MIAMI, FL. FILED 3-29-2007.

ECOLAV

THE MARK CONSISTS OF STANDARD CHARACTERS WITHOUT CLAIM TO ANY PARTICULAR FONT, STYLE, SIZE, OR COLOR.

FOR FRANCHISING, NAMELY, OFFERING TECHNICAL ASSISTANCE IN THE ESTABLISHMENT AND/OR OPERATION OF DRY CLEANING BUSINESSES (U.S. CLS. 100, 101 AND 102).

JOHN HWANG, EXAMINING ATTORNEY

SN 77-143,403. SCHOOLS INTEROPERABILITY FRAMEWORK ASSOCIATION, WASHINGTON, DC. FILED 3-29-2007.

SIFA

THE MARK CONSISTS OF STANDARD CHARACTERS WITHOUT CLAIM TO ANY PARTICULAR FONT, STYLE, SIZE, OR COLOR.

OWNER OF U.S. REG. NOS. 2,920,512, 3,039,090 AND OTHERS.

FOR ASSOCIATION SERVICES, NAMELY, PROMOTING THE INTERESTS OF SOFTWARE VENDORS, SCHOOLS, AND GOVERNMENT AGENCIES IN DEVELOPING INTEROPERABILITY BETWEEN EDUCATIONAL SOFTWARE APPLICATIONS (U.S. CLS. 100, 101 AND 102).

FIRST USE 4-2-2004; IN COMMERCE 4-2-2004.
ALICE BENMAMAN, EXAMINING ATTORNEY

CLASS 35—(Continued).

SN 77-143,438. QUALITY ASSURED SERVICES, INC., ORLANDO, FL. FILED 3-29-2007.

CLASS 35—(Continued).

SN 77-143,675. SALESFORCE.COM, INC., SAN FRANCISCO, CA. FILED 3-29-2007.

THE BEST WAY TO TEST

APPSPACE

THE MARK CONSISTS OF STANDARD CHARACTERS WITHOUT CLAIM TO ANY PARTICULAR FONT, STYLE, SIZE, OR COLOR.

FOR ON-LINE RETAIL STORE SERVICES FEATURING MEDICAL TESTING PRODUCTS (U.S. CLS. 100, 101 AND 102).

FIRST USE 9-1-2006; IN COMMERCE 9-1-2006.
SUE LAWRENCE, EXAMINING ATTORNEY

THE MARK CONSISTS OF STANDARD CHARACTERS WITHOUT CLAIM TO ANY PARTICULAR FONT, STYLE, SIZE, OR COLOR.

FOR ONLINE BUSINESS NETWORKING SERVICES; PROVIDING AN ONLINE WEBSITE, ONLINE DIRECTORY, AND AN ONLINE SEARCHABLE DATABASE FEATURING INFORMATION ABOUT THE PRODUCTS AND SERVICES OF OTHERS AND BUSINESS INFORMATION OF OTHERS (U.S. CLS. 100, 101 AND 102).
ROSELLE HERRERA, EXAMINING ATTORNEY

SN 77-143,595. SEAL INC. D/B/A SEAL & CO., SUMMIT, NJ. FILED 3-29-2007.

SN 77-143,710. TIMEPERKS LLC, HORSEHEADS, NY. FILED 3-29-2007.

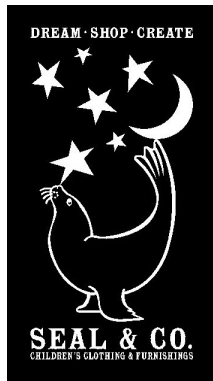

TimePerks

NO CLAIM IS MADE TO THE EXCLUSIVE RIGHT TO USE & CO. AND CHILDREN'S CLOTHING & FURNISHINGS, APART FROM THE MARK AS SHOWN.

THE MARK CONSISTS OF A PICTURE OF A SEAL WITH A STAR ON HIS NOSE AND A MOON ON HIS TAIL. STARS AND BACKGROUND ARE ALSO USED.

FOR ON-LINE RETAIL STORE SERVICES FEATURING CHILDREN'S CLOTHING, FURNISHINGS, FURNITURE, BEDDING, BAGS, GIFTS TOYS AND DECORATIVE ACCESSORIES; RETAIL STORES FEATURING CHILDREN'S CLOTHING, FURNISHINGS, FURNITURE, BEDDING, BAGS, GIFTS TOYS AND DECORATIVE ACCESSORIES (U.S. CLS. 100, 101 AND 102).

FIRST USE 2-13-2006; IN COMMERCE 2-13-2006.
JOHN WILKE, EXAMINING ATTORNEY

THE MARK CONSISTS OF STANDARD CHARACTERS WITHOUT CLAIM TO ANY PARTICULAR FONT, STYLE, SIZE, OR COLOR.

FOR PERSONAL CONVENIENCE SERVICES FOR EMPLOYEES OF CLIENT COMPANIES NAMELY, MAKING ARRANGEMENTS WITH THIRD PARTY SERVICE COMPANIES TO PROVIDE CLIENT EMPLOYEES WITH MEALS, DRY CLEANING, LAUNDRY, MAID SERVICE, CAR WASHING AND DETAILING, VIDEO RENTAL, GROCERY DELIVERY AND CATERING (U.S. CLS. 100, 101 AND 102).

LINDA ORNDORFF, EXAMINING ATTORNEY

CLASS 35—(Continued).

SN 77-143,715. MOUSER ELECTRONICS, INC., MANSFIELD, TX. FILED 3-29-2007.

MOUSER ELECTRONICS

THE MARK CONSISTS OF STANDARD CHARACTERS WITHOUT CLAIM TO ANY PARTICULAR FONT, STYLE, SIZE, OR COLOR.

OWNER OF U.S. REG. NOS. 2,207,030 AND 2,210,703.

NO CLAIM IS MADE TO THE EXCLUSIVE RIGHT TO USE "ELECTRONICS", APART FROM THE MARK AS SHOWN.

FOR CATALOG ORDERING SERVICE FEATURING SEMICONDUCTOR ELECTRONIC COMPONENTS; ELECTRONIC CATALOG SERVICES FEATURING SEMICONDUCTOR ELECTRONIC COMPONENTS; MAIL ORDER CATALOG SERVICES FEATURING SEMICONDUCTOR ELECTRONIC COMPONENTS; ELECTRONIC COMMERCE SERVICES, NAMELY PROVIDING INFORMATION ABOUT PRODUCTS VIA TELECOMMUNICATION NETWORKS FOR ADVERTISING AND SALES PURPOSES (U.S. CLS. 100, 101 AND 102).

FIRST USE 4-23-1973; IN COMMERCE 4-27-1973.

BILL DAWE, EXAMINING ATTORNEY

SN 77-143,809. THE R. FALLS AGENCY, INC., MINNEAPOLIS, MN. FILED 3-29-2007.

**STRONGER. FASTER. BETTER
ADVERTISING.**

THE MARK CONSISTS OF STANDARD CHARACTERS WITHOUT CLAIM TO ANY PARTICULAR FONT, STYLE, SIZE, OR COLOR.

FOR PROVIDING ADVERTISING AND MARKETING SERVICES TO MOTOR SPORTS DEALERS; DEVELOPING PROMOTIONAL CAMPAIGNS FOR MOTOR DEALERS (U.S. CLS. 100, 101 AND 102).

DANIEL BRODY, EXAMINING ATTORNEY

SN 77-143,893. MYBODYBEATS, INC., ATLANTA, GA. FILED 3-29-2007.

MY BODY BEATS

THE MARK CONSISTS OF STANDARD CHARACTERS WITHOUT CLAIM TO ANY PARTICULAR FONT, STYLE, SIZE, OR COLOR.

FOR ON-LINE RETAIL STORE SERVICES FEATURING DOWNLOADABLE AUDIO AND VIDEO RECORDINGS, NAMELY EXERCISE AND WORKOUT AUDIO AND VIDEO RECORDINGS (U.S. CLS. 100, 101 AND 102).

FIRST USE 9-28-2006; IN COMMERCE 2-28-2007.

CHARLES L. JENKINS, EXAMINING ATTORNEY

CLASS 35—(Continued).

SN 77-143,920. NEW ENGLAND SCIENCE FICTION ASSOCIATION, INC., MEDFORD, MA. FILED 3-29-2007.

NESFA

THE MARK CONSISTS OF STANDARD CHARACTERS WITHOUT CLAIM TO ANY PARTICULAR FONT, STYLE, SIZE, OR COLOR.

FOR ASSOCIATION SERVICES, NAMELY, PROMOTING THE INTERESTS OF SCIENCE FICTION (U.S. CLS. 100, 101 AND 102).

FIRST USE 9-26-1967; IN COMMERCE 9-26-1967.

CYNTHIA SLOAN, EXAMINING ATTORNEY

SN 77-143,998. STIEFEL, DANIEL, CHARLOTTE, NC. FILED 3-29-2007.



NO CLAIM IS MADE TO THE EXCLUSIVE RIGHT TO USE "DESSERTS", APART FROM THE MARK AS SHOWN. THE MARK CONSISTS OF A CHERRY ON A FORK AND THE TEXT SALARA DESSERTS.

FOR RETAIL BAKERY SHOPS (U.S. CLS. 100, 101 AND 102).

STEVEN R. FOSTER, EXAMINING ATTORNEY

SN 77-144,009. PASSIONATE GOLFER LLC., MINNEAPOLIS, MN. FILED 3-29-2007.

**Experience A Lifestyle
Without Limits**

THE MARK CONSISTS OF STANDARD CHARACTERS WITHOUT CLAIM TO ANY PARTICULAR FONT, STYLE, SIZE, OR COLOR.

FOR ADMINISTRATION OF A DISCOUNT PROGRAM FOR ENABLING PARTICIPANTS TO OBTAIN DISCOUNTS ON GOODS AND SERVICES THROUGH USE OF A DISCOUNT MEMBERSHIP CARD (U.S. CLS. 100, 101 AND 102).

AMEETA JORDAN, EXAMINING ATTORNEY

CLASS 35—(Continued).

SN 77-144,076. CTPARTNERS EXECUTIVE SEARCH LLC, CLEVELAND, OH. FILED 3-29-2007.

CTPartners

THE MARK CONSISTS OF STANDARD CHARACTERS WITHOUT CLAIM TO ANY PARTICULAR FONT, STYLE, SIZE, OR COLOR.

FOR EXECUTIVE SEARCH AND PLACEMENT SERVICES; EMPLOYMENT COUNSELING AND RECRUITING; BUSINESS RESEARCH; BUSINESS CONSULTATION; BUSINESS PLANNING (U.S. CLS. 100, 101 AND 102).
CARRIE GENOVESE, EXAMINING ATTORNEY

CLASS 35—(Continued).

SN 77-144,345. APPLERA CORPORATION, FOSTER CITY, CA. FILED 3-29-2007.

APPLERA

THE MARK CONSISTS OF STANDARD CHARACTERS WITHOUT CLAIM TO ANY PARTICULAR FONT, STYLE, SIZE, OR COLOR.

OWNER OF U.S. REG. NO. 3,130,445.
FOR INVENTORY CONTROL (U.S. CLS. 100, 101 AND 102).
KEVIN DINALLO, EXAMINING ATTORNEY

SN 77-144,143. NATIONAL BASKETBALL RETIRED PLAYERS ASSOCIATION, NEW YORK, NY. FILED 3-29-2007.

WE MADE THIS GAME

THE MARK CONSISTS OF STANDARD CHARACTERS WITHOUT CLAIM TO ANY PARTICULAR FONT, STYLE, SIZE, OR COLOR.

FOR ASSOCIATION SERVICES, NAMELY PROMOTING THE INTERESTS OF RETIRED BASKETBALL PLAYERS (U.S. CLS. 100, 101 AND 102).
FIRST USE 6-19-2006; IN COMMERCE 6-19-2006.
MIDGE BUTLER, EXAMINING ATTORNEY

SN 77-144,749. MATTERMAX LLC, STONE MOUNTAIN, GA. FILED 3-30-2007.

Maximize What Matters

THE MARK CONSISTS OF STANDARD CHARACTERS WITHOUT CLAIM TO ANY PARTICULAR FONT, STYLE, SIZE, OR COLOR.

FOR ADVERTISING AND MARKETING (U.S. CLS. 100, 101 AND 102).
FIRST USE 8-4-2005; IN COMMERCE 12-4-2006.
TINA KUAN, EXAMINING ATTORNEY

SN 77-144,324. SKYFACET LLC, NEW YORK, NY. FILED 3-29-2007.

Sky Facet

THE MARK CONSISTS OF STANDARD CHARACTERS WITHOUT CLAIM TO ANY PARTICULAR FONT, STYLE, SIZE, OR COLOR.

FOR ON-LINE RETAIL STORE SERVICES FEATURING FINE DIAMOND JEWELRY (U.S. CLS. 100, 101 AND 102).
FIRST USE 11-13-2004; IN COMMERCE 11-13-2004.
JAY FLOWERS, EXAMINING ATTORNEY

SN 77-145,045. BAGELMAN, BRUCE E., DALLAS, TX. FILED 3-30-2007.

green stop

THE MARK CONSISTS OF STANDARD CHARACTERS WITHOUT CLAIM TO ANY PARTICULAR FONT, STYLE, SIZE, OR COLOR.

FOR RETAIL STORE SERVICES FEATURING CONVENIENCE STORE ITEMS AND GASOLINE; RETAIL CONVENIENCE STORES; RETAIL GASOLINE SUPPLY SERVICES (U.S. CLS. 100, 101 AND 102).
JENNIFER KRISP, EXAMINING ATTORNEY

CLASS 35—(Continued).

SN 77-145,544. THE ALLIANCE FOR QUALITY CARE, MAPLEWOOD, NJ. FILED 3-31-2007.

AFQC - THE ALLIANCE FOR QUALITY CARE

THE MARK CONSISTS OF STANDARD CHARACTERS WITHOUT CLAIM TO ANY PARTICULAR FONT, STYLE, SIZE, OR COLOR.

NO CLAIM IS MADE TO THE EXCLUSIVE RIGHT TO USE "THE ALLIANCE FOR QUALITY CARE", APART FROM THE MARK AS SHOWN.

FOR ASSOCIATION SERVICES, NAMELY, PROMOTING THE INTERESTS OF HEALTHCARE PROVIDERS (U.S. CLS. 100, 101 AND 102).

FIRST USE 11-0-2005; IN COMMERCE 2-8-2007.

MARIAM MAHMOUDI, EXAMINING ATTORNEY

SN 77-146,768. ADAMS, WILLIAM, BEVERLY HILLS, CA. FILED 4-2-2007.

ELEPHUNK

THE MARK CONSISTS OF STANDARD CHARACTERS WITHOUT CLAIM TO ANY PARTICULAR FONT, STYLE, SIZE, OR COLOR.

FOR RETAIL STORE AND MAIL ORDER SERVICES IN THE FIELD OF GIFT ITEMS, CLOTHING AND ACCESSORIES (U.S. CLS. 100, 101 AND 102).

ELIZABETH KAJUBI, EXAMINING ATTORNEY

SN 77-147,862. ALBERTSON'S LLC, BOISE, ID. FILED 4-3-2007.

IT MEANS A GREAT DEAL.

THE MARK CONSISTS OF STANDARD CHARACTERS WITHOUT CLAIM TO ANY PARTICULAR FONT, STYLE, SIZE, OR COLOR.

FOR RETAIL GROCERY STORE SERVICES, ONLINE RETAIL GROCERY STORE AND RETAIL DRUG STORE SERVICES (U.S. CLS. 100, 101 AND 102).

FIRST USE 2-28-2007; IN COMMERCE 2-28-2007.

LINDSEY RUBIN, EXAMINING ATTORNEY

CLASS 35—(Continued).

SN 77-148,967. WORKRAGS, LLC, UNION CITY, NJ. FILED 4-4-2007.



NO CLAIM IS MADE TO THE EXCLUSIVE RIGHT TO USE "WORKRAGS", APART FROM THE MARK AS SHOWN.

THE STIPPLING IS FOR SHADING PURPOSES ONLY. THE MARK CONSISTS OF A CONSTRUCTION WORKER, ARMS CROSSED, WEARING A SHIRT AND HARD HAT WITH SKYLINE BEHIND HIM.

FOR ON-LINE RETAIL STORE SERVICES FEATURING T-SHIRTS, SWEATSHIRTS, DOO RAGS, BANDANAS, COVERALLS, JACKETS, GLOVES (U.S. CLS. 100, 101 AND 102).

ROBERT C. CLARK JR., EXAMINING ATTORNEY

SN 77-149,392. PEA SOUP, INC., DEERFIELD, IL. FILED 4-5-2007.



NO CLAIM IS MADE TO THE EXCLUSIVE RIGHT TO USE BABY, APART FROM THE MARK AS SHOWN.

THE COLOR(S) GREEN, PINK, PEACH, WHITE AND PURPLE IS/ARE CLAIMED AS A FEATURE OF THE MARK.

THE MARK CONSISTS OF STYLIZED LETTERS PEACH FADED TO PINK "PEA SOUP" WITH A GREEN OUTLINE AROUND THE LETTERS. A PURPLE OVAL UNDER "PEA SOUP" WITH STYLIZED "BABY" IN WHITE. THREE GREEN PEAS IN FRONT OF "PEA SOUP" AND ONE AFTER "BABY".

FOR WHOLESALE DISTRIBUTORSHIPS FEATURING BABY CLOTHING AND ACCESSORIES (U.S. CLS. 100, 101 AND 102).

FIRST USE 10-1-2006; IN COMMERCE 10-1-2006.

TASHIA BUNCH, EXAMINING ATTORNEY

CLASS 35—(Continued).

SN 77-152,819. COLUMBIA INSURANCE COMPANY, OMAHA, NE. FILED 4-10-2007.

CELEBRATION PANDA

THE MARK CONSISTS OF STANDARD CHARACTERS WITHOUT CLAIM TO ANY PARTICULAR FONT, STYLE, SIZE, OR COLOR.
FOR RETAIL JEWELRY STORE SERVICES (U.S. CLS. 100, 101 AND 102).
IRA J. GOODSaid, EXAMINING ATTORNEY

SN 77-153,793. THE WECK CORPORATION, NEW YORK, NY. FILED 4-11-2007.

GRACIOUS HOME

OWNER OF U.S. REG. NOS. 947,721 AND 2,284,659.
FOR RETAIL STORE SERVICES IN THE FIELD OF GIFTS, HARDWARE, HOUSEWARES AND HOME FURNISHINGS (U.S. CLS. 100, 101 AND 102).
FIRST USE 6-0-1996; IN COMMERCE 6-0-1996.
DAVID H. STINE, EXAMINING ATTORNEY

CLASS 35—(Continued).

SN 77-155,976. FEDERAL EXPRESS CORPORATION, MEMPHIS, TN. AND KINKO'S VENTURES, INC., DALLAS, TX. FILED 4-13-2007.



OWNER OF U.S. REG. NOS. 3,124,984, 3,234,282 AND OTHERS.

NO CLAIM IS MADE TO THE EXCLUSIVE RIGHT TO USE "OFFICE AND PRINT CENTER", APART FROM THE MARK AS SHOWN.

THE MARK CONSISTS OF THE WORDS FEDEX KINKO'S OFFICE AND PRINT CENTER WITH A STAR WITH CENTER TRIANGLE.

FOR RETAIL STORE SERVICES FEATURING PAPER, NAMELY WRITING, TYPING, PRINTING, DRAWING, PHOTOCOPYING, BOND, LASER, LETTERHEAD AND COLOR PAPER; PHOTOGRAPHS; STATIONERY; ENVELOPES; BUSINESS CARDS; POSTCARDS; CALENDARS; ANNOUNCEMENT CARDS; INVITATIONS; WRITING AND DRAFTING INSTRUMENTS, NAMELY PENS, PENCILS, MARKERS AND HIGHLIGHTING MARKERS; OFFICE REQUISITES, NAMELY BINDER CLIPS, BOOKMARKS, BUBBLE MAILERS, CORRECTION FLUID, GLUE STICKS, NOTEPADS, ORDER PADS, PLASTIC BAGS, PAPER CLIPS, SELF-ADHESIVE PADS, RUBBER BANDS, DRAWING RULERS AND ADHESIVE TAPE FOR HOUSEHOLD AND OFFICE USE; PRINTERS TYPE AND PRINTING BLOCKS; AND PHOTOGRAPHIC REPRODUCTIONS, BROCHURES RELATING TO RESUME DRAFTING, JOB INTERVIEWING AND DEVELOPING BUSINESS SKILLS; PHOTOGRAPHIC SUPPLIES, NAMELY PHOTO ALBUMS, PHOTOGRAPH MOUNTS AND PLASTIC PAGES FOR PHOTOGRAPH ALBUMS (U.S. CLS. 100, 101 AND 102).

FIRST USE 4-26-2004; IN COMMERCE 4-26-2004.
JORDAN BAKER, EXAMINING ATTORNEY

SN 77-159,989. KIM, PAUL K., BEVERLY HILLS, CA. FILED 4-18-2007.

Production Swatch

THE MARK CONSISTS OF STANDARD CHARACTERS WITHOUT CLAIM TO ANY PARTICULAR FONT, STYLE, SIZE, OR COLOR.

NO CLAIM IS MADE TO THE EXCLUSIVE RIGHT TO USE "PRODUCTION", APART FROM THE MARK AS SHOWN.

FOR PROVIDING CONSUMER INFORMATION SERVICES AND MAKING REFERRALS IN THE FIELD OF ENTERTAINMENT SERVICES FOR PRODUCTS, SERVICES, EVENTS, ACTIVITIES, FACILITIES AND LOCATIONS (U.S. CLS. 100, 101 AND 102).

AMEETA JORDAN, EXAMINING ATTORNEY

CLASS 35—(Continued).

SN 77-160,008. KIM, PAUL K., BEVERLY HILLS, CA. FILED 4-18-2007.

Location Swatch

THE MARK CONSISTS OF STANDARD CHARACTERS WITHOUT CLAIM TO ANY PARTICULAR FONT, STYLE, SIZE, OR COLOR.

NO CLAIM IS MADE TO THE EXCLUSIVE RIGHT TO USE LOCATION, APART FROM THE MARK AS SHOWN.

FOR PROVIDING CONSUMER INFORMATION SERVICES AND MAKING REFERRALS IN THE FIELD OF ENTERTAINMENT SERVICES FOR PRODUCTS, SERVICES, EVENTS, ACTIVITIES, FACILITIES AND LOCATIONS (U.S. CLS. 100, 101 AND 102).

AMEETA JORDAN, EXAMINING ATTORNEY

SN 77-162,274. ITRON, INC., LIBERTY LAKE, WA. FILED 4-20-2007.

CHOICECONNECT

THE MARK CONSISTS OF STANDARD CHARACTERS WITHOUT CLAIM TO ANY PARTICULAR FONT, STYLE, SIZE, OR COLOR.

FOR DATABASE MANAGEMENT; COMPUTERIZED DATABASE MANAGEMENT; DATA PROCESSING SERVICES ALL FOR USE IN THE UTILITY AND ENERGY INDUSTRIES (U.S. CLS. 100, 101 AND 102).

FRANK LATTUCA, EXAMINING ATTORNEY

SN 77-162,763. TXDC, L.P., IRVING, TX. FILED 4-23-2007.

ZALES COMPANY STORE

THE MARK CONSISTS OF STANDARD CHARACTERS WITHOUT CLAIM TO ANY PARTICULAR FONT, STYLE, SIZE, OR COLOR.

OWNER OF U.S. REG. NOS. 1,364,390, 2,133,109 AND OTHERS.

NO CLAIM IS MADE TO THE EXCLUSIVE RIGHT TO USE "COMPANY STORE", APART FROM THE MARK AS SHOWN.

FOR RETAIL JEWELRY STORE SERVICES (U.S. CLS. 100, 101 AND 102).

MARY CRAWFORD, EXAMINING ATTORNEY

CLASS 35—(Continued).

SN 77-167,809. U.S. NUTRACEUTICALS, L.L.C. D/B/A VA-LENSA INTERNATIONAL, EUSTIS, FL. FILED 4-27-2007.

SILLY NAME...SERIOUS SCIENCE

THE MARK CONSISTS OF STANDARD CHARACTERS WITHOUT CLAIM TO ANY PARTICULAR FONT, STYLE, SIZE, OR COLOR.

FOR RETAIL STORE SERVICES IN THE FIELD OF VITAMINS AND NUTRITIONAL SUPPLEMENTS; ONLINE RETAIL STORE SERVICES, CATALOG ORDERING SERVICES AND ELECTRONIC CATALOG SERVICES FEATURING VITAMINS AND NUTRITIONAL SUPPLEMENTS (U.S. CLS. 100, 101 AND 102).

LANA PHAM, EXAMINING ATTORNEY

SN 77-167,868. MERRILL LYNCH & CO., INC., NEW YORK, NY. FILED 4-27-2007.

ANYTIME, ANYWHERE, ANY AIRLINE

THE MARK CONSISTS OF STANDARD CHARACTERS WITHOUT CLAIM TO ANY PARTICULAR FONT, STYLE, SIZE, OR COLOR.

FOR PROMOTING THE SALE OF CREDIT CARD ACCOUNTS THROUGH THE ADMINISTRATION OF INCENTIVE AWARD PROGRAMS (U.S. CLS. 100, 101 AND 102).

FIRST USE 1-26-2007; IN COMMERCE 1-26-2007.

PAULA MAHONEY, EXAMINING ATTORNEY

CLASS 35—(Continued).

SN 77-168,202. CONFEDALOT, BALTIMORE, MD. FILED 4-27-2007.

CONFEDALOT

THE MARK CONSISTS OF STANDARD CHARACTERS WITHOUT CLAIM TO ANY PARTICULAR FONT, STYLE, SIZE, OR COLOR.

FOR ON-LINE RETAIL STORE SERVICES FEATURING GOODS IN THE FIELD OF CIVIL WAR AND CONFEDERATE HISTORY, NAMELY, CLOTHING, JEWELRY, WATCHES, NECKLACES, RINGS, EARRINGS, BODY JEWELRY, HAT AND LAPEL PINS, FABRIC, CURTAINS, CLOCKS, WALLPAPER, NAPKINS, TABLE CLOTHS, PILLOWS, BEDDING, BLANKETS, COMFORTERS, GLASSWARE, SALT AND PEPPER SHAKERS, ASHTRAYS, INSULATED COOLER BAGS, TOWELS, PILLOW CASES, AND HOUSE WARE ITEMS, NAMELY, FABRIC, CURTAINS, CLOCKS, WALLPAPER, NAPKINS, TABLE CLOTHS, PILLOWS, BEDDING, BLANKETS, COMFORTERS, GLASSWARE, SALT AND PEPPER SHAKERS, ASHTRAYS, INSULATED COOLER BAGS, TOWELS, PILLOW CASES, GLASSWARE GIFT SETS, KEY CHAINS, FLAGS, TAGS, AND PET ITEMS; RETAIL STORE SERVICES FEATURING GOODS IN THE FIELD OF CIVIL WAR AND CONFEDERATE HISTORY, NAMELY, CLOTHING, JEWELRY, WATCHES, NECKLACES, RINGS, EARRINGS, BODY JEWELRY, HAT AND LAPEL PINS, FABRIC, CURTAINS, CLOCKS, WALLPAPER, NAPKINS, TABLE CLOTHS, PILLOWS, BEDDING, BLANKETS, COMFORTERS, GLASSWARE, SALT AND PEPPER SHAKERS, ASHTRAYS, INSULATED COOLER BAGS, TOWELS, PILLOW CASES, AND HOUSE WARE ITEMS, NAMELY, FABRIC, CURTAINS, CLOCKS, WALLPAPER, NAPKINS, TABLE CLOTHS, PILLOWS, BEDDING, BLANKETS, COMFORTERS, GLASSWARE, SALT AND PEPPER SHAKERS, ASHTRAYS, INSULATED COOLER BAGS, TOWELS, PILLOW CASES, GLASSWARE GIFT SETS, KEY CHAINS, FLAGS, TAGS, AND PET ITEMS (U.S. CLS. 100, 101 AND 102).

FIRST USE 12-29-1998; IN COMMERCE 12-29-1999.
DAVID MILLER, EXAMINING ATTORNEY

SN 77-171,164. BATH & BODY WORKS BRAND MANAGEMENT, INC., REYNOLDSBURG, OH. FILED 5-2-2007.

HAPPY GIFTMAS

THE MARK CONSISTS OF STANDARD CHARACTERS WITHOUT CLAIM TO ANY PARTICULAR FONT, STYLE, SIZE, OR COLOR.

FOR RETAIL STORE SERVICES, MAIL ORDER RETAIL STORE SERVICES AND ONLINE RETAIL STORE SERVICES ALL IN THE FIELD OF PERSONAL CARE PRODUCTS, COSMETICS, HOME FRAGRANCE PRODUCTS AND ACCESSORIES (U.S. CLS. 100, 101 AND 102).

SUNG IN, EXAMINING ATTORNEY

CLASS 35—(Continued).

SN 77-171,171. BATH & BODY WORKS BRAND MANAGEMENT, INC., REYNOLDSBURG, OH. FILED 5-2-2007.

FRAGRANCE IS FASHION

THE MARK CONSISTS OF STANDARD CHARACTERS WITHOUT CLAIM TO ANY PARTICULAR FONT, STYLE, SIZE, OR COLOR.

FOR RETAIL STORE SERVICES, MAIL ORDER RETAIL STORE SERVICES AND ONLINE RETAIL STORE SERVICES ALL IN THE FIELD OF PERSONAL CARE PRODUCTS, COSMETICS, HOME FRAGRANCE PRODUCTS AND ACCESSORIES (U.S. CLS. 100, 101 AND 102).

SUNG IN, EXAMINING ATTORNEY

SN 77-171,179. BATH & BODY WORKS BRAND MANAGEMENT, INC., REYNOLDSBURG, OH. FILED 5-2-2007.

FRAGRANCE IS OUR FASHION

THE MARK CONSISTS OF STANDARD CHARACTERS WITHOUT CLAIM TO ANY PARTICULAR FONT, STYLE, SIZE, OR COLOR.

FOR RETAIL STORE SERVICES, MAIL ORDER RETAIL STORE SERVICES AND ONLINE RETAIL STORE SERVICES ALL IN THE FIELD OF PERSONAL CARE PRODUCTS, COSMETICS, HOME FRAGRANCE PRODUCTS AND ACCESSORIES (U.S. CLS. 100, 101 AND 102).

SUNG IN, EXAMINING ATTORNEY

SN 77-171,832. BACK TO BED, INC., BLOOMINGDALE, IL. FILED 5-3-2007.

FOR THE SLEEP YOU DREAM ABOUT!

THE MARK CONSISTS OF STANDARD CHARACTERS WITHOUT CLAIM TO ANY PARTICULAR FONT, STYLE, SIZE, OR COLOR.

FOR RETAIL STORE SERVICES FEATURING BEDROOM FURNITURE AND OTHER BEDROOM ACCESSORIES, MATTRESSES, BOX SPRINGS, BEDDING, NAMELY, PILLOWS, SHEETS, BLANKETS, BED COVERS, MATTRESS PADS AND PILLOW CASES; RETAIL STORE SERVICES ALSO FEATURING BACK CARE PRODUCTS, FEATURING MASSAGERS, CHAIRS, AND OTHER PRODUCTS TO CARE FOR A PERSON'S BACK (U.S. CLS. 100, 101 AND 102).

FIRST USE 5-5-2007; IN COMMERCE 5-5-2007.
LESLIE RICHARDS, EXAMINING ATTORNEY

CLASS 35—(Continued).

SN 77-173,773. FTEN, INC., NEW YORK, NY. FILED 5-5-2007.

EdgeXpress

THE MARK CONSISTS OF STANDARD CHARACTERS WITHOUT CLAIM TO ANY PARTICULAR FONT, STYLE, SIZE, OR COLOR.

FOR ANALYZING AND COMPILING DATA FOR MEASURING THE PERFORMANCE OF FINANCIAL MARKETS (U.S. CLS. 100, 101 AND 102).

TONI HICKEY, EXAMINING ATTORNEY

SN 77-177,079. ULTRA CONCURRENT, INC., APTOS, CA. FILED 5-9-2007.

ONTOBOX

THE MARK CONSISTS OF STANDARD CHARACTERS WITHOUT CLAIM TO ANY PARTICULAR FONT, STYLE, SIZE, OR COLOR.

FOR BUSINESS ADVICE AND COMMERCIAL INFORMATION; DISSEMINATION OF ADVERTISING FOR OTHERS VIA THE INTERNET; PROVIDING CONSUMER PRODUCT INFORMATION VIA THE INTERNET; COMPARISON SHOPPING SERVICES; PROVIDING ON-LINE DIRECTORY INFORMATION SERVICES ALSO FEATURING HYPERLINKS TO OTHER WEB SITES; ON-LINE ADVERTISING AND MARKETING SERVICES (U.S. CLS. 100, 101 AND 102).

KELLY BOULTON, EXAMINING ATTORNEY

SN 77-177,563. ULTRA CONCURRENT, INC., APTOS, CA. FILED 5-10-2007.

ONTOUP

THE MARK CONSISTS OF STANDARD CHARACTERS WITHOUT CLAIM TO ANY PARTICULAR FONT, STYLE, SIZE, OR COLOR.

FOR BUSINESS ADVICE AND COMMERCIAL INFORMATION; DISSEMINATION OF ADVERTISING FOR OTHERS VIA THE INTERNET; PROVIDING CONSUMER PRODUCT INFORMATION VIA THE INTERNET; COMPARISON SHOPPING SERVICES; PROVIDING ON-LINE DIRECTORY INFORMATION SERVICES ALSO FEATURING HYPERLINKS TO OTHER WEB SITES; ON-LINE ADVERTISING AND MARKETING SERVICES (U.S. CLS. 100, 101 AND 102).

KELLY BOULTON, EXAMINING ATTORNEY

CLASS 35—(Continued).

SN 77-177,565. ULTRA CONCURRENT, INC., APTOS, CA. FILED 5-10-2007.

ONTODOWN

THE MARK CONSISTS OF STANDARD CHARACTERS WITHOUT CLAIM TO ANY PARTICULAR FONT, STYLE, SIZE, OR COLOR.

FOR BUSINESS ADVICE AND COMMERCIAL INFORMATION; DISSEMINATION OF ADVERTISING FOR OTHERS VIA THE INTERNET; PROVIDING CONSUMER PRODUCT INFORMATION VIA THE INTERNET; COMPARISON SHOPPING SERVICES; PROVIDING ON-LINE DIRECTORY INFORMATION SERVICES ALSO FEATURING HYPERLINKS TO OTHER WEB SITES; ON-LINE ADVERTISING AND MARKETING SERVICES (U.S. CLS. 100, 101 AND 102).

KELLY BOULTON, EXAMINING ATTORNEY

SN 77-177,580. ULTRA CONCURRENT, INC., APTOS, CA. FILED 5-10-2007.

ONTOGAMBLING

THE MARK CONSISTS OF STANDARD CHARACTERS WITHOUT CLAIM TO ANY PARTICULAR FONT, STYLE, SIZE, OR COLOR.

FOR BUSINESS ADVICE AND COMMERCIAL INFORMATION; DISSEMINATION OF ADVERTISING FOR OTHERS VIA THE INTERNET; PROVIDING CONSUMER PRODUCT INFORMATION VIA THE INTERNET; COMPARISON SHOPPING SERVICES; PROVIDING ON-LINE DIRECTORY INFORMATION SERVICES ALSO FEATURING HYPERLINKS TO OTHER WEB SITES; ON-LINE ADVERTISING AND MARKETING SERVICES (U.S. CLS. 100, 101 AND 102).

KELLY BOULTON, EXAMINING ATTORNEY

SN 77-177,584. ULTRA CONCURRENT, INC., APTOS, CA. FILED 5-10-2007.

ONTOLIST

THE MARK CONSISTS OF STANDARD CHARACTERS WITHOUT CLAIM TO ANY PARTICULAR FONT, STYLE, SIZE, OR COLOR.

FOR BUSINESS ADVICE AND COMMERCIAL INFORMATION; DISSEMINATION OF ADVERTISING FOR OTHERS VIA THE INTERNET; PROVIDING CONSUMER PRODUCT INFORMATION VIA THE INTERNET; COMPARISON SHOPPING SERVICES; PROVIDING ON-LINE DIRECTORY INFORMATION SERVICES ALSO FEATURING HYPERLINKS TO OTHER WEB SITES; ON-LINE ADVERTISING AND MARKETING SERVICES (U.S. CLS. 100, 101 AND 102).

KELLY BOULTON, EXAMINING ATTORNEY

CLASS 35—(Continued).

SN 77-177,592. ULTRACONCURRENT, INC., APTOS, CA.
FILED 5-10-2007.

CLASS 35—(Continued).

SN 77-178,754. ABERCROMBIE & FITCH TRADING CO.,
NEW ALBANY, OH. FILED 5-11-2007.

ONTOSEARCH

THE MARK CONSISTS OF STANDARD CHARACTERS WITHOUT CLAIM TO ANY PARTICULAR FONT, STYLE, SIZE, OR COLOR.

FOR BUSINESS ADVICE AND COMMERCIAL INFORMATION; DISSEMINATION OF ADVERTISING FOR OTHERS VIA THE INTERNET; PROVIDING CONSUMER PRODUCT INFORMATION VIA THE INTERNET; COMPARISON SHOPPING SERVICES; PROVIDING ON-LINE DIRECTORY INFORMATION SERVICES ALSO FEATURING HYPERLINKS TO OTHER WEB SITES; ON-LINE ADVERTISING AND MARKETING SERVICES (U.S. CLS. 100, 101 AND 102).

KELLY BOULTON, EXAMINING ATTORNEY



SN 77-177,979. CALLAWAY GOLF COMPANY, CARLSBAD,
CA. FILED 5-10-2007.

MY CALLAWAY

THE MARK CONSISTS OF STANDARD CHARACTERS WITHOUT CLAIM TO ANY PARTICULAR FONT, STYLE, SIZE, OR COLOR.

OWNER OF U.S. REG. NOS. 2,097,166 AND 2,225,802.
FOR ONLINE SERVICES FOR GOLF PRODUCTS, NAMELY, GOLF EQUIPMENT REGISTRATION SERVICES FOR ADVERTISING AND MARKETING PURPOSES, PROMOTING THE SALE OF GOODS AND SERVICES OF OTHERS THROUGH THE DISTRIBUTION OF PRINTED MATERIAL AND PROMOTIONAL CONTESTS RELATED TO GOLF AND GOLF EQUIPMENT, TRACKING GOLF EQUIPMENT PURCHASES FOR OTHERS FOR ADVERTISING AND MARKETING PURPOSES AND PREPARING MAILING LISTS RELATED TO GOLF AND GOLF EQUIPMENT (U.S. CLS. 100, 101 AND 102).

FIRST USE 5-31-2006; IN COMMERCE 5-31-2006.
SAMUEL E. SHARPER JR., EXAMINING ATTORNEY

THE MARK CONSISTS OF A MISCELLANEOUS DESIGN.

FOR ON-LINE RETAIL STORE SERVICES FEATURING CLOTHING, INTIMATE APPAREL AND ACCESSORIES, ATHLETIC WEAR AND ACCESSORIES, SWIM WEAR AND ACCESSORIES, FASHION ACCESSORIES, BAGS, FRAGRANCES, AND JEWELRY; CATALOG ORDERING SERVICE FEATURING CLOTHING, INTIMATE APPAREL AND ACCESSORIES, ATHLETIC WEAR AND ACCESSORIES, SWIM WEAR AND ACCESSORIES, FASHION ACCESSORIES, BAGS, FRAGRANCES, AND JEWELRY; RETAIL STORE SERVICES FEATURING CLOTHING, INTIMATE APPAREL AND ACCESSORIES, ATHLETIC WEAR AND ACCESSORIES, SWIM WEAR AND ACCESSORIES, FASHION ACCESSORIES, BAGS, FRAGRANCES, AND JEWELRY (U.S. CLS. 100, 101 AND 102).

JOHN WILKE, EXAMINING ATTORNEY

CLASS 35—(Continued).

SN 77-178,777. ABERCROMBIE & FITCH TRADING CO., NEW ALBANY, OH. FILED 5-11-2007.



THE NAME(S), PORTRAIT(S), AND/OR SIGNATURE(S) SHOWN IN THE MARK DOES NOT IDENTIFY A PARTICULAR LIVING INDIVIDUAL.

THE MARK CONSISTS OF A MISCELLANEOUS DESIGN WITH THE TERM GILLY H.

FOR ON-LINE RETAIL STORE SERVICES FEATURING CLOTHING, INTIMATE APPAREL AND ACCESSORIES, ATHLETIC WEAR AND ACCESSORIES, SWIM WEAR AND ACCESSORIES, FASHION ACCESSORIES, BAGS, FRAGRANCES, JEWELRY AND CANDLES; RETAIL STORE SERVICES FEATURING CLOTHING, INTIMATE APPAREL AND ACCESSORIES, ATHLETIC WEAR AND ACCESSORIES, SWIM WEAR AND ACCESSORIES, FASHION ACCESSORIES, BAGS, FRAGRANCES, JEWELRY AND CANDLES; CATALOG ORDERING SERVICE FEATURING CLOTHING, INTIMATE APPAREL AND ACCESSORIES, ATHLETIC WEAR AND ACCESSORIES, SWIM WEAR AND ACCESSORIES, FASHION ACCESSORIES, BAGS, FRAGRANCES, JEWELRY AND CANDLES (U.S. CLS. 100, 101 AND 102).

JOHN WILKE, EXAMINING ATTORNEY

CLASS 35—(Continued).

SN 77-178,788. ABERCROMBIE & FITCH TRADING CO., NEW ALBANY, OH. FILED 5-11-2007.



THE NAME(S), PORTRAIT(S), AND/OR SIGNATURE(S) SHOWN IN THE MARK DOES NOT IDENTIFY A PARTICULAR LIVING INDIVIDUAL.

THE MARK CONSISTS OF A MISCELLANEOUS DESIGN WITH THE TERM GILLY H.

FOR ON-LINE RETAIL STORE SERVICES FEATURING CLOTHING, INTIMATE APPAREL AND ACCESSORIES, ATHLETIC WEAR AND ACCESSORIES, SWIM WEAR AND ACCESSORIES, FASHION ACCESSORIES, BAGS, FRAGRANCES, JEWELRY AND CANDLES; RETAIL STORE SERVICES FEATURING CLOTHING, INTIMATE APPAREL AND ACCESSORIES, ATHLETIC WEAR AND ACCESSORIES, SWIM WEAR AND ACCESSORIES, FASHION ACCESSORIES, BAGS, FRAGRANCES, JEWELRY AND CANDLES; CATALOG ORDERING SERVICE FEATURING CLOTHING, INTIMATE APPAREL AND ACCESSORIES, ATHLETIC WEAR AND ACCESSORIES, SWIM WEAR AND ACCESSORIES, FASHION ACCESSORIES, BAGS, FRAGRANCES, JEWELRY AND CANDLES (U.S. CLS. 100, 101 AND 102).

JOHN WILKE, EXAMINING ATTORNEY

SN 77-179,508. THE TRUSTEES OF THE GREATER GRACE NEW TESTAMENT CHURCH OF CONYERS 2000 CHURCH TRUST, CONYERS, GA. FILED 5-12-2007.

Boats for Christ

THE MARK CONSISTS OF STANDARD CHARACTERS WITHOUT CLAIM TO ANY PARTICULAR FONT, STYLE, SIZE, OR COLOR.

NO CLAIM IS MADE TO THE EXCLUSIVE RIGHT TO USE "BOATS", APART FROM THE MARK AS SHOWN.

FOR AUTOMOBILE DEALERSHIP (U.S. CLS. 100, 101 AND 102).

SHANNON TWOHIG, EXAMINING ATTORNEY

CLASS 35—(Continued).

SN 77-181,683. ULTRA CONCURRENT, INC., APTOS, CA. FILED 5-15-2007.

ONTOLEFT

THE MARK CONSISTS OF STANDARD CHARACTERS WITHOUT CLAIM TO ANY PARTICULAR FONT, STYLE, SIZE, OR COLOR.

FOR BUSINESS ADVICE AND COMMERCIAL INFORMATION; DISSEMINATION OF ADVERTISING FOR OTHERS VIA THE INTERNET; PROVIDING CONSUMER PRODUCT INFORMATION VIA THE INTERNET; COMPARISON SHOPPING SERVICES; PROVIDING ON-LINE DIRECTORY INFORMATION SERVICES ALSO FEATURING HYPERLINKS TO OTHER WEB SITES; ON-LINE ADVERTISING AND MARKETING SERVICES (U.S. CLS. 100, 101 AND 102).

KELLY BOULTON, EXAMINING ATTORNEY

CLASS 35—(Continued).

SN 77-181,692. ULTRA CONCURRENT, INC., APTOS, CA. FILED 5-15-2007.

ONTOHELP

THE MARK CONSISTS OF STANDARD CHARACTERS WITHOUT CLAIM TO ANY PARTICULAR FONT, STYLE, SIZE, OR COLOR.

FOR BUSINESS ADVICE AND COMMERCIAL INFORMATION; DISSEMINATION OF ADVERTISING FOR OTHERS VIA THE INTERNET; PROVIDING CONSUMER PRODUCT INFORMATION VIA THE INTERNET; COMPARISON SHOPPING SERVICES; PROVIDING ON-LINE DIRECTORY INFORMATION SERVICES ALSO FEATURING HYPERLINKS TO OTHER WEB SITES; ON-LINE ADVERTISING AND MARKETING SERVICES (U.S. CLS. 100, 101 AND 102).

KELLY BOULTON, EXAMINING ATTORNEY

SN 77-181,685. ULTRA CONCURRENT, INC., APTOS, CA. FILED 5-15-2007.

ONTORIGHT

THE MARK CONSISTS OF STANDARD CHARACTERS WITHOUT CLAIM TO ANY PARTICULAR FONT, STYLE, SIZE, OR COLOR.

FOR BUSINESS ADVICE AND COMMERCIAL INFORMATION; DISSEMINATION OF ADVERTISING FOR OTHERS VIA THE INTERNET; PROVIDING CONSUMER PRODUCT INFORMATION VIA THE INTERNET; COMPARISON SHOPPING SERVICES; PROVIDING ON-LINE DIRECTORY INFORMATION SERVICES ALSO FEATURING HYPERLINKS TO OTHER WEB SITES; ON-LINE ADVERTISING AND MARKETING SERVICES (U.S. CLS. 100, 101 AND 102).

KELLY BOULTON, EXAMINING ATTORNEY

SN 77-181,695. ULTRA CONCURRENT, INC., APTOS, CA. FILED 5-15-2007.

ONTOSUPPORT

THE MARK CONSISTS OF STANDARD CHARACTERS WITHOUT CLAIM TO ANY PARTICULAR FONT, STYLE, SIZE, OR COLOR.

FOR BUSINESS ADVICE AND COMMERCIAL INFORMATION; DISSEMINATION OF ADVERTISING FOR OTHERS VIA THE INTERNET; PROVIDING CONSUMER PRODUCT INFORMATION VIA THE INTERNET; COMPARISON SHOPPING SERVICES; PROVIDING ON-LINE DIRECTORY INFORMATION SERVICES ALSO FEATURING HYPERLINKS TO OTHER WEB SITES; ON-LINE ADVERTISING AND MARKETING SERVICES (U.S. CLS. 100, 101 AND 102).

KELLY BOULTON, EXAMINING ATTORNEY

SN 77-181,686. ULTRA CONCURRENT, INC., APTOS, CA. FILED 5-15-2007.

ONTOFINDER

THE MARK CONSISTS OF STANDARD CHARACTERS WITHOUT CLAIM TO ANY PARTICULAR FONT, STYLE, SIZE, OR COLOR.

FOR BUSINESS ADVICE AND COMMERCIAL INFORMATION; DISSEMINATION OF ADVERTISING FOR OTHERS VIA THE INTERNET; PROVIDING CONSUMER PRODUCT INFORMATION VIA THE INTERNET; COMPARISON SHOPPING SERVICES; PROVIDING ON-LINE DIRECTORY INFORMATION SERVICES ALSO FEATURING HYPERLINKS TO OTHER WEB SITES; ON-LINE ADVERTISING AND MARKETING SERVICES (U.S. CLS. 100, 101 AND 102).

KELLY BOULTON, EXAMINING ATTORNEY

SN 77-187,162. ULTRA CONCURRENT, INC., APTOS, CA. FILED 5-22-2007.

ONTOFORWARD

THE MARK CONSISTS OF STANDARD CHARACTERS WITHOUT CLAIM TO ANY PARTICULAR FONT, STYLE, SIZE, OR COLOR.

FOR BUSINESS ADVICE AND COMMERCIAL INFORMATION; DISSEMINATION OF ADVERTISING FOR OTHERS VIA THE INTERNET; PROVIDING CONSUMER PRODUCT INFORMATION VIA THE INTERNET; COMPARISON SHOPPING SERVICES; PROVIDING ON-LINE DIRECTORY INFORMATION SERVICES ALSO FEATURING HYPERLINKS TO OTHER WEB SITES; ON-LINE ADVERTISING AND MARKETING SERVICES (U.S. CLS. 100, 101 AND 102).

KELLY BOULTON, EXAMINING ATTORNEY

CLASS 35—(Continued).

SN 77-187,165. ULTRACONCURRENT, INC., APTOS, CA. FILED 5-22-2007.

ONTOBACK

THE MARK CONSISTS OF STANDARD CHARACTERS WITHOUT CLAIM TO ANY PARTICULAR FONT, STYLE, SIZE, OR COLOR.

FOR BUSINESS ADVICE AND COMMERCIAL INFORMATION; DISSEMINATION OF ADVERTISING FOR OTHERS VIA THE INTERNET; PROVIDING CONSUMER PRODUCT INFORMATION VIA THE INTERNET; COMPARISON SHOPPING SERVICES; PROVIDING ON-LINE DIRECTORY INFORMATION SERVICES ALSO FEATURING HYPERLINKS TO OTHER WEB SITES; ON-LINE ADVERTISING AND MARKETING SERVICES (U.S. CLS. 100, 101 AND 102).

KELLY BOULTON, EXAMINING ATTORNEY

SN 77-187,171. ULTRACONCURRENT, INC., APTOS, CA. FILED 5-22-2007.

ONTOCATEGORY

THE MARK CONSISTS OF STANDARD CHARACTERS WITHOUT CLAIM TO ANY PARTICULAR FONT, STYLE, SIZE, OR COLOR.

FOR BUSINESS ADVICE AND COMMERCIAL INFORMATION; DISSEMINATION OF ADVERTISING FOR OTHERS VIA THE INTERNET; PROVIDING CONSUMER PRODUCT INFORMATION VIA THE INTERNET; COMPARISON SHOPPING SERVICES; PROVIDING ON-LINE DIRECTORY INFORMATION SERVICES ALSO FEATURING HYPERLINKS TO OTHER WEB SITES; ON-LINE ADVERTISING AND MARKETING SERVICES (U.S. CLS. 100, 101 AND 102).

KELLY BOULTON, EXAMINING ATTORNEY

CLASS 35—(Continued).

SN 77-189,787. ALLERGAN, INC., IRVINE, CA. FILED 5-24-2007.

BOTOX CARE CONNECTION

THE MARK CONSISTS OF STANDARD CHARACTERS WITHOUT CLAIM TO ANY PARTICULAR FONT, STYLE, SIZE, OR COLOR.

OWNER OF U.S. REG. NOS. 1,692,384, 2,510,675 AND OTHERS.

NO CLAIM IS MADE TO THE EXCLUSIVE RIGHT TO USE "CARE", APART FROM THE MARK AS SHOWN.

FOR PROVIDING INFORMATION ABOUT THE ADMINISTRATION OF PATIENT REIMBURSEMENT PROGRAMS DESIGNED TO ASSIST PATIENTS REGARDING MEDICAL TREATMENT PAYMENT PLAN OPTIONS; ASSISTANCE TO PATIENTS REGARDING TREATMENT PAYMENT PLAN OPTIONS, NAMELY, ADMINISTRATION OF PATIENT REIMBURSEMENT PROGRAMS (U.S. CLS. 100, 101 AND 102).

FIRST USE 4-27-2007; IN COMMERCE 5-14-2007.

SIMON TENG, EXAMINING ATTORNEY

SN 77-195,173. HBI BRANDED APPAREL LIMITED, INC., WINSTON-SALEM, NC. FILED 6-1-2007.

ONE HANES PLACE

THE MARK CONSISTS OF STANDARD CHARACTERS WITHOUT CLAIM TO ANY PARTICULAR FONT, STYLE, SIZE, OR COLOR.

OWNER OF U.S. REG. NOS. 2,136,325 AND 2,978,187.

FOR ON-LINE RETAIL STORE SERVICES FEATURING CLOTHING AND RELATED ACCESSORIES (U.S. CLS. 100, 101 AND 102).

FIRST USE 10-31-1996; IN COMMERCE 10-31-1996.

LEE-ANNE BERNS, EXAMINING ATTORNEY

SN 77-201,206. QWEST COMMUNICATIONS INTERNATIONAL INC., DENVER, CO. FILED 6-8-2007.



THE MARK CONSISTS OF A CLOCK AND WORDS. FOR RESIDENTIAL RELOCATION SERVICES, NAMELY PROVIDING A SITE ON A GLOBAL COMPUTER NETWORK FEATURING INFORMATION ON SERVICES USED BY INDIVIDUALS IN THE PROCESS OF RELOCATING (U.S. CLS. 100, 101 AND 102).

FIRST USE 5-15-2007; IN COMMERCE 5-15-2007.

RONALD MCMORROW, EXAMINING ATTORNEY

CLASS 35—(Continued).

SN 77-207,893. CALZADO MINI-BURBUJAS, S.A. DE C.V., LEON, MEXICO, FILED 6-16-2007.

For Parents who care

OWNER OF U.S. REG. NOS. 2,389,143, 2,473,931 AND 3,262,285.

THE MARK CONSISTS OF THE WORDS MINI BUBBLES IN PROMINENT STYLIZED LETTERS BELOW OF WHICH APPEARS THE PHRASE FOR PARENTS WHO CARE IN SMALL STYLIZED LETTERS. ABOVE THE LETTERS "ES" OF THE WORD BUBBLES APPEAR FOUR CIRCLES IN DIFFERENT SIZES.

FOR RETAIL STORE SERVICES FEATURING FOOTWEAR FOR CHILDREN, NAMELY, SHOES, SANDALS, SLIPPERS, BOOTS, ATHLETIC SHOES, BEACH FOOTWEAR, SNEAKERS AND TENNIS SHOES (U.S. CLS. 100, 101 AND 102).

FIRST USE 9-2-2004; IN COMMERCE 5-8-2006.
ESTHER A. BORSUK, EXAMINING ATTORNEY

SN 77-212,281. JOYFUL EVENTS, LLC, CHANDLER, AZ. FILED 6-21-2007.

JOYFUL EVENTS PLANNER

THE MARK CONSISTS OF STANDARD CHARACTERS WITHOUT CLAIM TO ANY PARTICULAR FONT, STYLE, SIZE, OR COLOR.

NO CLAIM IS MADE TO THE EXCLUSIVE RIGHT TO USE "EVENTS PLANNER", APART FROM THE MARK AS SHOWN.

FOR RETAIL STORE SERVICES FEATURING A WIDE VARIETY OF CONSUMER PRODUCTS FOR WEDDINGS, QUINCEANERAS, PARTIES, PROMS, AND OTHER CELEBRATIONS; PROMOTING THE GOODS AND SERVICES OF OTHERS BY PROVIDING HYPERTEXT LINKS TO THE WEB SITES OF OTHERS; PROVIDING A WEB SITE WHICH FEATURES ADVERTISEMENTS FOR THE GOODS AND SERVICES OF OTHERS ON A GLOBAL COMPUTER NETWORK (U.S. CLS. 100, 101 AND 102).

FIRST USE 5-0-2007; IN COMMERCE 5-0-2007.
JENNIFER HETU, EXAMINING ATTORNEY

CLASS 35—(Continued).

SN 78-184,995. NETHERLANDS BOARD OF TOURISM, NEW YORK, NY. FILED 11-14-2002.

COOLCAPITALS

FOR PROVIDING ADVERTISING, MARKETING AND PROMOTIONAL SERVICES, NAMELY DISSEMINATION OF ADVERTISING MATERIAL. (U.S. CLS. 100, 101 AND 102).

GINA HAYES, EXAMINING ATTORNEY

SN 78-225,308. TAYLOR NELSON SOFRES PLC, LONDON, UNITED KINGDOM, FILED 3-13-2003.

TNS-GLOBAL

OWNER OF ERPN CMNTY TM OFC REG. NO. 003020955, DATED 9-25-2006, EXPIRES 2-3-2013.

FOR MARKET RESEARCH SERVICES; MARKET ANALYSIS SERVICES; CONDUCTING MARKETING STUDIES; COST AND/OR PRICE ANALYSIS SERVICES RELATING TO MARKET RESEARCH; BUSINESS MANAGEMENT AND BUSINESS CONSULTING SERVICES RELATING TO MARKET RESEARCH; BUSINESS INFORMATION SERVICES RELATING TO MARKET RESEARCH; BUSINESS RESEARCH AND SURVEY SERVICES RELATING TO MARKET RESEARCH; BUSINESS INVESTIGATIONS SERVICES RELATING TO MARKET RESEARCH; BUSINESS MONITORING SERVICES IN THE FIELD OF MARKET RESEARCH; STATISTICAL INFORMATION SERVICES; NAMELY PROVIDING STATISTICAL INFORMATION IN THE FIELD OF MARKET RESEARCH; TRADE INFORMATION SERVICES NAMELY, PROVIDING TRADE INFORMATION IN THE FIELD OF MARKET RESEARCH; OPINION POLLING SERVICES NAMELY, PUBLIC OPINION POLLING; MARKET DATA ANALYSIS IN THE FIELD OF MARKET RESEARCH; AND DATA PROCESSING ANALYSIS SERVICES RELATING TO THE ANALYSIS AND REPORTING OF MARKET RESEARCH STUDIES PROVIDED AS PART OF THE PROVISION OF MARKET RESEARCH SERVICES TO THIRD PARTIES (U.S. CLS. 100, 101 AND 102).

HEATHER BIDDULPH, EXAMINING ATTORNEY

SN 78-383,454. WIND TURBINE & ENERGY CABLES CORP., SUMMIT, NJ. FILED 3-12-2004.

PHOENIX WIRE

THE MARK CONSISTS OF STANDARD CHARACTERS WITHOUT CLAIM TO ANY PARTICULAR FONT, STYLE, SIZE, OR COLOR.

NO CLAIM IS MADE TO THE EXCLUSIVE RIGHT TO USE "WIRE", APART FROM THE MARK AS SHOWN.

FOR MANUFACTURE AND DISTRIBUTION OF WIRE AND CABLE; WHOLESALE DISTRIBUTORSHIPS FEATURING WIRE AND CABLE GOODS; MANUFACTURE OF WIRE AND CABLES (U.S. CLS. 100, 101 AND 102).

RONALD AIKENS, EXAMINING ATTORNEY

CLASS 35—(Continued).

SN 78-550,638. JSB ENTERPRISES, INC., FARMINGTON HILLS, MI. FILED 1-20-2005.

YOUR CELLULAR SUPERSTORE

THE MARK CONSISTS OF STANDARD CHARACTERS WITHOUT CLAIM TO ANY PARTICULAR FONT, STYLE, SIZE, OR COLOR.

OWNER OF U.S. REG. NO. 2,513,344.
NO CLAIM IS MADE TO THE EXCLUSIVE RIGHT TO USE "CELLULAR SUPERSTORE", APART FROM THE MARK AS SHOWN.

SEC. 2(F).
FOR RETAIL STORE SERVICES AND WHOLESALE DISTRIBUTORSHIP SERVICES FEATURING CELLULAR AND WIRELESS TELEPHONE SERVICES, HARDWARE AND ACCESSORIES, NAMELY, CAR CHARGERS, AC ADAPTORS/TRAVEL CHARGERS, HANDS-FREE KITS COMPRISED OF AN EARPHONE-TYPE SPEAKER, A MICROPHONE AND A JACK TO PLUG INTO THE PHONE AND CRADLE UNITS THAT PLUG INTO A CAR CIGARETTE LIGHTER, BATTERIES, LEATHER CASES, VINYL CASES, PLASTIC CASES AND REPLACEMENT HOUSINGS FOR CELLULAR TELEPHONES (U.S. CLS. 100, 101 AND 102).

FIRST USE 4-30-1999; IN COMMERCE 4-30-1999.
JILL C. ALT, EXAMINING ATTORNEY

SN 78-556,202. MINDWAVE RESEARCH, INC., AUSTIN, TX. FILED 1-28-2005.

TAP

THE MARK CONSISTS OF STANDARD CHARACTERS WITHOUT CLAIM TO ANY PARTICULAR FONT, STYLE, SIZE, OR COLOR.

FOR CONDUCTING AN ANNUAL MARKET SURVEY FOR OTHERS OF INFORMATION TECHNOLOGY DECISION MAKERS IN BUSINESS, CONDUCTED IN THE UNITED STATES OF AMERICA ONLY, TO COLLECT DATA THAT IS THEN USED AS A TOOL BY MEDIA PLANNERS AND BUYERS AT ADVERTISING AGENCIES AND THEIR TECHNOLOGY CLIENTS FOR MAKING DECISIONS ABOUT WHERE TO PLACE INFORMATION TECHNOLOGY ADVERTISING IN PRINT MAGAZINES AND WEBSITES (U.S. CLS. 100, 101 AND 102).

FIRST USE 10-25-2004; IN COMMERCE 10-25-2004.
DOMINIC J. FERRAIUOLO, EXAMINING ATTORNEY

CLASS 35—(Continued).

SN 78-631,327. COPELAND ENTERPRISES, DBA COPELAND SPORTS, SAN LUIS OBISPO, CA. FILED 5-17-2005.

A LITTLE OBSESSION AMONG FRIENDS

THE MARK CONSISTS OF STANDARD CHARACTERS WITHOUT CLAIM TO ANY PARTICULAR FONT, STYLE, SIZE, OR COLOR.

FOR RETAIL STORE SERVICES FEATURING CLOTHING, FOOTWEAR, SPORTING GOODS, SPORTING EQUIPMENT AND ACCESSORIES (U.S. CLS. 100, 101 AND 102).

FIRST USE 5-0-2003; IN COMMERCE 11-0-2003.
JASON TURNER, EXAMINING ATTORNEY

SN 78-646,709. AMAZON TECHNOLOGIES, INC., RENO, NV. FILED 6-8-2005.

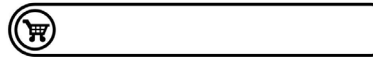

THE MARK CONSISTS OF A HORIZONTAL BAR WITH A SHOPPING CART IN A CIRCLE INSERTED IN THE LEFT SIDE OF THE BAR.

FOR HOUSE MARK FOR COMPUTERIZED ONLINE ORDERING SERVICES IN RETAIL AND WHOLESALE DISTRIBUTION OF GENERAL MERCHANDISE AND GENERAL CONSUMER GOODS (U.S. CLS. 100, 101 AND 102).

FIRST USE 2-2-2005; IN COMMERCE 2-2-2005.
LEIGH CAROLINE CASE, EXAMINING ATTORNEY

SN 78-675,385. KNOWLEDGE SOLUTIONS, LLC, BRIDGEWATER, NJ. FILED 7-21-2005.



NO CLAIM IS MADE TO THE EXCLUSIVE RIGHT TO USE "KNOWLEDGE SOLUTIONS", APART FROM THE MARK AS SHOWN.

FOR BUSINESS CONSULTATION SERVICES RELATING TO CORPORATE INFORMATION MANAGEMENT (U.S. CLS. 100, 101 AND 102).

FIRST USE 3-20-2002; IN COMMERCE 3-20-2002.
TONI HICKEY, EXAMINING ATTORNEY

CLASS 35—(Continued).

SN 78-696,625. AEGIS INTERWORLD, INC., MEMPHIS, TN.
FILED 8-19-2005.

Aegis InterWorld

THE MARK CONSISTS OF STANDARD CHARACTERS WITHOUT CLAIM TO ANY PARTICULAR FONT, STYLE, SIZE, OR COLOR.

FOR OUTSOURCING IN THE FIELD OF BUSINESS PROCESSES (U.S. CLS. 100, 101 AND 102).

SCOTT BALDWIN, EXAMINING ATTORNEY

SN 78-696,704. AEGIS INTERWORLD, INC., MEMPHIS, TN.
FILED 8-19-2005.



THE MARK CONSISTS OF THE LITERAL PORTION OF THE MARK PLUS A STYLIZED GLOBE SURROUNDED BY AN INTERTWINED RIBBON SHAPE.

FOR OUTSOURCING IN THE FIELD OF BUSINESS PROCESSES (U.S. CLS. 100, 101 AND 102).

SCOTT BALDWIN, EXAMINING ATTORNEY

SN 78-724,731. NATIONAL KIDNEY FOUNDATION, NEW YORK, NY. FILED 10-1-2005.



OWNER OF U.S. REG. NO. 1,267,908.

NO CLAIM IS MADE TO THE EXCLUSIVE RIGHT TO USE NATIONAL DONOR FAMILY COUNCIL AND KIDNEY FOUNDATION, APART FROM THE MARK AS SHOWN.

THE COLOR(S) RED, ORANGE AND WHITE ARE CLAIMED AS A FEATURE OF THE MARK.

THE OUTLINE OF THE INTERLOCKING KIDNEYS IN A CIRCULAR FORMATION SHAPED LOGO AND THE

CLASS 35—(Continued).

SQUARE AROUND THE WORD IS DEPICTED IN THE COLOR RED. THE WORDS NATIONAL KIDNEY FOUNDATION, THE LINES ABOVE AND BENEATH THE ACRONYM NDFC AND THE WORDS NATIONAL DONOR FAMILY COUNCIL ARE DEPICTED IN THE COLOR WHITE. THE INSIDE OF THE TWO INTERLOCKING KIDNEY SHAPED DESIGNS ON THE RIGHT OF THE DRAWING ARE DEPICTED IN THE COLOR ORANGE AND THE REMAINING KIDNEY SHAPED OVALS ARE DEPICTED IN THE COLOR WHITES.

THE MARK CONSISTS OF IN PART, OF A DEPICTION OF INTERLOCKING KIDNEYS IN A CIRCULAR FORMATION SHAPED LOGO.

SEC. 2(F) AS TO "NATIONAL KIDNEY FOUNDATION". FOR ASSOCIATION SERVICES, NAMELY, SUPPORTING PATIENTS AND THEIR FAMILIES BY PROMOTING THE PUBLIC AWARENESS OF THE IMPORTANCE OF PREVENTION AND TREATMENT OF KIDNEY AND URINARY TRACT DISEASES AND THE INTEREST, CONCERN AND NEED FOR HUMAN ORGAN DONATIONS AND TRANSPLANTS (U.S. CLS. 100, 101 AND 102).

BRIDGETT SMITH, EXAMINING ATTORNEY

SN 78-733,959. CHILDREN'S PLUS, INC., SOUTH CHICAGO HEIGHTS, IL. FILED 10-14-2005.

UNIVERSITY BOOK SERVICE

THE MARK CONSISTS OF STANDARD CHARACTERS WITHOUT CLAIM TO ANY PARTICULAR FONT, STYLE, SIZE, OR COLOR.

NO CLAIM IS MADE TO THE EXCLUSIVE RIGHT TO USE "BOOK SERVICE", APART FROM THE MARK AS SHOWN.

SEC. 2(F).

FOR MAIL ORDER AND ONLINE RETAIL STORE SERVICES FEATURING CHILDREN'S BOOKS; ONLINE RETAIL STORE ORDERING SERVICES FOR SCHOOLS AND LIBRARIES FEATURING CHILDREN'S BOOKS; DIRECT MAIL MARKETING OF CHILDREN'S BOOKS; CONDUCTING TRADE SHOWS IN THE FIELD OF CHILDREN'S BOOKS; ADVERTISING AND PROMOTION SERVICES AND RELATED CONSULTING TO SCHOOLS AND LIBRARIES IN THE FIELD OF CHILDREN'S BOOKS. (U.S. CLS. 100, 101 AND 102).

FIRST USE 12-31-1956; IN COMMERCE 12-31-1956.

DAHLIA GEORGE, EXAMINING ATTORNEY

CLASS 35—(Continued).

SN 78-741,051. DON'T BLINK AGENCY, LLC, SEATTLE, WA. FILED 10-26-2005.

DON'T BLINK

THE MARK CONSISTS OF STANDARD CHARACTERS WITHOUT CLAIM TO ANY PARTICULAR FONT, STYLE, SIZE, OR COLOR.

FOR INTERNET ADVERTISING AGENCY SERVICES, NAMELY— ONLINE MEDIA PLANNING AND BUYING SERVICES; ONLINE MEDIA ADVERTISING CAMPAIGN CONSULTING, PROGRAM MANAGEMENT AND DATA ANALYSIS SERVICES; EXCLUDING THE AFFILIATION OF THE GOODS AND SERVICES OF OTHERS WITH PROFESSIONAL FOOTBALL GAMES AND RELATED ACTIVITIES (U.S. CLS. 100, 101 AND 102).

FIRST USE 7-0-2005; IN COMMERCE 7-0-2005.
AMEETA JORDAN, EXAMINING ATTORNEY

SN 78-757,408. MISC US TRADEMARK LTD., MISSISSAUGA, ONTARIO, CANADA, FILED 11-18-2005.

BUYSMARTBURN.COM

THE MARK CONSISTS OF STANDARD CHARACTERS WITHOUT CLAIM TO ANY PARTICULAR FONT, STYLE, SIZE, OR COLOR.

FOR ONLINE RETAIL STORE SERVICES FEATURING NUTRITIONAL SUPPLEMENTS (U.S. CLS. 100, 101 AND 102).

LINDA MICKLEBURGH, EXAMINING ATTORNEY

SN 78-760,220. CLUB SWIM, INC., NEWARK, CA. FILED 11-23-2005.

SWIMOUTLET

THE MARK CONSISTS OF STANDARD CHARACTERS WITHOUT CLAIM TO ANY PARTICULAR FONT, STYLE, SIZE, OR COLOR.

SEC. 2(F).
FOR ON-LINE RETAIL STORE SERVICES FEATURING SWIMWEAR, APPAREL, AQUATICS GEAR AND EQUIPMENT, BOOKS AND VIDEOS, AWARDS, SPORTS NUTRITIONAL PRODUCTS, AND PERSONAL CARE PRODUCTS FOR SWIMMERS (U.S. CLS. 100, 101 AND 102).

FIRST USE 12-29-2002; IN COMMERCE 12-29-2002.
MICHELE SWAIN, EXAMINING ATTORNEY

CLASS 35—(Continued).

SN 78-769,363. CERTAINTED CORPORATION, VALLEY FORGE, PA. FILED 12-8-2005.



NO CLAIM IS MADE TO THE EXCLUSIVE RIGHT TO USE "ROOFER'S", APART FROM THE MARK AS SHOWN. SEC. 2(F) AS TO "TRACKRECORD".

FOR CONDUCTING CUSTOMER SATISFACTION SURVEYS IN THE FIELD OF ROOFING (U.S. CLS. 100, 101 AND 102).

FIRST USE 1-0-2001; IN COMMERCE 1-0-2001.
KELLY MCCOY, EXAMINING ATTORNEY

SN 78-806,241. FOODTOWN, INC., AVENEL, NJ. FILED 2-3-2006.

FOODTOWN NATURALLY

THE MARK CONSISTS OF STANDARD CHARACTERS WITHOUT CLAIM TO ANY PARTICULAR FONT, STYLE, SIZE, OR COLOR.

THE APPLICANT CLAIMS EXCLUSIVE USE OF THE MARK FOR RETAIL FOOD SUPERMARKET SERVICES ONLY IN THE STATES OF FLORIDA, ALABAMA, GEORGIA, SOUTH CAROLINA, NORTH CAROLINA, VIRGINIA, MARYLAND, DELAWARE, NEW JERSEY, NEW YORK, PENNSYLVANIA, CONNECTICUT, RHODE ISLAND, MASSACHUSETTS, NEW HAMPSHIRE, VERMONT AND MAINE; AND THE DISTRICT OF COLUMBIA. THE METHOD OF USE OF THE MARK IS ON SIGNS, DISPLAYS, BROCHURES AND ADVERTISING MATERIALS. THE EXPECTED USER CLAIMS EXCLUSIVE USE OF THE MARK IN OHIO, KENTUCKY, INDIANA, ILLINOIS, AND MICHIGAN EXCLUDING HARBOR BEACH AND HURON COUNTY.

OWNER OF U.S. REG. NOS. 1,635,779, 1,636,571 AND 2,183,203.

FOR RETAIL FOOD SUPERMARKET SERVICES (U.S. CLS. 100, 101 AND 102).

FIRST USE 10-5-2005; IN COMMERCE 10-5-2005.
ALICIA COLLINS, EXAMINING ATTORNEY

SN 78-806,264. FOODTOWN, INC., AVENEL, NJ. FILED 2-3-2006.



THE APPLICANT CLAIMS EXCLUSIVE USE OF THE MARK FOR RETAIL FOOD SUPERMARKET SERVICES ONLY IN THE STATES OF FLORIDA, ALABAMA, GEORGIA, SOUTH CAROLINA, NORTH CAROLINA, VIRGINIA,

CLASS 35—(Continued).

MARYLAND, DELAWARE, NEW JERSEY, NEW YORK, PENNSYLVANIA, CONNECTICUT, RHODE ISLAND, MASSACHUSETTS, NEW HAMPSHIRE, VERMONT AND MAINE; AND THE DISTRICT OF COLUMBIA. THE METHOD OF USE OF THE MARK IS ON SIGNS, DISPLAYS, BROCHURES AND ADVERTISING MATERIALS. THE EXCEPTED USER CLAIMS EXCLUSIVE USE OF THE MARK OF OHIO, KENTUCKY, INDIANA, ILLINOIS, AND MICHIGAN EXCLUDING HARBOR BEACH AND HURON COUNTY.

OWNER OF U.S. REG. NOS. 1,635,779, 1,636,571 AND 2,183,203.

THE COLOR(S) WHITE, BLUE RED, GREEN AND BROWN IS/ARE CLAIMED AS A FEATURE OF THE MARK.

THE WORDING "FOODTOWN" AND "NATURALLY" APPEARS IN WHITE. THE WORDING "FOODTOWN" IS OUTLINED IN BLUE WITH A GREEN LEAF ATTACHED TO THE "W". A RED LINE APPEARS BENEATH THE WORDING "FOODTOWN". THE RECTANGULAR BACKGROUND SHOWS GREEN AND BROWN FARMLAND IN THE FRONTAL VIEW WITH GREEN HILLS IN THE BACKGROUND BENEATH A BLUE SKY WITH WHITE CLOUDS.

FOR RETAIL FOOD SUPERMARKET SERVICES (U.S. CLS. 100, 101 AND 102).

FIRST USE 12-29-2005; IN COMMERCE 12-29-2005.
ALICIA COLLINS, EXAMINING ATTORNEY

SN 78-812,603. CHEN, JASON C.S., BELLEVUE, WA. FILED 2-10-2006.

TeaMaster

THE MARK CONSISTS OF STANDARD CHARACTERS WITHOUT CLAIM TO ANY PARTICULAR FONT, STYLE, SIZE, OR COLOR.

FOR COMPUTERIZED ON-LINE RETAIL STORE SERVICES IN THE FIELD OF TEA, TEA ACCESSORIES, TEA PRODUCTS; RETAIL BAKERY SHOPS; RETAIL FURNITURE STORES; RETAIL GIFT SHOPS; RETAIL SHOPS FEATURING TEA, TEA ACCESSORIES, TEA PRODUCTS (U.S. CLS. 100, 101 AND 102).

ALEXANDER L. POWERS, EXAMINING ATTORNEY

SN 78-819,174. NIFTY AFTER FIFTY, GARDEN GROVE, CA. FILED 2-20-2006.

NIFTY AFTER FIFTY

THE MARK CONSISTS OF STANDARD CHARACTERS WITHOUT CLAIM TO ANY PARTICULAR FONT, STYLE, SIZE, OR COLOR.

FOR FRANCHISE SERVICES, NAMELY OFFERING TECHNICAL AND BUSINESS MANAGEMENT ASSISTANCE IN THE ESTABLISHMENT AND/OR OPERATION OF FITNESS CENTERS, GYMS, DATING SERVICES FOR SENIORS, MEDICAL SPAS, FITNESS TRAINING FACILITIES AND PHYSICAL THERAPY FACILITIES; BUSINESS CONSULTATION AND MANAGEMENT SERVICES; PROVIDING INFORMATION TO FRANCHISEES CONCERNING BUSINESS MANAGEMENT (U.S. CLS. 100, 101 AND 102).

ALICIA COLLINS, EXAMINING ATTORNEY

CLASS 35—(Continued).

SN 78-824,004. COCO RIBBON LIMITED, LONDON, UNITED KINGDOM, FILED 2-27-2006.

THE PANTY POSTMAN

THE MARK CONSISTS OF STANDARD CHARACTERS WITHOUT CLAIM TO ANY PARTICULAR FONT, STYLE, SIZE, OR COLOR.

OWNER OF ERPN CMNTY TM OFC REG. NO. 004939914, DATED 2-27-2006, EXPIRES 2-27-2016.

NO CLAIM IS MADE TO THE EXCLUSIVE RIGHT TO USE "PANTY", APART FROM THE MARK AS SHOWN.

FOR THE BRINGING TOGETHER, FOR THE BENEFIT OF OTHERS, OF A VARIETY OF CLOTHING, LINGERIE, UNDERWEAR AND CLOTHING ACCESSORIES, ENABLING CUSTOMERS TO CONVENIENTLY VIEW AND PURCHASE THOSE GOODS; MAIL ORDER RETAIL SERVICES FEATURING CLOTHING, LINGERIE, UNDERWEAR AND CLOTHING ACCESSORIES; ON-LINE RETAIL STORE SERVICES FEATURING CLOTHING, LINGERIE, UNDERWEAR AND CLOTHING ACCESSORIES; THE BRINGING TOGETHER, FOR THE BENEFIT OF OTHERS, OF A VARIETY OF GOODS ENABLING CUSTOMERS TO CONVENIENTLY VIEW AND PURCHASE THOSE GOODS FROM A CLOTHING, LINGERIE, UNDERWEAR AND CLOTHING ACCESSORIES CATALOGUE BY MAIL ORDER; RETAIL STORE SERVICES, AVAILABLE THROUGH COMPUTER COMMUNICATIONS AND INTERACTIVE TELEVISION, FEATURING CLOTHING, LINGERIE, UNDERWEAR AND CLOTHING ACCESSORIES (U.S. CLS. 100, 101 AND 102).

MICHAEL SOUDERS, EXAMINING ATTORNEY

SN 78-832,569. ONCUE MARKETING, LLC, STILLWATER, OK. FILED 3-8-2006.

ONCUE EXPRESS

THE MARK CONSISTS OF STANDARD CHARACTERS WITHOUT CLAIM TO ANY PARTICULAR FONT, STYLE, SIZE, OR COLOR.

NO CLAIM IS MADE TO THE EXCLUSIVE RIGHT TO USE "EXPRESS", APART FROM THE MARK AS SHOWN.

FOR WHOLESALE DISTRIBUTORSHIPS FEATURING GASOLINE (U.S. CLS. 100, 101 AND 102).

MICHAEL GAUFAR, EXAMINING ATTORNEY

CLASS 35—(Continued).

SN 78-838,478. HAYS PLC, LONDON, UNITED KINGDOM, FILED 3-16-2006.



OWNER OF U.S. REG. NOS. 2,661,036 AND 2,905,470.
NO CLAIM IS MADE TO THE EXCLUSIVE RIGHT TO USE "SPECIALIST RECRUITMENT", APART FROM THE MARK AS SHOWN.

THE COLOR(S) WHITE, DARK BLUE AND LIGHT BLUE IS/ARE CLAIMED AS A FEATURE OF THE MARK.

THE MARK CONSISTS OF THE WORDS HAYS SPECIALIST RECRUITMENT IN WHITE LETTERS ON A DARK BLUE RECTANGULAR BACKGROUND WITH THE RIGHT FRONT CORNER OF THE RECTANGLE FOLDED BACK TO REVEAL A LIGHT BLUE UNDERSIDE.

SEC. 2(F).

FOR EMPLOYMENT AGENCY SERVICES; EMPLOYMENT RECRUITING SERVICES; HUMAN RESOURCES CONSULTATION AND MANAGEMENT; ADVISORY AND CONSULTANCY SERVICES RELATED THERETO (U.S. CLS. 100, 101 AND 102).

ADA HAN, EXAMINING ATTORNEY

SN 78-840,024. GFC BRANDS, INC., WILMINGTON, DE. FILED 3-17-2006.



NO CLAIM IS MADE TO THE EXCLUSIVE RIGHT TO USE "CINCO DE MAYO", APART FROM THE MARK AS SHOWN.

THE COLOR(S) YELLOW, ORANGE, PURPLE AND BLUE IS/ARE CLAIMED AS A FEATURE OF THE MARK.

THE MARK CONSISTS OF A GEOMETRIC DESIGN SURROUNDING THE WORDS "CINCO DE MAYO". THE COLOR PURPLE APPEARS IN THE WORDING AND IN THE CIRCLE DESIGNS ON THE SIDES OF THE BORDER. THE COLOR YELLOW APPEARS IN THE BACKGROUND. THE COLOR ORANGE APPEARS IN THE CORNERS OF THE BORDER. THE COLOR BLUE APPEARS IN THE SIDES OF THE BORDER.

THE FOREIGN WORDING IN THE MARK TRANSLATES INTO ENGLISH AS "THE FIFTH OF MAY."

FOR RETAIL GROCERY STORE SERVICES (U.S. CLS. 100, 101 AND 102).

FIRST USE 5-0-2000; IN COMMERCE 5-0-2000.

MARIA-VICTORIA SUAREZ, EXAMINING ATTORNEY

CLASS 35—(Continued).

SN 78-840,539. NIFTY AFTER FIFTY, GARDEN GROVE, CA. FILED 3-17-2006.

NIFTY AFTER FIFTY THRIFT AND GIFT SHOP

THE MARK CONSISTS OF STANDARD CHARACTERS WITHOUT CLAIM TO ANY PARTICULAR FONT, STYLE, SIZE, OR COLOR.

NO CLAIM IS MADE TO THE EXCLUSIVE RIGHT TO USE "THRIFT AND GIFT SHOP", APART FROM THE MARK AS SHOWN.

FOR RETAIL STORE SERVICES FEATURING A VARIETY OF HOUSEHOLD FURNITURE AND FURNISHINGS, CONSUMER ELECTRONICS, PERSONAL CARE PRODUCTS, CLOTHING, COSMETICS, HAIR CARE AND SKIN CARE PRODUCTS AND SUNDRIES; ONLINE RETAIL STORE SERVICES FEATURING A VARIETY OF HOUSEHOLD FURNITURE AND FURNISHINGS, CONSUMER ELECTRONICS, PERSONAL CARE PRODUCTS, CLOTHING, COSMETICS, HAIR CARE AND SKIN CARE PRODUCTS AND SUNDRIES (U.S. CLS. 100, 101 AND 102).

ALICIA COLLINS, EXAMINING ATTORNEY

SN 78-848,939. VEGAS.COM, LLC, HENDERSON, NV. FILED 3-29-2006.

VEGAS TV

THE MARK CONSISTS OF STANDARD CHARACTERS WITHOUT CLAIM TO ANY PARTICULAR FONT, STYLE, SIZE, OR COLOR.

OWNER OF U.S. REG. NOS. 2,148,921, 3,173,474 AND 3,200,635.

NO CLAIM IS MADE TO THE EXCLUSIVE RIGHT TO USE "TV", APART FROM THE MARK AS SHOWN.

SEC. 2(F) AS TO VEGAS.

FOR LICENSING OF VIDEO FOOTAGE (U.S. CLS. 100, 101 AND 102).

HEATHER THOMPSON, EXAMINING ATTORNEY

CLASS 35—(Continued).

SN 78-852,804. PARTSBANDIT.COM, LLC, SAN DIEGO, CA.
FILED 4-3-2006.

BikeBandit.com

THE MARK CONSISTS OF STANDARD CHARACTERS WITHOUT CLAIM TO ANY PARTICULAR FONT, STYLE, SIZE, OR COLOR.

FOR RETAIL STORE SERVICES FEATURING NEW AND USED PARTS, ACCESSORIES, APPAREL, AND MANUALS FOR MOTORCYCLES, ALL TERRAIN VEHICLES, ALSO KNOWN AS ATV, SNOWMOBILES, AND POWER AND RECREATIONAL WATERCRAFT, NAMELY BOATS, JET BOATS, AND PERSONAL WATERCRAFT, PROVIDED OVER A GLOBAL COMMUNICATION INFORMATION NETWORK; ADVERTISING SERVICES; PROVIDING MAIL ORDER CATALOG SERVICES FEATURING NEW AND USED PARTS, ACCESSORIES, APPAREL, AND MANUALS FOR MOTORCYCLES, ALL TERRAIN VEHICLES, ALSO KNOWN AS ATV, SNOWMOBILES, AND POWER AND RECREATIONAL WATERCRAFT, NAMELY BOATS, JET BOATS, AND PERSONAL WATERCRAFT; RETAIL AND ONLINE RETAIL STORE SERVICES AND COMPUTERIZED ON-LINE ORDERING AND MAIL ORDER SERVICES FEATURING NEW AND USED PARTS, ACCESSORIES, APPAREL, AND MANUALS FOR MOTORCYCLES, ALL TERRAIN VEHICLES, ALSO KNOWN AS ATV, SNOWMOBILES, AND POWER AND RECREATIONAL WATERCRAFT, NAMELY BOATS, JET BOATS, AND PERSONAL WATERCRAFT; PROVIDING AN ON-LINE COMMERCIAL INFORMATION DIRECTORY ON THE INTERNET REGARDING MOTORCYCLES, ALL TERRAIN VEHICLES, ALSO KNOWN AS ATV, SNOWMOBILES, AND POWER AND RECREATIONAL WATERCRAFT, NAMELY BOATS, JET BOATS, AND PERSONAL WATERCRAFT AND PARTS, ACCESSORIES, TOOLS, POWER TOOLS, APPAREL, AND MANUALS THEREFOR; PROVIDING A SEARCHABLE DATABASE AVAILABLE VIA A GLOBAL COMPUTER NETWORK IN THE FIELD OF MOTORCYCLES, ALL TERRAIN VEHICLES, ALSO KNOWN AS ATV, SNOWMOBILES, AND POWER AND RECREATIONAL WATERCRAFT, NAMELY BOATS, JET BOATS, AND PERSONAL WATERCRAFT AND PARTS, ACCESSORIES, TOOLS, POWER TOOLS, APPAREL, AND MANUALS THEREFOR; PROVIDING A SEARCHABLE ON-LINE ADVERTISING GUIDE FEATURING THE GOODS AND SERVICES OF OTHER ON-LINE VENDORS IN THE FIELD OF MOTORCYCLES, ALL TERRAIN VEHICLES, ALSO KNOWN AS ATV, SNOWMOBILES, AND POWER AND RECREATIONAL WATERCRAFT, NAMELY BOATS, JET BOATS, AND PERSONAL WATERCRAFT AND PARTS, ACCESSORIES, TOOLS, POWER TOOLS, APPAREL, AND MANUALS THEREFORE (U.S. CLS. 100, 101 AND 102).

FIRST USE 1-15-2000; IN COMMERCE 1-15-2000.

DAVID HOFFMAN, EXAMINING ATTORNEY

CLASS 35—(Continued).

SN 78-852,820. PARTSBANDIT.COM, LLC, SAN DIEGO, CA.
FILED 4-3-2006.



NO CLAIM IS MADE TO THE EXCLUSIVE RIGHT TO USE "BIKE" AND ".COM", APART FROM THE MARK AS SHOWN.

THE MARK CONSISTS OF THE LITERAL ELEMENT BIKEBANDIT.COM INCORPORATED INTO THE DESIGN OF A MOTORCYCLE.

FOR RETAIL STORE SERVICES FEATURING NEW AND USED PARTS, ACCESSORIES, APPAREL, AND MANUALS FOR MOTORCYCLES, ALL TERRAIN VEHICLES, ALSO KNOWN AS ATV, SNOWMOBILES, AND POWER AND RECREATIONAL WATERCRAFT, NAMELY BOATS, JET BOATS, AND PERSONAL WATERCRAFT, PROVIDED OVER A GLOBAL COMMUNICATION INFORMATION NETWORK; ADVERTISING SERVICES; PROVIDING MAIL ORDER CATALOG SERVICES FEATURING NEW AND USED PARTS, ACCESSORIES, APPAREL, AND MANUALS FOR MOTORCYCLES, ALL TERRAIN VEHICLES, ALSO KNOWN AS ATV, SNOWMOBILES, AND POWER AND RECREATIONAL WATERCRAFT, NAMELY BOATS, JET BOATS, AND PERSONAL WATERCRAFT; RETAIL AND ONLINE RETAIL STORE SERVICES AND COMPUTERIZED ON-LINE ORDERING AND MAIL ORDER SERVICES FEATURING NEW AND USED PARTS, ACCESSORIES, APPAREL, AND MANUALS FOR MOTORCYCLES, ALL TERRAIN VEHICLES, ALSO KNOWN AS ATV, SNOWMOBILES, AND POWER AND RECREATIONAL WATERCRAFT, NAMELY BOATS, JET BOATS, AND PERSONAL WATERCRAFT; PROVIDING AN ON-LINE COMMERCIAL INFORMATION DIRECTORY ON THE INTERNET REGARDING MOTORCYCLES, ALL TERRAIN VEHICLES, ALSO KNOWN AS ATV, SNOWMOBILES, AND POWER AND RECREATIONAL WATERCRAFT, NAMELY BOATS, JET BOATS, AND PERSONAL WATERCRAFT AND PARTS, ACCESSORIES, TOOLS, POWER TOOLS, APPAREL, AND MANUALS THEREFOR; PROVIDING A SEARCHABLE DATABASE AVAILABLE VIA A GLOBAL COMPUTER NETWORK IN THE FIELD OF MOTORCYCLES, ALL TERRAIN VEHICLES, ALSO KNOWN AS ATV, SNOWMOBILES, AND POWER AND RECREATIONAL WATERCRAFT, NAMELY BOATS, JET BOATS, AND PERSONAL WATERCRAFT AND PARTS, ACCESSORIES, TOOLS, POWER TOOLS, APPAREL, AND MANUALS THEREFOR; PROVIDING A SEARCHABLE ON-LINE ADVERTISING GUIDE FEATURING THE GOODS AND SERVICES OF OTHER ON-LINE VENDORS IN THE FIELD OF MOTORCYCLES, ALL TERRAIN VEHICLES, ALSO KNOWN AS ATV, SNOWMOBILES, AND POWER AND RECREATIONAL WATERCRAFT, NAMELY BOATS, JET BOATS, AND PERSONAL WATERCRAFT AND PARTS, ACCESSORIES, TOOLS, POWER TOOLS, APPAREL, AND MANUALS THEREFORE (U.S. CLS. 100, 101 AND 102).

FIRST USE 1-15-2000; IN COMMERCE 1-15-2000.

DAVID HOFFMAN, EXAMINING ATTORNEY

CLASS 35—(Continued).

SN 78-853,684. ISLAND INK-JET SYSTEMS INC., COURTENAY, B.C., CANADA, FILED 4-4-2006.

The logo for ISLAND INKJET features the words "ISLAND" and "INKJET" stacked vertically in a bold, outlined, sans-serif font. The letters are black with a white outline, giving them a three-dimensional appearance.

PRIORITY CLAIMED UNDER SEC. 44(D) ON CANADA APPLICATION NO. 1274530, FILED 10-4-2005, REG. NO. 683,826, DATED 3-16-2007, EXPIRES 3-16-2022.

OWNER OF U.S. REG. NOS. 2,785,602, 2,861,341 AND 3,106,114.

NO CLAIM IS MADE TO THE EXCLUSIVE RIGHT TO USE "INK-JET", APART FROM THE MARK AS SHOWN.

FOR WHOLESALE STORES AND RETAIL STORE SERVICES FEATURING INK JET PRINTER REFILL KITS, INK JET PRINTER CARTRIDGES, REFILL INK FOR INKJET PRINTER CARTRIDGES, LASER CARTRIDGES AND LASER TONER CARTRIDGES; AND INKJET PRINTER CARTRIDGE REFILL SERVICES (U.S. CLS. 100, 101 AND 102).

FIRST USE 9-0-2005; IN COMMERCE 9-0-2005.

RAY THOMAS, EXAMINING ATTORNEY

SN 78-865,758. ROCK YOUR AWARENESS, NEWARK, CA, FILED 4-20-2006.



NO CLAIM IS MADE TO THE EXCLUSIVE RIGHT TO USE "AIDS AWARENESS", APART FROM THE MARK AS SHOWN.

THE COLOR(S) RED, WHITE, BLACK IS/ARE CLAIMED AS A FEATURE OF THE MARK.

THE MARK CONSISTS OF THE WORDS "ROCK FOR AIDS AWARENESS" IN WHITE, INCORPORATING A RED MUSICAL CLEF. THE TOP PART OF THE MUSICAL CLEF ACTS AS THE "D" IN THE WORD AIDS. THE WORDING AND DESIGN ELEMENT ARE ON A BLACK BACKGROUND.

FOR PROMOTING PUBLIC AWARENESS OF HIV/AIDS, TESTING AND SEXUAL HEALTH EDUCATION (U.S. CLS. 100, 101 AND 102).

FIRST USE 10-1-2005; IN COMMERCE 11-1-2005.

MARY MUNSON, EXAMINING ATTORNEY

CLASS 35—(Continued).

SN 78-871,786. LORD AND MASON ENTERPRISES, INC., GERMANTOWN, MD. FILED 4-28-2006.



NO CLAIM IS MADE TO THE EXCLUSIVE RIGHT TO USE "ENTERPRISES" AND "INC.", APART FROM THE MARK AS SHOWN.

THE COLOR(S) THE COLORS GREEN, BLUE, BLACK AND WHITE IS/ARE CLAIMED AS A FEATURE OF THE MARK.

THE COLOR GREEN APPEARS IN THE WORDS ENTERPRISE AND MASON AND THE RECTANGLE IN THE UPPER LEFT CORNER; THE COLOR BLUE IN THE CONTINENTS AND THE WORD LORD, AND THE LOWER LEFT INTERIOR AND RIGHT HAND UPPER INTERIOR OF THE LARGE RECTANGLE DESIGN; THE COLOR WHITE IN THE PLUS SIGN AND THE COLOR BLACK IN THE INTERIOR RECTANGLE FOR THE WORDS LORD + MASON, THE OUTER RECTANGLE AND THE WORD INC. AND THE LINES ON THE GLOBE DESIGN.

FOR ON-LINE RETAIL STORE SERVICES IN THE FIELD OF FLOOR MATS FOR VEHICLES AND PORTABLE SHOE BAGS (U.S. CLS. 100, 101 AND 102).

HENRY S. ZAK, EXAMINING ATTORNEY

SN 78-884,847. ECONSULT CORPORATION, PHILADELPHIA, PA. FILED 5-16-2006.

ECONSULT CORPORATION

THE MARK CONSISTS OF STANDARD CHARACTERS WITHOUT CLAIM TO ANY PARTICULAR FONT, STYLE, SIZE, OR COLOR.

OWNER OF U.S. REG. NO. 1,968,151.

NO CLAIM IS MADE TO THE EXCLUSIVE RIGHT TO USE "CORPORATION", APART FROM THE MARK AS SHOWN.

FOR ECONOMIC CONSULTING AND INFORMATION TO ASSIST BUSINESS, NON-PROFIT AND GOVERNMENT DECISION MAKERS ON PUBLIC POLICY MATTERS; ECONOMIC CONSULTING AND INFORMATION TO ASSIST BUSINESS, NON-PROFIT AND PUBLIC ENTITIES IN PLANNING, ORGANIZING, MONITORING, EVALUATING AND EXECUTING PROJECTS; BUSINESS MANAGEMENT CONSULTANCY AS WELL AS DEVELOPMENT OF PROCESSES FOR THE ANALYSIS AND THE IMPLEMENTATION OF STRATEGY, PLANS AND MANAGEMENT PROJECTS; HUMAN RESOURCES CONSULTATION AND MANAGEMENT; BUSINESS INFORMATION SERVICES, NAMELY, PROVIDING ECONOMIC AND STATISTICAL INFORMATION AND ANALYSIS FOR USE IN THE LITIGATION PROCESS (U.S. CLS. 100, 101 AND 102).

FIRST USE 10-0-1979; IN COMMERCE 10-0-1979.

KAPIL BHANOT, EXAMINING ATTORNEY

CLASS 35—(Continued).

SN 78-903,710. RON SACHS COMMUNICATIONS, INC., TALLAHASSEE, FL. FILED 6-8-2006.



NO CLAIM IS MADE TO THE EXCLUSIVE RIGHT TO USE "AMERICAN INITIATIVES PARTNERSHIPS IN THE PUBLIC INTEREST", APART FROM THE MARK AS SHOWN.

THE COLOR(S) RED, BLUE, BLACK AND WHITE IS/ARE CLAIMED AS A FEATURE OF THE MARK.

THE MARK CONSISTS OF THE WORD AMERICAN IN RED SHADOWED IN BLACK AND INITIATIVES IN BLUE SHADOWED IN BLACK, BOTH WORDS IN A WAVY DESIGN ABOVE A WHITE FIVE POINT STAR WITH A BLUE BORDER, ALL ABOVE THE WORDS PARTNERSHIPS IN THE PUBLIC INTEREST IN BLUE, ALL AGAINST A WHITE BACKGROUND.

FOR PROMOTION AND MARKETING SERVICES AND RELATED CONSULTING (U.S. CLS. 100, 101 AND 102).

FIRST USE 7-1-2006; IN COMMERCE 7-1-2006.
KENNETH E. SHARPERSON, EXAMINING ATTORNEY

CLASS 35—(Continued).

SN 78-912,952. THE FRANCHISE GROUP LIMITED, CHESHIRE, ENGLAND, FILED 6-21-2006.



NO CLAIM IS MADE TO THE EXCLUSIVE RIGHT TO USE "FRANCHISE GROUP", APART FROM THE MARK AS SHOWN.

FOR BUSINESS CONSULTING SERVICES IN CONNECTION WITH THE ESTABLISHMENT AND DEVELOPMENT OF FRANCHISE ACTIVITIES; FRANCHISE MANAGEMENT SERVICES; FRANCHISE ASSISTANCE SERVICES; ASSISTANCE IN FRANCHISED COMMERCIAL BUSINESS MANAGEMENT; BUSINESS ADVISORY AND CONSULTANCY SERVICES RELATING TO BUSINESS FRANCHISING AND LICENSING; FRANCHISE ADMINISTRATION SERVICES; FRANCHISE MARKETING SERVICES; FRANCHISE ADVERTISING SERVICES; FRANCHISE PUBLIC RELATION SERVICES; INFORMATION, ADVISORY AND CONSULTANCY SERVICES RELATING TO THE AFORESAID SERVICES (U.S. CLS. 100, 101 AND 102).

CURTIS FRENCH, EXAMINING ATTORNEY

SN 78-924,589. U.S. FOAM TECHNOLOGIES, INC., LONGVIEW, TX. FILED 7-7-2006.

BIDTRAX

THE MARK CONSISTS OF STANDARD CHARACTERS WITHOUT CLAIM TO ANY PARTICULAR FONT, STYLE, SIZE, OR COLOR.

FOR BUSINESS MARKET RESEARCH SERVICES, NAMELY, TRACKING OF BID TRENDS INCLUDING ACTUAL PRICES PAID FOR SPECIFIC PRODUCTS (U.S. CLS. 100, 101 AND 102).

LYDIA BELZER, EXAMINING ATTORNEY

SN 78-912,622. TECHNICAL COMMUNITIES, INC, SAN BRUNO, CA. FILED 6-20-2006.



SN 78-924,912. MARKLEY, ALEXANDER, PATASKALA, OH. FILED 7-7-2006.

Malex

THE MARK CONSISTS OF STANDARD CHARACTERS WITHOUT CLAIM TO ANY PARTICULAR FONT, STYLE, SIZE, OR COLOR.

FOR ONLINE RETAIL STORE SERVICES FEATURING MUSIC IN ELECTRONIC FORM AND PHYSICAL MEDIA FORM, NAMELY, DOWNLOADABLE FILES, AND CDS. (U.S. CLS. 100, 101 AND 102).

FIRST USE 5-1-2003; IN COMMERCE 5-1-2003.
CARYN GLASSER, EXAMINING ATTORNEY

NO CLAIM IS MADE TO THE EXCLUSIVE RIGHT TO USE "MARKETING SERVICES", APART FROM THE MARK AS SHOWN.

THE MARK CONSISTS OF THE WORDS DECIBEL MARKETING SERVICES, FOLLOWED BY THREE DECIBEL SIGNS.

FOR MARKETING SERVICES, NAMELY BUSINESS MARKETING SERVICES (U.S. CLS. 100, 101 AND 102).

FIRST USE 12-31-2004; IN COMMERCE 12-31-2004.
SANI KHOURI, EXAMINING ATTORNEY

CLASS 35—(Continued).

SN 78-926,565. MASTERCARD INTERNATIONAL INCORPORATED, PURCHASE, NY. FILED 7-11-2006.

MASTERCARD NEARBY

THE MARK CONSISTS OF STANDARD CHARACTERS WITHOUT CLAIM TO ANY PARTICULAR FONT, STYLE, SIZE, OR COLOR.

FOR PROVIDING BUSINESS INFORMATION DIRECTORY SERVICES WIRELESSLY AND THROUGH A GLOBAL COMPUTER NETWORK, NAMELY, PROVIDING A SEARCHABLE DIRECTORY TO LOCATE MERCHANTS, AUTOMATED TELLER MACHINES AND OTHER LOCATIONS OF INTEREST; PROMOTING THE GOODS AND SERVICES OF OTHERS THROUGH DISCOUNT OFFERS; PROMOTIONAL INCENTIVES AVAILABLE THROUGH PROGRAM REGISTRATION AND ELECTRONIC COMMUNICATIONS BY E-MAIL OR TEXT MESSAGES (U.S. CLS. 100, 101 AND 102).

FIRST USE 9-29-2006; IN COMMERCE 9-29-2006.
TANYA AMOS, EXAMINING ATTORNEY

SN 78-927,349. SMITH, EVAN A., CLEVELAND, OH. FILED 7-12-2006.



NO CLAIM IS MADE TO THE EXCLUSIVE RIGHT TO USE "MEDIA", APART FROM THE MARK AS SHOWN.

THE MARK CONSISTS OF A STYLIZED ELECTRIC LIGHTBULB WITH THE WORDS "IDEA" AND "MEDIA".

FOR PREPARING AUDIO-VISUAL DISPLAYS IN THE FIELD OF TRADE SHOWS, CONFERENCES AND MEETINGS FOR MEDICAL EQUIPMENT SALES AND ADVERTISING (U.S. CLS. 100, 101 AND 102).

FIRST USE 9-10-1988; IN COMMERCE 9-10-1988.
NELSON SNYDER, EXAMINING ATTORNEY

CLASS 35—(Continued).

SN 78-928,068. AMERICAN INFORMATION STRATEGIES, INC., SAN CLEMENTE, CA. FILED 7-12-2006.

ASI

THE MARK CONSISTS OF STANDARD CHARACTERS WITHOUT CLAIM TO ANY PARTICULAR FONT, STYLE, SIZE, OR COLOR.

FOR PROVIDING INVESTOR LEADS IDENTIFIED THROUGH THE USE OF SURVEYS, NAMELY, PROVIDING INFORMATION IN THE NATURE OF LISTS PERTAINING TO INVESTORS WHO QUALIFY TO PURCHASE CERTAIN TYPES OF SECURITIES AND OTHER INVESTMENTS. (U.S. CLS. 100, 101 AND 102).

FIRST USE 6-2-2002; IN COMMERCE 6-2-2002.
JOHN DWYER, EXAMINING ATTORNEY

SN 78-928,610. FAITH REWARDS LLC, CHARLOTTE, NC. FILED 7-13-2006.

FAITH REWARDS

THE MARK CONSISTS OF STANDARD CHARACTERS WITHOUT CLAIM TO ANY PARTICULAR FONT, STYLE, SIZE, OR COLOR.

NO CLAIM IS MADE TO THE EXCLUSIVE RIGHT TO USE "FAITH", APART FROM THE MARK AS SHOWN.

FOR ADVERTISING SERVICES, NAMELY, PROVIDING A WEBSITE FORUM FOR BUSINESSES TO PROMOTE AND ADVERTISE GOODS AND SERVICES THROUGH FAITH-BASED RELATIONSHIPS (U.S. CLS. 100, 101 AND 102).

KRISTIN DAHLING, EXAMINING ATTORNEY

SN 78-928,917. GOODWIN, DR. NORMA J., BROOKLYN, NY. FILED 7-13-2006.

HEALTH POWER FOR MINORITIES

THE MARK CONSISTS OF STANDARD CHARACTERS WITHOUT CLAIM TO ANY PARTICULAR FONT, STYLE, SIZE, OR COLOR.

OWNER OF U.S. REG. NOS. 3,047,351 AND 3,047,352.

FOR PROMOTING PUBLIC AWARENESS OF MINORITY GROUP HEALTH CARE ISSUES (U.S. CLS. 100, 101 AND 102).

KAREN SEVERSON, EXAMINING ATTORNEY

CLASS 35—(Continued).

SN 78-929,536. NATIONAL ACADEMY OF ELDER LAW ATTORNEYS, INC., TUCSON, AZ. FILED 7-14-2006.

NATIONAL ACADEMY OF
SPECIAL NEEDS ATTORNEYS

THE MARK CONSISTS OF STANDARD CHARACTERS WITHOUT CLAIM TO ANY PARTICULAR FONT, STYLE, SIZE, OR COLOR.

NO CLAIM IS MADE TO THE EXCLUSIVE RIGHT TO USE "NATIONAL ACADEMY" AND "ATTORNEYS", APART FROM THE MARK AS SHOWN.

FOR ASSOCIATION SERVICES, NAMELY PROMOTING THE INTERESTS OF LEGAL PROFESSIONALS, BAR ORGANIZATIONS AND OTHERS WHO RENDER LEGAL SERVICES TO THOSE WITH SPECIAL NEEDS, NAMELY THE ELDERLY AND THOSE WITH MENTAL OR PHYSICAL DISABILITIES AND PROMOTING THE PUBLIC AWARENESS OF LEGAL RIGHTS AND CONCERNS OF THOSE WITH SPECIAL NEEDS, NAMELY THE ELDERLY AND THOSE WITH MENTAL OR PHYSICAL DISABILITIES. (U.S. CLS. 100, 101 AND 102).
DOMINICK J. SALEMI, EXAMINING ATTORNEY

CLASS 35—(Continued).

SN 78-932,045. SHANE CO., CENTENNIAL, CO. FILED 7-18-2006.



OWNER OF U.S. REG. NOS. 1,959,461, 2,966,306 AND OTHERS.

NO CLAIM IS MADE TO THE EXCLUSIVE RIGHT TO USE "CO.", "DIAMONDS", "RUBIES", "SAPPHIRES" OR "PEARLS", APART FROM THE MARK AS SHOWN.

FOR RETAIL JEWELRY STORE SERVICES (U.S. CLS. 100, 101 AND 102).
FIRST USE 10-0-2005; IN COMMERCE 10-0-2005.
HENRY S. ZAK, EXAMINING ATTORNEY

SN 78-930,657. TECHNOLOGY AND ENTREPRENEURSHIP CENTER OF HOUSTON, INC., HOUSTON, TX. FILED 7-17-2006.

HOUSTON TECHNOLOGY SHOWCASE

THE MARK CONSISTS OF STANDARD CHARACTERS WITHOUT CLAIM TO ANY PARTICULAR FONT, STYLE, SIZE, OR COLOR.

OWNER OF U.S. REG. NOS. 2,366,227, 2,557,682 AND 3,070,939.

NO CLAIM IS MADE TO THE EXCLUSIVE RIGHT TO USE "TECHNOLOGY SHOWCASE", APART FROM THE MARK AS SHOWN.

SEC. 2(F) AS TO "HOUSTON".
FOR ORGANIZING AND CONDUCTING PERIODIC PROFESSIONAL BUSINESS MEETINGS FOR OTHERS TO DISPLAY TECHNOLOGIES AND FOR OTHERS TO DISCUSS TECHNOLOGY ISSUES RELEVANT TO THE HOUSTON METROPOLITAN AREA FOR THE PURPOSES OF BUSINESS NETWORKING (U.S. CLS. 100, 101 AND 102).
FIRST USE 10-7-2003; IN COMMERCE 10-7-2003.
BERNICE MIDDLETON, EXAMINING ATTORNEY

SN 78-936,906. IRIS GROUP, INC., DBA MODERN POSTCARD, CARLSBAD, CA. FILED 7-25-2006.

B2U MARKETING

THE MARK CONSISTS OF STANDARD CHARACTERS WITHOUT CLAIM TO ANY PARTICULAR FONT, STYLE, SIZE, OR COLOR.

NO CLAIM IS MADE TO THE EXCLUSIVE RIGHT TO USE "MARKETING", APART FROM THE MARK AS SHOWN.

FOR ADVERTISING AND PUBLICITY SERVICES, NAMELY, PROMOTING THE GOODS, SERVICES, BRAND IDENTITY AND COMMERCIAL INFORMATION AND NEWS OF THIRD PARTIES THROUGH PRINT, AUDIO, VIDEO, DIGITAL AND ON-LINE MEDIUM (U.S. CLS. 100, 101 AND 102).
SCOTT BALDWIN, EXAMINING ATTORNEY

CLASS 35—(Continued).

SN 78-936,915. IRIS GROUP, INC., DBA MODERN POST-CARD, CARLSBAD, CA. FILED 7-25-2006.

BUSINESS-TO-YOU MARKETING

THE MARK CONSISTS OF STANDARD CHARACTERS WITHOUT CLAIM TO ANY PARTICULAR FONT, STYLE, SIZE, OR COLOR.

NO CLAIM IS MADE TO THE EXCLUSIVE RIGHT TO USE "MARKETING", APART FROM THE MARK AS SHOWN.

FOR ADVERTISING AND PUBLICITY SERVICES, NAMELY, PROMOTING THE GOODS, SERVICES, BRAND IDENTITY AND COMMERCIAL INFORMATION AND NEWS OF THIRD PARTIES THROUGH PRINT, AUDIO, VIDEO, DIGITAL AND ON-LINE MEDIUM (U.S. CLS. 100, 101 AND 102).

SCOTT BALDWIN, EXAMINING ATTORNEY

SN 78-937,292. MARIA MARTIN, INC., SEDONA, AZ. FILED 7-25-2006.



NO CLAIM IS MADE TO THE EXCLUSIVE RIGHT TO USE "PRODUCT", APART FROM THE MARK AS SHOWN.

THE NAME SHOWN IN THE MARK IDENTIFIES MARIA MARTIN, WHOSE CONSENT(S) TO REGISTER IS SUBMITTED.

THE COLOR(S) GREY, PINK AND BLACK IS/ARE CLAIMED AS A FEATURE OF THE MARK.

THE MARK CONSISTS OF THE WORD PRODUCT IN THE COLOR GREY WITH EXTENSIONS ON THE P, D & T ALSO IN THE COLOR GREY, THE INSIDE OF THE ENLARGED LETTER O OF THE WORD PRODUCT IS IN PINK AND THE WORDS BY MARIA MARTIN IN BLACK.

FOR RETAIL STORE AND ON-LINE RETAIL STORE SERVICES IN THE FIELD OF HEALTH, PERFUMERY, COSMETIC PRODUCTS, BEAUTY PRODUCTS, SKIN CARE PRODUCTS, MAKE-UP PRODUCTS, HAIR LOTIONS, PREPARATIONS AND SHAMPOOS, JEWELRY, SUNGLASSES, HANDBAGS AND ACCESSORIES (U.S. CLS. 100, 101 AND 102).

REBECCA EISINGER, EXAMINING ATTORNEY

CLASS 35—(Continued).

SN 78-937,810. ICBA BANCARD, INC., ARLINGTON, VA. FILED 7-26-2006.

TOTAL CARD MANAGEMENT

THE MARK CONSISTS OF STANDARD CHARACTERS WITHOUT CLAIM TO ANY PARTICULAR FONT, STYLE, SIZE, OR COLOR.

OWNER OF U.S. REG. NO. 2,258,181.

NO CLAIM IS MADE TO THE EXCLUSIVE RIGHT TO USE "CARD MANAGEMENT", APART FROM THE MARK AS SHOWN.

SEC. 2(F).

FOR BUSINESS MANAGEMENT SERVICES, NAMELY, MANAGEMENT OF CREDIT CARD SERVICES FOR OTHERS (U.S. CLS. 100, 101 AND 102).

FIRST USE 4-0-1996; IN COMMERCE 4-0-1996.

MARIAM MAHMOUDI, EXAMINING ATTORNEY

SN 78-939,049. MISS BEVERLY HILLS INC., LOS ANGELES, CA. FILED 7-27-2006.

MISS BEVERLY HILLS

THE MARK CONSISTS OF STANDARD CHARACTERS WITHOUT CLAIM TO ANY PARTICULAR FONT, STYLE, SIZE, OR COLOR.

NO CLAIM IS MADE TO THE EXCLUSIVE RIGHT TO USE "MISS BEVERLY HILLS", APART FROM THE MARK AS SHOWN.

FOR RETAIL AND ONLINE RETAIL CLOTHING AND APPAREL STORES (U.S. CLS. 100, 101 AND 102).

KEVON CHISOLM, EXAMINING ATTORNEY

SN 78-942,232. WAL-MART STORES, INC., BENTONVILLE, AR. FILED 8-1-2006.

HEALTHY LIFE ALWAYS

THE MARK CONSISTS OF STANDARD CHARACTERS WITHOUT CLAIM TO ANY PARTICULAR FONT, STYLE, SIZE, OR COLOR.

FOR RETAIL DEPARTMENT STORE SERVICES AND RETAIL GROCERY STORE SERVICES (U.S. CLS. 100, 101 AND 102).

LINDA LAVACHE, EXAMINING ATTORNEY

CLASS 35—(Continued).

SN 78-942,589. BOOMYEAH INC., OREM, UT. FILED 8-1-2006.



THE STIPPLING IS FOR SHADING PURPOSES ONLY.
THE MARK CONSISTS OF TWO BOOMERANG SHAPES PLACED ON A CIRCLE.

FOR ADVERTISING AND COMMERCIAL INFORMATION SERVICES, VIA THE INTERNET; ADVERTISING AND PUBLICITY SERVICES, NAMELY, PROMOTING THE GOODS, SERVICES, BRAND IDENTITY AND COMMERCIAL INFORMATION AND NEWS OF THIRD PARTIES THROUGH PRINT, AUDIO, VIDEO, DIGITAL AND ON-LINE MEDIUM; PROVIDING BUSINESS INFORMATION DIRECTORIES AND LISTINGS ON THE INTERNET FEATURING COMPANY PROFILES AND BUSINESS OPERATIONS AND HOURS; PROVIDING A WEB SITE FEATURING BUSINESS RATINGS AND REVIEWS, AND PRODUCT RATINGS AND REVIEWS OF THE CONSUMER GOODS AND SERVICES OF OTHERS; PROVIDING ON-LINE DIRECTORY INFORMATION SERVICES ALSO FEATURING HYPERLINKS TO OTHER WEB SITES; PROVIDING SPACE AT A WEB SITE FOR THE ADVERTISEMENT AND LISTINGS OF THE GOODS AND SERVICES OF OTHERS; COMPUTER SERVICES, NAMELY, PROVIDING ON-LINE TELEPHONE DIRECTORIES VIA THE GLOBAL COMPUTER NETWORK; COMPUTERIZED DATABASE MANAGEMENT; PROMOTING, ADVERTISING AND MARKETING OF ON-LINE WEB SITES OF OTHERS; PROVIDING A SEARCHABLE ONLINE ADVERTISING GUIDE FEATURING THE GOODS AND SERVICES OF OTHER ONLINE VENDORS ON THE INTERNET; PROVIDING A WEB SITE WHICH DISPLAYS COUPONS, DISCOUNTS, SPECIALS, AND OFFERS FOR THE GOODS AND SERVICES OF OTHERS ON A GLOBAL COMPUTER NETWORK; PROVIDING A WEB SITE AT WHICH USERS CAN OFFER GOODS FOR SALE AND BUY GOODS OFFERED BY OTHERS; OPERATING ON-LINE MARKETPLACES FOR SELLERS AND BUYERS OF GOODS AND/OR SERVICES; PROVIDING CLASSIFIED ADVERTISING SPACE VIA THE GLOBAL COMPUTER NETWORK; PROVIDING CONSUMER PRODUCT AND SERVICE INFORMATION VIA THE INTERNET THAT ENABLES USERS TO POST REVIEWS, ARTICLES AND RECOMMENDATIONS; PROVIDING ON-LINE COMPUTER DATABASES AND ON-LINE SEARCHABLE DATA-

CLASS 35—(Continued).

BASES FEATURING CLASSIFIED LISTINGS AND WANT ADS; PROVIDING ON-LINE COMPUTER DATABASES AND ON-LINE SEARCHABLE DATABASES FEATURING INFORMATION, CLASSIFIED LISTINGS AND ANNOUNCEMENTS ABOUT EMPLOYMENT INFORMATION AND RESUMES, JOB OPENINGS, VOLUNTEER INFORMATION AND VOLUNTEER OPPORTUNITIES THROUGH COMMUNITY AND CHARITABLE ORGANIZATIONS AND BUSINESSES, INFORMATION ABOUT COMMUNITY SERVICE PROGRAMS, INFORMATION ABOUT POLITICS, BUSINESS EVENTS, AND BUSINESS MEETINGS; PROVIDING ON-LINE COMPUTER DATABASES AND SEARCHABLE DATABASES FEATURING CLASSIFIED LISTINGS FOR RENTALS OF A WIDE-VARIETY OF CONSUMER AND BUSINESS GOODS; COMPUTER SERVICES, NAMELY, PROVIDING ON-LINE COMPUTER DATABASES AND ON-LINE SEARCHABLE DATABASES FEATURING CONSUMER INFORMATION ON A WIDE VARIETY OF TOPICS OF GENERAL INTEREST TO THE CONSUMING PUBLIC (U.S. CLS. 100, 101 AND 102).

FIRST USE 6-15-2006; IN COMMERCE 6-15-2006.
CARYN GLASSER, EXAMINING ATTORNEY

SN 78-942,612. BOOMYEAH INC., OREM, UT. FILED 8-1-2006.

BoomYEAH

THE MARK CONSISTS OF STANDARD CHARACTERS WITHOUT CLAIM TO ANY PARTICULAR FONT, STYLE, SIZE, OR COLOR.

FOR ADVERTISING AND COMMERCIAL INFORMATION SERVICES, VIA THE INTERNET; ADVERTISING AND PUBLICITY SERVICES, NAMELY, PROMOTING THE GOODS, SERVICES, BRAND IDENTITY AND COMMERCIAL INFORMATION AND NEWS OF THIRD PARTIES THROUGH PRINT, AUDIO, VIDEO, DIGITAL AND ON-LINE MEDIUM; PROVIDING BUSINESS INFORMATION DIRECTORIES AND LISTINGS ON THE INTERNET FEATURING COMPANY PROFILES AND BUSINESS OPERATIONS AND HOURS; PROVIDING A WEB SITE FEATURING BUSINESS RATINGS AND REVIEWS, AND PRODUCT RATINGS AND REVIEWS OF THE CONSUMER GOODS AND SERVICES OF OTHERS; PROVIDING ON-LINE DIRECTORY INFORMATION SERVICES ALSO FEATURING HYPERLINKS TO OTHER WEB SITES; PROVIDING SPACE AT A WEB SITE FOR THE ADVERTISEMENT AND LISTINGS OF THE GOODS AND SERVICES OF OTHERS; COMPUTER SERVICES, NAMELY, PROVIDING ON-LINE TELEPHONE DIRECTORIES VIA THE GLOBAL COMPUTER NETWORK; COMPUTERIZED DATABASE MANAGEMENT; PROMOTING, ADVERTISING AND MARKETING OF ON-LINE WEB SITES OF OTHERS; PROVIDING A SEARCHABLE ONLINE ADVERTISING GUIDE FEATURING THE GOODS AND SERVICES OF OTHER ONLINE VENDORS ON THE INTERNET; PROVIDING A WEB SITE WHICH DISPLAYS COUPONS, DISCOUNTS, SPECIALS, AND OFFERS FOR THE GOODS AND SERVICES OF OTHERS ON A GLOBAL COMPUTER NETWORK; PROVIDING A WEB SITE AT WHICH USERS CAN OFFER GOODS FOR SALE AND BUY GOODS OFFERED BY OTHERS; OPERATING ON-LINE MARKETPLACES FOR SELLERS AND BUYERS OF GOODS AND/OR SERVICES; PROVIDING CLASSIFIED ADVERTISING SPACE VIA THE GLOBAL COMPUTER NETWORK; PROVIDING CONSUMER PRODUCT AND SERVICE INFORMATION VIA THE INTERNET THAT ENABLES USERS TO POST REVIEW, ARTICLES AND RECOMMENDATIONS; PROVIDING ON-LINE COMPUTER DATABASES AND ON-LINE SEARCHABLE DATA-

CLASS 35—(Continued).

BASES FEATURING CLASSIFIED LISTINGS AND WANT ADS; PROVIDING ON-LINE COMPUTER DATABASES AND ON-LINE SEARCHABLE DATABASES FEATURING INFORMATION, CLASSIFIED LISTINGS AND ANNOUNCEMENTS ABOUT EMPLOYMENT INFORMATION AND RESUMES, JOB OPENINGS, VOLUNTEER INFORMATION AND VOLUNTEER OPPORTUNITIES THROUGH COMMUNITY AND CHARITABLE ORGANIZATIONS AND BUSINESSES, INFORMATION ABOUT COMMUNITY SERVICE PROGRAMS, INFORMATION ABOUT POLITICS, BUSINESS EVENTS, AND BUSINESS MEETINGS; PROVIDING ON-LINE COMPUTER DATABASES AND SEARCHABLE DATABASES FEATURING CLASSIFIED LISTINGS FOR RENTALS OF A WIDE-VARIETY OF CONSUMER AND BUSINESS GOODS; COMPUTER SERVICES, NAMELY, PROVIDING ON-LINE COMPUTER DATABASES AND ON-LINE SEARCHABLE DATABASES FEATURING CONSUMER INFORMATION ON A WIDE VARIETY OF TOPICS OF GENERAL INTEREST TO THE CONSUMING PUBLIC (U.S. CLS. 100, 101 AND 102).

FIRST USE 2-7-2006; IN COMMERCE 4-15-2006.
CARYN GLASSER, EXAMINING ATTORNEY

SN 78-944,000. CHEESEWORKS, INC., NEW YORK, NY.
FILED 8-3-2006.

THE CHEESE WORKS LTD

THE MARK CONSISTS OF STANDARD CHARACTERS WITHOUT CLAIM TO ANY PARTICULAR FONT, STYLE, SIZE, OR COLOR.

NO CLAIM IS MADE TO THE EXCLUSIVE RIGHT TO USE "LTD", APART FROM THE MARK AS SHOWN.

FOR IMPORTATION AND WHOLESALE DISTRIBUTORSHIP SERVICES FEATURING FOOD AND RELATED PRODUCTS, NAMELY, CHEESE KNIVES, CHEESE SLICERS, PAPER FOOD WRAP, AND BOOKS IN THE FIELD OF FOOD (U.S. CLS. 100, 101 AND 102).

FIRST USE 11-21-1977; IN COMMERCE 11-21-1977.
MICHAEL WEBSTER, EXAMINING ATTORNEY

SN 78-944,612. HEALTHTRANS LLC, GREENWOOD VIL-
LAGE, CO. FILED 8-3-2006.

RXRESOLVE

THE MARK CONSISTS OF STANDARD CHARACTERS WITHOUT CLAIM TO ANY PARTICULAR FONT, STYLE, SIZE, OR COLOR.

FOR CUSTOMER RELATIONSHIP MANAGEMENT SERVICES, NAMELY, OPERATING CUSTOMER SERVICE CALL CENTERS (U.S. CLS. 100, 101 AND 102).

REBECCA GAN, EXAMINING ATTORNEY

CLASS 35—(Continued).

SN 78-945,111. WAL-MART STORES, INC., BENTONVILLE,
AR. FILED 8-4-2006.

ROLLBACK

THE MARK CONSISTS OF STANDARD CHARACTERS WITHOUT CLAIM TO ANY PARTICULAR FONT, STYLE, SIZE, OR COLOR.

SEC. 2(F).

FOR ONLINE RETAIL DEPARTMENT STORE SERVICES AND RETAIL DEPARTMENT STORE SERVICES (U.S. CLS. 100, 101 AND 102).

FIRST USE 12-31-1992; IN COMMERCE 12-31-1992.
LINDA LAVACHE, EXAMINING ATTORNEY

SN 78-945,378. CORPORATE EXPRESS, INC., BROOMFIELD,
CO. FILED 8-4-2006.

IDECIDE

THE MARK CONSISTS OF STANDARD CHARACTERS WITHOUT CLAIM TO ANY PARTICULAR FONT, STYLE, SIZE, OR COLOR.

FOR PROVIDING A WEB SITE WHEREBY BUYERS OF PRINTER AND FAX MACHINE PARTS, SUPPLIES AND ACCESSORIES LOCATE AND RECEIVE QUOTATIONS FROM MULTIPLE COMPETITIVE SOURCES AND SELLERS OF PRINTER AND FAX MACHINE PARTS, SUPPLIES AND ACCESSORIES IDENTIFY AND BID ON MULTIPLE NEW SALES OPPORTUNITIES (U.S. CLS. 100, 101 AND 102).

DAVID COLLIER, EXAMINING ATTORNEY

SN 78-946,399. DIRECT IMPACT GROUP, LTD., NEWTON,
MA. FILED 8-7-2006.

CPR Test Network

THE MARK CONSISTS OF STANDARD CHARACTERS WITHOUT CLAIM TO ANY PARTICULAR FONT, STYLE, SIZE, OR COLOR.

NO CLAIM IS MADE TO THE EXCLUSIVE RIGHT TO USE "TEST NETWORK", APART FROM THE MARK AS SHOWN.

FOR MARKETING RESEARCH SERVICES, NAMELY, THE TESTING OF THE EFFECTIVENESS OF TELEVISION ADVERTISING. (U.S. CLS. 100, 101 AND 102).

DAVID TAYLOR, EXAMINING ATTORNEY

CLASS 35—(Continued).

SN 78-946,400. DIRECT IMPACT GROUP, LTD., NEWTON, MA. FILED 8-7-2006.

Broadcast Performance Network

THE MARK CONSISTS OF STANDARD CHARACTERS WITHOUT CLAIM TO ANY PARTICULAR FONT, STYLE, SIZE, OR COLOR.

NO CLAIM IS MADE TO THE EXCLUSIVE RIGHT TO USE "BROADCAST" AND "NETWORK", APART FROM THE MARK AS SHOWN.

FOR PROVIDING CONSULTING SERVICES IN THE FIELD OF FACILITATING THE PLANNING, BUYING AND SELLING OF MEDIA. (U.S. CLS. 100, 101 AND 102).
DAVID TAYLOR, EXAMINING ATTORNEY

SN 78-948,118. VERICOM TECHNOLOGIES, INC., COLUMBIA, MD. FILED 8-9-2006.

VERICOM TECHNOLOGIES

THE MARK CONSISTS OF STANDARD CHARACTERS WITHOUT CLAIM TO ANY PARTICULAR FONT, STYLE, SIZE, OR COLOR.

NO CLAIM IS MADE TO THE EXCLUSIVE RIGHT TO USE "TECHNOLOGIES", APART FROM THE MARK AS SHOWN.

FOR PROVIDING INFORMATION, ACCESSIBLE VIA THE INTERNET FOR TRACKING AND MONITORING VEHICLE, AND ASSET ACTIVITY, STATUS AND LOCATION FOR COMMERCIAL PURPOSES; PROVIDING BUSINESS MANAGEMENT SERVICES, NAMELY, MOBILE WORKFORCE MANAGEMENT SERVICES THAT ARE AN EXTENSION OF THE TRACKING AND MONITORING SOLUTION AND INCREASE WORKFORCE FUNCTIONALITY AND EFFICIENCY (U.S. CLS. 100, 101 AND 102).

FIRST USE 2-28-2001; IN COMMERCE 2-28-2001.
KATHLEEN LORENZO, EXAMINING ATTORNEY

SN 78-948,335. DUNCAN COFFEE COMPANY, HOUSTON, TX. FILED 8-9-2006.

WHAT TEXAS MAKES...MAKES TEXAS

THE MARK CONSISTS OF STANDARD CHARACTERS WITHOUT CLAIM TO ANY PARTICULAR FONT, STYLE, SIZE, OR COLOR.

FOR ONLINE RETAIL AND RETAIL STORE SERVICES FEATURING COFFEE, TEA, AND RELATED PRODUCTS AND MERCHANDISE (U.S. CLS. 100, 101 AND 102).

FIRST USE 1-31-2006; IN COMMERCE 1-31-2006.
NAAKWAMA ANKRAH, EXAMINING ATTORNEY

CLASS 35—(Continued).

SN 78-948,646. MASTERCARD INTERNATIONAL INCORPORATED, PURCHASE, NY. FILED 8-9-2006.



OWNER OF U.S. REG. NOS. 1,257,853, 3,108,581 AND OTHERS.

NO CLAIM IS MADE TO THE EXCLUSIVE RIGHT TO USE "WORLDWIDE", APART FROM THE MARK AS SHOWN.

THE COLOR(S) RED, PINK, ORANGE, YELLOW AND GRAY IS/ARE CLAIMED AS A FEATURE OF THE MARK.

THE MARK CONSISTS OF THE WORDS MASTERCARD WORLDWIDE IN THE COLOR GRAY AND THE DESIGN OF INTERSECTING CIRCLES THAT FADES FROM RED TO PINK TO ORANGE TO YELLOW. THE MARK IS DEPICTED ON A GRAY BACKGROUND AND THE GRAY BACKGROUND IS NOT CLAIMED AS A FEATURE OF THE MARK BUT MERELY DEPICTS DEPTH.

FOR ASSOCIATION SERVICES, NAMELY, PROMOTING THE INTERESTS OF BANKS, CREDIT UNIONS, AND OTHER REGULATED FINANCIAL INSTITUTIONS (U.S. CLS. 100, 101 AND 102).

FIRST USE 6-27-2006; IN COMMERCE 6-27-2006.
TANYA AMOS, EXAMINING ATTORNEY

SN 78-949,249. DATA TV NETWORKS, INC., CHICAGO, IL. FILED 8-10-2006.



home preview channel
properties on demand

OWNER OF U.S. REG. NOS. 2,307,834, 2,785,236 AND OTHERS.

NO CLAIM IS MADE TO THE EXCLUSIVE RIGHT TO USE "CHANNEL" AND "PROPERTIES ON DEMAND", APART FROM THE MARK AS SHOWN.

THE COLOR(S) BLACK, RED, YELLOW, GREEN, AND BLUE IS/ARE CLAIMED AS A FEATURE OF THE MARK."

"THE MARK CONSISTS OF THE COLORS BLUE, RED, AND YELLOW CORRESPOND TO A SIDE OF THE HOUSE/TELEVISION; INSIDE THE HOUSE/TELEVISION IS A YELLOW ARROW OR TRIANGLE; THE BOTTOMS OF THE LEGS ON THE HOUSE/TELEVISION ARE BLACK; THE PHRASES "HOME PREVIEW CHANNEL" AND "PROPERTIES ON DEMAND" APPEAR BELOW THE TELEVISION/HOUSE IN BLACK."

SEC. 2(F) HOME PREVIEW CHANNEL.
FOR ADVERTISING SERVICES FOR OTHERS IN THE FIELD OF REAL ESTATE THROUGH CABLE TELEVISION (U.S. CLS. 100, 101 AND 102).

DANIEL CAPSHAW, EXAMINING ATTORNEY

CLASS 35—(Continued).

SN 78-949,390. REDFLY MOTORSPORTS, INC., VIROQUA, WI. FILED 8-10-2006.

REDFLY MOTORSPORTS

THE MARK CONSISTS OF STANDARD CHARACTERS WITHOUT CLAIM TO ANY PARTICULAR FONT, STYLE, SIZE, OR COLOR.

NO CLAIM IS MADE TO THE EXCLUSIVE RIGHT TO USE "MOTORSPORTS", APART FROM THE MARK AS SHOWN.

FOR ONLINE RETAIL STORE SERVICES FEATURING AUTOMOBILE RACING AND AFTERMARKET RACING AND PERFORMANCE AUTOMOBILE PRODUCTS AND ACCESSORIES THEREFOR, AND ACCESSORIES FOR AUTOMOBILE RACING, NAMELY, BOOKS, MAGAZINES AND PRE-RECORDED DVD'S ON THE SUBJECT OF AUTOMOBILE RACING, WATCHES, BACKPACKS, HELMET BAGS, ATHLETIC BAGS, OVERNIGHT BAGS, HELMETS, REPLICA HELMETS, AND UMBRELLAS, ALL OF WHICH ARE RELATED TO AUTOMOBILE RACING (U.S. CLS. 100, 101 AND 102).

ANDREA BUTLER, EXAMINING ATTORNEY

CLASS 35—(Continued).

SN 78-950,864. ROYAL ARCH MARKETING, LLC, MIAMI, FL. FILED 8-12-2006.



NO CLAIM IS MADE TO THE EXCLUSIVE RIGHT TO USE "NAME", APART FROM THE MARK AS SHOWN.

THE COLOR(S) GOLD, BLUE AND BLACK IS/ARE CLAIMED AS A FEATURE OF THE MARK.

THE MARK CONSISTS OF DESIGN ELEMENT AND COLOR: THE SHIELDS AND THE SCROLL ARE GOLD. THE SHIELD IS OUTLINED IN BLACK AND THE SCROLL IS OUTLINED AND SHADED WITH BLACK. THE LETTERS ARE IN BLUE.

FOR RETAIL STORE AND ON-LINE RETAIL STORE SERVICES FEATURING PRINTOUTS, WOODEN AND GLASS FRAMES, PLAQUES, MUGS, TILES, T-SHIRTS, KEYRINGS, COASTERS AND RELATED GIFT ITEMS CONTAINING INFORMATION ABOUT FIRST NAME MEANINGS, SURNAME HISTORIES AND COAT OF ARMS (U.S. CLS. 100, 101 AND 102).

FIRST USE 7-1-2006; IN COMMERCE 7-11-2006.

KATHLEEN M. VANSTON, EXAMINING ATTORNEY

SN 78-949,564. CORE BTS, INC., INDIANAPOLIS, IN. FILED 8-10-2006.



NO CLAIM IS MADE TO THE EXCLUSIVE RIGHT TO USE "INC", APART FROM THE MARK AS SHOWN.

THE MARK CONSISTS OF A STAR DESIGN AND THE WORDS CORE BTS INC.

FOR BUSINESS CONSULTING AND INFORMATION SERVICES (U.S. CLS. 100, 101 AND 102).

FIRST USE 5-11-2006; IN COMMERCE 5-11-2006.

DOMINIC FATHY, EXAMINING ATTORNEY

SN 78-952,011. THE GLIDDEN COMPANY, STRONGSVILLE, OH. FILED 8-15-2006.

DONE ONCE. DONE RIGHT.

THE MARK CONSISTS OF STANDARD CHARACTERS WITHOUT CLAIM TO ANY PARTICULAR FONT, STYLE, SIZE, OR COLOR.

FOR ADVERTISING SERVICES FOR ADHESIVES FOR OTHERS (U.S. CLS. 100, 101 AND 102).

RICHARD WHITE, EXAMINING ATTORNEY

CLASS 35—(Continued).

SN 78-952,485. VIDEOPLUS, L.P., LAKE DALLAS, TX. FILED 8-15-2006.

TOOL CULTURE

THE MARK CONSISTS OF STANDARD CHARACTERS WITHOUT CLAIM TO ANY PARTICULAR FONT, STYLE, SIZE, OR COLOR.

NO CLAIM IS MADE TO THE EXCLUSIVE RIGHT TO USE "TOOL", APART FROM THE MARK AS SHOWN.

FOR ADVICE IN THE FIELD OF BUSINESS MANAGEMENT AND MARKETING; ARRANGING AND CONDUCTING MARKETING PROMOTIONAL EVENTS FOR OTHERS; BUSINESS CONSULTATION AND MANAGEMENT REGARDING MARKETING ACTIVITIES AND LAUNCHING OF NEW PRODUCTS; BUSINESS MARKETING CONSULTING SERVICES; BUSINESS MARKETING SERVICES; CREATION OF MARKETING TOOLS DESIGNED TO INCREASE A CLIENT COMPANY'S KNOWLEDGE OF CUSTOMER NEEDS, AND ITS COMPETITORS' PRODUCTS AND SERVICES, PRICING, ADVERTISING STRATEGY AND SALES STRATEGY; DEVELOPMENT OF MARKETING STRATEGIES AND CONCEPTS; DIRECT MARKETING SERVICES; MARKETING CONSULTING; MULTI-LEVEL MARKETING BUSINESS SERVICES; PROMOTION AND MARKETING SERVICES AND RELATED CONSULTING; PROVIDING BUSINESS MARKETING INFORMATION (U.S. CLS. 100, 101 AND 102).

FIRST USE 9-15-2003; IN COMMERCE 5-1-2006.
 NAAKWAMA ANKRAH, EXAMINING ATTORNEY

SN 78-954,702. ANALYSTS INTERNATIONAL CORPORATION, MINNEAPOLIS, MN. FILED 8-17-2006.

SYMMETRY WORKFORCE SOLUTIONS

THE MARK CONSISTS OF STANDARD CHARACTERS WITHOUT CLAIM TO ANY PARTICULAR FONT, STYLE, SIZE, OR COLOR.

NO CLAIM IS MADE TO THE EXCLUSIVE RIGHT TO USE "WORKFORCE SOLUTIONS", APART FROM THE MARK AS SHOWN.

FOR BUSINESS SERVICES, NAMELY, BUSINESS MANAGEMENT IN THE FIELDS OF CONTINGENT WORKFORCE ACQUISITION AND PERSONNEL MANAGEMENT, RATE MANAGEMENT, SUPPLIER SUPPORT AND BILLING, INVOICING AND PAYMENT, AND EXCLUDING BUSINESS SERVICES IN THE FIELD OF INFORMATION TECHNOLOGY CONSULTING SERVICES (U.S. CLS. 100, 101 AND 102).

FIRST USE 10-0-2006; IN COMMERCE 10-0-2006.
 ANDREW RHIM, EXAMINING ATTORNEY

CLASS 35—(Continued).

SN 78-954,987. WILSON MEDIA GROUP, INC., NEW YORK, NY. FILED 8-18-2006.

FLASHFOCUS

THE MARK CONSISTS OF STANDARD CHARACTERS WITHOUT CLAIM TO ANY PARTICULAR FONT, STYLE, SIZE, OR COLOR.

OWNER OF U.S. REG. NO. 2,384,450.

FOR BUSINESS RESEARCH SERVICES IN THE AREAS OF MARKETING AND PUBLIC OPINION, INCLUDING THE PROVISION OF SUCH SERVICES ONLINE (U.S. CLS. 100, 101 AND 102).

FIRST USE 12-0-1996; IN COMMERCE 12-0-1996.

RONALD MCMORROW, EXAMINING ATTORNEY

SN 78-955,030. HOLLANDER, ADAM, BETHESDA, MD. FILED 8-18-2006.

T-SHIRT TV

THE MARK CONSISTS OF STANDARD CHARACTERS WITHOUT CLAIM TO ANY PARTICULAR FONT, STYLE, SIZE, OR COLOR.

FOR ADVERTISING AND PUBLICITY SERVICES, NAMELY, PROMOTING THE GOODS, SERVICES, BRAND IDENTITY AND COMMERCIAL INFORMATION AND NEWS OF THIRD PARTIES THROUGH PRINT, AUDIO, VIDEO, DIGITAL AND ON-LINE MEDIUM (U.S. CLS. 100, 101 AND 102).

FIRST USE 5-31-2004; IN COMMERCE 5-31-2004.

RENEE MCCRAY, EXAMINING ATTORNEY

SN 78-955,298. FIRST CLASS CARE, INC., EVANSTON, IL. FILED 8-18-2006.

FIRST CLASS CARE

THE MARK CONSISTS OF STANDARD CHARACTERS WITHOUT CLAIM TO ANY PARTICULAR FONT, STYLE, SIZE, OR COLOR.

NO CLAIM IS MADE TO THE EXCLUSIVE RIGHT TO USE "CARE", APART FROM THE MARK AS SHOWN.

FOR DOMESTIC PLACEMENT SERVICES, NAMELY, JOB PLACEMENT OF CHILDCARE PROFESSIONALS, NANNIES, HOUSEKEEPERS, HOUSE MANAGERS, PERSONAL CHEFS AND OTHER HOUSEHOLD EMPLOYEES (U.S. CLS. 100, 101 AND 102).

TINA BROWN, EXAMINING ATTORNEY

CLASS 35—(Continued).

SN 78-957,820. ELEVATE GROUP HOLDINGS, LLC, DALLAS, TX. FILED 8-22-2006.

ELEVATE GROUP

THE MARK CONSISTS OF STANDARD CHARACTERS WITHOUT CLAIM TO ANY PARTICULAR FONT, STYLE, SIZE, OR COLOR.

NO CLAIM IS MADE TO THE EXCLUSIVE RIGHT TO USE "GROUP", APART FROM THE MARK AS SHOWN. FOR ADVERTISING SERVICES (U.S. CLS. 100, 101 AND 102).

FIRST USE 7-31-2006; IN COMMERCE 7-31-2006.
RUSS HERMAN, EXAMINING ATTORNEY

SN 78-958,949. ANTHONY W. BELL, GULFPORT, MS. FILED 8-23-2006.



NO CLAIM IS MADE TO THE EXCLUSIVE RIGHT TO USE "FURNITURE", APART FROM THE MARK AS SHOWN.

FOR RETAIL FURNITURE STORES (U.S. CLS. 100, 101 AND 102).

FIRST USE 10-15-1973; IN COMMERCE 10-15-1973.
COLLEEN KEARNEY, EXAMINING ATTORNEY

SN 78-960,938. CAVE SPRINGS, INC., WILMINGTON, DE. FILED 8-25-2006.



FOR ONLINE RETAIL STORE SERVICES FEATURING MATERNITY AND NURSING APPAREL (U.S. CLS. 100, 101 AND 102).

FIRST USE 1-9-1997; IN COMMERCE 1-9-1997.
TONJA GASKINS, EXAMINING ATTORNEY

CLASS 35—(Continued).

SN 78-961,797. R.H. DONNELLEY INC., CARY, NC. FILED 8-28-2006.

NET CLICKS

THE MARK CONSISTS OF STANDARD CHARACTERS WITHOUT CLAIM TO ANY PARTICULAR FONT, STYLE, SIZE, OR COLOR.

NO CLAIM IS MADE TO THE EXCLUSIVE RIGHT TO USE "NET", APART FROM THE MARK AS SHOWN.

FOR BUSINESS MARKETING SERVICES, NAMELY, PROVIDING CONSULTING AND FULFILLMENT SERVICES RELATING TO THE PLACEMENT OF INTERNET AND SEARCH ENGINE ADVERTISING FOR OTHERS AND CONSULTING SERVICES REGARDING THE OPTIMAL USE OF SEARCH ENGINES AND THE MANAGEMENT OF KEYWORD SEARCHES (U.S. CLS. 100, 101 AND 102).

FIRST USE 11-15-2005; IN COMMERCE 11-15-2005.
DAVID TAYLOR, EXAMINING ATTORNEY

SN 78-962,076. MARSHALL ASSOCIATES, INC., DBA PARTNERS IN HEALTHCARE COMMUNICATIONS, NEW YORK, NY. FILED 8-28-2006.

EMPINAGE

THE MARK CONSISTS OF STANDARD CHARACTERS WITHOUT CLAIM TO ANY PARTICULAR FONT, STYLE, SIZE, OR COLOR.

FOR PROVIDING AN ON-LINE, WEB-BASED, INTERACTIVE PROJECT MANAGEMENT DATABASE THAT ALLOWS OTHERS TO DETERMINE THE STATUS OF THEIR MARKETING PROJECTS (U.S. CLS. 100, 101 AND 102).

ANDREA K. NADELMAN, EXAMINING ATTORNEY

SN 78-966,085. XONAXI COSANA, OAXACA, MEXICO, FILED 9-1-2006.



THE MARK CONSISTS OF THE WORDS, XONAXI COSANA, IN STYLIZED PRINT WITH THE WORDS SEPARATED BY A PERPENDICULAR ARRANGEMENT OF SOLID BOX-SHAPED IMAGES, WITH A LINE OF CIRCULAR DESIGNS BENEATH THE WORDS.

FOR ONLINE RETAIL STORE SERVICES FEATURING PHOTOGRAPHS; ART GALLERIES FEATURING PHOTOGRAPHS; PROMOTION OF ART FAIRS FEATURING PHOTOGRAPHS FOR OTHERS; PROMOTION SERVICES FOR OTHERS IN THE FIELD OF ART GALLERIES AND ART FAIRS FEATURING PHOTOGRAPHS (U.S. CLS. 100, 101 AND 102).

DAVID MURRAY, EXAMINING ATTORNEY

CLASS 35—(Continued).

SN 78-971,679. WASHINGTON MUTUAL, INC., SEATTLE, WA. FILED 9-11-2006.



OWNER OF U.S. REG. NOS. 2,315,782, 2,478,344 AND OTHERS.

FOR COORDINATING THE RECRUITMENT AND REFERRAL OF VOLUNTEERS FOR COMMUNITY SERVICE AND TUTORING PROGRAMS; PROVIDING A REFERRAL NETWORK FOR LEGAL SERVICES; PROVIDING REFERRALS IN THE FIELD OF PRIVACY PROTECTION AND IDENTITY THEFT AND FRAUD PREVENTION PRODUCTS AND SERVICES; PROVIDING CONSULTING SERVICES, ADVICE AND INFORMATION CONCERNING MONITORING CONSUMER CREDIT REPORTS; MONITORING CONSUMER CREDIT REPORTS AND PROVIDING AN ALERT AS TO ANY CHANGES THEREIN; PROMOTION OF NON-PROFIT COMMUNITY, CULTURAL, THEATRICAL, ARTISTIC, MUSICAL, EDUCATIONAL AND SPORTING EVENTS AND PROGRAMS; PROVIDING INFORMATION REGARDING THE FOREGOING SERVICES VIA THE INTERNET (U.S. CLS. 100, 101 AND 102).
RENEE MCCRAY, EXAMINING ATTORNEY

SN 78-971,797. REDFLY MOTORSPORTS, INC., VIROQUA, WI. FILED 9-11-2006.



NO CLAIM IS MADE TO THE EXCLUSIVE RIGHT TO USE "MOTORSPORTS", APART FROM THE MARK AS SHOWN.

FOR ONLINE RETAIL STORE SERVICES FEATURING AUTOMOBILE RACING AND AFTERMARKET RACING AND PERFORMANCE AUTOMOBILE PRODUCTS AND ACCESSORIES THEREFOR, AND ACCESSORIES FOR AUTOMOBILE RACING, NAMELY, BOOKS, MAGAZINES AND PRE-RECORDED DVD'S ON THE SUBJECT OF AUTOMOBILE RACING, WATCHES, BACKPACKS, HELMET BAGS, ATHLETIC BAGS, OVERNIGHT BAGS, HELMETS, REPLICA HELMETS AND UMBRELLAS, ALL OF WHICH ARE RELATED TO AUTOMOBILE RACING (U.S. CLS. 100, 101 AND 102).
ANDREA BUTLER, EXAMINING ATTORNEY

CLASS 35—(Continued).

SN 78-972,112. REDFLY MOTORSPORTS, INC., VIROQUA, WI. FILED 9-12-2006.



NO CLAIM IS MADE TO THE EXCLUSIVE RIGHT TO USE "MOTORSPORTS", APART FROM THE MARK AS SHOWN.

FOR ONLINE RETAIL STORE SERVICES FEATURING AUTOMOBILE RACING AND AFTERMARKET RACING AND PERFORMANCE AUTOMOBILE PRODUCTS AND ACCESSORIES THEREFOR, AND ACCESSORIES FOR AUTOMOBILE RACING, NAMELY, BOOKS, MAGAZINES AND PRE-RECORDED DVD'S ON THE SUBJECT OF AUTOMOBILE RACING, WATCHES, BACKPACKS, HELMET BAGS, ATHLETIC BAGS, OVERNIGHT BAGS, HELMETS, REPLICA HELMETS, AND UMBRELLAS, ALL OF WHICH ARE RELATED TO AUTOMOBILE RACING (U.S. CLS. 100, 101 AND 102).

ANDREA BUTLER, EXAMINING ATTORNEY

SN 78-973,458. ADTERACTIVE, INC., SAN FRANCISCO, CA. FILED 9-13-2006.

AMPP

THE MARK CONSISTS OF STANDARD CHARACTERS WITHOUT CLAIM TO ANY PARTICULAR FONT, STYLE, SIZE, OR COLOR.

FOR ADVERTISING, MARKETING AND PROMOTION SERVICES; ON-LINE ADVERTISING AND MARKETING SERVICES (U.S. CLS. 100, 101 AND 102).

FIRST USE 1-31-2006; IN COMMERCE 1-31-2006.
JOHN KELLY, EXAMINING ATTORNEY

SN 78-978,512. STANDARD HOMEOPATHIC COMPANY, LOS ANGELES, CA. FILED 8-11-2005.

TxOptions

THE MARK CONSISTS OF STANDARD CHARACTERS WITHOUT CLAIM TO ANY PARTICULAR FONT, STYLE, SIZE, OR COLOR.

FOR ON-LINE RETAIL STORE SERVICES FEATURING MEDICAL PRODUCTS IN THE FIELD OF COMPLEMENTARY AND ALTERNATIVE MEDICINE, CAM (U.S. CLS. 100, 101 AND 102).

FIRST USE 10-13-2005; IN COMMERCE 10-13-2005.
CAROLYN CATALDO, EXAMINING ATTORNEY

CLASS 35—(Continued).

SN 79-030,202. GLOBALCOM PUBLIC RELATIONS; NETWORK GMBH, FED REP GERMANY, FILED 6-20-2006.



PRIORITY DATE OF 3-9-2006 IS CLAIMED.
OWNER OF INTERNATIONAL REGISTRATION 0901807
DATED 6-20-2006, EXPIRES 6-20-2016.

THE COLOR(S) ORANGE IS/ARE CLAIMED AS A FEATURE OF THE MARK.

ALL PRINCIPAL PARTS OF THE MARK ARE COLORED ORANGE.

THE MARK CONSISTS OF SPIRALS FORMING A GLOBE SHAPE IN ORANGE. THE WORDING GLOBALCOM APPEARS BELOW THE DESIGN IN ORANGE.

FOR ADVERTISING, MARKETING, PROFESSIONAL BUSINESS CONSULTANCY WITH REGARD TO ORGANISATION AND MANAGEMENT OF COMPANIES (U.S. CLS. 100, 101 AND 102).

BERNICE MIDDLETON, EXAMINING ATTORNEY

SN 79-036,461. MOISES COSTA PRIMO JALECO, P-1000-246 LISBOA, PORTUGAL, FILED 1-29-2007.

CHILL OUT CONCEPT

THE MARK CONSISTS OF STANDARD CHARACTERS WITHOUT CLAIM TO ANY PARTICULAR FONT, STYLE, SIZE, OR COLOR.

PRIORITY DATE OF 8-7-2006 IS CLAIMED.
OWNER OF INTERNATIONAL REGISTRATION 0918684
DATED 1-29-2007, EXPIRES 1-29-2017.

FOR FRANCHISING SERVICES CONCERNING THE PREPARATION AND TRANSFER OF BUSINESS KNOWLEDGE, COMMERCIAL AND ORGANIZATIONAL KNOWLEDGE REGARDING THE SETTING-UP AND/OR MANAGEMENT OF SHOPS AND COMMERCIAL ESTABLISHMENTS (U.S. CLS. 100, 101 AND 102).

ESTHER A. BORSUK, EXAMINING ATTORNEY

CLASS 35—(Continued).

SN 79-037,880. O'CONNELL MARKETING PTY LTD, AUSTRALIA, FILED 2-23-2007.



PRIORITY DATE OF 11-30-2006 IS CLAIMED.
OWNER OF INTERNATIONAL REGISTRATION 0922494
DATED 2-23-2007, EXPIRES 2-23-2017.

FOR CONSULTANCY RELATING TO PERSONNEL RECRUITMENT; RECRUITMENT CONSULTANCY SERVICES; STAFF RECRUITMENT SERVICES; JOB PLACEMENT SERVICES; ADVISORY AND INFORMATION SERVICES RELATING TO PERSONNEL RECRUITMENT AND STAFF RECRUITMENT; ADVERTISING; BUSINESS ADMINISTRATION; PROVIDING OFFICE FUNCTIONS (U.S. CLS. 100, 101 AND 102).

FLORENTINA BLANDU, EXAMINING ATTORNEY

CLASS 36—INSURANCE AND FINANCIAL

SN 76-225,486. DUNDEE CORPORATION, TORONTO, ONTARIO, CANADA, FILED 3-14-2001.

DYNAMIC INTERNATIONAL VALUE CLASS

PRIORITY CLAIMED UNDER SEC. 44(D) ON CANADA APPLICATION NO. 10908064, FILED 2-8-2001, REG. NO. TMA658404, DATED 2-8-2006, EXPIRES 2-8-2021.

NO CLAIM IS MADE TO THE EXCLUSIVE RIGHT TO USE "INTERNATIONAL VALUE CLASS", APART FROM THE MARK AS SHOWN.

FOR MANAGING MUTUAL FUNDS (U.S. CLS. 100, 101 AND 102).

RICHARD A. STRASER, EXAMINING ATTORNEY

SN 76-649,306. STATE AUTOMOBILE MUTUAL INS. CO., COLUMBUS, OH. FILED 10-27-2005.

CUSTOMFIT

THE MARK CONSISTS OF STANDARD CHARACTERS WITHOUT CLAIM TO ANY PARTICULAR FONT, STYLE, SIZE, OR COLOR.

FOR INSURANCE SERVICES, NAMELY, UNDERWRITING AUTOMOBILE INSURANCE CONTRACTS (U.S. CLS. 100, 101 AND 102).

SANJEEV VOHRA, EXAMINING ATTORNEY

CLASS 36—(Continued).

SN 76-651,242. NEW MEXICO CANCER CENTER FOUNDATION, ALBUQUERQUE, NM. FILED 12-1-2005.



NO CLAIM IS MADE TO THE EXCLUSIVE RIGHT TO USE "FOUNDATION", APART FROM THE MARK AS SHOWN.

THE COLOR(S) BLUE AND LIGHT BLUE IS/ARE CLAIMED AS A FEATURE OF THE MARK.

THE MARK CONSISTS OF A SUN DIVIDED IN TWO WITH THE LEFT HALF APPEARING IN LIGHT BLUE AND THE RIGHT HALF APPEARING IN BLUE. THE RIGHT HALF ALSO APPEARS TO BE THE PROFILE OF A FACE WITH THE NOSE AND ONE EYE VISIBLE. THE LETTERS "NMCC" APPEARS BELOW THE SUN IN BLUE AND THE WORD "FOUNDATION" APPEARS BELOW THAT, ALSO IN BLUE.

FOR ACCEPTING AND ADMINISTERING MONETARY CHARITABLE CONTRIBUTIONS FOR NEEDY PATIENTS (U.S. CLS. 100, 101 AND 102).

FIRST USE 1-0-2004; IN COMMERCE 1-0-2004.
JESSICA A. POWERS, EXAMINING ATTORNEY

SN 76-655,387. DEREK CLARK, TRACY, CA. FILED 2-21-2006.

FAST MORTGAGE

THE MARK CONSISTS OF STANDARD CHARACTERS WITHOUT CLAIM TO ANY PARTICULAR FONT, STYLE, SIZE, OR COLOR.

NO CLAIM IS MADE TO THE EXCLUSIVE RIGHT TO USE "MORTGAGE", APART FROM THE MARK AS SHOWN.

SEC. 2(F).
FOR FULL SERVICE MORTGAGE BROKERAGE PROVIDING RESIDENTIAL AND COMMERCIAL REAL ESTATE LOANS (U.S. CLS. 100, 101 AND 102).

FIRST USE 3-15-1998; IN COMMERCE 3-15-1998.
PAUL CROWLEY, EXAMINING ATTORNEY

CLASS 36—(Continued).

SN 76-664,751. ATLANTIC NATIONAL BANK, BRUNSWICK, GA. FILED 8-11-2006.



NO CLAIM IS MADE TO THE EXCLUSIVE RIGHT TO USE "NATIONAL BANK" AND "BRUNSWICK GEORGIA", APART FROM THE MARK AS SHOWN.

THE COLOR(S) BLUE AND YELLOW IS/ARE CLAIMED AS A FEATURE OF THE MARK.

THE COLOR BLUE APPEARS IN THE WORDING ATLANTIC NATIONAL BANK BRUNSWICK GEORGIA AND IN THE UPPER AND LOWER BAND OF THE FLAG AND YELLOW IN THE MIDDLE BAND OF THE FLAG AND THE LINE BELOW THE WORDING ATLANTIC.

FOR BANKING SERVICES (U.S. CLS. 100, 101 AND 102).

FIRST USE 8-31-1998; IN COMMERCE 8-31-1998.
ALICE BENMAMAN, EXAMINING ATTORNEY

SN 76-666,595. SHAWNEE HOLDING, INC., SHAWNEE-ON-DELAWARE, PA. FILED 9-25-2006.

SHAWNEE

THE MARK CONSISTS OF STANDARD CHARACTERS WITHOUT CLAIM TO ANY PARTICULAR FONT, STYLE, SIZE, OR COLOR.

OWNER OF U.S. REG. NO. 1,615,755.
SEC. 2(F).

FOR REAL ESTATE BROKERAGE AND MANAGEMENT SERVICES, NAMELY, REAL ESTATE AGENCY SERVICES, REAL ESTATE BROKERAGE, RENTAL OF REAL PROPERTY, REAL ESTATE TIME-SHARING, AND REAL ESTATE MANAGEMENT OF TIMESHARE RESORT RESIDENTIAL UNITS (U.S. CLS. 100, 101 AND 102).

FIRST USE 1-1-1978; IN COMMERCE 1-1-1978.
KATHY DE JONGE, EXAMINING ATTORNEY

SN 76-666,941. MANSION MAN VENTURES, LLC, TAMPA, FL. FILED 10-3-2006.

Good Faith Private Lending

THE MARK CONSISTS OF STANDARD CHARACTERS WITHOUT CLAIM TO ANY PARTICULAR FONT, STYLE, SIZE, OR COLOR.

NO CLAIM IS MADE TO THE EXCLUSIVE RIGHT TO USE "LENDING", APART FROM THE MARK AS SHOWN.

FOR REAL ESTATE INVESTMENT (U.S. CLS. 100, 101 AND 102).

RICHARD A. STRASER, EXAMINING ATTORNEY

CLASS 36—(Continued).

SN 76-672,909. HTDI FINANCIAL, INC., GILBER, AZ. FILED 2-21-2007.

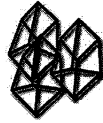

HTDI Financial

NO CLAIM IS MADE TO THE EXCLUSIVE RIGHT TO USE "FINANCIAL", APART FROM THE MARK AS SHOWN.

FOR FINANCIAL SERVICES, NAMELY CREDIT REPAIR ADVICE AND COUNSELING (U.S. CLS. 100, 101 AND 102).

FIRST USE 11-1-2004; IN COMMERCE 11-1-2004.
ELI HELLMAN, EXAMINING ATTORNEY

SN 76-673,325. MCMAHON, DOROTHY M., BLOOMFIELD HILLS, MI. FILED 2-28-2007.

DESIGNATED WOMAN

THE MARK CONSISTS OF STANDARD CHARACTERS WITHOUT CLAIM TO ANY PARTICULAR FONT, STYLE, SIZE, OR COLOR.

FOR INSURANCE BROKERAGE IN THE FIELD OF LONG-TERM CARE INSURANCE (U.S. CLS. 100, 101 AND 102).

FIRST USE 6-1-2006; IN COMMERCE 6-1-2006.
KAELIE KUNG, EXAMINING ATTORNEY

SN 76-675,282. HOMEVESTORS OF AMERICA, INC., DALLAS, TX. FILED 4-10-2007.

THE GOOD, THE BAD AND THE UGLY

THE MARK CONSISTS OF STANDARD CHARACTERS WITHOUT CLAIM TO ANY PARTICULAR FONT, STYLE, SIZE, OR COLOR.

FOR REAL ESTATE SERVICES, NAMELY, PURCHASE, FINANCE, ACQUISITION AND BROKERAGE OF RESIDENTIAL REAL ESTATE PROPERTIES FOR OTHERS (U.S. CLS. 100, 101 AND 102).

FIRST USE 3-2-2007; IN COMMERCE 3-2-2007.
EDWARD NELSON, EXAMINING ATTORNEY

CLASS 36—(Continued).

SN 77-009,879. INTEGRATED ASSET SERVICES, INC., DENVER, CO. FILED 9-28-2006.

IAS

THE MARK CONSISTS OF STANDARD CHARACTERS WITHOUT CLAIM TO ANY PARTICULAR FONT, STYLE, SIZE, OR COLOR.

FOR REAL ESTATE SERVICES, NAMELY PROPERTY VALUATION AND APPRAISAL SERVICES AND BROKER-PRICED OPINION SERVICES, REAL ESTATE LOAN DEFAULT MANAGEMENT SERVICES, LOAN PORTFOLIO MANAGEMENT AND CONSULTATION, SERVICES MANAGEMENT RELATING TO REAL ESTATE OWNED, "REO" TRANSACTIONS, NAMELY, FORECLOSURE SERVICES, PROVIDING VALUATION OF REAL ESTATE BY MEANS OF AUTOMATED COLLATERAL VALUE AND RISK FORECASTING METHODOLOGIES, PROPERTY RISK INFORMATION SERVICES, REAL ESTATE SERVICES IN THE NATURE OF AN ONLINE SEARCHABLE DATABASE OF PROPERTY LISTINGS (U.S. CLS. 100, 101 AND 102).

DORITT L. CARROLL, EXAMINING ATTORNEY

SN 77-022,788. KOWALIK, WENDY H., SAN ANTONIO, TX. AND OLIPHINT, THOMAS H., SAN ANTONIO, TX. FILED 10-17-2006.

GRAND PURPOSE ACTIVITY

THE MARK CONSISTS OF STANDARD CHARACTERS WITHOUT CLAIM TO ANY PARTICULAR FONT, STYLE, SIZE, OR COLOR.

FOR FINANCIAL AND INVESTMENT SERVICES, NAMELY, FINANCIAL ANALYSIS AND CONSULTATION; FINANCIAL DUE DILIGENCE; FINANCIAL EVALUATION FOR INSURANCE PURPOSES; FINANCIAL FORECASTING; FINANCIAL INFORMATION PROVIDED BY ELECTRONIC MEANS; FINANCIAL INVESTMENT IN THE FIELD OF SECURITIES; FINANCIAL PLANNING; FINANCIAL PORTFOLIO MANAGEMENT; FINANCIAL RESEARCH; FINANCIAL RISK MANAGEMENT; FINANCIAL SERVICES IN THE NATURE OF INVESTMENT SECURITY; FINANCIAL SERVICES, NAMELY ASSISTING OTHERS WITH THE COMPLETION OF FINANCIAL TRANSACTIONS FOR STOCKS, BONDS, SECURITIES AND EQUITIES, INVESTMENT FUND TRANSFER AND TRANSACTION SERVICES, A TOTAL PORTFOLIO OFFERING FOR HIGH NET WORTH CLIENTS CONSISTING OF BOTH SEPARATE ACCOUNTS AND MUTUAL FUNDS FOR EQUITY AND FIXED INCOME INVESTMENTS, SAVING PROGRAMS FOR YOUTHS, AND ESTATE SETTLEMENT SERVICES; PROVIDING ONLINE INFORMATION IN THE FIELD OF CHARITABLE MONETARY GIVING THROUGH FINANCIAL AND ESTATE PLANNING; PROVIDING ON-LINE FINANCIAL CALCULATOR; ADVICE RELATING TO INVESTMENTS; FUND INVESTMENT CONSULTATION; FUNDS INVESTMENT; HEDGE FUND INVESTMENT SERVICES; INVESTMENT ADVISORY SERVICES; INVESTMENT BROKERAGE; INVESTMENT CONSULTATION; INVESTMENT MANAGEMENT; INVESTMENT MANAGEMENT OF AND DISTRIBUTION OF VARIABLE ANNUITIES; PRIVATE EQUITY FUND INVESTMENT SERVICES; REAL ESTATE INVESTMENT (U.S. CLS. 100, 101 AND 102).

BRENDAN MCCAULEY, EXAMINING ATTORNEY

CLASS 36—(Continued).

SN 77-022,789. READY FINANCIAL GROUP, NAMPA, ID. FILED 10-17-2006.

READY FINANCIAL

THE MARK CONSISTS OF STANDARD CHARACTERS WITHOUT CLAIM TO ANY PARTICULAR FONT, STYLE, SIZE, OR COLOR.

NO CLAIM IS MADE TO THE EXCLUSIVE RIGHT TO USE "FINANCIAL", APART FROM THE MARK AS SHOWN.

FOR FINANCIAL SERVICES, NAMELY, PREPAID CARD SERVICES, CREDIT CARD SERVICES, CHECKING ACCOUNT SERVICES, AND SAVINGS ACCOUNT SERVICES (U.S. CLS. 100, 101 AND 102).

JOHN DALIER, EXAMINING ATTORNEY

SN 77-022,795. KOWALIK, WENDY H., SAN ANTONIO, TX. AND OLIPHINT, THOMAS H., SAN ANTONIO, TX. FILED 10-17-2006.

POSITIVE PROGRESS

THE MARK CONSISTS OF STANDARD CHARACTERS WITHOUT CLAIM TO ANY PARTICULAR FONT, STYLE, SIZE, OR COLOR.

FOR FINANCIAL AND INVESTMENT SERVICES, NAMELY, FINANCIAL ANALYSIS AND CONSULTATION; FINANCIAL DUE DILIGENCE; FINANCIAL EVALUATION FOR INSURANCE PURPOSES; FINANCIAL FORECASTING; FINANCIAL INFORMATION PROVIDED BY ELECTRONIC MEANS; FINANCIAL INVESTMENT IN THE FIELD OF SECURITIES; FINANCIAL PLANNING; FINANCIAL PORTFOLIO MANAGEMENT; FINANCIAL RESEARCH; FINANCIAL RISK MANAGEMENT; FINANCIAL SERVICES IN THE NATURE OF INVESTMENT SECURITY; FINANCIAL SERVICES, NAMELY ASSISTING OTHERS WITH THE COMPLETION OF FINANCIAL TRANSACTIONS FOR STOCKS, BONDS, SECURITIES AND EQUITIES, INVESTMENT FUND TRANSFER AND TRANSACTION SERVICES, A TOTAL PORTFOLIO OFFERING FOR HIGH NET WORTH CLIENTS CONSISTING OF BOTH SEPARATE ACCOUNTS AND MUTUAL FUNDS FOR EQUITY AND FIXED INCOME INVESTMENTS, SAVING PROGRAMS FOR YOUTHS, AND ESTATE SETTLEMENT SERVICES; PROVIDING ONLINE INFORMATION IN THE FIELD OF CHARITABLE MONETARY GIVING THROUGH FINANCIAL AND ESTATE PLANNING; PROVIDING ON-LINE FINANCIAL CALCULATOR; ADVICE RELATING TO INVESTMENTS; FUND INVESTMENT CONSULTATION; FUNDS INVESTMENT; HEDGE FUND INVESTMENT SERVICES; INVESTMENT ADVISORY SERVICES; INVESTMENT BROKERAGE; INVESTMENT CONSULTATION; INVESTMENT MANAGEMENT; INVESTMENT MANAGEMENT OF AND DISTRIBUTION OF VARIABLE ANNUITIES; PRIVATE EQUITY FUND INVESTMENT SERVICES; REAL ESTATE INVESTMENT (U.S. CLS. 100, 101 AND 102).

BRENDAN MCCAULEY, EXAMINING ATTORNEY

CLASS 36—(Continued).

SN 77-028,339. ROCHESTER BUSINESSMAN'S CHARITABLE ORGANIZATION, INC., ROCHESTER, NY. FILED 10-24-2006.

**Rochester Business Classic**

NO CLAIM IS MADE TO THE EXCLUSIVE RIGHT TO USE "ROCHESTER" OR "CLASSIC", APART FROM THE MARK AS SHOWN.

THE MARK CONSISTS OF LETTERS RBC IN STYLIZED TEXT, AND THE WORDING ROCHESTER BUSINESS CLASSIC

FOR CHARITABLE FUNDRAISING, NAMELY, SPONSORING A GOLF TOURNAMENT FOR CHARITABLE PURPOSES (U.S. CLS. 100, 101 AND 102).

FIRST USE 7-1-1987; IN COMMERCE 7-1-1987.

TEJBIR SINGH, EXAMINING ATTORNEY

SN 77-029,403. CMT ASSET MANAGEMENT LIMITED, CHICAGO, IL. FILED 10-25-2006.

CMT ASSET MANAGEMENT

THE MARK CONSISTS OF STANDARD CHARACTERS WITHOUT CLAIM TO ANY PARTICULAR FONT, STYLE, SIZE, OR COLOR.

NO CLAIM IS MADE TO THE EXCLUSIVE RIGHT TO USE "ASSET MANAGEMENT", APART FROM THE MARK AS SHOWN.

FOR FINANCIAL MANAGEMENT SERVICES, NAMELY, HEDGE FUND MANAGEMENT SERVICES; INVESTMENT MANAGEMENT SERVICES; AND OFF SHORE HEDGE FUND MANAGEMENT SERVICES (U.S. CLS. 100, 101 AND 102).

AMY BROZENIC, EXAMINING ATTORNEY

SN 77-030,737. WELLS FARGO & COMPANY, MINNEAPOLIS, MN. FILED 10-27-2006.

WELLS FARGO EXPRESS REFI

THE MARK CONSISTS OF STANDARD CHARACTERS WITHOUT CLAIM TO ANY PARTICULAR FONT, STYLE, SIZE, OR COLOR.

OWNER OF U.S. REG. NOS. 2,457,743 AND 2,526,696.

NO CLAIM IS MADE TO THE EXCLUSIVE RIGHT TO USE REFI, APART FROM THE MARK AS SHOWN.

SEC. 2(F) AS TO EXPRESS.

FOR FINANCIAL SERVICES, NAMELY, BUSINESS LOANS AND REAL ESTATE EQUITY FINANCING (U.S. CLS. 100, 101 AND 102).

FIRST USE 8-20-2004; IN COMMERCE 8-20-2004.

RAY THOMAS, EXAMINING ATTORNEY

CLASS 36—(Continued).

SN 77-030,745. WELLS FARGO & COMPANY, MINNEAPOLIS, MN. FILED 10-27-2006.

WELLS FARGO EXPRESS EQUITY

THE MARK CONSISTS OF STANDARD CHARACTERS WITHOUT CLAIM TO ANY PARTICULAR FONT, STYLE, SIZE, OR COLOR.

OWNER OF U.S. REG. NOS. 2,457,743 AND 2,526,696.

NO CLAIM IS MADE TO THE EXCLUSIVE RIGHT TO USE EQUITY, APART FROM THE MARK AS SHOWN. SEC. 2(F) AS TO EXPRESS.

FOR FINANCIAL SERVICES, NAMELY, CREDIT CARD SERVICES, BUSINESS LOANS, REAL ESTATE EQUITY FINANCING AND REVOLVING LINES OF CREDIT (U.S. CLS. 100, 101 AND 102).

FIRST USE 8-20-2004; IN COMMERCE 8-20-2004.
RAY THOMAS, EXAMINING ATTORNEY

CLASS 36—(Continued).

SN 77-040,855. MASRAF AL-RAYAN, DOHA, QATAR, FILED 11-9-2006.



NO CLAIM IS MADE TO THE EXCLUSIVE RIGHT TO USE "MASRAF", APART FROM THE MARK AS SHOWN.

THE NAME MASRAF AL RAYAN DOES NOT IDENTIFY A LIVING INDIVIDUAL.

THE MARK CONSISTS OF THE WORDS MASRAF AL RAYAN AND ITS ARABIC EQUIVALENT WITH A SEMI CIRCLES DESIGN.

"THE FOREIGN WORDING IN THE MARK TRANSLATES INTO ENGLISH AS AL RAYAN BANK."

FOR BANKING; INSURANCE UNDERWRITING SERVICES FOR ALL TYPES OF INSURANCE; FINANCIAL ANALYSIS; MONETARY EXCHANGE; ASSESSMENT AND MANAGEMENT OF REAL ESTATE; REAL ESTATE AGENCIES (U.S. CLS. 100, 101 AND 102).

ALEXANDER L. POWERS, EXAMINING ATTORNEY

SN 77-039,207. RCI TM CORP., LAS VEGAS, NV. FILED 11-8-2006.

RCI MEMBER DOLLARS

THE MARK CONSISTS OF STANDARD CHARACTERS WITHOUT CLAIM TO ANY PARTICULAR FONT, STYLE, SIZE, OR COLOR.

OWNER OF U.S. REG. NOS. 2,760,173, 3,089,999 AND OTHERS.

NO CLAIM IS MADE TO THE EXCLUSIVE RIGHT TO USE "MEMBER DOLLARS", APART FROM THE MARK AS SHOWN.

FOR REAL ESTATE TIME-SHARING EXCHANGE SERVICES (U.S. CLS. 100, 101 AND 102).

FIRST USE 10-0-2004; IN COMMERCE 10-0-2004.
JIM RINGLE, EXAMINING ATTORNEY

SN 77-053,323. BAGAN, KENNETH J., NILES, IL. FILED 11-29-2006.

BRINGING BETTER HEARING &
VISION TO THOSE IN NEED

THE MARK CONSISTS OF STANDARD CHARACTERS WITHOUT CLAIM TO ANY PARTICULAR FONT, STYLE, SIZE, OR COLOR.

FOR CHARITABLE FUND RAISING SERVICES IN THE NATURE OF SOLICITING DONATIONS IN THE FORM OF USED HEARING AIDS AND EYEGASSES TO BE SOLD TO RECYCLING SERVICE CENTERS, AND THEN DONATING THE PROCEEDS FROM SUCH SALES TO ORGANIZATIONS THAT DISTRIBUTE HEARING AIDS AND EYEGASSES TO THOSE IN NEED (U.S. CLS. 100, 101 AND 102).

FIRST USE 11-27-2006; IN COMMERCE 11-27-2006.
SEAN CROWLEY, EXAMINING ATTORNEY

CLASS 36—(Continued).

SN 77-053,349. BAGAN, KENNETH J., NILES, IL. FILED 11-29-2006.



NO CLAIM IS MADE TO THE EXCLUSIVE RIGHT TO USE "GROUP FOUNDATION", APART FROM THE MARK AS SHOWN.

THE MARK CONSISTS OF A STYLIZED DESIGN OF AN EYE; THE STYLIZED LETTERS BR, WHERE THE B IS BACKWARD; FOLLOWED BY THE WORDS GROUP FOUNDATION.

FOR CHARITABLE FUND RAISING SERVICES IN THE NATURE OF SOLICITING DONATIONS IN THE FORM OF USED HEARING AIDS AND EYEGLASSES TO BE SOLD TO RECYCLING SERVICE CENTERS, AND THEN DONATING THE PROCEEDS FROM SUCH SALES TO ORGANIZATIONS THAT DISTRIBUTE HEARING AIDS AND EYEGLASSES TO THOSE IN NEED (U.S. CLS. 100, 101 AND 102).

FIRST USE 11-27-2006; IN COMMERCE 11-27-2006.
SEAN CROWLEY, EXAMINING ATTORNEY

SN 77-067,569. GE MONEY BANK, SALT LAKE CITY, UT. FILED 12-19-2006.

FLASHSETTLE

THE MARK CONSISTS OF STANDARD CHARACTERS WITHOUT CLAIM TO ANY PARTICULAR FONT, STYLE, SIZE, OR COLOR.

FOR FINANCIAL MANAGEMENT, NAMELY, FINANCIAL LEDGER SETTLEMENT SERVICES (U.S. CLS. 100, 101 AND 102).

KATHERINE E. HALMEN, EXAMINING ATTORNEY

CLASS 36—(Continued).

SN 77-069,850. DEUTSCHE TELEKOM AG, BONN, FED REP GERMANY, FILED 12-21-2006.



PRIORITY CLAIMED UNDER SEC. 44(D) ON FED REP GERMANY APPLICATION NO. 30639011638, FILED 6-22-2006, REG. NO. 30639011, DATED 6-22-2006, EXPIRES 6-30-2016.

FOR INSURANCE SERVICES, NAMELY, INSURANCE BROKERAGE, INSURANCE CLAIMS PROCESSING; FINANCIAL SERVICES, NAMELY, CLEARING OF SECURE FINANCIAL TRANSACTIONS THROUGH ONLINE SERVICES; FINANCIAL ANALYSIS AND CONSULTATION; FINANCIAL INFORMATION PROVIDED BY ELECTRONIC MEANS; FINANCIAL INFORMATION PROCESSING; FINANCIAL PORTFOLIO MANAGEMENT; FINANCIAL SERVICES, NAMELY, FINANCIAL CONSULTATION IN THE FIELD OF FINANCIAL SECURITIES; SAFE DEPOSIT BOX SERVICES FOR THE SAFEKEEPING OF SECURITIES; FINANCIAL SPONSORSHIP OF SPORTS, EDUCATIONAL AND ENTERTAINMENT PROGRAMS AND EVENTS; COMMERCIAL LENDING SERVICES; MONETARY EXCHANGE; CREDIT CARD SERVICES; TELEPHONE CALLING CARD SERVICES; ELECTRONIC COMMERCE SERVICES, NAMELY, ELECTRONIC DEBIT AND CREDIT CARD TRANSACTION PROCESSING SERVICES, FUNDS TRANSFER AND BILL PAYMENT-PROCESSING SERVICES; DISCOUNT BROKERAGE SERVICES; SECURITY BROKERAGE; BROKERAGE IN THE FIELD OF INSURANCE, STOCKS, COMMODITIES; CUSTOM BROKERAGE FOR THIRD PARTIES IN THE FIELD OF INSURANCE, STOCKS, COMMODITIES; BROKERAGE OF SHARES AND VENTURE CAPITAL FUNDING SERVICES TO START-UP COMPANIES; BROKERAGE OF FUND SHARES; BROKERAGE OF PRODUCTIVE INVESTMENT OF FUNDS; REAL ESTATE SERVICES, NAMELY, BROKERAGE, MANAGEMENT, LEASING, AND APPRAISAL OF REAL PROPERTY; CONSULTING SERVICES RELATING TO INSURANCE SERVICES, NAMELY, PROVIDING INFORMATION AND BROKERAGE OF INSURANCES IN THE FIELD OF HOME INSURANCE, ACCIDENT INSURANCE AND HEALTH INSURANCE; CONSULTING SERVICES RELATING TO BANK SERVICES; PROVIDING INFORMATION VIA THE TELEPHONE AND THE GLOBAL COMMUNICATION NETWORKS IN THE FIELD OF FINANCE (U.S. CLS. 100, 101 AND 102).

FRED MANDIR, EXAMINING ATTORNEY

SN 77-072,731. DIAMOND NATIONAL ADJUSTING, L.L.C., MULVANE, KS. FILED 12-28-2006.

Diamond National

THE MARK CONSISTS OF STANDARD CHARACTERS WITHOUT CLAIM TO ANY PARTICULAR FONT, STYLE, SIZE, OR COLOR.

NO CLAIM IS MADE TO THE EXCLUSIVE RIGHT TO USE "NATIONAL", APART FROM THE MARK AS SHOWN. FOR CLAIMS ADJUSTMENT IN THE FIELD OF INSURANCE; INSURANCE CLAIMS ADMINISTRATION; INSURANCE CLAIMS PROCESSING (U.S. CLS. 100, 101 AND 102).

FIRST USE 6-1-2006; IN COMMERCE 6-1-2006.
EDWARD NELSON, EXAMINING ATTORNEY

CLASS 36—(Continued).

SN 77-073,365. DIABETES RESEARCH INSTITUTE FOUNDATION, INC., HOLLYWOOD, FL. FILED 12-29-2006.

EMPIRE BALL

THE MARK CONSISTS OF STANDARD CHARACTERS WITHOUT CLAIM TO ANY PARTICULAR FONT, STYLE, SIZE, OR COLOR.

NO CLAIM IS MADE TO THE EXCLUSIVE RIGHT TO USE "BALL", APART FROM THE MARK AS SHOWN.

FOR CHARITABLE FUND RAISING (U.S. CLS. 100, 101 AND 102).

FIRST USE 7-0-1999; IN COMMERCE 7-0-1999.
DANIEL CAPSHAW, EXAMINING ATTORNEY

CLASS 36—(Continued).

SN 77-073,379. DIABETES RESEARCH INSTITUTE FOUNDATION, INC., HOLLYWOOD, FL. FILED 12-29-2006.

DIABETES DIPLOMATS

THE MARK CONSISTS OF STANDARD CHARACTERS WITHOUT CLAIM TO ANY PARTICULAR FONT, STYLE, SIZE, OR COLOR.

NO CLAIM IS MADE TO THE EXCLUSIVE RIGHT TO USE "DIABETES", APART FROM THE MARK AS SHOWN.

FOR CHARITABLE FUND RAISING (U.S. CLS. 100, 101 AND 102).

FIRST USE 4-0-2003; IN COMMERCE 4-0-2003.
DANIEL CAPSHAW, EXAMINING ATTORNEY

SN 77-073,376. DIABETES RESEARCH INSTITUTE FOUNDATION, INC., HOLLYWOOD, FL. FILED 12-29-2006.

CARNIVAL FOR A CURE

THE MARK CONSISTS OF STANDARD CHARACTERS WITHOUT CLAIM TO ANY PARTICULAR FONT, STYLE, SIZE, OR COLOR.

NO CLAIM IS MADE TO THE EXCLUSIVE RIGHT TO USE "CARNIVAL", APART FROM THE MARK AS SHOWN.

FOR CHARITABLE FUND RAISING (U.S. CLS. 100, 101 AND 102).

FIRST USE 7-0-2005; IN COMMERCE 7-0-2005.
DANIEL CAPSHAW, EXAMINING ATTORNEY

SN 77-076,305. TODAY LENDING, LLC, TULSA, OK. FILED 1-4-2007.

Today Lending

THE MARK CONSISTS OF STANDARD CHARACTERS WITHOUT CLAIM TO ANY PARTICULAR FONT, STYLE, SIZE, OR COLOR.

NO CLAIM IS MADE TO THE EXCLUSIVE RIGHT TO USE "LENDING", APART FROM THE MARK AS SHOWN.

FOR MORTGAGE BROKERAGE (U.S. CLS. 100, 101 AND 102).

FIRST USE 12-7-2004; IN COMMERCE 12-7-2004.
LINDA ESTRADA, EXAMINING ATTORNEY

SN 77-073,377. DIABETES RESEARCH INSTITUTE FOUNDATION, INC., HOLLYWOOD, FL. FILED 12-29-2006.

KIDS PARTY FOR A CURE

THE MARK CONSISTS OF STANDARD CHARACTERS WITHOUT CLAIM TO ANY PARTICULAR FONT, STYLE, SIZE, OR COLOR.

NO CLAIM IS MADE TO THE EXCLUSIVE RIGHT TO USE "KIDS PARTY", APART FROM THE MARK AS SHOWN.

FOR CHARITABLE FUND RAISING (U.S. CLS. 100, 101 AND 102).

FIRST USE 4-0-2003; IN COMMERCE 4-0-2003.
DANIEL CAPSHAW, EXAMINING ATTORNEY

SN 77-078,921. TEXTURA, LLC, LAKE BLUFF, IL. FILED 1-9-2007.

TEXTURA

THE MARK CONSISTS OF STANDARD CHARACTERS WITHOUT CLAIM TO ANY PARTICULAR FONT, STYLE, SIZE, OR COLOR.

FOR ONLINE BILL PAYMENT SERVICES FOR CONSTRUCTION PROJECTS (U.S. CLS. 100, 101 AND 102).

FIRST USE 4-0-2004; IN COMMERCE 1-0-2005.
GEORGIA CARTY, EXAMINING ATTORNEY

CLASS 36—(Continued).

SN 77-078,982. TEXTURA, LLC, LAKE BLUFF, IL. FILED 1-9-2007.



THE MARK CONSISTS OF THE WORD TEXTURA TO THE RIGHT OF TWO OVERLAPPING SQUARES.
FOR ONLINE BILL PAYMENT SERVICES FOR CONSTRUCTION PROJECTS (U.S. CLS. 100, 101 AND 102).
FIRST USE 10-0-2004; IN COMMERCE 1-0-2005.
GEORGIA CARTY, EXAMINING ATTORNEY

SN 77-079,008. TEXTURA, LLC, LAKE BLUFF, IL. FILED 1-9-2007.



NO CLAIM IS MADE TO THE EXCLUSIVE RIGHT TO USE "CONSTRUCTION PAYMENT MANAGEMENT", APART FROM THE MARK AS SHOWN.
THE MARK CONSISTS OF THE WORD TEXTURA TO THE RIGHT OF TWO OVERLAPPING SQUARES WITH THE WORDS CONSTRUCTION PAYMENT MANAGEMENT BELOW.
FOR ONLINE BILL PAYMENT SERVICES FOR CONSTRUCTION PROJECTS (U.S. CLS. 100, 101 AND 102).
FIRST USE 4-0-2004; IN COMMERCE 1-0-2005.
GEORGIA CARTY, EXAMINING ATTORNEY

SN 77-084,398. P2 CAPITAL PARTNERS LLC, NEW YORK, NY. FILED 1-17-2007.

P2

THE MARK CONSISTS OF STANDARD CHARACTERS WITHOUT CLAIM TO ANY PARTICULAR FONT, STYLE, SIZE, OR COLOR.
FOR FINANCIAL SERVICES, NAMELY, INVESTMENT MANAGEMENT SERVICES, INVESTMENT ADVISORY SERVICES AND ASSET MANAGEMENT SERVICES, NAMELY, ASSET ACQUISITION (U.S. CLS. 100, 101 AND 102).
SALLY SHIH, EXAMINING ATTORNEY

CLASS 36—(Continued).

SN 77-084,406. P2 CAPITAL PARTNERS LLC, NEW YORK, NY. FILED 1-17-2007.

P2 CAPITAL PARTNERS

THE MARK CONSISTS OF STANDARD CHARACTERS WITHOUT CLAIM TO ANY PARTICULAR FONT, STYLE, SIZE, OR COLOR.
NO CLAIM IS MADE TO THE EXCLUSIVE RIGHT TO USE CAPITAL PARTNERS, APART FROM THE MARK AS SHOWN.
FOR FINANCIAL SERVICES, NAMELY, INVESTMENT MANAGEMENT SERVICES, INVESTMENT ADVISORY SERVICES AND ASSET MANAGEMENT SERVICES, NAMELY, ASSET ACQUISITION (U.S. CLS. 100, 101 AND 102).
SALLY SHIH, EXAMINING ATTORNEY

SN 77-084,631. TRADELINK HOLDINGS LLC, CHICAGO, IL. FILED 1-17-2007.



THE MARK CONSISTS OF "THREE GEARS OF VARIOUS SIZES".
FOR FINANCIAL CONSULTATION (U.S. CLS. 100, 101 AND 102).
FIRST USE 12-1-2006; IN COMMERCE 12-1-2006.
DAVID COLLIER, EXAMINING ATTORNEY

CLASS 36—(Continued).

SN 77-084,673. TRADELINK HOLDINGS LLC, CHICAGO, IL.
FILED 1-17-2007.



THE MARK CONSISTS OF "GEARS AND THE LOWER PORTION OF A HUMAN HEAD IN PROFILE".
FOR FINANCIAL CONSULTATION (U.S. CLS. 100, 101 AND 102).

FIRST USE 12-1-2006; IN COMMERCE 12-1-2006.
DAVID COLLIER, EXAMINING ATTORNEY

CLASS 36—(Continued).

SN 77-088,381. INVESTORS MORTGAGE HOLDINGS INC.,
SCOTTSDALE, AZ. FILED 1-22-2007.

IMH REAL ESTATE FINANCIERS

THE MARK CONSISTS OF STANDARD CHARACTERS WITHOUT CLAIM TO ANY PARTICULAR FONT, STYLE, SIZE, OR COLOR.

NO CLAIM IS MADE TO THE EXCLUSIVE RIGHT TO USE "REAL ESTATE FINANCIERS", APART FROM THE MARK AS SHOWN.

FOR LOAN UNDERWRITING; FINANCIAL SERVICES, NAMELY MONEY LENDING; MORTGAGE BROKERAGE (U.S. CLS. 100, 101 AND 102).

FIRST USE 1-4-2007; IN COMMERCE 1-4-2007.
YONG KIM, EXAMINING ATTORNEY

SN 77-088,628. ETF PORTFOLIO SOLUTIONS, INC., LEA-
WOOD, KS. FILED 1-23-2007.

ETF Portfolio Solutions

THE MARK CONSISTS OF STANDARD CHARACTERS WITHOUT CLAIM TO ANY PARTICULAR FONT, STYLE, SIZE, OR COLOR.

NO CLAIM IS MADE TO THE EXCLUSIVE RIGHT TO USE "ETF PORTFOLIO", APART FROM THE MARK AS SHOWN.

FOR INVESTMENT MANAGEMENT (U.S. CLS. 100, 101 AND 102).

FIRST USE 10-21-2006; IN COMMERCE 10-21-2006.
JUSTINE D. PARKER, EXAMINING ATTORNEY

SN 77-087,155. TOP AGENTS INTERNATIONAL, INC.,
ROSWELL, GA. FILED 1-19-2007.



NO CLAIM IS MADE TO THE EXCLUSIVE RIGHT TO USE "TOP AGENTS", APART FROM THE MARK AS SHOWN.

THE COLOR(S) RED AND BLUE IS/ARE CLAIMED AS A FEATURE OF THE MARK.

THE MARK CONSISTS OF THE WORDS "TOPAGENTS" WITH A KEY RING HOOKED TO THE UPPER PART OF THE LETTER S IN AGENTS AND 2 ROUND HEAD KEYS ON THE KEY RING. THE WORD TOP IS BLUE. THE WORD AGENTS IS RED. THE KEY RING IS BLUE AND THE LOWER KEY IS BLUE. THE UPPER KEY IS RED.

FOR REAL ESTATE BROKERAGE (U.S. CLS. 100, 101 AND 102).

FIRST USE 10-1-2006; IN COMMERCE 10-1-2006.
GINA FINK, EXAMINING ATTORNEY

SN 77-092,914. HISPANIC & LATINO STRATEGIES, INC.,
WASHINGTON, DC. FILED 1-27-2007.

SOMOS UNOS

THE MARK CONSISTS OF STANDARD CHARACTERS WITHOUT CLAIM TO ANY PARTICULAR FONT, STYLE, SIZE, OR COLOR.

"THE FOREIGN WORDING IN THE MARK TRANSLATES INTO ENGLISH AS WE ARE ALL ONE."

FOR POLITICAL FUND-RAISING SERVICES (U.S. CLS. 100, 101 AND 102).

LINDA M. KING, EXAMINING ATTORNEY

CLASS 36—(Continued).

SN 77-093,104. OUTSIDE THE DREAM FOUNDATION, MENLO PARK, CA. FILED 1-29-2007.

OUTSIDE THE DREAM

THE MARK CONSISTS OF STANDARD CHARACTERS WITHOUT CLAIM TO ANY PARTICULAR FONT, STYLE, SIZE, OR COLOR.

FOR CHARITABLE FUND RAISING SERVICES TO PROVIDE FINANCIAL SUPPORT TO UNDERPRIVILEGED CHILDREN TO ALLOW THEM TO OBTAIN EDUCATIONS (U.S. CLS. 100, 101 AND 102).

FIRST USE 9-1-2001; IN COMMERCE 9-1-2001.
DAWN HAN, EXAMINING ATTORNEY

SN 77-100,817. EQUITABLE LIFE & CASUALTY INSURANCE COMPANY, SALT LAKE CITY, UT. FILED 2-6-2007.

EQUILIFE LEGACY

THE MARK CONSISTS OF STANDARD CHARACTERS WITHOUT CLAIM TO ANY PARTICULAR FONT, STYLE, SIZE, OR COLOR.

NO CLAIM IS MADE TO THE EXCLUSIVE RIGHT TO USE "LEGACY", APART FROM THE MARK AS SHOWN.

FOR LIFE AND HEALTH INSURANCE UNDERWRITING SERVICES (U.S. CLS. 100, 101 AND 102).
MICHAEL WEBSTER, EXAMINING ATTORNEY

SN 77-107,215. BANK OF ATLANTA, ATLANTA, GA. FILED 2-14-2007.



NO CLAIM IS MADE TO THE EXCLUSIVE RIGHT TO USE "BANK OF ATLANTA", APART FROM THE MARK AS SHOWN.

THE MARK CONSISTS OF THE WORDS "BANK OF ATLANTA" IN FRONT OF A DRAWING OF THE CITY OF ATLANTA'S SKYLINE IN SILHOUETTE AND A HALF CIRCLE BEHIND THE CITY SILHOUETTE.

FOR BANKING SERVICES (U.S. CLS. 100, 101 AND 102).
FIRST USE 12-1-2004; IN COMMERCE 4-28-2006.
SOPHIA S. KIM, EXAMINING ATTORNEY

CLASS 36—(Continued).

SN 77-112,685. INVESTORS MORTGAGE HOLDINGS INC., SCOTTSDALE, AZ. FILED 2-21-2007.

IMH SECURED LOAN FUND

THE MARK CONSISTS OF STANDARD CHARACTERS WITHOUT CLAIM TO ANY PARTICULAR FONT, STYLE, SIZE, OR COLOR.

NO CLAIM IS MADE TO THE EXCLUSIVE RIGHT TO USE "SECURED LOAN FUND", APART FROM THE MARK AS SHOWN.

FOR FINANCIAL SERVICES, NAMELY MONEY LENDING (U.S. CLS. 100, 101 AND 102).
FIRST USE 0-0-2003; IN COMMERCE 0-0-2003.
YONG KIM, EXAMINING ATTORNEY

SN 77-114,512. NATIONAL LAND TITLE INSURANCE COMPANY, HOFFMAN ESTATES, IL. FILED 2-23-2007.



THE MARK CONSISTS OF FLYING FLAG.
FOR INSURANCE UNDERWRITING IN THE FIELD OF TITLE INSURANCE (U.S. CLS. 100, 101 AND 102).
FIRST USE 10-0-2005; IN COMMERCE 12-2-2005.
CURTIS FRENCH, EXAMINING ATTORNEY

SN 77-117,442. TERRA NOVA FINANCIAL GROUP, INC., CHICAGO, IL. FILED 2-27-2007.

TERRA NOVA

THE MARK CONSISTS OF STANDARD CHARACTERS WITHOUT CLAIM TO ANY PARTICULAR FONT, STYLE, SIZE, OR COLOR.

OWNER OF U.S. REG. NOS. 2,475,570 AND 2,560,101.
"THE FOREIGN WORDING IN THE MARK TRANSLATES INTO ENGLISH AS NEW EARTH."

FOR SECURITIES BROKERAGE SERVICES (U.S. CLS. 100, 101 AND 102).
FIRST USE 11-1-1994; IN COMMERCE 11-1-1994.
STANLEY I. OSBORNE, EXAMINING ATTORNEY

CLASS 36—(Continued).

SN 77-120,288. PRATHER, ROBERT A., MCLEAN, VA.
FILED 3-1-2007.

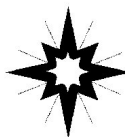

BUILDING BETTER STEWARDS

NO CLAIM IS MADE TO THE EXCLUSIVE RIGHT TO USE "STEWARDS", APART FROM THE MARK AS SHOWN. FOR FINANCIAL CONSULTATION (U.S. CLS. 100, 101 AND 102).

PAUL CROWLEY, EXAMINING ATTORNEY

SN 77-122,543. LJB ORGANIZERS LLC, LA JOLLA, CA.
FILED 3-5-2007.

CONEKTA

THE MARK CONSISTS OF STANDARD CHARACTERS WITHOUT CLAIM TO ANY PARTICULAR FONT, STYLE, SIZE, OR COLOR.

FOR BANKING SERVICES (U.S. CLS. 100, 101 AND 102).

APRIL ROACH, EXAMINING ATTORNEY

SN 77-122,974. CRAWFORD & COMPANY, ATLANTA, GA.
FILED 3-6-2007.

CRAWFORD CLAIMS CONNECTION

THE MARK CONSISTS OF STANDARD CHARACTERS WITHOUT CLAIM TO ANY PARTICULAR FONT, STYLE, SIZE, OR COLOR.

OWNER OF U.S. REG. NOS. 1,819,880 AND 1,821,260.

NO CLAIM IS MADE TO THE EXCLUSIVE RIGHT TO USE "CLAIMS", APART FROM THE MARK AS SHOWN.

FOR INSURANCE SERVICES, NAMELY, CLAIMS ADMINISTRATION SERVICES AND INSURANCE CLAIMS PROCESSING (U.S. CLS. 100, 101 AND 102).

DEIRDRE ROBERTSON, EXAMINING ATTORNEY

CLASS 36—(Continued).

SN 77-123,005. WESTCONSIN CREDIT UNION, MENOMONIE, WI. FILED 3-6-2007.

WESTconsin

FOR CREDIT UNION SERVICES; REAL ESTATE SERVICES, NAMELY, REAL ESTATE BROKERAGE SERVICES, EVALUATION OF REAL PROPERTY, REAL ESTATE AGENCY SERVICES, REAL ESTATE ACQUISITION SERVICES, MORTGAGE LENDING SERVICES, MORTGAGE BROKERAGE SERVICES IN THE FIELD OF REAL ESTATE; PROVIDING REAL ESTATE LISTINGS AND REAL ESTATE INFORMATION VIA THE INTERNET (U.S. CLS. 100, 101 AND 102).

FIRST USE 2-8-2007; IN COMMERCE 2-8-2007.
STEPHEN AQUILA, EXAMINING ATTORNEY

SN 77-123,120. WESTCONSIN CREDIT UNION, MENOMONIE, WI. FILED 3-6-2007.

WESTCONSIN

THE MARK CONSISTS OF STANDARD CHARACTERS WITHOUT CLAIM TO ANY PARTICULAR FONT, STYLE, SIZE, OR COLOR.

FOR CREDIT UNION SERVICES; REAL ESTATE SERVICES, NAMELY, REAL ESTATE BROKERAGE SERVICES, EVALUATION OF REAL PROPERTY, REAL ESTATE AGENCY SERVICES, REAL ESTATE ACQUISITION SERVICES, MORTGAGE LENDING SERVICES, MORTGAGE BROKERAGE SERVICES IN THE FIELD OF REAL ESTATE; PROVIDING REAL ESTATE LISTINGS AND REAL ESTATE INFORMATION VIA THE INTERNET (U.S. CLS. 100, 101 AND 102).

FIRST USE 7-16-1990; IN COMMERCE 7-16-1990.
STEPHEN AQUILA, EXAMINING ATTORNEY

CLASS 36—(Continued).

SN 77-124,137. TRISTA CONSULTING & INVESTMENTS, STAFFORD, VA. FILED 3-7-2007.



NO CLAIM IS MADE TO THE EXCLUSIVE RIGHT TO USE "CONSULTING & INVESTMENTS", APART FROM THE MARK AS SHOWN.

THE COLOR(S) LIGHT GREEN, MEDIUM GREEN, DARK GREEN, WHITE, AND GRAY IS/ARE CLAIMED AS A FEATURE OF THE MARK.

THE COLOR LIGHT GREEN APPEARS INSIDE THE FIRST SEMI-BOX SHAPE OF THE THREE LAYERED SHAPES; THIS SEMI-BOX SHAPE IS LOCATED WITHIN THE CLOSEST PROXIMITY TO THE TOP OF THE LETTERING IN THE TERM "TRISTA"; THE COLOR MEDIUM GREEN APPEARS AS A BORDER SURROUNDING THE DARKER GREEN SEMI-BOX SHAPE AS WELL AS THE "I" AND THE TWO TEAR DROP SHAPES ABOVE AND DIAGONAL TOWARDS THE RIGHT OFF THE TOP OF THE LETTER; THE COLOR DARK GREEN APPEARS ON THE LETTERING "CONSULTING & INVESTMENTS" AT THE BOTTOM OF THE MARK. ON THE OUTLINE OF THE FIRST SEMI-BOX SHAPE THAT IS THE FIRST OF THE THREE OVERLAPPING SHAPES, AND ON THE LARGE OUTLINE SEMI-BOX SHAPE SURROUNDING THE ENTIRE TEXT AND SHAPES IN THE MARK; THE COLOR GREY APPEARS IN THE LETTERS "T,R, S, T, A" IN THE "TRISTA" TEXT LOCATED ABOVE "CONSULTING & INVESTMENTS" IN THE MARK; THE COLOR WHITE APPEARS AS THE PRIMARY BACKGROUND COLOR UPON WHICH THE MARK IS DISPLAYED

FOR INVESTMENT CONSULTATION (U.S. CLS. 100, 101 AND 102).

JIM RINGLE, EXAMINING ATTORNEY

SN 77-124,290. MAGRO, MARIO, BEVERLY HILLS, CA. FILED 3-7-2007.

A CHILD'S KISS FOUNDATION

THE MARK CONSISTS OF STANDARD CHARACTERS WITHOUT CLAIM TO ANY PARTICULAR FONT, STYLE, SIZE, OR COLOR.

NO CLAIM IS MADE TO THE EXCLUSIVE RIGHT TO USE "FOUNDATION", APART FROM THE MARK AS SHOWN.

FOR CHARITABLE FUND RAISING (U.S. CLS. 100, 101 AND 102).

DEIRDRE ROBERTSON, EXAMINING ATTORNEY

CLASS 36—(Continued).

SN 77-124,402. AMERICAN EXPRESS MARKETING & DEVELOPMENT CORP., NEW YORK, NY. FILED 3-7-2007.



OWNER OF U.S. REG. NO. 1,161,278. THE COLOR(S) BLUE AND WHITE IS/ARE CLAIMED AS A FEATURE OF THE MARK.

THE MARK CONSISTS OF THE WORD AMEX IN A BLUE BOX. THE COLOR BLUE APPEARS IN THE WORDING AMEX AND IN THE BOX DESIGN; THE COLOR WHITE APPEARS IN THE OUTLINE OF THE WORD AMEX.

FOR FINANCIAL AND FINANCIALLY RELATED SERVICES, NAMELY, CHARGE CARD AND CREDIT CARD SERVICES; BILL PAYMENT SERVICES (U.S. CLS. 100, 101 AND 102).

B. PARADEWELAI, EXAMINING ATTORNEY

SN 77-126,414. SOMMERS, JONATHAN, ATLANTA, GA. FILED 3-9-2007.

DGA

THE MARK CONSISTS OF STANDARD CHARACTERS WITHOUT CLAIM TO ANY PARTICULAR FONT, STYLE, SIZE, OR COLOR.

FOR DIAMOND APPRAISALS; AND PREPARING REPORTS ON DIAMOND APPRAISALS FOR OTHERS (U.S. CLS. 100, 101 AND 102).

FIRST USE 8-10-2006; IN COMMERCE 10-1-2006.

RAY THOMAS, EXAMINING ATTORNEY

CLASS 36—(Continued).

SN 77-126,622. THE ALLEGHENY COUNTY BAR ASSOCIATION, PITTSBURGH, PA. FILED 3-9-2007.

Allegheny County Bar Foundation

THE MARK CONSISTS OF STANDARD CHARACTERS WITHOUT CLAIM TO ANY PARTICULAR FONT, STYLE, SIZE, OR COLOR.

NO CLAIM IS MADE TO THE EXCLUSIVE RIGHT TO USE "BAR FOUNDATION", APART FROM THE MARK AS SHOWN.

SEC. 2(F).

FOR ACCEPTING AND ADMINISTERING MONETARY CHARITABLE CONTRIBUTIONS (U.S. CLS. 100, 101 AND 102).

FIRST USE 0-0-1980; IN COMMERCE 0-0-1980.

CIMMERIAN COLEMAN, EXAMINING ATTORNEY

CLASS 36—(Continued).

SN 77-126,922. CHICAGO CLIMATE EXCHANGE, INC., CHICAGO, IL. FILED 3-9-2007.

CHICAGO CLIMATE INDEX

THE MARK CONSISTS OF STANDARD CHARACTERS WITHOUT CLAIM TO ANY PARTICULAR FONT, STYLE, SIZE, OR COLOR.

OWNER OF U.S. REG. NO. 2,692,174.

NO CLAIM IS MADE TO THE EXCLUSIVE RIGHT TO USE CHICAGO AND INDEX, APART FROM THE MARK AS SHOWN.

FOR COMMODITY, DERIVATIVES AND FUTURES EXCHANGE SERVICES AND FINANCIAL INSTRUMENTS AND INDICES THAT FACILITATE THE COMMODITIZATION OF AND TRADING OF ENVIRONMENTAL PRODUCTS, SERVICES AND RESOURCES, POLLUTANTS, EMISSIONS ALLOWANCES AND OFFSETS BETWEEN BUSINESS AND OTHER MARKET PARTICIPANTS (U.S. CLS. 100, 101 AND 102).

ARETHA SOMERVILLE, EXAMINING ATTORNEY

SN 77-126,909. CHICAGO CLIMATE EXCHANGE, INC., CHICAGO, IL. FILED 3-9-2007.

MONTREAL CLIMATE SHARE

THE MARK CONSISTS OF STANDARD CHARACTERS WITHOUT CLAIM TO ANY PARTICULAR FONT, STYLE, SIZE, OR COLOR.

NO CLAIM IS MADE TO THE EXCLUSIVE RIGHT TO USE MONTREAL AND SHARE, APART FROM THE MARK AS SHOWN.

FOR COMMODITY, DERIVATIVES AND FUTURES EXCHANGE SERVICES AND FINANCIAL INSTRUMENTS AND INDICES THAT FACILITATE THE COMMODITIZATION OF AND TRADING OF ENVIRONMENTAL PRODUCTS, SERVICES AND RESOURCES, POLLUTANTS, EMISSIONS ALLOWANCES AND OFFSETS BETWEEN BUSINESS AND OTHER MARKET PARTICIPANTS (U.S. CLS. 100, 101 AND 102).

ARETHA SOMERVILLE, EXAMINING ATTORNEY

SN 77-126,933. CHICAGO CLIMATE EXCHANGE, INC., CHICAGO, IL. FILED 3-9-2007.

MONTREAL CLIMATE INDEX

THE MARK CONSISTS OF STANDARD CHARACTERS WITHOUT CLAIM TO ANY PARTICULAR FONT, STYLE, SIZE, OR COLOR.

NO CLAIM IS MADE TO THE EXCLUSIVE RIGHT TO USE MONTREAL AND INDEX, APART FROM THE MARK AS SHOWN.

FOR COMMODITY, DERIVATIVES AND FUTURES EXCHANGE SERVICES AND FINANCIAL INSTRUMENTS AND INDICES THAT FACILITATE THE COMMODITIZATION OF AND TRADING OF ENVIRONMENTAL PRODUCTS, SERVICES AND RESOURCES, POLLUTANTS, EMISSIONS ALLOWANCES AND OFFSETS BETWEEN BUSINESS AND OTHER MARKET PARTICIPANTS (U.S. CLS. 100, 101 AND 102).

ARETHA SOMERVILLE, EXAMINING ATTORNEY

CLASS 36—(Continued).

SN 77-126,961. CHICAGO CLIMATE EXCHANGE, INC., CHICAGO, IL. FILED 3-9-2007.

EUROPEAN CLIMATE INDEX

THE MARK CONSISTS OF STANDARD CHARACTERS WITHOUT CLAIM TO ANY PARTICULAR FONT, STYLE, SIZE, OR COLOR.

OWNER OF U.S. REG. NO. 3,099,021.

NO CLAIM IS MADE TO THE EXCLUSIVE RIGHT TO USE EUROPEAN AND INDEX, APART FROM THE MARK AS SHOWN.

FOR COMMODITY, DERIVATIVES AND FUTURES EXCHANGE SERVICES AND FINANCIAL INSTRUMENTS AND INDICES THAT FACILITATE THE COMMODITIZATION OF AND TRADING OF ENVIRONMENTAL PRODUCTS, SERVICES AND RESOURCES, POLLUTANTS, EMISSIONS ALLOWANCES AND OFFSETS BETWEEN BUSINESS AND OTHER MARKET PARTICIPANTS (U.S. CLS. 100, 101 AND 102).
ARETHA SOMERVILLE, EXAMINING ATTORNEY

SN 77-127,140. MISSOURI PROFESSIONALS MUTUAL, ST. LOUIS, MO. FILED 3-9-2007.

MPM

THE MARK CONSISTS OF STANDARD CHARACTERS WITHOUT CLAIM TO ANY PARTICULAR FONT, STYLE, SIZE, OR COLOR.

FOR INSURANCE UNDERWRITING SERVICES IN THE FIELD OF MEDICAL MALPRACTICE (U.S. CLS. 100, 101 AND 102).

REBECCA GILBERT, EXAMINING ATTORNEY

SN 77-127,833. REAL- TY SAVINGS GROUP, LLC, ORLANDO, FL. FILED 3-11-2007.

**La Unica Manera De Comprar
y Vender Su Casa**

THE MARK CONSISTS OF STANDARD CHARACTERS WITHOUT CLAIM TO ANY PARTICULAR FONT, STYLE, SIZE, OR COLOR.

THE FOREIGN WORDING IN THE MARK TRANSLATES INTO ENGLISH AS THE ONLY WAY TO BUY AND SELL YOUR HOME.

FOR REAL ESTATE LISTING (U.S. CLS. 100, 101 AND 102).

MICHAEL LITZAU, EXAMINING ATTORNEY

CLASS 36—(Continued).

SN 77-128,177. TRANSPORTATION RESOURCES & ASSURANCE AGENCY CORP., MEDFORD, NY. FILED 3-12-2007.

We've Got Your Back

THE MARK CONSISTS OF STANDARD CHARACTERS WITHOUT CLAIM TO ANY PARTICULAR FONT, STYLE, SIZE, OR COLOR.

FOR COMMERCIAL INSURANCE SERVICES, NAMELY, INSURANCE UNDERWRITING SERVICES FOR ALL TYPES OF COMMERCIAL INSURANCE (U.S. CLS. 100, 101 AND 102).

FIRST USE 12-0-2005; IN COMMERCE 12-0-2005.

JAMES LOVELACE, EXAMINING ATTORNEY

SN 77-128,390. CIRCLE PEAK CAPITAL, LLC, NEW YORK, NY. FILED 3-12-2007.

CIRCLE PEAK CAPITAL

THE MARK CONSISTS OF STANDARD CHARACTERS WITHOUT CLAIM TO ANY PARTICULAR FONT, STYLE, SIZE, OR COLOR.

NO CLAIM IS MADE TO THE EXCLUSIVE RIGHT TO USE "CAPITAL", APART FROM THE MARK AS SHOWN.

FOR PRIVATE EQUITY INVESTMENTS (U.S. CLS. 100, 101 AND 102).

FIRST USE 0-0-2002; IN COMMERCE 0-0-2002.

KEVON CHISOLM, EXAMINING ATTORNEY

CLASS 36—(Continued).

SN 77-129,175. AMERICAN EXPRESS MARKETING & DEVELOPMENT CORP., NEW YORK, NY. FILED 3-13-2007.



OWNER OF U.S. REG. NO. 1,161,278.
"THE COLOR(S) BLUE AND WHITE IS/ARE CLAIMED AS A FEATURE OF THE MARK."
"THE MARK CONSISTS OF THE WORD AMEX IN A BLUE BOX. THE COLOR BLUE APPEARS IN THE WORDING AMEX AND IN THE BOX DESIGN; THE COLOR WHITE APPEARS IN THE OUTLINE OF THE WORD AMEX."

FOR FINANCIAL AND FINANCIALLY RELATED SERVICES, NAMELY, CHARGE CARD AND CREDIT CARD SERVICES; BILL PAYMENT SERVICES (U.S. CLS. 100, 101 AND 102).
CHRIS WELLS, EXAMINING ATTORNEY

SN 77-129,667. SENIORS FIRST MORTGAGE COMPANY, LLC, VIRGINIA BEACH, VA. FILED 3-13-2007.



REVERSE MORTGAGE SPECIALISTS

OWNER OF U.S. REG. NO. 2,407,702.
NO CLAIM IS MADE TO THE EXCLUSIVE RIGHT TO USE "SENIORS" OR "REVERSE MORTGAGE SPECIALISTS", APART FROM THE MARK AS SHOWN.
THE MARK CONSISTS OF AN ICON INCLUDING A HOUSE AND A TREE.
FOR MORTGAGE BROKERAGE; MORTGAGE LENDING (U.S. CLS. 100, 101 AND 102).
FIRST USE 2-0-1998; IN COMMERCE 2-0-1998.
SEAN CROWLEY, EXAMINING ATTORNEY

CLASS 36—(Continued).

SN 77-130,102. A.M. BEST COMPANY, INC., OLDWICK, NJ. FILED 3-13-2007.

BestAlert

THE MARK CONSISTS OF STANDARD CHARACTERS WITHOUT CLAIM TO ANY PARTICULAR FONT, STYLE, SIZE, OR COLOR.

OWNER OF U.S. REG. NOS. 1,877,618, 2,614,850 AND OTHERS.

FOR PROVIDING FINANCIAL INFORMATION AND UPDATES THERETO REGARDING RATINGS OF BANKS, FINANCIAL INSTITUTIONS, INSURANCE COMPANIES AND THEIR SECURITIES, BONDS AND OTHER FINANCIAL INSTRUMENTS VIA A GLOBAL COMPUTER NETWORK; PROVIDING ON-LINE NEWS IN THE FIELDS OF FINANCE AND INSURANCE VIA A GLOBAL COMPUTER NETWORK (U.S. CLS. 100, 101 AND 102).

FIRST USE 2-13-2007; IN COMMERCE 2-13-2007.
JAMES LOVELACE, EXAMINING ATTORNEY

SN 77-130,553. SANTA FE PROPERTIES, INC., SANTA FE, NM. FILED 3-14-2007.

SANTA FE LIVING

THE MARK CONSISTS OF STANDARD CHARACTERS WITHOUT CLAIM TO ANY PARTICULAR FONT, STYLE, SIZE, OR COLOR.

OWNER OF U.S. REG. NO. 2,804,483.

FOR REAL ESTATE INFORMATION AND REAL ESTATE SERVICES, NAMELY, BROKERAGE, APPRAISALS, LISTING OF REAL PROPERTIES AND LEASING OF REAL PROPERTIES, UTILIZING THE WORLD-WIDE WEB (U.S. CLS. 100, 101 AND 102).

FIRST USE 6-30-2004; IN COMMERCE 6-30-2004.
JILL C. ALT, EXAMINING ATTORNEY

SN 77-132,561. COMPUCREDIT INTELLECTUAL PROPERTY HOLDINGS CORP. II, LAS VEGAS, NV. FILED 3-15-2007.



FOR CREDIT CARD SERVICES (U.S. CLS. 100, 101 AND 102).
FIRST USE 12-6-2006; IN COMMERCE 12-6-2006.
STEVEN R. FOSTER, EXAMINING ATTORNEY

CLASS 36—(Continued).

SN 77-133,443. JB ASSOCIATES, LLC, PUYALLUP, WA. FILED 3-16-2007.

Wave Lending Group

THE MARK CONSISTS OF STANDARD CHARACTERS WITHOUT CLAIM TO ANY PARTICULAR FONT, STYLE, SIZE, OR COLOR.

NO CLAIM IS MADE TO THE EXCLUSIVE RIGHT TO USE "LENDING GROUP", APART FROM THE MARK AS SHOWN.

FOR MORTGAGE BROKERAGE (U.S. CLS. 100, 101 AND 102).

FIRST USE 12-15-2006; IN COMMERCE 12-15-2006. NELSON SNYDER, EXAMINING ATTORNEY

SN 77-134,445. MISSETT GROUP, LTD., PAOLI, PA. FILED 3-19-2007.

CRUCIBLE WEALTH MANAGEMENT

THE MARK CONSISTS OF STANDARD CHARACTERS WITHOUT CLAIM TO ANY PARTICULAR FONT, STYLE, SIZE, OR COLOR.

NO CLAIM IS MADE TO THE EXCLUSIVE RIGHT TO USE "WEALTH MANAGEMENT", APART FROM THE MARK AS SHOWN.

FOR FINANCIAL PLANNING SERVICES; FINANCIAL PLANNING FOR RETIREMENT; FINANCIAL PLANNING FOR EDUCATION; INVESTMENT MANAGEMENT AND BROKERAGE SERVICES; FINANCIAL RISK MANAGEMENT; FINANCIAL RISK MANAGEMENT CONSULTING; ADMINISTRATION OF EMPLOYEE BENEFIT PLANS CONCERNING INSURANCE AND FINANCE; INSURANCE CONSULTATION; INSURANCE BROKERAGE SERVICES (U.S. CLS. 100, 101 AND 102). MARK SPARACINO, EXAMINING ATTORNEY

SN 77-134,661. REALTY ONE GROUP, INC., LAS VEGAS, NV. FILED 3-19-2007.



NO CLAIM IS MADE TO THE EXCLUSIVE RIGHT TO USE "REALTY" AND "GROUP", APART FROM THE MARK AS SHOWN.

FOR LEASING OF REAL ESTATE; REAL ESTATE BROKERAGE; REAL ESTATE INVESTMENT; REAL ESTATE MANAGEMENT (U.S. CLS. 100, 101 AND 102).

FIRST USE 2-14-2005; IN COMMERCE 2-14-2005. BENJAMIN OKEKE, EXAMINING ATTORNEY

CLASS 36—(Continued).

SN 77-134,799. BENJAMIN J. KERPE, PORTLAND, OR. FILED 3-19-2007.

QUANTUMFX

THE MARK CONSISTS OF STANDARD CHARACTERS WITHOUT CLAIM TO ANY PARTICULAR FONT, STYLE, SIZE, OR COLOR.

FOR CURRENCY AND FOREX TRADING SERVICES (U.S. CLS. 100, 101 AND 102).

MICHAEL ENGEL, EXAMINING ATTORNEY

SN 77-134,926. CLEAR MOUNTAIN BANK, INC., BRUCETON MILLS, WV. FILED 3-19-2007.



NO CLAIM IS MADE TO THE EXCLUSIVE RIGHT TO USE HEALTH SAVINGS ACCOUNT, APART FROM THE MARK AS SHOWN.

THE COLOR(S) BLUE, GREEN, AND WHITE IS/ARE CLAIMED AS A FEATURE OF THE MARK.

THE MARK CONSISTS OF THE WORDS HSAVER IN GREEN; HEALTH SAVINGS ACCOUNT IN BLUE; AND A BLUE DOCTOR BAG WITH A GREEN CROSS IN A WHITE CIRCLE IN THE MIDDLE.

FOR SAVINGS ACCOUNT SERVICES (U.S. CLS. 100, 101 AND 102).

TOBY BULLOFF, EXAMINING ATTORNEY

SN 77-135,354. THE BEAR STEARNS COMPANIES INC., NEW YORK, NY. FILED 3-20-2007.

A CULTURE OF SERVICE. A TRADITION OF STRENGTH.

THE MARK CONSISTS OF STANDARD CHARACTERS WITHOUT CLAIM TO ANY PARTICULAR FONT, STYLE, SIZE, OR COLOR.

FOR FINANCIAL SERVICES, NAMELY, INVESTMENT BANKING, SECURITIES UNDERWRITING LOAN FINANCING, MORTGAGE BANKING AND BROKERAGE, INVESTMENT BROKERAGE/DEALERS IN THE FIELD OF SECURITIES, COMMODITIES, FUTURES AND DERIVATIVES; FINANCIAL ANALYSIS AND CONSULTATION; FINANCIAL RESEARCH; CORPORATE MERGERS AND ACQUISITIONS CONSULTATIONS; SECURITIES AND FINANCE CLEARING HOUSE; SECURITIES LOANS; SECURITIES CUSTODY SERVICES AND FINANCIAL MANAGEMENT (U.S. CLS. 100, 101 AND 102).

LINDA M. KING, EXAMINING ATTORNEY

CLASS 36—(Continued).

SN 77-135,536. OSO LLC, CONCORD, MA. FILED 3-20-2007.

OSO

THE MARK CONSISTS OF STANDARD CHARACTERS WITHOUT CLAIM TO ANY PARTICULAR FONT, STYLE, SIZE, OR COLOR.

"THE FOREIGN WORDING IN THE MARK TRANSLATES INTO ENGLISH AS BEAR."

FOR HOLDING COMPANY SERVICES, NAMELY, FINANCIAL MANAGEMENT SERVICES (U.S. CLS. 100, 101 AND 102).

FIRST USE 4-11-2006; IN COMMERCE 4-11-2006.
CHARLOTTE CORWIN, EXAMINING ATTORNEY

CLASS 36—(Continued).

SN 77-136,170. COMMUNITY BANK, NA, DEWITT, NY. FILED 3-21-2007.

BANK HAPPY

THE MARK CONSISTS OF STANDARD CHARACTERS WITHOUT CLAIM TO ANY PARTICULAR FONT, STYLE, SIZE, OR COLOR.

NO CLAIM IS MADE TO THE EXCLUSIVE RIGHT TO USE "BANK", APART FROM THE MARK AS SHOWN.

FOR BANKING; MORTGAGE BANKING; ON-LINE BANKING SERVICES; SAVINGS BANK SERVICES (U.S. CLS. 100, 101 AND 102).

HEATHER BIDDULPH, EXAMINING ATTORNEY

SN 77-136,401. PHOENIX AMERICAN WARRANTY COMPANY, INC., MIAMI, FL. FILED 3-21-2007.



NO CLAIM IS MADE TO THE EXCLUSIVE RIGHT TO USE "AMERICAN" OR "COMPANIES", APART FROM THE MARK AS SHOWN.

THE COLOR(S) DARK BLUE, SILVER, BLACK IS/ARE CLAIMED AS A FEATURE OF THE MARK.

THE MARK CONSISTS OF THE WORD PHOENIX IN DARK BLUE ABOVE THE WORD AMERICAN IN BLACK ABOVE THE WORD COMPANIES IN DARK BLUE, WITH A PHOENIX BIRD IN LIGHTER AND DARKER SHADES OF SILVER WITHIN THE LETTER "O" OF PHOENIX.

FOR INSURANCE SERVICES, NAMELY, UNDERWRITING EXTENDED WARRANTY CONTRACTS IN THE FIELD OF MOTOR VEHICLES AND MARINE; PROVIDING EXTENDED WARRANTIES ON MOTOR VEHICLES AND MARINE CRAFT; WARRANTY CLAIMS ADMINISTRATION SERVICES, NAMELY, PROCESSING WARRANTY CLAIMS FOR MOTOR VEHICLES AND MARINE CRAFT (U.S. CLS. 100, 101 AND 102).

ELIZABETH HUGHITT, EXAMINING ATTORNEY

SN 77-135,563. CHURCH GREEN BUSINESS SERVICES, TAUNTON, MA. FILED 3-20-2007.

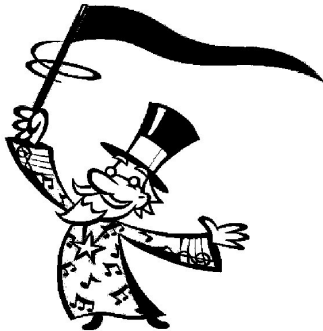

OWNER OF U.S. REG. NOS. 3,243,455 AND 3,244,840.
THE MARK CONSISTS OF A WIZARD WITH WAND. A STAR IS AROUND THE NECK OF THE WIZARD. MUSICAL NOTES ARE ON THE ATTIRE OF THE WIZARD. THE WIZARD IS WEARING A TOP HAT AND GLASSES. THE WIZARD HAS A BEARD.

FOR CHECKING ACCOUNT SERVICES; CREDIT CARD SERVICES; MORTGAGE LENDING; SAVINGS ACCOUNT SERVICES; SAVINGS AND LOAN SERVICES (U.S. CLS. 100, 101 AND 102).

FIRST USE 8-1-2002; IN COMMERCE 8-1-2002.
BRIAN CALLAGHAN, EXAMINING ATTORNEY

SN 77-136,804. FIRST BANK AND TRUST, NEW ORLEANS, LA. FILED 3-21-2007.

Business. Made Personal.

THE MARK CONSISTS OF STANDARD CHARACTERS WITHOUT CLAIM TO ANY PARTICULAR FONT, STYLE, SIZE, OR COLOR.

FOR BANKING (U.S. CLS. 100, 101 AND 102).

FIRST USE 1-25-2007; IN COMMERCE 1-25-2007.

JACLYN KIDWELL, EXAMINING ATTORNEY

CLASS 36—(Continued).

SN 77-136,877. THINKORSWIM GROUP, INC., CHICAGO, IL. FILED 3-21-2007.

SWIM FX

THE MARK CONSISTS OF STANDARD CHARACTERS WITHOUT CLAIM TO ANY PARTICULAR FONT, STYLE, SIZE, OR COLOR.

OWNER OF U.S. REG. NO. 2,568,003.

NO CLAIM IS MADE TO THE EXCLUSIVE RIGHT TO USE "FX", APART FROM THE MARK AS SHOWN.

FOR BROKERAGE OF FOREIGN EXCHANGE INSTRUMENTS EMPLOYED IN MAKING PAYMENTS BETWEEN COUNTRIES, NAMELY, PROVIDING FOR THE TRADING OF FOREIGN CURRENCY, COMMODITIES, FINANCIAL DERIVATIVES AND INTEREST RATE PRODUCTS VIA THE INTERNET (U.S. CLS. 100, 101 AND 102).

ELIZABETH HUGHITT, EXAMINING ATTORNEY

SN 77-137,590. HUB CITY PARTNERS, INC., AUSTIN, TX. FILED 3-22-2007.

HCP

THE MARK CONSISTS OF STANDARD CHARACTERS WITHOUT CLAIM TO ANY PARTICULAR FONT, STYLE, SIZE, OR COLOR.

FOR COMMERCIAL REALTY SERVICES, NAMELY, REAL ESTATE ADVISORY SERVICES, PROPERTY FINANCIAL DUE DILIGENCE SERVICES, VALUATION SERVICES, LOAN UNDERWRITING SERVICES, AND RIGHT-OF-ENTRY SERVICES IN THE NATURE OF REAL ESTATE ACQUISITION SERVICES FOR CORPORATE CLIENTS, FINANCIAL INSTITUTIONS AND PRIVATE INVESTORS (U.S. CLS. 100, 101 AND 102).

FIRST USE 5-31-2003; IN COMMERCE 5-31-2003.

JENNIFER VASQUEZ, EXAMINING ATTORNEY

SN 77-137,743. NORIDIAN MUTUAL INSURANCE COMPANY, FARGO, ND. FILED 3-22-2007.

NORIDIAN BENEFIT PLAN ADMINISTRATORS

THE MARK CONSISTS OF STANDARD CHARACTERS WITHOUT CLAIM TO ANY PARTICULAR FONT, STYLE, SIZE, OR COLOR.

OWNER OF U.S. REG. NOS. 2,283,528, 2,283,529 AND 2,306,606.

NO CLAIM IS MADE TO THE EXCLUSIVE RIGHT TO USE "BENEFIT PLAN ADMINISTRATORS", APART FROM THE MARK AS SHOWN.

FOR ADMINISTRATION OF HEALTH INSURANCE PROGRAMS FOR OTHER ENTITIES (U.S. CLS. 100, 101 AND 102).

HEATHER BIDDULPH, EXAMINING ATTORNEY

CLASS 36—(Continued).

SN 77-137,774. NORIDIAN MUTUAL INSURANCE COMPANY, FARGO, ND. FILED 3-22-2007.

NBPA

THE MARK CONSISTS OF STANDARD CHARACTERS WITHOUT CLAIM TO ANY PARTICULAR FONT, STYLE, SIZE, OR COLOR.

FOR ADMINISTRATION OF INSURANCE PROGRAMS FOR OTHER ENTITIES (U.S. CLS. 100, 101 AND 102).

HEATHER BIDDULPH, EXAMINING ATTORNEY

SN 77-137,961. NOVELLUS CAPITAL MANAGEMENT, LLC, BELLEVUE, WA. FILED 3-22-2007.

NOVELLUS CAPITAL MANAGEMENT

THE MARK CONSISTS OF STANDARD CHARACTERS WITHOUT CLAIM TO ANY PARTICULAR FONT, STYLE, SIZE, OR COLOR.

NO CLAIM IS MADE TO THE EXCLUSIVE RIGHT TO USE "CAPITAL MANAGEMENT", APART FROM THE MARK AS SHOWN.

THE FOREIGN WORDING IN THE MARK TRANSLATES INTO ENGLISH AS NEW, FRESH OR RECENT.

FOR FINANCIAL SERVICES, NAMELY, THE PURCHASE OF RESIDENTIAL MORTGAGES ON BEHALF OF OTHERS AND THE ISSUANCE OF MORTGAGE-BACKED SECURITIES; FINANCIAL SERVICES IN THE NATURE OF AN INVESTMENT SECURITY; INVESTMENT ADVISORY SERVICES; INVESTMENT MANAGEMENT; MUTUAL FUND DISTRIBUTION (U.S. CLS. 100, 101 AND 102).

SETH A. RAPPAPORT, EXAMINING ATTORNEY

SN 77-138,481. CHAMBERSELECT, LLC, NORFOLK, VA. FILED 3-23-2007.

CHAMBERCHARGE

THE MARK CONSISTS OF STANDARD CHARACTERS WITHOUT CLAIM TO ANY PARTICULAR FONT, STYLE, SIZE, OR COLOR.

FOR FINANCIAL SERVICES, NAMELY, ELECTRONIC ACCEPTANCE SERVICES FOR NON-CASH FORMS OF PAYMENT, NAMELY, CREDIT CARDS, DEBIT CARDS, CHECKS, GIFT CARDS, LOYALTY CARDS, AND ELECTRONIC FUNDS TRANSFERS. (U.S. CLS. 100, 101 AND 102).

FIRST USE 3-1-2007; IN COMMERCE 3-1-2007.

FRANK LATTUCA, EXAMINING ATTORNEY

CLASS 36—(Continued).

SN 77-138,528. MORDECAI INVESTMENTS, LLC, RALEIGH, NC. FILED 3-23-2007.

Mordecai Investments

THE MARK CONSISTS OF STANDARD CHARACTERS WITHOUT CLAIM TO ANY PARTICULAR FONT, STYLE, SIZE, OR COLOR.

NO CLAIM IS MADE TO THE EXCLUSIVE RIGHT TO USE INVESTMENTS, APART FROM THE MARK AS SHOWN.

FOR FINANCIAL SERVICES, NAMELY, PROVIDING A VIRTUAL CURRENCY FOR USE BY MEMBERS OF AN ONLINE COMMUNITY VIA A GLOBAL COMPUTER NETWORK (U.S. CLS. 100, 101 AND 102).

FIRST USE 11-21-2006; IN COMMERCE 11-21-2006.
BRIAN PINO, EXAMINING ATTORNEY

SN 77-138,585. URBAN TRUST HOLDINGS, INC., BETHESDA, MD. FILED 3-23-2007.

DREAMS KNOWLEDGE WEALTH

THE MARK CONSISTS OF STANDARD CHARACTERS WITHOUT CLAIM TO ANY PARTICULAR FONT, STYLE, SIZE, OR COLOR.

FOR BANKING SERVICES; CHECKING AND SAVINGS ACCOUNT SERVICES; INVESTMENT ANALYSIS, ADVICE, BROKERAGE, CONSULTATION AND MANAGEMENT; FINANCIAL ANALYSIS, ADVICE, CONSULTATION, PLANNING AND MANAGEMENT; DEBIT CARD AND CREDIT CARD SERVICES; MORTGAGE BANKING AND LENDING; LOAN FINANCING AND FINANCIAL LOAN CONSULTATION; COMMERCIAL AND CONSUMER LENDING; INSURANCE AND ANNUITY BROKERAGE; INSURANCE CONSULTATION AND ADMINISTRATION; PROVIDING INTERACTIVE BANKING, FINANCIAL, INVESTMENT AND INSURANCE CONSULTATION AND INFORMATION VIA THE INTERNET; ELECTRONIC PROCESSING AND TRANSMISSION OF BILL PAYMENT DATA; CASH MANAGEMENT; FINANCIAL INFORMATION IN THE NATURE OF RATES OF EXCHANGE; AUTOMATED TELLER MACHINE SERVICES (U.S. CLS. 100, 101 AND 102).

FIRST USE 10-1-2006; IN COMMERCE 10-1-2006.
KATHERINE M. DUBRAY, EXAMINING ATTORNEY

CLASS 36—(Continued).

SN 77-138,589. NEIGHBORHOOD SNOOP, DAWSONVILLE, GA. FILED 3-23-2007.

Neighborhood Snoop

THE MARK CONSISTS OF THE WORD "NEIGHBORHOOD" OVER THE WORD "SNOOP". THE TWO O'S IN "SNOOP" ARE EYES LOOKING DOWN AND TO THE RIGHT. THE WORDS ARE WRITTEN IN BLACK, OUTLINED IN WHITE WITH A GRAY SHADOW BEHIND ALL LETTERS.

FOR APPRAISAL OF REAL ESTATE; HOME APPRAISAL SERVICES; REAL ESTATE APPRAISAL; EVALUATION OF REAL PROPERTY (U.S. CLS. 100, 101 AND 102).

FIRST USE 5-9-2006; IN COMMERCE 5-9-2006.
ALEXANDER L. POWERS, EXAMINING ATTORNEY

SN 77-138,638. PLANCHOICE, INC., LOUISVILLE, KY. FILED 3-23-2007.

"Better Plans - Brighter Smiles"

THE MARK CONSISTS OF STANDARD CHARACTERS WITHOUT CLAIM TO ANY PARTICULAR FONT, STYLE, SIZE, OR COLOR.

FOR INSURANCE BROKERAGE IN THE FIELD OF DENTAL (U.S. CLS. 100, 101 AND 102).

FIRST USE 3-26-2006; IN COMMERCE 3-26-2006.
STEVEN R. FINE, EXAMINING ATTORNEY

SN 77-138,662. HESTER, DANIEL, WEST ORANGE, NJ. FILED 3-23-2007.

WHEN IT COMES TO MORTGAGES, BE SELECTIVE

THE MARK CONSISTS OF STANDARD CHARACTERS WITHOUT CLAIM TO ANY PARTICULAR FONT, STYLE, SIZE, OR COLOR.

FOR FINANCIAL SERVICES, NAMELY, MORTGAGE PLANNING; MORTGAGE BANKING SERVICES, NAMELY, ORIGINATION, ACQUISITION, SERVICING, SECURITIZATION AND BROKERAGE OF MORTGAGE LOANS; MORTGAGE LENDING; MORTGAGE PROCUREMENT FOR OTHERS; REAL ESTATE CONSULTATION; REAL ESTATE LENDING SERVICES (U.S. CLS. 100, 101 AND 102).

FIRST USE 4-0-2006; IN COMMERCE 10-0-2006.
ELISSA GARBER KON, EXAMINING ATTORNEY

CLASS 36—(Continued).

SN 77-138,709. CLAIRE AGENCY, INC., EDEN PRAIRIE, MN. FILED 3-23-2007.

GEMSHIELD

THE MARK CONSISTS OF STANDARD CHARACTERS WITHOUT CLAIM TO ANY PARTICULAR FONT, STYLE, SIZE, OR COLOR.

FOR INSURANCE BROKERAGE IN THE FIELD OF PERSONAL JEWELRY (U.S. CLS. 100, 101 AND 102).

FIRST USE 6-5-1999; IN COMMERCE 6-5-1999.
COLLEEN DOMBROW, EXAMINING ATTORNEY

CLASS 36—(Continued).

SN 77-139,235. C. V. STARR & CO., INC., NEW YORK, NY. FILED 3-23-2007.

STARR  MARINE

OWNER OF U.S. REG. NOS. 1,570,227, 2,877,409 AND OTHERS.

NO CLAIM IS MADE TO THE EXCLUSIVE RIGHT TO USE "MARINE", APART FROM THE MARK AS SHOWN.

FOR INSURANCE UNDERWRITING IN THE FIELD OF LIFE, ACCIDENT AND HEALTH (U.S. CLS. 100, 101 AND 102).

ELLEN B. AWRICH, EXAMINING ATTORNEY

SN 77-138,751. BLUE CROSS AND BLUE SHIELD OF SOUTH CAROLINA, COLUMBIA, SC. FILED 3-23-2007.

HOSPITALITYCARE

THE MARK CONSISTS OF STANDARD CHARACTERS WITHOUT CLAIM TO ANY PARTICULAR FONT, STYLE, SIZE, OR COLOR.

FOR INSURANCE UNDERWRITING IN THE FIELD OF HEALTH (U.S. CLS. 100, 101 AND 102).

REBECCA SMITH, EXAMINING ATTORNEY

SN 77-139,241. C. V. STARR & CO., INC., NEW YORK, NY. FILED 3-23-2007.

STARR MASS MARKETING UNDERWRITING AGENCY

THE MARK CONSISTS OF STANDARD CHARACTERS WITHOUT CLAIM TO ANY PARTICULAR FONT, STYLE, SIZE, OR COLOR.

OWNER OF U.S. REG. NOS. 1,570,227, 2,877,409 AND OTHERS.

NO CLAIM IS MADE TO THE EXCLUSIVE RIGHT TO USE "MASS MARKETING UNDERWRITING AGENCY", APART FROM THE MARK AS SHOWN.

FOR INSURANCE UNDERWRITING IN THE FIELD OF LIFE, ACCIDENT AND HEALTH (U.S. CLS. 100, 101 AND 102).

ELLEN B. AWRICH, EXAMINING ATTORNEY

SN 77-139,079. BANKLIBERTY, LIBERTY, MO. FILED 3-23-2007.

BANKLIBERTY

THE MARK CONSISTS OF STANDARD CHARACTERS WITHOUT CLAIM TO ANY PARTICULAR FONT, STYLE, SIZE, OR COLOR.

FOR BANKING (U.S. CLS. 100, 101 AND 102). FIRST USE 7-24-2006; IN COMMERCE 7-24-2006.

PAUL F. GAST, EXAMINING ATTORNEY

SN 77-139,247. C. V. STARR & CO., INC., NEW YORK, NY. FILED 3-23-2007.

STARR SYNDICATE LIMITED

THE MARK CONSISTS OF STANDARD CHARACTERS WITHOUT CLAIM TO ANY PARTICULAR FONT, STYLE, SIZE, OR COLOR.

OWNER OF U.S. REG. NOS. 1,570,227, 2,877,409 AND OTHERS.

NO CLAIM IS MADE TO THE EXCLUSIVE RIGHT TO USE "SYNDICATE LIMITED", APART FROM THE MARK AS SHOWN.

FOR INSURANCE UNDERWRITING IN THE FIELD OF LIFE, ACCIDENT AND HEALTH (U.S. CLS. 100, 101 AND 102).

ELLEN B. AWRICH, EXAMINING ATTORNEY

CLASS 36—(Continued).

SN 77-139,250. C. V. STARR & CO., INC., NEW YORK, NY.
FILED 3-23-2007.

STARR TECHNICAL RISKS AGENCY

THE MARK CONSISTS OF STANDARD CHARACTERS WITHOUT CLAIM TO ANY PARTICULAR FONT, STYLE, SIZE, OR COLOR.

OWNER OF U.S. REG. NOS. 1,570,227, 2,877,409 AND OTHERS.

NO CLAIM IS MADE TO THE EXCLUSIVE RIGHT TO USE "TECHNICAL RISKS AGENCY", APART FROM THE MARK AS SHOWN.

FOR INSURANCE UNDERWRITING IN THE FIELD OF LIFE, ACCIDENT AND HEALTH (U.S. CLS. 100, 101 AND 102).

ELLEN B. AWRICH, EXAMINING ATTORNEY

SN 77-139,255. C. V. STARR & CO., INC., NEW YORK, NY.
FILED 3-23-2007.

STARR UNDERWRITING AGENCIES

THE MARK CONSISTS OF STANDARD CHARACTERS WITHOUT CLAIM TO ANY PARTICULAR FONT, STYLE, SIZE, OR COLOR.

OWNER OF U.S. REG. NOS. 1,570,227, 2,877,409 AND OTHERS.

NO CLAIM IS MADE TO THE EXCLUSIVE RIGHT TO USE "UNDERWRITING AGENCIES", APART FROM THE MARK AS SHOWN.

FOR INSURANCE UNDERWRITING IN THE FIELD OF LIFE, ACCIDENT AND HEALTH (U.S. CLS. 100, 101 AND 102).

ELLEN B. AWRICH, EXAMINING ATTORNEY

SN 77-139,367. AMERICAN SAVINGS LIFE INSURANCE COMPANY, MESA, AZ. FILED 3-23-2007.

Not So Hard Money

THE MARK CONSISTS OF STANDARD CHARACTERS WITHOUT CLAIM TO ANY PARTICULAR FONT, STYLE, SIZE, OR COLOR.

FOR MORTGAGE BANKING SERVICES, NAMELY, ORIGINATION, ACQUISITION, SERVICING, SECURITIZATION AND BROKERAGE OF MORTGAGE LOANS (U.S. CLS. 100, 101 AND 102).

FIRST USE 5-1-2004; IN COMMERCE 5-1-2004.

ANDREA K. NADELMAN, EXAMINING ATTORNEY

CLASS 36—(Continued).

SN 77-139,496. A DWELLING PLACE REALTY, LLC, FORT MILL, SC. FILED 3-23-2007.

A Dwelling Place Realty

THE MARK CONSISTS OF STANDARD CHARACTERS WITHOUT CLAIM TO ANY PARTICULAR FONT, STYLE, SIZE, OR COLOR.

NO CLAIM IS MADE TO THE EXCLUSIVE RIGHT TO USE "REALTY", APART FROM THE MARK AS SHOWN.

FOR REAL ESTATE LISTING; HOUSING SERVICES, NAMELY, REAL PROPERTY ACQUISITION AND CONSUMER FINANCING TO FACILITATE HOME OWNERSHIP; PROVIDING INFORMATION IN THE FIELD OF REAL ESTATE BY MEANS OF LINKING THE WEB SITE TO OTHER WEB SITES FEATURING REAL ESTATE INFORMATION; PROVIDING INFORMATION IN THE FIELD OF REAL ESTATE VIA THE INTERNET; PROVIDING REAL ESTATE LISTINGS AND REAL ESTATE INFORMATION VIA THE INTERNET; REAL ESTATE AGENCIES; REAL ESTATE CONSULTATION (U.S. CLS. 100, 101 AND 102).

FIRST USE 10-1-2005; IN COMMERCE 4-18-2006.

DAVID TOOLEY, EXAMINING ATTORNEY

SN 77-139,737. YOUNG, MONIS, FAIRLAWN, NJ. AND YOUNG, SARIT, FAIRLAWN, NJ. FILED 3-25-2007.

MONOM

THE MARK CONSISTS OF STANDARD CHARACTERS WITHOUT CLAIM TO ANY PARTICULAR FONT, STYLE, SIZE, OR COLOR.

FOR REAL ESTATE BROKERAGE (U.S. CLS. 100, 101 AND 102).

TEJBIR SINGH, EXAMINING ATTORNEY

SN 77-139,941. REPUBLIC BANK & TRUST COMPANY, LOUISVILLE, KY. FILED 3-26-2007.

Helping you do more.

THE MARK CONSISTS OF STANDARD CHARACTERS WITHOUT CLAIM TO ANY PARTICULAR FONT, STYLE, SIZE, OR COLOR.

FOR BANKING SERVICES (U.S. CLS. 100, 101 AND 102).

FIRST USE 1-12-2007; IN COMMERCE 1-12-2007.

LINDA POWELL, EXAMINING ATTORNEY

CLASS 36—(Continued).

SN 77-139,965. CRUSADER FINANCIAL GROUP, INC., SOUTHAMPTON, NY. FILED 3-26-2007.



THE COLOR(S) FOREST GREEN IS/ARE CLAIMED AS A FEATURE OF THE MARK.

THE MARK CONSISTS OF A STYLIZED TREE DESIGN, ENTIRELY IN FOREST GREEN, CONSISTING OF FOUR WAVY BRANCHES BLOWN FROM LEFT TO RIGHT ATOP A CURVING TREE TRUNK.

FOR FINANCIAL SERVICES AND INVESTMENT MANAGEMENT SERVICES, NAMELY, INVESTMENT BANKING, INVESTMENT FUND AND CAPITAL MARKET MANAGEMENT, ASSET ACQUISITION, CONSULTATION AND DEVELOPMENT; REAL ESTATE ACQUISITION SERVICES; REAL ESTATE AND CORPORATE FINANCIAL VALUATIONS; MORTGAGE BANKING AND MORTGAGE BANKING SERVICES, NAMELY, ORIGINATION, ACQUISITION, SERVICING, SECURITIZATION AND BROKERAGE OF MORTGAGE LOANS; MORTGAGE BROKERAGE; COMMERCIAL LENDING SERVICES; FINANCIAL PLANNING; AND BANKING SERVICES (U.S. CLS. 100, 101 AND 102).

AHSEN KHAN, EXAMINING ATTORNEY

SN 77-140,013. NEW HAVEN MORTGAGE LLC, MESA, AZ. FILED 3-26-2007.

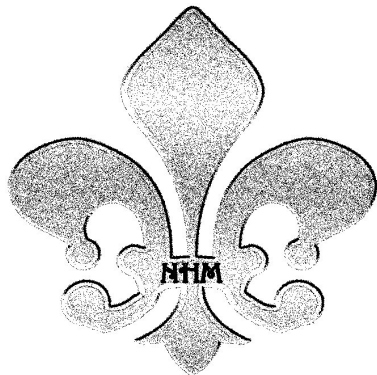

THE MARK CONSISTS OF FLEUR DE LIS WITH COMPANY INITIALS NHM.

FOR MORTGAGE BROKERAGE; MORTGAGE LENDING (U.S. CLS. 100, 101 AND 102).

FRANK LATTUCA, EXAMINING ATTORNEY

CLASS 36—(Continued).

SN 77-140,112. BOUDREAU, MICHELLE ANNE, LOS ANGELES, CA. FILED 3-26-2007.

ANGELS RESCUE

THE MARK CONSISTS OF STANDARD CHARACTERS WITHOUT CLAIM TO ANY PARTICULAR FONT, STYLE, SIZE, OR COLOR.

NO CLAIM IS MADE TO THE EXCLUSIVE RIGHT TO USE "RESCUE", APART FROM THE MARK AS SHOWN.

FOR PHILANTHROPIC SERVICES CONCERNING MONETARY DONATIONS; CHARITABLE FUND RAISING; PROVIDING GRANTS TO CHARITABLE RESEARCH ORGANIZATIONS; ACCEPTING AND ADMINISTERING MONETARY CHARITABLE CONTRIBUTIONS (U.S. CLS. 100, 101 AND 102).

ADA HAN, EXAMINING ATTORNEY

SN 77-140,220. WINCHESTER FINANCIAL GROUP, INC., STONEHAM, MA. FILED 3-26-2007.

WEALTHOLOGY

THE MARK CONSISTS OF STANDARD CHARACTERS WITHOUT CLAIM TO ANY PARTICULAR FONT, STYLE, SIZE, OR COLOR.

FOR FINANCIAL PLANNING, FINANCIAL MANAGEMENT, FINANCIAL CONSULTATION, INSURANCE CONSULTATION, INVESTMENT ADVISORY SERVICES, INVESTMENT CONSULTATION, INVESTMENT MANAGEMENT, INVESTMENT OF FUNDS FOR OTHERS (U.S. CLS. 100, 101 AND 102).

FIRST USE 7-28-2005; IN COMMERCE 7-28-2005.
BERYL GARDNER, EXAMINING ATTORNEY

SN 77-140,351. WEST VIRGINIA EMPLOYERS' MUTUAL INSURANCE COMPANY, CHARLESTON, WV. FILED 3-26-2007.

BRICKSTREET 360

THE MARK CONSISTS OF STANDARD CHARACTERS WITHOUT CLAIM TO ANY PARTICULAR FONT, STYLE, SIZE, OR COLOR.

FOR INSURANCE CLAIMS ADMINISTRATION; INSURANCE UNDERWRITING IN THE FIELD OF WORKERS COMPENSATION (U.S. CLS. 100, 101 AND 102).

ANDREA BUTLER, EXAMINING ATTORNEY

CLASS 36—(Continued).

SN 77-140,423. ALL STAR FUNDS, INC., AUSTIN, TX. FILED 3-26-2007.

Invest with an Edge

THE MARK CONSISTS OF STANDARD CHARACTERS WITHOUT CLAIM TO ANY PARTICULAR FONT, STYLE, SIZE, OR COLOR.

NO CLAIM IS MADE TO THE EXCLUSIVE RIGHT TO USE "INVEST", APART FROM THE MARK AS SHOWN.

FOR PROVIDING INFORMATION IN THE FIELD OF FINANCIAL INVESTMENTS VIA THE INTERNET (U.S. CLS. 100, 101 AND 102).

FIRST USE 7-21-2006; IN COMMERCE 7-21-2006.
DAWN FELDMAN, EXAMINING ATTORNEY

SN 77-140,558. FIRST COLONY BANK OF FLORIDA, MAITLAND, FL. FILED 3-26-2007.

FIRST COLONY BANK OF FLORIDA

THE MARK CONSISTS OF STANDARD CHARACTERS WITHOUT CLAIM TO ANY PARTICULAR FONT, STYLE, SIZE, OR COLOR.

NO CLAIM IS MADE TO THE EXCLUSIVE RIGHT TO USE BANK OF FLORIDA, APART FROM THE MARK AS SHOWN.

FOR BANKING SERVICES (U.S. CLS. 100, 101 AND 102).

JEFF DEFORD, EXAMINING ATTORNEY

SN 77-140,571. ZARVAD III LTDA., SAN JOSE, COSTA RICA, FILED 3-26-2007.

Mypaydayloan.com

THE MARK CONSISTS OF STANDARD CHARACTERS WITHOUT CLAIM TO ANY PARTICULAR FONT, STYLE, SIZE, OR COLOR.

FOR CHECK CASHING, CHECK ADVANCES, PAY-DAY LOANS (U.S. CLS. 100, 101 AND 102).

FIRST USE 10-1-2001; IN COMMERCE 10-1-2001.
JEFF DEFORD, EXAMINING ATTORNEY

CLASS 36—(Continued).

SN 77-140,717. MCUBE INVESTMENT TECHNOLOGIES LLC, PLANO, TX. FILED 3-26-2007.

SMART REBALANCING

THE MARK CONSISTS OF STANDARD CHARACTERS WITHOUT CLAIM TO ANY PARTICULAR FONT, STYLE, SIZE, OR COLOR.

NO CLAIM IS MADE TO THE EXCLUSIVE RIGHT TO USE "REBALANCING", APART FROM THE MARK AS SHOWN.

FOR FINANCIAL SERVICES, NAMELY INVESTMENT MANAGEMENT AND ADVISORY SERVICES (U.S. CLS. 100, 101 AND 102).

COLLEEN DOMBROW, EXAMINING ATTORNEY

SN 77-140,749. NEOPETS, INC., GLENDALE, CA. FILED 3-26-2007.

NEOCASH

THE MARK CONSISTS OF STANDARD CHARACTERS WITHOUT CLAIM TO ANY PARTICULAR FONT, STYLE, SIZE, OR COLOR.

FOR FINANCIAL SERVICES, NAMELY, PROVIDING A VIRTUAL CURRENCY FOR USE BY MEMBERS OF AN ONLINE COMMUNITY VIA A GLOBAL COMPUTER NETWORK (U.S. CLS. 100, 101 AND 102).

TASNEEM HUSSAIN, EXAMINING ATTORNEY

SN 77-140,912. DORFMAN, DRU A, SHERMAN OAKS, CA. FILED 3-26-2007.

EARTH MOTHERS

THE MARK CONSISTS OF STANDARD CHARACTERS WITHOUT CLAIM TO ANY PARTICULAR FONT, STYLE, SIZE, OR COLOR.

FOR CHARITABLE FUND RAISING (U.S. CLS. 100, 101 AND 102).

REBECCA SMITH, EXAMINING ATTORNEY

CLASS 36—(Continued).

SN 77-140,971. POPULAR, INC., SAN JUAN, PUERTO RICO, FILED 3-27-2007.

Gofree

THE MARK CONSISTS OF STANDARD CHARACTERS WITHOUT CLAIM TO ANY PARTICULAR FONT, STYLE, SIZE, OR COLOR.
 FOR CHECKING ACCOUNT SERVICES (U.S. CLS. 100, 101 AND 102).
 FIRST USE 8-1-2006; IN COMMERCE 8-1-2006.
 LINDA ORNDORFF, EXAMINING ATTORNEY

SN 77-140,972. DIAMOND STATE INSURANCE COMPANY, BALA CYNWYD, PA. FILED 3-27-2007.

vacantexpress.com

THE MARK CONSISTS OF STANDARD CHARACTERS WITHOUT CLAIM TO ANY PARTICULAR FONT, STYLE, SIZE, OR COLOR.
 FOR BROKERAGE IN THE FIELD OF PROPERTY AND CASUALTY INSURANCE; INSURANCE UNDERWRITING IN THE FIELD OF PROPERTY AND CASUALTY INSURANCE (U.S. CLS. 100, 101 AND 102).
 FIRST USE 11-28-2000; IN COMMERCE 11-28-2000.
 ELLEN B. AWRICH, EXAMINING ATTORNEY

SN 77-141,121. KEYS GATE REALTY, INC., HOMESTEAD, FL. FILED 3-27-2007.



OWNER OF U.S. REG. NOS. 2,440,495 AND 2,564,974.
 THE MARK CONSISTS OF THE WORDS "KEYS GATE" WITH A BUTTERFLY ABOVE AND TO THE RIGHT OF THE LETTER "E" IN "GATE" AND A BUTTERFLY BELOW AND TO THE LEFT OF THE LETTER "K" IN "KEYS", WITH EACH BUTTERFLY CASTING A SHADOW.
 FOR REAL ESTATE BROKERAGE; REAL ESTATE MANAGEMENT (U.S. CLS. 100, 101 AND 102).
 FIRST USE 2-1-2003; IN COMMERCE 2-1-2003.
 BARBARA GAYNOR, EXAMINING ATTORNEY

CLASS 36—(Continued).

SN 77-141,369. BLAZE BAIL BONDS, INC., PERTH AMBOY, NJ. FILED 3-27-2007.

BLAZE BAIL BONDS

THE MARK CONSISTS OF STANDARD CHARACTERS WITHOUT CLAIM TO ANY PARTICULAR FONT, STYLE, SIZE, OR COLOR.
 OWNER OF U.S. REG. NO. 3,115,859.
 NO CLAIM IS MADE TO THE EXCLUSIVE RIGHT TO USE "BAIL BONDS", APART FROM THE MARK AS SHOWN.
 FOR BAIL BONDING SERVICES (U.S. CLS. 100, 101 AND 102).
 FIRST USE 6-30-2000; IN COMMERCE 6-30-2000.
 MARY CRAWFORD, EXAMINING ATTORNEY

SN 77-141,453. DIAMOND STATE INSURANCE COMPANY, BALA CYNWYD, PA. FILED 3-27-2007.

VACANTEXPRESS

THE MARK CONSISTS OF STANDARD CHARACTERS WITHOUT CLAIM TO ANY PARTICULAR FONT, STYLE, SIZE, OR COLOR.
 FOR INSURANCE BROKERAGE IN THE FIELD OF PROPERTY AND CASUALTY INSURANCE; INSURANCE UNDERWRITING IN THE FIELD OF PROPERTY AND CASUALTY INSURANCE (U.S. CLS. 100, 101 AND 102).
 FIRST USE 11-28-2000; IN COMMERCE 11-28-2000.
 ELLEN B. AWRICH, EXAMINING ATTORNEY

SN 77-142,236. BERKSHIRE LIFE INSURANCE COMPANY OF AMERICA, PITTSFIELD, MA. FILED 3-28-2007.

Got Di?

FOR INSURANCE UNDERWRITING CONSULTATION; INSURANCE UNDERWRITING IN THE FIELD OF DISABILITY INSURANCE; PROVIDING INFORMATION IN INSURANCE MATTERS (U.S. CLS. 100, 101 AND 102).
 FIRST USE 7-0-2004; IN COMMERCE 7-0-2004.
 HANNO RITTNER, EXAMINING ATTORNEY

CLASS 36—(Continued).

SN 77-142,264. CRESCENT ELECTRIC SUPPLY COMPANY,
EAST DUBUQUE, IL. FILED 3-28-2007.

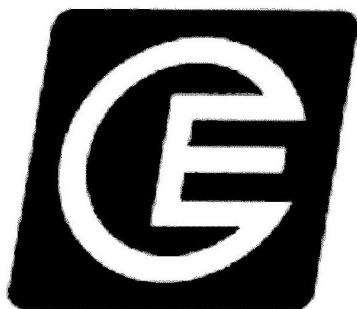

THE MARK CONSISTS OF A STYLIZED CE IN A
SLIGHTLY SLANTED, PARTIALLY SHADED SQUARE.
FOR FINANCING SERVICES (U.S. CLS. 100, 101 AND
102).

FIRST USE 12-31-1995; IN COMMERCE 12-31-1995.
TANYA AMOS, EXAMINING ATTORNEY

SN 77-142,506. AMERICAN LUNG ASSOCIATION-SOUTH-
EAST REGION, SMYRNA, GA. FILED 3-28-2007.

CLIMB ATLANTA

THE MARK CONSISTS OF STANDARD CHARACTERS
WITHOUT CLAIM TO ANY PARTICULAR FONT, STYLE,
SIZE, OR COLOR.

NO CLAIM IS MADE TO THE EXCLUSIVE RIGHT TO
USE "ATLANTA", APART FROM THE MARK AS SHOWN.
FOR CHARITABLE FUND RAISING BY MEANS OF
SPONSORED STAIRCLIMBING, WALKING, HIKING,
AND RACING EVENTS (U.S. CLS. 100, 101 AND 102).

FIRST USE 8-31-2006; IN COMMERCE 8-31-2006.
JENNIFER VASQUEZ, EXAMINING ATTORNEY

CLASS 36—(Continued).

SN 77-142,748. OSHARA VILLAGE, LLC, SANTA FE, NM.
FILED 3-28-2007.

OSHARA VILLAGE

THE MARK CONSISTS OF STANDARD CHARACTERS
WITHOUT CLAIM TO ANY PARTICULAR FONT, STYLE,
SIZE, OR COLOR.

NO CLAIM IS MADE TO THE EXCLUSIVE RIGHT TO
USE "VILLAGE", APART FROM THE MARK AS SHOWN.

FOR LEASING OF REAL ESTATE; REAL ESTATE
PROPERTY MANAGEMENT SERVICES; REAL ESTATE
COMMUNITY MANAGEMENT SERVICES; REAL ESTATE
EQUITY SHARING, NAMELY, MANAGING AND
ARRANGING FOR CO-OWNERSHIP OF REAL ESTATE;
REAL ESTATE ESCROW SERVICES; REAL ESTATE
LENDING SERVICES; REAL ESTATE LISTING; REAL
ESTATE TIME-SHARING; REAL ESTATE TRUSTEE
SERVICES; VACATION REAL ESTATE TIME-SHARE
SERVICES; AND REAL ESTATE MULTIPLE LISTING
SERVICES (U.S. CLS. 100, 101 AND 102).

WILLIAM VERHOSEK, EXAMINING ATTORNEY

SN 77-143,221. XLNT VETERINARY CARE, INC., LOS
GATOS, CA. FILED 3-28-2007.



NO CLAIM IS MADE TO THE EXCLUSIVE RIGHT TO
USE "PET", APART FROM THE MARK AS SHOWN.

THE COLOR(S) BLACK, GRAY, WHITE AND RED IS/
ARE CLAIMED AS A FEATURE OF THE MARK.

THE COLOR RED APPEARS IN THE WORDING "PET
DRX", THE EARPIECES OF THE STETHOSCOPE FORM-
ING A HEART, AND SHADING, REFLECTIONS, AND
TONALITIES ALONG A SPECTRUM FROM RED TO
BLACK IN THE SINGLE LUMEN TUBING OF THE
STETHOSCOPE; THE COLOR BLACK APPEARS IN THE
EARPIECE, TUBING AND OUTLINE OF THE STETHO-
SCOPE, AND, THE OUTLINE OF THE CROSS; THE COLOR
GRAY APPEARS IN THE SHADING OF THE STETHO-
SCOPE CHESTPIECE AND SHADOWS ON AND AROUND
THE CROSS; THE COLOR WHITE APPEARS IN THE CROSS
AND AS HIGHLIGHTS ON THE STETHOSCOPE.

FOR PET INSURANCE BROKERAGE SERVICES (U.S.
CLS. 100, 101 AND 102).

HANNO RITTNER, EXAMINING ATTORNEY

CLASS 36—(Continued).

SN 77-143,249. MOSTUN ENTERPRISES, INC., ALEXANDRIA, VA. FILED 3-28-2007.

CLASS 36—(Continued).

SN 77-143,356. FLANAGAN PROPERTIES, INC., LAKE MARY, FL. FILED 3-29-2007.

HelpMeGetMarried.com

WE BUY YUCKY HOUSES

THE MARK CONSISTS OF STANDARD CHARACTERS WITHOUT CLAIM TO ANY PARTICULAR FONT, STYLE, SIZE, OR COLOR.

FOR FACILITATING AND ARRANGING FOR THE FINANCING OF WEDDINGS (U.S. CLS. 100, 101 AND 102).

DAVID H. STINE, EXAMINING ATTORNEY

THE MARK CONSISTS OF STANDARD CHARACTERS WITHOUT CLAIM TO ANY PARTICULAR FONT, STYLE, SIZE, OR COLOR.

FOR REAL ESTATE INVESTMENT (U.S. CLS. 100, 101 AND 102).

JAMES LOVELACE, EXAMINING ATTORNEY

SN 77-143,305. FIRST PREMIER BANK, SIOUX FALLS, SD. FILED 3-29-2007.

SN 77-143,360. FLANAGAN PROPERTIES, INC., LAKE MARY, FL. FILED 3-29-2007.

Pledge

WE BUY YUCKY HOMES

THE MARK CONSISTS OF STANDARD CHARACTERS WITHOUT CLAIM TO ANY PARTICULAR FONT, STYLE, SIZE, OR COLOR.

FOR CREDIT CARD SERVICES (U.S. CLS. 100, 101 AND 102).

LINDSEY RUBIN, EXAMINING ATTORNEY

THE MARK CONSISTS OF STANDARD CHARACTERS WITHOUT CLAIM TO ANY PARTICULAR FONT, STYLE, SIZE, OR COLOR.

FOR REAL ESTATE INVESTMENT (U.S. CLS. 100, 101 AND 102).

JAMES LOVELACE, EXAMINING ATTORNEY

SN 77-143,321. FIRST PREMIER BANK, SIOUX FALLS, SD. FILED 3-29-2007.

SN 77-143,435. FIRST PREMIER BANK, SIOUX FALLS, SD. FILED 3-29-2007.

PREMIER LEGEND

PREMIER BANNER

THE MARK CONSISTS OF STANDARD CHARACTERS WITHOUT CLAIM TO ANY PARTICULAR FONT, STYLE, SIZE, OR COLOR.

FOR CREDIT CARD SERVICES (U.S. CLS. 100, 101 AND 102).

LINDSEY RUBIN, EXAMINING ATTORNEY

THE MARK CONSISTS OF STANDARD CHARACTERS WITHOUT CLAIM TO ANY PARTICULAR FONT, STYLE, SIZE, OR COLOR.

FOR CREDIT CARD SERVICES (U.S. CLS. 100, 101 AND 102).

LINDSEY RUBIN, EXAMINING ATTORNEY

CLASS 36—(Continued).

SN 77-143,650. AMERICAN INTERNATIONAL ASSURANCE, SPC, GRAND CAYMAN, CAYMAN ISLANDS, FILED 3-29-2007.

Investors  Trust

NO CLAIM IS MADE TO THE EXCLUSIVE RIGHT TO USE "INVESTORS" OR "TRUST", APART FROM THE MARK AS SHOWN.

THE MARK CONSISTS OF THE WORDS "INVESTORS" AND "TRUST" AND A SHADED EQUILATERAL TRIANGLE WITH A SPHERE GRAPHED WITH LONGITUDE/LATITUDE LINES SUPERIMPOSED ON THE TRIANGLE, CENTERED BETWEEN THE TWO WORDS.

FOR INVESTMENT MANAGEMENT OF AND DISTRIBUTION OF VARIABLE ANNUITIES; ISSUANCE AND ADMINISTRATION OF ANNUITIES (U.S. CLS. 100, 101 AND 102).

FIRST USE 9-1-2002; IN COMMERCE 9-1-2002.
REBECCA SMITH, EXAMINING ATTORNEY

SN 77-143,700. ENCHARTER INSURANCE, LLC, AMHERST, MA. FILED 3-29-2007.

ENCHARTER INSURANCE

THE MARK CONSISTS OF STANDARD CHARACTERS WITHOUT CLAIM TO ANY PARTICULAR FONT, STYLE, SIZE, OR COLOR.

NO CLAIM IS MADE TO THE EXCLUSIVE RIGHT TO USE "INSURANCE", APART FROM THE MARK AS SHOWN.

FOR INSURANCE SERVICES FOR INDIVIDUALS AND BUSINESSES, NAMELY INSURANCE AGENCY SERVICES PROVIDED THROUGH A SINGLE INSURANCE AGENCY OR A GROUP OF INSURANCE AGENCIES; INSURANCE UNDERWRITING SERVICES FOR PERSONAL PROPERTY AND CASUALTY INSURANCE, COMMERCIAL PROPERTY AND CASUALTY INSURANCE, ACCIDENT INSURANCE, LIFE INSURANCE, AND HEALTH INSURANCE; INSURANCE BROKERAGE; INSURANCE CLAIMS ADMINISTRATION SERVICES; AND INSURANCE CLAIMS PROCESSING (U.S. CLS. 100, 101 AND 102).

FIRST USE 1-25-2007; IN COMMERCE 1-25-2007.
ALICE BENMAMAN, EXAMINING ATTORNEY

SN 77-144,080. BLUEPRINT MORTGAGE, INC., CARLSBAD, CA. FILED 3-29-2007.

POWERED BY BLUEPRINT

THE MARK CONSISTS OF STANDARD CHARACTERS WITHOUT CLAIM TO ANY PARTICULAR FONT, STYLE, SIZE, OR COLOR.

FOR FINANCIAL SERVICES IN THE FIELD OF MONEY LENDING (U.S. CLS. 100, 101 AND 102).

FIRST USE 10-1-2005; IN COMMERCE 10-1-2005.
GEOFFREY FOSDICK, EXAMINING ATTORNEY

CLASS 36—(Continued).

SN 77-144,314. REAGENTFORECLOSURES, LLC, DEDHAM, MA. FILED 3-29-2007.

REAgentForeclosures

THE MARK CONSISTS OF STANDARD CHARACTERS WITHOUT CLAIM TO ANY PARTICULAR FONT, STYLE, SIZE, OR COLOR.

FOR PROVIDING DATABASES FEATURING REAL ESTATE FORECLOSURE DATA (U.S. CLS. 100, 101 AND 102).

FIRST USE 11-15-2006; IN COMMERCE 12-0-2006.
LAURA KOVALSKY, EXAMINING ATTORNEY

SN 77-145,211. NEW YORK MERCANTILE EXCHANGE, INC., NEW YORK, NY. FILED 3-30-2007.

NYMEX 3-2-1

THE MARK CONSISTS OF STANDARD CHARACTERS WITHOUT CLAIM TO ANY PARTICULAR FONT, STYLE, SIZE, OR COLOR.

OWNER OF U.S. REG. NOS. 1,731,593, 3,087,793 AND OTHERS.

FOR PROVIDING FINANCIAL AND INVESTMENT INFORMATION SERVICES; PROVIDING FINANCIAL SERVICES, NAMELY, TRADING OF FUTURES AND OPTIONS ON FUTURES CONTRACTS BASED ON A COMMODITY INDEX FOR OTHERS, THROUGH A COMPUTER NETWORK AND PROVIDING INFORMATION CONCERNING THE TRADING OF FUTURES AND OPTIONS ON FUTURES CONTRACTS BASED ON A COMMODITY INDEX, THROUGH A COMPUTER NETWORK (U.S. CLS. 100, 101 AND 102).

ANDREA K. NADELMAN, EXAMINING ATTORNEY

CLASS 36—(Continued).

SN 77-145,234. NEW YORK MERCANTILE EXCHANGE, INC., NEW YORK, NY. FILED 3-30-2007.

NYMEX CAT RISK

THE MARK CONSISTS OF STANDARD CHARACTERS WITHOUT CLAIM TO ANY PARTICULAR FONT, STYLE, SIZE, OR COLOR.

OWNER OF U.S. REG. NOS. 1,731,593, 3,087,793 AND OTHERS.

NO CLAIM IS MADE TO THE EXCLUSIVE RIGHT TO USE "CAT RISK", APART FROM THE MARK AS SHOWN.

FOR PROVIDING FINANCIAL AND INVESTMENT INFORMATION SERVICES; PROVIDING FINANCIAL SERVICES, NAMELY, TRADING OF FUTURES AND OPTIONS ON FUTURES CONTRACTS BASED ON AN INSURANCE CLAIMS INDEX FOR OTHERS, THROUGH A COMPUTER NETWORK AND PROVIDING INFORMATION CONCERNING THE TRADING OF FUTURES AND OPTIONS ON FUTURES CONTRACTS BASED ON AN INSURANCE RISK INDEX, THROUGH A COMPUTER NETWORK (U.S. CLS. 100, 101 AND 102).

ANDREA K. NADELMAN, EXAMINING ATTORNEY

CLASS 36—(Continued).

SN 77-148,529. FIRST BANK AND TRUST, NEW ORLEANS, LA. FILED 4-4-2007.

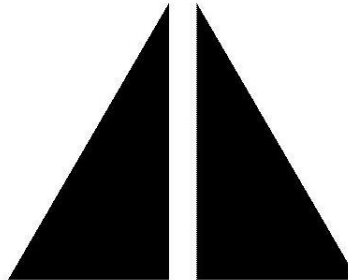

FOR BANKING (U.S. CLS. 100, 101 AND 102).

FIRST USE 8-1-1991; IN COMMERCE 8-1-1991.

JACLYN KIDWELL, EXAMINING ATTORNEY

SN 77-149,133. CITIGROUP INC., NEW YORK, NY. FILED 4-5-2007.

SIGN 'N FLY

THE MARK CONSISTS OF STANDARD CHARACTERS WITHOUT CLAIM TO ANY PARTICULAR FONT, STYLE, SIZE, OR COLOR.

FOR INSURANCE ADMINISTRATION IN THE NATURE OF ISSUING TRAVEL INSURANCE UNDERWRITTEN BY THIRD PARTIES TO CREDIT CARD HOLDERS (U.S. CLS. 100, 101 AND 102).

TOBY BULLOFF, EXAMINING ATTORNEY

SN 77-148,413. HESTER, DANIEL, WEST ORANGE, NJ. FILED 4-4-2007.

**OFFICIAL LOAN OFFICER FOR
THE SPRING HOMEBUYING
SEASON**

SN 77-149,394. FIRST BANK AND TRUST, NEW ORLEANS, LA. FILED 4-5-2007.

THE MARK CONSISTS OF STANDARD CHARACTERS WITHOUT CLAIM TO ANY PARTICULAR FONT, STYLE, SIZE, OR COLOR.

FOR FINANCIAL SERVICES, NAMELY, MORTGAGE PLANNING; MORTGAGE BANKING SERVICES, NAMELY, ORIGINATION, ACQUISITION, SERVICING, SECURITIZATION AND BROKERAGE OF MORTGAGE LOANS; MORTGAGE LENDING; MORTGAGE PROCUREMENT FOR OTHERS; REAL ESTATE CONSULTATION; REAL ESTATE LENDING SERVICES (U.S. CLS. 100, 101 AND 102).

FIRST USE 4-1-2007; IN COMMERCE 4-1-2007.

ELISSA GARBER KON, EXAMINING ATTORNEY

Lending. Made Personal.

THE MARK CONSISTS OF STANDARD CHARACTERS WITHOUT CLAIM TO ANY PARTICULAR FONT, STYLE, SIZE, OR COLOR.

FOR BANKING (U.S. CLS. 100, 101 AND 102).

JACLYN KIDWELL, EXAMINING ATTORNEY

CLASS 36—(Continued).

SN 77-151,735. C. V. STARR & CO., INC., NEW YORK, NY. FILED 4-9-2007.

THERE'S A STARR SOLUTION

THE MARK CONSISTS OF STANDARD CHARACTERS WITHOUT CLAIM TO ANY PARTICULAR FONT, STYLE, SIZE, OR COLOR.

OWNER OF U.S. REG. NOS. 1,570,227, 2,877,409 AND OTHERS.

FOR PROPERTY AND CASUALTY INSURANCE UNDERWRITING AND AGENCY SERVICES; INSURANCE UNDERWRITING IN THE FIELD OF LIFE, ACCIDENT AND HEALTH (U.S. CLS. 100, 101 AND 102).

ELLEN B. AWRICH, EXAMINING ATTORNEY

SN 77-151,749. C. V. STARR & CO., INC., NEW YORK, NY. FILED 4-9-2007.



OWNER OF U.S. REG. NOS. 1,570,227, 2,877,409 AND OTHERS.

NO CLAIM IS MADE TO THE EXCLUSIVE RIGHT TO USE GLOBAL ACCIDENT & HEALTH, APART FROM THE MARK AS SHOWN.

FOR PROPERTY AND CASUALTY INSURANCE UNDERWRITING AND AGENCY SERVICES; INSURANCE UNDERWRITING IN THE FIELD OF LIFE, ACCIDENT AND HEALTH (U.S. CLS. 100, 101 AND 102).

ELLEN B. AWRICH, EXAMINING ATTORNEY

SN 77-154,260. BLACKROCK, INC., NEW YORK, NY. FILED 4-11-2007.

VALLERIITE

THE MARK CONSISTS OF STANDARD CHARACTERS WITHOUT CLAIM TO ANY PARTICULAR FONT, STYLE, SIZE, OR COLOR.

FOR INVESTMENT MANAGEMENT SERVICES (U.S. CLS. 100, 101 AND 102).

ZHALEH DELANEY, EXAMINING ATTORNEY

CLASS 36—(Continued).

SN 77-162,611. CANIZARES, JEREMY, HOBOKEN, NJ. FILED 4-22-2007.



NO CLAIM IS MADE TO THE EXCLUSIVE RIGHT TO USE "CITY REALTY", APART FROM THE MARK AS SHOWN.

THE COLOR(S) ROYAL BLUE AND GOLDEN YELLOW IS/ARE CLAIMED AS A FEATURE OF THE MARK.

THE COLOR ROYAL BLUE APPEARS IN THE BACKGROUND OF THE MARK AND THE COLOR GOLDEN YELLOW APPEARS IN THE TEXT OF THE MARK AND THE CITYSCAPE DESIGN.

FOR APPRAISAL OF REAL ESTATE; APPRAISALS FOR INSURANCE CLAIMS OF REAL ESTATE; ASSESSMENT AND MANAGEMENT OF REAL ESTATE; ESTATE PLANNING; ESTATE TRUST MANAGEMENT; EVALUATION OF REAL PROPERTY; FINANCIAL INVESTMENT IN THE FIELD OF REAL ESTATE; FINANCIAL SERVICES, NAMELY, ESTATE SETTLEMENT SERVICES; FINANCIAL VALUATION OF PERSONAL PROPERTY AND REAL ESTATE; HOUSING SERVICES, NAMELY, REAL PROPERTY ACQUISITION AND CONSUMER FINANCING TO FACILITATE HOME OWNERSHIP; LAND ACQUISITION, NAMELY, REAL ESTATE BROKERAGE; LEASING OF REAL ESTATE; LEASING OF REAL PROPERTY; PROVIDING INFORMATION IN THE FIELD OF REAL ESTATE BY MEANS OF LINKING THE WEB SITE TO OTHER WEB SITES FEATURING REAL ESTATE INFORMATION; PROVIDING INFORMATION IN THE FIELD OF REAL ESTATE VIA THE INTERNET; PROVIDING ONLINE INFORMATION IN THE FIELD CHARITABLE MONETARY GIVING THROUGH FINANCIAL AND ESTATE PLANNING; PROVIDING REAL ESTATE LISTINGS AND REAL ESTATE INFORMATION VIA THE INTERNET; REAL ESTATE ACQUISITION SERVICES; REAL ESTATE AGENCIES; REAL ESTATE APPRAISAL; REAL ESTATE BROKERAGE; REAL ESTATE CONSULTANCY; REAL ESTATE CONSULTATION; REAL ESTATE EQUITY SHARING, NAMELY, MANAGING AND ARRANGING FOR CO-OWNERSHIP OF REAL ESTATE; REAL ESTATE ESCROW SERVICES; REAL ESTATE INVESTMENT; REAL ESTATE LENDING SERVICES; REAL ESTATE LISTING; REAL ESTATE MANAGEMENT; REAL ESTATE MANAGEMENT CONSULTATION; REAL ESTATE MULTIPLE LISTING SERVICES; REAL ESTATE PROCUREMENT FOR OTHERS; REAL ESTATE SERVICES, NAMELY, RENTAL OF VACATION HOMES, CONDOMINIUMS, CABINS, AND VILLAS USING PAY PER CLICK ADVERTISING ON A GLOBAL COMPUTER NETWORK; REAL ESTATE SYNDICATION; REAL ESTATE TIME-SHARING; REAL ESTATE TRUSTEE SERVICES; REAL ESTATE VALUATION SERVICES; REAL ESTATE VALUATIONS; VACATION REAL ESTATE TIME SHARE EXCHANGE SERVICES; VACATION REAL ESTATE TIME-SHARING; VACATION REAL ESTATE TIMESHARE SERVICES (U.S. CLS. 100, 101 AND 102).

SHANNON TWOHIG, EXAMINING ATTORNEY

CLASS 36—(Continued).

SN 77-164,995. C. V. STARR & CO., INC., NEW YORK, NY. FILED 4-25-2007.

STARR

THE MARK CONSISTS OF STANDARD CHARACTERS WITHOUT CLAIM TO ANY PARTICULAR FONT, STYLE, SIZE, OR COLOR.

OWNER OF U.S. REG. NOS. 1,570,227, 2,877,409 AND OTHERS.

FOR PROPERTY AND CASUALTY INSURANCE UNDERWRITING AND AGENCY SERVICES; INSURANCE UNDERWRITING IN THE FIELD OF LIFE, ACCIDENT AND HEALTH (U.S. CLS. 100, 101 AND 102).

ELLEN B. AWRICH, EXAMINING ATTORNEY

CLASS 36—(Continued).

SN 77-165,516. NEW YORK MERCANTILE EXCHANGE, INC., NEW YORK, NY. FILED 4-25-2007.

NYMEX 3-2-1 PLUS

THE MARK CONSISTS OF STANDARD CHARACTERS WITHOUT CLAIM TO ANY PARTICULAR FONT, STYLE, SIZE, OR COLOR.

OWNER OF U.S. REG. NOS. 1,731,593, 3,087,793 AND OTHERS.

FOR PROVIDING FINANCIAL AND INVESTMENT INFORMATION SERVICES; PROVIDING FINANCIAL SERVICES, NAMELY, TRADING OF FUTURES AND OPTIONS ON FUTURES CONTRACTS BASED ON A COMMODITY INDEX FOR OTHERS, THROUGH A COMPUTER NETWORK AND PROVIDING INFORMATION CONCERNING THE TRADING OF FUTURES AND OPTIONS ON FUTURES CONTRACTS BASED ON A COMMODITY INDEX, THROUGH A COMPUTER NETWORK (U.S. CLS. 100, 101 AND 102).

ANDREA K. NADELMAN, EXAMINING ATTORNEY

SN 77-165,116. TRUEBRIDGE CAPITAL PARTNERS LLC, CHAPEL HILL, NC. FILED 4-25-2007.

TRUEBRIDGE CAPITAL PARTNERS

THE MARK CONSISTS OF STANDARD CHARACTERS WITHOUT CLAIM TO ANY PARTICULAR FONT, STYLE, SIZE, OR COLOR.

NO CLAIM IS MADE TO THE EXCLUSIVE RIGHT TO USE "CAPITAL PARTNERS", APART FROM THE MARK AS SHOWN.

FOR FINANCIAL SERVICES IN THE FIELDS OF VENTURE CAPITAL FUNDS, GROWTH EQUITY FUNDS, AND PRIVATE EQUITY FUNDS; ASSET MANAGEMENT, NAMELY INVESTMENT MANAGEMENT OF VENTURE CAPITAL, GROWTH EQUITY, BUYOUTS, HEDGE FUNDS, PUBLIC AND PRIVATE EQUITIES, REAL ESTATE, ENERGY AND REAL ASSETS INVESTMENTS, FIXED INCOME, AND CASH; INVESTMENT AND BROKERAGE SERVICES; FUND MANAGEMENT SERVICES (U.S. CLS. 100, 101 AND 102).

RAUL CORDOVA, EXAMINING ATTORNEY

SN 77-165,627. SCIOTO PROPERTIES LLC, DUBLIN, OH. FILED 4-25-2007.



OWNER OF U.S. REG. NO. 2,936,302. THE MARK CONSISTS OF GRAPHICS OF HOUSES AND TEXT.

FOR REAL ESTATE SERVICES DIRECTED TO HOUSING FOR THE DISABLED, NAMELY, PURCHASE-LEASING ACTIVITIES, SALE LEASEBACK ACTIVITIES, LEASING OF REAL ESTATE, REAL ESTATE ACQUISITION SERVICES, REAL ESTATE INVESTMENT, REAL ESTATE MANAGEMENT INCLUDING FINANCING AND PROCURING RENOVATION DIRECTED TO MODIFYING REAL ESTATE FOR USE BY THE DISABLED, AND REAL ESTATE PROCUREMENT FOR OTHERS (U.S. CLS. 100, 101 AND 102).

ANTHONY RINKER, EXAMINING ATTORNEY

CLASS 36—(Continued).

SN 77-167,120. MEXICAN & AMERICANS THINKING TOGETHER-FOUNDATION, INC., SAN ANTONIO, TX. FILED 4-27-2007.

MATT MONEY TRANSFER

THE MARK CONSISTS OF STANDARD CHARACTERS WITHOUT CLAIM TO ANY PARTICULAR FONT, STYLE, SIZE, OR COLOR.

NO CLAIM IS MADE TO THE EXCLUSIVE RIGHT TO USE "MONEY TRANSFER", APART FROM THE MARK AS SHOWN.

FOR MONEY TRANSFER SERVICES; ELECTRONIC TRANSFER OF MONEY SERVICES (U.S. CLS. 100, 101 AND 102).

JESSICA A. POWERS, EXAMINING ATTORNEY

SN 77-167,617. WACHOVIA CORPORATION, CHARLOTTE, NC. FILED 4-27-2007.

**WACHOVIA COMPASS ETF
ADVANTAGE**

THE MARK CONSISTS OF STANDARD CHARACTERS WITHOUT CLAIM TO ANY PARTICULAR FONT, STYLE, SIZE, OR COLOR.

NO CLAIM IS MADE TO THE EXCLUSIVE RIGHT TO USE "ETF", APART FROM THE MARK AS SHOWN.

FOR FINANCIAL SERVICES IN THE NATURE OF AN INVESTMENT SECURITY (U.S. CLS. 100, 101 AND 102).
SIMON TENG, EXAMINING ATTORNEY

SN 77-167,637. WACHOVIA CORPORATION, CHARLOTTE, NC. FILED 4-27-2007.

WACHOVIA HYBRID FX

THE MARK CONSISTS OF STANDARD CHARACTERS WITHOUT CLAIM TO ANY PARTICULAR FONT, STYLE, SIZE, OR COLOR.

NO CLAIM IS MADE TO THE EXCLUSIVE RIGHT TO USE "HYBRID FX", APART FROM THE MARK AS SHOWN.

FOR INTERNATIONAL BANKING SERVICES FEATURING CURRENCY EXCHANGE SERVICES, PROCESSING CHECKS, DRAFTS AND WIRE TRANSFERS AMONG DIFFERING CURRENCIES, AND CASH MANAGEMENT SERVICES (U.S. CLS. 100, 101 AND 102).
SIMON TENG, EXAMINING ATTORNEY

CLASS 36—(Continued).

SN 77-168,179. NOVELLUS CAPITAL MANAGEMENT, LLC, BELLEVUE, WA. FILED 4-27-2007.



NO CLAIM IS MADE TO THE EXCLUSIVE RIGHT TO USE "CAPITAL MANAGEMENT", APART FROM THE MARK AS SHOWN.

THE MARK CONSISTS OF A GEOMETRICAL TRIANGULAR DESIGN ABOVE THE LITERAL ELEMENT.

THE LATIN WORDING NOVELLUS IN THE MARK TRANSLATES INTO ENGLISH AS NEW, FRESH OR RECENT.

FOR FINANCIAL SERVICES, NAMELY, THE PURCHASE OF RESIDENTIAL MORTGAGES ON BEHALF OF OTHERS AND THE ISSUANCE OF MORTGAGE-BACKED SECURITIES; FINANCIAL SERVICES IN THE NATURE OF AN INVESTMENT SECURITY; INVESTMENT ADVISORY SERVICES; INVESTMENT MANAGEMENT; MUTUAL FUND DISTRIBUTION (U.S. CLS. 100, 101 AND 102).

SETH A. RAPPAPORT, EXAMINING ATTORNEY

SN 77-168,715. POPULAR, INC., SAN JUAN, PUERTO RICO, FILED 4-30-2007.

B-SMART

THE MARK CONSISTS OF STANDARD CHARACTERS WITHOUT CLAIM TO ANY PARTICULAR FONT, STYLE, SIZE, OR COLOR.

FOR CHECKING ACCOUNT SERVICES (U.S. CLS. 100, 101 AND 102).

FIRST USE 2-1-2007; IN COMMERCE 2-1-2007.
LINDA ORNDORFF, EXAMINING ATTORNEY

CLASS 36—(Continued).

SN 77-169,644. BRAZCO INTERNATIONAL CORPORATION, ROAD TOWN, TORTOLA, BR.VIRGIN ISLANDS, FILED 5-1-2007.

POLICARD

THE MARK CONSISTS OF STANDARD CHARACTERS WITHOUT CLAIM TO ANY PARTICULAR FONT, STYLE, SIZE, OR COLOR.

FOR CREDIT AND CASH CARD SERVICES; CREDIT CARD SERVICES; DEBIT CARD SERVICES; FINANCING SERVICES (U.S. CLS. 100, 101 AND 102).

REBECCA SMITH, EXAMINING ATTORNEY

SN 77-169,777. HEALTH CARE SERVICE CORPORATION, CHICAGO, IL. FILED 5-1-2007.

COLORADO BANKERS LIFE INSURANCE COMPANY

THE MARK CONSISTS OF STANDARD CHARACTERS WITHOUT CLAIM TO ANY PARTICULAR FONT, STYLE, SIZE, OR COLOR.

OWNER OF U.S. REG. NO. 2,431,259.
NO CLAIM IS MADE TO THE EXCLUSIVE RIGHT TO USE "LIFE INSURANCE COMPANY", APART FROM THE MARK AS SHOWN.

SEC. 2(F).
FOR INSURANCE SERVICES NAMELY THE ADMINISTRATION AND UNDERWRITING OF LIFE, HEALTH AND CASUALTY INSURANCE (U.S. CLS. 100, 101 AND 102).

FIRST USE 11-14-1974; IN COMMERCE 11-14-1974.
BONNIE LUKEN, EXAMINING ATTORNEY

SN 77-171,002. THINKORSWIM GROUP, INC., CHICAGO, IL. FILED 5-2-2007.



OWNER OF U.S. REG. NO. 2,568,003.
THE COLOR(S) RED AND BLACK IS/ARE CLAIMED AS A FEATURE OF THE MARK.

THE MARK CONSISTS OF A RED ASTERISK DESIGN FOLLOWED BY THE WORD "THINKORSWIM" IN BLACK. FOR SECURITIES BROKERAGE (U.S. CLS. 100, 101 AND 102).

FIRST USE 1-11-2001; IN COMMERCE 1-11-2001.
ELIZABETH HUGHITT, EXAMINING ATTORNEY

CLASS 36—(Continued).

SN 77-172,623. GOLDMAN, SACHS & CO., NEW YORK, NY. FILED 5-3-2007.

ROTHESAY LIFE

THE MARK CONSISTS OF STANDARD CHARACTERS WITHOUT CLAIM TO ANY PARTICULAR FONT, STYLE, SIZE, OR COLOR.

NO CLAIM IS MADE TO THE EXCLUSIVE RIGHT TO USE "LIFE", APART FROM THE MARK AS SHOWN.

FOR INSURANCE SERVICES, NAMELY, LIFE INSURANCE BROKERAGE; LIFE INSURANCE UNDERWRITING SERVICES; CLAIMS MANAGEMENT AND ADJUSTMENT SERVICES FOR LIFE INSURANCE; INSURANCE ACTUARIAL SERVICES; INSURANCE CLAIMS ADMINISTRATION AND PROCESSING SERVICES; INSURANCE CONSULTING SERVICES; REINSURANCE SERVICES, NAMELY, REINSURANCE IN THE FIELD OF LIFE INSURANCE; REINSURANCE BROKERAGE SERVICES; REINSURANCE UNDERWRITING SERVICES; REINSURANCE CLAIMS ADMINISTRATION AND PROCESSING SERVICES; REINSURANCE CONSULTING SERVICES; REINSURANCE CLAIMS MANAGEMENT AND ADJUSTMENT SERVICES; FINANCIAL SERVICES, NAMELY, INVESTMENT AND ASSET MANAGEMENT SERVICES; COMPREHENSIVE FINANCIAL RISK MANAGEMENT SERVICES FOCUSING ON ASSETS AND LIABILITIES INCLUDING COMBINING INSURANCE AND REINSURANCE SERVICES WITH DERIVATIVE FINANCIAL INSTRUMENTS; FINANCIAL CONSULTING SERVICES; FINANCIAL PLANNING SERVICES; ASSET MANAGEMENT SERVICES, NAMELY, FINANCIAL AND INVESTMENT MANAGEMENT; FINANCIAL RESEARCH SERVICES; ANNUITY UNDERWRITING SERVICES; ANNUITY CLAIMS ADMINISTRATION AND PROCESSING; CONSULTING SERVICES IN THE FIELD OF ANNUITIES AND PENSIONS; MANAGEMENT AND ADMINISTRATION OF ANNUITY AND PENSION PLANS (U.S. CLS. 100, 101 AND 102).

EMILY CHUO, EXAMINING ATTORNEY

SN 77-180,295. AMERICAN INTERNATIONAL GROUP, INC., NEW YORK, NY. FILED 5-14-2007.

AIG VALIC PROFILE RETIREMENT PROGRAM

THE MARK CONSISTS OF STANDARD CHARACTERS WITHOUT CLAIM TO ANY PARTICULAR FONT, STYLE, SIZE, OR COLOR.

OWNER OF U.S. REG. NOS. 3,083,895, 3,105,289 AND OTHERS.

NO CLAIM IS MADE TO THE EXCLUSIVE RIGHT TO USE "RETIREMENT PROGRAM", APART FROM THE MARK AS SHOWN.

FOR FINANCIAL INVESTMENT IN THE FIELD OF ANNUITIES, MUTUAL FUNDS, AND RETIREMENT PLANS; INVESTMENT ADVISORY SERVICES (U.S. CLS. 100, 101 AND 102).

FIRST USE 5-1-2006; IN COMMERCE 5-1-2006.
BRIDGETT SMITH, EXAMINING ATTORNEY

CLASS 36—(Continued).

SN 77-183,280. PRUDENTIAL INSURANCE COMPANY OF AMERICA, THE, NEWARK, NJ. FILED 5-17-2007.

ADVANCED SERIES

THE MARK CONSISTS OF STANDARD CHARACTERS WITHOUT CLAIM TO ANY PARTICULAR FONT, STYLE, SIZE, OR COLOR.

FOR FINANCIAL SERVICES, NAMELY, INVESTMENT ADVISORY SERVICES, UNDERWRITING AND INVESTMENT MANAGEMENT OF ANNUITIES AND DEFINED CONTRIBUTION PLANS; INVESTMENT MANAGEMENT SERVICES; ADMINISTRATION OF EMPLOYEE RETIREMENT PLANS; RETIREMENT PLANNING SERVICES FOR INDIVIDUALS AND GROUPS; ESTATE PLANNING SERVICES; INSURANCE UNDERWRITING, ADMINISTRATION AND AGENCY SERVICES IN THE FIELDS OF LIFE, LONG TERM CARE AND DISABILITY INSURANCE; PROVIDING FINANCIAL INFORMATION AND RESEARCH BY MEANS OF A GLOBAL COMPUTER NETWORK, PERSONAL DIGITAL ASSISTANTS, BEEPERS, AND CELL PHONES (U.S. CLS. 100, 101 AND 102).

RICHARD A. STRASER, EXAMINING ATTORNEY

SN 77-192,282. AMERICAN INTERNATIONAL GROUP, INC., NEW YORK, NY. FILED 5-29-2007.

AIG HOUSEHOLD SAFEGUARD

THE MARK CONSISTS OF STANDARD CHARACTERS WITHOUT CLAIM TO ANY PARTICULAR FONT, STYLE, SIZE, OR COLOR.

OWNER OF U.S. REG. NOS. 1,151,229, 1,273,845 AND OTHERS.

NO CLAIM IS MADE TO THE EXCLUSIVE RIGHT TO USE "HOUSEHOLD", APART FROM THE MARK AS SHOWN.

FOR INSURANCE UNDERWRITING IN THE FIELD OF ACCIDENT AND HEALTH, PROPERTY AND CASUALTY, KIDNAP AND RANSOM, AUTOMOBILE THEFT, AND TRAUMATIC LOSS RELATED TO A FAMILY MEMBER (U.S. CLS. 100, 101 AND 102).

FIRST USE 12-20-2006; IN COMMERCE 12-20-2006.

BRIDGETT SMITH, EXAMINING ATTORNEY

CLASS 36—(Continued).

SN 77-194,607. AMERICAN INTERNATIONAL GROUP, INC., NEW YORK, NY. FILED 5-31-2007.

AIG INHERITANCE LIFE

THE MARK CONSISTS OF STANDARD CHARACTERS WITHOUT CLAIM TO ANY PARTICULAR FONT, STYLE, SIZE, OR COLOR.

OWNER OF U.S. REG. NOS. 1,151,229, 1,273,845 AND OTHERS.

NO CLAIM IS MADE TO THE EXCLUSIVE RIGHT TO USE "LIFE", APART FROM THE MARK AS SHOWN.

FOR INSURANCE UNDERWRITING IN THE FIELD OF UNIVERSAL LIFE INSURANCE (U.S. CLS. 100, 101 AND 102).

FIRST USE 7-1-2006; IN COMMERCE 7-1-2006.

BRIDGETT SMITH, EXAMINING ATTORNEY

SN 77-194,716. AMERICAN INTERNATIONAL GROUP, INC., NEW YORK, NY. FILED 5-31-2007.

**AIG UNITED GUARANTY'S MI
HOTLINE**

THE MARK CONSISTS OF STANDARD CHARACTERS WITHOUT CLAIM TO ANY PARTICULAR FONT, STYLE, SIZE, OR COLOR.

OWNER OF U.S. REG. NOS. 1,151,229, 3,083,810 AND OTHERS.

NO CLAIM IS MADE TO THE EXCLUSIVE RIGHT TO USE "GUARANTY'S MI HOTLINE", APART FROM THE MARK AS SHOWN.

FOR INSURANCE UNDERWRITING IN THE FIELD OF MORTGAGE GUARANTY INSURANCE (U.S. CLS. 100, 101 AND 102).

FIRST USE 3-1-2006; IN COMMERCE 3-1-2006.

BRIDGETT SMITH, EXAMINING ATTORNEY

SN 77-200,652. AMERICAN INTERNATIONAL GROUP, INC., NEW YORK, NY. FILED 6-7-2007.

**AIG HEALTHCARE MEDICAL
GROUP RISK SOLUTIONS**

THE MARK CONSISTS OF STANDARD CHARACTERS WITHOUT CLAIM TO ANY PARTICULAR FONT, STYLE, SIZE, OR COLOR.

OWNER OF U.S. REG. NOS. 1,151,229, 1,273,845 AND OTHERS.

NO CLAIM IS MADE TO THE EXCLUSIVE RIGHT TO USE "HEALTHCARE MEDICAL GROUP RISK SOLUTIONS", APART FROM THE MARK AS SHOWN.

FOR INSURANCE UNDERWRITING IN THE FIELD OF ACCIDENT AND HEALTH, PROFESSIONAL LIABILITY, AND GENERAL LIABILITY (U.S. CLS. 100, 101 AND 102).

BRIDGETT SMITH, EXAMINING ATTORNEY

CLASS 36—(Continued).

SN 77-200,698. AMERICAN INTERNATIONAL GROUP, INC., NEW YORK, NY. FILED 6-7-2007.

AIG GROUP INDEMNITY DENTAL

THE MARK CONSISTS OF STANDARD CHARACTERS WITHOUT CLAIM TO ANY PARTICULAR FONT, STYLE, SIZE, OR COLOR.

OWNER OF U.S. REG. NOS. 1,151,229, 3,083,810 AND OTHERS.

NO CLAIM IS MADE TO THE EXCLUSIVE RIGHT TO USE "GROUP INDEMNITY DENTAL", APART FROM THE MARK AS SHOWN.

FOR INSURANCE UNDERWRITING IN THE FIELD OF DENTAL HEALTH INSURANCE AND ADMINISTRATION (U.S. CLS. 100, 101 AND 102).

FIRST USE 5-1-2007; IN COMMERCE 5-1-2007.
BRIDGETT SMITH, EXAMINING ATTORNEY

SN 77-200,706. AMERICAN INTERNATIONAL GROUP, INC., NEW YORK, NY. FILED 6-7-2007.

AIG GROUP DISABILITYCARE

THE MARK CONSISTS OF STANDARD CHARACTERS WITHOUT CLAIM TO ANY PARTICULAR FONT, STYLE, SIZE, OR COLOR.

OWNER OF U.S. REG. NOS. 1,172,557, 3,135,938 AND OTHERS.

NO CLAIM IS MADE TO THE EXCLUSIVE RIGHT TO USE "GROUP DISABILITYCARE", APART FROM THE MARK AS SHOWN.

FOR INSURANCE UNDERWRITING IN THE FIELD OF DISABILITY INSURANCE (U.S. CLS. 100, 101 AND 102).

FIRST USE 1-1-2007; IN COMMERCE 1-1-2007.
BRIDGETT SMITH, EXAMINING ATTORNEY

SN 77-200,713. AMERICAN INTERNATIONAL GROUP, INC., NEW YORK, NY. FILED 6-7-2007.

AIG GROUP PPO DENTAL

THE MARK CONSISTS OF STANDARD CHARACTERS WITHOUT CLAIM TO ANY PARTICULAR FONT, STYLE, SIZE, OR COLOR.

OWNER OF U.S. REG. NOS. 1,151,229, 3,083,810 AND OTHERS.

NO CLAIM IS MADE TO THE EXCLUSIVE RIGHT TO USE "GROUP PPO DENTAL", APART FROM THE MARK AS SHOWN.

FOR INSURANCE UNDERWRITING IN THE FIELD OF DENTAL HEALTH INSURANCE AND ADMINISTRATION (U.S. CLS. 100, 101 AND 102).

FIRST USE 5-1-2007; IN COMMERCE 5-1-2007.
BRIDGETT SMITH, EXAMINING ATTORNEY

CLASS 36—(Continued).

SN 77-200,718. AMERICAN INTERNATIONAL GROUP, INC., NEW YORK, NY. FILED 6-7-2007.

AIG ROPTERM MVP

THE MARK CONSISTS OF STANDARD CHARACTERS WITHOUT CLAIM TO ANY PARTICULAR FONT, STYLE, SIZE, OR COLOR.

OWNER OF U.S. REG. NOS. 1,151,229, 2,703,343 AND OTHERS.

NO CLAIM IS MADE TO THE EXCLUSIVE RIGHT TO USE "ROPTERM", APART FROM THE MARK AS SHOWN.

FOR INSURANCE UNDERWRITING IN THE FIELD OF EMPLOYEE BENEFITS FOR LIFE INSURANCE AND ACCIDENT AND HEALTH (U.S. CLS. 100, 101 AND 102).

FIRST USE 8-1-2006; IN COMMERCE 8-1-2006.
BRIDGETT SMITH, EXAMINING ATTORNEY

SN 77-201,247. AMERICAN INTERNATIONAL GROUP, INC., NEW YORK, NY. FILED 6-8-2007.

AIG GROUP HOSPITALCARE

THE MARK CONSISTS OF STANDARD CHARACTERS WITHOUT CLAIM TO ANY PARTICULAR FONT, STYLE, SIZE, OR COLOR.

OWNER OF U.S. REG. NOS. 1,151,229, 1,273,845 AND OTHERS.

NO CLAIM IS MADE TO THE EXCLUSIVE RIGHT TO USE "GROUP HOSPITALCARE", APART FROM THE MARK AS SHOWN.

FOR INSURANCE UNDERWRITING IN THE FIELD OF SUPPLEMENTAL HOSPITAL HEALTH-RELATED EXPENSES (U.S. CLS. 100, 101 AND 102).

FIRST USE 10-1-2006; IN COMMERCE 10-1-2006.
BRIDGETT SMITH, EXAMINING ATTORNEY

SN 77-201,307. AMERICAN INTERNATIONAL GROUP, INC., NEW YORK, NY. FILED 6-8-2007.

AIG GROUP EMERGENCYCARE

THE MARK CONSISTS OF STANDARD CHARACTERS WITHOUT CLAIM TO ANY PARTICULAR FONT, STYLE, SIZE, OR COLOR.

OWNER OF U.S. REG. NOS. 1,151,229, 1,273,845 AND OTHERS.

NO CLAIM IS MADE TO THE EXCLUSIVE RIGHT TO USE "GROUP EMERGENCYCARE", APART FROM THE MARK AS SHOWN.

FOR INSURANCE UNDERWRITING IN THE FIELD OF SUPPLEMENTAL ACCIDENT AND HEALTH EXPENSES (U.S. CLS. 100, 101 AND 102).

FIRST USE 10-1-2006; IN COMMERCE 10-1-2006.
BRIDGETT SMITH, EXAMINING ATTORNEY

CLASS 36—(Continued).

SN 77-202,478. AMERICAN INTERNATIONAL GROUP, INC., NEW YORK, NY. FILED 6-11-2007.

AIG SELECT-A-TERM

THE MARK CONSISTS OF STANDARD CHARACTERS WITHOUT CLAIM TO ANY PARTICULAR FONT, STYLE, SIZE, OR COLOR.

OWNER OF U.S. REG. NOS. 1,151,229, 1,273,845 AND OTHERS.

NO CLAIM IS MADE TO THE EXCLUSIVE RIGHT TO USE "SELECT-A-TERM", APART FROM THE MARK AS SHOWN.

FOR INSURANCE UNDERWRITING IN THE FIELD OF TERM LIFE INSURANCE (U.S. CLS. 100, 101 AND 102).

FIRST USE 4-27-2007; IN COMMERCE 4-27-2007.
BRIDGETT SMITH, EXAMINING ATTORNEY

SN 77-222,796. AMERICAN INTERNATIONAL GROUP, INC., NEW YORK, NY. FILED 7-5-2007.

AIG ENERGY PLUS

THE MARK CONSISTS OF STANDARD CHARACTERS WITHOUT CLAIM TO ANY PARTICULAR FONT, STYLE, SIZE, OR COLOR.

OWNER OF U.S. REG. NOS. 1,172,557, 2,939,990 AND OTHERS.

NO CLAIM IS MADE TO THE EXCLUSIVE RIGHT TO USE "ENERGY", APART FROM THE MARK AS SHOWN.

FOR INSURANCE UNDERWRITING IN THE FIELD OF ALTERNATIVE RISK SOLUTIONS FOR THE ENERGY INDUSTRY (U.S. CLS. 100, 101 AND 102).

BRIDGETT SMITH, EXAMINING ATTORNEY

SN 78-155,345. AMERICAN EXPRESS COMPANY, NEW YORK, NY. FILED 8-19-2002.

SAVINGS AT WORK

FOR CREDIT CARD SERVICES (U.S. CLS. 100, 101 AND 102).

KATHY DE JONGE, EXAMINING ATTORNEY

CLASS 36—(Continued).

SN 78-578,539. MAINE ASSOCIATION OF REALTORS FOUNDATION, AUGUSTA, ME. FILED 3-2-2005.



MAINE ASSOCIATION OF
REALTORS FOUNDATION

NO CLAIM IS MADE TO THE EXCLUSIVE RIGHT TO USE "MAINE ASSOCIATION" AND "FOUNDATION", APART FROM THE MARK AS SHOWN.

FOR CHARITABLE SERVICES, NAMELY PROVIDING FUNDING TO GROUPS AND ORGANIZATIONS FOR THE PURPOSE OF FUNDING ACTIVITIES, PROGRAMS AND SERVICES RELATED TO THE DEVELOPMENT OF HOUSING OPPORTUNITIES FOR LOW INCOME INDIVIDUALS AND FAMILIES (U.S. CLS. 100, 101 AND 102).
FIRST USE 10-1-2004; IN COMMERCE 10-1-2004.
DORITT L. CARROLL, EXAMINING ATTORNEY

SN 78-671,227. ERNST & YOUNG ORENDA CORPORATE FINANCE INC., TORONTO, ONTARIO, CANADA, FILED 7-15-2005.

THE DEALMAKER YOU NEED

THE MARK CONSISTS OF STANDARD CHARACTERS WITHOUT CLAIM TO ANY PARTICULAR FONT, STYLE, SIZE, OR COLOR.

PRIORITY CLAIMED UNDER SEC. 44(D) ON CANADA APPLICATION NO. 1256742, FILED 5-5-2005, REG. NO. TMA687498, DATED 5-10-2007, EXPIRES 5-10-2022.

FOR FINANCIAL ADVISORY, CORPORATE FINANCE SERVICES, AND INVESTMENT BANKING SERVICES (U.S. CLS. 100, 101 AND 102).

RAMONA ORTIGA, EXAMINING ATTORNEY

SN 78-682,056. COMMUNITY FINANCE GROUP, LLC, SOUTH BARRINGTON, IL. FILED 7-30-2005.

NO CLAIM IS MADE TO THE EXCLUSIVE RIGHT TO USE "PRONTO PRESTAMOS", APART FROM THE MARK AS SHOWN.

THE COLOR(S) BLUE AND RED IS/ARE CLAIMED AS A FEATURE OF THE MARK.

THE MARK CONSISTS OF BLUE SPEED MARKS FOLLOWED BY PRONTO PRESTAMOS IN BLUE, WITH AN ACCENT OVER THE "E" IN PRESTAMOS AND THE FIRST "S" IN PRESTAMOS SHOWN AS A RED DOLLAR SIGN.

THE FOREIGN WORDING IN THE MARK TRANSLATES INTO ENGLISH AS LOANS.

FOR LOAN FINANCING (U.S. CLS. 100, 101 AND 102).
FIRST USE 7-28-2005; IN COMMERCE 7-28-2005.

SHAUNIA CARLYLE, EXAMINING ATTORNEY

CLASS 36—(Continued).

SN 78-718,987. DAVID WEBB-MANGAN, SCOTCH PLAINS, NJ. FILED 9-22-2005.

Chuck A Buck

THE MARK CONSISTS OF STANDARD CHARACTERS WITHOUT CLAIM TO ANY PARTICULAR FONT, STYLE, SIZE, OR COLOR.

FOR CHARITABLE FUND RAISING (U.S. CLS. 100, 101 AND 102).

FIRST USE 9-5-2005; IN COMMERCE 9-5-2005.

CHARLES L. JENKINS, EXAMINING ATTORNEY

SN 78-741,582. FIRST NATIONAL BANK OF WYOMING, LARAMIE, WY. FILED 10-27-2005.

CAPITAL WEST NATIONAL BANK

THE MARK CONSISTS OF STANDARD CHARACTERS WITHOUT CLAIM TO ANY PARTICULAR FONT, STYLE, SIZE, OR COLOR.

NO CLAIM IS MADE TO THE EXCLUSIVE RIGHT TO USE "CAPITAL" AND "NATIONAL BANK", APART FROM THE MARK AS SHOWN.

FOR BANKING AND FINANCIAL SERVICES, NAMELY, FULL SERVICE PERSONAL, BUSINESS AND COMMERCIAL BANKING SERVICES; FINANCIAL MANAGEMENT AND ADVISORY SERVICES FOR OTHERS; CREDIT AND DEBIT CARD SERVICES; COMMERCIAL LENDING SERVICES; MORTGAGE AND CONSUMER LENDING SERVICES; FINANCING AND GUARANTEEING LOANS; FINANCIAL INVESTMENT SERVICES IN THE FIELDS OF INVESTMENT SECURITIES AND CERTIFICATES OF DEPOSIT; ELECTRONIC FUND TRANSFER SERVICES; FINANCIAL TRUST OPERATIONS; FINANCIAL CLEARING HOUSES; FINANCIAL DUE DILIGENCE; FINANCIAL EXCHANGE SERVICES; INVESTMENT BROKERAGE, CONSULTATION AND MANAGEMENT; SECURITIES BROKERAGE; FINANCIAL MANAGEMENT; FINANCIAL PLANNING; FINANCIAL RESEARCH, ANALYSIS AND CONSULTATION; ELECTRONIC AND ONLINE BANKING SERVICES; INSURANCE BROKERAGE SERVICES; CREDIT AND FINANCIAL CONSULTATION; PROVIDING ONLINE FINANCIAL CALCULATORS; PROVIDING FINANCIAL AND LOAN INFORMATION (U.S. CLS. 100, 101 AND 102).

FIRST USE 12-1-2004; IN COMMERCE 12-1-2004.

KATHRYN COWARD, EXAMINING ATTORNEY

CLASS 36—(Continued).

SN 78-752,568. LOWERCASE PEOPLE JUSTICE FUND, INC., BRENTWOOD, TN. FILED 11-11-2005.

LOWERCASE PEOPLE JUSTICE FUND

THE MARK CONSISTS OF STANDARD CHARACTERS WITHOUT CLAIM TO ANY PARTICULAR FONT, STYLE, SIZE, OR COLOR.

NO CLAIM IS MADE TO THE EXCLUSIVE RIGHT TO USE "FUND", APART FROM THE MARK AS SHOWN.

FOR CHARITABLE FUNDRAISING SERVICES, CHARITABLE FUNDRAISING SERVICES IN THE NATURE OF ORGANIZING COMMUNITY SPORTING, ENTERTAINMENT AND CULTURAL EVENTS, NAMELY SURFING EVENTS, AUCTIONS, CONCERTS, ARTISTS SHOWS AND OTHER EVENTS AND SHOWS FOR FUNDRAISING PURPOSES (U.S. CLS. 100, 101 AND 102).

KRISTINA MORRIS, EXAMINING ATTORNEY

SN 78-756,352. WEST FINANCIAL, INC., EL PASO, TX. FILED 11-17-2005.

WestStar Bank

THE MARK CONSISTS OF STANDARD CHARACTERS WITHOUT CLAIM TO ANY PARTICULAR FONT, STYLE, SIZE, OR COLOR.

NO CLAIM IS MADE TO THE EXCLUSIVE RIGHT TO USE "BANK", APART FROM THE MARK AS SHOWN.

FOR BANKING SERVICES (U.S. CLS. 100, 101 AND 102).

GEORGE LORENZO, EXAMINING ATTORNEY

CLASS 36—(Continued).

SN 78-782,612. THE DANNON COMPANY, INC., WHITE PLAINS, NY. FILED 12-29-2005.



OWNER OF U.S. REG. NOS. 1,265,165 AND 2,552,713.
NO CLAIM IS MADE TO THE EXCLUSIVE RIGHT TO USE CLUB, APART FROM THE MARK AS SHOWN.
THE COLOR(S) BLUE, WHITE, RED, GREEN AND GOLD IS/ARE CLAIMED AS A FEATURE OF THE MARK.
THE MARK CONSISTS OF THE COLOR RED APPEARS IN THE SMILE, THE COLOR WHITE APPEARS IN THE WORD DANNON AND IN THE BORDER TO THE DANNON LOGO, THE COLOR BLUE APPEARS IN THE BACKGROUND TO THE DANNON LOGO, THE COLOR GREEN APPEARS THROUGHOUT THE EMERALD, AND THE COLOR GOLD APPEARS IN THE WORDS EMERALD CLUB.

FOR PROVIDING REBATES FOR PURCHASES OF GOOD AND SERVICES, INCENTIVE AWARDS, NAMELY, PROVIDING AND PAYING REBATES FOR OTHERS FOR PURCHASES OF GOODS AND SERVICES (U.S. CLS. 100, 101 AND 102).

JENNIFER KRISP, EXAMINING ATTORNEY

CLASS 36—(Continued).

SN 78-859,877. KEREN KAYEMETH LEISRAEL, JERUSALEM, ISRAEL, FILED 4-12-2006.

KKL

THE MARK CONSISTS OF STANDARD CHARACTERS WITHOUT CLAIM TO ANY PARTICULAR FONT, STYLE, SIZE, OR COLOR.

PRIORITY CLAIMED UNDER SEC. 44(D) ON ERP CMNTY TM OFC APPLICATION NO. 4694451, FILED 10-17-2005, REG. NO. 4694451, DATED 10-27-2006, EXPIRES 10-17-2015.

FOR CHARITABLE FUND RAISING SERVICES; FUND RAISING SERVICES, NAMELY, ACCEPTING AND ADMINISTERING MONETARY CHARITABLE CONTRIBUTIONS; ORGANIZING CHARITABLE COLLECTIONS; ORGANIZATION OF THE COLLECTION OF CHARITABLE FUNDS; PROVISION AND DISTRIBUTION OF CHARITABLE FUNDS FOR CHARITABLE PURPOSES (U.S. CLS. 100, 101 AND 102).

ESTHER BELENKER, EXAMINING ATTORNEY

SN 78-868,794. SOUTHLAND REGIONAL ASSOCIATION OF REALTORS, VAN NUYS, CA. FILED 4-25-2006.

SOUTHLAND REGIONAL
ASSOCIATION OF REALTORS

SN 78-784,649. THE CLIFFS COMMUNITIES, INC., TRAVELERS REST, SC. FILED 1-4-2006.

MULBERRY VILLAGE

THE MARK CONSISTS OF STANDARD CHARACTERS WITHOUT CLAIM TO ANY PARTICULAR FONT, STYLE, SIZE, OR COLOR.

FOR SHOPPING CENTER SERVICES, NAMELY, RENTAL OF RETAIL SHOPPING CENTER SPACE TO OTHERS (U.S. CLS. 100, 101 AND 102).

NELSON SNYDER, EXAMINING ATTORNEY

THE MARK CONSISTS OF STANDARD CHARACTERS WITHOUT CLAIM TO ANY PARTICULAR FONT, STYLE, SIZE, OR COLOR.

NO CLAIM IS MADE TO THE EXCLUSIVE RIGHT TO USE "ASSOCIATION", APART FROM THE MARK AS SHOWN.

SEC. 2(F) SOUTHLAND REGIONAL.

FOR REAL ESTATE INFORMATION SERVICES; NAMELY, PROVIDING REAL ESTATE INFORMATION ON MULTIPLE PROPERTY LISTINGS, SALES, LOANS, RENTALS, PROPERTY EVALUATIONS, INSURANCE, ESCROW, INVESTMENT MANAGEMENT, FINANCIAL ANALYSES REPORTS AND CONSUMER CREDIT REPORTS; AND PROVIDING ONLINE INFORMATION IN THE FIELD OF REAL ESTATE (U.S. CLS. 100, 101 AND 102).

FIRST USE 11-15-1995; IN COMMERCE 11-15-1995.

ROBERT STRUCK, EXAMINING ATTORNEY

CLASS 36—(Continued).

SN 78-885,711. OXFORD MARKETING CORPORATION, ATLANTA, GA. FILED 5-17-2006.

The Engagement Marketers

THE MARK CONSISTS OF STANDARD CHARACTERS WITHOUT CLAIM TO ANY PARTICULAR FONT, STYLE, SIZE, OR COLOR.
FOR INSURANCE CONSULTATION (U.S. CLS. 100, 101 AND 102).
FIRST USE 2-21-2005; IN COMMERCE 2-21-2005.
AMY HELLA, EXAMINING ATTORNEY

SN 78-887,681. IKB DEUTSCHE INDUSTRIEBANK AG, DUSSELDORF, FED REP GERMANY, FILED 5-19-2006.

BACCHUS

THE MARK CONSISTS OF STANDARD CHARACTERS WITHOUT CLAIM TO ANY PARTICULAR FONT, STYLE, SIZE, OR COLOR.
FOR BROKERAGE, DISTRIBUTION AND INVESTMENT OF A COLLATERAL LOAN OBLIGATION FUND AND MUTUAL FUNDS; FINANCIAL SERVICES, NAMELY FUND INVESTMENT SERVICES IN THE FIELD OF COLLATERALIZED LOAN OBLIGATIONS (U.S. CLS. 100, 101 AND 102).
ELLEN PERKINS, EXAMINING ATTORNEY

SN 78-898,904. MAGRO, MARIO JOSEPH, BEVERLY HILLS, CA. FILED 6-2-2006.

MARIO MAGRO KISS FOR A CURE

THE MARK CONSISTS OF STANDARD CHARACTERS WITHOUT CLAIM TO ANY PARTICULAR FONT, STYLE, SIZE, OR COLOR.
OWNER OF U.S. REG. NOS. 2,966,738 AND 3,053,897.
THE NAME(S), PORTRAIT(S), AND/OR SIGNATURE(S) SHOWN IN THE MARK IDENTIFIES MARIO MAGRO, WHOSE CONSENT(S) TO REGISTER IS MADE OF RECORD.
FOR CHARITABLE FUND RAISING (U.S. CLS. 100, 101 AND 102).
AMY HELLA, EXAMINING ATTORNEY

CLASS 36—(Continued).

SN 78-902,432. LOEFFLER, FRANK J., OVERLAND PARK, KS. FILED 6-7-2006.



NO CLAIM IS MADE TO THE EXCLUSIVE RIGHT TO USE "BENEFITS", APART FROM THE MARK AS SHOWN. THE COLOR(S) BLACK AND BLUE IS/ARE CLAIMED AS A FEATURE OF THE MARK.
THE MARK CONSISTS OF BLACK LETTERS OVER A STYLIZED BLUE STAR.
FOR HEALTH INSURANCE AND EMPLOYEE BENEFITS SERVICE, NAMELY, ADMINISTRATION OF EMPLOYEE BENEFIT PLANS CONCERNING INSURANCE, NOT INCLUDING RETIREMENT PLAN ADMINISTRATION (U.S. CLS. 100, 101 AND 102).
FIRST USE 1-1-2005; IN COMMERCE 1-1-2005.
CARRIE GENOVESE, EXAMINING ATTORNEY

SN 78-916,002. ST. MARCUS CORPORATION, ROAD TOWN, TORTOLA, BR. VIRGIN ISLANDS, FILED 6-23-2006.

LOPES

THE MARK CONSISTS OF STANDARD CHARACTERS WITHOUT CLAIM TO ANY PARTICULAR FONT, STYLE, SIZE, OR COLOR.
FOR REAL ESTATE CONSULTANCY (U.S. CLS. 100, 101 AND 102).
KHANH LE, EXAMINING ATTORNEY

CLASS 36—(Continued).

SN 78-929,670. PLAZA FIESTA, ATLANTA, GA. FILED S.R. 7-14-2006; AM. P.R. 6-13-2007.



NO CLAIM IS MADE TO THE EXCLUSIVE RIGHT TO USE "PLAZA", APART FROM THE MARK AS SHOWN.

"THE COLOR(S) RED, ORANGE, YELLOW, BLUE, GREEN, WHITE AND BLACK IS/ARE CLAIMED AS A FEATURE OF THE MARK."

"THE MARK CONSISTS OF A GREEN RECTANGLE SHAPE. THE OUTER BORDER OF THE RECTANGLE IS DARK GREEN, THE NEXT BORDER IS ORANGE, AND THE THIN INSIDE BORDER IS RED. THERE IS A BLUE GEOMETRIC SHAPE AT THE TOP AND BOTTOM OF THE RECTANGLE. THE WORDS PLAZA FIESTA ARE BLACK. THE LINE ABOVE THE WORDING IS ORANGE WITH WHITE CUTOUTS AND THE BOTTOM LINE IS BLUE WITH WHITE CUTOUTS. THE SUN IS YELLOW. THE EXCLAMATION POINTS ARE RED AND WHITE."

THE FOREIGN WORDING IN THE MARK TRANSLATES INTO ENGLISH AS FIESTA MALL.

THE NON-LATIN CHARACTER(S) IN THE MARK TRANSLITERATES INTO PLAZA FIESTA, AND THIS MEANS FIESTA MALL IN ENGLISH.

FOR SHOPPING CENTER SERVICES, NAMELY, RENTAL OF SHOPPING CENTER SPACE, OPERATING MARKET PLACES FOR SELLERS OF GOODS AND/OR SERVICES (U.S. CLS. 100, 101 AND 102).

FIRST USE 1-1-1999; IN COMMERCE 1-1-1999,
KIMBERLY FRYE, EXAMINING ATTORNEY

SN 78-930,512. IDT INSURANCE, INC., NEWARK, NJ. FILED 7-17-2006.

DEDICADOS A SU FUTURO

THE MARK CONSISTS OF STANDARD CHARACTERS WITHOUT CLAIM TO ANY PARTICULAR FONT, STYLE, SIZE, OR COLOR.

THE FOREIGN WORDING IN THE MARK TRANSLATES INTO ENGLISH AS DEDICATED TO YOUR FUTURE.

FOR INSURANCE AGENCIES, INSURANCE BROKERAGE (U.S. CLS. 100, 101 AND 102).

WOODROW HARTZOG, EXAMINING ATTORNEY

CLASS 36—(Continued).

SN 78-931,670. BIDS HOLDINGS L.P., NEW YORK, NY. FILED 7-18-2006.

BIDS TRADING

THE MARK CONSISTS OF STANDARD CHARACTERS WITHOUT CLAIM TO ANY PARTICULAR FONT, STYLE, SIZE, OR COLOR.

NO CLAIM IS MADE TO THE EXCLUSIVE RIGHT TO USE "TRADING", APART FROM THE MARK AS SHOWN.

FOR FINANCIAL SERVICES, NAMELY PROVIDING A STOCK TRADING SYSTEM FOR TRADING LARGE BLOCKS OF STOCK (U.S. CLS. 100, 101 AND 102).

ANDREA HACK, EXAMINING ATTORNEY

SN 78-932,244. DISCOVER RE MANAGERS, INC., FARMINGTON, CT. FILED 7-18-2006.

DISCOVER CUSTOM

THE MARK CONSISTS OF STANDARD CHARACTERS WITHOUT CLAIM TO ANY PARTICULAR FONT, STYLE, SIZE, OR COLOR.

OWNER OF U.S. REG. NOS. 2,424,266, 2,424,267 AND 2,424,268.

FOR PROPERTY AND CASUALTY INSURANCE UNDERWRITING SERVICES, NAMELY IN THE FIELD OF COMMERCIAL INSURANCE (U.S. CLS. 100, 101 AND 102).

JULIE WATSON, EXAMINING ATTORNEY

SN 78-933,626. TOYO TIRE & RUBBER CO., LTD., NISHI-KU OSAKA, JAPAN, FILED 7-20-2006.

TEAM TOYO MOTORSPORTS

THE MARK CONSISTS OF STANDARD CHARACTERS WITHOUT CLAIM TO ANY PARTICULAR FONT, STYLE, SIZE, OR COLOR.

NO CLAIM IS MADE TO THE EXCLUSIVE RIGHT TO USE "TEAM" AND "MOTORSPORTS", APART FROM THE MARK AS SHOWN.

THE ENGLISH TRANSLATION OF THE WORD TOYO IN THE MARK IS "EAST," "ORIENT," "PLENTIFUL," OR "FULL HARVEST".

FOR FINANCIAL SPONSORSHIP OF RACING EVENTS (U.S. CLS. 100, 101 AND 102).

DAHLIA GEORGE, EXAMINING ATTORNEY

CLASS 36—(Continued).

SN 78-934,459. FIRST INTERCONTINENTAL BANK, DORAVILLE, GA. FILED 7-21-2006.



OWNER OF U.S. REG. NO. 2,406,905.

NO CLAIM IS MADE TO THE EXCLUSIVE RIGHT TO USE "FIRST," "BANK," AND THE TRANSLITERATES OF THE KOREAN CHARACTERS "CHAE'IL EUNHAENG", APART FROM THE MARK AS SHOWN.

THE COLOR(S) BLUE-GREEN AND GOLD IS/ARE CLAIMED AS A FEATURE OF THE MARK.

THE COLOR GOLD APPEARS ON BOTH THE LEFT AND RIGHT HALVES OF THE MARK. GOLD IS USED IN THE CAPITAL STYLIZED I AND ST, AND IN THE LINING OF THE PARALLEL AND MERIDIAN LINES INSIDE THE CAPITAL C. GOLD IS ALSO USED IN THE KOREAN TRANSLATION OF FIRST BANK BELOW THE ENGLISH WORD BANK. THE COLOR BLUE-GREEN IS ALSO USED IN BOTH HALVES OF THE MARK. BLUE-GREEN IS USED IN THE CAPITAL C ON THE LEFT SIDE OF THE MARK, AND TO WRITE BANK IN CAPITAL LETTERS ON THE UPPER HALF OF THE RIGHT SIDE OF THE MARK. FINALLY, THE WORDING OF FIRST BANK IN KOREAN IS INTEGRATED WITH THE I AND C SYMBOL TO CREATE "FIRST IC BANK."

THE MARK CONSISTS OF THE ENGLISH WORDS IST IC BANK, WHERE IST IS A SLIGHT MISSPELLING OF THE WORD FIRST IN A STYLIZED FORM AND ALSO INCLUDES KOREAN CHARACTERS MEANING FIRST BANK BELOW THE WORD BANK.

THE FOREIGN WORDING IN THE MARK TRANSLATES INTO ENGLISH AS FIRST BANK.

THE NON-LATIN CHARACTER(S) IN THE MARK TRANSLITERATES INTO CHAE'IL EUNHAENG, AND THIS MEANS FIRST BANK OR BEST BANK IN ENGLISH. FOR BANKING (U.S. CLS. 100, 101 AND 102).

JOANNA DUKOVIC, EXAMINING ATTORNEY

SN 78-937,198. FIRST FRONTIER INVESTMENTS, INC., CHINO HILLS, CA. FILED 7-25-2006.

BULL'S EYE REALTY

THE MARK CONSISTS OF STANDARD CHARACTERS WITHOUT CLAIM TO ANY PARTICULAR FONT, STYLE, SIZE, OR COLOR.

NO CLAIM IS MADE TO THE EXCLUSIVE RIGHT TO USE "REALTY", APART FROM THE MARK AS SHOWN.

FOR AGENCIES OR BROKERAGE FOR LEASING OR RENTING OF LAND; APPRAISAL OF REAL ESTATE; APPRAISALS FOR INSURANCE CLAIMS OF REAL ESTATE; EVALUATION OF REAL PROPERTY; LAND ACQUISITION, NAMELY, REAL ESTATE BROKERAGE; LEASING OF REAL ESTATE; REAL ESTATE ACQUISITION SERVICES; REAL ESTATE AGENCIES; REAL ESTATE APPRAISAL; REAL ESTATE BROKERAGE; REAL ESTATE CONSULTANCY; REAL ESTATE CONSULTATION; REAL ESTATE ESCROW SERVICES; REAL ESTATE INVESTMENT; REAL ESTATE LISTING; REAL ESTATE MANAGEMENT; REAL ESTATE MANAGEMENT CONSULTATION; REAL ESTATE MULTIPLE LISTING SERVICES; REAL ESTATE TIME-SHARING (U.S. CLS. 100, 101 AND 102).

MICHAEL LITZAU, EXAMINING ATTORNEY

CLASS 36—(Continued).

SN 78-938,029. SEQUOIA INSURANCE COMPANY, MONTEREY, CA. FILED 7-26-2006.

SEQUOIA ENTERPRISE

THE MARK CONSISTS OF STANDARD CHARACTERS WITHOUT CLAIM TO ANY PARTICULAR FONT, STYLE, SIZE, OR COLOR.

OWNER OF U.S. REG. NO. 1,546,710.

NO CLAIM IS MADE TO THE EXCLUSIVE RIGHT TO USE "ENTERPRISE", APART FROM THE MARK AS SHOWN.

FOR PROPERTY AND CASUALTY INSURANCE UNDERWRITING SERVICES (U.S. CLS. 100, 101 AND 102).

FIRST USE 6-7-2006; IN COMMERCE 6-7-2006.

JILL PRATER, EXAMINING ATTORNEY

SN 78-940,970. HEALTHTRANS LLC, GREENWOOD VILLAGE, CO. FILED 7-31-2006.

HEALTHTRANSITIONS

THE MARK CONSISTS OF STANDARD CHARACTERS WITHOUT CLAIM TO ANY PARTICULAR FONT, STYLE, SIZE, OR COLOR.

OWNER OF U.S. REG. NO. 3,041,750.

FOR PHARMACEUTICAL BENEFIT MANAGEMENT SERVICES (U.S. CLS. 100, 101 AND 102).

REBECCA GAN, EXAMINING ATTORNEY

SN 78-945,210. MEDIMPACT HEALTHCARE SYSTEMS, INC., SAN DIEGO, CA. FILED 8-4-2006.

MEDIMPACT FIXED FEE PROGRAM

THE MARK CONSISTS OF STANDARD CHARACTERS WITHOUT CLAIM TO ANY PARTICULAR FONT, STYLE, SIZE, OR COLOR.

OWNER OF U.S. REG. NOS. 2,339,946, 2,403,199 AND 3,182,080.

NO CLAIM IS MADE TO THE EXCLUSIVE RIGHT TO USE "FIXED FEE PROGRAM", APART FROM THE MARK AS SHOWN.

FOR PHARMACY BENEFIT MANAGEMENT SERVICES (U.S. CLS. 100, 101 AND 102).

LINDA M. KING, EXAMINING ATTORNEY

CLASS 36—(Continued).

SN 78-945,693. AMERICAN REVERSE MORTGAGE CORPORATION, OCALA, FL. FILED 8-4-2006.

AMERICAN REVERSE MORTGAGE

THE MARK CONSISTS OF STANDARD CHARACTERS WITHOUT CLAIM TO ANY PARTICULAR FONT, STYLE, SIZE, OR COLOR.

OWNER OF U.S. REG. NOS. 2,980,272 AND 3,164,288.

NO CLAIM IS MADE TO THE EXCLUSIVE RIGHT TO USE "REVERSE MORTGAGE", APART FROM THE MARK AS SHOWN.

SEC. 2(F).

FOR REVERSE MORTGAGE LENDING (U.S. CLS. 100, 101 AND 102).

FIRST USE 4-1-2001; IN COMMERCE 8-3-2001.
LOURDES AYALA, EXAMINING ATTORNEY

SN 78-950,274. MASTERCARD INTERNATIONAL INCORPORATED, PURCHASE, NY. FILED 8-11-2006.

MASTERCARD TRAVEL CARD

THE MARK CONSISTS OF STANDARD CHARACTERS WITHOUT CLAIM TO ANY PARTICULAR FONT, STYLE, SIZE, OR COLOR.

NO CLAIM IS MADE TO THE EXCLUSIVE RIGHT TO USE "TRAVEL CARD", APART FROM THE MARK AS SHOWN.

FOR FINANCIAL SERVICES, NAMELY, BANKING AND CREDIT SERVICES; PROVIDING CREDIT CARD, DEBIT CARD, CHARGE CARD AND STORED VALUE PREPAID CARD SERVICES; BANKING SERVICES, BILL PAYMENT, CREDIT CARD SERVICES, DEBIT CARD SERVICES, CHARGE CARD SERVICES, CASH DISBURSEMENT, PROVIDING ONLINE STORED VALUE ACCOUNTS IN AN ELECTRONIC ENVIRONMENT; BILL PAYMENT SERVICES; AUTOMATED TELLER MACHINE SERVICES; PROCESSING OF ELECTRONIC BILL PAYMENT FINANCIAL TRANSACTIONS ONLINE VIA A COMPUTER DATABASE OR VIA TELECOMMUNICATIONS AND AT POINT OF SALE; ELECTRONIC BILL PAYMENT PROCESSING SERVICES FOR FINANCIAL TRANSACTIONS BY CARD HOLDERS VIA AUTOMATIC TELLER MACHINES; THE PROVISION OF BALANCE DETAILS, DEPOSITS AND WITHDRAWALS OF MONEY TO CARD HOLDERS VIA AUTOMATIC TELLER MACHINES; FINANCIAL SETTLEMENT AND AUTHORIZATION SERVICES RELATING TO PAYMENT CARD TRANSACTIONS; ISSUING AND REDEMPTION OF TRAVELLERS CHECKS; CHECK VERIFICATION AND CHECK CASHING SERVICES; VERIFICATION OF FINANCIAL INFORMATION; PAYER AUTHENTICATION SERVICES, NAMELY, PROVISION OF SERVICES RELATING TO THE AUTHENTICATION OF CARDHOLDERS, MERCHANTS AND BANKS FOR PAYMENT CARD TRANSACTIONS; ELECTRONIC FUNDS TRANSFER AND CURRENCY EXCHANGE SERVICES; DISSEMINATION OF FINANCIAL INFORMATION VIA THE INTERNET AND OTHER COMPUTER NETWORKS; REMOTE BILL PAYMENT SERVICES; STORED VALUE ELECTRONIC PURSE SERVICES, NAMELY, PROVIDING ONLINE STORED VALUE ACCOUNTS IN AN ELECTRONIC ENVIRONMENT; PROVIDING ELECTRONIC FUNDS AND CURRENCY TRANSFER SERVICES, ELECTRONIC BILL PAYMENTS SERVICES, PREPAID TELEPHONE CALLING CARD SERVICES, CASH DISBURSEMENT SERVICES, AND

CLASS 36—(Continued).

TRANSACTION AUTHORIZATION AND SETTLEMENT SERVICES; PROVISION OF DEBIT CARD, CREDIT CARD AND PREPAID CARD SERVICES BY MEANS OF RADIO FREQUENCY IDENTIFICATION DEVICES; PROVISION OF DEBIT CARD AND CREDIT CARD SERVICES BY MEANS OF COMMUNICATION AND TELECOMMUNICATION DEVICES; THE PROVISION OF FINANCIAL BILL PAYMENT SERVICES FOR THE SUPPORT OF RETAIL SERVICES PROVIDED THROUGH MOBILE TELECOMMUNICATIONS MEANS, INCLUDING PAYMENT SERVICES THROUGH WIRELESS DEVICES; THE PROVISION OF FINANCIAL BILL PAYMENT SERVICES FOR THE SUPPORT OF RETAIL SERVICES PROVIDED ON-LINE, THROUGH NETWORKS OR OTHER ELECTRONIC MEANS USING ELECTRONICALLY DIGITIZED INFORMATION; PROVIDING ONLINE STORED VALUE ACCOUNTS IN AN ELECTRONIC ENVIRONMENT FOR USE IN THE SECURE EXCHANGE OF VALUE, INCLUDING ELECTRONIC CASH, OVER COMPUTER NETWORKS, ON-LINE BANKING; FINANCIAL INFORMATION PROCESSING SERVICES PROVIDED OVER THE TELEPHONE AND BY MEANS OF A GLOBAL COMPUTER NETWORK OR THE INTERNET; PROVISION OF FINANCIAL INFORMATION PROCESSING SERVICES BY MEANS OF A GLOBAL COMPUTER NETWORK OR THE INTERNET (U.S. CLS. 100, 101 AND 102).

TANYA AMOS, EXAMINING ATTORNEY

SN 78-951,439. AGENT2AGENT LLC, SCOTTSDALE, AZ. FILED 8-14-2006.

Agent 2 Agent

THE COLOR(S) BLACK AND WHITE IS/ARE CLAIMED AS A FEATURE OF THE MARK.

THE MARK CONSISTS OF THREE WORDS TWO OF WHICH ARE THE WORD "AGENT." THE FIRST WORD "AGENT" IS SOLID BLACK. THE TWO IS THE NUMBER TWO AND IS BLACK IN COLOR. THE FOLLOWING WORD "AGENT" IS WHITE WITH A BLACK OUTLINE.

FOR PROVIDING INFORMATION REGARDING REAL ESTATE LISTINGS VIA THE INTERNET (U.S. CLS. 100, 101 AND 102).

FIRST USE 3-1-2006; IN COMMERCE 3-10-2006.

BRIDGETT SMITH, EXAMINING ATTORNEY

SN 78-952,921. SOCCER FOR PEACE, INC., NEW YORK, NY. FILED 8-15-2006.

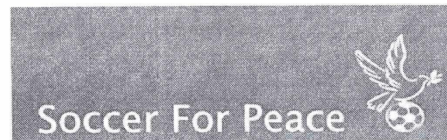

NO CLAIM IS MADE TO THE EXCLUSIVE RIGHT TO USE "SOCCER", APART FROM THE MARK AS SHOWN.

FOR CHARITABLE FUND RAISING SERVICES (U.S. CLS. 100, 101 AND 102).

FIRST USE 9-0-2002; IN COMMERCE 9-0-2002.

ODESSA BIBBINS, EXAMINING ATTORNEY

CLASS 36—(Continued).

SN 78-957,524. ESQUIRE LLC, BROOKLYN, NY. FILED 8-22-2006.

THE LAWYERS CARD

THE MARK CONSISTS OF STANDARD CHARACTERS WITHOUT CLAIM TO ANY PARTICULAR FONT, STYLE, SIZE, OR COLOR.

FOR BANKING; CREDIT CARD SERVICES; DEBIT CARD SERVICES; ELECTRONIC CREDIT CARD TRANSACTIONS; ISSUING CREDIT CARDS; PROVIDING ELECTRONIC PROCESSING OF CREDIT CARD TRANSACTIONS AND ELECTRONIC PAYMENTS VIA A GLOBAL COMPUTER NETWORK (U.S. CLS. 100, 101 AND 102).

JOHN WILKE, EXAMINING ATTORNEY

SN 78-958,137. MONTERO, JOSE, JR., WASHINGTON, DC. FILED 8-22-2006.

TREKKING FOR KIDS

THE MARK CONSISTS OF STANDARD CHARACTERS WITHOUT CLAIM TO ANY PARTICULAR FONT, STYLE, SIZE, OR COLOR.

NO CLAIM IS MADE TO THE EXCLUSIVE RIGHT TO USE "FOR KIDS", APART FROM THE MARK AS SHOWN.

FOR CHARITABLE FUNDRAISING SERVICES (U.S. CLS. 100, 101 AND 102).

FLORENTINA BLANDU, EXAMINING ATTORNEY

SN 78-962,433. CENTEX CORPORATION, DALLAS, TX. FILED 8-29-2006.



OWNER OF U.S. REG. NOS. 1,518,271, 2,555,845 AND OTHERS.

NO CLAIM IS MADE TO THE EXCLUSIVE RIGHT TO USE "PRICE" AND "HOME COST", APART FROM THE MARK AS SHOWN.

FOR REAL ESTATE PRICE GUARANTEE SERVICES (U.S. CLS. 100, 101 AND 102).

FIRST USE 6-25-2006; IN COMMERCE 6-25-2006.
STEVEN JACKSON, EXAMINING ATTORNEY

CLASS 36—(Continued).

SN 78-964,819. FIVE MILE CAPITAL PARTNERS LLC, STAMFORD, CT. FILED 8-31-2006.



THE COLOR(S) BLACK AND DARK ROYAL BLUE IS/ ARE CLAIMED AS A FEATURE OF THE MARK.

THE MARK CONSISTS OF THE TERM FIVE APPEARS IN BLACK UNDERLINED BY A DARK ROYAL BLUE LINE AND THE TERM MILE APPEARS IN BLACK BELOW THE DARK ROYAL BLUE LINE.

FOR INVESTMENT ADVISORY SERVICES (U.S. CLS. 100, 101 AND 102).

FIRST USE 2-0-2003; IN COMMERCE 2-0-2003.
KEVIN CORWIN, EXAMINING ATTORNEY

SN 78-965,055. INTERACTIVE BROKERS LLC, GREENWICH, CT. FILED 8-31-2006.

THE IB OPTIONS INTELLIGENCE REPORT

THE MARK CONSISTS OF STANDARD CHARACTERS WITHOUT CLAIM TO ANY PARTICULAR FONT, STYLE, SIZE, OR COLOR.

OWNER OF U.S. REG. NOS. 2,724,295 AND 3,045,411.

NO CLAIM IS MADE TO THE EXCLUSIVE RIGHT TO USE "OPTIONS INTELLIGENCE REPORT", APART FROM THE MARK AS SHOWN.

FOR FINANCIAL SERVICES, NAMELY REPORTING INFORMATION IN THE FIELD OF SECURITIES OPTIONS VIA THE INTERNET (U.S. CLS. 100, 101 AND 102).

FIRST USE 6-29-2006; IN COMMERCE 6-29-2006.
SUSAN LESLIE DUBOIS, EXAMINING ATTORNEY

CLASS 36—(Continued).

SN 78-966,186. BETTER CREDIT RESOURCES L.L.C., SUN-RISE, FL. FILED 9-1-2006.



NO CLAIM IS MADE TO THE EXCLUSIVE RIGHT TO USE "CREDIT", APART FROM THE MARK AS SHOWN.

THE MARK CONSISTS OF LETTERS BCR (WITH THE C IN FRONT OF A CIRCLE, WITH A SHADOW OF THE CIRCLE UNDER IT) THE WORDS BETTER CREDIT RESOURCES UNDERNEATH THE LETTERS & A SWOOSH DESIGN WITH AN ARROW POINT.

FOR BILL CONSOLIDATION SERVICES; COLLECTION OF DEBTS; CREDIT AND FINANCIAL CONSULTATION; CREDIT RECOVERY AND COLLECTION; DEBT MANAGEMENT CONSULTATION; FINANCIAL PLANNING CONSULTATION (U.S. CLS. 100, 101 AND 102).

RICHARD A. STRASER, EXAMINING ATTORNEY

CLASS 36—(Continued).

SN 78-968,257. WATERFIELD, J. RANDALL, IRVINE, CA. AND WATERFIELD, RICHARD R., IRVINE, CA. FILED 9-6-2006.



NO CLAIM IS MADE TO THE EXCLUSIVE RIGHT TO USE "CAPITAL", APART FROM THE MARK AS SHOWN.

THE MARK CONSISTS OF THE WORD WATERFIELD WITH THE WORD CAPITAL BELOW IT.

FOR INVESTMENT ADVICE; BANKING SERVICES; BANKING CONSULTATION; INVESTMENT MANAGEMENT, NAMELY, PUBLIC MARKET INVESTMENTS, PRIVATE EQUITY AND VENTURE CAPITAL INVESTMENTS; MORTGAGE BANKING (U.S. CLS. 100, 101 AND 102).

FIRST USE 1-1-1998; IN COMMERCE 1-1-1998.

ESTHER A. BORSUK, EXAMINING ATTORNEY

SN 78-969,221. MONEYGRAM INTERNATIONAL, INC., MINNEAPOLIS, MN. FILED 9-7-2006.

FORMFREE

THE MARK CONSISTS OF STANDARD CHARACTERS WITHOUT CLAIM TO ANY PARTICULAR FONT, STYLE, SIZE, OR COLOR.

SEC. 2(F).

FOR ELECTRONIC FUNDS TRANSFER AND BILL PAYMENT SERVICES (U.S. CLS. 100, 101 AND 102).

FIRST USE 5-31-2002; IN COMMERCE 5-31-2002.

RONALD MCMORROW, EXAMINING ATTORNEY

SN 78-968,194. WATERFIELD, J. RANDALL, IRVINE, CA. AND WATERFIELD, RICHARD R., IRVINE, CA. FILED 9-6-2006.



SN 78-970,514. PROJECT CC, LLC, LAS VEGAS, NV. FILED 9-8-2006.

VEER

THE MARK CONSISTS OF STANDARD CHARACTERS WITHOUT CLAIM TO ANY PARTICULAR FONT, STYLE, SIZE, OR COLOR.

NO CLAIM IS MADE TO THE EXCLUSIVE RIGHT TO USE "INVESTMENTS", APART FROM THE MARK AS SHOWN.

FOR INVESTMENT SERVICES, NAMELY ASSET ACQUISITION, DEVELOPMENT AND MANAGEMENT SERVICES (U.S. CLS. 100, 101 AND 102).

ESTHER A. BORSUK, EXAMINING ATTORNEY

THE MARK CONSISTS OF STANDARD CHARACTERS WITHOUT CLAIM TO ANY PARTICULAR FONT, STYLE, SIZE, OR COLOR.

FOR REAL ESTATE SERVICES, NAMELY, THE LISTING, LEASING, AND MANAGEMENT OF COMMERCIAL AND RESIDENTIAL PROPERTY; REAL ESTATE BROKERAGE; REAL ESTATE INVESTMENT (U.S. CLS. 100, 101 AND 102).

GEORGE LORENZO, EXAMINING ATTORNEY

CLASS 36—(Continued).

SN 78-971,009. ROAD RUNNERS CLUB OF AMERICA, COLUMBIA, MD. FILED 9-11-2006.

RRCA: GET MOVING GRANTS

THE MARK CONSISTS OF STANDARD CHARACTERS WITHOUT CLAIM TO ANY PARTICULAR FONT, STYLE, SIZE, OR COLOR.

NO CLAIM IS MADE TO THE EXCLUSIVE RIGHT TO USE "GRANTS", APART FROM THE MARK AS SHOWN.

FOR PROVIDING FINANCIAL ASSISTANCE THROUGH GRANTS TO RUNNING CLUBS AND EVENTS FOR USE IN DEVELOPMENT OR CONTINUATION OF BEGINNING RUNNING OR CHILDREN'S RUNNING PROGRAMS THROUGHOUT THE UNITED STATES (U.S. CLS. 100, 101 AND 102).

MORENO, PAUL, EXAMINING ATTORNEY

SN 78-974,333. ARMSTRONG, BEVERLY L., WASHINGTON, DC. FILED 9-14-2006.



NO CLAIM IS MADE TO THE EXCLUSIVE RIGHT TO USE "FOUNDATION INC.", APART FROM THE MARK AS SHOWN.

THE NAME AND PORTRAIT IN THE MARK DOES NOT IDENTIFY A LIVING INDIVIDUAL.

THE MARK CONSISTS OF A PICTURE OF AN INDIVIDUAL WITH STYLIZED TEXT OF THE WORDS "THE BESSIE COLEMAN FOUNDATION, INC. CONTINUING THE LEGACY"; THE WORDS SURROUND THE PICTURE IN THE SHAPE OF A CIRCLE.

FOR PROVIDING EDUCATIONAL SCHOLARSHIPS (U.S. CLS. 100, 101 AND 102).

FIRST USE 1-15-1995; IN COMMERCE 1-15-1995.
LINDA MICKLEBURGH, EXAMINING ATTORNEY

CLASS 36—(Continued).

SN 79-020,807. GMS ONLINE LIMITED, UNITED KINGDOM, FILED 12-23-2005.



OWNER OF INTERNATIONAL REGISTRATION 0876346 DATED 12-23-2005, EXPIRES 12-23-2015.

THE MARK CONSISTS OF TWO WORDS JOINED TOGETHER "INTER RETIRE". THE FIRST "R" IS ALSO PART OF A RAISED CAPITAL R FOR THE SECOND R IN THE NAME "INTERRETIRE".

FOR FINANCIAL SERVICES, NAMELY, AN INTERNATIONAL RETIREMENT SCHEME FEATURING A TOTAL PORTFOLIO OFFERING FOR HIGH NET WORTH CLIENTS CONSISTING OF BOTH SEPARATE ACCOUNTS AND MUTUAL FUNDS FOR EQUITY AND FIXED INTEREST INVESTMENTS, FINANCIAL TRUST OPERATIONS, FINANCIAL ANALYSIS AND CONSULTATION, FINANCIAL FORECASTING, FINANCIAL MANAGEMENT, FINANCIAL PLANNING, ADVICE RELATING TO INVESTMENTS, FUNDS INVESTMENT, INVESTMENT OF FUNDS FOR OTHERS, AND INVESTMENT SERVICES IN THE NATURE OF ASSET ACQUISITION, CONSULTATION, DEVELOPMENT AND MANAGEMENT SERVICES (U.S. CLS. 100, 101 AND 102).

JAY BESCH, EXAMINING ATTORNEY

SN 79-025,801. LABHA INVESTMENT ADVISORS SA, SWITZERLAND, FILED 5-18-2006.

ATYARTHA

THE MARK CONSISTS OF STANDARD CHARACTERS WITHOUT CLAIM TO ANY PARTICULAR FONT, STYLE, SIZE, OR COLOR.

PRIORITY DATE OF 11-24-2005 IS CLAIMED.

OWNER OF INTERNATIONAL REGISTRATION 0890180 DATED 5-18-2006, EXPIRES 5-18-2016.

FOR FINANCIAL SERVICES, NAMELY, MONEY LENDING, INVESTMENT FUND TRANSFER AND TRANSACTION SERVICES, ASSISTING OTHERS WITH THE COMPLETION OF FINANCIAL TRANSACTIONS FOR STOCKS, BONDS, SECURITIES AND EQUITIES, A TOTAL PORTFOLIO OFFERING FOR HIGH NET WORTH CLIENTS CONSISTING OF BOTH SEPARATE ACCOUNTS AND MUTUAL FUNDS FOR EQUITY AND FIXED INCOME INVESTMENTS, PROVIDING FOR THE EXCHANGE OF FOREIGN CURRENCY, COMMODITIES, FINANCIAL DERIVATIVES, INTEREST RATE PRODUCTS, AND EQUITIES VIA THE INTERNET AND INTRANET SYSTEMS, PROVIDING INFORMATION IN THE FIELDS OF FOREIGN CURRENCY, COMMODITIES, FINANCIAL DERIVATIVES, INTEREST RATE PRODUCTS, AND EQUITIES VIA THE INTERNET AND INTRANET SYSTEMS, MORTGAGE PLANNING; CREDIT AND FINANCIAL CONSULTATION; ELECTRONIC FINANCIAL SERVICE FOR THE PURCHASE OF SAVINGS BONDS; CASH AND FOREIGN EXCHANGE TRANSACTIONS; FINANCIAL ANALYSIS AND CONSULTATION; FINANCIAL CLEARING HOUSES; FINANCIAL EVALUATION FOR INSURANCE PURPOSES; FINANCIAL EXCHANGE AND FORECASTING; FINANCIAL GUARANTEE AND SURETY; FINANCIAL INFORMATION IN THE NATURE OF RATES OF EXCHANGE; FINANCIAL INFORMATION PROVIDED BY ELECTRONIC MEANS; FINANCIAL INFORMATION PROCESSING; FINANCIAL INVESTMENT IN THE FIELD OF STOCKS, SECURITIES; FINANCIAL PLAN-

CLASS 36—(Continued).

NING AND MANAGEMENT; FINANCIAL PORTFOLIO MANAGEMENT; FINANCIAL RESEARCH; FINANCIAL RISK MANAGEMENT; FINANCIAL SERVICES IN THE NATURE OF AN INVESTMENT SECURITY; FINANCIAL SERVICES IN THE FIELD OF MONEY LENDING; FINANCIAL SERVICES, NAMELY PROVIDING ON-LINE STORED VALUE ACCOUNTS IN AN ELECTRONIC ENVIRONMENT; FINANCIAL TRUST OPERATIONS; FINANCIAL VALUATION OF PERSONAL PROPERTY AND REAL ESTATE; ORGANIZATION OF STOCK EXCHANGES FOR THE BENEFIT OF THE TRADE OF STOCKS AND OTHER FINANCIAL VALUES; BANKING SERVICES; MONETARY EXCHANGE; CREDIT AGENCIES; CAPITAL INVESTMENT, NAMELY, CAPITAL INVESTMENT CONSULTATION, EQUITY CAPITAL INVESTMENT; CONSULTATION AND INVESTMENT ADVICE FOR PRIVATE CLIENTS AND INSTITUTIONS; BROKERAGE IN THE FIELD OF INSURANCE, STOCKS, COMMODITIES; FIDUCIARY REPRESENTATIVES; FUND INVESTMENT (U.S. CLS. 100, 101 AND 102).

ALYSSA PALADINO, EXAMINING ATTORNEY

SN 79-032,301. SKANDINAVISKA ENSKILDA BANKEN AB, SE-106 40 STOCKHOLM, SWEDEN, FILED 11-10-2006.

SEB BANK

PRIORITY DATE OF 9-22-2006 IS CLAIMED.
OWNER OF INTERNATIONAL REGISTRATION 0906966 DATED 11-10-2006, EXPIRES 11-10-2016.
OWNER OF U.S. REG. NOS. 2,643,199, 2,643,222 AND 3,133,408.

NO CLAIM IS MADE TO THE EXCLUSIVE RIGHT TO USE "BANK", APART FROM THE MARK AS SHOWN.

FOR INSURANCE BROKERAGE; FINANCIAL AFFAIRS, NAMELY, FINANCIAL CONSULTATION; MONETARY AFFAIRS, NAMELY, MONETARY EXCHANGE; REAL ESTATE BROKERAGE; FINANCIAL ANALYSIS; BANKING; INVESTMENT BROKERAGE; EQUITY CAPITAL INVESTMENTS; FINANCIAL CLEARING; FINANCIAL CLEARING-HOUSES; COLLECTION AGENCIES; FINANCIAL CONSULTANCY; INSURANCE CONSULTANCY; DEBT COLLECTION AGENCIES; REAL ESTATE MANAGEMENT; EXCHANGING MONEY; FACTORING AGENCY; FIDUCIARY REPRESENTATIVES; FINANCIAL EVALUATION FOR INSURANCE PURPOSES; FINANCIAL MANAGEMENT; FINANCING SERVICES; FIRE INSURANCE UNDERWRITING; FUND INVESTMENTS; GUARANTEE ASSURANCE UNDERWRITING; HEALTH INSURANCE UNDERWRITING; INSTALLMENT LOANS; INSURANCE BROKERAGE; PROVIDING INSURANCE INFORMATION; ISSUANCE OF CREDIT CARDS; ISSUING OF TRAVELERS' CHECKS; LEASE-PURCHASE FINANCING; LEASING OF REAL ESTATE; LENDING AGAINST SECURITY, NAMELY, PROVIDING LOANS SECURED BY COMMERCIAL PAPER; LIFE INSURANCE UNDERWRITING; LOANS FINANCING; MORTGAGE BANKING; MUTUAL FUND BROKERAGE; REAL ESTATE APPRAISAL; SAFE DEPOSIT SERVICES; SAVINGS BANKS; STOCK EXCHANGE QUOTATIONS; TRUSTEESHIP REPRESENTATIVES; DEPOSITS OF VALUABLES, NAMELY, SAFE DEPOSIT BOX SERVICES FOR VALUABLES; FISCAL VALUATIONS; HOME BANKING; ELECTRONIC BANKING (U.S. CLS. 100, 101 AND 102).

JENNIFER VASQUEZ, EXAMINING ATTORNEY

CLASS 37—CONSTRUCTION AND REPAIR

SN 76-100,241. CALSPER DEVELOPMENTS INC., VAUGHAN, ONTARIO L4K 1Y2, CANADA, FILED 8-1-2000.



PRIORITY CLAIMED UNDER SEC. 44(D) ON CANADA APPLICATION NO. 1,045,604, FILED 2-4-2000, REG. NO. TMA686,530, DATED 4-25-2007, EXPIRES 4-25-2022.

NO CLAIM IS MADE TO THE EXCLUSIVE RIGHT TO USE "GROUP", APART FROM THE MARK AS SHOWN.

COLOR IS NOT CLAIMED AS A FEATURE OF THE MARK.

THE MARK CONSISTS OF THE WORD REMINGTON IN A RECTANGLE AND A HORSESHOE, ALTOGETHER IN A BOX. ANY SHADING IS A FEATURE OF THE MARK AND DOES NOT INDICATE COLOR.

FOR REAL ESTATE DEVELOPMENT, CONSTRUCTION, MAINTENANCE AND REPAIR SERVICES, FOR RESIDENTIAL, COMMERCIAL AND INDUSTRIAL PROPERTIES AND REAL ESTATE PROJECTS (U.S. CLS. 100, 103 AND 106).

DORITT L. CARROLL, EXAMINING ATTORNEY

SN 76-667,451. BICYCLE CITY, LLC, CINCINNATI, OH, FILED 10-12-2006.

CIUDAD DE LA BICICLETA

THE MARK CONSISTS OF STANDARD CHARACTERS WITHOUT CLAIM TO ANY PARTICULAR FONT, STYLE, SIZE, OR COLOR.

"THE FOREIGN WORDING IN THE MARK TRANSLATES INTO ENGLISH AS BICYCLE CITY."

FOR PROVIDING A WEBSITE IN THE FIELD OF PLANNING AND LAYING OUT OF ENVIRONMENTALLY-FRIENDLY RESIDENTIAL AND COMMERCIAL PLANNED COMMUNITIES (U.S. CLS. 100, 103 AND 106).

DANIEL BRODY, EXAMINING ATTORNEY

SN 76-667,915. OWLS HEAD DEVELOPMENT, LLC, ATLANTA, GA, FILED 10-23-2006.

COASTAL INLAND HEIGHTS

THE MARK CONSISTS OF STANDARD CHARACTERS WITHOUT CLAIM TO ANY PARTICULAR FONT, STYLE, SIZE, OR COLOR.

NO CLAIM IS MADE TO THE EXCLUSIVE RIGHT TO USE "COASTAL", APART FROM THE MARK AS SHOWN.

FOR REAL ESTATE DEVELOPMENT SERVICES (U.S. CLS. 100, 103 AND 106).

FIRST USE 11-25-2005; IN COMMERCE 11-25-2005.

DAVID HOFFMAN, EXAMINING ATTORNEY

CLASS 37—(Continued).

SN 76-667,916. OWLS HEAD DEVELOPMENT, LLC, ATLANTA, GA. FILED 10-23-2006.

COASTAL *Inland* HEIGHTS

NO CLAIM IS MADE TO THE EXCLUSIVE RIGHT TO USE "COASTAL", APART FROM THE MARK AS SHOWN.
FOR REAL ESTATE DEVELOPMENT SERVICES (U.S. CLS. 100, 103 AND 106).
FIRST USE 11-25-2005; IN COMMERCE 11-25-2005.
DAVID HOFFMAN, EXAMINING ATTORNEY

SN 76-670,369. WINDOW-FIX, INC., BROOKLYN, NY. FILED 12-15-2006.

WINDOW-FIX 

NO CLAIM IS MADE TO THE EXCLUSIVE RIGHT TO USE "WINDOW-FIX", APART FROM THE MARK AS SHOWN.
FOR REPAIRING, REPLACING AND INSTALLING WINDOWS AND WINDOW GLASS IN BUILDINGS (U.S. CLS. 100, 103 AND 106).
FIRST USE 8-0-2004; IN COMMERCE 8-0-2004.
PAUL F. GAST, EXAMINING ATTORNEY

SN 77-000,767. ONTARIO AUTO MANAGEMENT INC., HAMILTON, ONTARIO, CANADA, FILED 9-15-2006.

A BANG UP JOB! EVERYTIME

THE MARK CONSISTS OF STANDARD CHARACTERS WITHOUT CLAIM TO ANY PARTICULAR FONT, STYLE, SIZE, OR COLOR.
PRIORITY CLAIMED UNDER SEC. 44(D) ON CANADA APPLICATION NO. 1294208, FILED 3-17-2006, REG. NO. TMA683392, DATED 3-9-2007, EXPIRES 3-9-2022.
FOR COLLISION REPAIR AND RESTORATION SERVICES FOR VEHICLES (U.S. CLS. 100, 103 AND 106).
JAMES MACFARLANE, EXAMINING ATTORNEY

SN 77-003,583. URBISTRUCT, LLC, PHOENIX, AZ. FILED 9-20-2006.

G R E E N R O O F

NO CLAIM IS MADE TO THE EXCLUSIVE RIGHT TO USE "GREEN ROOF", APART FROM THE MARK AS SHOWN.
THE MARK CONSISTS OF WHITE LETTERS WITHIN 8 BLACK SQUARES AND 1 GRAY CIRCLE.
FOR REAL ESTATE DEVELOPMENT (U.S. CLS. 100, 103 AND 106).
SALLY SHIH, EXAMINING ATTORNEY

CLASS 37—(Continued).

SN 77-047,282. PAVER SAVER CO., LUTZ, FL. FILED 11-18-2006.



NO CLAIM IS MADE TO THE EXCLUSIVE RIGHT TO USE "SYSTEM" AND "SEALING", APART FROM THE MARK AS SHOWN.

THE COLOR(S) ORANGE, BLACK, WHITE IS/ARE CLAIMED AS A FEATURE OF THE MARK.

THE SEAL DESIGN IN THE MARK APPEARS IN THE COLORS ORANGE AND WHITE, WITH A WHITE HEAD, AND ORANGE TO WHITE COLOR TRANSITION FROM THE BLACK TIP OF THE SEALS REAR FLIPPER TO FULL ORANGE OF THE SEAL'S LOWER BODY TO THE SEAL'S WHITE HEAD. A BLACK LINE OUTLINES THE SHAPE OF THE SEAL. THE LETTERING "SEAL" "LOCK" AND "INNOVATING THE FUTURE OF SEALING" IN THE MARK APPEARS IN THE COLOR BLACK, THE LETTERING "N" APPEARS IN THE COLOR ORANGE AND THE LETTERING "SYSTEM" APPEARS IN THE COLOR WHITE. THE WORDS SEAL 'N LOCK ARE UNDERLINED BY A HORIZONTAL BLACK LINE AND IS UNDERLINED BY A WIDER HORIZONTAL ORANGE STRIPE.

FOR PAVEMENT SEALING (U.S. CLS. 100, 103 AND 106).
GEORGIA CARTY, EXAMINING ATTORNEY

SN 77-064,596. SIGNATURE FLIGHT SUPPORT CORPORATION, ORLANDO, FL. FILED 12-14-2006.

FUEL UP

NO CLAIM IS MADE TO THE EXCLUSIVE RIGHT TO USE "FUEL", APART FROM THE MARK AS SHOWN.
FOR AVIATION FUELING SERVICES FOR CORPORATE AND GENERAL AVIATION AIRCRAFT (U.S. CLS. 100, 103 AND 106).
NAAKWAMA ANKRAH, EXAMINING ATTORNEY

CLASS 37—(Continued).

SN 77-065,135. BRADLEY AVIONICS, ENFIELD, CT. FILED 12-15-2006.

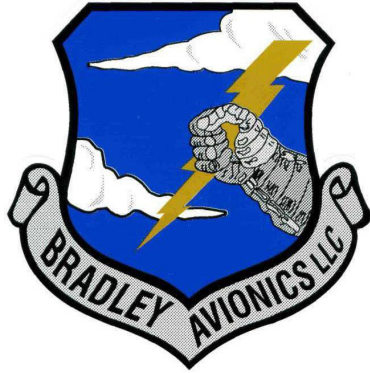

OWNER OF U.S. REG. NO. 3,218,581.
NO CLAIM IS MADE TO THE EXCLUSIVE RIGHT TO USE "AVIONICS LLC", APART FROM THE MARK AS SHOWN.

THE COLOR(S) BLUE, WHITE, GRAY, GOLD, AND BLACK IS/ARE CLAIMED AS A FEATURE OF THE MARK.

THE MARK CONSISTS OF THE COLOR BLUE APPEARS IN THE SKY PORTION OF THE SHIELD, THE COLOR WHITE APPEARS IN THE CLOUD PORTION OF THE SHIELD, THE COLOR GRAY APPEARS IN THE ARM WITHIN THE SHIELD AND THE BANNER BELOW THE SHIELD, THE COLOR GOLD APPEARS IN THE LIGHTNING BOLT WITHIN THE SHIELD, AND THE COLOR BLACK APPEARS IN THE OUTLINE OF THE ENTIRE DESIGN AND IN THE WORDING BRADLEY AVIONICS LLC.

FOR AVIONICS SERVICES, NAMELY, REPAIR, REBUILD, OVERHAUL, MODIFICATION AND/OR ALTERATION OF AIRCRAFT AND AIRCRAFT AIRFRAMES AND AIRCRAFT POWERPLANTS (U.S. CLS. 100, 103 AND 106).

FIRST USE 11-8-2006; IN COMMERCE 11-8-2006.
JOANNA DUKOVIC, EXAMINING ATTORNEY

CLASS 37—(Continued).

SN 77-073,302. JAMIESONS', INC., TOLEDO, OH. FILED 12-29-2006.

HEAR. SEE. BELIEVE.

THE MARK CONSISTS OF STANDARD CHARACTERS WITHOUT CLAIM TO ANY PARTICULAR FONT, STYLE, SIZE, OR COLOR.

FOR INSTALLATION OF AUDIO, VIDEO, AND HOME THEATER PRODUCTS AND SYSTEMS (U.S. CLS. 100, 103 AND 106).

FIRST USE 1-1-2006; IN COMMERCE 1-1-2006.
WENDY JUN, EXAMINING ATTORNEY

SN 77-068,310. MR. SWIRL PLUMBING & DRAIN CLEANING INC., PORT COQUITLAM, BRITISH COLUMBIA, CANADA, FILED 12-20-2006.



OWNER OF CANADA REG. NO. TMA668,513, DATED 7-24-2006, EXPIRES 7-24-2021.

NO CLAIM IS MADE TO THE EXCLUSIVE RIGHT TO USE "PLUMBING", APART FROM THE MARK AS SHOWN.

THE NAME SHOWN IN THE MARK DOES NOT IDENTIFY A PARTICULAR LIVING INDIVIDUAL.

THE MARK CONSISTS OF THE DESIGN OF A RUNNING MAN CARRYING A PLUNGER AND TOOL BOX.

FOR RESIDENTIAL AND COMMERCIAL PLUMBING AND DRAIN CLEANING SERVICES (U.S. CLS. 100, 103 AND 106).

ELLEN PERKINS, EXAMINING ATTORNEY

SN 77-075,516. LANGESLAG, JACOB, FARIBAULT, MN. FILED 1-3-2007.



NO CLAIM IS MADE TO THE EXCLUSIVE RIGHT TO USE "AQUA", APART FROM THE MARK AS SHOWN.

FOR CONSTRUCTION AND INSTALLATION OF PONDS, WATER GARDENS, FOUNTAINS, AND WATERSCAPES (U.S. CLS. 100, 103 AND 106).

FIRST USE 12-0-2006; IN COMMERCE 12-0-2006.
SCOTT BIBB, EXAMINING ATTORNEY

CLASS 37—(Continued).

SN 77-077,130. LANGFANG CANGFENG INDUSTRIAL & TRADE LTD., YONGQING, HEBEI, CHINA, FILED 1-5-2007.

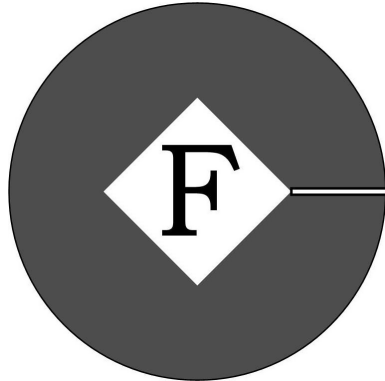

THE COLOR(S) WHITE, BLACK AND GREY IS/ARE CLAIMED AS A FEATURE OF THE MARK.
 THE MARK CONSISTS OF A STYLIZED LETTER C WITH DARKER BLACK FRAME. A BLACK LETTER F INSIDE WHITE SQUARE. REST ARE GREY.
 FOR ROAD STRIPPING (U.S. CLS. 100, 103 AND 106).
 JUSTINE D. PARKER, EXAMINING ATTORNEY

SN 77-084,829. HOLMANDER R.A. & CO., SOUTH BERWICK, ME. FILED 1-17-2007.

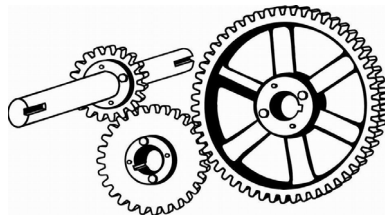

FOR MACHINERY MAINTENANCE AND REPAIR;
 REPAIR OR MAINTENANCE OF MACHINES AND APPARATUS FOR PROCESSING FOODS OR BEVERAGES (U.S. CLS. 100, 103 AND 106).
 FIRST USE 10-1-1997; IN COMMERCE 10-1-1997.
 JORDAN BAKER, EXAMINING ATTORNEY

CLASS 37—(Continued).

SN 77-085,426. THE MCKERNON GROUP, INC., BRANDON, VT. FILED 1-18-2007.



THE MARK CONSISTS OF FLYING SAUCER DIVIDED IN HALF HORIZONTALLY WITH "UFO" IN THE SPACE BETWEEN THE TWO HALVES.
 FOR INSTALLATION OF INSULATING MATERIALS (U.S. CLS. 100, 103 AND 106).
 FIRST USE 1-1-1975; IN COMMERCE 6-1-1975.
 INGRID C. EULIN, EXAMINING ATTORNEY

SN 77-100,946. BUBBA DUMP, INC., BAKERSFIELD, CA. FILED 2-6-2007.

BUBBA DUMP

THE MARK CONSISTS OF STANDARD CHARACTERS WITHOUT CLAIM TO ANY PARTICULAR FONT, STYLE, SIZE, OR COLOR.
 NO CLAIM IS MADE TO THE EXCLUSIVE RIGHT TO USE "DUMP", APART FROM THE MARK AS SHOWN.
 FOR WASTE DISPOSAL SERVICES (U.S. CLS. 100, 103 AND 106).
 FIRST USE 6-9-2006; IN COMMERCE 6-9-2006.
 EUGENIA MARTIN, EXAMINING ATTORNEY

SN 77-124,738. AUTO RECONDITIONING ENTERPRISES INC., SAN DIEGO, CA. FILED 3-7-2007.

Simply Dents

THE MARK CONSISTS OF STANDARD CHARACTERS WITHOUT CLAIM TO ANY PARTICULAR FONT, STYLE, SIZE, OR COLOR.
 NO CLAIM IS MADE TO THE EXCLUSIVE RIGHT TO USE "DENTS", APART FROM THE MARK AS SHOWN.
 FOR AUTOMOBILE BODY REPAIR AND BUMPER REPAIRS; AUTOMOBILE BODY REPAIRS (U.S. CLS. 100, 103 AND 106).
 KYLE PEETE, EXAMINING ATTORNEY

CLASS 37—(Continued).

SN 77-129,353. COX, ANTHONY B., WADSWORTH, IL. FILED 3-13-2007.



THE COLOR(S) TAN, BEIGE, BROWN, GREEN, PURPLE AND WHITE IS/ARE CLAIMED AS A FEATURE OF THE MARK.

THE COLOR BROWN APPEARS IN THE LETTERING FOR THE WORDS "GEARS" AND "GRINDS" AS WELL AS IN THE GEAR DESIGN ELEMENT OF THE MARK; THE COLOR TAN APPEARS IN THE GEAR DESIGN ELEMENT OF THE MARK AS WELL AS IN THE COFFEE BEAN DESIGN ELEMENT OF THE MARK, WHICH IS BEHIND THE LETTER "I" IN THE WORD "GRIND;" THE COLOR BEIGE APPEARS IN THE GEAR DESIGN ELEMENT OF THE MARK; THE COLOR GREEN APPEARS IN THE WORD "AND;" THE COLOR PURPLE APPEARS IN THE GEAR DESIGN ELEMENT OF THE MARK; AND THE COLOR WHITE APPEARS AS THE BACKGROUND FOR THE MARK.

FOR INSTALLATION, MAINTENANCE AND REPAIR OF AUTOMOBILE TIRES AND BATTERIES (U.S. CLS. 100, 103 AND 106).

NICHOLAS ALTREE, EXAMINING ATTORNEY

CLASS 37—(Continued).

SN 77-135,311. JMY INC., PHOENIX, AZ. FILED 3-20-2007.



SN 77-131,377. CONVEYERED AGGREGATE DELIVERY, INC., MEDFORD, OR. FILED 3-14-2007.

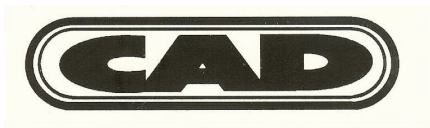

OWNER OF U.S. REG. NO. 2,537,988.

THE MARK CONSISTS OF THE LETTERS CAD SURROUNDED BY A THIN OVAL LINE, WHICH IS SURROUNDED BY A SECOND, WIDER OVAL LINE.

FOR CONSTRUCTION SERVICES FOR OTHERS ENGAGED IN ROAD CONSTRUCTION AND HOMEBUILDING, NAMELY, PLACING PARTICULATE MATERIALS WITH A VEHICLE MOUNTED CONVEYOR BELT (U.S. CLS. 100, 103 AND 106).

FIRST USE 8-0-1994; IN COMMERCE 12-0-1994.

STEVEN PEREZ, EXAMINING ATTORNEY

NO CLAIM IS MADE TO THE EXCLUSIVE RIGHT TO USE "CONCRETE COATINGS", APART FROM THE MARK AS SHOWN.

THE MARK CONSISTS OF STYLIZED DIAMOND WITH THE LITERAL ELEMENT "YEZCO CONCRETE COATINGS" SUPERIMPOSED UPON THE STYLIZED DIAMOND.

FOR INSTALLATION OF COMMERCIAL AND RESIDENTIAL FLOOR COATINGS, ACID STAIN AND CONCRETE POLISHING (U.S. CLS. 100, 103 AND 106).

MARGERY A. TIERNEY, EXAMINING ATTORNEY

CLASS 37—(Continued).

SN 77-137,008. DAVID LACK, SANTA BARBARA, CA. FILED 3-21-2007.

CLASS 37—(Continued).

SN 77-137,253. CADRE COMMUNICATIONS, INC., LAKE VILLA, IL. FILED 3-22-2007.

Sights & Sounds



THE MARK CONSISTS OF STANDARD CHARACTERS WITHOUT CLAIM TO ANY PARTICULAR FONT, STYLE, SIZE, OR COLOR.

FOR ANTENNA INSTALLATION AND REPAIR; COMPUTER INSTALLATION AND REPAIR; ELECTRICAL REPAIRS AND INSTALLATION OF RESIDENTIAL AND COMMERCIAL AUDIO, VISUAL, TELEPHONE, INTERCOM AND COMPUTER WIRING; INSTALLATION AND MAINTENANCE OF BURGLAR AND/OR FIRE ALARMS; INSTALLATION OF COMPUTER NETWORKS; INSTALLATION OF HOME THEATRES AND RELATED STRUCTURED WIRING; INSTALLATION OF SECURITY SYSTEM; INSTALLATION OF TELEPHONE LINES; SATELLITE DISH INSTALLATION AND REPAIR; TELECOMMUNICATION WIRING (U.S. CLS. 100, 103 AND 106).

JENNIFER KRISP, EXAMINING ATTORNEY

NO CLAIM IS MADE TO THE EXCLUSIVE RIGHT TO USE "CONSTRUCTION", APART FROM THE MARK AS SHOWN.

THE COLOR(S) BLUE, GREEN AND BEIGE IS/ARE CLAIMED AS A FEATURE OF THE MARK.

THE MARK CONSISTS OF A SQUARE BOX WHICH CONTAINS A SHAPE OF A BLUE L, A REPRESENTATION OF A WHITE BUILDING, A SHAPE OF AN UPSIDE DOWN BEIGE L, AND THE WORD LACK IN BLUE OVER THE WORD CONSTRUCTION IN GREEN.

FOR HOUSE BUILDING AND REPAIR; HOUSING SERVICES, NAMELY, DEVELOPMENT OF REAL PROPERTY, NAMELY, REPAIR, IMPROVEMENT, AND NEW CONSTRUCTION; HOUSING SERVICES, NAMELY, REPAIR, IMPROVEMENT, AND CONSTRUCTION OF RESIDENTIAL REAL PROPERTY; BUILDING CONSTRUCTION AND REPAIR; CONSTRUCTION AND RENOVATION OF BUILDINGS; CONSTRUCTION AND REPAIR OF BUILDINGS; CONSTRUCTION CONSULTATION; CONSTRUCTION MANAGEMENT; CONSTRUCTION PLANNING; CONSTRUCTION SERVICES, NAMELY, PLANNING, LAYING OUT AND CUSTOM CONSTRUCTION OF RESIDENTIAL AND COMMERCIAL COMMUNITIES; CONSTRUCTION SUPERVISION; CONSTRUCTION, MAINTENANCE AND RENOVATION OF PROPERTY; CONSULTATION IN BUILDING CONSTRUCTION SUPERVISION; CUSTOM CONSTRUCTION AND BUILDING RENOVATION; CUSTOM CONSTRUCTION OF HOMES; GENERAL CONSTRUCTION CONTRACTING; RESIDENTIAL AND COMMERCIAL BUILDING CONSTRUCTION (U.S. CLS. 100, 103 AND 106).

FIRST USE 4-28-2006; IN COMMERCE 4-28-2006.
CAROLINE WOOD, EXAMINING ATTORNEY

SN 77-137,357. HULETT ENVIRONMENTAL SERVICES, INC., WEST PALM BEACH, FL. FILED 3-22-2007.



NO CLAIM IS MADE TO THE EXCLUSIVE RIGHT TO USE "PEST PREVENTION", APART FROM THE MARK AS SHOWN.

THE MARK CONSISTS OF A PORTION OF A HOUSE, WITH THE WORDING "HEALTHY HOME PEST PREVENTION" BELOW THE HOUSE.

FOR ENVIRONMENTAL SERVICES, NAMELY, PEST CONTROL SERVICES (U.S. CLS. 100, 103 AND 106).

FIRST USE 3-1-2007; IN COMMERCE 3-1-2007.
MARIAM MAHMOUDI, EXAMINING ATTORNEY

CLASS 37—(Continued).

SN 77-137,766. DAVIS, BRAD, GILBERT, AZ. FILED 3-22-2007.



NO CLAIM IS MADE TO THE EXCLUSIVE RIGHT TO USE "MOBILE FORCE REFUELING", APART FROM THE MARK AS SHOWN.

FOR FUELING SERVICES FOR MOTOR VEHICLES (U.S. CLS. 100, 103 AND 106).

FIRST USE 2-15-2000; IN COMMERCE 2-15-2003.
BARNEY CHARLON, EXAMINING ATTORNEY

SN 77-138,059. TOLEDO BUILDING SERVICES CO., TOLEDO, OH. FILED 3-22-2007.

Serious Service

THE MARK CONSISTS OF STANDARD CHARACTERS WITHOUT CLAIM TO ANY PARTICULAR FONT, STYLE, SIZE, OR COLOR.

NO CLAIM IS MADE TO THE EXCLUSIVE RIGHT TO USE "SERVICE", APART FROM THE MARK AS SHOWN.

FOR COMMERCIAL AND RESIDENTIAL BUILDING MAINTENANCE SERVICES (U.S. CLS. 100, 103 AND 106).

GINA HAYES, EXAMINING ATTORNEY

SN 77-138,171. STING SURVEILLANCE, LLC, HENDERSON, NV. FILED 3-22-2007.

STING SURVEILLANCE

THE MARK CONSISTS OF STANDARD CHARACTERS WITHOUT CLAIM TO ANY PARTICULAR FONT, STYLE, SIZE, OR COLOR.

NO CLAIM IS MADE TO THE EXCLUSIVE RIGHT TO USE "SURVEILLANCE", APART FROM THE MARK AS SHOWN.

FOR INSTALLATION OF SECURITY SYSTEM (U.S. CLS. 100, 103 AND 106).

FIRST USE 2-26-2003; IN COMMERCE 2-26-2003.
RENEE SERVANCE, EXAMINING ATTORNEY

CLASS 37—(Continued).

SN 77-138,276. L1 SERVICES LLC, RICHARDSON, TX. FILED 3-22-2007.

VYSANT

THE MARK CONSISTS OF STANDARD CHARACTERS WITHOUT CLAIM TO ANY PARTICULAR FONT, STYLE, SIZE, OR COLOR.

FOR INSTALLATION, MAINTENANCE AND REPAIR OF TELEPHONE SYSTEMS (U.S. CLS. 100, 103 AND 106).
GENE MACIOL, EXAMINING ATTORNEY

SN 77-138,422. COGUN, INC., NORTH LIMA, OH. FILED 3-23-2007.

COGUN

THE MARK CONSISTS OF STANDARD CHARACTERS WITHOUT CLAIM TO ANY PARTICULAR FONT, STYLE, SIZE, OR COLOR.

OWNER OF U.S. REG. NOS. 1,573,854, 2,747,052 AND 2,750,186.

FOR CONSTRUCTION OF CHURCHES (U.S. CLS. 100, 103 AND 106).

FIRST USE 1-3-1971; IN COMMERCE 1-3-1971.
MARTHA FROMM, EXAMINING ATTORNEY

SN 77-138,505. YORK RESIDENTIAL, LLC, ATLANTA, GA. FILED 3-23-2007.

YORK RESIDENTIAL

THE MARK CONSISTS OF STANDARD CHARACTERS WITHOUT CLAIM TO ANY PARTICULAR FONT, STYLE, SIZE, OR COLOR.

NO CLAIM IS MADE TO THE EXCLUSIVE RIGHT TO USE RESIDENTIAL, APART FROM THE MARK AS SHOWN.

FOR REAL ESTATE DEVELOPMENT (U.S. CLS. 100, 103 AND 106).

FIRST USE 12-17-2004; IN COMMERCE 12-17-2004.
LINDSEY RUBIN, EXAMINING ATTORNEY

CLASS 37—(Continued).

SN 77-138,630. ARTESON ENTERPRISES INC., DAVIE, FL. FILED 3-23-2007.

ROOFMD

THE MARK CONSISTS OF STANDARD CHARACTERS WITHOUT CLAIM TO ANY PARTICULAR FONT, STYLE, SIZE, OR COLOR.
FOR MAINTENANCE AND/OR REPAIR OF ROOFS; RESTORATION IN THE FIELD OF ROOFS (U.S. CLS. 100, 103 AND 106).
STEVEN R. FINE, EXAMINING ATTORNEY

SN 77-138,976. RODGERSHARDIN, LLC, ATLANTA, GA. FILED 3-23-2007.

RODGERSHARDIN

THE MARK CONSISTS OF STANDARD CHARACTERS WITHOUT CLAIM TO ANY PARTICULAR FONT, STYLE, SIZE, OR COLOR.
FOR BUILDING CONSTRUCTION AND REPAIR (U.S. CLS. 100, 103 AND 106).
FIRST USE 6-13-1996; IN COMMERCE 6-13-1996.
REBECCA EISINGER, EXAMINING ATTORNEY

SN 77-139,053. RODGERSHARDIN, LLC, ATLANTA, GA. FILED 3-23-2007.



THE MARK CONSISTS OF HR.
FOR BUILDING CONSTRUCTION AND REPAIR (U.S. CLS. 100, 103 AND 106).
FIRST USE 12-1-2004; IN COMMERCE 12-1-2004.
REBECCA EISINGER, EXAMINING ATTORNEY

CLASS 37—(Continued).

SN 77-139,157. RARCCIM, LLC, SACRAMENTO, CA. FILED 3-23-2007.

BOBCAT'S ZIP WASH

THE MARK CONSISTS OF STANDARD CHARACTERS WITHOUT CLAIM TO ANY PARTICULAR FONT, STYLE, SIZE, OR COLOR.
NO CLAIM IS MADE TO THE EXCLUSIVE RIGHT TO USE "WASH", APART FROM THE MARK AS SHOWN.
FOR AUTOMOBILE WASHING (U.S. CLS. 100, 103 AND 106).
APRIL ROACH, EXAMINING ATTORNEY

SN 77-139,679. JLP AVIATION MAINTENANCE LLC, KISSIMMEE, FL. FILED 3-25-2007.



NO CLAIM IS MADE TO THE EXCLUSIVE RIGHT TO USE "AVIATION MAINTENANCE", APART FROM THE MARK AS SHOWN.
THE COLOR(S) BLUE, SILVER AND WHITE IS/ARE CLAIMED AS A FEATURE OF THE MARK.
THE MARK CONSISTS OF THREE EVENLY INTERLACED SILVER RINGS OUTLINED IN BLUE, CONTAINING THE BLUE LETTERS J, L, P INSIDE EACH RING THE THREE RINGS ARE ENCLOSED IN A SILVER CIRCLE WITH BLUE OUTLINING, WHICH CONTAINS THE BLUE WORDS AVIATION MAINTENANCE WRAPPED AROUND THE RINGS INSIDE THE CIRCLE. OUTSIDE THE RINGS TO THE LEFT AND RIGHT ARE SILVER AND BLUE OUTLINED WINGS, WITH THE UPPER FEATHERS LARGER GETTING SMALLER TOWARDS THE BOTTOM.
FOR AIRCRAFT MAINTENANCE OR REPAIR (U.S. CLS. 100, 103 AND 106).
FIRST USE 3-23-2007; IN COMMERCE 3-23-2007.
CHRISTINA SOBRAL, EXAMINING ATTORNEY

CLASS 37—(Continued).

SN 77-140,046. SETRA SYSTEMS, INC., BOXBOROUGH, MA.
FILED 3-26-2007.

SETRA

THE MARK CONSISTS OF STANDARD CHARACTERS WITHOUT CLAIM TO ANY PARTICULAR FONT, STYLE, SIZE, OR COLOR.

FOR REPAIR AND MAINTENANCE OF SENSORS MEASURING GAS AND LIQUID PRESSURES, PRESSURE SENSING DEVICES, PRESSURE TRANSDUCERS, PRESSURE MEASUREMENT DEVICES, ACCELERATION AND WEIGHT SENSING DEVICES, DIGITAL DISPLAYS, METERS, MANOMETERS, WEIGHING SYSTEMS, AND WEIGHING EQUIPMENT, NAMELY, SCALES AND BALANCES (U.S. CLS. 100, 103 AND 106).
FIRST USE 3-0-1972; IN COMMERCE 3-0-1972.

PAMELA HIRSCHMAN, EXAMINING ATTORNEY

SN 77-140,188. MYERS, JOHN E., ANCHORAGE, AK. FILED
3-26-2007.

AAUTO

THE MARK CONSISTS OF STANDARD CHARACTERS WITHOUT CLAIM TO ANY PARTICULAR FONT, STYLE, SIZE, OR COLOR.

FOR AUTOMOBILE LUBRICATION; VEHICLE LUBRICATION (U.S. CLS. 100, 103 AND 106).
ELLEN B. AWRICH, EXAMINING ATTORNEY

SN 77-140,539. WATERWAYS JOINT VENTURE IV, NAPLES,
FL. FILED 3-26-2007.



NO CLAIM IS MADE TO THE EXCLUSIVE RIGHT TO USE "WATERWAYS HOMES", APART FROM THE MARK AS SHOWN.

THE COLOR(S) RED, ORANGE AND YELLOW IS/ARE CLAIMED AS A FEATURE OF THE MARK.

THE MARK CONSISTS OF THE WORD WATERWAYS HOMES WITH A LARGE STYLIZED "W" IN THE MIDDLE OF THE MARK WITH TWO STYLIZED WAVY LINES

CLASS 37—(Continued).

JUXTPOSED THROUGH THE "W" WITH THE WORD WATERWAYS WRITTEN IN ALL CAPITAL LETTERS TO THE LEFT OF THE "W" AND BELOW THE TWO STYLIZED WAVY LINES AND THE WORD HOMES WRITTEN IN ALL CAPITAL LETTERS TO THE RIGHT OF THE "W" AND ABOVE THE TWO STYLIZED WAVY LINES. THE TOP OF THE MARK IS A YELLOW COLOR, WHICH IS BLENDED INTO AN ORANGE COLOR IN THE MIDDLE OF THE MARK WHICH IS THEN BLENDED INTO A RED COLOR AT THE BOTTOM OF THE MARK.

FOR CONSTRUCTION OF SINGLE FAMILY AND MULTIPLE FAMILY DWELLING UNITS; CONSTRUCTION SERVICES, NAMELY, PLANNING, LAYING OUT AND CUSTOM CONSTRUCTION OF RESIDENTIAL AND COMMERCIAL COMMUNITIES; REAL ESTATE DEVELOPMENT (U.S. CLS. 100, 103 AND 106).
FIRST USE 1-15-2007; IN COMMERCE 1-15-2007.

JENNIFER KRISP, EXAMINING ATTORNEY

SN 77-141,661. WYNDHAM HOMES, INC., BREWSTER, NY.
FILED 3-27-2007.

IT'S YOUR CHOICE

THE MARK CONSISTS OF STANDARD CHARACTERS WITHOUT CLAIM TO ANY PARTICULAR FONT, STYLE, SIZE, OR COLOR.

FOR LAND DEVELOPMENT SERVICES, NAMELY, PLANNING AND LAYING OUT OF RESIDENTIAL AND/OR COMMERCIAL COMMUNITIES; RESIDENTIAL AND COMMERCIAL BUILDING CONSTRUCTION (U.S. CLS. 100, 103 AND 106).
JULIE GUTTADAURO, EXAMINING ATTORNEY

SN 77-141,818. ETHIX MEDIA, LLC, SCOTTSDALE, AZ.
FILED 3-27-2007.

Homeminder

THE MARK CONSISTS OF STANDARD CHARACTERS WITHOUT CLAIM TO ANY PARTICULAR FONT, STYLE, SIZE, OR COLOR.

FOR PROVIDING INFORMATION ABOUT HOME MAINTENANCE AND HOME REPAIR VIA ELECTRONIC MAIL AND THE INTERNET (U.S. CLS. 100, 103 AND 106).
LINDA LAVACHE, EXAMINING ATTORNEY

CLASS 37—(Continued).

SN 77-141,997. AMBERWOOELECTRIC LLC, DBA MR. LIGHTBULB, HURRICANE, UT. FILED 3-27-2007.

Mr. Lightbulb

THE MARK CONSISTS OF STANDARD CHARACTERS WITHOUT CLAIM TO ANY PARTICULAR FONT, STYLE, SIZE, OR COLOR.

FOR ELECTRICAL CONTRACTING; GENERAL CONSTRUCTION CONTRACTING (U.S. CLS. 100, 103 AND 106).

FIRST USE 1-1-2002; IN COMMERCE 1-1-2002.
TEJBIR SINGH, EXAMINING ATTORNEY

CLASS 37—(Continued).

SN 77-142,821. ZERNCO, INC., AUGUSTA, KS. FILED 3-28-2007.

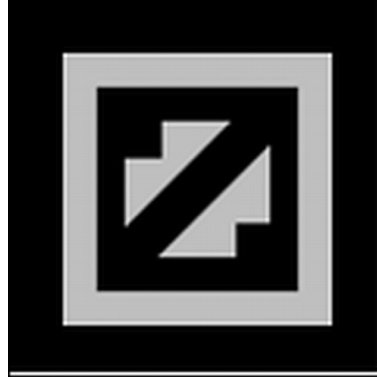

THE STIPLING IS A FEATURE OF THE MARK AND DOES NOT INDICATE COLOR.

THE MARK CONSISTS OF TWO ADJACENT TRIANGLES PARELLEL TO TWO UPSIDE ADJACENT TRIANGLES BOTH INSIDE A SQUARE WHICH IS INSIDE A LARGER SQUARE.

FOR CONSTRUCTION MANAGEMENT; CONSTRUCTION, MAINTENANCE AND RENOVATION OF PROPERTY (U.S. CLS. 100, 103 AND 106).

FIRST USE 1-23-1995; IN COMMERCE 1-23-1995.
MICHAEL WEBSTER, EXAMINING ATTORNEY

SN 77-142,493. ABC, INC., FARGO, ND. FILED 3-28-2007.



OWNER OF U.S. REG. NOS. 1,617,977, 2,197,851 AND OTHERS.

THE MARK CONSISTS OF A CARICATURE OF A DUCK WEARING AN OVERCOAT, NECKTIE AND A HAT, WITH AN OUTSTRETCHED ARM AND WITH THE INDEX FINGER EXTENDED.

FOR INSTALLATION OF SIDING, SOFFIT, FASCIA, GUTTERS, GUTTER PROTECTION COVERS, WINDOWS, DOORS, ROOFING, FLOORING, CABINETS, DECKS, PATIOS AND SUNROOMS; HOME REMODELING, NAMELY, KITCHENS, BATHROOMS, BASEMENTS; HOME REPAIR AND MAINTENANCE SERVICES, NAMELY SIDING AND GUTTER CLEANING, AIR DUCT CLEANING; HVAC CONTRACTOR SERVICES (U.S. CLS. 100, 103 AND 106).

DOMINICK J. SALEMI, EXAMINING ATTORNEY

SN 77-143,380. ECOLAVATION, LLC, MIAMI, FL. FILED 3-29-2007.

ECOLAV

THE MARK CONSISTS OF STANDARD CHARACTERS WITHOUT CLAIM TO ANY PARTICULAR FONT, STYLE, SIZE, OR COLOR.

FOR DRY CLEANING SERVICES (U.S. CLS. 100, 103 AND 106).

JOHN HWANG, EXAMINING ATTORNEY

SN 77-143,508. GOLD TOUCH CAR WASH, LLC, COLUMBUS, OH. FILED 3-29-2007.



NO CLAIM IS MADE TO THE EXCLUSIVE RIGHT TO USE "CAR WASH", APART FROM THE MARK AS SHOWN.

THE MARK CONSISTS OF CONCENTRIC OVALS CONTAINING THE WORD "KEN'S", TILTED SLIGHTLY TO THE LEFT, WITH THE WORDS "CAR WASH" TO THE RIGHT.

FOR CAR WASHING (U.S. CLS. 100, 103 AND 106).
FIRST USE 10-18-2006; IN COMMERCE 10-18-2006.
DAVID MURRAY, EXAMINING ATTORNEY

CLASS 37—(Continued).

SN 77-143,512. GOLD TOUCH CAR WASH, LLC, COLUMBUS, OH. FILED 3-29-2007.



NO CLAIM IS MADE TO THE EXCLUSIVE RIGHT TO USE "CAR WASH", APART FROM THE MARK AS SHOWN. THE MARK CONSISTS OF CONCENTRIC OVALS CONTAINING THE WORD "KEN'S", TILTED SLIGHTLY TO THE LEFT, WITH A STARBURST DESIGN BELOW THE LETTER "K", THE WORD "CAR" TO THE RIGHT WITH THE LETTER "C" SLIGHTLY OVERLAPPING THE OVAL, ALL ABOVE THE WORD "WASH", ALL OF WHICH IS ON A RECTANGULAR BACKGROUND WITH ROUNDED CORNERS.

FOR CAR WASHING (U.S. CLS. 100, 103 AND 106).
FIRST USE 10-18-2006; IN COMMERCE 10-18-2006.
DAVID MURRAY, EXAMINING ATTORNEY

CLASS 37—(Continued).

SN 77-144,343. APPLERA CORPORATION, FOSTER CITY, CA. FILED 3-29-2007.

APPLERA

THE MARK CONSISTS OF STANDARD CHARACTERS WITHOUT CLAIM TO ANY PARTICULAR FONT, STYLE, SIZE, OR COLOR.

OWNER OF U.S. REG. NO. 3,130,445.
FOR INSTALLATION, MAINTENANCE AND REPAIR OF LABORATORY INSTRUMENTS FOR SCIENTIFIC, RESEARCH, MEDICAL, OR DIAGNOSTIC USE; COMPUTER INSTALLATION AND REPAIR (U.S. CLS. 100, 103 AND 106).

KEVIN DINALLO, EXAMINING ATTORNEY

SN 77-143,556. PLANK ROAD REALTY, LLC, SALISBURY, MA. FILED 3-29-2007.



THE MARK CONSISTS OF OCEANIA VICTORIA WITH HERON ILLUSTRATION.

FOR LAND DEVELOPMENT SERVICES, NAMELY, PLANNING AND LAYING OUT OF RESIDENTIAL AND/OR COMMERCIAL COMMUNITIES (U.S. CLS. 100, 103 AND 106).

NATALIE POLZER, EXAMINING ATTORNEY

SN 77-147,014. MESSER CONSTRUCTION CO., CINCINNATI, OH. FILED 4-3-2007.

MESSER

THE MARK CONSISTS OF STANDARD CHARACTERS WITHOUT CLAIM TO ANY PARTICULAR FONT, STYLE, SIZE, OR COLOR.

OWNER OF U.S. REG. NOS. 2,670,982, 3,148,110 AND OTHERS.
SEC. 2(F).

FOR REAL ESTATE CONSTRUCTION SERVICES, NAMELY, RESIDENTIAL AND COMMERCIAL BUILDING CONSTRUCTION (U.S. CLS. 100, 103 AND 106).

FIRST USE 2-28-1967; IN COMMERCE 2-28-1967.

BERNICE MIDDLETON, EXAMINING ATTORNEY

CLASS 37—(Continued).

SN 77-149,291. MAIDS ON TIME TOO, INC., PARK RIDGE, IL. FILED 4-5-2007.



FOR MAID SERVICES; CARPET CLEANING; CLEANING OF BUILDING EXTERIOR SURFACES; CLEANING OF INDUSTRIAL PREMISES; CLEANING OF RESIDENTIAL HOUSES; RENTAL OF CLEANING EQUIPMENT; RUG CLEANING (U.S. CLS. 100, 103 AND 106).
FIRST USE 4-4-2007; IN COMMERCE 4-4-2007.
SHANNON TWOHIG, EXAMINING ATTORNEY

SN 77-164,333. STEVEN BUILDERS, L.L.C., HOUSTON, TX. FILED 4-24-2007.



FOR RESIDENTIAL CONSTRUCTION SERVICES (U.S. CLS. 100, 103 AND 106).
GRETTA YAO, EXAMINING ATTORNEY

CLASS 37—(Continued).

SN 78-723,452. THE ST. JOE COMPANY, JACKSONVILLE, FL. FILED 9-29-2005.

RIVERCAMPS

THE MARK CONSISTS OF STANDARD CHARACTERS WITHOUT CLAIM TO ANY PARTICULAR FONT, STYLE, SIZE, OR COLOR.
OWNER OF U.S. REG. NOS. 2,770,431 AND 2,770,432.
FOR REAL ESTATE DEVELOPMENT; REAL ESTATE SITE SELECTION (U.S. CLS. 100, 103 AND 106).
FIRST USE 4-4-2002; IN COMMERCE 4-4-2002.
RONALD MCMORROW, EXAMINING ATTORNEY

SN 78-808,045. PLUMBERS' SUCCESS INTERNATIONAL, LLC, ST. LOUIS, MO. FILED 2-6-2006.



NO CLAIM IS MADE TO THE EXCLUSIVE RIGHT TO USE "PLUMBER", APART FROM THE MARK AS SHOWN.
THE STIPPLING IS FOR SHADING PURPOSES ONLY.
FOR REPAIR, MAINTENANCE, AND INSTALLATION SERVICES IN THE FIELD OF PLUMBING (U.S. CLS. 100, 103 AND 106).
DANNEAN HETZEL, EXAMINING ATTORNEY

SN 78-822,968. ELECTRICIANS' SUCCESS INTERNATIONAL, LLC, ST. LOUIS, MO. FILED 2-24-2006.



NO CLAIM IS MADE TO THE EXCLUSIVE RIGHT TO USE "EXCELLENT ELECTRICIAN", APART FROM THE MARK AS SHOWN.
THE STIPPLING IS FOR SHADING PURPOSES ONLY.
FOR REPAIR, MAINTENANCE, AND INSTALLATION OF ELECTRICAL WIRING, OUTLETS, LIGHT FIXTURES, AND ELECTRICAL PANELS; ELECTRICAL CONTRACTING SERVICES (U.S. CLS. 100, 103 AND 106).
AMY MCMENAMIN, EXAMINING ATTORNEY

CLASS 37—(Continued).

SN 78-875,880. KUMMER DEVELOPMENT CORPORATION, ST. LOUIS, MO. FILED 5-3-2006.



NO CLAIM IS MADE TO THE EXCLUSIVE RIGHT TO USE "ADAM'S MOUNTAIN COUNTRY CLUB", APART FROM THE MARK AS SHOWN.

THE COLOR(S) BLACK AND ORANGE IS/ARE CLAIMED AS A FEATURE OF THE MARK.

THE MARK CONSISTS OF THE WORDS ADAM'S MOUNTAIN COUNTRY CLUB IN BLACK ALONGSIDE A STYLIZED A SHOWN IN ORANGE.

FOR REAL ESTATE DEVELOPMENT, NAMELY DEVELOPMENT OF LUXURY RESORT AND LUXURY SECOND-HOME REAL ESTATE (U.S. CLS. 100, 103 AND 106).

DAVID YONTEF, EXAMINING ATTORNEY

SN 78-931,440. GLEANER, STEVEN S., GILROY, CA. FILED 7-18-2006.

Driven Exotics

THE MARK CONSISTS OF STANDARD CHARACTERS WITHOUT CLAIM TO ANY PARTICULAR FONT, STYLE, SIZE, OR COLOR.

NO CLAIM IS MADE TO THE EXCLUSIVE RIGHT TO USE "EXOTICS", APART FROM THE MARK AS SHOWN.

FOR AUTOMOTIVE REPAIR SPECIALIZING IN ITALIAN MADE EXOTIC SPORTS CARS (U.S. CLS. 100, 103 AND 106).

FIRST USE 6-22-2006; IN COMMERCE 6-22-2006.
JASON LOTT, EXAMINING ATTORNEY

CLASS 37—(Continued).

SN 78-933,810. TECHNOLOGY DIMENSIONS, INC., ORANGE, CA. FILED 7-20-2006.

TECHNOLOGY DIMENSIONS

THE MARK CONSISTS OF STANDARD CHARACTERS WITHOUT CLAIM TO ANY PARTICULAR FONT, STYLE, SIZE, OR COLOR.

NO CLAIM IS MADE TO THE EXCLUSIVE RIGHT TO USE TECHNOLOGY, APART FROM THE MARK AS SHOWN.

FOR COMPUTER INSTALLATION AND REPAIR; INSTALLATION OF COMPUTER NETWORKS; INSTALLATION OF COMPUTER SYSTEMS; INSTALLATION, MAINTENANCE AND REPAIR OF COMPUTERS AND COMPUTER NETWORKS; MAINTENANCE AND REPAIR OF COMPUTER HARDWARE; MAINTENANCE AND REPAIR OF COMPUTER NETWORKS; REPAIR OF DAMAGED COMPUTERS; UPDATING OF COMPUTER HARDWARE; UPGRADING OF COMPUTER HARDWARE (U.S. CLS. 100, 103 AND 106).

FIRST USE 4-23-1999; IN COMMERCE 4-23-1999.
RAY THOMAS, EXAMINING ATTORNEY

SN 78-935,802. PAINTERS USA, INC., WHEATON, IL. FILED 7-24-2006.



THE COLOR(S) RED, WHITE, AND BLUE IS/ARE CLAIMED AS A FEATURE OF THE MARK.

THE MARK CONSISTS OF THE WORDS "PAINTERS USA INC." WITH THE WORDS "PAINTERS" AND "INC." IN BLUE AND THE WORD "USA" IN RED, ABOVE WHICH IS A BLUE PAINT BRUSH WITH RED AND WHITE BRISTLES WHICH APPEAR AS A WAVING FLAG.

SEC. 2(F) "PAINTERS USA INC." FOR HOUSE PAINTING; PAINTING CONTRACTOR SERVICES (U.S. CLS. 100, 103 AND 106).

FIRST USE 4-28-1982; IN COMMERCE 4-28-1982.
SCOTT SISUN, EXAMINING ATTORNEY

CLASS 37—(Continued).

SN 78-948,836. BICYCLE CITY, LLC, CINCINNATI, OH.
FILED 8-9-2006.

CLASS 37—(Continued).

SN 78-950,218. BICYCLE CITY, LLC, CINCINNATI, OH.
FILED 8-11-2006.

BICYCLE CITY

CYCLE CITY

THE MARK CONSISTS OF STANDARD CHARACTERS WITHOUT CLAIM TO ANY PARTICULAR FONT, STYLE, SIZE, OR COLOR.

FOR REAL ESTATE DEVELOPMENT, NAMELY PLANNED COMMUNITY DEVELOPMENT OF RESIDENTIAL, OFFICE, RETAIL AND COMMERCIAL PROPERTIES; LAND DEVELOPMENT SERVICES, NAMELY PLANNING AND LAYING OUT OF RESIDENTIAL AND/OR COMMERCIAL COMMUNITIES; CONSULTING SERVICES IN THE FIELD OF PLANNED COMMUNITY REAL ESTATE DEVELOPMENT; CONSULTING SERVICES IN THE FIELD OF LAYING OUT OF RESIDENTIAL AND COMMERCIAL PLANNED COMMUNITIES (U.S. CLS. 100, 103 AND 106).

DANIEL BRODY, EXAMINING ATTORNEY

THE MARK CONSISTS OF STANDARD CHARACTERS WITHOUT CLAIM TO ANY PARTICULAR FONT, STYLE, SIZE, OR COLOR.

FOR REAL ESTATE DEVELOPMENT, NAMELY, PLANNED COMMUNITY DEVELOPMENT OF RESIDENTIAL, OFFICE, RETAIL AND COMMERCIAL PROPERTIES; LAND DEVELOPMENT SERVICES, NAMELY, PLANNING AND LAYING OUT OF RESIDENTIAL AND/OR COMMERCIAL COMMUNITIES; CONSULTING SERVICES IN THE FIELD OF PLANNED COMMUNITY REAL ESTATE DEVELOPMENT; CONSULTING SERVICES IN THE FIELD OF LAYING OUT OF RESIDENTIAL AND COMMERCIAL PLANNED COMMUNITIES (U.S. CLS. 100, 103 AND 106).

BRENDAN REGAN, EXAMINING ATTORNEY

SN 78-948,875. BICYCLE CITY, LLC, CINCINNATI, OH.
FILED 8-9-2006.

SN 78-952,847. COBE DEVELOPMENT, LC, MESA, AZ.
FILED 8-15-2006.

CIUDAD DE LA BICICLETA

It's Not Just an Office, It's Your Business.

THE MARK CONSISTS OF STANDARD CHARACTERS WITHOUT CLAIM TO ANY PARTICULAR FONT, STYLE, SIZE, OR COLOR.

THE FOREIGN WORDING IN THE MARK TRANSLATES INTO ENGLISH AS BICYCLE CITY.

FOR REAL ESTATE DEVELOPMENT, NAMELY, PLANNED COMMUNITY DEVELOPMENT OF RESIDENTIAL, OFFICE, RETAIL AND COMMERCIAL PROPERTIES; LAND DEVELOPMENT SERVICES, NAMELY, PLANNING AND LAYING OUT OF RESIDENTIAL AND/OR COMMERCIAL COMMUNITIES; CONSULTING SERVICES IN THE FIELD OF PLANNED COMMUNITY REAL ESTATE DEVELOPMENT; CONSULTING SERVICES IN THE FIELD OF LAYING OUT OF RESIDENTIAL AND COMMERCIAL PLANNED COMMUNITIES (U.S. CLS. 100, 103 AND 106).

LINDA POWELL, EXAMINING ATTORNEY

THE MARK CONSISTS OF STANDARD CHARACTERS WITHOUT CLAIM TO ANY PARTICULAR FONT, STYLE, SIZE, OR COLOR.

FOR CONSTRUCTION SERVICES, NAMELY, PLANNING, LAYING OUT AND CUSTOM CONSTRUCTION OF RESIDENTIAL AND COMMERCIAL COMMUNITIES; LAND DEVELOPMENT SERVICES, NAMELY, PLANNING AND LAYING OUT OF RESIDENTIAL AND/OR COMMERCIAL COMMUNITIES; REAL ESTATE DEVELOPMENT (U.S. CLS. 100, 103 AND 106).

FIRST USE 8-5-2006; IN COMMERCE 8-11-2006.

KEVIN CORWIN, EXAMINING ATTORNEY

CLASS 37—(Continued).

SN 78-954,600. GAGNE, JOHN, GARDNERVILLE, NV.
FILED 8-17-2006.



OWNER OF U.S. REG. NO. 2,930,879.
NO CLAIM IS MADE TO THE EXCLUSIVE RIGHT TO
USE "PROTECTED BY" OR "PEST CONTROL", APART
FROM THE MARK AS SHOWN.

THE MARK CONSISTS OF A STOP SIGN SHAPE THAT
INCLUDES LITERAL ELEMENTS AND A CAT FIGURE.
FOR PEST CONTROL (U.S. CLS. 100, 103 AND 106).
FIRST USE 5-30-2006; IN COMMERCE 5-30-2006.
SETH A. RAPPAPORT, EXAMINING ATTORNEY

SN 78-954,619. VALLI CONSTRUCTION, INC., CAMPBELL,
CA. FILED 8-17-2006.

VALLI CONSTRUCTION

THE MARK CONSISTS OF STANDARD CHARACTERS
WITHOUT CLAIM TO ANY PARTICULAR FONT, STYLE,
SIZE, OR COLOR.

NO CLAIM IS MADE TO THE EXCLUSIVE RIGHT TO
USE "CONSTRUCTION", APART FROM THE MARK AS
SHOWN.

FOR CONSTRUCTION AND CONTRACTING SER-
VICES, NAMELY GENERAL CONSTRUCTION, CON-
TRACTING AND BUILDING SERVICES FOR
COMMERCIAL AND RESIDENTIAL PROJECTS; CON-
STRUCTION PLANNING AND MANAGEMENT (U.S.
CLS. 100, 103 AND 106).

FIRST USE 11-16-2004; IN COMMERCE 11-16-2004.
VERNA BETH RIRIE, EXAMINING ATTORNEY

CLASS 38—COMMUNICATION

SN 76-672,141. DASHBOARDHOSTING INC., CORAL
SPRINGS, FL. FILED 2-2-2007.

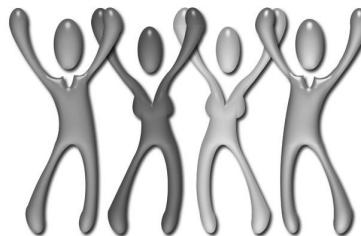

FOR COMMUNICATION SERVICES BY COMPUTER
TERMINALS, NAMELY, PROVIDING ON-LINE FACIL-
ITIES FOR REAL-TIME INTERACTION WITH OTHER
COMPUTER USERS CONCERNING ADULT THEMES,
DATING AND SWINGER LIFESTYLES (U.S. CLS. 100,
101 AND 104).

FIRST USE 10-7-2006; IN COMMERCE 10-7-2006.
ODESSA BIBBINS, EXAMINING ATTORNEY

SN 76-673,841. SPANISH BROADCASTING SYSTEM, INC.,
COCONUT GROVE, FL. FILED 3-9-2007.

LA's Official Party Station

THE MARK CONSISTS OF STANDARD CHARACTERS
WITHOUT CLAIM TO ANY PARTICULAR FONT, STYLE,
SIZE, OR COLOR.

OWNER OF U.S. REG. NO. 2,984,863.
NO CLAIM IS MADE TO THE EXCLUSIVE RIGHT TO
USE "LA'S" AND "STATION", APART FROM THE MARK
AS SHOWN.

FOR RADIO BROADCASTING SERVICES (U.S. CLS.
100, 101 AND 104).

MARY BOAGNI, EXAMINING ATTORNEY

SN 76-673,842. SPANISH BROADCASTING SYSTEM, INC.,
COCONUT GROVE, FL. FILED 3-9-2007.

LA's Original Party Station

THE MARK CONSISTS OF STANDARD CHARACTERS
WITHOUT CLAIM TO ANY PARTICULAR FONT, STYLE,
SIZE, OR COLOR.

OWNER OF U.S. REG. NO. 2,984,863.
NO CLAIM IS MADE TO THE EXCLUSIVE RIGHT TO
USE "LA'S" AND "STATION", APART FROM THE MARK
AS SHOWN.

FOR RADIO BROADCASTING SERVICES (U.S. CLS.
100, 101 AND 104).

MARY BOAGNI, EXAMINING ATTORNEY

CLASS 38—(Continued).

SN 76-674,163. THREE LEAF PARTNERS, LLC, SANTA BARBARA, CA. FILED 3-16-2007.

GREAT DIGITAL CARDS THAT SERVE A GREATER GOOD

THE MARK CONSISTS OF STANDARD CHARACTERS WITHOUT CLAIM TO ANY PARTICULAR FONT, STYLE, SIZE, OR COLOR.

FOR DELIVERY OF PERSONALIZED GREETING CARDS TO OTHERS VIA ELECTRONIC MAIL (U.S. CLS. 100, 101 AND 104).

FIRST USE 2-23-2007; IN COMMERCE 2-23-2007.
KENNETH E. SHARPERSON, EXAMINING ATTORNEY

SN 77-002,845. PODFERENCE TECHNOLOGIES, INC., SOLANA BEACH, CA. FILED 9-19-2006.

PODFERENCE

THE MARK CONSISTS OF STANDARD CHARACTERS WITHOUT CLAIM TO ANY PARTICULAR FONT, STYLE, SIZE, OR COLOR.

FOR PODCASTING SERVICES (U.S. CLS. 100, 101 AND 104).

FIRST USE 3-7-2006; IN COMMERCE 3-7-2006.
LINDA E. BLOHM, EXAMINING ATTORNEY

SN 77-007,066. ACT TELECONFERENCING, INC., GOLDEN, CO. FILED 9-25-2006.



NO CLAIM IS MADE TO THE EXCLUSIVE RIGHT TO USE "CONFERENCING", APART FROM THE MARK AS SHOWN.

THE MARK CONSISTS OF THE WORDS ACT CONFERENCING WITH MULTIPLE CURVED LINES AND DOTS.

FOR TELECOMMUNICATIONS SERVICES; NAMELY MULTIPLE-USER CONFERENCING SERVICES THAT ENABLE THE EXCHANGE OF VOICE, DATA, AND VIDEO (U.S. CLS. 100, 101 AND 104).

FIRST USE 6-7-2006; IN COMMERCE 6-7-2006.
HEATHER BIDDULPH, EXAMINING ATTORNEY

CLASS 38—(Continued).

SN 77-036,917. PODSHOW, INC., SAN FRANCISCO, CA. FILED 11-4-2006.

ALPHA CHANNEL

THE MARK CONSISTS OF STANDARD CHARACTERS WITHOUT CLAIM TO ANY PARTICULAR FONT, STYLE, SIZE, OR COLOR.

NO CLAIM IS MADE TO THE EXCLUSIVE RIGHT TO USE "CHANNEL", APART FROM THE MARK AS SHOWN.

FOR DISTRIBUTION OF AUDIO AND VISUAL CONTENT FILES OVER A COMPUTER NETWORK SUCH AS THE INTERNET, NAMELY, PODCASTING; AND PODCASTING ON A WIDE VARIETY OF SUBJECTS WHICH ARE GEARED TO MEN (U.S. CLS. 100, 101 AND 104).

DAVID ELTON, EXAMINING ATTORNEY

SN 77-069,849. DEUTSCHE TELEKOM AG, BONN, FED REP GERMANY, FILED 12-21-2006.

qiro

PRIORITY CLAIMED UNDER SEC. 44(D) ON FED REP GERMANY APPLICATION NO. 30639011638, FILED 6-22-2006, REG. NO. 30639011, DATED 6-22-2006, EXPIRES 6-30-2016.

FOR TELECOMMUNICATION AND INFORMATION TECHNOLOGY SERVICES, NAMELY, ELECTRIC, DIGITAL, CELLULAR AND WIRELESS TRANSMISSION OF VOICE, DATA, INFORMATION IMAGES, SIGNALS AND MESSAGES AND TRANSMISSION OF VOICE, DATA, IMAGES, AUDIO, VIDEO AND INFORMATION VIA TELEPHONE, TELEVISION AND GLOBAL COMMUNICATION NETWORKS; PROVIDING TELECOMMUNICATIONS CONNECTIONS OVER A GLOBAL COMMUNICATIONS NETWORK, ELECTRONIC STORE-AND-FORWARD MESSAGING; RENTAL OF TELECOMMUNICATIONS EQUIPMENT, NAMELY, EQUIPMENT FOR ELECTRONIC ACCESS TO GLOBAL TELECOMMUNICATIONS NETWORK, EQUIPMENT FOR TRANSMITTING, RECEIVING, RECORDING AND MONITORING VOICE, DATA, INFORMATION IMAGES, SIGNALS, MESSAGES COMPRISED OF DATA AND WORD PROCESSORS, AND TELECOMMUNICATIONS HARDWARE COMPONENTS AND PERIPHERALS THEREOF FOR USE IN THE TELECOMMUNICATIONS INDUSTRY, AND RENTAL OF EQUIPMENT FOR TRANSMITTING, RECEIVING, RECORDING AND MONITORING COMPUTER PROGRAMS FOR USE IN OPERATING AND ACCESSING TELECOMMUNICATIONS SYSTEMS; AUDIO AND VIDEO BROADCASTING; PROVIDING MULTIPLE-USER DIAL-UP AND DEDICATED ACCESS TO THE INTERNET; PERSONAL COMMUNICATIONS SERVICES; PAGER SERVICES; TRANSMISSION AND BROADCAST OF AUDIO AND VIDEO PROGRAMMING; LEASING OF TELECOMMUNICATIONS EQUIPMENT, COMPONENTS AND SYSTEMS; PROVIDING INFORMATION VIA THE TELEPHONE AND THE GLOBAL COMMUNICATION NETWORKS IN THE FIELD OF TELECOMMUNICATIONS; CONSULTING IN THE FIELD OF TELECOMMUNICATIONS (U.S. CLS. 100, 101 AND 104).

FRED MANDIR, EXAMINING ATTORNEY

CLASS 38—(Continued).

SN 77-081,976. AAP CONSULTING GROUP, INC., LOS ANGELES, CA. FILED 1-12-2007.

LOOPIN

THE MARK CONSISTS OF STANDARD CHARACTERS WITHOUT CLAIM TO ANY PARTICULAR FONT, STYLE, SIZE, OR COLOR.

FOR PROVIDING ON-LINE ELECTRONIC BULLETIN BOARDS FOR TRANSMISSION OF MESSAGES AMONG USERS IN THE FIELD OF GENERAL INTEREST; PROVIDING ON-LINE ELECTRONIC BULLETIN BOARDS FOR TRANSMISSION OF MESSAGES AMONG COMPUTER USERS CONCERNING EXISTING AND POTENTIAL BUSINESS AND INVESTMENT OPPORTUNITIES, TRANSACTIONS, AND CONTACTS (U.S. CLS. 100, 101 AND 104).

FIRST USE 9-14-2006; IN COMMERCE 9-14-2006.
ANDREA HACK, EXAMINING ATTORNEY

SN 77-120,717. CBS BROADCASTING INC., NEW YORK, NY. FILED 3-2-2007.



OWNER OF U.S. REG. NOS. 852,481 AND 2,928,976. NO CLAIM IS MADE TO THE EXCLUSIVE RIGHT TO USE "RADIO", APART FROM THE MARK AS SHOWN. THE MARK CONSISTS OF CBS RADIO & EYE DESIGN. FOR RADIO BROADCASTING SERVICES AND INTERNET BROADCASTING SERVICES, NAMELY, STREAMING OF AUDIO MATERIAL ON THE INTERNET (U.S. CLS. 100, 101 AND 104).

FIRST USE 12-14-2005; IN COMMERCE 12-14-2005.
WON TEAK OH, EXAMINING ATTORNEY

CLASS 38—(Continued).

SN 77-124,472. WOODS, TREVOR, BEVERLY HILLS, CA. FILED 3-7-2007.



NO CLAIM IS MADE TO THE EXCLUSIVE RIGHT TO USE THE AFRICAN AMERICAN CHANNEL, APART FROM THE MARK AS SHOWN.

THE MARK CONSISTS OF THE LETTER A IN STYLIZED FORM APPEARING IN A RECTANGLE AND THE WORDS THE AFRICAN AMERICAN CHANNEL APPEARING UNDERNEATH. THE STYLIZED LETTER "A" HAS A SHADOW TO THE REAR RIGHT SIDE OF IT.

FOR BROADCASTING SERVICES AND PROVISION OF TELECOMMUNICATION ACCESS TO FILMS AND TV PROGRAMMES PROVIDED VIA A VIDEO-ON-DEMAND SERVICE; BROADCASTING SERVICES AND PROVISION OF TELECOMMUNICATION ACCESS TO VIDEO AND AUDIO CONTENT PROVIDED VIA A VIDEO-ON-DEMAND SERVICE VIA THE INTERNET; COMMUNICATIONS SERVICES, NAMELY, TRANSMITTING STREAMED SOUND AND AUDIO-VISUAL RECORDINGS VIA THE INTERNET; STREAMING OF VIDEO MATERIAL ON THE INTERNET (U.S. CLS. 100, 101 AND 104).

FIRST USE 9-0-2006; IN COMMERCE 12-0-2006.
SANI KHOURI, EXAMINING ATTORNEY

SN 77-127,120. WIRELESS MATRIX USA, INC., RESTON, VA. FILED 3-9-2007.

SAPIAS

THE MARK CONSISTS OF STANDARD CHARACTERS WITHOUT CLAIM TO ANY PARTICULAR FONT, STYLE, SIZE, OR COLOR.

OWNER OF U.S. REG. NOS. 2,911,825, 2,968,153 AND OTHERS.

FOR SATELLITE TRANSMISSION SERVICES; PROVIDING ONLINE ELECTRONIC BULLETIN BOARDS, AND ONLINE FORUMS FOR THE TRANSMISSION OF MESSAGES AMONG COMPUTER USERS CONCERNING THE TRACKING, LOCATING AND MONITORING OF PRODUCTS, AND PACKAGES (U.S. CLS. 100, 101 AND 104).

JASON ROTH, EXAMINING ATTORNEY

CLASS 38—(Continued).

SN 77-131,234. JACKSON, DAVID FERRELL, PLEASANTON, CA. FILED 3-14-2007.

KYA RADIO

THE MARK CONSISTS OF STANDARD CHARACTERS WITHOUT CLAIM TO ANY PARTICULAR FONT, STYLE, SIZE, OR COLOR.

NO CLAIM IS MADE TO THE EXCLUSIVE RIGHT TO USE "RADIO", APART FROM THE MARK AS SHOWN.

FOR RADIO PROGRAM BROADCASTING (U.S. CLS. 100, 101 AND 104).

FIRST USE 3-29-1941; IN COMMERCE 3-29-1941.
DAVID H. STINE, EXAMINING ATTORNEY

SN 77-133,974. INTEGRITY MUTUAL INSURANCE COMPANY, APPLETON, WI. FILED 3-19-2007.

INTEGRITYLIVE

THE MARK CONSISTS OF STANDARD CHARACTERS WITHOUT CLAIM TO ANY PARTICULAR FONT, STYLE, SIZE, OR COLOR.

OWNER OF U.S. REG. NOS. 3,134,628, 3,134,629 AND 3,134,630.

FOR INSTANT MESSAGING SERVICES (U.S. CLS. 100, 101 AND 104).

BERNICE MIDDLETON, EXAMINING ATTORNEY

SN 77-137,308. GREENFLY NETWORKS, INC., BOZEMAN, MT. FILED 3-22-2007.

CLEARFLY COMMUNICATIONS

THE MARK CONSISTS OF STANDARD CHARACTERS WITHOUT CLAIM TO ANY PARTICULAR FONT, STYLE, SIZE, OR COLOR.

NO CLAIM IS MADE TO THE EXCLUSIVE RIGHT TO USE "COMMUNICATIONS", APART FROM THE MARK AS SHOWN.

FOR COMMUNICATIONS VIA MULTINATIONAL TELECOMMUNICATION NETWORKS; DATA TRANSMISSION AND RECEPTION SERVICES VIA TELECOMMUNICATION MEANS; ELECTRONIC EXCHANGE OF DATA STORED IN DATABASES ACCESSIBLE VIA TELECOMMUNICATION NETWORKS; HIGH BIT-RATE DATA TRANSMISSION SERVICES FOR TELECOMMUNICATION NETWORK OPERATORS; LEASING OF TELECOMMUNICATIONS LINES; PROVIDING ACCESS TO TELECOMMUNICATION NETWORKS; PROVIDING ELECTRONIC TELECOMMUNICATION CONNECTIONS; PROVIDING TELECOMMUNICATIONS CONNECTIONS TO A GLOBAL COMPUTER NETWORK; PROVIDING THIRD PARTY USERS WITH ACCESS TO TELECOMMUNICATION INFRASTRUCTURE; SIGNAL TRANSMISSION FOR ELECTRONIC COMMERCE VIA

CLASS 38—(Continued).

TELECOMMUNICATION SYSTEMS AND DATA COMMUNICATION SYSTEMS; TELECOMMUNICATION ACCESS SERVICES; TELECOMMUNICATION SERVICES, NAMELY, LOCAL AND LONG DISTANCE TRANSMISSION OF VOICE, DATA, GRAPHICS BY MEANS OF TELEPHONE, TELEGRAPHIC, CABLE, AND SATELLITE TRANSMISSION; TELECOMMUNICATION SERVICES, NAMELY, CALL HUNTING; TELECOMMUNICATIONS CONSULTATION; TELECOMMUNICATIONS GATEWAY SERVICES; TELECOMMUNICATIONS RESELLER SERVICES, NAMELY, PROVIDING LONG DISTANCE TELECOMMUNICATION SERVICES; TELECOMMUNICATIONS ROUTING AND JUNCTION SERVICES; TELECOMMUNICATIONS SERVICES, NAMELY, PROVIDING FIBER OPTIC NETWORK SERVICES; TRANSFER OF DATA BY TELECOMMUNICATIONS; TRANSMISSION OF INFORMATION ON OPTICAL TELECOMMUNICATION NETWORKS; WIRELESS TELEPHONE TELECOMMUNICATIONS SERVICES, NAMELY, WIRELESS MOBILE TELEPHONE CALLING PLANS; FIXED MOBILE CONVERGENCE, NAMELY, CONVERSION OF WIRELESS INTERNET TO MOBILE VOICE (U.S. CLS. 100, 101 AND 104).

KATHLEEN LORENZO, EXAMINING ATTORNEY

SN 77-138,464. EYESHOUT MEDIA, INC., WATERLOO, CANADA, FILED 3-23-2007.

ONE BAND ONE DAY ONE MASSIVE WORLD STAGE

THE MARK CONSISTS OF STANDARD CHARACTERS WITHOUT CLAIM TO ANY PARTICULAR FONT, STYLE, SIZE, OR COLOR.

FOR COMMUNICATIONS SERVICES, NAMELY, TRANSMITTING STREAMED SOUND AND AUDIO-VISUAL RECORDINGS VIA THE INTERNET; STREAMING OF AUDIO MATERIAL ON THE INTERNET; STREAMING OF VIDEO MATERIAL ON THE INTERNET; INFORMATION TRANSMISSION VIA ELECTRONIC COMMUNICATIONS NETWORKS; PROVIDING ON-LINE FORUMS FOR TRANSMISSION OF MESSAGES AMONG COMPUTER USERS CONCERNING MUSIC (U.S. CLS. 100, 101 AND 104).

FIRST USE 11-1-2006; IN COMMERCE 11-1-2006.
MARK SPARACINO, EXAMINING ATTORNEY

CLASS 38—(Continued).

SN 77-138,503. LAW ENFORCEMENT ASSOCIATES, INC.,
YOUNGSVILLE, NC. FILED 3-23-2007.

Bird Dog

THE MARK CONSISTS OF STANDARD CHARACTERS WITHOUT CLAIM TO ANY PARTICULAR FONT, STYLE, SIZE, OR COLOR.

FOR COMMUNICATION VIA RADIO, TELEGRAPH, TELEPHONE AND TELEVISION TRANSMISSIONS; COMPUTER AIDED TRANSMISSION OF INFORMATION AND IMAGES; COMPUTER TRANSMISSION OF INFORMATION ACCESSED VIA A CODE OR A TERMINAL; TRANSMISSION OF INFORMATION BY DATA COMMUNICATIONS FOR ASSISTING DECISION MAKING; TRANSMISSION OF INFORMATION BY ELECTRONIC COMMUNICATIONS NETWORKS; TRANSMISSION OF INFORMATION VIA NATIONAL AND INTERNATIONAL NETWORKS; DATA TRANSMISSION AND RECEPTION SERVICES VIA TELECOMMUNICATION MEANS; TRANSMISSION AND RECEPTION OF DATABASE INFORMATION VIA THE TELECOMMUNICATION NETWORK; DELIVERY OF MESSAGES BY ELECTRONIC TRANSMISSION; ELECTRONIC DATA TRANSMISSION; ELECTRONIC MESSAGE TRANSMISSION; COMMUNICATION SERVICES, NAMELY, ELECTRONIC TRANSMISSION OF DATA AND DOCUMENTS AMONG USERS OF COMPUTERS; ELECTRONIC TRANSMISSION OF DATA AND DOCUMENTS VIA COMPUTER TERMINALS; ELECTRONIC TRANSMISSION OF VOICE, DATA AND IMAGES BY TELEVISION AND VIDEO BROADCASTING; WIRELESS ELECTRONIC TRANSMISSION OF VOICE SIGNALS, DATA, FACSIMILES, IMAGES AND INFORMATIONS; ELECTRONIC VOICE MESSAGING, NAMELY, THE RECORDING AND SUBSEQUENT TRANSMISSION OF VOICE MESSAGES BY TELEPHONE; ELECTRONIC, ELECTRIC, AND DIGITAL TRANSMISSION OF VOICE, DATA, IMAGES, SIGNALS, AND MESSAGES (U.S. CLS. 100, 101 AND 104).

MICHAEL WEBSTER, EXAMINING ATTORNEY

SN 77-138,641. LVTV, INC., LAS VEGAS, NV. FILED 3-23-2007.

LVTV

THE MARK CONSISTS OF STANDARD CHARACTERS WITHOUT CLAIM TO ANY PARTICULAR FONT, STYLE, SIZE, OR COLOR.

SEC. 2(F).
FOR BROADCASTING PROGRAMS VIA A GLOBAL COMPUTER NETWORK (U.S. CLS. 100, 101 AND 104).
FIRST USE 8-1-1998; IN COMMERCE 8-1-1998.
STEVEN R. FINE, EXAMINING ATTORNEY

CLASS 38—(Continued).

SN 77-138,783. YOLLAMO, LLC, MIAMI, FL. FILED 3-23-2007.

YOLLAMO

THE MARK CONSISTS OF STANDARD CHARACTERS WITHOUT CLAIM TO ANY PARTICULAR FONT, STYLE, SIZE, OR COLOR.

THE ENGLISH TRANSLATION OF THE SPANISH WORD "YO LLAMO" IN THE MARK IS "I CALL".

FOR PREPAID LONG DISTANCE SERVICES (U.S. CLS. 100, 101 AND 104).

CHRISTINA SOBRAL, EXAMINING ATTORNEY

SN 77-138,856. ZISES, SAMUEL, NEW YORK, NY. FILED 3-23-2007.

Zteam Productions

THE MARK CONSISTS OF STANDARD CHARACTERS WITHOUT CLAIM TO ANY PARTICULAR FONT, STYLE, SIZE, OR COLOR.

NO CLAIM IS MADE TO THE EXCLUSIVE RIGHT TO USE "PRODUCTIONS", APART FROM THE MARK AS SHOWN.

FOR MOBILE MEDIA AND ENTERTAINMENT SERVICES IN THE NATURE OF ELECTRONIC TRANSMISSION OF ENTERTAINMENT MEDIA CONTENT (U.S. CLS. 100, 101 AND 104).

LINDSEY RUBIN, EXAMINING ATTORNEY

SN 77-138,857. WATKINS, WAYNE, BILOXI, MS. FILED 3-23-2007.



NO CLAIM IS MADE TO THE EXCLUSIVE RIGHT TO USE "GREAT CLASSICS ONLINE", APART FROM THE MARK AS SHOWN.

THE MARK CONSISTS OF INTERNET RADIO STATION LOGO WITH JUKEBOX AND RECORD PLAYER.

FOR RADIO BROADCASTING; STREAMING OF AUDIO MATERIAL ON THE INTERNET (U.S. CLS. 100, 101 AND 104).

CHRISTINA SOBRAL, EXAMINING ATTORNEY

CLASS 38—(Continued).

SN 77-139,527. TATAUROV VJACHESLAV SERGEEVICH, MOSCOW, RUSSIAN FED., FILED 3-24-2007.

Techinline

THE MARK CONSISTS OF STANDARD CHARACTERS WITHOUT CLAIM TO ANY PARTICULAR FONT, STYLE, SIZE, OR COLOR.
FOR WEB CONFERENCING SERVICES (U.S. CLS. 100, 101 AND 104).
FIRST USE 9-1-2006; IN COMMERCE 12-1-2006.
KIMBERLY FRYE, EXAMINING ATTORNEY

SN 77-139,731. WRITEFFECT PRODUCTIONS LTD., BRONX, NY. FILED 3-25-2007.

JTVNY

THE MARK CONSISTS OF STANDARD CHARACTERS WITHOUT CLAIM TO ANY PARTICULAR FONT, STYLE, SIZE, OR COLOR.
FOR CABLE TELEVISION BROADCASTING (U.S. CLS. 100, 101 AND 104).
ROBIN CHOSID, EXAMINING ATTORNEY

SN 77-139,746. MARTIN, CHERYL L., BETHESDA, MD. FILED 3-25-2007.

Excellent Living

THE MARK CONSISTS OF STANDARD CHARACTERS WITHOUT CLAIM TO ANY PARTICULAR FONT, STYLE, SIZE, OR COLOR.
FOR RADIO PROGRAM BROADCASTING (U.S. CLS. 100, 101 AND 104).
FIRST USE 2-1-2007; IN COMMERCE 3-1-2007.
TRACY WHITTAKER-BROWN, EXAMINING ATTORNEY

CLASS 38—(Continued).

SN 77-139,915. VIACOM INTERNATIONAL INC., NEW YORK, NY. FILED 3-26-2007.

OGOLOGO

THE MARK CONSISTS OF STANDARD CHARACTERS WITHOUT CLAIM TO ANY PARTICULAR FONT, STYLE, SIZE, OR COLOR.
FOR PROVIDING ON-LINE CHAT ROOMS, FORUMS AND ELECTRONIC BULLETIN BOARDS FOR TRANSMISSION OF MESSAGES AMONG USERS IN THE FIELD OF GENERAL INTEREST; PROVIDING EMAIL AND INSTANT MESSAGING SERVICES (U.S. CLS. 100, 101 AND 104).
B. PARADEWELAI, EXAMINING ATTORNEY

SN 77-140,234. BIGORB, LLC, SCOTTSDALE, AZ. FILED 3-26-2007.

ORBCAST

THE MARK CONSISTS OF STANDARD CHARACTERS WITHOUT CLAIM TO ANY PARTICULAR FONT, STYLE, SIZE, OR COLOR.
FOR BROADCASTING PROGRAMS VIA A GLOBAL COMPUTER NETWORK; BROADCASTING SERVICES AND PROVISION OF TELECOMMUNICATION ACCESS TO AUDIO AND VIDEO CONTENT PROVIDED VIA THE INTERNET; AND TELECOMMUNICATION SERVICES, NAMELY, TRANSMISSION OF PODCASTS (U.S. CLS. 100, 101 AND 104).
PATRICIA EVANKO, EXAMINING ATTORNEY

SN 77-141,006. SETANTA SPORTS NORTH AMERICA LTD., SAN FRANCISCO, CA. FILED 3-27-2007.



NO CLAIM IS MADE TO THE EXCLUSIVE RIGHT TO USE "SPORTS", APART FROM THE MARK AS SHOWN.
THE COLOR(S) YELLOW, BLACK, AND WHITE IS/ARE CLAIMED AS A FEATURE OF THE MARK.
THE MARK CONSISTS OF SETANTA IN BLACK SUPERIMPOSED ONTO A YELLOW RECTANGLE DIRECTLY ABOVE SPORTS IN WHITE SUPERIMPOSED ONTO A BLACK RECTANGLE.
FOR INTERNATIONAL SPORTS TELEVISION BROADCASTING SERVICES (U.S. CLS. 100, 101 AND 104).
FIRST USE 4-1-2005; IN COMMERCE 4-1-2005.
BRENDAN REGAN, EXAMINING ATTORNEY

CLASS 38—(Continued).

SN 77-141,021. SETANTA SPORTS NORTH AMERICA LTD.,
SAN FRANCISCO, CA. FILED 3-27-2007.

SETANTA SPORTS

THE MARK CONSISTS OF STANDARD CHARACTERS
WITHOUT CLAIM TO ANY PARTICULAR FONT, STYLE,
SIZE, OR COLOR.

NO CLAIM IS MADE TO THE EXCLUSIVE RIGHT TO
USE "SPORTS", APART FROM THE MARK AS SHOWN.

FOR INTERNATIONAL SPORTS TELEVISION
BROADCASTING SERVICES (U.S. CLS. 100, 101 AND
104).

FIRST USE 4-1-2005; IN COMMERCE 4-1-2005.
BRENDAN REGAN, EXAMINING ATTORNEY

SN 77-141,026. SETANTA SPORTS NORTH AMERICA LTD.,
SAN FRANCISCO, CA. FILED 3-27-2007.

SETANTA

THE MARK CONSISTS OF STANDARD CHARACTERS
WITHOUT CLAIM TO ANY PARTICULAR FONT, STYLE,
SIZE, OR COLOR.

FOR INTERNATIONAL SPORTS TELEVISION
BROADCASTING SERVICES (U.S. CLS. 100, 101 AND
104).

FIRST USE 4-1-2005; IN COMMERCE 4-1-2005.
BRENDAN REGAN, EXAMINING ATTORNEY

SN 77-141,912. BASISTA, CHRISTOPHER, MANVILLE, NJ.
FILED 3-27-2007.

ElectricFM

THE MARK CONSISTS OF STANDARD CHARACTERS
WITHOUT CLAIM TO ANY PARTICULAR FONT, STYLE,
SIZE, OR COLOR.

FOR RADIO BROADCASTING; WEBCASTING SER-
VICES; STREAMING OF AUDIO MATERIAL ON THE
INTERNET; RADIO BROADCASTING OF INFOR-
MATION AND OTHER PROGRAMS (U.S. CLS. 100, 101 AND
104).

TEJIBIR SINGH, EXAMINING ATTORNEY

CLASS 38—(Continued).

SN 77-141,966. COLLABNET, INC., BRISBANE, CA. FILED 3-
27-2007.



OWNER OF U.S. REG. NOS. 2,591,636 AND 3,215,006.
THE MARK CONSISTS OF A STYLIZED FLOWER WITH
WORD OPENCOLLABNET.

FOR PROVIDING ON-LINE ELECTRONIC BULLETIN
BOARDS AND FORUMS FOR TRANSMISSION OF
MESSAGES, ARTICLES, DOCUMENTS, WHITE PAPERS,
DATA AND INFORMATION AMONG COMPUTER
USERS CONCERNING OPEN-SOURCE DEVELOPMENT
TOOLS, COMPUTER AND TECHNOLOGY, COMPUTER
SOFTWARE DEVELOPMENT AND PROGRAMMING,
SOFTWARE TRAINING, WEB SITE DESIGN AND DE-
VELOPMENT, APPLICATION HOSTING RESOURCES,
AND TECHNICAL SUPPORT RESOURCES; PROVIDING
WEBCASTS, PODCASTS AND STREAMING AUDIO/
VIDEO IN THE FIELDS OF COMPUTER SOFTWARE
DEVELOPMENT, COMPUTER SOFTWARE DEVELOP-
MENT TOOLS, OPEN-SOURCE DEVELOPMENT TOOLS,
COMPUTER SOFTWARE, OPEN-SOURCE DEVELOP-
MENT COMMUNITIES, COMPUTER AND TECHNOL-
OGY, SOFTWARE TRAINING, AND TECHNICAL
SUPPORT RESOURCES (U.S. CLS. 100, 101 AND 104).

FIRST USE 10-20-2006; IN COMMERCE 10-20-2006.
CAROLINE WOOD, EXAMINING ATTORNEY

SN 77-142,024. CHARLES INFANTE, LOS ANGELES, CA.
FILED 3-27-2007.

The Confessional

THE MARK CONSISTS OF STANDARD CHARACTERS
WITHOUT CLAIM TO ANY PARTICULAR FONT, STYLE,
SIZE, OR COLOR.

FOR STREAMING OF VIDEO MATERIAL ON THE
INTERNET (U.S. CLS. 100, 101 AND 104).

EDWARD NELSON, EXAMINING ATTORNEY

CLASS 38—(Continued).

SN 77-143,060. UNITED FOOTBALL LEAGUE, LLC, SAN FRANCISCO, CA. FILED 3-28-2007.

CLASS 38—(Continued).

SN 77-143,210. AUTOMOTIVE RENTALS, INC., MOUNT LAUREL, NJ. FILED 3-28-2007.

UFL

ENVIROFLEET

THE MARK CONSISTS OF STANDARD CHARACTERS WITHOUT CLAIM TO ANY PARTICULAR FONT, STYLE, SIZE, OR COLOR.

FOR AUDIO BROADCASTING; BROADCAST OF CABLE TELEVISION PROGRAMMES; BROADCASTING PROGRAMS VIA A GLOBAL COMPUTER NETWORK; BROADCASTING SERVICES AND PROVISION OF TELECOMMUNICATION ACCESS TO FILMS AND TV PROGRAMMES PROVIDED VIA A VIDEO-ON-DEMAND SERVICE; BROADCASTING SERVICES AND PROVISION OF TELECOMMUNICATION ACCESS TO VIDEO AND AUDIO CONTENT PROVIDED VIA A VIDEO-ON-DEMAND SERVICE VIA THE INTERNET; CABLE CASTING SERVICES; CABLE RADIO BROADCASTING; CABLE RADIO TRANSMISSION; CABLE TELEVISION BROADCASTING; CABLE TELEVISION TRANSMISSION; COMPUTER AIDED TRANSMISSION OF INFORMATION AND IMAGES; ELECTRONIC EXCHANGE OF DATA STORED IN DATABASES ACCESSIBLE VIA TELECOMMUNICATION NETWORKS; MOBILE MEDIA AND ENTERTAINMENT SERVICES IN THE NATURE OF ELECTRONIC TRANSMISSION OF ENTERTAINMENT MEDIA CONTENT; NEWS AGENCIES, NAMELY, THE TRANSMISSION OF NEWS ITEMS TO NEWS REPORTING ORGANIZATIONS; PAY-PER-VIEW TELEVISION TRANSMISSION SERVICES; PODCASTING SERVICES; PROVIDING INTERNET CHATROOMS; PROVIDING ON-LINE CHAT ROOMS AND ELECTRONIC BULLETIN BOARDS FOR TRANSMISSION OF MESSAGES AMONG USERS IN THE FIELD OF GENERAL INTEREST; PROVIDING ON-LINE CHAT ROOMS FOR TRANSMISSION OF MESSAGES AMONG COMPUTER USERS CONCERNING SPORTS; PROVIDING ON-LINE COMMUNICATIONS LINKS WHICH TRANSFER THE WEBSITE USER TO OTHER LOCAL AND GLOBAL WEB PAGES; PROVIDING ON-LINE ELECTRONIC BULLETIN BOARDS FOR TRANSMISSION OF MESSAGES AMONG COMPUTER USERS CONCERNING SPORTS; RADIO BROADCASTING; RADIO BROADCASTING CONSULTATION; RADIO BROADCASTING INFORMATION; RADIO BROADCASTING OF INFORMATION AND OTHER PROGRAMS; RADIO COMMUNICATION; RADIO PROGRAM BROADCASTING; RADIO PROGRAMME BROADCASTING; SATELLITE TELEVISION BROADCASTING; SATELLITE TRANSMISSION OF MESSAGES AND DATA FOR NAVIGATION BY AIR; STREAMING OF AUDIO MATERIAL ON THE INTERNET; STREAMING OF VIDEO MATERIAL ON THE INTERNET; SUBSCRIPTION TELEVISION BROADCASTING; VIDEO-ON-DEMAND TRANSMISSION SERVICES (U.S. CLS. 100, 101 AND 104).
JORDAN BAKER, EXAMINING ATTORNEY

THE MARK CONSISTS OF STANDARD CHARACTERS WITHOUT CLAIM TO ANY PARTICULAR FONT, STYLE, SIZE, OR COLOR.

FOR EMAIL NOTIFICATIONS, NAMELY, DATA COMMUNICATION BY ELECTRONIC MAIL REGARDING SCHEDULED PREVENTATIVE MAINTENANCE OF VEHICLE FLEETS; VEHICLE FLEET PREVENTATIVE MAINTENANCE REMINDER SERVICE, NAMELY ELECTRONIC MAIL SERVICES FOR USE IN REMINDING CUSTOMERS OF PREVENTATIVE MAINTENANCE OF VEHICLE FLEETS (U.S. CLS. 100, 101 AND 104).
FIRST USE 3-5-2007; IN COMMERCE 3-5-2007.
ANDREW RHIM, EXAMINING ATTORNEY

SN 77-143,309. SONY PICTURES TELEVISION INC., CULVER CITY, CA. FILED 3-29-2007.

ENTERTAINMENT ON THE MOVE

THE MARK CONSISTS OF STANDARD CHARACTERS WITHOUT CLAIM TO ANY PARTICULAR FONT, STYLE, SIZE, OR COLOR.

NO CLAIM IS MADE TO THE EXCLUSIVE RIGHT TO USE "ENTERTAINMENT", APART FROM THE MARK AS SHOWN.
FOR ENTERTAINMENT SERVICES IN THE NATURE OF TRANSMITTING ENTERTAINMENT PROGRAMMING VIA GLOBAL COMPUTER NETWORKS FOR VIEWING ON WIRELESS DEVICES (U.S. CLS. 100, 101 AND 104).
FIRST USE 3-26-2007; IN COMMERCE 3-26-2007.
SANI KHOURI, EXAMINING ATTORNEY

CLASS 38—(Continued).

SN 77-147,475. AT&T KNOWLEDGE VENTURES II, L.P., RENO, TX. FILED 4-3-2007.

AT&T TECH CHANNEL

THE MARK CONSISTS OF STANDARD CHARACTERS WITHOUT CLAIM TO ANY PARTICULAR FONT, STYLE, SIZE, OR COLOR.

OWNER OF U.S. REG. NOS. 1,296,936 AND 1,298,084.

NO CLAIM IS MADE TO THE EXCLUSIVE RIGHT TO USE "TECH CHANNEL", APART FROM THE MARK AS SHOWN.

FOR TELECOMMUNICATIONS SERVICES, NAMELY THE ELECTRONIC TRANSMISSION OF VOICE, DATA, FACSIMILE, VIDEO AND INFORMATION; INTERNET AND CABLE TELEVISION BROADCASTING OF INFORMATION RELATING TO THE OPERATION, DEPLOYMENT, MAINTENANCE, AND SECURITY OF TELECOMMUNICATIONS, COMPUTER NETWORKS AND SYSTEMS (U.S. CLS. 100, 101 AND 104).

LEE-ANNE BERNS, EXAMINING ATTORNEY

SN 77-150,803. CLEAR CHANNEL BROADCASTING, INC., SAN ANTONIO, TX. FILED 4-6-2007.

PYOM

THE MARK CONSISTS OF STANDARD CHARACTERS WITHOUT CLAIM TO ANY PARTICULAR FONT, STYLE, SIZE, OR COLOR.

FOR RADIO BROADCASTING SERVICES VIA HIGH DEFINITION, SATELLITE, GLOBAL COMMUNICATIONS NETWORK, CABLE, COMPUTER, WIRELESS, TELEPHONE AND TERRESTRIAL MEANS; PROVIDING STREAMING OF DOWNLOADABLE AUDIO AND VIDEO PROGRAMS ON THE INTERNET (U.S. CLS. 100, 101 AND 104).

AMY HELLA, EXAMINING ATTORNEY

SN 77-150,812. CLEAR CHANNEL BROADCASTING, INC., SAN ANTONIO, TX. FILED 4-6-2007.

MYPLACE

THE MARK CONSISTS OF STANDARD CHARACTERS WITHOUT CLAIM TO ANY PARTICULAR FONT, STYLE, SIZE, OR COLOR.

FOR RADIO BROADCASTING SERVICES VIA HIGH DEFINITION, SATELLITE, GLOBAL COMMUNICATIONS NETWORK, CABLE, COMPUTER, WIRELESS, TELEPHONE AND TERRESTRIAL MEANS; PROVIDING STREAMING OF DOWNLOADABLE AUDIO AND VIDEO PROGRAMS ON THE INTERNET (U.S. CLS. 100, 101 AND 104).

AMY HELLA, EXAMINING ATTORNEY

CLASS 38—(Continued).

SN 77-161,479. SPC DIGITAL, INC., BIRMINGHAM, AL. FILED 4-20-2007.

MYRECIPES.COM

THE MARK CONSISTS OF STANDARD CHARACTERS WITHOUT CLAIM TO ANY PARTICULAR FONT, STYLE, SIZE, OR COLOR.

FOR STREAMING OF AUDIO AND VIDEO MATERIAL ON THE INTERNET AND THROUGH MOBILE COMMUNICATIONS DEVICES IN THE FIELDS OF COOKING, FOODS, BEVERAGES, ENTERTAINING, KITCHEN EQUIPMENT AND LIFESTYLES (U.S. CLS. 100, 101 AND 104).

LYDIA BELZER, EXAMINING ATTORNEY

SN 77-161,484. SPC DIGITAL, INC., BIRMINGHAM, AL. FILED 4-20-2007.

MYRECIPES

THE MARK CONSISTS OF STANDARD CHARACTERS WITHOUT CLAIM TO ANY PARTICULAR FONT, STYLE, SIZE, OR COLOR.

FOR STREAMING OF AUDIO AND VIDEO MATERIAL ON THE INTERNET AND THROUGH MOBILE COMMUNICATIONS DEVICES IN THE FIELDS OF COOKING, FOODS, BEVERAGES, ENTERTAINING, KITCHEN EQUIPMENT AND LIFESTYLES (U.S. CLS. 100, 101 AND 104).

LYDIA BELZER, EXAMINING ATTORNEY

SN 77-162,267. CLEAR CHANNEL BROADCASTING, INC., SAN ANTONIO, TX. FILED 4-20-2007.

PARTY TOWN

THE MARK CONSISTS OF STANDARD CHARACTERS WITHOUT CLAIM TO ANY PARTICULAR FONT, STYLE, SIZE, OR COLOR.

FOR RADIO BROADCASTING SERVICES VIA HIGH DEFINITION, SATELLITE, GLOBAL COMMUNICATIONS NETWORK, CABLE, COMPUTER, WIRELESS, TELEPHONE AND TERRESTRIAL MEANS; PROVIDING STREAMING OF DOWNLOADABLE AUDIO AND VIDEO PROGRAMS ON THE INTERNET (U.S. CLS. 100, 101 AND 104).

AMY HELLA, EXAMINING ATTORNEY

CLASS 38—(Continued).

SN 77-162,276. ITRON, INC., LIBERTY LAKE, WA. FILED 4-20-2007.

CHOICECONNECT

THE MARK CONSISTS OF STANDARD CHARACTERS WITHOUT CLAIM TO ANY PARTICULAR FONT, STYLE, SIZE, OR COLOR.

FOR TELECOMMUNICATION, COMMUNICATION AND NETWORKING SERVICES, NAMELY, ELECTRONIC DELIVERY AND TRANSMISSION OF MESSAGES, DATA, DOCUMENTS, AND INFORMATION VIA THE INTERNET, INTRANETS, EXTRANETS, RADIO FREQUENCY NETWORKS, SATELLITE, WIRELESS NETWORKS, TELEPHONE LINES, AND INTEGRATED COMMUNICATIONS NETWORKS, NAMELY, PUBLIC SWITCHED TELEPHONE NETWORKS, IP-BASED PUBLIC NETWORKS, VIRTUAL PRIVATE NETWORKS, PRIVATE NETWORKS, POWERLINE AND BROADBAND OVER POWERLINE NETWORKS, PUBLIC NETWORKS AND CELLULAR NETWORKS FOR UTILITY AND ENERGY DATA, AND OTHER UTILITY METER MONITORING POINTS; ELECTRONIC DELIVERY AND TRANSMISSION OF MESSAGES, ENERGY AND UTILITY CONSUMPTION AND EVENT INFORMATION (U.S. CLS. 100, 101 AND 104).

FRANK LATTUCA, EXAMINING ATTORNEY

CLASS 38—(Continued).

SN 77-175,213. AIRCELL LLC, LOUISVILLE, CO. FILED 5-8-2007.

AIRCELL ON BOARD

THE MARK CONSISTS OF STANDARD CHARACTERS WITHOUT CLAIM TO ANY PARTICULAR FONT, STYLE, SIZE, OR COLOR.

OWNER OF U.S. REG. NOS. 2,552,129 AND 2,606,334.
FOR BROADBAND AND NARROWBAND COMMUNICATION SERVICES ONBOARD AIRCRAFTS TO ENABLE USERS TO TRANSMIT AND RECEIVE VOICE, VIDEO, AND DATA WITHIN THE AIRCRAFTS, BETWEEN THE AIRCRAFTS, BETWEEN THE AIRCRAFTS AND THE GROUND, AND BETWEEN THE GROUND AND THE AIRCRAFTS; BROADBAND AND NARROWBAND COMMUNICATION SERVICES TO INTERCONNECT USERS, LOCATED ONBOARD AN AIRCRAFT, WITH USERS LOCATED ONBOARD ANOTHER AIRCRAFT, TO INTERCONNECT USERS LOCATED ONBOARD AN AIRCRAFT WITH USERS AND DESTINATIONS ON THE GROUND, TO INTERCONNECT USERS AND DESTINATIONS ON THE GROUND WITH USERS ONBOARD THE AIRCRAFTS, AND TO INTERCONNECT USERS LOCATED ONBOARD AN AIRCRAFT (U.S. CLS. 100, 101 AND 104).

BRENDAN MCCAULEY, EXAMINING ATTORNEY

SN 77-175,208. AIRCELL LLC, LOUISVILLE, CO. FILED 5-8-2007.

AIRCELL AXXESS

THE MARK CONSISTS OF STANDARD CHARACTERS WITHOUT CLAIM TO ANY PARTICULAR FONT, STYLE, SIZE, OR COLOR.

FOR BROADBAND AND NARROWBAND COMMUNICATION SERVICES ONBOARD AIRCRAFTS TO ENABLE USERS TO TRANSMIT AND RECEIVE VOICE, VIDEO, AND DATA WITHIN THE AIRCRAFTS, BETWEEN THE AIRCRAFTS, BETWEEN THE AIRCRAFTS AND THE GROUND, AND BETWEEN THE GROUND AND THE AIRCRAFTS; BROADBAND AND NARROWBAND COMMUNICATION SERVICES TO INTERCONNECT USERS, LOCATED ONBOARD AN AIRCRAFT, WITH USERS LOCATED ONBOARD ANOTHER AIRCRAFT, TO INTERCONNECT USERS LOCATED ONBOARD AN AIRCRAFT WITH USERS AND DESTINATIONS ON THE GROUND, TO INTERCONNECT USERS AND DESTINATIONS ON THE GROUND WITH USERS ONBOARD THE AIRCRAFTS, AND TO INTERCONNECT USERS LOCATED ONBOARD AN AIRCRAFT (U.S. CLS. 100, 101 AND 104).

BRENDAN MCCAULEY, EXAMINING ATTORNEY

SN 77-175,218. AIRCELL LLC, LOUISVILLE, CO. FILED 5-8-2007.

IN TOUCH, IN FLIGHT

THE MARK CONSISTS OF STANDARD CHARACTERS WITHOUT CLAIM TO ANY PARTICULAR FONT, STYLE, SIZE, OR COLOR.

OWNER OF U.S. REG. NOS. 2,307,311 AND 2,600,307.
FOR BROADBAND AND NARROWBAND COMMUNICATION SERVICES ONBOARD AIRCRAFTS TO ENABLE USERS TO TRANSMIT AND RECEIVE VOICE, VIDEO, AND DATA WITHIN THE AIRCRAFTS, BETWEEN THE AIRCRAFTS, BETWEEN THE AIRCRAFTS AND THE GROUND, AND BETWEEN THE GROUND AND THE AIRCRAFTS; BROADBAND AND NARROWBAND COMMUNICATION SERVICES TO INTERCONNECT USERS, LOCATED ONBOARD AN AIRCRAFT, WITH USERS LOCATED ONBOARD ANOTHER AIRCRAFT, TO INTERCONNECT USERS LOCATED ONBOARD AN AIRCRAFT WITH USERS AND DESTINATIONS ON THE GROUND, TO INTERCONNECT USERS AND DESTINATIONS ON THE GROUND WITH USERS ONBOARD THE AIRCRAFTS, AND TO INTERCONNECT USERS LOCATED ONBOARD AN AIRCRAFT (U.S. CLS. 100, 101 AND 104).

BRENDAN MCCAULEY, EXAMINING ATTORNEY

CLASS 38—(Continued).

SN 77-176,025. PEARSON,GREGORY A., DUNEDIN, FL.
FILED 5-8-2007.

STARCAM

THE MARK CONSISTS OF STANDARD CHARACTERS WITHOUT CLAIM TO ANY PARTICULAR FONT, STYLE, SIZE, OR COLOR.

FOR INSTANT MESSAGING SERVICES; AUDIO AND VIDEO BROADCASTING SERVICES OVER THE INTERNET; PROVIDING E-MAIL SERVICES; VIDEO TELECONFERENCING; VIDEO-ON-DEMAND TRANSMISSION SERVICES; WEB CONFERENCING SERVICES (U.S. CLS. 100, 101 AND 104).

DEZMONA MIZELLE, EXAMINING ATTORNEY

SN 77-176,669. CLEAR CHANNEL BROADCASTING, INC.,
SAN ANTONIO, TX. FILED 5-9-2007.

ALL DAY LONG

THE MARK CONSISTS OF STANDARD CHARACTERS WITHOUT CLAIM TO ANY PARTICULAR FONT, STYLE, SIZE, OR COLOR.

FOR RADIO BROADCASTING SERVICES VIA HIGH DEFINITION, SATELLITE, GLOBAL COMMUNICATIONS NETWORK, CABLE, COMPUTER, WIRELESS, TELEPHONE AND TERRESTRIAL MEANS; PROVIDING STREAMING OF DOWNLOADABLE AUDIO AND VIDEO PROGRAMS ON THE INTERNET (U.S. CLS. 100, 101 AND 104).

AMY HELLA, EXAMINING ATTORNEY

SN 77-178,319. USP COMMUNICATIONS, INC., SALT LAKE CITY, UT. FILED 5-10-2007.

USP Connect

THE MARK CONSISTS OF STANDARD CHARACTERS WITHOUT CLAIM TO ANY PARTICULAR FONT, STYLE, SIZE, OR COLOR.

NO CLAIM IS MADE TO THE EXCLUSIVE RIGHT TO USE "CONNECT", APART FROM THE MARK AS SHOWN.
FOR VOICE OVER INTERNET PROTOCOL (VOIP) SERVICES (U.S. CLS. 100, 101 AND 104).

LINDA LAVACHE, EXAMINING ATTORNEY

CLASS 38—(Continued).

SN 77-185,631. CLEAR CHANNEL BROADCASTING, INC.,
SAN ANTONIO, TX. FILED 5-21-2007.

BLANK CANVAS

THE MARK CONSISTS OF STANDARD CHARACTERS WITHOUT CLAIM TO ANY PARTICULAR FONT, STYLE, SIZE, OR COLOR.

FOR RADIO BROADCASTING SERVICES VIA HIGH DEFINITION, SATELLITE, GLOBAL COMMUNICATIONS NETWORK, CABLE, COMPUTER, WIRELESS, TELEPHONE AND TERRESTRIAL MEANS; PROVIDING STREAMING OF DOWNLOADABLE AUDIO AND VIDEO PROGRAMS ON THE INTERNET (U.S. CLS. 100, 101 AND 104).

AMY HELLA, EXAMINING ATTORNEY

SN 77-190,819. SPC DIGITAL, INC., BIRMINGHAM, AL.
FILED 5-25-2007.

MYHOMEIDEAS.COM

THE MARK CONSISTS OF STANDARD CHARACTERS WITHOUT CLAIM TO ANY PARTICULAR FONT, STYLE, SIZE, OR COLOR.

FOR STREAMING OF AUDIO AND VIDEO MATERIAL ON THE INTERNET AND THROUGH MOBILE COMMUNICATIONS DEVICES IN THE FIELDS OF HOMES, GARDENS, LANDSCAPING, HOME DESIGN, HOME DECORATING, HOME REMODELING, REAL ESTATE, AND LIFESTYLES (U.S. CLS. 100, 101 AND 104).

LYDIA BELZER, EXAMINING ATTORNEY

SN 78-290,265. QWEST COMMUNICATIONS INTERNATIONAL INC., DENVER, CO. FILED 8-21-2003.

QWEST DSL PRO DELUXE

OWNER OF U.S. REG. NOS. 1,966,694, 2,210,992 AND 2,646,655.

NO CLAIM IS MADE TO THE EXCLUSIVE RIGHT TO USE "DSL PRO DELUXE", APART FROM THE MARK AS SHOWN.

FOR TELECOMMUNICATION SERVICES, NAMELY, PROVIDING HIGH SPEED ACCESS TO COMPUTERS, MOBILE PHONES, PERSONAL DIGITAL ASSISTANTS, WIRELESS PAGERS OR AREA NETWORKS FOR DATA AND VOICE COMMUNICATION; TELEPHONE COMMUNICATION SERVICES; ELECTRONIC TRANSMISSION OF VOICE, VIDEO, MESSAGES AND DATA; PROVIDING ACCESS TO A FIBER-OPTIC TELECOMMUNICATIONS NETWORK; PROVIDING ACCESS TO A GLOBAL COMPUTER INFORMATION NETWORK; PROVIDING MULTIPLE USER ACCESS TO A GLOBAL COMPUTER NETWORK; BROADCASTING PROGRAMS VIA A GLOBAL COMPUTER NETWORK; VIDEO TELECONFERENCING SERVICES AND WIRELESS COMMUNICATION SERVICES (U.S. CLS. 100, 101 AND 104).

FIRST USE 8-15-2003; IN COMMERCE 8-15-2003.
ANDREA SAUNDERS, EXAMINING ATTORNEY

CLASS 38—(Continued).

SN 78-820,145. MYNETWORKTV, INC., LOS ANGELES, CA. FILED 2-21-2006.

MYNETWORKTV

THE MARK CONSISTS OF STANDARD CHARACTERS WITHOUT CLAIM TO ANY PARTICULAR FONT, STYLE, SIZE, OR COLOR.

FOR TELEVISION TRANSMISSION AND BROADCASTING SERVICES; STREAMING OF AUDIO MATERIALS ON THE INTERNET AND STREAMING OF VIDEO MATERIALS ON THE INTERNET (U.S. CLS. 100, 101 AND 104).

MARCIE MILONE, EXAMINING ATTORNEY

SN 78-843,814. SARDANA KARIN, CHANDLER, AZ. FILED 3-22-2006.



NO CLAIM IS MADE TO THE EXCLUSIVE RIGHT TO USE "TOTAL CALL MANAGEMENT SOLUTIONS", APART FROM THE MARK AS SHOWN.

THE COLOR(S) RED, GRAY AND GREEN IS/ARE CLAIMED AS A FEATURE OF THE MARK.

THE COLOR(S) RED APPEARS IN THE SERIES OF DOTS IN THE DESIGN ELEMENT OF THE MARK, THE COLOR GRAY APPEARS IN THE PAIR OF SEMI-ELLIPTICAL DESIGN ELEMENTS AND THE COLOR GREEN APPEARS IN ALL THE TEXTUAL ELEMENTS OF THE MARK.

FOR AUDIO BROADCASTING; AUDIO TELECONFERENCING; BROADCASTING PROGRAMS VIA A GLOBAL COMPUTER NETWORK; BROADCASTING SERVICES AND PROVISION OF TELECOMMUNICATION ACCESS TO FILMS AND TV PROGRAMMES PROVIDED VIA A VIDEO-ON-DEMAND SERVICE; CALL FORWARDING SERVICES; CELLULAR TELEPHONE COMMUNICATION; CELLULAR TELEPHONE SERVICES; COMMUNICATION BY ELECTRONIC COMPUTER TERMINALS; COMMUNICATION SERVICES, NAMELY, ELECTRONIC TRANSMISSION OF DATA AND DOCUMENTS AMONG USERS OF COMPUTERS; COMMUNICATION VIA ANALOGUE AND DIGITAL COMPUTER TERMINALS; COMMUNICATION VIA COMPUTER TERMINALS, BY DIGITAL TRANSMISSION OR BY SATELLITE; COMMUNICATION VIA FIBRE OPTICAL NETWORKS; COMMUNICATION VIA FIBRE-OPTIC NETWORKS; COMMUNICATION VIA OPTICAL FIBRE NETWORKS; COMMUNICATIONS BY COMPUTER TERMINALS; COMMUNICATIONS BY TELEVISION FOR MEETING; COMMUNICATIONS SERVICES, NAMELY, TRANSMITTING STREAMED SOUND AND AUDIO-VISUAL RECORDINGS VIA THE INTERNET; COMMUNICATIONS VIA ANALOGUE AND DIGITAL COMPUTER TERMINALS; COMMUNICATIONS VIA FIBER-OPTIC NETWORKS; COMMUNICATIONS VIA FIBRE-OPTIC NETWORKS; COMMUNICATIONS VIA MULTINATIONAL TELECOMMUNICATION NETWORKS; COMPUTER AIDED TRANSMISSION OF INFORMATION AND IMAGES; COMPUTER TRANSMISSION OF INFORMATION ACCESSED VIA A CODE OR A TERMINAL; DATA COMMUNICATION BY ELECTRONIC MAIL; DATA TRANSMISSION AND RECEPTION SERVICES VIA TELECOMMUNICATION MEANS; DELIVERY OF MESSAGES BY ELECTRONIC TRANSMISSION; ELECTRONIC DATA INTERCHANGE (EDI) SERVICES; ELECTRONIC DATA INTERCHANGE;

CLASS 38—(Continued).

ELECTRONIC DATA TRANSMISSION; ELECTRONIC DELIVERY OF IMAGES AND PHOTOGRAPHS VIA A GLOBAL COMPUTER NETWORK; ELECTRONIC EXCHANGE OF DATA STORED IN DATABASES ACCESSIBLE VIA TELECOMMUNICATION NETWORKS; ELECTRONIC MAIL SERVICES; ELECTRONIC MESSAGE SENDING; ELECTRONIC MESSAGE TRANSMISSION; ELECTRONIC STORE-AND-FORWARD MESSAGING; ELECTRONIC TRANSMISSION OF DATA AND DOCUMENTS VIA COMPUTER TERMINALS; ELECTRONIC TRANSMISSION OF FACSIMILE COMMUNICATIONS AND DATA FEATURING ENCRYPTION AND DECRYPTION; ELECTRONIC TRANSMISSION OF MESSAGES AND DATA; ELECTRONIC VOICE MESSAGING, NAMELY, THE RECORDING AND SUBSEQUENT TRANSMISSION OF VOICE MESSAGES BY TELEPHONE; ELECTRONIC, ELECTRIC, AND DIGITAL TRANSMISSION OF VOICE, DATA, IMAGES, SIGNALS, AND MESSAGES; E-MAIL FORWARDING SERVICES; FACSIMILE TRANSMISSION; INFORMATION TRANSMISSION SERVICES VIA DIGITAL NETWORKS; INFORMATION TRANSMISSION VIA ELECTRONIC COMMUNICATIONS NETWORKS; INSTANT MESSAGING SERVICES; INTERNET TELEPHONY SERVICES; INTERSTATE TELEPHONE SERVICES; INTRASTATE TELEPHONE SERVICES; LEASING OF TELECOMMUNICATION EQUIPMENT, NAMELY, COMPUTER AND TELEPHONE EQUIPMENT; LEASING OF TELECOMMUNICATIONS LINES; LEASING OF TELECOMMUNICATION EQUIPMENT; MOBILE TELEPHONE COMMUNICATION; OUTCALL NOTIFICATION SERVICES; PBX DIALING SERVICES; PREPAID LONG DISTANCE TELEPHONE SERVICES; PROVIDING A HIGH SPEED ACCESS TO AREA NETWORKS AND A GLOBAL COMPUTER INFORMATION NETWORK; PROVIDING ACCESS TO TELECOMMUNICATION NETWORKS; PROVIDING CO-LOCATION SERVICES FOR VOICE, VIDEO AND DATA COMMUNICATIONS APPLICATIONS; PROVIDING ELECTRONIC TELECOMMUNICATION CONNECTIONS; PROVIDING E-MAIL SERVICES; PROVIDING FRAME RELAY CONNECTIVITY SERVICES FOR DATA TRANSFER (U.S. CLS. 100, 101 AND 104).

FIRST USE 11-1-2001; IN COMMERCE 11-1-2001.

DAVID H. STINE, EXAMINING ATTORNEY

SN 78-861,447. WATERFALL MOBILE, SAN FRANCISCO, CA. FILED 4-13-2006.

Waterfall Mobile

THE MARK CONSISTS OF STANDARD CHARACTERS WITHOUT CLAIM TO ANY PARTICULAR FONT, STYLE, SIZE, OR COLOR.

NO CLAIM IS MADE TO THE EXCLUSIVE RIGHT TO USE "MOBILE", APART FROM THE MARK AS SHOWN.

FOR MOBILE MEDIA SERVICE IN THE NATURE OF ELECTRONIC TRANSMISSION OF ENTERTAINMENT MEDIA CONTENT (U.S. CLS. 100, 101 AND 104).

WOODROW HARTZOG, EXAMINING ATTORNEY

CLASS 38—(Continued).

SN 78-905,827. INTERNET INFIDELS, INC., COLORADO SPRINGS, CO. FILED 6-12-2006.

Internet Infidels

THE MARK CONSISTS OF STANDARD CHARACTERS WITHOUT CLAIM TO ANY PARTICULAR FONT, STYLE, SIZE, OR COLOR.

FOR PROVIDING ON-LINE CHAT ROOMS AND ELECTRONIC BULLETIN BOARDS FOR TRANSMISSION OF MESSAGES AMONG USERS IN THE FIELDS OF NON-THEISTIC WORLDVIEWS AND METAPHYSICAL NATURALISM (U.S. CLS. 100, 101 AND 104).

FIRST USE 7-31-1996; IN COMMERCE 7-31-1996.
GINA FINK, EXAMINING ATTORNEY

SN 78-921,013. MYNETWORKTV, INC., LOS ANGELES, CA. FILED 6-30-2006.

MYNETWORKTV

THE MARK CONSISTS OF STANDARD CHARACTERS WITHOUT CLAIM TO ANY PARTICULAR FONT, STYLE, SIZE, OR COLOR.

FOR PROVIDING ON-LINE CHAT ROOMS AND ELECTRONIC BULLETIN BOARDS FOR TRANSMISSION OF MESSAGES AMONG USERS IN THE FIELD OF GENERAL INTEREST; PROVIDING E-MAIL AND INSTANT MESSAGING SERVICES; PROVIDING MULTIPLE-USER ACCESS TO A GLOBAL COMPUTER INFORMATION NETWORK; PROVIDING MULTIPLE-USER ACCESS TO A GLOBAL COMPUTER NETWORK FOR THE TRANSFER AND DISSEMINATION OF A WIDE RANGE OF INFORMATION AND SERVICES, AND FOR ACCESSING THIRD PARTY AND PROPRIETARY WEB SITES; ELECTRONIC TRANSMISSION OF DATA AND DOCUMENTS VIA A GLOBAL COMPUTER NETWORK; DIGITAL TRANSMISSION OF DATA AND DOCUMENTS; VIDEO ON DEMAND TRANSMISSION SERVICES (U.S. CLS. 100, 101 AND 104).

MARCIE MILONE, EXAMINING ATTORNEY

CLASS 38—(Continued).

SN 78-927,853. KORE WIRELESS GROUP INC., HERNDON, VA. FILED 7-12-2006.

KORE TELEMATICS

THE MARK CONSISTS OF STANDARD CHARACTERS WITHOUT CLAIM TO ANY PARTICULAR FONT, STYLE, SIZE, OR COLOR.

NO CLAIM IS MADE TO THE EXCLUSIVE RIGHT TO USE "TELEMATICS", APART FROM THE MARK AS SHOWN.

FOR PROVISION OF WIRELESS COMMUNICATIONS SERVICES, EXCLUDING RETAIL CELLULAR TELEPHONE SERVICES, FOR USE IN TELEMETRY AND TELEMATICS APPLICATIONS FOR USE IN VEHICLE LOCATION AND TRACKING, POINT OF SALE AND VENDING, ASSET TRACKING, PERSONAL SECURITY, HEALTHCARE, ENERGY MANAGEMENT, ENVIRONMENTAL SERVICES, AND INDUSTRIAL MONITORING (U.S. CLS. 100, 101 AND 104).

LINDA POWELL, EXAMINING ATTORNEY

SN 78-927,860. KORE WIRELESS GROUP INC., HERNDON, VA. FILED 7-12-2006.

KORE M2M

THE MARK CONSISTS OF STANDARD CHARACTERS WITHOUT CLAIM TO ANY PARTICULAR FONT, STYLE, SIZE, OR COLOR.

NO CLAIM IS MADE TO THE EXCLUSIVE RIGHT TO USE "M2M", APART FROM THE MARK AS SHOWN.

FOR PROVISION OF WIRELESS COMMUNICATIONS SERVICES, EXCLUDING RETAIL CELLULAR TELEPHONE SERVICES, FOR USE IN TELEMETRY AND TELEMATICS APPLICATIONS FOR USE IN VEHICLE LOCATION AND TRACKING, POINT OF SALE AND VENDING, ASSET TRACKING, PERSONAL SECURITY, HEALTHCARE, ENERGY MANAGEMENT, ENVIRONMENTAL SERVICES, AND INDUSTRIAL MONITORING (U.S. CLS. 100, 101 AND 104).

LINDA POWELL, EXAMINING ATTORNEY

CLASS 38—(Continued).

SN 78-936,012. TIME INC., NEW YORK, NY. FILED 7-24-2006.

CLASS 38—(Continued).

SN 78-946,474. TALKPLUS, INC., SAN MATEO, CA. FILED 8-7-2006.

TRUSTED CONNECTIONS

SHADOWNUMBER

THE MARK CONSISTS OF STANDARD CHARACTERS WITHOUT CLAIM TO ANY PARTICULAR FONT, STYLE, SIZE, OR COLOR.

NO CLAIM IS MADE TO THE EXCLUSIVE RIGHT TO USE "CONNECTIONS", APART FROM THE MARK AS SHOWN.

FOR STREAMING OF AUDIO AND VIDEO MATERIAL ON THE INTERNET AND ON MOBILE PHONES, PERSONAL DIGITAL ASSISTANTS, HANDHELD DIGITAL ELECTRONIC DEVICES, AND OTHER PERSONAL MEDIA DEVICES; PROVIDING ONLINE CHAT ROOMS AND ONLINE ELECTRONIC BULLETIN BOARDS FOR TRANSMISSION OF MESSAGES AMONG COMPUTER USERS IN THE FIELD OF GENERAL INTEREST; WIRELESS ELECTRONIC TRANSMISSION OF VOICE SIGNALS, DATA, FACSIMILES, IMAGES AND INFORMATION (U.S. CLS. 100, 101 AND 104).

SHANNON TWOHIG, EXAMINING ATTORNEY

THE MARK CONSISTS OF STANDARD CHARACTERS WITHOUT CLAIM TO ANY PARTICULAR FONT, STYLE, SIZE, OR COLOR.

FOR PROVIDING LONG DISTANCE TELEPHONE COMMUNICATION SERVICES VIA THE INTERNET; PROVIDING WIRELESS COMMUNICATION SERVICES, NAMELY, CELLULAR TELEPHONE SERVICES, CELLULAR TELEPHONE COMMUNICATION SERVICES, NAMELY, IDENTITY MANAGEMENT FOR CONTROLLING AND MANAGING CALLS TO A USER'S WIRELESS, WIRE LINE, OR INTERNET PROTOCOL-CAPABLE TELEPHONY OR INSTANT MESSAGE DEVICE, MULTIPLE USER CONFERENCING, AND ROUTING AND JUNCTION SERVICES (U.S. CLS. 100, 101 AND 104).

JOANNA DUKOVIC, EXAMINING ATTORNEY



SN 78-940,179. GROUPVINE, INC., LOS ALTOS HILLS, CA. FILED 7-28-2006.

SN 78-952,953. CHANEY, DAVID M., LOS GATOS, CA. FILED 8-16-2006.

THE GROUPEY

THE CEO CORNER

THE MARK CONSISTS OF STANDARD CHARACTERS WITHOUT CLAIM TO ANY PARTICULAR FONT, STYLE, SIZE, OR COLOR.

FOR PROVIDING ONLINE BULLETIN BOARDS AND INTERACTIVE WEBPAGES FOR THE TRANSMISSION OF MESSAGES AND INFORMATION AMONG COMPUTER USERS CONCERNING EDUCATIONAL INSTITUTIONS AND COMMUNITY ORGANIZATIONS (U.S. CLS. 100, 101 AND 104).

JASON BLAIR, EXAMINING ATTORNEY

THE MARK CONSISTS OF STANDARD CHARACTERS WITHOUT CLAIM TO ANY PARTICULAR FONT, STYLE, SIZE, OR COLOR.

NO CLAIM IS MADE TO THE EXCLUSIVE RIGHT TO USE "CEO", APART FROM THE MARK AS SHOWN.

FOR COMMUNICATIONS SERVICES, NAMELY, TRANSMITTING STREAMED SOUND AND AUDIO-VISUAL RECORDINGS VIA THE INTERNET; MOBILE MEDIA AND ENTERTAINMENT SERVICES IN THE NATURE OF ELECTRONIC TRANSMISSION OF ENTERTAINMENT MEDIA CONTENT; PODCASTING SERVICES; WEBCASTING SERVICES (U.S. CLS. 100, 101 AND 104).

FIRST USE 9-1-2004; IN COMMERCE 9-1-2004.
ANDREA K. NADELMAN, EXAMINING ATTORNEY

CLASS 38—(Continued).

SN 78-969,653. KIRUSA INC, NEW PROVIDENCE, NJ. FILED 9-8-2006.

Kirusa Voice SMS

THE MARK CONSISTS OF STANDARD CHARACTERS WITHOUT CLAIM TO ANY PARTICULAR FONT, STYLE, SIZE, OR COLOR.

NO CLAIM IS MADE TO THE EXCLUSIVE RIGHT TO USE "VOICE SMS", APART FROM THE MARK AS SHOWN.

FOR VOICE MAIL SERVICES; ELECTRONIC VOICE MESSAGING, NAMELY, THE RECORDING AND SUBSEQUENT TRANSMISSION OF VOICE MESSAGES BY TELEPHONE; ELECTRONIC, ELECTRIC, AND DIGITAL TRANSMISSION OF VOICE, DATA, IMAGES, SIGNALS, AND MESSAGES; VOICE CHAT SERVICES; TELEPHONE VOICE MESSAGING SERVICES; WIRELESS ELECTRONIC TRANSMISSION OF VOICE SIGNALS, DATA, FACSIMILES, IMAGES AND INFORMATIONS; WIRELESS VOICE MAIL SERVICES; TELECOMMUNICATION SERVICES, NAMELY, LOCAL AND LONG DISTANCE TRANSMISSION OF VOICE, DATA, GRAPHICS BY MEANS OF TELEPHONE, TELEGRAPHIC, CABLE, AND SATELLITE TRANSMISSIONS; COMMUNICATION BY MOBILE TELEPHONE; COMMUNICATIONS BY MEANS OF MOBILE PHONES; MOBILE TELEPHONE COMMUNICATION; TELEPHONE COMMUNICATION SERVICES; CELLULAR TELEPHONE COMMUNICATION; TRANSMISSION OF SHORT MESSAGES; TRANSMISSION OF MESSAGES OVER ELECTRONIC MEDIA; DELIVERY OF MESSAGES BY ELECTRONIC TRANSMISSION; ELECTRONIC MESSAGE SENDING; ELECTRONIC MESSAGE TRANSMISSION (U.S. CLS. 100, 101 AND 104).

FIRST USE 7-9-2004; IN COMMERCE 7-9-2004.

ESTHER A. BORSUK, EXAMINING ATTORNEY

CLASS 39—TRANSPORTATION AND STORAGE

SN 76-671,298. CENTRAL MASS COURIERS, INC., WORCESTER, MA. FILED 1-11-2007.

LEADING THE WAY TO YOUR DOOR

THE MARK CONSISTS OF STANDARD CHARACTERS WITHOUT CLAIM TO ANY PARTICULAR FONT, STYLE, SIZE, OR COLOR.

OWNER OF U.S. REG. NO. 3,028,132.

FOR COURIER SERVICES OF GOODS, NAMELY, PARCELS AND MESSAGES, NAMELY, LETTERS, IN THE UNITED STATES AND ABROAD (U.S. CLS. 100 AND 105).

FIRST USE 10-4-2004; IN COMMERCE 10-4-2004.

ANDREA SAUNDERS, EXAMINING ATTORNEY

CLASS 39—(Continued).

SN 76-672,242. LUMASENSE, LLC, SOUTHPORT, CT. FILED 2-5-2007.

LUMASENSE

THE MARK CONSISTS OF STANDARD CHARACTERS WITHOUT CLAIM TO ANY PARTICULAR FONT, STYLE, SIZE, OR COLOR.

FOR DISTRIBUTION SERVICES, NAMELY, DELIVERY OF LED LIGHTING PRODUCTS FOR ARCHITECTURAL AND ENTERTAINMENT APPLICATIONS (U.S. CLS. 100 AND 105).

FIRST USE 1-10-2007; IN COMMERCE 1-10-2007.

CIMMERIAN COLEMAN, EXAMINING ATTORNEY

SN 76-672,443. ROYAL YACHT CRUISES, LLC, CELEBRATION, FL. FILED 2-8-2007.

ROYAL YACHT CRUISES

THE MARK CONSISTS OF STANDARD CHARACTERS WITHOUT CLAIM TO ANY PARTICULAR FONT, STYLE, SIZE, OR COLOR.

NO CLAIM IS MADE TO THE EXCLUSIVE RIGHT TO USE "YACHT CRUISES", APART FROM THE MARK AS SHOWN.

FOR CRUISE SHIP SERVICES, NAMELY THE OPERATION OF CRUISE SHIPS (U.S. CLS. 100 AND 105).

REBECCA SMITH, EXAMINING ATTORNEY

SN 76-674,786. FOODKITS, LLC, AVENEL, NJ. FILED 3-29-2007.

CHEF IN A BOX

THE MARK CONSISTS OF STANDARD CHARACTERS WITHOUT CLAIM TO ANY PARTICULAR FONT, STYLE, SIZE, OR COLOR.

FOR DELIVERY OF PREPARED MEALS AND PARTY KITS (U.S. CLS. 100 AND 105).

RICHARD A. STRASER, EXAMINING ATTORNEY

CLASS 39—(Continued).

SN 77-028,558. COAST 2 COAST FINE ART SERVICES, INC., PHOENIX, AZ. FILED 10-24-2006.



NO CLAIM IS MADE TO THE EXCLUSIVE RIGHT TO USE "COAST TO COAST" AND "FINE ART SERVICES, INC.", APART FROM THE MARK AS SHOWN.

THE MARK CONSISTS OF THE NO. 2 IS STYLIZED IN THE MARK.

FOR DELIVERY OF GOODS BY TRUCK; FREIGHT TRANSPORTATION BY TRUCK (U.S. CLS. 100 AND 105).

FIRST USE 12-31-2003; IN COMMERCE 12-31-2003.
ALICE BENMAMAN, EXAMINING ATTORNEY

CLASS 39—(Continued).

SN 77-085,627. 461462 ONTARIO LIMITED, TORONTO, CANADA, FILED 1-18-2007.

ROAD TO TRAVEL

SN 77-030,095. AVALON GLOBAL GROUP, ST. PETERSBURG, FL. FILED 10-26-2006.



OWNER OF U.S. REG. NOS. 1,399,850, 2,581,548 AND OTHERS.

NO CLAIM IS MADE TO THE EXCLUSIVE RIGHT TO USE "PERKS", APART FROM THE MARK AS SHOWN.

THE COLOR(S) BLUE, YELLOW AND RED IS/ARE CLAIMED AS A FEATURE OF THE MARK.

THE COLORS BLUE AND RED APPEAR IN THE WORDING, THE WORD PAYLESS APPEARS IN BLUE AND THE WORD PERKS APPEARS IN RED AND PARTIALLY OVERLYING THE WORD PAYLESS. FURTHER, THE COLORS BLUE, YELLOW APPEAR AS UNIFORM STRIPES ADJOINING A RED TRIANGLE.

FOR RENTAL OF VEHICLES (U.S. CLS. 100 AND 105).
FIRST USE 6-22-2005; IN COMMERCE 6-22-2005.
CIMMERIAN COLEMAN, EXAMINING ATTORNEY

THE MARK CONSISTS OF STANDARD CHARACTERS WITHOUT CLAIM TO ANY PARTICULAR FONT, STYLE, SIZE, OR COLOR.

PRIORITY CLAIMED UNDER SEC. 44(D) ON CANADA APPLICATION NO. 1,331,543, FILED 1-16-2007.

NO CLAIM IS MADE TO THE EXCLUSIVE RIGHT TO USE "TRAVEL", APART FROM THE MARK AS SHOWN.

FOR TRAVEL AGENCY SERVICES, NAMELY, MAKING RESERVATIONS AND BOOKINGS FOR TRANSPORTATION; PROVIDING A WEBSITE AND WEBSITE LINKS TO MAP IMAGES; PROVIDING TRAVEL INFORMATION OVER COMPUTER NETWORKS AND GLOBAL COMMUNICATION NETWORKS; PROVIDING INFORMATION IN THE FIELD OF TRAVEL VIA COMPUTER NETWORKS, GLOBAL INFORMATION NETWORKS, AND WIRELESS NETWORKS; ORGANIZING AND ARRANGING TRAVEL ACTIVITIES, NAMELY, TOURS, TRAVEL TO EVENTS AND TRAVEL TO ATTRACTIONS; MAKING TICKET RESERVATIONS FOR TRAVEL ACTIVITIES, NAMELY FOR TOURS, TRAVEL TO EVENTS AND TRAVEL TO ATTRACTIONS; PROVIDING GROUND TRANSPORTATION FOR PASSENGERS BY RAIL AND BUS TO TRAVEL ACTIVITIES, TOURS, EVENTS AND ATTRACTIONS; PROVIDING INFORMATION ABOUT TOURS AND TRAVEL TO EVENTS AND ATTRACTIONS; ORGANIZING AND CONDUCTING SIGHT-SEEING TOURS (U.S. CLS. 100 AND 105).

FIRST USE 8-1-2000; IN COMMERCE 8-1-2000.
DAVID YONTEF, EXAMINING ATTORNEY

SN 77-038,086. THOMAS GARRITY STEELE, PEQUANNOCK, NJ. FILED 11-6-2006.

LIMO TRAVELER

THE MARK CONSISTS OF STANDARD CHARACTERS WITHOUT CLAIM TO ANY PARTICULAR FONT, STYLE, SIZE, OR COLOR.

NO CLAIM IS MADE TO THE EXCLUSIVE RIGHT TO USE "LIMO", APART FROM THE MARK AS SHOWN.

FOR LIMOUSINE SERVICES (U.S. CLS. 100 AND 105).
FIRST USE 1-30-2006; IN COMMERCE 1-30-2006.
KEVON CHISOLM, EXAMINING ATTORNEY

CLASS 39—(Continued).

SN 77-085,641. 461462 ONTARIO LIMITED, TORONTO, CANADA, FILED 1-18-2007.

ROAD TO ITALY

THE MARK CONSISTS OF STANDARD CHARACTERS WITHOUT CLAIM TO ANY PARTICULAR FONT, STYLE, SIZE, OR COLOR.

PRIORITY CLAIMED UNDER SEC. 44(D) ON CANADA APPLICATION NO. 1,331,543, FILED 1-16-2007.

NO CLAIM IS MADE TO THE EXCLUSIVE RIGHT TO USE "ITALY", APART FROM THE MARK AS SHOWN.

FOR TRAVEL AGENCY SERVICES, NAMELY, MAKING RESERVATIONS AND BOOKINGS FOR TRANSPORTATION; PROVIDING A WEBSITE AND WEBSITE LINKS TO MAP IMAGES; PROVIDING TRAVEL INFORMATION OVER COMPUTER NETWORKS AND GLOBAL COMMUNICATION NETWORKS; PROVIDING INFORMATION IN THE FIELD OF TRAVEL VIA COMPUTER NETWORKS, GLOBAL INFORMATION NETWORKS, AND WIRELESS NETWORKS; ORGANIZING AND ARRANGING TRAVEL ACTIVITIES, NAMELY, TOURS, TRAVEL TO EVENTS AND TRAVEL TO ATTRACTIONS; MAKING TICKET RESERVATIONS FOR TRAVEL ACTIVITIES, NAMELY FOR TOURS, TRAVEL TO EVENTS AND TRAVEL TO ATTRACTIONS; PROVIDING GROUND TRANSPORTATION FOR PASSENGERS BY RAIL AND BUS TO TRAVEL ACTIVITIES, TOURS, EVENTS AND ATTRACTIONS; PROVIDING INFORMATION ABOUT TOURS AND TRAVEL TO EVENTS AND ATTRACTIONS; ORGANIZING AND CONDUCTING SIGHT-SEEING TOURS (U.S. CLS. 100 AND 105).

FIRST USE 8-1-2000; IN COMMERCE 8-1-2000.
DAVID YONTEF, EXAMINING ATTORNEY

SN 77-091,067. WILCZIEK, JEFFREY, A., ROSEMOUNT, MN. FILED 1-25-2007.

TRAVOIS

THE MARK CONSISTS OF STANDARD CHARACTERS WITHOUT CLAIM TO ANY PARTICULAR FONT, STYLE, SIZE, OR COLOR.

FOR TRANSPORT BY MAN-POWERED VEHICLE (U.S. CLS. 100 AND 105).

MARK T. MULLEN, EXAMINING ATTORNEY

CLASS 39—(Continued).

SN 77-102,128. QUINWELL TRAVEL SERVICES, INC., ASHLAND, MA. FILED 2-7-2007.

EDUCATIONAL ODYSSEYS

THE MARK CONSISTS OF STANDARD CHARACTERS WITHOUT CLAIM TO ANY PARTICULAR FONT, STYLE, SIZE, OR COLOR.

NO CLAIM IS MADE TO THE EXCLUSIVE RIGHT TO USE EDUCATIONAL, APART FROM THE MARK AS SHOWN.

FOR ORGANIZATION OF EXCURSIONS, SIGHTSEEING TOURS, HOLIDAYS, TOURS AND TRAVEL (U.S. CLS. 100 AND 105).

FIRST USE 6-15-2006; IN COMMERCE 2-1-2007.
MAUREEN DALL, EXAMINING ATTORNEY

SN 77-116,121. BLUE HEART TOURS, INC., ALEXANDRIA, VA. FILED 2-26-2007.



THE MARK CONSISTS OF A CLEF SYMBOL WITH A GLOBE IN THE BOTTOM LOOP OF THE SYMBOL.
FOR ARRANGING TRAVEL TOURS (U.S. CLS. 100 AND 105).

FIRST USE 10-0-1995; IN COMMERCE 10-0-1995.
DAVID ELTON, EXAMINING ATTORNEY

SN 77-128,378. NRTO, LLC, DENVER, CO. FILED 3-12-2007.

SMARTMOVE AUTO

THE MARK CONSISTS OF STANDARD CHARACTERS WITHOUT CLAIM TO ANY PARTICULAR FONT, STYLE, SIZE, OR COLOR.

NO CLAIM IS MADE TO THE EXCLUSIVE RIGHT TO USE "AUTO", APART FROM THE MARK AS SHOWN.

FOR LEASING OF CARS; RENTAL OF CARS (U.S. CLS. 100 AND 105).

FIRST USE 9-1-2005; IN COMMERCE 9-1-2005.
BRIAN CALLAGHAN, EXAMINING ATTORNEY

CLASS 39—(Continued).

SN 77-131,997. JACKSON, GREGORY L., ADDISON, TX. FILED 3-15-2007.

STAR MEDICAL

THE MARK CONSISTS OF STANDARD CHARACTERS WITHOUT CLAIM TO ANY PARTICULAR FONT, STYLE, SIZE, OR COLOR.

NO CLAIM IS MADE TO THE EXCLUSIVE RIGHT TO USE "MEDICAL", APART FROM THE MARK AS SHOWN.

FOR DISTRIBUTION SERVICES, NAMELY DELIVERY OF INFANT AND ADULT FORMULAS (U.S. CLS. 100 AND 105).

FIRST USE 3-5-1995; IN COMMERCE 3-5-1995.
ANGELA M. MICHELI, EXAMINING ATTORNEY

CLASS 39—(Continued).

SN 77-135,644. METROPOLITAN TRANSIT AUTHORITY OF HARRIS COUNTY, TEXAS, HOUSTON, TX. FILED 3-20-2007.

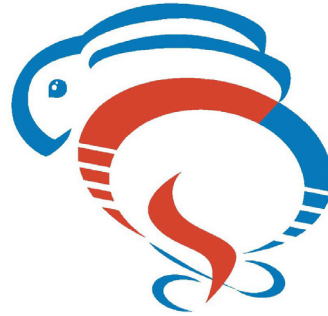

THE COLOR(S) RED AND BLUE IS/ARE CLAIMED AS A FEATURE OF THE MARK.

THE MARK CONSISTS OF THE STYLIZED LETTER Q IN THE SHAPE OF A RUNNING RABBIT.

FOR TRANSPORTATION OF PASSENGERS AND/OR GOODS BY BUS AND RAIL (U.S. CLS. 100 AND 105).

FIRST USE 12-1-2006; IN COMMERCE 12-1-2006.
NAPOLEON SHARMA, EXAMINING ATTORNEY

SN 77-133,363. GRAND LAKE MARINA SERVICE, INC., GRAND LAKE, CO. FILED 3-16-2007.

GRAND LAKE MARINA

THE MARK CONSISTS OF STANDARD CHARACTERS WITHOUT CLAIM TO ANY PARTICULAR FONT, STYLE, SIZE, OR COLOR.

NO CLAIM IS MADE TO THE EXCLUSIVE RIGHT TO USE "MARINA", APART FROM THE MARK AS SHOWN.

SEC. 2(F).
FOR MARINA SERVICES (U.S. CLS. 100 AND 105).

FIRST USE 3-27-1972; IN COMMERCE 3-27-1972.
TRACY WHITTAKER-BROWN, EXAMINING ATTORNEY

SN 77-135,811. METROPOLITAN TRANSIT AUTHORITY OF HARRIS COUNTY, TEXAS, HOUSTON, TX. FILED 3-20-2007.



THE COLOR(S) RED, BLUE, AND BLACK IS/ARE CLAIMED AS A FEATURE OF THE MARK.

THE MARK CONSISTS OF A STYLIZED RED AND BLUE CAPITAL LETTER Q, FOLLOWED BY THE WORDS SIMPLE, QUICK, AND EASY IN THE COLOR BLACK. THE LEFT HALF OF THE Q IS RED, THE RIGHT HALF IS BLUE.

FOR TRANSPORTATION OF PASSENGERS AND/OR GOODS BY BUS AND RAIL (U.S. CLS. 100 AND 105).

FIRST USE 2-1-2007; IN COMMERCE 2-1-2007.
NAPOLEON SHARMA, EXAMINING ATTORNEY

CLASS 39—(Continued).

SN 77-135,864. NEIGHBORHOOD STORAGE CENTER CO. CORPORATION, OCALA, FL. FILED 3-20-2007.

Neighborhood Storage

THE MARK CONSISTS OF STANDARD CHARACTERS WITHOUT CLAIM TO ANY PARTICULAR FONT, STYLE, SIZE, OR COLOR.

NO CLAIM IS MADE TO THE EXCLUSIVE RIGHT TO USE "STORAGE", APART FROM THE MARK AS SHOWN. FOR PROVIDING SELF-STORAGE FACILITIES FOR OTHERS; WAREHOUSE STORAGE; BOAT STORAGE (U.S. CLS. 100 AND 105).

FIRST USE 1-1-1990; IN COMMERCE 1-1-1990.
ZHALEH DELANEY, EXAMINING ATTORNEY

SN 77-138,292. JUST ROUGHIN IT ADVENTURE COMPANY, LLC, CHANDLER, AZ. FILED 3-22-2007.

JUST ROUGHIN' IT ADVENTURE CO.

THE MARK CONSISTS OF STANDARD CHARACTERS WITHOUT CLAIM TO ANY PARTICULAR FONT, STYLE, SIZE, OR COLOR.

NO CLAIM IS MADE TO THE EXCLUSIVE RIGHT TO USE "ADVENTURE CO.", APART FROM THE MARK AS SHOWN.

FOR TOUR CONDUCTING OR ESCORTING (U.S. CLS. 100 AND 105).

FIRST USE 3-15-2007; IN COMMERCE 3-15-2007.
KAREN BRACEY, EXAMINING ATTORNEY

SN 77-138,669. TXCO RESOURCES INC, SAN ANTONIO, TX. FILED 3-23-2007.



THE MARK CONSISTS OF THE MARK TXCO WITH A DRILL BIT CENTERED WITHIN THE "O".

FOR TRANSPORT BY PIPELINE OF NATURAL GAS AND GASES AND LIQUIDS SEPARATED FROM NATURAL GAS.; TRANSMISSION OF OIL OR GAS THROUGH PIPELINES; TRANSPORTATION AND STORAGE OF FUELS (U.S. CLS. 100 AND 105).

FIRST USE 10-1-2006; IN COMMERCE 10-1-2006.
TAMARA FRAZIER, EXAMINING ATTORNEY

CLASS 39—(Continued).

SN 77-138,918. ELIMNET, LLC, METAMORA, OH. FILED 3-23-2007.

BIRD DOG TRUCKING

THE MARK CONSISTS OF STANDARD CHARACTERS WITHOUT CLAIM TO ANY PARTICULAR FONT, STYLE, SIZE, OR COLOR.

NO CLAIM IS MADE TO THE EXCLUSIVE RIGHT TO USE "TRUCKING", APART FROM THE MARK AS SHOWN. FOR DUMP TRUCK HAULING SERVICES FOR THE CONSTRUCTION INDUSTRY (U.S. CLS. 100 AND 105).

FIRST USE 6-1-2006; IN COMMERCE 7-17-2006.
TINA KUAN, EXAMINING ATTORNEY

SN 77-139,066. CITYWHEELS, LLC, CLEVELAND, OH. FILED 3-23-2007.

CityWheels

THE MARK CONSISTS OF STANDARD CHARACTERS WITHOUT CLAIM TO ANY PARTICULAR FONT, STYLE, SIZE, OR COLOR.

FOR RENTAL OF VEHICLES (U.S. CLS. 100 AND 105). FIRST USE 10-1-2005; IN COMMERCE 2-1-2006.

PRISCILLA MILTON, EXAMINING ATTORNEY

SN 77-139,102. CLAYTON GENTRY, PENNSAUKEN, NJ. FILED 3-23-2007.



FOR SELF-STORAGE SERVICES, NAMELY, PROVIDING SELF STORAGE FACILITIES FOR OTHERS; AND RENTAL AND LEASING OF WAREHOUSE AND CLIMATE-CONTROLLED SELF-STORAGE SPACE (U.S. CLS. 100 AND 105).

FIRST USE 10-18-2002; IN COMMERCE 10-18-2002.
BENJAMIN OKEKE, EXAMINING ATTORNEY

CLASS 39—(Continued).

SN 77-139,242. SAVON FREIGHT LLC, YOUNGTOWN, AZ. FILED 3-23-2007.



NO CLAIM IS MADE TO THE EXCLUSIVE RIGHT TO USE FREIGHT, APART FROM THE MARK AS SHOWN. FOR FREIGHT BROKERAGE (U.S. CLS. 100 AND 105). FIRST USE 1-0-2007; IN COMMERCE 1-0-2007. BRIAN PINO, EXAMINING ATTORNEY

CLASS 39—(Continued).

SN 77-140,036. VANGUARD TRADEMARK HOLDINGS USA LLC, TULSA, OK. FILED 3-26-2007.



OWNER OF U.S. REG. NOS. 1,097,722, 2,427,041 AND OTHERS.

THE COLOR(S) BLUE, CREME, YELLOW, BLACK AND BROWN IS/ARE CLAIMED AS A FEATURE OF THE MARK.

THE MARK CONSISTS OF THE WORDS HAPPY TRAILS IN BLUE AND OUTLINED IN CREME AND BLACK WITH BLUE SHADOWS, THE WORD WITH IN BLUE ON A CREME OVAL OUTLINED IN BLUE, THE TERM ALAMO IN YELLOW SURROUNDED BY A BLUE RECTANGLE WITH YELLOW AND BLUE OUTLINES, THE TERMS AL AND MO IN BLUE SURROUNDED BY YELLOW CIRCLES WITH BLUE OUTLINES AND TWO BROWN ANIMALS IN YELLOW CIRCLES.

FOR VEHICLE RENTAL AND RESERVATION SERVICES; VEHICLE LEASING SERVICES (U.S. CLS. 100 AND 105).

FIRST USE 3-19-2007; IN COMMERCE 3-19-2007. AMY ALFIERI, EXAMINING ATTORNEY

SN 77-140,031. VANGUARD TRADEMARK HOLDINGS USA LLC, TULSA, OK. FILED 3-26-2007.

HAPPY TRAILS

SN 77-140,040. VANGUARD TRADEMARK HOLDINGS USA LLC, TULSA, OK. FILED 3-26-2007.



OWNER OF U.S. REG. NOS. 1,097,722, 2,427,041 AND OTHERS.

THE COLOR(S) BLUE, CREME, YELLOW AND BLACK IS/ARE CLAIMED AS A FEATURE OF THE MARK.

THE MARK CONSISTS OF THE WORDS HAPPY TRAILS IN BLUE OUTLINED IN CREME AND BLACK WITH BLUE SHADOWS, THE WORD WITH IN BLUE ON A CREME OVAL OUTLINED IN BLUE AND THE TERM ALAMO IN YELLOW SURROUNDED BY A BLUE RECTANGLE WITH YELLOW AND BLUE OUTLINES.

FOR VEHICLE RENTAL AND RESERVATION SERVICES; VEHICLE LEASING SERVICES (U.S. CLS. 100 AND 105).

FIRST USE 3-19-2007; IN COMMERCE 3-19-2007. AMY ALFIERI, EXAMINING ATTORNEY

THE MARK CONSISTS OF STANDARD CHARACTERS WITHOUT CLAIM TO ANY PARTICULAR FONT, STYLE, SIZE, OR COLOR.

FOR VEHICLE RENTAL AND RESERVATION SERVICES; VEHICLE LEASING SERVICES (U.S. CLS. 100 AND 105).

FIRST USE 3-19-2007; IN COMMERCE 3-19-2007. AMY ALFIERI, EXAMINING ATTORNEY

CLASS 39—(Continued).

SN 77-140,263. MASTERS PROPERTIES LLC, NEWTON, MA.
FILED 3-26-2007.

DIAMOND HEAD SELF STORAGE

THE MARK CONSISTS OF STANDARD CHARACTERS WITHOUT CLAIM TO ANY PARTICULAR FONT, STYLE, SIZE, OR COLOR.

NO CLAIM IS MADE TO THE EXCLUSIVE RIGHT TO USE SELF-STORAGE, APART FROM THE MARK AS SHOWN.

FOR PROVIDING SELF-STORAGE FACILITIES FOR OTHERS (U.S. CLS. 100 AND 105).

SUSAN STIGLITZ, EXAMINING ATTORNEY

SN 77-140,311. MASTERS PROPERTIES LLC, NEWTON, MA.
FILED 3-26-2007.



NO CLAIM IS MADE TO THE EXCLUSIVE RIGHT TO USE "SELF-STORAGE", APART FROM THE MARK AS SHOWN.

THE MARK CONSISTS OF A STYLIZED REPRESENTATION OF A PADLOCK IN THE FORM OF A SQUARE-SHAPED BUILDING WITH A UPSIDE-DOWN U SHAPE ON TOP.

FOR PROVIDING SELF-STORAGE FACILITIES FOR OTHERS (U.S. CLS. 100 AND 105).

SUSAN STIGLITZ, EXAMINING ATTORNEY

SN 77-140,598. PROM QUEEN-II, LLC, PENSACOLA BEACH, FL.
FILED 3-26-2007.

GRAND MARLIN

THE MARK CONSISTS OF STANDARD CHARACTERS WITHOUT CLAIM TO ANY PARTICULAR FONT, STYLE, SIZE, OR COLOR.

FOR MARINA SERVICES (U.S. CLS. 100 AND 105).

ROBIN CHOSID, EXAMINING ATTORNEY

CLASS 39—(Continued).

SN 77-140,686. EXPERT TRAVEL SERVICES, LLC, PATCHOGUE, NY. FILED 3-26-2007.

EXPERTFLYER

THE MARK CONSISTS OF STANDARD CHARACTERS WITHOUT CLAIM TO ANY PARTICULAR FONT, STYLE, SIZE, OR COLOR.

FOR TRAVEL INFORMATION SERVICES, NAMELY, PROVIDING INFORMATION CONCERNING TRAVEL AND TRAVEL-RELATED TOPICS INCLUDING FARES, FARE RULES, PENALTIES AND ROUTING INFORMATION, FLIGHT AVAILABILITY, SEATING WITH SEAT MAPS, UPGRADES, FREQUENT FLYER MILES, AWARDS AND UPGRADES, FLIGHT STATUS AND DELAYS, FLIGHT DETAILS, INCLUDING, MEALS, EQUIPMENT, FLIGHT TIMES, STOPOVERS, AIRPORT SECURITY LINE DELAY INFORMATION, AIRPORT DELAY INFORMATION; PROVIDING FLIGHT ALERT INFORMATION TO SUBSCRIBERS VIA E-MAIL, CELL PHONE, PDA, OR OTHER WIRELESS PORTABLE DEVICE (U.S. CLS. 100 AND 105).

NATALIE POLZER, EXAMINING ATTORNEY

SN 77-140,703. EXPERT TRAVEL SERVICES, LLC, PATCHOGUE, NY. FILED 3-26-2007.

EXPERT FLYER.COM

THE MARK CONSISTS OF STANDARD CHARACTERS WITHOUT CLAIM TO ANY PARTICULAR FONT, STYLE, SIZE, OR COLOR.

NO CLAIM IS MADE TO THE EXCLUSIVE RIGHT TO USE "FLYER.COM", APART FROM THE MARK AS SHOWN.

FOR TRAVEL INFORMATION SERVICES, NAMELY, PROVIDING INFORMATION CONCERNING TRAVEL AND TRAVEL-RELATED TOPICS INCLUDING FARES, FARE RULES, PENALTIES AND ROUTING INFORMATION, FLIGHT AVAILABILITY, SEATING WITH SEAT MAPS, UPGRADES, FREQUENT FLYER MILES, AWARDS AND UPGRADES, FLIGHT STATUS AND DELAYS, FLIGHT DETAILS, INCLUDING, MEALS, EQUIPMENT, FLIGHT TIMES, STOPOVERS, AIRPORT SECURITY LINE DELAY INFORMATION, AIRPORT DELAY INFORMATION; PROVIDING FLIGHT ALERT INFORMATION TO SUBSCRIBERS VIA E-MAIL, CELL PHONE, PDA, OR OTHER WIRELESS PORTABLE DEVICE (U.S. CLS. 100 AND 105).

FIRST USE 1-27-2004; IN COMMERCE 1-7-2005.

NATALIE POLZER, EXAMINING ATTORNEY

CLASS 39—(Continued).

SN 77-140,707. EXPERT TRAVEL SERVICES, LLC, PATCHOGUE, NY. FILED 3-26-2007.

EMPOWERING THE FREQUENT FLYER

THE MARK CONSISTS OF STANDARD CHARACTERS WITHOUT CLAIM TO ANY PARTICULAR FONT, STYLE, SIZE, OR COLOR.

NO CLAIM IS MADE TO THE EXCLUSIVE RIGHT TO USE "FREQUENT FLYER", APART FROM THE MARK AS SHOWN.

FOR TRAVEL INFORMATION SERVICES, NAMELY, PROVIDING INFORMATION CONCERNING TRAVEL AND TRAVEL-RELATED TOPICS INCLUDING FARES, FARE RULES, PENALTIES AND ROUTING INFORMATION, FLIGHT AVAILABILITY, SEATING WITH SEAT MAPS, UPGRADES, FREQUENT FLYER MILES, AWARDS AND UPGRADES, FLIGHT STATUS AND DELAYS, FLIGHT DETAILS, INCLUDING, MEALS, EQUIPMENT, FLIGHT TIMES, STOPOVERS, AIRPORT SECURITY LINE DELAY INFORMATION, AIRPORT DELAY INFORMATION; PROVIDING FLIGHT ALERT INFORMATION TO SUBSCRIBERS VIA E-MAIL, CELL PHONE, PDA, OR OTHER WIRELESS PORTABLE DEVICE (U.S. CLS. 100 AND 105).

FIRST USE 1-27-2004; IN COMMERCE 1-7-2005. NATALIE POLZER, EXAMINING ATTORNEY

SN 77-140,709. EXPERT TRAVEL SERVICES, LLC, PATCHOGUE, NY. FILED 3-26-2007.



NO CLAIM IS MADE TO THE EXCLUSIVE RIGHT TO USE "FLYER.COM", APART FROM THE MARK AS SHOWN.

THE MARK CONSISTS OF AN AIRPLANE CIRCUMSCRIBED BY A CIRCLE WITH TRAILING LINES AND THE WORDING "EXPERT FLYER.COM".

FOR TRAVEL INFORMATION SERVICES, NAMELY, PROVIDING INFORMATION CONCERNING TRAVEL AND TRAVEL-RELATED TOPICS INCLUDING FARES, FARE RULES, PENALTIES AND ROUTING INFORMATION, FLIGHT AVAILABILITY, SEATING WITH SEAT MAPS, UPGRADES, FREQUENT FLYER MILES, AWARDS AND UPGRADES, FLIGHT STATUS AND DELAYS, FLIGHT DETAILS, INCLUDING, MEALS, EQUIPMENT, FLIGHT TIMES, STOPOVERS, AIRPORT SECURITY LINE DELAY INFORMATION, AIRPORT DELAY INFORMATION; PROVIDING FLIGHT ALERT INFORMATION TO SUBSCRIBERS VIA E-MAIL, CELL PHONE, PDA, OR OTHER WIRELESS PORTABLE DEVICE (U.S. CLS. 100 AND 105).

FIRST USE 1-27-2004; IN COMMERCE 1-7-2005. NATALIE POLZER, EXAMINING ATTORNEY

CLASS 39—(Continued).

SN 77-141,020. DAVE'S AIRCRAFT, INC., EDGEWATER, FL. FILED 3-27-2007.

DAC PROJETS

THE MARK CONSISTS OF STANDARD CHARACTERS WITHOUT CLAIM TO ANY PARTICULAR FONT, STYLE, SIZE, OR COLOR.

FOR AIRCRAFT CHARTER, RENTAL AND LEASING SERVICES (U.S. CLS. 100 AND 105).

BRENDAN REGAN, EXAMINING ATTORNEY

SN 77-141,131. GOLDSMITH, JEFFREY, SAN FRANCISCO, CA. FILED 3-27-2007.

VIAmigo

THE MARK CONSISTS OF STANDARD CHARACTERS WITHOUT CLAIM TO ANY PARTICULAR FONT, STYLE, SIZE, OR COLOR.

FOR PROVIDING AN ON-LINE COMPUTER DATABASE IN THE FIELD OF TRAVEL INFORMATION SERVICES (U.S. CLS. 100 AND 105).

FIRST USE 12-1-2006; IN COMMERCE 12-8-2006. NAAKWAMA ANKRAH, EXAMINING ATTORNEY

SN 77-142,017. BLS LIMOUSINE SERVICE OF NY, ASTORIA, NY. FILED 3-27-2007.

AS DIRECTED

THE MARK CONSISTS OF STANDARD CHARACTERS WITHOUT CLAIM TO ANY PARTICULAR FONT, STYLE, SIZE, OR COLOR.

FOR TRANSPORT OF PASSENGERS (U.S. CLS. 100 AND 105).

STEVEN JACKSON, EXAMINING ATTORNEY

CLASS 39—(Continued).

SN 77-142,357. BIZMILEAGE NETWORKS LLC, SAN MATEO, CA. FILED 3-28-2007.

BIZMILEAGE

THE MARK CONSISTS OF STANDARD CHARACTERS WITHOUT CLAIM TO ANY PARTICULAR FONT, STYLE, SIZE, OR COLOR.

FOR TRAVEL INFORMATION SERVICES, NAMELY, PROVIDING INFORMATION ON MILES TRAVELED IN A MOVING VEHICLE BY MEANS OF A PDA, CELLULAR TELEPHONE OR OTHER MOBILE DEVICE (U.S. CLS. 100 AND 105).

DORITT L. CARROLL, EXAMINING ATTORNEY

CLASS 39—(Continued).

SN 77-143,899. CONTINENTAL AIRLINES, INC., HOUSTON, TX. FILED 3-29-2007.

BUSINESSFLAT

THE MARK CONSISTS OF STANDARD CHARACTERS WITHOUT CLAIM TO ANY PARTICULAR FONT, STYLE, SIZE, OR COLOR.

FOR AIRLINE TRANSPORTATION SERVICES (U.S. CLS. 100 AND 105).

SIMON TENG, EXAMINING ATTORNEY

SN 77-143,034. ADVENTURELINK INC., ALTADENA, CA. FILED 3-28-2007.



FOR PROVIDING AN ON-LINE COMPUTER DATABASE IN THE FIELD OF TRAVEL INFORMATION SERVICES; TRAVEL AND TOUR TICKET RESERVATION SERVICE; TRAVEL BOOKING AGENCIES (U.S. CLS. 100 AND 105).

FIRST USE 12-19-1996; IN COMMERCE 5-6-2006.
PAUL F. GAST, EXAMINING ATTORNEY

SN 77-148,003. PARK, PETE O., REDWOOD CITY, CA. FILED 4-3-2007.

Globesetter

SN 77-143,175. EPIC GLOBAL LOGISTICS, LLC, MISSION VIEJO, CA. FILED 3-28-2007.



NO CLAIM IS MADE TO THE EXCLUSIVE RIGHT TO USE "GLOBAL LOGISTICS LLC", APART FROM THE MARK AS SHOWN.

THE MARK CONSISTS OF THE STYLIZED WORD EPIC WITH THE LETTER C FORMING A GLOBE DESIGN ABOVE THE STYLIZED, UNDERLINED WORDING GLOBAL LOGISTICS LLC ABOVE THE STYLIZED WORDING EXPERTISE PARTNERSHIP INTEGRITY COMMITMENT.

FOR FREIGHT BROKERAGE (U.S. CLS. 100 AND 105).
DAVID TOOLEY, EXAMINING ATTORNEY

THE MARK CONSISTS OF STANDARD CHARACTERS WITHOUT CLAIM TO ANY PARTICULAR FONT, STYLE, SIZE, OR COLOR.

FOR TRAVEL INFORMATION SERVICES; PROVIDING AN ON-LINE COMPUTER DATABASE IN THE FIELD OF TRAVEL INFORMATION SERVICES; PROVIDING LINKS TO WEB SITES OF OTHERS FEATURING TRAVEL; TRAVEL AND TOUR INFORMATION SERVICE; TRAVEL BOOKING AGENCIES (U.S. CLS. 100 AND 105).

FIRST USE 3-17-2007; IN COMMERCE 3-17-2007.
BRIDGETT SMITH, EXAMINING ATTORNEY

CLASS 39—(Continued).

SN 77-148,379. FORT LAUDERDALE JET CENTER, LLC DBA SHELTAIR AVIATION SERVICES, FORT LAUDERDALE, FL. AND MIAMI JET CENTER, LLC DBA SHELTAIR AVIATION SERVICES, FORT LAUDERDALE, FL. AND ORLANDO JET CENTER, LLC DBA SHELTAIR AVIATION SERVICES, FORT LAUDERDALE, FL. AND DAYTONA BEACH JET CENTER, LLC DBA SHELTAIR AVIATION SERVICES, FORT LAUDERDALE, FL. AND JACKSONVILLE JET CENTER, LLC DBA SHELTAIR AVIATION SERVICES, FORT LAUDERDALE, FL. AND SHELTAIR PANAMA CITY, LLC DBA SHELTAIR AVIATION SERVICES, FORT LAUDERDALE, FL. AND PANAMA CITY JET CENTER, LLC DBA SHELTAIR AVIATION SERVICES, FORT LAUDERDALE, FL. AND SHELTAIR ST. PETERSBURG, LLC DBA SHELTAIR AVIATION SERVICES, FORT LAUDERDALE, FL. AND SHELTAIR AVIATION PUERTO RICO, LLC DBA SHELTAIR AVIATION SERVICES, FORT LAUDERDALE, FL. FILED 4-4-2007.



NO CLAIM IS MADE TO THE EXCLUSIVE RIGHT TO USE "AVIATION SERVICES", APART FROM THE MARK AS SHOWN.

THE COLOR(S) BLACK, BLUE, ORANGE, AND YELLOW IS/ARE CLAIMED AS A FEATURE OF THE MARK.

THE MARK CONSISTS OF "SHELT" IN BLACK, "AIR" IN BLUE, "AVIATION SERVICES" IN BLACK, A SUN FADING FROM ORANGE AT THE TOP TO YELLOW AT THE BOTTOM.

FOR AIRPORT SERVICES (U.S. CLS. 100 AND 105).
FIRST USE 0-0-2002; IN COMMERCE 0-0-2002.
ANDREA HACK, EXAMINING ATTORNEY

CLASS 39—(Continued).

SN 77-149,098. WASHINGTON METROPOLITAN AREA TRANSIT AUTHORITY (WMATA), WASHINGTON, DC, DC. FILED 4-5-2007.



OWNER OF U.S. REG. NOS. 1,035,552 AND 1,035,553.
NO CLAIM IS MADE TO THE EXCLUSIVE RIGHT TO USE THE REPRESENTATION OF THE UNIVERSAL HANDICAP SYMBOL, APART FROM THE MARK AS SHOWN.

THE COLOR(S) BLUE, WHITE, AND RED IS/ARE CLAIMED AS A FEATURE OF THE MARK.

THE MARK CONSISTS OF THE WORD "METRO" WRITTEN IN BLUE WITH THE "M" CAPITALIZED FOLLOWED BY A CIRCLE COLORED COMPLETELY IN BLUE WITH A DRAWING IN THE COLOR WHITE OF A SYMBOL REPRESENTING A DISABLED PERSON IN A WHEELCHAIR WITHIN THE BLUE CIRCLE FOLLOWED BY THE WORD "ACCESS" WRITTEN IN RED WITH THE "A" CAPITALIZED.

FOR TRANSPORTATION OF PASSENGERS BY VANS AND CARS FOR DISABLED CUSTOMERS WHO, DUE TO THEIR DISABILITIES, ARE UNABLE TO USE REGULAR, FIXED ROUTE RAIL AND/OR BUS SERVICE, SERVING THE DISTRICT OF COLUMBIA, MONTGOMERY AND PRINCE GEORGE'S COUNTIES IN MARYLAND, AND ARLINGTON AND FAIRFAX COUNTIES AND THE CITIES OF ALEXANDRIA, FAIRFAX, AND FALLS CHURCH IN VIRGINIA (U.S. CLS. 100 AND 105).

FIRST USE 1-15-2006; IN COMMERCE 1-15-2006.
CAROLINE WOOD, EXAMINING ATTORNEY

SN 77-149,104. WASHINGTON METROPOLITAN AREA TRANSIT AUTHORITY (WMATA), WASHINGTON, DC, DC. FILED 4-5-2007.



OWNER OF U.S. REG. NOS. 1,035,552 AND 1,035,553.
NO CLAIM IS MADE TO THE EXCLUSIVE RIGHT TO USE THE REPRESENTATION OF THE UNIVERSAL HANDICAP SYMBOL, APART FROM THE MARK AS SHOWN.

THE COLOR(S) BLUE, RED, AND WHITE IS/ARE CLAIMED AS A FEATURE OF THE MARK.

THE MARK CONSISTS OF A CAPITALIZED M ABOVE THE LOWER-CASED "METRO" BOTH OF WHICH ARE CONTAINED IN A SQUARE, ALL IN THE COLOR BLUE

CLASS 39—(Continued).

WITH THE BACKGROUND IN WHITE. THIS IS FOLLOWED BY THE WORD "METRO" IN BLUE, WHERE THE "M" OF THE WORD "METRO" IS AS LARGE AS THE PRECEDING SQUARE. FOLLOWING THE WORD "METRO" IS A CIRCLE COLORED COMPLETELY IN BLUE WITH AN OUTLINE OF A SYMBOL REPRESENTING A DISABLED PERSON IN A WHEELCHAIR DRAWN IN WHITE. FOLLOWING THIS DRAWING, IS THE WORD "ACCESS" WRITTEN IN THE COLOR RED WITH THE "A" CAPITALIZED.

FOR TRANSPORTATION OF PASSENGERS BY VANS AND CARS FOR DISABLED CUSTOMERS WHO, DUE TO THEIR DISABILITIES, ARE UNABLE TO USE REGULAR, FIXED ROUTE RAIL AND/OR BUS SERVICE, SERVING THE DISTRICT OF COLUMBIA, MONTGOMERY AND PRINCE GEORGE'S COUNTIES IN MARYLAND, AND ARLINGTON AND FAIRFAX COUNTIES AND THE CITIES OF ALEXANDRIA, FAIRFAX, AND FALLS CHURCH IN VIRGINIA (U.S. CLS. 100 AND 105).

FIRST USE 1-15-2006; IN COMMERCE 1-15-2006.
CAROLINE WOOD, EXAMINING ATTORNEY

SN 77-165,715. CHIPS TRANSPORT, INC., WALPOLE, MA. FILED 4-25-2007.

CHIP'S TRANSPORT

THE MARK CONSISTS OF STANDARD CHARACTERS WITHOUT CLAIM TO ANY PARTICULAR FONT, STYLE, SIZE, OR COLOR.

NO CLAIM IS MADE TO THE EXCLUSIVE RIGHT TO USE "TRANSPORT", APART FROM THE MARK AS SHOWN.

THE NAME SHOWN IN THE MARK DOES NOT IDENTIFY A PARTICULAR LIVING INDIVIDUAL.

FOR AUTOMOTIVE TRANSPORT SERVICE FOR OTHERS IN THE NATURE OF TRANSPORTATION AND RELOCATION OF AUTOMOBILES (U.S. CLS. 100 AND 105).

FIRST USE 12-19-1998; IN COMMERCE 12-19-1998.
PAUL F. GAST, EXAMINING ATTORNEY

CLASS 39—(Continued).

SN 77-166,230. CHIPS TRANSPORT, INC., WALPOLE, MA. FILED 4-26-2007.



NO CLAIM IS MADE TO THE EXCLUSIVE RIGHT TO USE "TRANSPORT", APART FROM THE MARK AS SHOWN.

THE NAME SHOWN IN THE MARK DOES NOT IDENTIFY A PARTICULAR LIVING INDIVIDUAL.

THE MARK CONSISTS OF A CURVED ROAD ATTACHED TO A STYLIZED CLOUD IN THE SHAPE OF A HAND HOLDING AN AUTOMOBILE, TOGETHER WITH THE LITERAL ELEMENTS.

FOR AUTOMOTIVE TRANSPORT SERVICE FOR OTHERS IN THE NATURE OF TRANSPORTATION AND RELOCATION OF AUTOMOBILES (U.S. CLS. 100 AND 105).

FIRST USE 4-2-2007; IN COMMERCE 4-2-2007.
PAUL F. GAST, EXAMINING ATTORNEY

SN 77-172,473. BREATHE EASY ENERGY TRANSPORTATION SYSTEMS LLC, WHITE PLAINS, NY. FILED 5-3-2007.

LIMOGREEN

THE MARK CONSISTS OF STANDARD CHARACTERS WITHOUT CLAIM TO ANY PARTICULAR FONT, STYLE, SIZE, OR COLOR.

FOR CAR TRANSPORT; CHAUFFEUR SERVICES; HIRED CAR TRANSPORT; LIMOUSINE SERVICES; TAXI TRANSPORT; TRANSPORT OF PASSENGERS; VEHICLE-DRIVING SERVICES (U.S. CLS. 100 AND 105).

FIRST USE 7-1-2007; IN COMMERCE 7-1-2007.
CARRIE GENOVESE, EXAMINING ATTORNEY

CLASS 39—(Continued).

SN 77-175,960. JUNE BUG ENTERPRISES, INC., BEVERLY HILLS, CA. FILED 5-8-2007.

1-888-GO-MAGIC

THE MARK CONSISTS OF STANDARD CHARACTERS WITHOUT CLAIM TO ANY PARTICULAR FONT, STYLE, SIZE, OR COLOR.

OWNER OF U.S. REG. NOS. 1,555,839, 2,699,394 AND OTHERS.

FOR TRAVEL AGENCY SERVICES, NAMELY, MAKING RESERVATIONS AND BOOKINGS FOR TRANSPORTATION; ARRANGING TRAVEL TOURS AND CRUISES; CONSULTANCY SERVICES IN THE FIELD OF TRAVEL RESERVATIONS; CAMPER RENTAL SERVICES; AND TOUR AND SIGHTSEEING RESERVATION SERVICES (U.S. CLS. 100 AND 105).

DAYNA BROWNE, EXAMINING ATTORNEY

SN 77-176,626. 1-800-TAXICAB, INC., CARLSBAD, CA. FILED 5-9-2007.

JUST CAB IT

THE MARK CONSISTS OF STANDARD CHARACTERS WITHOUT CLAIM TO ANY PARTICULAR FONT, STYLE, SIZE, OR COLOR.

FOR TRANSPORT OF PASSENGERS BY GROUND (U.S. CLS. 100 AND 105).

FIRST USE 4-27-2007; IN COMMERCE 4-27-2007.

VERNA BETH RIRIE, EXAMINING ATTORNEY

SN 77-194,389. MEDSPEED LLC, ELMHURST, IL. FILED 5-31-2007.



OWNER OF U.S. REG. NO. 2,783,211.
THE MARK CONSISTS OF CIRCULAR ARROW WITH WORDS MEDSPEED UNDERNEATH.
FOR COURIER SERVICES (U.S. CLS. 100 AND 105).
FIRST USE 2-1-2007; IN COMMERCE 2-1-2007.
MICHAEL SOUDERS, EXAMINING ATTORNEY

CLASS 39—(Continued).

SN 77-222,730. HERTZ SYSTEM, INC., PARK RIDGE, NJ. FILED 7-5-2007.



OWNER OF U.S. REG. NOS. 614,123, 1,733,621 AND OTHERS.

FOR VEHICLE RENTAL SERVICES (U.S. CLS. 100 AND 105).

WILLIAM VERHOSEK, EXAMINING ATTORNEY

SN 78-797,551. POSTAL CONNECTIONS OF AMERICA FRANCHISE CORP., SAN DIEGO, CA. FILED 1-23-2006.



OWNER OF U.S. REG. NO. 1,847,000.
NO CLAIM IS MADE TO THE EXCLUSIVE RIGHT TO USE "POSTAL", APART FROM THE MARK AS SHOWN.

THE COLOR(S) LIGHT BLUE, BLUE, GRAY, RED AND WHITE IS/ARE CLAIMED AS A FEATURE OF THE MARK.

THE MARK CONSISTS OF STAMP DESIGN APPEARS IN LIGHT BLUE, THE STAMP OUTLINE APPEARS IN BLUE, THE STAR DESIGN APPEARS IN GRAY, THE WORDING POSTAL CONNECTIONS APPEARS IN RED AND THE BACKGROUND APPEARS IN WHITE.

SEC. 2(F).

FOR PRIVATE POSTAL MAIL AND BUSINESS CENTERS, NAMELY MAIL BOX RENTAL, PACKAGING ARTICLES FOR SHIPMENT BY AIR, RAIL, MAIL AND BOAT, AND STORAGE AND DELIVERY OF DOCUMENTS FOR OTHERS (U.S. CLS. 100 AND 105).

FIRST USE 3-1-1985; IN COMMERCE 3-1-1985.

MICHELE SWAIN, EXAMINING ATTORNEY

SN 78-824,386. HELIX ENERGY SOLUTIONS GROUP, INC., HOUSTON, TX. FILED 2-27-2006.

HELIX

THE MARK CONSISTS OF STANDARD CHARACTERS WITHOUT CLAIM TO ANY PARTICULAR FONT, STYLE, SIZE, OR COLOR.

FOR RENTAL OF VESSELS AND REMOTELY OPERATED VEHICLES. (U.S. CLS. 100 AND 105).

ASMAT KHAN, EXAMINING ATTORNEY

CLASS 39—(Continued).

SN 78-828,884. HELIX ENERGY SOLUTIONS GROUP, INC., HOUSTON, TX. FILED 3-3-2006.



THE COLOR(S) GREY IN THE DRAWING IS USED TO INDICATE SHADING ONLY. THE SHADING IS PART OF THE MARK AND IS/ARE CLAIMED AS A FEATURE OF THE MARK.

"THE MARK CONSISTS OF A STYLIZED REPRESENTATION OF A HELIX."

FOR RENTAL OF VESSELS AND REMOTELY OPERATED VEHICLES. (U.S. CLS. 100 AND 105).
 ASMAT KHAN, EXAMINING ATTORNEY

SN 78-883,939. UNITED DRAYAGE COMPANY, MONTEBELLO, CA. FILED 5-15-2006.

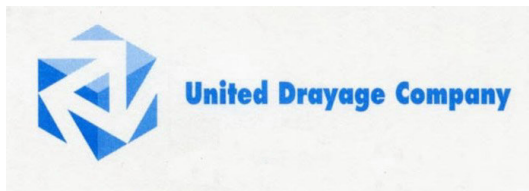

OWNER OF U.S. REG. NOS. 1,236,724 AND 1,811,137.
 NO CLAIM IS MADE TO THE EXCLUSIVE RIGHT TO USE "DRAYAGE COMPANY", APART FROM THE MARK AS SHOWN.

THE COLOR(S) THREE CONTRASTING SHADES OF BLUE IS/ARE CLAIMED AS A FEATURE OF THE MARK.

THE MARK CONSISTS OF A DESIGN RESEMBLING A GROUP OF COLOR TRIANGLES IN VARIOUS CONTRASTING SHADES OF BLUE WHICH FORM A CUBE WITH ARROWS POINTING IN THREE DIFFERENT DIRECTIONS ACCOMPANIED BY THE WORDS "UNITED DRAYAGE COMPANY", WHICH APPEARS IN BLUE.

FOR FREIGHT FORWARDING; FREIGHT TRANSPORTATION BY TRUCK; SUPPLY CHAIN, LOGISTICS AND REVERSE LOGISTICS SERVICES, NAMELY, STORAGE, TRANSPORTATION AND DELIVERY OF DOCUMENTS, PACKAGES, RAW MATERIALS, AND OTHER FREIGHT FOR OTHERS BY AIR, RAIL, SHIP OR TRUCK (U.S. CLS. 100 AND 105).

FIRST USE 2-24-1961; IN COMMERCE 2-24-1961.
 THOMAS MANOR, EXAMINING ATTORNEY

CLASS 39—(Continued).

SN 78-932,775. BENCHMARK PERFORMANCE GROUP, INC., HOUSTON, TX. FILED 7-19-2006.

BDS

THE MARK CONSISTS OF STANDARD CHARACTERS WITHOUT CLAIM TO ANY PARTICULAR FONT, STYLE, SIZE, OR COLOR.

FOR SUPPLY CHAIN, LOGISTICS AND REVERSE LOGISTICS SERVICES, NAMELY STORAGE, TRANSPORTATION AND DELIVERY OF RAW MATERIALS, FINISHED GOODS, AND OTHER FREIGHT IN THE FIELD OF INDUSTRIAL AND OILFIELD CHEMICALS AND INDUSTRIAL AND OILFIELD EQUIPMENT BY BULK-LIQUID TANKERS, INDUSTRY STANDARD TRANSPORT CONTAINERS, BULK LIQUID CONTAINERS, DRY BULK CONTAINERS, CURTAIN-SIDE TRAILERS, DRY VANS, AND FLATBED TRAILERS; WAREHOUSING SERVICES IN THE FIELD OF INDUSTRIAL AND OILFIELD CHEMICALS AND INDUSTRIAL AND OILFIELD EQUIPMENT; TRANSPORTATION SERVICES, NAMELY, TRANSPORT OF GOODS BY LAND IN THE FIELD OF INDUSTRIAL AND OILFIELD CHEMICALS AND INDUSTRIAL AND OILFIELD EQUIPMENT; DISTRIBUTION SERVICES, NAMELY DELIVERY OF RAW MATERIALS, FINISHED GOODS AND OTHER FREIGHT IN THE FIELD OF INDUSTRIAL AND OILFIELD CHEMICALS AND INDUSTRIAL AND OILFIELD EQUIPMENT BY BULK-LIQUID TANKERS, INDUSTRY STANDARD TRANSPORT CONTAINERS, BULK LIQUID CONTAINERS, DRY BULK CONTAINERS, CURTAIN-SIDE TRAILERS, DRY VANS, AND FLATBED TRAILERS (U.S. CLS. 100 AND 105).
 JAY BESCH, EXAMINING ATTORNEY

SN 78-932,778. BENCHMARK PERFORMANCE GROUP, INC., HOUSTON, TX. FILED 7-19-2006.

BENCHMARK DISTRIBUTION SERVICES

THE MARK CONSISTS OF STANDARD CHARACTERS WITHOUT CLAIM TO ANY PARTICULAR FONT, STYLE, SIZE, OR COLOR.

OWNER OF U.S. REG. NOS. 3,048,842 AND 3,062,236.
 NO CLAIM IS MADE TO THE EXCLUSIVE RIGHT TO USE "DISTRIBUTION SERVICES", APART FROM THE MARK AS SHOWN.

FOR SUPPLY CHAIN, LOGISTICS AND REVERSE LOGISTICS SERVICES, NAMELY STORAGE, TRANSPORTATION AND DELIVERY OF RAW MATERIALS, FINISHED GOODS, AND OTHER FREIGHT BY TRUCK OR VAN; WAREHOUSING SERVICES; TRANSPORTATION SERVICES, NAMELY, TRANSPORT OF GOODS; DISTRIBUTION SERVICES, NAMELY DELIVERY OF RAW MATERIALS, FINISHED GOODS AND OTHER FREIGHT (U.S. CLS. 100 AND 105).

FIRST USE 7-1-2006; IN COMMERCE 7-1-2006.
 JAY BESCH, EXAMINING ATTORNEY

CLASS 39—(Continued).

SN 78-933,436. BENCHMARK PERFORMANCE GROUP, INC., HOUSTON, TX. FILED 7-20-2006.



OWNER OF U.S. REG. NOS. 3,048,842 AND 3,062,236.
NO CLAIM IS MADE TO THE EXCLUSIVE RIGHT TO USE "DISTRIBUTION SERVICES", APART FROM THE MARK AS SHOWN.

"THE MARK CONSISTS OF THE STYLIZED WORDING BDS ABOVE THE STYLIZED WORDING BENCHMARK DISTRIBUTION SERVICES, HAVING A BANNER FORMED BY TWO WAVY LINES TO THE LEFT OF THE WORDING BDS, AND A HORIZONTAL LINE BENEATH THE WORDING BDS AND ABOVE THE WORDING BENCHMARK DISTRIBUTION SERVICES."

FOR SUPPLY CHAIN, LOGISTICS AND REVERSE LOGISTICS SERVICES, NAMELY STORAGE, TRANSPORTATION AND DELIVERY OF RAW MATERIALS, FINISHED GOODS, AND OTHER FREIGHT IN THE FIELD OF INDUSTRIAL AND OILFIELD CHEMICALS AND INDUSTRIAL AND OILFIELD EQUIPMENT BY BULK-LIQUID TANKERS, INDUSTRY STANDARD TRANSPORT CONTAINERS, BULK LIQUID CONTAINERS, DRY BULK CONTAINERS, CURTAIN-SIDE TRAILERS, DRY VANS, AND FLATBED TRAILERS; WAREHOUSING SERVICES IN THE FIELD OF INDUSTRIAL AND OILFIELD CHEMICALS AND INDUSTRIAL AND OILFIELD EQUIPMENT; TRANSPORTATION SERVICES, NAMELY, TRANSPORT OF GOODS BY LAND IN THE FIELD OF INDUSTRIAL AND OILFIELD CHEMICALS AND INDUSTRIAL AND OILFIELD EQUIPMENT; DISTRIBUTION SERVICES, NAMELY DELIVERY OF RAW MATERIALS, FINISHED GOODS AND OTHER FREIGHT IN THE FIELD OF INDUSTRIAL AND OILFIELD CHEMICALS AND INDUSTRIAL AND OILFIELD EQUIPMENT BY BULK-LIQUID TANKERS, INDUSTRY STANDARD TRANSPORT CONTAINERS, BULK LIQUID CONTAINERS, DRY BULK CONTAINERS, CURTAIN-SIDE TRAILERS, DRY VANS, AND FLATBED TRAILERS (U.S. CLS. 100 AND 105).

FIRST USE 7-1-2006; IN COMMERCE 7-1-2006.
JAY BESCH, EXAMINING ATTORNEY

CLASS 39—(Continued).

SN 78-933,437. BENCHMARK PERFORMANCE GROUP, INC., HOUSTON, TX. FILED 7-20-2006.



OWNER OF U.S. REG. NO. 3,062,236.

"THE MARK CONSISTS OF THE STYLIZED WORDING BDS, HAVING A BANNER FORMED BY TWO WAVY LINES TO THE LEFT OF THE WORDING."

FOR SUPPLY CHAIN, LOGISTICS AND REVERSE LOGISTICS SERVICES, NAMELY STORAGE, TRANSPORTATION AND DELIVERY OF RAW MATERIALS, FINISHED GOODS, AND OTHER FREIGHT IN THE FIELD OF INDUSTRIAL AND OILFIELD CHEMICALS AND INDUSTRIAL AND OILFIELD EQUIPMENT BY BULK-LIQUID TANKERS, INDUSTRY STANDARD TRANSPORT CONTAINERS, BULK LIQUID CONTAINERS, DRY BULK CONTAINERS, CURTAIN-SIDE TRAILERS, DRY VANS, AND FLATBED TRAILERS; WAREHOUSING SERVICES IN THE FIELD OF INDUSTRIAL AND OILFIELD CHEMICALS AND INDUSTRIAL AND OILFIELD EQUIPMENT; TRANSPORTATION SERVICES, NAMELY, TRANSPORT OF GOODS BY LAND IN THE FIELD OF INDUSTRIAL AND OILFIELD CHEMICALS AND INDUSTRIAL AND OILFIELD EQUIPMENT; DISTRIBUTION SERVICES, NAMELY DELIVERY OF RAW MATERIALS, FINISHED GOODS AND OTHER FREIGHT IN THE FIELD OF INDUSTRIAL AND OILFIELD CHEMICALS AND INDUSTRIAL AND OILFIELD EQUIPMENT BY BULK-LIQUID TANKERS, INDUSTRY STANDARD TRANSPORT CONTAINERS, BULK LIQUID CONTAINERS, DRY BULK CONTAINERS, CURTAIN-SIDE TRAILERS, DRY VANS, AND FLATBED TRAILERS (U.S. CLS. 100 AND 105).

JAY BESCH, EXAMINING ATTORNEY

SN 78-940,821. OAKLEAF WASTE MANAGEMENT, LLC, EAST HARTFORD, CT. FILED 7-31-2006.

TRASH BEE GONE

THE MARK CONSISTS OF STANDARD CHARACTERS WITHOUT CLAIM TO ANY PARTICULAR FONT, STYLE, SIZE, OR COLOR.

NO CLAIM IS MADE TO THE EXCLUSIVE RIGHT TO USE TRASH, APART FROM THE MARK AS SHOWN.

FOR TRASH COLLECTION FEATURING COORDINATING THE SCHEDULING AND DELIVERY OF RECEPTACLES FOR THE REMOVAL OF CONSTRUCTION DEBRIS FROM LARGE AND SMALL CONSTRUCTION SITES (U.S. CLS. 100 AND 105).

FIRST USE 6-1-2004; IN COMMERCE 7-1-2004.
FRED MANDIR, EXAMINING ATTORNEY

CLASS 39—(Continued).

SN 78-954,133. IANTOSCA, RALPH, IRVING, TX. FILED 8-17-2006.

GO GIRL.TRAVEL

THE MARK CONSISTS OF STANDARD CHARACTERS WITHOUT CLAIM TO ANY PARTICULAR FONT, STYLE, SIZE, OR COLOR.

NO CLAIM IS MADE TO THE EXCLUSIVE RIGHT TO USE "TRAVEL", APART FROM THE MARK AS SHOWN.

FOR ARRANGING TRAVEL TOURS; COORDINATING TRAVEL ARRANGEMENTS FOR INDIVIDUALS AND FOR GROUPS; ORGANIZATION OF EXCURSIONS, SIGHTSEEING TOURS, HOLIDAYS, TOURS AND TRAVEL; TRAVEL AND TOUR INFORMATION SERVICE; TRAVEL AND TOUR TICKET RESERVATION SERVICE; TRAVEL BOOKING AGENCIES; TRAVEL GUIDE SERVICES; TRAVEL INFORMATION SERVICES; TRAVEL, EXCURSION AND CRUISE ARRANGEMENT (U.S. CLS. 100 AND 105).

FIRST USE 1-24-2006; IN COMMERCE 1-24-2006.

RICHARD A. STRASER, EXAMINING ATTORNEY

SN 78-970,785. ACOUPLEONTHEGO LTD., CALGARY, CANADA, FILED 9-9-2006.



THE MARK CONSISTS OF A LADY'S HAT OVER A PAIR OF SUNGLASSES BESIDE A MAN'S HAT OVER A PAIR OF SUNGLASSES.

FOR TRAVEL AND TOUR INFORMATION SERVICE; TRAVEL INFORMATION SERVICES (U.S. CLS. 100 AND 105).

CAROLYN GRAY, EXAMINING ATTORNEY

SN 78-971,768. SPECTRA ENERGY CORP., HOUSTON, TX. FILED 9-11-2006.

SPECTRA ENERGY

THE MARK CONSISTS OF STANDARD CHARACTERS WITHOUT CLAIM TO ANY PARTICULAR FONT, STYLE, SIZE, OR COLOR.

NO CLAIM IS MADE TO THE EXCLUSIVE RIGHT TO USE "ENERGY", APART FROM THE MARK AS SHOWN.

FOR STORAGE OF PROCESSED NATURAL GAS AND NATURAL GAS LIQUIDS, NAMELY ETHANE, PROPANE, BUTANE, ISO-BUTANE, AND NATURAL GASOLINE; TRANSPORTATION OF FUELS, NAMELY NATURAL GAS AND NATURAL GAS LIQUIDS; AND DISTRIBUTION OF ENERGY, NAMELY NATURAL GAS AND NATURAL GAS LIQUIDS (U.S. CLS. 100 AND 105).

MEGAN WHITNEY, EXAMINING ATTORNEY

CLASS 39—(Continued).

SN 78-973,838. HOQUE ENTERPRISES LLC, DALLAS, TX. FILED 9-13-2006.

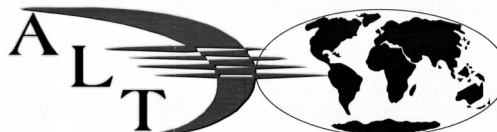
**Worldwide Chauffeured Services**

NO CLAIM IS MADE TO THE EXCLUSIVE RIGHT TO USE "WORLDWIDE CHAUFFEURED SERVICES", APART FROM THE MARK AS SHOWN.

FOR TRANSPORTATION OF PASSENGERS BY CAR, LIMOUSINE, VAN, AND BUS (U.S. CLS. 100 AND 105).

FIRST USE 1-1-1999; IN COMMERCE 1-1-1999.

JEAN IM, EXAMINING ATTORNEY

SN 79-035,480. KGB CO., LTD., REPUBLIC OF KOREA, FILED 11-10-2006.



OWNER OF INTERNATIONAL REGISTRATION 0916242 DATED 11-10-2006, EXPIRES 11-10-2016.

FOR TOUR GUIDE SERVICES; ARRANGING TRAVEL TOURS; TRANSPORTATION RESERVATION SERVICES; PROVIDING INFORMATION IN THE FIELD OF TRANSPORTATION; PARCEL DELIVERY SERVICES; FLOWER DELIVERY SERVICES; DELIVERY OF GOODS BY TRUCK OR AIR; WATER SUPPLYING SERVICES; TRANSPORT BROKERAGE; STORAGE OF BAGGAGE; EMERGENCY MESSAGE DELIVERY; EMERGENCY MERCHANDISE DELIVERY BY TRUCK OR AIR; DELIVERY OF GOODS BY TRUCK OR AIR, NAMELY, DELIVERY OF GIFTS; COURIER SERVICES; CAR TRANSPORT; FREIGHT TRANSPORTATION BY TRUCK, TRAIN OR AIR; FREIGHT BROKERAGE; TAXI TRANSPORT; PROVIDING INFORMATION IN THE FIELD OF STORAGE; AND WAREHOUSING SERVICES. (U.S. CLS. 100 AND 105).

KATHERINE E. HALMEN, EXAMINING ATTORNEY

CLASS 39—(Continued).

SN 79-035,481. KGB CO., LTD., REPUBLIC OF KOREA,
FILED 11-10-2006.

OWNER OF INTERNATIONAL REGISTRATION 0916243
DATED 11-10-2006, EXPIRES 11-10-2016.

FOR FREIGHT TRANSPORTATION BY TRUCK,
TRAIN OR AIR; PARCEL DELIVERY SERVICES; MOV-
ING, NAMELY, FURNITURE MOVING OR TRANSPOR-
TATION OF HOUSEHOLD GOODS OF OTHERS;
FREIGHT AGENCY SERVICES, NAMELY, FREIGHT
FORWARDING, FREIGHT SHIP TRANSPORT,
FREIGHT TRAIN TRANSPORT OR GLOBAL TRAN-
SPORTATION OF FREIGHT FOR OTHERS BY ALL
AVAILABLE MEANS; MARINE TRANSPORT; FREIGHT
BROKERAGE; INTERNATIONAL COMPLEX TRAN-
SPORTATION, NAMELY, GLOBAL TRANSPORTATION
OF FREIGHT FOR OTHERS BY ALL AVAILABLE
MEANS; DOCUMENT DELIVERY; COURIER SERVICES;
AND TRANSPORT BROKERAGE. (U.S. CLS. 100 AND
105).

KATHERINE E. HALMEN, EXAMINING ATTORNEY

CLASS 40—MATERIAL TREATMENT

SN 76-660,391. JAH INNOVATIONS INC., ATLANTA, GA.
FILED 5-22-2006.

NO CLAIM IS MADE TO THE EXCLUSIVE RIGHT TO
USE "PLASTICS", APART FROM THE MARK AS SHOWN.

FOR CUSTOM MANUFACTURE OF MEAL AND
SERVING TRAYS OF PRECIOUS METALS, MEAL AND
SERVING TRAYS NOT OF PRECIOUS METAL, AND
TABLEWARE IN THE NATURE OF PLASTIC KNIVES,
FORKS AND SPOONS (U.S. CLS. 100, 103 AND 106).

ROBERT LAVACHE, EXAMINING ATTORNEY

SN 79-035,482. KGB CO., LTD., REPUBLIC OF KOREA,
FILED 11-10-2006.

OWNER OF INTERNATIONAL REGISTRATION 0916244
DATED 11-10-2006, EXPIRES 11-10-2016.

FOR FREIGHT TRANSPORTATION BY TRUCK,
TRAIN OR AIR; PARCEL DELIVERY SERVICES; MOV-
ING, NAMELY, FURNITURE MOVING OR TRANSPOR-
TATION OF HOUSEHOLD GOODS OF OTHERS;
FREIGHT AGENCY SERVICES, NAMELY, FREIGHT
FORWARDING, FREIGHT SHIP TRANSPORT,
FREIGHT TRAIN TRANSPORT OR GLOBAL TRAN-
SPORTATION OF FREIGHT FOR OTHERS BY ALL
AVAILABLE MEANS; MARINE TRANSPORT; FREIGHT
BROKERAGE; INTERNATIONAL COMPLEX TRAN-
SPORTATION, NAMELY, GLOBAL TRANSPORTATION
OF FREIGHT FOR OTHERS BY ALL AVAILABLE
MEANS; DOCUMENT DELIVERY; COURIER SERVICES
(U.S. CLS. 100 AND 105).

KATHERINE E. HALMEN, EXAMINING ATTORNEY

SN 77-004,075. NINE COUTURE JEWELRY INC., PHOENIX,
AZ. FILED 9-21-2006.

couture jewelry

NO CLAIM IS MADE TO THE EXCLUSIVE RIGHT TO
USE "COUTURE JEWELRY", APART FROM THE MARK AS
SHOWN.

FOR CUSTOM MANUFACTURE OF JEWELRY (U.S.
CLS. 100, 103 AND 106).

NATALIE POLZER, EXAMINING ATTORNEY

CLASS 40—(Continued).

SN 77-064,330. SIGNATURE IMPRINTS, LLC, FAIRVIEW, PA. FILED 12-14-2006.

SIGNATURE IMPRINTS

THE MARK CONSISTS OF STANDARD CHARACTERS WITHOUT CLAIM TO ANY PARTICULAR FONT, STYLE, SIZE, OR COLOR.

FOR CUSTOMIZED PRINTING OF COMPANY NAMES AND LOGOS FOR PROMOTIONAL AND ADVERTISING PURPOSES ON THE GOODS OF OTHERS; DESIGN PRINTING FOR OTHERS; SCREEN PRINTING; ENGRAVING; PAD PRINTING; ROTARY PRINTING; AIR BRUSHING SERVICES; EMBROIDERY SERVICES; CUSTOM IMPRINTING OF CLOTHING AND GLASSWARE WITH DECORATIVE DESIGNS (U.S. CLS. 100, 103 AND 106).

JOHN WILKE, EXAMINING ATTORNEY

CLASS 40—(Continued).

SN 77-120,696. WP IP LLC, NEW YORK, NY. FILED 3-2-2007.



NO CLAIM IS MADE TO THE EXCLUSIVE RIGHT TO USE "HOME", APART FROM THE MARK AS SHOWN.

THE MARK CONSISTS OF A BOX WITH THE STYLIZED WORDS "WP HOME" INSIDE.

FOR MANUFACTURING SERVICES FOR OTHERS IN THE FIELD OF HOME TEXTILE PRODUCTS (U.S. CLS. 100, 103 AND 106).

FRANK LATTUCA, EXAMINING ATTORNEY

SN 77-083,311. COOLEY, FRANKLIN E., TEMPE, AZ. FILED 1-15-2007.

ROUTE 66 CLOTHING COMPANY

THE MARK CONSISTS OF STANDARD CHARACTERS WITHOUT CLAIM TO ANY PARTICULAR FONT, STYLE, SIZE, OR COLOR.

NO CLAIM IS MADE TO THE EXCLUSIVE RIGHT TO USE "CLOTHING COMPANY", APART FROM THE MARK AS SHOWN.

FOR CUSTOM IMPRINTING OF APPAREL WITH DECORATIVE DESIGNS (U.S. CLS. 100, 103 AND 106).

ANDREA SAUNDERS, EXAMINING ATTORNEY

SN 77-121,935. LUNDERVERVILLE ENTERPRISES INC., CHARLOTTE, NC. FILED 3-5-2007.

SN 77-093,793. DURGIN & CROWELL LUMBER COMPANY, INC., NEW LONDON, NH. FILED 1-29-2007.

**Asure**

THE MARK CONSISTS OF STANDARD CHARACTERS WITHOUT CLAIM TO ANY PARTICULAR FONT, STYLE, SIZE, OR COLOR.

FOR APPLYING PROTECTIVE COATINGS TO WOOD, NAMELY, APPLYING ULTRAVIOLET COATINGS TO PINE WOOD BOARDS (U.S. CLS. 100, 103 AND 106).

BARBARA BROWN, EXAMINING ATTORNEY

THE COLOR(S) BLACK, WHITE, LIGHT GREY, DARK GREY, AND ORANGE IS/ARE CLAIMED AS A FEATURE OF THE MARK.

THE MARK CONSISTS OF BLACK SKY, WHITE MOUNTAIN TOPS, LIGHT GREY MOUNTAINS, DARK GREY R AND V, ORANGE A.

FOR IMPRINTING MESSAGES ON WEARING APPAREL, ACCESSORIES AND MUGS (U.S. CLS. 100, 103 AND 106).

THOMAS MANOR, EXAMINING ATTORNEY

CLASS 40—(Continued).

SN 77-123,918. PLASTIC EARTH, SORRENTO, FL. FILED 3-6-2007.



NO CLAIM IS MADE TO THE EXCLUSIVE RIGHT TO USE "PLASTIC", APART FROM THE MARK AS SHOWN.

THE MARK CONSISTS OF THE WORDS "PLASTIC EARTH" DIAGONALLY WITH AN OUTLINE. THE WORD PLASTIC IS ON TOP OF THE WORD EARTH. BELOW THE LETTERS IS AN OUTLINE OF A BODY WITH OUT-STRETCHED ARMS AND LEGS WITH A GLOBE OF THE EARTH FOR A HEAD. BEHIND THE BODY IS A GRADIENT BACKGROUND OF STARS FADING FROM TOP TO BOTTOM.

FOR CUSTOM MANUFACTURE OF TOYS (U.S. CLS. 100, 103 AND 106).

FIRST USE 6-0-2004; IN COMMERCE 7-0-2004.

ESTHER A. BORSUK, EXAMINING ATTORNEY

SN 77-130,579. VETERANS ENERGY SOLUTIONS, LLC, MIAMI, FL. FILED 3-14-2007.



NO CLAIM IS MADE TO THE EXCLUSIVE RIGHT TO USE "VETERANS ENERGY SOLUTIONS, LLC", APART FROM THE MARK AS SHOWN.

THE MARK CONSISTS OF A CIRCULAR SEAL WITH AN EAGLE CARRYING A SOLAR PANEL IN ITS TALONS AND BURSTING OUT OF THE AMERICAN FLAG AND SUN IN THE BACKGROUND.

FOR PROVIDING CONSULTING SERVICES IN THE FIELD OF GENERATING RENEWABLE ENERGY (U.S. CLS. 100, 103 AND 106).

FIRST USE 1-6-2007; IN COMMERCE 1-6-2007.

PAM WILLIS, EXAMINING ATTORNEY

CLASS 40—(Continued).

SN 77-133,717. ICRETE LLC, BEVERLY HILLS, CA. FILED 3-17-2007.

IGREEN

THE MARK CONSISTS OF STANDARD CHARACTERS WITHOUT CLAIM TO ANY PARTICULAR FONT, STYLE, SIZE, OR COLOR.

FOR CONSULTING SERVICES IN THE FIELD OF PROVIDING CUSTOMIZED FORMULATIONS FOR PREFERRED, LOWER COST, AND HIGHER STRENGTH CONCRETE APPLICATIONS AND BATCHING PROCESSES (U.S. CLS. 100, 103 AND 106).

CHRISTINE COOPER, EXAMINING ATTORNEY

SN 77-138,716. JEFFREY PRESS, INC., WINDSOR MILL, MD. FILED 3-23-2007.

LASERITE

THE MARK CONSISTS OF STANDARD CHARACTERS WITHOUT CLAIM TO ANY PARTICULAR FONT, STYLE, SIZE, OR COLOR.

FOR PRINTING SERVICES, NAMELY PRINTING WITH RAISED LETTERING (U.S. CLS. 100, 103 AND 106).

FIRST USE 5-31-1987; IN COMMERCE 8-31-1987.

PETER CHENG, EXAMINING ATTORNEY

SN 77-139,014. ETCHED IMAGES, INC., NAPA, CA. FILED 3-23-2007.

ETCHED IMAGES

THE MARK CONSISTS OF STANDARD CHARACTERS WITHOUT CLAIM TO ANY PARTICULAR FONT, STYLE, SIZE, OR COLOR.

SEC. 2(F).

FOR GLASS ETCHING (U.S. CLS. 100, 103 AND 106).

FIRST USE 3-1-1993; IN COMMERCE 3-1-1993.

JAY BESCH, EXAMINING ATTORNEY

CLASS 40—(Continued).

SN 77-139,063. NEW GLARUS BREWING COMPANY, NEW GLARUS, WI. FILED 3-23-2007.

DRINK INDIGENOUS

THE MARK CONSISTS OF STANDARD CHARACTERS WITHOUT CLAIM TO ANY PARTICULAR FONT, STYLE, SIZE, OR COLOR.

NO CLAIM IS MADE TO THE EXCLUSIVE RIGHT TO USE "DRINK", APART FROM THE MARK AS SHOWN.

SEC. 2(F).

FOR BREWERY SERVICES (U.S. CLS. 100, 103 AND 106).

FIRST USE 9-24-2002; IN COMMERCE 9-24-2002.

TONI HICKEY, EXAMINING ATTORNEY

SN 77-139,084. NORWOOD ENTERPRISES, LLC, SILVER SPRING, MD. FILED 3-23-2007.

NO_H8!

THE MARK CONSISTS OF STANDARD CHARACTERS WITHOUT CLAIM TO ANY PARTICULAR FONT, STYLE, SIZE, OR COLOR.

FOR IMPRINTING MESSAGES ON WEARING APPAREL, ACCESSORIES AND MUGS (U.S. CLS. 100, 103 AND 106).

ELISSA GARBER KON, EXAMINING ATTORNEY

SN 77-140,276. WATERHEALTH INTERNATIONAL, INC., LAKE FOREST, CA. FILED 3-26-2007.

LEADING THE BLUE REVOLUTION

THE MARK CONSISTS OF STANDARD CHARACTERS WITHOUT CLAIM TO ANY PARTICULAR FONT, STYLE, SIZE, OR COLOR.

FOR WATER TREATMENT AND PURIFICATION SERVICES (U.S. CLS. 100, 103 AND 106).

GRETTA YAO, EXAMINING ATTORNEY

CLASS 40—(Continued).

SN 77-140,391. WATERHEALTH INTERNATIONAL, INC., LAKE FOREST, CA. FILED 3-26-2007.



FOR WATER TREATMENT AND PURIFICATION SERVICES (U.S. CLS. 100, 103 AND 106).
GRETTA YAO, EXAMINING ATTORNEY

SN 77-140,712. SEAWAX INTERNATIONAL, INC., GOLETA, CA. FILED 3-26-2007.

TERRAWAX

THE MARK CONSISTS OF STANDARD CHARACTERS WITHOUT CLAIM TO ANY PARTICULAR FONT, STYLE, SIZE, OR COLOR.

FOR GROUND AND GROUND WATER REMEDIATION SERVICES (U.S. CLS. 100, 103 AND 106).

HENRY S. ZAK, EXAMINING ATTORNEY

SN 77-140,862. DOWLEYNE, ALVIN L., MELBOURNE, FL. FILED 3-26-2007.

Fully Reliant on GOD

THE MARK CONSISTS OF STANDARD CHARACTERS WITHOUT CLAIM TO ANY PARTICULAR FONT, STYLE, SIZE, OR COLOR.

FOR IMPRINTING MESSAGES ON T-SHIRTS (U.S. CLS. 100, 103 AND 106).

ZHALEH DELANEY, EXAMINING ATTORNEY

CLASS 40—(Continued).

SN 77-141,136. SEAWAX INTERNATIONAL, INC., GOLETA, CA. FILED 3-27-2007.

SEAWAX

THE MARK CONSISTS OF STANDARD CHARACTERS WITHOUT CLAIM TO ANY PARTICULAR FONT, STYLE, SIZE, OR COLOR.
FOR WATER TREATMENT REMEDIATION SERVICES NAMELY, REMOVING OIL FROM BODIES OF WATER (U.S. CLS. 100, 103 AND 106).
HENRY S. ZAK, EXAMINING ATTORNEY

SN 77-141,903. MAD WILL'S FOOD COMPANY, INC., SAN FRANCISCO, CA. FILED 3-27-2007.

YOUR PARTNER IN PREMIUM PRIVATE LABEL

THE MARK CONSISTS OF STANDARD CHARACTERS WITHOUT CLAIM TO ANY PARTICULAR FONT, STYLE, SIZE, OR COLOR.
FOR MANUFACTURING SERVICES FOR OTHERS IN THE FIELD OF FOOD PRODUCTS (U.S. CLS. 100, 103 AND 106).
FIRST USE 1-0-1999; IN COMMERCE 1-0-1999.
BRIAN CALLAGHAN, EXAMINING ATTORNEY

SN 77-142,856. LAURENT, EVAN L, HYATTSVILLE, MD. FILED 3-28-2007.

Foreplay Rocks!

THE MARK CONSISTS OF STANDARD CHARACTERS WITHOUT CLAIM TO ANY PARTICULAR FONT, STYLE, SIZE, OR COLOR.
FOR IMPRINTING MESSAGES ON T-SHIRTS (U.S. CLS. 100, 103 AND 106).
BARNEY CHARLON, EXAMINING ATTORNEY

CLASS 40—(Continued).

SN 77-143,554. LASER TAPESTRY, WAPPINGERS FALLS, NY. FILED 3-29-2007.

LaserPals

THE MARK CONSISTS OF STANDARD CHARACTERS WITHOUT CLAIM TO ANY PARTICULAR FONT, STYLE, SIZE, OR COLOR.
FOR ETCHING OF GRANITE, MARBLE, GLASS, WOOD, ACRYLIC, METALS, STONE, AND LEATHER (U.S. CLS. 100, 103 AND 106).
LESLEY LAMOTHE, EXAMINING ATTORNEY

SN 77-155,093. PANEL PROCESSING, INC., ALPENA, MI. FILED 4-12-2007.

ALABAMA INTER-FOREST

THE MARK CONSISTS OF STANDARD CHARACTERS WITHOUT CLAIM TO ANY PARTICULAR FONT, STYLE, SIZE, OR COLOR.
SEC. 2(F) AS TO ALABAMA.
FOR CUSTOM MANUFACTURE OF HARDBOARD, FIBERBOARD, PARTICLEBOARD, PEGBOARD, SLAT-WALL, MARKERBOARD, CHALKBOARD, MEDIUM DENSITY FIBERBOARD (MDF), THERMALFUSED MELAMINE, SAMPLE BOARD AND TILE BOARD FOR COMPONENT PARTS FOR FURNITURE, CABINETS, STORE FIXTURES AND RELATED PRODUCTS (U.S. CLS. 100, 103 AND 106).
FIRST USE 0-0-1982; IN COMMERCE 0-0-1982.
SUE LAWRENCE, EXAMINING ATTORNEY

SN 78-787,443. BAKER HUGHES INCORPORATED, HOUSTON, TX. FILED 1-9-2006.

WELLPOINT

THE MARK CONSISTS OF STANDARD CHARACTERS WITHOUT CLAIM TO ANY PARTICULAR FONT, STYLE, SIZE, OR COLOR.
FOR OIL AND GAS WELL SERVICES, NAMELY, PROVIDING OTHERS WITH INFORMATION, REGARDING HYDROCARBON PRODUCTION OPTIMIZATION; CONSULTATION SERVICES REGARDING HYDROCARBON PRODUCTION OPTIMIZATION (U.S. CLS. 100, 103 AND 106).
ZACHARY BELLO, EXAMINING ATTORNEY

CLASS 40—(Continued).

SN 78-931,609. NATIONAL IMAGE COMPANY, LLC, PORTLAND, ME. FILED 7-18-2006.

CLASS 40—(Continued).

SN 78-957,895. SOLICO FIBER GLASS FACTORY L.L.C., DUBAI, UNITED ARAB EMIR., FILED 8-22-2006.

WALLGOLD



THE MARK CONSISTS OF STANDARD CHARACTERS WITHOUT CLAIM TO ANY PARTICULAR FONT, STYLE, SIZE, OR COLOR.

FOR PHOTOGRAPHIC AND PHOTOGRAPHIC IMAGE PROCESSING SERVICES, NAMELY, DEVELOPING, REPRINTING AND MODIFYING IMAGES; PRINTING SERVICES, NAMELY, TRANSFERRING PHOTOGRAPHIC AND DIGITAL PHOTOGRAPHIC IMAGES TO IMPRINTABLE SURFACES (U.S. CLS. 100, 103 AND 106).

KHANH LE, EXAMINING ATTORNEY

OWNER OF UNITED ARAB EMIR. REG. NO. 60283, DATED 5-14-2006, EXPIRES 1-19-2015.

NO CLAIM IS MADE TO THE EXCLUSIVE RIGHT TO USE "INFLATABLES", APART FROM THE MARK AS SHOWN.

FOR CUSTOM MANUFACTURING OF CRUISERS, BOATS, SHIPS, VESSELS AND YACHTS (U.S. CLS. 100, 103 AND 106).

LINDA ESTRADA, EXAMINING ATTORNEY

SN 78-940,229. COGSDILL TOOL PRODUCTS, INC., LUGOFF, SC. FILED 7-28-2006.

SN 79-028,944. AIMT HOLDING GMBH, FED REP GERMANY, FILED 9-26-2006.

LAAG

V-Proteq

THE MARK CONSISTS OF STANDARD CHARACTERS WITHOUT CLAIM TO ANY PARTICULAR FONT, STYLE, SIZE, OR COLOR.

FOR MANUFACTURE OF WORK HOLDING FOR THE PRODUCTION MACHINING INDUSTRY TO THE ORDER AND SPECIFICATION OF OTHERS; MANUFACTURE OF WORK HOLDING SYSTEMS TO THE ORDER AND SPECIFICATION OF OTHERS (U.S. CLS. 100, 103 AND 106).

FIRST USE 5-1-2006; IN COMMERCE 5-1-2006.
MICHAEL WIENER, EXAMINING ATTORNEY

PRIORITY DATE OF 3-30-2006 IS CLAIMED.
OWNER OF INTERNATIONAL REGISTRATION 0898630 DATED 9-26-2006, EXPIRES 9-26-2016.

FOR MATERIAL TREATMENT SERVICES IN THE NATURE OF HEAT TREATMENT, COATING, AND PLATING OF METAL AND PLASTIC; MATERIAL TREATMENT SERVICES, NAMELY, TREATMENT OF FERROUS AND NON-FERROUS COMPONENTS WITH SURFACE PROTECTION MATERIALS AND SPECIALTY SURFACTANTS TO ENHANCE THE PERFORMANCE, LENGTHEN THE SERVICE LIFE AND PROTECT THE PROPERTIES OF SUCH FINISHES (U.S. CLS. 100, 103 AND 106).

DANIEL CAPSHAW, EXAMINING ATTORNEY

CLASS 41—EDUCATION AND ENTERTAINMENT

SN 76-071,006. ROOM SERVICE INTERIORS LTD., PORT COQUITLAM, BRITISH COLUMBIA V3C 6H2, CANADA, FILED 6-15-2000.

ROOMSERVICE

PRIORITY CLAIMED UNDER SEC. 44(D) ON CANADA APPLICATION NO. 1040284, FILED 12-17-1999, REG. NO. TMA664327, DATED 5-16-2006, EXPIRES 5-16-2021.
OWNER OF U.S. REG. NO. 2,873,054.

FOR ONGOING TELEVISION AND RADIO PROGRAMS IN THE FIELD OF ARCHITECTURE, ANTIQUES, FURNITURE, INTERIOR DESIGN, AND DECORATING (U.S. CLS. 100, 101 AND 107).

NORA BUCHANAN WILL, EXAMINING ATTORNEY

SN 76-577,938. CHANGES FOR WOMEN FRANCHISE CORPORATION, GLOUCESTER, ONTARIO, CANADA, FILED 2-26-2004.

CHANGES FOR WOMEN

THE MARK CONSISTS OF STANDARD CHARACTERS WITHOUT CLAIM TO ANY PARTICULAR FONT, STYLE, SIZE, OR COLOR.

PRIORITY CLAIMED UNDER SEC. 44(D) ON CANADA APPLICATION NO. 1206836, FILED 2-12-2004, REG. NO. TMA620548, DATED 9-23-2004, EXPIRES 9-23-2019.

NO CLAIM IS MADE TO THE EXCLUSIVE RIGHT TO USE "FOR WOMEN", APART FROM THE MARK AS SHOWN.

FOR PROVIDING FITNESS AND EXERCISE FACILITIES AND INSTRUCTION FOR WOMEN (U.S. CLS. 100, 101 AND 107).

JOHN DALIER, EXAMINING ATTORNEY

SN 76-606,294. AMERICAN ACADEMY OF URGENT CARE MEDICINE, INC., ORLANDO, FL. FILED 8-10-2004.



NO CLAIM IS MADE TO THE EXCLUSIVE RIGHT TO USE "AMERICAN", "ACADEMY OF URGENT CARE MEDICINE" OR "EST. 1997", APART FROM THE MARK AS SHOWN.

THE MARK IS COMPRISED OF THE ACRONYM WORDS "AAUCM AMERICAN ACADEMY OF URGENT CARE MEDICINE EST. 1997 "THE DOCTOR WILL SEE YOU NOW!" IN COMBINATION WITH A STYLIZED FORMAT WITH A STYLIZED HORIZONTAL DESIGN SUPERIMPOSED THEREON.

FOR EDUCATIONAL SERVICES FOR PROFESSIONALS, NAMELY, CONDUCTING CLASSES IN THE FIELD OF AMBULATORY HEALTH CARE AND URGENT CARE MEDICINE (U.S. CLS. 100, 101 AND 107).

FIRST USE 8-20-2004; IN COMMERCE 8-20-2004.

NORA BUCHANAN WILL, EXAMINING ATTORNEY

CLASS 41—(Continued).

SN 76-638,805. THOMAS PUBLISHING COMPANY, NEW YORK, NY. FILED 5-17-2005.

PROGRESSIVE MANUFACTURING SUMMIT & AWARDS

THE MARK CONSISTS OF STANDARD CHARACTERS WITHOUT CLAIM TO ANY PARTICULAR FONT, STYLE, SIZE, OR COLOR.

NO CLAIM IS MADE TO THE EXCLUSIVE RIGHT TO USE "MANUFACTURING SUMMIT & AWARDS", APART FROM THE MARK AS SHOWN.

FOR PROVIDING RECOGNITION BY THE WAY OF PRESENTING AWARDS TO DEMONSTRATE EXCELLENCE IN THE FIELD OF INTRODUCING TECHNOLOGY INTO BUSINESS (U.S. CLS. 100, 101 AND 107).

FIRST USE 7-0-2004; IN COMMERCE 7-0-2004.

JOANNA DUKOVIC, EXAMINING ATTORNEY

SN 76-652,394. MY2CENTENCES LLC, WEST HOLLYWOOD, CA. FILED 12-22-2005.

FANISODE

FOR ENTERTAINMENT SERVICES, NAMELY PRODUCTION AND DISTRIBUTION OF FILMS, MOTION PICTURES, TELEVISION SHOWS, MULTIMEDIA INTERNET-BASED PRESENTATIONS, LIVE PERFORMANCES, AND VIDEOGAME PROGRAMS WHOSE CONTENT IS CREATED, CONCEPTUALIZED, AND INFLUENCED BY PARTICIPANT SUGGESTIONS, CONCEPTS, IDEAS, COLLABORATION, AND VOTING; ENTERTAINMENT SERVICES, NAMELY, PUBLICATION OF BOOKS, MAGAZINES, ELECTRONIC BOOKS, AND ELECTRONIC MAGAZINES WHOSE CONTENT IS CREATED, CONCEPTUALIZED, AND INFLUENCED BY PARTICIPANT SUGGESTIONS, CONCEPTS, IDEAS, COLLABORATION, AND VOTING (U.S. CLS. 100, 101 AND 107).

FIRST USE 1-23-2006; IN COMMERCE 1-23-2006.

ZACHARY BELLO, EXAMINING ATTORNEY

CLASS 41—(Continued).

SN 76-660,446. EDELMAN ENTERPRISES, INC., NEW ORLEANS, LA. FILED 5-23-2006.



NO CLAIM IS MADE TO THE EXCLUSIVE RIGHT TO USE "NEW ORLEANS", APART FROM THE MARK AS SHOWN.

THE PORTRAIT IN THE MARK DOES NOT IDENTIFY A LIVING INDIVIDUAL.

THE COLOR(S) RED AND WHITE IS/ARE CLAIMED AS A FEATURE OF THE MARK.

THE COLOR RED APPEARS IN THE SILHOUETTE OF THE TRUMPET PLAYER, THE TEXT NEW ORLEANS NOW.NET AND THE UPPPERCASE LETTER N, THE UPPPERCASE LETTER O AND THE PERIOD BETWEEN THESE TWO LETTERS. THE COLOR WHITE APPEARS IN THE PERIOD AND AND IN UPPPERCASE W WITHIN THE RED SILHOUETTE OF TRUMPET PLAYER.

FOR PHOTOGRAPHY SERVICES FEATURING THE CITY OF NEW ORLEANS, LOUISIANA (U.S. CLS. 100, 101 AND 107).

FIRST USE 3-0-2006; IN COMMERCE 3-0-2006.
EDWARD NELSON, EXAMINING ATTORNEY

SN 76-664,013. CHEYENNE MOUNTAIN ENTERTAINMENT, INC., MESA, AZ. FILED 8-2-2006.

CHEYENNE MOUNTAIN

THE MARK CONSISTS OF STANDARD CHARACTERS WITHOUT CLAIM TO ANY PARTICULAR FONT, STYLE, SIZE, OR COLOR.

FOR ENTERTAINMENT SERVICES, NAMELY, PRODUCTION AND DISTRIBUTION OF LIVE ACTION AND ANIMATED MOTION PICTURES AND TELEVISION SHOWS; RADIO SHOWS FEATURING A DISCUSSION OF CURRENT EVENTS AND TECHNOLOGY; PRESENTATION OF LIVE ACTION SHOW PERFORMANCES (U.S. CLS. 100, 101 AND 107).

TINA BROWN, EXAMINING ATTORNEY

CLASS 41—(Continued).

SN 76-664,953. THE OUTDOOR SHOW, INC., ST. AUGUSTINE, FL. FILED 8-22-2006.

LIFE BEGINS IN THE OUTDOORS

THE MARK CONSISTS OF STANDARD CHARACTERS WITHOUT CLAIM TO ANY PARTICULAR FONT, STYLE, SIZE, OR COLOR.

FOR PROVIDING NEWS AND ENTERTAINMENT VIA THE INTERNET AND A TELEVISION SHOW IN THE FIELD OF OUTDOOR ACTIVITIES NAMELY, FISHING AND HUNTING (U.S. CLS. 100, 101 AND 107).

RONALD AIKENS, EXAMINING ATTORNEY

SN 76-665,290. ROCK STARR ENTERTAINMENT, LLC, LAS VEGAS, NV. FILED 8-29-2006.



NO CLAIM IS MADE TO THE EXCLUSIVE RIGHT TO USE "ENTERTAINMENT", APART FROM THE MARK AS SHOWN.

THE COLOR(S) BLACK, WHITE, AND PURPLE IS/ARE CLAIMED AS A FEATURE OF THE MARK.

THE COLOR BLACK APPEARS IN THE SINGER, MICROPHONE, AND THE BACKGROUND OF THE SQUARE. THE LETTER WHITE APPEARS IN THE WORDING ROCK-STARR ENTERTAINMENT RS. THE COLOR PURPLE APPEARS IN THE WORDING THE SHOW MUST GO ON! AND THE LINE UNDER THE WORD MUST.

FOR RECORD LABEL SERVICES, NAMELY, AUDIO RECORDING AND PRODUCTION (U.S. CLS. 100, 101 AND 107).

ELLEN B. AWRICH, EXAMINING ATTORNEY

SN 76-666,436. EDUCATION PLUS CORPORATION, DBA THE FAMILY FOUNDATION SCHOOL, HANCOCK, NY. FILED 9-22-2006.

THE FAMILY FOUNDATION SCHOOL BUILDING CHARACTER. CHANGING LIVES.

THE MARK CONSISTS OF STANDARD CHARACTERS WITHOUT CLAIM TO ANY PARTICULAR FONT, STYLE, SIZE, OR COLOR.

NO CLAIM IS MADE TO THE EXCLUSIVE RIGHT TO USE "FOUNDATION SCHOOL", APART FROM THE MARK AS SHOWN.

FOR EDUCATIONAL SERVICES, NAMELY, COLLEGE PREPARATORY BOARDING SCHOOL FOR TEENAGERS AT RISK (U.S. CLS. 100, 101 AND 107).

FIRST USE 9-15-2006; IN COMMERCE 9-15-2006.
ALICE BENMAMAN, EXAMINING ATTORNEY

CLASS 41—(Continued).

SN 76-669,179. STANLEY WORLD, LTD., PINE BROOK, NJ. FILED 11-15-2006.

LIVE TO WIN

THE MARK CONSISTS OF STANDARD CHARACTERS WITHOUT CLAIM TO ANY PARTICULAR FONT, STYLE, SIZE, OR COLOR.

FOR ENTERTAINMENT, NAMELY, LIVE PERFORMANCES BY A MUSICAL BAND (U.S. CLS. 100, 101 AND 107).

SOPHIA S. KIM, EXAMINING ATTORNEY

SN 76-670,074. THE TRUSTEES OF THE UNIVERSITY OF PENNSYLVANIA, PHILADELPHIA, PA. FILED 12-7-2006.



FOR ENTERTAINMENT IN THE NATURE OF LIVE PERFORMANCES, AND MUSICAL, VARIETY AND COMEDY SHOWS (U.S. CLS. 100, 101 AND 107).

ANDREA BUTLER, EXAMINING ATTORNEY

SN 76-670,135. HILLSDALE COLLEGE, HILLSDALE, MI. FILED 12-8-2006.

HILLSDALE

THE MARK CONSISTS OF STANDARD CHARACTERS WITHOUT CLAIM TO ANY PARTICULAR FONT, STYLE, SIZE, OR COLOR.

OWNER OF U.S. REG. NOS. 1,620,488, 2,660,651 AND OTHERS.

SEC. 2(F).

FOR EDUCATIONAL SERVICES, NAMELY, PROVIDING COURSES OF INSTRUCTION AT THE COLLEGE LEVEL (U.S. CLS. 100, 101 AND 107).

FIRST USE 0-0-1879; IN COMMERCE 0-0-1879.

DOMINIC J. FERRAIUOLO, EXAMINING ATTORNEY

CLASS 41—(Continued).

SN 76-672,449. JOHNSON, IVEY JUSTMAN, JR., MANTEO, NC. FILED 2-8-2007.

TOUR OF CHAMPIONS

THE MARK CONSISTS OF STANDARD CHARACTERS WITHOUT CLAIM TO ANY PARTICULAR FONT, STYLE, SIZE, OR COLOR.

NO CLAIM IS MADE TO THE EXCLUSIVE RIGHT TO USE "TOUR", APART FROM THE MARK AS SHOWN.

FOR ENTERTAINMENT IN THE NATURE OF AUTOMOBILE DRAG WAY RACES WHETHER A SINGLE EVENT OR A SERIES OF RACES (U.S. CLS. 100, 101 AND 107).

TEJBIR SINGH, EXAMINING ATTORNEY

SN 76-673,693. SUNSET FINANCIAL MANAGEMENT, INC., ALBUQUERQUE, NM. FILED 3-7-2007.

TECHNOLOGY TOOLS FOR TODAY

THE MARK CONSISTS OF STANDARD CHARACTERS WITHOUT CLAIM TO ANY PARTICULAR FONT, STYLE, SIZE, OR COLOR.

FOR EDUCATIONAL CONFERENCE, NAMELY, CONFERENCES IN THE FIELD OF TECHNOLOGY FOR FINANCIAL ADVISORS. (U.S. CLS. 100, 101 AND 107).

FIRST USE 3-1-2005; IN COMMERCE 3-1-2005.

EMILY CARLSEN, EXAMINING ATTORNEY

SN 76-674,057. BROWN, SHAWN, CUMMING, GA. FILED 3-14-2007.

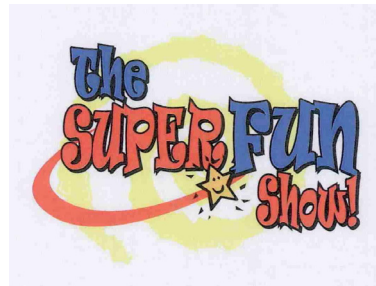

NO CLAIM IS MADE TO THE EXCLUSIVE RIGHT TO USE "SHOW", APART FROM THE MARK AS SHOWN.

THE COLOR(S) BLUE, RED, YELLOW, GREEN, AND BLACK IS/ARE CLAIMED AS A FEATURE OF THE MARK.

THE MARK CONSISTS OF THE WORDING "THE SUPER FUN SHOW!" AND DESIGNS. THE WORD "THE" APPEARS IN THE TOP LEFT PORTION OF THE MARK. THE WORDS "SUPER FUN" APPEAR IN THE CENTER OF THE MARK, ON A LINE BELOW "THE". AND THE WORD "SHOW!" APPEARS IN THE BOTTOM RIGHT PORTION OF THE MARK, ON A LINE BELOW "SUPER FUN". THE WORDS "THE" AND "FUN" ARE IN BLUE WITH BLACK OUTLINING. THE WORDS "SUPER" AND "SHOW!" ARE IN RED WITH BLACK OUTLINE. THE DESIGN OF THE

CLASS 41—(Continued).

MARK INCLUDES AN IMAGE OF A YELLOW STAR WITH A SMILEY FACE AND LINES REPRESENTING THAT THE STAR IS SHINING. THE SMILEY FACE IN THE STAR, AND THE OUTLINE AND SHINE LINES ARE ALL IN BLACK. THE STAR IS AT THE END OF A RED TRAIL THAT SWOOPS FROM THE LEFT OF THE MARK. IN THE BACKGROUND OF THE MARK, THERE IS A GREEN SPIRAL. ANY WHITE APPEARING IN THE DRAWING MERELY REPRESENTS TRANSPARENT BACKGROUND SPACE.

FOR EDUCATIONAL TRAINING IN THE FIELD OF EARLY CHILDHOOD DEVELOPMENT AND DISTRIBUTION OF AUDIO AND VIDEO COURSE MATERIALS IN CONNECTION THEREWITH (U.S. CLS. 100, 101 AND 107).

FIRST USE 1-16-2005; IN COMMERCE 1-28-2005.
CORY BOONE, EXAMINING ATTORNEY

CLASS 41—(Continued).

SN 76-675,360. KENTUCKY LOTTERY CORPORATION, LOUISVILLE, KY. FILED 4-11-2007.



SN 76-674,215. CHAPPELWOOD FINANCIAL SERVICES CORPORATION, EDMOND, OK. FILED 3-19-2007.

IT'S ALL ABOUT THE \$MONEY HONEY

THE MARK CONSISTS OF STANDARD CHARACTERS WITHOUT CLAIM TO ANY PARTICULAR FONT, STYLE, SIZE, OR COLOR.

FOR RADIO SHOWS DISCUSSING FINANCIAL MATTERS AND EDUCATIONAL SERVICES, NAMELY, PROVIDING WORKSHOPS, SEMINARS AND COURSES IN THE FIELD OF FINANCIAL MATTERS; PROVIDING EDUCATIONAL SPEAKERS IN THE FIELD OF FINANCIAL MATTERS (U.S. CLS. 100, 101 AND 107).

FIRST USE 6-30-2003; IN COMMERCE 6-30-2003.
WILLIAM BRECKENFELD, EXAMINING ATTORNEY

OWNER OF U.S. REG. NOS. 2,831,767, 3,093,678 AND OTHERS.

NO CLAIM IS MADE TO THE EXCLUSIVE RIGHT TO USE "KENTUCKY LOTTERY 3 THREE LINE LOTTO", APART FROM THE MARK AS SHOWN.

FOR LOTTERY SERVICES (U.S. CLS. 100, 101 AND 107).

FIRST USE 3-26-2007; IN COMMERCE 3-26-2007.
REBECCA POVARCHUK, EXAMINING ATTORNEY

SN 76-674,989. EDWARD L. MYERS, READING, PA. FILED 4-2-2007.

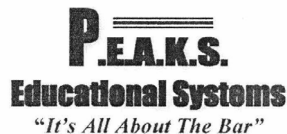

NO CLAIM IS MADE TO THE EXCLUSIVE RIGHT TO USE "EDUCATIONAL SYSTEMS", APART FROM THE MARK AS SHOWN.

FOR EDUCATION SERVICES, NAMELY, PROVIDING SEMINARS AND WORKSHOPS IN THE FIELDS OF PERSONAL DEVELOPMENT, LEADERSHIP, AND BEHAVIORAL HEALTH (U.S. CLS. 100, 101 AND 107).

FIRST USE 3-3-2007; IN COMMERCE 3-3-2007.
RICHARD A. STRASER, EXAMINING ATTORNEY

SN 77-001,160. BODY & SOUL WORKOUT, WEST HOLLYWOOD, CA. FILED 9-17-2006.

Ellipticore

THE MARK CONSISTS OF STANDARD CHARACTERS WITHOUT CLAIM TO ANY PARTICULAR FONT, STYLE, SIZE, OR COLOR.

FOR EDUCATIONAL SERVICES, NAMELY PROVIDING TRAINING IN THE FIELDS OF FITNESS; PHYSICAL FITNESS CONSULTATION; PHYSICAL FITNESS INSTRUCTION; PROVIDING FITNESS AND EXERCISE FACILITIES (U.S. CLS. 100, 101 AND 107).

THEODORE MCBRIDE, EXAMINING ATTORNEY

CLASS 41—(Continued).

SN 77-001,274. CYBERNET ENTERTAINMENT, LLC, SAN FRANCISCO, CA. FILED 9-18-2006.



THE COLOR(S) RED AND BLACK IS/ARE CLAIMED AS A FEATURE OF THE MARK.

THE MARK CONSISTS OF THE LETTER "K" IN A GRAPHICAL FORMAT, WITH THE STEM OF THE K STYLIZED INTO A POINTED TAIL. THE COLOR RED APPEARS AS THE STYLIZED LETTER "K" OVER A BLACK RECTANGLE.

FOR ENTERTAINMENT SERVICES NAMELY PROVIDING A WEBSITE FEATURING, PHOTOGRAPHIC, AUDIO, VIDEO AND PROSE PRESENTATIONS FEATURING ADULT ENTERTAINMENT (U.S. CLS. 100, 101 AND 107).

FIRST USE 1-1-2006; IN COMMERCE 9-18-2006.
JULIE THOMAS, EXAMINING ATTORNEY

CLASS 41—(Continued).

SN 77-012,135. ANDERSON, HOLLY, VENICE, CA. FILED 10-2-2006.

ExFactor

THE MARK CONSISTS OF STANDARD CHARACTERS WITHOUT CLAIM TO ANY PARTICULAR FONT, STYLE, SIZE, OR COLOR.

FOR PRODUCTION AND DISTRIBUTION OF TELEVISION SHOWS AND MOVIES (U.S. CLS. 100, 101 AND 107).

JAMES STEIN, EXAMINING ATTORNEY

SN 77-011,921. CAMPBELL, RONALD EDWIN, TUCSON, AZ. FILED 10-2-2006.



NO CLAIM IS MADE TO THE EXCLUSIVE RIGHT TO USE "CERTIFIED COMMERCIAL SPECIALIST", APART FROM THE MARK AS SHOWN.

FOR EDUCATIONAL SERVICES, NAMELY, CONDUCTING CLASSES, SEMINARS, AND WORKSHOPS IN THE FIELD OF COMMERCIAL REAL ESTATE AND DISTRIBUTION OF COURSE MATERIAL IN CONNECTION THEREWITH (U.S. CLS. 100, 101 AND 107).

ROBERT LAVACHE, EXAMINING ATTORNEY

SN 77-019,429. DEMARCO, DOROTHY J., BRONX, NY. FILED 10-12-2006.

GRAY GOURMET

THE MARK CONSISTS OF STANDARD CHARACTERS WITHOUT CLAIM TO ANY PARTICULAR FONT, STYLE, SIZE, OR COLOR.

NO CLAIM IS MADE TO THE EXCLUSIVE RIGHT TO USE "GOURMET", APART FROM THE MARK AS SHOWN.

FOR ENTERTAINMENT IN THE NATURE OF ONGOING TELEVISION PROGRAMS IN THE FIELDS OF COOKING, RECIPES, FOOD, WINE, NUTRITION, HEALTH AND SENIOR LIFESTYLE; ENTERTAINMENT SERVICES, NAMELY WINE AND FOOD TASTINGS; ONLINE JOURNALS, NAMELY, BLOGS FEATURING COOKING, RECIPES, FOOD, WINE, NUTRITION, HEALTH AND SENIOR LIFESTYLE (U.S. CLS. 100, 101 AND 107).

DOMINIC FATHY, EXAMINING ATTORNEY

CLASS 41—(Continued).

SN 77-022,579. CLASSIC PRODUCTIONS FOR STUDENTS, KNOXVILLE, TN. FILED 10-17-2006.

Classic Productions for Students

THE MARK CONSISTS OF STANDARD CHARACTERS WITHOUT CLAIM TO ANY PARTICULAR FONT, STYLE, SIZE, OR COLOR.

NO CLAIM IS MADE TO THE EXCLUSIVE RIGHT TO USE "PRODUCTIONS FOR STUDENTS", APART FROM THE MARK AS SHOWN.

FOR BOOKING OF SEATS AND TICKETS FOR THEATRICAL PRODUCTIONS FOR STUDENTS AND EDUCATORS, NAMELY THEATRICAL PRODUCTIONS THAT SUPPLEMENT THE STUDENTS' EDUCATIONAL OPPORTUNITIES AND EXPOSE THE STUDENTS TO THE ART OF THEATER; ENTERTAINMENT IN THE NATURE OF THEATRICAL PRODUCTIONS OFFERED TO STUDENTS AND EDUCATORS; THEATRICAL BOOKING AGENCIES, NAMELY BOOKING AGENCIES THAT PROMOTE THEATRICAL PRODUCTIONS TO EDUCATORS AND STUDENTS TO INTRODUCE THE STUDENTS TO THE ART OF THEATER AND TO SUPPLEMENT PROGRAMS OFFERED BY THE EDUCATORS (U.S. CLS. 100, 101 AND 107).

FIRST USE 2-12-1996; IN COMMERCE 2-12-1996.
GISELLE AGOSTO, EXAMINING ATTORNEY

CLASS 41—(Continued).

SN 77-023,287. BOSHES, ESTES, DEERFIELD, IL. FILED 10-17-2006.

Karen Heffernan's Strength Club

THE MARK CONSISTS OF STANDARD CHARACTERS WITHOUT CLAIM TO ANY PARTICULAR FONT, STYLE, SIZE, OR COLOR.

NO CLAIM IS MADE TO THE EXCLUSIVE RIGHT TO USE "STRENGTH CLUB", APART FROM THE MARK AS SHOWN.

THE NAME KAREN HEFFERNAN IDENTIFIES A LIVING INDIVIDUAL WHOSE CONSENT IS OF RECORD.

FOR HEALTH CLUB SERVICES, NAMELY PROVIDING INSTRUCTION AND EQUIPMENT IN THE FIELD OF PHYSICAL EXERCISE; PROVIDING FITNESS AND EXERCISE FACILITIES (U.S. CLS. 100, 101 AND 107).

FIRST USE 6-1-2001; IN COMMERCE 6-1-2001.
MARIAM MAHMOUDI, EXAMINING ATTORNEY

SN 77-023,529. JNJ ENTERTAINMENT, L.L.C., PRAIRIEVILLE, LA. FILED 10-18-2006.

SN 77-023,180. LAUGH FACTORY, INC., HOLLYWOOD, CA. FILED 10-17-2006.

LAUGH FACTORY DIGITAL STUDIOS



THE MARK CONSISTS OF STANDARD CHARACTERS WITHOUT CLAIM TO ANY PARTICULAR FONT, STYLE, SIZE, OR COLOR.

OWNER OF U.S. REG. NOS. 1,314,593 AND 1,721,950.
NO CLAIM IS MADE TO THE EXCLUSIVE RIGHT TO USE "DIGITAL STUDIOS", APART FROM THE MARK AS SHOWN.

FOR ENTERTAINMENT SERVICES, NAMELY, PROVIDING A WEB SITE FEATURING COMEDY PERFORMANCES, COMEDY VIDEOS, RELATED FILM CLIPS, PHOTOGRAPHS, AND OTHER MULTIMEDIA MATERIALS (U.S. CLS. 100, 101 AND 107).

STEVEN R. FINE, EXAMINING ATTORNEY

THE MARK CONSISTS OF A CARTOON FROG WEARING SHOES JUMPING TO THE LEFT OF THE STYLIZED WORDS JUMP-N-JIVE, WITH A SEMI-CIRCLE AROUND THE TOP OF THE DESIGN.

FOR PROVIDING PARTY AND PLAY FACILITIES FOR CHILDREN; AND PROVIDING PLANNING, ORGANIZING, AND ASSISTANCE SERVICES FOR CHILDREN'S PARTIES CONDUCTED AT SUCH FACILITIES (U.S. CLS. 100, 101 AND 107).

KATHERINE STOIDES, EXAMINING ATTORNEY

CLASS 41—(Continued).

SN 77-024,901. COUSINS SUBMARINES, INC., MENOMONEE FALLS, WI. FILED 10-19-2006.

MOO-LA-PALOOZA

THE MARK CONSISTS OF STANDARD CHARACTERS WITHOUT CLAIM TO ANY PARTICULAR FONT, STYLE, SIZE, OR COLOR.

FOR ENTERTAINMENT SERVICES, NAMELY, CONDUCTING LIVE CONTESTS WHICH RELY ON THE ORAL PRESENTATION OF THE SOUND OF A COW (U.S. CLS. 100, 101 AND 107).

FIRST USE 7-31-2004; IN COMMERCE 7-31-2004.
TANYA AMOS, EXAMINING ATTORNEY

SN 77-033,314. PERAZA, WILLIAM, JR, AKA CHAIRMAN OF POKER, MIAMI BEACH, FL. FILED 10-31-2006.

Chairman of Poker

THE MARK CONSISTS OF STANDARD CHARACTERS WITHOUT CLAIM TO ANY PARTICULAR FONT, STYLE, SIZE, OR COLOR.

NO CLAIM IS MADE TO THE EXCLUSIVE RIGHT TO USE "POKER", APART FROM THE MARK AS SHOWN.

FOR ENTERTAINMENT IN THE NATURE OF COMPETITIONS IN THE FIELD OF POKER; ENTERTAINMENT IN THE NATURE OF ON-GOING TELEVISION PROGRAMS IN THE FIELD OF POKER; ENTERTAINMENT IN THE NATURE OF POKER GAMES; PRODUCING ONGOING TELEVISION PROGRAMS ON POKER TOURNAMENTS; CONDUCTING LIVE POKER GAME TOURNAMENTS; ENTERTAINMENT SERVICES, NAMELY, PROVIDING A TELEVISION PROGRAM IN THE FIELD OF POKER VIA A GLOBAL COMPUTER NETWORK; ENTERTAINMENT SERVICES, NAMELY, PROVIDING AN ON-LINE COMPUTER GAME (U.S. CLS. 100, 101 AND 107).

FIRST USE 1-1-2002; IN COMMERCE 1-1-2005.
WENDY GOODMAN, EXAMINING ATTORNEY

SN 77-033,959. CAMP OLYMPIA, TRINITY, TX. FILED 11-1-2006.

Camp Olympia

THE MARK CONSISTS OF STANDARD CHARACTERS WITHOUT CLAIM TO ANY PARTICULAR FONT, STYLE, SIZE, OR COLOR.

NO CLAIM IS MADE TO THE EXCLUSIVE RIGHT TO USE "CAMP", APART FROM THE MARK AS SHOWN.

FOR RECREATIONAL CAMPS; SPORT CAMPS; SUMMER CAMPS (U.S. CLS. 100, 101 AND 107).

FIRST USE 5-1-1968; IN COMMERCE 5-1-1968.
RUSS HERMAN, EXAMINING ATTORNEY

CLASS 41—(Continued).

SN 77-036,482. FRAISE, TRAVIS E., MONTROSE, IA. FILED 11-3-2006.

Wild Wild West Band

THE MARK CONSISTS OF STANDARD CHARACTERS WITHOUT CLAIM TO ANY PARTICULAR FONT, STYLE, SIZE, OR COLOR.

NO CLAIM IS MADE TO THE EXCLUSIVE RIGHT TO USE "BAND", APART FROM THE MARK AS SHOWN.

FOR ENTERTAINMENT NAMELY, LIVE PERFORMANCES BY A MUSICAL BAND (U.S. CLS. 100, 101 AND 107).

FIRST USE 2-1-1995; IN COMMERCE 2-2-1995.
ESTHER BELENKER, EXAMINING ATTORNEY

SN 77-038,939. OSTERBERG, JAMES, LOS ANGELES, CA. FILED 11-7-2006.

IGGY POP

THE MARK CONSISTS OF STANDARD CHARACTERS WITHOUT CLAIM TO ANY PARTICULAR FONT, STYLE, SIZE, OR COLOR.

THE NAME(S), PORTRAIT(S), AND/OR SIGNATURE(S) SHOWN IN THE MARK IDENTIFIES IGGY POP, WHOSE CONSENT(S) TO REGISTER IS SUBMITTED.

FOR ENTERTAINMENT SERVICES IN THE NATURE OF LIVE MUSICAL PERFORMANCES BY A PERFORMER OR GROUP; FAN CLUB SERVICES; AND ENTERTAINMENT SERVICES, NAMELY, PROVIDING A WEB SITE FEATURING MUSICAL PERFORMANCES, MUSICAL VIDEOS, RELATED FILM CLIPS, PHOTOGRAPHS AND OTHER MULTIMEDIA MATERIALS, COMMENTARY AND ARTICLES ABOUT MUSIC, MOVIES, BOOKS AND TELEVISION, AND PERSONAL AND MUSICAL INFORMATION REGARDING A MUSICAL GROUP OR PERFORMER AND ITS LIVE AND RECORDED PERFORMANCES; PRODUCING RECORDS AND VIDEOS FOR OTHERS; ENTERTAINMENT SERVICES, NAMELY, VISUAL AND AUDIO PERFORMANCES IN THE NATURE OF TELEVISION, THEATRICAL AND OTHER ACTING PERFORMANCES (U.S. CLS. 100, 101 AND 107).

FIRST USE 12-1-1968; IN COMMERCE 12-1-1968.
SCOTT SISUN, EXAMINING ATTORNEY

CLASS 41—(Continued).

SN 77-039,257. RAZOR & TIE DIRECT, L.L.C., NEW YORK, NY. FILED 11-8-2006.

KIDZCAST

THE MARK CONSISTS OF STANDARD CHARACTERS WITHOUT CLAIM TO ANY PARTICULAR FONT, STYLE, SIZE, OR COLOR.

FOR PROVIDING A WEB SITE CONTAINING INFORMATION AND MULTIMEDIA CONTENT ON MOVIES, VIDEOS AND MUSIC; ENTERTAINMENT SERVICES, NAMELY, PROVIDING MUSIC, CARTOONS, VIDEOS, STILL PHOTOS AND TELEVISION AND CABLE TELEVISION PROGRAMS FEATURING MUSIC, CHILDREN'S ENTERTAINMENT, CARTOONS, PROMOTIONAL VIDEOS AND FILMS, MUSIC, MUSIC VIDEOS, NEWS, COMEDY, DRAMA, PERSONAL VIDEOS, ALL VIA WEBCASTS OR VIA A GLOBAL COMPUTER NETWORK (U.S. CLS. 100, 101 AND 107).

FIRST USE 7-31-2005; IN COMMERCE 7-31-2005.
AMY MCMENAMIN, EXAMINING ATTORNEY

CLASS 41—(Continued).

SN 77-041,717. LIFESTYLE FAMILY FITNESS, INC., SAINT PETERSBURG, FL. FILED 11-10-2006.



OWNER OF U.S. REG. NO. 2,712,411.

NO CLAIM IS MADE TO THE EXCLUSIVE RIGHT TO USE "FAMILY FITNESS", APART FROM THE MARK AS SHOWN.

THE MARK CONSISTS OF THE WORDS "LIFESTYLE FAMILY FITNESS" INSIDE A SWOOSH DESIGN.

FOR HEALTH CLUB SERVICES NAMELY, PROVIDING INSTRUCTION, EQUIPMENT AND FACILITIES FOR USE IN THE FIELD OF PHYSICAL EXERCISE (U.S. CLS. 100, 101 AND 107).

FIRST USE 4-30-2005; IN COMMERCE 4-30-2005.
VERNA BETH RIRIE, EXAMINING ATTORNEY

SN 77-041,713. LIFESTYLE FAMILY FITNESS, INC., SAINT PETERSBURG, FL. FILED 11-10-2006.

LIFESTYLE FAMILY FITNESS

THE MARK CONSISTS OF STANDARD CHARACTERS WITHOUT CLAIM TO ANY PARTICULAR FONT, STYLE, SIZE, OR COLOR.

OWNER OF U.S. REG. NO. 2,712,411.
NO CLAIM IS MADE TO THE EXCLUSIVE RIGHT TO USE "FAMILY FITNESS", APART FROM THE MARK AS SHOWN.

FOR HEALTH CLUB SERVICES NAMELY, PROVIDING INSTRUCTION, EQUIPMENT AND FACILITIES FOR USE IN THE FIELD OF PHYSICAL EXERCISE (U.S. CLS. 100, 101 AND 107).

FIRST USE 5-31-1995; IN COMMERCE 5-31-1995.
VERNA BETH RIRIE, EXAMINING ATTORNEY

SN 77-041,788. HEALDSBURG PERFORMING ARTS THEATER, HEALDSBURG, CA. FILED 11-10-2006.



NO CLAIM IS MADE TO THE EXCLUSIVE RIGHT TO USE "PERFORMING ARTS THEATER", APART FROM THE MARK AS SHOWN.

THE MARK CONSISTS OF A BIRD IN A BOW TIE PERCHED OVER THE WORDS; "RAVEN PERFORMING ARTS THEATER."

FOR ENTERTAINMENT IN THE NATURE OF LIVE PERFORMANCES BY THEATRICAL, MUSICAL AND ACTING GROUPS; ENTERTAINMENT IN THE NATURE OF THEATER PRODUCTIONS; ENTERTAINMENT IN THE NATURE OF VISUAL AND AUDIO PERFORMANCES, NAMELY, MUSICAL BAND, ROCK GROUP, GYMNASTIC, DANCE, AND BALLET PERFORMANCES (U.S. CLS. 100, 101 AND 107).

FIRST USE 8-1-2006; IN COMMERCE 9-21-2006.
CHRISTOPHER OTT, EXAMINING ATTORNEY

CLASS 41—(Continued).

SN 77-046,845. HANSEL 'N GRETEL BRAND, INC., GLENDALE, NY. FILED 11-17-2006.

W.O.W. WIZARD OF WORK

THE MARK CONSISTS OF STANDARD CHARACTERS WITHOUT CLAIM TO ANY PARTICULAR FONT, STYLE, SIZE, OR COLOR.

FOR TRAINING SERVICES FOR DELICATESSEN COUNTER EMPLOYEES (U.S. CLS. 100, 101 AND 107).

FIRST USE 11-15-2006; IN COMMERCE 11-15-2006.

SAMUEL E. SHARPER JR., EXAMINING ATTORNEY

SN 77-047,949. SUNNY FONG MIND AND BODY FITNESS, CONCORD, MA. FILED 11-20-2006.



THE MARK CONSISTS OF A SILHOUETTE OF A MAN OVER THE WORD TAICHILATES.

FOR PHYSICAL FITNESS CONDITIONING CLASSES (U.S. CLS. 100, 101 AND 107).

FIRST USE 10-17-2006; IN COMMERCE 10-17-2006.

ARETHA SOMERVILLE, EXAMINING ATTORNEY

SN 77-048,176. SPHERION ATLANTIC ENTERPRISES LLC, FORT LAUDERDALE, FL. FILED 11-20-2006.

**Seymour's INSIDER
CareerReport**

THE MARK CONSISTS OF STANDARD CHARACTERS WITHOUT CLAIM TO ANY PARTICULAR FONT, STYLE, SIZE, OR COLOR.

NO CLAIM IS MADE TO THE EXCLUSIVE RIGHT TO USE "CAREER REPORT", APART FROM THE MARK AS SHOWN.

FOR PROVIDING AN ON-LINE NON-DOWNLOADABLE PUBLICATION IN THE NATURE OF A NEWSLETTER IN THE FIELD OF CAREER TRENDS AND JOB TIPS WITH JOB SURVEY RESULTS (U.S. CLS. 100, 101 AND 107).

FIRST USE 8-9-2006; IN COMMERCE 8-9-2006.

ASMAT KHAN, EXAMINING ATTORNEY

CLASS 41—(Continued).

SN 77-050,078. UNIQUE DYNAMICS, INC., SAN DIEGO, CA. FILED 11-22-2006.

BATTERY RESURRECTION

THE MARK CONSISTS OF STANDARD CHARACTERS WITHOUT CLAIM TO ANY PARTICULAR FONT, STYLE, SIZE, OR COLOR.

NO CLAIM IS MADE TO THE EXCLUSIVE RIGHT TO USE "BATTERY", APART FROM THE MARK AS SHOWN.

FOR PROVIDING ONLINE PUBLICATIONS IN THE NATURE OF GUIDE BOOKS FEATURING BATTERY REPAIR (U.S. CLS. 100, 101 AND 107).

FIRST USE 4-14-2005; IN COMMERCE 4-24-2005.

AMY HELLA, EXAMINING ATTORNEY

SN 77-058,649. HERIZEN LIFE ADVENTURES INTERNATIONAL INC., NANAIMO, B.C., CANADA, FILED 12-6-2006.

HERIZEN

THE MARK CONSISTS OF STANDARD CHARACTERS WITHOUT CLAIM TO ANY PARTICULAR FONT, STYLE, SIZE, OR COLOR.

OWNER OF CANADA REG. NO. TMA638,962, DATED 5-3-2005, EXPIRES 5-3-2020.

FOR EDUCATIONAL SERVICES, NAMELY, SAILING COURSES, SPECIFICALLY SAILING COURSES FOR WOMEN (U.S. CLS. 100, 101 AND 107).

BERNICE MIDDLETON, EXAMINING ATTORNEY

SN 77-059,110. NATTRASS, SHERRIE, MESA, AZ. FILED 12-7-2006.



NO CLAIM IS MADE TO THE EXCLUSIVE RIGHT TO USE "FITNESS", APART FROM THE MARK AS SHOWN.

THE COLOR(S) RED AND BLACK IS/ARE CLAIMED AS A FEATURE OF THE MARK.

THE MARK CONSISTS OF THE NUMBER 180 DEGREES IN RED WITH THE STYLIZED WORD "FITNESS" IN BLACK BELOW THE NUMBERS.

FOR HEALTH CLUB SERVICES, NAMELY PROVIDING INSTRUCTION AND EQUIPMENT IN THE FIELD OF PHYSICAL EXERCISE; PROVIDING FITNESS AND EXERCISE FACILITIES (U.S. CLS. 100, 101 AND 107).

DARRYL SPRULL, EXAMINING ATTORNEY

CLASS 41—(Continued).

SN 77-060,649. GAMEZEBO, INC., SAN FRANCISCO, CA. FILED 12-8-2006.

GAMEZEBO

THE MARK CONSISTS OF STANDARD CHARACTERS WITHOUT CLAIM TO ANY PARTICULAR FONT, STYLE, SIZE, OR COLOR.

FOR ENTERTAINMENT SERVICES, NAMELY, PROVIDING ON-LINE COMPUTER GAMES, PROVIDING INFORMATION IN THE FIELD OF CASUAL ELECTRONIC GAMES; PROVIDING A WEBSITE FEATURING CASUAL ELECTRONIC GAMES AND INFORMATION ABOUT THEM (U.S. CLS. 100, 101 AND 107).

FIRST USE 10-10-2005; IN COMMERCE 10-10-2005.
JOANNA DUKOVIC, EXAMINING ATTORNEY

SN 77-062,280. ABSORBENT MIND MONTESSORI ACADEMY, INC., PARAMUS, NJ. FILED 12-12-2006.

ABSORBENT MIND MONTESSORI
ACADEMY

THE MARK CONSISTS OF STANDARD CHARACTERS WITHOUT CLAIM TO ANY PARTICULAR FONT, STYLE, SIZE, OR COLOR.

NO CLAIM IS MADE TO THE EXCLUSIVE RIGHT TO USE "MONTESSORI ACADEMY", APART FROM THE MARK AS SHOWN.

FOR EDUCATIONAL SERVICES IN THE NATURE OF MONTESSORI SCHOOLS (U.S. CLS. 100, 101 AND 107).

FIRST USE 10-31-2006; IN COMMERCE 10-31-2006.
KYLE PEETE, EXAMINING ATTORNEY

SN 77-062,303. ABSORBENT MIND MONTESSORI ACADEMY, INC., PARAMUS, NJ. FILED 12-12-2006.

AMMA

THE MARK CONSISTS OF STANDARD CHARACTERS WITHOUT CLAIM TO ANY PARTICULAR FONT, STYLE, SIZE, OR COLOR.

THE ENGLISH TRANSLATION OF AMMA IS MOTHER. FOR EDUCATIONAL SERVICES IN THE NATURE OF MONTESSORI SCHOOLS (U.S. CLS. 100, 101 AND 107).

FIRST USE 10-31-2006; IN COMMERCE 10-31-2006.
KYLE PEETE, EXAMINING ATTORNEY

CLASS 41—(Continued).

SN 77-063,643. KASZIEWICZ, ANTHONY G., VANCOUVER, WA. FILED 12-13-2006.

enfokus

THE COLOR(S) ORANGE, GRAY IS/ARE CLAIMED AS A FEATURE OF THE MARK.

THE MARK CONSISTS OF THE WORD ENFOKUS, "EN" COLORED ORANGE, "FOKUS" COLORED GRAY AND AN ORANGE LINE ABOVE THE "O" .

FOR PHOTOGRAPHY SERVICES; PORTRAIT PHOTOGRAPHY (U.S. CLS. 100, 101 AND 107).

FIRST USE 2-1-2002; IN COMMERCE 2-15-2002.
TAMARA FRAZIER, EXAMINING ATTORNEY

SN 77-063,673. THE FORT WORTH ZOOLOGICAL ASSOCIATION, FORT WORTH, TX. FILED 12-13-2006.

MOLA

THE MARK CONSISTS OF STANDARD CHARACTERS WITHOUT CLAIM TO ANY PARTICULAR FONT, STYLE, SIZE, OR COLOR.

FOR EDUCATIONAL AND ENTERTAINMENT SERVICES, NAMELY THE EXHIBITION OF ANIMALS, ORGANIZING AND CONDUCTING INSTRUCTIONAL AND ENTERTAINMENT PROGRAMS, CLASSES, SEMINARS, EXHIBITS, EVENTS, LECTURES, COSTUMED CHARACTER PERFORMANCES, SHOWS, AND WORKSHOPS IN THE FIELD OF PLANTS, ANIMALS, ANIMAL HABITATS, AND CONSERVATION; AND DISTRIBUTING COURSE MATERIALS IN CONNECTION THEREWITH; AND DEVELOPMENT AND DISSEMINATION OF EDUCATIONAL LITERATURE OF OTHERS IN THE FIELD OF PLANTS, ANIMALS, ANIMAL HABITATS, AND CONSERVATION (U.S. CLS. 100, 101 AND 107).

GINA FINK, EXAMINING ATTORNEY

CLASS 41—(Continued).

SN 77-074,257. DIRECTV, INC., EL SEGUNDO, CA. FILED 1-2-2007.

FAST RELIEF FROM ORDINARY TV

THE MARK CONSISTS OF STANDARD CHARACTERS WITHOUT CLAIM TO ANY PARTICULAR FONT, STYLE, SIZE, OR COLOR.

NO CLAIM IS MADE TO THE EXCLUSIVE RIGHT TO USE "TV", APART FROM THE MARK AS SHOWN.

FOR ENTERTAINMENT IN THE NATURE OF ONGOING TELEVISION PROGRAMS IN THE FIELD OF ART, NEWS, COMEDY, MUSIC, AUDIO AND VIDEO CLIPS INCLUDING SHORT FILMS AND ANIMATION; ENTERTAINMENT NAMELY, PRODUCTION OF TELEVISION PROGRAMS; ENTERTAINMENT, NAMELY A CONTINUING TELEVISION SHOW BROADCAST OVER TELEVISION, SATELLITE, AUDIO, AND VIDEO MEDIA (U.S. CLS. 100, 101 AND 107).

FIRST USE 11-6-2006; IN COMMERCE 11-6-2006.
 NAAKWAMA ANKRAH, EXAMINING ATTORNEY

SN 77-075,592. HECHMATI, LAURENT, LOS ANGELES, CA. FILED 1-3-2007.

Love Bill of Rights

THE MARK CONSISTS OF STANDARD CHARACTERS WITHOUT CLAIM TO ANY PARTICULAR FONT, STYLE, SIZE, OR COLOR.

NO CLAIM IS MADE TO THE EXCLUSIVE RIGHT TO USE "LOVE", APART FROM THE MARK AS SHOWN.

FOR PUBLICATION OF TEXTS, BOOKS, MAGAZINES AND OTHER PRINTED MATTER (U.S. CLS. 100, 101 AND 107).

TEJBIR SINGH, EXAMINING ATTORNEY

SN 77-078,076. LADY OF AMERICA FRANCHISE CORPORATION, FORT LAUDERDALE, FL. FILED 1-8-2007.



NO CLAIM IS MADE TO THE EXCLUSIVE RIGHT TO USE "FITNESS FOR WOMEN", APART FROM THE MARK AS SHOWN.

FOR HEALTH CLUB SERVICES, NAMELY PROVIDING INSTRUCTION AND EQUIPMENT IN THE FIELD OF PHYSICAL EXERCISE (U.S. CLS. 100, 101 AND 107).

FIRST USE 9-22-2006; IN COMMERCE 9-22-2006.
 ELI HELLMAN, EXAMINING ATTORNEY

CLASS 41—(Continued).

SN 77-078,091. LADY OF AMERICA FRANCHISE CORPORATION, FORT LAUDERDALE, FL. FILED 1-8-2007.



NO CLAIM IS MADE TO THE EXCLUSIVE RIGHT TO USE "FITNESS FOR WOMEN", APART FROM THE MARK AS SHOWN.

FOR HEALTH CLUB SERVICES, NAMELY, PROVIDING INSTRUCTION AND EQUIPMENT IN THE FIELD OF PHYSICAL EXERCISE (U.S. CLS. 100, 101 AND 107).

FIRST USE 11-20-2006; IN COMMERCE 12-5-2006.
 ELI HELLMAN, EXAMINING ATTORNEY

SN 77-078,911. WALL STREET CAFE, INC., FARMINGTON HILLS, MI. FILED 1-9-2007.



"THE COLOR(S) BROWN, GREEN AND WHITE IS/ARE CLAIMED AS A FEATURE OF THE MARK."

"THE MARK CONSISTS OF THE COLOR WHITE WHICH APPEARS IN THE OUTLINE OF THE COFFEE CUP, THE COLOR BROWN APPEARS IN THE COFFEE IN THE CUP AND THE WORDS THE AND EXCHANGE, AND THE COLOR GREEN APPEARS IN THE OUTLINE OF THE COFFEE CUP AND THE WORDS JAVA AND CAFE."

FOR PROVIDING A FACILITY IN A CAFE ENVIRONMENT FOR EDUCATIONAL SEMINARS ON GENERAL INTEREST TOPICS, NAMELY, ENTREPRENEURSHIP, INVESTING, RETIREMENT, EMPOWERMENT, HEALTH, HOME OWNERSHIP AND TRAVEL/LEISURE, NOT INCLUDING EDUCATIONAL SEMINARS ON COMPUTERS, COMPUTER HARDWARE, COMPUTER SOFTWARE, OTHER COMPUTER RELATED TECHNOLOGIES AND SERVICES, VOICE AND DATA COMMUNICATION PRODUCTS, TECHNOLOGIES AND SERVICES, COMPUTER AND COMMUNICATION NETWORKING PRODUCTS, TECHNOLOGIES AND SERVICES OR BUSINESS OPPORTUNITIES REGARDING SAME; PROVIDING A FACILITY IN A CAFE ENVIRONMENT FOR ENTERTAINMENT, NAMELY, POETRY READING, VOCAL PERFORMANCES AND LIVE MUSIC (U.S. CLS. 100, 101 AND 107).

FIRST USE 11-3-2006; IN COMMERCE 11-3-2006.
 DAVID MURRAY, EXAMINING ATTORNEY

CLASS 41—(Continued).

SN 77-081,026. CLAY LLC, NEW YORK, NY. FILED 1-11-2007.

OUR TEMPLE FOR YOURS

THE MARK CONSISTS OF STANDARD CHARACTERS WITHOUT CLAIM TO ANY PARTICULAR FONT, STYLE, SIZE, OR COLOR.

FOR HEALTH CLUB SERVICES, NAMELY PROVIDING INSTRUCTION AND EQUIPMENT IN THE FIELD OF PHYSICAL EXERCISE. (U.S. CLS. 100, 101 AND 107).

FIRST USE 4-1-2001; IN COMMERCE 4-1-2001.
VERNA BETH RIRIE, EXAMINING ATTORNEY

SN 77-083,061. DAVIDSON, ELI, LOS ANGELES, CA. FILED 1-15-2007.

TURNAROUND TECHNIQUES

THE MARK CONSISTS OF STANDARD CHARACTERS WITHOUT CLAIM TO ANY PARTICULAR FONT, STYLE, SIZE, OR COLOR.

FOR CONDUCTING WORKSHOPS AND SEMINARS IN PERSONAL AWARENESS (U.S. CLS. 100, 101 AND 107).

FIRST USE 10-1-2005; IN COMMERCE 10-1-2005.
BRIDGETT SMITH, EXAMINING ATTORNEY

SN 77-083,630. CHILDREN'S MUSEUM OF LOS ANGELES OPERATING COMPANY, VAN NUYS, CA. FILED 1-16-2007.



THE MARK CONSISTS OF DRAGON DESIGN.
FOR ENTERTAINMENT SERVICES, NAMELY THEATER PRODUCTIONS AND PRESENTATION OF MUSICAL PERFORMANCES AND PROVIDING LIVE STORYTELLING; AND EDUCATIONAL SERVICES, NAMELY, PROVIDING WORKSHOPS, SEMINARS AND CLASSES IN THE FIELDS OF ART, THEATRE, MUSIC, ENVIRONMENT, COMMUNITY AFFAIRS, MEDIA, LITERACY, TECHNOLOGY AND TOLERANCE CONDUCTED IN A MUSEUM (U.S. CLS. 100, 101 AND 107).
BILL DAWE, EXAMINING ATTORNEY

CLASS 41—(Continued).

SN 77-084,174. DAVIDOW, BETH R, SANTA BARBARA, CA. FILED 1-16-2007.

EarthOcean

THE MARK CONSISTS OF STANDARD CHARACTERS WITHOUT CLAIM TO ANY PARTICULAR FONT, STYLE, SIZE, OR COLOR.

FOR MOTION FILM PRODUCTION DEDICATED TO ENVIRONMENTAL AWARENESS (U.S. CLS. 100, 101 AND 107).

GEORGIA CARTY, EXAMINING ATTORNEY

SN 77-084,812. UNIVERSITY OF NORTH CAROLINA AT CHAPEL HILL, CHAPEL HILL, NC. FILED 1-17-2007.

SHAPING LEADERS DRIVING RESULTS

THE MARK CONSISTS OF STANDARD CHARACTERS WITHOUT CLAIM TO ANY PARTICULAR FONT, STYLE, SIZE, OR COLOR.

FOR EDUCATIONAL SERVICES, NAMELY PROVIDING CLASSES OF INSTRUCTION AT THE MASTER'S LEVEL TO BUSINESS EXECUTIVES (U.S. CLS. 100, 101 AND 107).

FIRST USE 5-19-2003; IN COMMERCE 5-19-2003.
BRENDAN REGAN, EXAMINING ATTORNEY

SN 77-084,841. FOUNDATION FOR WORLD AWAKENING, CALIFORNIA INC., MONTE SERENO, CA. FILED 1-17-2007.

Oneness Deeksha

THE MARK CONSISTS OF STANDARD CHARACTERS WITHOUT CLAIM TO ANY PARTICULAR FONT, STYLE, SIZE, OR COLOR.

THE TRANSLATION OF THE MARK IS INTELLIGENT ENERGY.

FOR EDUCATION SERVICES, NAMELY, PROVIDING SEMINARS AND WORKSHOPS IN THE FIELDS OF SPIRITUALITY, HEALING, AND ENERGY TRANSFER (U.S. CLS. 100, 101 AND 107).

FIRST USE 12-1-2006; IN COMMERCE 12-1-2006.
ZACHARY BELLO, EXAMINING ATTORNEY

CLASS 41—(Continued).

SN 77-085,858. GIVEN IMAGING LTD., YOQNEAM, ISRAEL,
FILED 1-18-2007.

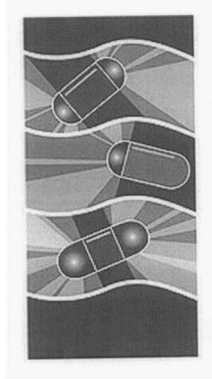

THE MARK CONSISTS OF THREE WAVES WITH A CAPSULE INSIDE EACH WAVE.

FOR ARRANGING, CONDUCTING, AND ORGANIZING EDUCATIONAL MEETINGS, CONFERENCES, AND CONGRESSES IN THE MEDICAL FIELD (U.S. CLS. 100, 101 AND 107).

FIRST USE 0-0-2006; IN COMMERCE 0-0-2006.
EVELYN BRADLEY, EXAMINING ATTORNEY

CLASS 41—(Continued).

SN 77-090,995. BOOMERBOX, LLC, ANNAPOLIS, MD.
FILED 1-25-2007.

BOOMERBOX

THE MARK CONSISTS OF STANDARD CHARACTERS WITHOUT CLAIM TO ANY PARTICULAR FONT, STYLE, SIZE, OR COLOR.

FOR EDUCATIONAL AND ONLINE COMMUNITY-BUILDING SERVICES IN THE NATURE OF WORKSHOPS FOR ADULTS IN TRANSITION WHO WERE BORN BETWEEN THE YEARS 1946 AND 1964, IN THE FIELDS OF BUSINESS, HEALTH, FITNESS, VOLUNTEERING, FAMILY RELATIONSHIPS, WORK, ECONOMIC SECURITY, INDEPENDENT LIVING, AGING, AND ATHLETICS AND DISTRIBUTION OF COURSE MATERIALS IN CONNECTION THEREWITH; ON-LINE JOURNALS, NAMELY, BLOGS AND NON-DOWNLOADABLE ONLINE VIDEOS FOR ADULTS IN TRANSITION WHO WERE BORN BETWEEN THE YEARS 1946 AND 1964, FEATURING ENTERTAINMENT AND EDUCATIONAL INFORMATION IN THE FIELDS OF BUSINESS, HEALTH, FITNESS, VOLUNTEERING, FAMILY RELATIONSHIPS, WORK, ECONOMIC SECURITY, INDEPENDENT LIVING, AGING AND ATHLETICS. (U.S. CLS. 100, 101 AND 107).

FIRST USE 1-5-2006; IN COMMERCE 10-6-2006.
INGRID C. EULIN, EXAMINING ATTORNEY

SN 77-088,945. FUN WITH PANDA, LLC, WEST BLOOMFIELD, MI. FILED 1-23-2007.



THE COLOR(S) YELLOW, BLUE AND BLACK IS/ARE CLAIMED AS A FEATURE OF THE MARK.

THE MARK CONSISTS OF THE WORD "FUN" IN THE COLOR OF YELLOW WITH BLACK LINING WITHIN THE LETTERS AND BLACK SHADING AROUND THE LETTERS AND THE WORDS "WITH PANDA" IN THE COLOR OF BLUE.

FOR EDUCATION SERVICES, NAMELY, PROVIDING LIVE AND ON-LINE CLASSES AND TUTORIAL SESSIONS IN THE FIELD OF CHINESE LANGUAGE AND CULTURE. (U.S. CLS. 100, 101 AND 107).

FIRST USE 7-7-2006; IN COMMERCE 7-7-2006.
SARA THOMAS, EXAMINING ATTORNEY

SN 77-095,241. MOTIVE8 STUDIO, INC., COSTA MESA, CA.
FILED 1-30-2007.

Motive8 Studios

THE MARK CONSISTS OF STANDARD CHARACTERS WITHOUT CLAIM TO ANY PARTICULAR FONT, STYLE, SIZE, OR COLOR.

NO CLAIM IS MADE TO THE EXCLUSIVE RIGHT TO USE "STUDIOS", APART FROM THE MARK AS SHOWN.

FOR MUSIC PRODUCTION SERVICES; PRODUCTION OF SOUND AND MUSIC VIDEO RECORDINGS; PRODUCTION OF VIDEO AND CREATION OF VISUAL EFFECTS FOR OTHERS FOR USE IN DVDS, TELEVISION PROGRAMS AND ON WEBSITES; TELEVISION PRODUCTION; VIDEOTAPE PRODUCTION (U.S. CLS. 100, 101 AND 107).

FIRST USE 6-1-2005; IN COMMERCE 6-1-2005.
PATRICIA EVANKO, EXAMINING ATTORNEY

CLASS 41—(Continued).

SN 77-095,419. FLAGSHIP PUBLISHING, LLC, DELTONA, FL. FILED 1-31-2007.

FLAGSHIP PUBLISHING GROUP

THE MARK CONSISTS OF STANDARD CHARACTERS WITHOUT CLAIM TO ANY PARTICULAR FONT, STYLE, SIZE, OR COLOR.

NO CLAIM IS MADE TO THE EXCLUSIVE RIGHT TO USE "PUBLISHING GROUP", APART FROM THE MARK AS SHOWN.

FOR BOOK AND REVIEW PUBLISHING; ELECTRONIC PUBLISHING SERVICES, NAMELY, PUBLICATION OF TEXT AND GRAPHIC WORKS OF OTHERS ON REMOVABLE DIGITAL MEDIA, ON-LINE FEATURING PICTURES AND TEXT; MAGAZINE PUBLISHING (U.S. CLS. 100, 101 AND 107).

FIRST USE 10-11-2004; IN COMMERCE 5-25-2005.
FLORENTINA BLANDU, EXAMINING ATTORNEY

CLASS 41—(Continued).

SN 77-099,483. STRELECKY, JOHN, WINDERMERE, FL. AND ZHAO, XIN, WINDERMERE, FL. FILED 2-5-2007.

Big Five for Life

THE MARK CONSISTS OF STANDARD CHARACTERS WITHOUT CLAIM TO ANY PARTICULAR FONT, STYLE, SIZE, OR COLOR.

FOR DEVELOPMENT AND DISSEMINATION OF EDUCATIONAL MATERIALS OF OTHERS IN THE FIELDS OF PURPOSE FOR EXISTING, PERSONAL GROWTH, GOAL SETTING AND IMPROVEMENT; EDUCATIONAL SERVICES, NAMELY, DEVELOPING, ARRANGING, AND CONDUCTING EDUCATIONAL CONFERENCES AND PROGRAMS AND PROVIDING COURSES OF INSTRUCTION IN THE FIELDS OF PURPOSE FOR EXISTING, PERSONAL GROWTH, GOAL SETTING AND IMPROVEMENT; PERSONAL COACHING SERVICES IN THE FIELDS OF LIFE PURPOSE, PERSONAL GROWTH, GOAL SETTING AND IMPROVEMENT (U.S. CLS. 100, 101 AND 107).

FIRST USE 11-18-2003; IN COMMERCE 11-18-2003.
IRA J. GOODSaid, EXAMINING ATTORNEY

SN 77-100,093. WISCONSIN STATE FAIR PARK, WEST ALLIS, WI. FILED 2-6-2007.

THE GRAND CHAMPION OF
SUMMER

THE MARK CONSISTS OF STANDARD CHARACTERS WITHOUT CLAIM TO ANY PARTICULAR FONT, STYLE, SIZE, OR COLOR.

FOR ENTERTAINMENT SERVICES, NAMELY, ORGANIZING AND CONDUCTING THE WISCONSIN STATE FAIR (U.S. CLS. 100, 101 AND 107).

MARY CRAWFORD, EXAMINING ATTORNEY

SN 77-096,886. SIERRA BUILDING SCIENCE CENTER, SACRAMENTO, CA. FILED 2-1-2007.

BTU GEEK

THE MARK CONSISTS OF STANDARD CHARACTERS WITHOUT CLAIM TO ANY PARTICULAR FONT, STYLE, SIZE, OR COLOR.

NO CLAIM IS MADE TO THE EXCLUSIVE RIGHT TO USE "BTU", APART FROM THE MARK AS SHOWN.

FOR ARRANGING PROFESSIONAL WORKSHOP AND TRAINING COURSES; TRAINING IN THE USE AND OPERATION OF DUCT TESTING EQUIPMENT; TRAINING IN THE USE OF BUILDING DIAGNOSTIC EQUIPMENT; TRAINING SERVICES IN THE FIELD OF HVAC AND ENERGY EFFICIENCY AND CONSULTING (U.S. CLS. 100, 101 AND 107).

FIRST USE 12-1-2006; IN COMMERCE 12-1-2006.
SUNG IN, EXAMINING ATTORNEY

SN 77-100,460. PLANET HIP HOP, LLC, NEW YORK, NY. FILED 2-6-2007.

PLANET HIP HOP TV

THE MARK CONSISTS OF STANDARD CHARACTERS WITHOUT CLAIM TO ANY PARTICULAR FONT, STYLE, SIZE, OR COLOR.

OWNER OF U.S. REG. NO. 2,770,556.

NO CLAIM IS MADE TO THE EXCLUSIVE RIGHT TO USE "HIP HOP TV", APART FROM THE MARK AS SHOWN.

FOR ENTERTAINMENT SERVICES, NAMELY, ONGOING TELEVISION PROGRAMS FEATURING LIVE ACTION, COMEDY, PERFORMING ARTISTS, COMEDY SKETCHES, MUSIC, NEWS, AND GENERAL ENTERTAINMENT; PROVIDING ONLINE INFORMATION IN THE FIELD OF ENTERTAINMENT CONCERNING TELEVISIONS PROGRAMS (U.S. CLS. 100, 101 AND 107).

MARILYN IZZI, EXAMINING ATTORNEY

CLASS 41—(Continued).

SN 77-102,052. INSITU, INC., BINGEN, WA. FILED 2-7-2007.

MAKING IDEAS SOAR

THE MARK CONSISTS OF STANDARD CHARACTERS WITHOUT CLAIM TO ANY PARTICULAR FONT, STYLE, SIZE, OR COLOR.

FOR EDUCATIONAL SERVICES AND TRAINING SERVICES IN THE NATURE OF WORKSHOPS, CLASSES, SEMINARS, TUTORIALS, AND ON-LINE EDUCATIONAL COURSES IN THE FIELDS OF OPERATION, MAINTENANCE, AND EVALUATION OF UNMANNED AERIAL VEHICLES (UAVS), AIRBORNE TRANSPORTATION, AERIAL AND GROUND CONTROL HARDWARE, SOFTWARE, VIDEO AND SENSOR APPARATUS, AIRBORNE SURVEILLANCE, RECONNAISSANCE AND AIRCRAFT CONTROL APPARATUS, IN THE FIELD OF ENHANCING, ANALYZING, AND INTERPRETING INFORMATION FROM UNMANNED AERIAL VEHICLES, AND IN THE FIELD OF ENGINEERING, NAMELY, THE DESIGN OF AIRPLANES, AIRCRAFT, UNMANNED AERIAL VEHICLES, AND STRUCTURAL PARTS THEREFOR, AERIAL AND GROUND CONTROL HARDWARE, SOFTWARE, VIDEO AND SENSOR APPARATUS (U.S. CLS. 100, 101 AND 107).

LEIGH CAROLINE CASE, EXAMINING ATTORNEY

SN 77-105,265. TOURNEASE, INC., LAKELAND, FL. FILED 2-12-2007.

PROVIEW

THE MARK CONSISTS OF STANDARD CHARACTERS WITHOUT CLAIM TO ANY PARTICULAR FONT, STYLE, SIZE, OR COLOR.

FOR ORGANIZING COMMUNITY SPORTING AND CULTURAL EVENTS (U.S. CLS. 100, 101 AND 107).

CURTIS FRENCH, EXAMINING ATTORNEY

SN 77-106,246. DIGITAL CITIZEN, L.L.C., BROOKLYN, NY. FILED 2-13-2007.

DIGITAL CITIZEN

THE MARK CONSISTS OF STANDARD CHARACTERS WITHOUT CLAIM TO ANY PARTICULAR FONT, STYLE, SIZE, OR COLOR.

NO CLAIM IS MADE TO THE EXCLUSIVE RIGHT TO USE "DIGITAL", APART FROM THE MARK AS SHOWN.

FOR ENTERTAINMENT SERVICES, NAMELY, PROVIDING A WEB SITE FEATURING MUSICAL PERFORMANCES, MUSICAL VIDEOS AND OTHER MULTIMEDIA MATERIALS (U.S. CLS. 100, 101 AND 107).

VIVIAN MICZNIK FIRST, EXAMINING ATTORNEY

CLASS 41—(Continued).

SN 77-107,382. MYSTIC PUBLISHING, INC., CENTERVILLE, IA. FILED 2-14-2007.

Freddie the Frog

THE MARK CONSISTS OF STANDARD CHARACTERS WITHOUT CLAIM TO ANY PARTICULAR FONT, STYLE, SIZE, OR COLOR.

FOR EDUCATIONAL SERVICES, NAMELY, PROVIDING INSTRUCTION, CLASSES, SEMINARS, AND WORKSHOPS USING BOOKS, COMPACT DISCS, DIGITAL VIDEO DISCS, FLASHCARDS, POSTERS, AND PUPPETS IN THE FIELD OF MUSIC EDUCATION (U.S. CLS. 100, 101 AND 107).

FIRST USE 10-1-2004; IN COMMERCE 10-1-2004.

ALLISON HOLTZ, EXAMINING ATTORNEY

SN 77-107,826. THE PARTNERSHIP OF AMY B CADY AND AARON CADY, LAGUNA NIGUEL, CA. FILED 2-14-2007.

ABC Pilates

THE MARK CONSISTS OF STANDARD CHARACTERS WITHOUT CLAIM TO ANY PARTICULAR FONT, STYLE, SIZE, OR COLOR.

NO CLAIM IS MADE TO THE EXCLUSIVE RIGHT TO USE "PILATES", APART FROM THE MARK AS SHOWN.

FOR PROVIDING FITNESS AND EXERCISE FACILITIES (U.S. CLS. 100, 101 AND 107).

FIRST USE 4-15-2003; IN COMMERCE 1-15-2007.

DORITT L. CARROLL, EXAMINING ATTORNEY

CLASS 41—(Continued).

SN 77-110,288. PAT & BILLY ENTERTAINMENT, INC., GARDEN GROVE, CA. FILED 2-18-2007.



FOR OPERATING FILM STUDIOS; PROVIDING FILM STUDIO SERVICES TO OTHERS FOR THE PRODUCTION OF TELEVISION SHOWS, MOVIES COMMERCIALS AND VIDEOS, NAMELY, PROVIDING FILMING LOCATIONS, SOUND STAGES, FILM STUDIO SETTINGS, AND RENTAL OF FILM EQUIPMENT; AND PROVIDING FILM PRODUCTION SERVICES AND TECHNICAL ASSISTANCE, NAMELY, PROVIDING ASSISTANCE IN THE OPERATION OF FILMING EQUIPMENT, DEVELOPMENT AND EDITING OF FILM, AND SELECTION OF FILMING LOCATIONS (U.S. CLS. 100, 101 AND 107).

FIRST USE 1-4-2007; IN COMMERCE 1-4-2007.
CHRISTOPHER BUONGIORNO, EXAMINING ATTORNEY

SN 77-110,602. WOMAN'S MISSIONARY UNION OF NORTH CAROLINA, CARY, NC. FILED 2-19-2007.

CAMP MUNDO VISTA

THE MARK CONSISTS OF STANDARD CHARACTERS WITHOUT CLAIM TO ANY PARTICULAR FONT, STYLE, SIZE, OR COLOR.

NO CLAIM IS MADE TO THE EXCLUSIVE RIGHT TO USE "CAMP", APART FROM THE MARK AS SHOWN.

FOR EDUCATIONAL SERVICES, NAMELY, CONDUCTING YEAR-ROUND CAMPS FOR SCHOOL AGE GIRLS, YOUTH AND ADULTS FEATURING CLASSES, SEMINARS, CONFERENCES, WORKSHOPS IN THE FIELD OF RELIGION AND MISSIONS AND DISTRIBUTION OF COURSE MATERIAL IN CONNECTION THEREWITH (U.S. CLS. 100, 101 AND 107).

FIRST USE 6-26-1969; IN COMMERCE 6-26-1969.
LINDA POWELL, EXAMINING ATTORNEY

CLASS 41—(Continued).

SN 77-110,830. PUBLIC EYE PRODUCTIONS, LLC, FAIRFAX, VA. FILED 2-19-2007.

Candid Conversations
with **Great Americans**

NO CLAIM IS MADE TO THE EXCLUSIVE RIGHT TO USE "CONVERSATIONS" AND "AMERICANS", APART FROM THE MARK AS SHOWN.

THE MARK CONSISTS OF STYLIZED TEXT .
FOR PRODUCTION OF RADIO OR TELEVISION PROGRAMS (U.S. CLS. 100, 101 AND 107).
DOMINICK J. SALEMI, EXAMINING ATTORNEY

SN 77-111,024. BENSON, BRENDA, L. HUNTINGTON, NY. FILED 2-20-2007.

CAPTAIN MUNCHY, FUN FOOD ADVENTURES

THE MARK CONSISTS OF STANDARD CHARACTERS WITHOUT CLAIM TO ANY PARTICULAR FONT, STYLE, SIZE, OR COLOR.

FOR ANIMATION AND AUDIO-VISUAL PRODUCTION SERVICES FOR TELEVISION AND THE INTERNET TO EDUCATE AND ENTERTAIN CHILDREN AGES 4 TO 10 AND THEIR PARENTS/CAREGIVERS ABOUT HEALTHY AND NUTRITIONAL COOKING AND EATING HABITS AND EXERCISE TO KEEP FIT AND HEALTHY (U.S. CLS. 100, 101 AND 107).

ELIZABETH BEYER, EXAMINING ATTORNEY

SN 77-111,380. JENEICE S. MILLER, SAN DIEGO, CA. FILED 2-20-2007.



NO CLAIM IS MADE TO THE EXCLUSIVE RIGHT TO USE "LIFESTYLE MAKEOVERS", APART FROM THE MARK AS SHOWN.

"THE COLOR(S) MAROON, PINK, BROWN, YELLOW AND GREEN IS/ARE CLAIMED AS A FEATURE OF THE MARK."

"THE MARK CONSISTS OF THE WORDING "LIFE" AND MAKEOVERS" APPEARING IN MAROON AND THE WORD "STYLE" IN PINK. THE ARM AND HAND IS BROWN. THE FLOWER PETALS ARE PINK WITH A YELLOW CENTER AND GREEN STEM/LEAF."

FOR PERSONAL COACHING SERVICES IN THE FIELD OF PERSONAL DEVELOPMENT (U.S. CLS. 100, 101 AND 107).

FIRST USE 2-16-2007; IN COMMERCE 2-16-2007.
INGRID C. EULIN, EXAMINING ATTORNEY

CLASS 41—(Continued).

SN 77-111,545. COPTERVIEWS, LLC, MYRTLE BEACH, SC. FILED 2-20-2007.



NO CLAIM IS MADE TO THE EXCLUSIVE RIGHT TO USE "SERVICE" AND "ENGINEERS, INC.", APART FROM THE MARK AS SHOWN.

THE MARK CONSISTS OF A HELICOPTER FLYING OVER A BEACH WITH PALM TREES AND CLOUDS AND MOON IN THE SKY. THE LETTERING COPTER VIEWS APPEARS BELOW THE PALM TREES WITH A RECTANGLE AROUND THE WORDING. BELOW THE WORDING COPTER VIEWS IS THE WORDING A SERVICE OF DDC ENGINEERS, INC.

FOR AERIAL PHOTOGRAPHY (U.S. CLS. 100, 101 AND 107).

FIRST USE 7-11-2006; IN COMMERCE 7-11-2006.
KAPIL BHANOT, EXAMINING ATTORNEY

SN 77-111,675. TALK-N-DRUM, YORKTOWN HEIGHTS, NY. FILED 2-20-2007.



THE COLOR(S) RED, GREEN, YELLOW, BLUE, ORANGE, LIGHT BLUE, PINK, AND WHITE IS/ARE CLAIMED AS A FEATURE OF THE MARK.

THE COLOR RED APPEARS IN THE LETTER "T". THE COLOR GREEN APPEARS IN THE LETTER "A". THE COLOR YELLOW APPEARS IN THE LETTER "L". THE COLOR PURPLE APPEARS IN THE LETTER "K". THE

CLASS 41—(Continued).

COLOR YELLOW APPEARS IN THE LETTER "N". THE COLOR BLUE APPEARS IN THE LETTER "D". THE COLOR PINK APPEARS IN THE LETTER "R". THE COLOR GREEN APPEARS IN THE LETTER "U". THE COLOR RED APPEARS IN THE LETTER "M". THE COLORS YELLOW AND PINK APPEAR IN THE FACE AND HANDS OF THE CARTOON CHARACTER WHICH IS REPRESENTED IN THE FORM OF A DRUM, WITH THE HANDS PLAYING THE DRUM. THE COLOR BLUE APPEARS IN THE EYES OF THE CARTOON CHARACTER.

FOR EDUCATIONAL SERVICES, NAMELY PROVIDING WORKSHOPS, SEMINARS, AND COURSES OF INSTRUCTION IN THE FIELD OF FOREIGN LANGUAGE AND THE DISTRIBUTION OF COURSE MATERIALS IN CONNECTION THEREWITH (U.S. CLS. 100, 101 AND 107).

FIRST USE 4-30-2006; IN COMMERCE 9-1-2006.
EVELYN BRADLEY, EXAMINING ATTORNEY

SN 77-112,402. SCOTTSDALE CENTER FOR DENTISTRY, LLC, SCOTTSDALE, AZ. FILED 2-21-2007.



NO CLAIM IS MADE TO THE EXCLUSIVE RIGHT TO USE "THE SCOTTSDALE CENTER FOR DENTISTRY", APART FROM THE MARK AS SHOWN.

THE COLOR(S) BROWN IS/ARE CLAIMED AS A FEATURE OF THE MARK.

THE MARK CONSISTS OF THE WORDING THE SCOTTSDALE CENTER FOR DENTISTRY IN STYLIZED LETTERING. THIS WORDING APPEARS NEXT TO A "C" SHAPED DESIGN WITH ADDITIONAL CURVED AND STRAIGHT LINES COMING OUT OF IT. THE ENTIRE MARK IS BROWN IN COLOR.

FOR PROVIDING CONTINUING DENTAL EDUCATION COURSES (U.S. CLS. 100, 101 AND 107).

FIRST USE 11-1-2006; IN COMMERCE 11-1-2006.
WENDY GOODMAN, EXAMINING ATTORNEY

SN 77-113,368. JOANNE FARBER, SKOKIE, IL. FILED 2-22-2007.

Harmony FusionWave Awareness

THE MARK CONSISTS OF STANDARD CHARACTERS WITHOUT CLAIM TO ANY PARTICULAR FONT, STYLE, SIZE, OR COLOR.

NO CLAIM IS MADE TO THE EXCLUSIVE RIGHT TO USE "AWARENESS", APART FROM THE MARK AS SHOWN.

FOR CONDUCTING WORKSHOPS AND SEMINARS IN SELF-AWARENESS AND WELL-BEING; EDUCATIONAL SERVICES, NAMELY, CONDUCTING CLASSES, SEMINARS, WORKSHOPS, TUTORING, AND MENTORING IN THE FIELD OF SELF-AWARENESS, WELL-BEING, ART INSTRUCTION, AND ART APPRECIATION AND DISTRIBUTION OF COURSE MATERIAL IN CONNECTION THEREWITH (U.S. CLS. 100, 101 AND 107).

FIRST USE 2-1-2007; IN COMMERCE 2-1-2007.
SCOTT BALDWIN, EXAMINING ATTORNEY

CLASS 41—(Continued).

SN 77-113,543. BIGG CITY HOLDINGS, LLC, COLORADO SPRINGS, CO. FILED 2-22-2007.

BIGG CITY

THE MARK CONSISTS OF STANDARD CHARACTERS WITHOUT CLAIM TO ANY PARTICULAR FONT, STYLE, SIZE, OR COLOR.

FOR ENTERTAINMENT SERVICES, NAMELY PROVIDING FACILITIES FOR RECREATION ACTIVITIES AND PROVIDING AMUSEMENT FACILITIES, AND EXCLUDING ENTERTAINMENT SERVICES IN THE NATURE OF COMPETITIONS IN THE FIELD OF FOOTBALL AND PERSONAL APPEARANCES BY SPORTS CELEBRITIES (U.S. CLS. 100, 101 AND 107).

FIRST USE 2-21-2007; IN COMMERCE 2-21-2007.

KATHERINE E. HALMEN, EXAMINING ATTORNEY

CLASS 41—(Continued).

SN 77-115,766. TOWER VISION RECORDS, INC., MIAMI, FL. FILED 2-26-2007.

TOWER VISION RECORDS

THE MARK CONSISTS OF STANDARD CHARACTERS WITHOUT CLAIM TO ANY PARTICULAR FONT, STYLE, SIZE, OR COLOR.

NO CLAIM IS MADE TO THE EXCLUSIVE RIGHT TO USE "RECORDS", APART FROM THE MARK AS SHOWN.

FOR MUSIC COMPOSITION AND TRANSCRIPTION FOR OTHERS; MUSIC COMPOSITION FOR OTHERS; MUSIC PRODUCTION SERVICES; PRODUCTION OF SOUND AND MUSIC VIDEO RECORDINGS; PUBLICATION OF MUSICAL TEXTS; RECORD MASTER PRODUCTION; RECORD PRODUCTION (U.S. CLS. 100, 101 AND 107).

DAVID TOOLEY, EXAMINING ATTORNEY

SN 77-115,133. ACCURIDE INTERNATIONAL INC., SANTA FE SPRINGS, CA. FILED 2-23-2007.



NO CLAIM IS MADE TO THE EXCLUSIVE RIGHT TO USE "BELT SANDER RACING ASSOCIATION", APART FROM THE MARK AS SHOWN.

THE COLOR(S) WHITE, RED, AND BLUE IS/ARE CLAIMED AS A FEATURE OF THE MARK.

THE MARK CONSISTS OF THE LETTERS AND WORDS BSRA BELT SANDER RACING ASSOCIATION, AND AN IMAGE OF A BELT SANDER IN SILHOUETTE, TOGETHER IN WHITE ON A RED AND BLUE BACKGROUND.

FOR ORGANIZING EXHIBITIONS FOR BELT SANDER RACING (U.S. CLS. 100, 101 AND 107).

FIRST USE 7-20-2007; IN COMMERCE 7-20-2007.

SHARON MEIER, EXAMINING ATTORNEY

SN 77-116,234. C2 EDUCATIONAL SYSTEMS, INC., DULUTH, GA. FILED 2-26-2007.



FOR EDUCATIONAL SERVICES, NAMELY, PROVIDING CLASSES, SEMINARS, CONFERENCES, WORKSHOPS, TUTORING, MENTORING, AND INSTRUCTION IN THE FIELD OF TEST PREPARATION, ACADEMIC COUNSELING, AND STUDENT ENRICHMENT PROGRAMS, AND DISTRIBUTION OF TRAINING MATERIALS, COURSE MATERIALS, AND ACADEMIC RESOURCES IN CONNECTION THEREWITH (U.S. CLS. 100, 101 AND 107).

FIRST USE 10-15-2002; IN COMMERCE 10-15-2002.

RICHARD WHITE, EXAMINING ATTORNEY

CLASS 41—(Continued).

SN 77-116,239. C2 EDUCATIONAL SYSTEMS, INC., DULUTH, GA. FILED 2-26-2007.

CLASS 41—(Continued).

SN 77-117,503. SUPERVALU INC., EDEN PRAIRIE, MN. FILED 2-27-2007.

C2

SUPERVALU UNIVERSITY

THE MARK CONSISTS OF STANDARD CHARACTERS WITHOUT CLAIM TO ANY PARTICULAR FONT, STYLE, SIZE, OR COLOR.

FOR EDUCATIONAL SERVICES, NAMELY, PROVIDING CLASSES, SEMINARS, CONFERENCES, WORKSHOPS, TUTORING, MENTORING, AND INSTRUCTION IN THE FIELD OF TEST PREPARATION, ACADEMIC COUNSELING, AND STUDENT ENRICHMENT PROGRAMS, AND DISTRIBUTION OF TRAINING MATERIALS, COURSE MATERIALS, AND ACADEMIC RESOURCES IN CONNECTION THEREWITH (U.S. CLS. 100, 101 AND 107).

FIRST USE 9-20-2002; IN COMMERCE 9-20-2002.
RICHARD WHITE, EXAMINING ATTORNEY

THE MARK CONSISTS OF STANDARD CHARACTERS WITHOUT CLAIM TO ANY PARTICULAR FONT, STYLE, SIZE, OR COLOR.

OWNER OF U.S. REG. NOS. 631,486, 646,916 AND OTHERS.

NO CLAIM IS MADE TO THE EXCLUSIVE RIGHT TO USE "UNIVERSITY", APART FROM THE MARK AS SHOWN.

FOR EDUCATIONAL SERVICES, NAMELY PROVIDING CLASSES, SEMINARS, WORKSHOPS AND INTERNET-BASED TRAINING IN THE FIELD OF PROFESSIONAL AND BUSINESS DEVELOPMENT FOR RETAIL AND SUPPLY CHAIN PROFESSIONALS ON THE SUBJECT OF RETAIL GROCERY STORE SERVICES (U.S. CLS. 100, 101 AND 107).

FIRST USE 0-0-1957; IN COMMERCE 0-0-1957.
TASHIA BUNCH, EXAMINING ATTORNEY

SN 77-117,398. JILL BOURQUE, SAN FRANCISCO, CA. FILED 2-27-2007.

SN 77-117,740. CINEMASaurus INC., SAN FRANCISCO, CA. FILED 2-27-2007.

CINEMASaurus

How We First Met

THE MARK CONSISTS OF STANDARD CHARACTERS WITHOUT CLAIM TO ANY PARTICULAR FONT, STYLE, SIZE, OR COLOR.

FOR ENTERTAINMENT SERVICES IN THE NATURE OF THE PRODUCTION OF LIVE COMEDY, MUSICAL AND/OR IMPROVISATIONAL SHOWS AND PERFORMANCES (U.S. CLS. 100, 101 AND 107).

FIRST USE 11-1-2000; IN COMMERCE 11-1-2000.
ANDREW RHIM, EXAMINING ATTORNEY

THE MARK CONSISTS OF STANDARD CHARACTERS WITHOUT CLAIM TO ANY PARTICULAR FONT, STYLE, SIZE, OR COLOR.

FOR RENTAL OF VIDEO RECORDINGS, PRE-RECORDED VIDEOTAPES, DIGITAL VIDEO DISKS, MULTIMEDIA RECORDINGS; RENTAL OF VIDEO RECORDINGS, PRE-RECORDED VIDEOTAPES, DIGITAL VIDEO DISKS, BY MEANS OF COMMUNICATIONS NETWORKS; PROVIDING INFORMATION, REVIEWS AND PERSONALIZED RECOMMENDATIONS IN THE FIELD OF ENTERTAINMENT; PROVIDING SCHEDULE AND LOCATION INFORMATION SERVICES FOR MOVIES, AND ARRANGING FOR MOVIE TICKET RESERVATIONS (U.S. CLS. 100, 101 AND 107).

GIANCARLO CASTRO, EXAMINING ATTORNEY

CLASS 41—(Continued).

SN 77-118,022. QUAN ENTERTAINMENT, SAINT LOUIS, MO. FILED 2-28-2007.



THE MARK CONSISTS OF THE DESIGN OF THE LOWER CASE LETTER "E" INSIDE A CAPITAL "Q" OVER A SMALLER VERSION OF THE SAME DESIGN NEXT TO THE STYLIZED TEXT OF "QUANENTERTAINMENT".

FOR MUSIC PRODUCTION SERVICES (U.S. CLS. 100, 101 AND 107).

FIRST USE 6-17-2006; IN COMMERCE 6-17-2006.
AMEETA JORDAN, EXAMINING ATTORNEY

CLASS 41—(Continued).

SN 77-120,576. CBS BROADCASTING INC., NEW YORK, NY. FILED 3-2-2007.



OWNER OF U.S. REG. NOS. 852,481 AND 2,928,976.
NO CLAIM IS MADE TO THE EXCLUSIVE RIGHT TO USE "RADIO", APART FROM THE MARK AS SHOWN.

THE MARK CONSISTS OF CBS RADIO & EYE DESIGN.
FOR ENTERTAINMENT SERVICES, NAMELY, RADIO PROGRAMMING SERVICES AND PRODUCTION OF RADIO PROGRAMS IN THE FIELD OF MUSIC, NEWS, SPORTS, CURRENT EVENTS AND ENTERTAINMENT; INTERNET AUDIO PROGRAMMING SERVICES AND PRODUCTION OF AUDIO PROGRAMS IN THE FIELD OF MUSIC, NEWS, SPORTS, CURRENT EVENTS AND ENTERTAINMENT; PROVIDING INFORMATION ABOUT RADIO PROGRAMMING AND INTERNET AUDIO PROGRAMMING FEATURING MUSIC AND MUSIC RELATED CONTENT, NEWS, SPORTS, CURRENT EVENTS AND ENTERTAINMENT VIA INTERNET (U.S. CLS. 100, 101 AND 107).

FIRST USE 12-14-2005; IN COMMERCE 12-14-2005.
WON TEAK OH, EXAMINING ATTORNEY

SN 77-118,170. PETER HARMAN, DBA FOOD GURU, BURLINGTON, IA. FILED 2-28-2007.

VIDEO COOKBOOK

THE MARK CONSISTS OF STANDARD CHARACTERS WITHOUT CLAIM TO ANY PARTICULAR FONT, STYLE, SIZE, OR COLOR.

NO CLAIM IS MADE TO THE EXCLUSIVE RIGHT TO USE "VIDEO", APART FROM THE MARK AS SHOWN.

FOR EDUCATIONAL DEMONSTRATIONS ON COOKING (U.S. CLS. 100, 101 AND 107).

FIRST USE 1-0-2007; IN COMMERCE 1-0-2007.
GEORGIA CARTY, EXAMINING ATTORNEY

SN 77-122,833. YES2YES COMPANY, ALLENTOWN, PA. FILED 3-6-2007.

YES2YES

THE MARK CONSISTS OF STANDARD CHARACTERS WITHOUT CLAIM TO ANY PARTICULAR FONT, STYLE, SIZE, OR COLOR.

FOR PROFESSIONAL COACHING SERVICES IN THE FIELD OF BUSINESS LEADERSHIP DEVELOPMENT AND CONSULTATION IN CONNECTION THEREWITH; EDUCATIONAL SERVICES, NAMELY, CONDUCTING SEMINARS IN THE FIELD OF LEADERSHIP (U.S. CLS. 100, 101 AND 107).

FIRST USE 4-21-2005; IN COMMERCE 6-2-2005.
ALICIA COLLINS, EXAMINING ATTORNEY

CLASS 41—(Continued).

SN 77-123,237. JEXAN HOLDINGS INCORPERATED, WESTLAKE VILLAGE, CA. FILED 3-6-2007.



NO CLAIM IS MADE TO THE EXCLUSIVE RIGHT TO USE "PICTURE", APART FROM THE MARK AS SHOWN.

THE COLOR(S) BLACK, WHITE, RED AND GREEN IS/ARE CLAIMED AS A FEATURE OF THE MARK.

THE MARK CONSISTS OF THE ME IN THE PICTURE LOGO IS ILLUSTRATED PRECISELY BY FOUR MAIN COLORS. THESE COLORS ARE GREEN, RED, BLACK, WHITE. THE MARK IS MADE UP FROM THE ILLUSTRATION OF A CAMERA FILM, A DISTORTED FRAME AND UNDERLINED TEXT. THE COLOR DEPICTING THAT OF A GREEN SCREEN (GREEN) APPEARS INSIDE THE FRAME. THE COLOR RED IS THE COLOR OF THE TEXT. THE COLOR BLACK IS THE COLOR OF THE CAMERA FILM AND THE FRAME THE COLOR WHITE IS THE COLOR OF THE HOLES IN THE CAMERA FILM EDGE ALL THESE COLORS AND ILLUSTRATIONS IS A FEATURE OF THE MARK. THE TEXT ME APPEARS INSIDE THE FRAME.

FOR PHOTOGRAPHY SERVICES (U.S. CLS. 100, 101 AND 107).

MIDGE BUTLER, EXAMINING ATTORNEY

CLASS 41—(Continued).

SN 77-124,843. CLEARWATER CAMP FOR GIRLS, MINOCQUA, WI. FILED 3-7-2007.

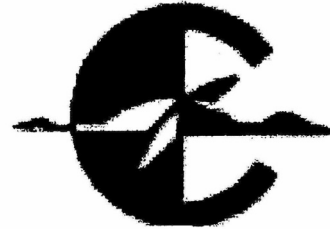

THE MARK CONSISTS OF A PARTIALLY FILLED INCOMPLETE CIRCLE FORMING THE LETTER "C." A PAIR OF GEESE LIKE BIRDS APPEARS WITHIN THE LETTER.

FOR SUMMER CAMP SERVICES FOR GIRLS (U.S. CLS. 100, 101 AND 107).

FIRST USE 5-1-1937; IN COMMERCE 5-1-1937.

BERNICE MIDDLETON, EXAMINING ATTORNEY

SN 77-123,789. MARLON WAYANS, LOS ANGELES, CA. FILED 3-6-2007.

FIGHTING WORDS

THE MARK CONSISTS OF STANDARD CHARACTERS WITHOUT CLAIM TO ANY PARTICULAR FONT, STYLE, SIZE, OR COLOR.

FOR ENTERTAINMENT IN THE NATURE OF ONGOING TELEVISION PROGRAMS IN THE FIELD OF DRAMA, COMEDY, VARIETY AND REALITY; ENTERTAINMENT IN THE NATURE OF LIVE THEATRICAL STAGE PERFORMANCES; ENTERTAINMENT SERVICES IN THE NATURE OF PROVIDING A WEBSITE FEATURING MUSIC AND INFORMATION PERTAINING TO THE COMEDY, DRAMA, VARIETY AND REALITY TELEVISION SHOWS AND CHARACTERS THEREOF AND FAN CLUBS OF THE REALITY, COMEDY, DRAMA AND VARIETY TELEVISION PROGRAMS (U.S. CLS. 100, 101 AND 107).

RAY THOMAS, EXAMINING ATTORNEY



NO CLAIM IS MADE TO THE EXCLUSIVE RIGHT TO USE "PRESENTS", APART FROM THE MARK AS SHOWN. THE COLOR(S) BLUE AND WHITE IS/ARE CLAIMED AS A FEATURE OF THE MARK.

THE COLOR WHITE APPEARS IN ALL OF THE ELEMENTS OF THE MARK EXCEPT THE BACKGROUND, THE OUTLINE OF THE KERCHIEF ON THE SKULL AND THE OUTLINE OF BOTH CHEEKS ON THE SKULL. THE COLOR BLUE APPEARS IN THE BACKGROUND, THE OUTLINE OF THE KERCHIEF ON THE SKULL AND THE OUTLINE OF BOTH CHEEKS ON THE SKULL.

FOR EDUCATIONAL PROGRAMS, NAMELY, PRESCHOOLS; PRESENTATION OF MUSICAL PERFORMANCE; ENTERTAINMENT IN THE NATURE OF LIVE MUSICAL PERFORMANCES BY THE PRETEND PIRATE CAPTAIN PAPILLION (U.S. CLS. 100, 101 AND 107).

FIRST USE 5-26-2007; IN COMMERCE 5-26-2007.

MICHAEL WIENER, EXAMINING ATTORNEY

CLASS 41—(Continued).

SN 77-125,361. THE BAZAR GROUP, INC., EAST PROVIDENCE, RI. FILED 3-8-2007.

PEARL PERSPECTIVES

THE MARK CONSISTS OF STANDARD CHARACTERS WITHOUT CLAIM TO ANY PARTICULAR FONT, STYLE, SIZE, OR COLOR.

NO CLAIM IS MADE TO THE EXCLUSIVE RIGHT TO USE PEARL, APART FROM THE MARK AS SHOWN.

FOR PROVIDING NEWSLETTERS IN THE FIELD OF PEARL JEWELRY VIA EMAIL (U.S. CLS. 100, 101 AND 107).

FIRST USE 8-1-2004; IN COMMERCE 8-1-2004.
ELLEN PERKINS, EXAMINING ATTORNEY

SN 77-126,447. ANDERSON COUNTY, SOUTH CAROLINA, ANDERSON, SC. FILED 3-9-2007.



NO CLAIM IS MADE TO THE EXCLUSIVE RIGHT TO USE "SOUTHEAST BALLOON FEST" AND "ANDERSON, SOUTH CAROLINA", APART FROM THE MARK AS SHOWN.

THE COLOR(S) RED, GREEN AND ORANGE IS/ARE CLAIMED AS A FEATURE OF THE MARK.

THE MARK CONSISTS OF THE PHRASE THE GREAT SOUTHEAST BALLOON FEST APPEARING IN GREEN; BELOW THAT, THE PHRASE ANDERSON, SOUTH CAROLINA APPEARS IN RED. IN BETWEEN THE WORDS BALLOON AND FEST IS THE DESIGN OF A BALLOON, DEPICTED IN RED AND ORANGE.

FOR ENTERTAINMENT SERVICES, NAMELY, CONDUCTING FAIRS; ENTERTAINMENT, NAMELY LIVE PERFORMANCES BY MUSICAL BANDS; ORGANIZING EXHIBITIONS FOR ENTERTAINMENT PURPOSES, NAMELY COMMUNITY FESTIVALS AND ART EXHIBITIONS; ORGANIZING COMMUNITY FESTIVALS FEATURING A VARIETY OF ACTIVITIES, NAMELY SPORTING EVENTS, ART EXHIBITIONS, FLEA MARKETS, ETHNIC DANCES AND THE LIKE (U.S. CLS. 100, 101 AND 107).

EMILY CARLSEN, EXAMINING ATTORNEY

CLASS 41—(Continued).

SN 77-126,450. ANDERSON COUNTY, SOUTH CAROLINA, ANDERSON, SC. FILED 3-9-2007.



NO CLAIM IS MADE TO THE EXCLUSIVE RIGHT TO USE "SOUTHEAST BALLOON FEST", APART FROM THE MARK AS SHOWN.

THE COLOR(S) RED, GREEN AND ORANGE IS/ARE CLAIMED AS A FEATURE OF THE MARK.

THE MARK CONSISTS OF THE PHRASE THE GREAT SOUTHEAST BALLOON FEST APPEARING IN GREEN. IN BETWEEN THE WORDS BALLOON AND FEST IS THE DESIGN OF A BALLOON, DEPICTED IN RED AND ORANGE.

FOR ENTERTAINMENT SERVICES, NAMELY, CONDUCTING FAIRS; ENTERTAINMENT, NAMELY LIVE PERFORMANCES BY MUSICAL BANDS; ORGANIZING EXHIBITIONS FOR ENTERTAINMENT PURPOSES, NAMELY COMMUNITY FESTIVALS AND ART EXHIBITIONS; ORGANIZING COMMUNITY FESTIVALS FEATURING A VARIETY OF ACTIVITIES, NAMELY SPORTING EVENTS, ART EXHIBITIONS, FLEA MARKETS, ETHNIC DANCES AND THE LIKE (U.S. CLS. 100, 101 AND 107).

EMILY CARLSEN, EXAMINING ATTORNEY

SN 77-126,466. AVELLAN, MARCOS, MIAMI, FL. FILED 3-9-2007.



NO CLAIM IS MADE TO THE EXCLUSIVE RIGHT TO USE "FREESTYLE FIGHTING ACADEMY", APART FROM THE MARK AS SHOWN.

THE COLOR(S) BLACK, BLUE, RED AND WHITE IS/ARE CLAIMED AS A FEATURE OF THE MARK.

THE MARK CONSISTS OF THE STYLIZED LETTERS "FFA" WHICH ARE JOINED TOGETHER, THE FIRST LETTER IS A "F" WHICH THE TOP PORTION IS BLUE WITH WHITE STARS AND THE BOTTOM PORTION HAS TWO RED STRIPES AND TWO WHITE STRIPES, THE SECOND LETTER "F", WHICH IS SHORTER THAN THE FIRST LETTER "F" IS BLUE WITH WHITE STARS AND ONE WHITE STRIPE, AND THE THIRD LETTER "A", WHICH IS SHORT ON ONE SIDE, IS BLUE WITH WHITE STARS AND ONE WHITE STRIPE AND THE RIGHT SIDE OF THE "A", WHICH IS LONGER, HAS FOUR RED STRIPES AND THREE WHITE STRIPES. THERE IS A WHITE BORDER AROUND THE LETTERS FFA WHICH IS OUTLINED IN BLUE. BEHIND THE "FFA" LETTERING IS A BLUE, RED, AND WHITE FLAME DESIGN. BELOW THE "FFA" LETTERING IS THE WORDING "FREESTYLE FIGHTING ACADEMY" IN BLACK LETTERING."

FOR OPERATING OF MARTIAL ARTS' SCHOOL (U.S. CLS. 100, 101 AND 107).

FIRST USE 11-1-2001; IN COMMERCE 11-1-2001.
REBECCA GAN, EXAMINING ATTORNEY

CLASS 41—(Continued).

SN 77-126,843. IT'S A WHOLE NEW BALL GAME, INC., WOODLAND HILLS, CA. FILED 3-9-2007.

Next Millionaire

THE MARK CONSISTS OF STANDARD CHARACTERS WITHOUT CLAIM TO ANY PARTICULAR FONT, STYLE, SIZE, OR COLOR.

FOR LOTTERY SERVICES (U.S. CLS. 100, 101 AND 107).

DEZMONA MIZELLE, EXAMINING ATTORNEY

SN 77-126,894. ROBINSON, LATONIA A., TAMPA, FL. FILED 3-9-2007.

Dana da Designated Hata

THE MARK CONSISTS OF STANDARD CHARACTERS WITHOUT CLAIM TO ANY PARTICULAR FONT, STYLE, SIZE, OR COLOR.

FOR RADIO ENTERTAINMENT SERVICES, NAMELY RADIO PROGRAMS FEATURING PERFORMANCES BY A RADIO PERSONALITY; TELEVISION AND RADIO PROGRAMMING; TELEVISION PRODUCTION; TELEVISION PROGRAM SYNDICATION; TELEVISION SHOW PRODUCTION; ENTERTAINMENT, NAMELY A CONTINUING COMEDY, DRAMA, AND MUSIC SHOW BROADCAST OVER TELEVISION, SATELLITE, AUDIO, AND VIDEO MEDIA; NEWS SYNDICATION FOR THE BROADCASTING INDUSTRY; PRODUCTION OF VISUAL EFFECTS FOR VIDEOS, DVDS, TELEVISION AND FOR INTERNET WEBSITES (U.S. CLS. 100, 101 AND 107).

FIRST USE 6-1-2004; IN COMMERCE 6-1-2004.
AMEETA JORDAN, EXAMINING ATTORNEY

SN 77-127,656. LARRABURE, RICARDO, WEST DES MOINES, IA. FILED 3-10-2007.

Summit Consulting: Executive and Business Coaching

THE MARK CONSISTS OF STANDARD CHARACTERS WITHOUT CLAIM TO ANY PARTICULAR FONT, STYLE, SIZE, OR COLOR.

NO CLAIM IS MADE TO THE EXCLUSIVE RIGHT TO USE "CONSULTING" AND "EXECUTIVE AND BUSINESS COACHING", APART FROM THE MARK AS SHOWN.

FOR PERSONAL COACHING SERVICES IN THE FIELD OF BUSINESS (U.S. CLS. 100, 101 AND 107).

ARETHA SOMERVILLE, EXAMINING ATTORNEY

CLASS 41—(Continued).

SN 77-128,704. KENDLE INTERNATIONAL, INC., CINCINNATI, OH. FILED 3-12-2007.

KENDLE COLLEGE

THE MARK CONSISTS OF STANDARD CHARACTERS WITHOUT CLAIM TO ANY PARTICULAR FONT, STYLE, SIZE, OR COLOR.

OWNER OF U.S. REG. NOS. 2,077,521 AND 2,557,313. NO CLAIM IS MADE TO THE EXCLUSIVE RIGHT TO USE "COLLEGE", APART FROM THE MARK AS SHOWN. FOR EDUCATIONAL SERVICES, NAMELY CONDUCTING CLASSES, WORKSHOPS AND SEMINARS IN THE FIELDS OF MEDICINE AND CLINICAL MEDICAL RESEARCH (U.S. CLS. 100, 101 AND 107).

FIRST USE 7-21-1999; IN COMMERCE 7-21-1999.
DEZMONA MIZELLE, EXAMINING ATTORNEY

SN 77-129,071. BETTER WORDS INC., NEW YORK, NY. FILED 3-12-2007.



NO CLAIM IS MADE TO THE EXCLUSIVE RIGHT TO USE .COM, APART FROM THE MARK AS SHOWN.

THE COLOR(S) RED, BLACK, WHITE IS/ARE CLAIMED AS A FEATURE OF THE MARK.

THE MARK CONSISTS OF A RED PARROT WITH A WHITE AND BLACK BEAK SITTING ATOP THE BLACK WORD PARROTPOD WITH ".COM" IN BLACK IN SMALLER FONT BENEATH THE LARGER WORD.

FOR EDUCATIONAL SERVICES, NAMELY, CONDUCTING LECTURES IN THE FIELD OF PET CARE ABOUT PET BIRDS, AND DISTRIBUTION OF COURSE MATERIAL IN CONNECTION THEREWITH (U.S. CLS. 100, 101 AND 107).

DOMINIC J. FERRAIUOLO, EXAMINING ATTORNEY

CLASS 41—(Continued).

SN 77-129,814. CHRISTIAAN ALLEBEST, LAGUNA HILLS, CA. FILED 3-13-2007.

CAPTAIN ALMIGHTY

THE MARK CONSISTS OF STANDARD CHARACTERS WITHOUT CLAIM TO ANY PARTICULAR FONT, STYLE, SIZE, OR COLOR.

FOR ENTERTAINMENT SERVICES, NAMELY, PROVIDING ONLINE REVIEWS, MAGAZINE ARTICLES AND MAGAZINE EDITORIALS ALL IN THE FIELD OF VIDEO GAMES AND COMPUTER GAMES, COMPUTER TECHNOLOGY AND MOVIES, AND PROVIDING ON-LINE COMPUTER GAMES; PROVIDING ONLINE PREVIEW FILM CLIPS OF MOTION PICTURES (U.S. CLS. 100, 101 AND 107).

FIRST USE 12-20-2006; IN COMMERCE 12-20-2006.
BARBARA A. GOLD, EXAMINING ATTORNEY

SN 77-130,277. MARCEL, CHRISTIAN, LOS ANGELES, CA. FILED 3-13-2007.

IBOD

THE MARK CONSISTS OF STANDARD CHARACTERS WITHOUT CLAIM TO ANY PARTICULAR FONT, STYLE, SIZE, OR COLOR.

FOR HEALTH CLUB SERVICES, NAMELY, PROVIDING INSTRUCTION AND EQUIPMENT IN THE FIELD OF PHYSICAL EXERCISE (U.S. CLS. 100, 101 AND 107).

JULIE GUTTADAURO, EXAMINING ATTORNEY

SN 77-130,288. SCHOLL, KAREN M, MESA, AZ. AND SCHOLL, MARK L, MESA, AZ. FILED 3-13-2007.

**Karen Scholl Horsemanship
for Women**

THE MARK CONSISTS OF STANDARD CHARACTERS WITHOUT CLAIM TO ANY PARTICULAR FONT, STYLE, SIZE, OR COLOR.

NO CLAIM IS MADE TO THE EXCLUSIVE RIGHT TO USE "HORSEMANSHIP FOR WOMEN", APART FROM THE MARK AS SHOWN.

FOR TRAINING SERVICES IN THE FIELD OF HORSEMANSHIP; EDUCATION SERVICES, NAMELY, PROVIDING CLASSES, SEMINARS, WORKSHOPS, CAMPS, CLINICS IN THE FIELD OF HORSEMANSHIP (U.S. CLS. 100, 101 AND 107).

FIRST USE 8-10-2005; IN COMMERCE 8-22-2005.
JULIE GUTTADAURO, EXAMINING ATTORNEY

CLASS 41—(Continued).

SN 77-130,311. LAGUNA BEACH HOSPITALITY ASSOCIATION, INC., LAGUNA BEACH, CA. FILED 3-13-2007.

A TASTE OF LAGUNA BEACH

THE MARK CONSISTS OF STANDARD CHARACTERS WITHOUT CLAIM TO ANY PARTICULAR FONT, STYLE, SIZE, OR COLOR.

NO CLAIM IS MADE TO THE EXCLUSIVE RIGHT TO USE "LAGUNA BEACH", APART FROM THE MARK AS SHOWN.

FOR ENTERTAINMENT AND CULTURAL ACTIVITIES, NAMELY ORGANIZING COMMUNITY FESTIVALS FEATURING MUSIC, ART AND FOOD EXHIBITIONS IN THE VICINITY OF LAGUNA BEACH, CALIFORNIA (U.S. CLS. 100, 101 AND 107).

JIM RINGLE, EXAMINING ATTORNEY

SN 77-130,384. FRANK D. FAKINOS, GARDEN GROVE, CA. FILED 3-14-2007.



THE COLOR(S) GREEN, YELLOW, ORANGE, RED AND PURPLE IS/ARE CLAIMED AS A FEATURE OF THE MARK.

THE MARK CONSISTS OF THE WORDS ISLAND GROOVIN', WITH GREEN PALM TREE LEAVES AT THE TOP OF THE LETTER "I" IN THE WORD ISLAND; EACH LETTER OF THE WORDS HAS GRADIENT COLOR BEGINNING WITH YELLOW AT THE TOP, ORANGE IN THE UPPER CENTER, RED IN THE LOWER CENTER AND PURPLE AT THE BOTTOM.

FOR ENTERTAINMENT, NAMELY LIVE PERFORMANCES BY MUSICAL BANDS (U.S. CLS. 100, 101 AND 107).

FIRST USE 1-1-2002; IN COMMERCE 1-1-2002.
TINA BROWN, EXAMINING ATTORNEY

SN 77-130,725. SMITHKLINE BEECHAM CORPORATION, PHILADELPHIA, PA. FILED 3-14-2007.

MYALLI.COM

THE MARK CONSISTS OF STANDARD CHARACTERS WITHOUT CLAIM TO ANY PARTICULAR FONT, STYLE, SIZE, OR COLOR.

FOR EDUCATIONAL SERVICES RENDERED VIA THE INTERNET IN THE NATURE OF INTERACTIVE EXHIBITS AND INFORMAL ONLINE PROGRAMS FEATURING GUIDELINES FOR WEIGHT LOSS (U.S. CLS. 100, 101 AND 107).

JAMES LOVELACE, EXAMINING ATTORNEY

CLASS 41—(Continued).

SN 77-131,137. SOFER, YEHOASHUA A., LOS ANGELES, CA. FILED 3-14-2007.

QESHETH

THE MARK CONSISTS OF STANDARD CHARACTERS WITHOUT CLAIM TO ANY PARTICULAR FONT, STYLE, SIZE, OR COLOR.

THE FOREIGN WORDING IN THE MARK TRANSLATES INTO ENGLISH AS "ARC."

FOR MARTIAL ARTS INSTRUCTION; OPERATING OF MARTIAL ARTS' SCHOOLS (U.S. CLS. 100, 101 AND 107).

FIRST USE 12-0-1989; IN COMMERCE 12-0-1989.
THOMAS MANOR, EXAMINING ATTORNEY

SN 77-131,140. BARDI, PETER W., PHILADELPHIA, PA. FILED 3-14-2007.

**Good Times Coalition Local
42**

THE MARK CONSISTS OF STANDARD CHARACTERS WITHOUT CLAIM TO ANY PARTICULAR FONT, STYLE, SIZE, OR COLOR.

FOR PARTY PLANNING (U.S. CLS. 100, 101 AND 107).
THOMAS MANOR, EXAMINING ATTORNEY

SN 77-131,346. THE ROB NELSON COMPANY, VANCOUVER, WA. FILED 3-14-2007.

DOUBLE FANTASY

THE MARK CONSISTS OF STANDARD CHARACTERS WITHOUT CLAIM TO ANY PARTICULAR FONT, STYLE, SIZE, OR COLOR.

NO CLAIM IS MADE TO THE EXCLUSIVE RIGHT TO USE "FANTASY", APART FROM THE MARK AS SHOWN.

FOR ENTERTAINMENT SERVICES IN THE NATURE OF FANTASY SPORTS LEAGUES; PROVIDING A WEBSITE THAT PROVIDES SPORTS LEAGUE PLAYER STATISTICS (U.S. CLS. 100, 101 AND 107).
CURTIS FRENCH, EXAMINING ATTORNEY

CLASS 41—(Continued).

SN 77-131,564. RESULTS IN LEARNING, INC., LAFAYETTE, LA. FILED 3-15-2007.



OWNER OF U.S. REG. NO. 3,060,097.
NO CLAIM IS MADE TO THE EXCLUSIVE RIGHT TO USE "SAFETY" AND "LEARNING PRODUCT", APART FROM THE MARK AS SHOWN.

THE MARK CONSISTS OF THE WORDS "BEYOND SAFETY" WITH THE LETTER "O" RESEMBLING A GLOBE AND THE WORDS "A RESULTS IN LEARNING PRODUCT".

FOR TRAINING SERVICES IN THE FIELD OF WORK-PLACE SAFETY (U.S. CLS. 100, 101 AND 107).

FIRST USE 3-9-2007; IN COMMERCE 3-9-2007.
TASHIA BUNCH, EXAMINING ATTORNEY

SN 77-131,832. SUN MOON STARS, INC., ATLANTA, GA. FILED 3-15-2007.



THE COLOR(S) BLACK AND BROWN IS/ARE CLAIMED AS A FEATURE OF THE MARK.

THE MARK CONSISTS OF SILHOUETTE OF DOG AND CAT IN BLACK WITH A HEART SHAPE AND TEXT WITHIN OF "YOUR BEST FRIEND" IN BROWN.

FOR ENTERTAINMENT AND EDUCATIONAL SERVICE IN THE NATURE OF A SERIES OF TELEVISION PROGRAMS IN THE FIELD OF PET CARE FOR BROADCAST ON CABLE, FREE TV, AND OVER THE INTERNET- OPERATING AN INTERNET WEBSITE FEATURING, PHOTOGRAPHIC, AUDIO, VIDEO AND PROSE PRESENTATIONS FEATURING PET CARE, PET HEALTH, PET TRAINING AND PET ADOPTION (U.S. CLS. 100, 101 AND 107).

FIRST USE 12-24-2005; IN COMMERCE 12-24-2005.
INGRID C. EULIN, EXAMINING ATTORNEY

CLASS 41—(Continued).

SN 77-131,999. PWNED RADIO, LLC, CANTON, MI. FILED 3-15-2007.

PWNED RADIO

THE MARK CONSISTS OF STANDARD CHARACTERS WITHOUT CLAIM TO ANY PARTICULAR FONT, STYLE, SIZE, OR COLOR.

NO CLAIM IS MADE TO THE EXCLUSIVE RIGHT TO USE "RADIO", APART FROM THE MARK AS SHOWN.

FOR ENTERTAINMENT, NAMELY A CONTINUING TALK SHOW BROADCAST OVER TELEVISION, SATELLITE, AUDIO, AND VIDEO MEDIA (U.S. CLS. 100, 101 AND 107).

ANGELA M. MICHELI, EXAMINING ATTORNEY

SN 77-132,143. APONTE, GRACIELA, HYATTSVILLE, MD. FILED 3-15-2007.

Dance With Grace

THE MARK CONSISTS OF STANDARD CHARACTERS WITHOUT CLAIM TO ANY PARTICULAR FONT, STYLE, SIZE, OR COLOR.

NO CLAIM IS MADE TO THE EXCLUSIVE RIGHT TO USE "DANCE", APART FROM THE MARK AS SHOWN.

FOR DANCE EVENTS; DANCE INSTRUCTION; DANCE SCHOOLS; DANCE STUDIOS; ENTERTAINMENT IN THE NATURE OF DANCE PERFORMANCES; ORGANIZATION OF DANCING EVENTS (U.S. CLS. 100, 101 AND 107).

KATHERINE STOIDES, EXAMINING ATTORNEY

CLASS 41—(Continued).

SN 77-132,414. HARRAH'S LICENSE COMPANY, LLC, LAS VEGAS, NV. FILED 3-15-2007.



OWNER OF U.S. REG. NOS. 1,067,887, 2,843,123 AND OTHERS.

THE MARK CONSISTS OF A MICROPHONE IN A RECTANGLE SHAPE WITH STARS INTERSPERSED ON THE BACKGROUND WITH THE WORDS HARRAH'S LUCKY-BREAK APPEARING IN A RECTANGLE SUPERIMPOSED ON THE LARGER RECTANGLE.

FOR ENTERTAINMENT SERVICES IN THE NATURE OF A TELEVISION TALENT SHOW (U.S. CLS. 100, 101 AND 107).

FIRST USE 7-31-2004; IN COMMERCE 7-31-2004.

JULIE THOMAS, EXAMINING ATTORNEY

SN 77-132,606. ADOFO, ADJOA, WASHINGTON D.C., DC. AND GARNER, JOSHUA, WASHINGTON D.C., DC. FILED 3-15-2007.



THE COLOR(S) BLACK, WHITE, DARK RED IS/ARE CLAIMED AS A FEATURE OF THE MARK.

THE MARK CONSISTS OF THE TEXT: "RAGMAG" IN STYLIZED BLACK LETTERING ON A WHITE RECTANGULAR BACKGROUND, WITH A RED HORIZONTAL BAR BELOW THE TEXT, AND A BLACK HALF CIRCLE ON THE LEFT SIDE OF THE MARK.

FOR ON-LINE JOURNALS, NAMELY, AUDIO AND VIDEO BLOGS FEATURING DISCUSSIONS ABOUT NEWS, POLITICS, ENTERTAINMENT, CULTURAL AFFAIRS, CRIME AND BUSINESS. (U.S. CLS. 100, 101 AND 107).

RENEE SERVANCE, EXAMINING ATTORNEY

CLASS 41—(Continued).

SN 77-133,455. FOX TELEVISION STATIONS, INC., LOS ANGELES, CA. FILED 3-16-2007.

YOU SHOOT IT, WE'LL SHARE IT

THE MARK CONSISTS OF STANDARD CHARACTERS WITHOUT CLAIM TO ANY PARTICULAR FONT, STYLE, SIZE, OR COLOR.

FOR ENTERTAINMENT SERVICES IN THE NATURE OF A ON-GOING TELEVISION PROGRAM SEGMENTS FEATURING SPORTS, NEWS AND ENTERTAINMENT; PROVIDING ON-LINE INFORMATION IN THE FIELD OF SPORTS, NEWS AND ENTERTAINMENT (U.S. CLS. 100, 101 AND 107).

HEATHER BIDDULPH, EXAMINING ATTORNEY

CLASS 41—(Continued).

SN 77-133,687. RE-ENERGIZING COMMUNICATIONS, INC., PROSPECT, KY. FILED 3-17-2007.



THE COLOR(S) RED, YELLOW, AND BLACK IS/ARE CLAIMED AS A FEATURE OF THE MARK.

THE MARK CONSISTS OF A YELLOW STREET SIGN, HAVING A BLACK LINE AROUND ITS PERIMETER, CONTAINING AN ARROW AND THE WORDS "THE POSITIVE ZONE" IN RED.

FOR CONDUCTING WORKSHOPS AND SEMINARS IN THE AREA OF WORKPLACE IMPROVEMENT, PRODUCTIVITY, AND PERFORMANCE (U.S. CLS. 100, 101 AND 107).

FIRST USE 3-10-2007; IN COMMERCE 3-10-2007.
BRIAN CALLAGHAN, EXAMINING ATTORNEY

SN 77-133,630. BIG DAY PHOTOGRAPHY, INC., STONE MOUNTAIN, GA. FILED 3-16-2007.

BIG DAY PHOTOGRAPHY

THE MARK CONSISTS OF STANDARD CHARACTERS WITHOUT CLAIM TO ANY PARTICULAR FONT, STYLE, SIZE, OR COLOR.

NO CLAIM IS MADE TO THE EXCLUSIVE RIGHT TO USE "PHOTOGRAPHY", APART FROM THE MARK AS SHOWN.

FOR PHOTOGRAPHY SERVICES (U.S. CLS. 100, 101 AND 107).

FIRST USE 9-0-2006; IN COMMERCE 9-0-2006.
B. PARADEWELAI, EXAMINING ATTORNEY

SN 77-133,695. PHOBIA INC., HOUSTON, TX. FILED 3-17-2007.



SN 77-133,634. SUBLIME PHOTOGRAPHY, INC., STONE MOUNTAIN, GA. FILED 3-16-2007.

SUBLIME PHOTOGRAPHY

THE MARK CONSISTS OF STANDARD CHARACTERS WITHOUT CLAIM TO ANY PARTICULAR FONT, STYLE, SIZE, OR COLOR.

NO CLAIM IS MADE TO THE EXCLUSIVE RIGHT TO USE "PHOTOGRAPHY", APART FROM THE MARK AS SHOWN.

FOR PHOTOGRAPHY SERVICES (U.S. CLS. 100, 101 AND 107).

FIRST USE 1-1-2007; IN COMMERCE 1-1-2007.
B. PARADEWELAI, EXAMINING ATTORNEY

NO CLAIM IS MADE TO THE EXCLUSIVE RIGHT TO USE "HAUNTED HOUSE", APART FROM THE MARK AS SHOWN.

THE COLOR(S) RED, BLACK IS/ARE CLAIMED AS A FEATURE OF THE MARK.

THE MARK CONSISTS OF MANIA IN BOLD RED LETTERS AND HAUNTED HOUSE IN STENCIL BLACK LETTERS.

FOR ENTERTAINMENT SERVICES IN THE NATURE OF AN AMUSEMENT PARK SHOW (U.S. CLS. 100, 101 AND 107).

FIRST USE 10-1-1997; IN COMMERCE 10-1-1997.
LA TONIA FISHER, EXAMINING ATTORNEY

CLASS 41—(Continued).

SN 77-133,728. IQ212, INC., MARTINEZ, CA. FILED 3-17-2007.

iQ212

THE MARK CONSISTS OF STANDARD CHARACTERS WITHOUT CLAIM TO ANY PARTICULAR FONT, STYLE, SIZE, OR COLOR.

FOR ENTERTAINMENT SERVICES, NAMELY, PROVIDING ON-LINE COMPUTER GAMES; PRODUCTION OF VIDEO AND COMPUTER GAME SOFTWARE; PROVIDING A COMPUTER GAME THAT MAY BE ACCESSED NETWORK-WIDE BY NETWORK USERS; PROVIDING INFORMATION ON-LINE RELATING TO COMPUTER GAMES AND COMPUTER ENHANCEMENTS FOR GAMES (U.S. CLS. 100, 101 AND 107).

FIRST USE 1-10-2007; IN COMMERCE 1-10-2007.

JENNIFER HETU, EXAMINING ATTORNEY

SN 77-133,774. KINDRED, ARON BRANT, OFALLON, MO. AND SMITH, STEPHEN MICHAEL, ST CHARLES, MO. FILED 3-17-2007.

4

THE MARK CONSISTS OF THE NUMBER 4 USED TO IDENTIFY A MUSICAL GROUP WITH VOCAL.

FOR ENTERTAINMENT IN THE NATURE OF VISUAL AND AUDIO PERFORMANCES, NAMELY, MUSICAL BAND, ROCK GROUP, GYMNASIAC, DANCE, AND BALLET PERFORMANCES (U.S. CLS. 100, 101 AND 107).

FIRST USE 9-11-2004; IN COMMERCE 9-11-2004.

ALLISON HOLTZ, EXAMINING ATTORNEY

CLASS 41—(Continued).

SN 77-133,954. JUDAH EARLY, OAKWOOD VILLAGE, OH. FILED 3-19-2007.



NO CLAIM IS MADE TO THE EXCLUSIVE RIGHT TO USE "PRODUCTIONS", APART FROM THE MARK AS SHOWN.

THE MARK CONSISTS OF AN "O" BEHIND A MAN WITH HIS HANDS UP, SORT OF KNEELING. "OBADIAH IS ABOVE THE "O" AND "PRODUCTIONS" IS UNDER THE "O."

FOR ENTERTAINMENT IN THE NATURE OF VISUAL AND AUDIO PERFORMANCES, NAMELY, MUSICAL BAND, ROCK GROUP, GYMNASIAC, DANCE, AND BALLET PERFORMANCES; ENTERTAINMENT NAMELY, LIVE PERFORMANCES BY A MUSICAL BAND; MUSIC COMPOSITION FOR OTHERS; MUSIC PRODUCTION SERVICES; PRESENTATION OF MUSICAL PERFORMANCE (U.S. CLS. 100, 101 AND 107).

ANGELA GAW, EXAMINING ATTORNEY

SN 77-134,008. HARRAH'S LICENSE COMPANY, LLC, LAS VEGAS, NV. FILED 3-19-2007.



NO CLAIM IS MADE TO THE EXCLUSIVE RIGHT TO USE "SUPPER CLUB", APART FROM THE MARK AS SHOWN.

THE MARK CONSISTS OF THE WORDS TUESDAY NIGHT SUPPER CLUB WITH A MARTINI GLASS SUPERIMPOSED ON AN IRREGULAR DESIGN WITH A MISCELLANEOUS DESIGN INTERSPERSED ON THE LOGO.

FOR DINNER THEATERS (U.S. CLS. 100, 101 AND 107).

FIRST USE 1-9-2007; IN COMMERCE 1-9-2007.

JULIE THOMAS, EXAMINING ATTORNEY

CLASS 41—(Continued).

SN 77-134,324. ULTIMATE PRODUCTIONS, FORESTVILLE, MD. FILED 3-19-2007.

Ultimate Productions

THE MARK CONSISTS OF STANDARD CHARACTERS WITHOUT CLAIM TO ANY PARTICULAR FONT, STYLE, SIZE, OR COLOR.

NO CLAIM IS MADE TO THE EXCLUSIVE RIGHT TO USE "PRODUCTIONS", APART FROM THE MARK AS SHOWN.

FOR OPERATION OF VIDEO EQUIPMENT OR AUDIO EQUIPMENT ETC FOR PRODUCTION OF RADIO OR TELEVISION PROGRAMS; PRODUCTION OF VIDEO AND CREATION OF VISUAL EFFECTS FOR OTHERS FOR USE IN DVDS, TELEVISION PROGRAMS AND ON WEBSITES; VIDEO EDITING; VIDEO MASTERING SERVICES; VIDEO TAPE EDITING; VIDEO TAPE RECORDING FOR OTHERS (U.S. CLS. 100, 101 AND 107).
LINDA M. KING, EXAMINING ATTORNEY

CLASS 41—(Continued).

SN 77-134,495. ARCADE FIRE MUSIC LLC, LOS ANGELES, CA. FILED 3-19-2007.

THE ARCADE FIRE

THE MARK CONSISTS OF STANDARD CHARACTERS WITHOUT CLAIM TO ANY PARTICULAR FONT, STYLE, SIZE, OR COLOR.

FOR ENTERTAINMENT SERVICES IN THE NATURE OF LIVE MUSICAL PERFORMANCES BY A PERFORMER OR GROUP; FAN CLUB SERVICES; AND ENTERTAINMENT SERVICES, NAMELY, PROVIDING A WEB SITE FEATURING MUSICAL PERFORMANCES, MUSICAL VIDEOS, RELATED FILM CLIPS, PHOTOGRAPHS AND OTHER MULTIMEDIA MATERIALS, COMMENTARY AND ARTICLES ABOUT MUSIC, MOVIES, BOOKS AND TELEVISION, AND PERSONAL AND MUSICAL INFORMATION REGARDING A MUSICAL GROUP OR PERFORMER AND ITS LIVE AND RECORDED PERFORMANCES (U.S. CLS. 100, 101 AND 107).

FIRST USE 6-1-2003; IN COMMERCE 6-2-2003.
LEIGH CAROLINE CASE, EXAMINING ATTORNEY

SN 77-134,646. NEW YORK INTERACTIVE MEDIA, INC, BROOKLYN, NY. FILED 3-19-2007.

New York Interactive Media

THE MARK CONSISTS OF STANDARD CHARACTERS WITHOUT CLAIM TO ANY PARTICULAR FONT, STYLE, SIZE, OR COLOR.

NO CLAIM IS MADE TO THE EXCLUSIVE RIGHT TO USE "INTERACTIVE MEDIA", APART FROM THE MARK AS SHOWN.

SEC. 2(F).
FOR BUSINESS TRAINING; COMPUTER EDUCATION TRAINING; COMPUTER EDUCATION TRAINING SERVICES; PROVIDING FACILITIES FOR MOVIES, SHOWS, PLAYS, MUSIC OR EDUCATIONAL TRAINING; PROVIDING ONLINE COMPUTER TRAINING CLASSES, SEMINARS, AND TUTORIALS IN THE FIELD OF SPREADSHEETS, PRESENTATION SOFTWARE, GRAPHIC ILLUSTRATION SOFTWARE, FINANCIAL ACCOUNTING SOFTWARE, BOOKKEEPING SOFTWARE, AND WEBSITE DESIGN SOFTWARE; TRAINING IN THE USE OF COMPUTERS; TRAINING SERVICES IN THE FIELD OF COMPUTERS (U.S. CLS. 100, 101 AND 107).

FIRST USE 1-1-1996; IN COMMERCE 1-1-1996.
DANNEAN HETZEL, EXAMINING ATTORNEY

SN 77-134,473. A&E TELEVISION NETWORKS, NEW YORK, NY. FILED 3-19-2007.

CRIME 360

THE MARK CONSISTS OF STANDARD CHARACTERS WITHOUT CLAIM TO ANY PARTICULAR FONT, STYLE, SIZE, OR COLOR.

NO CLAIM IS MADE TO THE EXCLUSIVE RIGHT TO USE "CRIME", APART FROM THE MARK AS SHOWN.

FOR ENTERTAINMENT SERVICES, NAMELY CONTINUING SERIES OF TELEVISION PROGRAMS FEATURING CRIMINAL INVESTIGATIONS (U.S. CLS. 100, 101 AND 107).
PRISCILLA MILTON, EXAMINING ATTORNEY

CLASS 41—(Continued).

SN 77-134,762. ZAHER, AHMED, DALLAS, TX. AND BRODE, STACI, DALLAS, TX. FILED 3-19-2007.

Playtri

THE MARK CONSISTS OF STANDARD CHARACTERS WITHOUT CLAIM TO ANY PARTICULAR FONT, STYLE, SIZE, OR COLOR.

FOR PERSONAL COACHING SERVICES IN THE FIELD OF MULTISPORT COMPETITION, NAMELY, TRIATHLON, DUATHLON, SWIMMING, CYCLING AND RUNNING COMPETITIONS; TRAINING SERVICES IN THE FIELD OF MULTISPORT COMPETITION, NAMELY, TRIATHLON, DUATHLON, SWIMMING, CYCLING COMPETITIONS (U.S. CLS. 100, 101 AND 107).

FIRST USE 11-15-2000; IN COMMERCE 11-15-2000.

AMY BROZENIC, EXAMINING ATTORNEY

SN 77-135,067. DEES COMMUNICATIONS, INC., MONTGOMERY, AL. FILED 3-20-2007.



THE MARK CONSISTS OF STYLIZED LETTERS APC WITH THE LETTERS "AP" CAPITALIZED AND A DOT ABOVE THE LOWER CASE "C" INSIDE OF A RECTANGLE. FOR PUBLICATION OF ATHLETIC DIRECTORIES (U.S. CLS. 100, 101 AND 107).

FIRST USE 1-31-1970; IN COMMERCE 1-31-1970.

COLLEEN DOMBROW, EXAMINING ATTORNEY

SN 77-135,657. THE MONEY COLLEGE, LLC, LEXINGTON, KY. FILED 3-20-2007.



THE MONEY COLLEGE

Your Source for Financial Education

NO CLAIM IS MADE TO THE EXCLUSIVE RIGHT TO USE "MONEY" AND "COLLEGE", APART FROM THE MARK AS SHOWN.

THE COLOR(S) BURGUNDY, WHITE AND BLACK IS/ARE CLAIMED AS A FEATURE OF THE MARK.

THE MARK CONSISTS OF CIRCULAR RING IN BURGUNDY WITH THE WORDING THE MONEY COLLEGE APPLIED KNOWLEDGE IS POWER IN WHITE. AT THE CENTER LEFT AND RIGHT SIDES OF THE BANNER ARE WHITE DIAMOND-LIKE DESIGNS. THE INSIDE OF THE RING IS WHITE WITH LIBRARY STYLED LOGO CONSISTING OF THREE SHIELDS SURROUNDED BY A FERN

CLASS 41—(Continued).

LAUREL IN BLACK. THE TOPMOST SHIELD HAS BLACK CROSS ON A WHITE BACKGROUND. THE LEFTMOST SHIELD HAS A BLACK BACKGROUND WITH A WHITE URN, AND THE RIGHTMOST SHIELD HAS BLACK BACKGROUND WITH A WHITE HAND. BENEATH THESE SHIELDS IS A WHITE BANNER WITH THE WORDING NON SEBI SED ALIIS IN BLACK. TO THE RIGHT OF THE CIRCULAR RING IS THE WORDING THE MONEY COLLEGE YOUR SOURCE FOR FINANCIAL EDUCATION IN BURGUNDY.

THE FOREIGN WORDING IN THE MARK TRANSLATES INTO ENGLISH AS "NOT FOR THE SELF BUT FOR OTHERS".

FOR EDUCATION SERVICES, NAMELY, PROVIDING LIVE AND ON-LINE SEMINARS, WORKSHOPS AND CLASSES IN THE FIELD OF FINANCIAL SERVICES SALES AND MARKETING (U.S. CLS. 100, 101 AND 107).

FIRST USE 10-1-2006; IN COMMERCE 10-1-2006.

TAMARA FRAZIER, EXAMINING ATTORNEY

SN 77-135,842. COLOR ME MINE ENTERPRISES, INC., GLENDALE, CA. FILED 3-20-2007.

PAINT ME A STORY

THE MARK CONSISTS OF STANDARD CHARACTERS WITHOUT CLAIM TO ANY PARTICULAR FONT, STYLE, SIZE, OR COLOR.

FOR "DO-IT-YOURSELF" CERAMIC STUDIO, PROVIDING USE OF VARIOUS SUPPLIES AND EQUIPMENT; NAMELY, UNPAINTED CERAMIC BOWLS, DISHES, AND CONTAINERS IN A VARIETY OF SHAPES AND SIZES, PICTURE FRAMES, NIGHT LIGHTS, SALT AND PEPPER SHAKERS, PAINTS, GLAZES AND FIRING MATERIAL (U.S. CLS. 100, 101 AND 107).

LA TONIA FISHER, EXAMINING ATTORNEY

CLASS 41—(Continued).

SN 77-135,942. LENNON, ERIK, COACHELLA, CA. FILED 3-20-2007.



NO CLAIM IS MADE TO THE EXCLUSIVE RIGHT TO USE "SOUND", APART FROM THE MARK AS SHOWN. THE STIPPLING IS FOR SHADING PURPOSES ONLY. "THE MARK CONSISTS OF YELLOW, RED AND/OR ORANGE FIRE, BURNING ABOVE AND/OR BEHIND A BLACK AND/OR GREY AUDIO SPEAKER." FOR RECORDING, MIXING, AND MASTERING OF MUSIC AND POST-PRODUCTION SOUND, IN INTERNATIONAL CLASS 41. (U.S. CLS. 100, 101 AND 107). FIRST USE 6-1-2006; IN COMMERCE 6-1-2006. RONALD AIKENS, EXAMINING ATTORNEY

CLASS 41—(Continued).

SN 77-136,416. DEPARTMENT OF DEFENSE, ALEXANDRIA, VA. FILED 3-21-2007.



OWNER OF U.S. REG. NOS. 3,035,867 AND 3,035,868. THE MARK CONSISTS OF THE CAPITAL LETTERS AFN. A STAR DESIGN IS SHOWN LOCATED IN THE CENTER OF THE CAPITAL LETTER "A".

FOR DISTRIBUTION OF RADIO PROGRAMS FOR OTHERS; DISTRIBUTION OF TELEVISION PROGRAMMING TO CABLE TELEVISION SYSTEMS; DISTRIBUTION OF TELEVISION PROGRAMS FOR OTHERS; ENTERTAINMENT SERVICES, NAMELY, PROVIDING A RADIO PROGRAM IN THE FIELD OF NEWS, SPORTS, COMMENTARY AND FAMILY ENTERTAINMENT VIA A GLOBAL COMPUTER NETWORK; ENTERTAINMENT SERVICES, NAMELY, PROVIDING A TELEVISION PROGRAM IN THE FIELD OF NEWS, SPORTS, COMMENTARY AND FAMILY ENTERTAINMENT VIA A GLOBAL COMPUTER NETWORK; PRODUCTION OF RADIO AND TELEVISION PROGRAMS (U.S. CLS. 100, 101 AND 107).

FIRST USE 1-1-2003; IN COMMERCE 1-1-2003. ALICIA COLLINS, EXAMINING ATTORNEY

SN 77-136,445. HARTFORD GROUP INC., DAYTON, NJ. FILED 3-21-2007.



SN 77-135,950. CONSCIOUSLY SOCIAL LLC, SOLANA BEACH, CA. FILED 3-20-2007.

CONSCIOUSLY SOCIAL

THE MARK CONSISTS OF STANDARD CHARACTERS WITHOUT CLAIM TO ANY PARTICULAR FONT, STYLE, SIZE, OR COLOR. FOR SPECIAL EVENT PLANNING (U.S. CLS. 100, 101 AND 107). FIRST USE 10-15-2005; IN COMMERCE 10-15-2005. PAULA MAHONEY, EXAMINING ATTORNEY

NO CLAIM IS MADE TO THE EXCLUSIVE RIGHT TO USE "MATH TUTOR FOR KIDS", APART FROM THE MARK AS SHOWN.

THE MARK CONSISTS OF THE FOLLOWING LETTERS. SQUARE ROOT, LETTER E LIKE MATHEMATICAL NOTATION SIGMA, LETTER S, LETTER U LIKE MATHEMATICAL NOTATION MU, LETTER M, LETTER Z, LETTER ESUMZ APPEAR WITHIN THE SQUARE ROOT. MATH TUTOR FOR KIDS APPEAR AT THE BOTTOM OF THE SYMBOL.

FOR EDUCATIONAL SERVICES, NAMELY, CONDUCTING INFORMAL ON-LINE PROGRAMS IN THE FIELDS OF MATH, SCIENCE AND ENGLISH, AND PRINTABLE MATERIALS DISTRIBUTED THEREWITH (U.S. CLS. 100, 101 AND 107).

FIRST USE 1-25-2007; IN COMMERCE 1-25-2007. PAMELA HIRSCHMAN, EXAMINING ATTORNEY

CLASS 41—(Continued).

SN 77-136,723. CLASSY ME ENTERTAINMENT CORPORATION, YONKERS, NY. FILED 3-21-2007.



THE MARK CONSISTS OF THE WORDS CLASSY ME OVER THE PICTURE A WOMAN IN A CIRCULAR DESIGN.
FOR RENTAL OF PRE-RECORDED ADULT DIGITAL VIDEO DISKS BY MEANS OF COMMUNICATIONS NETWORKS (U.S. CLS. 100, 101 AND 107).
TRACY CROSS, EXAMINING ATTORNEY

SN 77-136,996. FITNESS BY CORRY, LLC, ALEXANDRIA, VA. FILED 3-21-2007.

FITNESS BY CORRY

THE MARK CONSISTS OF STANDARD CHARACTERS WITHOUT CLAIM TO ANY PARTICULAR FONT, STYLE, SIZE, OR COLOR.

NO CLAIM IS MADE TO THE EXCLUSIVE RIGHT TO USE "FITNESS", APART FROM THE MARK AS SHOWN.

FOR ENTERTAINMENT SERVICES, NAMELY, PROVIDING A WEBSITE FEATURING, PHOTOGRAPHIC, AUDIO, VIDEO AND PROSE PRESENTATIONS FEATURING FITNESS INFORMATION (U.S. CLS. 100, 101 AND 107).

FIRST USE 5-0-2000; IN COMMERCE 1-0-2005.
NAPOLEON SHARMA, EXAMINING ATTORNEY

SN 77-137,003. CELEBSTER, INC., MELBOURNE, FL. FILED 3-21-2007.

CELEBSTER

THE MARK CONSISTS OF STANDARD CHARACTERS WITHOUT CLAIM TO ANY PARTICULAR FONT, STYLE, SIZE, OR COLOR.

FOR ENTERTAINMENT SERVICES NAMELY PROVIDING A WEBSITE FEATURING, PHOTOGRAPHIC, AUDIO, VIDEO AND PROSE PRESENTATIONS FEATURING CELEBRITY IMPERSONATORS, VIDEO MESSAGES TO CELEBRITIES, AND VIDEOS FROM CELEBRITIES (U.S. CLS. 100, 101 AND 107).

FIRST USE 3-4-2007; IN COMMERCE 3-4-2007.
CAROLINE WOOD, EXAMINING ATTORNEY

CLASS 41—(Continued).

SN 77-137,052. HALFWAY TO HAZARD, LLC, NASHVILLE, TN. FILED 3-21-2007.

Halfway To Hazard

THE MARK CONSISTS OF STANDARD CHARACTERS WITHOUT CLAIM TO ANY PARTICULAR FONT, STYLE, SIZE, OR COLOR.

FOR ENTERTAINMENT IN THE NATURE OF LIVE PERFORMANCES BY A MUSICAL GROUP; ENTERTAINMENT IN THE NATURE OF VISUAL AND AUDIO PERFORMANCES, AND MUSICAL, VARIETY, NEWS AND COMEDY SHOWS; ENTERTAINMENT IN THE NATURE OF VISUAL AND AUDIO PERFORMANCES, NAMELY, MUSICAL BAND, ROCK GROUP, GYMNAS-TIC, DANCE, AND BALLET PERFORMANCES; ENTERTAINMENT NAMELY, LIVE PERFORMANCES BY A MUSICAL BAND (U.S. CLS. 100, 101 AND 107).

FIRST USE 2-6-2006; IN COMMERCE 2-6-2006.
ELLEN PERKINS, EXAMINING ATTORNEY

SN 77-137,260. HARB, JONATHAN, SAN RAFAEL, CA. FILED 3-22-2007.

WHISKYTREE

THE MARK CONSISTS OF STANDARD CHARACTERS WITHOUT CLAIM TO ANY PARTICULAR FONT, STYLE, SIZE, OR COLOR.

FOR ENTERTAINMENT NAMELY, PREPARATION OF SPECIAL EFFECTS; FILM STUDIOS; MOVIE STUDIOS; OPERATING OF FILM STUDIOS; PRODUCTION OF VIDEO AND CREATION OF VISUAL EFFECTS FOR OTHERS FOR USE IN DVDS, TELEVISION PROGRAMS AND ON WEBSITES; PRODUCTION OF VISUAL EFFECTS FOR VIDEOS, DVDS, TELEVISION AND FOR INTERNET WEBSITES; PROVIDING AUDIO OR VIDEO STUDIOS; SOUND RECORDING STUDIOS; SPECIAL EFFECTS ANIMATION SERVICES FOR FILM AND VIDEO (U.S. CLS. 100, 101 AND 107).

REBECCA EISINGER, EXAMINING ATTORNEY

CLASS 41—(Continued).

SN 77-137,817. REPUBLIC PROMOTION CO., ORLANDO, FL. FILED 3-22-2007.



THE MARK CONSISTS OF THE ST CIRCLE SYMBOL AND THE SPLIT "SATUR", "THURS" LETTERING ENDING WITH A DOUBLE HEIGHT "DAY".

FOR ARRANGING FOR TICKET RESERVATIONS FOR SHOWS AND OTHER ENTERTAINMENT EVENTS; DANCE EVENTS; DISC JOCKEYS FOR PARTIES AND SPECIAL EVENTS; MASTER OF CEREMONY SERVICES FOR PARTIES AND SPECIAL EVENTS; ORGANIZATION OF DANCING EVENTS; PROVIDING A WEB SITE WHERE USERS CAN POST RATINGS, REVIEWS AND RECOMMENDATIONS ON EVENTS AND ACTIVITIES IN THE FIELD OF ENTERTAINMENT AND EDUCATION; PROVIDING NEWS IN THE NATURE OF CURRENT EVENT REPORTING; SPECIAL EVENT PLANNING; SPECIAL EVENT PLANNING CONSULTATION (U.S. CLS. 100, 101 AND 107).

FIRST USE 12-21-2006; IN COMMERCE 12-21-2006.
HOWARD B. LEVINE, EXAMINING ATTORNEY

CLASS 41—(Continued).

SN 77-138,131. AAFL ENTERPRISES, LLC, NEW YORK, NY. FILED 3-22-2007.

ALL AMERICAN FOOTBALL LEAGUE

THE MARK CONSISTS OF STANDARD CHARACTERS WITHOUT CLAIM TO ANY PARTICULAR FONT, STYLE, SIZE, OR COLOR.

NO CLAIM IS MADE TO THE EXCLUSIVE RIGHT TO USE "FOOTBALL LEAGUE", APART FROM THE MARK AS SHOWN.

FOR ENTERTAINMENT IN THE NATURE OF FOOTBALL GAMES (U.S. CLS. 100, 101 AND 107).

FIRST USE 7-3-2007; IN COMMERCE 7-3-2007.
CHERYL CLAYTON, EXAMINING ATTORNEY

SN 77-138,318. BRITT ALLCROFT PRODUCTIONS, LLC, SANTA MONICA, CA. FILED 3-22-2007.

CUBLEY

THE MARK CONSISTS OF STANDARD CHARACTERS WITHOUT CLAIM TO ANY PARTICULAR FONT, STYLE, SIZE, OR COLOR.

FOR ENTERTAINMENT SERVICES, NAMELY, PRODUCTION OF TELEVISION PROGRAMS AND MOTION PICTURE FILM PRODUCTION FEATURING ANIMATION; PROVIDING A WEBSITE FEATURING INFORMATION IN THE FIELD OF ANIMATED TELEVISION AND MOTION PICTURE ENTERTAINMENT (U.S. CLS. 100, 101 AND 107).

CHARISMA HAMPTON, EXAMINING ATTORNEY

SN 77-138,326. BRITT ALLCROFT PRODUCTIONS, LLC, SANTA MONICA, CA. FILED 3-22-2007.

CUBLEY AND THE CITY KIDS

THE MARK CONSISTS OF STANDARD CHARACTERS WITHOUT CLAIM TO ANY PARTICULAR FONT, STYLE, SIZE, OR COLOR.

FOR ENTERTAINMENT SERVICES, NAMELY, PRODUCTION OF TELEVISION PROGRAMS AND MOTION PICTURE FILM PRODUCTION FEATURING ANIMATION; PROVIDING A WEBSITE FEATURING INFORMATION IN THE FIELD OF ANIMATED TELEVISION AND MOTION PICTURE ENTERTAINMENT (U.S. CLS. 100, 101 AND 107).

CHARISMA HAMPTON, EXAMINING ATTORNEY

SN 77-137,947. DISCIPLES OF CHRIST HISTORICAL SOCIETY, NASHVILLE, TN. FILED 3-22-2007.



NO CLAIM IS MADE TO THE EXCLUSIVE RIGHT TO USE HISTORY, APART FROM THE MARK AS SHOWN.

THE MARK CONSISTS OF A CROSS WITH THREE CIRCLES ON THE TOP, BOTTOM AND LEFT SIDE, THE RIGHT SIDE OF THE CROSS HAS AN ARROW. TO THE RIGHT OF THE CROSS ARE THE WORDS DCHS THE FUTURE OF HISTORY.

FOR EDUCATION SERVICES, NAMELY, PROVIDING A LIBRARY OF REFERENCE MATERIALS IN THE FIELDS OF RELIGIOUS STUDIES AND HISTORY OF THE STONE-CAMPBELL MOVEMENT WHICH INCLUDES THE CHRISTIAN CHURCH (DISCIPLES OF CHRIST) CHURCHES OF CHRIST, AND CHRISTIAN CHURCHES/CHURCHES OF CHRIST (U.S. CLS. 100, 101 AND 107).

FIRST USE 1-31-2006; IN COMMERCE 1-31-2006.
TASNEEM HUSSAIN, EXAMINING ATTORNEY

CLASS 41—(Continued).

SN 77-138,437. T.R. WORLD GYM- IP, LLC, DOVER, NH.
FILED 3-23-2007.

AN INTELLIGENT APPROACH TO
FITNESS

THE MARK CONSISTS OF STANDARD CHARACTERS
WITHOUT CLAIM TO ANY PARTICULAR FONT, STYLE,
SIZE, OR COLOR.

FOR FITNESS CENTER SERVICES, GYMNASIUM
SERVICES, CONDUCTING SEMINARS ON FITNESS
AND PROVIDING PERSONAL INSTRUCTIONS ON EX-
ERCISE AND PHYSICAL FITNESS BY MANNER OF
INDIVIDUALIZED COURSES, CONDUCTING BODY-
BUILDING EXHIBITIONS, CONTESTS, CONDUCTING
EXERCISE CLASSES, CONDUCTING SEMINARS ON
NUTRITION AND FITNESS (U.S. CLS. 100, 101 AND
107).

FIRST USE 11-19-2006; IN COMMERCE 11-19-2006.
ROBIN CHOSID, EXAMINING ATTORNEY

SN 77-138,446. GREGER, BETH, FT. LAUDERDALE, FL.
FILED 3-23-2007.

FIORE

THE MARK CONSISTS OF STANDARD CHARACTERS
WITHOUT CLAIM TO ANY PARTICULAR FONT, STYLE,
SIZE, OR COLOR.

THE ENGLISH TRANSLATION OF FIORE IS BLOSSOM.
FOR ENTERTAINMENT IN THE NATURE OF LIVE
PERFORMANCES BY A SINGER/ SONGWRITER (U.S.
CLS. 100, 101 AND 107).

ROBIN CHOSID, EXAMINING ATTORNEY

SN 77-138,501. EQUATOR HD COMPANY LLC, BETHAGE,
NY. FILED 3-23-2007.

EARTHTRIPPING

THE MARK CONSISTS OF STANDARD CHARACTERS
WITHOUT CLAIM TO ANY PARTICULAR FONT, STYLE,
SIZE, OR COLOR.

FOR ENTERTAINMENT SERVICES, NAMELY, AN
ON-GOING TELEVISION PROGRAM ON THE SUBJECT
OF TRAVEL (U.S. CLS. 100, 101 AND 107).

MARIAM MAHMOUDI, EXAMINING ATTORNEY

CLASS 41—(Continued).

SN 77-138,575. ATLANTIC CITY COIN & SLOT SERVICE,
PLEASANTVILLE, NJ. FILED 3-23-2007.

ALL ABOUT THE WIN!

THE MARK CONSISTS OF STANDARD CHARACTERS
WITHOUT CLAIM TO ANY PARTICULAR FONT, STYLE,
SIZE, OR COLOR.

FOR LEASING OF ELECTRONIC GAMING MA-
CHINES (U.S. CLS. 100, 101 AND 107).

FIRST USE 3-5-2007; IN COMMERCE 3-5-2007.

AHSEN KHAN, EXAMINING ATTORNEY

SN 77-138,664. THALMANN, CHRIS, SAN FRANCISCO, CA.
FILED 3-23-2007.

Hippie Grenade

THE MARK CONSISTS OF STANDARD CHARACTERS
WITHOUT CLAIM TO ANY PARTICULAR FONT, STYLE,
SIZE, OR COLOR.

FOR ENTERTAINMENT, NAMELY, LIVE PERFOR-
MANCES BY ROCK GROUPS (U.S. CLS. 100, 101 AND
107).

FIRST USE 11-30-2002; IN COMMERCE 11-30-2002.

MICHAEL ENGEL, EXAMINING ATTORNEY

SN 77-138,706. INTERAMERICA STAGE, INC., SANFORD,
FL. FILED 3-23-2007.

Sky Deck

THE MARK CONSISTS OF STANDARD CHARACTERS
WITHOUT CLAIM TO ANY PARTICULAR FONT, STYLE,
SIZE, OR COLOR.

FOR ENTERTAINMENT IN THE NATURE OF LIVE
THEATER PRODUCTIONS (U.S. CLS. 100, 101 AND 107).

PATRICIA EVANKO, EXAMINING ATTORNEY

CLASS 41—(Continued).

SN 77-138,802. CHICAGO ARCHITECTURE FOUNDATION, CHICAGO, IL. FILED 3-23-2007.

**CHICAGO ARCHITECTURE
FOUNDATION**

THE MARK CONSISTS OF STANDARD CHARACTERS WITHOUT CLAIM TO ANY PARTICULAR FONT, STYLE, SIZE, OR COLOR.

NO CLAIM IS MADE TO THE EXCLUSIVE RIGHT TO USE "FOUNDATION", APART FROM THE MARK AS SHOWN.

SEC. 2(F).
FOR GUIDED TOURS OF THE BUILT ENVIRONMENT (U.S. CLS. 100, 101 AND 107).

FIRST USE 1-1-1970; IN COMMERCE 1-1-1970.
LYDIA BELZER, EXAMINING ATTORNEY

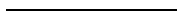

SN 77-139,024. MANN, TRACI, BROOKLYN, NY. FILED 3-23-2007.

Tap Extravaganza

THE MARK CONSISTS OF STANDARD CHARACTERS WITHOUT CLAIM TO ANY PARTICULAR FONT, STYLE, SIZE, OR COLOR.

NO CLAIM IS MADE TO THE EXCLUSIVE RIGHT TO USE "TAP", APART FROM THE MARK AS SHOWN.

FOR DANCE EVENTS; DANCE INSTRUCTION; ENTERTAINMENT IN THE NATURE OF DANCE PERFORMANCES; ENTERTAINMENT IN THE NATURE OF VISUAL AND AUDIO PERFORMANCES, NAMELY, MUSICAL BAND, ROCK GROUP, GYMNASTIC, DANCE, AND BALLET PERFORMANCES; ORGANIZATION OF DANCING EVENTS; ORGANIZING COMMUNITY FESTIVALS FEATURING A VARIETY OF ACTIVITIES, NAMELY SPORTING EVENTS, ART EXHIBITIONS, FLEA MARKETS, ETHNIC DANCES AND THE LIKE (U.S. CLS. 100, 101 AND 107).
JAY BESCH, EXAMINING ATTORNEY



SN 77-139,130. ODYSSEYWARE, INC., CHANDLER, AZ. FILED 3-23-2007.

WE'RE IN YOUR CORNER

THE MARK CONSISTS OF STANDARD CHARACTERS WITHOUT CLAIM TO ANY PARTICULAR FONT, STYLE, SIZE, OR COLOR.

FOR EDUCATIONAL SERVICES, NAMELY, PROVIDING COURSES OF INSTRUCTION AT THE PRIMARY AND SECONDARY LEVEL (U.S. CLS. 100, 101 AND 107).

FIRST USE 6-10-2006; IN COMMERCE 9-1-2006.
TIMOTHY FINNEGAN, EXAMINING ATTORNEY

CLASS 41—(Continued).

SN 77-139,142. THINKOUT SOLUTION, LA JOLLA, CA. FILED 3-23-2007.

Kidsland

THE MARK CONSISTS OF STANDARD CHARACTERS WITHOUT CLAIM TO ANY PARTICULAR FONT, STYLE, SIZE, OR COLOR.

FOR ENTERTAINMENT SERVICES, NAMELY, PROVIDING ON-LINE COMPUTER GAMES (U.S. CLS. 100, 101 AND 107).

FIRST USE 1-22-2007; IN COMMERCE 2-6-2007.
KATHERINE CONNOLLY, EXAMINING ATTORNEY



SN 77-139,153. DRURY SOUTHWEST, INC., SAN ANTONIO, TX. FILED 3-23-2007.

TEXAS ROSE

THE MARK CONSISTS OF STANDARD CHARACTERS WITHOUT CLAIM TO ANY PARTICULAR FONT, STYLE, SIZE, OR COLOR.

NO CLAIM IS MADE TO THE EXCLUSIVE RIGHT TO USE "TEXAS", APART FROM THE MARK AS SHOWN.

FOR ENTERTAINMENT IN THE NATURE OF THEATER PRODUCTIONS; CONDUCTING ENTERTAINMENT EXHIBITIONS IN THE NATURE OF LIVE THEATRICAL AND MUSICAL PERFORMANCES; ENTERTAINMENT IN THE NATURE OF LIVE PERFORMANCES BY PERFORMING AND MUSICAL ARTISTS AND GROUPS; ENTERTAINMENT NAMELY, PRODUCTION OF RADIO AND TELEVISION SHOWS; ENTERTAINMENT IN THE NATURE OF VISUAL AND AUDIO PERFORMANCES, AND MUSICAL, VARIETY, NEWS AND COMEDY SHOWS (U.S. CLS. 100, 101 AND 107).

ALEXANDER L. POWERS, EXAMINING ATTORNEY

CLASS 41—(Continued).

SN 77-139,186. DRURY SOUTHWEST, INC., SAN ANTONIO, TX. FILED 3-23-2007.

SAN ANTONIO ROSE

THE MARK CONSISTS OF STANDARD CHARACTERS WITHOUT CLAIM TO ANY PARTICULAR FONT, STYLE, SIZE, OR COLOR.

NO CLAIM IS MADE TO THE EXCLUSIVE RIGHT TO USE "SAN ANTONIO", APART FROM THE MARK AS SHOWN.

FOR ENTERTAINMENT IN THE NATURE OF LIVE PERFORMANCES BY PERFORMING AND MUSICAL ARTISTS AND GROUPS; ENTERTAINMENT IN THE NATURE OF THEATER PRODUCTIONS; ENTERTAINMENT NAMELY, PRODUCTION OF RADIO AND TELEVISION; CONDUCTING ENTERTAINMENT EXHIBITIONS IN THE NATURE OF LIVE THEATRICAL AND MUSICAL PERFORMANCES; ENTERTAINMENT IN THE NATURE OF VISUAL AND AUDIO PERFORMANCES, AND MUSICAL, VARIETY, NEWS AND COMEDY SHOWS (U.S. CLS. 100, 101 AND 107).

ALEXANDER L. POWERS, EXAMINING ATTORNEY

CLASS 41—(Continued).

SN 77-139,378. ZOGRAFOS, PETER J., TACOMA, WA. FILED 3-23-2007.

Discipleship Days

THE MARK CONSISTS OF STANDARD CHARACTERS WITHOUT CLAIM TO ANY PARTICULAR FONT, STYLE, SIZE, OR COLOR.

NO CLAIM IS MADE TO THE EXCLUSIVE RIGHT TO USE "DISCIPLESHIP", APART FROM THE MARK AS SHOWN.

FOR ARRANGING PROFESSIONAL WORKSHOP AND TRAINING COURSES; CONDUCTING WORKSHOPS AND SEMINARS IN THEOLOGY, SPIRITUALITY, WORSHIP, AND RELIGIOUS STUDIES; EDUCATIONAL SERVICES, NAMELY, CONDUCTING CLASSES, SEMINARS, CONFERENCES, WORKSHOPS IN THE FIELD OF THEOLOGY, SCRIPTURE, SPIRITUALITY, WORSHIP, AND RELIGIOUS STUDIES; PROVIDING ON-LINE TRAINING CLASSES IN THE FIELD OF WORSHIP, THEOLOGY, SPIRITUALITY, SCRIPTURE, AND RELIGIOUS STUDIES; PROVIDING ON-LINE PUBLICATIONS IN THE NATURE OF BROCHURES IN THE FIELDS OF WORSHIP, THEOLOGY, SPIRITUALITY, SCRIPTURE, AND RELIGIOUS STUDIES; WORKSHOPS AND SEMINARS IN THE FIELD OF THEOLOGY, SPIRITUALITY, WORSHIP, SCRIPTURE, AND RELIGIOUS STUDIES (U.S. CLS. 100, 101 AND 107).

MICHAEL LITZAU, EXAMINING ATTORNEY

SN 77-139,245. BOJIC, DZANER, GLEN ELLYN, IL. FILED 3-23-2007.

BALKAN BEATZ

THE MARK CONSISTS OF STANDARD CHARACTERS WITHOUT CLAIM TO ANY PARTICULAR FONT, STYLE, SIZE, OR COLOR.

NO CLAIM IS MADE TO THE EXCLUSIVE RIGHT TO USE "BALKAN", APART FROM THE MARK AS SHOWN.

FOR MUSIC PRODUCTION SERVICES; MUSIC PUBLISHING SERVICES (U.S. CLS. 100, 101 AND 107).

FIRST USE 8-0-2001; IN COMMERCE 8-0-2001.

AHSEN KHAN, EXAMINING ATTORNEY

SN 77-139,533. BRATT, JAMES F., DRAPER, UT. AND BRATT, KAY C., DRAPER, UT. AND BRATT, JACOB R., DRAPER, UT. FILED 3-24-2007.

**MMT - Movie Music
Television**

THE MARK CONSISTS OF STANDARD CHARACTERS WITHOUT CLAIM TO ANY PARTICULAR FONT, STYLE, SIZE, OR COLOR.

NO CLAIM IS MADE TO THE EXCLUSIVE RIGHT TO USE "MOVIE MUSIC TELEVISION", APART FROM THE MARK AS SHOWN.

FOR CABLE TELEVISION PROGRAMMING; ENTERTAINMENT IN THE NATURE OF ON-GOING TELEVISION PROGRAMS IN THE FIELD OF VARIETY; PRODUCTION OF CABLE TELEVISION PROGRAMS; PRODUCTION OF RADIO AND TELEVISION PROGRAMS; PRODUCTION OF RADIO OR TELEVISION PROGRAMS; PRODUCTION OF VIDEO AND CREATION OF VISUAL EFFECTS FOR OTHERS FOR USE IN DVDS, TELEVISION PROGRAMS AND ON WEBSITES; TELEVISION PROGRAM SYNDICATION (U.S. CLS. 100, 101 AND 107).

STEVEN JACKSON, EXAMINING ATTORNEY

CLASS 41—(Continued).

SN 77-139,611. BLUBET, INC., SAN FRANCISCO, CA. FILED 3-24-2007.

BLUBET

THE MARK CONSISTS OF STANDARD CHARACTERS WITHOUT CLAIM TO ANY PARTICULAR FONT, STYLE, SIZE, OR COLOR.

FOR BETTING AND SWEEPSTAKES SERVICES OFFERED VIA THE INTERNET (U.S. CLS. 100, 101 AND 107).

ANDREA SAUNDERS, EXAMINING ATTORNEY

SN 77-139,631. LLOYD HUGH MAGBIE, WARREN, ME. FILED 3-24-2007.



THE COLOR(S) ORANGE, YELLOW, BLUE AND GREY IS/ARE CLAIMED AS A FEATURE OF THE MARK.

THE MARK CONSISTS OF "NIMBLE" IN ORANGE TO YELLOW GRADIENT, "MIND" IN GREY GRADIENT, CIRCLE OF DOTS ABOVE "I" IN NIMBLE IN BLUE GRADIENT, DOT ABOVE "I" IN MIND IN BLUE.

FOR EDUCATIONAL SERVICES, NAMELY, CONDUCTING DISTANCE LEARNING INSTRUCTION AT THE SECONDARY, COLLEGE AND GRADUATE LEVELS (U.S. CLS. 100, 101 AND 107).

FIRST USE 4-6-2005; IN COMMERCE 3-21-2007.
HENRY S. ZAK, EXAMINING ATTORNEY

SN 77-139,653. BE PUBLISHED INC, ST AUGUSTINE, FL. FILED 3-25-2007.

i can tap
dance

THE MARK CONSISTS OF THE WORDS "I CAN TAP DANCE" IN LOWER CASE HAND PRINTED TYPE FONT.

FOR CONDUCTING WORKSHOPS AND SEMINARS IN SELF AWARENESS (U.S. CLS. 100, 101 AND 107).

PAMELA HIRSCHMAN, EXAMINING ATTORNEY

CLASS 41—(Continued).

SN 77-139,686. GAUTHIER, LUIS, T., PHILADELPHIA, PA. FILED 3-25-2007.

2COMPLEX

THE MARK CONSISTS OF STANDARD CHARACTERS WITHOUT CLAIM TO ANY PARTICULAR FONT, STYLE, SIZE, OR COLOR.

FOR COMPOSITION OF MUSIC FOR OTHERS; ENTERTAINMENT IN THE NATURE OF VISUAL AND AUDIO PERFORMANCES, AND MUSICAL, VARIETY, NEWS AND COMEDY SHOWS; ENTERTAINMENT IN THE NATURE OF VISUAL AND AUDIO PERFORMANCES, NAMELY, MUSICAL BAND, ROCK GROUP, GYMNASIUM, DANCE, AND BALLET PERFORMANCES; ENTERTAINMENT NAMELY, LIVE PERFORMANCES BY A MUSICAL BAND; ENTERTAINMENT SERVICES, NAMELY, AN ONLINE ACTIVITY WHERE YOU CREATE YOUR OWN MUSIC VIDEOS; ENTERTAINMENT SERVICES, NAMELY, NON-DOWNLOADABLE RINGTONES, PRE-RECORDED MUSIC, VIDEO AND GRAPHICS PRESENTED TO MOBILE COMMUNICATIONS DEVICES VIA A GLOBAL COMPUTER NETWORK AND WIRELESS NETWORKS; ENTERTAINMENT SERVICES, NAMELY, PROVIDING A WEB SITE FEATURING MUSICAL PERFORMANCES, MUSICAL VIDEOS, RELATED FILM CLIPS, PHOTOGRAPHS, AND OTHER MULTIMEDIA MATERIALS; ENTERTAINMENT SERVICES, NAMELY, PROVIDING PRERECORDED MUSIC, INFORMATION IN THE FIELD OF MUSIC, AND COMMENTARY AND ARTICLES ABOUT MUSIC. ALL ONLINE VIA A GLOBAL COMPUTER NETWORK; ENTERTAINMENT, NAMELY LIVE MUSIC CONCERTS; ENTERTAINMENT, NAMELY LIVE PERFORMANCES BY MUSICAL BANDS; MOBILE MEDIA AND ENTERTAINMENT SERVICES IN THE NATURE OF CONTENT PREPARATION, POST-PRODUCTION; MULTIMEDIA ENTERTAINMENT SERVICES IN THE NATURE OF RECORDING, PRODUCTION AND POST-PRODUCTION SERVICES IN THE FIELDS OF MUSIC, VIDEO, AND FILMS; MUSIC COMPOSITION AND TRANSCRIPTION FOR OTHERS; MUSIC COMPOSITION FOR OTHERS; MUSIC PRODUCTION SERVICES; MUSIC PUBLISHING SERVICES; PLANNING ARRANGEMENT OF SHOWING MOVIES, SHOWS, PLAYS OR MUSICAL PERFORMANCES; POST-PRODUCTION EDITING SERVICES IN THE FIELD OF MUSIC, VIDEOS AND FILMS; PRESENTATION OF MUSICAL PERFORMANCE; PUBLICATION OF MUSICAL TEXTS (U.S. CLS. 100, 101 AND 107).

FIRST USE 2-5-2000; IN COMMERCE 2-5-2000.
DANIEL CAPSHAW, EXAMINING ATTORNEY

SN 77-139,701. FLORES, JIMMY, TARZANA, CA. FILED 3-25-2007.

BLACK ROGUE

THE MARK CONSISTS OF STANDARD CHARACTERS WITHOUT CLAIM TO ANY PARTICULAR FONT, STYLE, SIZE, OR COLOR.

FOR ENTERTAINMENT IN THE NATURE OF AIR-SOFT TACTICAL TEAM GAMES (U.S. CLS. 100, 101 AND 107).

FIRST USE 2-1-2007; IN COMMERCE 2-1-2007.
ALEX KEAM, EXAMINING ATTORNEY

CLASS 41—(Continued).

SN 77-139,722. MILLER, CATHY P., HUNTSVILLE, AL. FILED 3-25-2007.

The Literacy Ambassador

THE MARK CONSISTS OF STANDARD CHARACTERS WITHOUT CLAIM TO ANY PARTICULAR FONT, STYLE, SIZE, OR COLOR.

NO CLAIM IS MADE TO THE EXCLUSIVE RIGHT TO USE "LITERACY", APART FROM THE MARK AS SHOWN, FOR EDUCATION SERVICES, NAMELY, PROVIDING SEMINARS, CLASSES, WORKSHOPS AND CONSULTING IN THE FIELD OF CHILDREN'S LITERACY (U.S. CLS. 100, 101 AND 107).

FIRST USE 1-1-1998; IN COMMERCE 1-1-1998.
TARAH HARDY, EXAMINING ATTORNEY

SN 77-139,727. PENDERGAST, CHARLES R., BODEGA, CA. FILED 3-25-2007.

RISKPRESS

THE MARK CONSISTS OF STANDARD CHARACTERS WITHOUT CLAIM TO ANY PARTICULAR FONT, STYLE, SIZE, OR COLOR.

FOR PUBLICATION OF BOOKS (U.S. CLS. 100, 101 AND 107).

FIRST USE 10-1-2003; IN COMMERCE 10-1-2003.
TARAH HARDY, EXAMINING ATTORNEY

SN 77-139,736. DEAN SHARENOW, NEW YORK, NY. FILED 3-25-2007.

dickyvibe

THE MARK CONSISTS OF STANDARD CHARACTERS WITHOUT CLAIM TO ANY PARTICULAR FONT, STYLE, SIZE, OR COLOR.

FOR COMPOSITION OF MUSIC FOR OTHERS; ENTERTAINMENT IN THE NATURE OF VISUAL AND AUDIO PERFORMANCES, AND MUSICAL, VARIETY, NEWS AND COMEDY SHOWS; ENTERTAINMENT IN THE NATURE OF VISUAL AND AUDIO PERFORMANCES, NAMELY, MUSICAL BAND, ROCK GROUP, GYMNASTIC, DANCE, AND BALLET PERFORMANCES; MULTIMEDIA ENTERTAINMENT SERVICES IN THE NATURE OF RECORDING, PRODUCTION AND POST-PRODUCTION SERVICES IN THE FIELDS OF MUSIC, VIDEO, AND FILMS; MUSIC COMPOSITION FOR OTHERS; MUSIC PRODUCTION SERVICES (U.S. CLS. 100, 101 AND 107).

FIRST USE 3-5-2005; IN COMMERCE 3-5-2005.
ROBIN CHOSID, EXAMINING ATTORNEY

CLASS 41—(Continued).

SN 77-139,951. BLACK PLAGUE ENTERTAINMENT, INC., BURLINGTON, NC. FILED 3-26-2007.

BLACK PLAGUE ENTERTAINMENT

THE MARK CONSISTS OF STANDARD CHARACTERS WITHOUT CLAIM TO ANY PARTICULAR FONT, STYLE, SIZE, OR COLOR.

NO CLAIM IS MADE TO THE EXCLUSIVE RIGHT TO USE "ENTERTAINMENT", APART FROM THE MARK AS SHOWN.

FOR MULTIMEDIA ENTERTAINMENT SERVICES IN THE NATURE OF RECORDING, PRODUCTION AND POST-PRODUCTION SERVICES IN THE FIELDS OF MUSIC, VIDEO, AND FILMS (U.S. CLS. 100, 101 AND 107).

FIRST USE 1-1-2005; IN COMMERCE 1-1-2005.
LOURDES AYALA, EXAMINING ATTORNEY

SN 77-140,051. DAVE, DAYRON, CERRITOS, CA. FILED 3-26-2007.

So Fly

THE MARK CONSISTS OF STANDARD CHARACTERS WITHOUT CLAIM TO ANY PARTICULAR FONT, STYLE, SIZE, OR COLOR.

FOR ENTERTAINMENT IN THE NATURE OF VISUAL AND AUDIO PERFORMANCES, NAMELY, MUSICAL BAND, ROCK GROUP, GYMNASTIC, DANCE, AND BALLET PERFORMANCES; ENTERTAINMENT IN THE NATURE OF LIVE PERFORMANCES BY MUSICAL ARTISTS; ENTERTAINMENT SERVICES, NAMELY, PERSONAL APPEARANCES BY A MUSICAL ARTIST; ENTERTAINMENT SERVICES NAMELY LIVE, TELEVISED AND MOVIE APPEARANCES BY A PROFESSIONAL ENTERTAINER; ENTERTAINMENT, NAMELY LIVE MUSIC CONCERTS (U.S. CLS. 100, 101 AND 107).

JENNIFER HETU, EXAMINING ATTORNEY

CLASS 41—(Continued).

SN 77-140,170. MAXIMUM REVOLUTION KART RACING, CONSHOHOCKEN, PA. FILED 3-26-2007.



NO CLAIM IS MADE TO THE EXCLUSIVE RIGHT TO USE "INDOOR KART RACING", APART FROM THE MARK AS SHOWN.

THE MARK CONSISTS OF THE WORDS MAXREV IN WITH TWO CHECKERED FLAGS ON THE X OF MAX. A "DIGITAL TACHOMETER" CIRCUMFERENCING THE TOP HALF OF THE LOGO WITH RANGING UNDERNEATH THE NAME MAXREV IS "INDOOR KART RACING".

FOR AMUSEMENT ARCADES; ENTERTAINMENT SERVICES, NAMELY, PARTICIPATION IN KART RACING; PROVIDING AMUSEMENT FACILITIES (U.S. CLS. 100, 101 AND 107).

ANDREA SAUNDERS, EXAMINING ATTORNEY

SN 77-140,228. CHICA WORLDWIDE, LLC, NEW YORK, NY. FILED 3-26-2007.

LATIN TWIST

THE MARK CONSISTS OF STANDARD CHARACTERS WITHOUT CLAIM TO ANY PARTICULAR FONT, STYLE, SIZE, OR COLOR.

NO CLAIM IS MADE TO THE EXCLUSIVE RIGHT TO USE LATIN, APART FROM THE MARK AS SHOWN.

FOR AN ONGOING TELEVISION SERIES IN THE FIELDS OF CUISINE, COOKING, DATING, DECORATING, SHOPPING, HOME CARE, GARDENING, HOME-MAKING, BEAUTY, HEALTH AND LIFESTYLE; PROVIDING A WEBSITE WITH INFORMATION ON A TELEVISION SERIES IN THE FIELDS OF CUISINE, COOKING, DATING, DECORATING, SHOPPING, BEAUTY, HOME CARE, HOME-MAKING, GARDENING, HEALTH AND LIFESTYLE (U.S. CLS. 100, 101 AND 107).

PATRICIA EVANKO, EXAMINING ATTORNEY

SN 77-140,253. DUSABLON, KEVIN, ALLSTON, MA. FILED 3-26-2007.

HONEST THOMAS

THE MARK CONSISTS OF STANDARD CHARACTERS WITHOUT CLAIM TO ANY PARTICULAR FONT, STYLE, SIZE, OR COLOR.

FOR ENTERTAINMENT NAMELY, LIVE PERFORMANCES BY A MUSICAL BAND (U.S. CLS. 100, 101 AND 107).

FIRST USE 4-21-2005; IN COMMERCE 12-1-2005.
MICHAEL SOUDERS, EXAMINING ATTORNEY

CLASS 41—(Continued).

SN 77-140,273. PHI DELTA KAPPA INTERNATIONAL, INC., BLOOMINGTON, IN. FILED 3-26-2007.

FUTURE EDUCATORS ASSOCIATION

THE MARK CONSISTS OF STANDARD CHARACTERS WITHOUT CLAIM TO ANY PARTICULAR FONT, STYLE, SIZE, OR COLOR.

NO CLAIM IS MADE TO THE EXCLUSIVE RIGHT TO USE "ASSOCIATION", APART FROM THE MARK AS SHOWN.

FOR PROVIDING EDUCATIONAL MENTORING SERVICES AND PROGRAMS FOR MIDDLE SCHOOL AND HIGH SCHOOL STUDENTS INTERESTED IN THE TEACHING PROFESSION (U.S. CLS. 100, 101 AND 107).

FIRST USE 7-0-2005; IN COMMERCE 7-0-2005.

COLLEEN DOMBROW, EXAMINING ATTORNEY

SN 77-140,684. LITTLETON DIANA M., ELK GROVE, CA. FILED 3-26-2007.

BLaNKThaT Entertainment!

THE MARK CONSISTS OF STANDARD CHARACTERS WITHOUT CLAIM TO ANY PARTICULAR FONT, STYLE, SIZE, OR COLOR.

NO CLAIM IS MADE TO THE EXCLUSIVE RIGHT TO USE "ENTERTAINMENT", APART FROM THE MARK AS SHOWN.

FOR ENTERTAINMENT SERVICES NAMELY PROVIDING A WEBSITE FEATURING, PHOTOGRAPHIC, AUDIO, VIDEO AND PROSE PRESENTATIONS FEATURING A COMEDIAN AND RAP ARTIST; ENTERTAINMENT IN THE NATURE OF LIVE PERFORMANCES BY A COMEDIAN AND RAP ARTIST; ENTERTAINMENT IN THE NATURE OF VISUAL AND AUDIO PERFORMANCES, AND MUSICAL, VARIETY, NEWS AND COMEDY SHOWS; MULTIMEDIA ENTERTAINMENT SERVICES IN THE NATURE OF RECORDING, PRODUCTION AND POST-PRODUCTION SERVICES IN THE FIELDS OF MUSIC, VIDEO, AND FILMS (U.S. CLS. 100, 101 AND 107).

PAMELA HIRSCHMAN, EXAMINING ATTORNEY

CLASS 41—(Continued).

SN 77-140,710. MOLLY M. ROBERTS, TUCSON, AZ. AND
BRUCE A. ROBERTS, TUCSON, AZ. FILED 3-26-2007.

THE MEDICINE BAG

THE MARK CONSISTS OF STANDARD CHARACTERS
WITHOUT CLAIM TO ANY PARTICULAR FONT, STYLE,
SIZE, OR COLOR.

FOR EDUCATION SERVICES, NAMELY, PROVIDING
CLASSES, SEMINARS, AND WORKSHOPS IN THE
FIELDS OF HOLISTIC MEDICINE AND NATURAL
HEALING (U.S. CLS. 100, 101 AND 107).

REBECCA GILBERT, EXAMINING ATTORNEY

SN 77-140,819. TYLER, AISHA, BEVERLY HILLS, CA. FILED
3-26-2007.

HOT MACHINE

THE MARK CONSISTS OF STANDARD CHARACTERS
WITHOUT CLAIM TO ANY PARTICULAR FONT, STYLE,
SIZE, OR COLOR.

FOR PRODUCTION AND DISTRIBUTION OF MO-
TION PICTURES; PRODUCTION AND DISTRIBUTION
OF TELEVISION SHOWS AND MOVIES (U.S. CLS. 100,
101 AND 107).

THOMAS MANOR, EXAMINING ATTORNEY

CLASS 41—(Continued).

SN 77-140,925. LIANYUNGANG XIYOUJI GIFT AND TOYS
DEVELOPMENT CO., LTD., LIANYUNGANG CITY, CHI-
NA, FILED 3-27-2007.

XYJ
西游記

THE MARK CONSISTS OF ENGLISH LETTERS "XYJ"
AND THE CHINESE CHARACTERS.

THE FOREIGN WORDING IN THE MARK TRANSLATES
INTO ENGLISH AS "WEST", "TO TRAVEL" AND "TO
REMEMBER".

THE NON-LATIN CHARACTER(S) IN THE MARK
TRANSLITERATE INTO "XI YOU JI", AND THIS MEANS
"WEST", "TO TRAVEL" AND "TO REMEMBER", BUT THE
CHINESE CHARACTERS READ TOGETHER HAS NO
MEANING IN ENGLISH.

FOR EDUCATIONAL SERVICES, NAMELY, CON-
DUCTING INFORMAL ON-LINE PROGRAMS IN THE
FIELDS OF CHINESE CULTURE, AND PRINTABLE
MATERIALS DISTRIBUTED THEREWITH; ORGANIZ-
ING EXHIBITIONS FOR CHINESE CULTURE; ORGA-
NIZATION OF FASHION SHOWS; PUBLICATION OF
ELECTRONIC NEWSPAPERS ACCESSIBLE VIA A GLO-
BAL COMPUTER NETWORK; MOTION PICTURE FILM
PRODUCTION; AMUSEMENT PARKS; AMUSEMENT
CENTERS; COUNTRY CLUBS (U.S. CLS. 100, 101 AND
107).

MARY CRAWFORD, EXAMINING ATTORNEY

SN 77-140,970. UNITED PARCEL SERVICE OF AMERICA,
INC., ATLANTA, GA. FILED 3-27-2007.

OFF TO THE RACES DELIVERED
BY UPS

THE MARK CONSISTS OF STANDARD CHARACTERS
WITHOUT CLAIM TO ANY PARTICULAR FONT, STYLE,
SIZE, OR COLOR.

OWNER OF U.S. REG. NOS. 2,965,392, 2,973,599 AND
OTHERS.

FOR SWEEPSTAKE SERVICES PROVIDED OVER A
GLOBAL COMPUTER NETWORK (U.S. CLS. 100, 101
AND 107).

LINDA E. BLOHM, EXAMINING ATTORNEY

CLASS 41—(Continued).

SN 77-141,424. CAKE MEDIA ENTERPRISES, INC., LITTLE SILVER, NJ. FILED 3-27-2007.

CAKE

THE MARK CONSISTS OF STANDARD CHARACTERS WITHOUT CLAIM TO ANY PARTICULAR FONT, STYLE, SIZE, OR COLOR.

FOR ONLINE MAGAZINE DIRECTED TOWARDS WOMEN FEATURING TOPICS THAT ARE EMPOWERING TO WOMEN EXCLUDING THE TOPICS OF FOOD, RECIPES AND MUSIC (U.S. CLS. 100, 101 AND 107).

JILL C. ALT, EXAMINING ATTORNEY

SN 77-141,457. DENNIS, FELIX, LONDON, ENGLAND, FILED 3-27-2007.

BLENDER THEATER

THE MARK CONSISTS OF STANDARD CHARACTERS WITHOUT CLAIM TO ANY PARTICULAR FONT, STYLE, SIZE, OR COLOR.

OWNER OF U.S. REG. NOS. 1,957,138, 3,195,851 AND OTHERS.

NO CLAIM IS MADE TO THE EXCLUSIVE RIGHT TO USE THEATER, APART FROM THE MARK AS SHOWN.

FOR PLANNING ARRANGEMENT OF SHOWING MOVIES, SHOWS, PLAYS OR MUSICAL PERFORMANCES; ENTERTAINMENT IN THE NATURE OF VISUAL AND AUDIO PERFORMANCES, AND MUSICAL, VARIETY, NEWS AND COMEDY SHOWS; ENTERTAINMENT, NAMELY LIVE PERFORMANCES BY MUSICAL BANDS; PROVIDING FACILITIES FOR MOVIES, SHOWS, PLAYS, MUSIC OR EDUCATIONAL TRAINING (U.S. CLS. 100, 101 AND 107).

KATHLEEN M. VANSTON, EXAMINING ATTORNEY

SN 77-141,490. MARTI GRIFFIN & ASSOCIATES, INC., ATLANTA, GA. FILED 3-27-2007.

PETRAITURE

THE MARK CONSISTS OF STANDARD CHARACTERS WITHOUT CLAIM TO ANY PARTICULAR FONT, STYLE, SIZE, OR COLOR.

FOR PET PORTRAIT PHOTOGRAPHY SERVICES, NAMELY, DESIGNING, SETTING UP AND SHOOTING PRE-ARRANGED PHOTOGRAPHS OF PETS WITH AND WITHOUT THEIR OWNERS (U.S. CLS. 100, 101 AND 107).

FIRST USE 2-24-1999; IN COMMERCE 11-15-1999.
ERIN FALK, EXAMINING ATTORNEY

CLASS 41—(Continued).

SN 77-141,497. HARRIS, ALICE, NEW YORK, NY. FILED 3-27-2007.

BOOKS WITH STYLE

THE MARK CONSISTS OF STANDARD CHARACTERS WITHOUT CLAIM TO ANY PARTICULAR FONT, STYLE, SIZE, OR COLOR.

NO CLAIM IS MADE TO THE EXCLUSIVE RIGHT TO USE "BOOKS", APART FROM THE MARK AS SHOWN.

FOR ENTERTAINMENT IN THE NATURE OF AN ONGOING TELEVISION SHOW ABOUT BOOKS AND AUTHORS DISTRIBUTED VIA TELEVISION AND THE INTERNET (U.S. CLS. 100, 101 AND 107).

TASNEEM HUSSAIN, EXAMINING ATTORNEY

SN 77-141,670. SIGIL GAMES ONLINE, INC., CARLSBAD, CA. FILED 3-27-2007.



NO CLAIM IS MADE TO THE EXCLUSIVE RIGHT TO USE "GAMES ONLINE", APART FROM THE MARK AS SHOWN.

THE MARK CONSISTS OF THE WORD SIGIL WITH THE STYLIZED S EMBEDDED IN A STONE AND THE WORDS GAMES ONLINE IN SMALLER SIZE BELOW THE LETTERS IGIL MAKING UP THE WORD SIGIL.

FOR PRODUCTION OF CD-ROMS, DVDS AND AUDIO DISCS; PROVIDING ONLINE MULTI-PLAYER COMPUTER GAMES; ENTERTAINMENT SERVICES, NAMELY PROVIDING ENTERTAINMENT INFORMATION RELATING TO COMPUTER GAMES AND COMPUTER ENHANCEMENTS FOR GAMES (U.S. CLS. 100, 101 AND 107).

FIRST USE 8-0-2003; IN COMMERCE 8-0-2003.

CHRISTINA SOBRAL, EXAMINING ATTORNEY

SN 77-141,698. SIGIL GAMES ONLINE, INC., CARLSBAD, CA. FILED 3-27-2007.



THE MARK CONSISTS OF THE WORD SIGIL WITH THE STYLIZED S EMBEDDED IN A STONE AND THE WORDS GAMES ONLINE IN SMALLER SIZE BELOW THE LETTERS IGIL MAKING UP THE WORD SIGIL.

FOR ENTERTAINMENT SERVICES, NAMELY, PROVIDING A CONTINUING TELEVISION SERIES IN THE FIELD OF ANIMATED ACTION AND ADVENTURE PROGRAMMING; PRODUCTION AND DISTRIBUTION OF MOTION PICTURE FILMS AND TELEVISION SHOWS (U.S. CLS. 100, 101 AND 107).

CHRISTINA SOBRAL, EXAMINING ATTORNEY

CLASS 41—(Continued).

SN 77-141,699. ARTIX ENTERTAINMENT, LLC, LAND O' LAKES, FL. FILED 3-27-2007.

MechQuest

THE MARK CONSISTS OF STANDARD CHARACTERS WITHOUT CLAIM TO ANY PARTICULAR FONT, STYLE, SIZE, OR COLOR.

FOR ENTERTAINMENT SERVICES, NAMELY, PROVIDING AN ONLINE, REAL-TIME COMPUTER GAME FOR OTHERS OVER GLOBAL AND LOCAL AREA COMPUTER NETWORKS (U.S. CLS. 100, 101 AND 107).

TEJBIR SINGH, EXAMINING ATTORNEY

SN 77-141,723. SIGIL GAMES ONLINE, INC., CARLSBAD, CA. FILED 3-27-2007.



THE MARK CONSISTS OF THE WORD VANGUARD ABOVE A LINE POINTED AT BOTH ENDS AND THE WORDS SAGA OF HEROES BELOW THE LINE.

FOR PRODUCTION OF CD-ROMS, DVDS AND AUDIO DISCS; PROVIDING ONLINE MULTI-PLAYER COMPUTER GAMES; ENTERTAINMENT SERVICES, NAMELY PROVIDING ENTERTAINMENT INFORMATION RELATING TO COMPUTER GAMES AND COMPUTER ENHANCEMENTS FOR GAMES (U.S. CLS. 100, 101 AND 107).

FIRST USE 3-16-2004; IN COMMERCE 3-16-2004.
CHRISTINA SOBRAL, EXAMINING ATTORNEY

SN 77-141,758. WORLD WRESTLING ENTERTAINMENT, INC., STAMFORD, CT. FILED 3-27-2007.

JOHNNY NITRO

THE MARK CONSISTS OF STANDARD CHARACTERS WITHOUT CLAIM TO ANY PARTICULAR FONT, STYLE, SIZE, OR COLOR.

THE NAME(S), PORTRAIT(S), AND/OR SIGNATURE(S) SHOWN IN THE MARK DOES NOT IDENTIFY A PARTICULAR LIVING INDIVIDUAL.

FOR ENTERTAINMENT SERVICES, NAMELY, WRESTLING EXHIBITIONS AND PERFORMANCES BY A PROFESSIONAL WRESTLER AND ENTERTAINER; PROVIDING WRESTLING NEWS AND INFORMATION VIA A GLOBAL COMPUTER NETWORK (U.S. CLS. 100, 101 AND 107).

TASHIA BUNCH, EXAMINING ATTORNEY

CLASS 41—(Continued).

SN 77-141,768. GRAY, JAMES, EWA BEACH, HI. FILED 3-27-2007.

It's your reality. And
it's pretty compelling
stuff!

THE MARK CONSISTS OF STANDARD CHARACTERS WITHOUT CLAIM TO ANY PARTICULAR FONT, STYLE, SIZE, OR COLOR.

FOR MULTIMEDIA ENTERTAINMENT SERVICES IN THE NATURE OF RECORDING, PRODUCTION AND POST-PRODUCTION SERVICES IN THE FIELDS OF MUSIC, VIDEO, AND FILMS (U.S. CLS. 100, 101 AND 107).

FIRST USE 8-0-2006; IN COMMERCE 8-0-2006.
RICHARD A. STRASER, EXAMINING ATTORNEY

SN 77-141,833. KYC NEWS, INC., MIAMI, FL. FILED 3-27-2007.

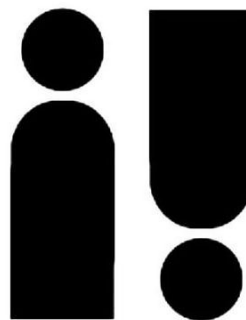

THE MARK CONSISTS OF TWO GEOMETRIC FIGURES SIDE BY SIDE, THE ONE ON THE LEFT REPRESENTING A MAN, THE ONE ON THE RIGHT REPRESENTING AN UPSIDE-DOWN MAN AND AN EXCLAMATION MARK.

FOR ON-LINE NEWSLETTERS IN THE FIELD OF INTERNATIONAL FINANCE (U.S. CLS. 100, 101 AND 107).

REBECCA GILBERT, EXAMINING ATTORNEY

CLASS 41—(Continued).

SN 77-141,970. COLLABNET, INC., BRISBANE, CA. FILED 3-27-2007.



OWNER OF U.S. REG. NOS. 2,591,636 AND 3,215,006.
THE MARK CONSISTS OF A STYLIZED FLOWER WITH WORD OPENCOLLABNET.

FOR ON-LINE JOURNALS, NAMELY, BLOGS FEATURING COMPUTER SOFTWARE DEVELOPMENT TOOLS, COMPUTER SOFTWARE, OPEN-SOURCE DEVELOPMENT COMMUNITIES, COMPUTER AND TECHNOLOGY, COMPUTER SOFTWARE DEVELOPMENT AND PROGRAMMING, SOFTWARE TRAINING, AND TECHNICAL SUPPORT RESOURCES; PROVIDING ON-LINE PUBLICATIONS IN THE NATURE OF WHITE PAPERS, TECHNICAL PAPERS, ARTICLES, BOOKS AND GUIDES IN THE FIELD OF COMPUTER SOFTWARE DEVELOPMENT, COMPUTER SOFTWARE DEVELOPMENT TOOLS, COMPUTER SOFTWARE, OPEN-SOURCE DEVELOPMENT COMMUNITIES, COMPUTER AND TECHNOLOGY, COMPUTER SOFTWARE DEVELOPMENT AND PROGRAMMING, SOFTWARE TRAINING, AND TECHNICAL SUPPORT RESOURCES; PROVIDING INFORMATION IN THE FIELD OF SOFTWARE TRAINING; PROVIDING LINKS TO WEB SITES, ARTICLES, WEBCASTS, PODCASTS AND STREAMING AUDIO/VIDEO OF OTHERS FEATURING SOFTWARE TRAINING (U.S. CLS. 100, 101 AND 107).

FIRST USE 10-20-2006; IN COMMERCE 10-20-2006.
CAROLINE WOOD, EXAMINING ATTORNEY

SN 77-141,992. CARDTRAK LLC, PORT CHARLOTTE, FL. FILED 3-27-2007.

Professor Cardworthy

THE MARK CONSISTS OF STANDARD CHARACTERS WITHOUT CLAIM TO ANY PARTICULAR FONT, STYLE, SIZE, OR COLOR.

FOR ENTERTAINMENT IN THE NATURE OF LIVE PERFORMANCES BY A COMEDIC FINANCIAL CELEBRITY; ENTERTAINMENT SERVICES, NAMELY, PERSONAL APPEARANCES BY A FINANCIAL CELEBRITY; RADIO ENTERTAINMENT SERVICES, NAMELY RADIO PROGRAMS FEATURING PERFORMANCES BY A FINANCIAL CELEBRITY; PRODUCTION AND DISTRIBUTION OF TELEVISION SHOWS AND MOVIES; EDUCATIONAL AND ENTERTAINMENT SERVICES, NAMELY, PROVIDING MOTIVATIONAL AND EDUCATIONAL SPEAKERS; ENTERTAINMENT SERVICES NAMELY PROVIDING A WEBSITE FEATURING, PHOTOGRAPHIC, AUDIO, VIDEO AND PROSE PRESENTATIONS FEATURING A FINANCIAL CELEBRITY (U.S. CLS. 100, 101 AND 107).

LESLEY LAMOTHE, EXAMINING ATTORNEY

CLASS 41—(Continued).

SN 77-142,010. ADAIR, NANCI WESTON, PORTLAND, ME. FILED 3-27-2007.

GoalModel

THE MARK CONSISTS OF STANDARD CHARACTERS WITHOUT CLAIM TO ANY PARTICULAR FONT, STYLE, SIZE, OR COLOR.

FOR PERSONAL COACHING SERVICES IN THE FIELD OF PERSONAL AND PROFESSIONAL ACHIEVEMENT; PROVIDING EDUCATIONAL MENTORING SERVICES AND PROGRAMS FOR BUSINESS CONSULTING AND PERSONAL GROWTH (U.S. CLS. 100, 101 AND 107).

SALLY SHIH, EXAMINING ATTORNEY

SN 77-142,012. LOCKE, JOE, CAMARILLO, CA. FILED 3-27-2007.

Dr. Seymour Clearly

THE MARK CONSISTS OF STANDARD CHARACTERS WITHOUT CLAIM TO ANY PARTICULAR FONT, STYLE, SIZE, OR COLOR.

FOR ENTERTAINMENT IN THE NATURE OF COMEDY; EDUCATIONAL AND ENTERTAINMENT SERVICES, NAMELY, PROVIDING MOTIVATIONAL AND EDUCATIONAL SPEAKERS; EDUCATIONAL SERVICES, NAMELY, CONDUCTING SEMINARS IN THE FIELD OF SALES TRAINING AND DISTRIBUTION OF COURSE MATERIAL IN CONNECTION THEREWITH (U.S. CLS. 100, 101 AND 107).

SALLY SHIH, EXAMINING ATTORNEY

SN 77-142,389. BRIAN K. YOST, FORT WORTH, TX. AND GEOFFREY A. MANTOOTH, FORT WORTH, TX. FILED 3-28-2007.

Clutchdown

THE MARK CONSISTS OF STANDARD CHARACTERS WITHOUT CLAIM TO ANY PARTICULAR FONT, STYLE, SIZE, OR COLOR.

FOR PROVIDING A WEBSITE FEATURING SPORTING INFORMATION (U.S. CLS. 100, 101 AND 107).

PATRICIA EVANKO, EXAMINING ATTORNEY

CLASS 41—(Continued).

SN 77-142,444. INTERNATIONAL LABOR-MANAGEMENT COMMITTEE FOR THE FLOOR AND WALL INDUSTRY, PHILADELPHIA, PA. FILED 3-28-2007.

INSTALL
INTERNATIONAL STANDARDS & TRAINING ALLIANCE
FLOORCOVERING PROFESSIONALS

NO CLAIM IS MADE TO THE EXCLUSIVE RIGHT TO USE INTERNATIONAL STANDARDS & TRAINING ALLIANCE FLOORCOVERING PROFESSIONALS, APART FROM THE MARK AS SHOWN.

THE MARK CONSISTS OF STYLIZED WORDS. FOR TRAINING SERVICES IN THE FIELD OF FLOOR COVERING SERVICES (U.S. CLS. 100, 101 AND 107). FIRST USE 1-1-1990; IN COMMERCE 1-0-1990. IRA J. GOODSID, EXAMINING ATTORNEY

SN 77-142,450. KINGSBURY, BEVERLY, PACIFICA, CA. FILED 3-28-2007.

PAWSITIVE THINKING

THE MARK CONSISTS OF STANDARD CHARACTERS WITHOUT CLAIM TO ANY PARTICULAR FONT, STYLE, SIZE, OR COLOR.

FOR OBEDIENCE SCHOOL TRAINING FOR ANIMALS; TRAINING ANIMALS FOR OTHERS (U.S. CLS. 100, 101 AND 107).

FIRST USE 10-31-2002; IN COMMERCE 10-31-2002. ROSELLE HERRERA, EXAMINING ATTORNEY

SN 77-142,550. ENTERTAINMENT, INC., CINCINNATI, OH. FILED 3-28-2007.

IMAGINATION JUNCTION

THE MARK CONSISTS OF STANDARD CHARACTERS WITHOUT CLAIM TO ANY PARTICULAR FONT, STYLE, SIZE, OR COLOR.

FOR PROVIDING RECREATIONAL AREAS IN THE NATURE OF CHILDREN'S PLAY AREAS; CHILDREN'S ENTERTAINMENT AND AMUSEMENT CENTERS, NAMELY, INTERACTIVE PLAY AREAS (U.S. CLS. 100, 101 AND 107).

ANDREA HACK, EXAMINING ATTORNEY

CLASS 41—(Continued).

SN 77-142,601. THE MOSTERT GROUP, LLC DBA EQUIX, LEXINGTON, KY. FILED 3-28-2007.

EQUIX STRIDE DIAMONDS

THE MARK CONSISTS OF STANDARD CHARACTERS WITHOUT CLAIM TO ANY PARTICULAR FONT, STYLE, SIZE, OR COLOR.

FOR WAGERING SERVICES (U.S. CLS. 100, 101 AND 107).

MATTHEW PAPPAS, EXAMINING ATTORNEY

SN 77-142,716. THE MOSTERT GROUP, LLC, DBA EQUIX, LEXINGTON, KY. FILED 3-28-2007.

Stride Diamonds

THE MARK CONSISTS OF STANDARD CHARACTERS WITHOUT CLAIM TO ANY PARTICULAR FONT, STYLE, SIZE, OR COLOR.

FOR WAGERING SERVICES (U.S. CLS. 100, 101 AND 107).

MATTHEW PAPPAS, EXAMINING ATTORNEY

SN 77-142,725. THE MOSTERT GROUP, LLC, DBA EQUIX, LEXINGTON, KY. FILED 3-28-2007.

Case The Race

THE MARK CONSISTS OF STANDARD CHARACTERS WITHOUT CLAIM TO ANY PARTICULAR FONT, STYLE, SIZE, OR COLOR.

FOR WAGERING SERVICES (U.S. CLS. 100, 101 AND 107).

MATTHEW PAPPAS, EXAMINING ATTORNEY

CLASS 41—(Continued).

SN 77-142,886. RHONDA HACKETT, ATLANTA, GA. FILED 3-28-2007.

Clothing My Emotions.
Which One Has More Power?
You? Or Your Clothes?

THE MARK CONSISTS OF STANDARD CHARACTERS WITHOUT CLAIM TO ANY PARTICULAR FONT, STYLE, SIZE, OR COLOR.

FOR PLANNING ARRANGEMENT OF SHOWING MOVIES, SHOWS, PLAYS OR MUSICAL PERFORMANCES (U.S. CLS. 100, 101 AND 107).

ALEX KEAM, EXAMINING ATTORNEY

SN 77-143,098. UNITED FOOTBALL LEAGUE, LLC, SAN FRANCISCO, CA. FILED 3-28-2007.

UFL

THE MARK CONSISTS OF STANDARD CHARACTERS WITHOUT CLAIM TO ANY PARTICULAR FONT, STYLE, SIZE, OR COLOR.

FOR AMATEUR YOUTH SPORTS SERVICES, NAMELY, ORGANIZING, PROVIDING AND MANAGING YOUTH SPORTS ACTIVITIES; ARRANGING AND CONDUCTING ATHLETIC COMPETITIONS; ARRANGING AND CONDUCTING OF CONCERTS; ARRANGING FOR TICKET RESERVATIONS FOR SHOWS AND OTHER ENTERTAINMENT EVENTS; ARRANGING OF CONTESTS; ARRANGING OF EXHIBITIONS, SEMINARS AND CONFERENCES; CONDUCTING ENTERTAINMENT EXHIBITIONS IN THE NATURE OF SPORTING EVENTS; DIRECTION OF MAKING RADIO OR TELEVISION PROGRAMS; DISTRIBUTION OF TELEVISION PROGRAMMING TO CABLE TELEVISION SYSTEMS; DISTRIBUTION OF TELEVISION PROGRAMS FOR OTHERS; ENTERTAINMENT IN THE NATURE OF COMPETITIONS IN THE FIELD OF ATHLETICS; ENTERTAINMENT IN THE NATURE OF FOOTBALL GAMES; ENTERTAINMENT IN THE NATURE OF FOOTBALL GAMES; ENTERTAINMENT SERVICES, NAMELY, PARTICIPATION IN SPORTING EVENTS; ENTERTAINMENT SERVICES, NAMELY, PERSONAL APPEARANCES BY A SPORTS CELEBRITY; ENTERTAINMENT SERVICES, NAMELY, PROVIDING A RADIO PROGRAM IN THE FIELD OF SPORTS VIA A GLOBAL COMPUTER NETWORK; ENTERTAINMENT SERVICES, NAMELY, PROVIDING A TELEVISION PROGRAM IN THE FIELD OF SPORTS VIA A GLOBAL COMPUTER NETWORK; ENTERTAINMENT SERVICES, NAMELY, PROVIDING A WEB SITE FEATURING MUSICAL PERFORMANCES, MUSICAL VIDEOS, RELATED FILM CLIPS, PHOTOGRAPHS, AND OTHER MULTIMEDIA MATERIALS; ENTERTAINMENT SERVICES, NAMELY, PROVIDING AN ON-LINE COMPUTER GAME; ENTERTAINMENT SERVICES, NAMELY, PROVIDING ON-LINE REVIEWS OF SPORTS; ENTERTAINMENT SERVICES IN THE NATURE OF FANTASY SPORTS LEAGUES; FAN CLUBS; MULTIMEDIA ENTERTAINMENT SOFTWARE PRODUCTION SERVICES; MULTIMEDIA PUBLISHING OF BOOKS, MAGAZINES, JOURNALS, SOFTWARE, GAMES, MUSIC, AND ELECTRONIC PUBLICATIONS; OFFICIATING AT SPORTS CONTESTS; OPERATION OF SPORTS CAMPS; ORGANISATION OF GAMES; ORGANISATION OF SPORTS EVENTS IN THE FIELD OF FOOTBALL; ORGANIZING COMMUNITY SPORTING AND CULTURAL EVENTS; ORGANIZING EXHIBITIONS FOR SPORTING EVENTS;

CLASS 41—(Continued).

ORGANIZING SPORTING EVENTS, NAMELY, FOOTBALL GAMES AND COMPETITIONS; PRODUCTION AND DISTRIBUTION OF TELEVISION SHOWS AND MOVIES; PRODUCTION OF CABLE TELEVISION PROGRAMS; PRODUCTION OF CLOSED CAPTION TELEVISION PROGRAMS; PRODUCTION OF RADIO AND TELEVISION PROGRAMS; PRODUCTION OF RADIO OR TELEVISION PROGRAMS; PRODUCTION OF VIDEO DISCS AND TAPES; PROGRAMMING ON A GLOBAL COMPUTER NETWORK; PROVIDING A COMPUTER GAME THAT MAY BE ACCESSED NETWORK-WIDE BY NETWORK USERS; PROVIDING A WEBSITE FEATURING SPORTING INFORMATION; PROVIDING A WEBSITE THAT PROVIDES SPORTS LEAGUE PLAYER STATISTICS; PROVIDING SPORTS INFORMATION BY MEANS OF TELEPHONE PRERECORDED MESSAGES; PUBLICATION OF BOOKS, OF MAGAZINES, OF JOURNALS, OF NEWSPAPERS, OF PERIODICALS, OF CATALOGS, OF BROCHURES; RENTAL OF STADIUM FACILITIES; SPORT CAMPS; SPORTS REFEREEING AND OFFICIATING; TELEVISION PROGRAMMING; TELEVISION SCHEDULING; TIMING OF SPORTS EVENTS (U.S. CLS. 100, 101 AND 107).

JORDAN BAKER, EXAMINING ATTORNEY

SN 77-143,133. GAUGHAN SOUTH LLC, LAS VEGAS, NV. FILED 3-28-2007.



THE MARK CONSISTS OF THE WORD FEVER WITH THE SILHOUETTE OF A RECLINING WOMAN FORMING THE "V" IN THE DESIGN.

FOR NIGHTCLUB SERVICES, DANCE EVENTS, DANCE INSTRUCTION, PRESENTATION OF LIVE SHOW PERFORMANCE, PRESENTATION OF MUSICAL PERFORMANCE, PROVIDING DANCE HALLS, THEATRICAL AND MUSICAL FLOOR SHOWS PROVIDED AT DISCOTHEQUES AND NIGHTCLUBS, DISC JOCKEYS FOR PARTIES OR SPECIAL EVENTS, ENTERTAINMENT NAMELY, LIVE PERFORMANCES BY A MUSICAL BAND, ENTERTAINMENT, NAMELY LIVE MUSIC CONCERTS AND ENTERTAINMENT, NAMELY LIVE PERFORMANCES BY ROCK GROUPS (U.S. CLS. 100, 101 AND 107).

Laurie Mayes, Examining Attorney

CLASS 41—(Continued).

SN 77-143,462. RENZULLI LEARNING SYSTEMS, LLC, AVON, CT. FILED 3-29-2007.

PROVEN DIFFERENTIATION

THE MARK CONSISTS OF STANDARD CHARACTERS WITHOUT CLAIM TO ANY PARTICULAR FONT, STYLE, SIZE, OR COLOR.

FOR EDUCATIONAL SERVICES FOR PRIMARY AND SECONDARY SCHOOL STUDENTS, NAMELY, PROVIDING A DATABASE OF ENRICHMENT RESOURCES AND ACTIVITIES SUITABLE FOR PRIMARY AND SECONDARY SCHOOL STUDENTS, GENERATING STRENGTH ASSESSMENTS AND LEARNING PROFILES OF PRIMARY AND SECONDARY SCHOOL STUDENTS FOR EDUCATIONAL PURPOSES, MATCHING PRIMARY AND SECONDARY SCHOOL STUDENTS TO SUITABLE ENRICHMENT RESOURCES AND ACTIVITIES, AND MAINTAINING ONGOING EDUCATIONAL STUDENT RECORDS (U.S. CLS. 100, 101 AND 107).

IRA J. GOODSaid, EXAMINING ATTORNEY

SN 77-143,482. RENZULLI LEARNING SYSTEMS, LLC, AVON, CT. FILED 3-29-2007.

DIFFERENTIATION ENGINE

THE MARK CONSISTS OF STANDARD CHARACTERS WITHOUT CLAIM TO ANY PARTICULAR FONT, STYLE, SIZE, OR COLOR.

NO CLAIM IS MADE TO THE EXCLUSIVE RIGHT TO USE "ENGINE", APART FROM THE MARK AS SHOWN.

FOR EDUCATIONAL SERVICES FOR PRIMARY AND SECONDARY SCHOOL STUDENTS, NAMELY, PROVIDING A DATABASE OF ENRICHMENT RESOURCES AND ACTIVITIES SUITABLE FOR PRIMARY AND SECONDARY SCHOOL STUDENTS, GENERATING STRENGTH ASSESSMENTS AND LEARNING PROFILES OF PRIMARY AND SECONDARY SCHOOL STUDENTS FOR EDUCATIONAL PURPOSES, MATCHING PRIMARY AND SECONDARY SCHOOL STUDENTS TO SUITABLE ENRICHMENT RESOURCES AND ACTIVITIES, AND MAINTAINING ONGOING EDUCATIONAL STUDENT RECORDS (U.S. CLS. 100, 101 AND 107).

IRA J. GOODSaid, EXAMINING ATTORNEY

CLASS 41—(Continued).

SN 77-143,500. RENZULLI LEARNING SYSTEMS, LLC, AVON, CT. FILED 3-29-2007.

CLOSING THE ACHIEVEMENT GAP

THE MARK CONSISTS OF STANDARD CHARACTERS WITHOUT CLAIM TO ANY PARTICULAR FONT, STYLE, SIZE, OR COLOR.

FOR EDUCATIONAL SERVICES FOR PRIMARY AND SECONDARY SCHOOL STUDENTS, NAMELY, PROVIDING A DATABASE OF ENRICHMENT RESOURCES AND ACTIVITIES SUITABLE FOR PRIMARY AND SECONDARY SCHOOL STUDENTS, GENERATING STRENGTH ASSESSMENTS AND LEARNING PROFILES OF PRIMARY AND SECONDARY SCHOOL STUDENTS FOR EDUCATIONAL PURPOSES, MATCHING PRIMARY AND SECONDARY SCHOOL STUDENTS TO SUITABLE ENRICHMENT RESOURCES AND ACTIVITIES, AND MAINTAINING ONGOING EDUCATIONAL STUDENT RECORDS (U.S. CLS. 100, 101 AND 107).

IRA J. GOODSaid, EXAMINING ATTORNEY

SN 77-143,523. PEARSON EDUCATION INC., UPPER SADDLE RIVER, NJ. FILED 3-29-2007.

TEACHERVISION

THE MARK CONSISTS OF STANDARD CHARACTERS WITHOUT CLAIM TO ANY PARTICULAR FONT, STYLE, SIZE, OR COLOR.

OWNER OF U.S. REG. NO. 2,413,921.

FOR PROVIDING ON-LINE EDUCATIONAL INFORMATION IN THE FIELDS OF CHILD DEVELOPMENT AND EDUCATION (U.S. CLS. 100, 101 AND 107).

FIRST USE 8-0-1999; IN COMMERCE 8-0-1999.

JIM RINGLE, EXAMINING ATTORNEY

SN 77-143,607. MUN2 TELEVISION, LLC, HIALEAH, FL. FILED 3-29-2007.

BEAUTY ES COOL

THE MARK CONSISTS OF STANDARD CHARACTERS WITHOUT CLAIM TO ANY PARTICULAR FONT, STYLE, SIZE, OR COLOR.

FOR ENTERTAINMENT SERVICES IN THE NATURE OF AN ON-GOING REALITY BASED TELEVISION PROGRAM (U.S. CLS. 100, 101 AND 107).

LINDA ORNDORFF, EXAMINING ATTORNEY

CLASS 41—(Continued).

SN 77-143,636. MUN2 TELEVISION, LLC, HIALEAH, FL. FILED 3-29-2007.

THE CHICAS PROJECT

THE MARK CONSISTS OF STANDARD CHARACTERS WITHOUT CLAIM TO ANY PARTICULAR FONT, STYLE, SIZE, OR COLOR.

THE FOREIGN WORDING IN THE MARK TRANSLATES INTO ENGLISH AS GIRLS.

FOR ENTERTAINMENT SERVICES IN THE NATURE OF AN ON-GOING REALITY BASED TELEVISION PROGRAM (U.S. CLS. 100, 101 AND 107).

LINDA ORNDORFF, EXAMINING ATTORNEY

SN 77-143,728. PC APPLETON, LLC, APPLETON, WI. FILED 3-29-2007.

Play Pals

THE MARK CONSISTS OF STANDARD CHARACTERS WITHOUT CLAIM TO ANY PARTICULAR FONT, STYLE, SIZE, OR COLOR.

FOR PROVIDING AND ORGANIZING, TEAM SPORTS LEAGUES, SPORTING EVENTS, TRAINING, AND SPORTS FACILITIES FOR CHILDREN, ADOLESCENTS, AND ADULTS WITH AN EMPHASIS ON SKILL DEVELOPMENT, SPORTSMANSHIP, AND TEAMWORK, IN SPORTS; ORGANIZING AND CONDUCTING SPORTS CAMPS FOR CHILDREN, ADOLESCENTS, AND ADULTS; PROVIDING SEMINARS, CONFERENCES AND WORKSHOPS IN THE FIELD OF CHILDREN AND SPORTS AND CHILD DEVELOPMENT (U.S. CLS. 100, 101 AND 107).

FIRST USE 2-1-2005; IN COMMERCE 2-1-2005.
PAUL F. GAST, EXAMINING ATTORNEY

SN 77-143,871. TREE FORT, LLC, SAINT LOUIS, MO. FILED 3-29-2007.

KING THIEF

THE MARK CONSISTS OF STANDARD CHARACTERS WITHOUT CLAIM TO ANY PARTICULAR FONT, STYLE, SIZE, OR COLOR.

FOR ENTERTAINMENT, NAMELY LIVE PERFORMANCES BY MUSICAL BANDS (U.S. CLS. 100, 101 AND 107).

FIRST USE 2-1-2007; IN COMMERCE 2-1-2007.
PAMELA HIRSCHMAN, EXAMINING ATTORNEY

CLASS 41—(Continued).

SN 77-143,934. YOUNGS, LESLIE G., CARMICHAEL, CA. FILED 3-29-2007.

Red Sixty

THE MARK CONSISTS OF STANDARD CHARACTERS WITHOUT CLAIM TO ANY PARTICULAR FONT, STYLE, SIZE, OR COLOR.

FOR ENTERTAINMENT IN THE NATURE OF VISUAL AND AUDIO PERFORMANCES, NAMELY, MUSICAL BAND, ROCK GROUP, GYMNASTIC, DANCE, AND BALLET PERFORMANCES (U.S. CLS. 100, 101 AND 107).
FIRST USE 8-13-2006; IN COMMERCE 8-17-2006.

CYNTHIA SLOAN, EXAMINING ATTORNEY

SN 77-143,963. OCHOA, JOE, CORONADO, CA. FILED 3-29-2007.

ANY SIZE CAN EXERCISE

THE MARK CONSISTS OF STANDARD CHARACTERS WITHOUT CLAIM TO ANY PARTICULAR FONT, STYLE, SIZE, OR COLOR.

FOR HEALTH CLUB SERVICES, NAMELY, PROVIDING INSTRUCTION AND EQUIPMENT IN THE FIELD OF PHYSICAL EXERCISE (U.S. CLS. 100, 101 AND 107).

KAREN BRACEY, EXAMINING ATTORNEY

SN 77-144,316. EASTMAN, THOMAS, ROCHESTER, MN. FILED 3-29-2007.

ENCENUE

THE MARK CONSISTS OF THE BUSINESS NAME ENCENUE WITH THE COMPANY MARK WHICH IS A STRAIGHT LINE EXTENDING OFF AN UPERCASE "N" IN "ENCENUE" WHICH EXTENDS UNTIL IT REACHES EVEN WITH THE "E" IN "ENCENUE".

FOR TRAINING SERVICES IN THE FIELD OF HOSPITALITY INDUSTRY (U.S. CLS. 100, 101 AND 107).

FIRST USE 7-28-2006; IN COMMERCE 9-15-2006.
MARK T. MULLEN, EXAMINING ATTORNEY

CLASS 41—(Continued).

SN 77-144,348. MCLEAR, THOMAS P., WALLINGFORD, CT.
FILED 3-29-2007.

THE WHISKEY RIVER BAND

THE MARK CONSISTS OF STANDARD CHARACTERS WITHOUT CLAIM TO ANY PARTICULAR FONT, STYLE, SIZE, OR COLOR.

NO CLAIM IS MADE TO THE EXCLUSIVE RIGHT TO USE "BAND", APART FROM THE MARK AS SHOWN.

FOR ENTERTAINMENT NAMELY, LIVE PERFORMANCES BY A MUSICAL BAND (U.S. CLS. 100, 101 AND 107).

FIRST USE 0-0-1987; IN COMMERCE 0-0-1987.

SAMUEL E. SHARPER JR., EXAMINING ATTORNEY

SN 77-144,368. CALDWELL, BETTY A., COLUMBIA, MD.
FILED 3-29-2007.

The Stressless Tests
Program

THE MARK CONSISTS OF STANDARD CHARACTERS WITHOUT CLAIM TO ANY PARTICULAR FONT, STYLE, SIZE, OR COLOR.

NO CLAIM IS MADE TO THE EXCLUSIVE RIGHT TO USE "TESTS PROGRAM", APART FROM THE MARK AS SHOWN.

FOR EDUCATIONAL SERVICES, NAMELY, CONDUCTING CLASSES IN THE FIELDS OF RELAXATION, SELF AWARENESS AND STUDY SKILLS (U.S. CLS. 100, 101 AND 107).

FIRST USE 9-0-2003; IN COMMERCE 1-0-2004.

IRA J. GOODSaid, EXAMINING ATTORNEY

CLASS 41—(Continued).

SN 77-144,730. ARNOLD, ANTHONY, LA-CHAPELLE-SUR, FRANCE, FILED 3-30-2007.



THE COLOR(S) BLACK, WHITE, ORANGE, AND YELLOW IS/ARE CLAIMED AS A FEATURE OF THE MARK.

THE MARK CONSISTS OF DRAWING OF THE SUN IN YELLOW, ON ORANGE BACKGROUND, THE WORD "HELIOS" IN YELLOW WITH WHITE BACKGROUND AND BLACK SHADOWING.

FOR AUDIO RECORDING AND PRODUCTION; EDITING OR RECORDING OF SOUNDS AND IMAGES; MULTIMEDIA ENTERTAINMENT SERVICES IN THE NATURE OF RECORDING, PRODUCTION AND POST-PRODUCTION SERVICES IN THE FIELDS OF MUSIC, VIDEO, AND FILMS; PRODUCTION OF SOUND AND MUSIC VIDEO RECORDINGS; RECORD MASTER PRODUCTION; RECORD PRODUCTION; RECORDING STUDIOS; RENTAL OF TAPE RECORDING EQUIPMENT; SOUND RECORDING STUDIOS; VIDEO TAPE RECORDING FOR OTHERS (U.S. CLS. 100, 101 AND 107).

GENE MACIOL, EXAMINING ATTORNEY

SN 77-145,400. LAKELAND COLLEGE, SHEBOYGAN, WI.
FILED 3-30-2007.

LAKELAND COLLEGE ONLINE

THE MARK CONSISTS OF STANDARD CHARACTERS WITHOUT CLAIM TO ANY PARTICULAR FONT, STYLE, SIZE, OR COLOR.

NO CLAIM IS MADE TO THE EXCLUSIVE RIGHT TO USE "COLLEGE ONLINE", APART FROM THE MARK AS SHOWN.

FOR EDUCATIONAL SERVICES, NAMELY, PROVIDING ON-LINE ACCREDITED AND NON-ACCREDITED CURRICULUM AND COURSES OF INSTRUCTION AT THE COLLEGIATE AND GRADUATE LEVELS, LEADING TO BACHELOR OF ARTS OR MASTERS DEGREES (U.S. CLS. 100, 101 AND 107).

FIRST USE 11-0-2001; IN COMMERCE 11-0-2001.

FLORENTINA BLANDU, EXAMINING ATTORNEY

CLASS 41—(Continued).

SN 77-146,280. LITTLETON DIANA M., ELK GROVE, CA. FILED 4-2-2007.

CLASS 41—(Continued).

SN 77-148,482. THE RITZ-CARLTON HOTEL COMPANY, L.L.C., BETHESDA, MD. FILED 4-4-2007.

BLaNKThaT!

RITZ-CARLTON RESERVE

THE MARK CONSISTS OF STANDARD CHARACTERS WITHOUT CLAIM TO ANY PARTICULAR FONT, STYLE, SIZE, OR COLOR.

FOR RADIO ENTERTAINMENT SERVICES, NAMELY RADIO PROGRAMS FEATURING PERFORMANCES BY A RADIO PERSONALITY (U.S. CLS. 100, 101 AND 107).
PAMELA HIRSCHMAN, EXAMINING ATTORNEY

THE MARK CONSISTS OF STANDARD CHARACTERS WITHOUT CLAIM TO ANY PARTICULAR FONT, STYLE, SIZE, OR COLOR.

OWNER OF U.S. REG. NOS. 1,094,823, 3,135,656 AND OTHERS.

FOR HEALTH CLUB SERVICES, NAMELY, PROVIDING INSTRUCTION AND CONSULTATION IN THE FIELD OF PHYSICAL EXERCISE AND FITNESS; PROVIDING USE OF EXERCISE EQUIPMENT; PROVIDING FITNESS AND EXERCISE FACILITIES; PROVIDING GOLF, TENNIS, AND SWIMMING FACILITIES; PROVIDING FACILITIES FOR RECREATIONAL ACTIVITIES; PROVIDING BEACH FACILITIES FOR SWIMMING AND BATHING; GOLF CLUB, GOLF COURSE AND GOLF INSTRUCTION SERVICES (U.S. CLS. 100, 101 AND 107).

ZHALEH DELANEY, EXAMINING ATTORNEY

SN 77-147,518. GOLDEN EAGLE PUBLISHING COMPANY, INC., HOUSTON, TX. FILED 4-3-2007.



SN 77-149,184. CHICAGO DANCING COMPANY NFP, CHICAGO, IL. FILED 4-5-2007.



THE COLOR(S) YELLOW, BLACK, WHITE, BLUE, AND ORANGE IS/ARE CLAIMED AS A FEATURE OF THE MARK.

THE MARK CONSISTS OF YELLOW, WHITE, AND BLACK IN ALL LETTERING, ALL OVER THE LETTERING, WITH BLACK MAINLY AROUND THE EDGES AS A SHADOWING AND WHITE IN THE CENTER OFFSETTING THE YELLOW AND BLACK. IN THE EAGLE, THE FOLLOWING COLORS EXIST: YELLOW, ORANGE, WHITE, BLUE, AND BLACK. WHERE BLUE IS LOCATED ONLY IN THE ACTUAL CIRCLE OF THE EYE. WHERE THE CIRCLE AROUND THE EYE HAS ORANGE. WHERE THE BEAK HAS YELLOW ENCIRCLED BY ORANGE, WHERE ALL OUTLINE IS IN BLACK AND THERE IS YELLOWISH-ORANGE AT END OF MOST FEATHERS.

FOR BOOK PUBLISHING SERVICES (U.S. CLS. 100, 101 AND 107).

FIRST USE 2-1-2007; IN COMMERCE 3-3-2007.

RICHARD A. STRASER, EXAMINING ATTORNEY

NO CLAIM IS MADE TO THE EXCLUSIVE RIGHT TO USE "CHICAGO DANCING COMPANY", APART FROM THE MARK AS SHOWN.

THE MARK CONSISTS OF A STAR ABOVE THE WORDS "CHICAGO DANCING COMPANY" IN SCRIPT.

FOR ENTERTAINMENT IN THE NATURE OF DANCE PERFORMANCES; ORGANIZATION OF DANCING EVENTS (U.S. CLS. 100, 101 AND 107).

FIRST USE 4-11-2007; IN COMMERCE 4-11-2007.

JUSTINE D. PARKER, EXAMINING ATTORNEY

CLASS 41—(Continued).

SN 77-149,576. EXECUFITUSA, LLC, HAMILTON SQUARE, NJ. FILED 4-5-2007.



execufitusa

THE COLOR(S) BLACK AND GREY IS/ARE CLAIMED AS A FEATURE OF THE MARK.

THE MARK CONSISTS OF SMALL CASE LETTER "E" IN BLACK SUPERIMPOSED WITH SMALL CASE LETTER "F" IN GREY AND "EXECUFITUSA" DIRECTLY BELOW. THE TERMS "EXECU" AND "USA" APPEAR IN BLACK AND "FIT" APPEARS IN GREY.

FOR PERSONAL COACHING SERVICES IN THE FIELD OF BUSINESS AND PERSONAL EXERCISE TRAINING (U.S. CLS. 100, 101 AND 107).

ANDREA BUTLER, EXAMINING ATTORNEY

SN 77-149,925. BRUCE A. ROBERTS, TUCSON, AZ. AND MOLLY M. ROBERTS, TUCSON, AZ. FILED 4-5-2007.

THE LOVE SCHOOL

THE MARK CONSISTS OF STANDARD CHARACTERS WITHOUT CLAIM TO ANY PARTICULAR FONT, STYLE, SIZE, OR COLOR.

NO CLAIM IS MADE TO THE EXCLUSIVE RIGHT TO USE SCHOOL, APART FROM THE MARK AS SHOWN.

FOR EDUCATION SERVICES, NAMELY, PROVIDING CLASSES, SEMINARS, AND WORKSHOPS IN THE FIELDS OF HOLISTIC MEDICINE AND NATURAL HEALING (U.S. CLS. 100, 101 AND 107).

REBECCA GILBERT, EXAMINING ATTORNEY

CLASS 41—(Continued).

SN 77-150,001. LOUISE HOLYFIELD, DALLAS, TX. FILED 4-5-2007.

Don't Drag The Rag

THE MARK CONSISTS OF STANDARD CHARACTERS WITHOUT CLAIM TO ANY PARTICULAR FONT, STYLE, SIZE, OR COLOR.

FOR TEACHING AND TRAINING ON PROPER SKINCARE AND MAKE-UP APPLICATION (U.S. CLS. 100, 101 AND 107).

GINA FINK, EXAMINING ATTORNEY

SN 77-150,369. SMITHKLINE BEECHAM CORPORATION, PHILADELPHIA, PA. FILED 4-6-2007.

MIALLI.COM

THE MARK CONSISTS OF STANDARD CHARACTERS WITHOUT CLAIM TO ANY PARTICULAR FONT, STYLE, SIZE, OR COLOR.

FOR EDUCATIONAL SERVICES RENDERED VIA THE INTERNET IN THE NATURE OF INTERACTIVE EXHIBITS AND INFORMAL ONLINE PROGRAMS FEATURING GUIDELINES FOR WEIGHT LOSS (U.S. CLS. 100, 101 AND 107).

JAMES LOVELACE, EXAMINING ATTORNEY

SN 77-150,390. SMITHKLINE BEECHAM CORPORATION, PHILADELPHIA, PA. FILED 4-6-2007.

MYALLIPLAN

THE MARK CONSISTS OF STANDARD CHARACTERS WITHOUT CLAIM TO ANY PARTICULAR FONT, STYLE, SIZE, OR COLOR.

FOR EDUCATIONAL SERVICES RENDERED VIA THE INTERNET IN THE NATURE OF INTERACTIVE EXHIBITS AND INFORMAL ONLINE PROGRAMS FEATURING GUIDELINES FOR WEIGHT LOSS (U.S. CLS. 100, 101 AND 107).

JAMES LOVELACE, EXAMINING ATTORNEY

CLASS 41—(Continued).

SN 77-151,517. BIG BEAR PRODUCTIONS, LTD., FALLS CHURCH, VA. FILED 4-9-2007.

Big Bear Productions, Ltd.

THE MARK CONSISTS OF STANDARD CHARACTERS WITHOUT CLAIM TO ANY PARTICULAR FONT, STYLE, SIZE, OR COLOR.
NO CLAIM IS MADE TO THE EXCLUSIVE RIGHT TO USE "PRODUCTIONS, LTD.", APART FROM THE MARK AS SHOWN.

FOR ENTERTAINMENT, NAMELY, LIVE MUSIC CONCERTS; POST-PRODUCTION EDITING SERVICES IN THE FIELD OF MUSIC, VIDEOS AND FILMS; PRESENTATION OF MUSICAL PERFORMANCE (U.S. CLS. 100, 101 AND 107).
FIRST USE 10-1-1995; IN COMMERCE 10-1-1995.
RENEE SERVANCE, EXAMINING ATTORNEY

SN 77-152,322. DENNIS, FELIX, LONDON, ENGLAND, FILED 4-9-2007.

MAXIM COMEDY ALL STARS

THE MARK CONSISTS OF STANDARD CHARACTERS WITHOUT CLAIM TO ANY PARTICULAR FONT, STYLE, SIZE, OR COLOR.
NO CLAIM IS MADE TO THE EXCLUSIVE RIGHT TO USE "COMEDY", APART FROM THE MARK AS SHOWN.
FOR ENTERTAINMENT IN THE NATURE OF ONGOING TELEVISION PROGRAMS IN THE FIELD OF COMEDY; ENTERTAINMENT IN THE NATURE OF LIVE COMEDY PERFORMANCES (U.S. CLS. 100, 101 AND 107).
KATHLEEN M. VANSTON, EXAMINING ATTORNEY

CLASS 41—(Continued).

SN 77-153,714. HARRAH'S LICENSE COMPANY, LLC, LAS VEGAS, NV. FILED 4-11-2007.

**World Series of Poker
Players Championship**

THE MARK CONSISTS OF STANDARD CHARACTERS WITHOUT CLAIM TO ANY PARTICULAR FONT, STYLE, SIZE, OR COLOR.
OWNER OF U.S. REG. NOS. 1,025,395, 3,154,905 AND OTHERS.
NO CLAIM IS MADE TO THE EXCLUSIVE RIGHT TO USE "CHAMPIONSHIP", APART FROM THE MARK AS SHOWN.
FOR ENTERTAINMENT SERVICES, NAMELY, ORGANIZING, CONDUCTING, PRODUCING AND EXHIBITING POKER EVENTS RENDERED LIVE AND THROUGH THE MEDIA OF TELEVISION AND THE INTERNET, AND PROVIDING POKER NEWS AND INFORMATION VIA A GLOBAL COMPUTER NETWORK (U.S. CLS. 100, 101 AND 107).
JULIE THOMAS, EXAMINING ATTORNEY

SN 77-154,002. NO OTHER NAME, LLC, NASHVILLE, TN. FILED 4-11-2007.

No Other Name

THE MARK CONSISTS OF STANDARD CHARACTERS WITHOUT CLAIM TO ANY PARTICULAR FONT, STYLE, SIZE, OR COLOR.
OWNER OF U.S. REG. NO. 3,219,278.
FOR ENTERTAINMENT, NAMELY, LIVE MUSIC CONCERTS (U.S. CLS. 100, 101 AND 107).
FIRST USE 12-8-2002; IN COMMERCE 12-8-2002.
IRA J. GOODSID, EXAMINING ATTORNEY

SN 77-155,220. DELTA AXIS, INC., MEMPHIS, TN. FILED 4-12-2007.



NO CLAIM IS MADE TO THE EXCLUSIVE RIGHT TO USE "INDIE" AND "MEMPHIS", APART FROM THE MARK AS SHOWN.
THE MARK CONSISTS OF A LINE OF FIVE RECTANGLES HAVING A LINE OF ATTACHMENT, THE RECTANGLES CONTAINING STYLIZED LETTERS, TO THE RIGHT IS A LINE OF TWO RECTANGLES HAVING A LINE OF ATTACHMENT, THE RECTANGLES CONTAINING STARS, AND UNDERNEATH IS A LINE OF SEVEN RECTANGLES HAVING A LINE OF ATTACHMENT, THE RECTANGLES CONTAINING STYLIZED LETTERS.
FOR ORGANIZING AND CONDUCTING FILM FESTIVALS (U.S. CLS. 100, 101 AND 107).
FIRST USE 5-1-2004; IN COMMERCE 5-1-2004.
ALEX KEAM, EXAMINING ATTORNEY

CLASS 41—(Continued).

SN 77-157,734. MACCABEE, PAMELA A., GLASTONBURY, CT. FILED 4-16-2007.

PORK UNIVERSITY (P.U.)
An Unaccreditable
University for Incurable
Hams

THE MARK CONSISTS OF STANDARD CHARACTERS WITHOUT CLAIM TO ANY PARTICULAR FONT, STYLE, SIZE, OR COLOR.

NO CLAIM IS MADE TO THE EXCLUSIVE RIGHT TO USE "UNIVERSITY", APART FROM THE MARK AS SHOWN.

FOR EDUCATION SERVICES, NAMELY, PROVIDING CLASSES, TRAINING SEMINARS, WORKSHOPS IN THE FIELDS OF HUMAN RELATIONSHIPS AND INTELLECTUAL AND SOCIAL SKILL DEVELOPMENT, AND DISTRIBUTING COURSE MATERIALS IN CONNECTION THEREWITH; EDUCATIONAL DEMONSTRATIONS IN THE FIELDS OF HUMAN RELATIONSHIPS AND INTELLECTUAL AND SOCIAL SKILL DEVELOPMENT; EDUCATIONAL SERVICES, NAMELY, CONDUCTING INFORMAL PROGRAMS IN THE FIELDS OF HUMAN RELATIONSHIPS AND INTELLECTUAL AND SOCIAL SKILL DEVELOPMENT, USING ON-LINE ACTIVITIES AND INTERACTIVE EXHIBITS, AND PRINTABLE MATERIALS DISTRIBUTED THEREWITH; EDUCATIONAL SERVICES, NAMELY, CONDUCTING CLASS, TRAINING SEMINARS, WORKSHOPS IN THE FIELD OF HUMAN RELATIONSHIPS AND INTELLECTUAL AND SOCIAL SKILL DEVELOPMENT AND DISTRIBUTION OF COURSE MATERIAL IN CONNECTION THEREWITH (U.S. CLS. 100, 101 AND 107).

JAY BESCH, EXAMINING ATTORNEY

SN 77-157,915. PRIME FITNESS, LLC, BONNEY LAKE, WA. FILED 4-16-2007.



THE COLOR(S) RED, LIGHT GREY, DARK GREY, AND WHITE IS/ARE CLAIMED AS A FEATURE OF THE MARK.

THE MARK CONSISTS OF A STYLIZED RUNNER IN RED ON A DARK GRAY PATH IN THE FOREGROUND, WITH A MOUNTAIN IN THE BACKGROUND DEFINED BY LIGHT GREY SHADING AND INCLUDING WHITE AREAS TO DEPICT A SNOW COVERED MOUNTAIN.

FOR HEALTH CLUB SERVICES, NAMELY PROVIDING INSTRUCTION AND EQUIPMENT IN THE FIELD OF PHYSICAL EXERCISE, PROVIDING CLASSROOM WORKSHOPS AND CLINICS IN THE FIELD OF EXERCISE, SPORTS, AND STRENGTH TRAINING (U.S. CLS. 100, 101 AND 107).

KATHERINE CHANG, EXAMINING ATTORNEY

CLASS 41—(Continued).

SN 77-158,463. ARTIX ENTERTAINMENT, LLC, LAND O' LAKES, FL. FILED 4-17-2007.

Undead Assault

THE MARK CONSISTS OF STANDARD CHARACTERS WITHOUT CLAIM TO ANY PARTICULAR FONT, STYLE, SIZE, OR COLOR.

FOR ENTERTAINMENT SERVICES, NAMELY, PROVIDING AN ON-LINE COMPUTER GAME (U.S. CLS. 100, 101 AND 107).

FIRST USE 1-16-2006; IN COMMERCE 1-16-2006.
 TEJBIR SINGH, EXAMINING ATTORNEY

SN 77-158,484. ARTIX ENTERTAINMENT, LLC, LAND O' LAKES, FL. FILED 4-17-2007.

Monster Joust Madness

THE MARK CONSISTS OF STANDARD CHARACTERS WITHOUT CLAIM TO ANY PARTICULAR FONT, STYLE, SIZE, OR COLOR.

FOR ENTERTAINMENT SERVICES, NAMELY, PROVIDING AN ON-LINE COMPUTER GAME (U.S. CLS. 100, 101 AND 107).

FIRST USE 10-27-2006; IN COMMERCE 10-27-2006.
 TEJBIR SINGH, EXAMINING ATTORNEY

SN 77-158,492. ARTIX ENTERTAINMENT, LLC, LAND O' LAKES, FL. FILED 4-17-2007.

Robina Hood's Monster Hunt

THE MARK CONSISTS OF STANDARD CHARACTERS WITHOUT CLAIM TO ANY PARTICULAR FONT, STYLE, SIZE, OR COLOR.

FOR ENTERTAINMENT SERVICES, NAMELY, PROVIDING AN ON-LINE COMPUTER GAME (U.S. CLS. 100, 101 AND 107).

FIRST USE 1-30-2007; IN COMMERCE 1-30-2007.
 TEJBIR SINGH, EXAMINING ATTORNEY

CLASS 41—(Continued).

SN 77-158,635. PC APPLETON, LLC, APPLETON, WI. FILED 4-17-2007.

**REVOLUTION
SPORTS TRAINING**

THE MARK CONSISTS OF STANDARD CHARACTERS WITHOUT CLAIM TO ANY PARTICULAR FONT, STYLE, SIZE, OR COLOR.

NO CLAIM IS MADE TO THE EXCLUSIVE RIGHT TO USE "SPORTS TRAINING", APART FROM THE MARK AS SHOWN.

FOR PROVIDING AND ORGANIZING, TEAM SPORTS LEAGUES, SPORTING EVENTS, TRAINING, AND SPORTS FACILITIES FOR CHILDREN, ADOLESCENTS, AND ADULTS WITH AN EMPHASIS ON SKILL DEVELOPMENT, SPORTSMANSHIP, AND TEAMWORK, IN SPORTS; ORGANIZING AND CONDUCTING SPORTS CAMPS FOR CHILDREN, ADOLESCENTS, AND ADULTS; PROVIDING SEMINARS, CONFERENCES AND WORKSHOPS IN THE FIELD OF CHILDREN AND SPORTS AND CHILD DEVELOPMENT (U.S. CLS. 100, 101 AND 107).

FIRST USE 3-20-2007; IN COMMERCE 3-20-2007.
PAUL F. GAST, EXAMINING ATTORNEY

CLASS 41—(Continued).

SN 77-162,353. SMITH, KATIE, EVENSVILLE, TN. FILED 4-20-2007.



THE MARK CONSISTS OF THE WORDS "JOY JUMP" WRITTEN WITH ONE BIG LOWER-CASE "J" FOLLOWED BY THE REST. THERE IS A SILOUHETTE OF A MAN JUMPING IN THE CORNER. THE WHOLE DESIGN IS SHADOWED.

FOR RENTAL OF INFLATABLE BOUNCE/JUMP HOUSES (U.S. CLS. 100, 101 AND 107).

FIRST USE 6-1-2007; IN COMMERCE 6-1-2007.
KATHERINE CONNOLLY, EXAMINING ATTORNEY

SN 77-159,918. MATCH-E-BE-NASH-SHE-WISH BAND OF POTTAWATOMI INDIANS OF MICHIGAN, DORR, MI. FILED 4-18-2007.

JACKPOT CAPITAL OF MICHIGAN

THE MARK CONSISTS OF STANDARD CHARACTERS WITHOUT CLAIM TO ANY PARTICULAR FONT, STYLE, SIZE, OR COLOR.

NO CLAIM IS MADE TO THE EXCLUSIVE RIGHT TO USE "MICHIGAN", APART FROM THE MARK AS SHOWN.

FOR CASINO AND ENTERTAINMENT SERVICES, NAMELY, LIVE PERFORMANCES FEATURING MUSICIANS AND SINGERS, DANCERS, MAGICIANS, ACTORS, ACROBATS, COMEDIANS AND PRERECORDED MUSIC AND VIDEO; AMUSEMENT ARCADES; NIGHT-CLUB SERVICES (U.S. CLS. 100, 101 AND 107).

KATHLEEN M. VANSTON, EXAMINING ATTORNEY

SN 77-162,471. 29:11, INC., SPRING, TX. FILED 4-21-2007.



THE COLOR(S) YELLOW, BLUE AND RED IS/ARE CLAIMED AS A FEATURE OF THE MARK.

THE MARK CONSISTS OF STYLIZED YELLOW LETTERS I AND W WITH BLUE SHADOWING INSIDE A RED CIRCLE.

FOR PROVIDING FACILITIES FOR RECREATION ACTIVITIES (U.S. CLS. 100, 101 AND 107).

FIRST USE 6-23-2005; IN COMMERCE 6-23-2005.
NAAKWAMA ANKRAH, EXAMINING ATTORNEY

CLASS 41—(Continued).

SN 77-162,774. SWIRL EVENTS INC., NEW YORK, NY.
FILED 4-23-2007.

Swirl Events

THE MARK CONSISTS OF STANDARD CHARACTERS WITHOUT CLAIM TO ANY PARTICULAR FONT, STYLE, SIZE, OR COLOR.

NO CLAIM IS MADE TO THE EXCLUSIVE RIGHT TO USE "EVENTS", APART FROM THE MARK AS SHOWN.

FOR ENTERTAINMENT SERVICES, NAMELY WINE AND FOOD TASTINGS (U.S. CLS. 100, 101 AND 107).

FIRST USE 4-11-2007; IN COMMERCE 4-11-2007.

PAULA MAHONEY, EXAMINING ATTORNEY

SN 77-165,968. RIVERS, BRITISH L. G. CREEK, SC. FILED 4-26-2007.

Big Youngsta

THE MARK CONSISTS OF STANDARD CHARACTERS WITHOUT CLAIM TO ANY PARTICULAR FONT, STYLE, SIZE, OR COLOR.

BIG YOUNGSTA IDENTIFIES THE STAGE NAME OF A LIVING INDIVIDUAL WHOSE CONSENT IS OF RECORD.

FOR ENTERTAINMENT, NAMELY, LIVE PERFORMANCES BY A HIP HOP MUSICAL BAND; MUSIC PRODUCTION SERVICES; SONG WRITING SERVICES (U.S. CLS. 100, 101 AND 107).

TANYA AMOS, EXAMINING ATTORNEY

CLASS 41—(Continued).

SN 77-168,352. PATIENT CAREGIVERS, LLC, HOUSTON, TX. FILED 4-28-2007.



NO CLAIM IS MADE TO THE EXCLUSIVE RIGHT TO USE "CAREGIVERS ACADEMY", APART FROM THE MARK AS SHOWN.

THE COLOR(S) BLUE, BLACK AND WHITE IS/ARE CLAIMED AS A FEATURE OF THE MARK.

THE COLOR BLUE APPEARS IN THE GRADUATION CAP; THE COLOR BLACK APPEARS IN THE LANGUAGE THE CAREGIVERS ACADEMY, THE COLOR WHITE APPEARS IN THE STICK FIGURES IN THE CAP.

FOR EDUCATIONAL SERVICES IN THE NATURE OF PERSONAL ASSISTANCE SERVICES & CAREGIVING SCHOOLS (U.S. CLS. 100, 101 AND 107).

LAURIE MAYES, EXAMINING ATTORNEY

SN 77-175,965. JUNE BUG ENTERPRISES, INC., BEVERLY HILLS, CA. FILED 5-8-2007.

1-888-GO-MAGIC

THE MARK CONSISTS OF STANDARD CHARACTERS WITHOUT CLAIM TO ANY PARTICULAR FONT, STYLE, SIZE, OR COLOR.

OWNER OF U.S. REG. NOS. 1,555,839, 2,699,394 AND OTHERS.

FOR RESERVATION AND BOOKING SERVICES FOR CONCERTS, THEATRE, SHOWS, AND CINEMA TICKETS; AND PROVIDING INFORMATION IN THE FIELD OF TICKET INFORMATION FOR ENTERTAINMENT EVENTS (U.S. CLS. 100, 101 AND 107).

DAYNA BROWNE, EXAMINING ATTORNEY

CLASS 41—(Continued).

SN 77-183,372. DENNIS, FELIX, LONDON, ENGLAND, FILED 5-17-2007.

FACE OF MAXIM

THE MARK CONSISTS OF STANDARD CHARACTERS WITHOUT CLAIM TO ANY PARTICULAR FONT, STYLE, SIZE, OR COLOR.

OWNER OF U.S. REG. NO. 3,228,883 AND OTHERS. FOR ENTERTAINMENT IN THE NATURE OF BEAUTY PAGEANTS; ENTERTAINMENT IN THE NATURE OF MODEL SEARCH COMPETITIONS (U.S. CLS. 100, 101 AND 107).

KATHLEEN M. VANSTON, EXAMINING ATTORNEY

SN 77-183,572. SEMINOLE TRIBE OF FLORIDA, HOLLYWOOD, FL. FILED 5-17-2007.

LUCKYSWIPE



THE COLOR(S) GREEN AND BLACK IS/ARE CLAIMED AS A FEATURE OF THE MARK.

THE MARK CONSISTS OF THE WORD "LUCKYSWIPE" APPEARING ABOVE THE NECK OF A GUITAR, WITH THE WORD "LUCKY" APPEARING IN GREEN AND THE WORD "SWIPE" APPEARING ON BLACK. THE NECK OF THE GUITAR IS GREEN UNDERNEATH THE WORD LUCKY AND BLACK UNDERNEATH THE WORD SWIPE. FOR CONDUCTING AND PROVIDING FACILITIES FOR SPECIAL EVENTS FEATURING CASINO AND GAMING CONTESTS AND TOURNAMENTS (U.S. CLS. 100, 101 AND 107).

FIRST USE 2-1-2007; IN COMMERCE 2-1-2007.

KATHLEEN M. VANSTON, EXAMINING ATTORNEY

SN 77-193,956. ROBINS, KAPLAN, MILLER & CIRESI L.L.P., MINNEAPOLIS, MN. FILED 5-31-2007.

APaTS



ADVANCED PATENT TRIAL STRATEGIES

NO CLAIM IS MADE TO THE EXCLUSIVE RIGHT TO USE "ADVANCED PATENT TRIAL STRATEGIES", APART FROM THE MARK AS SHOWN.

THE MARK CONSISTS OF THE ACRONYM APATS IN UPPER CASE AND LOWER CASE LETTERING WITHIN A RECTANGLE AND THE WORDS "ADVANCED PATENT TRIAL STRATEGIES" BELOW THE RECTANGLE.

FOR PROVIDING ONLINE PUBLICATIONS IN THE NATURE OF NEWSLETTERS IN THE FIELD OF INTELLECTUAL PROPERTY (U.S. CLS. 100, 101 AND 107).

FIRST USE 5-10-2007; IN COMMERCE 5-10-2007.

JACLYN KIDWELL, EXAMINING ATTORNEY

CLASS 41—(Continued).

SN 78-382,452. INTERNATIONAL UNDERWRITERS GROUP LIMITED, GLEN INNES, AUCKLAND, NEW ZEALAND, FILED 3-11-2004.

S.M.A.R.T. T.A.L.K.

THE MARK CONSISTS OF STANDARD CHARACTERS WITHOUT CLAIM TO ANY PARTICULAR FONT, STYLE, SIZE, OR COLOR.

OWNER OF NEW ZEALAND REG. NO. 683323, DATED 1-29-2004, EXPIRES 7-23-2010.

FOR SALES AND TRAINING PROGRAMS, NAMELY, SALES AND MANAGEMENT TRAINING PROGRAMS CONDUCTED AND OFFERED VIA INSTRUCTIONAL TEACHING, MANUALS, COMPUTER GENERATED DISPLAYS, AND THE INTERNET, NAMELY, A TRAINING PROGRAM DESIGNED TO AID SALES CONSULTANTS AND SALES MANAGERS IN INCREASING PERFORMANCE AND PROFIT LEVELS, NONE OF THE AFOREMENTIONED SERVICES BEING EDUCATIONAL AND TRAINING SERVICES RELATED TO SPEECH COACHING, THE FINDING OF EXPERT SPEAKERS, OR WOMEN-RELATED LECTURES AND ORAL PRESENTATIONS (U.S. CLS. 100, 101 AND 107).

TONI HICKEY, EXAMINING ATTORNEY

SN 78-512,956. REGIME IMPERIA LLC, NEW YORK, NY. FILED 11-8-2004.

REGIME IMPERIA

THE MARK CONSISTS OF STANDARD CHARACTERS WITHOUT CLAIM TO ANY PARTICULAR FONT, STYLE, SIZE, OR COLOR.

FOR ENTERTAINMENT SERVICES IN THE NATURE OF PROVIDING A FEE-FOR-ACCESS WEBSITE FEATURING ARTICLES, INFORMATION, AND ARTISTIC DRAWINGS ALL ON THE TOPIC OF THE FEMALE-DOMINATED SOCIETY IN THE FIELD OF EDUCATION AND ENTERTAINMENT (U.S. CLS. 100, 101 AND 107).

FIRST USE 4-1-2004; IN COMMERCE 11-5-2004.

LINDA ORNDORFF, EXAMINING ATTORNEY

CLASS 41—(Continued).

SN 78-563,393. LIFESTYLE FAMILY FITNESS, INC., ST. PETERSBURG, FL. FILED 2-9-2005.



OWNER OF U.S. REG. NOS. 2,637,081 AND 2,712,411. FOR HEALTH CLUB SERVICES, NAMELY, PROVIDING INSTRUCTION, EQUIPMENT, AND FACILITIES FOR USE IN THE FIELD OF PHYSICAL EXERCISE (U.S. CLS. 100, 101 AND 107).
BARBARA RUTLAND, EXAMINING ATTORNEY

CLASS 41—(Continued).

SN 78-644,658. BUTLER, CEDRIC E., PLAINFIELD, NJ. AND ELMERA, JENS U., EAST ORANGE, NJ. FILED 6-6-2005.



THE MARK CONSISTS OF STANDARD CHARACTERS WITHOUT CLAIM TO ANY PARTICULAR FONT, STYLE, SIZE, OR COLOR.
FOR ENTERTAINMENT SERVICES, NAMELY, LIVE PERFORMANCES BY A MUSIC GROUP (U.S. CLS. 100, 101 AND 107).
H. M. FISHER, EXAMINING ATTORNEY

SN 78-623,378. INSTITUTE OF INTERFAITH DIALOG FOR THE WORLD PEACE, INC., HOUSTON, TX. FILED 5-4-2005.

PEACEFUL HEROES

THE MARK CONSISTS OF STANDARD CHARACTERS WITHOUT CLAIM TO ANY PARTICULAR FONT, STYLE, SIZE, OR COLOR.
FOR EDUCATION SERVICES, NAMELY, ORGANIZING CONFERENCES AND SYMPOSIA IN THE FIELD OF INTERFAITH DIALOGUE; EDUCATION SERVICES, NAMELY, PROVIDING CLASSES, SEMINARS, WORKSHOPS IN THE FIELD OF INTERFAITH DIALOGUE, INFORMATION ON EDUCATION. (U.S. CLS. 100, 101 AND 107).
FIRST USE 4-3-2003; IN COMMERCE 4-3-2003.
GINA FINK, EXAMINING ATTORNEY

SN 78-679,258. EDUCATIONAL COMMISSION FOR FOREIGN MEDICAL GRADUATES, PHILADELPHIA, PA. FILED 7-27-2005.



OWNER OF U.S. REG. NO. 1,018,521.
THE MARK CONSISTS OF A GLOBE DESIGN.
FOR TESTING AND EVALUATING THE QUALIFICATIONS OF INTERNATIONAL MEDICAL GRADUATES FOR ENTRY INTO GRADUATE MEDICAL EDUCATION AND HEALTH CARE SYSTEMS IN THE UNITED STATES; PROVIDING EDUCATIONAL INFORMATION TO INTERNATIONAL MEDICAL GRADUATES REGARDING ENTRY INTO GRADUATE MEDICAL EDUCATION AND HEALTH CARE SYSTEMS IN THE UNITED STATES; ASSISTING IN THE ESTABLISHMENT OF EDUCATIONAL POLICIES AND PROGRAMS TO MEET THE CULTURAL AND PROFESSIONAL NEEDS OF INTERNATIONAL MEDICAL GRADUATES ENTERING THE UNITED STATES HEALTH CARE SYSTEM BY IDENTIFYING AND ADDRESSING THEIR ACCULTURATION NEEDS; CONDUCTING RESEARCH AND GATHERING AND DISSEMINATING DATA ABOUT INTERNATIONAL MEDICAL EDUCATION AND INTERNATIONAL MEDICAL GRADUATES; RESEARCH, COLLABORATION, AND CONSULTING SERVICES OFFERED TO MEDICAL SCHOOLS, INSTITUTIONAL HEALTH CARE PROVIDERS, MEDICAL CERTIFICATION ORGANIZATIONS, GOVERNMENT AGENCIES, AND INDIVIDUALS IN CONNECTION WITH EDUCATIONAL PROGRAM DEVELOPMENT, STANDARD SETTING AND EVALUATION (U.S. CLS. 100, 101 AND 107).
RICHARD WHITE, EXAMINING ATTORNEY

SN 78-640,246. GAY & LESBIAN LEADERSHIP INSTITUTE, INC., WASHINGTON, DC. FILED 5-31-2005.



NO CLAIM IS MADE TO THE EXCLUSIVE RIGHT TO USE "GAY & LESBIAN LEADERSHIP CONFERENCE", APART FROM THE MARK AS SHOWN.
FOR EDUCATIONAL SERVICES, NAMELY, ARRANGING AND CONDUCTING CONFERENCES, SEMINARS, AND WORKSHOPS IN THE FIELDS OF PROFESSIONAL DEVELOPMENT, LEADERSHIP TRAINING, AND PUBLIC SERVICE; AND DISTRIBUTING COURSE MATERIAL IN CONNECTION THEREWITH (U.S. CLS. 100, 101 AND 107).
FIRST USE 3-17-2004; IN COMMERCE 3-17-2004.
LINDA MICKLEBURGH, EXAMINING ATTORNEY

CLASS 41—(Continued).

SN 78-689,725. FORSTHOFF, FRIDAY, DAVIS, CA. FILED 8-10-2005.

Faith Pets

THE MARK CONSISTS OF STANDARD CHARACTERS WITHOUT CLAIM TO ANY PARTICULAR FONT, STYLE, SIZE, OR COLOR.

NO CLAIM IS MADE TO THE EXCLUSIVE RIGHT TO USE PETS, APART FROM THE MARK AS SHOWN.

FOR EDUCATIONAL SERVICES, NAMELY, CONDUCTING PRESENTATIONS, WORKSHOPS, SEMINARS AND TRAINING ON THE USE OF PETS FOR AWAKENING SPIRITUALITY AND RELIGIOUS FAITH, ON THE POTENTIAL USE OF PETS FOR ANIMAL ASSISTED THERAPY AND ON THE USE OF SERVICE ANIMALS FOR DISABLED PEOPLE; ORGANIZING RECREATIONAL ACTIVITIES FOR OTHERS IN THE NATURE OF WALKS, HIKES, HORSEBACK RIDING AND OTHER OUTINGS THAT ENCOURAGE HUMAN AND PET INTERACTION AMONG INDIVIDUALS AND/OR ORGANIZATIONS TO PROMOTE FAITH BASED OUTREACH, ANIMAL ASSISTED THERAPY AND SERVICE ANIMALS; ENTERTAINMENT SERVICES, NAMELY PERSONAL APPEARANCES BY A PET TRAINER AND PRESENTATION OF LIVE SHOW PERFORMANCES FEATURING PETS; PROVIDING EDUCATIONAL INFORMATION ABOUT THE TRAINING OF PETS AND SERVICE ANIMALS FOR AWAKENING SPIRITUALITY AND RELIGIOUS FAITH VIA THE INTERNET; AND CONSULTING SERVICES FOR THE ABOVE IDENTIFIED EDUCATIONAL AND RECREATIONAL SERVICES (U.S. CLS. 100, 101 AND 107).

FIRST USE 2-14-2005; IN COMMERCE 2-14-2005.
KATHERINE STOIDES, EXAMINING ATTORNEY

CLASS 41—(Continued).

SN 78-719,998. DISNEY ENTERPRISES, INC., BURBANK, CA. FILED 9-24-2005.

HANNAH MONTANA

THE MARK CONSISTS OF STANDARD CHARACTERS WITHOUT CLAIM TO ANY PARTICULAR FONT, STYLE, SIZE, OR COLOR.

HANNAH MONTANA DOES NOT IDENTIFY A LIVING INDIVIDUAL.

FOR PRODUCTION, PRESENTATION AND RENTAL OF MOTION PICTURE FILMS; PRODUCTION, PRESENTATION, AND RENTAL OF TELEVISION AND RADIO PROGRAMS; PRODUCTION, PRESENTATION, AND RENTAL OF SOUND AND VIDEO RECORDINGS; PROVIDING ENTERTAINMENT INFORMATION IN THE FIELDS OF LIVE MUSICAL PERFORMANCES, SINGERS AND ACTORS, AND RECORDED MUSIC; PRODUCTION OF ENTERTAINMENT SHOWS AND INTERACTIVE PROGRAMS FOR DISTRIBUTION VIA TELEVISION, CABLE, SATELLITE, AUDIO AND VIDEO MEDIA, CARTRIDGES, LASER DISCS, COMPUTER DISCS AND ELECTRONIC MEANS; PRODUCTION AND PROVISION OF TELEVISION SHOWS AND INFORMATION IN THE FIELD OF ENTERTAINMENT FOR CHILDREN AND TEENAGERS VIA COMMUNICATION AND COMPUTER NETWORKS; AMUSEMENT PARK AND THEME PARK SERVICES; PRESENTATION OF LIVE STAGE SHOWS; PRESENTATION OF LIVE SHOW PERFORMANCES; THEATER PRODUCTIONS; ENTERTAINER SERVICES, NAMELY TELEVISED AND MOVIE APPEARANCES BY A PROFESSIONAL ENTERTAINER (U.S. CLS. 100, 101 AND 107).

ERNEST SHOSHÖ, EXAMINING ATTORNEY

SN 78-711,760. THOMAS AND STACEY SIEBEL FOUNDATION, SAN MATEO, CA. FILED 9-13-2005.

MONTANA METH PROJECT

THE MARK CONSISTS OF STANDARD CHARACTERS WITHOUT CLAIM TO ANY PARTICULAR FONT, STYLE, SIZE, OR COLOR.

SEC. 2(F).

FOR PREPARING AND DISSEMINATING EDUCATIONAL AND PUBLIC SERVICE ADVERTISING MATERIAL RELATED TO THE PREVENTION OF METHAMPHETAMINE ABUSE FOR OTHERS; ELECTRONIC PUBLISHING SERVICES, NAMELY, PUBLICATION OF VIDEO, TEXT, AUDIO, AND GRAPHIC WORKS OF OTHERS ON ELECTRONIC MEDIA, NAMELY, ONLINE WEB AND INTERNET, VIDEOTAPE, CDS, DVDS FEATURING METHAMPHETAMINE ABUSE AND PREVENTION INFORMATION (U.S. CLS. 100, 101 AND 107).

FIRST USE 8-30-2005; IN COMMERCE 8-30-2005.
KATHRYN COWARD, EXAMINING ATTORNEY

SN 78-724,883. MULTICAST MEDIA TECHNOLOGIES, INC., ATLANTA, GA. FILED 10-3-2005.



THE MARK CONSISTS OF A STYLIZED "Q" FOLLOWED BY THE LETTERS "NN" WITH THE "Q" SUPERIMPOSED OVER A STAR-LIKE GRAPHIC.

FOR PROVIDING ENTERTAINMENT INFORMATION ON QUILTING, KNITTING AND CRAFTS VIA WEBSITES ON THE INTERNET; ENTERTAINMENT, NAMELY, CONTINUING SHOWS IN THE FIELDS OF QUILTING AND KNITTING BROADCAST OVER TELEVISION AND SATELLITE VIDEO MEDIA (U.S. CLS. 100, 101 AND 107).

FIRST USE 4-29-2005; IN COMMERCE 4-29-2005.
JOHN GARTNER, EXAMINING ATTORNEY

CLASS 41—(Continued).

SN 78-746,499. SPENCER, DAVID, ANTHONY, NORWALK, CT. FILED 11-3-2005.



NO CLAIM IS MADE TO THE EXCLUSIVE RIGHT TO USE "ENTERPRISES", APART FROM THE MARK AS SHOWN.

THE COLOR(S) DARK BLUE, BLUE, LIGHT BLUE, SILVER, WHITE IS/ARE CLAIMED AS A FEATURE OF THE MARK.

THE MARK CONSISTS OF A CENTERED OPEN EYE THAT IS DARK BLUE, BLUE, LIGHT BLUE, WHITE. BELOW THE EYE IS A CIRCULAR STRUCTURE THAT HAS AN OPENING AT THE TOP OF IT. THE CIRCULAR STRUCTURE IS DARK BLUE THAT FADES INTO DIFFERENT SHADES OF LIGHTER BLUES AND THEN EVENTUALLY INTO WHITE CLOSER TO THE TOP OF THE STRUCTURE. ATTACHED TO THE CIRCULAR STRUCTURE IS ARE TEN FLARES (FIVE ON THE LEFT AND FIVE ON THE RIGHT). THESE FLARES ARE EXTENDING OUTWARD AWAY FROM THE CIRCULAR STRUCTURE. THESE FLARES ARE DARK BLUE AND WHITE. THERE IS A STREAMING TEAR DROP COMING FROM THE CENTER OF THE EYE DRIPPING DOWN TOWARDS THE BOTTOM CENTER OF THE CIRCULAR STRUCTURE. BELOW THE CIRCULAR STRUCTURE IS THE WORD

CLASS 41—(Continued).

NEXT, WHICH IS DARK BLUE, BLUE, SILVER, AND WHITE. BELOW THE WORD NEXT, ARE THE WORDS LEVEL ENTERPRISES, WHICH ARE ALL IN DARK BLUE AND UNDERLINED. FROM THE TOP OF THE WORDS LEVEL ENTERPRISES TO THE GAP BETWEEN THE CIRCULAR STRUCTURE THAT IS ABOVE, THERE IS A LIGHT BLUE PYRAMID IN THE BACKGROUND OF THE LOGO. UNDERNEATH THE WORDS LEVEL ENTERPRISES IS THE SLOGAN "TAKING YOU TO THE NEXT LEVEL OF EXISTENCE".

FOR MUSIC RECORDING AND PRODUCTION; COMPOSITION OF MUSIC FOR OTHERS; EDITING OR RECORDING OF SOUNDS AND IMAGES; ENTERTAINMENT IN THE NATURE OF ON-GOING TELEVISION PROGRAMS IN THE FIELD OF MUSIC, INSTRUMENTALS, INTERVIEWS, LIVE PERFORMANCES OF MUSICAL ARTISTS, BANDS, GROUPS, POETRY, SPOKEN WORD, COMEDY; SHORT FILMS, MOVIES, MUSIC VIDEOS; ENTERTAINMENT IN THE NATURE OF TELEVISION NEWS SHOWS; ENTERTAINMENT IN THE NATURE OF VISUAL AND AUDIO PERFORMANCES, NAMELY, MUSICAL BAND, ROCK GROUP, GYMNASIUM, DANCE, AND BALLET PERFORMANCES; ENTERTAINMENT IN THE NATURE OF MUSIC, MUSIC EDUCATION, MUSIC PRODUCTION, MUSIC RECORDING, MUSIC CREATION; ENTERTAINMENT SERVICES IN THE NATURE OF ON-GOING TELEVISION PROGRAMS IN THE FIELD OF CHILDREN'S ENTERTAINMENT; ENTERTAINMENT SERVICES, NAMELY, AN ONLINE ACTIVITY WHERE YOU CREATE YOUR OWN MUSIC VIDEOS; ENTERTAINMENT SERVICES, NAMELY, PROVIDING A WEB SITE FEATURING MUSICAL PERFORMANCES, MUSICAL VIDEOS, RELATED FILM CLIPS, PHOTOGRAPHS, AND OTHER MULTIMEDIA MATERIALS; ENTERTAINMENT SERVICES, NAMELY, PROVIDING ON-LINE REVIEWS OF MUSIC; ENTERTAINMENT, NAMELY, A CONTINUING MUSIC, MUSIC EDUCATION, MUSIC RECORDING, MUSIC CREATION, POETRY, SPOKEN WORD, COMEDY, STUDIO SESSION MATERIAL, LIVE PERFORMANCE OF MUSICAL ARTISTS, BANDS AND GROUPS, SHORT FILM, MOVIE, MUSIC VIDEO AND INTERVIEW SHOW BROADCAST OVER TELEVISION, SATELLITE, RADIO, AND VIDEO MEDIA (U.S. CLS. 100, 101 AND 107).

DAVID H. STINE, EXAMINING ATTORNEY

CLASS 41—(Continued).

SN 78-753,386. UNIVERSITY OF LOUISVILLE ATHLETIC ASSOCIATION, INC., LOUISVILLE, KY. FILED 11-14-2005.

LCARE

THE MARK CONSISTS OF STANDARD CHARACTERS WITHOUT CLAIM TO ANY PARTICULAR FONT, STYLE, SIZE, OR COLOR.

FOR EDUCATIONAL SERVICES AND CONSULTATION IN THE FIELD OF CURRICULUM SELECTION; GUIDANCE AND MENTORING SERVICES IN THE FIELDS OF EDUCATIONAL PLANNING AND DEVELOPMENT, LEADERSHIP DEVELOPMENT, AND CAREER PLANNING AND DEVELOPMENT; DEVELOPMENT AND IMPLEMENTATION OF STUDENT DEVELOPMENT PROGRAMS IN THE FIELDS OF EDUCATION, PERSONAL CARE, PERSONAL RESPONSIBILITY, LEADERSHIP AND CAREER PLANNING; HEALTH AND FITNESS SERVICES, NAMELY, TRAINING IN THE FIELDS OF PHYSICAL FITNESS, HEALTH, PERSONAL CARE AND NUTRITION; PROVIDING TRAINING AND INSTRUCTION IN THE FIELDS OF PHYSICAL EXERCISE AND FITNESS; PHYSICAL EDUCATION SERVICES; PHYSICAL FITNESS CONSULTATION; PHYSICAL FITNESS INSTRUCTION; PROVIDING FITNESS AND EXERCISE FACILITIES; EDUCATIONAL SERVICES, NAMELY, PROVIDING MOTIVATIONAL AND CAREER DEVELOPMENT SPEAKERS; PROVIDING DISTANCE LEARNING FACILITIES AND SERVICES, NAMELY, CONDUCTING DISTANCE LEARNING INSTRUCTION AT THE COLLEGE, GRADUATE AND POST-GRADUATE LEVELS; CAREER COUNSELING; AND ON-LINE EDUCATIONAL AND MULTIMEDIA SERVICES, NAMELY, THE DEVELOPMENT AND IMPLEMENTATION OF TUTORIALS AND COURSES OF INSTRUCTION AT THE COLLEGE, GRADUATE AND POST-GRADUATE LEVELS, AND DISTRIBUTING MATERIALS IN CONNECTION WITH THOSE SERVICES (U.S. CLS. 100, 101 AND 107).

FIRST USE 4-30-2005; IN COMMERCE 8-10-2005.
ANDREA SAUNDERS, EXAMINING ATTORNEY

SN 78-755,420. LTB, II, LLC, ROCKVILLE, MD. FILED 11-16-2005.

MAXIMUM ACCELERATION

THE MARK CONSISTS OF STANDARD CHARACTERS WITHOUT CLAIM TO ANY PARTICULAR FONT, STYLE, SIZE, OR COLOR.

FOR EDUCATION SERVICES, NAMELY, PROVIDING CLASSES, SEMINARS, WORKSHOPS, AND ON-LINE INSTRUCTION IN THE FIELD OF MORTGAGE LOANS AND MORTGAGE LOAN ORIGATION; PERSONAL COACHING SERVICES IN THE FIELD OF MORTGAGE LOANS AND MORTGAGE LOAN ORIGATION (U.S. CLS. 100, 101 AND 107).

MARY BOAGNI, EXAMINING ATTORNEY

CLASS 41—(Continued).

SN 78-759,478. ART RESOURCES FOR CHILDREN'S HEALTH, INC., NEW YORK, NY. FILED 11-22-2005.

THE COLOR(S) GRAY AND BLUE IS/ARE CLAIMED AS A FEATURE OF THE MARK.

THE MARK CONSISTS OF THE WORD "ARCH" IN STYLIZED FORM. THE COLOR GRAY APPEARS IN THE MARK, SPECIFICALLY IN THE LETTERS "A" "R" AND "H"; THE LETTER "C" AND "." ARE IN THE COLOR BLUE.

FOR EDUCATION SERVICES, NAMELY, PROVIDING NON-PROFIT WORKSHOPS IN THE FIELD OF DANCE, MUSIC, DRAMA, PAINTING, PHOTOGRAPHY AND OTHER VISUAL AND PERFORMING ARTS, TOGETHER WITH MENTORING AND INTERNSHIPS, FOR DISADVANTAGED CHILDREN WITH ATTENTION DEFICIT/HYPERACTIVE DISORDER AND OTHER MENTAL DISORDERS (U.S. CLS. 100, 101 AND 107).

DOMINIC FATHY, EXAMINING ATTORNEY

SN 78-760,579. ABC RADIO NETWORK, INC., BURBANK, CA. FILED 11-23-2005.

ESCAPE FM

THE MARK CONSISTS OF STANDARD CHARACTERS WITHOUT CLAIM TO ANY PARTICULAR FONT, STYLE, SIZE, OR COLOR.

NO CLAIM IS MADE TO THE EXCLUSIVE RIGHT TO USE "FM", APART FROM THE MARK AS SHOWN.

FOR RADIO PROGRAMMING SERVICES; ONLINE INFORMATION IN THE FIELD OF MUSIC (U.S. CLS. 100, 101 AND 107).

KIMBERLY FRYE, EXAMINING ATTORNEY

SN 78-768,639. CAREER EDUCATION CORPORATION, HOFFMAN ESTATES, IL. FILED 12-7-2005.

CECYBRARY

THE MARK CONSISTS OF STANDARD CHARACTERS WITHOUT CLAIM TO ANY PARTICULAR FONT, STYLE, SIZE, OR COLOR.

FOR ONLINE INFORMATION SERVICES, NAMELY, ONLINE LIBRARY SERVICES AND PROVIDING INFORMATION TO FACILITATE EDUCATIONAL SERVICES AT THE POST-SECONDARY LEVEL, NAMELY, PROVIDING ONLINE INFORMATION ABOUT EDUCATIONAL COURSES (U.S. CLS. 100, 101 AND 107).

FIRST USE 7-1-2000; IN COMMERCE 7-1-2000.

ALEX KEAM, EXAMINING ATTORNEY

CLASS 41—(Continued).

SN 78-769,557. CERTAINTTEED CORPORATION, VALLEY FORGE, PA. FILED 12-8-2005.



NO CLAIM IS MADE TO THE EXCLUSIVE RIGHT TO USE "COMPANY", APART FROM THE MARK AS SHOWN. SEC. 2(F) "SHINGLEMASTER".

FOR PROVIDING RECOGNITION BY WAY OF CERTIFICATE AND AWARDS TO DEMONSTRATE EXCELLENCE IN THE FIELD OF ROOFING (U.S. CLS. 100, 101 AND 107).

FIRST USE 1-0-2001; IN COMMERCE 1-0-2001.
KELLY MCCOY, EXAMINING ATTORNEY

CLASS 41—(Continued).

SN 78-781,257. MUSICGREMLIN, INC., NEW YORK, NY. FILED 12-27-2005.

Gremlist

THE MARK CONSISTS OF STANDARD CHARACTERS WITHOUT CLAIM TO ANY PARTICULAR FONT, STYLE, SIZE, OR COLOR.

FOR ENTERTAINMENT SERVICES NAMELY PROVIDING PRERECORDED MUSIC, INFORMATION ABOUT MUSIC AND COMMENTARY ABOUT MUSIC ALL VIA A WIRELESS NETWORK. (U.S. CLS. 100, 101 AND 107).

CARRIE GENOVESE, EXAMINING ATTORNEY

SN 78-782,571. WHITEN, LEON, CHICAGO, IL. FILED 12-29-2005.

SN 78-769,919. CANALES, VIRGILIO, LAREDO, TX. FILED 12-9-2005.

Stepper's Network

LIBERACIÓN

THE MARK CONSISTS OF STANDARD CHARACTERS WITHOUT CLAIM TO ANY PARTICULAR FONT, STYLE, SIZE, OR COLOR.

THE FOREIGN WORDING IN THE MARK TRANSLATES INTO ENGLISH AS "LIBERATION".

FOR ENTERTAINMENT IN THE NATURE OF A LIVE MUSICAL GROUP AND VISUAL AND AUDIO PERFORMANCES BY A MUSICAL GROUP; ENTERTAINMENT NAMELY, LIVE PERFORMANCES BY A MUSICAL BAND; ENTERTAINMENT, NAMELY LIVE MUSIC CONCERTS (U.S. CLS. 100, 101 AND 107).

FIRST USE 6-19-1990; IN COMMERCE 6-19-1990.
KELLY CHOE, EXAMINING ATTORNEY

THE MARK CONSISTS OF STANDARD CHARACTERS WITHOUT CLAIM TO ANY PARTICULAR FONT, STYLE, SIZE, OR COLOR.

OWNER OF U.S. REG. NO. 2,852,176.

NO CLAIM IS MADE TO THE EXCLUSIVE RIGHT TO USE "STEPPER'S", APART FROM THE MARK AS SHOWN. SEC. 2(F).

FOR CONDUCTING WORKSHOPS AND SEMINARS IN STEPPING; CONDUCTING WORKSHOPS AND SEMINARS IN DANCING; CONDUCTING ENTERTAINMENT EXHIBITIONS IN THE NATURE OF STEPPING CONTESTS; DANCE SCHOOLS; EDUCATIONAL SERVICES, NAMELY, PROVIDING ONE-ON-ONE INSTRUCTION IN THE FIELD OF STEP DANCING; ENTERTAINMENT IN THE NATURE OF STEP DANCE PERFORMANCES; ENTERTAINMENT IN THE NATURE OF STEP DANCE CONTESTS (U.S. CLS. 100, 101 AND 107).

FIRST USE 6-1-1999; IN COMMERCE 6-1-1999.
YONG KIM, EXAMINING ATTORNEY

CLASS 41—(Continued).

SN 78-784,840. BENNETT, DAWN J., CHEVY CHASE, MD.
FILED 1-4-2006.

DAWN J. BENNETT'S FAIRYTALE FINANCES

THE MARK CONSISTS OF STANDARD CHARACTERS WITHOUT CLAIM TO ANY PARTICULAR FONT, STYLE, SIZE, OR COLOR.

NO CLAIM IS MADE TO THE EXCLUSIVE RIGHT TO USE "FINANCES", APART FROM THE MARK AS SHOWN. THE NAME DAWN J. BENNETT IDENTIFIES A LIVING INDIVIDUAL WHOSE CONSENT IS OF RECORD.

FOR ENTERTAINMENT SERVICES IN THE NATURE OF RADIO PROGRAMS IN THE FIELD OF BUSINESS AND FINANCE AND ONGOING TELEVISION PROGRAMS IN THE FIELD OF BUSINESS AND FINANCE; CONDUCTING LECTURES, SEMINARS, CONFERENCES IN THE FIELD OF BUSINESS AND FINANCE (U.S. CLS. 100, 101 AND 107).

ASMAT KHAN, EXAMINING ATTORNEY

SN 78-797,416. TRADE CENTER MANAGEMENT ASSOCIATES, WASHINGTON, DC. FILED 1-23-2006.

WASHINGTON LINK

THE MARK CONSISTS OF STANDARD CHARACTERS WITHOUT CLAIM TO ANY PARTICULAR FONT, STYLE, SIZE, OR COLOR.

NO CLAIM IS MADE TO THE EXCLUSIVE RIGHT TO USE "WASHINGTON", APART FROM THE MARK AS SHOWN.

FOR SPECIAL EVENT AND RECEPTION PLANNING SERVICES; PRODUCTION OF SPECIAL EVENTS AND ENTERTAINMENT EVENTS, NAMELY, GALAS, EDUCATIONAL EXHIBITIONS, PRESIDENTIAL INAUGURATION PARTIES, AWARD PROGRAMS, WEDDINGS, DINNERS, RECEPTIONS, EDUCATIONAL CONFERENCES AND MEETINGS (U.S. CLS. 100, 101 AND 107).

WILLIAM VERHOSEK, EXAMINING ATTORNEY

CLASS 41—(Continued).

SN 78-807,644. FITNESS FOR HEALTH, ROCKVILLE, MD.
FILED 2-6-2006.

Fitness for health

THE MARK CONSISTS OF STANDARD CHARACTERS WITHOUT CLAIM TO ANY PARTICULAR FONT, STYLE, SIZE, OR COLOR.

SEC. 2(F).

FOR HEALTH CLUB SERVICES, NAMELY PROVIDING INSTRUCTION AND EQUIPMENT IN THE FIELD OF PHYSICAL EXERCISE; PHYSICAL EDUCATION SERVICES; PHYSICAL FITNESS CONSULTATION; PHYSICAL FITNESS INSTRUCTION; PROVIDING FITNESS AND EXERCISE FACILITIES (U.S. CLS. 100, 101 AND 107).

FIRST USE 6-1-1995; IN COMMERCE 6-1-1995.

AMY HELLA, EXAMINING ATTORNEY

SN 78-808,061. KIDZ ONLINE, INC., HERNDON, VA. FILED 2-6-2006.

KZO

THE MARK CONSISTS OF STANDARD CHARACTERS WITHOUT CLAIM TO ANY PARTICULAR FONT, STYLE, SIZE, OR COLOR.

FOR EDUCATIONAL SERVICES, PROVIDING ONLINE TRAINING IN THE FIELDS OF INFORMATION TECHNOLOGY; GEOSPATIAL TECHNOLOGY; ELECTRICAL ENERGY GENERATION; HEALTH AND NUTRITION, FINANCIAL LITERACY AND INVESTING; AND FOREIGN LANGUAGE MEDIA. (U.S. CLS. 100, 101 AND 107).

SUSAN RICHARDS, EXAMINING ATTORNEY

SN 78-816,143. KATILLAC, KELEE, KANSAS CITY, MO.
FILED 2-16-2006.

KIDS' SACRED CIRCLE

THE MARK CONSISTS OF STANDARD CHARACTERS WITHOUT CLAIM TO ANY PARTICULAR FONT, STYLE, SIZE, OR COLOR.

NO CLAIM IS MADE TO THE EXCLUSIVE RIGHT TO USE "KIDS", APART FROM THE MARK AS SHOWN.

FOR ARRANGING AND CONDUCTING OF WORKSHOPS AND SEMINARS IN THE FIELD OF HOME DECORATING, SELF HELP AND CREATIVITY PROJECTS AND INSTRUCTION IN THE FIELD OF HOME DECORATING, SELF HELP AND CREATIVITY PROJECTS (U.S. CLS. 100, 101 AND 107).

EVELYN BRADLEY, EXAMINING ATTORNEY

CLASS 41—(Continued).

SN 78-817,001. MATTEL, INC., EL SEGUNDO, CA. FILED 2-16-2006.

DIGITAL PLAY FOR GIRLS
TODAY!

THE MARK CONSISTS OF STANDARD CHARACTERS WITHOUT CLAIM TO ANY PARTICULAR FONT, STYLE, SIZE, OR COLOR.

FOR ENTERTAINMENT SERVICES, NAMELY, PROVIDING ONLINE GAMES, ONLINE CONTESTS AND ONLINE PRODUCT TRIVIA ABOUT GAMES AND TOYS, INTENDED FOR CONSUMERS OF ALL AGES (U.S. CLS. 100, 101 AND 107).

FIRST USE 1-30-2007; IN COMMERCE 1-30-2007.

ROBIN CHOSID, EXAMINING ATTORNEY

CLASS 41—(Continued).

SN 78-861,816. ST. LOUIS FAMILY CHURCH, INC., CHESTERFIELD, MO. FILED 4-14-2006.



ABOVE ENTERTAINMENT

NO CLAIM IS MADE TO THE EXCLUSIVE RIGHT TO USE "ENTERTAINMENT", APART FROM THE MARK AS SHOWN.

FOR AUDIO AND VIDEO RECORDING AND PRODUCTION (U.S. CLS. 100, 101 AND 107).

FIRST USE 4-1-2006; IN COMMERCE 4-1-2006.

RENEE SERVANCE, EXAMINING ATTORNEY

SN 78-831,281. QUAPAW TRIBE OF OKLAHOMA, QUAPAW, OK. FILED 3-7-2006.



NO CLAIM IS MADE TO THE EXCLUSIVE RIGHT TO USE "QUAPAW CASINO", APART FROM THE MARK AS SHOWN.

THE COLOR(S) RED, YELLOW, BLUE, BROWN, BLACK AND WHITE IS/ARE CLAIMED AS A FEATURE OF THE MARK.

THE COLORS RED, BLUE AND YELLOW APPEARS IN THE CIRCULAR DESIGN, THE COLORS BROWN AND RED APPEARS IN THE WORDS QUAPAW CASINO AND THE COLORS BLACK AND WHITE APPEARS IN THE FEATHERS.

FOR CASINO (U.S. CLS. 100, 101 AND 107).

AMOS T. MATTHEWS, JR., EXAMINING ATTORNEY

SN 78-865,385. RUYLE, ANGIE VALENCIA, BEAUMONT, CA. FILED 4-20-2006.

ANGIE B

THE MARK CONSISTS OF STANDARD CHARACTERS WITHOUT CLAIM TO ANY PARTICULAR FONT, STYLE, SIZE, OR COLOR.

THE NAME "ANGIE B" IDENTIFIES A LIVING INDIVIDUAL WHOSE CONSENT IS OF RECORD.

FOR ENTERTAINMENT IN THE NATURE OF LIVE PERFORMANCES BY A SINGER; ENTERTAINMENT IN THE NATURE OF VISUAL AND AUDIO PERFORMANCES, AND MUSICAL, VARIETY, NEWS AND COMEDY SHOWS; ENTERTAINMENT SERVICES, NAMELY, PERSONAL APPEARANCES BY A SINGER; ENTERTAINMENT SERVICES, NAMELY, PROVIDING A WEB SITE FEATURING MUSICAL PERFORMANCES, MUSICAL VIDEOS, RELATED FILM CLIPS, PHOTOGRAPHS, AND OTHER MULTIMEDIA MATERIALS; ENTERTAINMENT SERVICES, NAMELY, PROVIDING ON-LINE REVIEWS OF A SINGER; ENTERTAINMENT, NAMELY LIVE MUSIC CONCERTS (U.S. CLS. 100, 101 AND 107).

KATHERINE STOIDES, EXAMINING ATTORNEY

CLASS 41—(Continued).

SN 78-875,972. TRIBAL TONGUE L.L.C., PALM CITY, FL. FILED 5-3-2006.



THE STIPPLING IS FOR SHADING PURPOSES ONLY. THE MARK CONSISTS OF A TRIBAL DESIGN WITH FEATHERS AND THE STYLIZED TEXT TRIBAL TONGUE. FOR ENTERTAINMENT NAMELY, LIVE PERFORMANCES BY A MUSICAL BAND (U.S. CLS. 100, 101 AND 107).

DAVID HOFFMAN, EXAMINING ATTORNEY

CLASS 41—(Continued).

SN 78-913,151. COEXISTENCE, INC., SARASOTA, FL. FILED 6-21-2006.



THE COLOR(S) RED, BLUE, GREEN, ORANGE IS/ARE CLAIMED AS A FEATURE OF THE MARK.

THE MARK CONSISTS OF FOUR HUMAN FIGURES WITH OUT STRETCHED ARMS, FORMING A CIRCLE. EACH OF THE FIGURE ARE OF DIFFERENT COLORS WITH THE RED FIGURE ON THE BOTTOM RIGHT, BLUE FIGURE ON THE BOTTOM LEFT, GREEN FIGURE TOP LEFT, AND ORANGE FIGURE TOP RIGHT.

FOR EDUCATION SERVICES, NAMELY, PROVIDING PROGRAMS IN THE NATURE OF OUTDOOR ART EXHIBITIONS TO THE COMMUNITY IN THE FIELDS OF DIVERSITY AND ACCEPTANCE (U.S. CLS. 100, 101 AND 107).

FIRST USE 2-0-2004; IN COMMERCE 2-0-2004. MARTHA FROMM, EXAMINING ATTORNEY

SN 78-885,151. FRIENDS OF AFRICA - INTERNATIONAL, ASPEN, CO. FILED 5-16-2006.

Friends of Africa -
International

THE MARK CONSISTS OF STANDARD CHARACTERS WITHOUT CLAIM TO ANY PARTICULAR FONT, STYLE, SIZE, OR COLOR.

FOR ARRANGING AND CONDUCTING EDUCATIONAL CONFERENCES; CONDUCTING EDUCATIONAL EXHIBITIONS IN THE NATURE OF AFRICAN WILDLIFE, CULTURE AND ENVIRONMENT (U.S. CLS. 100, 101 AND 107).

FIRST USE 3-2-2001; IN COMMERCE 3-2-2001. KEVON CHISOLM, EXAMINING ATTORNEY

SN 78-917,322. ALPHAGIRLZ, HOUSTON, TX. FILED 6-26-2006.



NO CLAIM IS MADE TO THE EXCLUSIVE RIGHT TO USE "SPORTSPLEX FOR FEMALE ATHLETES", APART FROM THE MARK AS SHOWN.

THE MARK CONSISTS OF A FEMALE FLEXING HER MUSCLES AND THE STYLIZED TEXT OF THE WORDING ALPHAGIRLZ SPORTSPLEX FOR FEMALE ATHLETES.

FOR EDUCATIONAL SERVICES NAMELY CONDUCTING PROGRAMS IN THE FIELD OF HEALTH AND FITNESS FOR FEMALES; PHYSICAL FITNESS CONSULTATION; TRAINING SERVICES IN THE FIELD OF HEALTH AND FITNESS FOR FEMALES (U.S. CLS. 100, 101 AND 107).

FIRST USE 10-27-2006; IN COMMERCE 10-27-2006. DOMINICK J. SALEMI, EXAMINING ATTORNEY

CLASS 41—(Continued).

SN 78-921,476. APOLLO GROUP, INC., PHOENIX, AZ. FILED 6-30-2006.

ACCESS

THE MARK CONSISTS OF STANDARD CHARACTERS WITHOUT CLAIM TO ANY PARTICULAR FONT, STYLE, SIZE, OR COLOR.

OWNER OF U.S. REG. NOS. 2,953,536 AND 2,958,369.
FOR PROVIDING UNIVERSITY-LEVEL EDUCATIONAL COURSES OF INSTRUCTION IN THE FIELDS OF ACCOUNTING, ADMINISTRATION, BUSINESS, COUNSELING, CRIMINAL JUSTICE, EDUCATION, HEALTH CARE, HUMAN SERVICES, MANAGEMENT, MARKETING, NURSING, AND TECHNOLOGY VIA A GLOBAL COMPUTER NETWORK, AND DISTRIBUTION OF COURSE MATERIALS IN CONNECTION THEREWITH (U.S. CLS. 100, 101 AND 107).

FIRST USE 4-1-2006; IN COMMERCE 6-26-2006.
SANJEEV VOHRA, EXAMINING ATTORNEY

SN 78-921,497. APOLLO GROUP, INC., PHOENIX, AZ. FILED 6-30-2006.



OWNER OF U.S. REG. NOS. 2,953,536 AND 2,958,369.
FOR PROVIDING UNIVERSITY-LEVEL EDUCATIONAL COURSES OF INSTRUCTION IN THE FIELDS OF ACCOUNTING, ADMINISTRATION, BUSINESS, COUNSELING, CRIMINAL JUSTICE, EDUCATION, HEALTH CARE, HUMAN SERVICES, MANAGEMENT, MARKETING, NURSING, AND TECHNOLOGY VIA A GLOBAL COMPUTER NETWORK, AND DISTRIBUTION OF COURSE MATERIALS IN CONNECTION THEREWITH (U.S. CLS. 100, 101 AND 107).

FIRST USE 4-1-2006; IN COMMERCE 6-26-2006.
SANJEEV VOHRA, EXAMINING ATTORNEY

SN 78-924,117. SUTTON, CLINT WADE, KIRVIN, TX. FILED 7-7-2006.

STRAIGHTWAY

THE MARK CONSISTS OF STANDARD CHARACTERS WITHOUT CLAIM TO ANY PARTICULAR FONT, STYLE, SIZE, OR COLOR.

FOR ENTERTAINMENT, NAMELY, LIVE PERFORMANCES BY A MUSICAL BAND (U.S. CLS. 100, 101 AND 107).

FIRST USE 12-0-2005; IN COMMERCE 12-0-2005.
KHANH LE, EXAMINING ATTORNEY

CLASS 41—(Continued).

SN 78-926,471. AVIATOR SPORTS AND RECREATION, LLC, BROOKLYN, NY. FILED 7-11-2006.



THE MARK CONSISTS OF A WING DESIGN WITH A PROPELLER IN THE MIDDLE.

FOR ARRANGING AND CONDUCTING ATHLETIC COMPETITIONS; ARRANGING OF CONTESTS; ARRANGING OF EXHIBITIONS, SEMINARS AND CONFERENCES; BASEBALL CAMPS; BASKETBALL CAMPS; BOOKING OF ENTERTAINMENT HALLS; BOOKING OF SEATS FOR SHOWS AND BOOKING OF THEATRE TICKETS; CONCERT BOOKING; DANCE EVENTS; DANCE INSTRUCTION; DANCE SCHOOLS; DANCE STUDIOS; ENTERTAINMENT IN THE NATURE OF BASKETBALL GAMES; ENTERTAINMENT IN THE NATURE OF COMPETITIONS IN THE FIELD OF ICE SKATING, GYMNASTICS, DANCE, CHEERLEADING, ROLLER HOCKEY, VOLLEYBALL, BASKETBALL, SOCCER, FOOTBALL, LACROSSE, HOCKEY, FLAG FOOTBALL, FUTSAL (A TYPE OF BRAZILIAN INDOOR SOCCER), ROCK CLIMBING; ENTERTAINMENT IN THE NATURE OF DANCE PERFORMANCES; ENTERTAINMENT IN THE NATURE OF FOOTBALL GAMES; ENTERTAINMENT IN THE NATURE OF GYMNASTIC PERFORMANCES; ENTERTAINMENT IN THE NATURE OF HOCKEY GAMES; ENTERTAINMENT IN THE NATURE OF SOCCER GAMES; ENTERTAINMENT IN THE NATURE OF TRACK AND FIELD COMPETITIONS; ENTERTAINMENT IN THE NATURE OF VISUAL AND AUDIO PERFORMANCES, NAMELY, MUSICAL BAND, ROCK GROUP, GYMNASTIC, DANCE, AND BALLET PERFORMANCES; ENTERTAINMENT IN THE NATURE OF WEIGHT LIFTING COMPETITIONS; ENTERTAINMENT IN THE NATURE OF WRESTLING CONTESTS; ENTERTAINMENT IN THE NATURE OF BASKETBALL LEAGUE PLAY, BASKETBALL TOURNAMENT PLAY, RECREATIONAL SKATING, PROFESSIONAL, COLLEGIATE, HIGH SCHOOL, AND COMMUNITY SUPPORTED SPORTS COMPETITIONS, ENTERTAINMENT MAGIC SHOWS, SKATING EXHIBITIONS, SKATING EXPOS, SUMMER BASKETBALL CAMPS, AND FESTIVALS FEATURING A VARIETY OF ACTIVITIES, NAMELY SPORTING EVENTS, ART EXHIBITIONS, FLEA MARKETS, AND ETHNIC DANCES; ENTERTAINMENT IN THE NATURE OF ROLLER HOCKEY, VOLLEYBALL, BASKETBALL, SOCCER, FUTSAL (A TYPE OF BRAZILIAN INDOOR SOCCER), FOOTBALL, LACROSSE, HOCKEY, FLAG FOOTBALL GAMES; ENTERTAINMENT IN THE NATURE OF HOCKEY, ROLLER HOCKEY, SKATING, BASKETBALL, VOLLEYBALL, FLAG FOOTBALL, SOCCER, FUTSAL (A TYPE OF BRAZILIAN INDOOR SOCCER), BADMINTON, AND GYMNASTICS TOURNAMENTS; ENTERTAINMENT SERVICES IN THE NATURE OF A WRESTLING CLUB; ENTERTAINMENT SERVICES, NAMELY, ARRANGING AND CONDUCTING OF COMPETITIONS FOR CHEERLEADING, DANCE, ICE SKATING, GYMNASTICS, ROLLER HOCKEY, ICE HOCKEY, VOLLEYBALL, BASKETBALL, SOCCER, FOOTBALL, LACROSSE, FLAG FOOTBALL, FUTSAL (A TYPE OF BRAZILIAN INDOOR SOCCER) AND ROCK CLIMBING; ENTERTAINMENT SERVICES, NAMELY, CONDUCTING CONTESTS; ENTERTAINMENT SERVICES, NAMELY, PARTICIPATION IN BASKETBALL LEAGUE PLAY, BASKETBALL TOURNAMENTS, BASKETBALL EDUCATIONAL CLINICS, RECREATIONAL SKATING, ROLLER HOCKEY, PROFESSIONAL SKATING EXHIBITIONS, SPECIAL SPORTING EVENTS, RECREATIONAL SPORT PLAY, ATHLETIC PERFORMANCE TRAINING, PHYSICAL THERAPY, AND MARTIAL ARTS; ENTERTAINMENT, NAMELY LIVE PERFORMANCES BY MUSICAL BANDS; GYMNASIUMS; HEALTH CLUB SERVICES, NAMELY PROVIDING INSTRUCTION AND EQUIPMENT IN THE FIELD OF PHYSICAL EXERCISE; ICE

CLASS 41—(Continued).

SKATING INSTRUCTION; KARATE INSTRUCTION; MARTIAL ARTS INSTRUCTION; OPERATING OF MARTIAL ARTS' SCHOOLS; OPERATION OF SPORTS CAMPS; ORGANISATION AND PROVISION OF SPORTS INSTALLATIONS FOR FIGURE AND SPEED SKATING CHAMPIONSHIPS; ORGANISATION OF GAMES; ORGANISATION OF SPORTS EVENTS IN THE FIELD OF FOOTBALL; ORGANISING AND HOLDING FIGURE AND SPEED SKATING CHAMPIONSHIPS AND COMPETITIONS; ORGANIZATION OF DANCING EVENTS; ORGANIZING COMMUNITY FESTIVALS FEATURING A VARIETY OF ACTIVITIES, NAMELY SPORTING EVENTS, ART EXHIBITIONS, FLEA MARKETS, ETHNIC DANCES AND THE LIKE; ORGANIZING COMMUNITY SPORTING AND CULTURAL EVENTS; ORGANIZING EXHIBITIONS FOR PROFESSIONAL SPORTING EVENTS; ORGANIZING SPORTING EVENTS, NAMELY, TRIATHLONS; ORGANIZING SPORTING EVENTS, NAMELY, BASKETBALL LEAGUES, BASKETBALL TOURNAMENTS, BASKETBALL COMPETITIONS, AND BASKETBALL GAMES; PARTY PLANNING; PERSONAL COACHING SERVICES IN THE FIELD OF GYMNASTICS, CHEERLEADING, DANCE, HOCKEY, BASKETBALL, VOLLEYBALL, BADMINTON, SUMMER CAMPS, MARTIAL ARTS, PHYSICAL THERAPY, ATHLETIC PERFORMANCE TRAINING; PERSONAL TRAINER SERVICES; PERSONAL TRAINING SERVICES, NAMELY, STRENGTH AND CONDITIONING TRAINING; PHYSICAL EDUCATION SERVICES; PHYSICAL FITNESS CONSULTATION; PHYSICAL FITNESS INSTRUCTION; PRESENTATION OF LIVE SHOW PERFORMANCES; PRESENTATION OF MUSICAL PERFORMANCE; PROVIDING FACILITIES FOR MOVIES, SHOWS, PLAYS, MUSIC OR EDUCATIONAL TRAINING; PROVIDING FACILITIES FOR RECREATION ACTIVITIES; PROVIDING FACILITIES FOR SPORTS TOURNAMENTS; PROVIDING FACILITIES FOR HOCKEY, ICE SKATING, SOCCER, BASKETBALL, VOLLEYBALL, FUTSAL (A TYPE OF BRAZILIAN INDOOR SOCCER), FLAG FOOTBALL, AND FOOTBALL TOURNAMENTS; PROVIDING FITNESS AND EXERCISE FACILITIES; PROVIDING GYMNASIUMS; PROVIDING GYMNASTIC FACILITIES; PROVIDING INFORMATION IN THE FIELD OF EXERCISE TRAINING; PROVIDING RECREATIONAL AREAS IN THE NATURE OF CHILDREN'S PLAY AREAS; PROVIDING SKATING RINKS; PROVIDING SPORTS FACILITIES; PROVIDING TRACK AND FIELD FACILITIES; PROVIDING VARIOUS FACILITIES FOR AN ARRAY OF SPORTING EVENTS, SPORTS AND ATHLETIC COMPETITIONS AND AWARDS PROGRAMMES; PUBLICATION OF BROCHURES; RECREATIONAL CAMPS; RECREATIONAL SERVICES IN THE NATURE OF BASKETBALL TOURNAMENTS, BASKETBALL LEAGUES, PROFESSIONAL SKATING EXHIBITIONS, EDUCATION BASKETBALL CLINICS, SKATING, ROLLER HOCKEY, SPECIAL SPORTING EVENTS, BASKETBALL, VOLLEYBALL, BADMINTON, SUMMER CAMP, GYMNASTICS, DANCE, CHEERLEADING, ROCK CLIMBING, FOOTBALL, LACROSSE, ENTERTAINMENT MAGIC SHOWS, PHYSICAL FITNESS EXPOS, FLAG FOOTBALL, FUTSAL (A TYPE OF BRAZILIAN INDOOR SOCCER), SOCCER, AFTER SCHOOL BASKETBALL PROGRAMS, YOGA, PILATES, PHYSICAL FITNESS CONVENTIONS, BIRTHDAY PARTIES, AND FESTIVALS FEATURING A VARIETY OF ACTIVITIES, NAMELY SPORTING EVENTS, ART EXHIBITIONS, FLEA MARKETS, AND ETHNIC DANCES; YOGA INSTRUCTION (U.S. CLS. 100, 101 AND 107).

FIRST USE 5-11-2005; IN COMMERCE 5-11-2005.

CAROL SPILS, EXAMINING ATTORNEY

CLASS 41—(Continued).

SN 78-926,525. AVIATOR SPORTS AND RECREATION, LLC, BROOKLYN, NY. FILED 7-11-2006.

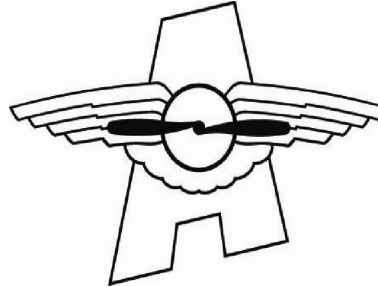

THE MARK CONSISTS OF AN OUTLINED LETTER A WITH A WING AND PROPELLER DESIGN IN THE MIDDLE OF THE A.

FOR ARRANGING AND CONDUCTING ATHLETIC COMPETITIONS; ARRANGING OF CONTESTS; ARRANGING OF EXHIBITIONS, SEMINARS AND CONFERENCES; BASEBALL CAMPS; BASKETBALL CAMPS; BOOKING OF ENTERTAINMENT HALLS; BOOKING OF SEATS FOR SHOWS AND BOOKING OF THEATRE TICKETS; CONCERT BOOKING; DANCE EVENTS; DANCE INSTRUCTION; DANCE SCHOOLS; DANCE STUDIOS; ENTERTAINMENT IN THE NATURE OF BASKETBALL GAMES; ENTERTAINMENT IN THE NATURE OF COMPETITIONS IN THE FIELD OF ICE SKATING, GYMNASTICS, DANCE, CHEERLEADING, ROLLER HOCKEY, VOLLEYBALL, BASKETBALL, SOCCER, FOOTBALL, LACROSSE, HOCKEY, FLAG FOOTBALL, FUTSAL (A TYPE OF BRAZILIAN INDOOR SOCCER), ROCK CLIMBING; ENTERTAINMENT IN THE NATURE OF DANCE PERFORMANCES; ENTERTAINMENT IN THE NATURE OF FOOTBALL GAMES; ENTERTAINMENT IN THE NATURE OF GYMNASTIC PERFORMANCES; ENTERTAINMENT IN THE NATURE OF HOCKEY GAMES; ENTERTAINMENT IN THE NATURE OF SOCCER GAMES; ENTERTAINMENT IN THE NATURE OF TRACK AND FIELD COMPETITIONS; ENTERTAINMENT IN THE NATURE OF VISUAL AND AUDIO PERFORMANCES, NAMELY, MUSICAL BAND, ROCK GROUP, GYMNASTIC, DANCE, AND BALLET PERFORMANCES; ENTERTAINMENT IN THE NATURE OF WEIGHT LIFTING COMPETITIONS; ENTERTAINMENT IN THE NATURE OF WRESTLING CONTESTS; ENTERTAINMENT IN THE NATURE OF BASKETBALL LEAGUE PLAY, BASKETBALL TOURNAMENT PLAY, RECREATIONAL SKATING, PROFESSIONAL, COLLEGIATE, HIGH SCHOOL, AND COMMUNITY SUPPORTED SPORTS COMPETITIONS, ENTERTAINMENT MAGIC SHOWS, SKATING EXHIBITIONS, SKATING EXPOS, SUMMER BASKETBALL CAMPS, AND FESTIVALS FEATURING A VARIETY OF ACTIVITIES, NAMELY SPORTING EVENTS, ART EXHIBITIONS, FLEA MARKETS, AND ETHNIC DANCES; ENTERTAINMENT IN THE NATURE OF ROLLER HOCKEY, VOLLEYBALL, BASKETBALL, SOCCER, FUTSAL (A TYPE OF BRAZILIAN INDOOR SOCCER), FOOTBALL, LACROSSE, HOCKEY, FLAG FOOTBALL GAMES; ENTERTAINMENT IN THE NATURE OF ROLLER HOCKEY, VOLLEYBALL, BASKETBALL, SOCCER, FUTSAL (A TYPE OF BRAZILIAN INDOOR SOCCER), FOOTBALL, LACROSSE, HOCKEY, FLAG FOOTBALL GAMES; ENTERTAINMENT IN THE NATURE OF HOCKEY, ROLLER HOCKEY, SKATING, BASKETBALL, VOLLEYBALL, FLAG FOOTBALL, SOCCER, FUTSAL (A TYPE OF BRAZILIAN INDOOR SOCCER), BADMINTON, AND GYMNASTICS TOURNAMENTS; ENTERTAINMENT SERVICES IN THE NATURE OF A WRESTLING CLUB; ENTERTAINMENT SERVICES, NAMELY, ARRANGING AND CONDUCTING OF COMPETITIONS FOR CHEERLEADING, DANCE, ICE SKATING, GYMNASTICS, ROLLER HOCKEY, ICE HOCKEY, VOLLEYBALL, BASKETBALL, SOCCER, FOOTBALL, LACROSSE, FLAG FOOTBALL, FUTSAL (A TYPE OF BRAZILIAN INDOOR SOCCER) AND ROCK CLIMBING; ENTERTAINMENT SERVICES, NAMELY, CONDUCTING CONTESTS; ENTERTAINMENT SERVICES, NAMELY, PARTICIPATION IN BASKETBALL LEAGUE PLAY, BASKETBALL TOURNAMENTS, BASKETBALL EDUCATIONAL CLINICS,

CLASS 41—(Continued).

RECREATIONAL SKATING, ROLLER HOCKEY, PROFESSIONAL SKATING EXHIBITIONS, SPECIAL SPORTING EVENTS, RECREATIONAL SPORT PLAY, ATHLETIC PERFORMANCE TRAINING, PHYSICAL THERAPY, AND MARTIAL ARTS; ENTERTAINMENT, NAMELY LIVE PERFORMANCES BY MUSICAL BANDS; GYMNASIUMS; HEALTH CLUB SERVICES, NAMELY PROVIDING INSTRUCTION AND EQUIPMENT IN THE FIELD OF PHYSICAL EXERCISE; ICE SKATING INSTRUCTION; KARATE INSTRUCTION; MARTIAL ARTS INSTRUCTION; OPERATING OF MARTIAL ARTS' SCHOOLS; OPERATION OF SPORTS CAMPS; ORGANISATION AND PROVISION OF SPORTS INSTALLATIONS FOR FIGURE AND SPEED SKATING CHAMPIONSHIPS; ORGANISATION OF GAMES; ORGANISATION OF SPORTS EVENTS IN THE FIELD OF FOOTBALL; ORGANISING AND HOLDING FIGURE AND SPEED SKATING CHAMPIONSHIPS AND COMPETITIONS; ORGANIZATION OF DANCING EVENTS; ORGANIZING COMMUNITY FESTIVALS FEATURING A VARIETY OF ACTIVITIES, NAMELY SPORTING EVENTS, ART EXHIBITIONS, FLEA MARKETS, ETHNIC DANCES AND THE LIKE; ORGANIZING COMMUNITY SPORTING AND CULTURAL EVENTS; ORGANIZING EXHIBITIONS FOR PROFESSIONAL SPORTING EVENTS; ORGANIZING SPORTING EVENTS, NAMELY, TRIATHLONS; ORGANIZING SPORTING EVENTS, NAMELY, BASKETBALL LEAGUES, BASKETBALL TOURNAMENTS, BASKETBALL COMPETITIONS, AND BASKETBALL GAMES; PARTY PLANNING; PERSONAL COACHING SERVICES IN THE FIELD OF GYMNASTICS, CHEERLEADING, DANCE, HOCKEY, BASKETBALL, VOLLEYBALL, BADMINTON, SUMMER CAMPS, MARTIAL ARTS, PHYSICAL THERAPY, ATHLETIC PERFORMANCE TRAINING; PERSONAL TRAINER SERVICES; PERSONAL TRAINING SERVICES, NAMELY, STRENGTH AND CONDITIONING TRAINING; PHYSICAL EDUCATION SERVICES; PHYSICAL FITNESS CONSULTATION; PHYSICAL FITNESS INSTRUCTION; PRESENTATION OF LIVE SHOW PERFORMANCES; PRESENTATION OF MUSICAL PERFORMANCE; PROVIDING FACILITIES FOR MOVIES, SHOWS, PLAYS, MUSIC OR EDUCATIONAL TRAINING; PROVIDING FACILITIES FOR RECREATION ACTIVITIES; PROVIDING FACILITIES FOR SPORTS TOURNAMENTS; PROVIDING FACILITIES FOR HOCKEY, ICE SKATING, SOCCER, BASKETBALL, VOLLEYBALL, FUTSAL (A TYPE OF BRAZILIAN INDOOR SOCCER), FLAG FOOTBALL, AND FOOTBALL TOURNAMENTS; PROVIDING FITNESS AND EXERCISE FACILITIES; PROVIDING GYMNASIUMS; PROVIDING GYMNASIUM FACILITIES; PROVIDING INFORMATION IN THE FIELD OF EXERCISE TRAINING; PROVIDING RECREATIONAL AREAS IN THE NATURE OF CHILDREN'S PLAY AREAS; PROVIDING SKATING RINKS; PROVIDING SPORTS FACILITIES; PROVIDING TRACK AND FIELD FACILITIES; PROVIDING VARIOUS FACILITIES FOR AN ARRAY OF SPORTING EVENTS, SPORTS AND ATHLETIC COMPETITIONS AND AWARDS PROGRAMMES; PUBLICATION OF BROCHURES; RECREATIONAL CAMPS; RECREATIONAL SERVICES IN THE NATURE OF BASKETBALL TOURNAMENTS, BASKETBALL LEAGUES, PROFESSIONAL SKATING EXHIBITIONS, EDUCATION BASKETBALL CLINICS, SKATING, ROLLER HOCKEY, SPECIAL SPORTING EVENTS, BASKETBALL, VOLLEYBALL, BADMINTON, SUMMER CAMP, GYMNASTICS, DANCE, CHEERLEADING, ROCK CLIMBING, FOOTBALL, LACROSSE, ENTERTAINMENT MAGIC SHOWS, PHYSICAL FITNESS EXPOS, FLAG FOOTBALL, FUTSAL (A TYPE OF BRAZILIAN INDOOR SOCCER), SOCCER, AFTER SCHOOL BASKETBALL PROGRAMS, YOGA, PILATES, PHYSICAL FITNESS CONVENTIONS, BIRTHDAY PARTIES, AND FESTIVALS FEATURING A VARIETY OF ACTIVITIES, NAMELY SPORTING EVENTS, ART EXHIBITIONS, FLEA MARKETS, AND ETHNIC DANCES; YOGA INSTRUCTION (U.S. CLS. 100, 101 AND 107).

FIRST USE 5-11-2005; IN COMMERCE 5-11-2005.

CAROL SPILS, EXAMINING ATTORNEY

CLASS 41—(Continued).

SN 78-926,556. GRAHAM, MAURICE, RICHMOND, VA. FILED 7-11-2006.

Call and Identity Coaching

THE MARK CONSISTS OF STANDARD CHARACTERS WITHOUT CLAIM TO ANY PARTICULAR FONT, STYLE, SIZE, OR COLOR.

NO CLAIM IS MADE TO THE EXCLUSIVE RIGHT TO USE "COACHING", APART FROM THE MARK AS SHOWN.

FOR PREPARING, ADMINISTERING AND ANALYZING EXAMINATIONS IN THE FIELD OF CHRISTIAN RELIGION, INCLUDING SUCH SERVICES ACCESSED IN-PERSON OR THROUGH A GLOBAL COMPUTER NETWORK; PERSONAL COACHING SERVICES IN THE FIELD OF CHRISTIAN RELIGION; EDUCATIONAL SERVICES, NAMELY, CONFERENCES, WORKSHOPS, INDIVIDUAL INSTRUCTION AND SEMINARS IN THE FIELD OF CHRISTIAN RELIGION, AND DISTRIBUTION OF COURSE MATERIAL IN CONNECTION THEREWITH, ACCESSED IN-PERSON OR THROUGH A GLOBAL COMPUTER NETWORK; EDUCATIONAL CONSULTING SERVICES FOR TRAINING, TEACHING AND EQUIPPING CHRISTIAN LEADERS (U.S. CLS. 100, 101 AND 107).

FIRST USE 9-7-2004; IN COMMERCE 9-24-2004.

INGRID C. EULIN, EXAMINING ATTORNEY

SN 78-926,563. AVIATOR SPORTS AND RECREATION, LLC, BROOKLYN, NY. FILED 7-11-2006.

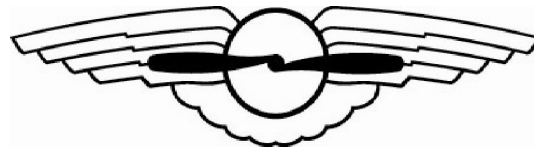

THE MARK CONSISTS OF AN OUTLINED WING DESIGN WITH A PROPELLER IN THE MIDDLE.

FOR ARRANGING AND CONDUCTING ATHLETIC COMPETITIONS; ARRANGING OF CONTESTS; ARRANGING OF EXHIBITIONS, SEMINARS AND CONFERENCES; BASEBALL CAMPS; BASKETBALL CAMPS; BOOKING OF ENTERTAINMENT HALLS; BOOKING OF SEATS FOR SHOWS AND BOOKING OF THEATRE TICKETS; CONCERT BOOKING; DANCE EVENTS; DANCE INSTRUCTION; DANCE SCHOOLS; DANCE STUDIOS; ENTERTAINMENT IN THE NATURE OF BASKETBALL GAMES; ENTERTAINMENT IN THE NATURE OF COMPETITIONS IN THE FIELD OF ICE SKATING, GYMNASTICS, DANCE, CHEERLEADING, ROLLER HOCKEY, VOLLEYBALL, BASKETBALL, SOCCER, FOOTBALL, LACROSSE, HOCKEY, FLAG FOOTBALL, FUTSAL (A TYPE OF BRAZILIAN INDOOR SOCCER), ROCK CLIMBING; ENTERTAINMENT IN THE NATURE OF DANCE PERFORMANCES; ENTERTAINMENT IN THE NATURE OF FOOTBALL GAMES; ENTERTAINMENT IN THE NATURE OF GYMNASIUM PERFORMANCES; ENTERTAINMENT IN THE NATURE OF HOCKEY GAMES; ENTERTAINMENT IN THE NATURE OF SOCCER GAMES; ENTERTAINMENT IN THE NATURE OF TRACK AND FIELD COMPETITIONS; ENTERTAINMENT IN THE NATURE OF VISUAL AND AUDIO PERFORMANCES, NAMELY, MUSICAL BAND, ROCK GROUP, GYMNASIUM, DANCE, AND BALLET PERFORMANCES; ENTERTAINMENT IN THE NATURE OF WEIGHT LIFTING COMPETITIONS; ENTERTAINMENT IN THE NATURE OF WRESTLING CONTESTS; ENTERTAINMENT IN THE NATURE OF BASKETBALL LEAGUE PLAY, BASKETBALL TOURNAMENT PLAY, RECREATIONAL SKATING, PROFESSIONAL, COLLEGIATE, HIGH SCHOOL, AND COMMUNITY SUP-

CLASS 41—(Continued).

PORTED SPORTS COMPETITIONS, ENTERTAINMENT MAGIC SHOWS, SKATING EXHIBITIONS, SKATING EXPOS, SUMMER BASKETBALL CAMPS, AND FESTIVALS FEATURING A VARIETY OF ACTIVITIES, NAMELY, SPORTING EVENTS, ART EXHIBITIONS, FLEA MARKETS, AND ETHNIC DANCES; ENTERTAINMENT IN THE NATURE OF ROLLER HOCKEY, VOLLEYBALL, BASKETBALL, SOCCER, FUTSAL (A TYPE OF BRAZILIAN INDOOR SOCCER), FOOTBALL, LACROSSE, HOCKEY, FLAG FOOTBALL GAMES; ENTERTAINMENT IN THE NATURE OF ROLLER HOCKEY, VOLLEYBALL, BASKETBALL, SOCCER, FUTSAL (A TYPE OF BRAZILIAN INDOOR SOCCER), FOOTBALL, LACROSSE, HOCKEY, FLAG FOOTBALL GAMES; ENTERTAINMENT IN THE NATURE OF HOCKEY, ROLLER HOCKEY, SKATING, BASKETBALL, VOLLEYBALL, FLAG FOOTBALL, SOCCER, FUTSAL (A TYPE OF BRAZILIAN INDOOR SOCCER), BADMINTON, AND GYMNASTICS TOURNAMENTS; ENTERTAINMENT SERVICES IN THE NATURE OF A WRESTLING CLUB, ENTERTAINMENT SERVICES, NAMELY, ARRANGING AND CONDUCTING OF COMPETITIONS FOR CHEERLEADING, DANCE, ICE SKATING, GYMNASTICS, ROLLER HOCKEY, ICE HOCKEY, VOLLEYBALL, BASKETBALL, SOCCER, FOOTBALL, LACROSSE, FLAG FOOTBALL, FUTSAL (A TYPE OF BRAZILIAN INDOOR SOCCER) AND ROCK CLIMBING; ENTERTAINMENT SERVICES, NAMELY, CONDUCTING CONTESTS; ENTERTAINMENT SERVICES, NAMELY, PARTICIPATION IN BASKETBALL LEAGUE PLAY, BASKETBALL TOURNAMENTS, BASKETBALL EDUCATIONAL CLINICS, RECREATIONAL SKATING, ROLLER HOCKEY, PROFESSIONAL SKATING EXHIBITIONS, SPECIAL SPORTING EVENTS, RECREATIONAL SPORT PLAY, ATHLETIC PERFORMANCE TRAINING, PHYSICAL THERAPY, AND MARTIAL ARTS; ENTERTAINMENT, NAMELY, LIVE PERFORMANCES BY MUSICAL BANDS; GYMNASIUMS; HEALTH CLUB SERVICES, NAMELY, PROVIDING INSTRUCTION AND EQUIPMENT IN THE FIELD OF PHYSICAL EXERCISE; ICE SKATING INSTRUCTION; KARATE INSTRUCTION; MARTIAL ARTS INSTRUCTION; OPERATING OF MARTIAL ARTS' SCHOOLS; OPERATION OF SPORTS CAMPS; ORGANIZATION AND PROVISION OF SPORTS INSTALLATIONS FOR FIGURE AND SPEED SKATING CHAMPIONSHIPS; ORGANIZATION OF GAMES; ORGANIZATION OF SPORTS EVENTS IN THE FIELD OF FOOTBALL; ORGANIZING AND HOLDING FIGURE AND SPEED SKATING CHAMPIONSHIPS AND COMPETITIONS; ORGANIZATION OF DANCING EVENTS; ORGANIZING COMMUNITY FESTIVALS FEATURING A VARIETY OF ACTIVITIES, NAMELY, SPORTING EVENTS, ART EXHIBITIONS, FLEA MARKETS, ETHNIC DANCES AND THE LIKE; ORGANIZING COMMUNITY SPORTING AND CULTURAL EVENTS; ORGANIZING EXHIBITIONS FOR PROFESSIONAL SPORTING EVENTS; ORGANIZING SPORTING EVENTS, NAMELY, TRIATHLONS; ORGANIZING SPORTING EVENTS, NAMELY, BASKETBALL LEAGUES, BASKETBALL TOURNAMENTS, BASKETBALL COMPETITIONS, AND BASKETBALL GAMES; PARTY PLANNING; PERSONAL COACHING SERVICES IN THE FIELD OF GYMNASTICS, CHEERLEADING, DANCE, HOCKEY, BASKETBALL, VOLLEYBALL, BADMINTON, SUMMER CAMPS, MARTIAL ARTS, PHYSICAL THERAPY, ATHLETIC PERFORMANCE TRAINING; PERSONAL TRAINER SERVICES; PERSONAL TRAINING SERVICES, NAMELY, STRENGTH AND CONDITIONING TRAINING; PHYSICAL EDUCATION SERVICES; PHYSICAL FITNESS CONSULTATION; PHYSICAL FITNESS INSTRUCTION; PRESENTATION OF LIVE SHOW PERFORMANCES; PRESENTATION OF MUSICAL PERFORMANCE; PROVIDING FACILITIES FOR MOVIES, SHOWS, PLAYS, MUSIC OR EDUCATIONAL TRAINING; PROVIDING FACILITIES FOR RECREATION ACTIVITIES; PROVIDING FACILITIES FOR SPORTS TOURNAMENTS; PROVIDING FACILITIES FOR HOCKEY, ICE SKATING, SOCCER, BASKETBALL, VOLLEYBALL, FUTSAL (A TYPE OF BRAZILIAN INDOOR SOCCER), FLAG FOOTBALL, AND FOOTBALL TOURNAMENTS; PROVIDING FITNESS AND EXERCISE FACILITIES; PROVIDING GYMNASIUMS; PROVIDING GYMNASTIC FACILITIES; PROVIDING INFORMATION IN THE FIELD OF EXERCISE TRAINING; PROVIDING RECREATIONAL AREAS IN THE NATURE OF CHILDREN'S PLAY AREAS; PROVIDING SKATING RINKS; PROVIDING SPORTS FACILITIES; PROVIDING TRACK

CLASS 41—(Continued).

AND FIELD FACILITIES; PROVIDING VARIOUS FACILITIES FOR AN ARRAY OF SPORTING EVENTS, SPORTS AND ATHLETIC COMPETITIONS AND AWARDS PROGRAMMES; PUBLICATION OF BROCHURES; RECREATIONAL CAMPS; RECREATIONAL SERVICES IN THE NATURE OF BASKETBALL TOURNAMENTS, BASKETBALL LEAGUES, PROFESSIONAL SKATING EXHIBITIONS, EDUCATION BASKETBALL CLINICS, SKATING, ROLLER HOCKEY, SPECIAL SPORTING EVENTS, BASKETBALL, VOLLEYBALL, BADMINTON, SUMMER CAMP, GYMNASTICS, DANCE, CHEERLEADING, ROCK CLIMBING, FOOTBALL, LACROSSE, ENTERTAINMENT MAGIC SHOWS, PHYSICAL FITNESS EXPOSE, FLAG FOOTBALL, FUTSAL (A TYPE OF BRAZILIAN INDOOR SOCCER), SOCCER, AFTER SCHOOL BASKETBALL PROGRAMS, YOGA, PILATES, PHYSICAL FITNESS CONVENTIONS, BIRTHDAY PARTIES, AND FESTIVALS FEATURING A VARIETY OF ACTIVITIES, NAMELY, SPORTING EVENTS, ART EXHIBITIONS, FLEA MARKETS, AND ETHNIC DANCES; YOGA INSTRUCTION (U.S. CLS. 100, 101 AND 107).

FIRST USE 5-11-2005; IN COMMERCE 5-11-2005.
CAROL SPILS, EXAMINING ATTORNEY

SN 78-926,813. TWENTIETH CENTURY FOX FILM CORPORATION, LOS ANGELES, CA. FILED 7-11-2006.

CRISTINA'S COURT

THE MARK CONSISTS OF STANDARD CHARACTERS WITHOUT CLAIM TO ANY PARTICULAR FONT, STYLE, SIZE, OR COLOR.

NO CLAIM IS MADE TO THE EXCLUSIVE RIGHT TO USE "COURT", APART FROM THE MARK AS SHOWN.

THE NAME(S), PORTRAIT(S), AND/OR SIGNATURE(S) SHOWN IN THE MARK IDENTIFIES CRISTINA PEREZ GONZALEZ, WHOSE CONSENT(S) TO REGISTER IS SUBMITTED.

FOR ENTERTAINMENT SERVICES IN THE NATURE OF A TELEVISION SERIES IN THE FIELD OF LAW (U.S. CLS. 100, 101 AND 107).

NICHOLAS ALTREE, EXAMINING ATTORNEY

CLASS 41—(Continued).

SN 78-938,669. USA BASKETBALL, COLORADO SPRINGS, CO. FILED 7-27-2006.

CLASS 41—(Continued).

SN 78-938,686. SOCIETY OF PLASTICS ENGINEERS, INC., BROOKFIELD, CT. FILED 7-27-2006.

THERMOPLASTIC ELASTOMERS
TOPICAL CONFERENCE

PLEDGE ALLEGIANCE TO THE
GAME

THE MARK CONSISTS OF STANDARD CHARACTERS WITHOUT CLAIM TO ANY PARTICULAR FONT, STYLE, SIZE, OR COLOR.

NO CLAIM IS MADE TO THE EXCLUSIVE RIGHT TO USE "TOPICAL CONFERENCE", APART FROM THE MARK AS SHOWN.

SEC. 2(F).

FOR EDUCATIONAL SERVICES, NAMELY, PROVIDING SEMINARS IN THE FIELD OF PLASTICS ENGINEERING (U.S. CLS. 100, 101 AND 107).

FIRST USE 5-0-1996; IN COMMERCE 5-0-1996.

INGRID C. EULIN, EXAMINING ATTORNEY

THE MARK CONSISTS OF STANDARD CHARACTERS WITHOUT CLAIM TO ANY PARTICULAR FONT, STYLE, SIZE, OR COLOR.

FOR ENTERTAINMENT AND EDUCATIONAL SERVICES IN THE NATURE OF ONGOING TELEVISION AND RADIO PROGRAMS IN THE FIELD OF BASKETBALL AND RENDERING LIVE BASKETBALL GAMES AND BASKETBALL EXHIBITIONS; PRODUCTION AND DISTRIBUTION OF RADIO AND TELEVISION BROADCASTS OF BASKETBALL GAMES, BASKETBALL EVENTS AND PROGRAMS IN THE FIELD OF BASKETBALL; CONDUCTING AND ARRANGING BASKETBALL CLINICS AND CAMPS, COACHES CLINICS AND CAMPS, DANCE TEAM CLINICS AND CAMPS AND BASKETBALL EVENTS; ENTERTAINMENT SERVICES IN THE NATURE OF PERSONAL APPEARANCES BY A COSTUMED MASCOT AND/OR DANCE TEAM AT BASKETBALL GAMES AND EXHIBITIONS, CLINICS, CAMPS, PROMOTIONS, AND OTHER BASKETBALL-RELATED EVENTS, SPECIAL EVENTS AND PARTIES; FAN CLUB SERVICES; ENTERTAINMENT SERVICES, NAMELY, PROVIDING A WEBSITE FEATURING MULTIMEDIA MATERIAL IN THE NATURE OF TELEVISION HIGHLIGHTS, INTERACTIVE TELEVISION HIGHLIGHTS, VIDEO RECORDINGS, VIDEO STREAM RECORDINGS, INTERACTIVE VIDEO HIGHLIGHT SELECTIONS, RADIO PROGRAMS, RADIO HIGHLIGHTS, AND AUDIO RECORDINGS IN THE FIELD OF BASKETBALL; PROVIDING BASKETBALL NEWS IN THE NATURE OF INFORMATION, STATISTICS, AND TRIVIA ABOUT BASKETBALL; ON-LINE NON-DOWNLOADABLE GAMES, NAMELY, COMPUTER GAMES, VIDEO GAMES, INTERACTIVE VIDEO GAMES, ACTION SKILL GAMES, ARCADE GAMES, ADULTS' AND CHILDREN'S PARTY GAMES, BOARD GAMES, PUZZLES, AND TRIVIA GAMES; PROVIDING ON-LINE NON-DOWNLOADABLE PUBLICATIONS IN THE NATURE OF MAGAZINES, GUIDES, NEWSLETTERS, COLORING BOOKS, GAME SCHEDULES IN THE FIELD OF BASKETBALL THAT CAN BE PRINTED OVER THE INTERNET; PROVIDING AN ONLINE COMPUTER DATABASE IN THE FIELD OF BASKETBALL (U.S. CLS. 100, 101 AND 107).

CHRISTOPHER BUONGIORNO, EXAMINING ATTORNEY

SN 78-938,982. BRENT HATCH, SOUTH PASADENA, CA. FILED 7-27-2006.

FAMILY 911

THE MARK CONSISTS OF STANDARD CHARACTERS WITHOUT CLAIM TO ANY PARTICULAR FONT, STYLE, SIZE, OR COLOR.

NO CLAIM IS MADE TO THE EXCLUSIVE RIGHT TO USE "FAMILY", APART FROM THE MARK AS SHOWN.

FOR ENTERTAINMENT NAMELY, PRODUCTION OF CHILD CARE AND CHILD REARING SHOWS (U.S. CLS. 100, 101 AND 107).

FIRST USE 1-1-2006; IN COMMERCE 1-1-2006.

CARYN GLASSER, EXAMINING ATTORNEY

CLASS 41—(Continued).

SN 78-939,867. VILA SOL II - EMPREENDIMENTOS TUR-
ISTICOS, SA, VILAMOURA, PORTUGAL, FILED 7-28-
2006.



"THE FOREIGN WORDING IN THE MARK TRANS-
LATES INTO ENGLISH AS SUN VILLAGE."

FOR PROVIDING SPORTS FACILITIES; PROVIDING
VARIOUS FACILITIES FOR AN ARRAY OF SPORTING
EVENTS, SPORTS AND ATHLETIC COMPETITIONS
AND AWARDS PROGRAMS; SPORT CAMPS; ENTER-
TAINMENT IN THE NATURE OF GOLF TOURNA-
MENTS; ENTERTAINMENT IN THE NATURE OF
SPORT TOURNAMENTS; FITTING OF GOLF CLUBS
TO INDIVIDUAL USERS; GOLF CADDIE SERVICES;
GOLF COURSES; GOLF INSTRUCTION; PROVIDING A
WEBSITE THROUGH WHICH GOLFERS RESERVE TEE
TIMES AT GOLF COURSES AND INFORMATION
ABOUT GOLF COURSES AND GOLF TOURNAMENTS;
PROVIDING GOLF FACILITIES; RENTAL OF GOLF
EQUIPMENT. (U.S. CLS. 100, 101 AND 107).
SAIMA MAKHDOOM, EXAMINING ATTORNEY

CLASS 41—(Continued).

SN 78-943,205. SOURCE MEDIA INC., NEW YORK, NY.
FILED 8-2-2006.

**NRS CENTER FOR COMPLIANCE
PROFESSIONALS**

THE MARK CONSISTS OF STANDARD CHARACTERS
WITHOUT CLAIM TO ANY PARTICULAR FONT, STYLE,
SIZE, OR COLOR.

OWNER OF U.S. REG. NOS. 2,084,118, 2,084,121 AND
2,084,122.

NO CLAIM IS MADE TO THE EXCLUSIVE RIGHT TO
USE "CENTER FOR COMPLIANCE PROFESSIONALS",
APART FROM THE MARK AS SHOWN.

FOR PROFESSIONAL EDUCATIONAL SERVICES,
NAMELY, CLASSES, TRAINING SESSIONS, SEMINARS
AND ONLINE SEMINARS IN THE FIELD OF FINAN-
CIAL REGULATIONS FOR FINANCIAL AND COMPLI-
ANCE PROFESSIONALS (U.S. CLS. 100, 101 AND 107).
FIRST USE 10-11-2004; IN COMMERCE 10-11-2004.

KRISTINA MORRIS, EXAMINING ATTORNEY

SN 78-944,028. OPEN ENTERPRISES, INC., SAN FRANCIS-
CO, CA. FILED 8-3-2006.

SN 78-941,094. DOUBLE EAGLE PRODUCTION, LLC, LAW-
RENCEVILLE, GA. FILED 7-31-2006.

GOOD VIBRATIONS

REAL GUYS...REAL GOLF

THE MARK CONSISTS OF STANDARD CHARACTERS
WITHOUT CLAIM TO ANY PARTICULAR FONT, STYLE,
SIZE, OR COLOR.

NO CLAIM IS MADE TO THE EXCLUSIVE RIGHT TO
USE "GOLF", APART FROM THE MARK AS SHOWN.

FOR ENTERTAINMENT IN THE NATURE OF ON-
GOING TELEVISION PROGRAMS IN THE FIELD OF
GOLF (U.S. CLS. 100, 101 AND 107).

PETER CHENG, EXAMINING ATTORNEY

THE MARK CONSISTS OF STANDARD CHARACTERS
WITHOUT CLAIM TO ANY PARTICULAR FONT, STYLE,
SIZE, OR COLOR.

OWNER OF U.S. REG. NO. 2,040,239.

FOR PLANNING AND CONDUCTING ENTERTAIN-
MENT EXHIBITIONS IN THE NATURE OF FILM
COMPETITIONS AND FILM FESTIVALS, ALL IN THE
FIELD OF HUMAN SEXUALITY (U.S. CLS. 100, 101 AND
107).

MICHAEL WEBSTER, EXAMINING ATTORNEY

CLASS 41—(Continued).

SN 78-946,052. DIANE CAMERON LAWRENCE, LOUISVILLE, KY. FILED 8-7-2006.

DOWN TO EARTH PRODUCTIONS

THE MARK CONSISTS OF STANDARD CHARACTERS WITHOUT CLAIM TO ANY PARTICULAR FONT, STYLE, SIZE, OR COLOR.

OWNER OF U.S. REG. NO. 2,016,211.

NO CLAIM IS MADE TO THE EXCLUSIVE RIGHT TO USE "PRODUCTIONS", APART FROM THE MARK AS SHOWN.

FOR EDUCATIONAL AND ENTERTAINMENT SERVICES, NAMELY, THE PRODUCTION OF RADIO AND TELEVISION PROGRAMS; PROVIDING A WEB SITE FEATURING RADIO AND TELEVISION PROGRAMS, AUDIO AND VIDEO CLIPS, OR NEWS ARTICLES, FEATURE STORIES, ESSAYS OR COMMENTARY ON THE SUBJECTS OF CONTEMPORARY PUBLIC AFFAIRS AND HISTORICAL TOPICS, INCLUDING THE ENVIRONMENT AND NATURAL HISTORY, ANIMAL WELFARE, WOMEN'S ISSUES, SOCIAL AND POLITICAL ISSUES, AND PROFILES OF MODERN AND HISTORICAL FIGURES (U.S. CLS. 100, 101 AND 107).

GILBERT SWIFT, EXAMINING ATTORNEY

SN 78-947,406. STONE CREEK ENTERTAINMENT LLC, RIDGEFIELD, CT. FILED 8-8-2006.

KARIZMAC

THE MARK CONSISTS OF STANDARD CHARACTERS WITHOUT CLAIM TO ANY PARTICULAR FONT, STYLE, SIZE, OR COLOR.

FOR ONLINE SERVICES, NAMELY PROVIDING ONLINE COMPUTER GAMES FOR GIRLS AND YOUNG WOMEN TO SHARE OPINIONS, THOUGHTS, EXPRESSIONS AND IDEAS ON A VARIETY OF SUBJECTS; EDUCATIONAL SERVICES, NAMELY PROVIDING ONLINE ACTIVITIES IN THE NATURE OF EDUCATIONAL GAMES FOR GIRLS AND YOUNG WOMEN TO SHARE OPINIONS, THOUGHTS, EXPRESSIONS AND IDEAS ON A VARIETY OF SUBJECTS (U.S. CLS. 100, 101 AND 107).

NAAKWAMA ANKRAH, EXAMINING ATTORNEY

CLASS 41—(Continued).

SN 78-947,550. RTM PRODUCTIONS, INC., FRANKLIN, TN. FILED 8-8-2006.

POWERBLOCK

THE MARK CONSISTS OF STANDARD CHARACTERS WITHOUT CLAIM TO ANY PARTICULAR FONT, STYLE, SIZE, OR COLOR.

OWNER OF U.S. REG. NOS. 2,982,794 AND 2,984,460.

FOR ENTERTAINMENT SERVICES, NAMELY, A GROUP OF TELEVISION PROGRAMS AIRING CONSECUTIVELY WITH RELATED CONTENT OR A RELATED THEME OF AUTOMOBILES. (U.S. CLS. 100, 101 AND 107).

JOANNA DUKOVIC, EXAMINING ATTORNEY

SN 78-948,361. SARATHAN RECORDS, LLC, LOS ANGELES, CA. FILED 8-9-2006.



NO CLAIM IS MADE TO THE EXCLUSIVE RIGHT TO USE "RECORDS", APART FROM THE MARK AS SHOWN.

FOR ENTERTAINMENT SERVICES, NAMELY, PRODUCTION OF MUSICAL SOUND RECORDINGS, MUSICAL VIDEO RECORDINGS, AND AUDIO-VISUAL RECORDINGS (U.S. CLS. 100, 101 AND 107).

FIRST USE 11-1-1999; IN COMMERCE 11-1-1999.

ROBERT STRUCK, EXAMINING ATTORNEY

CLASS 41—(Continued).

SN 78-948,811. B.A.S.S. (IP), LLC, BRISTOL, CT. FILED 8-9-2006.

BASSSPOTTER

THE MARK CONSISTS OF STANDARD CHARACTERS WITHOUT CLAIM TO ANY PARTICULAR FONT, STYLE, SIZE, OR COLOR.

OWNER OF U.S. REG. NOS. 1,348,785, 3,099,239 AND OTHERS.

FOR AN ONGOING TELEVISION PROGRAM FEATURING ANIMATED TRACKING OF THE MOVEMENTS OF A VARIETY OF FISH SPECIES VIA A RADIO TRANSMITTER (U.S. CLS. 100, 101 AND 107).

SUSAN STIGLITZ, EXAMINING ATTORNEY

SN 78-952,545. SICA, DANIELE, SALERNO, ITALY, FILED 8-15-2006.

PROCORE & FIT

THE MARK CONSISTS OF STANDARD CHARACTERS WITHOUT CLAIM TO ANY PARTICULAR FONT, STYLE, SIZE, OR COLOR.

NO CLAIM IS MADE TO THE EXCLUSIVE RIGHT TO USE "FIT", APART FROM THE MARK AS SHOWN.

FOR PHYSICAL FITNESS CONSULTATION; PHYSICAL FITNESS INSTRUCTION; PROVIDING FITNESS AND EXERCISE FACILITIES; PERSONAL TRAINING SERVICES, NAMELY, STRENGTH AND CONDITIONING TRAINING; PERSONAL COACHING SERVICES IN THE FIELD OF PHYSICAL FITNESS AND PERSONAL TRAINING (U.S. CLS. 100, 101 AND 107).

JILL C. ALT, EXAMINING ATTORNEY

SN 78-954,160. BRIGHT HORIZONS FOUNDATION FOR CHILDREN, NASHVILLE, TN. FILED 8-17-2006.

BRIGHT SPACE

THE MARK CONSISTS OF STANDARD CHARACTERS WITHOUT CLAIM TO ANY PARTICULAR FONT, STYLE, SIZE, OR COLOR.

NO CLAIM IS MADE TO THE EXCLUSIVE RIGHT TO USE "SPACE", APART FROM THE MARK AS SHOWN.

FOR CHARITABLE SERVICES, NAMELY PROVIDING RECREATIONAL AREAS IN THE NATURE OF CHILDREN'S PLAY AREAS; CHARITABLE SERVICES, NAMELY, PROVIDING SPORTING GOODS, TOYS, SCHOOL SUPPLIES, BOOKS, ARTS AND CRAFTS AND EDUCATIONAL MATERIALS TO CHILDREN (U.S. CLS. 100, 101 AND 107).

FIRST USE 5-2-1999; IN COMMERCE 3-16-2000.

PRISCILLA MILTON, EXAMINING ATTORNEY

CLASS 41—(Continued).

SN 78-955,188. WESSELS, JOSEPH H., HIGH RIDGE, MO. FILED 8-18-2006.

SPORTSBANC

THE MARK CONSISTS OF STANDARD CHARACTERS WITHOUT CLAIM TO ANY PARTICULAR FONT, STYLE, SIZE, OR COLOR.

FOR SPORT ENTERTAINMENT SERVICES, NAMELY, AMUSEMENT FACILITIES THAT PROVIDE ACTIVITIES TO ALLOW SPORTS FANS TO RESEARCH DATA FOR A SPECIFIC ATHLETE, AND THEN CREATE, SAVE, AND DISPLAY DIGITAL PROFILES THAT CONTAIN PHOTOS, AUDIO EXCERPTS, STATISTICS, AND VIDEO IMAGES OF THE ATHLETE AS WELL AS OTHER PERSONAL NOTES FROM THE SPORTS FAN WHO IS CREATING THE DIGITAL PROFILE (U.S. CLS. 100, 101 AND 107).

JENNIFER KRISP, EXAMINING ATTORNEY

SN 78-958,846. KAHLER SLATER ARCHITECTS, INC., MILWAUKEE, WI. FILED 8-23-2006.

**TRANSFER-MATIONAL
ARTICULATION**

THE MARK CONSISTS OF STANDARD CHARACTERS WITHOUT CLAIM TO ANY PARTICULAR FONT, STYLE, SIZE, OR COLOR.

NO CLAIM IS MADE TO THE EXCLUSIVE RIGHT TO USE "ARTICULATION", APART FROM THE MARK AS SHOWN.

FOR CONSULTING SERVICES IN THE FIELD OF UNIVERSITY AND COLLEGE ENROLLMENT (U.S. CLS. 100, 101 AND 107).

FIRST USE 10-4-2004; IN COMMERCE 10-4-2004.

FRANK LATTUCA, EXAMINING ATTORNEY

SN 78-961,900. INSIDE ULTRASOUND, INC., PEARCE, AZ. FILED 8-28-2006.

**The Peripheral Vascular
Pocket Reference**

THE MARK CONSISTS OF STANDARD CHARACTERS WITHOUT CLAIM TO ANY PARTICULAR FONT, STYLE, SIZE, OR COLOR.

NO CLAIM IS MADE TO THE EXCLUSIVE RIGHT TO USE "POCKET REFERENCE", APART FROM THE MARK AS SHOWN.

FOR PUBLICATION OF TEXT BOOKS (U.S. CLS. 100, 101 AND 107).

LINDA POWELL, EXAMINING ATTORNEY

CLASS 41—(Continued).

SN 78-962,453. XM SATELLITE RADIO INC., WASHINGTON, DC. FILED 8-29-2006.

THE VIRUS

THE MARK CONSISTS OF STANDARD CHARACTERS WITHOUT CLAIM TO ANY PARTICULAR FONT, STYLE, SIZE, OR COLOR.

FOR ENTERTAINMENT SERVICES, NAMELY, PROVIDING ON-GOING RADIO PROGRAMS AND DIGITAL AUDIO RADIO SERVICES FEATURING MUSIC, SPORTS, TALK, NEWS AND DATA VIA SATELLITE AND THE INTERNET (U.S. CLS. 100, 101 AND 107).

MARK T. MULLEN, EXAMINING ATTORNEY

SN 78-965,086. DAVENPORT, BRANDON (IN HIS CAPACITY AS THE PARENT, AND ON BEHALF OF, MADISON DAVENPORT), LOS ANGELES, CA. FILED 8-31-2006.

Shapesville

THE MARK CONSISTS OF STANDARD CHARACTERS WITHOUT CLAIM TO ANY PARTICULAR FONT, STYLE, SIZE, OR COLOR.

FOR ENTERTAINMENT SERVICES IN THE NATURE OF ONGOING CHILDREN'S ANIMATION TELEVISION PROGRAMS (U.S. CLS. 100, 101 AND 107).

LAURA HAMMEL, EXAMINING ATTORNEY

SN 78-969,600. WHEELER, FAITH, SAN FRANCISCO, CA. FILED 9-7-2006.

TV DINNER

THE MARK CONSISTS OF STANDARD CHARACTERS WITHOUT CLAIM TO ANY PARTICULAR FONT, STYLE, SIZE, OR COLOR.

FOR ENTERTAINMENT SERVICES, NAMELY, PROVIDING AN ONGOING TELEVISION PROGRAM IN THE FIELDS OF FOOD, COOKING, RECIPES, THE CULINARY ARTS AND COMEDY AND PROVIDING A PROGRAM IN THE FIELD OF FOOD, COOKING, RECIPES, THE CULINARY ARTS AND COMEDY VIA A GLOBAL COMPUTER NETWORK (U.S. CLS. 100, 101 AND 107).

KIMBERLY FRYE, EXAMINING ATTORNEY

CLASS 41—(Continued).

SN 78-970,221. VIACOM INTERNATIONAL INC., NEW YORK, NY. FILED 9-8-2006.

VIDEOLOGIA

THE MARK CONSISTS OF STANDARD CHARACTERS WITHOUT CLAIM TO ANY PARTICULAR FONT, STYLE, SIZE, OR COLOR.

FOR ENTERTAINMENT SERVICES IN THE NATURE OF TELEVISION SERIES, FEATURING LIVE ACTION, COMEDY AND DRAMA; PROVIDING ONLINE INFORMATION IN THE FIELD OF ENTERTAINMENT CONCERNING TELEVISION PROGRAMS (U.S. CLS. 100, 101 AND 107).

MATTHEW MCDOWELL, EXAMINING ATTORNEY

SN 78-970,793. AMINOV, GAVRIEL R, NORTH MIAMI, FL. FILED 9-9-2006.

VEIN

THE MARK CONSISTS OF STANDARD CHARACTERS WITHOUT CLAIM TO ANY PARTICULAR FONT, STYLE, SIZE, OR COLOR.

FOR ENTERTAINMENT IN THE NATURE OF ONGOING TELEVISION PROGRAMS IN THE FIELD OF MUSIC VIDEOS; ENTERTAINMENT IN THE NATURE OF VISUAL AND AUDIO PERFORMANCES, AND MUSICAL, VARIETY, NEWS AND COMEDY SHOWS; ENTERTAINMENT SERVICES NAMELY LIVE, TELEVISED AND MOVIE APPEARANCES BY VEIN, PROFESSIONAL ENTERTAINER; ENTERTAINMENT SERVICES, NAMELY, PERSONAL APPEARANCES BY VEIN, A PROFESSIONAL ENTERTAINER; ENTERTAINMENT SERVICES, NAMELY, PROVIDING A RADIO PROGRAM IN THE FIELD OF HIP HOP, RAP AND POP MUSIC VIA A GLOBAL COMPUTER NETWORK; ENTERTAINMENT SERVICES, NAMELY, PROVIDING A WEB SITE FEATURING MUSICAL PERFORMANCES, MUSICAL VIDEOS, RELATED FILM CLIPS, PHOTOGRAPHS, AUDIO AND VIDEO PROSE PRESENTATIONS AND OTHER MULTIMEDIA MATERIALS; ENTERTAINMENT SERVICES, NAMELY, PROVIDING AN ON-LINE COMPUTER GAME; ENTERTAINMENT SERVICES, NAMELY, PROVIDING ON-LINE COMPUTER GAMES; ENTERTAINMENT SERVICES, NAMELY, PROVIDING PRERECORDED MUSIC, INFORMATION IN THE FIELD OF MUSIC, AND COMMENTARY AND ARTICLES ABOUT MUSIC, ALL ON-LINE VIA A GLOBAL COMPUTER NETWORK; ENTERTAINMENT, NAMELY A CONTINUING HIP HOP RAP AND POP MUSIC SHOW BROADCAST OVER TELEVISION, SATELLITE, AUDIO, AND VIDEO MEDIA; ENTERTAINMENT, NAMELY LIVE MUSIC CONCERTS; ENTERTAINMENT, NAMELY LIVE PERFORMANCES BY MUSICAL BANDS; RADIO PRODUCTION; RADIO ENTERTAINMENT SERVICES, NAMELY RADIO PROGRAMS FEATURING PERFORMANCES BY VEIN, A PROFESSIONAL ENTERTAINER; ENTERTAINMENT NAMELY A CONTINUING HIP HOP RAP, HOUSE AND POP MUSIC SHOW BROADCAST OVER TELEVISION, SATELLITE, AUDIO AND VIDEO MEDIA; ORGANIZING EXHIBITIONS FOR ENTERTAINMENT SERVICES BY VEIN, A PROFESSIONAL ENTERTAINER (U.S. CLS. 100, 101 AND 107).

FIRST USE 9-1-2002; IN COMMERCE 9-1-2002.

CAROLYN GRAY, EXAMINING ATTORNEY

CLASS 41—(Continued).

SN 78-970,926. MALINI SASTRI, LEXINGTON, MA. FILED 9-10-2006.

jaggery

THE MARK CONSISTS OF STANDARD CHARACTERS WITHOUT CLAIM TO ANY PARTICULAR FONT, STYLE, SIZE, OR COLOR.

FOR LIVE PERFORMANCES BY A MUSICAL BAND (U.S. CLS. 100, 101 AND 107).

FIRST USE 6-0-2004; IN COMMERCE 10-30-2004.
AMEETA JORDAN, EXAMINING ATTORNEY

SN 78-971,003. ROAD RUNNERS CLUB OF AMERICA, COLUMBIA, MD. FILED 9-11-2006.

WE RUN THE NATION

THE MARK CONSISTS OF STANDARD CHARACTERS WITHOUT CLAIM TO ANY PARTICULAR FONT, STYLE, SIZE, OR COLOR.

FOR ENTERTAINMENT SERVICES, NAMELY, ORGANIZING RUNNERS CLUBS; RUNNING CLUBS (U.S. CLS. 100, 101 AND 107).

MORENO, PAUL, EXAMINING ATTORNEY

SN 78-973,748. SMITH, CHASE GARRETT, AUSTIN, TX. FILED 9-13-2006.

MEASURE UP

THE MARK CONSISTS OF STANDARD CHARACTERS WITHOUT CLAIM TO ANY PARTICULAR FONT, STYLE, SIZE, OR COLOR.

FOR ENTERTAINMENT IN THE NATURE OF ON-GOING TELEVISION PROGRAMS IN THE FIELD OF SPORT FISHING AND ANGLING (U.S. CLS. 100, 101 AND 107).

JANICE L. MCMORROW, EXAMINING ATTORNEY

CLASS 41—(Continued).

SN 78-978,003. BFTV, LLC, LOSANGELES, CA. FILED 4-28-2006.

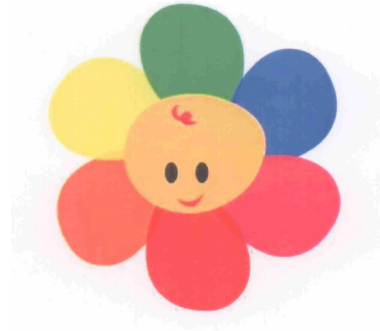

THE COLOR(S) TAN, YELLOW, BLACK, RED, PINK, PURPLE, LIGHT GREEN, ORANGE IS/ARE CLAIMED AS A FEATURE OF THE MARK.

THE MARK CONSISTS OF THE DESIGN OF A FLOWER, WITH THE COLOR TAN APPEARING IN THE MIDDLE OF THE FLOWER, AND THE COLOR BLACK AS THE "EYES" AND THE COLOR RED AS THE "MOUTH" AND "HAIR" DESIGNS THEREIN; THE PETALS OF THE FLOWERS AS IN THE COLORS PINK, PURPLE, LIGHT GREEN, YELLOW, ORANGE AND RED SEPARATELY.

FOR PRODUCTION OF TELEVISION PROGRAMS IN THE FIELD OF CHILDREN'S EDUCATION AND ENTERTAINMENT; DISTRIBUTION OF TELEVISION PROGRAMS FOR OTHERS IN THE FIELD OF CHILDREN'S EDUCATION AND ENTERTAINMENT; ENTERTAINMENT SERVICES IN THE NATURE OF ON-GOING TELEVISION PROGRAMS IN THE FIELD OF CHILDREN'S EDUCATION AND ENTERTAINMENT; EDITING OR RECORDING OF SOUNDS AND IMAGES; PRODUCTION OF SOUND AND MUSIC VIDEO RECORDINGS; PROVIDING A WEBSITE FEATURING CHILDREN'S EDUCATION AND ENTERTAINMENT (U.S. CLS. 100, 101 AND 107).

FIRST USE 2-28-2006; IN COMMERCE 5-11-2006.
DAWN HAN, EXAMINING ATTORNEY

SN 79-032,526. CCP HF., COMPANY NR. 450697-3469, ICELAND, FILED 6-9-2006.

EVE ONLINE

THE MARK CONSISTS OF STANDARD CHARACTERS WITHOUT CLAIM TO ANY PARTICULAR FONT, STYLE, SIZE, OR COLOR.

PRIORITY DATE OF 12-23-2005 IS CLAIMED.

OWNER OF INTERNATIONAL REGISTRATION 0907570 DATED 6-9-2006, EXPIRES 6-9-2016.

OWNER OF U.S. REG. NO. 2,805,666.

NO CLAIM IS MADE TO THE EXCLUSIVE RIGHT TO USE "ONLINE", APART FROM THE MARK AS SHOWN.

FOR ENTERTAINMENT SERVICES, NAMELY, PROVIDING ONLINE NETWORKED AND INTERACTIVE COMPUTER GAMES VIA THE INTERNET. (U.S. CLS. 100, 101 AND 107).

DANIEL BRODY, EXAMINING ATTORNEY

CLASS 42—SCIENTIFIC, COMPUTER AND LEGAL SERVICES

SN 76-035,462. CUSTOM LASIK INC., RICHMOND HILL, ONTARIO, CANADA, FILED 4-26-2000.

WAVEFRONT GUIDED LASIK

NO CLAIM IS MADE TO THE EXCLUSIVE RIGHT TO USE "GUIDED LASIK", APART FROM THE MARK AS SHOWN.

FOR MEDICAL AND EYE SURGICAL SERVICES (U.S. CLS. 100 AND 101).

JEFF DEFORD, EXAMINING ATTORNEY

SN 76-181,452. FOXBORO COMPANY, THE, FOXBORO, MA, FILED 12-15-2000.

PLUG AND PRODUCE

FOR PROVIDING COMPUTER SUPPORT AND SERVICES RELATING TO ENHANCING THE CAPABILITY OF PROVIDING COMPLETE CUSTOM SOLUTIONS AND TECHNOLOGY RECOMMENDATIONS IN THE FIELDS OF FACTORY AUTOMATION AND INDUSTRIAL PROCESS MANAGEMENT THROUGH AN OPEN SYSTEMS ARCHITECTURE OF HARDWARE AND SOFTWARE INCLUDING WEB-ENABLED ENTERPRISE INFORMATION MANAGEMENT (U.S. CLS. 100 AND 101).

FIRST USE 8-16-1999; IN COMMERCE 8-16-1999.
ZACHARY BELLO, EXAMINING ATTORNEY

SN 76-671,275. COMMUNITY ASSOCIATION WEB SOLUTIONS, INC., DBA MYCOMMUNITYASSOCIATION.COM, PLANTATION, FL. FILED 1-8-2007.



FOR COMPUTER CONSULTING SERVICES, NAMELY, DESIGN, CREATION, MAINTENANCE, UPDATING AND HOSTING OF WEBSITES FOR MEMBERSHIP ORGANIZATIONS FOR MAINTAINING THEIR WEBSITES (U.S. CLS. 100 AND 101).

FIRST USE 12-26-2006. THE MARK WAS FIRST USED ANYWHERE IN A DIFFERENT FORM OTHER THAN THAT SOUGHT TO BE REGISTERED ON 07/20/2006.; IN COMMERCE 12-26-2006.

DAWN FELDMAN, EXAMINING ATTORNEY

CLASS 42—(Continued).

SN 77-002,802. HOLOGRAM PTY, LTD., DBA HOLOGRAM BI, TOORAK GARDENS, AUSTRALIA, FILED 9-19-2006.



THE COLOR(S) BLUE, GREEN AND ORANGE IS/ARE CLAIMED AS A FEATURE OF THE MARK.

THE MARK CONSISTS OF THE FANCIFUL DESIGN OF A UPPERCASE LETTER "H", JUXTOPOSED INTO A CUBE DESIGN, WITH THE TOP "H" IN THE COLOR ORANGE, THE RIGHT SIDE "H" IN THE COLOR BLUE AND THE LEFT SIDE "H" IN THE COLOR GREEN.

FOR COMPUTER PROGRAMMING FOR OTHERS; RENTAL AND LEASING OF COMPUTER PROGRAMS AND COMPUTER SOFTWARE; COMPUTER SERVICES, NAMELY, IMPLEMENTING COMPUTER PROGRAMS IN COMPUTER NETWORKS FOR OTHERS; INSTALLATION AND MAINTENANCE OF COMPUTER SOFTWARE; AND COMPUTER SOFTWARE CONSULTATION SERVICES (U.S. CLS. 100 AND 101).

STEVEN R. FINE, EXAMINING ATTORNEY

SN 77-003,584. CIS DATA SYSTEMS, INC., OAKLAND, CA, FILED 9-20-2006.

MARKETREACH

THE MARK CONSISTS OF STANDARD CHARACTERS WITHOUT CLAIM TO ANY PARTICULAR FONT, STYLE, SIZE, OR COLOR.

FOR E-MAIL SYSTEM DESIGN AND IMPLEMENTATION FOR OTHERS (U.S. CLS. 100 AND 101).

FIRST USE 1-17-2006; IN COMMERCE 1-17-2006.

KIMBERLY PERRY, EXAMINING ATTORNEY

CLASS 42—(Continued).

SN 77-012,098. AMERICAN SOCIETY FOR BARIATRIC SURGERY, GAINESVILLE, FL. FILED 10-2-2006.

CBN

THE MARK CONSISTS OF STANDARD CHARACTERS WITHOUT CLAIM TO ANY PARTICULAR FONT, STYLE, SIZE, OR COLOR.

FOR ACCREDITATION SERVICES, NAMELY, DEVELOPING, EVALUATING, AND TESTING STANDARDS FOR BARIATRIC SURGICAL NURSING FOR THE PURPOSE OF ACCREDITATION (U.S. CLS. 100 AND 101).

ESTHER A. BORSUK, EXAMINING ATTORNEY

SN 77-024,997. INICIS CO., LTD., SEOUL, REPUBLIC OF KOREA, FILED 10-19-2006.

ONE PAYMENT ALLIANCE

THE MARK CONSISTS OF STANDARD CHARACTERS WITHOUT CLAIM TO ANY PARTICULAR FONT, STYLE, SIZE, OR COLOR.

FOR COMPUTER SOFTWARE DEVELOPMENT, COMPUTER PROGRAMMING, MAINTENANCE OF COMPUTER SOFTWARE, HOSTING WEB SITES OF OTHERS, CONVERSION OF DATA OR DOCUMENTS FROM PHYSICAL TO ELECTRONIC MEDIA, INSTALLATION OF COMPUTER SOFTWARE, COMPUTER SOFTWARE DESIGN FOR OTHERS, DATA CONVERSION OF COMPUTER PROGRAMS AND DATA, DUPLICATION OF COMPUTER PROGRAMS, RECOVERY OF COMPUTER DATA, RENTAL OF COMPUTER SOFTWARE, COMPUTER SYSTEMS ANALYSIS, RENTAL AND TRANSLATION OF COMPUTER PROGRAMS, UPDATING OF COMPUTER SOFTWARE FOR OTHERS (U.S. CLS. 100 AND 101).

MARCIE MILONE, EXAMINING ATTORNEY

CLASS 42—(Continued).

SN 77-026,147. LOGIC INFORMATION SYSTEMS, INC., INVER GROVE HEIGHTS, MN. FILED 10-20-2006.

LOGIC

THE MARK CONSISTS OF STANDARD CHARACTERS WITHOUT CLAIM TO ANY PARTICULAR FONT, STYLE, SIZE, OR COLOR.

OWNER OF U.S. REG. NO. 2,822,845.
FOR CONSULTING SERVICES IN THE FIELD OF DESIGN, SELECTION, CUSTOMIZATION, IMPLEMENTATION AND USE OF HARDWARE, SOFTWARE AND EMERGING TECHNOLOGIES IN THE FIELDS OF RETAIL AND HEALTHCARE SERVICES; DESIGN, DEVELOPMENT, INTEGRATION AND IMPLEMENTATION SERVICES RELATING TO HARDWARE, SOFTWARE AND EMERGING TECHNOLOGIES IN THE FIELDS OF RETAIL AND HEALTHCARE SERVICES (U.S. CLS. 100 AND 101).

DANIEL RUSSELL, EXAMINING ATTORNEY

SN 77-030,351. HARVEST TEC, INC., HUDSON, WI. FILED 10-26-2006.

HARVEST TEC

THE MARK CONSISTS OF STANDARD CHARACTERS WITHOUT CLAIM TO ANY PARTICULAR FONT, STYLE, SIZE, OR COLOR.

NO CLAIM IS MADE TO THE EXCLUSIVE RIGHT TO USE "TEC", APART FROM THE MARK AS SHOWN.

FOR DESIGN SERVICES FOR OTHERS IN THE AGRICULTURAL FIELD, NAMELY DESIGN OF APPLICATION, PRESERVATIVE, AND FIELD MAPPING EQUIPMENT FOR HAY (U.S. CLS. 100 AND 101).

FIRST USE 11-1-1983; IN COMMERCE 11-1-1983.

ELIZABETH BEYER, EXAMINING ATTORNEY

SN 77-032,102. GOSEETELL NETWORK, INC., PORTLAND, OR. FILED 10-30-2006.

ALTEREGOTRIPS

THE MARK CONSISTS OF STANDARD CHARACTERS WITHOUT CLAIM TO ANY PARTICULAR FONT, STYLE, SIZE, OR COLOR.

FOR ONLINE COMPUTER SERVICES, NAMELY, PROVIDING SEARCH ENGINES FOR OBTAINING TRAVEL-RELATED INFORMATION ON A COMPUTER NETWORK; AND DESIGN, CREATION AND MAINTENANCE OF TRAVEL-RELATED WEBSITES FOR OTHERS (U.S. CLS. 100 AND 101).

CAROLINE WOOD, EXAMINING ATTORNEY

CLASS 42—(Continued).

SN 77-039,432. AOL LLC, DULLES, VA. FILED 11-8-2006.

BLUESTRING

THE MARK CONSISTS OF STANDARD CHARACTERS WITHOUT CLAIM TO ANY PARTICULAR FONT, STYLE, SIZE, OR COLOR.

FOR COMPUTER SERVICES, NAMELY, PROVIDING TEMPORARY USE OF NON-DOWNLOADABLE COMPUTER SOFTWARE FOR ORGANIZING AND SHARING DATA, INFORMATION, TEXT, IMAGES, GRAPHICS, VIDEOS, MUSIC, AND E-MAIL VIA A GLOBAL COMPUTER NETWORK. (U.S. CLS. 100 AND 101).

TOBY BULLOFF, EXAMINING ATTORNEY

SN 77-043,281. BRISTOL-MYERS SQUIBB COMPANY, NEW YORK, NY. FILED 11-14-2006.

ADOPT

THE MARK CONSISTS OF STANDARD CHARACTERS WITHOUT CLAIM TO ANY PARTICULAR FONT, STYLE, SIZE, OR COLOR.

FOR MEDICAL AND SCIENTIFIC RESEARCH, NAMELY, CONDUCTING CLINICAL TRIALS RELATING TO PHARMACEUTICAL PREPARATIONS AND/OR DIAGNOSTIC IMAGING AGENTS FOR HUMAN USE (U.S. CLS. 100 AND 101).

KIM SAITO, EXAMINING ATTORNEY

SN 77-050,417. NORTHWEST NOTARY NETWORK, LLC, PORTLAND, OR. FILED 11-24-2006.



NO CLAIM IS MADE TO THE EXCLUSIVE RIGHT TO USE "NATIONWIDE NOTARY NETWORK", APART FROM THE MARK AS SHOWN.

THE COLOR(S) RED, ROYAL BLUE, WHITE AND NAVY BLUE IS/ARE CLAIMED AS A FEATURE OF THE MARK.

THE COLOR RED APPEARS IN THE INTERIOR OF THE INNER MOST CIRCLE AND STAR DESIGNS, THE COLOR

CLASS 42—(Continued).

NAVY BLUE APPEARS AS A THIN BAND COMPRISING THE SECOND CIRCLE FROM THE CENTER, A THIN BAND COMPRISING THE FOURTH CIRCLE FROM THE CENTER, A THICKER BAND COMPRISING THE SIXTH OUTERMOST CIRCLE AND IN THE WORDING NATIONWIDE NOTARY NETWORK, THE COLOR WHITE APPEARS IN THE LETTER/NUMBER COMBINATION N3 AND THE BACKGROUND OF THE THIRD CIRCLE FROM THE CENTER AND THE COLOR ROYAL BLUE APPEARS IN THE FIFTH CIRCLE FROM THE CENTER.

FOR NOTARY PUBLIC SERVICES (U.S. CLS. 100 AND 101).

GENE MACIOL, EXAMINING ATTORNEY

SN 77-052,395. FEDERAL RESERVE BANK OF RICHMOND, RICHMOND, VA. FILED 11-28-2006.

FEDERAL RESERVE INFORMATION TECHNOLOGY

THE MARK CONSISTS OF STANDARD CHARACTERS WITHOUT CLAIM TO ANY PARTICULAR FONT, STYLE, SIZE, OR COLOR.

NO CLAIM IS MADE TO THE EXCLUSIVE RIGHT TO USE "INFORMATION TECHNOLOGY", APART FROM THE MARK AS SHOWN.

SEC. 2(F).

FOR NETWORK AND MANAGED COMPUTING SERVICES, NAMELY, DESIGN, DEVELOPMENT, AND ENGINEERING SERVICES FOR COMPUTER NETWORKS; NETWORK SERVICES, NAMELY, OPERATIONAL TECHNICAL SUPPORT FOR COMPUTER NETWORKS, NAMELY, TROUBLESHOOTING OF COMPUTER SOFTWARE PROBLEMS, MONITORING OF NETWORKS SYSTEMS, PROVIDING BACK-UP COMPUTER PROGRAMS AND FACILITIES, AND PROVIDING TECHNOLOGY ADVICE TO USERS; HOSTING SERVICES, NAMELY WEB SITE HOSTING SERVICES, HOSTING OF DIGITAL CONTENT ON THE INTERNET, HOSTING AN ONLINE COMMUNITY WEBSITE FEATURING SUBJECT MATTER IN THE FIELDS FINANCE, ECONOMICS, NATIONAL INFORMATION TECHNOLOGY STANDARDS AND SECURITY POLICIES; PROJECT SERVICES, NAMELY, DESIGN, DEVELOPMENT AND IMPLEMENTATION OF COMPUTER NETWORKS AND SOFTWARE FOR OTHERS THAT PROVIDE TECHNOLOGY SOLUTIONS FOR BUSINESS APPLICATIONS AND FOR INFRASTRUCTURE PROBLEMS (U.S. CLS. 100 AND 101).

FIRST USE 2-2-1998; IN COMMERCE 2-2-1998.

PAUL F. GAST, EXAMINING ATTORNEY

CLASS 42—(Continued).

SN 77-055,627. SLIDE, INC., SAN FRANCISCO, CA. FILED 12-1-2006.

PEOPLE LIKE ME

THE MARK CONSISTS OF STANDARD CHARACTERS WITHOUT CLAIM TO ANY PARTICULAR FONT, STYLE, SIZE, OR COLOR.

FOR HOSTING OF DIGITAL CONTENT ON THE INTERNET FOR OTHERS, NAMELY, PROVIDING A MEANS FOR USERS TO CREATE, STORE, AND PROVIDE ACCESS TO CUSTOMIZED ONLINE INFORMATION ON A GLOBAL COMPUTER NETWORK; DATA MINING APPLICATION SERVICE PROVIDER FOR EXTRACTING, DATA MINING, AND CREATING INDEXES OF SELECTED INFORMATION FROM ONLINE COMMUNICATIONS, WEB SITES, DATABASES, INDICES, AND OTHER CONTENT, FOR USERS, AVAILABLE ON A GLOBAL COMPUTER NETWORK (U.S. CLS. 100 AND 101).

BENJAMIN OKEKE, EXAMINING ATTORNEY

CLASS 42—(Continued).

SN 77-061,087. WORLDTELEMETRY, INC., TULSA, OK. FILED 12-11-2006.



WORLDTELEMETRY

THE COLOR(S) DARK BLUE AND LIGHT BLUE IS/ARE CLAIMED AS A FEATURE OF THE MARK.

THE MARK CONSISTS OF A GLOBE ELEMENT MADE UP OF HALF LONGITUDE AND LATITUDE LINES COLORED IN DARK BLUE AND HALF OF TRANSMISSION LINES IN A LIGHTER BLUE COLOR WITH THE WORD WORLDTELEMETRY IN AVENIR FONT UNDERNEATH COLORED THE DARKER BLUE COLOR. TELEMETRY IS IN BOLD FONT.

FOR WIRELESS MONITORING OF TANKS CONTAINING FUELS AND OTHER LIQUID STOCK FOR SAFETY PURPOSES AND ANALYSIS OF GATHERED DATA (U.S. CLS. 100 AND 101).

FIRST USE 4-8-2005; IN COMMERCE 4-8-2005.
ELLEN PERKINS, EXAMINING ATTORNEY

SN 77-069,848. DEUTSCHE TELEKOM AG, BONN, FED REP GERMANY, FILED 12-21-2006.

giro

SN 77-055,765. WYLE LABORATORIES, INC., EL SEGUNDO, CA. FILED 12-1-2006.

WYLE

THE MARK CONSISTS OF STANDARD CHARACTERS WITHOUT CLAIM TO ANY PARTICULAR FONT, STYLE, SIZE, OR COLOR.

OWNER OF U.S. REG. NOS. 2,023,091, 2,125,993 AND OTHERS.

SEC. 2(F).
FOR RESEARCH, ENGINEERING, AND TESTING IN THE FIELDS OF AEROSPACE DEVELOPMENT, NATIONAL DEFENSE, AND COMMERCIAL NUCLEAR POWER PROVIDED TO FIRMS IN THOSE INDUSTRIES (U.S. CLS. 100 AND 101).

FIRST USE 1-0-1950; IN COMMERCE 1-0-1950.
SEAN CROWLEY, EXAMINING ATTORNEY

PRIORITY CLAIMED UNDER SEC. 44(D) ON FED REP GERMANY APPLICATION NO. 30639011638, FILED 6-22-2006, REG. NO. 30639011, DATED 6-22-2006, EXPIRES 6-30-2016.

FOR COMPUTER PROGRAMMING SERVICES FOR OTHERS; RENTAL OF COMPUTER SOFTWARE AND HARDWARE FOR ONLINE ACCESS; DATA ENCRYPTION SERVICES; APPLICATION SERVICE PROVIDER, NAMELY, HOSTING COMPUTER SOFTWARE APPLICATIONS FOR OTHERS, HOSTING OF DIGITAL CONTENT ON THE INTERNET; HOSTING THE WEBSITES OF OTHERS ON A COMPUTER SERVER FOR A GLOBAL COMPUTER NETWORK; COMPUTER SERVICES, NAMELY, CREATING INDEXES OF INFORMATION AVAILABLE ON COMPUTER NETWORKS; PROVIDING INFORMATION VIA THE TELEPHONE AND THE GLOBAL COMMUNICATION NETWORKS IN THE FIELD OF INFORMATION TECHNOLOGY; CONSULTING SERVICES IN THE FIELD OF DESIGN, SELECTION, IMPLEMENTATION AND USE OF COMPUTER HARDWARE AND SOFTWARE SYSTEMS FOR OTHERS; INSTALLATION, MAINTENANCE AND REPAIR OF COMPUTER SOFTWARE; TECHNICAL PROJECT PLANNING SERVICES RELATED TO TELECOMMUNICATIONS EQUIPMENT; PROVIDING INFORMATION AT THE SPECIFIC REQUEST OF END-USERS BY MEANS OF TELEPHONE OR GLOBAL COMMUNICATIONS NETWORKS; PROVIDING TEMPORARY USE OF ONLINE NON-DOWNLOADABLE TELECOMMUNICATIONS SOFTWARE FOR PROVIDING MULTIPLE USER ACCESS TO THE GLOBAL COMPUTER NETWORK (U.S. CLS. 100 AND 101).

FRED MANDIR, EXAMINING ATTORNEY

CLASS 42—(Continued).

SN 77-078,641. STEORN, LTD., DUBLIN 3, IRELAND, FILED 1-9-2007.



THE MARK CONSISTS OF COLORED TRIANGLE WITH CONTRASTING INTERNAL LETTERS.

FOR TECHNOLOGICAL SERVICES, NAMELY, RESEARCH DESIGN AND DEVELOPMENT IN THE FIELD OF ENERGY SYSTEMS, TECHNOLOGY CONSULTANCY ADVICE AND ANALYSIS IN THE FIELD OF ENERGY SYSTEMS (U.S. CLS. 100 AND 101).

DAVID TAYLOR, EXAMINING ATTORNEY

SN 77-085,973. SMARTSHEET.COM, INC., BELLEVUE, WA, FILED 1-18-2007.

SMARTSHEET.COM

THE MARK CONSISTS OF STANDARD CHARACTERS WITHOUT CLAIM TO ANY PARTICULAR FONT, STYLE, SIZE, OR COLOR.

FOR APPLICATION SERVICE PROVIDER FEATURING SOFTWARE IN THE NATURE OF A PLATFORM USED TO LIST, UPDATE AND TRACK GOALS, TASK LISTS, DUE DATES, ASSIGNMENT OF TASKS, AND PROGRESS AND COMPLETION OF TASKS FOR SINGLE USER WORKGROUPS AND DISTRIBUTED TEAM ENVIRONMENTS. (U.S. CLS. 100 AND 101).

FIRST USE 8-28-2006; IN COMMERCE 8-28-2006.

DAVID C. REIHNER, EXAMINING ATTORNEY

CLASS 42—(Continued).

SN 77-087,230. TWEET, LYLE MARVIN, TUCSON, AZ, FILED 1-19-2007.

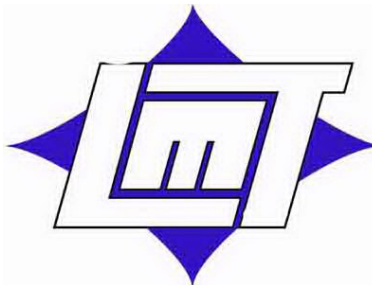

THE COLOR(S) BLUE, WHITE AND BLACK IS/ARE CLAIMED AS A FEATURE OF THE MARK.

THE MARK CONSISTS OF THREE RECTANGULAR, BLOCK-TYPE WHITE INTERWOVEN LETTERS WITH BLACK TRIM ON THE EDGES, "LMT" WITH A CONCAVE SLANTED BLUE DIAMOND BACKGROUND FRAMING THE BLOCK-TYPE LETTERS. THE CONCAVE DIAMOND ALSO HAS BLACK TRIM ON THE EDGES. THE LETTERS "LMT" ARE IN THE SLANTED-TO-THE-RIGHT RECTANGULAR FORM OF A RHOMBOID.

FOR CIVIL ENGINEERING; ENGINEERING; TESTING OR RESEARCH ON CIVIL ENGINEERING (U.S. CLS. 100 AND 101).

MARK SPARACINO, EXAMINING ATTORNEY

SN 77-087,558. OLLIPHANT, HUGH, SAN FRANCISCO, CA, FILED 1-22-2007.

SITE SAFARI

THE MARK CONSISTS OF STANDARD CHARACTERS WITHOUT CLAIM TO ANY PARTICULAR FONT, STYLE, SIZE, OR COLOR.

NO CLAIM IS MADE TO THE EXCLUSIVE RIGHT TO USE "SITE", APART FROM THE MARK AS SHOWN.

FOR PROVIDING TEMPORARY USE OF ON-LINE NON-DOWNLOADABLE SOFTWARE FOR USE IN AUTOMATICALLY LOADING USER-DEFINED WEPPAGES TO ACT AS A HOMEPAGE ON A GLOBAL COMPUTER NETWORK (U.S. CLS. 100 AND 101).

FIRST USE 12-1-2006; IN COMMERCE 1-1-2007.

MARK T. MULLEN, EXAMINING ATTORNEY

SN 77-097,032. VETHAN, INC., FARMINGTON HILLS, MI, FILED 2-1-2007.

Vethan Inc, Thought is Energy.

THE MARK CONSISTS OF STANDARD CHARACTERS WITHOUT CLAIM TO ANY PARTICULAR FONT, STYLE, SIZE, OR COLOR.

NO CLAIM IS MADE TO THE EXCLUSIVE RIGHT TO USE "INC", APART FROM THE MARK AS SHOWN.

FOR COMPUTER SOFTWARE CONSULTANCY (U.S. CLS. 100 AND 101).

ANDREW RHIM, EXAMINING ATTORNEY

CLASS 42—(Continued).

SN 77-098,362. SMARTSHEET.COM, INC., BELLEVUE, WA.
FILED 2-2-2007.

SMARTSHEET

THE MARK CONSISTS OF STANDARD CHARACTERS WITHOUT CLAIM TO ANY PARTICULAR FONT, STYLE, SIZE, OR COLOR.

FOR APPLICATION SERVICE PROVIDER FEATURING SOFTWARE IN THE NATURE OF A PLATFORM USED TO LIST, UPDATE AND TRACK GOALS, TASK LISTS, DUE DATES, ASSIGNMENT OF TASKS, AND PROGRESS AND COMPLETION OF TASKS FOR SINGLE USER WORKGROUPS AND DISTRIBUTED TEAM ENVIRONMENTS (U.S. CLS. 100 AND 101).

FIRST USE 8-28-2006; IN COMMERCE 8-28-2006.
DAVID C. REIHNER, EXAMINING ATTORNEY

SN 77-101,604. SPECIALIZED COMMUNICATIONS CORPORATION, SMITHSBURG, MD. FILED 2-7-2007.



NO CLAIM IS MADE TO THE EXCLUSIVE RIGHT TO USE "SPECIALIZED COMMUNICATIONS", APART FROM THE MARK AS SHOWN.

THE COLOR(S) BLUE IS/ARE CLAIMED AS A FEATURE OF THE MARK.

THE MARK CONSISTS OF BLUE STYLIZED "S" TO THE LEFT OF THE WORDS "SPECIALIZED COMMUNICATIONS" ALSO IN BLUE.

FOR ENGINEERING SERVICES, NAMELY, ENGINEERING FOR THE BROADCAST VIDEO INDUSTRY (U.S. CLS. 100 AND 101).

FIRST USE 1-23-2007; IN COMMERCE 1-23-2007.
ERNEST SHOSHO, EXAMINING ATTORNEY

SN 77-111,209. TANDEM LABS, INC., SALT LAKE CITY, UT.
FILED 2-20-2007.

TANDEM LABS

THE MARK CONSISTS OF STANDARD CHARACTERS WITHOUT CLAIM TO ANY PARTICULAR FONT, STYLE, SIZE, OR COLOR.

NO CLAIM IS MADE TO THE EXCLUSIVE RIGHT TO USE "LABS", APART FROM THE MARK AS SHOWN.

FOR SCIENTIFIC RESEARCH AND LABORATORY SERVICES IN THE FIELDS OF BIOLOGY, BIOCHEMISTRY, BIOPHARMACEUTICALS, AND PHARMACEUTICALS; SCIENTIFIC RESEARCH AND LABORATORY SERVICES, NAMELY, BIOANALYSIS, MASS SPECTROMETRY, IMMUNOANALYSIS, AND PHARMACOKINETICS (U.S. CLS. 100 AND 101).

JOHN DALIER, EXAMINING ATTORNEY

CLASS 42—(Continued).

SN 77-112,472. ELECTRIC PIG, LLC, SAN FRANCISCO, CA.
FILED 2-21-2007.

SINGLEBOUND CREATIVE

THE MARK CONSISTS OF STANDARD CHARACTERS WITHOUT CLAIM TO ANY PARTICULAR FONT, STYLE, SIZE, OR COLOR.

NO CLAIM IS MADE TO THE EXCLUSIVE RIGHT TO USE "CREATIVE", APART FROM THE MARK AS SHOWN.

FOR COMPUTER SERVICES, NAMELY, CREATING AND MAINTAINING WEB SITES FOR OTHERS; COMPUTER SERVICES, NAMELY, DESIGNING AND IMPLEMENTING WEB SITES FOR OTHERS; DESIGN, DEVELOPMENT AND IMPLEMENTATION OF SOFTWARE; GRAPHIC DESIGN SERVICES; GRAPHIC ILLUSTRATION SERVICES FOR OTHERS; WEB SITE HOSTING SERVICES; WEBSITE DEVELOPMENT FOR OTHERS (U.S. CLS. 100 AND 101).

FIRST USE 3-17-2006; IN COMMERCE 3-17-2006.
ELLEN BURNS, EXAMINING ATTORNEY

SN 77-120,982. SEE A ROOM INC., BRADENTON, FL. FILED 3-2-2007.

SEE A ROOM

THE MARK CONSISTS OF STANDARD CHARACTERS WITHOUT CLAIM TO ANY PARTICULAR FONT, STYLE, SIZE, OR COLOR.

SEC. 2(F).

FOR COMPUTER SERVICES, NAMELY, PROVIDING SEARCH ENGINES FOR OBTAINING DATA ON A GLOBAL COMPUTER NETWORK (U.S. CLS. 100 AND 101).

FIRST USE 11-20-2001; IN COMMERCE 11-20-2001.
BRENDAN REGAN, EXAMINING ATTORNEY

SN 77-121,782. RAYNALDO GARZA, MONARCH BEACH, CA. FILED 3-4-2007.

WEBSITE SQUAD

THE MARK CONSISTS OF STANDARD CHARACTERS WITHOUT CLAIM TO ANY PARTICULAR FONT, STYLE, SIZE, OR COLOR.

NO CLAIM IS MADE TO THE EXCLUSIVE RIGHT TO USE "WEBSITE", APART FROM THE MARK AS SHOWN.

FOR DESIGN, CREATION, HOSTING, MAINTENANCE OF WEBSITES FOR OTHERS (U.S. CLS. 100 AND 101).

FIRST USE 6-7-2005; IN COMMERCE 4-4-2006.
TINA KUAN, EXAMINING ATTORNEY

CLASS 42—(Continued).

SN 77-122,171. ZEPHYROS, INC., ROMEO, MI. FILED 3-5-2007.

L&L ARMOR SYSTEMS

THE MARK CONSISTS OF STANDARD CHARACTERS WITHOUT CLAIM TO ANY PARTICULAR FONT, STYLE, SIZE, OR COLOR.

NO CLAIM IS MADE TO THE EXCLUSIVE RIGHT TO USE "SYSTEMS", APART FROM THE MARK AS SHOWN.

FOR DESIGN AND TESTING OF NEW PRODUCTS FOR OTHERS, NAMELY, CONSULTING IN THE FIELD OF ARMORED COMPONENTS AND ASSEMBLIES, STRUCTURAL REINFORCEMENT PARTS, SEALANTS, AND CHEMICAL COMPOUNDS ALL TO PROVIDE BALLISTIC AND BLAST PROTECTION, ENHANCE STRUCTURAL RIGIDITY, SEAL AGAINST MOISTURE, AND DAMPEN NOISE AND VIBRATION FOR USE IN MILITARY AND DEFENSE APPLICATIONS, SECURITY, LAW ENFORCEMENT APPLICATIONS, AND RELATED MILITARY AND DEFENSE, SECURITY, AND LAW ENFORCEMENT LAND, AIR, AND SEA TRANSPORTATION VEHICLE APPLICATIONS, AND BUILDING STRUCTURE APPLICATIONS (U.S. CLS. 100 AND 101).
JASON TURNER, EXAMINING ATTORNEY

SN 77-123,517. RENTLIX LLC, WEST BLOOMFIELD, MI. FILED 3-6-2007.

RentLinx

THE MARK CONSISTS OF STANDARD CHARACTERS WITHOUT CLAIM TO ANY PARTICULAR FONT, STYLE, SIZE, OR COLOR.

FOR APPLICATION SERVICE PROVIDER (ASP) PROVIDING TEMPORARY USE OF ONLINE NON-DOWNLOADABLE SOFTWARE TO STORE, MANAGE, TRACK, ANALYZE AND REPORT DATA IN THE FIELD OF PROPERTY MANAGEMENT (U.S. CLS. 100 AND 101).
FIRST USE 8-15-2005; IN COMMERCE 9-30-2005.
AISHA SALEM, EXAMINING ATTORNEY

SN 77-125,431. SAM STATHIS, NEW YORK, NY. FILED 3-8-2007.

THEOMETRICS

THE MARK CONSISTS OF STANDARD CHARACTERS WITHOUT CLAIM TO ANY PARTICULAR FONT, STYLE, SIZE, OR COLOR.

FOR DEVELOPMENT OF COMPUTER PROGRAMS RECORDED ON DATA MEDIA (SOFTWARE) DESIGNED FOR USE IN CONSTRUCTION AND AUTOMATED MANUFACTURING (CAD/CAM) (U.S. CLS. 100 AND 101).
APRIL ROACH, EXAMINING ATTORNEY

CLASS 42—(Continued).

SN 77-127,703. TERRA SOLUTIONS GROUP, GLASTONBURY, CT. FILED 3-10-2007.



NO CLAIM IS MADE TO THE EXCLUSIVE RIGHT TO USE "SOLUTIONS GROUP" AND "GEOGRAPHIC INFORMATION SYSTEMS FOR BUSINESS", APART FROM THE MARK AS SHOWN.

THE COLOR(S) GREEN, BLACK, AND WHITE IS/ARE CLAIMED AS A FEATURE OF THE MARK.

THE MARK CONSISTS OF A GLOBE (OR BALL) WITH A GREEN GRADIENT AND THREE WHITE LINES GOING THROUGH IT. THE LINES ARE ANGLED FROM THE LEFT SIDE SLIGHTLY UPWARDS TO THE RIGHT SIDE OF THE GLOBE, SIMILAR TO THE LATITUDE LINES ON A GLOBE. A GREEN LINE EXTENDS FROM THE BOTTOM OF THE GLOBE HORIZONTALLY BENEATH THE WORDS "TERRA SOLUTIONS GROUP" AND ABOVE THE WORDS "GEOGRAPHIC INFORMATION SYSTEMS FOR BUSINESS". "TERRA SOLUTIONS GROUP" IS IN GREEN LETTERING AND "GEOGRAPHIC INFORMATION SYSTEMS FOR BUSINESS" IS IN BLACK LETTERING.

THE ENGLISH TRANSLATION OF THE WORD TERRA IN THE MARK IS EARTH.

FOR COMPUTER CONSULTATION; COMPUTER SOFTWARE CONSULTANCY; COMPUTER SOFTWARE CONSULTATION; CONSULTANCY IN THE FIELD OF SOFTWARE DESIGN; INFORMATION TECHNOLOGY CONSULTATION; TECHNOLOGY CONSULTATION IN THE FIELD OF GEOGRAPHIC INFORMATION SYSTEMS (U.S. CLS. 100 AND 101).
FIRST USE 3-1-2007; IN COMMERCE 3-1-2007.
MICHAEL LEWIS, EXAMINING ATTORNEY

SN 77-127,821. CHEW KEVIN M., ANKENY, IA. FILED 3-11-2007.



THE COLOR(S) WHITE, RED, BLACK, GREY IS/ARE CLAIMED AS A FEATURE OF THE MARK.

THE MARK CONSISTS OF A RED OPEN 3D REALISTIC VECTOR SET OF WHITE TEETH AND A SLIGHT DROP SHADOW DEPICTED IN BLACK AND GREY THAT FADES TO A WHITE BACKGROUND.

FOR DESIGN, CREATION, HOSTING, MAINTENANCE OF WEBSITES FOR OTHERS (U.S. CLS. 100 AND 101).
EMILY CARLSEN, EXAMINING ATTORNEY

CLASS 42—(Continued).

SN 77-127,831. DESYATNIK, YURI, PACIFICA, CA. FILED 3-11-2007.



THE COLOR(S) GREEN (RGB 66,121,72) DARK GREY (RGB 94,88,80) LIGHT GREY (RGB 156,156,155) WHITE IS/ ARE CLAIMED AS A FEATURE OF THE MARK.

THE MARK CONSISTS OF THE "MEGA" PART OF THE WORD MEGAMAVEN.COM APPEARING IN BOLD, ITALICIZED ARIAL FONT EXECUTED IN DARK GREY. THE "MAVEN" PART OF MEGAMAVEN.COM APPEARS IN BOLD, ITALICIZED, ARIAL FONT, IN WHITE ON A GREEN TRAPEZOID. THE ".COM" PART OF MEGAMAVEN.COM IS SMALLER ARIAL FONT THAT IS NOT BOLD OR ITALICIZED. THE PHRASE "WHERE YOU ARE THE FUND MANAGER" APPEARS IN A LIGHT GREY, WITH A SMALLER ARIAL FONT. THIS PHRASE FITS EXACTLY BELOW THE "MEGAMAVEN" IMAGE ABOVE IT.

FOR COMPUTER SERVICES, NAMELY, CREATING AN ONLINE COMMUNITY FOR REGISTERED INDIVIDUALS OR ORGANIZATIONS TO MANAGE VIRTUAL SECURITIES FUNDS THAT ARE BASED ON REAL-WORLD MARKET PRICES AND OTHER INDIVIDUALS OR ORGANIZATIONS TO VIEW THE PERFORMANCE OF THESE VIRTUAL FUNDS (U.S. CLS. 100 AND 101).
EMILY CARLSEN, EXAMINING ATTORNEY

SN 77-129,664. ELECTRO-SENSORS, INC., MINNETONKA, MN. FILED 3-13-2007.

NetE-nable

THE MARK CONSISTS OF STANDARD CHARACTERS WITHOUT CLAIM TO ANY PARTICULAR FONT, STYLE, SIZE, OR COLOR.

FOR COMPUTER SOFTWARE DEVELOPMENT (U.S. CLS. 100 AND 101).
SEAN CROWLEY, EXAMINING ATTORNEY

SN 77-131,123. ITMUSTBE.COM, INC., VIDA, OR. FILED 3-14-2007.

ITMUSTBE

THE MARK CONSISTS OF STANDARD CHARACTERS WITHOUT CLAIM TO ANY PARTICULAR FONT, STYLE, SIZE, OR COLOR.

FOR COMPUTER SERVICES, NAMELY, CREATING AND MAINTAINING WEB SITES FOR OTHERS; DESIGN OF HOME PAGES, COMPUTER SOFTWARE AND WEB SITES; COMPUTER SERVICES, NAMELY, DESIGNING AND IMPLEMENTING WEB SITES FOR OTHERS (U.S. CLS. 100 AND 101).

FIRST USE 1-2-2002; IN COMMERCE 1-2-2002.
THOMAS MANOR, EXAMINING ATTORNEY

CLASS 42—(Continued).

SN 77-131,667. ORGANIZERS DIRECT, L.L.C., SCOTTS-DALE, AZ. FILED 3-15-2007.



OWNER OF U.S. REG. NOS. 2,075,179, 2,094,240 AND OTHERS.

NO CLAIM IS MADE TO THE EXCLUSIVE RIGHT TO USE "ORGANIZERS", APART FROM THE MARK AS SHOWN.

THE MARK CONSISTS OF THE WORDS "ORGANIZERS DIRECT" AND A CIRCLE AND HALF SPHERE.

FOR DESIGN OF STORAGE SYSTEMS FOR HOME OR OFFICE USE, COMPRISING, NON-METAL RACKS, SHELVES, DRAWERS, DIVIDERS, RODS, BASKETS, HANGERS (U.S. CLS. 100 AND 101).

FIRST USE 1-6-2007; IN COMMERCE 1-13-2007.
KHANH LE, EXAMINING ATTORNEY

SN 77-131,923. INDIEKAZOO LLC, AUSTIN, TX. FILED 3-15-2007.

INDIEKAZOO

THE MARK CONSISTS OF STANDARD CHARACTERS WITHOUT CLAIM TO ANY PARTICULAR FONT, STYLE, SIZE, OR COLOR.

FOR PROVIDING TEMPORARY USE OF ON-LINE NON-DOWNLOADABLE SOFTWARE FOR USE IN AUTHORIZING, DOWNLOADING, TRANSMITTING, RECEIVING, EDITING, EXTRACTING, ENCODING, DECODING, PLAYING, STORING AND ORGANIZING, AND SELLING AUDIO DATA (U.S. CLS. 100 AND 101).

FIRST USE 3-1-2006; IN COMMERCE 3-1-2006.
BRIAN PINO, EXAMINING ATTORNEY

SN 77-134,904. GAMEFLY, INC., LOS ANGELES, CA. FILED 3-19-2007.

CHEATSERVER

THE MARK CONSISTS OF STANDARD CHARACTERS WITHOUT CLAIM TO ANY PARTICULAR FONT, STYLE, SIZE, OR COLOR.

FOR COMPUTER SERVICES, NAMELY, PROVIDING SEARCH ENGINES FOR OBTAINING DATA ON A GLOBAL COMPUTER NETWORK; DEVELOPMENT, MAINTENANCE AND UPDATING OF A TELECOMMUNICATION NETWORK SEARCH ENGINE (U.S. CLS. 100 AND 101).

FIRST USE 7-0-2003; IN COMMERCE 7-0-2003.
JAMES MACFARLANE, EXAMINING ATTORNEY

CLASS 42—(Continued).

SN 77-135,310. NEXSTAR, INC., WHITE BEAR LAKE, MN. FILED 3-20-2007.

NEXSTAR SELECT SERVICE

THE MARK CONSISTS OF STANDARD CHARACTERS WITHOUT CLAIM TO ANY PARTICULAR FONT, STYLE, SIZE, OR COLOR.

NO CLAIM IS MADE TO THE EXCLUSIVE RIGHT TO USE SERVICE, APART FROM THE MARK AS SHOWN.

FOR ACCREDITATION SERVICES, NAMELY, DEVELOPING, EVALUATING, AND TESTING STANDARDS FOR PLUMBING, ELECTRICAL, HEATING, VENTILATING, AND AIR CONDITIONING SERVICE PROVIDERS, FOR THE PURPOSE OF ACCREDITATION; ANALYSIS AND EVALUATION OF THE SERVICES OF OTHERS FOR THE PURPOSE OF CERTIFICATION; PROVIDING QUALITY ASSURANCE SERVICES IN THE FIELD OF PLUMBING, ELECTRICAL, HEATING, VENTILATING, AND AIR CONDITIONING SERVICE PROVIDERS (U.S. CLS. 100 AND 101).

JILL PRATER, EXAMINING ATTORNEY

SN 77-135,344. IP APPLICATIONS SOLUTIONS INC., VANCOUVER, CANADA, FILED 3-20-2007.

MYHELPDESK

THE MARK CONSISTS OF STANDARD CHARACTERS WITHOUT CLAIM TO ANY PARTICULAR FONT, STYLE, SIZE, OR COLOR.

FOR TECHNICAL SUPPORT SERVICES, NAMELY, TROUBLESHOOTING OF COMPUTER HARDWARE AND SOFTWARE PROBLEMS VIA GLOBAL COMPUTER NETWORK, E-MAIL AND TELEPHONE (U.S. CLS. 100 AND 101).

FIRST USE 12-14-2006; IN COMMERCE 12-14-2006.
BRIAN NEVILLE, EXAMINING ATTORNEY

SN 77-135,531. AQUA MONKEY DESIGNS, EASTON, PA. FILED 3-20-2007.

Aqua Monkey Designs

THE MARK CONSISTS OF STANDARD CHARACTERS WITHOUT CLAIM TO ANY PARTICULAR FONT, STYLE, SIZE, OR COLOR.

NO CLAIM IS MADE TO THE EXCLUSIVE RIGHT TO USE "DESIGNS", APART FROM THE MARK AS SHOWN.

FOR COMPUTER SERVICES, NAMELY, CREATING AND MAINTAINING WEB SITES FOR OTHERS (U.S. CLS. 100 AND 101).

FIRST USE 7-4-2006; IN COMMERCE 7-4-2006.
AISHA CLARKE, EXAMINING ATTORNEY

CLASS 42—(Continued).

SN 77-135,726. NTEGRA IT SOLUTIONS, INC., CHESAPEAKE, VA. FILED 3-20-2007.

NTEGRA IT SOLUTIONS

THE MARK CONSISTS OF STANDARD CHARACTERS WITHOUT CLAIM TO ANY PARTICULAR FONT, STYLE, SIZE, OR COLOR.

NO CLAIM IS MADE TO THE EXCLUSIVE RIGHT TO USE "IT SOLUTIONS", APART FROM THE MARK AS SHOWN.

FOR INSTALLATION OF COMPUTER SOFTWARE; APPLICATION SERVICE PROVIDER (ASP), NAMELY, HOSTING COMPUTER SOFTWARE APPLICATIONS OF OTHERS; COMPUTER CONSULTATION; COMPUTER CONSULTATION IN THE FIELD OF COMPUTER SECURITY; COMPUTER DIAGNOSTIC SERVICES; COMPUTER SERVICES, NAMELY, CREATING AND MAINTAINING WEB SITES FOR OTHERS; COMPUTER SERVICES, NAMELY, MANAGING WEB SITES FOR OTHERS; COMPUTER SOFTWARE CONSULTATION; CONSULTING SERVICES IN THE FIELD OF DESIGN, SELECTION, IMPLEMENTATION AND USE OF COMPUTER HARDWARE AND SOFTWARE SYSTEMS FOR OTHERS; CUSTOMIZATION OF COMPUTER HARDWARE AND SOFTWARE; DESIGN OF COMPUTERS FOR OTHERS; HOSTING THE WEB SITES OF OTHERS ON A COMPUTER SERVER FOR A GLOBAL COMPUTER NETWORK; TECHNICAL SUPPORT SERVICES, NAMELY, TROUBLESHOOTING OF COMPUTER HARDWARE AND SOFTWARE PROBLEMS; INFORMATION TECHNOLOGY CONSULTATION; DESIGN OF HOMEPAGES AND WEBSITES; INTEGRATION OF COMPUTER SYSTEMS AND NETWORKS; COMPUTER NETWORK DESIGN FOR OTHERS (U.S. CLS. 100 AND 101).

FIRST USE 12-16-2005; IN COMMERCE 12-16-2005.
MARY MUNSON, EXAMINING ATTORNEY

SN 77-136,106. DANDRIDGE-MCKINNEY, KENYETTA, CLAYTON, NJ. FILED 3-20-2007.

GrindModeConnect.com

THE MARK CONSISTS OF STANDARD CHARACTERS WITHOUT CLAIM TO ANY PARTICULAR FONT, STYLE, SIZE, OR COLOR.

FOR COMPUTER SERVICES, NAMELY, CREATING AN ONLINE COMMUNITY FOR REGISTERED USERS TO PARTICIPATE IN COMPETITIONS, SHOWCASE THEIR SKILLS, GET FEEDBACK FROM THEIR PEERS, FORM VIRTUAL COMMUNITIES, ENGAGE IN SOCIAL NETWORKING AND IMPROVE THEIR TALENT (U.S. CLS. 100 AND 101).

FIRST USE 6-5-2006; IN COMMERCE 11-11-2006.
GIANCARLO CASTRO, EXAMINING ATTORNEY

CLASS 42—(Continued).

SN 77-136,556. WEALTH2K, INC., HINGHAM, MA. FILED 3-21-2007.

TRAJECT

THE MARK CONSISTS OF STANDARD CHARACTERS WITHOUT CLAIM TO ANY PARTICULAR FONT, STYLE, SIZE, OR COLOR.

FOR PROVIDING TEMPORARY USE OF ON-LINE NON-DOWNLOADABLE SOFTWARE FOR CREATING AND TRANSMITTING WEB-BASED MARKETING AND ADVERTISING OVER A GLOBAL COMPUTER NETWORK IN THE FINANCIAL SERVICE FIELD (U.S. CLS. 100 AND 101).

REGINA DRUMMOND, EXAMINING ATTORNEY

SN 77-136,855. ITRIBUTE, INC., BROOKLYN, NY. FILED 3-21-2007.



NO CLAIM IS MADE TO THE EXCLUSIVE RIGHT TO USE "ITRIBUTE", APART FROM THE MARK AS SHOWN.

THE COLOR(S) BROWN, TAN AND CREAM IS/ARE CLAIMED AS A FEATURE OF THE MARK.

THE MARK CONSISTS OF A BROWN TREE ON A BROWN HILL ENCLOSED IN A BROWN CIRCLE WITH TAN RAYS RADIATING OUT ALTERNATELY WITH BROWN RAYS FROM THE TREE. THE WORKING ITRIBUTE IS IN BROWN AND TO THE RIGHT OF THE TREE DESIGN. THE BACKGROUND OF THE ENTIRE MARK IS IN ALTERNATING TAN AND CREAM RAYS RADIATING FROM THE CENTER OF THE TREE DESIGN.

FOR HOSTING OF DIGITAL CONTENT ON THE INTERNET AND GRAPHIC DESIGN SERVICES, NAMELY, MANIPULATION OF PHOTOS, VIDEO AND DIGITAL CONTENT FOR USE IN PRINT AND ON THE INTERNET (U.S. CLS. 100 AND 101).

FIRST USE 7-1-2006; IN COMMERCE 7-1-2006.
PAULA MAHONEY, EXAMINING ATTORNEY

SN 77-137,522. ONREQUEST IMAGES, INC., SEATTLE, WA. FILED 3-22-2007.

REMOTE CONTROLLED CREATIVITY

THE MARK CONSISTS OF STANDARD CHARACTERS WITHOUT CLAIM TO ANY PARTICULAR FONT, STYLE, SIZE, OR COLOR.

FOR PROVIDING TEMPORARY USE OF ON-LINE NON-DOWNLOADABLE SOFTWARE FOR CREATING, MANAGING, SHARING AND REVIEWING CUSTOM IMAGERY, CONDUCTING ONLINE CASTING, AND CONDUCTING REMOTE PHOTOGRAPHER PORTFOLIO REVIEW (U.S. CLS. 100 AND 101).

STEVEN PEREZ, EXAMINING ATTORNEY

CLASS 42—(Continued).

SN 77-137,574. HERITAGE SURVEYING LLC, LAS VEGAS, NV. FILED 3-22-2007.



THE MARK CONSISTS OF A LARGE BELL ON TOP OF A PARCHMENT PAPER OR SCROLL OF PAPER.

FOR CONDUCTING ENGINEERING SURVEYS; GEOLOGICAL SURVEYS OR RESEARCH; LAND SURVEYING; SURVEYING; TECHNICAL SURVEYING; CARTOGRAPHY AND MAPPING; MAPPING (U.S. CLS. 100 AND 101).

FIRST USE 7-19-2006; IN COMMERCE 7-19-2006.
PAULA MAYS, EXAMINING ATTORNEY

SN 77-137,627. WORLD ANTHEM TECHNOLOGIES, INC., PENNS PARK, PA. FILED 3-22-2007.

TIMEDIRECT

THE MARK CONSISTS OF STANDARD CHARACTERS WITHOUT CLAIM TO ANY PARTICULAR FONT, STYLE, SIZE, OR COLOR.

FOR PROVIDING TEMPORARY USE OF ON-LINE NON-DOWNLOADABLE SOFTWARE FOR TRACKING EMPLOYEE TIME USAGE (U.S. CLS. 100 AND 101).

FIRST USE 12-10-1998; IN COMMERCE 12-10-1998.
DOMINICK J. SALEMI, EXAMINING ATTORNEY

CLASS 42—(Continued).

SN 77-137,753. TW POWELL CO. INC., NEW YORK, NY.
FILED 3-22-2007.

KNOWLEDGEAGENCY A TW
POWELL COMPANY

THE MARK CONSISTS OF STANDARD CHARACTERS WITHOUT CLAIM TO ANY PARTICULAR FONT, STYLE, SIZE, OR COLOR.

OWNER OF U.S. REG. NO. 2,935,236.

NO CLAIM IS MADE TO THE EXCLUSIVE RIGHT TO USE "COMPANY", APART FROM THE MARK AS SHOWN.

FOR PROVIDING TEMPORARY USE OF NON-DOWNLOADABLE COMPUTER SOFTWARE FOR THE COLLECTION, EDITING, ORGANIZING, MODIFYING, BOOK MARKING, TRANSMISSION, STORAGE AND SHARING OF DATA AND INFORMATION (U.S. CLS. 100 AND 101).

FIRST USE 0-0-2006; IN COMMERCE 0-0-2006.
NICHOLAS ALTREE, EXAMINING ATTORNEY

SN 77-138,037. RHINEER, GREG, PLEASANT GROVE, UT.
FILED 3-22-2007.

RCAST

THE MARK CONSISTS OF STANDARD CHARACTERS WITHOUT CLAIM TO ANY PARTICULAR FONT, STYLE, SIZE, OR COLOR.

FOR HOSTING THE WEBSITES OF OTHERS, NAMELY, HOSTING WEBSITES THAT FEATURE CELEBRITY AND REAL ESTATE INFORMATION (U.S. CLS. 100 AND 101).

LINDA LAVACHÉ, EXAMINING ATTORNEY

SN 77-138,428. USEFUL TECHNOLOGY CORPORATION,
PLANTATION, FL. FILED 3-23-2007.

Creating new paths and
opportunities for
information exchange

THE MARK CONSISTS OF STANDARD CHARACTERS WITHOUT CLAIM TO ANY PARTICULAR FONT, STYLE, SIZE, OR COLOR.

FOR DEVELOPMENT OF SOFTWARE FOR SECURE NETWORK OPERATIONS; DESIGN, DEVELOPMENT AND IMPLEMENTATION OF SOFTWARE; DESIGN AND DEVELOPMENT OF INFORMATION AND DATA BASES; DESIGN AND DEVELOPMENT OF ON-LINE COMPUTER SOFTWARE SYSTEMS; DEVELOPMENT, UPDATING AND MAINTENANCE OF SOFTWARE AND DATA BASES (U.S. CLS. 100 AND 101).

MARTHA FROMM, EXAMINING ATTORNEY

CLASS 42—(Continued).

SN 77-138,553. ALLIANCE HR NETWORK, INC., ARLINGTON HEIGHTS, IL. FILED 3-23-2007.

ALIVE & GRATIFY'D

THE MARK CONSISTS OF STANDARD CHARACTERS WITHOUT CLAIM TO ANY PARTICULAR FONT, STYLE, SIZE, OR COLOR.

FOR COMPUTER SERVICES, NAMELY, HOSTING AND MAINTAINING AN ONLINE WEBSITE FOR OTHERS TO FIND EMPLOYMENT AND WORK/LIFE BALANCE THROUGH INTERACTIVE MATCHING SERVICES (U.S. CLS. 100 AND 101).

WILLIAM VERHOSEK, EXAMINING ATTORNEY

SN 77-138,622. DECODE BIOSTRUCTURES, INC., BAINBRIDGE ISLAND, WA. FILED 3-23-2007.

CRYSTAL READY

THE MARK CONSISTS OF STANDARD CHARACTERS WITHOUT CLAIM TO ANY PARTICULAR FONT, STYLE, SIZE, OR COLOR.

NO CLAIM IS MADE TO THE EXCLUSIVE RIGHT TO USE "CRYSTAL", APART FROM THE MARK AS SHOWN.

FOR MEDICAL AND BIOCHEMICAL RESEARCH SERVICES IN FIELD OF CRYSTALLIZATION OR STRUCTURAL DETERMINATION OF BIOLOGICAL AND CHEMICAL MATERIALS (U.S. CLS. 100 AND 101).

ANDREA K. NADELMAN, EXAMINING ATTORNEY

CLASS 42—(Continued).

SN 77-138,673. TXCO RESOURCES INC, SAN ANTONIO, TX. FILED 3-23-2007.



THE MARK CONSISTS OF THE WORD TXCO WITH A DRILL BIT CENTERED WITHIN THE "O".
 FOR GEOPHYSICAL EXPLORATION FOR THE OIL, GAS AND MINING INDUSTRIES; OIL FIELD EXPLORATION; OIL PROSPECTING; OIL AND GAS WELL DRILLING SERVICES, NAMELY, PROVIDING MEASUREMENTS AND DOWNHOLE TELEMETRY WHILE DRILLING; TECHNOLOGY SUPERVISION AND INSPECTION IN THE FIELD OF OIL AND GAS EXPLORATION, EXPLOITATION, PRODUCTION AND DRILLING SERVICES; SCIENTIFIC SERVICES, NAMELY GEOLOGICAL AND GEOPHYSICAL MAPPING AND INTERPRETATIONS IN THE FIELDS OF ENERGY EXPLORATION, EXPLOITATION, PRODUCTION AND DRILLING SERVICES RENDERED BY PERSONS, BOTH INDIVIDUALLY AND COLLECTIVELY, NAMELY, SERVICES PROVIDED BY GEOLOGISTS, GEOPHYSICISTS, ENGINEERS, COMPUTER SPECIALISTS IN THE FIELDS OF ENERGY EXPLORATION, EXPLOITATION AND PRODUCTION (U.S. CLS. 100 AND 101).
 FIRST USE 10-1-2006; IN COMMERCE 10-1-2006.
 TAMARA FRAZIER, EXAMINING ATTORNEY

SN 77-138,863. ESTECH, LLC, COLUMBUS, OH. FILED 3-23-2007.

WATERCYCLE

THE MARK CONSISTS OF STANDARD CHARACTERS WITHOUT CLAIM TO ANY PARTICULAR FONT, STYLE, SIZE, OR COLOR.
 FOR ENGINEERING SERVICES FOR THE CONSTRUCTION OF WATER TREATMENT AND PURIFICATION PLANTS, SOLID WASTE TREATMENT PLANTS AND OTHER MUNICIPAL INFRASTRUCTURE FACILITIES (U.S. CLS. 100 AND 101).
 TEJBIR SINGH, EXAMINING ATTORNEY

CLASS 42—(Continued).

SN 77-139,016. SNAPT, INC., DELAND, FL. FILED 3-23-2007.



THE COLOR(S) GRAY, GREEN, YELLOW, BLUE, RED AND WHITE IS/ARE CLAIMED AS A FEATURE OF THE MARK.
 THE MARK CONSISTS OF THE WORDS SNAPT REACH. RENT. RETAIN. IN GRAY ALONGSIDE A PUZZLE DESIGN CONSISTING OF FOUR INTERLOCKING PIECES SHOWN IN GREEN, YELLOW, BLUE, RED AND WHITE.
 FOR DESIGN, CREATION, HOSTING, MAINTENANCE OF WEBSITES FOR OTHERS (U.S. CLS. 100 AND 101).
 FIRST USE 1-10-2007; IN COMMERCE 1-10-2007.
 DAVID YONTEF, EXAMINING ATTORNEY

SN 77-139,093. SNAPT, INC., DELAND, FL. FILED 3-23-2007.

Snapt Shot

THE MARK CONSISTS OF STANDARD CHARACTERS WITHOUT CLAIM TO ANY PARTICULAR FONT, STYLE, SIZE, OR COLOR.
 FOR DESIGN, CREATION, HOSTING, MAINTENANCE OF WEBSITES FOR OTHERS (U.S. CLS. 100 AND 101).
 FIRST USE 1-10-2007; IN COMMERCE 1-10-2007.
 DAVID YONTEF, EXAMINING ATTORNEY

SN 77-139,151. COSTICK WORLDWIDE, LAS VEGAS, NV. FILED 3-23-2007.

Costick Worldwide

THE MARK CONSISTS OF STANDARD CHARACTERS WITHOUT CLAIM TO ANY PARTICULAR FONT, STYLE, SIZE, OR COLOR.
 NO CLAIM IS MADE TO THE EXCLUSIVE RIGHT TO USE "WORLDWIDE", APART FROM THE MARK AS SHOWN.
 FOR GRAPHIC DESIGN SERVICES (U.S. CLS. 100 AND 101).
 APRIL ROACH, EXAMINING ATTORNEY

CLASS 42—(Continued).

SN 77-139,571. RAUL ANGEL MIRELES, AUSTIN, TX. FILED 3-24-2007.



THE MARK CONSISTS OF SILHOUETTE OF A WIRE STAND TO THE LEFT OF THE SITE NAME 'THEWIRESTAND.COM' WITH THE TAGLINE UNDER THE SITE NAME 'UNFOLD YOUR STAGE-'; THE LETTER D AT THE END OF THE SITE NAME IS REPRESENTED BY A HALF-NOTE SYMBOL RATHER THAN A CONVENTIONAL LETTER.

FOR COMPUTER SERVICES, NAMELY, CREATING AN ONLINE COMMUNITY FOR REGISTERED USERS CLASSIFIED BY THEIR LOCATION AND MEMBERSHIP IN MUSIC PROGRAMS BY STATE, AREA, REGION, DISTRICT, OR CITY, TO PREPARE THEM FOR VARIOUS AUDITION PROCESSES, PARTICIPATE IN COMPETITIONS, SHOWCASE THEIR SKILLS, GET FEEDBACK FROM THEIR PEERS AND INSTRUCTORS, FORM VIRTUAL COMMUNITIES, ENGAGE IN SOCIAL NETWORKING, IMPROVE THEIR TALENT, AND THEIR AUDITION PROWESS (U.S. CLS. 100 AND 101).
TARAH HARDY, EXAMINING ATTORNEY

SN 77-139,919. VIACOM INTERNATIONAL INC., NEW YORK, NY. FILED 3-26-2007.

OGOLOGO

THE MARK CONSISTS OF STANDARD CHARACTERS WITHOUT CLAIM TO ANY PARTICULAR FONT, STYLE, SIZE, OR COLOR.

FOR COMPUTER SERVICES, NAMELY, CREATING AN ONLINE COMMUNITY FOR REGISTERED USERS TO ENGAGE IN SOCIAL NETWORKING (U.S. CLS. 100 AND 101).
B. PARADEWELAI, EXAMINING ATTORNEY

SN 77-139,992. VASTPLANET CORPORATION, TAMPA, FL. FILED 3-26-2007.

VASTPLANET

THE MARK CONSISTS OF STANDARD CHARACTERS WITHOUT CLAIM TO ANY PARTICULAR FONT, STYLE, SIZE, OR COLOR.

FOR COMPUTER SERVICES, NAMELY, DESIGNING AND IMPLEMENTING WEB SITES FOR OTHERS (U.S. CLS. 100 AND 101).
FIRST USE 11-30-1998; IN COMMERCE 11-30-1998.
NAPOLEON SHARMA, EXAMINING ATTORNEY

CLASS 42—(Continued).

SN 77-140,018. SOURCEONE CAD, SAN CLEMENTE, CA. FILED 3-26-2007.



THE MARK CONSISTS OF STYLIZED TEXT, FOR ARCHITECTURAL DESIGN; DRAFTING (U.S. CLS. 100 AND 101).
FRANK LATTUCA, EXAMINING ATTORNEY

SN 77-140,137. COMMONWEALTH NETWORK SOLUTIONS, GLEN ALLEN, VA. FILED 3-26-2007.



THE MARK CONSISTS OF THE CAPITAL LETTERS "C" AND "N" FOLLOWED BY A DESIGN OF LOCK, A LOWERCASE "T" AND A CAPITAL "S".
FOR COMPUTER CONSULTATION IN THE FIELD OF COMPUTER SECURITY (U.S. CLS. 100 AND 101).
FIRST USE 7-29-2006; IN COMMERCE 9-20-2006.
ROSELLE HERRERA, EXAMINING ATTORNEY

SN 77-140,946. ELUMA, INC., TEWKSBURY, MA. FILED 3-27-2007.



FOR COMPUTER CONSULTATION; COMPUTER PROGRAMMING; COMPUTER SERVICES IN THE NATURE OF CUSTOMIZED WEB PAGES FEATURING USER-DEFINED INFORMATION, PERSONAL PROFILES AND INFORMATION; COMPUTER SERVICES, NAMELY CREATING INDEXES OF INFORMATION, SITES AND OTHER RESOURCES AVAILABLE ON COMPUTER NETWORKS; COMPUTER SERVICES, NAMELY, CREATING AN ONLINE COMMUNITY FOR REGISTERED USERS TO PARTICIPATE IN COMPETITIONS, SHOWCASE THEIR SKILLS, GET FEEDBACK FROM THEIR PEERS, FORM VIRTUAL COMMUNITIES, ENGAGE IN SOCIAL NETWORKING AND IMPROVE THEIR TALENT; COMPUTER SERVICES, NAMELY, DESIGNING AND IMPLEMENTING NETWORK WEB PAGES FOR OTHERS; COMPUTER SERVICES, NAMELY, HOSTING ON-LINE INTERACTIVE PUBLIC CALENDARS THAT ALLOW MULTIPLE PARTICI-

CLASS 42—(Continued).

PANTS TO SHARE EVENT SCHEDULES, FACILITY RESERVATIONS, AND TRANSPORTATION REQUESTS; COMPUTER SERVICES, NAMELY, HOSTING ON-LINE WEB FACILITIES FOR OTHERS FOR ORGANIZING AND CONDUCTING ONLINE MEETINGS, GATHERINGS, AND INTERACTIVE DISCUSSIONS; COMPUTER SERVICES, NAMELY, PROVIDING SEARCH ENGINES FOR OBTAINING DATA ON A GLOBAL COMPUTER NETWORK; COMPUTER SOFTWARE CONSULTANCY; COMPUTER SOFTWARE CONSULTATION; COMPUTER SOFTWARE DESIGN, COMPUTER PROGRAMMING, OR MAINTENANCE OF COMPUTER SOFTWARE; CREATION AND PROVISION OF WEB PAGES TO AND FOR THIRD PARTIES; CUSTOMIZATION OF COMPUTER HARDWARE AND SOFTWARE; DESIGN AND DEVELOPMENT OF ON-LINE COMPUTER SOFTWARE SYSTEMS; DESIGN OF HOME PAGES; DESIGN OF HOME PAGES, COMPUTER SOFTWARE AND WEB SITES; DESIGN OF HOMEPAGES AND WEB-SITES; DESIGN OF HOMEPAGES AND WEBSITES; DESIGN, CREATION, HOSTING AND MAINTENANCE OF INTERNET SITES FOR THIRD PARTIES; DESIGN, CREATION, HOSTING, MAINTENANCE OF WEBSITES FOR OTHERS; HOSTING THE WEB SITES OF OTHERS ON A COMPUTER SERVER FOR A GLOBAL COMPUTER NETWORK; INSTALLATION OF COMPUTER SOFTWARE; INTEGRATION OF COMPUTER SYSTEMS AND NETWORKS; PROVIDING CUSTOMIZED ON-LINE WEB PAGES FEATURING USER-DEFINED INFORMATION, WHICH INCLUDES SEARCH ENGINES AND ON-LINE WEB LINKS TO OTHER WEB SITES; WEB SITE HOSTING SERVICES; WEBSITE DEVELOPMENT FOR OTHERS (U.S. CLS. 100 AND 101).

JASON BLAIR, EXAMINING ATTORNEY

SN 77-141,355. TELLING STONE SOFTWARE, L.L.C., DURHAM, NH. FILED 3-27-2007.

TELLING STONE SOFTWARE

THE MARK CONSISTS OF STANDARD CHARACTERS WITHOUT CLAIM TO ANY PARTICULAR FONT, STYLE, SIZE, OR COLOR.

NO CLAIM IS MADE TO THE EXCLUSIVE RIGHT TO USE "SOFTWARE", APART FROM THE MARK AS SHOWN. FOR COMPUTER SOFTWARE DEVELOPMENT (U.S. CLS. 100 AND 101).

ELISSA GARBER KON, EXAMINING ATTORNEY

SN 77-141,477. ROTH, KENNETH J., PHOENIX, AZ. FILED 3-27-2007.

PLANCHECK

THE MARK CONSISTS OF STANDARD CHARACTERS WITHOUT CLAIM TO ANY PARTICULAR FONT, STYLE, SIZE, OR COLOR.

FOR ARCHITECTURAL DESIGN AND CONSULTATION SERVICES, NAMELY, MANUAL REVIEW AND ELECTRONIC REVIEW AND ANALYSIS OF CONSTRUCTION DRAWINGS AND PLANS (U.S. CLS. 100 AND 101).

ERIN FALK, EXAMINING ATTORNEY

CLASS 42—(Continued).

SN 77-141,739. DEUTSCHE TELEKOM AG, BONN, FED REP GERMANY, FILED 3-27-2007.

Octopus Open

THE MARK CONSISTS OF STANDARD CHARACTERS WITHOUT CLAIM TO ANY PARTICULAR FONT, STYLE, SIZE, OR COLOR.

OWNER OF FED REP GERMANY REG. NO. 30620822, DATED 2-9-2007, EXPIRES 4-30-2016.

FOR COMPUTER PROGRAMMING SERVICES FOR OTHERS; RENTAL OF COMPUTER SOFTWARE AND HARDWARE FOR ONLINE ACCESS; DATA ENCRYPTION SERVICES; APPLICATION SERVICE PROVIDER, NAMELY, HOSTING COMPUTER SOFTWARE APPLICATIONS FOR OTHERS, HOSTING OF DIGITAL CONTENT ON THE INTERNET; HOSTING THE WEBSITES OF OTHERS ON A COMPUTER SERVER FOR A GLOBAL COMPUTER NETWORK; COMPUTER SERVICES, NAMELY, CREATING INDEXES OF INFORMATION AVAILABLE ON COMPUTER NETWORKS; PROVIDING INFORMATION VIA THE TELEPHONE AND THE GLOBAL COMMUNICATION NETWORKS IN THE FIELD OF INFORMATION TECHNOLOGY; CONSULTING SERVICES IN THE FIELD OF DESIGN, SELECTION, IMPLEMENTATION AND USE OF COMPUTER HARDWARE AND SOFTWARE SYSTEMS FOR OTHERS; INSTALLATION, MAINTENANCE AND REPAIR OF COMPUTER SOFTWARE; TECHNICAL PROJECT PLANNING SERVICES RELATED TO TELECOMMUNICATIONS EQUIPMENT; PROVIDING INFORMATION AT THE SPECIFIC REQUEST OF END-USERS BY MEANS OF TELEPHONE OR GLOBAL COMMUNICATIONS NETWORKS; PROVIDING TEMPORARY USE OF ONLINE NON-DOWNLOADABLE TELECOMMUNICATIONS SOFTWARE FOR PROVIDING MULTIPLE USER ACCESS TO THE GLOBAL COMPUTER NETWORK (U.S. CLS. 100 AND 101).

LINDA ORNDORFF, EXAMINING ATTORNEY

SN 77-141,948. SCJ VENDING CORP., WOODBURY, NY. FILED 3-27-2007.

THESTEMCELLEXCHANGE.COM

THE MARK CONSISTS OF STANDARD CHARACTERS WITHOUT CLAIM TO ANY PARTICULAR FONT, STYLE, SIZE, OR COLOR.

FOR PROVIDING MEDICAL AND SCIENTIFIC RESEARCH INFORMATION CONCERNING STEM CELLS VIA THE INTERNET OR A GLOBAL COMPUTER NETWORK (U.S. CLS. 100 AND 101).

FIRST USE 1-31-2007; IN COMMERCE 1-31-2007.

CAROLINE WOOD, EXAMINING ATTORNEY

CLASS 42—(Continued).

SN 77-141,978. COLLABNET, INC., BRISBANE, CA. FILED 3-27-2007.



OWNER OF U.S. REG. NOS. 2,591,636 AND 3,215,006.
THE MARK CONSISTS OF A STYLIZED FLOWER WITH WORD OPENCOLLABNET.

FOR PROVIDING INFORMATION IN THE FIELDS OF COMPUTER SOFTWARE DEVELOPMENT, COMPUTER SOFTWARE DEVELOPMENT TOOLS, COMPUTER SOFTWARE, OPEN-SOURCE DEVELOPMENT COMMUNITIES, COMPUTER AND TECHNOLOGY, COMPUTER SOFTWARE DEVELOPMENT AND PROGRAMMING, AND TECHNICAL SUPPORT RESOURCES, ALL VIA AN INTERACTIVE WEB SITE ON THE INTERNET; PROVIDING LINKS TO WEB SITES, ARTICLES, WEBCASTS, PODCASTS AND STREAMING AUDIO/VIDEO OF OTHERS FEATURING INFORMATION ON COMPUTER SOFTWARE DEVELOPMENT, COMPUTER SOFTWARE DEVELOPMENT TOOLS, COMPUTER SOFTWARE, OPEN-SOURCE DEVELOPMENT COMMUNITIES, COMPUTER AND TECHNOLOGY, COMPUTER SOFTWARE DEVELOPMENT AND PROGRAMMING, AND TECHNICAL SUPPORT RESOURCES; TECHNICAL SUPPORT SERVICES, NAMELY TROUBLESHOOTING OF COMPUTER SOFTWARE PROBLEMS; COMPUTER SOFTWARE AND INFORMATION TECHNOLOGY CONSULTATION; COMPUTER AND TECHNOLOGY SERVICES FOR OTHERS, NAMELY, SOFTWARE DESIGN, DEVELOPMENT AND PROGRAMMING; COMPUTER SERVICES, NAMELY, DESIGNING AND IMPLEMENTING WEBSITES FOR OTHERS; HOSTING THE WEBSITES OF OTHERS ON A COMPUTER SERVER FOR A GLOBAL COMPUTER NETWORK; APPLICATION SERVICE PROVIDER, NAMELY, HOSTING COMPUTER SOFTWARE APPLICATIONS OF OTHERS; PROVIDING TEMPORARY USE OF ON-LINE NON-DOWNLOADABLE SOFTWARE FOR SOFTWARE DEVELOPMENT, TRACKING CHANGES AND MODIFICATIONS TO SOFTWARE AND FOR MANAGING SOFTWARE DEVELOPMENT PROJECTS; COMPUTER SERVICES, NAMELY DESIGNING, DEVELOPING, IMPLEMENTING, INSTALLING, MAINTAINING, UPGRADING, SUPPORTING AND CONFIGURING COMPUTER SOFTWARE AND CONSULTING RELATED THERETO (U.S. CLS. 100 AND 101).

FIRST USE 10-20-2006; IN COMMERCE 10-20-2006.
CAROLINE WOOD, EXAMINING ATTORNEY

CLASS 42—(Continued).

SN 77-142,650. ONREQUEST IMAGES, INC., SEATTLE, WA. FILED 3-28-2007.

ONTAP

THE MARK CONSISTS OF STANDARD CHARACTERS WITHOUT CLAIM TO ANY PARTICULAR FONT, STYLE, SIZE, OR COLOR.

FOR PROVIDING TEMPORARY USE OF ON-LINE NON-DOWNLOADABLE SOFTWARE FOR CREATING, MANAGING, SHARING AND REVIEWING CUSTOM IMAGERY, CONDUCTING ONLINE CASTING, SETTING UP PHOTO SHOOTS, CATERING, STYLISTS AND DIGITAL TECHNICIANS, AND CONDUCTING PHOTOGRAPHER PORTFOLIO REVIEW (U.S. CLS. 100 AND 101).

STEVEN PEREZ, EXAMINING ATTORNEY

SN 77-142,714. INVOLUTION STUDIOS LLC, SUNNYVALE, CA. FILED 3-28-2007.

INVOLUTION

THE MARK CONSISTS OF STANDARD CHARACTERS WITHOUT CLAIM TO ANY PARTICULAR FONT, STYLE, SIZE, OR COLOR.

FOR COMPUTER SOFTWARE DESIGN FOR OTHERS (U.S. CLS. 100 AND 101).

FIRST USE 6-3-2004; IN COMMERCE 6-3-2004.
GEORGIA CARTY, EXAMINING ATTORNEY

SN 77-142,727. DRAWLOOP TECHNOLOGIES, INC., TAMPA, FL. FILED 3-28-2007.

S-LOOP

THE MARK CONSISTS OF STANDARD CHARACTERS WITHOUT CLAIM TO ANY PARTICULAR FONT, STYLE, SIZE, OR COLOR.

FOR NON-DOWNLOADABLE SOFTWARE FOR DATA ENTRY AND DOCUMENT GENERATION (U.S. CLS. 100 AND 101).

FIRST USE 1-1-2007; IN COMMERCE 1-1-2007.
GISELLE AGOSTO, EXAMINING ATTORNEY

CLASS 42—(Continued).

SN 77-142,770. DRAWLOOP TECHNOLOGIES, INC., TAM-PA, FL. FILED 3-28-2007.

LOOP

THE MARK CONSISTS OF STANDARD CHARACTERS WITHOUT CLAIM TO ANY PARTICULAR FONT, STYLE, SIZE, OR COLOR.

FOR NON-DOWNLOADABLE SOFTWARE FOR COMBINING MULTIPLE FILES IN A PLURALITY OF FORMATS INTO A SINGLE, PORTABLE DOCUMENT (U.S. CLS. 100 AND 101).

FIRST USE 1-1-2007; IN COMMERCE 1-1-2007.
GISELLE AGOSTO, EXAMINING ATTORNEY

SN 77-142,908. SURECOMP INTERNATIONAL LTD., BRIDGETOWN, BARBADOS, FILED 3-28-2007.

ALLNETT

THE MARK CONSISTS OF STANDARD CHARACTERS WITHOUT CLAIM TO ANY PARTICULAR FONT, STYLE, SIZE, OR COLOR.

OWNER OF U.S. REG. NOS. 2,706,933 AND 3,083,702.
FOR PROVIDING ON-LINE NON-DOWNLOADABLE COMPUTER SOFTWARE IN THE FIELD OF BANKING, NAMELY, SOFTWARE THAT FACILITATES VIA THE GLOBAL COMPUTER NETWORK ELECTRONIC PAYMENT, CREDIT, AND DEBIT TRANSACTIONS IN THE AREA OF CREDIT AND COLLECTION (U.S. CLS. 100 AND 101).

WENDY JUN, EXAMINING ATTORNEY

SN 77-142,918. STAGEFFECT, INC., CHAPPAQUA, NY. FILED 3-28-2007.

STAGEFFECT

THE MARK CONSISTS OF STANDARD CHARACTERS WITHOUT CLAIM TO ANY PARTICULAR FONT, STYLE, SIZE, OR COLOR.

FOR HOME STAGING CONSULTATION, NAMELY, TEMPORARY INTERIOR AND EXTERIOR HOME DECORATION CONSULTATION FOR THE PURPOSE OF MAKING HOMES MORE APPEALING TO PROSPECTIVE BUYERS; TEMPORARY INTERIOR AND EXTERIOR HOME DECORATION CONSULTATION, NAMELY HOME STAGING CONSULTATION FOR THE PURPOSE OF MAKING HOMES MORE APPEALING TO PROSPECTIVE BUYERS (U.S. CLS. 100 AND 101).

MARK T. MULLEN, EXAMINING ATTORNEY

CLASS 42—(Continued).

SN 77-143,005. KMS TECHNOLOGIES-KJT ENTERPRISES INC., HOUSTON, TX. FILED 3-28-2007.

SeisTEM

THE MARK CONSISTS OF STANDARD CHARACTERS WITHOUT CLAIM TO ANY PARTICULAR FONT, STYLE, SIZE, OR COLOR.

FOR EXPLORATION AND SEARCHING OF OIL AND GAS; GEOPHYSICAL EXPLORATION FOR THE OIL, GAS AND MINING INDUSTRIES; OIL EXPLORATION; OIL FIELD EXPLORATION; OIL FIELD SURVEYING; OIL PROSPECTING; SURVEYING OF OIL BEDS AND FIELDS; SURVEYING OF OIL-BEARING SEAMS; GAS EXPLORATION (U.S. CLS. 100 AND 101).

ALEX KEAM, EXAMINING ATTORNEY

SN 77-143,084. HICKEY, SEAN P. VANDERGRIFT, PA. FILED 3-28-2007.

Headzoo

THE MARK CONSISTS OF STANDARD CHARACTERS WITHOUT CLAIM TO ANY PARTICULAR FONT, STYLE, SIZE, OR COLOR.

FOR SOFTWARE AUTHORIZING (U.S. CLS. 100 AND 101).

MICHAEL KEATING, EXAMINING ATTORNEY

SN 77-143,212. AUTOMOTIVE RENTALS, INC., MOUNT LAUREL, NJ. FILED 3-28-2007.

ENVIROFLEET

THE MARK CONSISTS OF STANDARD CHARACTERS WITHOUT CLAIM TO ANY PARTICULAR FONT, STYLE, SIZE, OR COLOR.

FOR FLEET VEHICLE MONITORING SERVICES WHICH TRACK CARBON EMISSIONS LEVELS; DEVELOPMENT OF VOLUNTARY STANDARDS FOR VEHICLE FLEET ENERGY EFFICIENCY (U.S. CLS. 100 AND 101).

FIRST USE 3-5-2007; IN COMMERCE 3-5-2007.
ANDREW RHIM, EXAMINING ATTORNEY

CLASS 42—(Continued).

SN 77-143,282. SIREAU, JEAN-YVES, CYBERJAYA, MALAYSIA, FILED 3-29-2007.

Genseq

THE MARK CONSISTS OF STANDARD CHARACTERS WITHOUT CLAIM TO ANY PARTICULAR FONT, STYLE, SIZE, OR COLOR.

FOR DEVELOPMENT OF NEW TECHNOLOGY FOR OTHERS IN THE FIELD OF BIOTECHNOLOGY; INFORMATION ON THE SUBJECT OF SCIENTIFIC RESEARCH IN THE FIELD OF BIOCHEMISTRY AND BIOTECHNOLOGY; GENOME AMPLIFICATION; STRUCTURAL AND FUNCTIONAL ANALYSIS OF GENOMES (U.S. CLS. 100 AND 101).

LESLEY LAMOTHE, EXAMINING ATTORNEY

SN 77-146,057. CROSSBOW CONSULTING, L.P., DALLAS, TX. FILED 4-2-2007.

the unbiased, practical link
between what management
needs and what technology
can deliver

THE MARK CONSISTS OF STANDARD CHARACTERS WITHOUT CLAIM TO ANY PARTICULAR FONT, STYLE, SIZE, OR COLOR.

FOR COMPUTER PROGRAMMING FOR OTHERS; COMPUTER PROJECT MANAGEMENT SERVICES; COMPUTER SOFTWARE CONSULTATION; COMPUTER SOFTWARE DESIGN, COMPUTER PROGRAMMING, OR MAINTENANCE OF COMPUTER SOFTWARE; CONSULTING SERVICES IN THE FIELD OF DESIGN, SELECTION, IMPLEMENTATION AND USE OF COMPUTER HARDWARE AND SOFTWARE SYSTEMS FOR OTHERS; CUSTOMIZATION OF COMPUTER HARDWARE AND SOFTWARE (U.S. CLS. 100 AND 101).

FIRST USE 4-21-2001; IN COMMERCE 4-21-2001.
LINDA POWELL, EXAMINING ATTORNEY

SN 77-150,726. SHAFTEL, LISA F., FRAMINGHAM, MA. FILED 4-6-2007.

s2do

THE MARK CONSISTS OF STANDARD CHARACTERS WITHOUT CLAIM TO ANY PARTICULAR FONT, STYLE, SIZE, OR COLOR.

FOR COMMERCIAL ART DESIGN; DESIGN OF SPECIALTY INTERIOR AND EXTERIOR ENVIRONMENT SETTINGS; GRAPHIC ART DESIGN; DESIGN OF CUSTOM PAINTINGS (U.S. CLS. 100 AND 101).

FIRST USE 1-1-1995; IN COMMERCE 1-1-1995.
CHRISTOPHER OTT, EXAMINING ATTORNEY

CLASS 42—(Continued).

SN 77-153,968. ESTECH, LLC, COLUMBUS, OH. FILED 4-11-2007.

POWERCYCLE

THE MARK CONSISTS OF STANDARD CHARACTERS WITHOUT CLAIM TO ANY PARTICULAR FONT, STYLE, SIZE, OR COLOR.

FOR ENGINEERING SERVICES FOR THE CONSTRUCTION OF WATER TREATMENT AND PURIFICATION PLANTS, SOLID WASTE TREATMENT PLANTS AND OTHER MUNICIPAL INFRASTRUCTURE FACILITIES (U.S. CLS. 100 AND 101).

TEJBIR SINGH, EXAMINING ATTORNEY

SN 77-158,512. HEALTHFUSION, INC., SOLANA BEACH, CA. FILED 4-17-2007.

DENIAL DEFENDER

THE MARK CONSISTS OF STANDARD CHARACTERS WITHOUT CLAIM TO ANY PARTICULAR FONT, STYLE, SIZE, OR COLOR.

FOR PROVIDING TEMPORARY USE OF NON-DOWNLOADABLE SOFTWARE FOR USE TO AID IN THE DETERMINATION OF PATIENT ELIGIBILITY FOR MEDICAL BENEFITS AND IN THE COORDINATION OF PATIENT REFERRALS AND PROVIDER CLAIMS, AND TO PROVIDE INFORMATION RELATING TO PROVIDERS, LABORATORY AND PHARMACY DATA, MEDICAL AND OPTICAL SUPPLIES AND INVENTORY, AND MEDICAL QUALITY MAINTENANCE OVER COMPUTER NETWORKS, INTRANETS AND THE INTERNET (U.S. CLS. 100 AND 101).

BRIAN CALLAGHAN, EXAMINING ATTORNEY

CLASS 42—(Continued).

SN 77-158,518. HEALTHFUSION, INC., SOLANA BEACH, CA. FILED 4-17-2007.

PRO-ACTIVE RCM

THE MARK CONSISTS OF STANDARD CHARACTERS WITHOUT CLAIM TO ANY PARTICULAR FONT, STYLE, SIZE, OR COLOR.

NO CLAIM IS MADE TO THE EXCLUSIVE RIGHT TO USE "RCM", APART FROM THE MARK AS SHOWN.

FOR PROVIDING TEMPORARY USE OF NON-DOWNLOADABLE SOFTWARE FOR USE TO AID IN THE DETERMINATION OF PATIENT ELIGIBILITY FOR MEDICAL BENEFITS AND IN THE COORDINATION OF PATIENT REFERRALS AND PROVIDER CLAIMS, AND TO PROVIDE INFORMATION RELATING TO PROVIDERS, LABORATORY AND PHARMACY DATA, MEDICAL AND OPTICAL SUPPLIES AND INVENTORY, AND MEDICAL QUALITY MAINTENANCE OVER COMPUTER NETWORKS, INTRANETS AND THE INTERNET (U.S. CLS. 100 AND 101).

BRIAN CALLAGHAN, EXAMINING ATTORNEY

CLASS 42—(Continued).

SN 77-171,405. DSCI, FREEHOLD, NJ. FILED 5-2-2007.

MRS

THE MARK CONSISTS OF STANDARD CHARACTERS WITHOUT CLAIM TO ANY PARTICULAR FONT, STYLE, SIZE, OR COLOR.

FOR COMPUTER SERVICE, NAMELY, ACTING AS AN APPLICATION SERVICE PROVIDER IN THE FIELD OF KNOWLEDGE MANAGEMENT TO HOST COMPUTER APPLICATION SOFTWARE FOR THE COLLECTION, EDITING, ORGANIZING, MODIFYING, BOOK MARKING, TRANSMISSION, STORAGE AND SHARING OF DATA AND INFORMATION (U.S. CLS. 100 AND 101).

CARYN GLASSER, EXAMINING ATTORNEY

SN 77-175,369. PARDOT LLC, ATLANTA, GA. FILED 5-8-2007.

Prospect Insight

THE MARK CONSISTS OF STANDARD CHARACTERS WITHOUT CLAIM TO ANY PARTICULAR FONT, STYLE, SIZE, OR COLOR.

FOR APPLICATION SERVICE PROVIDER (ASP) FEATURING SOFTWARE FOR USE IN SALES AND MARKETING (U.S. CLS. 100 AND 101).

FIRST USE 5-1-2007; IN COMMERCE 5-1-2007.

C. DIONNE CLYBURN, EXAMINING ATTORNEY

SN 77-159,695. EMERGING MEDIA GROUP, INC., NEW YORK, NY. FILED 4-18-2007.

TRAFFIQ

THE MARK CONSISTS OF STANDARD CHARACTERS WITHOUT CLAIM TO ANY PARTICULAR FONT, STYLE, SIZE, OR COLOR.

FOR PROVIDING TEMPORARY USE OF ON-LINE, NON-DOWNLOADABLE COMPUTER SOFTWARE FOR USE BY OTHERS IN AUCTIONING OF ADVERTISEMENT OPPORTUNITIES AND MANAGEMENT OF ADVERTISING ACTIVITIES AND INVENTORY, AND MONITORING ADVERTISEMENT INFORMATION, THROUGH AN ONLINE SITE ON A GLOBAL COMPUTER NETWORK (U.S. CLS. 100 AND 101).

JOANNA DUKOVIC, EXAMINING ATTORNEY

SN 77-177,022. DSCI, FREEHOLD, NJ. FILED 5-9-2007.



NO CLAIM IS MADE TO THE EXCLUSIVE RIGHT TO USE "TEAM" AND "RAPID RESPONSE", APART FROM THE MARK AS SHOWN.

THE COLOR(S) BLACK, WHITE, BLUE, AND RED IS/ARE CLAIMED AS A FEATURE OF THE MARK.

THE MARK CONSISTS OF THE CHARACTERS R23G IN WHITE, WITH THE R AND G OUTLINED IN RED AND

CLASS 42—(Continued).

THE 2 AND 3 OUTLINED IN BLUE, ON A BLACK RECTANGULAR BACKGROUND, THE WORDS DSCI TEAM FADING FROM RED TO WHITE TO BLUE, IN SMALLER FONT ABOVE THE R, THE WORDS RAPID RESPONSE THIRD GENERATION IN WHITE IN SMALLER FONT BELOW THE 3G, A BLUE STAR ON TOP OF THE LOWER PART OF THE 23, WITH RED, WHITE, AND BLUE HORIZONTAL BARS TO THE RIGHT OF THE G, AND A BLUE AND RED UNDERLINE BELOW THE 3G AND THE BLUE HORIZONTAL BAR.

FOR ENGINEERING SERVICES, NAMELY, ENGINEERING FOR THE DEVELOPING, UPGRADING, MAINTAINING, AND SUPPORT OF A BROAD RANGE OF NEW AND EXISTING COMPUTER PLATFORMS AND COMPUTER SYSTEMS FOR THE DEPARTMENT OF DEFENSE (U.S. CLS. 100 AND 101).

CARYN GLASSER, EXAMINING ATTORNEY

SN 77-177,408. LEE, SPIDEY, CARROLLTON, GA. FILED 5-10-2007.

BETWEEN YOUR HOPES AND
YOUR DREAMS LIFE HAPPENS

THE MARK CONSISTS OF STANDARD CHARACTERS WITHOUT CLAIM TO ANY PARTICULAR FONT, STYLE, SIZE, OR COLOR.

FOR RESEARCH AND DEVELOPMENT AND CONSULTATION RELATED THERETO IN THE FIELD OF GLOBAL WARMING (U.S. CLS. 100 AND 101).

CAROL SPILS, EXAMINING ATTORNEY

SN 77-178,295. LEE, SPIDEY, CARROLLTON, GA. FILED 5-10-2007.

Population E²

THE MARK CONSISTS OF THE WORD POPULATION FIRST, THEN THE LETTER E FOLLOWED BY THE NUMBER 2 WHICH IS SMALLER IN SHAPE THAN THE E AND SLIGHTLY HIGHER THAN THE E. THE PHRASE IS PRONOUNCED POPULATION E SQUARED.

FOR RESEARCH AND DEVELOPMENT AND CONSULTATION RELATED THERETO IN THE FIELD OF GLOBAL WARMING (U.S. CLS. 100 AND 101).

CAROL SPILS, EXAMINING ATTORNEY

CLASS 42—(Continued).

SN 77-183,676. ONREQUEST IMAGES, INC., SEATTLE, WA. FILED 5-17-2007.

ONBRAND CENTRAL

THE MARK CONSISTS OF STANDARD CHARACTERS WITHOUT CLAIM TO ANY PARTICULAR FONT, STYLE, SIZE, OR COLOR.

FOR PROVIDING TEMPORARY USE OF ON-LINE NON-DOWNLOADABLE SOFTWARE FOR USE IN THE FIELD OF PHOTOGRAPHY SERVICES, NAMELY, MANAGING IMAGES USED IN ADVERTISING, PRINT COLLATERAL, WEBSITES, AND SIGNAGE (U.S. CLS. 100 AND 101).

STEVEN PEREZ, EXAMINING ATTORNEY

SN 77-187,399. KMS TECHNOLOGIES - KJT ENTERPRISES INC., HOUSTON, TX. FILED 5-22-2007.

VECTOREM

THE MARK CONSISTS OF STANDARD CHARACTERS WITHOUT CLAIM TO ANY PARTICULAR FONT, STYLE, SIZE, OR COLOR.

FOR ANALYSIS OF OIL FIELDS; ANALYSIS SERVICES FOR OIL FIELD EXPLORATION; EXPLORATION AND SEARCHING OF OIL AND GAS; GAS EXPLORATION; GEOPHYSICAL EXPLORATION FOR THE OIL, GAS AND MINING INDUSTRIES; INSPECTION OF OIL FIELDS; MINING AND MINERAL EXPLORATION SERVICES; OIL EXPLORATION; OIL FIELD EXPLORATION; OIL FIELD SURVEYING; OIL PROSPECTING; PETROLEUM EXPLORATION; PROVIDING TECHNOLOGY INFORMATION IN THE OIL AND GAS INDUSTRY; UNDERWATER EXPLORATION (U.S. CLS. 100 AND 101).

ALEX KEAM, EXAMINING ATTORNEY

SN 77-975,056. ABB SCHWEIZ AG, BADEN, SWITZERLAND, FILED S.R. 10-6-2006; AM. P.R. 10-10-2006.

FOCS

THE MARK CONSISTS OF STANDARD CHARACTERS WITHOUT CLAIM TO ANY PARTICULAR FONT, STYLE, SIZE, OR COLOR.

OWNER OF SWITZERLAND REG. NO. 526545, DATED 8-18-2004, EXPIRES 8-18-2014.

FOR CALIBRATION (U.S. CLS. 100 AND 101). FIRST USE 2-22-2005; IN COMMERCE 12-21-2005.

KATHY DE JONGE, EXAMINING ATTORNEY

CLASS 42—(Continued).

SN 78-362,977. PARTNERSHIP BUCCI, GEORGE, A / HUDSON, SCOTT, T, TOLLAND, CT. FILED 2-5-2004.

MindSpin
Technologies

THE MARK CONSISTS OF STANDARD CHARACTERS WITHOUT CLAIM TO ANY PARTICULAR FONT, STYLE, SIZE, OR COLOR.

NO CLAIM IS MADE TO THE EXCLUSIVE RIGHT TO USE "TECHNOLOGIES", APART FROM THE MARK AS SHOWN.

FOR COMPUTER SOFTWARE DEVELOPMENT (U.S. CLS. 100 AND 101).

FIRST USE 7-23-2004; IN COMMERCE 7-23-2004.
TRACY CROSS, EXAMINING ATTORNEY

SN 78-604,115. IMPRESSIONS BY DESIGN INTERIORS, LLC, KATONAH, NY. FILED 4-7-2005.

IMPRESSIONS BY
DESIGN

THE MARK CONSISTS OF STANDARD CHARACTERS WITHOUT CLAIM TO ANY PARTICULAR FONT, STYLE, SIZE, OR COLOR.

FOR INTERIOR DESIGN AND CONSULTATION SERVICES, NAMELY, INTERIOR DESIGN, INTERIOR DECORATING AND INTERIOR REDESIGN; INTERIOR DECORATING CONSULTATIONS; PROVIDING INTERIOR DESIGN AND DECORATION CONSULTATION SERVICES TO PREPARE AND SHOWCASE HOMES FOR SALE; INTERIOR DECORATING FOR PARTIES (U.S. CLS. 100 AND 101).

COLLEEN KEARNEY, EXAMINING ATTORNEY

CLASS 42—(Continued).

SN 78-705,190. PINEROCK, INC., WASHINGTON, DC. FILED 9-1-2005.



OWNER OF U.S. REG. NOS. 2,428,843 AND 2,567,667.
THE COLOR(S) ORANGE AND BLUE IS/ARE CLAIMED AS A FEATURE OF THE MARK.

THE COLOR ORANGE APPEARS IN THE STYLIZED LETTER "P" AND IN THE DOT OF THE LOWER CASE LETTER "I" AND THE COLOR BLUE APPEARS IN THE WORDING, "PINEROCK EXPERIENCE. RESULTS."

FOR DESIGN FOR OTHERS IN THE FIELD OF TRADE SHOW EXHIBIT BOOTHS (U.S. CLS. 100 AND 101).

LANA PHAM, EXAMINING ATTORNEY

SN 78-705,192. PINEROCK, INC., WASHINGTON, DC. FILED 9-1-2005.



OWNER OF U.S. REG. NOS. 2,428,843 AND 2,567,667.
FOR DESIGN FOR OTHERS IN THE FIELD OF TRADE SHOW EXHIBIT BOOTHS (U.S. CLS. 100 AND 101).

LANA PHAM, EXAMINING ATTORNEY

SN 78-736,099. GENETIC SAVINGS & CLONE, INC., SAUSALITO, CA. FILED 10-19-2005.

BIOARTS

THE MARK CONSISTS OF STANDARD CHARACTERS WITHOUT CLAIM TO ANY PARTICULAR FONT, STYLE, SIZE, OR COLOR.

FOR ANIMAL AND BIOLOGICAL CLONING SERVICES; LICENSING OF INTELLECTUAL PROPERTY; DATABASE DESIGN AND DEVELOPMENT SERVICES, NAMELY, BIOLOGICAL AND CHEMICAL DATABASES FOR THE IDENTIFICATION AND ANALYSIS OF GENES AND PROTEINS (U.S. CLS. 100 AND 101).

KATHERINE E. HALMEN, EXAMINING ATTORNEY

CLASS 42—(Continued).

SN 78-755,683. GOODNIGHT, NICHOLLE F., BRISTOL, VA.
FILED 11-16-2005.



THE COLOR(S) ORANGE, BLUE, GREEN AND GRAY IS/
ARE CLAIMED AS A FEATURE OF THE MARK.

THE MARK CONSISTS OF THREE OVALS, EACH WITH
A GRAY OVAL INSIDE IT; THE FIRST OUTER OVAL IS
BLUE, THE SECOND GREEN AND THE THIRD ORANGE.
THE TEXT POSH TOT APPEARS IN GRAY BELOW THE
OVALS. AN ORANGE OVAL IS BETWEEN THE WORDS IN
THE TEXT. WHITE APPEARS IN THE DRAWING TO
INDICATE A TRANSPARENT BACKGROUND.

FOR DESIGN, CREATION, HOSTING, MAINTENANCE
OF WEBSITES FOR OTHERS (U.S. CLS. 100
AND 101).

REBECCA EISINGER, EXAMINING ATTORNEY

CLASS 42—(Continued).

SN 78-779,840. INTEL CORPORATION, SANTA CLARA, CA.
FILED 12-22-2005.



OWNER OF U.S. REG. NOS. 2,585,551 AND 3,029,954.

FOR WEB SITE HOSTING SERVICES; COMPUTER
NETWORK MANAGEMENT SERVICES, NAMELY,
MONITORING OF NETWORK SYSTEMS FOR TECHNICAL
PURPOSES; HOSTING OF DIGITAL CONTENT ON
THE INTERNET; COMPUTER NETWORK MONITORING
SERVICES, NAMELY, PROVIDING INFORMATION
ON THE OPERATION OF COMPUTER NETWORKS;
CUSTOMIZATION OF WEB SOFTWARE, COMPUTER
USER INTERFACE DESIGN FOR OTHERS, AND MAINTENANCE
OF WEBSITES FOR OTHERS, NAMELY, WEB
SITE CONTENT MANAGEMENT AND INTEGRATION;
WEB SITE DEVELOPMENT AND MAINTENANCE FOR
OTHERS; CONSULTING SERVICES IN THE FIELD OF
COMPUTERS AND WIRELESS COMPUTING; PROVIDING
TEMPORARY USE OF NON-DOWNLOADABLE
SOFTWARE FOR ENHANCING AND PROVIDING
REAL-TIME TRANSFER, TRANSMISSION, RECEPTION,
PROCESSING AND DIGITIZING OF AUDIO AND VIDEO
GRAPHICS INFORMATION; PROVIDING TEMPORARY
USE OF NON-DOWNLOADABLE SOFTWARE FOR
PROCESSING, STORAGE, RETRIEVAL, TRANSMISSION,
DISPLAY, INPUT, OUTPUT, COMPRESSING,
DECOMPRESSING, MODIFYING, BROADCASTING
AND PRINTOUT OF DATA; PROVIDING TEMPORARY
USE OF NON-DOWNLOADABLE SOFTWARE FOR ENSURING
THE SECURITY OF COMPUTER NETWORKS,
FOR ACCESS CONTROL AND SECURITY, AND FOR
USE IN PROTECTING COMPUTER NETWORKS FROM
DATA THEFT OR DAMAGE BY UNAUTHORIZED
USERS; PROVIDING TEMPORARY USE OF NON-
DOWNLOADABLE SOFTWARE FOR THE TRANSMISSION
AND RECEIPT OF FACSIMILES; PROVIDING
TEMPORARY USE OF NON-DOWNLOADABLE SOFTWARE
FOR THE DEVELOPMENT, MAINTENANCE,
AND USE OF LOCAL AND WIDE AREA COMPUTER
NETWORKS; PROVIDING TEMPORARY USE OF NON-
DOWNLOADABLE SOFTWARE FOR THE DEVELOPMENT,
MAINTENANCE, AND USE OF INTERACTIVE
AUDIO-VIDEO COMPUTER CONFERENCE SYSTEMS;
PROVIDING TEMPORARY USE OF NON-DOWNLOADABLE
SOFTWARE FOR THE RECEIPT, DISPLAY, AND
USE OF BROADCAST VIDEO, AUDIO, AND DIGITAL
DATA SIGNALS; PROVIDING TEMPORARY USE OF
NON-DOWNLOADABLE SOFTWARE FOR CREATING,
FACILITATING, AND MANAGING REMOTE ACCESS
TO AND COMMUNICATION WITH LOCAL AREA
NETWORKS (LANS), VIRTUAL PRIVATE NETWORKS
(VPN), WIDE AREA NETWORKS (WANS) AND GLOBAL
COMPUTER NETWORKS; PROVIDING TEMPORARY
USE OF NON-DOWNLOADABLE SOFTWARE FOR USE
IN PROVIDING MULTIPLE USER ACCESS TO A GLOBAL
COMPUTER INFORMATION NETWORK FOR
SEARCHING, RETRIEVING, TRANSFERRING, MANIPULATING
AND DISSEMINATING A WIDE RANGE OF
INFORMATION; PROVIDING TEMPORARY USE OF
NON-DOWNLOADABLE SOFTWARE TOOLS FOR THE
FACILITATION OF THIRD PARTY SOFTWARE APPLICATIONS;
PROVIDING TEMPORARY USE OF NON-DOWNLOADABLE
SOFTWARE FOR WIRELESS NETWORK COMMUNICATIONS;
CUSTOM COMPUTER

SN 78-774,398. COUPONS, INC., MOUNTAIN VIEW, CA.
FILED 12-15-2005.

MOTIVATE

THE MARK CONSISTS OF STANDARD CHARACTERS
WITHOUT CLAIM TO ANY PARTICULAR FONT, STYLE,
SIZE, OR COLOR.

FOR PROVIDING ONLINE, NON-DOWNLOADABLE
SOFTWARE FOR USE IN DISPLAYING INFORMATION
AND ADVERTISEMENTS OF OTHERS THAT ARE
LINKED TO KEYWORDS, PHRASES OR ICONS (U.S.
CLS. 100 AND 101).

PETER B. BROMAGHIM, EXAMINING ATTORNEY

CLASS 42—(Continued).

SOFTWARE AND HARDWARE DEVELOPMENT, DESIGN, AND CONSULTING SERVICES; LEASING OF COMPUTER EQUIPMENT, NAMELY, COMPUTERS, COMPUTER HARDWARE, PERIPHERALS, COMPUTER COMPONENTS, COMPUTER SOFTWARE AND COMPUTER PRINTERS; DESIGNING AND DEVELOPING STANDARDS FOR OTHERS IN THE DESIGN AND IMPLEMENTATION OF COMPUTER SOFTWARE, COMPUTER HARDWARE AND TELECOMMUNICATIONS EQUIPMENT; PROVIDING CUSTOMERS AND TECHNICIANS WITH INFORMATION RELATING TO COMPUTER PROJECT MANAGEMENT (U.S. CLS. 100 AND 101).
TARAH HARDY, EXAMINING ATTORNEY

SN 78-783,291. QILINSOFT, LLC, MENLO PARK, CA. FILED 12-30-2005.

QILINSOFT

THE MARK CONSISTS OF STANDARD CHARACTERS WITHOUT CLAIM TO ANY PARTICULAR FONT, STYLE, SIZE, OR COLOR.

FOR COMPUTER SOFTWARE CONSULTING, DEVELOPMENT AND MAINTENANCE FOR THE STRUCTURING AND MANAGING OF DATA FOR INFORMATION EXCHANGE (U.S. CLS. 100 AND 101).

FIRST USE 1-1-2004; IN COMMERCE 1-1-2004.
AMY GEARIN, EXAMINING ATTORNEY

SN 78-797,878. SYNDIANT, INC., DALLAS, TX. FILED 1-24-2006.



THE COLOR(S) RED, GREEN AND BLUE IS/ARE CLAIMED AS A FEATURE OF THE MARK.

THE MARK CONSISTS OF THE WORD "SYNDIANT" RADIATING PRISMS OF RED, GREEN AND BLUE FROM THE TOP OF THE WORD. THE LETTERS SYN ARE IN RED, THE LETTERS DI ARE IN GREEN AND THE LETTERS ANT ARE IN BLUE.

FOR DESIGNING ELECTRONIC COMPONENTS USED IN TELEVISIONS, MONITORS AND OTHER DISPLAY UNITS (U.S. CLS. 100 AND 101).

FIRST USE 12-15-2004; IN COMMERCE 12-15-2004.
TARAH HARDY, EXAMINING ATTORNEY

CLASS 42—(Continued).

SN 78-851,813. ENGAGE THOUGHTWARE, LLC, BOUNTIFUL, UT. FILED 3-31-2006.

ENGAGE

THE MARK CONSISTS OF STANDARD CHARACTERS WITHOUT CLAIM TO ANY PARTICULAR FONT, STYLE, SIZE, OR COLOR.

FOR HOSTING OF ORGANIZATIONAL IDEA CULTURE DIGITAL CONTENT ON A COMPUTER NETWORK (U.S. CLS. 100 AND 101).

FIRST USE 4-7-2006; IN COMMERCE 4-7-2006.
CHARLOTTE CORWIN, EXAMINING ATTORNEY

SN 78-865,167. UPTIME SCIENCE CORPORATION, DBA UPTIME SCIENCE CORPORATION, ALPHARETTA, GA. FILED 4-19-2006.

UPTIME SCIENCE

THE MARK CONSISTS OF STANDARD CHARACTERS WITHOUT CLAIM TO ANY PARTICULAR FONT, STYLE, SIZE, OR COLOR.

NO CLAIM IS MADE TO THE EXCLUSIVE RIGHT TO USE "UPTIME", APART FROM THE MARK AS SHOWN.

FOR TECHNICAL SUPPORT, NAMELY MONITORING OF NETWORK SYSTEMS, COMPUTER SERVICES, NAMELY TECHNOLOGICAL CONSULTATION OF MONITORING, TESTING, ANALYZING, AND REPORTING ON THE AVAILABILITY AND RELIABILITY OF COMPUTER DATA FACILITIES AND ELECTRONIC TELECOMMUNICATIONS SYSTEMS OF OTHERS; TECHNOLOGICAL CONSULTATION IN THE FIELD OF BIOLOGICAL ANALYSIS FOR MONITORING AND REPORTING ON THE AVAILABILITY AND RELIABILITY OF COMPUTER DATA FACILITIES AND OTHERS. (U.S. CLS. 100 AND 101).

FIRST USE 12-23-2003; IN COMMERCE 12-23-2003.
LEIGH LOWRY, EXAMINING ATTORNEY

SN 78-913,018. HIKARI HOLDINGS, L.C., VALLEY CENTER, CA. FILED 6-21-2006.

YOUNG PHRIENDLY

THE MARK CONSISTS OF STANDARD CHARACTERS WITHOUT CLAIM TO ANY PARTICULAR FONT, STYLE, SIZE, OR COLOR.

FOR TESTING, ANALYSIS AND EVALUATION OF THE GOODS OF OTHERS FOR THE PURPOSE OF CERTIFICATION IN THE FIELDS OF DIETARY AND NUTRITIONAL PRODUCTS, AND BODY, HAIR AND SKIN CARE PRODUCTS (U.S. CLS. 100 AND 101).

BARNEY CHARLON, EXAMINING ATTORNEY

CLASS 42—(Continued).

SN 78-919,135. TWENTY AND SEVEN, LLC, NEW YORK, NY. FILED 6-28-2006.

KRISTINA WRENN

THE MARK CONSISTS OF STANDARD CHARACTERS WITHOUT CLAIM TO ANY PARTICULAR FONT, STYLE, SIZE, OR COLOR.

KRISTINA WRENN IDENTIFIES A LIVING INDIVIDUAL WHOSE CONSENT IS OF RECORD.

FOR GRAPHIC ART DESIGN; GRAPHIC DESIGN SERVICES; CONSULTING AND DESIGN SERVICES FOR OTHERS IN THE FIELDS OF STATIONERY, ENVELOPES AND INVITATIONS; PACKAGING DESIGN AND OTHER PRINTED MATERIAL DESIGN FOR OTHERS (U.S. CLS. 100 AND 101).

ANDREA BUTLER, EXAMINING ATTORNEY

SN 78-919,515. MANIC WEBS, INC., PHOENIX, AZ. FILED 6-29-2006.

GET MANIC

THE MARK CONSISTS OF STANDARD CHARACTERS WITHOUT CLAIM TO ANY PARTICULAR FONT, STYLE, SIZE, OR COLOR.

FOR COMPUTER SERVICES, NAMELY, PROVIDING SEARCH ENGINES FOR OBTAINING DATA ON A GLOBAL COMPUTER NETWORK (U.S. CLS. 100 AND 101).

FIRST USE 6-21-2006; IN COMMERCE 6-21-2006.
GINA HAYES, EXAMINING ATTORNEY

SN 78-924,018. NEW YORK MANOTO, WOODLAND HILLS, CA. FILED 7-6-2006.



THE COLOR(S) RED, GREEN, BLUE, SILVER, GRAY IS/ARE CLAIMED AS A FEATURE OF THE MARK.

THE MARK CONSISTS OF THE WORD MANOTO AND THE DESIGN OF A MOLECULE. THE LETTERING IS GRAY WITH SILVER OUTLINING. THE MOLECULE CONSISTS OF FOUR SPHERES WHICH ARE GREEN, RED, AND BLUE AND A SILVER SPHERE IN THE CENTER. THE FOUR SPHERES ARE CONNECTED BY THREE SILVER RODS.

THE FOREIGN WORDING IN THE MARK TRANSLATES INTO ENGLISH AS YOU AND I.

FOR DESIGN, DEVELOPMENT AND IMPLEMENTATION OF SOFTWARE (U.S. CLS. 100 AND 101).

FIRST USE 5-1-2006; IN COMMERCE 5-1-2006.
WENDY GOODMAN, EXAMINING ATTORNEY

CLASS 42—(Continued).

SN 78-931,373. SERVERVAULT CORP., DULLES, VA. FILED 7-17-2006.

SERVERVAULT

THE MARK CONSISTS OF STANDARD CHARACTERS WITHOUT CLAIM TO ANY PARTICULAR FONT, STYLE, SIZE, OR COLOR.

FOR PROVIDING MANAGED HOSTING IN THE NATURE OF HOSTING COMPUTER SOFTWARE, INTERNET WEBSITES, INTERNET WEB SOFTWARE APPLICATIONS, ELECTRONIC DATABASES, DIGITAL CONTENT, AND BUSINESS COMPUTER SOFTWARE APPLICATIONS OF OTHERS THAT ARE ACCESSIBLE VIA THE INTERNET THROUGH THE USE OF HIGHLY SECURE AND ENVIRONMENTALLY CONTROLLED SPECIAL PURPOSE BUILT COMPUTER FACILITIES. (U.S. CLS. 100 AND 101).

FIRST USE 0-0-1999; IN COMMERCE 0-0-1999.
DAVID I, EXAMINING ATTORNEY

SN 78-935,324. ATHLETEFOCUS.COM, INC., GREENVILLE, SC. FILED 7-21-2006.

ATHLETE FOCUS

THE MARK CONSISTS OF STANDARD CHARACTERS WITHOUT CLAIM TO ANY PARTICULAR FONT, STYLE, SIZE, OR COLOR.

NO CLAIM IS MADE TO THE EXCLUSIVE RIGHT TO USE "ATHLETE", APART FROM THE MARK AS SHOWN.

FOR COMPUTER SERVICES, NAMELY, HOSTING ONLINE WEB FACILITIES USING CUSTOMIZABLE ATHLETE PROFILES FOR ORGANIZING AND CONDUCTING ONLINE MEETINGS, GATHERINGS, AND INTERACTIVE DISCUSSIONS IN THE FIELDS OF PROVIDING INCREASED EXPOSURE OF ACTION SPORTS ATHLETES, REFERRING ACTION SPORTS ATHLETES TO ORGANIZATIONS THAT MAY WISH TO PROVIDE ATHLETE SPONSORSHIPS FOR PROMOTIONAL PURPOSES, AND HELPING ACTION SPORTS ATHLETES NETWORK WITHIN THEIR SPORT(S) (U.S. CLS. 100 AND 101).

KELLY BOULTON, EXAMINING ATTORNEY

CLASS 42—(Continued).

SN 78-935,822. 2020 COMPANY, LLC, CHICAGO, IL. FILED 7-24-2006.



THE COLOR(S) BLUE AND ORANGE IS/ARE CLAIMED AS A FEATURE OF THE MARK.

THE MARK CONSISTS OF AN UPPER CURVED PORTION IN THE COLOR ORANGE AND A LOWER ROUNDED PORTION IN THE COLOR BLUE.

FOR INFORMATION TECHNOLOGY CONSULTATION SERVICES (U.S. CLS. 100 AND 101).

FIRST USE 0-0-2001; IN COMMERCE 0-0-2001.

HEATHER BIDDULPH, EXAMINING ATTORNEY

SN 78-943,586. TRUEDOG LLC, MILL VALLEY, CA. FILED 8-2-2006.

BLUE.COM

THE MARK CONSISTS OF STANDARD CHARACTERS WITHOUT CLAIM TO ANY PARTICULAR FONT, STYLE, SIZE, OR COLOR.

FOR COMPUTER SERVICES, NAMELY, PROVIDING CUSTOMIZED WEB PAGES FEATURING USER-DEFINED INFORMATION, IN THE FIELD OF JOB LISTINGS, CLASSIFIED LISTINGS, FOR SALE ADVERTISEMENTS, EVENT LISTINGS, COMMERCIAL NOTICES, RESUME LISTINGS, POLITICAL INFORMATION, PERSONAL PROFILES, GIFT LISTS AND INFORMATION ON A WIDE VARIETY OF TOPICS OF GENERAL INTEREST TO THE PUBLIC (U.S. CLS. 100 AND 101).

DAVID H. STINE, EXAMINING ATTORNEY

SN 78-945,650. SHARI MOSS DBA SHARI MOSS & ASSOCIATES, SAN FRANCISCO, CA. FILED 8-4-2006.

TranscrIPts

NO CLAIM IS MADE TO THE EXCLUSIVE RIGHT TO USE "TRANSCRIPTS" AND "IP", APART FROM THE MARK AS SHOWN.

FOR COURT REPORTING; LITIGATION SUPPORT SERVICES; COURT REPORTING SERVICES VIA A GLOBAL COMMUNICATIONS NETWORK; LEGAL SUPPORT SERVICES, NAMELY, CONVERSION OF DOCUMENTS AND EXHIBITS FROM PHYSICAL TO ELECTRONIC MEDIA (U.S. CLS. 100 AND 101).

G. MAYERSCHOFF, EXAMINING ATTORNEY

CLASS 42—(Continued).

SN 78-947,000. IRM CORPORATION, DALLAS, TX. FILED 8-8-2006.

PROMOLYTICS

THE MARK CONSISTS OF STANDARD CHARACTERS WITHOUT CLAIM TO ANY PARTICULAR FONT, STYLE, SIZE, OR COLOR.

FOR PROVIDING ON-LINE NON-DOWNLOADABLE TRADE PROMOTION SOFTWARE MARKETED TO THE FOODSERVICE AND CONSUMER PACKAGED GOODS INDUSTRIES (U.S. CLS. 100 AND 101).

MICHAEL KEATING, EXAMINING ATTORNEY

SN 78-948,262. INA CORPORATION, PHILADELPHIA, PA. FILED 8-9-2006.

ESIS E-RISK MANAGER

THE MARK CONSISTS OF STANDARD CHARACTERS WITHOUT CLAIM TO ANY PARTICULAR FONT, STYLE, SIZE, OR COLOR.

NO CLAIM IS MADE TO THE EXCLUSIVE RIGHT TO USE "E-RISK MANAGER", APART FROM THE MARK AS SHOWN.

FOR PROVIDING TEMPORARY USE OF ONLINE NON-DOWNLOADABLE COMPUTER SOFTWARE FOR USE IN THE FIELD OF RISK MANAGEMENT, NAMELY, TRACKING, MONITORING AND REPORTING OCCUPATIONAL AND NON-OCCUPATIONAL SAFETY AND HEALTH RISKS, IN THE NATURE OF EMPLOYEE HEALTH AND SAFETY DATA, FIRE SAFETY DATA, FOOD SAFETY DATA, EMPLOYEE ABSENCE MANAGEMENT DATA, AND EMPLOYEE TRAINING AND SKILLS MANAGEMENT DATA (U.S. CLS. 100 AND 101).

FIRST USE 7-1-2004; IN COMMERCE 7-1-2004.

ELLEN PERKINS, EXAMINING ATTORNEY

CLASS 42—(Continued).

SN 78-949,992. ORDWAY RESEARCH INSTITUTE, INC., ALBANY, NY. FILED 8-11-2006.

LEARN. CONFIRM. SUCCEED.

THE MARK CONSISTS OF STANDARD CHARACTERS WITHOUT CLAIM TO ANY PARTICULAR FONT, STYLE, SIZE, OR COLOR.

FOR PHARMACEUTICAL DRUG DEVELOPMENT SERVICES, PHARMACEUTICAL RESEARCH SERVICES, PHARMACEUTICAL PRODUCT EVALUATION, CONDUCTING EARLY EVALUATIONS IN THE FIELD OF NEW PHARMACEUTICALS, CONSULTANCY PERTAINING TO PHARMACOLOGY, PHARMACOKINETIC AND PHARMACOKINETIC-PHARMACODYNAMIC STUDIES AND ANALYSES RELATING TO DRUG DEVELOPMENT FOR OTHERS. (U.S. CLS. 100 AND 101).

FIRST USE 5-31-2006; IN COMMERCE 5-31-2006.
BERYL GARDNER, EXAMINING ATTORNEY

SN 78-950,719. THELEN REID BROWN RAYSMAN & STEINER LLP, SAN FRANCISCO, CA. FILED 8-11-2006.

THELEN

THE MARK CONSISTS OF STANDARD CHARACTERS WITHOUT CLAIM TO ANY PARTICULAR FONT, STYLE, SIZE, OR COLOR.

OWNER OF U.S. REG. NOS. 2,308,743 AND 2,310,885. SEC. 2(F).
FOR LEGAL SERVICES (U.S. CLS. 100 AND 101).
MICHAEL TANNER, EXAMINING ATTORNEY

SN 78-961,059. GDX NETWORK, INC., DENVER, CO. FILED 8-25-2006.

GDX

THE MARK CONSISTS OF STANDARD CHARACTERS WITHOUT CLAIM TO ANY PARTICULAR FONT, STYLE, SIZE, OR COLOR.

FOR ONLINE SERVICES, NAMELY, PROVIDING INTERNET-BASED AND NETWORK-BASED COMPUTER VIRUS PROTECTION SERVICES FOR OTHERS, AS WELL AS ELECTRONIC SCREENING OF DATA TRANSMISSIONS OF OTHERS FOR COMPUTER VIRUSES AND OTHER MALICIOUS OR UNDESIRABLE CONTENT OVER A GLOBAL BUSINESS COMMUNICATION NETWORK USED FOR FACILITATION OF TRUSTED DATA EXCHANGE (U.S. CLS. 100 AND 101).
MICHAEL TANNER, EXAMINING ATTORNEY

CLASS 42—(Continued).

SN 78-962,439. SPLASHIE.COM, INC., LOS ANGELES, CA. FILED 8-29-2006.

Splashie Slam

THE MARK CONSISTS OF STANDARD CHARACTERS WITHOUT CLAIM TO ANY PARTICULAR FONT, STYLE, SIZE, OR COLOR.

FOR ONLINE NONDOWNLOADABLE SOFTWARE FEATURING A PERSONAL GOLF SCORING SYSTEM FOR RECORDING AND TRANSMITTING GOLF SCORES AND COMPUTING HANDICAPS FOR GOLFERS (U.S. CLS. 100 AND 101).

KIMBERLY PERRY, EXAMINING ATTORNEY

SN 78-962,441. SPLASHIE.COM, INC., LOS ANGELES, CA. FILED 8-29-2006.

What's your Splashie Score?

THE MARK CONSISTS OF STANDARD CHARACTERS WITHOUT CLAIM TO ANY PARTICULAR FONT, STYLE, SIZE, OR COLOR.

NO CLAIM IS MADE TO THE EXCLUSIVE RIGHT TO USE "SCORE", APART FROM THE MARK AS SHOWN.

FOR ONLINE NONDOWNLOADABLE SOFTWARE FEATURING A PERSONAL GOLF SCORING SYSTEM FOR RECORDING AND TRANSMITTING GOLF SCORES AND COMPUTING HANDICAPS FOR GOLFERS (U.S. CLS. 100 AND 101).

KIMBERLY PERRY, EXAMINING ATTORNEY

SN 78-966,878. ORDWAY RESEARCH INSTITUTE, INC., ALBANY, NY. FILED 9-5-2006.

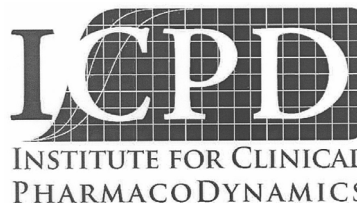

INSTITUTE FOR CLINICAL
PHARMACODYNAMICS

NO CLAIM IS MADE TO THE EXCLUSIVE RIGHT TO USE "INSTITUTE FOR CLINICAL PHARMACODYNAMICS", APART FROM THE MARK AS SHOWN.

FOR PHARMACEUTICAL DRUG DEVELOPMENT SERVICES, PHARMACEUTICAL RESEARCH SERVICES, PHARMACEUTICAL PRODUCT EVALUATION, CONDUCTING EARLY EVALUATIONS IN THE FIELD OF NEW PHARMACEUTICALS, CONSULTANCY PERTAINING TO PHARMACOLOGY, PHARMACOKINETIC AND PHARMACOKINETIC-PHARMACODYNAMIC STUDIES AND ANALYSES RELATING TO DRUG DEVELOPMENT FOR OTHERS. (U.S. CLS. 100 AND 101).

FIRST USE 12-31-2004; IN COMMERCE 12-31-2004.
BERYL GARDNER, EXAMINING ATTORNEY

CLASS 42—(Continued).

SN 78-967,828. KANAKUK KAMPS, INC., BRANSON, MO. FILED 9-6-2006.

CLASS 42—(Continued).

SN 78-969,717. GEO CENTURY LIMITED, ABERDEEN, UNITED KINGDOM, FILED 9-8-2006.

CIRCUITREE

GEO CENTURY

THE MARK CONSISTS OF STANDARD CHARACTERS WITHOUT CLAIM TO ANY PARTICULAR FONT, STYLE, SIZE, OR COLOR.

FOR APPLICATION SERVICE PROVIDER (ASP) FEATURING SOFTWARE IN THE FIELD OF EVENT REGISTRATION, ACCOUNTING, DATABASE MANAGEMENT AND CONTRACT MANAGEMENT FOR USE IN CAMP MANAGEMENT (U.S. CLS. 100 AND 101).

HOWARD B. LEVINE, EXAMINING ATTORNEY

THE MARK CONSISTS OF STANDARD CHARACTERS WITHOUT CLAIM TO ANY PARTICULAR FONT, STYLE, SIZE, OR COLOR.

PRIORITY CLAIMED UNDER SEC. 44(D) ON UNITED KINGDOM APPLICATION NO. 2416062, FILED 3-8-2006, REG. NO. 2416062, DATED 3-8-2006, EXPIRES 3-8-2016.

NO CLAIM IS MADE TO THE EXCLUSIVE RIGHT TO USE "GEO", APART FROM THE MARK AS SHOWN.

FOR PROFESSIONAL HYDROGRAPHIC CONSULTANCY SERVICES; PROFESSIONAL CONSULTANCY SERVICES RELATING TO SEABED MAPPING; PROFESSIONAL CONSULTANCY SERVICES RELATING TO GEOPHYSICAL SITE SURVEYING; PROFESSIONAL CONSULTANCY SERVICES RELATING TO GEOTECHNICAL ROUTE AND SITE SURVEYING SERVICES; PROFESSIONAL CONSULTANCY SERVICES RELATING TO THE EXPLOITATION OF UNREFINED OIL AND GAS; PROFESSIONAL CONSULTANCY SERVICES RELATING TO PIPELINES, SUB-SEA TECHNOLOGIES AND ENGINEERING; PROFESSIONAL CONSULTANCY SERVICES RELATING TO OIL HELD EXPLOITATION, SURVEYING, LOGGING AND TESTING; PROFESSIONAL CONSULTANCY SERVICES RELATING TO OIL AND GAS RIGS AND PLATFORMS AND THE DRILLING OF OIL AND GAS WELLS; PROFESSIONAL CONSULTANCY SERVICES RELATING TO THE USE OF SCIENTIFIC AND TECHNICAL REMOTELY OPERATED VEHICLES IN CONNECTION WITH SEA BED MAPPING, GEOGRAPHICAL SITE SURVEYING, GEOTECHNICAL ROUTE AND SITE SURVEYING, OIL AND GAS SERVICES, PIPELINES, SUB SEA TECHNOLOGIES AND ENGINEERING, OIL FIELD EXPLORATION, SURVEYING, LOGGING AND TESTING, OIL AND GAS RIGS AND PLATFORMS, AND THE DRILLING OF OIL AND GAS WELLS; ENGINEERING PROJECT MANAGEMENT SERVICES; MANAGEMENT OF SCIENTIFIC RESEARCH PROJECTS (U.S. CLS. 100 AND 101).

INGA ERVIN, EXAMINING ATTORNEY

SN 78-968,804. ROVION, INC., OWINGS MILLS, MD. FILED 9-7-2006.



SN 78-971,080. NEW STAGES HOME DESIGN, INC., ROCHESTER HILLS, MI. FILED 9-11-2006.

"For every stage of your life"

THE COLOR(S) ORANGE AND BLACK IS/ARE CLAIMED AS A FEATURE OF THE MARK.

THE COLOR(S) ORANGE APPEARS IN THE WORDS "IN PERSON." THE COLOR BLACK APPEARS IN THE SILHOUETTE OF THE MAN.

FOR COMPUTER SERVICES, NAMELY DESIGNING, CREATING, IMPLEMENTING AND HOSTING AUDIO-VISUAL MESSAGES INCORPORATED INTO WEBSITES (U.S. CLS. 100 AND 101).

FIRST USE 3-27-2006; IN COMMERCE 3-27-2006. KHANH LE, EXAMINING ATTORNEY

THE MARK CONSISTS OF STANDARD CHARACTERS WITHOUT CLAIM TO ANY PARTICULAR FONT, STYLE, SIZE, OR COLOR.

FOR HOME STAGING CONSULTATION, NAMELY, TEMPORARY INTERIOR AND EXTERIOR HOME DECORATION CONSULTATION FOR THE PURPOSE OF MAKING HOMES MORE APPEALING TO PROSPECTIVE BUYERS (U.S. CLS. 100 AND 101).

FIRST USE 6-19-2006; IN COMMERCE 6-19-2006. JASON LOTT, EXAMINING ATTORNEY

CLASS 42—(Continued).

SN 78-973,593. INTEGRATED E SOLUTIONS, INC., CHICAGO, IL. FILED 9-13-2006.

Integrated e Solutions

THE MARK CONSISTS OF STANDARD CHARACTERS WITHOUT CLAIM TO ANY PARTICULAR FONT, STYLE, SIZE, OR COLOR.

NO CLAIM IS MADE TO THE EXCLUSIVE RIGHT TO USE "E SOLUTIONS", APART FROM THE MARK AS SHOWN.

FOR AUTOMATED LITIGATION SUPPORT, CONSULTING AND TRIAL PRESENTATION SERVICES, NAMELY, FOR PREPARING AND PRESENTING AUDIO AND VIDEO TESTIMONY AND EXHIBITS (U.S. CLS. 100 AND 101).

FIRST USE 12-4-2003; IN COMMERCE 12-4-2003.
DAWN FELDMAN, EXAMINING ATTORNEY

CLASS 43—HOTEL AND RESTAURANT SERVICES

SN 76-660,779. PACIFIC FOOD, INC., WALLINGFORD, CT. FILED 5-30-2006.

PACIFIC BUFFET & GRILL

THE MARK CONSISTS OF STANDARD CHARACTERS WITHOUT CLAIM TO ANY PARTICULAR FONT, STYLE, SIZE, OR COLOR.

NO CLAIM IS MADE TO THE EXCLUSIVE RIGHT TO USE "BUFFET & GRILL", APART FROM THE MARK AS SHOWN.

FOR RESTAURANT SERVICES (U.S. CLS. 100 AND 101).

FIRST USE 11-1-2004; IN COMMERCE 11-0-2004.
DAWN HAN, EXAMINING ATTORNEY

SN 76-669,087. KING BUFFET BROTHERS LLC, PHILADELPHIA, PA. FILED 11-16-2006.

RUBY BUFFET

THE MARK CONSISTS OF STANDARD CHARACTERS WITHOUT CLAIM TO ANY PARTICULAR FONT, STYLE, SIZE, OR COLOR.

NO CLAIM IS MADE TO THE EXCLUSIVE RIGHT TO USE "BUFFET", APART FROM THE MARK AS SHOWN.

FOR BUFFET STYLE RESTAURANT OFFERING INTERNATIONAL CUISINE PROVIDING CHINESE, AMERICAN, ITALIAN AND JAPANESE DISHES (U.S. CLS. 100 AND 101).

FIRST USE 7-15-2006; IN COMMERCE 8-24-2006.
RONALD MCMORROW, EXAMINING ATTORNEY

CLASS 43—(Continued).

SN 76-672,562. IMAGES & BEYOND, INC., MIAMI, FL. FILED 2-12-2007.



THE COLOR(S) RED, WHITE, BROWN, BEIGE, TAN AND BLACK IS/ARE CLAIMED AS A FEATURE OF THE MARK.

THE COLOR RED APPEARS IN THE BACKGROUND OF THE BANNER, THE BOWTIE OF THE CHICKEN AND THE LETTERING ON THE CHEF'S HAT; THE COLOR WHITE APPEARS IN THE LETTERING ON THE BANNER AND THE CHICKEN'S EYES; THE COLOR BROWN APPEARS IN THE CHICKEN'S NECK; THE COLOR BEIGE APPEARS IN THE CHICKEN'S BEAK; THE COLOR TAN APPEARS IN THE CHEF'S HAT AND THE COLOR BLACK APPEARS IN THE OUTLINING OF ALL THE DESIGN ELEMENTS OF THE CHICKEN.

FOR RESTAURANT SERVICES (U.S. CLS. 100 AND 101).

FIRST USE 11-1-2004; IN COMMERCE 11-1-2004.
JULIE GUTTADAURO, EXAMINING ATTORNEY

SN 76-673,451. TUPINAMBA, INC, DALLAS, TX. FILED 3-2-2007.



NO CLAIM IS MADE TO THE EXCLUSIVE RIGHT TO USE "MEXICAN FOOD SUPREME", APART FROM THE MARK AS SHOWN.

THE NAME "EDDIE DOMINGUEZ" IDENTIFIES A LIVING INDIVIDUAL WHOSE CONSENT IS OF RECORD.

FOR RESTAURANT SERVICES (U.S. CLS. 100 AND 101).

FIRST USE 6-1-1986; IN COMMERCE 6-1-1986.
PAUL E. FAHRENKOPF, EXAMINING ATTORNEY

CLASS 43—(Continued).

SN 76-674,266. KIM, JONG OH, LA CANADA, CA. FILED 3-19-2007.

HANBAT SHUL-LUNG-TANG

THE MARK CONSISTS OF STANDARD CHARACTERS WITHOUT CLAIM TO ANY PARTICULAR FONT, STYLE, SIZE, OR COLOR.

NO CLAIM IS MADE TO THE EXCLUSIVE RIGHT TO USE "SHUL-LUNG-TANG", APART FROM THE MARK AS SHOWN.

THE ENGLISH TRANSLATION OF HANBAT SHUL-LUNG-TANG IN THE MARK IS BIG FIELD BEEF BONE SOUP

FOR RESTAURANT, NAMELY, PROVIDING OF FOOD AND DRINK; AND CARRY-OUT RESTAURANT SERVICES FEATURING KOREAN FOODS (U.S. CLS. 100 AND 101).

FIRST USE 1-1-1988; IN COMMERCE 1-1-1988.
MAUREEN DALL, EXAMINING ATTORNEY

CLASS 43—(Continued).

SN 77-010,064. COLD STONE CREAMERY, INC., SCOTTS-DALE, AZ. FILED 9-28-2006.

10-MINUTE VACATION

THE MARK CONSISTS OF STANDARD CHARACTERS WITHOUT CLAIM TO ANY PARTICULAR FONT, STYLE, SIZE, OR COLOR.

OWNER OF U.S. REG. NO. 2,160,423.
FOR RESTAURANT SERVICES; RESTAURANTS FEATURING ICE CREAM (U.S. CLS. 100 AND 101).
DANIEL BRODY, EXAMINING ATTORNEY

SN 76-674,267. KIM, JONG OH, LA CANADA, CA. FILED 3-19-2007.

NO CLAIM IS MADE TO THE EXCLUSIVE RIGHT TO USE THE NON-LATIN CHARACTERS THAT MEAN "BEEF BONE SOUP", APART FROM THE MARK AS SHOWN.

THE NON-LATIN CHARACTERS IN THE MARK TRANSLITERATE TO HANBAHT SUL LUNG TANG, AND THIS MEANS BIG FIELD BEEF BONE SOUP IN ENGLISH.

FOR RESTAURANT, NAMELY, PROVIDING OF FOOD AND DRINK; AND CARRY-OUT RESTAURANT SERVICES FEATURING KOREAN FOODS (U.S. CLS. 100 AND 101).

FIRST USE 1-1-1988; IN COMMERCE 1-1-1988.
MAUREEN DALL, EXAMINING ATTORNEY

SN 77-027,018. FINANCIERE GERARD JOULIE, PARIS, FRANCE, FILED 10-23-2006.

OWNER OF FRANCE REG. NO. 93487812, DATED 4-15-1993, EXPIRES 4-14-2013.

THE ENGLISH TRANSLATION OF "BATIFOL" IS "FROLIC ABOUT."

FOR RESTAURANTS; FOOD AND DRINK CATERING (U.S. CLS. 100 AND 101).

MATTHEW PAPPAS, EXAMINING ATTORNEY

SN 76-674,584. COSSETTA'S, INC., ST. PAUL, MN. FILED 3-26-2007.

THE MARK CONSISTS OF STANDARD CHARACTERS WITHOUT CLAIM TO ANY PARTICULAR FONT, STYLE, SIZE, OR COLOR.

SEC. 2(F).
FOR RESTAURANT SERVICES (U.S. CLS. 100 AND 101).

FIRST USE 10-27-1996; IN COMMERCE 8-9-1999.
GIANCARLO CASTRO, EXAMINING ATTORNEY

SN 77-027,162. FELDMAN, TUVIA, PASSAIC, NJ. FILED 10-23-2006.

THE MARK CONSISTS OF STANDARD CHARACTERS WITHOUT CLAIM TO ANY PARTICULAR FONT, STYLE, SIZE, OR COLOR.

FOR RESTAURANT SERVICES, EXCLUDING PIZZA AND NOT FEATURING A SEPARATE MARKET FOR THE SALE OF MEATS (U.S. CLS. 100 AND 101).

RUSS HERMAN, EXAMINING ATTORNEY

CLASS 43—(Continued).

SN 77-032,288. SETHURAMAN, BRATHIBBE DR., GILROY, CA. FILED 10-30-2006.



NO CLAIM IS MADE TO THE EXCLUSIVE RIGHT TO USE "BHAVAN", "UNAVAGAM" AND "SEIVA SUVAIYAGAM", APART FROM THE MARK AS SHOWN.

"THE COLOR(S) GREEN, YELLOW, WHITE, ORANGE, BLACK, RED AND BLUE IS/ARE CLAIMED AS A FEATURE OF THE MARK."

THE MARK CONSISTS OF THE COLOR GREEN APPEARING IN THE DESIGN BACKGROUND AND THE CHARACTER'S PANTS; THE COLOR YELLOW APPEARING IN ALL WORDING EXCEPT FOR THE SECOND ROW OF WORDING IN THE CENTER OF THE MARK AND APPEARING IN THE HEADWEAR AND CLOTHING ON THE UPPER BODY OF THE DEPICTED CHARACTER; THE COLOR WHITE APPEARING IN THE NON-LATIN MARKS IN THE SECOND ROW OF THE CENTER OF THE MARK; THE COLORS ORANGE, RED, BLUE, AND WHITE APPEARING IN A PLATE HELD BY THE DEPICTED HUMAN CHARACTER; THE COLORS RED, WHITE, AND YELLOW APPEARING IN THE JEWELRY WORN BY THE DEPICTED CHARACTER; THE COLOR RED APPEARING IN THE LIPS OF THE DEPICTED CHARACTER; AND THE COLOR BLACK APPEARING IN THE VISIBLE HAIR AND IN THE FOOTWEAR OF THE DEPICTED CHARACTER; THE COLOR WHITE APPEARS IN THE BORDER SURROUNDING BOTH WORDING ARCH OF QUALITY AND THE DESIGN INCORPORATING A YELLOW ARCH AND TWO WHITE VERTICAL LINES AT THE LEFT OF THE MARK.

THE ENGLISH TRANSLATION OF THE WORD "BHAVAN" IN THE MARK IS "HOUSE".

THE NON-LATIN CHARACTERS IN THE TOP-CENTER TRANSLITERATE INTO MEENAKSHI UNAVAGAM WHICH TRANSLATES AS MEENAKSHI EATING PLACE. THE NON-LATIN CHARACTERS IN THE SECOND ROW OF THE CENTER TRANSLITERATE INTO SEIVA SUVAIYAGAM WHICH TRANSLATES AS VEGETARIAN EATING PLACE. THE NON-LATIN CHARACTERS IN THE LOWER RIGHT CORNER TRANSLITERATE INTO NALAHAGA CHAKKARAVARTHY WHICH TRANSLATES TO KING OF GOOD TASTY FOOD.

FOR RESTAURANT SERVICES (U.S. CLS. 100 AND 101).

KEVIN CORWIN, EXAMINING ATTORNEY

SN 77-034,202. ELMER'S FRANCHISE SYSTEMS, INC., PORTLAND, OR. FILED 11-1-2006.

**CHEF ELMER'S
NORTHWEST GRILL**

THE MARK CONSISTS OF STANDARD CHARACTERS WITHOUT CLAIM TO ANY PARTICULAR FONT, STYLE, SIZE, OR COLOR.

NO CLAIM IS MADE TO THE EXCLUSIVE RIGHT TO USE "NORTHWEST GRILL", APART FROM THE MARK AS SHOWN.

THE NAME CHEF ELMER DOES NOT IDENTIFY A LIVING INDIVIDUAL.

FOR RESTAURANT SERVICES (U.S. CLS. 100 AND 101).

RONALD MCMORROW, EXAMINING ATTORNEY

CLASS 43—(Continued).

SN 77-038,083. RITCHIE, SUSANNE, HIGLEY, AZ. FILED 11-7-2006.

THE SLICERY

THE MARK CONSISTS OF STANDARD CHARACTERS WITHOUT CLAIM TO ANY PARTICULAR FONT, STYLE, SIZE, OR COLOR.

FOR RESTAURANTS (U.S. CLS. 100 AND 101).
KATHERINE E. HALMEN, EXAMINING ATTORNEY

SN 77-049,165. BEST WESTERN INTERNATIONAL, INC., PHOENIX, AZ. FILED 11-21-2006.

**NO DRAWING-SENSORY
MARK**

THE MARK CONSISTS OF THE SOUND OF A HAND KNOCKING ON A DOOR TWICE.

FOR HOTEL, MOTEL AND RESORT HOTEL SERVICES; HOTEL, MOTEL AND RESORT HOTEL RESERVATION SERVICES FOR OTHERS (U.S. CLS. 100 AND 101).

JASON BLAIR, EXAMINING ATTORNEY

SN 77-054,703. CHONGQING CHUANGMEI FOOD AND BEVERAGE CO., LTD., CHONGQING, CHINA, FILED 12-1-2006.

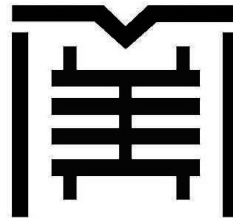

THE MARK CONSISTS OF A STYLIZED "M" AND A STYLIZED CHINESE CHARACTER.

THE NON-LATIN CHARACTERS IN THE MARK TRANSLITERATE TO "MEI" AND THIS MEANS "PRETTY" IN ENGLISH.

FOR CATERING OF FOOD AND DRINKS; CAFES; CANTEN SERVICES; BOARDING HOUSES; RESTAURANTS; CAFETERIAS; FAST-FOOD RESTAURANTS; RESORT LODGING SERVICES; WINE BARS; TEA ROOMS; BAR SERVICES; PROVIDING CAMPGROUND FACILITIES (U.S. CLS. 100 AND 101).

KELLEY WELLS, EXAMINING ATTORNEY

CLASS 43—(Continued).

SN 77-054,704. CHONGQING CHUANGMEI FOOD AND BEVERAGE CO., LTD., CHONGQING, CHINA, FILED 12-1-2006.

美食美客
MEISHIMEIKE

NO CLAIM IS MADE TO THE EXCLUSIVE RIGHT TO USE "THE NON-LATIN CHARACTER THAT MEANS FOOD IN ENGLISH", APART FROM THE MARK AS SHOWN.

THE NON-LATIN CHARACTERS IN THE MARK TRANSLITERATE TO MEI; SHI; MEI; KE AND THIS MEANS PRETTY; FOOD; PRETTY; GUEST IN ENGLISH.

FOR CATERING OF FOOD AND DRINKS; CAFES; CANTEEN SERVICES; BOARDING HOUSES; RESTAURANTS; CAFETERIAS; FAST-FOOD RESTAURANTS; RESORT LODGING SERVICES; WINE BARS; TEA ROOMS; BAR SERVICES; PROVIDING CAMPGROUND FACILITIES (U.S. CLS. 100 AND 101).

KELLEY WELLS, EXAMINING ATTORNEY

SN 77-061,717. WESTIN HOTEL MANAGEMENT, LP, WHITE PLAINS, NY. FILED 12-11-2006.



element

INSPIRED BY WESTIN

OWNER OF U.S. REG. NOS. 1,320,080, 3,182,786 AND OTHERS.

THE COLOR(S) BROWN AND GREEN IS/ARE CLAIMED AS A FEATURE OF THE MARK.

THE COLOR GREEN APPEARS WITHIN THE SEMICIRCLE DESIGN AND THE WORD ELEMENT. THE COLOR BROWN APPEARS IN THE CIRCULAR DESIGN AND THE WORDS INSPIRED BY WESTIN.

FOR HOTELS, MOTELS, RESORT HOTELS, RESORT LODGING SERVICES, EXTENDED STAY HOTEL SERVICES (U.S. CLS. 100 AND 101).

DAVID COLLIER, EXAMINING ATTORNEY

CLASS 43—(Continued).

SN 77-072,982. IVANKA TRUMP MARKS LLC, NEW YORK, NY. FILED 12-28-2006.

IVANKA

THE MARK CONSISTS OF STANDARD CHARACTERS WITHOUT CLAIM TO ANY PARTICULAR FONT, STYLE, SIZE, OR COLOR.

THE NAME SHOWN IN THE MARK IDENTIFIES IVANKA TRUMP, WHOSE CONSENT(S) TO REGISTER IS SUBMITTED.

FOR HOTEL SERVICES; RESTAURANT SERVICES (U.S. CLS. 100 AND 101).

DEIRDRE ROBERTSON, EXAMINING ATTORNEY

SN 77-072,998. IVANKA TRUMP MARKS LLC, NEW YORK, NY. FILED 12-28-2006.

IVANKA TRUMP

THE MARK CONSISTS OF STANDARD CHARACTERS WITHOUT CLAIM TO ANY PARTICULAR FONT, STYLE, SIZE, OR COLOR.

THE NAME "IVANKA TRUMP" IDENTIFIES A LIVING INDIVIDUAL WHOSE CONSENT IS OF RECORD.

FOR HOTEL SERVICES; RESTAURANT SERVICES (U.S. CLS. 100 AND 101).

DEIRDRE ROBERTSON, EXAMINING ATTORNEY

SN 77-084,332. EAST OF CHICAGO PIZZA COMPANY, WILLARD, OH. FILED 1-17-2007.

PETE ZADUNRITE

THE MARK CONSISTS OF STANDARD CHARACTERS WITHOUT CLAIM TO ANY PARTICULAR FONT, STYLE, SIZE, OR COLOR.

THE NAME(S), PORTRAIT(S), AND/OR SIGNATURE(S) SHOWN IN THE MARK DOES NOT IDENTIFY A PARTICULAR LIVING INDIVIDUAL.

FOR RESTAURANT SERVICES (U.S. CLS. 100 AND 101).

FIRST USE 10-31-2006; IN COMMERCE 10-31-2006.

AISHA CLARKE, EXAMINING ATTORNEY

CLASS 43—(Continued).

SN 77-091,915. BROWN PALACE HOTEL ASSOCIATES LIMITED PARTNERSHIP, DENVER, CO. FILED 1-26-2007.



OWNER OF U.S. REG. NOS. 2,693,210, 2,693,214 AND OTHERS.

NO CLAIM IS MADE TO THE EXCLUSIVE RIGHT TO USE "HOTEL", APART FROM THE MARK AS SHOWN.

THE MARK CONSISTS OF A THREE DIMENSIONAL DRAWING OF A BUILDING EXTERIOR AND THE WORDING BROWN PALACE HOTEL.

SEC. 2(F) AS TO THE DEPICTION OF THE BUILDING EXTERIOR.

FOR HOTEL, BAR AND RESTAURANT SERVICES; PROVIDING BANQUET AND SOCIAL FUNCTION FACILITIES FOR SPECIAL OCCASIONS; PROVIDING TEMPORARY ACCOMMODATION; PROVISION OF CONFERENCE, EXHIBITION AND MEETING FACILITIES; RESERVATION OF HOTEL ROOMS FOR TRAVELERS; SPA SERVICES, NAMELY, PROVIDING TEMPORARY ACCOMMODATIONS AND MEALS TO CLIENTS OF A HEALTH OR BEAUTY SPA (U.S. CLS. 100 AND 101).

FIRST USE 12-1-1942; IN COMMERCE 12-1-1942.
DEIRDRE ROBERTSON, EXAMINING ATTORNEY

SN 77-098,987. POMPONIO, GREGORY, MERRICK, NY. FILED 2-5-2007.

HOG ROCK GRILL

THE MARK CONSISTS OF STANDARD CHARACTERS WITHOUT CLAIM TO ANY PARTICULAR FONT, STYLE, SIZE, OR COLOR.

NO CLAIM IS MADE TO THE EXCLUSIVE RIGHT TO USE "GRILL", APART FROM THE MARK AS SHOWN.

FOR RESTAURANT (U.S. CLS. 100 AND 101).
DORITT L. CARROLL, EXAMINING ATTORNEY

CLASS 43—(Continued).

SN 77-099,390. ZLM ACQUISITIONS, L.L.C., ORANGE BEACH, AL. FILED 2-5-2007.

Geno's Fresh Catch Grill

THE MARK CONSISTS OF STANDARD CHARACTERS WITHOUT CLAIM TO ANY PARTICULAR FONT, STYLE, SIZE, OR COLOR.

NO CLAIM IS MADE TO THE EXCLUSIVE RIGHT TO USE "FRESH CATCH GRILL", APART FROM THE MARK AS SHOWN.

FOR RESTAURANT SERVICES (U.S. CLS. 100 AND 101).

FIRST USE 11-13-2006; IN COMMERCE 11-13-2006.
RICHARD WHITE, EXAMINING ATTORNEY

SN 77-099,479. ZLM ACQUISITIONS, L.L.C., ORANGE BEACH, AL. FILED 2-5-2007.

Geno's Dockside Deli

THE MARK CONSISTS OF STANDARD CHARACTERS WITHOUT CLAIM TO ANY PARTICULAR FONT, STYLE, SIZE, OR COLOR.

NO CLAIM IS MADE TO THE EXCLUSIVE RIGHT TO USE "DELI", APART FROM THE MARK AS SHOWN.

FOR DELICATESSENS (U.S. CLS. 100 AND 101).

FIRST USE 12-26-2006; IN COMMERCE 12-26-2006.
RICHARD WHITE, EXAMINING ATTORNEY

SN 77-102,029. FRALEY, BRIAN, TOLEDO, OH. FILED 2-7-2007.



NO CLAIM IS MADE TO THE EXCLUSIVE RIGHT TO USE "GOURMET HOT DOGS", APART FROM THE MARK AS SHOWN.

THE MARK CONSISTS OF A CHEF'S HAT AND THE STYLIZED TEXT OF THE WORDING "FILLET MON DOG GOURMET HOTDOGS".

THE ENGLISH TRANSLATION OF THE WORD MON IN THE MARK IS MY.

FOR RESTAURANT SERVICES (U.S. CLS. 100 AND 101).

FIRST USE 6-11-2006; IN COMMERCE 1-30-2007.
WOODROW HARTZOG, EXAMINING ATTORNEY

CLASS 43—(Continued).

SN 77-105,305. RISKER ENTERPRISES, LLC, BULGER, PA. FILED 2-12-2007.

The Original Shake and Twist

THE MARK CONSISTS OF STANDARD CHARACTERS WITHOUT CLAIM TO ANY PARTICULAR FONT, STYLE, SIZE, OR COLOR.

OWNER OF U.S. REG. NO. 683,636.
NO CLAIM IS MADE TO THE EXCLUSIVE RIGHT TO USE "THE ORIGINAL SHAKE", APART FROM THE MARK AS SHOWN.
FOR RESTAURANTS (U.S. CLS. 100 AND 101).
AMY BROZENIC, EXAMINING ATTORNEY

SN 77-110,408. RICOBENE, SAM, CHICAGO, IL. FILED 2-19-2007.

Eat At Ricobene's Since 1946

THE MARK CONSISTS OF STANDARD CHARACTERS WITHOUT CLAIM TO ANY PARTICULAR FONT, STYLE, SIZE, OR COLOR.

NO CLAIM IS MADE TO THE EXCLUSIVE RIGHT TO USE "SINCE 1946", APART FROM THE MARK AS SHOWN.
FOR RESTAURANT SERVICES (U.S. CLS. 100 AND 101).
FIRST USE 2-2-1946; IN COMMERCE 2-2-1946.
FRANK LATTUCA, EXAMINING ATTORNEY

SN 77-116,852. JOE'S CRAB SHACK HOLDINGS, INC., HOUSTON, TX. FILED 2-27-2007.



NO CLAIM IS MADE TO THE EXCLUSIVE RIGHT TO USE "CRAB SHACK", APART FROM THE MARK AS SHOWN.

THE NAME JOE DOES NOT IDENTIFY A LIVING INDIVIDUAL.
THE MARK CONSISTS OF JOE'S CRAB SHACK AND DESIGN OF ISLAND WITH PALM TREE.
FOR RESTAURANT AND BAR SERVICES (U.S. CLS. 100 AND 101).
SOPHIA S. KIM, EXAMINING ATTORNEY

CLASS 43—(Continued).

SN 77-118,885. BURROUGHS & CHAPIN COMPANY, INC., MYRTLE BEACH, SC. FILED 2-28-2007.

REFLECTIONS

THE MARK CONSISTS OF STANDARD CHARACTERS WITHOUT CLAIM TO ANY PARTICULAR FONT, STYLE, SIZE, OR COLOR.

FOR RESTAURANT AND BAR SERVICES (U.S. CLS. 100 AND 101).
FIRST USE 11-1-2006; IN COMMERCE 11-1-2006.
STEVEN PEREZ, EXAMINING ATTORNEY

SN 77-119,060. FOOD (THAT IS) FAST, FRESH & DELICIOUS, INC., NEW YORK, NY. FILED 2-28-2007.



THE COLOR(S) GREEN AND ORANGE IS/ARE CLAIMED AS A FEATURE OF THE MARK.

THE COLOR GREEN APPEARS IN THE WORDING "F3OO" AND IN THE DESIGN OF THE LEAVES, AND THE COLOR ORANGE APPEARS IN THE SECOND LETTER "O" AND IN THE LETTER "D."
FOR FAST-FOOD RESTAURANTS (U.S. CLS. 100 AND 101).
DAYNA BROWNE, EXAMINING ATTORNEY

SN 77-130,317. ELDERCARE SOLUTIONS, INC., SAN DIEGO, CA. FILED 3-13-2007.

PLATINUM ELDERCARE

THE MARK CONSISTS OF STANDARD CHARACTERS WITHOUT CLAIM TO ANY PARTICULAR FONT, STYLE, SIZE, OR COLOR.

NO CLAIM IS MADE TO THE EXCLUSIVE RIGHT TO USE "ELDERCARE", APART FROM THE MARK AS SHOWN.
FOR PROVIDING DAY CARE SERVICES TO ELDERLY, DISABLED, AND RETIRED PERSONS (U.S. CLS. 100 AND 101).
WILLIAM ROSSMAN, EXAMINING ATTORNEY

CLASS 43—(Continued).

SN 77-133,243. EQUUS HOSPITALITY LLC, WICHITA, KS.
FILED 3-16-2007.



NO CLAIM IS MADE TO THE EXCLUSIVE RIGHT TO USE "PIZZA WINGS CHIPS DAIQUIRIS", APART FROM THE MARK AS SHOWN.

THE NAME(S), PORTRAIT(S), AND/OR SIGNATURE(S) SHOWN IN THE MARK DOES NOT IDENTIFY A PARTICULAR LIVING INDIVIDUAL.

THE COLOR(S) RED, YELLOW, ORANGE, WHITE AND BLACK IS/ARE CLAIMED AS A FEATURE OF THE MARK.

THE MARK CONSISTS OF A UNIQUELY SHAPED ELONGATED BACKGROUND WITH A SEMICIRCLE LOCATED ON TOP AND WITH THE ENDS ENLARGED AND CURVED, IN THE COLOR RED, EDGED BY THE COLOR ORANGE WITH THE WORD "JOE" IN THE COLOR WHITE CENTERED ABOVE THE WORD "SMUCKATELLI'S" IN THE COLOR WHITE WITH A BLACK BAND ACROSS THE BOTTOM OF THE BACKGROUND WITH THE WORDS "PIZZA", "WINGS", "CHIPS" AND "DAIQUIRIS" IN THE COLOR WHITE LOCATED THEREON SEPARATED BY SMALL RED DIAMONDS WITH A YELLOW SCROLLWORK SHAPED FIGURE CENTERED UNDER THE BACKGROUND.

FOR RESTAURANTS (U.S. CLS. 100 AND 101).
STANLEY I. OSBORNE, EXAMINING ATTORNEY

SN 77-133,364. EQUUS HOSPITALITY LLC, WICHITA, KS.
FILED 3-16-2007.

pizzo's
pizza & daiquiris

NO CLAIM IS MADE TO THE EXCLUSIVE RIGHT TO USE "PIZZA & DAIQUIRIS", APART FROM THE MARK AS SHOWN.

THE COLOR(S) RED AND BLACK IS/ARE CLAIMED AS A FEATURE OF THE MARK.

THE MARK CONSISTS OF THE WORD "PIZZO'S" COMPRISED OF LETTERS IN THE COLOR BLACK EXCEPT FOR THE "I" AND "O" WHICH ARE IN THE COLOR RED AND CONSISTS OF THE WORDS "PIZZA" AND "DAIQUIRIS" IN THE COLOR BLACK SEPARATED BY "&" IN THE COLOR RED ALL BENEATH A RED LINE THAT ALSO SEPARATES THE TWO SETS OF WORDS.

FOR RESTAURANTS (U.S. CLS. 100 AND 101).
STANLEY I. OSBORNE, EXAMINING ATTORNEY

CLASS 43—(Continued).

SN 77-133,379. YU-HUANG CHU, TAIPEI CITY, TAIWAN,
FILED 3-16-2007.

青蛙包二奶

Pearls plus "double" Milk

NO CLAIM IS MADE TO THE EXCLUSIVE RIGHT TO USE PEARLS PLUS "DOUBLE" MILK AND THE NON-LATIN CHARACTERS MEANING DOUBLE MILK, APART FROM THE MARK AS SHOWN.

THE MARK CONSISTS OF THE WORDS "PEARLS PLUS "DOUBLE" MILK" AND CHINESE CHARACTERS.

THE NON-LATIN CHARACTER(S) IN THE MARK TRANSLITERATE INTO CHING, WA, PAO, ERH, NAI, AND THIS MEANS GREEN, FROG, WRAP, DOUBLE, MILK IN ENGLISH.

FOR CAFES; CAFETERIAS; CANTEEN SERVICES; BOARDING HOUSES; HOTELS; RESTAURANTS; SNACK BARS; BAR SERVICES; MOBILE CAFE SERVICES FOR PROVIDING FOOD AND DRINK; AND TEA ROOMS (U.S. CLS. 100 AND 101).

EMILY CHUO, EXAMINING ATTORNEY

SN 77-134,684. GO BREW COFFEE COMPANY, LLC, GREGORY, MI. FILED 3-19-2007.

Go Brew Coffee Company

THE MARK CONSISTS OF STANDARD CHARACTERS WITHOUT CLAIM TO ANY PARTICULAR FONT, STYLE, SIZE, OR COLOR.

NO CLAIM IS MADE TO THE EXCLUSIVE RIGHT TO USE "COFFEE COMPANY", APART FROM THE MARK AS SHOWN.

FOR COFFEE SHOPS (U.S. CLS. 100 AND 101).
KATHERINE CHANG, EXAMINING ATTORNEY

SN 77-136,260. THE RITZ-CARLTON HOTEL COMPANY, L.L.C., BETHESDA, MD. FILED 3-21-2007.

THE RITZ-CARLTON COBALTE
CARD

THE MARK CONSISTS OF STANDARD CHARACTERS WITHOUT CLAIM TO ANY PARTICULAR FONT, STYLE, SIZE, OR COLOR.

OWNER OF U.S. REG. NOS. 1,094,823, 1,905,234 AND OTHERS.

NO CLAIM IS MADE TO THE EXCLUSIVE RIGHT TO USE "CARD", APART FROM THE MARK AS SHOWN.

FOR HOTEL SERVICES (U.S. CLS. 100 AND 101).
ZHALEH DELANEY, EXAMINING ATTORNEY

CLASS 43—(Continued).

SN 77-136,285. THE RITZ-CARLTON HOTEL COMPANY, L.L.C., BETHESDA, MD. FILED 3-21-2007.

THE RITZ-CARLTON COBALT CARD

THE MARK CONSISTS OF STANDARD CHARACTERS WITHOUT CLAIM TO ANY PARTICULAR FONT, STYLE, SIZE, OR COLOR.

OWNER OF U.S. REG. NOS. 1,094,823, 1,905,234 AND OTHERS.

NO CLAIM IS MADE TO THE EXCLUSIVE RIGHT TO USE "CARD", APART FROM THE MARK AS SHOWN.

FOR HOTEL SERVICES (U.S. CLS. 100 AND 101).
ZHALEH DELANEY, EXAMINING ATTORNEY

SN 77-136,296. THE RITZ-CARLTON HOTEL COMPANY, L.L.C., BETHESDA, MD. FILED 3-21-2007.

COBALTE CARD

THE MARK CONSISTS OF STANDARD CHARACTERS WITHOUT CLAIM TO ANY PARTICULAR FONT, STYLE, SIZE, OR COLOR.

NO CLAIM IS MADE TO THE EXCLUSIVE RIGHT TO USE "CARD", APART FROM THE MARK AS SHOWN.

FOR HOTEL SERVICES (U.S. CLS. 100 AND 101).
ZHALEH DELANEY, EXAMINING ATTORNEY

SN 77-136,311. THE RITZ-CARLTON HOTEL COMPANY, L.L.C., BETHESDA, MD. FILED 3-21-2007.

COBALT CARD

THE MARK CONSISTS OF STANDARD CHARACTERS WITHOUT CLAIM TO ANY PARTICULAR FONT, STYLE, SIZE, OR COLOR.

NO CLAIM IS MADE TO THE EXCLUSIVE RIGHT TO USE "CARD", APART FROM THE MARK AS SHOWN.

FOR HOTEL SERVICES (U.S. CLS. 100 AND 101).
ZHALEH DELANEY, EXAMINING ATTORNEY

CLASS 43—(Continued).

SN 77-137,978. JOHN JEON, NORTHRIDGE, CA. FILED 3-22-2007.



NO CLAIM IS MADE TO THE EXCLUSIVE RIGHT TO USE "BAGEL & BAGEL" AND "THE NEW YORK STYLE BAGEL CAFE", APART FROM THE MARK AS SHOWN.

THE COLOR(S) BLUE, ORANGE AND WHITE IS/ARE CLAIMED AS A FEATURE OF THE MARK.

THE MARK CONSISTS OF A BLUE CIRCLE OUTLINED IN ORANGE. INSIDE THE CIRCLE IS ANOTHER ORANGE RING WITH A WHITE COFFEE MUG WITHIN WHICH HAS FIVE (5) WHITE COFFEE BEANS FLOWING OUT OF IT. THE MUG ALSO HAS AN ORANGE BAR ON IT WITH "B&B" WRITTEN IN BLUE ON IT. INSIDE THE OUTER ORANGE BORDER OF THE BLUE CIRCLE BUT OUTSIDE THE INNER ORANGE RING ARE THE WORDS "BAGEL & BAGEL" WRITTEN IN WHITE FOLLOWING THE TOP CIRCUMFERENCE OF THE CIRCLE AND THE WORDS "THE NEW YORK STYLE BAGEL CAFE" WRITTEN IN WHITE FOLLOWING THE BOTTOM CIRCUMFERENCE OF THE CIRCLE.

FOR RESTAURANT SERVICES; NAMELY, DELICATESSEN FEATURING BAGELS, CREAM CHEESE, SPREADS, FISH, SALADS, BAKED GOODS, AND BEVERAGES (U.S. CLS. 100 AND 101).
JENNIFER VASQUEZ, EXAMINING ATTORNEY

SN 77-138,643. JIMMY JOHN'S ENTERPRISES, LLC, CHAMPAIGN, IL. FILED 3-23-2007.

FREAKY FAST FREAKY GOOD

THE MARK CONSISTS OF STANDARD CHARACTERS WITHOUT CLAIM TO ANY PARTICULAR FONT, STYLE, SIZE, OR COLOR.

FOR RESTAURANT SERVICES (U.S. CLS. 100 AND 101).

CHARLOTTE CORWIN, EXAMINING ATTORNEY

CLASS 43—(Continued).

SN 77-138,824. BAR-B-KOSHER, INC., WOODLAND HILLS, CA. FILED 3-23-2007.

BAR-B-KOSHER

THE MARK CONSISTS OF STANDARD CHARACTERS WITHOUT CLAIM TO ANY PARTICULAR FONT, STYLE, SIZE, OR COLOR.

FOR RESTAURANT SERVICES FEATURING KOSHER FOOD (U.S. CLS. 100 AND 101).
EMILY CHUO, EXAMINING ATTORNEY

SN 77-139,598. MY GOODNESS INC, SCOTTSDALE, AZ. FILED 3-24-2007.



THE MARK CONSISTS OF TWO BIRDS WITH KNOTWORK.

FOR RESTAURANT AND BAR SERVICES; CAFE-RESTAURANTS; CARRY-OUT RESTAURANTS; HOTEL, BAR AND RESTAURANT SERVICES; RESTAURANTS; TAKE-OUT RESTAURANT SERVICES (U.S. CLS. 100 AND 101).

FIRST USE 12-11-2006; IN COMMERCE 2-1-2007.
BARBARA BROWN, EXAMINING ATTORNEY

SN 77-140,012. FTC INVESTMENTS, LLC, CORAL SPRINGS, FL. FILED 3-26-2007.

Jackbit & Joltz

THE MARK CONSISTS OF STANDARD CHARACTERS WITHOUT CLAIM TO ANY PARTICULAR FONT, STYLE, SIZE, OR COLOR.

FOR RESTAURANT SERVICES (U.S. CLS. 100 AND 101).

APRIL ROACH, EXAMINING ATTORNEY

CLASS 43—(Continued).

SN 77-140,288. VARGA, CLAYTON, PASADENA, CA. FILED 3-26-2007.

SMOKIN PENGUIN

THE MARK CONSISTS OF STANDARD CHARACTERS WITHOUT CLAIM TO ANY PARTICULAR FONT, STYLE, SIZE, OR COLOR.

FOR RESTAURANT SERVICES (U.S. CLS. 100 AND 101).

FRANK LATTUCA, EXAMINING ATTORNEY

SN 77-140,459. FTC INVESTMENTS, LLC, CORAL SPRINGS, FL. FILED 3-26-2007.



NO CLAIM IS MADE TO THE EXCLUSIVE RIGHT TO USE "GOOD FOOD" AND "GOOD DRINK", APART FROM THE MARK AS SHOWN.

THE COLOR(S) RED, BLACK, TAN AND WHITE IS/ARE CLAIMED AS A FEATURE OF THE MARK.

THE MARK CONSISTS OF THE WORD "JACKBIT" IN THIN BLACK LETTERS WITH A THICK RED BORDER AND THE WORDING "& JOLTZ" IN WHITE INSIDE OF A BLACK OVAL AND AN OVERLAPPING THIN RED OVAL, WITH A TAN AND BLACK KANGAROO ABOVE THE LETTER "K" IN THE WORD JACKBIT AND THE WORDS "GOOD FOOD," "GOOD DRINK," AND "G'DAY" IN BLACK LETTERS, SEPARATED WITH RED DIAMONDS.

FOR RESTAURANT SERVICES (U.S. CLS. 100 AND 101).

APRIL ROACH, EXAMINING ATTORNEY

SN 77-140,553. CROSS KEYS HOTEL PARTNERS, LLC, ARLINGTON, VA. FILED 3-26-2007.

THE INN AT CROSS KEYS

THE MARK CONSISTS OF STANDARD CHARACTERS WITHOUT CLAIM TO ANY PARTICULAR FONT, STYLE, SIZE, OR COLOR.

NO CLAIM IS MADE TO THE EXCLUSIVE RIGHT TO USE "INN", APART FROM THE MARK AS SHOWN.

FOR HOTEL AND RESORT SERVICES (U.S. CLS. 100 AND 101).

JEFF DEFORD, EXAMINING ATTORNEY

CLASS 43—(Continued).

SN 77-140,599. PROM QUEEN-II, LLC, PENSACOLA BEACH, FL. FILED 3-26-2007.

GRAND MARLIN

THE MARK CONSISTS OF STANDARD CHARACTERS WITHOUT CLAIM TO ANY PARTICULAR FONT, STYLE, SIZE, OR COLOR.

FOR RESTAURANT AND BAR SERVICES (U.S. CLS. 100 AND 101).

ROBIN CHOSID, EXAMINING ATTORNEY

SN 77-140,857. REDD, DOMINIC, WASHINGTON, DC. AND REDD, JENNIFER GRAHAM, WASHINGTON, DC. FILED 3-26-2007.



VEGETATE

THE COLOR(S) GREEN AND BLACK IS/ARE CLAIMED AS A FEATURE OF THE MARK.

THE MARK CONSISTS OF BRUSHSTROKES FORMING A V-SHAPE WITHIN A BOX, WITH A STROKE OF COLOR BEHIND IT, POSITIONED ABOVE THE TYPED WORD VEGETATE. THE COLOR(S) BLACK APPEARS IN THE LETTER "V" AND THE BROKEN RECTANGLE. THE COLOR GREEN APPEARS IN THE BACKGROUND OF THE STYLIZED RECTANGLE. THE COLOR GRAY APPEARS BEHIND THE RECTANGLE AS SHADING ONLY.

FOR RESTAURANT SERVICES (U.S. CLS. 100 AND 101).

FIRST USE 10-18-2005; IN COMMERCE 10-18-2005.
LOURDES AYALA, EXAMINING ATTORNEY

SN 77-140,910. BELLA PITA INC., SANTA MONICA, CA. FILED 3-26-2007.

BELLA PITA

THE MARK CONSISTS OF STANDARD CHARACTERS WITHOUT CLAIM TO ANY PARTICULAR FONT, STYLE, SIZE, OR COLOR.

NO CLAIM IS MADE TO THE EXCLUSIVE RIGHT TO USE "PITA", APART FROM THE MARK AS SHOWN.

THE ENGLISH TRANSLATION OF BELLA IS "BEAUTIFUL".

FOR RESTAURANTS (U.S. CLS. 100 AND 101).
FIRST USE 8-1-2005; IN COMMERCE 3-15-2007.
ELLEN B. AWRICH, EXAMINING ATTORNEY

CLASS 43—(Continued).

SN 77-141,011. TRI-CEE CORP., HILLSBOROUGH, NJ. FILED 3-27-2007.

Culinary Creations Catering with A Creative Touch

THE MARK CONSISTS OF STANDARD CHARACTERS WITHOUT CLAIM TO ANY PARTICULAR FONT, STYLE, SIZE, OR COLOR.

NO CLAIM IS MADE TO THE EXCLUSIVE RIGHT TO USE "CULINARY", APART FROM THE MARK AS SHOWN. FOR CATERING (U.S. CLS. 100 AND 101).

FIRST USE 10-15-1995; IN COMMERCE 10-15-1995.
BRENDAN REGAN, EXAMINING ATTORNEY

SN 77-141,013. TRI-CEE CORP., HILLSBOROUGH, NJ. FILED 3-27-2007.

Culinary Creations Café & Pastry Shoppe

THE MARK CONSISTS OF STANDARD CHARACTERS WITHOUT CLAIM TO ANY PARTICULAR FONT, STYLE, SIZE, OR COLOR.

NO CLAIM IS MADE TO THE EXCLUSIVE RIGHT TO USE "CULINARY" OR "CAFÉ & PASTRY SHOPPE", APART FROM THE MARK AS SHOWN.

FOR CAFES (U.S. CLS. 100 AND 101).
FIRST USE 10-15-1995; IN COMMERCE 10-15-1995.
BRENDAN REGAN, EXAMINING ATTORNEY

SN 77-141,019. TRI-CEE CORP., HILLSBOROUGH, NJ. FILED 3-27-2007.

Culinary Creations Catering

THE MARK CONSISTS OF STANDARD CHARACTERS WITHOUT CLAIM TO ANY PARTICULAR FONT, STYLE, SIZE, OR COLOR.

NO CLAIM IS MADE TO THE EXCLUSIVE RIGHT TO USE "CULINARY" OR "CATERING", APART FROM THE MARK AS SHOWN.

FOR CATERING (U.S. CLS. 100 AND 101).
FIRST USE 10-15-1995; IN COMMERCE 10-15-1995.
BRENDAN REGAN, EXAMINING ATTORNEY

CLASS 43—(Continued).

SN 77-141,025. TRI-CEE CORP., HILLSBOROUGH, NJ. FILED 3-27-2007.

Culinary Creations

THE MARK CONSISTS OF STANDARD CHARACTERS WITHOUT CLAIM TO ANY PARTICULAR FONT, STYLE, SIZE, OR COLOR.
NO CLAIM IS MADE TO THE EXCLUSIVE RIGHT TO USE "CULINARY", APART FROM THE MARK AS SHOWN. FOR CAFES (U.S. CLS. 100 AND 101).
FIRST USE 10-15-1995; IN COMMERCE 10-15-1995.
BRENDAN REGAN, EXAMINING ATTORNEY

SN 77-141,680. PIZZA HUT, INC., DALLAST, TX. FILED 3-27-2007.

IT'S ALL IN THE HUT

THE MARK CONSISTS OF STANDARD CHARACTERS WITHOUT CLAIM TO ANY PARTICULAR FONT, STYLE, SIZE, OR COLOR.
OWNER OF U.S. REG. NOS. 2,357,045, 2,446,056 AND OTHERS.
FOR RESTAURANT SERVICES (U.S. CLS. 100 AND 101).
TAMARA FRAZIER, EXAMINING ATTORNEY

SN 77-142,034. HAMBURG DONER L.L.C., LOVETTSVILLE, VA. FILED 3-27-2007.

Make it Original

THE MARK CONSISTS OF STANDARD CHARACTERS WITHOUT CLAIM TO ANY PARTICULAR FONT, STYLE, SIZE, OR COLOR.
FOR RESTAURANT SERVICES (U.S. CLS. 100 AND 101).
FIRST USE 7-4-2006; IN COMMERCE 7-4-2006.
RONALD MCMORROW, EXAMINING ATTORNEY

CLASS 43—(Continued).

SN 77-142,514. STRUTS, LLC, OXFORD, AL. FILED 3-28-2007.

STRUTS

THE MARK CONSISTS OF STANDARD CHARACTERS WITHOUT CLAIM TO ANY PARTICULAR FONT, STYLE, SIZE, OR COLOR.
FOR RESTAURANT AND BAR SERVICES (U.S. CLS. 100 AND 101).
FIRST USE 10-5-1999; IN COMMERCE 10-5-1999.
PAUL F. GAST, EXAMINING ATTORNEY

SN 77-143,112. SILVER NUGGET HOLDINGS, LLC, HENDERSON, NV. FILED 3-28-2007.

MANGO POP

THE MARK CONSISTS OF STANDARD CHARACTERS WITHOUT CLAIM TO ANY PARTICULAR FONT, STYLE, SIZE, OR COLOR.
FOR RESTAURANT SERVICES; BAR SERVICES; TAVERN SERVICES (U.S. CLS. 100 AND 101).
THEODORE MCBRIDE, EXAMINING ATTORNEY

SN 77-143,113. SILVER NUGGET HOLDINGS, LLC, HENDERSON, NV. FILED 3-28-2007.

DRINK SUM, PLAY SUM, DIM SUM

THE MARK CONSISTS OF STANDARD CHARACTERS WITHOUT CLAIM TO ANY PARTICULAR FONT, STYLE, SIZE, OR COLOR.
FOR RESTAURANT SERVICES; BAR SERVICES; TAVERN SERVICES (U.S. CLS. 100 AND 101).
THEODORE MCBRIDE, EXAMINING ATTORNEY

CLASS 43—(Continued).

SN 77-144,389. JEON, JEONG SOON, FLUSHING, NY. FILED 3-29-2007.



NO CLAIM IS MADE TO THE EXCLUSIVE RIGHT TO USE "COFFEE", APART FROM THE MARK AS SHOWN.
THE MARK CONSISTS OF THE STYLIZED WORDS ESPARKS COFFEE WITHIN A MISCELLANEOUS CIRCULAR DESIGN.
FOR COFFEE SHOPS (U.S. CLS. 100 AND 101).
FIRST USE 11-7-2006; IN COMMERCE 11-7-2006.
TEJBIR SINGH, EXAMINING ATTORNEY

CLASS 43—(Continued).

SN 77-150,894. THAI PASSION INC., AUSTIN, TX. FILED S.R. 4-6-2007; AM. P.R. 8-15-2007.

Thai Passion

THE MARK CONSISTS OF STANDARD CHARACTERS WITHOUT CLAIM TO ANY PARTICULAR FONT, STYLE, SIZE, OR COLOR.
NO CLAIM IS MADE TO THE EXCLUSIVE RIGHT TO USE "THAI", APART FROM THE MARK AS SHOWN.
FOR RESTAURANTS; FOOD SERVICES IN THE NATURE OF SERVING OF FOOD AND DRINKS (U.S. CLS. 100 AND 101).
FIRST USE 8-14-1996; IN COMMERCE 8-14-1996.
KELLY CHOE, EXAMINING ATTORNEY

SN 77-154,735. STRUTS, LLC, OXFORD, AL. FILED 4-12-2007.

SN 77-149,165. TAN IP, LLC, GLEN BURNIE, MD. FILED 4-5-2007.

THE TAN RESORT GROUP

THE MARK CONSISTS OF STANDARD CHARACTERS WITHOUT CLAIM TO ANY PARTICULAR FONT, STYLE, SIZE, OR COLOR.
OWNER OF U.S. REG. NO. 2,446,656.
NO CLAIM IS MADE TO THE EXCLUSIVE RIGHT TO USE "RESORT GROUP", APART FROM THE MARK AS SHOWN.
FOR PROVISION OF RESORT LODGING SERVICES, HOTEL SERVICES, TOURIST INNS, MOTEL SERVICES AND BED AND BREAKFAST ACCOMMODATIONS (U.S. CLS. 100 AND 101).
FIRST USE 11-15-2006; IN COMMERCE 11-15-2006.
EDWARD NELSON, EXAMINING ATTORNEY



NO CLAIM IS MADE TO THE EXCLUSIVE RIGHT TO USE "WINGS BURGERS", APART FROM THE MARK AS SHOWN.
THE MARK CONSISTS OF A STYLIZED ROOSTER HEAD AND WINGS ON A BACKGROUND CONSISTING OF SHIELD AND DIAMOND SHAPES.
FOR RESTAURANT AND BAR SERVICES (U.S. CLS. 100 AND 101).
FIRST USE 6-4-2000; IN COMMERCE 6-4-2000.
PAUL F. GAST, EXAMINING ATTORNEY

CLASS 43—(Continued).

SN 77-157,038. LA JOLLA INVESTMENTS & MANAGEMENT, INC., LA JOLLA, CA. FILED 4-15-2007.

LOOP VACATION RENTALS

THE MARK CONSISTS OF STANDARD CHARACTERS WITHOUT CLAIM TO ANY PARTICULAR FONT, STYLE, SIZE, OR COLOR.

NO CLAIM IS MADE TO THE EXCLUSIVE RIGHT TO USE "VACATION RENTALS", APART FROM THE MARK AS SHOWN.

FOR PROVIDING TRAVEL LODGING INFORMATION SERVICES AND TRAVEL LODGING BOOKING AGENCY SERVICES FOR TRAVELERS; RESERVATION OF ROOMS FOR TRAVELLERS; TRAVEL AGENCY SERVICES, NAMELY, MAKING RESERVATIONS AND BOOKING FOR TEMPORARY LODGING (U.S. CLS. 100 AND 101).

KIM SAITO, EXAMINING ATTORNEY

SN 77-162,918. MARRIOTT INTERNATIONAL, INC., BETHESDA, MD. FILED 4-23-2007.



THE MARK CONSISTS OF THE LETTERS "MB" SURROUNDED BY A PARTIAL CIRCLE.

FOR HOTEL SERVICES; RESTAURANT SERVICES; CATERING (U.S. CLS. 100 AND 101).

CAROLYN CATALDO, EXAMINING ATTORNEY

SN 77-163,423. SAGE HOSPITALITY RESOURCES LLC, DENVER, CO. FILED 4-23-2007.

STAY HAPPY

THE MARK CONSISTS OF STANDARD CHARACTERS WITHOUT CLAIM TO ANY PARTICULAR FONT, STYLE, SIZE, OR COLOR.

FOR HOTEL, BAR AND RESTAURANT SERVICES (U.S. CLS. 100 AND 101).

FIRST USE 1-12-2007; IN COMMERCE 1-12-2007.

ERIN FALK, EXAMINING ATTORNEY

CLASS 43—(Continued).

SN 77-167,065. THE SHERATON LLC, WHITE PLAINS, NY. FILED 4-26-2007.

ASTOR COURT

THE MARK CONSISTS OF STANDARD CHARACTERS WITHOUT CLAIM TO ANY PARTICULAR FONT, STYLE, SIZE, OR COLOR.

FOR HOTEL SERVICES, NAMELY PROVIDING FOOD AND BEVERAGE; RESTAURANT, BAR AND COCKTAIL LOUNGE SERVICES (U.S. CLS. 100 AND 101).

HANNO RITTNER, EXAMINING ATTORNEY

SN 77-171,889. TAN IP, LLC, GLEN BURNIE, MD. FILED 5-3-2007.



OWNER OF U.S. REG. NO. 2,446,656.

NO CLAIM IS MADE TO THE EXCLUSIVE RIGHT TO USE "TRAVEL" AND "NETWORK", APART FROM THE MARK AS SHOWN.

THE MARK CONSISTS IN PART OF A STYLIZED SUN WITH SIX RAYS.

FOR TRAVEL AGENCY SERVICES, NAMELY, RESERVATIONS AND BOOKINGS FOR TEMPORARY LODGING ACCOMMODATIONS (U.S. CLS. 100 AND 101).

FIRST USE 1-0-2002; IN COMMERCE 1-0-2002.

EDWARD NELSON, EXAMINING ATTORNEY

SN 77-175,167. CBS BROADCASTING INC., NEW YORK, NY. FILED 5-8-2007.

JETHRO BODINE'S BEVERLY HILLBILLIES MANSION & CASINO

THE MARK CONSISTS OF STANDARD CHARACTERS WITHOUT CLAIM TO ANY PARTICULAR FONT, STYLE, SIZE, OR COLOR.

THE NAME JETHRO BODINE'S DOES NOT IDENTIFY A LIVING INDIVIDUAL.

FOR RESTAURANT SERVICES (U.S. CLS. 100 AND 101).

CHRIS WELLS, EXAMINING ATTORNEY

CLASS 43—(Continued).

SN 77-175,969. JUNE BUG ENTERPRISES, INC., BEVERLY HILLS, CA. FILED 5-8-2007.

CLASS 43—(Continued).

SN 77-179,936. OTG MANAGEMENT, INC., PHILADELPHIA, PA. FILED 5-14-2007.

1-888-GO-MAGIC



THE MARK CONSISTS OF STANDARD CHARACTERS WITHOUT CLAIM TO ANY PARTICULAR FONT, STYLE, SIZE, OR COLOR.

OWNER OF U.S. REG. NOS. 1,555,839, 2,699,394 AND OTHERS.

FOR RESERVATION OF HOTEL ROOMS FOR OTHERS, CONSULTANCY SERVICES IN THE FIELD OF HOTEL ROOM RESERVATIONS (U.S. CLS. 100 AND 101).

DAYNA BROWNE, EXAMINING ATTORNEY

NO CLAIM IS MADE TO THE EXCLUSIVE RIGHT TO USE "SPORTS GRILL", APART FROM THE MARK AS SHOWN.

THE COLOR(S) RED, BLUE AND WHITE IS/ARE CLAIMED AS A FEATURE OF THE MARK.

THE MARK CONSISTS OF THE WORD JSG IN LARGE RED LETTERS OUTLINED IN BLUE AND WHITE, WITH THE WORDS JERSEY SPORTS GRILL IN WHITE LETTERS IN A BOX OUTLINED WITH THE COLORS RED, BLUE AND WHITE.

FOR RESTAURANT AND BAR SERVICES (U.S. CLS. 100 AND 101).

KARANENDRA S. CHHINA, EXAMINING ATTORNEY

SN 77-176,141. OTG MANAGEMENT, INC., PHILADELPHIA, PA. FILED 5-9-2007.

SN 77-180,062. AUTUMN TIME, LLC, WILMINGTON, DE. FILED 5-14-2007.

Revolución

FLAVOR YOUR DAY

THE MARK CONSISTS OF STANDARD CHARACTERS WITHOUT CLAIM TO ANY PARTICULAR FONT, STYLE, SIZE, OR COLOR.

THE ENGLISH TRANSLATION OF REVOLUCION IS "REVOLUTION".

FOR RESTAURANT AND BAR SERVICES (U.S. CLS. 100 AND 101).

KARANENDRA S. CHHINA, EXAMINING ATTORNEY

THE MARK CONSISTS OF STANDARD CHARACTERS WITHOUT CLAIM TO ANY PARTICULAR FONT, STYLE, SIZE, OR COLOR.

FOR RESTAURANT SERVICES (U.S. CLS. 100 AND 101).

TASHIA BUNCH, EXAMINING ATTORNEY

CLASS 43—(Continued).

SN 77-186,318. TIMES GRILL RESTAURANT GROUP, LLC, JACKSONVILLE, FL. FILED 5-21-2007.

TIMES TO GO

THE MARK CONSISTS OF STANDARD CHARACTERS WITHOUT CLAIM TO ANY PARTICULAR FONT, STYLE, SIZE, OR COLOR.

OWNER OF U.S. REG. NO. 3,144,659.
NO CLAIM IS MADE TO THE EXCLUSIVE RIGHT TO USE "TO GO", APART FROM THE MARK AS SHOWN.
FOR RESTAURANT SERVICES (U.S. CLS. 100 AND 101).

BRIDGETT SMITH, EXAMINING ATTORNEY

SN 77-209,342. TIMES GRILL RESTAURANT GROUP, LLC, JACKSONVILLE, FL. FILED 6-19-2007.

CHIEF BURGER OFFICER

THE MARK CONSISTS OF STANDARD CHARACTERS WITHOUT CLAIM TO ANY PARTICULAR FONT, STYLE, SIZE, OR COLOR.

NO CLAIM IS MADE TO THE EXCLUSIVE RIGHT TO USE "BURGER", APART FROM THE MARK AS SHOWN.
FOR RESTAURANT AND BAR SERVICES (U.S. CLS. 100 AND 101).

BRIDGETT SMITH, EXAMINING ATTORNEY

SN 78-738,381. THE KATI ROLL COMPANY INC., NEW YORK, NY. FILED 10-21-2005.

The Kati Roll Company

THE MARK CONSISTS OF STANDARD CHARACTERS WITHOUT CLAIM TO ANY PARTICULAR FONT, STYLE, SIZE, OR COLOR.

NO CLAIM IS MADE TO THE EXCLUSIVE RIGHT TO USE "COMPANY", APART FROM THE MARK AS SHOWN.
THE FOREIGN WORDING IN THE MARK TRANSLATES INTO ENGLISH AS "SKEWER".

SEC. 2(F) AS TO "KATI ROLL".
FOR RESTAURANT AND CARRY-OUT RESTAURANT SERVICES (U.S. CLS. 100 AND 101).
FIRST USE 6-7-2002; IN COMMERCE 6-7-2002.
MICHAEL LEWIS, EXAMINING ATTORNEY

CLASS 43—(Continued).

SN 78-779,320. KALIPOLI INTERNATIONAL INC., TITUSVILLE, FL. FILED 12-22-2005.



OWNER OF U.S. REG. NO. 1,616,163.
NO CLAIM IS MADE TO THE EXCLUSIVE RIGHT TO USE "PIZZERIA & EATERY", APART FROM THE MARK AS SHOWN.

FOR CARRY-OUT RESTAURANTS; RESTAURANTS; RESTAURANTS FEATURING HOME DELIVERY (U.S. CLS. 100 AND 101).

FIRST USE 11-26-1983; IN COMMERCE 11-26-1983.
DEZMONA MIZELLE, EXAMINING ATTORNEY

SN 78-791,133. HEMCHER FAMILY PARTNERSHIP, ROSEMONT, PA. FILED 1-13-2006.

Great American Pub

THE MARK CONSISTS OF STANDARD CHARACTERS WITHOUT CLAIM TO ANY PARTICULAR FONT, STYLE, SIZE, OR COLOR.

NO CLAIM IS MADE TO THE EXCLUSIVE RIGHT TO USE "PUB", APART FROM THE MARK AS SHOWN.
FOR RESTAURANT AND BAR SERVICES; RESTAURANTS (U.S. CLS. 100 AND 101).

FIRST USE 1-1-1992; IN COMMERCE 1-1-1992.
LYDIA BELZER, EXAMINING ATTORNEY

SN 78-793,719. MANDALAY RESORT GROUP, LAS VEGAS, NV. FILED 1-18-2006.



OWNER OF U.S. REG. NO. 3,090,689.
NO CLAIM IS MADE TO THE EXCLUSIVE RIGHT TO USE "WINE", APART FROM THE MARK AS SHOWN.

THE MARK CONSISTS OF THE NUMBERS 55 WITH A DEGREE SIGN, THE WORDS "FIFTY FIVE DEGREES WINE" THE + SIGN AND THE WORD "DESIGN".

FOR PROVIDING INFORMATION ABOUT WINE CHARACTERISTICS; WINE BARS (U.S. CLS. 100 AND 101).

FIRST USE 12-9-2003; IN COMMERCE 12-9-2003.
KATHRYN COWARD, EXAMINING ATTORNEY

CLASS 43—(Continued).

SN 78-850,686. WOOD RANCH BARBECUE & GRILL, INC., AGOURA HILLS, CA. FILED 3-30-2006.



NO CLAIM IS MADE TO THE EXCLUSIVE RIGHT TO USE "BBQ & GRILL", APART FROM THE MARK AS SHOWN.

THE COLOR(S) BLACK, RED AND ORANGE IS/ARE CLAIMED AS A FEATURE OF THE MARK.

THE CHARACTERS "WOOD RANCH" ARE RED. THE SOLID CIRCLE FRAMING THE HORSE AND THE WORDS "WOOD RANCH" IS ORANGE. ALL OTHER CHARACTERS IN THE MARK, I.E., THE COWBOY ON THE BUCKING HORSE AND THE WORDS 'BBQ & GRILL', ARE IN BLACK."

FOR RESTAURANT SERVICES, FOOD CATERING (U.S. CLS. 100 AND 101).

FIRST USE 1-1-1992; IN COMMERCE 1-1-1992.
RAMONA ORTIGA, EXAMINING ATTORNEY

SN 78-864,489. LOGAN'S ROADHOUSE, INC., NASHVILLE, TN. FILED 4-19-2006.

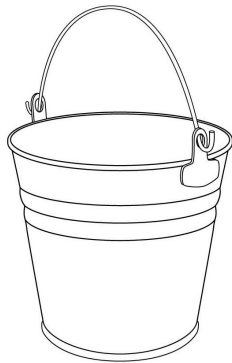

THE MARK CONSISTS OF A CONFIGURATION OF A BUCKET WITH A HANDLE. THE HANDLE IS A CURVED PIECE OF WIRE WITHOUT ANY ADDITIONAL BENDS IN THE GRIPPING AREA, AND IS ATTACHED TO THE BUCKET WITH SMALL FLANGES. THE ENDS OF THE HANDLE THAT ATTACH THROUGH THE FLANGES ARE BENT UPWARDS AND ARE RELATIVELY SMALL. THE FEATURES OF THE MARK THAT THE APPLICANT CLAIMS AS ITS MARK ARE SHOWN IN SOLID LINES.

SEC. 2(F).
FOR RESTAURANT SERVICES (U.S. CLS. 100 AND 101).

FIRST USE 8-25-1991; IN COMMERCE 8-25-1991.
JOHN DWYER, EXAMINING ATTORNEY

CLASS 43—(Continued).

SN 78-864,746. MISTER JIM'S JUMBO SUBMARINES, INC., CHESAPEAKE, VA. FILED 4-19-2006.



NO CLAIM IS MADE TO THE EXCLUSIVE RIGHT TO USE "JUMBO SUBMARINE SANDWICHES, PIZZA AND WINGS", APART FROM THE MARK AS SHOWN.

FOR RESTAURANTS; RESTAURANTS FEATURING HOME DELIVERY; AND CATERING (U.S. CLS. 100 AND 101).

FIRST USE 0-0-1969; IN COMMERCE 0-0-1969.
RAY THOMAS, EXAMINING ATTORNEY

SN 78-878,760. DATHAO BALMOREZ, LOUISVILLE, KY. FILED 5-8-2006.

IRON PLATE GRILL

THE MARK CONSISTS OF STANDARD CHARACTERS WITHOUT CLAIM TO ANY PARTICULAR FONT, STYLE, SIZE, OR COLOR.

NO CLAIM IS MADE TO THE EXCLUSIVE RIGHT TO USE "GRILL", APART FROM THE MARK AS SHOWN.

FOR RESTAURANT SERVICES (U.S. CLS. 100 AND 101).

PRISCILLA MILTON, EXAMINING ATTORNEY

SN 78-891,626. SNOWCREEK HILLTOP DEVELOPMENT COMPANY, L.P., SANTA MONICA, CA. FILED 5-24-2006.



"THE COLOR(S) GOLD AND YELLOW IS/ARE CLAIMED AS A FEATURE OF THE MARK."

"THE MARK CONSISTS OF A SNOWFLAKE WITH THE WORDING SNOWCREEK UNDERNEATH THE SNOWFLAKE AND THE COLOR GOLD APPEARS IN THE SNOWFLAKE AND THE COLOR YELLOW APPEARS IN THE WORDING SNOWCREEK."

FOR RESTAURANT AND BAR SERVICES; CATERING; PROVIDING CONFERENCE ROOMS; PROVISION OF CONFERENCE, EXHIBITION AND MEETING FACILITIES (U.S. CLS. 100 AND 101).

FIRST USE 12-31-1989; IN COMMERCE 12-31-1989.
MICHAEL WEBSTER, EXAMINING ATTORNEY

CLASS 43—(Continued).

SN 78-891,735. SNOWCREEK HILLTOP DEVELOPMENT COMPANY, L.P., SANTA MONICA, CA. FILED 5-24-2006.

SNOWCREEK

THE MARK CONSISTS OF STANDARD CHARACTERS WITHOUT CLAIM TO ANY PARTICULAR FONT, STYLE, SIZE, OR COLOR.

FOR RESTAURANT AND BAR SERVICES; CATERING; PROVIDING CONFERENCE ROOMS; PROVISION OF CONFERENCE, EXHIBITION AND MEETING FACILITIES (U.S. CLS. 100 AND 101).

FIRST USE 12-31-1989; IN COMMERCE 12-31-1989.
MICHAEL WEBSTER, EXAMINING ATTORNEY

CLASS 43—(Continued).

SN 78-931,514. PATILLO, KEVIN J., DAYTON, OH. FILED 7-18-2006.



NO CLAIM IS MADE TO THE EXCLUSIVE RIGHT TO USE "BBQ, LINKS, & SAUCE" AND THE REPRESENTATION OF THE STATE OF TEXAS, APART FROM THE MARK AS SHOWN.

THE NAME(S), PORTRAIT(S), AND/OR SIGNATURE(S) SHOWN IN THE MARK DOES NOT IDENTIFY A PARTICULAR LIVING INDIVIDUAL.

THE MARK CONSISTS OF THE LITERAL ELEMENT OF THE MARK DISPLAYED INSIDE AN OUTLINE OF THE STATE OF TEXAS BORDER.

FOR RESTAURANT AND BAR SERVICES (U.S. CLS. 100 AND 101).
LAURIE KAUFMAN, EXAMINING ATTORNEY

SN 78-928,046. WORLDWIDE THROTTLE, LLC, DYERSBERG, TN. FILED 7-12-2006.

STURGIS SALOON

THE MARK CONSISTS OF STANDARD CHARACTERS WITHOUT CLAIM TO ANY PARTICULAR FONT, STYLE, SIZE, OR COLOR.

NO CLAIM IS MADE TO THE EXCLUSIVE RIGHT TO USE "SALOON", APART FROM THE MARK AS SHOWN.

FOR RESTAURANT AND BAR SERVICES (U.S. CLS. 100 AND 101).
JENNIFER MARTIN, EXAMINING ATTORNEY

SN 78-940,002. PICCADILLY RESTAURANTS, LLC, BATON ROUGE, LA. FILED 7-28-2006.

PETE'S GRILL

THE MARK CONSISTS OF STANDARD CHARACTERS WITHOUT CLAIM TO ANY PARTICULAR FONT, STYLE, SIZE, OR COLOR.

NO CLAIM IS MADE TO THE EXCLUSIVE RIGHT TO USE "GRILL", APART FROM THE MARK AS SHOWN.

FOR RESTAURANT SERVICES, NAMELY, SERVING HAMBURGER RESTAURANT FOOD IN A FOOD COURT IN AN INSTITUTIONAL SETTING (U.S. CLS. 100 AND 101).

FIRST USE 8-31-2005; IN COMMERCE 8-31-2005.
JAMES LOVELACE, EXAMINING ATTORNEY

CLASS 43—(Continued).

SN 78-940,337. PICCADILLY RESTAURANTS, LLC, BATON ROUGE, LA. FILED 7-28-2006.



THE COLOR(S) BLACK, WHITE, AND BEIGE IS/ARE CLAIMED AS A FEATURE OF THE MARK.

THE MARK CONSISTS OF A RECTANGLE, THE LEFT HALF OF WHICH HAS THE WORD "CLASSICS" IN WHITE LETTERS ON A BLACK BACKGROUND AND THE RIGHT HALF OF WHICH HAS A DRAWING OF A CHEF'S TOQUE IN BLACK AND A DRAWING OF A FORK IN BLACK ON A BEIGE BACKGROUND.

FOR RESTAURANT SERVICES, NAMELY, SERVING TRADITIONAL HOME-COOKED STYLE MEALS IN A FOOD COURT IN AN INSTITUTIONAL SETTING (U.S. CLS. 100 AND 101).

FIRST USE 8-31-2005; IN COMMERCE 8-31-2005.
JAMES LOVELACE, EXAMINING ATTORNEY

CLASS 43—(Continued).

SN 78-940,353. PICCADILLY RESTAURANTS, LLC, BATON ROUGE, LA. FILED 7-28-2006.



NO CLAIM IS MADE TO THE EXCLUSIVE RIGHT TO USE "GRILL", APART FROM THE MARK AS SHOWN.

THE COLOR(S) BLACK, WHITE, AND TAN IS/ARE CLAIMED AS A FEATURE OF THE MARK.

THE MARK CONSISTS OF THE WORD "PETE'S" IN BLACK WITH THE WORD "GRILL" BELOW IT IN WHITE ON A TAN BACKGROUND THAT IS IN A SHAPE APPROXIMATING AN ARTIST'S PALETTE.

FOR RESTAURANT SERVICES, NAMELY, SERVING HAMBURGER FOOD IN A FOOD COURT IN AN INSTITUTIONAL SETTING (U.S. CLS. 100 AND 101).

FIRST USE 8-31-2005; IN COMMERCE 8-31-2005.
JAMES LOVELACE, EXAMINING ATTORNEY

SN 78-940,340. PICCADILLY RESTAURANTS, LLC, BATON ROUGE, LA. FILED 7-28-2006.



NO CLAIM IS MADE TO THE EXCLUSIVE RIGHT TO USE "PIZZA & PASTA", APART FROM THE MARK AS SHOWN.

THE COLOR(S) RED, WHITE, GREEN AND BLACK IS/ARE CLAIMED AS A FEATURE OF THE MARK.

THE MARK CONSISTS OF THE WORD "CAVALLO'S" IN RED LETTERS WITH A WHITE BORDER AND BLACK SHADOWING ON A GREEN RECTANGLE WITH THE PHRASE "PIZZA & PASTA" IN WHITE WITH A BLACK BORDER BELOW THE WORD "CAVALLO'S" AND A GREEN AND WHITE TILE PATTERN IN AN ARC ABOVE THE WORD "CAVALLO'S".

FOR RESTAURANT SERVICES (U.S. CLS. 100 AND 101).
FIRST USE 8-31-2005; IN COMMERCE 8-31-2005.
JAMES LOVELACE, EXAMINING ATTORNEY

SN 78-943,822. FINANCIERE GERARD JOULIE, PARIS, FRANCE, FILED 8-3-2006.

SEBILLON

THE MARK CONSISTS OF STANDARD CHARACTERS WITHOUT CLAIM TO ANY PARTICULAR FONT, STYLE, SIZE, OR COLOR.

OWNER OF FRANCE REG. NO. 93491636, DATED 11-10-1993, EXPIRES 11-9-2013.

FOR HOTELS; RESTAURANTS; FOOD AND DRINK CATERING; WINE CELLAR BAR SERVICES; CAFETERIAS; CAFES; BAR SERVICES (U.S. CLS. 100 AND 101).

MATTHEW PAPPAS, EXAMINING ATTORNEY

CLASS 43—(Continued).

SN 78-946,246. B.D. PROMOTORA TURISTA SA DE CV, CANCUN, MEXICO, FILED 8-7-2006.

The ROYAL Cancun

THE MARK CONSISTS OF STANDARD CHARACTERS WITHOUT CLAIM TO ANY PARTICULAR FONT, STYLE, SIZE, OR COLOR.

NO CLAIM IS MADE TO THE EXCLUSIVE RIGHT TO USE "CANCUN", APART FROM THE MARK AS SHOWN.

FOR HOTEL SERVICES; HOTEL, BAR AND RESTAURANT SERVICES; RESORT HOTELS (U.S. CLS. 100 AND 101).

GIANCARLO CASTRO, EXAMINING ATTORNEY

SN 78-946,888. WOODSIDE HOTELS AND RESORTS GROUP SERVICES CORPORATION, MENLO PARK, CA. FILED 8-7-2006.

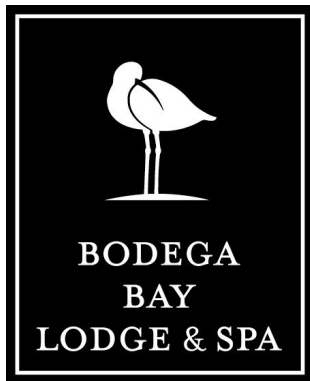

SEC. 2(F) AS TO "BODEGA BAY".
 FOR HOTELS; RESTAURANTS; AND SPA SERVICES, NAMELY, PROVIDING TEMPORARY ACCOMMODATIONS AND MEALS TO CLIENTS OF A HEALTH OR BEAUTY SPA (U.S. CLS. 100 AND 101).
 FIRST USE 12-31-1999; IN COMMERCE 12-31-1999.
 LINDA M. KING, EXAMINING ATTORNEY

CLASS 43—(Continued).

SN 78-949,442. LA SALSA, INC., CARPINTERIA, CA. FILED 8-10-2006.



OWNER OF U.S. REG. NOS. 2,484,633, 2,898,518 AND OTHERS.

NO CLAIM IS MADE TO THE EXCLUSIVE RIGHT TO USE "MEXICAN GRILL", APART FROM THE MARK AS SHOWN.

THE COLOR(S) YELLOW, RED, GREEN, ORANGE, BLUE AND WHITE IS/ARE CLAIMED AS A FEATURE OF THE MARK.

THE COLOR YELLOW APPEARS IN THE LARGER RECTANGLE. THE COLOR RED APPEARS IN THE WORDING LA SALSA. THE COLOR GREEN APPEARS IN THE JAGGED OUTLINE AROUND THE LARGER RECTANGLE AND IN THE SMALLER RECTANGLE AROUND THE WORDING FRESH MEXICAN GRILL. THE COLOR ORANGE APPEARS IN THE FLOWER-LIKE DESIGNS ON EACH END OF THE WORDS LA SALSA. THE COLOR BLUE APPEARS IN THE ABSTRACT DESIGNS ON THE LEFT AND RIGHT SIDES OF THE LARGER RECTANGLE. THE COLOR WHITE APPEARS IN THE WORDING FRESH MEXICAN GRILL.

SEC. 2(F) "FRESH MEXICAN GRILL".

FOR RESTAURANT SERVICES (U.S. CLS. 100 AND 101).

COLLEEN KEARNEY, EXAMINING ATTORNEY

SN 78-949,874. LA SALSA, INC., CARPINTERIA, CA. FILED 8-10-2006.



OWNER OF U.S. REG. NOS. 2,484,633, 2,898,518 AND OTHERS.

NO CLAIM IS MADE TO THE EXCLUSIVE RIGHT TO USE "MEXICAN GRILL", APART FROM THE MARK AS SHOWN.

THE MARK CONSISTS OF THE STYLIZED WORDS "LA SALSA" SUPERIMPOSED OVER A RECTANGLE WITH A FANCIFUL BORDER. ADDITIONAL FANCIFUL DESIGNS ARE WITHIN THE RECTANGLE. THE STYLIZED WORDS "FRESH MEXICAN GRILL" ARE BELOW THE RECTANGLE.

SEC. 2(F) "FRESH MEXICAN GRILL".

FOR RESTAURANT SERVICES (U.S. CLS. 100 AND 101).

COLLEEN KEARNEY, EXAMINING ATTORNEY

CLASS 43—(Continued).

SN 78-950,506. METROPOLE AXA, INC., NEW YORK, NY.
FILED 8-11-2006.

Pangaea

THE MARK CONSISTS OF STANDARD CHARACTERS
WITHOUT CLAIM TO ANY PARTICULAR FONT, STYLE,
SIZE, OR COLOR.

FOR HOTEL SERVICES; BED AND BREAKFAST
SERVICES (U.S. CLS. 100 AND 101).
EDWARD FENNESSY, EXAMINING ATTORNEY

SN 78-956,482. ADVENTUROUS CONCEPTS, LLC, LOS
ANGELES, CA. FILED 8-21-2006.

MENDOCINO FARMS

THE MARK CONSISTS OF STANDARD CHARACTERS
WITHOUT CLAIM TO ANY PARTICULAR FONT, STYLE,
SIZE, OR COLOR.

FOR RESTAURANT SERVICES; TAKE OUT RESTAU-
RANT SERVICES; CATERING (U.S. CLS. 100 AND 101).
FIRST USE 12-15-2005; IN COMMERCE 12-15-2005.
GENE MACIOL, EXAMINING ATTORNEY

SN 78-956,858. SOEHNER, ERIC, WAYNESVILLE, OH.
FILED 8-21-2006.



NO CLAIM IS MADE TO THE EXCLUSIVE RIGHT TO
USE "FIRE TRUCK", APART FROM THE MARK AS
SHOWN.

THE MARK CONSISTS OF THE WORDS "BIG E FIRE
TRUCK" AND DESIGN DEPICTED THEREWITH.
FOR RESTAURANT SERVICES (U.S. CLS. 100 AND
101).

FIRST USE 8-17-2006; IN COMMERCE 8-17-2006.
DOMINIC FATHY, EXAMINING ATTORNEY

CLASS 43—(Continued).

SN 78-957,962. WESTERN KENTUCKY UNIVERSITY,
BOWLING GREEN, KY. FILED 8-22-2006.

WESTERN KENTUCKY

THE MARK CONSISTS OF STANDARD CHARACTERS
WITHOUT CLAIM TO ANY PARTICULAR FONT, STYLE,
SIZE, OR COLOR.

OWNER OF U.S. REG. NOS. 2,709,407, 2,784,182 AND
2,949,523.
SEC. 2(F).
FOR PROVIDING TEMPORARY HOUSING ACCOM-
MODATIONS (U.S. CLS. 100 AND 101).
FIRST USE 3-21-1922; IN COMMERCE 3-21-1922.
MICHELE SWAIN, EXAMINING ATTORNEY

SN 78-958,737. DAVIS, CHARLES C., DALLAS, TX. FILED 8-
23-2006.

SEATTLE BROTHERS

THE MARK CONSISTS OF STANDARD CHARACTERS
WITHOUT CLAIM TO ANY PARTICULAR FONT, STYLE,
SIZE, OR COLOR.

NO CLAIM IS MADE TO THE EXCLUSIVE RIGHT TO
USE "SEATTLE", APART FROM THE MARK AS SHOWN.
FOR COFFEE SHOPS; COFFEE-HOUSE AND SNACK-
BAR SERVICES (U.S. CLS. 100 AND 101).
KIM SAITO, EXAMINING ATTORNEY

SN 78-973,087. WEYRAUCH, DAMIEN, TIGARD, OR. AND
MOBRAY, CHRIS, TIGARD, OR. FILED 9-13-2006.

BIG WIENERS

THE MARK CONSISTS OF STANDARD CHARACTERS
WITHOUT CLAIM TO ANY PARTICULAR FONT, STYLE,
SIZE, OR COLOR.

NO CLAIM IS MADE TO THE EXCLUSIVE RIGHT TO
USE "WIENERS", APART FROM THE MARK AS SHOWN.
FOR RESTAURANT SERVICES (U.S. CLS. 100 AND
101).

MICHAEL GAAFAR, EXAMINING ATTORNEY

CLASS 43—(Continued).

SN 79-030,401. ET&ZEUS INC., REPUBLIC OF KOREA,
FILED 8-4-2006.

**CLASS 43—(Continued).**

SN 79-030,402. ET&ZEUS INC., REPUBLIC OF KOREA,
FILED 8-4-2006.



PRIORITY DATE OF 5-15-2006 IS CLAIMED.
OWNER OF INTERNATIONAL REGISTRATION 0902216
DATED 8-4-2006. EXPIRES 8-4-2016.

NO CLAIM IS MADE TO THE EXCLUSIVE RIGHT TO
USE "BULGOGI" AND "KOREAN BARBECUE RESTAU-
RANT", APART FROM THE MARK AS SHOWN.

THE COLOR(S) RED, ORANGE, YELLOW, WHITE, AND
BLACK IS/ARE CLAIMED AS A FEATURE OF THE MARK.

THE COLOR BLACK APPEARS IN THE WORDING
BULGOGI BROTHERS. THE COLOR WHITE APPEARS IN
THE WORDING KOREAN BARBECUE RESTAURANT IN-
SIDE A RECTANGULAR BOX IN THE COLOR YELLOW.
THE COLORS RED AND ORANGE APPEAR IN THE
DESIGN OF THE FIRE FLAME.

THE ENGLISH TRANSLATION OF THE WORD "BULGO-
GI" IN THE MARK IS "BARBEQUED BEEF."

FOR CANTEEN SERVICES; RESTAURANTS SERVIC-
ING TOURISTS; TEA ROOMS; RESTAURANTS; BUF-
FET RESTAURANTS; WESTERN STYLE
RESTAURANTS; SELF-SERVICE RESTAURANTS;
SNACK-BARS; CHAIN RESTAURANT SERVICES; FOOD
PREPARATION SERVICES; CATERING; GENERAL BAR
SERVICES; JAPANESE RESTAURANTS; BAKERIES;
CHINESE RESTAURANTS; CAFE; CAFETERIAS; COCK-
TAIL LOUNGE SERVICES; KOREAN BAR SERVICES;
KOREAN RESTAURANTS (U.S. CLS. 100 AND 101).

WENDY JUN, EXAMINING ATTORNEY

PRIORITY DATE OF 5-15-2006 IS CLAIMED.
OWNER OF INTERNATIONAL REGISTRATION 0902217
DATED 8-4-2006. EXPIRES 8-4-2016.

NO CLAIM IS MADE TO THE EXCLUSIVE RIGHT TO
USE "BULGOGI" AND "KOREAN BARBECUE RESTAU-
RANT", APART FROM THE MARK AS SHOWN.

THE COLOR(S) RED, ORANGE, YELLOW, WHITE, AND
BLACK IS/ARE CLAIMED AS A FEATURE OF THE MARK.

THE COLOR BLACK APPEARS IN THE KOREAN CHAR-
ACTERS. THE COLOR WHITE APPEARS IN THE WORD-
ING KOREAN BARBECUE RESTAURANT INSIDE A
RECTANGULAR BOX IN THE COLOR YELLOW. THE
COLORS RED AND ORANGE APPEAR IN THE DESIGN
OF THE FIRE FLAME.

THE NON-LATIN CHARACTERS IN THE MARK TRANS-
LITERATE TO "BULGOGI BROTHERS" AND THIS MEANS
'BARBEQUED BEEF BROTHERS' IN ENGLISH.

FOR CANTEEN SERVICES; RESTAURANTS SERVIC-
ING TOURISTS; TEA ROOMS; RESTAURANTS; BUF-
FET RESTAURANTS; WESTERN STYLE
RESTAURANTS; SELF-SERVICE RESTAURANTS;
SNACK-BARS; CHAIN RESTAURANT SERVICES; FOOD
PREPARATION SERVICES; CATERING; GENERAL BAR
SERVICES; JAPANESE RESTAURANTS; BAKERIES;
CHINESE RESTAURANTS; CAFE; CAFETERIAS; COCK-
TAIL LOUNGE SERVICES; KOREAN BAR SERVICES;
KOREAN RESTAURANTS (U.S. CLS. 100 AND 101).

WENDY JUN, EXAMINING ATTORNEY

CLASS 43—(Continued).

SN 79-030,413. ET&ZEUS INC., REPUBLIC OF KOREA,
FILED 8-4-2006.



PRIORITY DATE OF 5-15-2006 IS CLAIMED.
OWNER OF INTERNATIONAL REGISTRATION 0902244
DATED 8-4-2006, EXPIRES 8-4-2016.

NO CLAIM IS MADE TO THE EXCLUSIVE RIGHT TO
USE "BULOGI" AND "KOREAN BARBECUE RESTAU-
RANT", APART FROM THE MARK AS SHOWN.

THE COLOR(S) RED, ORANGE, YELLOW, WHITE, AND
BLACK IS/ARE CLAIMED AS A FEATURE OF THE MARK.

THE COLOR BLACK APPEARS IN THE NON-LATIN
CHARACTERS THAT TRANSLITERATES TO BULGOGI
SISTERS. THE COLOR WHITE APPEARS IN THE WORD-
ING KOREAN BARBECUE RESTAURANT INSIDE A REC-
TANGULAR BOX IN THE COLOR YELLOW. THE COLORS
RED AND ORANGE APPEAR IN THE DESIGN OF THE
FIRE FLAME.

THE NON-LATIN CHARACTERS IN THE MARK TRANS-
LITERATE TO "BULGOGI SISTERS" AND THIS MEANS
"BARBECUED BEEF SISTERS" IN ENGLISH.

THE TRANSLITERATION OF THE NON-LATIN CHAR-
ACTERS IN THE MARK IS: BULGOGI SISTERS.

FOR CANTEEN SERVICES; RESTAURANTS SERVI-
NG TOURISTS; TEA ROOMS; RESTAURANTS; BUF-
FET RESTAURANTS; WESTERN STYLE
RESTAURANTS; SELF-SERVICE RESTAURANTS;
SNACK-BARS; CHAIN RESTAURANT SERVICES; FOOD
PREPARATION SERVICES; CATERING; GENERAL BAR
SERVICES; JAPANESE RESTAURANTS; BAKERIES;
CHINESE RESTAURANTS; CAFE; CAFETERIAS; COCK-
TAIL LOUNGE SERVICES; KOREAN BAR SERVICES;
KOREAN RESTAURANTS (U.S. CLS. 100 AND 101).

WENDY JUN, EXAMINING ATTORNEY

**CLASS 44—MEDICAL, BEAUTY AND AGRI-
CULTURAL SERVICES**

SN 76-672,590. NEWSPORT PHYSICAL THERAPY, CORONA
DEL MAR, CA. FILED 2-12-2007.



NO CLAIM IS MADE TO THE EXCLUSIVE RIGHT TO
USE PHYSICAL THERAPY, APART FROM THE MARK AS
SHOWN.

THE COLOR(S) BLUE, YELLOW, AND BLACK IS/ARE
CLAIMED AS A FEATURE OF THE MARK.

THE COLOR BLUE APPEARS IN THE WORD SPORT
AND THE UNDERLINING AND CURVED UNDERLINING
BENEATH THE WORD THERAPY. THE COLOR YELLOW
APPEARS IN THE CURVE TO THE RIGHT. THE COLOR
BLACK APPEARS IN THE WORDING NEW AND PHYSI-
CAL THERAPY.

FOR PHYSICAL THERAPY (U.S. CLS. 100 AND 101).
FIRST USE 9-1-2006; IN COMMERCE 9-1-2006.
ALLISON HOLTZ, EXAMINING ATTORNEY

SN 77-005,254. POLLARD ENTERPRISES, INC., PROSPECT,
KY. FILED 9-22-2006.

KNUCKLEBUSTER

THE MARK CONSISTS OF STANDARD CHARACTERS
WITHOUT CLAIM TO ANY PARTICULAR FONT, STYLE,
SIZE, OR COLOR.

FOR HAIR CUTTING AND STYLING; PROVIDING
INFORMATION IN THE FIELD OF HAIR STYLING
AND HAIR CARE (U.S. CLS. 100 AND 101).

JENNIFER MARTIN, EXAMINING ATTORNEY

CLASS 44—(Continued).

SN 77-006,004. PSYCHODIAGNOSTICS, LAS VEGAS, NV. FILED 9-23-2006.



NO CLAIM IS MADE TO THE EXCLUSIVE RIGHT TO USE "PSYCHODIAGNOSTICS CORPORATION", APART FROM THE MARK AS SHOWN.

THE MARK CONSISTS OF THE STYLIZED GREEK LETTER PSI SUPERIMPOSED UPON A GLOBE FEATURING SHADOW PATTERNS WITH THE WORDING PSYCHODIAGNOSTICS CORPORATION APPEARING BELOW. FOR PSYCHOLOGICAL TESTS (U.S. CLS. 100 AND 101).

LINDA LAVACHE, EXAMINING ATTORNEY

CLASS 44—(Continued).

SN 77-031,340. CURA HOME CARE SERVICES, LLC, PHOENIX, AZ. FILED 10-27-2006.

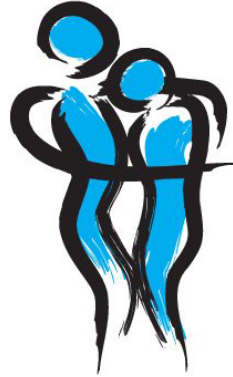

THE COLOR(S) BLUE, BLACK, WHITE IS/ARE CLAIMED AS A FEATURE OF THE MARK.

"THE MARK CONSISTS OF FIGURES OUTLINED IN BLACK; THE FIGURES HAVE A MAINLY BLUE INTERIOR WITH SOME WHITE."

FOR HOME HEALTH CARE SERVICES (U.S. CLS. 100 AND 101).

MARY CRAWFORD, EXAMINING ATTORNEY

SN 77-023,995. PFIZER INC., NEW YORK, NY. FILED 10-18-2006.



NO CLAIM IS MADE TO THE EXCLUSIVE RIGHT TO USE "HEART EDUCATION & ADHERENCE REMINDERS", APART FROM THE MARK AS SHOWN.

THE MARK CONSISTS OF PICTURE OF AN EAR WITH WORDS HEAR AND HEART EDUCATION & ADHERENCE REMINDERS.

FOR AUTOMATED TELEPHONE ADVISORY SERVICE PROVIDED TO PATIENTS TO ASSIST WITH THEIR COMPLIANCE WITH MEDICATION REGIMENS AND TO PROVIDE HEALTH TIPS AND INFORMATION (U.S. CLS. 100 AND 101).

MICHAEL KEATING, EXAMINING ATTORNEY

SN 77-042,163. SCULPTED SOUL, LLC, CHICAGO, IL. FILED 11-12-2006.



THE COLOR(S) PURPLE AND WHITE IS/ARE CLAIMED AS A FEATURE OF THE MARK.

THE MARK CONSISTS OF PRIMARILY SHADES OF PURPLE AND WHITE. THE LOTUS FLOWER ILLUSTRATION IS MADE UP OF A WHITE CENTER AND PETALS THAT ARE A GRADIENT SHADE OF LIGHT TO DARK PURPLE WITH A DARK PURPLE OUTLINE. THE WORDS "SCULPTED SOUL" AND "FOOD FOR YOUR LIFE" ARE COLORED SOLID PURPLE.

FOR HEALTH CARE SERVICES, NAMELY WELLNESS PROGRAMS (U.S. CLS. 100 AND 101).

SCOTT SISUN, EXAMINING ATTORNEY

CLASS 44—(Continued).

SN 77-075,024. HEALTH FROM WITHIN, SC, ORLAND PARK, IL. FILED 1-3-2007.



NO CLAIM IS MADE TO THE EXCLUSIVE RIGHT TO USE "HEALTH" AND "CHIROPRACTIC WELLNESS CENTERS", APART FROM THE MARK AS SHOWN.

THE MARK CONSISTS OF A MAN, WOMAN, AND CHILD IN AN OVAL-LIKE DESIGN WITH THE WORDS "HEALTH FROM WITHIN" TO THE RIGHT AND THE WORDS "CHIROPRACTIC WELLNESS CENTERS" UNDERNEATH.

FOR CHIROPRACTIC SERVICES (U.S. CLS. 100 AND 101).

FIRST USE 12-23-2004; IN COMMERCE 12-24-2004.
RICHARD A. STRASER, EXAMINING ATTORNEY

SN 77-098,374. CENTER FOR TOXICOLOGY AND ENVIRONMENTAL HEALTH, LLC, LITTLE ROCK, AR. FILED 2-2-2007.

WERP

THE MARK CONSISTS OF STANDARD CHARACTERS WITHOUT CLAIM TO ANY PARTICULAR FONT, STYLE, SIZE, OR COLOR.

FOR PROVIDING WORKER EXPOSURE CONSULTATION FOR THE CARE OF ACUTE CHEMICAL EXPOSURE IN THE WORKPLACE (U.S. CLS. 100 AND 101).

FIRST USE 0-0-2001; IN COMMERCE 0-0-2001.
CYNTHIA SLOAN, EXAMINING ATTORNEY

SN 77-100,918. MK3SD, LTD., HOUSTON, TX. FILED 2-6-2007.

PPD

THE MARK CONSISTS OF STANDARD CHARACTERS WITHOUT CLAIM TO ANY PARTICULAR FONT, STYLE, SIZE, OR COLOR.

FOR SLEEP APNEA SCREENING; MEDICAL TESTING; MEDICAL EVALUATION SERVICES, NAMELY, FUNCTIONAL ASSESSMENT PROGRAM FOR SLEEP APNEA PATIENTS RECEIVING MEDICAL REHABILITATION SERVICES FOR PURPOSES OF GUIDING TREATMENT AND ASSESSING PROGRAM EFFECTIVENESS; PROVIDING MEDICAL INFORMATION, MEDICAL CONSULTATION SERVICES; MEDICAL TREATMENT SERVICES FOR SLEEPING DISORDERS, NAMELY, SLEEP APNEA (U.S. CLS. 100 AND 101).

CHARISMA HAMPTON, EXAMINING ATTORNEY

CLASS 44—(Continued).

SN 77-100,935. MK3SD, LTD., HOUSTON, TX. FILED 2-6-2007.



THE MARK CONSISTS OF A CIRCLE WITH TWO, SEMI-STACKED WAVE DESIGN FEATURES TO THE LEFT OF THE MARK WHEREIN ONE WAVE FEATURE INTERSECTS THE CIRCLE.

FOR SLEEP APNEA SCREENING; MEDICAL TESTING; MEDICAL EVALUATION SERVICES, NAMELY, FUNCTIONAL ASSESSMENT PROGRAM FOR SLEEP APNEA PATIENTS RECEIVING MEDICAL REHABILITATION SERVICES FOR PURPOSES OF GUIDING TREATMENT AND ASSESSING PROGRAM EFFECTIVENESS; PROVIDING MEDICAL INFORMATION, MEDICAL CONSULTATION SERVICES; MEDICAL TREATMENT SERVICES FOR SLEEPING DISORDERS, NAMELY, SLEEP APNEA (U.S. CLS. 100 AND 101).

FIRST USE 6-0-2006; IN COMMERCE 6-0-2006.
CHARISMA HAMPTON, EXAMINING ATTORNEY

SN 77-101,754. YAMAGOBO ENTERPRISES LLC, PRINCETON, NJ. FILED 2-7-2007.

ZWEENA

THE MARK CONSISTS OF STANDARD CHARACTERS WITHOUT CLAIM TO ANY PARTICULAR FONT, STYLE, SIZE, OR COLOR.

THE NAME(S), PORTRAIT(S), AND/OR SIGNATURE(S) SHOWN IN THE MARK DOES NOT IDENTIFY A PARTICULAR LIVING INDIVIDUAL.

FOR PROVIDING AN ONLINE, INTERACTIVE COMPUTER DATABASE IN THE FIELDS OF HEALTH INFORMATION AND PERSONAL HEALTH DATA; MAINTAINING PERSONAL MEDICAL HISTORY RECORDS AND FILES; PROVIDING MEDICAL INFORMATION, CONSULTANCY AND ADVISORY SERVICES (U.S. CLS. 100 AND 101).

ODESSA BIBBINS, EXAMINING ATTORNEY

CLASS 44—(Continued).

SN 77-107,014. EDGAR, JOHN C, KILDEER, IL. FILED 2-14-2007.



THE MARK CONSISTS OF A TOOTH AND THE WORD CARE.

FOR DENTISTRY (U.S. CLS. 100 AND 101).
FIRST USE 1-1-2002; IN COMMERCE 1-1-2002.
REBECCA EISINGER, EXAMINING ATTORNEY

SN 77-115,649. OXBURY PORT O TOILETS, OXFORD, CT. FILED 2-25-2007.

OXBURY

THE MARK CONSISTS OF STANDARD CHARACTERS WITHOUT CLAIM TO ANY PARTICULAR FONT, STYLE, SIZE, OR COLOR.

FOR PROVIDING TOILET SERVICES FOR INDIVIDUALS THROUGH THE USE OF PORTABLE TOILETS; RENTAL OF PORTABLE TOILETS; RENTAL OF SANITATION FACILITIES (U.S. CLS. 100 AND 101).
FIRST USE 8-2-2005; IN COMMERCE 2-23-2007.
LINDSEY RUBIN, EXAMINING ATTORNEY

SN 77-115,684. PAPIILLION PEDIATRIC DENTISTRY, PAPIILLION, NE. FILED 2-25-2007.



NO CLAIM IS MADE TO THE EXCLUSIVE RIGHT TO USE "PAPIILLION PEDIATRIC DENTISTRY" AND "SPECIALIZED CARE FOR INFANTS, CHILDREN, AND TEENS", APART FROM THE MARK AS SHOWN.

THE COLOR(S) BLACK, WHITE AND RED IS/ARE CLAIMED AS A FEATURE OF THE MARK.
THE MARK CONSISTS OF THE WORDING PAPIILLION

CLASS 44—(Continued).

PEDIATRIC DENTISTRY SPECIALIZED CARE FOR INFANTS, CHILDREN, AND TEENS IN BLACK AND A RED BARN WITH A BLACK ROOF AND WHITE TOP ON THE ATTACHED RED SILO. A BLACK STYLIZED WEATHER VANE WITH A WHITE TOOTH OUTLINED IN BLACK ON TOP, SITS AT THE FRONT TOP OF THE BLACK ROOF. A RED AND BLACK BUTTERFLY SITS ON THE RIGHT TOP OF THE N IN PAPIILLION AND IS FOLLOWED BY A BLACK DOTTED LINE CONNECTED TO THE P IN SPECIALIZED.

FOR DENTISTRY (U.S. CLS. 100 AND 101).
FIRST USE 10-19-2004; IN COMMERCE 6-10-2005.
KEVIN DINALLO, EXAMINING ATTORNEY

SN 77-117,623. JIHUI PENG, NEW YORK, NY. FILED 2-27-2007.

ELIXIR LIGHT HEALING

THE MARK CONSISTS OF STANDARD CHARACTERS WITHOUT CLAIM TO ANY PARTICULAR FONT, STYLE, SIZE, OR COLOR.

NO CLAIM IS MADE TO THE EXCLUSIVE RIGHT TO USE "LIGHT HEALING", APART FROM THE MARK AS SHOWN.

FOR MASSAGE THERAPY AND PHYSICAL THERAPY SERVICES; HEALTH CARE SERVICES, NAMELY, PROVIDING HEALTH CARE SERVICES THAT FEATURE CHINESE MEDICAL PRACTICES (U.S. CLS. 100 AND 101).

FIRST USE 12-5-2005; IN COMMERCE 6-30-2006.
REBECCA SMITH, EXAMINING ATTORNEY

SN 77-119,508. DALE D. GOLDSCHLAG, NEW YORK, NY. FILED 3-1-2007.

**CONTEMPORARY DENTAL
IMPLANT CENTRE**

THE MARK CONSISTS OF STANDARD CHARACTERS WITHOUT CLAIM TO ANY PARTICULAR FONT, STYLE, SIZE, OR COLOR.

NO CLAIM IS MADE TO THE EXCLUSIVE RIGHT TO USE "DENTAL IMPLANT CENTER", APART FROM THE MARK AS SHOWN.

FOR DENTAL IMPLANT SERVICES (U.S. CLS. 100 AND 101).

FIRST USE 10-15-2003; IN COMMERCE 10-15-2003.
HENRY S. ZAK, EXAMINING ATTORNEY

CLASS 44—(Continued).

SN 77-121,536. INTEGRATED HEALTH SERVICES, LLC, DBA BEHAVIORAL HEALTH LINK, ATLANTA, GA. FILED 3-2-2007.

A CRISIS HAS NO SCHEDULE

THE MARK CONSISTS OF STANDARD CHARACTERS WITHOUT CLAIM TO ANY PARTICULAR FONT, STYLE, SIZE, OR COLOR.

FOR PROVIDING MENTAL HEALTH COUNSELING VIA TELEPHONE; PROVIDING DRUG AND ALCOHOL ABUSE TREATMENT AND COUNSELING VIA TELEPHONE (U.S. CLS. 100 AND 101).

ESTHER BELENKER, EXAMINING ATTORNEY

SN 77-123,643. HOMEKEEPERS INTERNATIONAL FRANCHISING, LLC, ROCHESTER, MN. FILED 3-6-2007.



THE COLOR(S) PURPLE BLUE AND RED IS/ARE CLAIMED AS A FEATURE OF THE MARK.

THE MARK CONSISTS OF THE IMAGE OF A HOUSE WITH THE BASE OF THE HOUSE IN PURPLE AND THE ROOF OF THE HOUSE IN BLUE. THERE IS A RED CIRCLE IN THE MIDDLE OF THE HOUSE WITH A BLUE FLAME APPEARING IN THE CIRCLE.

FOR HOME HEALTHCARE SERVICES (U.S. CLS. 100 AND 101).

PAUL E. FAHRENKOPF, EXAMINING ATTORNEY

SN 77-123,716. PER AMORE, SANTA MONICA, CA. FILED 3-6-2007.

Brilliant Aging

THE MARK CONSISTS OF STANDARD CHARACTERS WITHOUT CLAIM TO ANY PARTICULAR FONT, STYLE, SIZE, OR COLOR.

NO CLAIM IS MADE TO THE EXCLUSIVE RIGHT TO USE "AGING", APART FROM THE MARK AS SHOWN.

FOR HEALTH CARE; HEALTH CARE SERVICES, NAMELY WELLNESS PROGRAMS; HEALTH SPA SERVICES FOR HEALTH AND WELLNESS OF THE BODY AND SPIRIT OFFERED AT A HEALTH RESORT; HEALTH SPA SERVICES FOR HEALTH AND WELLNESS OF THE MIND, BODY AND SPIRIT OFFERED IN OR FROM A REMOTE, MOBILE OR TEMPORARY ON-SITE LOCATION; HEALTH SPA SERVICES, NAMELY, COSMETIC BODY CARE SERVICES (U.S. CLS. 100 AND 101).

KEVIN CORWIN, EXAMINING ATTORNEY

CLASS 44—(Continued).

SN 77-127,690. LATE NITE PEDIATRIC URGENT CARE, LLC, STAMFORD, CT. FILED 3-10-2007.

Firefly After Hours Pediatrics

THE MARK CONSISTS OF STANDARD CHARACTERS WITHOUT CLAIM TO ANY PARTICULAR FONT, STYLE, SIZE, OR COLOR.

NO CLAIM IS MADE TO THE EXCLUSIVE RIGHT TO USE "AFTER HOURS PEDIATRICS", APART FROM THE MARK AS SHOWN.

FOR HEALTH CARE (U.S. CLS. 100 AND 101).

KEVON CHISOLM, EXAMINING ATTORNEY

SN 77-128,343. I-DONTICS, LLC, NEW YORK, NY. FILED 3-12-2007.

i-dontics

THE MARK CONSISTS OF STANDARD CHARACTERS WITHOUT CLAIM TO ANY PARTICULAR FONT, STYLE, SIZE, OR COLOR.

FOR MEDICAL IMAGING SERVICES NAMELY CONSULTING SERVICES IN THE FIELD OF USING AND OPERATING MEDICAL IMAGING APPARATUS INCLUDING X-RAY, COMPUTED TOMOGRAPHY, MAGNETIC RESONANCE IMAGING, ULTRASOUND, AND POSITRON EMISSION TOMOGRAPHY APPARATUS (U.S. CLS. 100 AND 101).

PAMELA HIRSCHMAN, EXAMINING ATTORNEY

SN 77-129,164. GRIGGS, ROBERT, OLD BRIDGE, NJ. FILED 3-13-2007.

OLD BRIDGE DENTAL

THE MARK CONSISTS OF STANDARD CHARACTERS WITHOUT CLAIM TO ANY PARTICULAR FONT, STYLE, SIZE, OR COLOR.

NO CLAIM IS MADE TO THE EXCLUSIVE RIGHT TO USE "DENTAL", APART FROM THE MARK AS SHOWN.

FOR DENTIST SERVICES (U.S. CLS. 100 AND 101).

FIRST USE 1-1-1989; IN COMMERCE 1-1-1989.

SHARON MEIER, EXAMINING ATTORNEY

CLASS 44—(Continued).

SN 77-129,341. SABOE AVIATION MEDICINE, BULVERDE, TX. FILED 3-13-2007.



NO CLAIM IS MADE TO THE EXCLUSIVE RIGHT TO USE "AVIATION MEDICINE", APART FROM THE MARK AS SHOWN.

THE MARK CONSISTS OF "SABOE AVIATION MEDICINE" POSITIONED TOGETHER TO THE LEFT OF A STYLIZED "S" SHAPE. THE CENTER PORTION OF STYLIZED "S" IS INTERRUPTED BY THE INSERTION OF A SMALL MEDICAL CROSS "+" SYMBOL. TWO, TAPERED AT EACH END, STYLIZED CURVE SHAPES FORM THE "S" SHAPE.

FOR MEDICAL SERVICES (U.S. CLS. 100 AND 101).
FIRST USE 2-12-2007; IN COMMERCE 2-26-2007.
ANNE MADDEN, EXAMINING ATTORNEY

CLASS 44—(Continued).

SN 77-133,295. THE SANCTUARY, RENO, NV. FILED 3-16-2007.



THE MARK CONSISTS OF A STYLIZED LETTER S WITH THREE SOLID SQUARES ALONG THE INSIDE OF THE UPPER CURVE OF THE S AND FOUR SOLID SQUARES ALONG THE INSIDE OF THE LOWER CURVE OF THE S.

FOR HEALTH SPA SERVICES, NAMELY, COSMETIC BODY CARE SERVICES; HEALTH SPA SERVICES FOR HEALTH AND WELLNESS OF THE BODY AND SPIRIT OFFERED AT A HEALTH RESORT; BEAUTY SALON SERVICES (U.S. CLS. 100 AND 101).
SIMON TENG, EXAMINING ATTORNEY

SN 77-130,715. SMITHKLINE BEECHAM CORPORATION, PHILADELPHIA, PA. FILED 3-14-2007.

MYALLI.COM

THE MARK CONSISTS OF STANDARD CHARACTERS WITHOUT CLAIM TO ANY PARTICULAR FONT, STYLE, SIZE, OR COLOR.

FOR PROVIDING HEALTH INFORMATION IN THE FIELD OF WEIGHT LOSS AND NUTRITION (U.S. CLS. 100 AND 101).
JAMES LOVELACE, EXAMINING ATTORNEY

SN 77-134,035. NAME RITE, LLC, SOUTH TEMECULA, CA. FILED 3-19-2007.

SN 77-132,860. BYBEE, TODD L., MADISON, WI. AND TROTTER, MARK A., WAUNAKEE, WI. FILED 3-16-2007.



NO CLAIM IS MADE TO THE EXCLUSIVE RIGHT TO USE "MASSAGE", APART FROM THE MARK AS SHOWN.
FOR MASSAGE (U.S. CLS. 100 AND 101).
FIRST USE 3-10-2002; IN COMMERCE 3-10-2002.
CARRIE GENOVESE, EXAMINING ATTORNEY

RITE CARE

THE MARK CONSISTS OF THE LITERAL ELEMENT RITE AID RITE CARE AND A SHIELD DESIGN.
FOR PHARMACEUTICAL CONSULTATION SERVICES (U.S. CLS. 100 AND 101).
FIRST USE 5-0-2005; IN COMMERCE 5-0-2005.
COLLEEN KEARNEY, EXAMINING ATTORNEY

CLASS 44—(Continued).

SN 77-134,462. WHITE, JEFFEORY H. MD/PC, DALTON, GA. FILED 3-19-2007.



NO CLAIM IS MADE TO THE EXCLUSIVE RIGHT TO USE "PEDIATRICS" AND "HEALTH", APART FROM THE MARK AS SHOWN.

THE COLOR(S) BURGUNDY IS/ARE CLAIMED AS A FEATURE OF THE MARK.

THE COLOR BURGUNDY APPEARS IN THE ANGEL FIGURE AND HALO, THE WORDING WHITE'S PEDIATRIC HALOS FOR HEALTH AND THE UNDERLINING.

FOR HEALTH CARE; HEALTH CARE SERVICES, NAMELY, DISEASE MANAGEMENT PROGRAMS; HEALTH CARE SERVICES, NAMELY, WELLNESS PROGRAMS (U.S. CLS. 100 AND 101).

FIRST USE 1-1-2002; IN COMMERCE 1-1-2002.
CYNTHIA SLOAN, EXAMINING ATTORNEY

SN 77-134,731. SEDONA MEDSPA, LLC, ALPHARETTA, GA. FILED 3-19-2007.



NO CLAIM IS MADE TO THE EXCLUSIVE RIGHT TO USE MEDSPA, APART FROM THE MARK AS SHOWN.

THE COLOR(S) BROWN AND GOLD IS/ARE CLAIMED AS A FEATURE OF THE MARK.

THE MARK CONSISTS OF THE WORDS SEDONA MEDSPA, WITH THE WORD SEDONA WRITTEN IN GOLD WITH BROWN SHADING ABOVE THE WORD MEDSPA WRITTEN IN BROWN, WITH A GOLD LINE BETWEEN THE WORDS, AND A BROWN OUTLINE OF MOUNTAINS IN THE BACKGROUND.

FOR MEDICAL SPA SERVICES, NAMELY, LASER HAIR REMOVAL, NONINVASIVE TREATMENT OF ACNE, AND OTHER NONINVASIVE COSMETIC PROCEDURES AND TREATMENTS; SKIN REJUVENATION SERVICES, NAMELY, MICRODERMABRASION AND OTHER NONINVASIVE SKIN TREATMENT SERVICES; AND HEALTH SPA SERVICES, NAMELY, WELLNESS PROGRAMS AND COSMETIC BODY-CARE SERVICES (U.S. CLS. 100 AND 101).

FIRST USE 5-1-2006; IN COMMERCE 5-1-2006.
NAPOLEON SHARMA, EXAMINING ATTORNEY

CLASS 44—(Continued).

SN 77-134,935. NELSON, RENDY S., CHICAGO, IL. FILED 3-19-2007.



NO CLAIM IS MADE TO THE EXCLUSIVE RIGHT TO USE SPA EVENTS, APART FROM THE MARK AS SHOWN. THE COLOR(S) TEAL/TURQUOISE AND MINT GREEN IS/ARE CLAIMED AS A FEATURE OF THE MARK.

THE COLOR(S) APPEAR AS FOLLOWS: THE LETTERS "S P A T" ARE IN TEAL COLOR WITH A MARTINI GLASS WITH A MINT GREEN OLIVE IN THE PLACE OF THE "I" WITH 2 TILDAS UNDERNEATH, FOLLOWED BY THE LETTERS "N I" IN TEAL COLOR. TAG LINE "SPA EVENTS WITH A TWIST" IS IN TEAL COLOR.

FOR HEALTH SPA SERVICES FOR HEALTH AND WELLNESS OF THE MIND, BODY AND SPIRIT OFFERED IN OR FROM A REMOTE, MOBILE OR TEMPORARY ON-SITE LOCATION; ON-SITE FULL-SERVICE SPA TREATMENTS AND WELLNESS SERVICES FOR INDIVIDUALS, GROUP OR PARTY SETTINGS, NAMELY, PROVIDING MASSAGE, FACIALS, AND SKIN CARE TREATMENTS; HEALTH SPA SERVICES, NAMELY, PROVIDING COSMETIC WET AND DRY BODY TREATMENTS; NAIL CARE, MANICURES AND PEDICURES; AND BEAUTY AND WELLNESS CONSULTATION SERVICES, NAMELY, PROVIDING INFORMATION ABOUT BEAUTY AND PERSONAL ASSESSMENTS, PERSONALIZED ROUTINES, MAINTENANCE SCHEDULES, AND COUNSELING (U.S. CLS. 100 AND 101).

FIRST USE 3-7-2002; IN COMMERCE 4-20-2002.
GINA FINK, EXAMINING ATTORNEY

SN 77-136,358. NS3 HEALTH, LLC, FORT LAUDERDALE, FL. FILED 3-21-2007.

HIV Assist

THE MARK CONSISTS OF STANDARD CHARACTERS WITHOUT CLAIM TO ANY PARTICULAR FONT, STYLE, SIZE, OR COLOR.

NO CLAIM IS MADE TO THE EXCLUSIVE RIGHT TO USE "HIV", APART FROM THE MARK AS SHOWN.

FOR HEALTH CARE SERVICES, NAMELY DISEASE MANAGEMENT PROGRAMS (U.S. CLS. 100 AND 101).

FIRST USE 1-1-2007; IN COMMERCE 1-1-2007.
DAVID TAYLOR, EXAMINING ATTORNEY

CLASS 44—(Continued).

SN 77-136,499. NS3 HEALTH, LLC, FORT LAUDERDALE, FL. FILED 3-21-2007.

ONCOLOGY Assist

THE MARK CONSISTS OF STANDARD CHARACTERS WITHOUT CLAIM TO ANY PARTICULAR FONT, STYLE, SIZE, OR COLOR.

NO CLAIM IS MADE TO THE EXCLUSIVE RIGHT TO USE "ONCOLOGY", APART FROM THE MARK AS SHOWN.

FOR HEALTH CARE SERVICES, NAMELY DISEASE MANAGEMENT PROGRAMS (U.S. CLS. 100 AND 101).

FIRST USE 1-1-2007; IN COMMERCE 1-1-2007.

DAVID TAYLOR, EXAMINING ATTORNEY

SN 77-136,691. WISCONSIN HEART SC, MADISON, WI. FILED 3-21-2007.



OWNER OF U.S. REG. NO. 2,982,572.

NO CLAIM IS MADE TO THE EXCLUSIVE RIGHT TO USE "WISCONSIN HEART & VASCULAR INSTITUTE", APART FROM THE MARK AS SHOWN.

FOR HEALTH CARE SERVICES; MEDICAL SERVICES, MEDICAL TESTING AND PROVIDING INFORMATION IN THE FIELDS OF PREVENTION, DIAGNOSIS, TREATMENT, AND MANAGEMENT OF CARDIOVASCULAR DISEASE (U.S. CLS. 100 AND 101).

FIRST USE 3-20-2007; IN COMMERCE 3-20-2007.

MARGERIE A. TIERNEY, EXAMINING ATTORNEY

SN 77-138,284. SPAMEDICA INTERNATIONAL SRL, WARRENS, ST. MICHAEL, BARBADOS, FILED 3-22-2007.

SONOPHOTONIC

THE MARK CONSISTS OF STANDARD CHARACTERS WITHOUT CLAIM TO ANY PARTICULAR FONT, STYLE, SIZE, OR COLOR.

FOR NONINVASIVE AND MINIMALLY INVASIVE COSMETIC AND AESTHETIC SURGERY SERVICES (U.S. CLS. 100 AND 101).

LAURA HAMMEL, EXAMINING ATTORNEY

CLASS 44—(Continued).

SN 77-138,547. BRIGGS, ELLEN DOBBS, BOCA RATON, FL. FILED 3-23-2007.

Fuel My Dreams

THE MARK CONSISTS OF STANDARD CHARACTERS WITHOUT CLAIM TO ANY PARTICULAR FONT, STYLE, SIZE, OR COLOR.

FOR HEALTH CARE; CONSULTING SERVICES IN THE FIELD OF MENTAL HEALTH AND WELLNESS; HEALTH CARE IN THE NATURE OF HEALTH MAINTENANCE ORGANIZATIONS; HEALTH CARE SERVICES, NAMELY DISEASE MANAGEMENT PROGRAMS; HEALTH CARE SERVICES, NAMELY WELLNESS PROGRAMS; HEALTH CARE, NAMELY, ASSISTING INDIVIDUALS TO STOP SMOKING; HEALTH SPA SERVICES FOR HEALTH AND WELLNESS OF THE BODY AND SPIRIT OFFERED AT A HEALTH RESORT; HEALTH SPA SERVICES FOR HEALTH AND WELLNESS OF THE MIND, BODY AND SPIRIT OFFERED IN OR FROM A REMOTE, MOBILE OR TEMPORARY ON-SITE LOCATION; HEALTH SPA SERVICES, NAMELY, COSMETIC BODY CARE SERVICES; HOME HEALTH CARE SERVICES; MANAGED HEALTH CARE SERVICES; MENTAL HEALTH COUNSELING AND PSYCHOTHERAPY AS IT RELATES TO RELATIONSHIPS; MENTAL HEALTH SERVICES; PROVIDING A WEBSITE FEATURING INFORMATION IN THE FIELD OF MENTAL HEALTH AND WELLNESS; PROVIDING HEALTH CARE INFORMATION BY TELEPHONE; PROVIDING HEALTH CARE INFORMATION BY TELEPHONE AND THE INTERNET; PROVIDING HEALTH INFORMATION; REMOTE MONITORING OF DATA INDICATIVE OF THE HEALTH OR CONDITION OF AN INDIVIDUAL OR GROUP OF INDIVIDUALS (U.S. CLS. 100 AND 101).

CHARLOTTE CORWIN, EXAMINING ATTORNEY

SN 77-139,113. DSY HOLDING COMPANY, WATAUGA, TX. FILED 3-23-2007.

Smart Looks

THE MARK CONSISTS OF STANDARD CHARACTERS WITHOUT CLAIM TO ANY PARTICULAR FONT, STYLE, SIZE, OR COLOR.

FOR HAIR CUTTING; HAIR STYLING (U.S. CLS. 100 AND 101).

FIRST USE 12-1-1999; IN COMMERCE 4-1-2000.

SETH A. RAPPAPORT, EXAMINING ATTORNEY

CLASS 44—(Continued).

SN 77-139,295. JONES, MATHEW LYMAN, LOGAN, UT. FILED 3-23-2007.

Aloha
ORTHODONTICS

THE MARK CONSISTS OF STANDARD CHARACTERS WITHOUT CLAIM TO ANY PARTICULAR FONT, STYLE, SIZE, OR COLOR.

NO CLAIM IS MADE TO THE EXCLUSIVE RIGHT TO USE "ORTHODONTICS", APART FROM THE MARK AS SHOWN.

FOR ORTHODONTIC SERVICES (U.S. CLS. 100 AND 101).

STACY WAHLBERG, EXAMINING ATTORNEY

CLASS 44—(Continued).

SN 77-139,620. FRANCIS F. POLANSKY, M.D. AND RICHARD J. SCHMIDT, M.D., INC., PALO ALTO, CA. FILED 3-24-2007.

La Optima

THE MARK CONSISTS OF THE STYLIZED WORDS "LA OPTIMA".

THE FOREIGN WORDING IN THE MARK TRANSLATES INTO ENGLISH AS THE OPTIMAL ONE.

FOR MEDICAL CLINICS; MEDICAL SERVICES, NAMELY, COSMETIC SURGERY SERVICES, COSMETIC LASER TREATMENTS, LASER HAIR REMOVAL, SKIN AND VEIN TREATMENT, MESOTHERAPY AND RADIOFREQUENCY VEIN ABLATION, SKIN PHOTOREJUVENATION, LASER SKIN RESURFACING, LASER VEIN THERAPY, MICRODERMABRASION, SCLEROTHERAPY, SKIN SUNSPOT REMOVAL, CHEMICAL PEELS FOR SKIN, ACNE TREATMENT, COMPLEXION ANALYSIS, PHOTOFACIALS, FACIALS, LASER WRINKLE REDUCTION, INJECTION WRINKLE AND LINE REDUCTION, INJECTION FILLING OF CREASES AND WRINKLES, SKIN TIGHTENING, TISSUE TIGHTENING AND SKIN LIGHTENING (U.S. CLS. 100 AND 101).

FIRST USE 2-7-2007; IN COMMERCE 2-7-2007.

HENRY S. ZAK, EXAMINING ATTORNEY

SN 77-139,616. FRANCIS F. POLANSKY, M.D. AND RICHARD J. SCHMIDT, M.D., INC., PALO ALTO, CA. FILED 3-24-2007.

La Optima

THE MARK CONSISTS OF STANDARD CHARACTERS WITHOUT CLAIM TO ANY PARTICULAR FONT, STYLE, SIZE, OR COLOR.

THE FOREIGN WORDING IN THE MARK TRANSLATES INTO ENGLISH AS THE OPTIMAL ONE.

FOR MEDICAL CLINICS; MEDICAL SERVICES, NAMELY, COSMETIC SURGERY SERVICES, COSMETIC LASER TREATMENTS, LASER HAIR REMOVAL, SKIN AND VEIN TREATMENT, MESOTHERAPY AND RADIOFREQUENCY VEIN ABLATION, SKIN PHOTOREJUVENATION, LASER SKIN RESURFACING, LASER VEIN THERAPY, MICRODERMABRASION, SCLEROTHERAPY, SKIN SUNSPOT REMOVAL, CHEMICAL PEELS FOR SKIN, ACNE TREATMENT, COMPLEXION ANALYSIS, PHOTOFACIALS, FACIALS, LASER WRINKLE REDUCTION, INJECTION WRINKLE AND LINE REDUCTION, INJECTION FILLING OF CREASES AND WRINKLES, SKIN TIGHTENING, TISSUE TIGHTENING AND SKIN LIGHTENING (U.S. CLS. 100 AND 101).

FIRST USE 12-20-2006; IN COMMERCE 12-20-2006.

HENRY S. ZAK, EXAMINING ATTORNEY

SN 77-139,724. HIATUS, L.L.C., DALLAS, TX. FILED 3-25-2007.

Hiatus

THE MARK CONSISTS OF STANDARD CHARACTERS WITHOUT CLAIM TO ANY PARTICULAR FONT, STYLE, SIZE, OR COLOR.

FOR HEALTH SPA SERVICES, NAMELY, COSMETIC BODY CARE SERVICES; MASSAGE (U.S. CLS. 100 AND 101).

C. DIONNE CLYBURN, EXAMINING ATTORNEY

SN 77-139,863. PRIORITY HEALTH, GRAND RAPIDS, MI. FILED 3-26-2007.

PRIORITYNETWORK

THE MARK CONSISTS OF STANDARD CHARACTERS WITHOUT CLAIM TO ANY PARTICULAR FONT, STYLE, SIZE, OR COLOR.

FOR HEALTHCARE IN THE NATURE OF HEALTH MAINTENANCE ORGANIZATIONS (U.S. CLS. 100 AND 101).

RONALD MCMORROW, EXAMINING ATTORNEY

CLASS 44—(Continued).

SN 77-140,071. VOGT, BETH, COLORADO SPRINGS, CO. FILED 3-26-2007.



THE MARK CONSISTS OF AN OLD-FASHIONED ALARM CLOCK WITH STYLIZED CLOCK HANDS THAT LOOK LIKE A DIAPER PIN, WITH THE WORDING MOMMY COME LATELY WRITTEN IN STYLIZED TEXT BENEATH THE CLOCK.

FOR PROVIDING INFORMATION IN THE FIELD OF PARENTING, PARTICULARLY LATE-IN-LIFE PARENTING ISSUES VIA THE INTERNET (U.S. CLS. 100 AND 101).

FIRST USE 6-1-2006; IN COMMERCE 1-10-2007.
ODESSA BIBBINS, EXAMINING ATTORNEY

SN 77-140,778. NEUROGISTICS CORPORATION, NEW BRAUNFELS, TX. FILED 3-26-2007.

NEUROGISTICS

THE MARK CONSISTS OF STANDARD CHARACTERS WITHOUT CLAIM TO ANY PARTICULAR FONT, STYLE, SIZE, OR COLOR.

FOR DIETARY AND NUTRITIONAL GUIDANCE (U.S. CLS. 100 AND 101).

FIRST USE 7-1-2005; IN COMMERCE 7-1-2005.
CARRIE GENOVESE, EXAMINING ATTORNEY

SN 77-141,151. BEAGLE, JAY R., INDIANAPOLIS, IN. FILED 3-27-2007.

More with Less

THE MARK CONSISTS OF STANDARD CHARACTERS WITHOUT CLAIM TO ANY PARTICULAR FONT, STYLE, SIZE, OR COLOR.

FOR COSMETIC DENTISTRY, DENTISTRY, DENTIST SERVICES, ORTHODONTIC SERVICES (U.S. CLS. 100 AND 101).

MICHAEL ENGEL, EXAMINING ATTORNEY

CLASS 44—(Continued).

SN 77-141,158. BEAGLE, JAY R., INDIANAPOLIS, IN. FILED 3-27-2007.

Simply more with less

THE MARK CONSISTS OF STANDARD CHARACTERS WITHOUT CLAIM TO ANY PARTICULAR FONT, STYLE, SIZE, OR COLOR.

FOR COSMETIC DENTISTRY, DENTISTRY, DENTIST SERVICES, ORTHODONTIC SERVICES (U.S. CLS. 100 AND 101).

MICHAEL ENGEL, EXAMINING ATTORNEY

SN 77-141,327. COGENT HEALTHCARE, INC., IRVINE, CA. FILED 3-27-2007.

The Cogent Group

THE MARK CONSISTS OF STANDARD CHARACTERS WITHOUT CLAIM TO ANY PARTICULAR FONT, STYLE, SIZE, OR COLOR.

NO CLAIM IS MADE TO THE EXCLUSIVE RIGHT TO USE "GROUP", APART FROM THE MARK AS SHOWN.

FOR MEDICAL CONSULTING SERVICES FOR INPATIENT CARE SERVICES (U.S. CLS. 100 AND 101).

MELISSA VALLILLO, EXAMINING ATTORNEY

SN 77-141,348. COGENT HEALTHCARE, INC., IRVINE, CA. FILED 3-27-2007.

Cogent Healthcare

THE MARK CONSISTS OF STANDARD CHARACTERS WITHOUT CLAIM TO ANY PARTICULAR FONT, STYLE, SIZE, OR COLOR.

NO CLAIM IS MADE TO THE EXCLUSIVE RIGHT TO USE "HEALTHCARE", APART FROM THE MARK AS SHOWN.

FOR CONTRACT INPATIENT MEDICAL CARE SERVICES (U.S. CLS. 100 AND 101).

FIRST USE 1-1-1999; IN COMMERCE 1-1-1999.

MELISSA VALLILLO, EXAMINING ATTORNEY

CLASS 44—(Continued).

SN 77-141,591. PAULITS, CYNTHIA A., CHALFONT, PA. FILED 3-27-2007.

body, mind, spirit ...
healing through harmony

THE MARK CONSISTS OF STANDARD CHARACTERS WITHOUT CLAIM TO ANY PARTICULAR FONT, STYLE, SIZE, OR COLOR.
FOR AROMATHERAPY SERVICES (U.S. CLS. 100 AND 101).
MICHAEL GAAFAR, EXAMINING ATTORNEY

SN 77-141,790. COSMIC REIKI LLC, PHILADELPHIA, PA. FILED 3-27-2007.

Cosmic Reiki

THE MARK CONSISTS OF STANDARD CHARACTERS WITHOUT CLAIM TO ANY PARTICULAR FONT, STYLE, SIZE, OR COLOR.
NO CLAIM IS MADE TO THE EXCLUSIVE RIGHT TO USE REIKI, APART FROM THE MARK AS SHOWN.
FOR PROVIDING BOTH IN-PERSON AND ONLINE VIBRATIONAL ENERGY HEALING SERVICES (U.S. CLS. 100 AND 101).
FIRST USE 10-7-2006; IN COMMERCE 12-18-2006.
AMY HELLA, EXAMINING ATTORNEY

SN 77-142,674. THE NEUROPATHY ASSOCIATION, NEW YORK, NY. FILED 3-28-2007.

THE NEUROPATHY ASSOCIATION

THE MARK CONSISTS OF STANDARD CHARACTERS WITHOUT CLAIM TO ANY PARTICULAR FONT, STYLE, SIZE, OR COLOR.
OWNER OF U.S. REG. NOS. 2,093,877 AND 2,119,250.
NO CLAIM IS MADE TO THE EXCLUSIVE RIGHT TO USE "ASSOCIATION", APART FROM THE MARK AS SHOWN.
SEC. 2(F).
FOR INFORMATION SERVICES, NAMELY, PROVIDING INFORMATION REGARDING PERIPHERAL NEUROPATHY (U.S. CLS. 100 AND 101).
FIRST USE 6-19-1995; IN COMMERCE 6-19-1995.
KEVIN DINALLO, EXAMINING ATTORNEY

CLASS 44—(Continued).

SN 77-143,048. MILLIKEN, MARK C., SARASOTA, FL. FILED 3-28-2007.

BIOTEK CENTER FOR WEIGHT
LOSS

THE MARK CONSISTS OF STANDARD CHARACTERS WITHOUT CLAIM TO ANY PARTICULAR FONT, STYLE, SIZE, OR COLOR.
NO CLAIM IS MADE TO THE EXCLUSIVE RIGHT TO USE "CENTER FOR WEIGHT LOSS", APART FROM THE MARK AS SHOWN.
FOR WEIGHT REDUCTION DIET PLANNING AND SUPERVISION (U.S. CLS. 100 AND 101).
FIRST USE 5-1-2005; IN COMMERCE 5-1-2005.
ZACHARY BELLO, EXAMINING ATTORNEY

SN 77-143,088. DERESPINIS MD, PATRICK A., STATEN ISLAND, NY. FILED 3-28-2007.

PEDIATRIC EYECARE OF STATEN ISLAND



NO CLAIM IS MADE TO THE EXCLUSIVE RIGHT TO USE PEDIATRIC EYECARE OF STATEN ISLAND, APART FROM THE MARK AS SHOWN.
THE MARK CONSISTS OF STYLIZED TEXT WITH A STYLIZED MAN WEARING EYEGLASSES.
FOR MEDICAL SERVICES SPECIALIZING IN THE CARE OF CHILDREN FROM THE AGES OF 0 TO 20 YEARS OLD WHO REQUIRE OPHTHALMIC EXAMINATION AND TREATMENT, NAMELY, MEDICAL, SURGICAL AND REFRACTION (U.S. CLS. 100 AND 101).
FIRST USE 8-15-2002; IN COMMERCE 8-15-2002.
ALEXANDER L. POWERS, EXAMINING ATTORNEY

SN 77-143,324. KNOW, INC., TAMPA, FL. FILED 3-29-2007.

KNOW NOT ME

THE MARK CONSISTS OF STANDARD CHARACTERS WITHOUT CLAIM TO ANY PARTICULAR FONT, STYLE, SIZE, OR COLOR.
FOR DRUG TESTING FOR SUBSTANCE ABUSE (U.S. CLS. 100 AND 101).
JOHN HWANG, EXAMINING ATTORNEY

CLASS 44—(Continued).

SN 77-143,932. PARENTS OF KIDS WITH INFECTIOUS DISEASES, VANCOUVER, WA. FILED 3-29-2007.

PKIDS

THE MARK CONSISTS OF STANDARD CHARACTERS WITHOUT CLAIM TO ANY PARTICULAR FONT, STYLE, SIZE, OR COLOR.
FOR PROVIDING HEALTH INFORMATION (U.S. CLS. 100 AND 101).
FIRST USE 3-30-1997; IN COMMERCE 3-30-1997.
JOHN HWANG, EXAMINING ATTORNEY

SN 77-144,084. BRAVO, MICHELLE A., SAN FRANCISCO, CA. FILED 3-29-2007.

BELIEVE... AND LIVE IT.

THE MARK CONSISTS OF STANDARD CHARACTERS WITHOUT CLAIM TO ANY PARTICULAR FONT, STYLE, SIZE, OR COLOR.
FOR MASSAGE SERVICES; HEALTH CARE SERVICES, NAMELY WELLNESS PROGRAMS; CHIROPRACTIC SERVICES; HOLISTIC HEALTH COUNSELING (U.S. CLS. 100 AND 101).
FIRST USE 6-30-2006; IN COMMERCE 6-30-2006.
GEOFFREY FOSDICK, EXAMINING ATTORNEY

SN 77-144,245. THE VISITING NURSE ASSOCIATION OF TEXAS, DALLAS, TX. FILED 3-29-2007.

VNACARES

THE MARK CONSISTS OF STANDARD CHARACTERS WITHOUT CLAIM TO ANY PARTICULAR FONT, STYLE, SIZE, OR COLOR.
FOR HOME HEALTH CARE SERVICES; HOSPICE SERVICES; IN-HOME LONG TERM HEALTH CARE SERVICES; PHYSICAL REHABILITATION AND THERAPY SERVICES (U.S. CLS. 100 AND 101).
BILL DAWE, EXAMINING ATTORNEY

CLASS 44—(Continued).

SN 77-144,375. MATHESON, DINA R. DELANEY, TUCSON, AZ. FILED 3-29-2007.

Kitchen Intervention

THE MARK CONSISTS OF STANDARD CHARACTERS WITHOUT CLAIM TO ANY PARTICULAR FONT, STYLE, SIZE, OR COLOR.
FOR FOOD NUTRITION CONSULTATION (U.S. CLS. 100 AND 101).
MELISSA VALLILLO, EXAMINING ATTORNEY

SN 77-145,994. ELI LILLY AND COMPANY, INDIANAPOLIS, IN. FILED 4-2-2007.

FULL VALUE PIGS

THE MARK CONSISTS OF STANDARD CHARACTERS WITHOUT CLAIM TO ANY PARTICULAR FONT, STYLE, SIZE, OR COLOR.
NO CLAIM IS MADE TO THE EXCLUSIVE RIGHT TO USE "PIGS", APART FROM THE MARK AS SHOWN.
FOR VETERINARY AND NUTRITIONAL INFORMATION SERVICES FOR LIVESTOCK (U.S. CLS. 100 AND 101).
SANI KHOURI, EXAMINING ATTORNEY

SN 77-146,342. INTERCHURCH MEDICAL ASSISTANCE, INC., NEW WINDSOR, MD. FILED 4-2-2007.

IMA WORLD HEALTH

THE MARK CONSISTS OF STANDARD CHARACTERS WITHOUT CLAIM TO ANY PARTICULAR FONT, STYLE, SIZE, OR COLOR.
OWNER OF U.S. REG. NOS. 1,827,689, 2,204,854 AND OTHERS.
NO CLAIM IS MADE TO THE EXCLUSIVE RIGHT TO USE "WORLD HEALTH", APART FROM THE MARK AS SHOWN.
FOR CHARITABLE SERVICES, NAMELY, PROCURING AND DISTRIBUTING DONATED MEDICINES AND MEDICAL SUPPLIES AND TECHNICAL ASSISTANCE FOR EMERGENCY, HEALTH CARE AND DEVELOPMENT PROGRAMS, AND CONSULTATION RELATED THERETO (U.S. CLS. 100 AND 101).
FIRST USE 3-26-2007; IN COMMERCE 3-26-2007.
TASHIA BUNCH, EXAMINING ATTORNEY

CLASS 44—(Continued).

SN 77-149,934. BRUCE A. ROBERTS, TUCSON, AZ. AND MOLLY M. ROBERTS, TUCSON, AZ. FILED 4-5-2007.

THE MEDICINE BAG

THE MARK CONSISTS OF STANDARD CHARACTERS WITHOUT CLAIM TO ANY PARTICULAR FONT, STYLE, SIZE, OR COLOR.
FOR HEALTH CARE (U.S. CLS. 100 AND 101).
REBECCA GILBERT, EXAMINING ATTORNEY

SN 77-150,367. SMITHKLINE BEECHAM CORPORATION, PHILADELPHIA, PA. FILED 4-6-2007.

MIALLI.COM

THE MARK CONSISTS OF STANDARD CHARACTERS WITHOUT CLAIM TO ANY PARTICULAR FONT, STYLE, SIZE, OR COLOR.
FOR PROVIDING HEALTH INFORMATION IN THE FIELD OF WEIGHT LOSS AND NUTRITION (U.S. CLS. 100 AND 101).
JAMES LOVELACE, EXAMINING ATTORNEY

SN 77-150,371. SMITHKLINE BEECHAM CORPORATION, PHILADELPHIA, PA. FILED 4-6-2007.

MYALLIPLAN

THE MARK CONSISTS OF STANDARD CHARACTERS WITHOUT CLAIM TO ANY PARTICULAR FONT, STYLE, SIZE, OR COLOR.
FOR PROVIDING HEALTH INFORMATION IN THE FIELD OF WEIGHT LOSS AND NUTRITION (U.S. CLS. 100 AND 101).
JAMES LOVELACE, EXAMINING ATTORNEY

CLASS 44—(Continued).

SN 77-159,394. INJURED WORKERS PHARMACY, LLC, METHUEN, MA. FILED 4-18-2007.

IWP

OWNER OF U.S. REG. NO. 3,025,290.
THE MARK CONSISTS OF THE LETTERS IWP. THE W IS THE LARGER OF THE THREE LETTERS IN THE MARK.
FOR DISPENSING OF PHARMACEUTICALS; AND DISPENSING OF PHARMACEUTICALS THROUGH THE MAIL (U.S. CLS. 100 AND 101).
FIRST USE 4-11-2007; IN COMMERCE 4-11-2007.
JOHN E. MICHOS, EXAMINING ATTORNEY

SN 77-182,191. LIFESTYLE LIFT HOLDING, INC., TROY, MI. FILED 5-16-2007.

LIFESTYLE SURGERY

THE MARK CONSISTS OF STANDARD CHARACTERS WITHOUT CLAIM TO ANY PARTICULAR FONT, STYLE, SIZE, OR COLOR.
NO CLAIM IS MADE TO THE EXCLUSIVE RIGHT TO USE "SURGERY", APART FROM THE MARK AS SHOWN.
FOR COSMETIC AND PLASTIC SURGERY (U.S. CLS. 100 AND 101).
JAY BESCH, EXAMINING ATTORNEY

SN 78-735,046. SPECIALTY DISEASE MANAGEMENT SERVICES, INC., JACKSONVILLE, FL. FILED 10-18-2005.

SDM SERVICES THE PERSONAL TOUCH IN HEALTH MANAGEMENT

THE MARK CONSISTS OF STANDARD CHARACTERS WITHOUT CLAIM TO ANY PARTICULAR FONT, STYLE, SIZE, OR COLOR.
NO CLAIM IS MADE TO THE EXCLUSIVE RIGHT TO USE "SERVICES", APART FROM THE MARK AS SHOWN.
FOR PROVIDING MEDICAL CARE MANAGEMENT SERVICES, NAMELY, DISEASE MANAGEMENT SERVICES, TO PUBLIC AND PRIVATE EMPLOYERS AND GOVERNMENT AGENCIES (U.S. CLS. 100 AND 101).
FIRST USE 7-15-2005; IN COMMERCE 7-15-2005.
MICHAEL WIENER, EXAMINING ATTORNEY

CLASS 44—(Continued).

SN 78-807,690. FITNESS FOR HEALTH, ROCKVILLE, MD.
FILED 2-6-2006.

Fitness for health

THE MARK CONSISTS OF STANDARD CHARACTERS WITHOUT CLAIM TO ANY PARTICULAR FONT, STYLE, SIZE, OR COLOR.

SEC. 2(F).

FOR PHYSICAL REHABILITATION; PHYSICAL THERAPY; PROVIDING PHYSICAL REHABILITATION FACILITIES; PSYCHOTHERAPY COMPLEMENTED BY BODY WORK, NAMELY, MYOFASCIAL PHYSICAL THERAPY TECHNIQUES (U.S. CLS. 100 AND 101).

FIRST USE 6-1-1995; IN COMMERCE 6-1-1995.

AMY HELLA, EXAMINING ATTORNEY

SN 78-840,582. SHEAR MADNESS, INC., LEAWOOD, KS.
FILED 3-18-2006.



THE COLOR(S) PURPLE AND BLACK IS/ARE CLAIMED AS A FEATURE OF THE MARK.

THE WORD SHEAR APPEARS IN PURPLE AND THE WORD HARMONY APPEARS IN BLACK.

FOR HAIR CUTTING; HAIR STYLING (U.S. CLS. 100 AND 101).

FIRST USE 11-15-2005; IN COMMERCE 11-15-2005.

RONALD MCMORROW, EXAMINING ATTORNEY

SN 78-862,647. LAS COLINAS EAR NOSE THROAT AND ALLERGY, IRVING, TX. FILED 4-17-2006.



LasColinas

Ear, Nose, Throat & Allergy

NO CLAIM IS MADE TO THE EXCLUSIVE RIGHT TO USE "LASCOLINAS EAR NOSE THROAT AND ALLERGY", APART FROM THE MARK AS SHOWN.

FOR MEDICAL CLINIC (U.S. CLS. 100 AND 101).

FIRST USE 10-0-2005; IN COMMERCE 10-0-2005.

DEZMONA MIZELLE, EXAMINING ATTORNEY

CLASS 44—(Continued).

SN 78-925,794. SCHRATZ, WALTER W., MCMURRAY, PA.
FILED 7-10-2006.

IMPROVE YOUR SMILE. IMPROVE YOUR LIFE.

THE MARK CONSISTS OF STANDARD CHARACTERS WITHOUT CLAIM TO ANY PARTICULAR FONT, STYLE, SIZE, OR COLOR.

SUBJECT TO CONCURRENT USE PROCEEDINGS WITH DR. GIOVANNA DUKCEVICH, 116 CENTRAL PARK SOUTH, SUITE 8, 2ND FLOOR, NEW YORK, NY 10019 AND BROADSTONE DENTAL INC., 2784 E. BIDWELL ST SUITE 350, FOLSOM, CA 95630. APPLICANT CLAIMS THE EXCLUSIVE RIGHT TO USE THE MARK IN THE AREA COMPRISING THE UNITED STATES OF AMERICA WITH THE EXCEPTION OF THE CITY OF NEW YORK IN THE STATE OF NEW YORK AND THE CITY OF FOLSOM IN THE STATE OF CALIFORNIA. THE METHOD OF USE IS ON ADVERTISING AND PROMOTIONAL MATERIALS, NAMELY, SIGNS, BROCHURES, AND INTERNET ADVERTISING. THE APPLICANT ACKNOWLEDGES THAT THE PARTIES LISTED HEREIN ARE EXCEPTIONS TO THE APPLICANT'S CLAIM OF EXCLUSIVE USE MADE IN THE DECLARATION.

FOR ORTHODONTIC SERVICES (U.S. CLS. 100 AND 101).

FIRST USE 4-1-2006; IN COMMERCE 4-1-2006.

KAPIL BHANOT, EXAMINING ATTORNEY

SN 78-935,004. THE MOUNT SINAI HOSPITAL, NEW YORK, NY. FILED 7-21-2006.

HERE'S TO YOUR HEALTH

THE MARK CONSISTS OF STANDARD CHARACTERS WITHOUT CLAIM TO ANY PARTICULAR FONT, STYLE, SIZE, OR COLOR.

FOR HEALTH CARE SERVICES FEATURING A HEALTH CARD PROGRAM THAT PROVIDES PROVIDERS AND PATIENTS WITH ACCESS TO PERSONAL MEDICAL INFORMATION (U.S. CLS. 100 AND 101).

FIRST USE 7-20-2006; IN COMMERCE 7-20-2006.

JOHN GARTNER, EXAMINING ATTORNEY

CLASS 44—(Continued).

SN 78-935,073. THE MOUNT SINAI HOSPITAL, NEW YORK, NY. FILED 7-21-2006.

**SMART PATIENTS, SMART
CARDS, SMART MEDICINE**

THE MARK CONSISTS OF STANDARD CHARACTERS WITHOUT CLAIM TO ANY PARTICULAR FONT, STYLE, SIZE, OR COLOR.

FOR HEALTH CARE SERVICES FEATURING A HEALTH CARD PROGRAM THAT PROVIDES PROVIDERS AND PATIENTS WITH ACCESS TO PERSONAL MEDICAL INFORMATION (U.S. CLS. 100 AND 101).

FIRST USE 7-20-2006; IN COMMERCE 7-20-2006.
JOHN GARTNER, EXAMINING ATTORNEY

SN 78-936,323. ASK DR. MAO, LLC, NEW YORK, NY. FILED 7-24-2006.

ASK DR. MAO

THE MARK CONSISTS OF STANDARD CHARACTERS WITHOUT CLAIM TO ANY PARTICULAR FONT, STYLE, SIZE, OR COLOR.

THE NAME DR. MAOSHING NI IDENTIFIES A LIVING INDIVIDUAL WHOSE CONSENT IS OF RECORD.

FOR PROVIDING INFORMATION IN THE FIELDS OF HEALTH, MEDICINE AND LONGEVITY (U.S. CLS. 100 AND 101).

FIRST USE 6-15-2006; IN COMMERCE 6-15-2006.
INGRID C. EULIN, EXAMINING ATTORNEY

SN 78-937,526. ASHEVILLE PLASTIC SURGERY, P.A., ASHEVILLE, NC. FILED 7-26-2006.

ASHEVILLE PLASTIC SURGERY

THE MARK CONSISTS OF STANDARD CHARACTERS WITHOUT CLAIM TO ANY PARTICULAR FONT, STYLE, SIZE, OR COLOR.

OWNER OF U.S. REG. NO. 3,094,548.

NO CLAIM IS MADE TO THE EXCLUSIVE RIGHT TO USE "PLASTIC SURGERY", APART FROM THE MARK AS SHOWN.

SEC. 2(F).

FOR COSMETIC AND PLASTIC SURGERY (U.S. CLS. 100 AND 101).

FIRST USE 9-25-1982; IN COMMERCE 9-25-1982.
RONALD AIKENS, EXAMINING ATTORNEY

CLASS 44—(Continued).

SN 78-955,968. TRES JOLIE DAY SPA LLC, SOUTHURY, CT. FILED 8-19-2006.



Experience the Difference

NO CLAIM IS MADE TO THE EXCLUSIVE RIGHT TO USE "DAY SPA L.L.C.", APART FROM THE MARK AS SHOWN.

THE ENGLISH EQUIVALENT TO THE WORDS "TRES JOLIE" IS "VERY PRETTY."

FOR HEALTH SPA SERVICES, NAMELY, COSMETIC BODY CARE SERVICES (U.S. CLS. 100 AND 101).

FIRST USE 6-0-2003; IN COMMERCE 6-0-2003.
EDWARD NELSON, EXAMINING ATTORNEY

SN 78-958,004. HIRSCH, CHARLES S., SANTA MONICA, CA. FILED 8-22-2006.

PSYCHO-CELLULAR HEALING

THE MARK CONSISTS OF STANDARD CHARACTERS WITHOUT CLAIM TO ANY PARTICULAR FONT, STYLE, SIZE, OR COLOR.

NO CLAIM IS MADE TO THE EXCLUSIVE RIGHT TO USE "HEALING", APART FROM THE MARK AS SHOWN.

FOR MIND-BODY THERAPY SERVICES IN THE NATURE OF HYPNOSIS SESSIONS AND ASSOCIATED AUDIO TAPES, CUSTOMIZED FOR PATIENTS, DISTRIBUTED IN CONNECTION THEREWITH (U.S. CLS. 100 AND 101).

FIRST USE 2-1-1995; IN COMMERCE 2-1-1995.
WON TEAK OH, EXAMINING ATTORNEY

CLASS 44—(Continued).

SN 78-961,529. HARRIS, JOHN B., PONTE VEDRA BEACH, FL. FILED 8-28-2006.

REJUVANENCE MEDSPA

THE MARK CONSISTS OF STANDARD CHARACTERS WITHOUT CLAIM TO ANY PARTICULAR FONT, STYLE, SIZE, OR COLOR.

NO CLAIM IS MADE TO THE EXCLUSIVE RIGHT TO USE "MEDSPA", APART FROM THE MARK AS SHOWN.

FOR CONSULTATION SERVICES IN THE FIELD OF SKIN CARE, WEIGHT LOSS, AND NUTRITION SUPPORT; PROVIDING INTEGRATED SKIN CARE AND BODY CARE SERVICES IN THE NATURE OF WEIGHT REDUCTION DIET PLANNING AND SUPERVISION AND SKIN CARE SALONS; MEDSPA SERVICES, NAMELY, MASSAGES, FACIALS, WAXING FOR HAIR REMOVAL, TANNING, SOFT TISSUE FILLER INJECTION, INJECTIONS FOR THE TREATMENT OF WRINKLES, LASER HAIR REMOVAL, LASER CELLULITE TREATMENT, LASER SKIN MANAGEMENT, LASER VEIN MANAGEMENT, MICRODERMABRASION, AND MESOTHERAPY (U.S. CLS. 100 AND 101).

HEATHER THOMPSON, EXAMINING ATTORNEY

SN 78-967,726. TREELINE LANDSCAPING AND NURSERY, INC., STOKESDALE, NC. FILED 9-6-2006.



NO CLAIM IS MADE TO THE EXCLUSIVE RIGHT TO USE "TREELINE LANDSCAPING AND NURSERY", APART FROM THE MARK AS SHOWN.

FOR LANDSCAPING AND NURSERY SERVICES (U.S. CLS. 100 AND 101).

KELLY MCCOY, EXAMINING ATTORNEY

SN 78-971,646. CONNOLLY, THOMAS JOHN, NEW YORK, NY. FILED 9-11-2006.

NYPERIO

THE MARK CONSISTS OF STANDARD CHARACTERS WITHOUT CLAIM TO ANY PARTICULAR FONT, STYLE, SIZE, OR COLOR.

FOR PERIODONTAL SERVICES (U.S. CLS. 100 AND 101).

FIRST USE 2-7-2006; IN COMMERCE 2-7-2006.

C. DIONNE CLYBURN, EXAMINING ATTORNEY

CLASS 45—PERSONAL SERVICES

SN 76-666,959. FRASER, DAVID J., DUBLIN, CA. FILED 10-3-2006.

heavenforbid.org

THE MARK CONSISTS OF STANDARD CHARACTERS WITHOUT CLAIM TO ANY PARTICULAR FONT, STYLE, SIZE, OR COLOR.

FOR PROVIDING A WEBSITE FEATURING VITAL PERSONAL INFORMATION NEEDED DURING PERSONAL EMERGENCIES IN THE NATURE OF A FAMILY PLAN FOR SAFETY (U.S. CLS. 100 AND 101).

JAMES STEIN, EXAMINING ATTORNEY

SN 76-674,586. NYLAND, CHARLES SCOTT, ALPHARETTA, GA. FILED 3-26-2007.

P.I.G.S.

THE MARK CONSISTS OF STANDARD CHARACTERS WITHOUT CLAIM TO ANY PARTICULAR FONT, STYLE, SIZE, OR COLOR.

FOR INVESTIGATION AND SURVEILLANCE SERVICES, NAMELY SERVICES RELATING TO MONITORING, REPORTING, AND CATALOGING INSTANCES OF MISCONDUCT BY LAW ENFORCEMENT OFFICERS AND AGENCIES, GRIEVANCE PROCEDURES, WEBSITE AND HYPERLINKS TO INFORMATION FOR ASSISTING VICTIMS OF POLICE MISCONDUCT (U.S. CLS. 100 AND 101).

GINA FINK, EXAMINING ATTORNEY

SN 76-677,242. ADVANCE MAGAZINE PUBLISHERS INC., NEW YORK, NY. FILED 5-21-2007.

LUCKY STYLE SPOTTER

THE MARK CONSISTS OF STANDARD CHARACTERS WITHOUT CLAIM TO ANY PARTICULAR FONT, STYLE, SIZE, OR COLOR.

OWNER OF U.S. REG. NOS. 2,469,245, 2,953,777 AND OTHERS.

NO CLAIM IS MADE TO THE EXCLUSIVE RIGHT TO USE "STYLE", APART FROM THE MARK AS SHOWN.

FOR PROVIDING INFORMATION VIA THE INTERNET IN THE FIELD OF FASHION AND STYLE (U.S. CLS. 100 AND 101).

FRED MANDIR, EXAMINING ATTORNEY

CLASS 45—(Continued).

SN 77-004,203. DELANEY, PHEBE, DENVER, CO. FILED 9-21-2006.

Catnip Manor

THE MARK CONSISTS OF STANDARD CHARACTERS WITHOUT CLAIM TO ANY PARTICULAR FONT, STYLE, SIZE, OR COLOR.

FOR SPIRITUAL CONSULTATION SERVICES, NAMELY, PROVIDING CLAIRVOYANT READINGS, TAROT READINGS, PALMISTRY ANALYSIS AND PAST LIVES ANALYSIS AND TEACHING OF SUCH SERVICES; FACILITATING COMMUNICATION BETWEEN INDIVIDUALS AND THEIR PETS (U.S. CLS. 100 AND 101).

FIRST USE 8-1-2003; IN COMMERCE 8-1-2003.
ALLISON HOLTZ, EXAMINING ATTORNEY

SN 77-017,354. COLOR BLIND DATING, LLC, ST. CLAIR SHORES, MI. FILED 10-10-2006.

COLOR BLIND DATING

THE MARK CONSISTS OF STANDARD CHARACTERS WITHOUT CLAIM TO ANY PARTICULAR FONT, STYLE, SIZE, OR COLOR.

NO CLAIM IS MADE TO THE EXCLUSIVE RIGHT TO USE "DATING", APART FROM THE MARK AS SHOWN.

FOR ON-LINE DATING SERVICE (U.S. CLS. 100 AND 101).

FIRST USE 10-1-2006; IN COMMERCE 10-1-2006.
AMY MCMENAMIN, EXAMINING ATTORNEY

SN 77-032,533. CKK LLC, ATHENS, GA. FILED 10-30-2006.

GUARDIAN PET TAG

THE MARK CONSISTS OF STANDARD CHARACTERS WITHOUT CLAIM TO ANY PARTICULAR FONT, STYLE, SIZE, OR COLOR.

NO CLAIM IS MADE TO THE EXCLUSIVE RIGHT TO USE "PET TAG", APART FROM THE MARK AS SHOWN.

FOR PROVIDING PET IDENTIFICATION TAGS FEATURING IDENTIFICATION CODES THAT ALLOW THE USER TO RETRIEVE PET INFORMATION FROM A WEBSITE (U.S. CLS. 100 AND 101).

FIRST USE 5-1-2006; IN COMMERCE 5-1-2006.
KRISTINA MORRIS, EXAMINING ATTORNEY

CLASS 45—(Continued).

SN 77-040,064. THE UPPER ROOM, NASHVILLE, TN. FILED 11-8-2006.

THE LIVING PRAYER CENTER

THE MARK CONSISTS OF STANDARD CHARACTERS WITHOUT CLAIM TO ANY PARTICULAR FONT, STYLE, SIZE, OR COLOR.

NO CLAIM IS MADE TO THE EXCLUSIVE RIGHT TO USE "CENTER", APART FROM THE MARK AS SHOWN. SEC. 2(F).

FOR MINISTERIAL SERVICES, NAMELY, PROVIDING PRAYER SERVICES; PROVIDING MINISTERIAL INFORMATION IN THE FIELDS OF CHRISTIANITY, CHRISTIAN, RELIGIOUS AND SPIRITUAL DEVELOPMENT, CHRISTIAN, RELIGIOUS AND SPIRITUAL MINISTRY, PRAYER, RELIGION, SELF-HELP, SPIRITUALITY, AND SPIRITUAL GROWTH (U.S. CLS. 100 AND 101).

FIRST USE 4-0-1977; IN COMMERCE 4-0-1977.
LINDSEY RUBIN, EXAMINING ATTORNEY

SN 77-046,206. MAD PACKERS, INC., NEW YORK, NY. FILED 11-16-2006.

MadCollege

THE MARK CONSISTS OF STANDARD CHARACTERS WITHOUT CLAIM TO ANY PARTICULAR FONT, STYLE, SIZE, OR COLOR.

FOR CONCIERGE SERVICES FOR COLLEGE STUDENTS IN THE NATURE OF ACCOMMODATING REQUESTED PERSONAL ARRANGEMENTS AND RESERVATIONS AND PROVIDING CUSTOMER-SPECIFIC INFORMATION TO MEET INDIVIDUAL NEEDS OF COLLEGE STUDENTS, RENDERED TOGETHER IN A COLLEGE ENVIRONMENT (U.S. CLS. 100 AND 101).

RUSS HERMAN, EXAMINING ATTORNEY

SN 77-046,212. MAD PACKERS, INC., NEW YORK, NY. FILED 11-16-2006.

Mad

THE MARK CONSISTS OF STANDARD CHARACTERS WITHOUT CLAIM TO ANY PARTICULAR FONT, STYLE, SIZE, OR COLOR.

FOR CONCIERGE SERVICES FOR COLLEGE STUDENTS IN THE NATURE OF ACCOMMODATING REQUESTED PERSONAL ARRANGEMENTS AND RESERVATIONS AND PROVIDING CUSTOMER-SPECIFIC INFORMATION TO MEET INDIVIDUAL NEEDS OF COLLEGE STUDENTS, RENDERED TOGETHER IN A COLLEGE ENVIRONMENT (U.S. CLS. 100 AND 101).

RUSS HERMAN, EXAMINING ATTORNEY

CLASS 45—(Continued).

SN 77-056,357. JOHNSON, LARRY, PALM SPRINGS, CA. FILED 12-4-2006.

BECAUSE THEY WERE THERE
FOR YOU WE ARE THERE FOR
THEM

THE MARK CONSISTS OF STANDARD CHARACTERS WITHOUT CLAIM TO ANY PARTICULAR FONT, STYLE, SIZE, OR COLOR.

FOR PET CREMATION AND RELATED SERVICES, NAMELY, PET FUNERAL ARRANGEMENTS AND PET FUNERAL UNDERTAKING SERVICES (U.S. CLS. 100 AND 101).

AMY MCMENAMIN, EXAMINING ATTORNEY

SN 77-088,822. OUR EARTH MUSIC, INC., REDWOOD CITY, CA. FILED 1-23-2007.

OUR EARTH MUSIC

THE MARK CONSISTS OF STANDARD CHARACTERS WITHOUT CLAIM TO ANY PARTICULAR FONT, STYLE, SIZE, OR COLOR.

NO CLAIM IS MADE TO THE EXCLUSIVE RIGHT TO USE "MUSIC", APART FROM THE MARK AS SHOWN.

FOR LICENSING OF MUSICAL COMPOSITIONS AND MASTER RECORDINGS (U.S. CLS. 100 AND 101).

FIRST USE 1-1-2007; IN COMMERCE 8-1-2007.
PRISCILLA MILTON, EXAMINING ATTORNEY

SN 77-090,971. FREEMAN, VIVIAN V, NEWSOMS, VA. FILED 1-25-2007.

**Faith Fellowship Christian
Center**

THE MARK CONSISTS OF STANDARD CHARACTERS WITHOUT CLAIM TO ANY PARTICULAR FONT, STYLE, SIZE, OR COLOR.

NO CLAIM IS MADE TO THE EXCLUSIVE RIGHT TO USE FELLOWSHIP CHRISTIAN CENTER, APART FROM THE MARK AS SHOWN.

FOR EVANGELISTIC AND MINISTERIAL SERVICES; EVANGELISTIC MINISTERIAL SERVICES; MINISTERIAL SERVICES; MINISTERIAL SERVICES, NAMELY HOLDING SPIRITUAL RETREATS TO ASSIST RELIGIOUS LEADERS, BOTH CLERGY AND LAY, TO DEVELOP AND ENHANCE THEIR SPIRITUAL LIVES (U.S. CLS. 100 AND 101).

TARAH HARDY, EXAMINING ATTORNEY

CLASS 45—(Continued).

SN 77-091,998. ALSCHULER GROSSMAN LLP, SANTA MONICA, CA. FILED 1-26-2007.

WE FIGHT TO WIN

THE MARK CONSISTS OF STANDARD CHARACTERS WITHOUT CLAIM TO ANY PARTICULAR FONT, STYLE, SIZE, OR COLOR.

FOR LEGAL SERVICES (U.S. CLS. 100 AND 101).
FIRST USE 8-1-1996; IN COMMERCE 8-1-1996.
DEIRDRE ROBERTSON, EXAMINING ATTORNEY

SN 77-115,440. CHALLENGER-NIBBS, KENDRA, BROOKLYN, NY. FILED 2-24-2007.

PaperWitness

THE MARK CONSISTS OF STANDARD CHARACTERS WITHOUT CLAIM TO ANY PARTICULAR FONT, STYLE, SIZE, OR COLOR.

FOR LEGAL DOCUMENT PREPARATION SERVICES FOR INDIVIDUALS AND ATTORNEYS (U.S. CLS. 100 AND 101).

MARY CRAWFORD, EXAMINING ATTORNEY

SN 77-119,042. THE COIN CLUB, LLC, NORTH HOLLYWOOD, CA. FILED 2-28-2007.



thecoinclub.net

NO CLAIM IS MADE TO THE EXCLUSIVE RIGHT TO USE "COIN CLUB.NET", APART FROM THE MARK AS SHOWN.

THE COLOR(S) GOLD, WHITE, AND BLACK IS/ARE CLAIMED AS A FEATURE OF THE MARK.

THE MARK CONSISTS OF THE LETTERS "CC" IN WHITE ON TOP OF A GOLD COIN, WITH THE LETTERS "THECOINCLUB.NET" IN BLACK BENEATH THE COIN.

FOR ONLINE SOCIAL NETWORKING SERVICES FOR THOSE INTERESTED IN COIN COLLECTING (U.S. CLS. 100 AND 101).

MORGAN WYNNE, EXAMINING ATTORNEY

CLASS 45—(Continued).

SN 77-125,470. ADAMS, ADRIAN, LOS ANGELES, CA. FILED 3-8-2007.



THE MARK CONSISTS OF CAPITALIZED LETTER D, LOWER CASE LETTERS AVIS-, CAPITALIZED LETTER S, LOWER CASE LETTERS TIRLING.COM, BELOW LETTERS IS A PAINT BRUSH STROKE.
FOR PROVIDING INFORMATION RELATING TO LEGAL AFFAIRS (U.S. CLS. 100 AND 101).
FIRST USE 11-2-2002; IN COMMERCE 11-2-2002.
COLLEEN KEARNEY, EXAMINING ATTORNEY

SN 77-127,144. STEPHEN M. CHOUET AND ASSOCIATES, APLC, METAIRIE, LA. FILED 3-9-2007.



THE MARK CONSISTS OF SCALES OF JUSTICE IN WHICH TWO PAN BALANCE SCALES HANG FROM A FLEUR-DE-LIS .
FOR LEGAL SERVICES (U.S. CLS. 100 AND 101).
FIRST USE 11-7-2006; IN COMMERCE 11-7-2006.
DEZMONA MIZELLE, EXAMINING ATTORNEY

SN 77-131,327. BIOAUTHORIZE, INC., SCOTTSDALE, AZ. FILED 3-14-2007.

BIOAUTHORIZE

THE MARK CONSISTS OF STANDARD CHARACTERS WITHOUT CLAIM TO ANY PARTICULAR FONT, STYLE, SIZE, OR COLOR.
FOR PROVIDING USER AUTHENTICATION SERVICES IN E-COMMERCE TRANSACTIONS SPECIFICALLY FOR ONLINE BANKING AND BUSINESS INVOICE PROCESSING (U.S. CLS. 100 AND 101).
DAVID MURRAY, EXAMINING ATTORNEY

CLASS 45—(Continued).

SN 77-133,288. EDUCATIONAL COMMUNICATION LLC, COLUMBIA, MD. FILED 3-16-2007.

Teach The People

THE MARK CONSISTS OF STANDARD CHARACTERS WITHOUT CLAIM TO ANY PARTICULAR FONT, STYLE, SIZE, OR COLOR.
FOR ONLINE SOCIAL NETWORKING SERVICES (U.S. CLS. 100 AND 101).
MICHAEL LITZAU, EXAMINING ATTORNEY

SN 77-133,980. KATHY ANN BOLTON, BLUFFTON, SC. FILED 3-19-2007.



THE COLOR(S) GOLD, RED, BLACK, AND WHITE IS/ ARE CLAIMED AS A FEATURE OF THE MARK.
THE COLOR GOLD APPEARS IN THE BACKGROUND AT TOP, RED HEARTS, BLACK TABLE AND A MAN AND WOMEN TOASTING AT TABLE ALSO IN BLACK, LUNCH IS IN GOLD WITH RED OUTLINE AND A RED & SIGN, AND DATES SOUL MATES IN SOFT BLACK ON A WHITE BACKGROUND AND DATES FOR A LIFETIME IN SOFT BLACK ON A GOLD BACKGROUND.
FOR MARRIAGE PARTNER INTRODUCTION OR DATING SERVICES (U.S. CLS. 100 AND 101).
TASHIA BUNCH, EXAMINING ATTORNEY

SN 77-139,559. RELATED WORLD INC, ALPHARETTA, GA. FILED 3-24-2007.

Related World

THE MARK CONSISTS OF STANDARD CHARACTERS WITHOUT CLAIM TO ANY PARTICULAR FONT, STYLE, SIZE, OR COLOR.
FOR INTERNET BASED SOCIAL NETWORKING, INTRODUCTION, AND DATING SERVICES; ONLINE SOCIAL NETWORKING SERVICES (U.S. CLS. 100 AND 101).
MARK T. MULLEN, EXAMINING ATTORNEY

CLASS 45—(Continued).

SN 77-139,606. WITHERSPOON, ALLISON N., SAINT HELENA, CA. FILED 3-24-2007.

DATEBOOK

THE MARK CONSISTS OF STANDARD CHARACTERS WITHOUT CLAIM TO ANY PARTICULAR FONT, STYLE, SIZE, OR COLOR.

FOR INTERNET BASED SOCIAL NETWORKING, INTRODUCTION, AND DATING SERVICES (U.S. CLS. 100 AND 101).

NATALIE POLZER, EXAMINING ATTORNEY

SN 77-139,945. MCSHANE & HITCHINGS, LLC, HARRISBURG, PA. FILED 3-26-2007.

WAS HIS

THE MARK CONSISTS OF STANDARD CHARACTERS WITHOUT CLAIM TO ANY PARTICULAR FONT, STYLE, SIZE, OR COLOR.

FOR LEGAL SERVICES (U.S. CLS. 100 AND 101).

FIRST USE 3-0-2006; IN COMMERCE 3-0-2006.

GINA FINK, EXAMINING ATTORNEY

SN 77-140,189. WITTS, LIZ, SELLERSVILLE, PA. FILED 3-26-2007.

WHEN IN DOUBT THROW IT OUT!

THE MARK CONSISTS OF STANDARD CHARACTERS WITHOUT CLAIM TO ANY PARTICULAR FONT, STYLE, SIZE, OR COLOR.

FOR ORGANIZATIONAL SERVICES FOR HOME OR PERSONAL PURPOSES, NAMELY, HOMES AND HOME OFFICES (U.S. CLS. 100 AND 101).

AMY ALFIERI, EXAMINING ATTORNEY

CLASS 45—(Continued).

SN 77-140,781. LIFLE INC., SAN FRANCISCO, CA. FILED 3-26-2007.

LIFLE

THE MARK CONSISTS OF STANDARD CHARACTERS WITHOUT CLAIM TO ANY PARTICULAR FONT, STYLE, SIZE, OR COLOR.

FOR ONLINE SOCIAL NETWORKING SERVICES (U.S. CLS. 100 AND 101).

CARRIE GENOVESE, EXAMINING ATTORNEY

SN 77-140,823. MEHMET, BADISSE DAVID, NEW YORK, NY. FILED 3-26-2007.

MINDFREEZE

THE MARK CONSISTS OF STANDARD CHARACTERS WITHOUT CLAIM TO ANY PARTICULAR FONT, STYLE, SIZE, OR COLOR.

FOR ONLINE SOCIAL NETWORKING SERVICES (U.S. CLS. 100 AND 101).

FIRST USE 5-10-2004; IN COMMERCE 5-10-2004.

CHRISTINA SOBRAL, EXAMINING ATTORNEY

SN 77-141,287. 45FIX, LLC, CHARLOTTESVILLE, VA. FILED 3-27-2007.

45FIX

THE MARK CONSISTS OF STANDARD CHARACTERS WITHOUT CLAIM TO ANY PARTICULAR FONT, STYLE, SIZE, OR COLOR.

FOR LICENSING OF COMPUTER SOFTWARE AND SERVICES FOR USE WITH MANAGEMENT OF RESIDENTIAL AND COMMERCIAL PROPERTY, HOME IMPROVEMENT, HANDYMAN AND MAINTENANCE AND REPAIR PROJECTS (U.S. CLS. 100 AND 101).

DAVID H. STINE, EXAMINING ATTORNEY

CLASS 45—(Continued).

SN 77-141,964. DELISH FOODS INTERNATIONAL, AGOURA, CA. FILED 3-27-2007.

Wake up your toast, America

THE MARK CONSISTS OF STANDARD CHARACTERS WITHOUT CLAIM TO ANY PARTICULAR FONT, STYLE, SIZE, OR COLOR.

FOR ADVERTISING SLOGAN AND CARTOON CHARACTER LICENSING (U.S. CLS. 100 AND 101).
PATRICIA EVANKO, EXAMINING ATTORNEY

CLASS 45—(Continued).

SN 77-142,739. LUTHERAN ASSOCIATION OF MISSIONARIES AND PILOTS - U.S., BROOKFIELD, WI. FILED 3-28-2007.



SN 77-142,080. URCUTE ENTERTAINMENT, LLC, BRIDGEPORT, CT. FILED 3-28-2007.

YOU ARE CUTE, SHOW THE WORLD!

THE MARK CONSISTS OF STANDARD CHARACTERS WITHOUT CLAIM TO ANY PARTICULAR FONT, STYLE, SIZE, OR COLOR.

FOR INTERNET BASED INTRODUCTION AND SOCIAL NETWORKING SERVICES (U.S. CLS. 100 AND 101).

FIRST USE 12-31-1999; IN COMMERCE 12-31-1999.
RENEE MCCRAY, EXAMINING ATTORNEY

THE COLOR(S) RED, WHITE, YELLOW AND BLACK IS/ ARE CLAIMED AS A FEATURE OF THE MARK.

THE MARK CONSISTS OF A CROSS USING A NATIVE AMERICAN DESIGN THAT IS WHITE ON TOP, YELLOW ON THE RIGHT, BLACK ON THE BOTTOM, AND RED ON THE LEFT.

FOR MINISTERIAL SERVICES, NAMELY TO PROVIDE CHRISTIAN SPIRITUAL WITNESS AND NUTURE AND SOCIAL HEALING TO NATIVE AMERICANS LIVING IN REMOTE AREAS OF ALASKA, CANADA, AND THE OLYMPIC PENINSULA OF WASHINGTON STATE (U.S. CLS. 100 AND 101).

FIRST USE 4-0-2004; IN COMMERCE 4-0-2004.
ANDREA SAUNDERS, EXAMINING ATTORNEY

SN 77-143,952. ALLEN STEWART PC, DALLAS, TX. FILED 3-29-2007.

ALLEN STEWART

OWN YOUR IDEAS

THE MARK CONSISTS OF STANDARD CHARACTERS WITHOUT CLAIM TO ANY PARTICULAR FONT, STYLE, SIZE, OR COLOR.

FOR LEGAL SERVICES (U.S. CLS. 100 AND 101).
LINDA E. BLOHM, EXAMINING ATTORNEY

THE MARK CONSISTS OF STANDARD CHARACTERS WITHOUT CLAIM TO ANY PARTICULAR FONT, STYLE, SIZE, OR COLOR.

"ALLEN STEWART" IDENTIFIES A LIVING INDIVIDUAL WHOSE CONSENT IS OF RECORD.

FOR LEGAL SERVICES (U.S. CLS. 100 AND 101).
FIRST USE 3-15-2007; IN COMMERCE 3-15-2007.
DAVID C. REIHNER, EXAMINING ATTORNEY

CLASS 45—(Continued).

SN 77-144,342. AITON, ANGELA, LOS ANGELES, CA. FILED 3-29-2007.

The Model Match

THE MARK CONSISTS OF STANDARD CHARACTERS WITHOUT CLAIM TO ANY PARTICULAR FONT, STYLE, SIZE, OR COLOR.

NO CLAIM IS MADE TO THE EXCLUSIVE RIGHT TO USE MATCH, APART FROM THE MARK AS SHOWN.

FOR COMPUTER DATING SERVICES; DATING SERVICES; INTERNET BASED SOCIAL NETWORKING, INTRODUCTION, AND DATING SERVICES; WEB SITE SERVICES FEATURING ON-LINE DATING CLUB (U.S. CLS. 100 AND 101).

FIRST USE 10-1-2006; IN COMMERCE 3-20-2007.
CYNTHIA SLOAN, EXAMINING ATTORNEY

CLASS 45—(Continued).

SN 77-148,277. EMERGINGTRADERS.COM, INC., NORTH SALEM, NY. FILED 4-4-2007.



NO CLAIM IS MADE TO THE EXCLUSIVE RIGHT TO USE "EMERGING TRADERS.COM", APART FROM THE MARK AS SHOWN.

THE MARK CONSISTS OF A CIRCLE OF DOTS WITH A SINGLE DOT AT 12 O'CLOCK IN THE CIRCLE. EMERGINGTRADERS.COM IS RIGHT BESIDE IT.

FOR REVIEWING STANDARDS AND PRACTICES TO ASSURE COMPLIANCE WITH COMMODITY FUTURES AND OPTIONS LAWS AND REGULATIONS (U.S. CLS. 100 AND 101).

FIRST USE 2-1-2007; IN COMMERCE 2-1-2007.
ALEX KEAM, EXAMINING ATTORNEY

SN 77-157,830. 100% PRODUCTIONS, INC., WESTLAKE VILLAGE, CA. FILED 4-16-2007.

PraiseDates

THE MARK CONSISTS OF STANDARD CHARACTERS WITHOUT CLAIM TO ANY PARTICULAR FONT, STYLE, SIZE, OR COLOR.

FOR INTERNET BASED SOCIAL NETWORKING, INTRODUCTION, AND DATING SERVICES (U.S. CLS. 100 AND 101).

CARYN GLASSER, EXAMINING ATTORNEY

SN 77-157,841. 100% PRODUCTIONS, INC., WESTLAKE VILLAGE, CA. FILED 4-16-2007.

WHINOSAURS

THE MARK CONSISTS OF STANDARD CHARACTERS WITHOUT CLAIM TO ANY PARTICULAR FONT, STYLE, SIZE, OR COLOR.

FOR LICENSING OF ARTWORK, CHARACTERS, AND BRANDS TO OTHERS FOR INCORPORATION INTO PRODUCTS, NAMELY, BOOKS, SCRAPBOOKS, BUMPER STICKERS, STICKERS, POSTERS, CARDS, PRINTS, MAGAZINES, PAPER PICTURE FRAMES, WORKBOOKS, ADDRESS BOOKS, STATIONERY, CALENDARS, FOLDERS, ENVELOPES, POSTCARDS, GREETING CARDS, ADHESIVE NOTE PADS, TAGS FOR CLOTHING, JOURNALS AND DIARIES, CHILDREN'S BOOKS, TOYS AND GAMES, CLOTHING, TELEVISION PROGRAMS, VIDEOS AND DVDS, AND COMPUTER GAMES (U.S. CLS. 100 AND 101).

ELIZABETH HUGHITT, EXAMINING ATTORNEY

PraiseDate

THE MARK CONSISTS OF STANDARD CHARACTERS WITHOUT CLAIM TO ANY PARTICULAR FONT, STYLE, SIZE, OR COLOR.

FOR INTERNET BASED SOCIAL NETWORKING, INTRODUCTION, AND DATING SERVICES (U.S. CLS. 100 AND 101).

CARYN GLASSER, EXAMINING ATTORNEY

SN 77-147,605. RED LETTER DESIGN STUDIO LLC, ALTOONA, IA. FILED 4-3-2007.

CLASS 45—(Continued).

SN 77-178,508. THE TRUSTEES OF THE GREATER GRACE NEW TESTAMENT CHURCH OF CONYERS 2000 CHURCH TRUST, CONYERS, GA. FILED 5-11-2007.

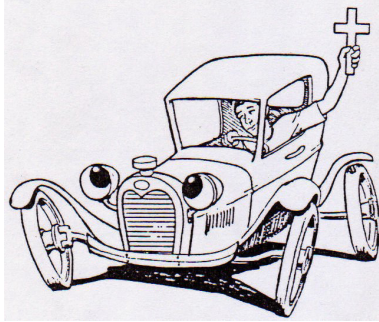

THE MARK CONSISTS OF A MAN SITTING IN A CAR, HOLDING A CROSS OUT OF THE CAR WINDOW. FOR EVANGELISTIC AND MINISTERIAL SERVICES (U.S. CLS. 100 AND 101). SHANNON TWOHIG, EXAMINING ATTORNEY

CLASS 45—(Continued).

SN 78-754,597. STONECROFT MINISTRIES, INC., KANSAS CITY, MO. FILED 11-15-2005.

CHRISTIAN WOMEN'S CLUBS

THE MARK CONSISTS OF STANDARD CHARACTERS WITHOUT CLAIM TO ANY PARTICULAR FONT, STYLE, SIZE, OR COLOR.
SEC. 2(F).
FOR EVANGELISTIC MINISTERIAL SERVICES, NAMELY, PROMOTING THE CHRISTIAN RELIGION (U.S. CLS. 100 AND 101).
FIRST USE 12-31-1949; IN COMMERCE 12-31-1949.
ELIZABETH KAJUBI, EXAMINING ATTORNEY

SN 78-787,143. WHITTAKER, SARAH J., WAYCROSS, GA. FILED 1-8-2006.

The Wardrobe Shrink

SN 78-725,553. GOLDEN YEARS COMPANION CARE, INC., CHICAGO, IL. FILED 10-3-2005.

GOLDEN YEARS COMPANION CARE

NO CLAIM IS MADE TO THE EXCLUSIVE RIGHT TO USE "COMPANION CARE", APART FROM THE MARK AS SHOWN.

FOR PROVIDING PERSONAL CARE ASSISTANCE OF ACTIVITIES OF DAILY LIVING SUCH AS VISITS TO A CLIENT'S NURSING FACILITY OR RESIDENCE TO PROVIDE COMPANIONSHIP, MAKE MEDICAL REMINDERS, CHECK FOOD SUPPLY, CHECK FOOD SPOilage, ASSIST WITH APPAREL SELECTION, MAKE HOME SAFETY CHECK, INCLUDING CHECKS FOR FALL PREVENTION, BRINGING IN MAIL, BRINGING IN NEWSPAPER, REMOVING TRASH, ADJUSTING ROOM TEMPERATURE, SUPPLYING FRESH FLOWERS, AND INCLUDING HOME CARE SERVICES TO INDIVIDUAL CLIENTS INCLUDING HOUSEKEEPING, KITCHEN CHORES, FOOD PLANNING AND PREPARATION, PROVIDING TRANSPORTATION, DOING ERRANDS, ASSISTING CORRESPONDENCE, INCLUDING PAYING BILLS AND ORDERING SUBSCRIPTIONS, PROVIDING COMPANIONSHIP, TELEPHONE ANSWERING AND TELEPHONE MESSAGE RETRIEVAL, ARRANGING APPOINTMENTS, AND ASSISTING PRIVATE ENTERTAINMENT INCLUDING RENTING MOVIES, PLAYING RECORDED MUSIC, ENCOURAGING VISITING ACTIVITIES, PLAYING CARDS AND BOARD GAMES WITH CLIENT, AND ASSISTING CLIENT WITH ARTS AND CRAFTS PROJECTS (U.S. CLS. 100 AND 101). MIDGE BUTLER, EXAMINING ATTORNEY

THE MARK CONSISTS OF STANDARD CHARACTERS WITHOUT CLAIM TO ANY PARTICULAR FONT, STYLE, SIZE, OR COLOR.

OWNER OF UNITED KINGDOM REG. NO. 2373368, DATED 2-3-2006, EXPIRES 9-18-2014.

NO CLAIM IS MADE TO THE EXCLUSIVE RIGHT TO USE "WARDROBE", APART FROM THE MARK AS SHOWN.

FOR PERSONAL LIFESTYLE CONSULTING SERVICES (U.S. CLS. 100 AND 101).

FIRST USE 11-10-2004; IN COMMERCE 11-10-2004.
ALEX KEAM, EXAMINING ATTORNEY

SN 78-788,763. COHEN, SHERI, E, LOS ANGELES, CA. FILED 1-10-2006.

HELPING BUILD HAPPY FAMILIES

THE MARK CONSISTS OF STANDARD CHARACTERS WITHOUT CLAIM TO ANY PARTICULAR FONT, STYLE, SIZE, OR COLOR.

FOR ADOPTION COUNSELING IN THE FIELD OF DOMESTIC INFANT AND TODDLER ADOPTION, STEP-PARENT ADOPTION, GRANDPARENT ADOPTION AND RELATIVE ADOPTION, AND SPECIAL NEEDS ADOPTION (U.S. CLS. 100 AND 101).

FIRST USE 1-10-2002; IN COMMERCE 1-10-2002.
DAVID TAYLOR, EXAMINING ATTORNEY

CLASS 45—(Continued).

SN 78-789,479. NIFTY AFTER FIFTY, GARDEN GROVE, CA.
FILED 1-11-2006.

NIFTY AFTER FIFTY

THE MARK CONSISTS OF STANDARD CHARACTERS WITHOUT CLAIM TO ANY PARTICULAR FONT, STYLE, SIZE, OR COLOR.

FOR DATING SERVICES; MARRIAGE PARTNER INTRODUCTION SERVICES; COMPANION INTRODUCTION SERVICES; SOCIAL SERVICES, NAMELY COMPANIONSHIP SERVICES FOR SENIOR CITIZENS; WEB SITE SERVICES FEATURING AN ON-LINE DATING CLUB. (U.S. CLS. 100 AND 101).

ALICIA COLLINS, EXAMINING ATTORNEY

SN 78-903,830. NIES, MARVIN, LODI, CA. FILED 6-8-2006.

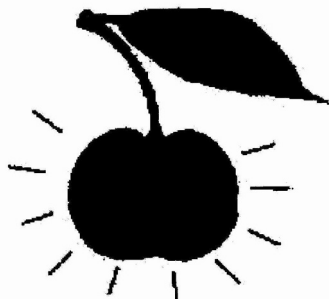

THE MARK CONSISTS OF A CHERRY WITH A SINGLE LEAF AND SMALL LINES AROUND THE PERIMETER OF THE CHERRY SIGNIFYING THAT THE CHERRY IS SHINY.

FOR LICENSING OF PATENTS FOR ONE OR MORE VARIETIES OF CHERRY (U.S. CLS. 100 AND 101).
SUSAN STIGLITZ, EXAMINING ATTORNEY

CLASS 45—(Continued).

SN 78-919,302. CARLTON, MATT, FLOWER MOUND, TX.
FILED 6-28-2006.

LUNCHPRO

THE MARK CONSISTS OF STANDARD CHARACTERS WITHOUT CLAIM TO ANY PARTICULAR FONT, STYLE, SIZE, OR COLOR.

FOR CONCIERGE SERVICES FOR OTHERS COMPRISING OF MAKING REQUESTED PERSONAL ARRANGEMENTS AND RESERVATIONS AND PROVIDING CUSTOMER-SPECIFIC INFORMATION TO MEET INDIVIDUAL NEEDS RENDERED TOGETHER IN A BUSINESS MEETING ENVIRONMENT, NAMELY COORDINATING MEETINGS WITH SERVICE PROVIDERS AND PROSPECTIVE CLIENTS. (U.S. CLS. 100 AND 101).

JASON BLAIR, EXAMINING ATTORNEY

SN 78-953,129. WOODSON BARBARA A, INKSTER, MI.
FILED 8-16-2006.

W.O.M.B. WOMEN OF MIGHTY BATTLES

THE MARK CONSISTS OF STANDARD CHARACTERS WITHOUT CLAIM TO ANY PARTICULAR FONT, STYLE, SIZE, OR COLOR.

NO CLAIM IS MADE TO THE EXCLUSIVE RIGHT TO USE "WOMEN", APART FROM THE MARK AS SHOWN.
FOR ORGANIZING AND CONDUCTING SUPPORT GROUPS IN THE FIELD OF EMOTIONAL/MENTAL HEALTH (U.S. CLS. 100 AND 101).

PATRICIA EVANKO, EXAMINING ATTORNEY

SN 78-953,143. FAMILY FEAST FRANCHISE MANAGEMENT LTD, CYPRESS, TX. FILED 8-16-2006.

THE FAMILY FEAST

THE MARK CONSISTS OF STANDARD CHARACTERS WITHOUT CLAIM TO ANY PARTICULAR FONT, STYLE, SIZE, OR COLOR.

FOR CUSTOMIZED CREATION OF MEAL MENUS FOR OTHERS AND CUSTOMIZED PREPARATION OF MEALS FOR OTHERS ACCORDING TO SPECIFIC MEDICAL AND/OR DIETARY NEEDS (U.S. CLS. 100 AND 101).

FIRST USE 9-10-2005; IN COMMERCE 9-10-2005.

DEIRDRE ROBERTSON, EXAMINING ATTORNEY

CLASS 45—(Continued).

SN 78-956,309. HOT TONIC, LLC, DALLAS, TX. FILED 8-21-2006.

CLASS 45—(Continued).

SN 78-960,772. INSTANT CREDIT CARD SECURITY SYSTEMS, INC., FREMONT, CA. FILED 8-25-2006.

HOT TONIC

THE MARK CONSISTS OF STANDARD CHARACTERS WITHOUT CLAIM TO ANY PARTICULAR FONT, STYLE, SIZE, OR COLOR.

FOR LICENSING OF MUSICAL COMPOSITIONS, SONGS AND SOUNDS (U.S. CLS. 100 AND 101).
CAROLINE WOOD, EXAMINING ATTORNEY

FRAUDDOG

THE MARK CONSISTS OF STANDARD CHARACTERS WITHOUT CLAIM TO ANY PARTICULAR FONT, STYLE, SIZE, OR COLOR.

FOR CREDIT CARD FRAUD PREVENTION SERVICES NAMELY PROVIDING AUTHENTICATION OF PERSONAL IDENTIFICATION INFORMATION; FRAUD DETECTION SERVICES IN THE FIELD OF CREDIT CARDS FOR ON-LINE PURCHASING; CONSULTATION IN THE FIELD OF DATA THEFT AND IDENTITY THEFT; FINANCIAL IDENTITY MONITORING SERVICE; REAL-TIME REPORTING OF FINANCIAL TRANSACTIONS IN CONJUNCTION WITH CREDIT CARD SECURITY AND IDENTITY THEFT (U.S. CLS. 100 AND 101).
ELLEN PERKINS, EXAMINING ATTORNE

* * * * *

SECTION 4.—PRIOR UNITED STATES CLASSIFICATION

APPLICATION IN ONE CLASS

COLLECTIVE MEMBERSHIP MARKS

SN 77-165,388. SAILORS FOR THE SEA, INC., BOSTON, MA.
FILED 4-25-2007.

CLASS 200—COLLECTIVE MEMBERSHIP
SN 77-126,509. THE ALLEGHENY COUNTY BAR ASSOCIA-
TION, PITTSBURGH, PA. FILED 3-9-2007.

Allegheny County Bar
Association

SAILORS FOR THE SEA

THE MARK CONSISTS OF STANDARD CHARACTERS
WITHOUT CLAIM TO ANY PARTICULAR FONT, STYLE,
SIZE, OR COLOR.

NO CLAIM IS MADE TO THE EXCLUSIVE RIGHT TO
USE "BAR ASSOCIATION", APART FROM THE MARK AS
SHOWN.

SEC. 2(F).
FOR INDICATING MEMBERSHIP IN A(N) BAR AS-
SOCIATION/LEGAL MEMBERSHIP ORGANIZATION.
FIRST USE 0-0-1907; IN COMMERCE 0-0-1907.
CIMMERIAN COLEMAN, EXAMINING ATTORNEY

THE MARK CONSISTS OF STANDARD CHARACTERS
WITHOUT CLAIM TO ANY PARTICULAR FONT, STYLE,
SIZE, OR COLOR.

FOR INDICATING MEMBERSHIP IN A(N) ORGANI-
ZATION THAT PROMOTES OCEAN AND BEACH CON-
SERVATION AND SOUND MARINE ENVIRONMENTAL
PRACTICES.

FIRST USE 8-31-2004; IN COMMERCE 8-31-2004.
TAMARA FRAZIER, EXAMINING ATTORNEY

SN 77-141,505. PHI KAPPA SIGMA FRATERNITY, INC.,
CHESTER SPRINGS, PA. FILED 3-27-2007.

SN 78-903,051. RETIREMENT INCOME INDUSTRY ASSO-
CIATION, WASHINGTON, DC. FILED 6-7-2006.

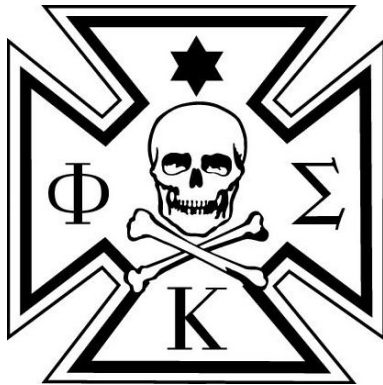

OWNER OF U.S. REG. NOS. 2,515,036 AND 2,529,663.
THE MARK CONSISTS OF A MALTESE CROSS DESIGN
CONTAINING A STAR OF DAVID AND SKULL AND
CROSSBONES GRAPHIC DESIGNS ALONG WITH THE
GREEK ALPHABET LETTERS "PHI," "KAPPA" AND "SIG-
MA".

FOR INDICATING MEMBERSHIP IN A(N) COLLEGI-
ATE FRATERNITY.
FIRST USE 0-0-1850; IN COMMERCE 0-0-1850.
KAREN BRACEY, EXAMINING ATTORNEY



NO CLAIM IS MADE TO THE EXCLUSIVE RIGHT TO
USE RETIREMENT INCOME INDUSTRY ASSOCIATION,
APART FROM THE MARK AS SHOWN.

THE MARK CONSISTS OF THE LETTERS RIIA WITH A
SWIRL EXTENDING THEREACROSS AND IN A RECTAN-
GULAR BLOCK INCLUDING IN SMALLER TYPE THE
WORDS RETIREMENT INCOME INDUSTRY ASSOCIA-
TION.

FOR INDICATING MEMBERSHIP IN A(N) ASSOCIA-
TION OF PERSONS IN THE RETIREMENT INCOME
INDUSTRY.
FIRST USE 5-1-2007; IN COMMERCE 5-1-2007.
ALICE BENMAMAN, EXAMINING ATTORNEY

SN 78-928,251. TOWXCHANGE, INC., CHATTANOOGA, TN. FILED 7-12-2006.

towPartners

THE MARK CONSISTS OF STANDARD CHARACTERS WITHOUT CLAIM TO ANY PARTICULAR FONT, STYLE, SIZE, OR COLOR.

SEC. 2(F).

FOR INDICATING MEMBERSHIP IN A(N) ORGANIZATION OF INDIVIDUALS, COMPANIES, AND ORGANIZATIONS THAT PROVIDE TOWING, VEHICLE RECOVERY, AND ROAD SERVICES.

FIRST USE 2-15-2003; IN COMMERCE 8-15-2003. SALLY SHIH, EXAMINING ATTORNEY

CERTIFICATION MARKS

CLASS A—GOODS

SN 77-132,370. AUTOMATION TECHNOLOGIES COUNCIL, DBA AUTOMATED IMAGING ASSOCIATION, ANN ARBOR, MI. FILED 3-15-2007.



OWNER OF U.S. REG. NOS. 2,687,627 AND 2,708,786. THE CERTIFICATION MARK, AS USED BY PERSONS AUTHORIZED BY THE CERTIFIER, CERTIFIES THAT DATA TRANSMISSION AND DATA RECEIVER EQUIPMENT AND CABLES MEET CERTAIN COMMUNICATIONS CONNECTIVITY INTERFACE STANDARDS.

FOR DATA TRANSMISSION AND DATA RECEIVER EQUIPMENT AND CABLES FOR USE IN PHOTOGRAPHIC IMAGING.

FIRST USE 1-10-2007; IN COMMERCE 1-10-2007. MARY ROSSMAN, EXAMINING ATTORNEY

CLASS B—SERVICES

SN 78-926,857. ECOQUEST INTERNATIONAL, INC., KNOXVILLE, TN. FILED 7-11-2006.

ECOCERTIFIED

THE MARK CONSISTS OF STANDARD CHARACTERS WITHOUT CLAIM TO ANY PARTICULAR FONT, STYLE, SIZE, OR COLOR.

MARK CERTIFIES THAT A RESIDENTIAL STRUCTURE HAS MET THE CERTIFIER'S QUALITY STANDARDS FOR WATER AND AIR PURIFICATION THROUGH THE USE AND INSTALLATION OF CERTAIN WATER AND AIR PURIFICATION PRODUCTS

FOR MARK CERTIFIES THAT A RESIDENTIAL STRUCTURE HAS MET THE CERTIFIER'S QUALITY STANDARDS FOR WATER AND AIR PURIFICATION THROUGH THE USE AND INSTALLATION OF CERTAIN WATER AND AIR PURIFICATION PRODUCTS.

FIRST USE 11-29-2005; IN COMMERCE 11-29-2005. NORA BUCHANAN WILL, EXAMINING ATTORNEY

SN 78-964,369. COUNCIL ON EDUCATION FOR PUBLIC HEALTH, WASHINGTON, DC. FILED 8-30-2006.



CEPH

COUNCIL *on* EDUCATION *for* PUBLIC HEALTH

NO CLAIM IS MADE TO THE EXCLUSIVE RIGHT TO USE "COUNCIL ON EDUCATION FOR PUBLIC HEALTH", APART FROM THE MARK AS SHOWN.

THE MARK CONSISTS OF THE STYLIZED WORDING "CEPH", HAVING THE DESIGN OF AN EIGHT COLUMN ANCIENT-STYLE STRUCTURE TO THE LEFT OF THE WORDING "CEPH", ALL ABOVE THE STYLIZED WORDING "COUNCIL ON EDUCATION FOR PUBLIC HEALTH".

THE CERTIFICATION MARK AS USED BY AUTHORIZED EDUCATIONAL INSTITUTIONS CERTIFIES THAT AN EDUCATIONAL INSTITUTION, OR A SPECIFIC PROGRAM OF STUDY OFFERED BY AN EDUCATIONAL INSTITUTION, SATISFIES THE ACCREDITATION CRITERIA OF THE CERTIFIER.

FOR EDUCATIONAL SERVICES, NAMELY, PROVIDING COURSES OF INSTRUCTION IN THE FIELD OF PUBLIC HEALTH.

FIRST USE 11-0-2004; IN COMMERCE 11-0-2004. JAY BESCH, EXAMINING ATTORNEY

SN 78-964,381. COUNCIL ON EDUCATION FOR PUBLIC HEALTH, WASHINGTON, DC. FILED 8-30-2006.

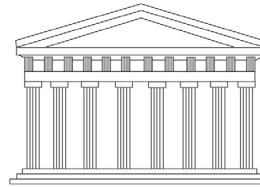

CEPH

COUNCIL *on* EDUCATION *for* PUBLIC HEALTH

NO CLAIM IS MADE TO THE EXCLUSIVE RIGHT TO USE "COUNCIL ON EDUCATION FOR PUBLIC HEALTH", APART FROM THE MARK AS SHOWN.

THE MARK CONSISTS OF THE DESIGN OF AN EIGHT COLUMN ANCIENT-STYLE STRUCTURE ABOVE THE WORDING "CEPH", ALL ABOVE THE STYLIZED WORDING "COUNCIL ON EDUCATION FOR PUBLIC HEALTH".

THE CERTIFICATION MARK AS USED BY AUTHORIZED EDUCATIONAL INSTITUTIONS CERTIFIES THAT AN EDUCATIONAL INSTITUTION, OR A SPECIFIC PROGRAM OF STUDY OFFERED BY AN EDUCATIONAL INSTITUTION, SATISFIES THE ACCREDITATION CRITERIA OF THE CERTIFIER.

JAY BESCH, EXAMINING ATTORNE

FOR EDUCATIONAL SERVICES, NAMELY, PROVIDING COURSES OF INSTRUCTION IN THE FIELD OF PUBLIC HEALTH.

FIRST USE 11-0-2004; IN COMMERCE 11-0-2004.

* * * * *

TRADEMARK REGISTRATIONS ISSUED

PRINCIPAL REGISTER

SECTION 1.— INTERNATIONAL CLASSIFICATION

The short titles associated below with the international class numbers are terms designed merely for quick identification and are not an official part of the international classification. The full names of international classes are given in section 6.1 of the trademark rules of practice.

The designation "U.S. Cl." appearing in this section refers to the U.S. class in effect prior to Sep. 1, 1973 rather than the international class which applies to applications filed on or after that date. For adoption of international classification see notice in the OFFICIAL GAZETTE of Jun. 26, 1973 (911 O.G. TM 210).

CLASS 1—CHEMICALS

- 3,295,977. **PROTOTHERM (BLOCK FORM)**. DSM DESOTECH, INC., (U.S. CLS. 1, 5, 6, 10, 26 AND 46). SN 76-511,130. PUB. 3-16-2004. FILED 5-2-2003.
- 3,295,992. **AFTERBREW (BLOCK FORM)**. IT'S OUR EARTH, INC., (U.S. CLS. 1, 5, 6, 10, 26 AND 46). SN 76-598,462. PUB. 6-28-2005. FILED 6-22-2004.
- 3,295,994. **HIGH TRAFFIC (STYLIZED)**. SPECIFIED TECHNOLOGIES INC., MULTIPLE CLASS, (INT. CLS. 1 AND 6), (U.S. CLS. 1, 2, 5, 6, 10, 12, 13, 14, 23, 25, 26, 46 AND 50). SN 76-603,707. PUB. 7-10-2007. FILED 7-23-2004.
- 3,296,249. **HYABEST (BLOCK FORM)**. KEWPIE KABUSHIKI KAISHA, DBA Q.P. CORPORATION, MULTIPLE CLASS, (INT. CLS. 1, 3 AND 5), (U.S. CLS. 1, 4, 5, 6, 10, 18, 26, 44, 46, 50, 51 AND 52). SN 77-008,358. PUB. 7-10-2007. FILED 9-27-2006.
- 3,296,256. **SYNOVEA (BLOCK FORM)**. CHAUDHURI, RATAN K., (U.S. CLS. 1, 5, 6, 10, 26 AND 46). SN 77-011,186. PUB. 7-10-2007. FILED 9-30-2006.
- 3,296,584. **RL-2 (BLOCK FORM)**. LAB SAFETY CORPORATION, (U.S. CLS. 1, 5, 6, 10, 26 AND 46). SN 77-060,716. PUB. 7-10-2007. FILED 12-9-2006.
- 3,296,792. **BIG STICKY AND DESIGN**. ILLINOIS TOOL WORK INC., (U.S. CLS. 1, 5, 6, 10, 26 AND 46). SN 77-079,233. PUB. 7-10-2007. FILED 1-9-2007.
- 3,296,829. **MD-3 (BLOCK FORM)**. CHEVRON INTELLECTUAL PROPERTY LLC, (U.S. CLS. 1, 5, 6, 10, 26 AND 46). SN 77-083,994. PUB. 7-10-2007. FILED 1-16-2007.
- 3,296,956. **CITRUCLEAN (BLOCK FORM)**. DI-CHEM, INC., (U.S. CLS. 1, 5, 6, 10, 26 AND 46). SN 77-090,964. PUB. 7-10-2007. FILED 1-25-2007.
- 3,297,100. **EPG (BLOCK FORM)**. TRIDENT PRODUCTS AND SERVICES LLC, (U.S. CLS. 1, 5, 6, 10, 26 AND 46). SN 77-105,317. PUB. 7-10-2007. FILED 2-12-2007.
- 3,297,101. **VECTOR+ (BLOCK FORM)**. TRIDENT PRODUCTS AND SERVICES LLC, (U.S. CLS. 1, 5, 6, 10, 26 AND 46). SN 77-105,338. PUB. 7-10-2007. FILED 2-12-2007.
- 3,297,102. **GROWTASTIC (BLOCK FORM)**. TRIDENT PRODUCTS AND SERVICES LLC, (U.S. CLS. 1, 5, 6, 10, 26 AND 46). SN 77-105,361. PUB. 7-10-2007. FILED 2-12-2007.
- 3,297,122. **L-X (BLOCK FORM)**. LUBRICATION ENGINEERS, INC., (U.S. CLS. 1, 5, 6, 10, 26 AND 46). SN 77-113,234. PUB. 7-10-2007. FILED 2-22-2007.
- 3,297,206. **NANOBYK (BLOCK FORM)**. BYK-CHEMIE GMBH, MULTIPLE CLASS, (INT. CLS. 1, 40, 41 AND 42), (U.S. CLS. 1, 5, 6, 10, 26, 46, 100, 101, 103, 106 AND 107). SN 78-506,504. PUB. 7-10-2007. FILED 10-27-2004.
- 3,297,209. **KINAROL (BLOCK FORM)**. CYCLACEL LIMITED, MULTIPLE CLASS, (INT. CLS. 1 AND 5), (U.S. CLS. 1, 5, 6, 10, 18, 26, 44, 46, 51 AND 52). SN 78-523,839. PUB. 7-10-2007. FILED 11-29-2004.
- 3,297,210. **KINAROS (BLOCK FORM)**. CYCLACEL LIMITED, MULTIPLE CLASS, (INT. CLS. 1 AND 5), (U.S. CLS. 1, 5, 6, 10, 18, 26, 44, 46, 51 AND 52). SN 78-523,856. PUB. 7-10-2007. FILED 11-29-2004.
- 3,297,238. **URBAN ORGANICS (BLOCK FORM)**. URBAN ORGANICS, INC., MULTIPLE CLASS, (INT. CLS. 1 AND 31), (U.S. CLS. 1, 5, 6, 10, 26 AND 46). SN 78-594,417. PUB. 7-10-2007. FILED 3-24-2005.
- 3,297,283. **SUB-ZERO (BLOCK FORM)**. E F PRODUCTS, INC., (U.S. CLS. 1, 5, 6, 10, 26 AND 46). SN 78-694,831. PUB. 7-10-2007. FILED 8-17-2005.
- 3,297,304. **BANSHEE (BLOCK FORM)**. CEREXAGRI, MULTIPLE CLASS, (INT. CLS. 1 AND 5), (U.S. CLS. 1, 5, 6, 10, 18, 26, 44, 46, 51 AND 52). SN 78-708,808. PUB. 7-10-2007. FILED 9-8-2005.
- 3,297,320. **MISCELLANEOUS DESIGN**. STONE PLUS, INC., MULTIPLE CLASS, (INT. CLS. 1, 11, 19 AND 20), (U.S. CLS. 1, 2, 5, 6, 10, 12, 13, 21, 22, 23, 25, 26, 31, 32, 33, 34, 46 AND 50). SN 78-714,677. PUB. 7-10-2007. FILED 9-16-2005.
- 3,297,334. **GENEGLOBE (BLOCK FORM)**. QIAGEN GMBH, MULTIPLE CLASS, (INT. CLS. 1, 5, 9 AND 42), (U.S. CLS. 1, 5, 6, 10, 18, 21, 23, 26, 36, 38, 44, 46, 51, 52, 100 AND 101). SN 78-722,164. PUB. 7-10-2007. FILED 9-28-2005.
- 3,297,337. **BRENCOAT (BLOCK FORM)**. BRESCO SURFACE ENGINEERING PTY LTD, MULTIPLE CLASS, (INT. CLS. 1 AND 2), (U.S. CLS. 1, 5, 6, 10, 11, 16, 26 AND 46). SN 78-723,969. PUB. 7-10-2007. FILED 9-30-2005.
- 3,297,389. **MVP (BLOCK FORM)**. STRATAGENE CALIFORNIA, (U.S. CLS. 1, 5, 6, 10, 26 AND 46). SN 78-769,169. PUB. 7-10-2007. FILED 12-8-2005.
- 3,297,425. **MEMORYGIFT (BLOCK FORM)**. CRAWFORD, CHARLES GARVIN, MULTIPLE CLASS, (INT. CLS. 1, 9, 16, 35 AND 38), (U.S. CLS. 1, 2, 5, 6, 10, 21, 22, 23, 26, 29, 36, 37, 38, 46, 50, 100, 101, 102 AND 104). SN 78-792,864. PUB. 7-10-2007. FILED 1-17-2006.
- 3,297,427. **TIME IS BRAIN (BLOCK FORM)**. PAION DEUTSCHLAND GMBH, MULTIPLE CLASS, (INT. CLS. 1, 5, 10, 35, 41 AND 42), (U.S. CLS. 1, 5, 6, 10, 18, 26, 39, 44, 46, 51, 52, 100, 101, 102 AND 107). SN 78-793,870. PUB. 7-10-2007. FILED 1-18-2006.
- 3,297,533. **PHYTOGEM (BLOCK FORM)**. ZYGEN CORPORATION LIMITED, MULTIPLE CLASS, (INT. CLS. 1 AND 5), (U.S. CLS. 1, 5, 6, 10, 18, 26, 44, 46, 51 AND 52). SN 78-844,647. PUB. 7-10-2007. FILED 3-23-2006.
- 3,297,557. **MACDERMID (BLOCK FORM)**. MACDERMID ACUMEN, INC., MULTIPLE CLASS, (INT. CLS. 1 AND 17), (U.S. CLS. 1, 5, 6, 10, 12, 13, 26, 35, 46 AND 50). SN 78-852,602. PUB. 7-10-2007. FILED 4-3-2006.
- 3,297,567. **DRIVELUBE (BLOCK FORM)**. HAMILTON SUNSTRAND CORPORATION, (U.S. CLS. 1, 5, 6, 10, 26 AND 46). SN 78-856,366. PUB. 7-10-2007. FILED 4-7-2006.
- 3,297,611. **TBG AND DESIGN**. TBG INC., MULTIPLE CLASS, (INT. CLS. 1 AND 5), (U.S. CLS. 1, 5, 6, 10, 18, 26, 44, 46, 51 AND 52). SN 78-863,371. PUB. 7-10-2007. FILED 4-18-2006.
- 3,297,693. **MISCELLANEOUS DESIGN**. MOLECULAR DEVICES CORPORATION, MULTIPLE CLASS, (INT. CLS. 1 AND 9), (U.S. CLS. 1, 5, 6, 10, 21, 23, 26, 36, 38 AND 46). SN 78-877,856. PUB. 7-10-2007. FILED 5-5-2006.
- 3,297,758. **GLASSMERE FUEL SERVICE AND DESIGN**. GLASSMERE FUEL SERVICE, INC., (U.S. CLS. 1, 5, 6, 10, 26 AND 46). SN 78-887,897. PUB. 7-10-2007. FILED 5-19-2006.
- 3,297,804. **STEVENS EV (BLOCK FORM)**. JPS ELASTOMERICS CORPORATION, MULTIPLE CLASS, (INT. CLS. 1 AND 19), (U.S. CLS. 1, 5, 6, 10, 12, 26, 33, 46 AND 50). SN 78-897,812. PUB. 7-10-2007. FILED 6-1-2006.
- 3,297,834. **KEYSTONE (BLOCK FORM)**. MAIN STREET INGREDIENTS LLC, (U.S. CLS. 1, 5, 6, 10, 26 AND 46).

- SN 78-902,648. PUB. 7-10-2007. FILED 6-7-2006.
- 3,297,958. **MONO PALS (BLOCK FORM)**. PALS GAARD A/S, MULTIPLE CLASS, (INT. CLS. 1 AND 29), (U.S. CLS. 1, 5, 6, 10, 26 AND 46). SN 78-923,361. PUB. 7-10-2007. FILED 7-6-2006.
- 3,297,962. **STRUCT BOND (BLOCK FORM)**. MITSUI CHEMICALS, INC., (U.S. CLS. 1, 5, 6, 10, 26 AND 46). SN 78-924,338. PUB. 7-10-2007. FILED 7-7-2006.
- 3,298,154. **ADVANCE (BLOCK FORM)**. DAKOCYTOMATION DENMARK A/S, MULTIPLE CLASS, (INT. CLS. 1 AND 5), (U.S. CLS. 1, 5, 6, 10, 18, 26, 44, 46, 51 AND 52). SN 79-011,375. PUB. 3-6-2007. FILED 4-20-2005.
- 3,298,155. **LATEXFALT (STYLIZED)**. LATEXFALT B.V., MULTIPLE CLASS, (INT. CLS. 1 AND 19), (U.S. CLS. 1, 5, 6, 10, 12, 26, 33, 46 AND 50). SN 79-011,400. PUB. 7-10-2007. FILED 11-29-2004.
- 3,298,171. **BREWERS CLAREX (BLOCK FORM)**. DSM IP ASSETS B.V., (U.S. CLS. 1, 5, 6, 10, 26 AND 46). SN 79-017,168. PUB. 7-10-2007. FILED 9-28-2005.
- 3,298,187. **BASOSCALE (BLOCK FORM)**. BASF AKTIENGESSELLSCHAFT, (U.S. CLS. 1, 5, 6, 10, 26 AND 46). SN 79-019,500. PUB. 7-10-2007. FILED 12-2-2005.
- 3,298,205. **MISCELLANEOUS DESIGN**. ARGILLON GMBH, MULTIPLE CLASS, (INT. CLS. 1, 7, 9 AND 17), (U.S. CLS. 1, 5, 6, 10, 12, 13, 19, 21, 23, 26, 31, 34, 35, 36, 38, 46 AND 50). SN 79-021,835. PUB. 7-10-2007. FILED 9-26-2005.
- 3,298,246. **SHINEZYME (BLOCK FORM)**. NOVOZYMES A/S, (U.S. CLS. 1, 5, 6, 10, 26 AND 46). SN 79-024,963. PUB. 7-10-2007. FILED 3-30-2006.
- 3,298,249. **AROSTIT (BLOCK FORM)**. CLARIANT AG, MULTIPLE CLASS, (INT. CLS. 1 AND 3), (U.S. CLS. 1, 4, 5, 6, 10, 26, 46, 50, 51 AND 52). SN 79-025,316. PUB. 7-10-2007. FILED 5-23-2006.
- 3,298,253. **FOSCORECO (BLOCK FORM)**. BRIGITTE ELEANORE LHENRY, (U.S. CLS. 1, 5, 6, 10, 26 AND 46). SN 79-025,601. PUB. 7-10-2007. FILED 5-16-2006.
- 3,298,255. **STARISIC (STYLIZED)**. SNECMA PROPULSION SOLIDE, MULTIPLE CLASS, (INT. CLS. 1, 9 AND 19), (U.S. CLS. 1, 5, 6, 10, 12, 21, 23, 26, 33, 36, 38, 46 AND 50). SN 79-025,664. PUB. 7-10-2007. FILED 3-2-2006.
- 3,298,267. **ISITAG (BLOCK FORM)**. MERCK KGAA, (U.S. CLS. 1, 5, 6, 10, 26 AND 46). SN 79-026,138. PUB. 7-10-2007. FILED 5-18-2006.
- 3,298,284. **GRILBOND EASYDIP (BLOCK FORM)**. EMS-CHEMIE AG, (U.S. CLS. 1, 5, 6, 10, 26 AND 46). SN 79-027,081. PUB. 7-10-2007. FILED 6-20-2006.
- 3,298,285. **EASYDIP (BLOCK FORM)**. EMS-CHEMIE AG, (U.S. CLS. 1, 5, 6, 10, 26 AND 46). SN 79-027,082. PUB. 7-10-2007. FILED 6-20-2006.
- 3,298,288. **CERALUBE (BLOCK FORM)**. CLARIANT AG, (U.S. CLS. 1, 5, 6, 10, 26 AND 46). SN 79-027,355. PUB. 7-10-2007. FILED 7-19-2006.
- 3,298,314. **OPTICAKE (BLOCK FORM)**. NOVOZYMES SWITZERLAND AG, (U.S. CLS. 1, 5, 6, 10, 26 AND 46). SN 79-028,132. PUB. 7-10-2007. FILED 9-8-2006.
- 3,298,330. **AFREEZE (BLOCK FORM)**. DR. GERALD FISCHER; DR. FLORIAN HINTRINGER, MULTIPLE CLASS, (INT. CLS. 1, 10, 11, 42 AND 44), (U.S. CLS. 1, 5, 6, 10, 13, 21, 23, 26, 31, 34, 39, 44, 46, 100 AND 101). SN 79-029,239. PUB. 7-10-2007. FILED 6-13-2006.
- 3,298,344. **MISCELLANEOUS DESIGN**. SINOCEM CORPORATION, MULTIPLE CLASS, (INT. CLS. 1, 2, 4, 5 AND 35), (U.S. CLS. 1, 5, 6, 10, 11, 15, 16, 18, 26, 44, 46, 51, 52, 100, 101 AND 102). SN 79-029,872. PUB. 7-10-2007. FILED 3-13-2006.
- 3,298,392. **MERIVA (BLOCK FORM)**. INDENA S.P.A., MULTIPLE CLASS, (INT. CLS. 1, 3 AND 5), (U.S. CLS. 1, 4, 5, 6, 10, 18, 26, 44, 46, 50, 51 AND 52). SN 79-034,263. PUB. 7-10-2007. FILED 12-1-2006.

CLASS 2—PAINTS

- 3,295,999. **ROTECH DIGITAL (BLOCK FORM)**. PRINT VILLAGI, DBA USSUBLIMATION, (U.S. CLS. 6, 11 AND 16). SN 76-617,694. PUB. 12-20-2005. FILED 10-22-2004.
- 3,296,162. **SUZUKA AND DESIGN**. SUZUKA CHEMICAL

- CO., LTD., (U.S. CLS. 6, 11 AND 16). SN 76-670,419. PUB. 7-10-2007. FILED 12-15-2006.
- 3,296,401. **ECOFLO (BLOCK FORM)**. TANDY LEATHER FACTORY, INC., (U.S. CLS. 6, 11 AND 16). SN 77-038,341. PUB. 7-10-2007. FILED 11-7-2006.
- 3,296,627. **CRYSTAL-LOK (BLOCK FORM)**. TOWLE, VAUGHAN C., (U.S. CLS. 6, 11 AND 16). SN 77-063,015. PUB. 7-10-2007. FILED 12-13-2006.
- 3,297,107. **COLORBLADE (BLOCK FORM)**. THE VALSPAR CORPORATION, (U.S. CLS. 6, 11 AND 16). SN 77-107,348. PUB. 7-10-2007. FILED 2-14-2007.
- 3,297,219. **CONTÉ A PARIS (STYLIZED)**. COLART INTERNATIONAL, (U.S. CLS. 6, 11 AND 16). SN 78-563,083. PUB. 7-10-2007. FILED 2-8-2005.
- 3,297,337 (*See Class 1 for this trademark*).
- 3,297,342. **PERMA-SEAL (BLOCK FORM)**. STAUF USA, LLC., (U.S. CLS. 6, 11 AND 16). SN 78-727,528. PUB. 7-10-2007. FILED 10-6-2005.
- 3,297,700. **OPTIMAIL (BLOCK FORM)**. FRANCO TYP-POSTALIA GMBH, MULTIPLE CLASS, (INT. CLS. 2 AND 16), (U.S. CLS. 2, 5, 6, 11, 16, 22, 23, 29, 37, 38 AND 50). SN 78-878,721. PUB. 7-10-2007. FILED 5-8-2006.
- 3,298,344 (*See Class 1 for this trademark*).

CLASS 3—COSMETICS AND CLEANING PREPARATIONS

- 3,295,985. **BERINGER BLACK BEAUTY EQUINE PRODUCTS AND DESIGN**. BERINGER, ALESSA, MULTIPLE CLASS, (INT. CLS. 3 AND 5), (U.S. CLS. 1, 4, 6, 18, 44, 46, 50, 51 AND 52). SN 76-580,469. PUB. 7-10-2007. FILED 3-10-2004.
- 3,296,002. **EPIDERMA AND DESIGN**. CORPORATION EPIDERMA INC., MULTIPLE CLASS, (INT. CLS. 3 AND 44), (U.S. CLS. 1, 4, 6, 50, 51, 52, 100 AND 101). SN 76-624,529. PUB. 7-10-2007. FILED 12-14-2004.
- 3,296,058. **ANS AND DESIGN**. TON, QUY, (U.S. CLS. 1, 4, 6, 50, 51 AND 52). SN 76-658,008. PUB. 7-10-2007. FILED 4-7-2006.
- 3,296,069. **PARLAY (BLOCK FORM)**. ROGERS, JENNIFER L., (U.S. CLS. 1, 4, 6, 50, 51 AND 52). SN 76-659,141. PUB. 7-10-2007. FILED 4-27-2006.
- 3,296,091. **DERMACOLOR (BLOCK FORM)**. KRYOLAN CORPORATION, (U.S. CLS. 1, 4, 6, 50, 51 AND 52). SN 76-662,487. PUB. 7-10-2007. FILED 7-3-2006.
- 3,296,092. **DERMACOLOR LIGHT (BLOCK FORM)**. KRYOLAN CORPORATION, (U.S. CLS. 1, 4, 6, 50, 51 AND 52). SN 76-662,488. PUB. 7-10-2007. FILED 7-3-2006.
- 3,296,229. **BYE-BYE, BOO! (STYLIZED)**. THE CREATIVE CONCEPT, (U.S. CLS. 1, 4, 6, 50, 51 AND 52). SN 77-003,264. PUB. 7-10-2007. FILED 9-20-2006.
- 3,296,249 (*See Class 1 for this trademark*).
- 3,296,286. **COLORTRATION (BLOCK FORM)**. MASON, ALEXANDER S, (U.S. CLS. 1, 4, 6, 50, 51 AND 52). SN 77-017,642. PUB. 7-10-2007. FILED 10-10-2006.
- 3,296,337. **AMBEX (BLOCK FORM)**. INDUSTRIA LA POPULAR, S.A., (U.S. CLS. 1, 4, 6, 50, 51 AND 52). SN 77-028,283. PUB. 7-10-2007. FILED 10-24-2006.
- 3,296,338. **ESPUMIL (BLOCK FORM)**. INDUSTRIA LA POPULAR, S.A., (U.S. CLS. 1, 4, 6, 50, 51 AND 52). SN 77-028,326. PUB. 7-10-2007. FILED 10-24-2006.
- 3,296,440. **JANELLE BEAUTY ONLY PURE GOODNESS AND DESIGN**. JANELLE BEAUTY INC, (U.S. CLS. 1, 4, 6, 50, 51 AND 52). SN 77-044,432. PUB. 7-10-2007. FILED 11-15-2006.
- 3,296,587. **FOR LOCKS THAT ROCK (STYLIZED)**. RAVINDRA JHAVERI, (U.S. CLS. 1, 4, 6, 50, 51 AND 52). SN 77-060,820. PUB. 7-10-2007. FILED 12-10-2006.
- 3,296,651. **MAXI ESSENTIALS (BLOCK FORM)**. QMAX SYSTEMS, LLC, (U.S. CLS. 1, 4, 6, 50, 51 AND 52). SN 77-063,844. PUB. 7-10-2007. FILED 12-13-2006.
- 3,296,734. **AMPLI TONIC (BLOCK FORM)**. L'OREAL, (U.S. CLS. 1, 4, 6, 50, 51 AND 52). SN 77-067,714. PUB. 7-10-2007. FILED 12-19-2006.
- 3,296,846. **THE ESSENTIAL GARAGE FINE AUTOMOTIVE CARE PRODUCTS AND DESIGN**. THE ESSENTIAL GARAGE, INC., (U.S. CLS. 1, 4, 6, 50, 51 AND 52). SN 77-084,950. PUB. 7-10-2007. FILED 1-17-2007.
- 3,296,848. **INVENTEK COLLOIDAL CLEANERS AND DE-**

- SIGN. INVENTEK COLLOIDAL CLEANERS, LLC.** (U.S. CLS. 1, 4, 6, 50, 51 AND 52). SN 77-085,085. PUB. 7-10-2007. FILED 1-17-2007.
- 3,296,936. **L'ANSEUR (BLOCK FORM).** TRIAD CATALOG CO., LLC. (U.S. CLS. 1, 4, 6, 50, 51 AND 52). SN 77-089,932. PUB. 7-10-2007. FILED 1-24-2007.
- 3,296,961. **BEAUTY BOX (BLOCK FORM),** IN THE BEAUTY BOX, INC., (U.S. CLS. 1, 4, 6, 50, 51 AND 52). SN 77-091,087. PUB. 7-10-2007. FILED 1-25-2007.
- 3,297,078. **K-DERM (BLOCK FORM).** DONELL, INC., (U.S. CLS. 1, 4, 6, 50, 51 AND 52). SN 77-100,595. PUB. 7-10-2007. FILED 2-6-2007.
- 3,297,103. **COLLECTION CROISIERE (BLOCK FORM).** PAFUMS CHRISTIAN DIOR, (U.S. CLS. 1, 4, 6, 50, 51 AND 52). SN 77-105,409. PUB. 7-10-2007. FILED 2-12-2007.
- 3,297,239. **FUENTE FUENTE OPUS X (BLOCK FORM).** FUENTE MARKETING LTD., (U.S. CLS. 1, 4, 6, 50, 51 AND 52). SN 78-597,263. PUB. 7-10-2007. FILED 3-29-2005.
- 3,297,261. **DIOR (BLOCK FORM),** PARFUMS CHRISTIAN DIOR, (U.S. CLS. 1, 4, 6, 50, 51 AND 52). SN 78-641,493. PUB. 7-10-2007. FILED 6-1-2005.
- 3,297,345. **SLAZENGER (STYLIZED).** SLAZENGRS LIMITED, MULTIPLE CLASS, (INT. CLS. 3, 5, 9, 11, 12, 14, 16, 18, 24, 25, 28, 30 AND 32), (U.S. CLS. 1, 2, 3, 4, 5, 6, 13, 18, 19, 21, 22, 23, 26, 27, 28, 29, 31, 34, 35, 36, 37, 38, 39, 41, 42, 44, 45, 46, 48, 50, 51 AND 52). SN 78-729,771. PUB. 7-10-2007. FILED 10-10-2005.
- 3,297,363. **HAERU (BLOCK FORM).** C'WATRE, (U.S. CLS. 1, 4, 6, 50, 51 AND 52). SN 78-754,185. PUB. 7-10-2007. FILED 11-15-2005.
- 3,297,364. **ZENKAI (BLOCK FORM).** C'WATRE, (U.S. CLS. 1, 4, 6, 50, 51 AND 52). SN 78-754,210. PUB. 7-10-2007. FILED 11-15-2005.
- 3,297,369. **DRENCH YOUR SKIN (BLOCK FORM).** C'WATRE, (U.S. CLS. 1, 4, 6, 50, 51 AND 52). SN 78-757,604. PUB. 7-10-2007. FILED 11-18-2005.
- 3,297,373. **MESSY LAB AND DESIGN.** HSIAO, CHENG-YI, (U.S. CLS. 1, 4, 6, 50, 51 AND 52). SN 78-760,923. PUB. 7-10-2007. FILED 11-25-2005.
- 3,297,377. **VISCO-MATIC (BLOCK FORM).** SCHWAN-STABLO COSMETICS GMBH & CO. KG, (U.S. CLS. 1, 4, 6, 50, 51 AND 52). SN 78-764,468. PUB. 7-10-2007. FILED 12-1-2005.
- 3,297,405. **MISCELLANEOUS DESIGN.** DECATHLON, MULTIPLE CLASS, (INT. CLS. 3, 4, 5, 6, 8, 9, 11, 12, 16, 18, 20, 21, 25, 28, 31, 39, 41, 43 AND 44), (U.S. CLS. 1, 2, 3, 4, 5, 6, 12, 13, 14, 15, 18, 19, 21, 22, 23, 25, 26, 28, 29, 30, 31, 32, 33, 34, 35, 36, 37, 38, 39, 40, 41, 44, 46, 50, 51, 52, 100, 101, 105 AND 107). SN 78-782,855. PUB. 7-10-2007. FILED 12-30-2005.
- 3,297,408. **ECCO BELLA DISCOVER INTELLIGENT BEAUTY (BLOCK FORM).** E. B. BOTANICALS, LLC, (U.S. CLS. 1, 4, 6, 50, 51 AND 52). SN 78-783,972. PUB. 7-10-2007. FILED 1-3-2006.
- 3,297,409. **THE PERFECT SHAVE (BLOCK FORM).** ERIC MALKA, (U.S. CLS. 1, 4, 6, 50, 51 AND 52). SN 78-784,191. PUB. 7-10-2007. FILED 1-3-2006.
- 3,297,654. **SPA AND DESIGN.** COSMOS CORPORATION, (U.S. CLS. 1, 4, 6, 50, 51 AND 52). SN 78-871,174. PUB. 7-10-2007. FILED 4-27-2006.
- 3,297,655. **LAVISH YOUR PET (BLOCK FORM).** COSMOS CORPORATION, (U.S. CLS. 1, 4, 6, 50, 51 AND 52). SN 78-871,188. PUB. 7-10-2007. FILED 4-27-2006.
- 3,297,660. **GINGER GLOSS (BLOCK FORM).** ORIGINS NATURAL RESOURCES, INC., (U.S. CLS. 1, 4, 6, 50, 51 AND 52). SN 78-871,707. PUB. 7-10-2007. FILED 4-27-2006.
- 3,297,703. **DIFIABA (BLOCK FORM).** DIFIABA, LLC, (U.S. CLS. 1, 4, 6, 50, 51 AND 52). SN 78-879,108. PUB. 7-10-2007. FILED 5-8-2006.
- 3,297,740. **AUTHENTIC HENDRIX AND DESIGN.** EXPERIENCE HENDRIX, L.L.C., (U.S. CLS. 1, 4, 6, 50, 51 AND 52). SN 78-886,086. PUB. 7-10-2007. FILED 5-17-2006.
- 3,297,787. **FIFTH AVENUE EYE ASSOCIATES (BLOCK FORM).** ELAHI, EBRAHIM, MULTIPLE CLASS, (INT. CLS. 3, 9 AND 44), (U.S. CLS. 1, 4, 6, 21, 23, 26, 36, 38, 50, 51, 52, 100 AND 101). SN 78-894,073. PUB. 7-10-2007. FILED 5-26-2006.
- 3,297,832. **'THE PEOPLE OF BEAUTIFUL HAIR' (BLOCK FORM).** OJON CORPORATION, MULTIPLE CLASS, (INT. CLS. 3 AND 26), (U.S. CLS. 1, 4, 6, 37, 39, 40, 42, 50, 51 AND 52). SN 78-902,570. PUB. 7-10-2007. FILED 6-7-2006.
- 3,298,019. **CLINIGUARD (BLOCK FORM).** SCA HYGIENE PRODUCTS AB, MULTIPLE CLASS, (INT. CLS. 3 AND 10), (U.S. CLS. 1, 4, 6, 26, 39, 44, 50, 51 AND 52). SN 78-940,189. PUB. 7-10-2007. FILED 7-28-2006.
- 3,298,093. **HOLLYTEX (BLOCK FORM).** BEAULIEU GROUP, LLC, (U.S. CLS. 1, 4, 6, 50, 51 AND 52). SN 78-961,690. PUB. 7-10-2007. FILED 8-28-2006.
- 3,298,179. **THIRTYFIVE VIA TORTONA 35 (BLOCK FORM).** C.I.T. S.P.A. CONFEZIONI ITALIANE TESSILI COMMERCIO INDUSTRIA TESSUTI, MULTIPLE CLASS, (INT. CLS. 3, 18 AND 25), (U.S. CLS. 1, 2, 3, 4, 6, 22, 39, 41, 50, 51 AND 52). SN 79-018,753. PUB. 7-10-2007. FILED 9-30-2005.
- 3,298,180. **THIRTYFIVE VIA TORTONA 35 MILANO AND DESIGN.** C.I.T. S.P.A. CONFEZIONI ITALIANE TESSILI COMMERCIO INDUSTRIA TESSUTI, MULTIPLE CLASS, (INT. CLS. 3, 18 AND 25), (U.S. CLS. 1, 2, 3, 4, 6, 22, 39, 41, 50, 51 AND 52). SN 79-018,843. PUB. 7-10-2007. FILED 9-30-2005.
- 3,298,214. **GUNA AND DESIGN.** GUNA S.P.A., MULTIPLE CLASS, (INT. CLS. 3, 5, 9, 16, 32, 39 AND 41), (U.S. CLS. 1, 2, 4, 5, 6, 18, 21, 22, 23, 26, 29, 36, 37, 38, 44, 45, 46, 48, 50, 51, 52, 100, 101, 105 AND 107). SN 79-022,637. PUB. 7-10-2007. FILED 11-23-2005.
- 3,298,232. **EVIDENS DE BEAUTÉ (STYLIZED).** BHL S.A., (U.S. CLS. 1, 4, 6, 50, 51 AND 52). SN 79-024,393. PUB. 7-10-2007. FILED 4-21-2006.
- 3,298,248. **TINO COSMA (BLOCK FORM).** COSMA S.P.A., MULTIPLE CLASS, (INT. CLS. 3 AND 25), (U.S. CLS. 1, 4, 6, 22, 39, 50, 51 AND 52). SN 79-025,135. PUB. 7-10-2007. FILED 3-21-2006.
- 3,298,249 (*See Class 1 for this trademark*).
- 3,298,250. **BREF JUMBO (BLOCK FORM).** HENKEL KGAA, MULTIPLE CLASS, (INT. CLS. 3 AND 5), (U.S. CLS. 1, 4, 6, 18, 44, 46, 50, 51 AND 52). SN 79-025,440. PUB. 7-10-2007. FILED 4-11-2006.
- 3,298,265. **MATIS PARIS AND DESIGN.** MARKLINE S.A., MULTIPLE CLASS, (INT. CLS. 3, 5 AND 44), (U.S. CLS. 1, 4, 6, 18, 44, 46, 50, 51, 52, 100 AND 101). SN 79-026,085. PUB. 7-10-2007. FILED 6-22-2006.
- 3,298,266. **POWER MAN (BLOCK FORM).** EUROITALIA S.R.L., (U.S. CLS. 1, 4, 6, 50, 51 AND 52). SN 79-026,086. PUB. 7-10-2007. FILED 5-5-2006.
- 3,298,287. **CAT DELUXE (BLOCK FORM).** MÜLHENS GMBH & CO. KG, (U.S. CLS. 1, 4, 6, 50, 51 AND 52). SN 79-027,331. PUB. 7-10-2007. FILED 7-7-2006.
- 3,298,299. **AQUA LAIT (BLOCK FORM).** CASTER, (U.S. CLS. 1, 4, 6, 50, 51 AND 52). SN 79-027,653. PUB. 7-10-2007. FILED 7-19-2006.
- 3,298,315. **IBED (BLOCK FORM).** UWE GMBH, MULTIPLE CLASS, (INT. CLS. 3 AND 11), (U.S. CLS. 1, 4, 6, 13, 21, 23, 31, 34, 50, 51 AND 52). SN 79-028,312. PUB. 7-10-2007. FILED 4-10-2006.
- 3,298,345. **VENATRIX (BLOCK FORM).** NANNIC INT, BVBA, MULTIPLE CLASS, (INT. CLS. 3, 5 AND 44), (U.S. CLS. 1, 4, 6, 18, 44, 46, 50, 51, 52, 100 AND 101). SN 79-029,881. PUB. 7-10-2007. FILED 8-3-2006.
- 3,298,349. **ENRICO LUMANI (STYLIZED).** LUNEMANN, HEINRICH, MULTIPLE CLASS, (INT. CLS. 3, 14, 18, 24 AND 25), (U.S. CLS. 1, 2, 3, 4, 6, 22, 27, 28, 39, 41, 42, 50, 51 AND 52). SN 79-030,540. PUB. 7-10-2007. FILED 5-3-2006.
- 3,298,360. **KYLIE MINOGUE DARLING (BLOCK FORM).** KDB PTY LTD, (U.S. CLS. 1, 4, 6, 50, 51 AND 52). SN 79-031,337. PUB. 7-10-2007. FILED 11-6-2006.
- 3,298,372. **LOSTMARCH (STYLIZED).** SOCIETE BRETONNE DE BIEN-ÊTRE, MULTIPLE CLASS, (INT. CLS. 3, 4 AND 24), (U.S. CLS. 1, 4, 6, 15, 42, 50, 51 AND 52). SN 79-032,277. PUB. 7-10-2007. FILED 9-28-2006.
- 3,298,386. **MP3 AND DESIGN.** UNHYCOS, MULTIPLE CLASS, (INT. CLS. 3 AND 8), (U.S. CLS. 1, 4, 6, 23, 28, 44, 50, 51 AND 52). SN 79-033,661. PUB. 7-10-2007. FILED 6-26-2006.
- 3,298,391. **HOSS INTROPIA (STYLIZED).** AT LEAST, S.A., MULTIPLE CLASS, (INT. CLS. 3, 18 AND 25), (U.S. CLS. 1, 2, 3, 4, 6, 22, 39, 41, 50, 51 AND 52). SN 79-034,199. PUB. 7-10-2007. FILED 4-28-2006.
- 3,298,392 (*See Class 1 for this trademark*).

CLASS 4—LUBRICANTS AND FUELS

- 3,296,193. **12/34 MIRACLE FORMULA AND DESIGN**. AR-MITE LABORATORIES, (U.S. CLS. 1, 6 AND 15). SN 76-671,816. PUB. 7-10-2007. FILED 1-25-2007.
- 3,296,891. **WINTER WARMTH WOOD PELLETS (BLOCK FORM)**. HAMER PELLET FUEL COMPANY, (U.S. CLS. 1, 6 AND 15). SN 77-087,669. PUB. 7-10-2007. FILED 1-22-2007.
- 3,296,921. **MONOLEX (BLOCK FORM)**. LUBRICATION ENGINEERS, INC., (U.S. CLS. 1, 6 AND 15). SN 77-089,177. PUB. 7-10-2007. FILED 1-23-2007.
- 3,296,923. **MULTILEC (BLOCK FORM)**. LUBRICATION ENGINEERS, INC., (U.S. CLS. 1, 6 AND 15). SN 77-089,302. PUB. 7-10-2007. FILED 1-23-2007.
- 3,296,924. **SYNTEMP (BLOCK FORM)**. LUBRICATION ENGINEERS, INC., (U.S. CLS. 1, 6 AND 15). SN 77-089,363. PUB. 7-10-2007. FILED 1-23-2007.
- 3,296,925. **QUINPLEX (BLOCK FORM)**. LUBRICATION ENGINEERS, INC., (U.S. CLS. 1, 6 AND 15). SN 77-089,447. PUB. 7-10-2007. FILED 1-23-2007.
- 3,296,929. **SYNOLEC (BLOCK FORM)**. LUBRICATION ENGINEERS, INC., (U.S. CLS. 1, 6 AND 15). SN 77-089,670. PUB. 7-10-2007. FILED 1-24-2007.
- 3,296,930. **ALMAPLEX (BLOCK FORM)**. LUBRICATION ENGINEERS, INC., (U.S. CLS. 1, 6 AND 15). SN 77-089,677. PUB. 7-10-2007. FILED 1-24-2007.
- 3,297,123. **ALMATEK (BLOCK FORM)**. LUBRICATION ENGINEERS, INC., (U.S. CLS. 1, 6 AND 15). SN 77-113,242. PUB. 7-10-2007. FILED 2-22-2007.
- 3,297,360. **PLUME (STYLIZED)**. A CANDLE IN THE WINDOW, INC., (U.S. CLS. 1, 6 AND 15). SN 78-751,523. PUB. 7-10-2007. FILED 11-10-2005.
- 3,297,405 (*See Class 3 for this trademark*).
- 3,297,838. **TULA (BLOCK FORM)**. ASTRAEA, LLC, (U.S. CLS. 1, 6 AND 15). SN 78-902,903. PUB. 7-10-2007. FILED 6-7-2006.
- 3,297,853. **ORIGINAL RECIPE (BLOCK FORM)**. CANDLE CORPORATION OF AMERICA, (U.S. CLS. 1, 6 AND 15). SN 78-905,052. PUB. 7-10-2007. FILED 6-9-2006.
- 3,298,344 (*See Class 1 for this trademark*).
- 3,298,372 (*See Class 3 for this trademark*).

CLASS 5—PHARMACEUTICALS

- 3,295,985 (*See Class 3 for this trademark*).
- 3,296,016. **UNIFLEX AND DESIGN**. SCHIFF NUTRITION INTERNATIONAL, INC., (U.S. CLS. 6, 18, 44, 46, 51 AND 52). SN 76-643,743. PUB. 7-10-2007. FILED 7-27-2005.
- 3,296,027. **PONTIC COVER LT2 (BLOCK FORM)**. PRECIOUS CHEMICALS LTD., (U.S. CLS. 6, 18, 44, 46, 51 AND 52). SN 76-646,275. PUB. 7-10-2007. FILED 9-6-2005.
- 3,296,035. **BG BAR (BLOCK FORM)**. CELL TECH INTERNATIONAL INC., (U.S. CLS. 6, 18, 44, 46, 51 AND 52). SN 76-648,283. PUB. 7-10-2007. FILED 10-12-2005.
- 3,296,071. **MULTI JUICE 4-LIFE (BLOCK FORM)**. ONLY NATURAL, INC., (U.S. CLS. 6, 18, 44, 46, 51 AND 52). SN 76-659,851. PUB. 3-27-2007. FILED 5-5-2006.
- 3,296,082. **BARIELLE FUNGUSRX AND DESIGN**. J.E.B. VENTURES, INC., (U.S. CLS. 6, 18, 44, 46, 51 AND 52). SN 76-661,470. PUB. 7-10-2007. FILED 6-12-2006.
- 3,296,089. **XENADRINE EFX AND DESIGN**. NUTRAQUEST, INC., (U.S. CLS. 6, 18, 44, 46, 51 AND 52). SN 76-662,180. PUB. 7-10-2007. FILED 6-27-2006.
- 3,296,116. **CALAMBRAIN CRAMP-NOT (BLOCK FORM)**. MEDICAL PRODUCTS PANAMERICANA, INC., (U.S. CLS. 6, 18, 44, 46, 51 AND 52). SN 76-665,350. PUB. 7-10-2007. FILED 8-28-2006.
- 3,296,180. **DREX-PH3 (STYLIZED)**. DREXEL CHEMICAL COMPANY, (U.S. CLS. 6, 18, 44, 46, 51 AND 52). SN 76-671,037. PUB. 7-10-2007. FILED 1-4-2007.
- 3,296,214. **PSORICAID (BLOCK FORM)**. CHI'S ENTERPRISE, INC., (U.S. CLS. 6, 18, 44, 46, 51 AND 52). SN 76-673,516. PUB. 7-10-2007. FILED 3-2-2007.
- 3,296,215. **CHI (STYLIZED)**. CHI'S ENTERPRISE, INC., (U.S. CLS. 6, 18, 44, 46, 51 AND 52). SN 76-673,517. PUB. 7-10-2007. FILED 3-2-2007.
- 3,296,223. **AURILOY (BLOCK FORM)**. THE ARGEN CORPORATION, (U.S. CLS. 6, 18, 44, 46, 51 AND 52). SN 77-001,431. PUB. 7-10-2007. FILED 9-18-2006.
- 3,296,249 (*See Class 1 for this trademark*).
- 3,296,434. **WISDOM 3 (BLOCK FORM)**. VERYWISE NUTRITION LIMITED, (U.S. CLS. 6, 18, 44, 46, 51 AND 52). SN 77-043,188. PUB. 7-10-2007. FILED 11-14-2006.
- 3,296,439. **TR CAPS TIME RELEASE AND DESIGN**. OSMOPHARM, USA, (U.S. CLS. 6, 18, 44, 46, 51 AND 52). SN 77-044,385. PUB. 7-10-2007. FILED 11-15-2006.
- 3,296,484. **OPHTHIMAL (BLOCK FORM)**. BUTLER ANIMAL HEALTH SUPPLY, LLC, (U.S. CLS. 6, 18, 44, 46, 51 AND 52). SN 77-050,405. PUB. 7-10-2007. FILED 11-24-2006.
- 3,296,596. **DONG-QUAI POWER (BLOCK FORM)**. ISI BRANDS, INC., (U.S. CLS. 6, 18, 44, 46, 51 AND 52). SN 77-061,361. PUB. 7-10-2007. FILED 12-11-2006.
- 3,296,599. **BORAGE-POWER (BLOCK FORM)**. ISI BRANDS, INC., (U.S. CLS. 6, 18, 44, 46, 51 AND 52). SN 77-061,405. PUB. 7-10-2007. FILED 12-11-2006.
- 3,296,600. **GLUCOSAMINE FUEL (BLOCK FORM)**. ISI BRANDS, INC., (U.S. CLS. 6, 18, 44, 46, 51 AND 52). SN 77-061,459. PUB. 7-10-2007. FILED 12-11-2006.
- 3,296,601. **INFLAM-AID (BLOCK FORM)**. ISI BRANDS, INC., (U.S. CLS. 6, 18, 44, 46, 51 AND 52). SN 77-061,487. PUB. 7-10-2007. FILED 12-11-2006.
- 3,296,602. **MEGA SOY (BLOCK FORM)**. ISI BRANDS, INC., (U.S. CLS. 6, 18, 44, 46, 51 AND 52). SN 77-061,500. PUB. 7-10-2007. FILED 12-11-2006.
- 3,296,708. **OSTEOCHON (BLOCK FORM)**. KINETIC TECHNOLOGIES, LLC, (U.S. CLS. 6, 18, 44, 46, 51 AND 52). SN 77-065,222. PUB. 7-10-2007. FILED 12-15-2006.
- 3,296,714. **EQUI-SALVE (BLOCK FORM)**. NUTOPICALS, L.L.C., (U.S. CLS. 6, 18, 44, 46, 51 AND 52). SN 77-065,551. PUB. 7-10-2007. FILED 12-15-2006.
- 3,296,820. **L'IL CRITTERS FRUIT & VEGGIE BEARS (BLOCK FORM)**. NORTHWEST NATURAL PRODUCTS, INC., (U.S. CLS. 6, 18, 44, 46, 51 AND 52). SN 77-083,260. PUB. 7-10-2007. FILED 1-15-2007.
- 3,296,832. **ECONOLUX (BLOCK FORM)**. HARTMANN-CONCO, INC., (U.S. CLS. 6, 18, 44, 46, 51 AND 52). SN 77-084,390. PUB. 7-10-2007. FILED 1-17-2007.
- 3,296,878. **DERM-CHEWS (BLOCK FORM)**. HEALTHY PETS, INC., (U.S. CLS. 6, 18, 44, 46, 51 AND 52). SN 77-087,171. PUB. 7-10-2007. FILED 1-19-2007.
- 3,296,889. **SPECIES (BLOCK FORM)**. RX MUSCLE, INC., (U.S. CLS. 6, 18, 44, 46, 51 AND 52). SN 77-087,541. PUB. 7-10-2007. FILED 1-21-2007.
- 3,296,890. **LIPOLYZE (BLOCK FORM)**. RX MUSCLE, INC., (U.S. CLS. 6, 18, 44, 46, 51 AND 52). SN 77-087,545. PUB. 7-10-2007. FILED 1-22-2007.
- 3,297,081. **ARTHURIN (BLOCK FORM)**. HEALTHY PETS, INC., (U.S. CLS. 6, 18, 44, 46, 51 AND 52). SN 77-100,835. PUB. 7-10-2007. FILED 2-6-2007.
- 3,297,105. **RHINO CALCIUMS (BLOCK FORM)**. NUTRITION NOW, INC., (U.S. CLS. 6, 18, 44, 46, 51 AND 52). SN 77-106,721. PUB. 7-10-2007. FILED 2-13-2007.
- 3,297,119. **ALLURE PLUS (BLOCK FORM)**. CARGILL, INCORPORATED, (U.S. CLS. 6, 18, 44, 46, 51 AND 52). SN 77-112,300. PUB. 7-10-2007. FILED 2-21-2007.
- 3,297,146. **MISCELLANEOUS DESIGN**. ECONUGENICS, INC., (U.S. CLS. 6, 18, 44, 46, 51 AND 52). SN 77-125,954. PUB. 7-10-2007. FILED 3-8-2007.
- 3,297,161. **SHED-PRO (BLOCK FORM)**. HEALTHY PETS, INC., (U.S. CLS. 6, 18, 44, 46, 51 AND 52). SN 77-138,302. PUB. 7-10-2007. FILED 3-22-2007.
- 3,297,198. **DIETEX (BLOCK FORM)**. VITAL PHARMACEUTICALS, INC., (U.S. CLS. 6, 18, 44, 46, 51 AND 52). SN 78-488,660. PUB. 7-10-2007. FILED 9-23-2004.
- 3,297,209 (*See Class 1 for this trademark*).
- 3,297,210 (*See Class 1 for this trademark*).
- 3,297,220. **S.T.CHEMICAL (BLOCK FORM)**. S.T.CHEMICAL CO., LTD., MULTIPLE CLASS, (INT. CLS. 5 AND 11), (U.S. CLS. 6, 13, 18, 21, 23, 31, 34, 44, 46, 51 AND 52). SN 78-567,950. PUB. 12-5-2006. FILED 2-15-2005.
- 3,297,241. **LUROSIL (BLOCK FORM)**. ROCKY MOUNTAIN VITAMINS, INC., (U.S. CLS. 6, 18, 44, 46, 51 AND 52). SN 78-609,710. PUB. 7-10-2007. FILED 4-15-2005.
- 3,297,266. **PTS (BLOCK FORM)**. POLYMER TECHNOLOGY

- SYSTEMS, INC., MULTIPLE CLASS, (INT. CLS. 5 AND 10), (U.S. CLS. 6, 18, 26, 39, 44, 46, 51 AND 52). SN 78-646,600. PUB. 7-10-2007. FILED 6-8-2005.
- 3,297,270. **GANMAOLING TABLETS AND DESIGN**. MADISON ONE ACME, INC., DBA SOLSTICE MEDICINE COMPANY, (U.S. CLS. 6, 18, 44, 46, 51 AND 52). SN 78-673,800. PUB. 7-10-2007. FILED 7-19-2005.
- 3,297,285. **LIQUA TRITON AND DESIGN**. FRONTIER NUTRITION INCORPORATED, (U.S. CLS. 6, 18, 44, 46, 51 AND 52). SN 78-697,032. PUB. 4-10-2007. FILED 8-21-2005.
- 3,297,304 (*See Class 1 for this trademark*).
- 3,297,307. **DOGMATIL (BLOCK FORM)**. SANOFI-AVENTIS, (U.S. CLS. 6, 18, 44, 46, 51 AND 52). SN 78-709,394. PUB. 7-10-2007. FILED 9-8-2005.
- 3,297,333. **CRITICAL CARE (BLOCK FORM)**. OXBOW ENTERPRISES, INC., (U.S. CLS. 6, 18, 44, 46, 51 AND 52). SN 78-721,680. PUB. 7-10-2007. FILED 9-27-2005.
- 3,297,334 (*See Class 1 for this trademark*).
- 3,297,345 (*See Class 3 for this trademark*).
- 3,297,361. **SLEEPSENSE (BLOCK FORM)**. PREFERRED NUTRITION INC., (U.S. CLS. 6, 18, 44, 46, 51 AND 52). SN 78-753,532. PUB. 7-10-2007. FILED 11-14-2005.
- 3,297,372. **WISE SHOPPER (BLOCK FORM)**. ABALINE PAPER PRODUCTS, INC., MULTIPLE CLASS, (INT. CLS. 5 AND 21), (U.S. CLS. 2, 6, 13, 18, 23, 29, 30, 33, 40, 44, 46, 50, 51 AND 52). SN 78-760,690. PUB. 7-10-2007. FILED 11-23-2005.
- 3,297,405 (*See Class 3 for this trademark*).
- 3,297,427 (*See Class 1 for this trademark*).
- 3,297,442. **DETOXION (BLOCK FORM)**. STEPHEN WOO, (U.S. CLS. 6, 18, 44, 46, 51 AND 52). SN 78-803,007. PUB. 7-10-2007. FILED 1-31-2006.
- 3,297,446. **ZZZ-EES AND DESIGN**. NAVAJO MANUFACTURING COMPANY, (U.S. CLS. 6, 18, 44, 46, 51 AND 52). SN 78-804,797. PUB. 7-10-2007. FILED 2-1-2006.
- 3,297,502. **SCAN'SPRAY (BLOCK FORM)**. DENTACO DENTALINDUSTRIE UND -MARKETING GMBH, (U.S. CLS. 6, 18, 44, 46, 51 AND 52). SN 78-832,612. PUB. 7-10-2007. FILED 3-8-2006.
- 3,297,533 (*See Class 1 for this trademark*).
- 3,297,554. **FLY SAFE (BLOCK FORM)**. JEFFREY A. COHEN, (U.S. CLS. 6, 18, 44, 46, 51 AND 52). SN 78-852,201. PUB. 7-10-2007. FILED 4-3-2006.
- 3,297,599. **ZEMA (BLOCK FORM)**. VIRBAC CORPORATION, (U.S. CLS. 6, 18, 44, 46, 51 AND 52). SN 78-862,101. PUB. 7-10-2007. FILED 4-14-2006.
- 3,297,611 (*See Class 1 for this trademark*).
- 3,297,625. **DOUXO (BLOCK FORM)**. SOGEVAL, SOCIÉTÉ ANONYME, (U.S. CLS. 6, 18, 44, 46, 51 AND 52). SN 78-865,950. PUB. 7-10-2007. FILED 4-20-2006.
- 3,297,627. **STRAIGHT ARROW (BLOCK FORM)**. STRAIGHT ARROW PRODUCTS, INC., (U.S. CLS. 6, 18, 44, 46, 51 AND 52). SN 78-866,417. PUB. 12-5-2006. FILED 4-21-2006.
- 3,297,630. **20 20 LIFESTYLES AND DESIGN**. PROFESSIONAL RECREATION ORGANIZATION, INC., MULTIPLE CLASS, (INT. CLS. 5, 9 AND 44), (U.S. CLS. 6, 18, 21, 23, 26, 36, 38, 44, 46, 51, 52, 100 AND 101). SN 78-866,532. PUB. 7-10-2007. FILED 4-21-2006.
- 3,297,639. **F FRIO TECHNOLOGIES INC. AND DESIGN**. FRIO TECHNOLOGIES INC., (U.S. CLS. 6, 18, 44, 46, 51 AND 52). SN 78-869,029. PUB. 7-10-2007. FILED 4-25-2006.
- 3,297,688. **TEYMP'S TOPICAL POTASSIUM OINTMENT (BLOCK FORM)**. DESHAY, SAMUEL L., (U.S. CLS. 6, 18, 44, 46, 51 AND 52). SN 78-876,422. PUB. 7-10-2007. FILED 5-4-2006.
- 3,297,690. **VI-PAK (BLOCK FORM)**. VISALUS HOLDINGS LLC, (U.S. CLS. 6, 18, 44, 46, 51 AND 52). SN 78-876,826. PUB. 7-10-2007. FILED 5-4-2006.
- 3,297,719. **TEMPSAN (BLOCK FORM)**. JENERIC/PENTRON, MULTIPLE CLASS, (INT. CLS. 5 AND 10), (U.S. CLS. 6, 18, 26, 39, 44, 46, 51 AND 52). SN 78-883,222. PUB. 7-10-2007. FILED 5-15-2006.
- 3,297,766. **SATISE (BLOCK FORM)**. KEMIN INDUSTRIES, INC., (U.S. CLS. 6, 18, 44, 46, 51 AND 52). SN 78-889,197. PUB. 7-10-2007. FILED 5-22-2006.
- 3,297,801. **FOLMOR (BLOCK FORM)**. THERAGENEX PROPERTIES LIMITED, (U.S. CLS. 6, 18, 44, 46, 51 AND 52). SN 78-897,375. PUB. 7-10-2007. FILED 5-31-2006.
- 3,297,859. **POUND-X (BLOCK FORM)**. CCA INDUSTRIES, INC., (U.S. CLS. 6, 18, 44, 46, 51 AND 52). SN 78-905,779. PUB. 7-10-2007. FILED 6-12-2006.
- 3,297,902. **FRUIT ADVANTAGE CHERRY PRIME (BLOCK FORM)**. LAPTE ENTREPRISES, INC., (U.S. CLS. 6, 18, 44, 46, 51 AND 52). SN 78-910,716. PUB. 7-10-2007. FILED 6-17-2006.
- 3,297,918. **NATUROPATHICA (BLOCK FORM)**. NATUROPATHICA HOLISTIC HEALTH LLC, (U.S. CLS. 6, 18, 44, 46, 51 AND 52). SN 78-913,952. PUB. 7-10-2007. FILED 6-22-2006.
- 3,297,995. **MELTEEZ (BLOCK FORM)**. L. PERRIGO COMPANY, (U.S. CLS. 6, 18, 44, 46, 51 AND 52). SN 78-931,468. PUB. 7-10-2007. FILED 7-18-2006.
- 3,298,098. **KOALA COVERS (BLOCK FORM)**. FETA MED, INC., (U.S. CLS. 6, 18, 44, 46, 51 AND 52). SN 78-962,643. PUB. 7-10-2007. FILED 8-29-2006.
- 3,298,104. **MISCELLANEOUS DESIGN**. INTERVET INC., (U.S. CLS. 6, 18, 44, 46, 51 AND 52). SN 78-963,109. PUB. 7-10-2007. FILED 8-29-2006.
- 3,298,134. **KREMEZIN (BLOCK FORM)**. KUREHA CORPORATION, (U.S. CLS. 6, 18, 44, 46, 51 AND 52). SN 78-970,713. PUB. 7-10-2007. FILED 9-9-2006.
- 3,298,154 (*See Class 1 for this trademark*).
- 3,298,163. **ENZINAVIS (BLOCK FORM)**. AREXIS AB, (U.S. CLS. 6, 18, 44, 46, 51 AND 52). SN 79-016,111. PUB. 7-10-2007. FILED 9-7-2005.
- 3,298,164. **CERLIANZA (BLOCK FORM)**. AREXIS AB, (U.S. CLS. 6, 18, 44, 46, 51 AND 52). SN 79-016,132. PUB. 7-10-2007. FILED 9-7-2005.
- 3,298,174. **BIOSFOUR (BLOCK FORM)**. VITARGET GMBH & CO. KG, MULTIPLE CLASS, (INT. CLS. 5, 30 AND 31), (U.S. CLS. 1, 6, 18, 44, 46, 51 AND 52). SN 79-018,499. PUB. 7-10-2007. FILED 10-20-2005.
- 3,298,199. **CERAMENT (STYLIZED)**. BONE SUPPORT AB, MULTIPLE CLASS, (INT. CLS. 5 AND 41), (U.S. CLS. 6, 18, 44, 46, 51, 52, 100, 101 AND 107). SN 79-020,794. PUB. 7-10-2007. FILED 11-10-2005.
- 3,298,214 (*See Class 3 for this trademark*).
- 3,298,218. **VIGIFLU (BLOCK FORM)**. SANOFI-AVENTIS, MULTIPLE CLASS, (INT. CLS. 5, 41, 42 AND 44), (U.S. CLS. 6, 18, 44, 46, 51, 52, 100, 101 AND 107). SN 79-022,924. PUB. 7-10-2007. FILED 3-13-2006.
- 3,298,250 (*See Class 3 for this trademark*).
- 3,298,265 (*See Class 3 for this trademark*).
- 3,298,281. **CELTURA (BLOCK FORM)**. NOVARTIS VACCINES AND DIAGNOSTICS GMBH & CO. KG, (U.S. CLS. 6, 18, 44, 46, 51 AND 52). SN 79-027,061. PUB. 7-10-2007. FILED 5-31-2006.
- 3,298,282. **OPTAFLU (BLOCK FORM)**. NOVARTIS VACCINES AND DIAGNOSTICS GMBH & CO. KG, (U.S. CLS. 6, 18, 44, 46, 51 AND 52). SN 79-027,062. PUB. 7-10-2007. FILED 5-31-2006.
- 3,298,300. **NICO-SLIM (BLOCK FORM)**. SPIRITUAL & PERSONAL GROWTH TRUST, MULTIPLE CLASS, (INT. CLS. 5 AND 30), (U.S. CLS. 6, 18, 44, 46, 51 AND 52). SN 79-027,657. PUB. 7-10-2007. FILED 4-26-2006.
- 3,298,307. **FLAVOMYCIN AND DESIGN**. BIOVET JSC, MULTIPLE CLASS, (INT. CLS. 5 AND 31), (U.S. CLS. 1, 6, 18, 44, 46, 51 AND 52). SN 79-027,861. PUB. 7-10-2007. FILED 6-14-2006.
- 3,298,318. **CIMZIA AND DESIGN**. UCB PHARMA, S.A., (U.S. CLS. 6, 18, 44, 46, 51 AND 52). SN 79-028,492. PUB. 7-10-2007. FILED 6-22-2006.
- 3,298,319. **VERISMO (BLOCK FORM)**. BASF AKTIENGESELLSCHAFT, (U.S. CLS. 6, 18, 44, 46, 51 AND 52). SN 79-028,556. PUB. 7-10-2007. FILED 7-12-2006.
- 3,298,323. **VETMULIN (BLOCK FORM)**. AKTSIONERNO DROUJESTVO; "HUVEPHARMA", MULTIPLE CLASS, (INT. CLS. 5 AND 31), (U.S. CLS. 1, 6, 18, 44, 46, 51 AND 52). SN 79-028,749. PUB. 7-10-2007. FILED 8-28-2006.
- 3,298,324. **ADLENS (BLOCK FORM)**. J & J TECHNOLOGIES LIMITED, MULTIPLE CLASS, (INT. CLS. 5, 9 AND 10), (U.S. CLS. 6, 18, 21, 23, 26, 36, 38, 39, 44, 46, 51 AND 52). SN 79-028,793. PUB. 7-10-2007. FILED 1-18-2006.
- 3,298,337. **PRAZIMEC (BLOCK FORM)**. AKTSIONERNO DROUJESTVO; "HUVEPHARMA", (U.S. CLS. 6, 18, 44, 46, 51 AND 52). SN 79-029,612. PUB. 7-10-2007. FILED 8-25-2006.
- 3,298,344 (*See Class 1 for this trademark*).

- 3,298,345 (*See Class 3 for this trademark*).
 3,298,359. **ALK-ABELLO (BLOCK FORM)**. ALK-ABELLÓ A/S, MULTIPLE CLASS, (INT. CLS. 5, 42 AND 44), (U.S. CLS. 6, 18, 44, 46, 51, 52, 100 AND 101). SN 79-031,317. PUB. 7-10-2007. FILED 7-7-2006.
 3,298,365. **EQUIOXX (BLOCK FORM)**. MERIAL LIMITED, (U.S. CLS. 6, 18, 44, 46, 51 AND 52). SN 79-031,787. PUB. 7-10-2007. FILED 6-10-2006.
 3,298,367. **WOODWAY (STYLIZED)**. WILLY SCHÖNENBERGER, MULTIPLE CLASS, (INT. CLS. 5, 10, 25, 26 AND 28), (U.S. CLS. 6, 18, 22, 23, 26, 37, 38, 39, 40, 42, 44, 46, 50, 51 AND 52). SN 79-031,900. PUB. 7-10-2007. FILED 7-12-2006.
 3,298,384. **CATHEJELL (STYLIZED)**. PHARMAZEUTISCHE FABRIK MONTAVIT GESELLSCHAFT M.B.H., (U.S. CLS. 6, 18, 44, 46, 51 AND 52). SN 79-033,462. PUB. 7-10-2007. FILED 10-16-2006.
 3,298,388. **FARZOST (BLOCK FORM)**. NOVARTIS AG, (U.S. CLS. 6, 18, 44, 46, 51 AND 52). SN 79-033,969. PUB. 7-10-2007. FILED 1-8-2007.
 3,298,392 (*See Class 1 for this trademark*).

CLASS 6—METAL GOODS

- 3,295,968. **CENTURION**. LIBERTY SAFE & SECURITY PRODUCTS, INC., (U.S. CLS. 2, 12, 13, 14, 23, 25 AND 50). SN 75-732,123. PUB. 11-5-2002. FILED 6-18-1999.
 3,295,973. **M AND DESIGN**. LEMANS CORPORATION, (U.S. CLS. 2, 12, 13, 14, 23, 25 AND 50). SN 76-387,046. PUB. 7-10-2007. FILED 3-27-2002.
 3,295,989. **MAGNUM DUAL SEAL (BLOCK FORM)**. WORLD-WIDE OILFIELD MACHINE, INC., MULTIPLE CLASS, (INT. CLS. 6 AND 9), (U.S. CLS. 2, 12, 13, 14, 21, 23, 25, 26, 36, 38 AND 50). SN 76-598,074. PUB. 7-10-2007. FILED 6-15-2004.
 3,295,994 (*See Class 1 for this trademark*).
 3,296,003. **SUREPACK ELEMENTS (BLOCK FORM)**. HOWDEN POWER SPAIN, S.L., (U.S. CLS. 2, 12, 13, 14, 23, 25 AND 50). SN 76-625,563. PUB. 7-10-2007. FILED 12-22-2004.
 3,296,115. **SPLATS! (BLOCK FORM)**. EXHART ENVIRONMENTAL SYSTEMS, INC., MULTIPLE CLASS, (INT. CLS. 6 AND 20), (U.S. CLS. 2, 12, 13, 14, 22, 23, 25, 32 AND 50). SN 76-665,135. PUB. 7-10-2007. FILED 8-25-2006.
 3,296,119. **GOTCHA (BLOCK FORM)**. TAPER INTERNATIONAL, INC., (U.S. CLS. 2, 12, 13, 14, 23, 25 AND 50). SN 76-665,531. PUB. 7-10-2007. FILED 8-31-2006.
 3,296,129. **VALUE EXPRESS (BLOCK FORM)**. NCI BUILDING SYSTEMS, L.P., (U.S. CLS. 2, 12, 13, 14, 23, 25 AND 50). SN 76-666,670. PUB. 7-10-2007. FILED 9-26-2006.
 3,296,172. **HAN-D-RING (BLOCK FORM)**. KEEPER CORPORATION, (U.S. CLS. 2, 12, 13, 14, 23, 25 AND 50). SN 76-670,841. PUB. 7-10-2007. FILED 12-26-2006.
 3,296,221. **MISCELLANEOUS DESIGN**. HONG YUE DEVELOPMENT CO., LTD., (U.S. CLS. 2, 12, 13, 14, 23, 25 AND 50). SN 77-000,907. PUB. 7-10-2007. FILED 9-15-2006.
 3,296,273. **HARKER (STYLIZED)**. THE HARKER SCHOOL, MULTIPLE CLASS, (INT. CLS. 6, 14, 16, 18, 21 AND 25), (U.S. CLS. 1, 2, 3, 5, 12, 13, 14, 22, 23, 25, 27, 28, 29, 30, 33, 37, 38, 39, 40, 41 AND 50). SN 77-014,567. PUB. 7-10-2007. FILED 10-5-2006.
 3,296,274. **H AND DESIGN**. THE HARKER SCHOOL, MULTIPLE CLASS, (INT. CLS. 6, 9, 14, 16, 18 AND 21), (U.S. CLS. 1, 2, 3, 5, 12, 13, 14, 21, 22, 23, 25, 26, 27, 28, 29, 30, 33, 36, 37, 38, 40, 41 AND 50). SN 77-014,603. PUB. 7-10-2007. FILED 10-5-2006.
 3,296,421. **COASTAL METAL SERVICE (BLOCK FORM)**. BEACON ROOFING SUPPLY, INC., (U.S. CLS. 2, 12, 13, 14, 23, 25 AND 50). SN 77-041,394. PUB. 7-10-2007. FILED 11-10-2006.
 3,296,482. **GRAMBLING STATE UNIVERSITY (BLOCK FORM)**. GRAMBLING STATE UNIVERSITY, MULTIPLE CLASS, (INT. CLS. 6, 12, 16, 18, 20, 21, 24, 25, 27, 28 AND 41), (U.S. CLS. 1, 2, 3, 5, 12, 13, 14, 19, 20, 21, 22, 23, 25, 29, 30, 31, 32, 33, 35, 37, 38, 39, 40, 41, 42, 44, 50, 100, 101 AND 107). SN 77-050,174. PUB. 7-10-2007. FILED 11-22-2006.
 3,296,514. **EASY STRIKE (BLOCK FORM)**. MG SYSTEMS & WELDING, INC., (U.S. CLS. 2, 12, 13, 14, 23, 25 AND 50). SN 77-054,046. PUB. 7-10-2007. FILED 11-30-2006.
 3,296,569. **VLS (BLOCK FORM)**. LUVATA OY, (U.S. CLS. 2, 12, 13, 14, 23, 25 AND 50). SN 77-059,964. PUB. 7-10-2007. FILED 12-8-2006.
 3,296,790. **PRO SOURCE AND DESIGN**. ORGILL, INC., (U.S. CLS. 2, 12, 13, 14, 23, 25 AND 50). SN 77-078,922. PUB. 7-10-2007. FILED 1-9-2007.
 3,296,948. **DECOR GRATES (BLOCK FORM)**. DECOR GRATES INCORPORATED, MULTIPLE CLASS, (INT. CLS. 6 AND 20), (U.S. CLS. 2, 12, 13, 14, 22, 23, 25, 32 AND 50). SN 77-090,706. PUB. 7-10-2007. FILED 1-25-2007.
 3,297,037. **TRUBOLT (BLOCK FORM)**. ILLINOIS TOOL WORKS INC., (U.S. CLS. 2, 12, 13, 14, 23, 25 AND 50). SN 77-093,021. PUB. 7-10-2007. FILED 1-28-2007.
 3,297,183. **BRINGING LIFE AND STYLE TOGETHER (BLOCK FORM)**. PEAK INNOVATIONS INC., (U.S. CLS. 2, 12, 13, 14, 23, 25 AND 50). SN 78-371,594. PUB. 11-21-2006. FILED 2-20-2004.
 3,297,271. **Z LOKK (BLOCK FORM)**. D & D GROUP PTY LTD, (U.S. CLS. 2, 12, 13, 14, 23, 25 AND 50). SN 78-675,177. PUB. 7-10-2007. FILED 7-21-2005.
 3,297,385. **ULTRA ARC AND DESIGN**. NELSON STUD WELDING, INC., (U.S. CLS. 2, 12, 13, 14, 23, 25 AND 50). SN 78-768,190. PUB. 7-10-2007. FILED 12-7-2005.
 3,297,386. **STUD WELDING ASSOCIATES, INC. ULTRA ARC AND DESIGN**. NELSON STUD WELDING, INC., MULTIPLE CLASS, (INT. CLS. 6, 7 AND 9), (U.S. CLS. 2, 12, 13, 14, 19, 21, 23, 25, 26, 31, 34, 35, 36, 38 AND 50). SN 78-768,224. PUB. 7-10-2007. FILED 12-7-2005.
 3,297,405 (*See Class 3 for this trademark*).
 3,297,475. **ALLIGATOR BRAND AND DESIGN**. FLORIDA HARWARDE, LLC, (U.S. CLS. 2, 12, 13, 14, 23, 25 AND 50). SN 78-820,277. PUB. 7-10-2007. FILED 2-22-2006.
 3,297,582. **TANK CONNECTION AND DESIGN**. TANK CONNECTION, LLC, MULTIPLE CLASS, (INT. CLS. 6 AND 42), (U.S. CLS. 2, 12, 13, 14, 23, 25, 50, 100 AND 101). SN 78-860,193. PUB. 7-10-2007. FILED 4-12-2006.
 3,297,734. **SEASTROM (BLOCK FORM)**. SEASTROM MANUFACTURING CO., INC., (U.S. CLS. 2, 12, 13, 14, 23, 25 AND 50). SN 78-885,185. PUB. 7-10-2007. FILED 5-17-2006.
 3,297,742. **AUTHENTIC HENDRIX AND DESIGN**. EXPERIENCE HENDRIX, L.L.C., (U.S. CLS. 2, 12, 13, 14, 23, 25 AND 50). SN 78-886,100. PUB. 7-10-2007. FILED 5-17-2006.
 3,297,753. **NEWPORT BRASS AND DESIGN**. BRASSTECH, INC., MULTIPLE CLASS, (INT. CLS. 6, 11, 20 AND 21), (U.S. CLS. 2, 12, 13, 14, 21, 22, 23, 25, 29, 30, 31, 32, 33, 34, 40 AND 50). SN 78-887,530. PUB. 7-10-2007. FILED 5-19-2006.
 3,297,823. **PAKMATE (BLOCK FORM)**. ARKEMA INC., MULTIPLE CLASS, (INT. CLS. 6 AND 17), (U.S. CLS. 1, 2, 5, 12, 13, 14, 23, 25, 35 AND 50). SN 78-901,636. PUB. 7-10-2007. FILED 6-6-2006.
 3,297,985. **CANNON (BLOCK FORM)**. CANNON SAFE, INC., (U.S. CLS. 2, 12, 13, 14, 23, 25 AND 50). SN 78-930,058. PUB. 7-10-2007. FILED 7-14-2006.
 3,297,988. **SUPERCUT 150 (BLOCK FORM)**. A.M. CASTLE & CO., (U.S. CLS. 2, 12, 13, 14, 23, 25 AND 50). SN 78-930,866. PUB. 7-10-2007. FILED 7-17-2006.
 3,298,031. **CORDECK (BLOCK FORM)**. KAM INDUSTRIES, LTD., MULTIPLE CLASS, (INT. CLS. 6 AND 37), (U.S. CLS. 2, 12, 13, 14, 23, 25, 50, 100, 103 AND 106). SN 78-944,298. PUB. 7-10-2007. FILED 8-3-2006.
 3,298,144. **LCF (BLOCK FORM)**. SHANXI LUCHENG SINTONG CASTING CO., LTD., (U.S. CLS. 2, 12, 13, 14, 23, 25 AND 50). SN 78-974,373. PUB. 7-10-2007. FILED 9-14-2006.
 3,298,176. **VAHLE (BLOCK FORM)**. PAUL VAHLE GMBH & CO. KG, MULTIPLE CLASS, (INT. CLS. 6, 7 AND 9), (U.S. CLS. 2, 12, 13, 14, 19, 21, 23, 25, 26, 31, 34, 35, 36, 38 AND 50). SN 79-018,615. PUB. 7-10-2007. FILED 8-27-2004.
 3,298,185. **SAFEPLUG (BLOCK FORM)**. SAFETRACK INFRASTRUCTURES SISAB AB, MULTIPLE CLASS, (INT. CLS. 6, 7 AND 9), (U.S. CLS. 2, 12, 13, 14, 19, 21, 23, 25, 26, 31, 34, 35, 36, 38 AND 50). SN 79-019,324. PUB. 7-10-2007. FILED 5-30-2005.
 3,298,200. **ZOOM (BLOCK FORM)**. H.G.V. HAUS UND GARTEN - MARKETING- UND; VERTRIEBSGESELLSCHAFT MBH, MULTIPLE CLASS, (INT. CLS. 6, 7 AND 12), (U.S. CLS. 2, 12, 13, 14, 19, 21, 23, 25, 31, 34, 35, 44 AND 50). SN 79-020,826. PUB. 7-10-2007. FILED 10-20-2005.
 3,298,209. **KEEP LIVING AND DESIGN**. PRESSALIT GROUP

- A/S, MULTIPLE CLASS, (INT. CLS. 6, 11 AND 20), (U.S. CLS. 2, 12, 13, 14, 21, 22, 23, 25, 31, 32, 34 AND 50). SN 79-022,219. PUB. 7-10-2007. FILED 11-30-2005.
- 3,298,227. **I VENEZIANI AND DESIGN**. GRUPPO PIAZZETTA SPA, MULTIPLE CLASS, (INT. CLS. 6, 11 AND 19), (U.S. CLS. 1, 2, 12, 13, 14, 21, 23, 25, 31, 33, 34 AND 50). SN 79-024,167. PUB. 7-10-2007. FILED 2-21-2006.
- 3,298,243. **J&E HALL LIMITED AND DESIGN**. AAF - MCQUAY INC, MULTIPLE CLASS, (INT. CLS. 6, 7, 9 AND 11), (U.S. CLS. 2, 12, 13, 14, 19, 21, 23, 25, 26, 31, 34, 35, 36, 38 AND 50). SN 79-024,841. PUB. 7-10-2007. FILED 7-15-2005.
- 3,298,259. **BUGATTI GROUP V AND DESIGN**. VALVOSANITARIA BUGATTI S.P.A., (U.S. CLS. 2, 12, 13, 14, 23, 25 AND 50). SN 79-025,762. PUB. 7-10-2007. FILED 4-14-2006.
- 3,298,297. **FPIPE (STYLIZED)**. IBAU; HAMBURG INGENIEURGESELLSCHAFT INDUSTRIEBAU; MBH, MULTIPLE CLASS, (INT. CLS. 6 AND 7), (U.S. CLS. 2, 12, 13, 14, 19, 21, 23, 25, 31, 34, 35 AND 50). SN 79-027,630. PUB. 7-10-2007. FILED 7-18-2006.
- 3,298,326. **ZINIFEX (BLOCK FORM)**. ZINIFEX LIMITED, MULTIPLE CLASS, (INT. CLS. 6, 37 AND 40), (U.S. CLS. 2, 12, 13, 14, 23, 25, 50, 100, 103 AND 106). SN 79-029,145. PUB. 7-10-2007. FILED 6-6-2006.
- 3,298,385. **BETTER TOGETHER (BLOCK FORM)**. N.V. BEKAERT S.A., MULTIPLE CLASS, (INT. CLS. 6, 11, 17 AND 42), (U.S. CLS. 1, 2, 5, 12, 13, 14, 21, 23, 25, 31, 34, 35, 50, 100 AND 101). SN 79-033,487. PUB. 7-10-2007. FILED 11-22-2006.

CLASS 7—MACHINERY

- 3,295,991. **HALDEX (STYLIZED)**. HALDEX AB, (U.S. CLS. 13, 19, 21, 23, 31, 34 AND 35). SN 76-598,255. PUB. 7-10-2007. FILED 6-21-2004.
- 3,295,993. **IMAO AND DESIGN**. KABUSHIKI KAISHA IMAO CORPORATION, (U.S. CLS. 13, 19, 21, 23, 31, 34 AND 35). SN 76-602,718. PUB. 7-10-2007. FILED 7-19-2004.
- 3,296,015. **NUTRI-CENTER (BLOCK FORM)**. MIRAMA ENTERPRISES INC., (U.S. CLS. 13, 19, 21, 23, 31, 34 AND 35). SN 76-642,497. PUB. 8-22-2006. FILED 7-11-2005.
- 3,296,029. **SPINNER II (BLOCK FORM)**. T.F. HUDGINS, INCORPORATED, (U.S. CLS. 13, 19, 21, 23, 31, 34 AND 35). SN 76-646,994. PUB. 7-10-2007. FILED 9-19-2005.
- 3,296,123. **MAGSTAR (BLOCK FORM)**. MAGSTAR TECHNOLOGIES, INC., (U.S. CLS. 13, 19, 21, 23, 31, 34 AND 35). SN 76-666,204. PUB. 7-10-2007. FILED 9-18-2006.
- 3,296,213. **XL PRO (BLOCK FORM)**. PAXAR AMERICAS, INC., (U.S. CLS. 13, 19, 21, 23, 31, 34 AND 35). SN 76-673,366. PUB. 7-10-2007. FILED 2-28-2007.
- 3,296,336. **GE (BLOCK FORM)**. GENERAL ELECTRIC COMPANY, MULTIPLE CLASS, (INT. CLS. 7, 37 AND 42), (U.S. CLS. 13, 19, 21, 23, 31, 34, 35, 100, 101, 103 AND 106). SN 77-028,249. PUB. 7-10-2007. FILED 10-24-2006.
- 3,296,391. **DURATRANS CLASSIC (BLOCK FORM)**. BELANGER, INC., (U.S. CLS. 13, 19, 21, 23, 31, 34 AND 35). SN 77-036,458. PUB. 7-10-2007. FILED 11-3-2006.
- 3,296,431. **MISCELLANEOUS DESIGN**. INFINITY DIAMOND PRODUCTS, INC., MULTIPLE CLASS, (INT. CLS. 7 AND 8), (U.S. CLS. 13, 19, 21, 23, 28, 31, 34, 35 AND 44). SN 77-042,296. PUB. 7-10-2007. FILED 11-13-2006.
- 3,296,447. **BALE BAND-IT (BLOCK FORM)**. BROWN, OWEN J. JR., (U.S. CLS. 13, 19, 21, 23, 31, 34 AND 35). SN 77-044,844. PUB. 7-10-2007. FILED 11-15-2006.
- 3,296,479. **SUPER GP (BLOCK FORM)**. WORLD DIAMOND SOURCE, INC., (U.S. CLS. 13, 19, 21, 23, 31, 34 AND 35). SN 77-049,599. PUB. 7-10-2007. FILED 11-22-2006.
- 3,296,522. **BULLMAN (BLOCK FORM)**. R&G GROUP INTERNATIONAL, INC., MULTIPLE CLASS, (INT. CLS. 7 AND 12), (U.S. CLS. 13, 19, 21, 23, 31, 34, 35 AND 44). SN 77-054,838. PUB. 7-10-2007. FILED 12-1-2006.
- 3,296,531. **DITCH RUNNER (BLOCK FORM)**. REID, ROBERT L., (U.S. CLS. 13, 19, 21, 23, 31, 34 AND 35). SN 77-056,103. PUB. 7-10-2007. FILED 12-4-2006.
- 3,296,536. **TEXFINISH (BLOCK FORM)**. GRACO MINNESOTA INC., (U.S. CLS. 13, 19, 21, 23, 31, 34 AND 35). SN 77-056,581. PUB. 7-10-2007. FILED 12-4-2006.
- 3,296,663. **DCI (BLOCK FORM)**. DAVIS, DANIEL E., (U.S. CLS. 13, 19, 21, 23, 31, 34 AND 35). SN 77-064,112. PUB. 7-10-2007. FILED 12-14-2006.
- 3,296,705. **INTELLIPAV (BLOCK FORM)**. NOVATEK INTERNATIONAL INC., (U.S. CLS. 13, 19, 21, 23, 31, 34 AND 35). SN 77-065,091. PUB. 7-10-2007. FILED 12-15-2006.
- 3,296,979. **SPRAYFINE (BLOCK FORM)**. LOVE, PHILIP A., (U.S. CLS. 13, 19, 21, 23, 31, 34 AND 35). SN 77-091,473. PUB. 7-10-2007. FILED 1-25-2007.
- 3,296,987. **PCS PRODUCTION CONTROL SERVICES AND DESIGN**. PRODUCTION CONTROL SERVICES, INC., (U.S. CLS. 13, 19, 21, 23, 31, 34 AND 35). SN 77-091,583. PUB. 7-10-2007. FILED 1-25-2007.
- 3,296,988. **PCS AND DESIGN**. PRODUCTION CONTROL SERVICES, INC., (U.S. CLS. 13, 19, 21, 23, 31, 34 AND 35). SN 77-091,587. PUB. 7-10-2007. FILED 1-25-2007.
- 3,296,994. **PCS PLUNGER LIFT EQUIPMENT MFR. AND DESIGN**. PRODUCTION CONTROL SERVICES, INC., (U.S. CLS. 13, 19, 21, 23, 31, 34 AND 35). SN 77-091,599. PUB. 7-10-2007. FILED 1-25-2007.
- 3,297,090. **TURBOMIX (BLOCK FORM)**. BETE FOG NOZZLE, INC., (U.S. CLS. 13, 19, 21, 23, 31, 34 AND 35). SN 77-103,091. PUB. 7-10-2007. FILED 2-8-2007.
- 3,297,121. **ITW MULLER (BLOCK FORM)**. ILLINOIS TOOL WORKS INC., MULTIPLE CLASS, (INT. CLS. 7 AND 17), (U.S. CLS. 1, 5, 12, 13, 19, 21, 23, 31, 34, 35 AND 50). SN 77-112,569. PUB. 7-10-2007. FILED 2-21-2007.
- 3,297,130. **HXX PRODIGY (BLOCK FORM)**. VACTOR MANUFACTURING, INC., (U.S. CLS. 13, 19, 21, 23, 31, 34 AND 35). SN 77-116,425. PUB. 7-10-2007. FILED 2-26-2007.
- 3,297,131. **ICE BREAKER (BLOCK FORM)**. HAMILTON BEACH/PROCTOR-SILEX, INC., (U.S. CLS. 13, 19, 21, 23, 31, 34 AND 35). SN 77-116,571. PUB. 7-10-2007. FILED 2-26-2007.
- 3,297,133. **SPUDVEYOR (BLOCK FORM)**. MCGUIRE BEARING COMPANY, (U.S. CLS. 13, 19, 21, 23, 31, 34 AND 35). SN 77-119,016. PUB. 7-10-2007. FILED 2-28-2007.
- 3,297,136. **PCS (BLOCK FORM)**. PRODUCTION CONTROL SERVICES, INC., (U.S. CLS. 13, 19, 21, 23, 31, 34 AND 35). SN 77-120,207. PUB. 7-10-2007. FILED 3-1-2007.
- 3,297,168. **TERRAIN LEVELER AND DESIGN**. VERMEER MANUFACTURING COMPANY, (U.S. CLS. 13, 19, 21, 23, 31, 34 AND 35). SN 77-149,360. PUB. 7-10-2007. FILED 4-5-2007.
- 3,297,228. **TWINSTER (BLOCK FORM)**. GETRAG GETRIEBE-UND ZAHNRADFABRIK HERMANN HAGENMEYER GMBH & CIE KG, MULTIPLE CLASS, (INT. CLS. 7, 9 AND 12), (U.S. CLS. 13, 19, 21, 23, 26, 31, 34, 35, 36, 38 AND 44). SN 78-580,932. PUB. 7-10-2007. FILED 3-4-2005.
- 3,297,256. **CLAM (BLOCK FORM)**. HUNTING CROMAR LIMITED, (U.S. CLS. 13, 19, 21, 23, 31, 34 AND 35). SN 78-633,751. PUB. 7-10-2007. FILED 5-20-2005.
- 3,297,294. **MISCELLANEOUS DESIGN**. ORECK HOLDINGS, LLC, MULTIPLE CLASS, (INT. CLS. 7 AND 11), (U.S. CLS. 13, 19, 21, 23, 31, 34 AND 35). SN 78-703,760. PUB. 7-10-2007. FILED 8-30-2005.
- 3,297,305. **KIKKI'S WORKSHOP (BLOCK FORM)**. KABUSHIKI KAISHA KOMATSU SEISAKUSHO (D.B.A. KOMATSU LTD.), MULTIPLE CLASS, (INT. CLS. 7, 9, 12, 14, 16, 18, 25, 28, 41 AND 42), (U.S. CLS. 1, 2, 3, 5, 13, 19, 21, 22, 23, 26, 27, 28, 29, 31, 34, 35, 36, 37, 38, 39, 41, 44, 50, 100, 101 AND 107). SN 78-708,809. PUB. 7-10-2007. FILED 9-8-2005.
- 3,297,326. **FULLVISION (BLOCK FORM)**. FULL VISION, INC., (U.S. CLS. 13, 19, 21, 23, 31, 34 AND 35). SN 78-718,928. PUB. 7-10-2007. FILED 9-22-2005.
- 3,297,379. **GX (STYLIZED)**. HONDA MOTOR CO., LTD., (U.S. CLS. 13, 19, 21, 23, 31, 34 AND 35). SN 78-765,763. PUB. 7-10-2007. FILED 12-2-2005.
- 3,297,386 (See Class 6 for this trademark).
- 3,297,483. **COMFORTPRO (BLOCK FORM)**. TELEFLEX INCORPORATED, (U.S. CLS. 13, 19, 21, 23, 31, 34 AND 35). SN 78-823,232. PUB. 7-10-2007. FILED 2-24-2006.
- 3,297,591. **MAX PROP AND DESIGN**. MAX PROP S.R.L., MULTIPLE CLASS, (INT. CLS. 7, 12 AND 22), (U.S. CLS. 1, 2, 7, 13, 19, 21, 22, 23, 31, 34, 35, 42, 44 AND 50). SN 78-861,719. PUB. 7-10-2007. FILED 4-14-2006.
- 3,297,622. **PROHOISTS (BLOCK FORM)**. AMERICAN HUNTER, INC., (U.S. CLS. 13, 19, 21, 23, 31, 34 AND 35). SN 78-

- 864,717. PUB. 7-10-2007. FILED 4-19-2006.
- 3,297,628. **ROCKFORD MACHINE TOOL (BLOCK FORM)**. BOURN & KOCH, INC., (U.S. CLS. 13, 19, 21, 23, 31, 34 AND 35). SN 78-866,459. PUB. 7-10-2007. FILED 4-21-2006.
- 3,297,668. **SUPREMA (BLOCK FORM)**. WATERJET S.R.L., (U.S. CLS. 13, 19, 21, 23, 31, 34 AND 35). SN 78-872,469. PUB. 7-10-2007. FILED 4-28-2006.
- 3,297,716. **HI LIFE (BLOCK FORM)**. HANSEN MANUFACTURING CORP., (U.S. CLS. 13, 19, 21, 23, 31, 34 AND 35). SN 78-882,865. PUB. 7-10-2007. FILED 5-12-2006.
- 3,297,786. **ASTRO (BLOCK FORM)**. S. A. ARMSTRONG LIMITED, (U.S. CLS. 13, 19, 21, 23, 31, 34 AND 35). SN 78-894,037. PUB. 7-10-2007. FILED 5-26-2006.
- 3,297,805. **SPECTRA (BLOCK FORM)**. TGW-ERMANCO, INC., (U.S. CLS. 13, 19, 21, 23, 31, 34 AND 35). SN 78-898,024. PUB. 7-10-2007. FILED 6-1-2006.
- 3,297,818. **FLOORSMART (BLOCK FORM)**. TENNANT COMPANY, (U.S. CLS. 13, 19, 21, 23, 31, 34 AND 35). SN 78-900,869. PUB. 7-10-2007. FILED 6-5-2006.
- 3,297,824. **GCSMART (STYLIZED)**. GLATT MASCHINEN-UND APPARATEBAU AG, (U.S. CLS. 13, 19, 21, 23, 31, 34 AND 35). SN 78-901,774. PUB. 7-10-2007. FILED 6-6-2006.
- 3,297,891. **MELCO (BLOCK FORM)**. MELCO INDUSTRIES, INC., MULTIPLE CLASS, (INT. CLS. 7, 23 AND 26), (U.S. CLS. 13, 19, 21, 23, 31, 34, 35, 37, 39, 40, 42, 43 AND 50). SN 78-908,742. PUB. 7-10-2007. FILED 6-15-2006.
- 3,297,946. **MADEWELL (BLOCK FORM)**. BISHOP-WISECARTER CORPORATION, (U.S. CLS. 13, 19, 21, 23, 31, 34 AND 35). SN 78-920,077. PUB. 7-10-2007. FILED 6-29-2006.
- 3,298,002. **ROBONANO (BLOCK FORM)**. FANUC LTD., (U.S. CLS. 13, 19, 21, 23, 31, 34 AND 35). SN 78-934,023. PUB. 7-10-2007. FILED 7-20-2006.
- 3,298,116. **NEWBURY (BLOCK FORM)**. VAN DORN DEMAG CORPORATION, (U.S. CLS. 13, 19, 21, 23, 31, 34 AND 35). SN 78-964,911. PUB. 7-10-2007. FILED 8-31-2006.
- 3,298,167. **PON (BLOCK FORM)**. PON HOLDINGS B.V., MULTIPLE CLASS, (INT. CLS. 7, 12, 35, 36, 37 AND 39), (U.S. CLS. 13, 19, 21, 23, 31, 34, 35, 44, 100, 101, 102, 103, 105 AND 106). SN 79-016,638. PUB. 7-10-2007. FILED 3-16-2005.
- 3,298,170. **FLUIDSPLIT (BLOCK FORM)**. COPERION WAESCHLE GMBH & CO. KG, (U.S. CLS. 13, 19, 21, 23, 31, 34 AND 35). SN 79-016,895. PUB. 7-10-2007. FILED 4-28-2005.
- 3,298,176 (*See Class 6 for this trademark*).
- 3,298,181. **TCL (STYLIZED)**. TCL CORPORATION, MULTIPLE CLASS, (INT. CLS. 7, 9 AND 11), (U.S. CLS. 13, 19, 21, 23, 26, 31, 34, 35, 36 AND 38). SN 79-018,892. PUB. 7-10-2007. FILED 3-18-2005.
- 3,298,183. **TWIN-AF-MAG (BLOCK FORM)**. APPLIED MATERIALS GMBH & CO. KG, (U.S. CLS. 13, 19, 21, 23, 31, 34 AND 35). SN 79-019,030. PUB. 7-10-2007. FILED 10-28-2005.
- 3,298,185 (*See Class 6 for this trademark*).
- 3,298,194. **RUVILLE AND DESIGN**. EGON VON RUVILLE GMBH, MULTIPLE CLASS, (INT. CLS. 7, 12 AND 17), (U.S. CLS. 1, 5, 12, 13, 19, 21, 23, 31, 34, 35, 44 AND 50). SN 79-020,004. PUB. 7-10-2007. FILED 10-4-2005.
- 3,298,200 (*See Class 6 for this trademark*).
- 3,298,205 (*See Class 1 for this trademark*).
- 3,298,223. **DYNASPEC (BLOCK FORM)**. KOBELCO CONSTRUCTION MACHINERY CO., LTD., (U.S. CLS. 13, 19, 21, 23, 31, 34 AND 35). SN 79-023,857. PUB. 7-10-2007. FILED 3-30-2006.
- 3,298,229. **SLURRYSAVE (BLOCK FORM)**. LEVITRONIX GMBH, MULTIPLE CLASS, (INT. CLS. 7 AND 9), (U.S. CLS. 13, 19, 21, 23, 26, 31, 34, 35, 36 AND 38). SN 79-024,314. PUB. 7-10-2007. FILED 2-22-2006.
- 3,298,241. **HUMAN MED AND DESIGN**. HUMAN MED AG, MULTIPLE CLASS, (INT. CLS. 7 AND 10), (U.S. CLS. 13, 19, 21, 23, 26, 31, 34, 35, 39 AND 44). SN 79-024,744. PUB. 7-10-2007. FILED 4-19-2006.
- 3,298,243 (*See Class 6 for this trademark*).
- 3,298,262. **CLURING AND DESIGN**. BYUN, DONGHWAN, MULTIPLE CLASS, (INT. CLS. 7 AND 12), (U.S. CLS. 13, 19, 21, 23, 31, 34, 35 AND 44). SN 79-026,014. PUB. 7-10-2007. FILED 4-12-2006.
- 3,298,277. **SWING LASER AND DESIGN**. COMAU SPA, MULTIPLE CLASS, (INT. CLS. 7 AND 9), (U.S. CLS. 13, 19, 21, 23, 26, 31, 34, 35, 36 AND 38). SN 79-026,927. PUB. 7-10-2007. FILED 4-14-2006.
- 3,298,279. **IMO AND DESIGN**. ERICH RUSS, MULTIPLE CLASS, (INT. CLS. 7 AND 12), (U.S. CLS. 13, 19, 21, 23, 31, 34, 35 AND 44). SN 79-026,998. PUB. 7-10-2007. FILED 12-30-2005.
- 3,298,280. **ELMARCO AND DESIGN**. ELMARCO S.R.O., MULTIPLE CLASS, (INT. CLS. 7 AND 24), (U.S. CLS. 13, 19, 21, 23, 31, 34, 35, 42 AND 50). SN 79-027,008. PUB. 7-10-2007. FILED 5-24-2006.
- 3,298,297 (*See Class 6 for this trademark*).
- 3,298,316. **VRM (BLOCK FORM)**. HANS HUBER AG MASCHINEN-; UND ANLAGENBAU, MULTIPLE CLASS, (INT. CLS. 7, 11 AND 37), (U.S. CLS. 13, 19, 21, 23, 31, 34, 35, 100, 103 AND 106). SN 79-028,323. PUB. 7-10-2007. FILED 6-20-2006.
- 3,298,331. **DISCOVERY WELLS (BLOCK FORM)**. SENSE INTELLIFIELD AS, MULTIPLE CLASS, (INT. CLS. 7 AND 9), (U.S. CLS. 13, 19, 21, 23, 26, 31, 34, 35, 36 AND 38). SN 79-029,242. PUB. 7-10-2007. FILED 6-22-2006.
- 3,298,346. **UM COOLING AND DESIGN**. SHENZHEN U-MAN INDUSTRIAL CO., LTD., MULTIPLE CLASS, (INT. CLS. 7 AND 11), (U.S. CLS. 13, 19, 21, 23, 31, 34 AND 35). SN 79-029,968. PUB. 7-10-2007. FILED 6-20-2006.
- 3,298,358. **HYDRAULIC PARTS AISIN AND DESIGN**. AISIN SEIKI KABUSHIKI KAISHA, MULTIPLE CLASS, (INT. CLS. 7 AND 12), (U.S. CLS. 13, 19, 21, 23, 31, 34, 35 AND 44). SN 79-031,144. PUB. 7-10-2007. FILED 6-7-2006.

CLASS 8—HAND TOOLS

- 3,296,164. **SG (BLOCK FORM)**. PAXAR AMERICAS, INC., (U.S. CLS. 23, 28 AND 44). SN 76-670,467. PUB. 7-10-2007. FILED 12-18-2006.
- 3,296,242. **KA-JINKER (BLOCK FORM)**. BLUMENTHAL LANSING COMPANY, MULTIPLE CLASS, (INT. CLS. 8 AND 26), (U.S. CLS. 23, 28, 37, 39, 40, 42, 44 AND 50). SN 77-006,296. PUB. 7-10-2007. FILED 9-25-2006.
- 3,296,431 (*See Class 7 for this trademark*).
- 3,296,504. **TRISTICK (BLOCK FORM)**. SHIRAZI, KAMRAN, (U.S. CLS. 23, 28 AND 44). SN 77-053,273. PUB. 7-10-2007. FILED 11-29-2006.
- 3,296,593. **TWEEZEX (STYLIZED)**. TECHNO AESTHETICS, INC., (U.S. CLS. 23, 28 AND 44). SN 77-061,259. PUB. 7-10-2007. FILED 12-11-2006.
- 3,296,677. **ALUM-A-BRAKE (BLOCK FORM)**. ALUM-A-POLE CORPORATION, (U.S. CLS. 23, 28 AND 44). SN 77-064,428. PUB. 7-10-2007. FILED 12-14-2006.
- 3,296,802. **STILETTO AND DESIGN**. STILETTO TOOLS, INC., (U.S. CLS. 23, 28 AND 44). SN 77-080,155. PUB. 7-10-2007. FILED 1-10-2007.
- 3,296,926. **TICK IT AWAY (BLOCK FORM)**. JOSEPH, LICATA C., (U.S. CLS. 23, 28 AND 44). SN 77-089,543. PUB. 7-10-2007. FILED 1-23-2007.
- 3,296,953. **CLASSIC (BLOCK FORM)**. UNITED STATES GYPSUM COMPANY, (U.S. CLS. 23, 28 AND 44). SN 77-090,862. PUB. 7-10-2007. FILED 1-25-2007.
- 3,297,018. **HANDY SAW (BLOCK FORM)**. ALLWAY TOOLS, INC., (U.S. CLS. 23, 28 AND 44). SN 77-092,286. PUB. 7-10-2007. FILED 1-26-2007.
- 3,297,163. **ELEVATE (BLOCK FORM)**. ANDIS COMPANY, MULTIPLE CLASS, (INT. CLS. 8, 9 AND 11), (U.S. CLS. 13, 21, 23, 26, 28, 31, 34, 36, 38 AND 44). SN 77-141,184. PUB. 7-10-2007. FILED 3-27-2007.
- 3,297,336. **HUNTER'S EDGE (BLOCK FORM)**. SAVAGE SPORTS CORPORATION, (U.S. CLS. 23, 28 AND 44). SN 78-723,290. PUB. 7-10-2007. FILED 9-29-2005.
- 3,297,405 (*See Class 3 for this trademark*).
- 3,297,532. **H THUNDER GROUP AND DESIGN**. THUNDER GROUP INC., MULTIPLE CLASS, (INT. CLS. 8, 11, 20, 21 AND 27), (U.S. CLS. 2, 13, 19, 20, 21, 22, 23, 25, 28, 29, 30, 31, 32, 33, 34, 37, 40, 42, 44 AND 50). SN 78-843,568. PUB. 7-10-2007. FILED 3-22-2006.
- 3,297,970. **SLEEVE 'N STORE (BLOCK FORM)**. CHANCE ENTERPRISES, L.L.C., MULTIPLE CLASS, (INT. CLS. 8, 20 AND 21), (U.S. CLS. 2, 13, 22, 23, 25, 28, 29, 30, 32, 33, 40, 44 AND 50). SN 78-926,155. PUB. 7-10-2007. FILED 7-10-2006.

- 3,298,034. **CHEESE BREEZE CHEESE SLICER (BLOCK FORM)**. KYLE ELLISON, (U.S. CLS. 23, 28 AND 44). SN 78-945,557. PUB. 7-10-2007. FILED 8-4-2006.
- 3,298,206. **VALENTINO (STYLIZED)**. VALENTINO S.P.A., (U.S. CLS. 23, 28 AND 44). SN 79-021,883. PUB. 7-10-2007. FILED 7-28-2005.
- 3,298,386 (*See Class 3 for this trademark*).

CLASS 9—ELECTRICAL AND SCIENTIFIC APPARATUS

- 3,295,971. **JEWEL**. KILCHER, JEWEL, MULTIPLE CLASS, (INT. CLS. 9 AND 41), (U.S. CLS. 21, 23, 26, 36, 38, 100, 101 AND 107). SN 76-300,504. PUB. 6-5-2007. FILED 8-16-2001.
- 3,295,975. **YOYO TV AND DESIGN**. EASTERN BROADCASTING CO., LTD., MULTIPLE CLASS, (INT. CLS. 9, 16, 35, 38 AND 41), (U.S. CLS. 2, 5, 21, 22, 23, 26, 29, 36, 37, 38, 50, 100, 101, 102, 104 AND 107). SN 76-507,414. PUB. 7-10-2007. FILED 4-8-2003.
- 3,295,976. **SMART VDO AND DESIGN**. YUAN HIGH-TECH DEVELOPMENT CO., LTD., (U.S. CLS. 21, 23, 26, 36 AND 38). SN 76-510,790. PUB. 7-10-2007. FILED 4-29-2003.
- 3,295,980. **CME (STYLIZED)**. CUSTOM MANUFACTURING & ENGINEERING, INC., (U.S. CLS. 21, 23, 26, 36 AND 38). SN 76-558,541. PUB. 7-10-2007. FILED 11-10-2003.
- 3,295,981. **ELLORA'S CAVE ROMANTICA PUBLISHING AND DESIGN**. ELLORA'S CAVE PUBLISHING, INC., MULTIPLE CLASS, (INT. CLS. 9 AND 16), (U.S. CLS. 2, 5, 21, 22, 23, 26, 29, 36, 37, 38 AND 50). SN 76-567,070. PUB. 7-10-2007. FILED 12-24-2003.
- 3,295,983. **GERMANE SYSTEMS (STYLIZED)**. GERMANE SYSTEMS, LC, MULTIPLE CLASS, (INT. CLS. 9 AND 42), (U.S. CLS. 21, 23, 26, 36, 38, 100 AND 101). SN 76-570,726. PUB. 7-10-2007. FILED 1-20-2004.
- 3,295,989 (*See Class 6 for this trademark*).
- 3,295,995. **THREE BAGS FULL (BLOCK FORM)**. ARISTOCRAT TECHNOLOGIES AUSTRALIA PTY LTD., (U.S. CLS. 21, 23, 26, 36 AND 38). SN 76-613,503. PUB. 7-10-2007. FILED 9-23-2004.
- 3,295,997. **MISCELLANEOUS DESIGN**. OKI ELECTRIC INDUSTRY CO., LTD., (U.S. CLS. 21, 23, 26, 36 AND 38). SN 76-617,504. PUB. 7-10-2007. FILED 10-21-2004.
- 3,296,000. **VIENNA ACOUSTICS AND DESIGN**. GANSTERER, PETER, (U.S. CLS. 21, 23, 26, 36 AND 38). SN 76-621,924. PUB. 7-10-2007. FILED 11-23-2004.
- 3,296,007. **DURABIS AND DESIGN**. TDK CORPORATION, (U.S. CLS. 21, 23, 26, 36 AND 38). SN 76-628,675. PUB. 7-10-2007. FILED 1-25-2005.
- 3,296,008. **HI CAPACITY (BLOCK FORM)**. BATTERY-BIZ, INC., (U.S. CLS. 21, 23, 26, 36 AND 38). SN 76-631,222. PUB. 7-10-2007. FILED 2-14-2005.
- 3,296,010. **MISCELLANEOUS DESIGN**. EMPIRE LEVEL MANUFACTURING CORPORATION, (U.S. CLS. 21, 23, 26, 36 AND 38). SN 76-636,693. PUB. 7-10-2007. FILED 4-21-2005.
- 3,296,014. **MITEL NAVIGATOR (BLOCK FORM)**. MITEL NETWORKS CORPORATION, (U.S. CLS. 21, 23, 26, 36 AND 38). SN 76-639,564. PUB. 12-5-2006. FILED 5-25-2005.
- 3,296,042. **JUST 4D (BLOCK FORM)**. MEDGE PLATFORMS, INC., (U.S. CLS. 21, 23, 26, 36 AND 38). SN 76-649,888. PUB. 7-10-2007. FILED 11-7-2005.
- 3,296,044. **ICETECH (BLOCK FORM)**. KUPTSOV, SERGE P, (U.S. CLS. 21, 23, 26, 36 AND 38). SN 76-650,710. PUB. 7-10-2007. FILED 11-22-2005.
- 3,296,046. **HEALTHY U YOUR PATHWAY TO WELLNESS AND DESIGN**. NORTHWESTERN HEALTH SCIENCES UNIVERSITY, MULTIPLE CLASS, (INT. CLS. 9, 16, 41 AND 44), (U.S. CLS. 2, 5, 21, 22, 23, 26, 29, 36, 37, 38, 50, 100, 101 AND 107). SN 76-651,640. PUB. 7-10-2007. FILED 12-8-2005.
- 3,296,051. **ZOTAC AND DESIGN**. PC PARTNER LIMITED, (U.S. CLS. 21, 23, 26, 36 AND 38). SN 76-655,664. PUB. 7-10-2007. FILED 2-21-2006.
- 3,296,064. **CLINSCAN (BLOCK FORM)**. BRUKER BIOSPIN MRI GMBH, MULTIPLE CLASS, (INT. CLS. 9 AND 10), (U.S. CLS. 21, 23, 26, 36, 38, 39 AND 44). SN 76-658,872. PUB. 7-10-2007. FILED 4-24-2006.
- 3,296,077. **TOOLSGROUP AND DESIGN**. INNOVATION TECHNOLOGY TOOLS, B.V., (U.S. CLS. 21, 23, 26, 36 AND 38). SN 76-660,683. PUB. 7-10-2007. FILED 5-26-2006.
- 3,296,083. **REMOTO (BLOCK FORM)**. REMOTES UNLIMITED, INC., (U.S. CLS. 21, 23, 26, 36 AND 38). SN 76-661,487. PUB. 7-10-2007. FILED 6-12-2006.
- 3,296,093. **OUTRAGEOUS EYES (BLOCK FORM)**. STARFIRE PRODUCTIONS, INC., (U.S. CLS. 21, 23, 26, 36 AND 38). SN 76-662,553. PUB. 7-10-2007. FILED 7-3-2006.
- 3,296,098. **MARSHAL AND DESIGN**. MARSHAL LIMITED, (U.S. CLS. 21, 23, 26, 36 AND 38). SN 76-663,197. PUB. 7-10-2007. FILED 7-17-2006.
- 3,296,128. **H HIDDEN RECORDINGS AND DESIGN**. SHARMA, DEEPAK, (U.S. CLS. 21, 23, 26, 36 AND 38). SN 76-666,391. PUB. 7-10-2007. FILED 9-21-2006.
- 3,296,141. **GRAPHIC-VISION (BLOCK FORM)**. PANELS & CONTROLS CORP., (U.S. CLS. 21, 23, 26, 36 AND 38). SN 76-668,042. PUB. 7-10-2007. FILED 10-25-2006.
- 3,296,154. **SOLITEL (BLOCK FORM)**. MAGNETROL INTERNATIONAL, INCORPORATED, (U.S. CLS. 21, 23, 26, 36 AND 38). SN 76-669,593. PUB. 7-10-2007. FILED 11-28-2006.
- 3,296,170. **DATA SURFER (BLOCK FORM)**. QUINTAL RESEARCH, INC., (U.S. CLS. 21, 23, 26, 36 AND 38). SN 76-670,629. PUB. 7-10-2007. FILED 12-21-2006.
- 3,296,183. **OOHLALA (BLOCK FORM)**. CHACONIE, OOHLALA, MULTIPLE CLASS, (INT. CLS. 9 AND 41), (U.S. CLS. 21, 23, 26, 36, 38, 100, 101 AND 107). SN 76-671,253. PUB. 7-10-2007. FILED 1-11-2007.
- 3,296,191. **ALL YOUR INFORMATION WITHIN REACH (BLOCK FORM)**. EASYREACH CORPORATION, MULTIPLE CLASS, (INT. CLS. 9 AND 38), (U.S. CLS. 21, 23, 26, 36, 38, 100, 101 AND 104). SN 76-671,789. PUB. 7-10-2007. FILED 1-25-2007.
- 3,296,192. **THE POWER TO GET THINGS DONE (BLOCK FORM)**. EASYREACH CORPORATION, MULTIPLE CLASS, (INT. CLS. 9 AND 38), (U.S. CLS. 21, 23, 26, 36, 38, 100, 101 AND 104). SN 76-671,790. PUB. 7-10-2007. FILED 1-25-2007.
- 3,296,217. **OPTIMIS (BLOCK FORM)**. PHYSICAL THERAPY HOLDINGS, INC., (U.S. CLS. 21, 23, 26, 36 AND 38). SN 77-000,001. PUB. 7-10-2007. FILED 9-14-2006.
- 3,296,219. **CENTURIA (BLOCK FORM)**. CENTURIA CORPORATION, (U.S. CLS. 21, 23, 26, 36 AND 38). SN 77-000,146. PUB. 7-10-2007. FILED 9-15-2006.
- 3,296,228. **MISCELLANEOUS DESIGN**. CAMPUS CRUSADE FOR CHRIST, INC., (U.S. CLS. 21, 23, 26, 36 AND 38). SN 77-002,971. PUB. 7-10-2007. FILED 9-20-2006.
- 3,296,233. **POW-R TOTE (BLOCK FORM)**. SOUTHWEST ELECTRONIC ENERGY CORPORATION, (U.S. CLS. 21, 23, 26, 36 AND 38). SN 77-003,520. PUB. 7-10-2007. FILED 9-20-2006.
- 3,296,248. **HAWKEYE (BLOCK FORM)**. LITESENTRY CORPORATION, (U.S. CLS. 21, 23, 26, 36 AND 38). SN 77-008,182. PUB. 7-10-2007. FILED 9-26-2006.
- 3,296,252. **RUSLYN CORDWHEEL (BLOCK FORM)**. RUSLYN HOLDINGS PTY LTD, (U.S. CLS. 21, 23, 26, 36 AND 38). SN 77-009,355. PUB. 7-10-2007. FILED 9-28-2006.
- 3,296,274 (*See Class 6 for this trademark*).
- 3,296,285. **SPEAKMORE (BLOCK FORM)**. TRANSPARENT LANGUAGE, INC., (U.S. CLS. 21, 23, 26, 36 AND 38). SN 77-017,373. PUB. 7-10-2007. FILED 10-10-2006.
- 3,296,288. **DOCUMENT ADVANTAGE (BLOCK FORM)**. DOCUMENT ADVANTAGE CORPORATION, (U.S. CLS. 21, 23, 26, 36 AND 38). SN 77-018,305. PUB. 7-10-2007. FILED 10-11-2006.
- 3,296,301. **INTELLICA PRACTITIONER (BLOCK FORM)**. LAGO, JOSE R., (U.S. CLS. 21, 23, 26, 36 AND 38). SN 77-022,246. PUB. 7-10-2007. FILED 10-16-2006.
- 3,296,314. **HAIL TO THE CHIMP (BLOCK FORM)**. WIDELOAD GAMES, INC., (U.S. CLS. 21, 23, 26, 36 AND 38). SN 77-024,734. PUB. 7-10-2007. FILED S.R. 10-19-2006; AM. P.R. 4-23-2007.
- 3,296,320. **MINI-DIVER (BLOCK FORM)**. VAN ESSEN INSTRUMENTS B.V., (U.S. CLS. 21, 23, 26, 36 AND 38). SN 77-025,749. PUB. 7-10-2007. FILED 10-20-2006.
- 3,296,321. **MISCELLANEOUS DESIGN**. CALVARY CHAPEL CHURCH, INC., MULTIPLE CLASS, (INT. CLS. 9, 38, 41

- AND 45), (U.S. CLS. 21, 23, 26, 36, 38, 100, 101, 104 AND 107). SN 77-025,845. PUB. 7-10-2007. FILED 10-20-2006.
- 3,296,322. **THE WORLD OF BEATRIX POTTER PETER RABBIT AND DESIGN**. FREDERICK WARNE & CO., INC., MULTIPLE CLASS, (INT. CLS. 9 AND 16), (U.S. CLS. 2, 5, 21, 22, 23, 26, 29, 36, 37, 38 AND 50). SN 77-025,990. PUB. 7-10-2007. FILED 10-20-2006.
- 3,296,323. **MAGNUM ENERGY (BLOCK FORM)**. MAGNUM ENERGY, INC., (U.S. CLS. 21, 23, 26, 36 AND 38). SN 77-026,171. PUB. 7-10-2007. FILED 10-20-2006.
- 3,296,331. **PETBEHAVE (BLOCK FORM)**. WHITLOCK INTERNATIONAL, LLC, (U.S. CLS. 21, 23, 26, 36 AND 38). SN 77-027,289. PUB. 7-10-2007. FILED 10-23-2006.
- 3,296,332. **FACS (BLOCK FORM)**. ONTARIO SYSTEMS, LLC, (U.S. CLS. 21, 23, 26, 36 AND 38). SN 77-027,682. PUB. 7-10-2007. FILED 10-24-2006.
- 3,296,349. **IMMIX (BLOCK FORM)**. SUREVIEW SYSTEMS, (U.S. CLS. 21, 23, 26, 36 AND 38). SN 77-030,360. PUB. 7-10-2007. FILED 10-26-2006.
- 3,296,372. **BLINKERBEAM (BLOCK FORM)**. TRAFFIC & PARKING CONTROL CO., INC., (U.S. CLS. 21, 23, 26, 36 AND 38). SN 77-033,268. PUB. 7-10-2007. FILED 10-31-2006.
- 3,296,381. **THE PROCLAIMERS QUARTET (BLOCK FORM)**. THE GOSPEL PROCLAIMERS, INC., MULTIPLE CLASS, (INT. CLS. 9 AND 41), (U.S. CLS. 21, 23, 26, 36, 38, 100, 101 AND 107). SN 77-034,512. PUB. 7-10-2007. FILED 11-1-2006.
- 3,296,393. **VIRTUAL MECHANICS (BLOCK FORM)**. VIRTUAL MECHANICS INC., (U.S. CLS. 21, 23, 26, 36 AND 38). SN 77-037,139. PUB. 7-10-2007. FILED 11-5-2006.
- 3,296,399. **ILIO (BLOCK FORM)**. ILIO, (U.S. CLS. 21, 23, 26, 36 AND 38). SN 77-038,078. PUB. 7-10-2007. FILED 11-7-2006.
- 3,296,405. **TOTAL TECHNOLOGIES, LTD. (BLOCK FORM)**. TURN-LUCKILY INTERNATIONAL, INC., (U.S. CLS. 21, 23, 26, 36 AND 38). SN 77-039,134. PUB. 7-10-2007. FILED 11-7-2006.
- 3,296,408. **TIMOTHY NOONAN'S INSTANT RECALL (BLOCK FORM)**. NOONAN, TIMOTHY F., (U.S. CLS. 21, 23, 26, 36 AND 38). SN 77-040,018. PUB. 7-10-2007. FILED S.R. 11-8-2006; AM. P.R. 6-1-2007.
- 3,296,414. **LEGACY INTERACTIVE (BLOCK FORM)**. LEGACY INTERACTIVE, INC., (U.S. CLS. 21, 23, 26, 36 AND 38). SN 77-041,054. PUB. 7-10-2007. FILED 11-9-2006.
- 3,296,416. **LEGACY GAMES (BLOCK FORM)**. LEGACY INTERACTIVE, INC., (U.S. CLS. 21, 23, 26, 36 AND 38). SN 77-041,065. PUB. 7-10-2007. FILED 11-9-2006.
- 3,296,423. **DYKNOW AND DESIGN**. DYNAMIC KNOWLEDGE TRANSFER, LLC, MULTIPLE CLASS, (INT. CLS. 9 AND 42), (U.S. CLS. 21, 23, 26, 36, 38, 100 AND 101). SN 77-041,549. PUB. 7-10-2007. FILED 11-10-2006.
- 3,296,425. **TANGIBLEFUTURE (BLOCK FORM)**. TANGIBLEFUTURE, INC., MULTIPLE CLASS, (INT. CLS. 9, 16, 35 AND 41), (U.S. CLS. 2, 5, 21, 22, 23, 26, 29, 36, 37, 38, 50, 100, 101, 102 AND 107). SN 77-041,641. PUB. 7-10-2007. FILED 11-10-2006.
- 3,296,427. **TANGIBLEFUTURE AND DESIGN**. TANGIBLEFUTURE, INC., MULTIPLE CLASS, (INT. CLS. 9, 16, 35 AND 41), (U.S. CLS. 2, 5, 21, 22, 23, 26, 29, 36, 37, 38, 50, 100, 101, 102 AND 107). SN 77-041,802. PUB. 7-10-2007. FILED 11-10-2006.
- 3,296,428. **A ARMOR CODE AND DESIGN**. TOM KANE, JR., AND CHAIM LOWENSTEIN, (U.S. CLS. 21, 23, 26, 36 AND 38). SN 77-042,140. PUB. 7-10-2007. FILED 11-12-2006.
- 3,296,429. **ARMORCODE (BLOCK FORM)**. CHAIM LOWENSTEIN, (U.S. CLS. 21, 23, 26, 36 AND 38). SN 77-042,158. PUB. 7-10-2007. FILED 11-12-2006.
- 3,296,433. **TOM AND JERRY TALES (BLOCK FORM)**. TURNER ENTERTAINMENT CO., (U.S. CLS. 21, 23, 26, 36 AND 38). SN 77-043,025. PUB. 7-10-2007. FILED 11-13-2006.
- 3,296,441. **GLOBE AND DESIGN**. GLOBE HOLDING COMPANY, LLC, (U.S. CLS. 21, 23, 26, 36 AND 38). SN 77-044,442. PUB. 7-10-2007. FILED 11-15-2006.
- 3,296,444. **ROVER'S PINKY (BLOCK FORM)**. HERION, ALLEN, (U.S. CLS. 21, 23, 26, 36 AND 38). SN 77-044,583. PUB. 7-10-2007. FILED S.R. 11-15-2006; AM. P.R. 5-2-2007.
- 3,296,449. **2500M (BLOCK FORM)**. AQUABANC, LLC, (U.S. CLS. 21, 23, 26, 36 AND 38). SN 77-044,957. PUB. 7-10-2007. FILED 11-15-2006.
- 3,296,463. **CASECOMPLETE (BLOCK FORM)**. SERLIO SOFTWARE DEVELOPMENT CORPORATION, (U.S. CLS. 21, 23, 26, 36 AND 38). SN 77-046,961. PUB. 7-10-2007. FILED 11-17-2006.
- 3,296,464. **CASECOMPLETE AND DESIGN**. SERLIO SOFTWARE DEVELOPMENT CORPORATION, (U.S. CLS. 21, 23, 26, 36 AND 38). SN 77-047,074. PUB. 7-10-2007. FILED 11-17-2006.
- 3,296,465. **STARRFADU (BLOCK FORM)**. HARTLEY, ROBERT AUSTIN, MULTIPLE CLASS, (INT. CLS. 9 AND 41), (U.S. CLS. 21, 23, 26, 36, 38, 100, 101 AND 107). SN 77-047,183. PUB. 7-10-2007. FILED 11-17-2006.
- 3,296,466. **MOSTART AND DESIGN**. KONDRATTSEV, MOSTART YEVGENIY Y., (U.S. CLS. 21, 23, 26, 36 AND 38). SN 77-047,231. PUB. 7-10-2007. FILED 11-18-2006.
- 3,296,472. **IXCM 1-10-100-1000 (STYLIZED)**. PROCURELINK, LLC, MULTIPLE CLASS, (INT. CLS. 9 AND 35), (U.S. CLS. 21, 23, 26, 36, 38, 100, 101 AND 102). SN 77-048,122. PUB. 6-26-2007. FILED 11-20-2006.
- 3,296,477. **VOLTAGE (STYLIZED)**. COOPER, AARON A., (U.S. CLS. 21, 23, 26, 36 AND 38). SN 77-049,370. PUB. 7-10-2007. FILED 11-22-2006.
- 3,296,488. **BP LIMBO (BLOCK FORM)**. DATADANCER MEDICAL SYSTEMS, (U.S. CLS. 21, 23, 26, 36 AND 38). SN 77-050,761. PUB. 7-10-2007. FILED 11-27-2006.
- 3,296,489. **BP TANGO (BLOCK FORM)**. DATADANCER MEDICAL SYSTEMS, (U.S. CLS. 21, 23, 26, 36 AND 38). SN 77-051,027. PUB. 7-10-2007. FILED 11-27-2006.
- 3,296,495. **MEDIA MODIFICATIONS AND DESIGN**. MEDIA MODIFICATIONS LLC, (U.S. CLS. 21, 23, 26, 36 AND 38). SN 77-051,995. PUB. 6-26-2007. FILED 11-28-2006.
- 3,296,497. **TOOX (BLOCK FORM)**. RENTABILIWEE EUROPE, MULTIPLE CLASS, (INT. CLS. 9, 38 AND 42), (U.S. CLS. 21, 23, 26, 36, 38, 100, 101 AND 104). SN 77-052,133. PUB. 7-10-2007. FILED 11-28-2006.
- 3,296,498. **XCEEDIUM (BLOCK FORM)**. XCEEDIUM, INC., (U.S. CLS. 21, 23, 26, 36 AND 38). SN 77-052,224. PUB. 7-10-2007. FILED 11-28-2006.
- 3,296,506. **SPICES.NET (BLOCK FORM)**. VICTOROV, VICTOR, MULTIPLE CLASS, (INT. CLS. 9 AND 42), (U.S. CLS. 21, 23, 26, 36, 38, 100 AND 101). SN 77-053,366. PUB. 7-10-2007. FILED 11-29-2006.
- 3,296,511. **INGLES MP3 AND DESIGN**. S&L MARKETING GROUP, (U.S. CLS. 21, 23, 26, 36 AND 38). SN 77-053,827. PUB. 7-10-2007. FILED 11-30-2006.
- 3,296,515. **LEARN MAGIC ON DVD WITH TIM NOONAN (BLOCK FORM)**. NOONAN, TIMOTHY F., (U.S. CLS. 21, 23, 26, 36 AND 38). SN 77-054,400. PUB. 7-10-2007. FILED 11-30-2006.
- 3,296,556. **TRANCE HEAVEN (BLOCK FORM)**. CHOU, POHSIU, (U.S. CLS. 21, 23, 26, 36 AND 38). SN 77-058,557. PUB. 7-10-2007. FILED 12-6-2006.
- 3,296,558. **GRAYSTONE (BLOCK FORM)**. ELBEX VIDEO LTD., (U.S. CLS. 21, 23, 26, 36 AND 38). SN 77-058,849. PUB. 7-10-2007. FILED 12-7-2006.
- 3,296,564. **MISSIONARY RECORDS (BLOCK FORM)**. MISSIONARY ENTERTAINMENT, LLC, MULTIPLE CLASS, (INT. CLS. 9 AND 25), (U.S. CLS. 21, 22, 23, 26, 36, 38 AND 39). SN 77-059,503. PUB. 7-10-2007. FILED 12-7-2006.
- 3,296,578. **VIRTUE (BLOCK FORM)**. VIRTUE PAINTBALL LLC, (U.S. CLS. 21, 23, 26, 36 AND 38). SN 77-060,265. PUB. 7-10-2007. FILED 12-8-2006.
- 3,296,595. **V VIRTUE AND DESIGN**. VIRTUE PAINTBALL LLC, (U.S. CLS. 21, 23, 26, 36 AND 38). SN 77-061,360. PUB. 7-10-2007. FILED 12-11-2006.
- 3,296,597. **UPGRADE THE ENGINE (BLOCK FORM)**. VIRTUE PAINTBALL LLC, (U.S. CLS. 21, 23, 26, 36 AND 38). SN 77-061,370. PUB. 7-10-2007. FILED 12-11-2006.
- 3,296,625. **EF AND DESIGN**. VERONIKA ELSNER, GUENTHER FLAKE GBR, (U.S. CLS. 21, 23, 26, 36 AND 38). SN 77-063,005. PUB. 7-10-2007. FILED 12-13-2006.
- 3,296,626. **TYPART (BLOCK FORM)**. VERONIKA ELSNER, GUENTHER FLAKE GBR, (U.S. CLS. 21, 23, 26, 36 AND 38). SN 77-063,008. PUB. 7-10-2007. FILED 12-13-2006.
- 3,296,640. **WIRELESS ON THE MOVE (BLOCK FORM)**. EXTRICOM INC., (U.S. CLS. 21, 23, 26, 36 AND 38). SN 77-063,506. PUB. 7-10-2007. FILED 12-13-2006.
- 3,296,669. **EYEROUTE (BLOCK FORM)**. TOPCON MEDICAL SYSTEMS, INC., (U.S. CLS. 21, 23, 26, 36 AND 38). SN 77-

- 064,203. PUB. 7-10-2007. FILED 12-14-2006.
- 3,296,674. **MYPLAYCITY (BLOCK FORM)**. BULAVIN, DMITRY, MULTIPLE CLASS, (INT. CLS. 9, 35 AND 41), (U.S. CLS. 21, 23, 26, 36, 38, 100, 101, 102 AND 107). SN 77-064,349. PUB. 7-10-2007. FILED 12-14-2006.
- 3,296,682. **DOKMEE (BLOCK FORM)**. OFFICE GEMINI, LLC, (U.S. CLS. 21, 23, 26, 36 AND 38). SN 77-064,535. PUB. 7-10-2007. FILED 12-14-2006.
- 3,296,687. **S AND DESIGN**. ANDREWS, JAMES, S., (U.S. CLS. 21, 23, 26, 36 AND 38). SN 77-064,686. PUB. 7-10-2007. FILED 12-14-2006.
- 3,296,701. **ASLMS AND DESIGN**. AMERICAN SOCIETY FOR LASER MEDICINE AND SURGERY, INC., MULTIPLE CLASS, (INT. CLS. 9, 16, 35, 38 AND 41), (U.S. CLS. 2, 5, 21, 22, 23, 26, 29, 36, 37, 38, 50, 100, 101, 102, 104 AND 107). SN 77-064,986. PUB. 7-10-2007. FILED 12-15-2006.
- 3,296,703. **SPRING THING (BLOCK FORM)**. VALVETRAIN AMPLIFICATION, LLC, (U.S. CLS. 21, 23, 26, 36 AND 38). SN 77-065,057. PUB. 7-10-2007. FILED 12-15-2006.
- 3,296,745. **BIQUAD (BLOCK FORM)**. GOFF, EUGENE F., (U.S. CLS. 21, 23, 26, 36 AND 38). SN 77-070,931. PUB. 7-10-2007. FILED 12-23-2006.
- 3,296,747. **BIODAQ (BLOCK FORM)**. RESEARCH DIETS, INC., (U.S. CLS. 21, 23, 26, 36 AND 38). SN 77-071,552. PUB. 7-10-2007. FILED 12-27-2006.
- 3,296,754. **PERSONIFY DESIGN (BLOCK FORM)**. PERSONIFY DESIGN INC., MULTIPLE CLASS, (INT. CLS. 9 AND 42), (U.S. CLS. 21, 23, 26, 36, 38, 100 AND 101). SN 77-073,281. PUB. 7-10-2007. FILED 12-29-2006.
- 3,296,768. **BURNING BLUE AND DESIGN**. CRILLY, JAMES P, MULTIPLE CLASS, (INT. CLS. 9 AND 41), (U.S. CLS. 21, 23, 26, 36, 38, 100, 101 AND 107). SN 77-075,607. PUB. 7-10-2007. FILED 1-4-2007.
- 3,296,810. **KNOWLEDGEPORTAL360 (BLOCK FORM)**. TFACTOR INC., (U.S. CLS. 21, 23, 26, 36 AND 38). SN 77-080,919. PUB. 7-10-2007. FILED 1-11-2007.
- 3,296,826. **DR PRO AND DESIGN**. GUITAR CENTER, INC., MULTIPLE CLASS, (INT. CLS. 9 AND 15), (U.S. CLS. 2, 21, 23, 26, 36 AND 38). SN 77-083,519. PUB. 6-26-2007. FILED 1-16-2007.
- 3,296,836. **BASS PRO SHOPS (BLOCK FORM)**. BASS PRO TRADEMARKS, L.L.C., (U.S. CLS. 21, 23, 26, 36 AND 38). SN 77-084,471. PUB. 7-10-2007. FILED 1-17-2007.
- 3,296,843. **DOLICA (STYLIZED)**. BRAINSTORM CORPORATION, (U.S. CLS. 21, 23, 26, 36 AND 38). SN 77-084,758. PUB. 7-10-2007. FILED 1-17-2007.
- 3,296,851. **GRADIENCE (BLOCK FORM)**. EVERGLADES DIRECT, INC., (U.S. CLS. 21, 23, 26, 36 AND 38). SN 77-085,377. PUB. 7-10-2007. FILED 1-18-2007.
- 3,296,861. **MISCELLANEOUS DESIGN**. CLOONAN PETER J, DBA COMPUTER REPAIR PROS, (U.S. CLS. 21, 23, 26, 36 AND 38). SN 77-086,176. PUB. 7-10-2007. FILED 1-18-2007.
- 3,296,863. **ROBIN RECORDS AND DESIGN**. FERR, JAMES, (U.S. CLS. 21, 23, 26, 36 AND 38). SN 77-086,284. PUB. 7-10-2007. FILED 1-19-2007.
- 3,296,869. **GOING GLOBAL (BLOCK FORM)**. GOING GLOBAL, INC., (U.S. CLS. 21, 23, 26, 36 AND 38). SN 77-086,653. PUB. 7-10-2007. FILED 1-19-2007.
- 3,296,877. **YOZONE (BLOCK FORM)**. YATES, NICHOLAS, (U.S. CLS. 21, 23, 26, 36 AND 38). SN 77-087,162. PUB. 7-10-2007. FILED 1-19-2007.
- 3,296,901. **MOLEZILLA (BLOCK FORM)**. ABSOLUTE MOLE CONTROL, LLC, (U.S. CLS. 21, 23, 26, 36 AND 38). SN 77-088,386. PUB. 7-10-2007. FILED 1-22-2007.
- 3,296,914. **TOUCH MARK (BLOCK FORM)**. FOURSTAR GROUP INC., (U.S. CLS. 21, 23, 26, 36 AND 38). SN 77-088,878. PUB. 7-10-2007. FILED 1-23-2007.
- 3,296,916. **CALCUDIVA (BLOCK FORM)**. JOBDIVA, INC., (U.S. CLS. 21, 23, 26, 36 AND 38). SN 77-088,921. PUB. 7-10-2007. FILED 1-23-2007.
- 3,296,917. **PAD MATE (BLOCK FORM)**. BARCLAY ENTERPRISES, INC., (U.S. CLS. 21, 23, 26, 36 AND 38). SN 77-088,928. PUB. 7-10-2007. FILED 1-23-2007.
- 3,296,935. **PERMA-PAD (BLOCK FORM)**. BARCLAY ENTERPRISES, INC., (U.S. CLS. 21, 23, 26, 36 AND 38). SN 77-089,908. PUB. 7-10-2007. FILED 1-24-2007.
- 3,296,962. **ACTIONBRIDGE (BLOCK FORM)**. NIMAYA INC., (U.S. CLS. 21, 23, 26, 36 AND 38). SN 77-091,110. PUB. 7-10-2007. FILED 1-25-2007.
- 3,296,973. **NINJABEE (BLOCK FORM)**. WAHOO STUDIOS, INC., (U.S. CLS. 21, 23, 26, 36 AND 38). SN 77-091,300. PUB. 7-10-2007. FILED 1-25-2007.
- 3,296,977. **AUTEC POWER SYSTEMS (BLOCK FORM)**. AUTEC POWER SYSTEMS, INC., (U.S. CLS. 21, 23, 26, 36 AND 38). SN 77-091,389. PUB. 7-10-2007. FILED 1-25-2007.
- 3,296,980. **AZURO (BLOCK FORM)**. AZURO, INC., (U.S. CLS. 21, 23, 26, 36 AND 38). SN 77-091,480. PUB. 7-10-2007. FILED 1-25-2007.
- 3,296,981. **POWERCENTRIC (BLOCK FORM)**. AZURO, INC., (U.S. CLS. 21, 23, 26, 36 AND 38). SN 77-091,481. PUB. 7-10-2007. FILED 1-25-2007.
- 3,296,984. **PELUSO AND DESIGN**. PELUSO MICROPHONE LAB, LLC, (U.S. CLS. 21, 23, 26, 36 AND 38). SN 77-091,561. PUB. 7-10-2007. FILED 1-25-2007.
- 3,296,990. **WELL TENDER II (BLOCK FORM)**. PRODUCTION CONTROL SERVICES, INC., (U.S. CLS. 21, 23, 26, 36 AND 38). SN 77-091,590. PUB. 7-10-2007. FILED 1-25-2007.
- 3,296,991. **WELL TENDER (BLOCK FORM)**. PRODUCTION CONTROL SERVICES, INC., (U.S. CLS. 21, 23, 26, 36 AND 38). SN 77-091,592. PUB. 7-10-2007. FILED 1-25-2007.
- 3,296,992. **PCS 3000 CONTROLLER (BLOCK FORM)**. PRODUCTION CONTROL SERVICES, INC., (U.S. CLS. 21, 23, 26, 36 AND 38). SN 77-091,594. PUB. 7-10-2007. FILED 1-25-2007.
- 3,296,995. **PCS 2000 CONTROLLER (BLOCK FORM)**. PRODUCTION CONTROL SERVICES, INC., (U.S. CLS. 21, 23, 26, 36 AND 38). SN 77-091,602. PUB. 7-10-2007. FILED 1-25-2007.
- 3,296,996. **PCS 1000 CONTROLLER (BLOCK FORM)**. PRODUCTION CONTROL SERVICES, INC., (U.S. CLS. 21, 23, 26, 36 AND 38). SN 77-091,604. PUB. 7-10-2007. FILED 1-25-2007.
- 3,296,998. **GEOKING (BLOCK FORM)**. Q L ENTERPRISES, INC., (U.S. CLS. 21, 23, 26, 36 AND 38). SN 77-091,638. PUB. 7-10-2007. FILED 1-25-2007.
- 3,297,003. **EARNMYALLOWANCE AND DESIGN**. MAGUY, INC., (U.S. CLS. 21, 23, 26, 36 AND 38). SN 77-091,989. PUB. 7-10-2007. FILED 1-26-2007.
- 3,297,043. **FLOCAD (BLOCK FORM)**. CULLIMORE AND RING TECHNOLOGIES, INC., (U.S. CLS. 21, 23, 26, 36 AND 38). SN 77-093,462. PUB. 7-10-2007. FILED 1-29-2007.
- 3,297,048. **BLUELINE (BLOCK FORM)**. ALSTOM POWER INC., (U.S. CLS. 21, 23, 26, 36 AND 38). SN 77-093,687. PUB. 7-10-2007. FILED 1-29-2007.
- 3,297,058. **NERVOUS... AND DESIGN**. NERVOUS, INC., (U.S. CLS. 21, 23, 26, 36 AND 38). SN 77-095,365. PUB. 7-10-2007. FILED 1-31-2007.
- 3,297,064. **ARMITAGE AND DESIGN**. EYE OJO CORP., (U.S. CLS. 21, 23, 26, 36 AND 38). SN 77-096,385. PUB. 7-10-2007. FILED 2-1-2007.
- 3,297,066. **ON THE TRADING DESK (BLOCK FORM)**. WELLS FARGO & COMPANY, (U.S. CLS. 21, 23, 26, 36 AND 38). SN 77-097,589. PUB. 7-10-2007. FILED 2-2-2007.
- 3,297,074. **LINDY FRALIN (BLOCK FORM)**. LINDY FRALIN, (U.S. CLS. 21, 23, 26, 36 AND 38). SN 77-100,083. PUB. 7-10-2007. FILED 2-6-2007.
- 3,297,085. **TOMS TOTAL OPERATIONS MONITORING SYSTEM AND DESIGN**. ITT CORPORATION, (U.S. CLS. 21, 23, 26, 36 AND 38). SN 77-101,603. PUB. 7-10-2007. FILED 2-7-2007.
- 3,297,097. **MISCELLANEOUS DESIGN**. T-MOBILE USA, INC., (U.S. CLS. 21, 23, 26, 36 AND 38). SN 77-104,690. PUB. 7-10-2007. FILED 2-12-2007.
- 3,297,109. **COVER FLOW (BLOCK FORM)**. APPLE INC., (U.S. CLS. 21, 23, 26, 36 AND 38). SN 77-107,545. PUB. 7-10-2007. FILED 2-14-2007.
- 3,297,134. **REBOUND (BLOCK FORM)**. ADVANCED FUNCTIONS TECHNOLOGY OF FLORIDA, INC., (U.S. CLS. 21, 23, 26, 36 AND 38). SN 77-119,348. PUB. 7-10-2007. FILED 3-1-2007.
- 3,297,137. **PCS 4000 CONTROLLER (BLOCK FORM)**. PRODUCTION CONTROL SERVICES, INC., (U.S. CLS. 21, 23, 26, 36 AND 38). SN 77-120,217. PUB. 7-10-2007. FILED 3-1-2007.
- 3,297,138. **RONALD MCDONALD (BLOCK FORM)**. MCDONALD'S CORPORATION, (U.S. CLS. 21, 23, 26, 36 AND 38).

- SN 77-120,744. PUB. 7-10-2007. FILED 3-2-2007.
- 3,297,143. **REDHEAD EPIC (BLOCK FORM)**. BASS PRO TRADEMARKS, L.L.C., (U.S. CLS. 21, 23, 26, 36 AND 38). SN 77-123,807. PUB. 7-10-2007. FILED 3-6-2007.
- 3,297,157. **STEELHEAD (BLOCK FORM)**. MANLEY LABORATORIES INCORPORATED, (U.S. CLS. 21, 23, 26, 36 AND 38). SN 77-138,235. PUB. 7-10-2007. FILED 3-22-2007.
- 3,297,158. **SHRIMP (BLOCK FORM)**. MANLEY LABORATORIES INCORPORATED, (U.S. CLS. 21, 23, 26, 36 AND 38). SN 77-138,243. PUB. 7-10-2007. FILED 3-22-2007.
- 3,297,159. **MAHI (BLOCK FORM)**. MANLEY LABORATORIES INCORPORATED, (U.S. CLS. 21, 23, 26, 36 AND 38). SN 77-138,253. PUB. 7-10-2007. FILED 3-22-2007.
- 3,297,160. **SNAPPER (BLOCK FORM)**. MANLEY LABORATORIES INCORPORATED, (U.S. CLS. 21, 23, 26, 36 AND 38). SN 77-138,262. PUB. 7-10-2007. FILED 3-22-2007.
- 3,297,163 (*See Class 8 for this trademark*).
- 3,297,182. **LISA (BLOCK FORM)**. INTERACTIVE TKO INC., (U.S. CLS. 21, 23, 26, 36 AND 38). SN 78-365,909. PUB. 7-10-2007. FILED 2-10-2004.
- 3,297,193. **4 ACES AND DESIGN**. IMAGINATION HOLDINGS LIMITED, MULTIPLE CLASS, (INT. CLS. 9, 16 AND 41), (U.S. CLS. 2, 5, 21, 22, 23, 26, 29, 36, 37, 38, 50, 100, 101 AND 107). SN 78-447,928. PUB. 7-10-2007. FILED 7-8-2004.
- 3,297,195. **LITHIUM AND DESIGN**. LITHIUM TECHNOLOGIES, MULTIPLE CLASS, (INT. CLS. 9 AND 42), (U.S. CLS. 21, 23, 26, 36, 38, 100 AND 101). SN 78-469,089. PUB. 7-10-2007. FILED 8-17-2004.
- 3,297,205. **AUTONOMY ICS (BLOCK FORM)**. AUTONOMY CORPORATION PLC, MULTIPLE CLASS, (INT. CLS. 9, 35, 38 AND 42), (U.S. CLS. 21, 23, 26, 36, 38, 100, 101, 102 AND 104). SN 78-499,917. PUB. 7-10-2007. FILED 10-14-2004.
- 3,297,208. **VCOM (BLOCK FORM)**. AVANQUEST PUBLISHING USA, INC., (U.S. CLS. 21, 23, 26, 36 AND 38). SN 78-511,194. PUB. 7-10-2007. FILED 11-4-2004.
- 3,297,225. **CLEARCALM (STYLIZED)**. CLEARCALM INC., (U.S. CLS. 21, 23, 26, 36 AND 38). SN 78-574,718. PUB. 7-10-2007. FILED 2-24-2005.
- 3,297,226. **OPTIMODE AND DESIGN**. ARM LIMITED, MULTIPLE CLASS, (INT. CLS. 9, 16 AND 42), (U.S. CLS. 2, 5, 21, 22, 23, 26, 29, 36, 37, 38, 50, 100 AND 101). SN 78-577,750. PUB. 7-10-2007. FILED 3-1-2005.
- 3,297,228 (*See Class 7 for this trademark*).
- 3,297,229. **EKOSYSTEM ENVIRONMENTAL KNOWLEDGE ORGANIZER (BLOCK FORM)**. PALADIN DATA SYSTEMS CORPORATION, MULTIPLE CLASS, (INT. CLS. 9 AND 42), (U.S. CLS. 21, 23, 26, 36, 38, 100 AND 101). SN 78-582,096. PUB. 7-10-2007. FILED 3-7-2005.
- 3,297,237. **V & A (STYLIZED)**. V&A ENTERPRISES LIMITED, MULTIPLE CLASS, (INT. CLS. 9, 14, 16, 18, 19, 21, 24, 25, 27 AND 41), (U.S. CLS. 1, 2, 3, 5, 12, 13, 19, 20, 21, 22, 23, 26, 27, 28, 29, 30, 33, 36, 37, 38, 39, 40, 41, 42, 50, 100, 101 AND 107). SN 78-594,383. PUB. 7-10-2007. FILED 3-24-2005.
- 3,297,243. **MISCELLANEOUS DESIGN**. KABUSHIKI KAISHA TANITA, MULTIPLE CLASS, (INT. CLS. 9, 10, 16, 41, 42 AND 44), (U.S. CLS. 2, 5, 21, 22, 23, 26, 29, 36, 37, 38, 39, 44, 50, 100, 101 AND 107). SN 78-612,562. PUB. 7-10-2007. FILED 4-20-2005.
- 3,297,244. **GET ME TO THE BANQUET ON TIME! (BLOCK FORM)**. NATIONAL DAIRY COUNCIL, MULTIPLE CLASS, (INT. CLS. 9 AND 41), (U.S. CLS. 21, 23, 26, 36, 38, 100, 101 AND 107). SN 78-614,142. PUB. 7-10-2007. FILED 4-21-2005.
- 3,297,248. **ACCUVISION HANDSFREE (BLOCK FORM)**. ACCU-SORT SYSTEMS, INC., (U.S. CLS. 21, 23, 26, 36 AND 38). SN 78-622,848. PUB. 7-10-2007. FILED 5-4-2005.
- 3,297,262. **AMERICAN TECHNOLOGY (BLOCK FORM)**. AMERICAN TECHNOLOGY CORPORATION, (U.S. CLS. 21, 23, 26, 36 AND 38). SN 78-642,772. PUB. 7-10-2007. FILED 6-2-2005.
- 3,297,265. **MODELSTATION (BLOCK FORM)**. CLARIFI, INC., MULTIPLE CLASS, (INT. CLS. 9 AND 41), (U.S. CLS. 21, 23, 26, 36, 38, 100, 101 AND 107). SN 78-645,787. PUB. 7-10-2007. FILED 6-7-2005.
- 3,297,269. **BRICKLOCK AND DESIGN**. CLARK, JAMES, (U.S. CLS. 21, 23, 26, 36 AND 38). SN 78-670,512. PUB. 7-10-2007. FILED 7-14-2005.
- 3,297,275. **F A AND DESIGN**. FULTON INDUSTRIES AUSTRALIA PTY LTD., MULTIPLE CLASS, (INT. CLS. 9 AND 42), (U.S. CLS. 21, 23, 26, 36, 38, 100 AND 101). SN 78-682,939. PUB. 7-10-2007. FILED 8-1-2005.
- 3,297,297. **LOTTE BERK METHOD (BLOCK FORM)**. L. B. BRIDGEHAMPTON CORP., MULTIPLE CLASS, (INT. CLS. 9 AND 25), (U.S. CLS. 21, 22, 23, 26, 36, 38 AND 39). SN 78-705,319. PUB. 7-10-2007. FILED 9-1-2005.
- 3,297,303. **VOICE100 (BLOCK FORM)**. SYFT TECHNOLOGIES LTD, MULTIPLE CLASS, (INT. CLS. 9, 10, 42 AND 44), (U.S. CLS. 21, 23, 26, 36, 38, 39, 44, 100 AND 101). SN 78-708,388. PUB. 7-10-2007. FILED 9-7-2005.
- 3,297,305 (*See Class 7 for this trademark*).
- 3,297,310. **IP MEDIA MONITOR AND DESIGN**. EMERGING MEDIA DYNAMICS, INC., (U.S. CLS. 21, 23, 26, 36 AND 38). SN 78-710,357. PUB. 7-10-2007. FILED 9-9-2005.
- 3,297,311. **ENSEQUENCE (STYLIZED)**. ENSEQUENCE, INC., MULTIPLE CLASS, (INT. CLS. 9 AND 42), (U.S. CLS. 21, 23, 26, 36, 38, 100 AND 101). SN 78-710,430. PUB. 7-10-2007. FILED 9-9-2005.
- 3,297,315. **FORCECOM AND DESIGN**. FORCECOM, (U.S. CLS. 21, 23, 26, 36 AND 38). SN 78-711,990. PUB. 7-10-2007. FILED 9-13-2005.
- 3,297,318. **SEVENDUST (BLOCK FORM)**. MPC INCORPORATED, AND SEVENDUST, LLC, (U.S. CLS. 21, 23, 26, 36 AND 38). SN 78-713,243. PUB. 7-10-2007. FILED 9-14-2005.
- 3,297,334 (*See Class 1 for this trademark*).
- 3,297,345 (*See Class 3 for this trademark*).
- 3,297,349. **MAPFRAME (BLOCK FORM)**. MAPFRAME CORPORATION, (U.S. CLS. 21, 23, 26, 36 AND 38). SN 78-731,116. PUB. 7-10-2007. FILED 10-11-2005.
- 3,297,357. **TEN4 BODY ARMOR (BLOCK FORM)**. PANTALONS STAR & CIE, (U.S. CLS. 21, 23, 26, 36 AND 38). SN 78-744,588. PUB. 7-10-2007. FILED 11-1-2005.
- 3,297,371. **MISCELLANEOUS DESIGN**. DAVID ALLEN & CO., MULTIPLE CLASS, (INT. CLS. 9 AND 16), (U.S. CLS. 2, 5, 21, 22, 23, 26, 29, 36, 37, 38 AND 50). SN 78-760,593. PUB. 7-10-2007. FILED 11-23-2005.
- 3,297,381. **HEROES OF THE PACIFIC (BLOCK FORM)**. PALMER, BEN, MULTIPLE CLASS, (INT. CLS. 9 AND 41), (U.S. CLS. 21, 23, 26, 36, 38, 100, 101 AND 107). SN 78-766,863. PUB. 7-10-2007. FILED 12-5-2005.
- 3,297,386 (*See Class 6 for this trademark*).
- 3,297,391. **F-SHINE (BLOCK FORM)**. NIPPON SHEET GLASS COMPANY, LIMITED, MULTIPLE CLASS, (INT. CLS. 9, 19 AND 21), (U.S. CLS. 1, 2, 12, 13, 21, 23, 26, 29, 30, 33, 36, 38, 40 AND 50). SN 78-771,250. PUB. 7-10-2007. FILED 12-12-2005.
- 3,297,392. **CERTIPAY AND DESIGN**. CERTIPAY AMERICA, LLC, MULTIPLE CLASS, (INT. CLS. 9 AND 35), (U.S. CLS. 21, 23, 26, 36, 38, 100, 101 AND 102). SN 78-771,634. PUB. 7-10-2007. FILED 12-12-2005.
- 3,297,393. **ROSEN INTEGRITY COCKPIT (BLOCK FORM)**. ROSEN SWISS AG, (U.S. CLS. 21, 23, 26, 36 AND 38). SN 78-772,984. PUB. 7-10-2007. FILED 12-14-2005.
- 3,297,395. **WE MAKE PAPERLESS HAPPEN (BLOCK FORM)**. SILANIS TECHNOLOGY INC., MULTIPLE CLASS, (INT. CLS. 9 AND 42), (U.S. CLS. 21, 23, 26, 36, 38, 100 AND 101). SN 78-776,554. PUB. 7-10-2007. FILED 12-19-2005.
- 3,297,398. **COMPOSE (BLOCK FORM)**. BMRB LTD., MULTIPLE CLASS, (INT. CLS. 9, 35 AND 42), (U.S. CLS. 21, 23, 26, 36, 38, 100, 101 AND 102). SN 78-779,694. PUB. 7-10-2007. FILED 12-22-2005.
- 3,297,405 (*See Class 3 for this trademark*).
- 3,297,415. **BECKER (BLOCK FORM)**. DRESSER, INC., (U.S. CLS. 21, 23, 26, 36 AND 38). SN 78-788,449. PUB. 7-10-2007. FILED 1-10-2006.
- 3,297,425 (*See Class 1 for this trademark*).
- 3,297,428. **INPDF AND DESIGN**. ARTWORK SYSTEMS GROUP NV, MULTIPLE CLASS, (INT. CLS. 9, 35 AND 42), (U.S. CLS. 21, 23, 26, 36, 38, 100, 101 AND 102). SN 78-794,204. PUB. 7-10-2007. FILED 1-18-2006.
- 3,297,429. **PA:CT (BLOCK FORM)**. ARTWORK SYSTEMS GROUP NV, MULTIPLE CLASS, (INT. CLS. 9, 35 AND 42), (U.S. CLS. 21, 23, 26, 36, 38, 100, 101 AND 102). SN 78-794,209. PUB. 7-10-2007. FILED 1-18-2006.
- 3,297,430. **PA:CT PACKAGING: CERTIFIED TECHNOLOGY AND DESIGN**. ARTWORK SYSTEMS GROUP NV, MULTIPLE CLASS, (INT. CLS. 9, 35 AND 42), (U.S. CLS. 21, 23, 26, 36, 38, 100, 101 AND 102). SN 78-794,214. PUB. 7-10-2007.

- FILED 1-18-2006.
- 3,297,432. **ENVIROINSITE AND DESIGN**. HYDROANALYSIS, INC., (U.S. CLS. 21, 23, 26, 36 AND 38). SN 78-795,407. PUB. 7-10-2007. FILED 1-19-2006.
- 3,297,436. **FORCENET TRANSFORMING INFORMATION INTO COMBAT POWER NETWORKS DECISIONS AIDS WEAPONS SENSORS SEA SPACE AIR SHORE SEABED WARFIGHTER DEPARTMENT OF THE NAVY UNITED STATES OF AMERICA DEPARTMENT OF UNITED STATES MARINE CORPS AND DESIGN**. DEPARTMENT OF THE UNITED STATES NAVY AS REPRESENTED BY SPACE AND NAVAL WARFARE SYSTEMS COMMAND, MULTIPLE CLASS, (INT. CLS. 9 AND 42), (U.S. CLS. 21, 23, 26, 36, 38, 100 AND 101). SN 78-798,918. PUB. 7-10-2007. FILED 1-25-2006.
- 3,297,437. **PROFESSIONAL GLOBAL MANAGEMENT (BLOCK FORM)**. EMPLOYMENT LEARNING INNOVATIONS, INC., MULTIPLE CLASS, (INT. CLS. 9, 16 AND 41), (U.S. CLS. 2, 5, 21, 22, 23, 26, 29, 36, 37, 38, 50, 100, 101 AND 107). SN 78-800,113. PUB. 7-10-2007. FILED 1-26-2006.
- 3,297,443. **MOVIE MATE (BLOCK FORM)**. MOVIE MATE INC., (U.S. CLS. 21, 23, 26, 36 AND 38). SN 78-803,102. PUB. 7-10-2007. FILED 1-31-2006.
- 3,297,448. **YOUR AD DEPT AND DESIGN**. STEP-BY-STEP COMMUNICATIONS, LLC, (U.S. CLS. 21, 23, 26, 36 AND 38). SN 78-805,873. PUB. 7-10-2007. FILED 2-2-2006.
- 3,297,464. **IP2PHONE AND DESIGN**. FOGEL, SERGIO, E, MULTIPLE CLASS, (INT. CLS. 9 AND 36), (U.S. CLS. 21, 23, 26, 36, 38, 100, 101 AND 102). SN 78-813,623. PUB. 7-10-2007. FILED 2-13-2006.
- 3,297,477. **HS285 (BLOCK FORM)**. SOUTHWIRE COMPANY, (U.S. CLS. 21, 23, 26, 36 AND 38). SN 78-821,747. PUB. 7-10-2007. FILED 2-23-2006.
- 3,297,481. **INSTANT HOUSECALL ANY TIME, ANYWHERE, INSTANTLY AND DESIGN**. FRUITMAN, COREY, (U.S. CLS. 21, 23, 26, 36 AND 38). SN 78-822,223. PUB. 7-10-2007. FILED 2-23-2006.
- 3,297,484. **TATLIFE (BLOCK FORM)**. KAUFMAN, ELIZABETH M, MULTIPLE CLASS, (INT. CLS. 9, 16, 41 AND 44), (U.S. CLS. 2, 5, 21, 22, 23, 26, 29, 36, 37, 38, 50, 100, 101 AND 107). SN 78-823,653. PUB. 7-10-2007. FILED 2-26-2006.
- 3,297,488. **SOL HELMET AND DESIGN**. BO CAI ENTERPRISE CO., LTD., (U.S. CLS. 21, 23, 26, 36 AND 38). SN 78-826,258. PUB. 7-10-2007. FILED 3-1-2006.
- 3,297,494. **MISCELLANEOUS DESIGN**. HARBINGER TECHNOLOGIES GROUP, INC., MULTIPLE CLASS, (INT. CLS. 9 AND 45), (U.S. CLS. 21, 23, 26, 36, 38, 100 AND 101). SN 78-830,762. PUB. 7-10-2007. FILED 3-7-2006.
- 3,297,512. **HEADSTART (BLOCK FORM)**. CONCEPT INTERACTIVE INC., MULTIPLE CLASS, (INT. CLS. 9 AND 42), (U.S. CLS. 21, 23, 26, 36, 38, 100 AND 101). SN 78-836,483. PUB. 7-10-2007. FILED 3-14-2006.
- 3,297,517. **ZEMOGA CREATIVEDIGITALLY. (STYLIZED)**. ZEMOGA, INC., (U.S. CLS. 21, 23, 26, 36 AND 38). SN 78-839,061. PUB. 7-10-2007. FILED 3-16-2006.
- 3,297,525. **SYMBOL (BLOCK FORM)**. SYMBOL TECHNOLOGIES, INC., MULTIPLE CLASS, (INT. CLS. 9, 35, 37 AND 42), (U.S. CLS. 21, 23, 26, 36, 38, 100, 101, 102, 103 AND 106). SN 78-841,530. PUB. 7-10-2007. FILED 3-20-2006.
- 3,297,546. **FIST (BLOCK FORM)**. KNIGHT'S ARMAMENT COMPANY, (U.S. CLS. 21, 23, 26, 36 AND 38). SN 78-850,132. PUB. 7-10-2007. FILED 3-30-2006.
- 3,297,552. **BETTER BASKETBALL (BLOCK FORM)**. BETTER BASKETBALL, INC., (U.S. CLS. 21, 23, 26, 36 AND 38). SN 78-852,146. PUB. 7-10-2007. FILED 4-2-2006.
- 3,297,568. **HISTORY COMPASS (BLOCK FORM)**. BLACKWELL PUBLISHING INC., MULTIPLE CLASS, (INT. CLS. 9, 16 AND 41), (U.S. CLS. 2, 5, 21, 22, 23, 26, 29, 36, 37, 38, 50, 100, 101 AND 107). SN 78-856,425. PUB. 7-10-2007. FILED 4-7-2006.
- 3,297,574. **INCEPTOR (BLOCK FORM)**. ADDITECH, INC., (U.S. CLS. 21, 23, 26, 36 AND 38). SN 78-857,688. PUB. 7-10-2007. FILED 4-10-2006.
- 3,297,584. **MDLSOLUTIONS (BLOCK FORM)**. MDLSOLUTIONS, INC, (U.S. CLS. 21, 23, 26, 36 AND 38). SN 78-860,392. PUB. 7-10-2007. FILED 4-12-2006.
- 3,297,586. **PICO MACOM AND DESIGN**. PICO MACOM, INC., (U.S. CLS. 21, 23, 26, 36 AND 38). SN 78-860,725. PUB. 7-10-2007. FILED 4-13-2006.
- 3,297,606. **YESCO ELECTRONICS (BLOCK FORM)**. YOUNG ELECTRIC SIGN COMPANY, MULTIPLE CLASS, (INT. CLS. 9, 37 AND 40), (U.S. CLS. 21, 23, 26, 36, 38, 100, 103 AND 106). SN 78-862,728. PUB. 7-10-2007. FILED 4-17-2006.
- 3,297,615. **LYONS LEGACY (BLOCK FORM)**. JOHN LYONS SYMPOSIUMS, INC., MULTIPLE CLASS, (INT. CLS. 9 AND 16), (U.S. CLS. 2, 5, 21, 22, 23, 26, 29, 36, 37, 38 AND 50). SN 78-863,761. PUB. 7-10-2007. FILED 4-18-2006.
- 3,297,630 (*See Class 5 for this trademark*).
- 3,297,631. **BREEZE (BLOCK FORM)**. BREESE, CHRISTINE, C., (U.S. CLS. 21, 23, 26, 36 AND 38). SN 78-867,327. PUB. 7-10-2007. FILED 4-21-2006.
- 3,297,633. **SECUREBAK (BLOCK FORM)**. YETT, KARL R., (U.S. CLS. 21, 23, 26, 36 AND 38). SN 78-867,493. PUB. 7-10-2007. FILED 4-22-2006.
- 3,297,638. **INERTIAL EXPLORER (BLOCK FORM)**. NOVATEL INC., (U.S. CLS. 21, 23, 26, 36 AND 38). SN 78-868,972. PUB. 7-10-2007. FILED 4-25-2006.
- 3,297,641. **PROVIGENT (BLOCK FORM)**. PROVIGENT LTD., (U.S. CLS. 21, 23, 26, 36 AND 38). SN 78-869,061. PUB. 7-10-2007. FILED 4-25-2006.
- 3,297,646. **MISCELLANEOUS DESIGN**. YEAR LIMITED, MULTIPLE CLASS, (INT. CLS. 9, 35, 41 AND 42), (U.S. CLS. 21, 23, 26, 36, 38, 100, 101, 102 AND 107). SN 78-869,786. PUB. 7-10-2007. FILED 4-26-2006.
- 3,297,659. **FOXMARKS (BLOCK FORM)**. FOXMARKS, INC., MULTIPLE CLASS, (INT. CLS. 9 AND 42), (U.S. CLS. 21, 23, 26, 36, 38, 100 AND 101). SN 78-871,590. PUB. 7-10-2007. FILED 4-27-2006.
- 3,297,661. **VIDOOP (BLOCK FORM)**. VIDOOP LLC, (U.S. CLS. 21, 23, 26, 36 AND 38). SN 78-872,064. PUB. 7-10-2007. FILED 4-28-2006.
- 3,297,664. **RAT VISION (BLOCK FORM)**. CURTIS, TIM, (U.S. CLS. 21, 23, 26, 36 AND 38). SN 78-872,175. PUB. 7-10-2007. FILED 4-28-2006.
- 3,297,665. **JDA REAL DEMAND CHAIN RESULTS. AND DESIGN**. JDA SOFTWARE GROUP, INC., MULTIPLE CLASS, (INT. CLS. 9 AND 42), (U.S. CLS. 21, 23, 26, 36, 38, 100 AND 101). SN 78-872,183. PUB. 7-10-2007. FILED 4-28-2006.
- 3,297,670. **SAFETY LADY (BLOCK FORM)**. SAFETY LADY LLC, MULTIPLE CLASS, (INT. CLS. 9, 16, 41 AND 45), (U.S. CLS. 2, 5, 21, 22, 23, 26, 29, 36, 37, 38, 50, 100, 101 AND 107). SN 78-872,783. PUB. 7-10-2007. FILED 4-29-2006.
- 3,297,675. **THE GLOBAL THINKER (BLOCK FORM)**. THE STRATEGIC COACH INC., MULTIPLE CLASS, (INT. CLS. 9 AND 16), (U.S. CLS. 2, 5, 21, 22, 23, 26, 29, 36, 37, 38 AND 50). SN 78-873,638. PUB. 7-10-2007. FILED 5-1-2006.
- 3,297,681. **RESPONSIVESOLUTIONS SYSTEMS THAT MEAN BUSINESS AND DESIGN**. RESPONSIVE SOLUTIONS INC., (U.S. CLS. 21, 23, 26, 36 AND 38). SN 78-875,282. PUB. 7-10-2007. FILED 5-3-2006.
- 3,297,684. **POSTAGE FROM YOUR PRINTER (BLOCK FORM)**. STAMPS.COM, INC., (U.S. CLS. 21, 23, 26, 36 AND 38). SN 78-875,860. PUB. 7-10-2007. FILED 5-3-2006.
- 3,297,685. **XXX NEXXT GENERATION AND DESIGN**. PLAYHOUSE, (U.S. CLS. 21, 23, 26, 36 AND 38). SN 78-876,113. PUB. 7-10-2007. FILED 5-4-2006.
- 3,297,686. **PROCELL (BLOCK FORM)**. SPECIALIZED INDUSTRIAL SOLUTIONS, INC., (U.S. CLS. 21, 23, 26, 36 AND 38). SN 78-876,207. PUB. 7-10-2007. FILED 5-4-2006.
- 3,297,691. **STRIVE (BLOCK FORM)**. CAE INC., (U.S. CLS. 21, 23, 26, 36 AND 38). SN 78-876,849. PUB. 7-10-2007. FILED 5-4-2006.
- 3,297,693 (*See Class 1 for this trademark*).
- 3,297,694. **DVE (BLOCK FORM)**. JOE KANE PRODUCTIONS, INC., (U.S. CLS. 21, 23, 26, 36 AND 38). SN 78-878,109. PUB. 7-10-2007. FILED 5-5-2006.
- 3,297,707. **PRODUCTIVIDAD MOVIL TELCEL (BLOCK FORM)**. ADMINISTRADORA DE MARCAS RD, S. DE R.L. DE C.V., MULTIPLE CLASS, (INT. CLS. 9 AND 38), (U.S. CLS. 21, 23, 26, 36, 38, 100, 101 AND 104). SN 78-880,602. PUB. 7-10-2007. FILED 5-10-2006.
- 3,297,722. **ANTIBALAS (BLOCK FORM)**. MARTIN PERNA, (U.S. CLS. 21, 23, 26, 36 AND 38). SN 78-883,658. PUB. 7-10-2007. FILED 5-15-2006.
- 3,297,725. **DETECTILE (BLOCK FORM)**. BINDAN COR-

- PORATION, (U.S. CLS. 21, 23, 26, 36 AND 38). SN 78-884,114. PUB. 7-10-2007. FILED 5-15-2006.
- 3,297,730. **HMT (BLOCK FORM)**. MITSUI HIGH-TEC INC., (U.S. CLS. 21, 23, 26, 36 AND 38). SN 78-884,800. PUB. 7-10-2007. FILED 5-16-2006.
- 3,297,731. **SIMBIONIX (STYLIZED)**. SIMBIONIX USA CORPORATION, (U.S. CLS. 21, 23, 26, 36 AND 38). SN 78-884,866. PUB. 7-10-2007. FILED 5-16-2006.
- 3,297,735. **SEASTROM (BLOCK FORM)**. SEASTROM MANUFACTURING CO., INC., (U.S. CLS. 21, 23, 26, 36 AND 38). SN 78-885,188. PUB. 7-10-2007. FILED 5-16-2006.
- 3,297,743. **MINIBB (BLOCK FORM)**. PUZIREVS PAVELS, (U.S. CLS. 21, 23, 26, 36 AND 38). SN 78-886,375. PUB. 7-10-2007. FILED 5-18-2006.
- 3,297,750. **STARTLY (BLOCK FORM)**. STARTLY TECHNOLOGIES, LLC, (U.S. CLS. 21, 23, 26, 36 AND 38). SN 78-887,226. PUB. 7-10-2007. FILED 5-18-2006.
- 3,297,751. **BALANCE BALANCE DIGITAL TECHNOLOGY AND DESIGN**. MTS PRODUCTS, (U.S. CLS. 21, 23, 26, 36 AND 38). SN 78-887,336. PUB. 7-10-2007. FILED 5-18-2006.
- 3,297,752. **DYNATRACE DIAGNOSTICS (BLOCK FORM)**. DYNATRACE SOFTWARE GMBH, (U.S. CLS. 21, 23, 26, 36 AND 38). SN 78-887,443. PUB. 7-10-2007. FILED 5-19-2006.
- 3,297,757. **LISTENING. LEARNING. LEADING. (BLOCK FORM)**. EDUCATIONAL TESTING SERVICE, MULTIPLE CLASS, (INT. CLS. 9, 16, 35, 36, 41 AND 42), (U.S. CLS. 2, 5, 21, 22, 23, 26, 29, 36, 37, 38, 50, 100, 101, 102 AND 107). SN 78-887,821. PUB. 7-10-2007. FILED 5-19-2006.
- 3,297,760. **SYRENS ONBOARD WIFI AND DESIGN**. MOBILE INTERNET ACCESS, INC., (U.S. CLS. 21, 23, 26, 36 AND 38). SN 78-888,029. PUB. 7-10-2007. FILED 5-19-2006.
- 3,297,772. **OFICINA MOVIL TELCEL (BLOCK FORM)**. ADMINISTRADORA DE MARCAS RD, S. DE R.L. DE C.V., MULTIPLE CLASS, (INT. CLS. 9 AND 38), (U.S. CLS. 21, 23, 26, 36, 38, 100, 101 AND 104). SN 78-891,269. PUB. 7-10-2007. FILED 5-24-2006.
- 3,297,777. **I-360 (BLOCK FORM)**. NATIONAL CENTER FOR MISSING AND EXPLOITED CHILDREN, (U.S. CLS. 21, 23, 26, 36 AND 38). SN 78-891,907. PUB. 7-10-2007. FILED 5-24-2006.
- 3,297,787 (*See Class 3 for this trademark*).
- 3,297,796. **ALL.NET P-RAS AND DESIGN**. KABUSHIKI KAISHA SEGA, DBA SEGA CORPORATION, MULTIPLE CLASS, (INT. CLS. 9, 28 AND 41), (U.S. CLS. 21, 22, 23, 26, 36, 38, 50, 100, 101 AND 107). SN 78-896,113. PUB. 7-10-2007. FILED 5-30-2006.
- 3,297,797. **LPS (BLOCK FORM)**. LOFTWARE, INC., (U.S. CLS. 21, 23, 26, 36 AND 38). SN 78-896,171. PUB. 7-10-2007. FILED 5-30-2006.
- 3,297,799. **NEAR PRO (BLOCK FORM)**. SEIKO EPSON KABUSHIKI KAISHA, AKA SEIKO EPSON CORPORATION, (U.S. CLS. 21, 23, 26, 36 AND 38). SN 78-897,007. PUB. 7-10-2007. FILED 5-31-2006.
- 3,297,800. **FINANCE ACCORDING TO YOUR FAITH \$ AND DESIGN**. THE INSTITUTE OF WEALTH AND FINANCIAL MANAGEMENT, LLC, MULTIPLE CLASS, (INT. CLS. 9, 16, 21, 25 AND 41), (U.S. CLS. 2, 5, 13, 21, 22, 23, 26, 29, 30, 33, 36, 37, 38, 39, 40, 50, 100, 101 AND 107). SN 78-897,324. PUB. 7-10-2007. FILED 5-31-2006.
- 3,297,814. **PREDATOR QUEST (BLOCK FORM)**. PREDATOR QUEST, L.L.C., (U.S. CLS. 21, 23, 26, 36 AND 38). SN 78-900,281. PUB. 7-10-2007. FILED 6-5-2006.
- 3,297,826. **DYNACAP (BLOCK FORM)**. MERRICK SYSTEMS, INC., (U.S. CLS. 21, 23, 26, 36 AND 38). SN 78-901,972. PUB. 4-3-2007. FILED 6-6-2006.
- 3,297,835. **ECUBE AND DESIGN**. FRESENIUS MEDICAL CARE HOLDINGS, INC., (U.S. CLS. 21, 23, 26, 36 AND 38). SN 78-902,762. PUB. 7-10-2007. FILED 6-7-2006.
- 3,297,839. **GOODFINDING (BLOCK FORM)**. DEFOORE, WILLIAM GRAY, AND DEFOORE, CINDY P., MULTIPLE CLASS, (INT. CLS. 9 AND 41), (U.S. CLS. 21, 23, 26, 36, 38, 100, 101 AND 107). SN 78-903,001. PUB. 7-10-2007. FILED 6-7-2006.
- 3,297,843. **ECUBE EXPERIENCE EXCELLENCE EVERYWHERE AND DESIGN**. FRESENIUS MEDICAL CARE HOLDINGS, INC., (U.S. CLS. 21, 23, 26, 36 AND 38). SN 78-903,514. PUB. 7-10-2007. FILED 6-8-2006.
- 3,297,844. **SMA SOLUTION (BLOCK FORM)**. FAIRBANKS, DONNA C., (U.S. CLS. 21, 23, 26, 36 AND 38). SN 78-903,920. PUB. 7-10-2007. FILED S.R. 6-8-2006; AM. P.R. 5-17-2007.
- 3,297,845. **STUFFIT WIRELESS (BLOCK FORM)**. SMITH MICRO SOFTWARE, INC., (U.S. CLS. 21, 23, 26, 36 AND 38). SN 78-903,939. PUB. 7-10-2007. FILED 6-8-2006.
- 3,297,846. **LITTLE BEAN RECORDS (BLOCK FORM)**. BEL HOLDINGS, LLC, MULTIPLE CLASS, (INT. CLS. 9 AND 41), (U.S. CLS. 21, 23, 26, 36, 38, 100, 101 AND 107). SN 78-903,977. PUB. 7-10-2007. FILED 6-8-2006.
- 3,297,847. **TRE MESSAGE MANAGER (BLOCK FORM)**. BROADCAST ELECTRONICS, INC., MULTIPLE CLASS, (INT. CLS. 9 AND 38), (U.S. CLS. 21, 23, 26, 36, 38, 100, 101 AND 104). SN 78-904,127. PUB. 7-10-2007. FILED 6-8-2006.
- 3,297,848. **MULTIMEDIA MENTOR (BLOCK FORM)**. KNOWLEDGE NETWORKS, INC., MULTIPLE CLASS, (INT. CLS. 9 AND 35), (U.S. CLS. 21, 23, 26, 36, 38, 100, 101 AND 102). SN 78-904,306. PUB. 7-10-2007. FILED 6-8-2006.
- 3,297,849. **LO DUCA (STYLIZED)**. LO DUCA BROS., INC., MULTIPLE CLASS, (INT. CLS. 9, 15, 16, 20 AND 33), (U.S. CLS. 2, 5, 13, 21, 22, 23, 25, 26, 29, 32, 36, 37, 38, 47, 49 AND 50). SN 78-904,504. PUB. 7-10-2007. FILED 6-9-2006.
- 3,297,850. **LO DUCA BROS. AND DESIGN**. LO DUCA BROS., INC., MULTIPLE CLASS, (INT. CLS. 9, 15, 16, 20 AND 33), (U.S. CLS. 2, 5, 13, 21, 22, 23, 25, 26, 29, 32, 36, 37, 38, 47, 49 AND 50). SN 78-904,543. PUB. 7-10-2007. FILED 6-9-2006.
- 3,297,851. **ACUOSTORE (BLOCK FORM)**. ACUO TECHNOLOGIES, LLC, MULTIPLE CLASS, (INT. CLS. 9 AND 39), (U.S. CLS. 21, 23, 26, 36, 38, 100 AND 105). SN 78-904,697. PUB. 7-10-2007. FILED 6-9-2006.
- 3,297,893. **PROJECT SYLPHUED (BLOCK FORM)**. KABUSHIKI KAISHA SQUARE ENIX, TA SQUARE ENIX CO., LTD., MULTIPLE CLASS, (INT. CLS. 9 AND 16), (U.S. CLS. 2, 5, 21, 22, 23, 26, 29, 36, 37, 38 AND 50). SN 78-908,882. PUB. 7-10-2007. FILED 6-15-2006.
- 3,297,906. **RFL AND DESIGN**. RFL ELECTRONICS INC., (U.S. CLS. 21, 23, 26, 36 AND 38). SN 78-911,227. PUB. 7-10-2007. FILED 6-19-2006.
- 3,297,932. **YANKBACK (BLOCK FORM)**. YANKBACK, INC, (U.S. CLS. 21, 23, 26, 36 AND 38). SN 78-918,342. PUB. 7-10-2007. FILED 6-27-2006.
- 3,297,933. **FLUIDMESH (BLOCK FORM)**. FLUIDMESH NETWORKS, INC., (U.S. CLS. 21, 23, 26, 36 AND 38). SN 78-918,531. PUB. 7-10-2007. FILED 6-28-2006.
- 3,297,975. **NIAGARA C-STORE MANAGER (BLOCK FORM)**. TRIDIUM, INC., (U.S. CLS. 21, 23, 26, 36 AND 38). SN 78-926,844. PUB. 7-10-2007. FILED 7-11-2006.
- 3,298,004. **CIRCLE OF WEALTH (BLOCK FORM)**. MONEYTRAX, INC., (U.S. CLS. 21, 23, 26, 36 AND 38). SN 78-934,115. PUB. 7-10-2007. FILED 7-20-2006.
- 3,298,014. **JOB MASTER (BLOCK FORM)**. LINK IT SOFTWARE CORPORATION, (U.S. CLS. 21, 23, 26, 36 AND 38). SN 78-937,024. PUB. 7-10-2007. FILED 7-25-2006.
- 3,298,020. **THE POWER OUT COMFORT KIT AND DESIGN**. ELITE COMFORT INC., (U.S. CLS. 21, 23, 26, 36 AND 38). SN 78-940,546. PUB. 7-10-2007. FILED 7-29-2006.
- 3,298,037. **TOOLS & TOYS FOR A MOBILE GENERATION (BLOCK FORM)**. HANDMARK, INC., MULTIPLE CLASS, (INT. CLS. 9, 35 AND 38), (U.S. CLS. 21, 23, 26, 36, 38, 100, 101, 102 AND 104). SN 78-946,519. PUB. 7-10-2007. FILED 8-7-2006.
- 3,298,039. **GOTCHA! (BLOCK FORM)**. RAB LIGHTING INC., (U.S. CLS. 21, 23, 26, 36 AND 38). SN 78-947,738. PUB. 7-10-2007. FILED 8-8-2006.
- 3,298,079. **GLASSJET (BLOCK FORM)**. DIP TECH LTD, (U.S. CLS. 21, 23, 26, 36 AND 38). SN 78-957,186. PUB. 7-10-2007. FILED 8-22-2006.
- 3,298,094. **FLÖSSER AND DESIGN**. FLÖSSER GMBH & CO., MULTIPLE CLASS, (INT. CLS. 9 AND 11), (U.S. CLS. 13, 21, 23, 26, 31, 34, 36 AND 38). SN 78-961,722. PUB. 7-10-2007. FILED 8-28-2006.
- 3,298,128. **LEARN-RECOGNIZE-ACT (BLOCK FORM)**. NEURAL ID, LLC, (U.S. CLS. 21, 23, 26, 36 AND 38). SN 78-969,577. PUB. 7-10-2007. FILED 9-7-2006.
- 3,298,131. **LIGHTNING (BLOCK FORM)**. SHELTERED WINGS, INC., (U.S. CLS. 21, 23, 26, 36 AND 38). SN 78-970,293. PUB. 7-10-2007. FILED 9-8-2006.
- 3,298,136. **SPLAT! (BLOCK FORM)**. CHINA WIDE GROUP

- HOLDINGS LIMITED, (U.S. CLS. 21, 23, 26, 36 AND 38). SN 78-971,975. PUB. 7-10-2007. FILED 9-12-2006.
- 3,298,139. **E AND DESIGN**, EN NOVATIVE TECHNOLOGIES, INC., (U.S. CLS. 21, 23, 26, 36 AND 38). SN 78-973,160. PUB. 7-10-2007. FILED 9-13-2006.
- 3,298,148. **IHOME (BLOCK FORM)**, SDI TECHNOLOGIES INC., (U.S. CLS. 21, 23, 26, 36 AND 38). SN 78-978,111. PUB. 7-10-2007. FILED 1-21-2005.
- 3,298,149. **GIANTS OF THE TRIAL BAR (BLOCK FORM)**, THE ASSOCIATION OF THE BAR OF THE CITY OF NEW YORK, MULTIPLE CLASS, (INT. CLS. 9 AND 42), (U.S. CLS. 21, 23, 26, 36, 38, 100 AND 101). SN 78-978,269. PUB. 7-10-2007. FILED 6-6-2005.
- 3,298,157. **PARITY (STYLIZED)**, KURARAY CO., LTD., MULTIPLE CLASS, (INT. CLS. 9, 18, 21, 25 AND 28), (U.S. CLS. 1, 2, 3, 13, 21, 22, 23, 26, 29, 30, 33, 36, 38, 39, 40, 41 AND 50). SN 79-012,443. PUB. 7-10-2007. FILED 6-1-2004.
- 3,298,162. **IPRBOX (BLOCK FORM)**, IPRBOX OY, MULTIPLE CLASS, (INT. CLS. 9, 35, 36 AND 42), (U.S. CLS. 21, 23, 26, 36, 38, 100, 101 AND 102). SN 79-015,462. PUB. 7-10-2007. FILED 5-26-2005.
- 3,298,166. **SWISSCOM SOLUTIONS (BLOCK FORM)**, SWISSCOM AG, MULTIPLE CLASS, (INT. CLS. 9, 16, 35, 36, 37, 38, 41 AND 42), (U.S. CLS. 2, 5, 21, 22, 23, 26, 29, 36, 37, 38, 50, 100, 101, 102, 103, 104, 106 AND 107). SN 79-016,620. PUB. 7-10-2007. FILED 5-27-2005.
- 3,298,169. **MISCELLANEOUS DESIGN**, FRAUNHOFER-GESSELLSCHAFT ZUR FÖRDERUNG DER ANGEWANDTEN FORSCHUNG E.V., MULTIPLE CLASS, (INT. CLS. 9, 16, 41 AND 42), (U.S. CLS. 2, 5, 21, 22, 23, 26, 29, 36, 37, 38, 50, 100, 101 AND 107). SN 79-016,862. PUB. 7-10-2007. FILED 8-13-2004.
- 3,298,173. **MYPIXX (STYLIZED)**, FOTOVISTA, MULTIPLE CLASS, (INT. CLS. 9, 16, 35, 38 AND 42), (U.S. CLS. 2, 5, 21, 22, 23, 26, 29, 36, 37, 38, 50, 100, 101, 102 AND 104). SN 79-018,478. PUB. 7-10-2007. FILED 7-26-2005.
- 3,298,176 (*See Class 6 for this trademark*).
- 3,298,178. **WISDOM (BLOCK FORM)**, REAL ENTERPRISE SOLUTIONS NEDERLAND BV, MULTIPLE CLASS, (INT. CLS. 9, 16, 18, 21, 35, 38 AND 41), (U.S. CLS. 1, 2, 3, 5, 13, 21, 22, 23, 26, 29, 30, 33, 36, 37, 38, 40, 41, 50, 100, 101, 102, 104 AND 107). SN 79-018,741. PUB. 7-10-2007. FILED 11-5-2004.
- 3,298,181 (*See Class 7 for this trademark*).
- 3,298,185 (*See Class 6 for this trademark*).
- 3,298,186. **MYDIOMA AND DESIGN**, WOLF GROUP S.P.A., MULTIPLE CLASS, (INT. CLS. 9, 38 AND 41), (U.S. CLS. 21, 23, 26, 36, 38, 100, 101, 104 AND 107). SN 79-019,488. PUB. 7-10-2007. FILED 12-6-2005.
- 3,298,195. **IO-LINK (BLOCK FORM)**, IFM ELECTRONIC GMBH, (U.S. CLS. 21, 23, 26, 36 AND 38). SN 79-020,605. PUB. 7-10-2007. FILED 10-20-2005.
- 3,298,202. **HOT WIND (BLOCK FORM)**, DANIELI & C. OFFICINE MECCANICHE SPA, MULTIPLE CLASS, (INT. CLS. 9 AND 11), (U.S. CLS. 13, 21, 23, 26, 31, 34, 36 AND 38). SN 79-021,444. PUB. 7-10-2007. FILED 6-17-2005.
- 3,298,205 (*See Class 1 for this trademark*).
- 3,298,211. **LEVIMATRIX (BLOCK FORM)**, LEVITRONIX GMBH, (U.S. CLS. 21, 23, 26, 36 AND 38). SN 79-022,351. PUB. 7-10-2007. FILED 3-15-2006.
- 3,298,214 (*See Class 3 for this trademark*).
- 3,298,216. **EBRO (BLOCK FORM)**, EBRO ELECTRONIC GMBH & CO. KG, MULTIPLE CLASS, (INT. CLS. 9 AND 42), (U.S. CLS. 21, 23, 26, 36, 38, 100 AND 101). SN 79-022,763. PUB. 7-10-2007. FILED 12-23-2005.
- 3,298,224. **LIGHT BOOK (STYLIZED)**, ERCO LEUCHTEN GMBH, (U.S. CLS. 21, 23, 26, 36 AND 38). SN 79-023,981. PUB. 4-3-2007. FILED 3-20-2006.
- 3,298,225. **J'AIME LE CINEMA (BLOCK FORM)**, MADAME AGNÈS TROUBLE, MULTIPLE CLASS, (INT. CLS. 9, 14, 16, 18, 24, 25 AND 41), (U.S. CLS. 1, 2, 3, 5, 21, 22, 23, 26, 27, 28, 29, 36, 37, 38, 39, 41, 42, 50, 100, 101 AND 107). SN 79-024,034. PUB. 7-10-2007. FILED 11-10-2005.
- 3,298,229 (*See Class 7 for this trademark*).
- 3,298,230. **ELVEON (BLOCK FORM)**, 10TACLE STUDIOS AG, MULTIPLE CLASS, (INT. CLS. 9, 16, 28, 38 AND 41), (U.S. CLS. 2, 5, 21, 22, 23, 26, 29, 36, 37, 38, 50, 100, 101, 104 AND 107). SN 79-024,319. PUB. 7-10-2007. FILED 9-5-2005.
- 3,298,231. **GR61PP (STYLIZED)**, ALFA LAVAL NAKSKOV A/S, (U.S. CLS. 21, 23, 26, 36 AND 38). SN 79-024,352. PUB. 7-10-2007. FILED 4-10-2006.
- 3,298,240. **REPORTAL (STYLIZED)**, (FIRM AS); FUTURE INFORMATION RESEARCH MANAGEMENT AS, MULTIPLE CLASS, (INT. CLS. 9, 35 AND 42), (U.S. CLS. 21, 23, 26, 36, 38, 100, 101 AND 102). SN 79-024,728. PUB. 7-10-2007. FILED 11-24-2005.
- 3,298,243 (*See Class 6 for this trademark*).
- 3,298,255 (*See Class 1 for this trademark*).
- 3,298,268. **TEXA AND DESIGN**, TEXA S.P.A., MULTIPLE CLASS, (INT. CLS. 9, 38, 41 AND 42), (U.S. CLS. 21, 23, 26, 36, 38, 100, 101, 104 AND 107). SN 79-026,221. PUB. 7-10-2007. FILED 3-23-2006.
- 3,298,269. **POSIROT (BLOCK FORM)**, ASM; AUTOMATION SENSORIK MESSTECHNIK GMBH, (U.S. CLS. 21, 23, 26, 36 AND 38). SN 79-026,249. PUB. 7-10-2007. FILED 5-15-2006.
- 3,298,272. **W800 (STYLIZED)**, SONY ERICSSON MOBILE COMMUNICATIONS AB, (U.S. CLS. 21, 23, 26, 36 AND 38). SN 79-026,482. PUB. 7-10-2007. FILED 7-18-2005.
- 3,298,275. **MY OWN TV (BLOCK FORM)**, ALCATEL LUCENT, (U.S. CLS. 21, 23, 26, 36 AND 38). SN 79-026,830. PUB. 7-10-2007. FILED 3-20-2006.
- 3,298,277 (*See Class 7 for this trademark*).
- 3,298,294. **S AND DESIGN**, STELVIO S.P.A., (U.S. CLS. 21, 23, 26, 36 AND 38). SN 79-027,542. PUB. 7-10-2007. FILED 4-7-2006.
- 3,298,308. **K510 (STYLIZED)**, SONY ERICSSON MOBILE COMMUNICATIONS AB, MULTIPLE CLASS, (INT. CLS. 9 AND 38), (U.S. CLS. 21, 23, 26, 36, 38, 100, 101 AND 104). SN 79-027,916. PUB. 7-10-2007. FILED 6-20-2006.
- 3,298,309. **K310 (STYLIZED)**, SONY ERICSSON MOBILE COMMUNICATIONS AB, MULTIPLE CLASS, (INT. CLS. 9 AND 38), (U.S. CLS. 21, 23, 26, 36, 38, 100, 101 AND 104). SN 79-027,917. PUB. 7-10-2007. FILED 6-20-2006.
- 3,298,310. **J100 (STYLIZED)**, SONY ERICSSON MOBILE COMMUNICATIONS AB, MULTIPLE CLASS, (INT. CLS. 9 AND 38), (U.S. CLS. 21, 23, 26, 36, 38, 100, 101 AND 104). SN 79-027,919. PUB. 7-10-2007. FILED 6-20-2006.
- 3,298,311. **W700 (STYLIZED)**, SONY ERICSSON MOBILE COMMUNICATIONS AB, MULTIPLE CLASS, (INT. CLS. 9 AND 38), (U.S. CLS. 21, 23, 26, 36, 38, 100, 101 AND 104). SN 79-028,067. PUB. 7-10-2007. FILED 6-20-2006.
- 3,298,312. **M600 (STYLIZED)**, SONY ERICSSON MOBILE COMMUNICATIONS AB, MULTIPLE CLASS, (INT. CLS. 9 AND 38), (U.S. CLS. 21, 23, 26, 36, 38, 100, 101 AND 104). SN 79-028,068. PUB. 7-10-2007. FILED 6-20-2006.
- 3,298,313. **W710 (STYLIZED)**, SONY ERICSSON MOBILE COMMUNICATIONS AB, MULTIPLE CLASS, (INT. CLS. 9 AND 38), (U.S. CLS. 21, 23, 26, 36, 38, 100, 101 AND 104). SN 79-028,070. PUB. 7-10-2007. FILED 6-20-2006.
- 3,298,324 (*See Class 5 for this trademark*).
- 3,298,331 (*See Class 7 for this trademark*).
- 3,298,332. **ESERIES (STYLIZED)**, NOKIA CORPORATION, MULTIPLE CLASS, (INT. CLS. 9, 38 AND 41), (U.S. CLS. 21, 23, 26, 36, 38, 100, 101, 104 AND 107). SN 79-029,292. PUB. 7-10-2007. FILED 6-1-2006.
- 3,298,339. **GENIUM (STYLIZED)**, OMX AB, MULTIPLE CLASS, (INT. CLS. 9, 35 AND 42), (U.S. CLS. 21, 23, 26, 36, 38, 100, 101 AND 102). SN 79-029,682. PUB. 7-10-2007. FILED 5-16-2006.
- 3,298,343. **NOCTUA (BLOCK FORM)**, RASCOM; COMPUTERDISTRIBUTION GESMBH, (U.S. CLS. 21, 23, 26, 36 AND 38). SN 79-029,860. PUB. 7-10-2007. FILED 8-7-2006.
- 3,298,347. **EC-LAB (BLOCK FORM)**, BIO-LOGIC, MULTIPLE CLASS, (INT. CLS. 9 AND 42), (U.S. CLS. 21, 23, 26, 36, 38, 100 AND 101). SN 79-029,997. PUB. 7-10-2007. FILED 9-12-2006.
- 3,298,348. **BLOODLYSER (BLOCK FORM)**, SEBO GMBH, (U.S. CLS. 21, 23, 26, 36 AND 38). SN 79-030,031. PUB. 7-10-2007. FILED 9-13-2006.
- 3,298,362. **INFOPAINTER (STYLIZED)**, KATHERL SOFTWARE GMBH, MULTIPLE CLASS, (INT. CLS. 9 AND 42), (U.S. CLS. 21, 23, 26, 36, 38, 100 AND 101). SN 79-031,577. PUB. 7-10-2007. FILED 10-24-2006.
- 3,298,364. **LICAM (BLOCK FORM)**, SIEMENS AKTIENGESELLSCHAFT, (U.S. CLS. 21, 23, 26, 36 AND 38). SN 79-031,662. PUB. 7-10-2007. FILED 9-19-2006.
- 3,298,368. **SINDOPOWER (BLOCK FORM)**, SEMIKRON IN-

- TERNATIONAL GMBH, (U.S. CLS. 21, 23, 26, 36 AND 38). SN 79-032,057. PUB. 7-10-2007. FILED 10-6-2006.
- 3,298,373. **SMARTTV (STYLIZED)**. KUDELSKI SA, MULTIPLE CLASS, (INT. CLS. 9 AND 42), (U.S. CLS. 21, 23, 26, 36, 38, 100 AND 101). SN 79-032,436. PUB. 7-10-2007. FILED 11-13-2006.
- 3,298,378. **MISCELLANEOUS DESIGN**. INSTITUTE OF COMPUTING TECHNOLOGY.; CHINESE ACADEMY OF SCIENCES, (U.S. CLS. 21, 23, 26, 36 AND 38). SN 79-032,730. PUB. 7-10-2007. FILED 10-9-2006.
- 3,298,379. **MISCELLANEOUS DESIGN**. INSTITUTE OF COMPUTING TECHNOLOGY.; CHINESE ACADEMY OF SCIENCES, (U.S. CLS. 21, 23, 26, 36 AND 38). SN 79-032,758. PUB. 7-10-2007. FILED 10-9-2006.
- 3,298,380. **PIANOTEQ (BLOCK FORM)**. PHILIPPE GUILLAUME, MULTIPLE CLASS, (INT. CLS. 9, 15 AND 41), (U.S. CLS. 2, 21, 23, 26, 36, 38, 100, 101 AND 107). SN 79-032,853. PUB. 7-10-2007. FILED 11-2-2006.
- 3,298,381. **GPSGATE (BLOCK FORM)**. FRANSON TECHNOLOGY AB, MULTIPLE CLASS, (INT. CLS. 9 AND 42), (U.S. CLS. 21, 23, 26, 36, 38, 100 AND 101). SN 79-032,878. PUB. 7-10-2007. FILED 10-26-2006.
- 3,298,395. **RAYSOURCE (STYLIZED)**. A. RAYMOND & CIE, MULTIPLE CLASS, (INT. CLS. 9, 16 AND 35), (U.S. CLS. 2, 5, 21, 22, 23, 26, 29, 36, 37, 38, 50, 100, 101 AND 102). SN 79-035,550. PUB. 7-10-2007. FILED 12-26-2006.
- 3,298,396. **HALLELUJAH (BLOCK FORM)**. LINN PRODUCTS LIMITED, (U.S. CLS. 21, 23, 26, 36 AND 38). SN 79-035,856. PUB. 7-10-2007. FILED 1-20-2007.

CLASS 10—MEDICAL APPARATUS

- 3,296,064 (*See Class 9 for this trademark*).
- 3,296,100. **AEROLASE (BLOCK FORM)**. INNOTECH USA, INC., (U.S. CLS. 26, 39 AND 44). SN 76-663,501. PUB. 7-10-2007. FILED 7-24-2006.
- 3,296,291. **LITECURE (BLOCK FORM)**. LITECURE LLC, (U.S. CLS. 26, 39 AND 44). SN 77-018,462. PUB. 7-10-2007. FILED 10-11-2006.
- 3,296,457. **ULTRASHAPE AND DESIGN**. ULTRASHAPE LTD., (U.S. CLS. 26, 39 AND 44). SN 77-046,483. PUB. 7-10-2007. FILED 11-17-2006.
- 3,296,478. **S.A.F.E. II (BLOCK FORM)**. CUSTOM CARBON COMPOSITE CREATIONS, INC., (U.S. CLS. 26, 39 AND 44). SN 77-049,478. PUB. 7-10-2007. FILED 11-22-2006.
- 3,296,507. **BIOSPHERE MEDICAL AND DESIGN**. BIOSPHERE MEDICAL, INC., (U.S. CLS. 26, 39 AND 44). SN 77-053,387. PUB. 7-10-2007. FILED 11-29-2006.
- 3,296,508. **BIOSPHERE MEDICAL (BLOCK FORM)**. BIOSPHERE MEDICAL, INC., (U.S. CLS. 26, 39 AND 44). SN 77-053,408. PUB. 7-10-2007. FILED 11-29-2006.
- 3,296,510. **30 SECOND REFRACTION BY MARCO AND DESIGN**. MARCO OPHTHALMIC, INC., (U.S. CLS. 26, 39 AND 44). SN 77-053,796. PUB. 7-10-2007. FILED 11-30-2006.
- 3,296,594. **ORTHO DX (BLOCK FORM)**. ENCORE MEDICAL ASSET CORPORATION, (U.S. CLS. 26, 39 AND 44). SN 77-061,304. PUB. 7-10-2007. FILED 12-11-2006.
- 3,296,678. **NAPA (BLOCK FORM)**. GEORGE, PETER T., (U.S. CLS. 26, 39 AND 44). SN 77-064,468. PUB. 7-10-2007. FILED 12-14-2006.
- 3,296,724. **ACCIN (BLOCK FORM)**. ACCIN CORPORATION, (U.S. CLS. 26, 39 AND 44). SN 77-065,775. PUB. 7-10-2007. FILED 12-15-2006.
- 3,296,833. **FOURPRESS (BLOCK FORM)**. HARTMANN-CONCO, INC., (U.S. CLS. 26, 39 AND 44). SN 77-084,417. PUB. 7-10-2007. FILED 1-17-2007.
- 3,296,835. **THREEPRESS (BLOCK FORM)**. HARTMANN-CONCO, INC., (U.S. CLS. 26, 39 AND 44). SN 77-084,437. PUB. 7-10-2007. FILED 1-17-2007.
- 3,296,839. **COMPERM (BLOCK FORM)**. HARTMANN-CONCO, INC., (U.S. CLS. 26, 39 AND 44). SN 77-084,592. PUB. 7-10-2007. FILED 1-17-2007.
- 3,296,840. **FOAM TRAC (BLOCK FORM)**. HARTMANN-CONCO, INC., (U.S. CLS. 26, 39 AND 44). SN 77-084,626. PUB. 7-10-2007. FILED 1-17-2007.
- 3,296,849. **KCI THE CLINICAL ADVANTAGE (BLOCK FORM)**. KCI LICENSING, INC., (U.S. CLS. 26, 39 AND 44). SN 77-085,316. PUB. 7-10-2007. FILED 1-18-2007.
- 3,296,870. **PANTY PAL (BLOCK FORM)**. CALIFORNIA EXOTIC NOVELTIES LLC, (U.S. CLS. 26, 39 AND 44). SN 77-086,786. PUB. 7-10-2007. FILED 1-19-2007.
- 3,296,871. **PERSONAL TUNER (BLOCK FORM)**. CAMS MEDICAL INSTRUMENTS, INC., (U.S. CLS. 26, 39 AND 44). SN 77-086,828. PUB. 7-10-2007. FILED 1-19-2007.
- 3,297,062. **TOYS JUST FOR BOYS (BLOCK FORM)**. TANTUS, INC., (U.S. CLS. 26, 39 AND 44). SN 77-096,317. PUB. 7-10-2007. FILED 1-31-2007.
- 3,297,063. **BEND OVER BEGINNER (BLOCK FORM)**. TANTUS, INC., (U.S. CLS. 26, 39 AND 44). SN 77-096,318. PUB. 7-10-2007. FILED 1-31-2007.
- 3,297,170. **TEASE AND PLEASE (BLOCK FORM)**. CALIFORNIA EXOTIC NOVELTIES LLC, (U.S. CLS. 26, 39 AND 44). SN 77-150,245. PUB. 7-10-2007. FILED 4-5-2007.
- 3,297,243 (*See Class 9 for this trademark*).
- 3,297,259. **FICE (BLOCK FORM)**. FUJINON CORPORATION, (U.S. CLS. 26, 39 AND 44). SN 78-637,705. PUB. 10-10-2006. FILED 5-26-2005.
- 3,297,266 (*See Class 5 for this trademark*).
- 3,297,303 (*See Class 9 for this trademark*).
- 3,297,427 (*See Class 1 for this trademark*).
- 3,297,476. **242 BLUE (BLOCK FORM)**. DALE MEDICAL PRODUCTS, INC., (U.S. CLS. 26, 39 AND 44). SN 78-820,297. PUB. 7-10-2007. FILED 2-22-2006.
- 3,297,503. **ALIGNMED AND DESIGN**. ALIGNMED, INC., (U.S. CLS. 26, 39 AND 44). SN 78-833,749. PUB. 7-10-2007. FILED 3-9-2006.
- 3,297,566. **CASCADE AND DESIGN**. CASCADE MEDICAL ENTERPRISES, LLC, (U.S. CLS. 26, 39 AND 44). SN 78-855,933. PUB. 7-10-2007. FILED 4-6-2006.
- 3,297,676. **TRACE LIFE SCIENCES (BLOCK FORM)**. TRACE LIFE SCIENCES, INC., (U.S. CLS. 26, 39 AND 44). SN 78-873,652. PUB. 7-10-2007. FILED 5-1-2006.
- 3,297,719 (*See Class 5 for this trademark*).
- 3,297,729. **STRESSERASER BREATHWAVE (BLOCK FORM)**. HELICOR, INC., (U.S. CLS. 26, 39 AND 44). SN 78-884,731. PUB. 7-10-2007. FILED 5-16-2006.
- 3,297,738. **ACUMEN AND DESIGN**. ACUMEN MEDICAL, INC., (U.S. CLS. 26, 39 AND 44). SN 78-885,669. PUB. 7-10-2007. FILED 5-17-2006.
- 3,297,773. **IBUZZ (BLOCK FORM)**. LOVE LABS LLP, MULTIPLE CLASS, (INT. CLS. 10 AND 35), (U.S. CLS. 26, 39, 44, 100, 101 AND 102). SN 78-891,343. PUB. 7-10-2007. FILED 5-24-2006.
- 3,297,794. **TABOO (BLOCK FORM)**. VAST RESOURCES, INC., (U.S. CLS. 26, 39 AND 44). SN 78-895,722. PUB. 7-10-2007. FILED 5-30-2006.
- 3,297,922. **SHENERGY (BLOCK FORM)**. BODET & HORST GMBH & CO. KG, MULTIPLE CLASS, (INT. CLS. 10, 20 AND 24), (U.S. CLS. 2, 13, 22, 25, 26, 32, 39, 42, 44 AND 50). SN 78-915,775. PUB. 7-10-2007. FILED 6-23-2006.
- 3,297,930. **CPTMED INC. CUSTOM SOLUTIONS TO FIT YOUR NEEDS. AND DESIGN**. CPTMED, INC., (U.S. CLS. 26, 39 AND 44). SN 78-917,527. PUB. 7-10-2007. FILED 6-27-2006.
- 3,298,005. **AM/PM TIMEWISE (BLOCK FORM)**. A&D ENGINEERING, INC., (U.S. CLS. 26, 39 AND 44). SN 78-934,439. PUB. 7-10-2007. FILED 7-21-2006.
- 3,298,019 (*See Class 3 for this trademark*).
- 3,298,087. **MARS (BLOCK FORM)**. GAMBRO LUNDIA AB, (U.S. CLS. 26, 39 AND 44). SN 78-959,975. PUB. 7-10-2007. FILED 8-24-2006.
- 3,298,088. **DIAMARS (BLOCK FORM)**. GAMBRO LUNDIA AB, (U.S. CLS. 26, 39 AND 44). SN 78-960,013. PUB. 7-10-2007. FILED 8-24-2006.
- 3,298,159. **BIEN AIR AND DESIGN**. BIEN-AIR HOLDING SA, (U.S. CLS. 26, 39 AND 44). SN 79-013,059. PUB. 7-10-2007. FILED 6-22-2005.
- 3,298,172. **RAUMEDIC (BLOCK FORM)**. RAUMEDIC AG, MULTIPLE CLASS, (INT. CLS. 10, 17 AND 42), (U.S. CLS. 1, 5, 12, 13, 26, 35, 39, 44, 50, 100 AND 101). SN 79-018,092. PUB. 7-10-2007. FILED 12-2-2004.
- 3,298,241 (*See Class 7 for this trademark*).
- 3,298,273. **LACHESIS (BLOCK FORM)**. LACHESIS BIOSCIENCES PTY LTD, MULTIPLE CLASS, (INT. CLS. 10, 41

AND 44), (U.S. CLS. 26, 39, 44, 100, 101 AND 107). SN 79-026,584. PUB. 7-10-2007. FILED 12-14-2005.
 3,298,324 (*See Class 5 for this trademark*).
 3,298,330 (*See Class 1 for this trademark*).
 3,298,341. **ANATOMIX (BLOCK FORM)**. BIOTECHNI, (U.S. CLS. 26, 39 AND 44). SN 79-029,830. PUB. 7-10-2007. FILED 4-12-2006.
 3,298,366. **S.A.F.E. BT (STYLIZED)**. SEBO GMBH, (U.S. CLS. 26, 39 AND 44). SN 79-031,876. PUB. 7-10-2007. FILED 11-2-2006.
 3,298,367 (*See Class 5 for this trademark*).
 3,298,370. **KASIOS (BLOCK FORM)**, KASIOS, (U.S. CLS. 26, 39 AND 44). SN 79-032,193. PUB. 7-10-2007. FILED 11-17-2006.
 3,298,393. **CENTRA (BLOCK FORM)**. SIEMENS AUDIOLOGISCHE TECHNIK GMBH, (U.S. CLS. 26, 39 AND 44). SN 79-035,060. PUB. 7-10-2007. FILED 12-11-2006.
 3,298,398. **INTEO (BLOCK FORM)**. WIDEX A/S, (U.S. CLS. 26, 39 AND 44). SN 79-036,498. PUB. 7-10-2007. FILED 10-26-2005.

CLASS 11—ENVIRONMENTAL CONTROL APPARATUS

3,296,006. **ACCLAIM LIGHTING (BLOCK FORM)**. ACCLAIM LIGHTING LLC, (U.S. CLS. 13, 21, 23, 31 AND 34). SN 76-628,096. PUB. 7-10-2007. FILED 1-18-2005.
 3,296,012. **MCS AND DESIGN**. MCS WATER TECHNOLOGY CORP., MULTIPLE CLASS, (INT. CLS. 11 AND 37), (U.S. CLS. 13, 21, 23, 31, 34, 100, 103 AND 106). SN 76-637,356. PUB. 7-10-2007. FILED 4-28-2005.
 3,296,025. **AM AUTHENTIC MODELS (BLOCK FORM)**. AUTHENTIC MODELS, INC., MULTIPLE CLASS, (INT. CLS. 11, 16, 20, 21 AND 28), (U.S. CLS. 2, 5, 13, 21, 22, 23, 25, 29, 30, 31, 32, 33, 34, 37, 38, 40 AND 50). SN 76-646,004. PUB. 7-10-2007. FILED 8-29-2005.
 3,296,026. **AM AU MUSÉE (BLOCK FORM)**. AUTHENTIC MODELS, U.S.A., INC., MULTIPLE CLASS, (INT. CLS. 11, 16, 20, 21 AND 28), (U.S. CLS. 2, 5, 13, 21, 22, 23, 25, 29, 30, 31, 32, 33, 34, 37, 38, 40 AND 50). SN 76-646,005. PUB. 7-10-2007. FILED 8-29-2005.
 3,296,125. **FINE FAUCETS (BLOCK FORM)**. HIRSCH PIPE & SUPPLY CO., INC., (U.S. CLS. 13, 21, 23, 31 AND 34). SN 76-666,303. PUB. 7-10-2007. FILED 9-18-2006.
 3,296,234. **LIFE IONIZERS ION WATER FOR LIFE AND DESIGN**. CABADOS, RICHARD, (U.S. CLS. 13, 21, 23, 31 AND 34). SN 77-003,872. PUB. 6-5-2007. FILED 9-21-2006.
 3,296,300. **A SMART WAY TO SAVE ENERGY (BLOCK FORM)**. GENERAL ELECTRIC COMPANY, (U.S. CLS. 13, 21, 23, 31 AND 34). SN 77-021,903. PUB. 7-10-2007. FILED 10-16-2006.
 3,296,568. **JOAPE (BLOCK FORM)**. METALURGICA JOAPE LTDA, (U.S. CLS. 13, 21, 23, 31 AND 34). SN 77-059,952. PUB. 7-10-2007. FILED 12-8-2006.
 3,296,605. **INNOVALITE AND DESIGN**. INNOVALITE TECHNOLOGY LTD., (U.S. CLS. 13, 21, 23, 31 AND 34). SN 77-061,822. PUB. 7-10-2007. FILED 12-11-2006.
 3,296,618. **TRAEGER PELLET GRILLS (BLOCK FORM)**. TRAEGER PELLET GRILLS LLC, (U.S. CLS. 13, 21, 23, 31 AND 34). SN 77-062,706. PUB. 7-10-2007. FILED 12-12-2006.
 3,296,647. **MYFINE (BLOCK FORM)**. X.J. GROUP USA, (U.S. CLS. 13, 21, 23, 31 AND 34). SN 77-063,744. PUB. 7-10-2007. FILED 12-13-2006.
 3,296,785. **SECURE-FILL (BLOCK FORM)**. SNL PRODUCTS, (U.S. CLS. 13, 21, 23, 31 AND 34). SN 77-078,244. PUB. 7-10-2007. FILED 1-8-2007.
 3,296,927. **SHENGFA AND DESIGN**. NINGBO SHENGFA ELECTRICAL APPLIANCE CO., LTD., (U.S. CLS. 13, 21, 23, 31 AND 34). SN 77-089,577. PUB. 7-10-2007. FILED 1-24-2007.
 3,297,065. **BENNOTI (BLOCK FORM)**. BENNOTI INC., MULTIPLE CLASS, (INT. CLS. 11 AND 30), (U.S. CLS. 13, 21, 23, 31, 34 AND 46). SN 77-096,442. PUB. 7-10-2007. FILED 2-1-2007.
 3,297,163 (*See Class 8 for this trademark*).
 3,297,220 (*See Class 5 for this trademark*).
 3,297,294 (*See Class 7 for this trademark*).

3,297,320 (*See Class 1 for this trademark*).
 3,297,330. **ILLUMILITE (BLOCK FORM)**. ILLUMILITE INCORPORATED, (U.S. CLS. 13, 21, 23, 31 AND 34). SN 78-720,575. PUB. 7-10-2007. FILED 9-26-2005.
 3,297,345 (*See Class 3 for this trademark*).
 3,297,405 (*See Class 3 for this trademark*).
 3,297,466. **ESIS (BLOCK FORM)**. NAGATO, HAROLD K., (U.S. CLS. 13, 21, 23, 31 AND 34). SN 78-814,590. PUB. 7-10-2007. FILED 2-14-2006.
 3,297,478. **JASCO (BLOCK FORM)**. JASCO PRODUCTS COMPANY LLC, (U.S. CLS. 13, 21, 23, 31 AND 34). SN 78-821,777. PUB. 7-10-2007. FILED 2-23-2006.
 3,297,480. **JASCO AND DESIGN**. JASCO PRODUCTS COMPANY LLC, (U.S. CLS. 13, 21, 23, 31 AND 34). SN 78-821,934. PUB. 7-10-2007. FILED 2-23-2006.
 3,297,532 (*See Class 8 for this trademark*).
 3,297,536. **THE ORIGINAL DOUBLE T LED PATENT PENDING CHINA TLR AND DESIGN**. AMERICAN WEST MARKETING, INC., (U.S. CLS. 13, 21, 23, 31 AND 34). SN 78-845,199. PUB. 4-17-2007. FILED 3-24-2006.
 3,297,753 (*See Class 6 for this trademark*).
 3,297,827. **COLONIAL GLASSTEEL SHOWER DOORS AND DESIGN**. COLONIAL MIRROR & GLASS CORPORATION, (U.S. CLS. 13, 21, 23, 31 AND 34). SN 78-901,983. PUB. 7-10-2007. FILED 6-6-2006.
 3,297,887. **STYLUS (BLOCK FORM)**. STYLUS PTY LTD., (U.S. CLS. 13, 21, 23, 31 AND 34). SN 78-907,944. PUB. 7-10-2007. FILED 6-14-2006.
 3,297,895. **COOLERADO (BLOCK FORM)**. IDALEX TECHNOLOGIES, INC., (U.S. CLS. 13, 21, 23, 31 AND 34). SN 78-909,511. PUB. 7-10-2007. FILED 6-15-2006.
 3,297,917. **EXTREME TAILGATING (BLOCK FORM)**. FREEDOM GRILL, INC., (U.S. CLS. 13, 21, 23, 31 AND 34). SN 78-913,887. PUB. 11-21-2006. FILED 6-21-2006.
 3,297,964. **MVB (BLOCK FORM)**. RAYPAK INC., (U.S. CLS. 13, 21, 23, 31 AND 34). SN 78-924,610. PUB. 7-10-2007. FILED 7-7-2006.
 3,297,999. **"WE PUT THE EE IN GREEN!" (STYLIZED)**. ADVANCED ENERGY PRODUCTS CORP., (U.S. CLS. 13, 21, 23, 31 AND 34). SN 78-932,882. PUB. 7-10-2007. FILED 7-19-2006.
 3,298,094 (*See Class 9 for this trademark*).
 3,298,121. **CLEARPLEAT (BLOCK FORM)**. FILTER SPECIALISTS, INC., (U.S. CLS. 13, 21, 23, 31 AND 34). SN 78-966,914. PUB. 7-10-2007. FILED 9-5-2006.
 3,298,181 (*See Class 7 for this trademark*).
 3,298,188. **SITA SUEZ AND DESIGN**. SUEZ ENVIRONNEMENT, MULTIPLE CLASS, (INT. CLS. 11, 37, 39, 40 AND 42), (U.S. CLS. 13, 21, 23, 31, 34, 100, 101, 103, 105 AND 106). SN 79-019,533. PUB. 7-10-2007. FILED 8-26-2005.
 3,298,198. **KALEVIT (BLOCK FORM)**. KALEVIT ROCA SANITER SERAMIK; SANAYI ANONIM SIRKETI, MULTIPLE CLASS, (INT. CLS. 11, 19 AND 21), (U.S. CLS. 1, 2, 12, 13, 21, 23, 29, 30, 31, 33, 34, 40 AND 50). SN 79-020,774. PUB. 7-10-2007. FILED 5-27-2005.
 3,298,202 (*See Class 9 for this trademark*).
 3,298,209 (*See Class 6 for this trademark*).
 3,298,227 (*See Class 6 for this trademark*).
 3,298,233. **VCR VALLI & VALLI AND DESIGN**. PASQUALE VALLI S.A.S.; DI VALLI CARLO EDOARDO, MULTIPLE CLASS, (INT. CLS. 11, 20 AND 21), (U.S. CLS. 2, 13, 21, 22, 23, 25, 29, 30, 31, 32, 33, 34, 40 AND 50). SN 79-024,440. PUB. 7-10-2007. FILED 5-26-2005.
 3,298,243 (*See Class 6 for this trademark*).
 3,298,264. **DDG AND DESIGN**. D.D.G., NAAMLOZE VENNOOTSCHAP, (U.S. CLS. 13, 21, 23, 31 AND 34). SN 79-026,052. PUB. 7-10-2007. FILED 3-3-2006.
 3,298,315 (*See Class 3 for this trademark*).
 3,298,316 (*See Class 7 for this trademark*).
 3,298,330 (*See Class 1 for this trademark*).
 3,298,346 (*See Class 7 for this trademark*).
 3,298,385 (*See Class 6 for this trademark*).

CLASS 12—VEHICLES

3,296,038. **Z ZIMMERMANN AND DESIGN**. OTTO ZIMMER-

- MANN GMBH, (U.S. CLS. 19, 21, 23, 31, 35 AND 44). SN 76-649,330. PUB. 7-10-2007. FILED 10-27-2005.
- 3,296,049. **JOIN THE NATION (BLOCK FORM)**. SPORT NATION MERCHANDISING CORP., MULTIPLE CLASS, (INT. CLS. 12 AND 16), (U.S. CLS. 2, 5, 19, 21, 22, 23, 29, 31, 35, 37, 38, 44 AND 50). SN 76-654,916. PUB. 6-5-2007. FILED 2-13-2006.
- 3,296,075. **ZOKES (BLOCK FORM)**. FAIRLY BIKE MANUFACTURING CO., LTD., (U.S. CLS. 19, 21, 23, 31, 35 AND 44). SN 76-660,517. PUB. 7-10-2007. FILED 5-23-2006.
- 3,296,159. **KCNC (BLOCK FORM)**. LIN, CHANG HUI, (U.S. CLS. 19, 21, 23, 31, 35 AND 44). SN 76-670,279. PUB. 7-10-2007. FILED 12-13-2006.
- 3,296,259. **MARATHON (BLOCK FORM)**. MARATHON COACH, INC., (U.S. CLS. 19, 21, 23, 31, 35 AND 44). SN 77-011,593. PUB. 7-10-2007. FILED 10-2-2006.
- 3,296,359. **412 (STYLIZED)**. MEANS, RAFAEL R., MULTIPLE CLASS, (INT. CLS. 12 AND 16), (U.S. CLS. 2, 5, 19, 21, 22, 23, 29, 31, 35, 37, 38, 44 AND 50). SN 77-031,694. PUB. 7-10-2007. FILED 10-28-2006.
- 3,296,482 (*See Class 6 for this trademark*).
- 3,296,522 (*See Class 7 for this trademark*).
- 3,296,818. **ABIIE (BLOCK FORM)**. CHUAH, KHAI GAN, (U.S. CLS. 19, 21, 23, 31, 35 AND 44). SN 77-083,212. PUB. 7-10-2007. FILED 1-15-2007.
- 3,296,830. **HAIDA AND DESIGN**. SICHUAN TYRE & RUBBER CO., LTD, (U.S. CLS. 19, 21, 23, 31, 35 AND 44). SN 77-084,191. PUB. 7-10-2007. FILED 1-16-2007.
- 3,296,941. **XTREME FX (BLOCK FORM)**. RALLY MANUFACTURING INC., (U.S. CLS. 19, 21, 23, 31, 35 AND 44). SN 77-090,381. PUB. 7-10-2007. FILED 1-24-2007.
- 3,297,084. **JANE AND DESIGN**. JANE, S.A., (U.S. CLS. 19, 21, 23, 31, 35 AND 44). SN 77-101,519. PUB. 7-10-2007. FILED 2-7-2007.
- 3,297,140. **ZAPINO (BLOCK FORM)**. ZAP, (U.S. CLS. 19, 21, 23, 31, 35 AND 44). SN 77-121,360. PUB. 7-10-2007. FILED 3-2-2007.
- 3,297,162. **WORKMAN (BLOCK FORM)**. THE TORO COMPANY, (U.S. CLS. 19, 21, 23, 31, 35 AND 44). SN 77-140,317. PUB. 7-10-2007. FILED 3-26-2007.
- 3,297,166. **SPO (BLOCK FORM)**. S&S CYCLE, INC., (U.S. CLS. 19, 21, 23, 31, 35 AND 44). SN 77-144,004. PUB. 7-10-2007. FILED 3-29-2007.
- 3,297,177. **HAWK AND DESIGN**. HOSER, LORENZ, (U.S. CLS. 19, 21, 23, 31, 35 AND 44). SN 78-187,724. PUB. 6-5-2007. FILED 11-21-2002.
- 3,297,211. **LIFT-UP (BLOCK FORM)**. BRUNO INDEPENDENT LIVING AIDS, INC., (U.S. CLS. 19, 21, 23, 31, 35 AND 44). SN 78-527,483. PUB. 7-10-2007. FILED 12-6-2004.
- 3,297,228 (*See Class 7 for this trademark*).
- 3,297,231. **C&C YACHTS AND DESIGN**. CHALLENGER PARTNERS, LTD., (U.S. CLS. 19, 21, 23, 31, 35 AND 44). SN 78-591,207. PUB. 7-10-2007. FILED 3-21-2005.
- 3,297,245. **RHINO (STYLIZED)**. BLUE VENTURE SOLUTIONS, INC., (U.S. CLS. 19, 21, 23, 31, 35 AND 44). SN 78-614,571. PUB. 7-10-2007. FILED 4-22-2005.
- 3,297,305 (*See Class 7 for this trademark*).
- 3,297,319. **AIRPLEX (BLOCK FORM)**. SAINT-GOBAIN SULLY, MULTIPLE CLASS, (INT. CLS. 12 AND 21), (U.S. CLS. 2, 13, 19, 21, 23, 29, 30, 31, 33, 35, 40, 44 AND 50). SN 78-714,499. PUB. 7-10-2007. FILED 9-16-2005.
- 3,297,345 (*See Class 3 for this trademark*).
- 3,297,375. **CLAZZIO (STYLIZED)**. ELEVEN INTERNATIONAL CO., LTD., (U.S. CLS. 19, 21, 23, 31, 35 AND 44). SN 78-763,186. PUB. 1-2-2007. FILED 11-30-2005.
- 3,297,402. **EZ BELT SECURE FOR SURE AND DESIGN**. FRENCH COMPONENTS CORPORATION, (U.S. CLS. 19, 21, 23, 31, 35 AND 44). SN 78-781,842. PUB. 7-10-2007. FILED 12-28-2005.
- 3,297,405 (*See Class 3 for this trademark*).
- 3,297,535. **SHADOW MARINE (BLOCK FORM)**. SHADOW MARINE, (U.S. CLS. 19, 21, 23, 31, 35 AND 44). SN 78-845,086. PUB. 7-10-2007. FILED 3-24-2006.
- 3,297,591 (*See Class 7 for this trademark*).
- 3,297,900. **XEBRA (BLOCK FORM)**. ZAP, (U.S. CLS. 19, 21, 23, 31, 35 AND 44). SN 78-910,500. PUB. 7-10-2007. FILED 6-16-2006.
- 3,297,976. **SEABANDIT (BLOCK FORM)**. SEABANDIT BOATS LIMITED, (U.S. CLS. 19, 21, 23, 31, 35 AND 44). SN 78-927,626. PUB. 7-10-2007. FILED 7-12-2006.
- 3,298,010. **TRAILAIR (BLOCK FORM)**. LIPPERT COMPONENTS MANUFACTURING, INC., (U.S. CLS. 19, 21, 23, 31, 35 AND 44). SN 78-935,763. PUB. 7-10-2007. FILED 7-24-2006.
- 3,298,032. **SUMMERLAND (BLOCK FORM)**. THOR TECH, INC., (U.S. CLS. 19, 21, 23, 31, 35 AND 44). SN 78-944,546. PUB. 7-10-2007. FILED 8-3-2006.
- 3,298,035. **SIGNAL THE FROG (BLOCK FORM)**. GROUND-SPEAK, INC., MULTIPLE CLASS, (INT. CLS. 12 AND 28), (U.S. CLS. 19, 21, 22, 23, 31, 35, 38, 44 AND 50). SN 78-945,560. PUB. 7-10-2007. FILED 8-4-2006.
- 3,298,167 (*See Class 7 for this trademark*).
- 3,298,194 (*See Class 7 for this trademark*).
- 3,298,200 (*See Class 6 for this trademark*).
- 3,298,234. **RL AND DESIGN**. FUZHOU RONGLIN JIXIE; YOUXIAN GONGSI, (U.S. CLS. 19, 21, 23, 31, 35 AND 44). SN 79-024,482. PUB. 7-10-2007. FILED 6-15-2006.
- 3,298,262 (*See Class 7 for this trademark*).
- 3,298,279 (*See Class 7 for this trademark*).
- 3,298,322. **TWINTOP (BLOCK FORM)**. OPEL EISENACH GMBH, (U.S. CLS. 19, 21, 23, 31, 35 AND 44). SN 79-028,727. PUB. 7-10-2007. FILED 7-6-2006.
- 3,298,338. **T TANABE AND DESIGN**. TANABE CO., LTD., (U.S. CLS. 19, 21, 23, 31, 35 AND 44). SN 79-029,679. PUB. 7-10-2007. FILED 7-11-2006.
- 3,298,358 (*See Class 7 for this trademark*).
- 3,298,382. **PEECON (BLOCK FORM)**. PEETERS LANDBOUWMACHINES B.V., (U.S. CLS. 19, 21, 23, 31, 35 AND 44). SN 79-033,223. PUB. 7-10-2007. FILED 8-9-2006.
-
- CLASS 13—FIREARMS**
- 3,296,133. **CRIMSON TRACE (BLOCK FORM)**. CRIMSON TRACE CORPORATION, (U.S. CLS. 2 AND 9). SN 76-666,915. PUB. 7-10-2007. FILED 10-3-2006.
- 3,296,152. **GET IT STARTED (BLOCK FORM)**. WINCO FIREWORKS INTERNATIONAL, L.L.C., (U.S. CLS. 2 AND 9). SN 76-669,005. PUB. 7-10-2007. FILED 11-14-2006.
- 3,296,862. **SURENKAMP FIREWORKS AND DESIGN**. PATRIOTIC FIREWORKS, INC., (U.S. CLS. 2 AND 9). SN 77-086,268. PUB. 7-10-2007. FILED 1-19-2007.
- 3,297,008. **BOONE AND CROCKETT CLUB (BLOCK FORM)**. BOONE AND CROCKETT CLUB, (U.S. CLS. 2 AND 9). SN 77-092,049. PUB. 7-10-2007. FILED 1-26-2007.
- 3,297,390. **PREDATOR (BLOCK FORM)**. STILLER'S PRECISION FIREARMS, LLC, (U.S. CLS. 2 AND 9). SN 78-770,699. PUB. 7-10-2007. FILED 12-10-2005.
-
- CLASS 14—JEWELRY**
- 3,295,987. **FOUNDED 1914 AND DESIGN**. PHI BETA SIGMA FRATERNITY, INC., MULTIPLE CLASS, (INT. CLS. 14, 16, 25 AND 35), (U.S. CLS. 2, 5, 22, 23, 27, 28, 29, 37, 38, 39, 50, 100, 101 AND 102). SN 76-590,045. PUB. 7-10-2007. FILED 4-30-2004.
- 3,296,065. **DUO (BLOCK FORM)**. LEVIAN CORP., (U.S. CLS. 2, 27, 28 AND 50). SN 76-658,903. PUB. 7-10-2007. FILED 4-24-2006.
- 3,296,074. **MISCELLANEOUS DESIGN**. RON JON SURF SHOP OF FLA., INC., MULTIPLE CLASS, (INT. CLS. 14, 21, 24, 25, 28, 32, 35 AND 43), (U.S. CLS. 2, 13, 22, 23, 27, 28, 29, 30, 33, 38, 39, 40, 42, 45, 46, 48, 50, 100, 101 AND 102). SN 76-660,206. PUB. 7-10-2007. FILED 5-17-2006.
- 3,296,225. **PLAYFUL WEARABLE ART (BLOCK FORM)**. WISEMAN, ZACHARY D., (U.S. CLS. 2, 27, 28 AND 50). SN 77-002,293. PUB. 7-10-2007. FILED 9-19-2006.
- 3,296,273 (*See Class 6 for this trademark*).
- 3,296,274 (*See Class 6 for this trademark*).
- 3,296,278. **FRIGHT FACTORY (STYLIZED)**. KLEIN INTERNATIONAL, LTD., MULTIPLE CLASS, (INT. CLS. 14 AND 26), (U.S. CLS. 2, 27, 28, 37, 39, 40, 42 AND 50). SN 77-015,581. PUB. 7-10-2007. FILED 10-6-2006.

3,296,474. **H H H AND DESIGN**. HOORSEN BUHS, LLC, (U.S. CLS. 2, 27, 28 AND 50). SN 77-048,579. PUB. 6-26-2007. FILED 11-21-2006.

3,296,493. **ALENTIEFF AND DESIGN**. RARE STONES, MULTIPLE CLASS, (INT. CLS. 14, 35, 36 AND 40), (U.S. CLS. 2, 27, 28, 50, 100, 101, 102, 103 AND 106). SN 77-051,480. PUB. 7-10-2007. FILED 11-27-2006.

3,296,519. **BRILLIANT ELEGANCE (BLOCK FORM)**. INTERNATIONAL LAPIDARIES CO., LTD., (U.S. CLS. 2, 27, 28 AND 50). SN 77-054,725. PUB. 7-10-2007. FILED 12-1-2006.

3,296,733. **COWGIRL CHILE COMPANY (BLOCK FORM)**. RUTKOWSKI, LAURA S, (U.S. CLS. 2, 27, 28 AND 50). SN 77-067,431. PUB. 7-10-2007. FILED 12-19-2006.

3,297,071. **ALUXE (BLOCK FORM)**. DIAMOND ALLURE INC, (U.S. CLS. 2, 27, 28 AND 50). SN 77-098,898. PUB. 7-10-2007. FILED 2-5-2007.

3,297,237 (*See Class 9 for this trademark*).

3,297,242. **MOSSO (BLOCK FORM)**. MOSSO, ERNESTO FERNANDO, (U.S. CLS. 2, 27, 28 AND 50). SN 78-612,427. PUB. 7-10-2007. FILED 4-20-2005.

3,297,305 (*See Class 7 for this trademark*).

3,297,345 (*See Class 3 for this trademark*).

3,297,394. **THE BRIDE'S PENDANT (BLOCK FORM)**. STUCKEY DIAMOND, INC. D/B/A THE STUCKEY COMPANY, (U.S. CLS. 2, 27, 28 AND 50). SN 78-775,861. PUB. 7-10-2007. FILED 12-19-2005.

3,297,438. **EFFY (BLOCK FORM)**. HEMATIAN, FATOLLAH, (U.S. CLS. 2, 27, 28 AND 50). SN 78-800,131. PUB. 7-10-2007. FILED 1-26-2006.

3,297,444. **EFFY AND DESIGN**. HEMATIAN, FATOLLAH, (U.S. CLS. 2, 27, 28 AND 50). SN 78-803,676. PUB. 7-10-2007. FILED 1-31-2006.

3,297,479. **JASCO (BLOCK FORM)**. JASCO PRODUCTS COMPANY LLC, (U.S. CLS. 2, 27, 28 AND 50). SN 78-821,802. PUB. 7-10-2007. FILED 2-23-2006.

3,297,732. **DAZZLE FLYZ (BLOCK FORM)**. JONES, WINDY, (U.S. CLS. 2, 27, 28 AND 50). SN 78-885,053. PUB. 7-10-2007. FILED 5-16-2006.

3,297,929. **GOSPEL EASTER EGGS (BLOCK FORM)**. CTA, INC., MULTIPLE CLASS, (INT. CLS. 14 AND 16), (U.S. CLS. 2, 5, 22, 23, 27, 28, 29, 37, 38 AND 50). SN 78-917,515. PUB. 7-10-2007. FILED 6-27-2006.

3,298,074. **L'AVARE (BLOCK FORM)**. L'AVARE SARL, (U.S. CLS. 2, 27, 28 AND 50). SN 78-955,794. PUB. 7-10-2007. FILED 8-18-2006.

3,298,075. **THE MYSTIC WAVE (BLOCK FORM)**. DEXTER, THOMAS H., (U.S. CLS. 2, 27, 28 AND 50). SN 78-955,970. PUB. 7-10-2007. FILED 8-19-2006.

3,298,147. **AKA (BLOCK FORM)**. ALPHA KAPPA ALPHA SORORITY, INC., MULTIPLE CLASS, (INT. CLS. 14, 16 AND 35), (U.S. CLS. 2, 5, 22, 23, 27, 28, 29, 37, 38, 50, 100, 101 AND 102). SN 78-978,053. PUB. 7-10-2007. FILED 11-7-2005.

3,298,153. **SUG (BLOCK FORM)**. SCHMIDT, LOTHAR, (U.S. CLS. 2, 27, 28 AND 50). SN 79-007,594. PUB. 7-10-2007. FILED 11-27-2004.

3,298,192. **ADAMENCE (BLOCK FORM)**. ADAMENCE INTERNATIONAL LIMITED (SOCIÉTÉ DE DROIT IRLANDAIS IMMATRICULÉE SOUS LE NUMÉRO 400262), (U.S. CLS. 2, 27, 28 AND 50). SN 79-019,580. PUB. 7-10-2007. FILED 7-12-2005.

3,298,210. **SWATCH SHAKE THE WORLD (BLOCK FORM)**. SWATCH AG (SWATCH SA) (SWATCH LTD.), (U.S. CLS. 2, 27, 28 AND 50). SN 79-022,254. PUB. 7-10-2007. FILED 3-14-2006.

3,298,217. **MISCELLANEOUS DESIGN**. OK'AM S.A.S. DI GREGIS DANIELA & C., MULTIPLE CLASS, (INT. CLS. 14, 16, 18, 24 AND 25), (U.S. CLS. 1, 2, 3, 5, 22, 23, 27, 28, 29, 37, 38, 39, 41, 42 AND 50). SN 79-022,833. PUB. 7-10-2007. FILED 10-31-2005.

3,298,225 (*See Class 9 for this trademark*).

3,298,226. **OMEGA FLIGHTMASTER (BLOCK FORM)**. OMEGA SA (OMEGA AG) (OMEGA LTD.), (U.S. CLS. 2, 27, 28 AND 50). SN 79-024,105. PUB. 7-10-2007. FILED 5-12-2006.

3,298,228. **FLAT SIX (BLOCK FORM)**. ETERNA AG UHREN-FABRIK; (ETERNA SA FABRIQUE D'HORLOGERIE); (ETERNA LTD WATCH FACTORY), (U.S. CLS. 2, 27, 28 AND 50). SN 79-024,297. PUB. 7-10-2007. FILED 5-18-2006.

3,298,254. **J & T WINDMILLS JT AND DESIGN**. FABRIQUE

DE MONTRES ROTARY S.A.; (ROTARY WATCH COMPANY LIMITED), (U.S. CLS. 2, 27, 28 AND 50). SN 79-025,640. PUB. 7-10-2007. FILED 6-21-2006.

3,298,263. **RAVI RAVI (STYLIZED)**. YAMATOYA CO., LTD., MULTIPLE CLASS, (INT. CLS. 14, 18 AND 26), (U.S. CLS. 1, 2, 3, 22, 27, 28, 37, 39, 40, 41, 42 AND 50). SN 79-026,032. PUB. 7-10-2007. FILED 1-20-2006.

3,298,278. **MISCELLANEOUS DESIGN**. FRANKLIN LOU-FRANI, MULTIPLE CLASS, (INT. CLS. 14, 18 AND 25), (U.S. CLS. 1, 2, 3, 22, 27, 28, 39, 41 AND 50). SN 79-026,986. PUB. 7-10-2007. FILED 4-14-2006.

3,298,292. **YOUR PERSONAL DIAMOND AND DESIGN**. OBSHCHESTVO S OGRANICHENNOY; OTVETSTVENNOSTYU "BRILLANT DUSHI", MULTIPLE CLASS, (INT. CLS. 14 AND 42), (U.S. CLS. 2, 27, 28, 50, 100 AND 101). SN 79-027,492. PUB. 7-10-2007. FILED 5-25-2006.

3,298,317. **GEYA (STYLIZED)**. SHENZHEN KANGHEDA WATCHES CO., LTD., (U.S. CLS. 2, 27, 28 AND 50). SN 79-028,399. PUB. 7-10-2007. FILED 8-15-2006.

3,298,349 (*See Class 3 for this trademark*).

CLASS 15—MUSICAL INSTRUMENTS

3,296,430. **HAILUN (BLOCK FORM)**. NINGBO HAILUN MUSICAL INSTRUMENTS CO. LTD., (U.S. CLS. 2, 21 AND 36). SN 77-042,249. PUB. 7-10-2007. FILED 11-13-2006.

3,296,606. **MONO (STYLIZED)**. MONO, (U.S. CLS. 2, 21 AND 36). SN 77-061,952. PUB. 7-10-2007. FILED 12-12-2006.

3,296,821. **TORTEX (BLOCK FORM)**. DUNLOP MANUFACTURING, INC., (U.S. CLS. 2, 21 AND 36). SN 77-083,291. PUB. 7-10-2007. FILED 1-15-2007.

3,296,826 (*See Class 9 for this trademark*).

3,297,207. **VINEYARD (STYLIZED)**. PRAISELAND MUSIC INC., (U.S. CLS. 2, 21 AND 36). SN 78-509,273. PUB. 7-10-2007. FILED 11-1-2004.

3,297,849 (*See Class 9 for this trademark*).

3,297,850 (*See Class 9 for this trademark*).

3,298,055. **JMP GUITARS (BLOCK FORM)**. PEROMSIK, JOSHUA MICHAEL, (U.S. CLS. 2, 21 AND 36). SN 78-950,968. PUB. 7-10-2007. FILED 8-13-2006.

3,298,380 (*See Class 9 for this trademark*).

CLASS 16—PAPER GOODS AND PRINTED MATTER

3,295,975 (*See Class 9 for this trademark*).

3,295,981 (*See Class 9 for this trademark*).

3,295,987 (*See Class 14 for this trademark*).

3,295,996. **SECURE-A-KID AND DESIGN**. IMAGELINK INC., (U.S. CLS. 2, 5, 22, 23, 29, 37, 38 AND 50). SN 76-615,437. PUB. 7-10-2007. FILED 10-12-2004.

3,296,025 (*See Class 11 for this trademark*).

3,296,026 (*See Class 11 for this trademark*).

3,296,036. **3LT (BLOCK FORM)**. QUARTO, MULTIPLE CLASS, (INT. CLS. 16 AND 41), (U.S. CLS. 2, 5, 22, 23, 29, 37, 38, 50, 100, 101 AND 107). SN 76-648,556. PUB. 7-10-2007. FILED 10-17-2005.

3,296,046 (*See Class 9 for this trademark*).

3,296,049 (*See Class 12 for this trademark*).

3,296,050. **GET CAUGHT ! AND DESIGN**. STATE OF KANSAS, KANSAS DEPARTMENT OF HEALTH AND ENVIRONMENT STATE AGENCY KANSAS, (U.S. CLS. 2, 5, 22, 23, 29, 37, 38 AND 50). SN 76-655,432. PUB. 7-10-2007. FILED 2-21-2006.

3,296,054. **BEYOND BASICS (BLOCK FORM)**. Z-INTERNATIONAL, INC., (U.S. CLS. 2, 5, 22, 23, 29, 37, 38 AND 50). SN 76-656,638. PUB. 7-10-2007. FILED 3-15-2006.

3,296,060. **OLD TIME TRUCKS AND DESIGN**. SPONHOLTZ GROUP, INC., (U.S. CLS. 2, 5, 22, 23, 29, 37, 38 AND 50). SN 76-658,174. PUB. 7-10-2007. FILED 4-11-2006.

3,296,084. **ROLLAND MATTE (BLOCK FORM)**. CASCADES FINE PAPERS GROUP INC./CASCADES GROUPE PAPIERS FINS INC., (U.S. CLS. 2, 5, 22, 23, 29, 37, 38 AND 50).

- SN 76-661,725. PUB. 7-10-2007. FILED 6-15-2006.
- 3,296,094. **DOGGYGRAM (BLOCK FORM)**. HACKLER, RICK, (U.S. CLS. 2, 5, 22, 23, 29, 37, 38 AND 50). SN 76-662,563. PUB. 7-10-2007. FILED 7-5-2006.
- 3,296,105. **OBAR'S WORLD (BLOCK FORM)**. WISZNEAUCKAS, NICKI TABOR, (U.S. CLS. 2, 5, 22, 23, 29, 37, 38 AND 50). SN 76-663,724. PUB. 7-10-2007. FILED 7-27-2006.
- 3,296,108. **JOHNSON & JOHNSON (STYLIZED)**. JOHNSON & JOHNSON, MULTIPLE CLASS, (INT. CLS. 16, 18, 21 AND 25), (U.S. CLS. 1, 2, 3, 5, 13, 22, 23, 29, 30, 33, 37, 38, 39, 40, 41 AND 50). SN 76-664,612. PUB. 7-10-2007. FILED 8-14-2006.
- 3,296,112. **COUNCIL ON UNDERGRADUATE RESEARCH (BLOCK FORM)**. COUNCIL ON UNDERGRADUATE RESEARCH, MULTIPLE CLASS, (INT. CLS. 16, 35 AND 41), (U.S. CLS. 2, 5, 22, 23, 29, 37, 38, 50, 100, 101, 102 AND 107). SN 76-664,787. PUB. 7-10-2007. FILED 8-17-2006.
- 3,296,113. **COLOSSUS REX (BLOCK FORM)**. SCHAEFFER, GARY, AND BIRNKRANT, MEL, (U.S. CLS. 2, 5, 22, 23, 29, 37, 38 AND 50). SN 76-664,974. PUB. 7-10-2007. FILED 8-22-2006.
- 3,296,132. **COMMANDER COMET THE MAN FROM VENUS (BLOCK FORM)**. SCHAEFFER, GARY, AND BIRNKRANT, MEL, MULTIPLE CLASS, (INT. CLS. 16 AND 28), (U.S. CLS. 2, 5, 22, 23, 29, 37, 38 AND 50). SN 76-666,872. PUB. 7-10-2007. FILED 10-2-2006.
- 3,296,134. **SYNERA AND DESIGN**. ZARS, INC., (U.S. CLS. 2, 5, 22, 23, 29, 37, 38 AND 50). SN 76-667,214. PUB. 7-10-2007. FILED 10-10-2006.
- 3,296,173. **UNIVERSITY OF VIRGINIA (BLOCK FORM)**. RECTOR AND VISITORS OF THE UNIVERSITY OF VIRGINIA, (U.S. CLS. 2, 5, 22, 23, 29, 37, 38 AND 50). SN 76-670,884. PUB. 7-10-2007. FILED 12-28-2006.
- 3,296,178. **VIRGINIA CAVALIERS (BLOCK FORM)**. RECTOR AND VISITORS OF THE UNIVERSITY OF VIRGINIA, (U.S. CLS. 2, 5, 22, 23, 29, 37, 38 AND 50). SN 76-670,889. PUB. 7-10-2007. FILED 12-28-2006.
- 3,296,218. **"WE PUT YOUR THOUGHTS IN PRINT." (BLOCK FORM)**. CARDS 4 TWINS, (U.S. CLS. 2, 5, 22, 23, 29, 37, 38 AND 50). SN 77-000,075. PUB. 7-10-2007. FILED 9-15-2006.
- 3,296,220. **KIDDY KEYS AND DESIGN**. KIDDYKEYS, MULTIPLE CLASS, (INT. CLS. 16, 28 AND 41), (U.S. CLS. 2, 5, 22, 23, 29, 37, 38, 50, 100, 101 AND 107). SN 77-000,347. PUB. 7-10-2007. FILED 9-15-2006.
- 3,296,222. **MISCELLANEOUS DESIGN**. RANDOM LENGTHS PUBLICATIONS, INC., MULTIPLE CLASS, (INT. CLS. 16 AND 35), (U.S. CLS. 2, 5, 22, 23, 29, 37, 38, 50, 100, 101 AND 102). SN 77-001,030. PUB. 7-10-2007. FILED 9-15-2006.
- 3,296,230. **STEWART, TABORI & CHANG (BLOCK FORM)**. HARRY N. ABRAMS, INC., MULTIPLE CLASS, (INT. CLS. 16 AND 41), (U.S. CLS. 2, 5, 22, 23, 29, 37, 38, 50, 100, 101 AND 107). SN 77-003,275. PUB. 7-10-2007. FILED 9-20-2006.
- 3,296,231. **STC CRAFT (BLOCK FORM)**. HARRY N. ABRAMS, INC., MULTIPLE CLASS, (INT. CLS. 16 AND 41), (U.S. CLS. 2, 5, 22, 23, 29, 37, 38, 50, 100, 101 AND 107). SN 77-003,295. PUB. 7-10-2007. FILED 9-20-2006.
- 3,296,273 (*See Class 6 for this trademark*).
- 3,296,274 (*See Class 6 for this trademark*).
- 3,296,295. **CIRCLE OF SAFETY INTERNATIONAL AND DESIGN**. MARTIN, KIMBERLY S., (U.S. CLS. 2, 5, 22, 23, 29, 37, 38 AND 50). SN 77-019,549. PUB. 7-10-2007. FILED 10-12-2006.
- 3,296,298. **NOTES FROM THE WRITERS ROOM (BLOCK FORM)**. HUTZLER, LAURIE H, (U.S. CLS. 2, 5, 22, 23, 29, 37, 38 AND 50). SN 77-020,747. PUB. 7-10-2007. FILED 10-13-2006.
- 3,296,322 (*See Class 9 for this trademark*).
- 3,296,359 (*See Class 12 for this trademark*).
- 3,296,367. **TRT (BLOCK FORM)**. TWO RIVER TIMES LLC, (U.S. CLS. 2, 5, 22, 23, 29, 37, 38 AND 50). SN 77-032,566. PUB. 7-10-2007. FILED 10-30-2006.
- 3,296,425 (*See Class 9 for this trademark*).
- 3,296,427 (*See Class 9 for this trademark*).
- 3,296,455. **PRISCA PRESS AND DESIGN**. GLASENAPP, GERALDINE, (U.S. CLS. 2, 5, 22, 23, 29, 37, 38 AND 50). SN 77-045,896. PUB. 7-10-2007. FILED 11-16-2006.
- 3,296,469. **THE FOUR AGREEMENTS (BLOCK FORM)**. ALLYLESS, INC., (U.S. CLS. 2, 5, 22, 23, 29, 37, 38 AND 50). SN 77-047,774. PUB. 7-10-2007. FILED 11-20-2006.
- 3,296,470. **COFFEE BREAK (BLOCK FORM)**. KENNETH T. AKAMA, (U.S. CLS. 2, 5, 22, 23, 29, 37, 38 AND 50). SN 77-047,840. PUB. 7-10-2007. FILED 11-20-2006.
- 3,296,471. **HOT & CRISPY (BLOCK FORM)**. DURO BAG MANUFACTURING COMPANY, MULTIPLE CLASS, (INT. CLS. 16 AND 21), (U.S. CLS. 2, 5, 13, 22, 23, 29, 30, 33, 37, 38, 40 AND 50). SN 77-048,015. PUB. 7-10-2007. FILED 11-20-2006.
- 3,296,482 (*See Class 6 for this trademark*).
- 3,296,563. **QUICKSEALS (BLOCK FORM)**. INVENTOR MOM LLC, (U.S. CLS. 2, 5, 22, 23, 29, 37, 38 AND 50). SN 77-059,470. PUB. 7-10-2007. FILED 12-7-2006.
- 3,296,571. **VINTAGE FUEL AND DESIGN**. VINTAGE FUEL, LLC, MULTIPLE CLASS, (INT. CLS. 16 AND 25), (U.S. CLS. 2, 5, 22, 23, 29, 37, 38, 39 AND 50). SN 77-060,062. PUB. 7-10-2007. FILED 12-8-2006.
- 3,296,573. **SERVICE FOR THE CURE AND DESIGN**. PRINCE, RICHARD, (U.S. CLS. 2, 5, 22, 23, 29, 37, 38 AND 50). SN 77-060,126. PUB. 7-10-2007. FILED 12-8-2006.
- 3,296,692. **PLUS (BLOCK FORM)**. PROFESSIONAL LIABILITY UNDERWRITING SOCIETY, MULTIPLE CLASS, (INT. CLS. 16 AND 41), (U.S. CLS. 2, 5, 22, 23, 29, 37, 38, 50, 100, 101 AND 107). SN 77-064,747. PUB. 7-10-2007. FILED 12-14-2006.
- 3,296,701 (*See Class 9 for this trademark*).
- 3,296,702. **LESSONS FOR LITTLE ONES (BLOCK FORM)**. OUAF ENTERPRISES, LLC, (U.S. CLS. 2, 5, 22, 23, 29, 37, 38 AND 50). SN 77-065,050. PUB. 7-10-2007. FILED 12-15-2006.
- 3,296,740. **FAMILY PAGES (BLOCK FORM)**. THE ATLANTA FAMILY PAGES, LLC, MULTIPLE CLASS, (INT. CLS. 16 AND 35), (U.S. CLS. 2, 5, 22, 23, 29, 37, 38, 50, 100, 101 AND 102). SN 77-068,824. PUB. 7-10-2007. FILED 12-20-2006.
- 3,296,741. **THE ATLANTA FAMILY PAGES (BLOCK FORM)**. THE ATLANTA FAMILY PAGES, LLC, MULTIPLE CLASS, (INT. CLS. 16 AND 35), (U.S. CLS. 2, 5, 22, 23, 29, 37, 38, 50, 100, 101 AND 102). SN 77-068,835. PUB. 7-10-2007. FILED 12-20-2006.
- 3,296,742. **EMPHASIS (STYLIZED)**. PUBLIGROUPE S.A., MULTIPLE CLASS, (INT. CLS. 16, 35 AND 41), (U.S. CLS. 2, 5, 22, 23, 29, 37, 38, 50, 100, 101, 102 AND 107). SN 77-069,076. PUB. 7-10-2007. FILED 12-21-2006.
- 3,296,751. **DRP (BLOCK FORM)**. QUESTAR ASSESSMENT, INC., MULTIPLE CLASS, (INT. CLS. 16 AND 41), (U.S. CLS. 2, 5, 22, 23, 29, 37, 38, 50, 100, 101 AND 107). SN 77-072,604. PUB. 7-10-2007. FILED 12-28-2006.
- 3,296,766. **TIKI MASTER (BLOCK FORM)**. GABRIEL MCCUBBIN, (U.S. CLS. 2, 5, 22, 23, 29, 37, 38 AND 50). SN 77-075,143. PUB. 7-10-2007. FILED 1-3-2007.
- 3,296,767. **TRIBAL MASTER (BLOCK FORM)**. MCCUBBIN, GABRIEL, (U.S. CLS. 2, 5, 22, 23, 29, 37, 38 AND 50). SN 77-075,175. PUB. 7-10-2007. FILED 1-3-2007.
- 3,296,777. **KELSEY'S LEARNING ADVENTURES (BLOCK FORM)**. KNOWLEDGE LEARNING CORPORATION, MULTIPLE CLASS, (INT. CLS. 16 AND 41), (U.S. CLS. 2, 5, 22, 23, 29, 37, 38, 50, 100, 101 AND 107). SN 77-077,042. PUB. 7-10-2007. FILED 1-5-2007.
- 3,296,778. **KELSEY'S MATH ADVENTURES (BLOCK FORM)**. KNOWLEDGE LEARNING CORPORATION, MULTIPLE CLASS, (INT. CLS. 16 AND 41), (U.S. CLS. 2, 5, 22, 23, 29, 37, 38, 50, 100, 101 AND 107). SN 77-077,074. PUB. 7-10-2007. FILED 1-5-2007.
- 3,296,780. **KELSEY'S READING ADVENTURES (BLOCK FORM)**. KNOWLEDGE LEARNING CORPORATION, MULTIPLE CLASS, (INT. CLS. 16 AND 41), (U.S. CLS. 2, 5, 22, 23, 29, 37, 38, 50, 100, 101 AND 107). SN 77-077,098. PUB. 7-10-2007. FILED 1-5-2007.
- 3,296,788. **SOCIOLOGY OF EDUCATION (BLOCK FORM)**. AMERICAN SOCIOLOGICAL ASSOCIATION, (U.S. CLS. 2, 5, 22, 23, 29, 37, 38 AND 50). SN 77-078,703. PUB. 7-10-2007. FILED 1-9-2007.
- 3,296,797. **COASTER BOOK AND DESIGN**. PHILIP C. ARNOLD, (U.S. CLS. 2, 5, 22, 23, 29, 37, 38 AND 50). SN 77-079,617. PUB. 7-10-2007. FILED 1-10-2007.
- 3,296,825. **VULCAN UV SHIELD (BLOCK FORM)**. REEVES BROTHERS, INC., (U.S. CLS. 2, 5, 22, 23, 29, 37, 38 AND 50). SN 77-083,435. PUB. 7-10-2007. FILED 1-16-2007.
- 3,296,831. **ISLAND ARCHITECTS (BLOCK FORM)**. ISLAND ARCHITECTS, INC., MULTIPLE CLASS, (INT. CLS. 16

- AND 42), (U.S. CLS. 2, 5, 22, 23, 29, 37, 38, 50, 100 AND 101). SN 77-084,305. PUB. 7-10-2007. FILED 1-17-2007.
- 3,296,852. **POPCORN GREETINGS AND DESIGN**. PLACEK SUSANNA, MULTIPLE CLASS, (INT. CLS. 16 AND 30), (U.S. CLS. 2, 5, 22, 23, 29, 37, 38, 46 AND 50). SN 77-085,537. PUB. 7-10-2007. FILED 1-18-2007.
- 3,296,884. **FLIRT GREETING CARDS AND DESIGN**. HOPKINS, VICKIE L., (U.S. CLS. 2, 5, 22, 23, 29, 37, 38 AND 50). SN 77-087,448. PUB. 7-10-2007. FILED 1-21-2007.
- 3,296,888. **ARCANI ARTS (BLOCK FORM)**. RIVADENEYRA, DAVID ALEXANDER, (U.S. CLS. 2, 5, 22, 23, 29, 37, 38 AND 50). SN 77-087,501. PUB. 7-10-2007. FILED 1-21-2007.
- 3,296,896. **HUB PEN COMPANY (BLOCK FORM)**. HUB PEN COMPANY, INC., (U.S. CLS. 2, 5, 22, 23, 29, 37, 38 AND 50). SN 77-087,834. PUB. 7-10-2007. FILED 1-22-2007.
- 3,296,897. **SILVER CORINTHIAN (BLOCK FORM)**. HUB PEN COMPANY, INC., (U.S. CLS. 2, 5, 22, 23, 29, 37, 38 AND 50). SN 77-087,904. PUB. 7-10-2007. FILED 1-22-2007.
- 3,296,909. **COCO'S (BLOCK FORM)**. GARRETT S. BLACKWELDER, MULTIPLE CLASS, (INT. CLS. 16 AND 28), (U.S. CLS. 2, 5, 22, 23, 29, 37, 38 AND 50). SN 77-088,766. PUB. 7-10-2007. FILED 1-23-2007.
- 3,296,946. **ART WITH INTENTION (BLOCK FORM)**. BLACK, MARIAN T., (U.S. CLS. 2, 5, 22, 23, 29, 37, 38 AND 50). SN 77-090,575. PUB. 7-10-2007. FILED 1-24-2007.
- 3,296,958. **TENANTS IN COMMON (BLOCK FORM)**. NATIONAL RETAIL TENANTS ASSOCIATION, (U.S. CLS. 2, 5, 22, 23, 29, 37, 38 AND 50). SN 77-091,028. PUB. 7-10-2007. FILED 1-25-2007.
- 3,296,985. **INSTONE INC. (BLOCK FORM)**. INSTONE, INC., (U.S. CLS. 2, 5, 22, 23, 29, 37, 38 AND 50). SN 77-091,569. PUB. 7-10-2007. FILED 1-25-2007.
- 3,297,000. **LOBO (BLOCK FORM)**. HUB PEN COMPANY, INC., (U.S. CLS. 2, 5, 22, 23, 29, 37, 38 AND 50). SN 77-091,733. PUB. 7-10-2007. FILED 1-26-2007.
- 3,297,021. **YRB (BLOCK FORM)**. YRB NYC, INC. (U.S. CLS. 2, 5, 22, 23, 29, 37, 38 AND 50). SN 77-092,427. PUB. 7-10-2007. FILED 1-26-2007.
- 3,297,027. **FOLGERSHAKESPEARE LIBRARY ADVANCING KNOWLEDGE & THE ARTS (STYLIZED)**. THE TRUSTEES OF AMHERST COLLEGE/DBA/THE FOLGER SHAKESPEARE LIBRARY, MULTIPLE CLASS, (INT. CLS. 16, 35 AND 41), (U.S. CLS. 2, 5, 22, 23, 29, 37, 38, 50, 100, 101, 102 AND 107). SN 77-092,556. PUB. 7-10-2007. FILED 1-26-2007.
- 3,297,051. **MISCELLANEOUS DESIGN**. EDUCATIONAL EXPERIENCES INC., (U.S. CLS. 2, 5, 22, 23, 29, 37, 38 AND 50). SN 77-093,873. PUB. 7-10-2007. FILED 1-29-2007.
- 3,297,061. **PARADISUS AND DESIGN**. DORPAN, S.L., MULTIPLE CLASS, (INT. CLS. 16 AND 43), (U.S. CLS. 2, 5, 22, 23, 29, 37, 38, 50, 100 AND 101). SN 77-096,098. PUB. 7-10-2007. FILED 1-31-2007.
- 3,297,083. **RED AVON AND DESIGN**. HARPERCOLLINS PUBLISHERS L.L.C., (U.S. CLS. 2, 5, 22, 23, 29, 37, 38 AND 50). SN 77-101,317. PUB. 7-10-2007. FILED 2-7-2007.
- 3,297,110. **MISCELLANEOUS DESIGN**. SPEAK YOUR MIND GREETING CARDS, LLC, (U.S. CLS. 2, 5, 22, 23, 29, 37, 38 AND 50). SN 77-107,893. PUB. 7-10-2007. FILED 2-14-2007.
- 3,297,114. **HEARTS & HANDS (BLOCK FORM)**. MCDONALD'S CORPORATION, (U.S. CLS. 2, 5, 22, 23, 29, 37, 38 AND 50). SN 77-108,387. PUB. 7-10-2007. FILED 2-15-2007.
- 3,297,148. **TEACHING SOCIOLOGY (BLOCK FORM)**. AMERICAN SOCIOLOGICAL ASSOCIATION, (U.S. CLS. 2, 5, 22, 23, 29, 37, 38 AND 50). SN 77-127,131. PUB. 7-10-2007. FILED 3-9-2007.
- 3,297,165. **TRANSPORTATION MANAGEMENT & ENGINEERING (BLOCK FORM)**. SCRANTON GILLETTE COMMUNICATIONS, INC., (U.S. CLS. 2, 5, 22, 23, 29, 37, 38 AND 50). SN 77-142,780. PUB. 7-10-2007. FILED 3-28-2007.
- 3,297,176. **POINT VILLAGE AND DESIGN**. POINT VILLAGE RESORTS LIMITED, MULTIPLE CLASS, (INT. CLS. 16, 25, 41 AND 43), (U.S. CLS. 2, 5, 22, 23, 29, 37, 38, 39, 50, 100, 101 AND 107). SN 78-179,476. PUB. 7-10-2007. FILED 10-29-2002.
- 3,297,186. **BULBPACK AND DESIGN**. MAVERIDGE INTERNATIONAL B.V., MULTIPLE CLASS, (INT. CLS. 16 AND 31), (U.S. CLS. 1, 2, 5, 22, 23, 29, 37, 38, 46 AND 50). SN 78-382,794. PUB. 6-27-2006. FILED 3-11-2004.
- 3,297,193 (*See Class 9 for this trademark*).
- 3,297,226 (*See Class 9 for this trademark*).
- 3,297,233. **INGREDIENTS (BLOCK FORM)**. SUB-ZERO FREEZER COMPANY, INC., (U.S. CLS. 2, 5, 22, 23, 29, 37, 38 AND 50). SN 78-592,690. PUB. 7-10-2007. FILED 3-22-2005.
- 3,297,237 (*See Class 9 for this trademark*).
- 3,297,243 (*See Class 9 for this trademark*).
- 3,297,260. **SURVIVAL STRATEGIES (BLOCK FORM)**. SURVIVAL STRATEGIES, INC., MULTIPLE CLASS, (INT. CLS. 16, 35 AND 41), (U.S. CLS. 2, 5, 22, 23, 29, 37, 38, 50, 100, 101, 102 AND 107). SN 78-637,951. PUB. 7-10-2007. FILED 5-26-2005.
- 3,297,305 (*See Class 7 for this trademark*).
- 3,297,325. **HEALTH ALLIANCE ON ALCOHOL H AND DESIGN**. HEINEKEN USA INC., MULTIPLE CLASS, (INT. CLS. 16, 41 AND 44), (U.S. CLS. 2, 5, 22, 23, 29, 37, 38, 50, 100, 101 AND 107). SN 78-718,816. PUB. 7-10-2007. FILED 9-22-2005.
- 3,297,328. **THE FRANCIS FRITH COLLECTION (BLOCK FORM)**. HERITAGE PHOTOGRAPHIC RESOURCES LIMITED, (U.S. CLS. 2, 5, 22, 23, 29, 37, 38 AND 50). SN 78-719,451. PUB. 7-10-2007. FILED 9-23-2005.
- 3,297,341. **SYNERGY PALS LOOK-ABOUT LION GRASS GREEN SKY BLUE 1 2 3 4 5 6 7 8 9 10 11 12 13 14 15 16 START COUNTING FROM CENTER EARTHY RED SUNNY YELLOW THINK-ABOUT OWL FEEL-ABOUT KOALA TALK-ABOUT CHIMP AND DESIGN**. REVERMAN, ARDYS U., (U.S. CLS. 2, 5, 22, 23, 29, 37, 38 AND 50). SN 78-725,717. PUB. 7-10-2007. FILED 10-3-2005.
- 3,297,345 (*See Class 3 for this trademark*).
- 3,297,352. **MY OTHER VEHICLE IS UNMANNED (BLOCK FORM)**. ASSOCIATION FOR UNMANNED VEHICLE SYSTEMS INTERNATIONAL, (U.S. CLS. 2, 5, 22, 23, 29, 37, 38 AND 50). SN 78-739,903. PUB. 7-10-2007. FILED 10-25-2005.
- 3,297,354. **LUMBERSHIELD AND DESIGN**. BULLDOG BAG LTD., MULTIPLE CLASS, (INT. CLS. 16 AND 17), (U.S. CLS. 1, 2, 5, 12, 13, 22, 23, 29, 35, 37, 38 AND 50). SN 78-740,908. PUB. 7-10-2007. FILED 10-26-2005.
- 3,297,356. **YOUR BEST LIFE NOW (BLOCK FORM)**. OSTEEEN, JOEL, (U.S. CLS. 2, 5, 22, 23, 29, 37, 38 AND 50). SN 78-744,323. PUB. 7-10-2007. FILED 11-1-2005.
- 3,297,365. **EASY OPEN (BLOCK FORM)**. CARDINAL BRANDS, INC., (U.S. CLS. 2, 5, 22, 23, 29, 37, 38 AND 50). SN 78-755,186. PUB. 7-10-2007. FILED 11-16-2005.
- 3,297,371 (*See Class 9 for this trademark*).
- 3,297,388. **AKER KVAERNER SOLUTIONS AND DESIGN**. INTELLECTUAL PROPERTY HOLDINGS AS, MULTIPLE CLASS, (INT. CLS. 16, 35, 38 AND 41), (U.S. CLS. 2, 5, 22, 23, 29, 37, 38, 50, 100, 101, 102, 104 AND 107). SN 78-769,057. PUB. 7-10-2007. FILED 12-8-2005.
- 3,297,405 (*See Class 3 for this trademark*).
- 3,297,425 (*See Class 1 for this trademark*).
- 3,297,437 (*See Class 9 for this trademark*).
- 3,297,441. **MANGIE MUTTS AND DESIGN**. MARSH, TAYLOR ALEXIS, MULTIPLE CLASS, (INT. CLS. 16 AND 40), (U.S. CLS. 2, 5, 22, 23, 29, 37, 38, 50, 100, 103 AND 106). SN 78-802,673. PUB. 3-27-2007. FILED 1-30-2006.
- 3,297,484 (*See Class 9 for this trademark*).
- 3,297,509. **STUDIO MA (BLOCK FORM)**. STUDIO MA, INC., MULTIPLE CLASS, (INT. CLS. 16 AND 42), (U.S. CLS. 2, 5, 22, 23, 29, 37, 38, 50, 100 AND 101). SN 78-834,892. PUB. 7-10-2007. FILED 3-10-2006.
- 3,297,529. **GOT MY KIDS AND DESIGN**. 2090185 ONTARIO INC., MULTIPLE CLASS, (INT. CLS. 16 AND 35), (U.S. CLS. 2, 5, 22, 23, 29, 37, 38, 50, 100, 101 AND 102). SN 78-842,906. PUB. 7-10-2007. FILED 3-22-2006.
- 3,297,531. **H2O - TOOS (STYLIZED)**. H2O - TOOS LLC, (U.S. CLS. 2, 5, 22, 23, 29, 37, 38 AND 50). SN 78-843,410. PUB. 7-10-2007. FILED 3-22-2006.
- 3,297,539. **CHUBBY BUM CREATIONS WWW.CHUBBY-BUM.COM AND DESIGN**. BIONDI, AMY, (U.S. CLS. 2, 5, 22, 23, 29, 37, 38 AND 50). SN 78-846,783. PUB. 7-10-2007. FILED 3-27-2006.
- 3,297,559. **PERSONAL DOCUMENT ORGANIZER AND DESIGN**. MY HELPER, INC., (U.S. CLS. 2, 5, 22, 23, 29, 37, 38 AND 50). SN 78-854,144. PUB. 7-10-2007. FILED 4-5-2006.
- 3,297,560. **MY HELPER AND DESIGN**. MY HELPER, INC., (U.S. CLS. 2, 5, 22, 23, 29, 37, 38 AND 50). SN 78-854,163. PUB. 7-10-2007. FILED 4-5-2006.

- 3,297,568 (*See Class 9 for this trademark*).
- 3,297,572. **AMERICA'S SIGNATURES FOR FREEDOM (BLOCK FORM)**, MONTBLANC-SIMPLO GMBH, (U.S. CLS. 2, 5, 22, 23, 29, 37, 38 AND 50). SN 78-857,507. PUB. 7-10-2007. FILED 4-10-2006.
- 3,297,607. **THE HEART OF DAVID (BLOCK FORM)**, SINAI CALVARY MINISTRIES, (U.S. CLS. 2, 5, 22, 23, 29, 37, 38 AND 50). SN 78-862,752. PUB. 7-10-2007. FILED 4-17-2006.
- 3,297,615 (*See Class 9 for this trademark*).
- 3,297,626. **JANAI-AMI (BLOCK FORM)**, HALIKMAN, AMY B. DBA JANAI-AMI, (U.S. CLS. 2, 5, 22, 23, 29, 37, 38 AND 50). SN 78-866,390. PUB. 7-10-2007. FILED 4-21-2006.
- 3,297,632. **UNIVERSAL FOOTBALL (BLOCK FORM)**, HOLLIS, JOHN H, (U.S. CLS. 2, 5, 22, 23, 29, 37, 38 AND 50). SN 78-867,439. PUB. 7-10-2007. FILED 4-22-2006.
- 3,297,635. **RUSTLE THE LEAF (BLOCK FORM)**, GO NATU'R'L STUDIOS, LLC, MULTIPLE CLASS, (INT. CLS. 16, 21 AND 41), (U.S. CLS. 2, 5, 13, 22, 23, 29, 30, 33, 37, 38, 40, 50, 100, 101 AND 107). SN 78-867,720. PUB. 7-10-2007. FILED 4-24-2006.
- 3,297,670 (*See Class 9 for this trademark*).
- 3,297,675 (*See Class 9 for this trademark*).
- 3,297,700 (*See Class 2 for this trademark*).
- 3,297,702. **MISCELLANEOUS DESIGN**, THE GETHSEMANE FOUNDATION, (U.S. CLS. 2, 5, 22, 23, 29, 37, 38 AND 50). SN 78-878,952. PUB. 7-10-2007. FILED 5-8-2006.
- 3,297,706. **THE BRAIN ANEURYSM FOUNDATION (BLOCK FORM)**, THE BRAIN ANEURYSM FOUNDATION, INC., (U.S. CLS. 2, 5, 22, 23, 29, 37, 38 AND 50). SN 78-880,426. PUB. 7-10-2007. FILED 5-10-2006.
- 3,297,711. **MISCELLANEOUS DESIGN**, SECOND BAPTIST CHURCH, MULTIPLE CLASS, (INT. CLS. 16, 41 AND 45), (U.S. CLS. 2, 5, 22, 23, 29, 37, 38, 50, 100, 101 AND 107). SN 78-881,678. PUB. 7-10-2007. FILED 5-11-2006.
- 3,297,712. **THE DELICATE PEN (BLOCK FORM)**, LABANZ, JANE A., MULTIPLE CLASS, (INT. CLS. 16 AND 41), (U.S. CLS. 2, 5, 22, 23, 29, 37, 38, 50, 100, 101 AND 107). SN 78-881,818. PUB. 7-10-2007. FILED 5-11-2006.
- 3,297,744. **RONDO-PAK (BLOCK FORM)**, DIVIDELLA AG, (U.S. CLS. 2, 5, 22, 23, 29, 37, 38 AND 50). SN 78-886,399. PUB. 7-10-2007. FILED 5-18-2006.
- 3,297,757 (*See Class 9 for this trademark*).
- 3,297,780. **JEPPGUIDE (BLOCK FORM)**, JEPPESEN MARINE, INC., (U.S. CLS. 2, 5, 22, 23, 29, 37, 38 AND 50). SN 78-892,080. PUB. 7-10-2007. FILED 5-24-2006.
- 3,297,800 (*See Class 9 for this trademark*).
- 3,297,849 (*See Class 9 for this trademark*).
- 3,297,850 (*See Class 9 for this trademark*).
- 3,297,862. **TIPS 'N' TAILS (BLOCK FORM)**, DINGO, INC., (U.S. CLS. 2, 5, 22, 23, 29, 37, 38 AND 50). SN 78-905,935. PUB. 7-10-2007. FILED 6-12-2006.
- 3,297,878. **LA MOVIDA NUTRITIVA! AND DESIGN**, FAMILY CARE SPECIALISTS MEDICAL CORPORATION, MULTIPLE CLASS, (INT. CLS. 16 AND 41), (U.S. CLS. 2, 5, 22, 23, 29, 37, 38, 50, 100, 101 AND 107). SN 78-907,336. PUB. 7-10-2007. FILED 6-13-2006.
- 3,297,880. **EQUITIES (BLOCK FORM)**, EQUITIES GLOBAL COMMUNICATIONS, INC., MULTIPLE CLASS, (INT. CLS. 16, 36 AND 41), (U.S. CLS. 2, 5, 22, 23, 29, 37, 38, 50, 100, 101, 102 AND 107). SN 78-907,346. PUB. 7-10-2007. FILED 6-13-2006.
- 3,297,893 (*See Class 9 for this trademark*).
- 3,297,904. **MISCELLANEOUS DESIGN**, STANFORD FINANCIAL GROUP COMPANY, MULTIPLE CLASS, (INT. CLS. 16 AND 36), (U.S. CLS. 2, 5, 22, 23, 29, 37, 38, 50, 100, 101 AND 102). SN 78-911,153. PUB. 7-10-2007. FILED 6-19-2006.
- 3,297,929 (*See Class 14 for this trademark*).
- 3,297,936. **LIPSTICK & DIPSTICK (BLOCK FORM)**, LIPSTICK & DIPSTICK, LLC, MULTIPLE CLASS, (INT. CLS. 16 AND 45), (U.S. CLS. 2, 5, 22, 23, 29, 37, 38, 50, 100 AND 101). SN 78-918,954. PUB. 7-10-2007. FILED 6-28-2006.
- 3,297,952. **BRAINWARE BULLETIN (BLOCK FORM)**, LEARNING ENHANCEMENT CORPORATION, (U.S. CLS. 2, 5, 22, 23, 29, 37, 38 AND 50). SN 78-921,200. PUB. 7-10-2007. FILED 6-30-2006.
- 3,297,981. **REMY BUMPPPO THINK THEATRE AND DESIGN**, REMY BUMPPPO THEATRE COMPANY, MULTIPLE CLASS, (INT. CLS. 16, 25 AND 41), (U.S. CLS. 2, 5, 22, 23, 29, 37, 38, 39, 50, 100, 101 AND 107). SN 78-929,039. PUB. 7-10-2007. FILED 7-13-2006.
- 3,298,025. **MORNINGSIDE CENTER FOR TEACHING SOCIAL RESPONSIBILITY (BLOCK FORM)**, MORNINGSIDE CENTER FOR TEACHING SOCIAL RESPONSIBILITY, INC., MULTIPLE CLASS, (INT. CLS. 16 AND 41), (U.S. CLS. 2, 5, 22, 23, 29, 37, 38, 50, 100, 101 AND 107). SN 78-942,070. PUB. 7-10-2007. FILED 8-1-2006.
- 3,298,026. **CARE PAK SOLUTIONS, INC. WE CARE ENOUGH TO PAK IT FOR YOU AND DESIGN**, CAREPAK SOLUTIONS, INC., (U.S. CLS. 2, 5, 22, 23, 29, 37, 38 AND 50). SN 78-942,796. PUB. 7-10-2007. FILED 8-2-2006.
- 3,298,056. **NURSING 2006 CRITICAL CARE (BLOCK FORM)**, WOLTERS KLUWER HEALTH, INC., (U.S. CLS. 2, 5, 22, 23, 29, 37, 38 AND 50). SN 78-951,995. PUB. 7-10-2007. FILED 8-15-2006.
- 3,298,107. **CHRISTIE'S MAGAZINE (BLOCK FORM)**, CHRISTIE MANSON & WOODS LTD., (U.S. CLS. 2, 5, 22, 23, 29, 37, 38 AND 50). SN 78-963,597. PUB. 7-10-2007. FILED 8-30-2006.
- 3,298,138. **SENIOR LIVING CHOICES (BLOCK FORM)**, NETWORK COMMUNICATIONS, INC., MULTIPLE CLASS, (INT. CLS. 16, 35 AND 36), (U.S. CLS. 2, 5, 22, 23, 29, 37, 38, 50, 100, 101 AND 102). SN 78-972,849. PUB. 7-10-2007. FILED 9-12-2006.
- 3,298,147 (*See Class 14 for this trademark*).
- 3,298,152. **ALDERBROOK (BLOCK FORM)**, NORTH FORTY LODGING LLC, MULTIPLE CLASS, (INT. CLS. 16, 18, 20, 25, 28, 35, 39, 41, 43 AND 44), (U.S. CLS. 1, 2, 3, 5, 13, 22, 23, 25, 29, 32, 37, 38, 39, 41, 50, 100, 101, 102, 105 AND 107). SN 78-978,991. PUB. 2-13-2007. FILED 11-15-2005.
- 3,298,166 (*See Class 9 for this trademark*).
- 3,298,168. **IDEAMARATHON (STYLIZED)**, HIGUCHI TAKEO, MULTIPLE CLASS, (INT. CLS. 16 AND 41), (U.S. CLS. 2, 5, 22, 23, 29, 37, 38, 50, 100, 101 AND 107). SN 79-016,773. PUB. 7-10-2007. FILED 9-26-2005.
- 3,298,169 (*See Class 9 for this trademark*).
- 3,298,173 (*See Class 9 for this trademark*).
- 3,298,178 (*See Class 9 for this trademark*).
- 3,298,208. **SEFAR DECOVISION (BLOCK FORM)**, SEFAR HOLDING AG, MULTIPLE CLASS, (INT. CLS. 16 AND 24), (U.S. CLS. 2, 5, 22, 23, 29, 37, 38, 42 AND 50). SN 79-022,108. PUB. 7-10-2007. FILED 3-2-2006.
- 3,298,212. **SEFAR DECOVIEW (BLOCK FORM)**, SEFAR HOLDING AG, (U.S. CLS. 2, 5, 22, 23, 29, 37, 38 AND 50). SN 79-022,507. PUB. 7-10-2007. FILED 3-2-2006.
- 3,298,214 (*See Class 3 for this trademark*).
- 3,298,217 (*See Class 14 for this trademark*).
- 3,298,225 (*See Class 9 for this trademark*).
- 3,298,230 (*See Class 9 for this trademark*).
- 3,298,236. **SENECHAL (BLOCK FORM)**, CONFRÉRIE DE LA CHAÎNE DES RÔTISSEURS, MULTIPLE CLASS, (INT. CLS. 16, 41 AND 43), (U.S. CLS. 2, 5, 22, 23, 29, 37, 38, 50, 100, 101 AND 107). SN 79-024,653. PUB. 4-3-2007. FILED 1-26-2006.
- 3,298,286. **WESTDEUTSCHE IMMOBILIENBANK AND DESIGN**, WESTLB AG, MULTIPLE CLASS, (INT. CLS. 16, 35, 36, 38 AND 41), (U.S. CLS. 2, 5, 22, 23, 29, 37, 38, 50, 100, 101, 102, 104 AND 107). SN 79-027,302. PUB. 7-10-2007. FILED 5-30-2006.
- 3,298,291. **ROJO REVISTA ROJO MAGAZINE (STYLIZED)**, SINTONISON, S.L., (U.S. CLS. 2, 5, 22, 23, 29, 37, 38 AND 50). SN 79-027,477. PUB. 7-10-2007. FILED 3-14-2006.
- 3,298,295. **JEANSCODE (STYLIZED)**, REDCATS, MULTIPLE CLASS, (INT. CLS. 16, 25 AND 35), (U.S. CLS. 2, 5, 22, 23, 29, 37, 38, 39, 50, 100, 101 AND 102). SN 79-027,578. PUB. 7-10-2007. FILED 4-10-2006.
- 3,298,325. **WORLDWORKS AND DESIGN**, GOLDCREDIT INTERNATIONAL; ENTERPRISES LTD., MULTIPLE CLASS, (INT. CLS. 16 AND 21), (U.S. CLS. 2, 5, 13, 22, 23, 29, 30, 33, 37, 38, 40 AND 50). SN 79-029,048. PUB. 7-10-2007. FILED 3-22-2006.
- 3,298,342. **SCRIPTA VOLANT (BLOCK FORM)**, BULGARI S.P.A., (U.S. CLS. 2, 5, 22, 23, 29, 37, 38 AND 50). SN 79-029,831. PUB. 7-10-2007. FILED 6-12-2006.
- 3,298,387. **NEXTAGE (STYLIZED)**, KABUSHIKI KAISHA PILOT CORPORATION; (ALSO TRADING AS PILOT CORPORATION), (U.S. CLS. 2, 5, 22, 23, 29, 37, 38 AND

50). SN 79-033,946. PUB. 7-10-2007. FILED 12-14-2006.
3,298,395 (*See Class 9 for this trademark.*)

CLASS 17—RUBBER GOODS

3,296,561. **POLYDYNE (BLOCK FORM)**. LEHIGH TECHNOLOGIES, LLC, (U.S. CLS. 1, 5, 12, 13, 35 AND 50). SN 77-059,363. PUB. 7-10-2007. FILED 12-7-2006.
3,296,873. **ECO WRAP (BLOCK FORM)**. CORTEC CORPORATION, (U.S. CLS. 1, 5, 12, 13, 35 AND 50). SN 77-086,935. PUB. 7-10-2007. FILED 1-19-2007.
3,297,120. **PLUS 3 (BLOCK FORM)**. UNITED STATES GYPSUM COMPANY, (U.S. CLS. 1, 5, 12, 13, 35 AND 50). SN 77-112,497. PUB. 7-10-2007. FILED 2-21-2007.
3,297,121 (*See Class 7 for this trademark.*)
3,297,306. **S AND DESIGN**. SPILLTECH HOLDING COMPANY, MULTIPLE CLASS, (INT. CLS. 17 AND 27), (U.S. CLS. 1, 5, 12, 13, 19, 20, 35, 37, 42 AND 50). SN 78-709,382. PUB. 7-10-2007. FILED 9-8-2005.
3,297,354 (*See Class 16 for this trademark.*)
3,297,470. **CLOPAY (BLOCK FORM)**. CLOPAY BUILDING PRODUCTS R&D COMPANY, INC., DBA CLOPAY BUILDING PRODUCTS COMPANY, INC., MULTIPLE CLASS, (INT. CLS. 17 AND 19), (U.S. CLS. 1, 5, 12, 13, 33, 35 AND 50). SN 78-816,127. PUB. 7-10-2007. FILED 2-16-2006.
3,297,557 (*See Class 1 for this trademark.*)
3,297,708. **HYDE AND DESIGN**. HYDE TOOLS, INC., (U.S. CLS. 1, 5, 12, 13, 35 AND 50). SN 78-880,695. PUB. 7-10-2007. FILED 5-10-2006.
3,297,823 (*See Class 6 for this trademark.*)
3,297,990. **CARPET HERO (BLOCK FORM)**. SURFACE PROTECTOR, INC., (U.S. CLS. 1, 5, 12, 13, 35 AND 50). SN 78-930,985. PUB. 7-10-2007. FILED 7-17-2006.
3,298,122. **"3010" ULTRA (BLOCK FORM)**. BESTOLIFE CORPORATION, (U.S. CLS. 1, 5, 12, 13, 35 AND 50). SN 78-967,213. PUB. 7-10-2007. FILED 9-5-2006.
3,298,172 (*See Class 10 for this trademark.*)
3,298,194 (*See Class 7 for this trademark.*)
3,298,205 (*See Class 1 for this trademark.*)
3,298,276. **CRYOFLEX AND DESIGN**. RECIPNEU - EMPRESA NACIONAL; DE RECICLAGEM DE PNEUS, LDA., (U.S. CLS. 1, 5, 12, 13, 35 AND 50). SN 79-026,889. PUB. 7-10-2007. FILED 6-8-2006.
3,298,385 (*See Class 6 for this trademark.*)

CLASS 18—LEATHER GOODS

3,295,967. **MISCELLANEOUS DESIGN**. CUEROFLEX S.A., (U.S. CLS. 1, 2, 3, 22 AND 41). SN 75-670,124. PUB. 6-26-2007. FILED 3-29-1999.
3,295,978. **GLOBE-TROTTER AND DESIGN**. ICBM HOLDINGS LIMITED, (U.S. CLS. 1, 2, 3, 22 AND 41). SN 76-525,988. PUB. 9-7-2004. FILED 6-25-2003.
3,296,108 (*See Class 16 for this trademark.*)
3,296,195. **RINDA RAY (BLOCK FORM)**. BFSM, L.L.C., (U.S. CLS. 1, 2, 3, 22 AND 41). SN 76-671,826. PUB. 7-10-2007. FILED 1-25-2007.
3,296,268. **AMT ADVANCED MODULAR TECHNOLOGY AND DESIGN**. RMK ACCESSORIES, INC., (U.S. CLS. 1, 2, 3, 22 AND 41). SN 77-013,156. PUB. 7-10-2007. FILED 10-4-2006.
3,296,269. **TF TRAILFLEX AND DESIGN**. RMK ACCESSORIES, INC., (U.S. CLS. 1, 2, 3, 22 AND 41). SN 77-013,183. PUB. 7-10-2007. FILED 10-4-2006.
3,296,273 (*See Class 6 for this trademark.*)
3,296,274 (*See Class 6 for this trademark.*)
3,296,279. **RV RONCATO (STYLIZED)**. VALIGERIA RONCATO S.P.A., (U.S. CLS. 1, 2, 3, 22 AND 41). SN 77-016,041. PUB. 7-10-2007. FILED 10-6-2006.
3,296,329. **LARISA BARRERA (BLOCK FORM)**. JOSE & MARIA BARRERA COMPANY, LTD., (U.S. CLS. 1, 2, 3, 22 AND 41). SN 77-027,126. PUB. 7-10-2007. FILED 10-23-2006.

3,296,482 (*See Class 6 for this trademark.*)
3,296,486. **THE SMART HANDBAG (BLOCK FORM)**. CARUSO, GEORGIA, (U.S. CLS. 1, 2, 3, 22 AND 41). SN 77-050,494. PUB. 7-10-2007. FILED 11-24-2006.
3,296,638. **SHEDRAIN (BLOCK FORM)**. SHEDRAIN CORPORATION, MULTIPLE CLASS, (INT. CLS. 18, 20 AND 25), (U.S. CLS. 1, 2, 3, 13, 22, 25, 32, 39, 41 AND 50). SN 77-063,461. PUB. 7-10-2007. FILED 12-13-2006.
3,296,673. **GHHG (STYLIZED)**. OLYMPIC BRASS LIMITED, (U.S. CLS. 1, 2, 3, 22 AND 41). SN 77-064,325. PUB. 7-10-2007. FILED 12-14-2006.
3,296,800. **YOTO BAGS (BLOCK FORM)**. OM FREELY, LLC, (U.S. CLS. 1, 2, 3, 22 AND 41). SN 77-079,730. PUB. 7-10-2007. FILED 1-10-2007.
3,296,841. **KAVIAR AND KIND AND DESIGN**. KAVIAR AND KIND, LLC, (U.S. CLS. 1, 2, 3, 22 AND 41). SN 77-084,711. PUB. 7-10-2007. FILED 1-17-2007.
3,296,858. **GIGGLY GEAR (BLOCK FORM)**. GIGGLE WEAR L.L.C., (U.S. CLS. 1, 2, 3, 22 AND 41). SN 77-085,819. PUB. 7-10-2007. FILED 1-18-2007.
3,297,237 (*See Class 9 for this trademark.*)
3,297,305 (*See Class 7 for this trademark.*)
3,297,317. **DOGUE DESIGNS AND DESIGN**. TRITTER, SUSAN JOY, (U.S. CLS. 1, 2, 3, 22 AND 41). SN 78-712,164. PUB. 7-10-2007. FILED 9-13-2005.
3,297,345 (*See Class 3 for this trademark.*)
3,297,405 (*See Class 3 for this trademark.*)
3,297,421. **AARON BARAK (BLOCK FORM)**. LEWIS, ELI, B., (U.S. CLS. 1, 2, 3, 22 AND 41). SN 78-792,496. PUB. 7-10-2007. FILED 1-16-2006.
3,297,468. **SYLA (BLOCK FORM)**. SYLA LLC, MULTIPLE CLASS, (INT. CLS. 18 AND 25), (U.S. CLS. 1, 2, 3, 22, 39 AND 41). SN 78-815,920. PUB. 7-10-2007. FILED 2-15-2006.
3,297,469. **SYLA BY SYLVIE CACHAY (BLOCK FORM)**. SYLA LLC, MULTIPLE CLASS, (INT. CLS. 18 AND 25), (U.S. CLS. 1, 2, 3, 22, 39 AND 41). SN 78-815,923. PUB. 7-10-2007. FILED 2-15-2006.
3,297,576. **MISCELLANEOUS DESIGN**. NINTENDO CO., LTD., (U.S. CLS. 1, 2, 3, 22 AND 41). SN 78-858,321. PUB. 7-10-2007. FILED 4-10-2006.
3,297,921. **RANDY BAG (BLOCK FORM)**. MCM MARKETING LTD., (U.S. CLS. 1, 2, 3, 22 AND 41). SN 78-915,759. PUB. 7-10-2007. FILED 6-23-2006.
3,298,152 (*See Class 16 for this trademark.*)
3,298,157 (*See Class 9 for this trademark.*)
3,298,178 (*See Class 9 for this trademark.*)
3,298,179 (*See Class 3 for this trademark.*)
3,298,180 (*See Class 3 for this trademark.*)
3,298,217 (*See Class 14 for this trademark.*)
3,298,225 (*See Class 9 for this trademark.*)
3,298,239. **CLP (BLOCK FORM)**. ROSENUIST - GESTAO E SERVIÇOS, LDA., MULTIPLE CLASS, (INT. CLS. 18 AND 25), (U.S. CLS. 1, 2, 3, 22, 39 AND 41). SN 79-024,721. PUB. 7-10-2007. FILED 5-2-2006.
3,298,242. **ARMANI COLLEZIONI (BLOCK FORM)**. GA MODEFINE S.A., MULTIPLE CLASS, (INT. CLS. 18 AND 35), (U.S. CLS. 1, 2, 3, 22, 41, 100, 101 AND 102). SN 79-024,795. PUB. 7-10-2007. FILED 5-5-2006.
3,298,263 (*See Class 14 for this trademark.*)
3,298,278 (*See Class 14 for this trademark.*)
3,298,293. **TER ET BANTINE (STYLIZED)**. G.F.M. INDUSTRIA SPA, (U.S. CLS. 1, 2, 3, 22 AND 41). SN 79-027,526. PUB. 7-10-2007. FILED 3-21-2006.
3,298,302. **SPS SUPERSTAR (BLOCK FORM)**. COLTEX B.V., MULTIPLE CLASS, (INT. CLS. 18, 25 AND 35), (U.S. CLS. 1, 2, 3, 22, 39, 41, 100, 101 AND 102). SN 79-027,739. PUB. 7-10-2007. FILED 4-5-2006.
3,298,335. **D-SIDE AND DESIGN**. NOVARESE SRL, MULTIPLE CLASS, (INT. CLS. 18 AND 25), (U.S. CLS. 1, 2, 3, 22, 39 AND 41). SN 79-029,431. PUB. 7-10-2007. FILED 1-16-2006.
3,298,349 (*See Class 3 for this trademark.*)
3,298,357. **TRUNKI (STYLIZED)**. MAGMATIC LIMITED, MULTIPLE CLASS, (INT. CLS. 18 AND 28), (U.S. CLS. 1, 2, 3, 22, 23, 38, 41 AND 50). SN 79-031,117. PUB. 7-10-2007. FILED 8-9-2006.
3,298,391 (*See Class 3 for this trademark.*)
3,298,397. **ANLI AND DESIGN**. ANHUI ANLI ARTIFICIAL LEATHER CO., LTD, (U.S. CLS. 1, 2, 3, 22 AND 41). SN 79-

035,942. PUB. 7-10-2007. FILED 1-22-2007.

CLASS 19—NON-METALLIC BUILDING MATERIALS

- 3,295,988. **INFINITY BY ABS (BLOCK FORM)**. AMERICAN BUILDING SUPPLY, INC., (U.S. CLS. 1, 12, 33 AND 50). SN 76-590,716. PUB. 7-10-2007. FILED 5-6-2004.
- 3,296,045. **STRI-DECK (BLOCK FORM)**. NORTHCOAST VENTURES, LTD., MULTIPLE CLASS, (INT. CLS. 19 AND 35), (U.S. CLS. 1, 12, 33, 50, 100, 101 AND 102). SN 76-650,861. PUB. 7-10-2007. FILED 11-25-2005.
- 3,296,062. **LEXWOOD (STYLIZED)**. TA CHEN INTERNATIONAL, INC., (U.S. CLS. 1, 12, 33 AND 50). SN 76-658,453. PUB. 7-10-2007. FILED 4-14-2006.
- 3,296,081. **CARLTON HARDWOOD FLOORING (BLOCK FORM)**. CINTEK SYSTEM, INC., (U.S. CLS. 1, 12, 33 AND 50). SN 76-661,364. PUB. 7-10-2007. FILED 6-9-2006.
- 3,296,157. **SPECTRA LOCK (BLOCK FORM)**. LATIURE INTERNATIONAL, INC., (U.S. CLS. 1, 12, 33 AND 50). SN 76-669,998. PUB. 7-10-2007. FILED 12-6-2006.
- 3,296,276. **PAC TANK (BLOCK FORM)**. PACTEC, INC., (U.S. CLS. 1, 12, 33 AND 50). SN 77-015,072. PUB. 7-10-2007. FILED 10-5-2006.
- 3,296,296. **DELTEC HOMES (BLOCK FORM)**. DELTEC HOMES, INC., (U.S. CLS. 1, 12, 33 AND 50). SN 77-020,369. PUB. 7-10-2007. FILED 10-13-2006.
- 3,296,334. **HUSKY VENEER AND DESIGN**. COMMONWEALTH PLYWOOD, LTD., (U.S. CLS. 1, 12, 33 AND 50). SN 77-027,965. PUB. 7-10-2007. FILED 10-24-2006.
- 3,296,403. **CLIMAGUARD SPF (BLOCK FORM)**. GUARDIAN INDUSTRIES CORP., (U.S. CLS. 1, 12, 33 AND 50). SN 77-038,486. PUB. 7-10-2007. FILED 11-7-2006.
- 3,296,407. **GRIP H CLIP (BLOCK FORM)**. M&O PRODUCTS, INC., (U.S. CLS. 1, 12, 33 AND 50). SN 77-039,978. PUB. 7-10-2007. FILED 11-8-2006.
- 3,296,485. **ATOMICRAK AND DESIGN**. BAHIR, TAL, (U.S. CLS. 1, 12, 33 AND 50). SN 77-050,434. PUB. 7-10-2007. FILED 11-24-2006.
- 3,296,509. **CASCADES CUT STONE AND DESIGN**. CASCADES CUT STONE COMPANY, (U.S. CLS. 1, 12, 33 AND 50). SN 77-053,767. PUB. 7-10-2007. FILED 11-30-2006.
- 3,296,676. **BRONCO (BLOCK FORM)**. KILTIE CORPORATION, (U.S. CLS. 1, 12, 33 AND 50). SN 77-064,418. PUB. 7-10-2007. FILED 12-14-2006.
- 3,296,798. **DRI-ROK (BLOCK FORM)**. ALLIED MINERAL PRODUCTS, INC., (U.S. CLS. 1, 12, 33 AND 50). SN 77-079,702. PUB. 7-10-2007. FILED 1-10-2007.
- 3,296,799. **GUNCAST (BLOCK FORM)**. ALLIED MINERAL PRODUCTS, INC., (U.S. CLS. 1, 12, 33 AND 50). SN 77-079,729. PUB. 7-10-2007. FILED 1-10-2007.
- 3,297,151. **CARRIAGE HOUSE SHANGLE (BLOCK FORM)**. CERTAINTED CORPORATION, (U.S. CLS. 1, 12, 33 AND 50). SN 77-132,274. PUB. 7-10-2007. FILED 3-15-2007.
- 3,297,153. **DURA-WOOD (BLOCK FORM)**. LUMBER LIQUIDATORS, INC., (U.S. CLS. 1, 12, 33 AND 50). SN 77-134,705. PUB. 7-10-2007. FILED 3-19-2007.
- 3,297,237 (*See Class 9 for this trademark*).
- 3,297,320 (*See Class 1 for this trademark*).
- 3,297,391 (*See Class 9 for this trademark*).
- 3,297,434. **AMDECK (BLOCK FORM)**. AMVIC INC., (U.S. CLS. 1, 12, 33 AND 50). SN 78-798,169. PUB. 7-10-2007. FILED 1-24-2006.
- 3,297,470 (*See Class 17 for this trademark*).
- 3,297,499. **CARIB SEA (BLOCK FORM)**. CARIB SEA, INC., (U.S. CLS. 1, 12, 33 AND 50). SN 78-831,992. PUB. 7-10-2007. FILED 3-8-2006.
- 3,297,548. **STOP FEEDING MOLD (BLOCK FORM)**. GEORGIA-PACIFIC GYPSUM LLC, (U.S. CLS. 1, 12, 33 AND 50). SN 78-850,784. PUB. 7-10-2007. FILED 3-31-2006.
- 3,297,623. **SPLIT KNUCKLE (BLOCK FORM)**. ANDERSON BROTHERS ARTISTIC IRON, INC., (U.S. CLS. 1, 12, 33 AND 50). SN 78-865,275. PUB. 7-10-2007. FILED 4-19-2006.
- 3,297,651. **HOMESTEAD VERTICAL SIDING (BLOCK FORM)**. NICHIIHA CORPORATION, (U.S. CLS. 1, 12, 33 AND 50). SN 78-870,332. PUB. 7-10-2007. FILED 4-26-2006.

- 3,297,652. **SONOTUBE AND DESIGN**. SPC RESOURCES, INC., (U.S. CLS. 1, 12, 33 AND 50). SN 78-871,092. PUB. 7-10-2007. FILED 4-27-2006.
- 3,297,804 (*See Class 1 for this trademark*).
- 3,297,825. **COLONIAL INSULTEEL INSULATED UNITS AND DESIGN**. COLONIAL MIRROR & GLASS CORPORATION, (U.S. CLS. 1, 12, 33 AND 50). SN 78-901,966. PUB. 7-10-2007. FILED 6-6-2006.
- 3,297,828. **COLONIAL GLASSTEEL TEMPERED DOORS AND DESIGN**. COLONIAL MIRROR & GLASS CORPORATION, (U.S. CLS. 1, 12, 33 AND 50). SN 78-901,987. PUB. 7-10-2007. FILED 6-6-2006.
- 3,297,868. **TVC (BLOCK FORM)**. TVC - TOTAL VIEW COMPANY, INC., (U.S. CLS. 1, 12, 33 AND 50). SN 78-906,549. PUB. 7-10-2007. FILED 6-13-2006.
- 3,298,155 (*See Class 1 for this trademark*).
- 3,298,198 (*See Class 11 for this trademark*).
- 3,298,227 (*See Class 6 for this trademark*).
- 3,298,255 (*See Class 1 for this trademark*).

CLASS 20—FURNITURE AND ARTICLES NOT OTHERWISE CLASSIFIED

- 3,296,025 (*See Class 11 for this trademark*).
- 3,296,026 (*See Class 11 for this trademark*).
- 3,296,115 (*See Class 6 for this trademark*).
- 3,296,482 (*See Class 6 for this trademark*).
- 3,296,638 (*See Class 18 for this trademark*).
- 3,296,948 (*See Class 6 for this trademark*).
- 3,296,969. **FABOWLOUS (BLOCK FORM)**. SIMPLY FABOWLOUS, LLC, (U.S. CLS. 2, 13, 22, 25, 32 AND 50). SN 77-091,193. PUB. 7-10-2007. FILED 1-25-2007.
- 3,296,974. **GRIP QUICK (BLOCK FORM)**. SHELFWORKS TECHNOLOGIES, LLC, (U.S. CLS. 2, 13, 22, 25, 32 AND 50). SN 77-091,304. PUB. 7-10-2007. FILED 1-25-2007.
- 3,297,009. **LYNWOOD (BLOCK FORM)**. KITCHEN KOMPACT, INC., (U.S. CLS. 2, 13, 22, 25, 32 AND 50). SN 77-092,058. PUB. 7-10-2007. FILED 1-26-2007.
- 3,297,082. **ORGANIC REST (BLOCK FORM)**. KRAUS, PHILIP, (U.S. CLS. 2, 13, 22, 25, 32 AND 50). SN 77-101,266. PUB. 7-10-2007. FILED 2-7-2007.
- 3,297,098. **GRIP QUICK TECHNOLOGY (BLOCK FORM)**. SHELFWORKS TECHNOLOGIES LLC, (U.S. CLS. 2, 13, 22, 25, 32 AND 50). SN 77-104,911. PUB. 7-10-2007. FILED 2-12-2007.
- 3,297,147. **THE ULTIMATE IN BODY SUPPORT (BLOCK FORM)**. KRAUS, PHILIP, (U.S. CLS. 2, 13, 22, 25, 32 AND 50). SN 77-126,873. PUB. 7-10-2007. FILED 3-9-2007.
- 3,297,202. **LOCKABULL (BLOCK FORM)**. RMS PRODUCTS, (U.S. CLS. 2, 13, 22, 25, 32 AND 50). SN 78-497,230. PUB. 7-10-2007. FILED 10-8-2004.
- 3,297,272. **Z LOKK (BLOCK FORM)**. D & D GROUP PTY LTD, (U.S. CLS. 2, 13, 22, 25, 32 AND 50). SN 78-675,195. PUB. 7-10-2007. FILED 7-21-2005.
- 3,297,291. **AXE TOTEM (BLOCK FORM)**. WINTERS, LISA J., (U.S. CLS. 2, 13, 22, 25, 32 AND 50). SN 78-702,550. PUB. 7-10-2007. FILED 8-29-2005.
- 3,297,299. **I SMELL NICE AND DESIGN**. FALLEN LEAF VENTURES, INC., DBA THE SOOTHEZE COMPANY, MULTIPLE CLASS, (INT. CLS. 20, 24 AND 28), (U.S. CLS. 2, 13, 22, 23, 25, 32, 38, 42 AND 50). SN 78-706,436. PUB. 7-10-2007. FILED 9-2-2005.
- 3,297,320 (*See Class 1 for this trademark*).
- 3,297,400. **EZ SECURE PRODUCTS (BLOCK FORM)**. FRENCH COMPONENTS CORPORATION, (U.S. CLS. 2, 13, 22, 25, 32 AND 50). SN 78-781,798. PUB. 7-10-2007. FILED 12-28-2005.
- 3,297,401. **EZ FASTENER (BLOCK FORM)**. FRENCH COMPONENTS CORPORATION, (U.S. CLS. 2, 13, 22, 25, 32 AND 50). SN 78-781,836. PUB. 7-10-2007. FILED 12-28-2005.
- 3,297,405 (*See Class 3 for this trademark*).
- 3,297,532 (*See Class 8 for this trademark*).
- 3,297,575. **SLF. SAMUEL LAWRENCE FURNITURE AND DESIGN**. WOODSTUFF MANUFACTURING, INC., MULTIPLE CLASS, (INT. CLS. 20, 39 AND 42), (U.S. CLS. 2, 13, 22, 25, 32, 50, 100, 101 AND 105). SN 78-857,740. PUB. 7-10-

2007. FILED 4-10-2006.
 3,297,682. **BEVTRAC (BLOCK FORM)**. RTC INDUSTRIES, INC., (U.S. CLS. 2, 13, 22, 25, 32 AND 50). SN 78-875,395. PUB. 7-10-2007. FILED 5-3-2006.
 3,297,753 (*See Class 6 for this trademark*).
 3,297,754. **ENVIRO-CORR (BLOCK FORM)**. LIBERTY CARTON COMPANY, (U.S. CLS. 2, 13, 22, 25, 32 AND 50). SN 78-887,562. PUB. 7-10-2007. FILED 5-19-2006.
 3,297,759. **HANGERS HOOKS AND DESIGN**. HANGERS-N-HOOKS INTERNATIONAL LIMITED, (U.S. CLS. 2, 13, 22, 25, 32 AND 50). SN 78-887,960. PUB. 7-10-2007. FILED 5-19-2006.
 3,297,849 (*See Class 9 for this trademark*).
 3,297,850 (*See Class 9 for this trademark*).
 3,297,920. **SILK IMPRESSIONS (BLOCK FORM)**. 974514 ALBERTA LTD., MULTIPLE CLASS, (INT. CLS. 20, 24 AND 35), (U.S. CLS. 2, 13, 22, 25, 32, 42, 50, 100, 101 AND 102). SN 78-915,289. PUB. 7-10-2007. FILED 6-23-2006.
 3,297,922 (*See Class 10 for this trademark*).
 3,297,970 (*See Class 8 for this trademark*).
 3,298,072. **JARDINE BABY AND DESIGN**. JARDINE ENTERPRISE LTD., (U.S. CLS. 2, 13, 22, 25, 32 AND 50). SN 78-955,162. PUB. 7-10-2007. FILED 8-18-2006.
 3,298,073. **THE PALLET WEASEL (BLOCK FORM)**. LAMBIE ENTREPRENEURIAL INC., (U.S. CLS. 2, 13, 22, 25, 32 AND 50). SN 78-955,342. PUB. 7-10-2007. FILED 8-18-2006.
 3,298,152 (*See Class 16 for this trademark*).
 3,298,156. **AEROBIN (BLOCK FORM)**. GLOBAL ENVIRONMENT MANAGEMENT (FZC), (U.S. CLS. 2, 13, 22, 25, 32 AND 50). SN 79-011,949. PUB. 7-10-2007. FILED 12-24-2004.
 3,298,160. **BRAMBLES (STYLIZED)**. BRAMBLES INDUSTRIES LIMITED, MULTIPLE CLASS, (INT. CLS. 20, 35, 37, 38, 39, 40 AND 42), (U.S. CLS. 2, 13, 22, 25, 32, 50, 100, 101, 102, 103, 104, 105 AND 106). SN 79-014,594. PUB. 7-10-2007. FILED 6-2-2004.
 3,298,209 (*See Class 6 for this trademark*).
 3,298,233 (*See Class 11 for this trademark*).
 3,298,244. **SOFAART AND DESIGN**. NICOLETTI CENTRAL WORLD B.V., (U.S. CLS. 2, 13, 22, 25, 32 AND 50). SN 79-024,861. PUB. 7-10-2007. FILED 5-26-2006.

CLASS 21—HOUSEWARES AND GLASS

- 3,296,011. **GUN SLINGER (BLOCK FORM)**. PERMANENT PROMOTIONS PTY LTD, MULTIPLE CLASS, (INT. CLS. 21 AND 33), (U.S. CLS. 2, 13, 23, 29, 30, 33, 40, 47, 49 AND 50). SN 76-637,050. PUB. 7-10-2007. FILED 4-26-2005.
 3,296,025 (*See Class 11 for this trademark*).
 3,296,026 (*See Class 11 for this trademark*).
 3,296,074 (*See Class 14 for this trademark*).
 3,296,108 (*See Class 16 for this trademark*).
 3,296,169. **ECO FORMS AND DESIGN**. SWEETWATER NURSERY, LLC, (U.S. CLS. 2, 13, 23, 29, 30, 33, 40 AND 50). SN 76-670,600. PUB. 7-10-2007. FILED 12-13-2006.
 3,296,273 (*See Class 6 for this trademark*).
 3,296,274 (*See Class 6 for this trademark*).
 3,296,375. **STAGHORN OCTOBERFEST BEER (BLOCK FORM)**. NEW GLARUS BREWING COMPANY, MULTIPLE CLASS, (INT. CLS. 21 AND 32), (U.S. CLS. 2, 13, 23, 29, 30, 33, 40, 45, 46, 48 AND 50). SN 77-033,751. PUB. 7-10-2007. FILED 10-31-2006.
 3,296,471 (*See Class 16 for this trademark*).
 3,296,482 (*See Class 6 for this trademark*).
 3,296,575. **BIG HOUSE (BLOCK FORM)**. REGENTS OF THE UNIVERSITY OF MICHIGAN, (U.S. CLS. 2, 13, 23, 29, 30, 33, 40 AND 50). SN 77-060,213. PUB. 7-10-2007. FILED 12-8-2006.
 3,296,632. **SCRUBSY (BLOCK FORM)**. ABSOLUTELYNEW, (U.S. CLS. 2, 13, 23, 29, 30, 33, 40 AND 50). SN 77-063,094. PUB. 7-10-2007. FILED 12-13-2006.
 3,296,636. **MISCELLANEOUS DESIGN**. BICYCLE TOOLS, INC., DBA PARK TOOL CO., (U.S. CLS. 2, 13, 23, 29, 30, 33, 40 AND 50). SN 77-063,373. PUB. 7-10-2007. FILED 12-13-2006.
 3,296,685. **CTI (BLOCK FORM)**. CENTRADE INC., (U.S. CLS. 2, 13, 23, 29, 30, 33, 40 AND 50). SN 77-064,595. PUB. 7-10-2007. FILED 12-14-2006.
 3,296,882. **JAR YOUR MEMORY (BLOCK FORM)**. SALVATI, ALLISON, (U.S. CLS. 2, 13, 23, 29, 30, 33, 40 AND 50). SN 77-087,344. PUB. 7-10-2007. FILED 1-20-2007.
 3,296,986. **ANT BUSTER (BLOCK FORM)**. TEMPLER, JOHN, AND SALMON, STEVE, (U.S. CLS. 2, 13, 23, 29, 30, 33, 40 AND 50). SN 77-091,570. PUB. 7-10-2007. FILED 1-25-2007.
 3,297,002. **ANT BUSTER PET FOOD DISH AND DESIGN**. TEMPLER, JOHN, AND SALMON, STEVE, (U.S. CLS. 2, 13, 23, 29, 30, 33, 40 AND 50). SN 77-091,932. PUB. 7-10-2007. FILED 1-26-2007.
 3,297,116. **ORALFRESH (BLOCK FORM)**. DR. FRESH, INC., (U.S. CLS. 2, 13, 23, 29, 30, 33, 40 AND 50). SN 77-110,171. PUB. 7-10-2007. FILED 2-17-2007.
 3,297,117. **ORAFRESH (BLOCK FORM)**. DR. FRESH, INC., (U.S. CLS. 2, 13, 23, 29, 30, 33, 40 AND 50). SN 77-110,192. PUB. 7-10-2007. FILED 2-17-2007.
 3,297,173. **MUSH MON! (BLOCK FORM)**. MARGARITAVILLE ENTERPRISES, LLC, (U.S. CLS. 2, 13, 23, 29, 30, 33, 40 AND 50). SN 77-152,810. PUB. 7-10-2007. FILED 4-10-2007.
 3,297,237 (*See Class 9 for this trademark*).
 3,297,319 (*See Class 12 for this trademark*).
 3,297,346. **KOHLER (BLOCK FORM)**. KOHLER CO., (U.S. CLS. 2, 13, 23, 29, 30, 33, 40 AND 50). SN 78-730,139. PUB. 7-10-2007. FILED 10-10-2005.
 3,297,372 (*See Class 5 for this trademark*).
 3,297,391 (*See Class 9 for this trademark*).
 3,297,405 (*See Class 3 for this trademark*).
 3,297,453. **DYNA GRIP (BLOCK FORM)**. S A S SAFETY CORP., (U.S. CLS. 2, 13, 23, 29, 30, 33, 40 AND 50). SN 78-808,416. PUB. 7-10-2007. FILED 2-6-2006.
 3,297,455. **THANK GOD YOU'RE HERE (BLOCK FORM)**. WORKING DOG PTY LTD, (U.S. CLS. 2, 13, 23, 29, 30, 33, 40 AND 50). SN 78-809,480. PUB. 7-10-2007. FILED 2-7-2006.
 3,297,513. **LYNN'S AND DESIGN**. REGENT ALLIANCE INC., (U.S. CLS. 2, 13, 23, 29, 30, 33, 40 AND 50). SN 78-837,754. PUB. 7-10-2007. FILED 3-15-2006.
 3,297,532 (*See Class 8 for this trademark*).
 3,297,569. **HANDY LADDER PAIL (BLOCK FORM)**. BERCON INTERNATIONAL, LLC, (U.S. CLS. 2, 13, 23, 29, 30, 33, 40 AND 50). SN 78-856,823. PUB. 7-10-2007. FILED 4-7-2006.
 3,297,635 (*See Class 16 for this trademark*).
 3,297,667. **AMERICAN CHEF (BLOCK FORM)**. DEXAS INTERNATIONAL, LTD., (U.S. CLS. 2, 13, 23, 29, 30, 33, 40 AND 50). SN 78-872,299. PUB. 7-10-2007. FILED 4-28-2006.
 3,297,753 (*See Class 6 for this trademark*).
 3,297,763. **CRYSTALWAVE (BLOCK FORM)**. DART INDUSTRIES INC., (U.S. CLS. 2, 13, 23, 29, 30, 33, 40 AND 50). SN 78-888,772. PUB. 7-10-2007. FILED 5-22-2006.
 3,297,771. **SPIN 'N SAVE (BLOCK FORM)**. DART INDUSTRIES INC., (U.S. CLS. 2, 13, 23, 29, 30, 33, 40 AND 50). SN 78-890,103. PUB. 7-10-2007. FILED 5-23-2006.
 3,297,800 (*See Class 9 for this trademark*).
 3,297,831. **COLONIAL GLASSTEEL TEMPERED GLASS AND DESIGN**. COLONIAL MIRROR & GLASS CORPORATION, (U.S. CLS. 2, 13, 23, 29, 30, 33, 40 AND 50). SN 78-902,522. PUB. 7-10-2007. FILED 6-7-2006.
 3,297,970 (*See Class 8 for this trademark*).
 3,298,157 (*See Class 9 for this trademark*).
 3,298,178 (*See Class 9 for this trademark*).
 3,298,198 (*See Class 11 for this trademark*).
 3,298,233 (*See Class 11 for this trademark*).
 3,298,270. **IVV (STYLIZED)**. INDUSTRIA VETRARIA VALDARNESE - I.V.V.; SOC. COOP. A.R.L., (U.S. CLS. 2, 13, 23, 29, 30, 33, 40 AND 50). SN 79-026,387. PUB. 7-10-2007. FILED 5-5-2006.
 3,298,306. **MISCELLANEOUS DESIGN**. FUZHOU CANGSHAN TIANJIAN; CHOPSTICKS FACTORY, (U.S. CLS. 2, 13, 23, 29, 30, 33, 40 AND 50). SN 79-027,850. PUB. 7-10-2007. FILED 4-25-2006.
 3,298,325 (*See Class 16 for this trademark*).
 3,298,327. **BX GLASS (STYLIZED)**. BEIJING BEIXIONG TEC. & IND. CO., LTD., (U.S. CLS. 2, 13, 23, 29, 30, 33, 40 AND 50). SN 79-029,164. PUB. 7-10-2007. FILED 4-24-2006.
 3,298,336. **OXY VITAL AND DESIGN**. OXY VITAL; VERWALTUNGSGESELLSCHAFT MBH, MULTIPLE CLASS, (INT. CLS. 21 AND 32), (U.S. CLS. 2, 13, 23, 29, 30, 33, 40, 45, 46, 48

AND 50). SN 79-029,557. PUB. 7-10-2007. FILED 8-1-2006.

CLASS 22—CORDAGE AND FIBERS

- 3,296,018. **HATTERAS MARINE THE HAMMOCKSOURCE # 800.334.1078 AND DESIGN**. HATTERAS HAMMOCKS, INC., (U.S. CLS. 1, 2, 7, 19, 22, 42 AND 50). SN 76-644,546. PUB. 7-10-2007. FILED 8-10-2005.
- 3,296,544. **B BAZIC AND DESIGN**. BANGKIT U.S.A., INC., (U.S. CLS. 1, 2, 7, 19, 22, 42 AND 50). SN 77-057,229. PUB. 7-10-2007. FILED 12-5-2006.
- 3,296,576. **PURE SMOKE (BLOCK FORM)**. PROFESSIONAL'S CHOICE ROPES, INC., (U.S. CLS. 1, 2, 7, 19, 22, 42 AND 50). SN 77-060,234. PUB. 7-10-2007. FILED 12-8-2006.
- 3,296,899. **CORONEX (BLOCK FORM)**. SUNPACK PACIFIC, LLC, (U.S. CLS. 1, 2, 7, 19, 22, 42 AND 50). SN 77-088,023. PUB. 7-10-2007. FILED 1-22-2007.
- 3,297,418. **SOFT & NATURAL NEEDLEPUNCHED 100% COTTON BATTING AND DESIGN**. CHUMBLEY, JAMES F, (U.S. CLS. 1, 2, 7, 19, 22, 42 AND 50). SN 78-790,640. PUB. 7-10-2007. FILED 1-12-2006.
- 3,297,419. **WARM BOND AND DESIGN**. CHUMBLEY, JAMES F, (U.S. CLS. 1, 2, 7, 19, 22, 42 AND 50). SN 78-790,647. PUB. 7-10-2007. FILED 1-12-2006.
- 3,297,591 (*See Class 7 for this trademark*).
- 3,298,394. **EWOL (BLOCK FORM)**. DAITO WOOLEN SPINNING & WEAVING; CO., LTD, MULTIPLE CLASS, (INT. CLS. 22 AND 23), (U.S. CLS. 1, 2, 7, 19, 22, 42, 43 AND 50). SN 79-035,411. PUB. 7-10-2007. FILED 1-29-2007.

CLASS 23—YARNS AND THREADS

- 3,297,891 (*See Class 7 for this trademark*).
- 3,298,394 (*See Class 22 for this trademark*).

CLASS 24—FABRICS

- 3,296,074 (*See Class 14 for this trademark*).
- 3,296,118. **THE NEW YORKER (BLOCK FORM)**. ADVANCE MAGAZINE PUBLISHERS INC., (U.S. CLS. 42 AND 50). SN 76-665,474. PUB. 7-10-2007. FILED 9-1-2006.
- 3,296,340. **CINNAMON STICKS (BLOCK FORM)**. AMBER BLANCO, (U.S. CLS. 42 AND 50). SN 77-028,367. PUB. 7-10-2007. FILED 10-24-2006.
- 3,296,341. **FOR THE NEW OLD-FASHIONED MOM (BLOCK FORM)**. AMBER BLANCO, (U.S. CLS. 42 AND 50). SN 77-028,418. PUB. 7-10-2007. FILED 10-24-2006.
- 3,296,400. **HOTSHIELD (BLOCK FORM)**. IRONCLAD PERFORMANCE WEAR CORP., (U.S. CLS. 42 AND 50). SN 77-038,094. PUB. 7-10-2007. FILED 11-6-2006.
- 3,296,482 (*See Class 6 for this trademark*).
- 3,297,237 (*See Class 9 for this trademark*).
- 3,297,299 (*See Class 20 for this trademark*).
- 3,297,345 (*See Class 3 for this trademark*).
- 3,297,497. **MINATO (BLOCK FORM)**. ASIA FOODS INTERNATIONAL, LLC, MULTIPLE CLASS, (INT. CLS. 24, 29 AND 30), (U.S. CLS. 42, 46 AND 50). SN 78-831,090. PUB. 7-10-2007. FILED 3-7-2006.
- 3,297,741. **AUTHENTIC HENDRIX AND DESIGN**. EXPERIENCE HENDRIX, L.L.C., (U.S. CLS. 42 AND 50). SN 78-886,093. PUB. 7-10-2007. FILED 5-17-2006.
- 3,297,920 (*See Class 20 for this trademark*).
- 3,297,922 (*See Class 10 for this trademark*).
- 3,298,042. **COMFY COZY AND DESIGN**. VINCENT, MARGARET SCHAFER, (U.S. CLS. 42 AND 50). SN 78-948,771. PUB. 4-3-2007. FILED 8-9-2006.
- 3,298,182. **BOTTO GIUSEPPE AND DESIGN**. BOTTO GIUSEPPE & FIGLI S.P.A., MULTIPLE CLASS, (INT. CLS. 24 AND 25), (U.S. CLS. 22, 39, 42 AND 50). SN 79-018,936. PUB. 7-10-2007. FILED 10-21-2005.
- 3,298,208 (*See Class 16 for this trademark*).

- 3,298,217 (*See Class 14 for this trademark*).
- 3,298,225 (*See Class 9 for this trademark*).
- 3,298,280 (*See Class 7 for this trademark*).
- 3,298,349 (*See Class 3 for this trademark*).
- 3,298,372 (*See Class 3 for this trademark*).

CLASS 25—CLOTHING

- 3,295,972. **JUS D'ORANGE**. JUS D'ORANGE, (U.S. CLS. 22 AND 39). SN 76-364,064. PUB. 3-11-2003. FILED 1-29-2002.
- 3,295,987 (*See Class 14 for this trademark*).
- 3,296,022. **CREST JEANS (BLOCK FORM)**. U.S.A. DESIGN, INC., (U.S. CLS. 22 AND 39). SN 76-645,599. PUB. 7-10-2007. FILED 8-25-2005.
- 3,296,032. **SUNNY CALIFORNIA (BLOCK FORM)**. CHO, SU B., (U.S. CLS. 22 AND 39). SN 76-647,906. PUB. 7-10-2007. FILED 10-4-2005.
- 3,296,052. **I THINK IEM AND DESIGN**. INNOVATIVE EMERGENCY MANAGEMENT, INC., (U.S. CLS. 22 AND 39). SN 76-656,346. PUB. 7-10-2007. FILED 3-9-2006.
- 3,296,056. **ROMANTIC FLAG AND DESIGN**. ROMANTIC FLAG CO., LTD., (U.S. CLS. 22 AND 39). SN 76-657,183. PUB. 7-10-2007. FILED 3-23-2006.
- 3,296,057. **NO DRUGS AND DESIGN**. ESTRADA, JOHNNY P., III, (U.S. CLS. 22 AND 39). SN 76-657,568. PUB. 7-10-2007. FILED 3-30-2006.
- 3,296,074 (*See Class 14 for this trademark*).
- 3,296,108 (*See Class 16 for this trademark*).
- 3,296,117. **RUNNERS ROOST AND DESIGN**. ONE STEP AHEAD, INC., MULTIPLE CLASS, (INT. CLS. 25 AND 35), (U.S. CLS. 22, 39, 100, 101 AND 102). SN 76-665,368. PUB. 7-10-2007. FILED 8-30-2006.
- 3,296,149. **BAKKA SPORTS AND DESIGN**. BAKKA CORP., (U.S. CLS. 22 AND 39). SN 76-668,846. PUB. 7-10-2007. FILED 11-13-2006.
- 3,296,150. **NAKED JUNGLE AND DESIGN**. BROTHERS, LONNY, AND BROTHERS, ROBIN, (U.S. CLS. 22 AND 39). SN 76-668,904. PUB. 6-26-2007. FILED 11-13-2006.
- 3,296,160. **MARIAPIA AND DESIGN**. PAJAR DISTRIBUTION LTD./PAJAR DISTRIBUTION LTÉE, (U.S. CLS. 22 AND 39). SN 76-670,287. PUB. 7-10-2007. FILED 12-13-2006.
- 3,296,174. **VIRGINIA CAVALIERS (BLOCK FORM)**. RECTOR AND VISITORS OF THE UNIVERSITY OF VIRGINIA, (U.S. CLS. 22 AND 39). SN 76-670,885. PUB. 7-10-2007. FILED 12-28-2006.
- 3,296,176. **UVA (BLOCK FORM)**. RECTOR AND VISITORS OF THE UNIVERSITY OF VIRGINIA, (U.S. CLS. 22 AND 39). SN 76-670,887. PUB. 7-10-2007. FILED 12-28-2006.
- 3,296,177. **UNIVERSITY OF VIRGINIA (BLOCK FORM)**. RECTOR AND VISITORS OF THE UNIVERSITY OF VIRGINIA, (U.S. CLS. 22 AND 39). SN 76-670,888. PUB. 7-10-2007. FILED 12-28-2006.
- 3,296,208. **PEGLEG NYC (BLOCK FORM)**. NHB INC., (U.S. CLS. 22 AND 39). SN 76-672,006. PUB. 7-10-2007. FILED 1-30-2007.
- 3,296,244. **BLACK RAG AND DESIGN**. BLACK RAG CLOTHING, (U.S. CLS. 22 AND 39). SN 77-007,139. PUB. 7-10-2007. FILED 9-25-2006.
- 3,296,247. **MESZHONI BY TIFFANY V AND DESIGN**. FREEMAN, TIFFANY, (U.S. CLS. 22 AND 39). SN 77-008,170. PUB. 7-10-2007. FILED 9-26-2006.
- 3,296,262. **BLACK JESUS (BLOCK FORM)**. BLACK JESUS LLC, (U.S. CLS. 22 AND 39). SN 77-012,122. PUB. 7-10-2007. FILED 10-2-2006.
- 3,296,264. **M RIGHTEOUS MOVEMENT AND DESIGN**. RIGHTEOUS MOVEMENT, LLC, (U.S. CLS. 22 AND 39). SN 77-012,149. PUB. 7-10-2007. FILED 10-3-2006.
- 3,296,273 (*See Class 6 for this trademark*).
- 3,296,275. **MISCELLANEOUS DESIGN**. ROONGTA EITEL, BELA S., (U.S. CLS. 22 AND 39). SN 77-014,740. PUB. 7-10-2007. FILED 10-5-2006.
- 3,296,366. **MISCELLANEOUS DESIGN**. GOLD'S GYM LICENSING LLC, MULTIPLE CLASS, (INT. CLS. 25, 28 AND 41), (U.S. CLS. 22, 23, 38, 39, 50, 100, 101 AND 107). SN 77-032,541. PUB. 7-10-2007. FILED 10-30-2006.
- 3,296,377. **ENDOVANERA (BLOCK FORM)**. MOSELEY,

- JAMES M., (U.S. CLS. 22 AND 39). SN 77-034,072. PUB. 7-10-2007. FILED 11-1-2006.
 3,296,482 (*See Class 6 for this trademark*).
 3,296,491. **MIRACLES HAPPEN (BLOCK FORM)**. YOUNG, ROXANNA S., (U.S. CLS. 22 AND 39). SN 77-051,349. PUB. 7-10-2007. FILED 11-27-2006.
 3,296,525. **TINY BUBBLES (BLOCK FORM)**. TINY BUBBLES DESIGNS, LLC, (U.S. CLS. 22 AND 39). SN 77-055,030. PUB. 7-10-2007. FILED 12-1-2006.
 3,296,543. **POF AND DESIGN**. CANTER, CYNTHIA K., (U.S. CLS. 22 AND 39). SN 77-057,099. PUB. 7-10-2007. FILED 12-5-2006.
 3,296,564 (*See Class 9 for this trademark*).
 3,296,571 (*See Class 16 for this trademark*).
 3,296,572. **UNPARALLELED IN QUALITY (BLOCK FORM)**. ABERCROMBIE & FITCH TRADING CO., (U.S. CLS. 22 AND 39). SN 77-060,066. PUB. 7-10-2007. FILED 12-8-2006.
 3,296,583. **KINKLAB AND DESIGN**. TUCKER, JOEL G., (U.S. CLS. 22 AND 39). SN 77-060,566. PUB. 6-26-2007. FILED 12-8-2006.
 3,296,637. **IGUANA AND DESIGN**. WALRUS BRANDS LLC, (U.S. CLS. 22 AND 39). SN 77-063,397. PUB. 7-10-2007. FILED 12-13-2006.
 3,296,638 (*See Class 18 for this trademark*).
 3,296,644. **SUPER Z (BLOCK FORM)**. SKECHERS U.S.A., INC. II, (U.S. CLS. 22 AND 39). SN 77-063,700. PUB. 7-10-2007. FILED 12-13-2006.
 3,296,649. **ISLAND DOG (BLOCK FORM)**. RUGGED PRODUCTS LLC, DBA ISLAND DOG, (U.S. CLS. 22 AND 39). SN 77-063,773. PUB. 7-10-2007. FILED 12-13-2006.
 3,296,684. **LIV & DI (BLOCK FORM)**. LITTLE BIG MOUTH, (U.S. CLS. 22 AND 39). SN 77-064,551. PUB. 7-10-2007. FILED 12-14-2006.
 3,296,713. **BULLHEAD B AND DESIGN**. PACIFIC SUNWEAR OF CALIFORNIA, INC., (U.S. CLS. 22 AND 39). SN 77-065,533. PUB. 7-10-2007. FILED 12-15-2006.
 3,296,715. **NIEVES LAVI NEW YORK (STYLIZED)**. NIEVES LAVI LLC, (U.S. CLS. 22 AND 39). SN 77-065,562. PUB. 7-10-2007. FILED 12-15-2006.
 3,296,716. **NIEVES LAVI (BLOCK FORM)**. NIEVES LAVI LLC, (U.S. CLS. 22 AND 39). SN 77-065,564. PUB. 7-10-2007. FILED 12-15-2006.
 3,296,729. **OPERATION OPTIMISTIC AND DESIGN**. ANGELA WRIGHT COLLECTION, INC., (U.S. CLS. 22 AND 39). SN 77-066,568. PUB. 7-10-2007. FILED 12-18-2006.
 3,296,731. **ANGELA WRIGHT COLLECTION AND DESIGN**. ANGELA WRIGHT COLLECTION, INC., (U.S. CLS. 22 AND 39). SN 77-066,630. PUB. 7-10-2007. FILED 12-18-2006.
 3,296,783. **PARA TU (BLOCK FORM)**. JOY MARK, INC., (U.S. CLS. 22 AND 39). SN 77-077,787. PUB. 7-10-2007. FILED 1-8-2007.
 3,296,857. **FRIENDS&CO (BLOCK FORM)**. FRIENDS&CO APPAREL INC., (U.S. CLS. 22 AND 39). SN 77-085,817. PUB. 7-10-2007. FILED 1-18-2007.
 3,296,931. **THE STYLES OF FOREVER (BLOCK FORM)**. MARY JAMES, INC., (U.S. CLS. 22 AND 39). SN 77-089,703. PUB. 7-10-2007. FILED 1-24-2007.
 3,296,965. **MISCELLANEOUS DESIGN**. SHINCA PRODUCTIONS, INC., (U.S. CLS. 22 AND 39). SN 77-091,176. PUB. 7-10-2007. FILED 1-25-2007.
 3,297,006. **SHELAGH COSTELLO (BLOCK FORM)**. COSTELLO, SHELAGH, (U.S. CLS. 22 AND 39). SN 77-092,044. PUB. 7-10-2007. FILED 1-26-2007.
 3,297,024. **GOLD MEDAL (BLOCK FORM)**. PREGER & WERTENTEIL, INC., (U.S. CLS. 22 AND 39). SN 77-092,504. PUB. 7-10-2007. FILED 1-26-2007.
 3,297,039. **BRANCH OUT WHEN YOU BRANCH OUT HOPE GROWS AND DESIGN**. LICHTCSIEN, TERESA, (U.S. CLS. 22 AND 39). SN 77-093,232. PUB. 7-10-2007. FILED 1-29-2007.
 3,297,049. **LUV2DIVE (BLOCK FORM)**. GRAF PAMELA L, (U.S. CLS. 22 AND 39). SN 77-093,701. PUB. 7-10-2007. FILED 1-29-2007.
 3,297,052. **PINK BUBBLE DREAMS AND DESIGN**. PINK BUBBLE DREAMS, LLC, (U.S. CLS. 22 AND 39). SN 77-093,924. PUB. 7-10-2007. FILED 1-29-2007.
 3,297,093. **CAROCUORE AND DESIGN**. DEMIBELL S.A.C.I.F.I., (U.S. CLS. 22 AND 39). SN 77-103,569. PUB. 7-10-2007. FILED 2-9-2007.
 3,297,115. **"WHAT'LL YA HAVE" (BLOCK FORM)**. THE VARSITY, INC., (U.S. CLS. 22 AND 39). SN 77-109,448. PUB. 7-10-2007. FILED 2-16-2007.
 3,297,154. **KS (STYLIZED)**. BOARD OF REGENTS OF THE UNIVERSITY SYSTEM OF GEORGIA, MULTIPLE CLASS, (INT. CLS. 25 AND 41), (U.S. CLS. 22, 39, 100, 101 AND 107). SN 77-134,786. PUB. 7-10-2007. FILED 3-19-2007.
 3,297,155. **MYCONSERVATIONBABY.COM BABY APPAREL FOR THE ECO-FRIENDLY BABY AND DESIGN**. ELLEN MCNEILL/CONSERVATION CONCEPTS, (U.S. CLS. 22 AND 39). SN 77-134,789. PUB. 7-10-2007. FILED 3-19-2007.
 3,297,172. **MUSH MON! (BLOCK FORM)**. MARGARITAVILLE ENTERPRISES, LLC, (U.S. CLS. 22 AND 39). SN 77-152,809. PUB. 7-10-2007. FILED 4-10-2007.
 3,297,174. **THE WOMAN TO BLAME (BLOCK FORM)**. MARGARITAVILLE ENTERPRISES, LLC, (U.S. CLS. 22 AND 39). SN 77-154,161. PUB. 7-10-2007. FILED 4-11-2007.
 3,297,176 (*See Class 16 for this trademark*).
 3,297,222. **GALGO AND DESIGN**. GRUPO INGRAM, S.A. DE C.V., (U.S. CLS. 22 AND 39). SN 78-571,525. PUB. 7-10-2007. FILED 2-21-2005.
 3,297,224. **N AND DESIGN**. RECREATIONAL EQUIPMENT, INC., (U.S. CLS. 22 AND 39). SN 78-573,763. PUB. 6-13-2006. FILED 2-23-2005.
 3,297,230. **MADUSA (BLOCK FORM)**. MICELI, DEBRAH, MULTIPLE CLASS, (INT. CLS. 25, 28 AND 41), (U.S. CLS. 22, 23, 38, 39, 50, 100, 101 AND 107). SN 78-585,476. PUB. 4-3-2007. FILED 3-11-2005.
 3,297,237 (*See Class 9 for this trademark*).
 3,297,252. **NAKED MOTEL AND DESIGN**. FOTOFICTION, INC., (U.S. CLS. 22 AND 39). SN 78-627,198. PUB. 7-10-2007. FILED 5-10-2005.
 3,297,254. **DARN TOUGH (BLOCK FORM)**. CABOT HOSIERY MILLS, INC., (U.S. CLS. 22 AND 39). SN 78-632,036. PUB. 7-10-2007. FILED 5-18-2005.
 3,297,297 (*See Class 9 for this trademark*).
 3,297,298. **RUN CHICAGO (BLOCK FORM)**. DOMANTAY, GREG A., MULTIPLE CLASS, (INT. CLS. 25 AND 35), (U.S. CLS. 22, 39, 100, 101 AND 102). SN 78-706,120. PUB. 7-10-2007. FILED 9-2-2005.
 3,297,305 (*See Class 7 for this trademark*).
 3,297,313. **ALLBALL (BLOCK FORM)**. KOLARAS, THOMAS, GEORGE, (U.S. CLS. 22 AND 39). SN 78-711,795. PUB. 7-10-2007. FILED 9-13-2005.
 3,297,345 (*See Class 3 for this trademark*).
 3,297,399. **PENSHU (BLOCK FORM)**. PENSHU INC., (U.S. CLS. 22 AND 39). SN 78-780,378. PUB. 7-10-2007. FILED 12-23-2005.
 3,297,405 (*See Class 3 for this trademark*).
 3,297,417. **GONGSHOW HOCKEY (BLOCK FORM)**. 1514890 ONTARIO INC., DBA GONGSHOW GEAR, (U.S. CLS. 22 AND 39). SN 78-788,503. PUB. 7-10-2007. FILED 1-10-2006.
 3,297,431. **CUSTARD WALLY (BLOCK FORM)**. GIUNTA, CHRISTOPHER, (U.S. CLS. 22 AND 39). SN 78-794,834. PUB. 9-12-2006. FILED 1-19-2006.
 3,297,454. **STUPILITY (BLOCK FORM)**. STADNICKA, NATALIA, MULTIPLE CLASS, (INT. CLS. 25 AND 41), (U.S. CLS. 22, 39, 100, 101 AND 107). SN 78-808,882. PUB. 7-10-2007. FILED 2-7-2006.
 3,297,468 (*See Class 18 for this trademark*).
 3,297,469 (*See Class 18 for this trademark*).
 3,297,482. **PSYCHO SIDESHOW (BLOCK FORM)**. CALIFORNIA COSTUME COLLECTIONS, INC., (U.S. CLS. 22 AND 39). SN 78-822,253. PUB. 7-10-2007. FILED 2-23-2006.
 3,297,506. **LOVEMACHINE (BLOCK FORM)**. SIEVERS, DAVE, MULTIPLE CLASS, (INT. CLS. 25 AND 41), (U.S. CLS. 22, 39, 100, 101 AND 107). SN 78-834,196. PUB. 7-10-2007. FILED 3-10-2006.
 3,297,527. **WHITE MARLIE AND DESIGN**. WHITE MARLIE DESIGN, LLC, MULTIPLE CLASS, (INT. CLS. 25 AND 35), (U.S. CLS. 22, 39, 100, 101 AND 102). SN 78-842,169. PUB. 7-10-2007. FILED 3-21-2006.
 3,297,678. **ALUMNI HALL (BLOCK FORM)**. JFD, LLC, MULTIPLE CLASS, (INT. CLS. 25 AND 35), (U.S. CLS. 22, 39, 100, 101 AND 102). SN 78-874,387. PUB. 7-10-2007. FILED 5-2-2006.
 3,297,697. **STOP SINNIN! (BLOCK FORM)**. CARTER, T., DBA HONOR WEAR, (U.S. CLS. 22 AND 39). SN 78-878,426. PUB.

- 7-10-2007. FILED 5-8-2006.
- 3,297,699. **SUBCOUTURE (BLOCK FORM)**. PORK EMPIRE, INC., (U.S. CLS. 22 AND 39). SN 78-878,675. PUB. 7-10-2007. FILED 5-8-2006.
- 3,297,714. **THE LIVING SEA (BLOCK FORM)**. MACGILLIVRAY FREEMAN FILMS, MULTIPLE CLASS, (INT. CLS. 25 AND 41), (U.S. CLS. 22, 39, 100, 101 AND 107). SN 78-882,731. PUB. 7-10-2007. FILED 5-12-2006.
- 3,297,715. **RANCHO LOCO (BLOCK FORM)**. CAB FOOTWEAR, LP, (U.S. CLS. 22 AND 39). SN 78-882,772. PUB. 7-10-2007. FILED 5-12-2006.
- 3,297,764. **FASHIONMOMMY (BLOCK FORM)**. LOYD-FIORELLI, ANGELA, (U.S. CLS. 22 AND 39). SN 78-888,911. PUB. 7-10-2007. FILED 5-22-2006.
- 3,297,776. **CAKELOVE CAKES FROM SCRATCH AND DESIGN**. WEB'S CAKES, LLC, (U.S. CLS. 22 AND 39). SN 78-891,785. PUB. 7-10-2007. FILED 5-24-2006.
- 3,297,791. **AQUAPROTECT AQUAPROTECT AND DESIGN**. 3074153 CANADA INC., (U.S. CLS. 22 AND 39). SN 78-895,488. PUB. 7-10-2007. FILED 5-30-2006.
- 3,297,795. **ANNE JORDAN (BLOCK FORM)**. CAVORT INTERNATIONAL, INC., (U.S. CLS. 22 AND 39). SN 78-895,907. PUB. 7-10-2007. FILED 5-30-2006.
- 3,297,800 (*See Class 9 for this trademark*).
- 3,297,809. **RESPECT IS EARNED (BLOCK FORM)**. ROEHL, LANCE, (U.S. CLS. 22 AND 39). SN 78-899,395. PUB. 5-22-2007. FILED 6-2-2006.
- 3,297,869. **B AND DESIGN**. CORDER, BEVERLY, (U.S. CLS. 22 AND 39). SN 78-906,704. PUB. 7-10-2007. FILED 6-13-2006.
- 3,297,876. **NEVER SAY DIE CLOTHING (BLOCK FORM)**. NEVER SAY DIE CLOTHING, INC., (U.S. CLS. 22 AND 39). SN 78-907,239. PUB. 7-10-2007. FILED 6-13-2006.
- 3,297,957. **MISCELLANEOUS DESIGN**. TAYLORMADE CREATIONS, INC., (U.S. CLS. 22 AND 39). SN 78-923,089. PUB. 7-10-2007. FILED 7-5-2006.
- 3,297,963. **DRAYLON (BLOCK FORM)**. SASCHA, LLC, (U.S. CLS. 22 AND 39). SN 78-924,426. PUB. 7-10-2007. FILED 7-7-2006.
- 3,297,981 (*See Class 16 for this trademark*).
- 3,297,994. **MAC DRE (BLOCK FORM)**. SALVATTO, WANDA, (U.S. CLS. 22 AND 39). SN 78-931,299. PUB. 7-10-2007. FILED 7-17-2006.
- 3,297,996. **THE ATLANTIC PARANORMAL SOCIETY (BLOCK FORM)**. HAWES, JASON, DBA THE ATLANTIC PARANORMAL SOCIETY, AND WILSON, GRANT, DBA THE ATLANTIC PARANORMAL SOCIETY, (U.S. CLS. 22 AND 39). SN 78-932,364. PUB. 7-10-2007. FILED 7-18-2006.
- 3,297,998. **GOODTEASE (STYLIZED)**. YOU, ANTHONY, (U.S. CLS. 22 AND 39). SN 78-932,719. PUB. 7-10-2007. FILED 7-19-2006.
- 3,298,013. **TOP MAN (BLOCK FORM)**. ARCADIA GROUP BRANDS LIMITED, (U.S. CLS. 22 AND 39). SN 78-936,634. PUB. 7-10-2007. FILED 7-25-2006.
- 3,298,045. **SOLE MIO (BLOCK FORM)**. VICMOJESS ENTERPRISES, INC., (U.S. CLS. 22 AND 39). SN 78-949,301. PUB. 7-10-2007. FILED 8-10-2006.
- 3,298,082. **HEARSE WEAR (BLOCK FORM)**. FARRAR, CATHERINE, (U.S. CLS. 22 AND 39). SN 78-957,638. PUB. 7-10-2007. FILED 8-22-2006.
- 3,298,113. **KEEP WACO WACKO (BLOCK FORM)**. LENCO, INC., (U.S. CLS. 22 AND 39). SN 78-964,094. PUB. 7-10-2007. FILED 8-30-2006.
- 3,298,146. **MISCELLANEOUS DESIGN**. WU, BILL, (U.S. CLS. 22 AND 39). SN 78-974,951. PUB. 7-10-2007. FILED 9-14-2006.
- 3,298,152 (*See Class 16 for this trademark*).
- 3,298,157 (*See Class 9 for this trademark*).
- 3,298,175. **STENO AND DESIGN**. HECIN TRIKO TEKSTIL SANAYI VE TICARET LIMITED SIRKETI, (U.S. CLS. 22 AND 39). SN 79-018,613. PUB. 7-10-2007. FILED 12-15-2004.
- 3,298,179 (*See Class 3 for this trademark*).
- 3,298,180 (*See Class 3 for this trademark*).
- 3,298,182 (*See Class 24 for this trademark*).
- 3,298,203. **HUMANEST (STYLIZED)**. ELIANE SABON, (U.S. CLS. 22 AND 39). SN 79-021,655. PUB. 7-10-2007. FILED 1-23-2006.
- 3,298,204. **KASK AND DESIGN**. KAJ & SVERRE AB, (U.S. CLS. 22 AND 39). SN 79-021,675. PUB. 7-10-2007. FILED 10-14-2005.
- 3,298,207. **POWER AND DESIGN**. BATA BRANDS S.À R.L., LUXEMBOURG, SUCCURSALE DE LAUSANNE, (U.S. CLS. 22 AND 39). SN 79-022,046. PUB. 7-10-2007. FILED 3-22-2006.
- 3,298,217 (*See Class 14 for this trademark*).
- 3,298,225 (*See Class 9 for this trademark*).
- 3,298,239 (*See Class 18 for this trademark*).
- 3,298,245. **CAMPER LOCUS (BLOCK FORM)**. CAMPER, S.L., (U.S. CLS. 22 AND 39). SN 79-024,875. PUB. 7-10-2007. FILED 3-14-2006.
- 3,298,248 (*See Class 3 for this trademark*).
- 3,298,256. **MISS BILLET DOUX (STYLIZED)**. WOLF LINGERIE, (U.S. CLS. 22 AND 39). SN 79-025,669. PUB. 7-10-2007. FILED 5-12-2006.
- 3,298,257. **BILLET DOUX (STYLIZED)**. WOLF LINGERIE, (U.S. CLS. 22 AND 39). SN 79-025,670. PUB. 7-10-2007. FILED 5-12-2006.
- 3,298,258. **COPA AND DESIGN**. CEES AKKERMANS, (U.S. CLS. 22 AND 39). SN 79-025,704. PUB. 7-10-2007. FILED 5-19-2006.
- 3,298,260. **LUCA VENTURINI (BLOCK FORM)**. VENTURINI LUCA, (U.S. CLS. 22 AND 39). SN 79-025,835. PUB. 7-10-2007. FILED 4-26-2006.
- 3,298,278 (*See Class 14 for this trademark*).
- 3,298,295 (*See Class 16 for this trademark*).
- 3,298,298. **SKINFIT (BLOCK FORM)**. WERNER BATTISTI, (U.S. CLS. 22 AND 39). SN 79-027,642. PUB. 7-10-2007. FILED 3-2-2006.
- 3,298,302 (*See Class 18 for this trademark*).
- 3,298,335 (*See Class 18 for this trademark*).
- 3,298,349 (*See Class 3 for this trademark*).
- 3,298,352. **P AND DESIGN**. PIRELLI & C. S.P.A., (U.S. CLS. 22 AND 39). SN 79-030,874. PUB. 7-10-2007. FILED 9-14-2006.
- 3,298,353. **SCANDINAVIAN TRAVEL AND DESIGN**. SCANDINAVIAN TRAVEL CONSULT, MULTIPLE CLASS, (INT. CLS. 25, 28 AND 39), (U.S. CLS. 22, 23, 38, 39, 50, 100 AND 105). SN 79-030,969. PUB. 7-10-2007. FILED 3-29-2006.
- 3,298,354. **CALEFFI AND DESIGN**. CALEFFI S.P.A., (U.S. CLS. 22 AND 39). SN 79-030,975. PUB. 7-10-2007. FILED 10-31-2006.
- 3,298,356. **ACTIFLEX (BLOCK FORM)**. SCHEIN ORTHOPÄDIE-SERVICE KG, (U.S. CLS. 22 AND 39). SN 79-031,080. PUB. 7-10-2007. FILED 2-23-2006.
- 3,298,361. **I. CODE (BLOCK FORM)**. I CODE, SOCIÉTÉ PAR ACTIONS SIMPLIFIÉE, (U.S. CLS. 22 AND 39). SN 79-031,549. PUB. 7-10-2007. FILED 5-16-2006.
- 3,298,363. **25° SOUTH AND DESIGN**. JACARU AUSTRALIA PTY LTD, (U.S. CLS. 22 AND 39). SN 79-031,652. PUB. 7-10-2007. FILED 10-31-2006.
- 3,298,367 (*See Class 5 for this trademark*).
- 3,298,369. **LASTING AND DESIGN**. LASTING SPORT, S.R.O., (U.S. CLS. 22 AND 39). SN 79-032,160. PUB. 7-10-2007. FILED 6-9-2006.
- 3,298,389. **2 BLOCKS SOUTH (STYLIZED)**. C.O.D CREATIONS OF DENIM PTY LTD, (U.S. CLS. 22 AND 39). SN 79-034,058. PUB. 7-10-2007. FILED 12-15-2006.
- 3,298,391 (*See Class 3 for this trademark*).

CLASS 26—FANCY GOODS

- 3,296,239. **MEMORY SPRAY (BLOCK FORM)**. 2108807 ONTARIO INC., DBA ABOVE AND BEYOND, (U.S. CLS. 37, 39, 40, 42 AND 50). SN 77-005,207. PUB. 7-10-2007. FILED 9-22-2006.
- 3,296,242 (*See Class 8 for this trademark*).
- 3,296,278 (*See Class 14 for this trademark*).
- 3,297,832 (*See Class 3 for this trademark*).
- 3,297,891 (*See Class 7 for this trademark*).
- 3,297,961. **HYDROPEL (BLOCK FORM)**. IDEAL FASTENER CORPORATION, (U.S. CLS. 37, 39, 40, 42 AND 50). SN 78-924,292. PUB. 7-10-2007. FILED 7-7-2006.
- 3,297,986. **GLAMORGLOVE (BLOCK FORM)**. EXCEPTIONAL PRODUCTS, INC., (U.S. CLS. 37, 39, 40, 42 AND 50). SN 78-930,090. PUB. 7-10-2007. FILED 7-14-2006.
- 3,298,263 (*See Class 14 for this trademark*).
- 3,298,367 (*See Class 5 for this trademark*).

CLASS 27—FLOOR COVERINGS

- 3,296,482 (*See Class 6 for this trademark*).
 3,296,837. **ERGOKNEEL (BLOCK FORM)**. WORKING CONCEPTS, INC., (U.S. CLS. 19, 20, 37, 42 AND 50). SN 77-084,488. PUB. 7-10-2007. FILED 1-17-2007.
 3,297,237 (*See Class 9 for this trademark*).
 3,297,306 (*See Class 17 for this trademark*).
 3,297,532 (*See Class 8 for this trademark*).
 3,298,219. **PARQWALL (STYLIZED)**. P.L. S.P.A., (U.S. CLS. 19, 20, 37, 42 AND 50). SN 79-022,999. PUB. 7-10-2007. FILED 3-31-2006.

CLASS 28—TOYS AND SPORTING GOODS

- 3,295,979. **CARNIVORE (BLOCK FORM)**. JT SPORTS LLC, (U.S. CLS. 22, 23, 38 AND 50). SN 76-557,438. PUB. 10-26-2004. FILED 11-6-2003.
 3,295,982. **MOJO (BLOCK FORM)**. HUNTWISE, INC., (U.S. CLS. 22, 23, 38 AND 50). SN 76-568,285. PUB. 7-10-2007. FILED 12-19-2003.
 3,296,025 (*See Class 11 for this trademark*).
 3,296,026 (*See Class 11 for this trademark*).
 3,296,066. **AQUA BUGS (BLOCK FORM)**. NOKES, RONALD W., (U.S. CLS. 22, 23, 38 AND 50). SN 76-658,998. PUB. 2-6-2007. FILED 4-24-2006.
 3,296,074 (*See Class 14 for this trademark*).
 3,296,120. **CRAPPIE MAGNET AND DESIGN**. LELAND'S LURES, LLC, (U.S. CLS. 22, 23, 38 AND 50). SN 76-665,552. PUB. 7-10-2007. FILED 9-5-2006.
 3,296,132 (*See Class 16 for this trademark*).
 3,296,163. **BIG TOP (STYLIZED)**. BRIAN QUAGLIA, (U.S. CLS. 22, 23, 38 AND 50). SN 76-670,431. PUB. 7-10-2007. FILED 12-14-2006.
 3,296,175. **VIRGINIA CAVALIERS (BLOCK FORM)**. RECTOR AND VISITORS OF THE UNIVERSITY OF VIRGINIA, (U.S. CLS. 22, 23, 38 AND 50). SN 76-670,886. PUB. 7-10-2007. FILED 12-28-2006.
 3,296,196. **LIGHTS OUT! GAME ON! (BLOCK FORM)**. HASBRO, INC., (U.S. CLS. 22, 23, 38 AND 50). SN 76-671,833. PUB. 7-10-2007. FILED 1-25-2007.
 3,296,200. **THE OPERATOR (BLOCK FORM)**. RENEGADE PRODUCTIONS, INC., (U.S. CLS. 22, 23, 38 AND 50). SN 76-671,838. PUB. 7-10-2007. FILED 1-26-2007.
 3,296,209. **WEATHER BLITZ (BLOCK FORM)**. HASBRO, INC., (U.S. CLS. 22, 23, 38 AND 50). SN 76-672,381. PUB. 7-10-2007. FILED 2-5-2007.
 3,296,211. **FAMILY BOWL (BLOCK FORM)**. NAMCO BANDAI GAMES INC., (U.S. CLS. 22, 23, 38 AND 50). SN 76-672,569. PUB. 7-10-2007. FILED 2-12-2007.
 3,296,220 (*See Class 16 for this trademark*).
 3,296,292. **FLEECY MCGEES (BLOCK FORM)**. FAT CAT, INC., (U.S. CLS. 22, 23, 38 AND 50). SN 77-018,547. PUB. 7-10-2007. FILED 10-11-2006.
 3,296,304. **AVITON AND DESIGN**. MUSICAL ELECTRONICS LIMITED, (U.S. CLS. 22, 23, 38 AND 50). SN 77-023,061. PUB. 7-10-2007. FILED 10-17-2006.
 3,296,366 (*See Class 25 for this trademark*).
 3,296,368. **BORIS' (BLOCK FORM)**. SOUTHERN STATES MARKETING, INC., (U.S. CLS. 22, 23, 38 AND 50). SN 77-032,865. PUB. 7-10-2007. FILED 10-31-2006.
 3,296,369. **BORIS' BUBBLE LAB (BLOCK FORM)**. SOUTHERN STATES MARKETING, INC., (U.S. CLS. 22, 23, 38 AND 50). SN 77-032,876. PUB. 7-10-2007. FILED 10-31-2006.
 3,296,482 (*See Class 6 for this trademark*).
 3,296,524. **TRAXSTECH (BLOCK FORM)**. TRAXSTECH CORPORATION, (U.S. CLS. 22, 23, 38 AND 50). SN 77-054,902. PUB. 7-10-2007. FILED 12-1-2006.
 3,296,554. **FRISLA (BLOCK FORM)**. JOP AMERICA CORPORATION, (U.S. CLS. 22, 23, 38 AND 50). SN 77-058,387. PUB. 7-10-2007. FILED 12-6-2006.
 3,296,566. **MISS NAUGHTY (BLOCK FORM)**. M.D.I. INTERNATIONAL PTY. LTD., (U.S. CLS. 22, 23, 38 AND 50). SN 77-059,919. PUB. 7-10-2007. FILED 12-8-2006.
 3,296,762. **BABY PETZ AND DESIGN**. K.S. TOYS LTD., (U.S. CLS. 22, 23, 38 AND 50). SN 77-074,767. PUB. 7-10-2007.

- FILED 1-3-2007.
 3,296,763. **CANDY FRUITIE AND DESIGN**. K.S. TOYS LTD., (U.S. CLS. 22, 23, 38 AND 50). SN 77-074,770. PUB. 7-10-2007. FILED 1-3-2007.
 3,296,764. **SUNDAE BABY AND DESIGN**. K.S. TOYS LTD., (U.S. CLS. 22, 23, 38 AND 50). SN 77-074,779. PUB. 7-10-2007. FILED 1-3-2007.
 3,296,791. **SILLY'ABLES (BLOCK FORM)**. RAINBOW GAMES, INC., (U.S. CLS. 22, 23, 38 AND 50). SN 77-079,222. PUB. 7-10-2007. FILED S.R. 1-9-2007; AM. P.R. 5-10-2007.
 3,296,793. **BLINDSIDE (BLOCK FORM)**. RAINBOW GAMES, INC., (U.S. CLS. 22, 23, 38 AND 50). SN 77-079,259. PUB. 7-10-2007. FILED S.R. 1-9-2007; AM. P.R. 5-10-2007.
 3,296,794. **COMPUTERAMA (BLOCK FORM)**. RAINBOW GAMES, INC., (U.S. CLS. 22, 23, 38 AND 50). SN 77-079,284. PUB. 7-10-2007. FILED S.R. 1-9-2007; AM. P.R. 5-10-2007.
 3,296,886. **LOGAN EARTH SKI (BLOCK FORM)**. LOGAN, BRUCE LEWIS, (U.S. CLS. 22, 23, 38 AND 50). SN 77-087,473. PUB. 7-10-2007. FILED 1-21-2007.
 3,296,909 (*See Class 16 for this trademark*).
 3,296,922. **SPIN RIM (BLOCK FORM)**. WILLIAM MARK CORPORATION, (U.S. CLS. 22, 23, 38 AND 50). SN 77-089,240. PUB. 7-10-2007. FILED 1-23-2007.
 3,297,128. **TROPHY ROCK (BLOCK FORM)**. REDMOND, INCORPORATED, (U.S. CLS. 22, 23, 38 AND 50). SN 77-114,987. PUB. 7-10-2007. FILED 2-23-2007.
 3,297,230 (*See Class 25 for this trademark*).
 3,297,264. **NEW BREED (BLOCK FORM)**. SRI SPORTS KABUSHIKI KAISHA, AKA SRI SPORTS LIMITED, (U.S. CLS. 22, 23, 38 AND 50). SN 78-645,240. PUB. 7-10-2007. FILED 6-7-2005.
 3,297,267. **REVELATION SUPERLONG (BLOCK FORM)**. DUNLOP SLAZENGER GROUP LIMITED, (U.S. CLS. 22, 23, 38 AND 50). SN 78-646,620. PUB. 7-10-2007. FILED 6-8-2005.
 3,297,299 (*See Class 20 for this trademark*).
 3,297,305 (*See Class 7 for this trademark*).
 3,297,345 (*See Class 3 for this trademark*).
 3,297,376. **SQUIDGIES (BLOCK FORM)**. DUNPHY SPORTS/FISHING IMPORTS PTY LTD, (U.S. CLS. 22, 23, 38 AND 50). SN 78-763,612. PUB. 7-10-2007. FILED 11-30-2005.
 3,297,405 (*See Class 3 for this trademark*).
 3,297,411. **KALENJI (BLOCK FORM)**. PROJECTCLUB, (U.S. CLS. 22, 23, 38 AND 50). SN 78-786,270. PUB. 7-10-2007. FILED 1-6-2006.
 3,297,486. **METAL MISSION (BLOCK FORM)**. MATTEL, INC., (U.S. CLS. 22, 23, 38 AND 50). SN 78-825,047. PUB. 7-10-2007. FILED 2-28-2006.
 3,297,588. **POWER TEE (BLOCK FORM)**. GOLF-TECH LIMITED, (U.S. CLS. 22, 23, 38 AND 50). SN 78-861,080. PUB. 7-10-2007. FILED 4-13-2006.
 3,297,747. **SAGITTA (BLOCK FORM)**. AEROSPHERE, INC., (U.S. CLS. 22, 23, 38 AND 50). SN 78-886,626. PUB. 7-10-2007. FILED 5-18-2006.
 3,297,761. **BATACTION SELF TRAINER (BLOCK FORM)**. NEDCO SPORTS PRODUCTS, INC., (U.S. CLS. 22, 23, 38 AND 50). SN 78-888,207. PUB. 7-10-2007. FILED 5-19-2006.
 3,297,792. **LIMINI (BLOCK FORM)**. KYOSHO CORPORATION, (U.S. CLS. 22, 23, 38 AND 50). SN 78-895,527. PUB. 7-10-2007. FILED 5-30-2006.
 3,297,796 (*See Class 9 for this trademark*).
 3,297,819. **ULTIMATE BODY PRESS (BLOCK FORM)**. ULTIMATE BODY PRESS LLC, (U.S. CLS. 22, 23, 38 AND 50). SN 78-901,339. PUB. 7-10-2007. FILED 6-6-2006.
 3,297,821. **M-SERIES (BLOCK FORM)**. GOLF GALAXY GOLFWORKS, INC., (U.S. CLS. 22, 23, 38 AND 50). SN 78-901,393. PUB. 7-10-2007. FILED 6-6-2006.
 3,297,871. **ANGEL CAT SUGAR (BLOCK FORM)**. TACT COMMUNICATIONS INC., (U.S. CLS. 22, 23, 38 AND 50). SN 78-906,848. PUB. 7-10-2007. FILED 6-13-2006.
 3,297,967. **ROGUE SNOWBOARDS (BLOCK FORM)**. ROGUE, LLC, (U.S. CLS. 22, 23, 38 AND 50). SN 78-925,090. PUB. 7-10-2007. FILED 7-8-2006.
 3,297,984. **SNOW BOLT (BLOCK FORM)**. WHAM-O, INC., (U.S. CLS. 22, 23, 38 AND 50). SN 78-929,833. PUB. 7-10-2007. FILED 7-14-2006.

- 3,298,027. **RIPSTIK (BLOCK FORM)**. RAZOR USA LLC, (U.S. CLS. 22, 23, 38 AND 50). SN 78-943,426. PUB. 6-5-2007. FILED 8-2-2006.
- 3,298,035 (*See Class 12 for this trademark*).
- 3,298,036. **GLITZY GRAPE (BLOCK FORM)**. MATTEL, INC., (U.S. CLS. 22, 23, 38 AND 50). SN 78-946,336. PUB. 7-10-2007. FILED 8-7-2006.
- 3,298,044. **VOODOO SKATEBOARDS (BLOCK FORM)**. CORDES, AMANDA M, (U.S. CLS. 22, 23, 38 AND 50). SN 78-949,035. PUB. 7-10-2007. FILED 8-10-2006.
- 3,298,120. **UBOARDS LTD. (STYLIZED)**. UBOARDS LTD., LLC, (U.S. CLS. 22, 23, 38 AND 50). SN 78-966,404. PUB. 7-10-2007. FILED 9-1-2006.
- 3,298,152 (*See Class 16 for this trademark*).
- 3,298,157 (*See Class 9 for this trademark*).
- 3,298,221. **GIANT DRAGON AND DESIGN**. GUANGZHOU DONGXING; GIANTDRAGON STATIONERY & SPORTING GOODS CO., LTD., (U.S. CLS. 22, 23, 38 AND 50). SN 79-023,789. PUB. 7-10-2007. FILED 2-15-2006.
- 3,298,230 (*See Class 9 for this trademark*).
- 3,298,305. **CORE PILOT (BLOCK FORM)**. JUSTWISE GROUP LIMITED, (U.S. CLS. 22, 23, 38 AND 50). SN 79-027,827. PUB. 7-10-2007. FILED 4-21-2006.
- 3,298,353 (*See Class 25 for this trademark*).
- 3,298,357 (*See Class 18 for this trademark*).
- 3,298,367 (*See Class 5 for this trademark*).

CLASS 29—MEATS AND PROCESSED FOODS

- 3,296,021. **MARINARA MIX (BLOCK FORM)**. SEA PORT PRODUCTS CORPORATION, (U.S. CL. 46). SN 76-645,386. PUB. 7-10-2007. FILED 8-22-2005.
- 3,296,040. **NOTTOLI (BLOCK FORM)**. GEORGE NOTTOLI & SON, INC., (U.S. CL. 46). SN 76-649,549. PUB. 7-10-2007. FILED 11-1-2005.
- 3,296,202. **MAMMA-RANNE'S (BLOCK FORM)**. CAPITOL WHOLESALE MEATS, INC., (U.S. CL. 46). SN 76-671,900. PUB. 7-10-2007. FILED 1-25-2007.
- 3,296,243. **BERRY CHOCOLATE BOUQUET (BLOCK FORM)**. EDIBLE ARRANGEMENTS, LLC, MULTIPLE CLASS, (INT. CLS. 29 AND 30), (U.S. CL. 46). SN 77-006,508. PUB. 7-10-2007. FILED 9-25-2006.
- 3,296,245. **KAR'S ALWAYS FRESH SINCE 1933 AND DESIGN**. KAR NUT PRODUCTS COMPANY, (U.S. CL. 46). SN 77-007,847. PUB. 7-10-2007. FILED 9-26-2006.
- 3,296,260. **ASAGE (BLOCK FORM)**. KABUSHIKI KAISHA NAGATANEN, DBA NAGATANEN CO., LTD., (U.S. CL. 46). SN 77-011,803. PUB. 7-10-2007. FILED 10-2-2006.
- 3,296,297. **RAO'S AND DESIGN**. RAO'S SPECIALTY FOODS, INC., MULTIPLE CLASS, (INT. CLS. 29 AND 30), (U.S. CL. 46). SN 77-020,721. PUB. 6-26-2007. FILED 10-13-2006.
- 3,296,324. **BIGGINS (BLOCK FORM)**. PARAGON POTATO FARMS, INC., MULTIPLE CLASS, (INT. CLS. 29 AND 31), (U.S. CLS. 1 AND 46). SN 77-026,306. PUB. 7-10-2007. FILED 10-20-2006.
- 3,296,326. **BIGGINS AND DESIGN**. PARAGON POTATO FARMS, INC., MULTIPLE CLASS, (INT. CLS. 29 AND 31), (U.S. CLS. 1 AND 46). SN 77-026,353. PUB. 7-10-2007. FILED 10-20-2006.
- 3,296,345. **POPPASQUASH OYSTERS (BLOCK FORM)**. WINDFALL SHELLFISH, LLC, (U.S. CL. 46). SN 77-029,667. PUB. 7-10-2007. FILED 10-26-2006.
- 3,296,446. **JAMBA (BLOCK FORM)**. JAMBA JUICE COMPANY, (U.S. CL. 46). SN 77-044,812. PUB. 7-10-2007. FILED 11-15-2006.
- 3,296,503. **SACHS (BLOCK FORM)**. E. J. COX COMPANY, INC., (U.S. CL. 46). SN 77-053,148. PUB. 7-10-2007. FILED 11-29-2006.
- 3,296,523. **SOYTATO (BLOCK FORM)**. GENISOY FOOD COMPANY, INC., (U.S. CL. 46). SN 77-054,869. PUB. 7-10-2007. FILED 12-1-2006.
- 3,296,655. **SUBWAY FRESH FIT (BLOCK FORM)**. DOCTOR'S ASSOCAITES INC., MULTIPLE CLASS, (INT. CLS. 29, 31 AND 43), (U.S. CLS. 1, 46, 100 AND 101). SN 77-063,963. PUB. 7-10-2007. FILED 12-14-2006.
- 3,296,722. **RICEOTEIN (BLOCK FORM)**. SINGH, JACK J., (U.S. CL. 46). SN 77-065,675. PUB. 7-10-2007. FILED 12-15-2006.
- 3,296,784. **CARIBBEAN CLASSIC BRAND AND DESIGN**. FIRST WORLD IMPORTS, INC., (U.S. CL. 46). SN 77-078,174. PUB. 7-10-2007. FILED 1-8-2007.
- 3,296,920. **GOLDEN HARBOUR AND DESIGN**. SUSTAINABLE SEAFOODS, LLC, (U.S. CL. 46). SN 77-089,076. PUB. 6-26-2007. FILED 1-23-2007.
- 3,297,247. **MISCELLANEOUS DESIGN**. FLAVOR FULL FOODS INC., (U.S. CL. 46). SN 78-617,243. PUB. 7-10-2007. FILED 4-26-2005.
- 3,297,255. **E4B AND DESIGN**. EASY4BUSY, (U.S. CL. 46). SN 78-632,263. PUB. 7-10-2007. FILED 5-18-2005.
- 3,297,314. **ROBERT AND DESIGN**. ROBERT DAMKJAER A/S, (U.S. CL. 46). SN 78-711,970. PUB. 7-10-2007. FILED 9-13-2005.
- 3,297,321. **CARIBE (BLOCK FORM)**. CARIBE FOODS, INC., (U.S. CL. 46). SN 78-716,626. PUB. 7-10-2007. FILED 9-20-2005.
- 3,297,340. **WOK CREATIONS (BLOCK FORM)**. H J HEINZ COMPANY AUSTRALIA LTD, MULTIPLE CLASS, (INT. CLS. 29 AND 30), (U.S. CL. 46). SN 78-724,899. PUB. 7-10-2007. FILED 10-3-2005.
- 3,297,433. **OLD SMOKEHOUSE (BLOCK FORM)**. HORMEL FOODS, LLC, (U.S. CL. 46). SN 78-796,871. PUB. 7-10-2007. FILED 1-23-2006.
- 3,297,492. **LA BELLA OLIVES AND DESIGN**. SACKMANN, STEVEN, (U.S. CL. 46). SN 78-829,012. PUB. 7-10-2007. FILED 3-3-2006.
- 3,297,497 (*See Class 24 for this trademark*).
- 3,297,565. **EAT SMART (BLOCK FORM)**. APIO, INC., (U.S. CL. 46). SN 78-855,553. PUB. 7-10-2007. FILED 4-6-2006.
- 3,297,579. **DEVANCO FOODS CHICAGO'S FAVORITE AND DESIGN**. BKBG ENTERPRISES, INC., DBA DEVANCO FOODS, (U.S. CL. 46). SN 78-858,473. PUB. 7-10-2007. FILED 4-11-2006.
- 3,297,602. **BLT BURGER (BLOCK FORM)**. BLT MANAGEMENT LLC, MULTIPLE CLASS, (INT. CLS. 29, 30 AND 43), (U.S. CLS. 46, 100 AND 101). SN 78-862,566. PUB. 7-10-2007. FILED 4-17-2006.
- 3,297,650. **ALLEN BROTHERS (BLOCK FORM)**. ALLEN BROTHERS, INC., MULTIPLE CLASS, (INT. CLS. 29 AND 30), (U.S. CL. 46). SN 78-870,325. PUB. 7-10-2007. FILED 4-26-2006.
- 3,297,705. **POWER UP (BLOCK FORM)**. THE DANNON COMPANY, INC., MULTIPLE CLASS, (INT. CLS. 29 AND 32), (U.S. CLS. 45, 46 AND 48). SN 78-879,742. PUB. 7-10-2007. FILED 5-9-2006.
- 3,297,756. **LYNCH BBQ CO. PRIDE OF IOWA AND DESIGN**. LYNCEY BBQ COMPANY, MULTIPLE CLASS, (INT. CLS. 29 AND 30), (U.S. CL. 46). SN 78-887,772. PUB. 7-10-2007. FILED 5-19-2006.
- 3,297,802. **WE TAKE DINNER OFF YOUR MIND AND PUT IT ON YOUR TABLE! (BLOCK FORM)**. TRUE COURSE HOLDINGS, INC., (U.S. CL. 46). SN 78-897,710. PUB. 7-10-2007. FILED 6-1-2006.
- 3,297,813. **1881 AND DESIGN**. SOCIEDAD AGRARIA DE TRANSFORMACION N. 1941 SANTA TERESA, (U.S. CL. 46). SN 78-900,214. PUB. 7-10-2007. FILED 6-5-2006.
- 3,297,852. **ATLANTIC PEARL (BLOCK FORM)**. SEATRADE INTERNATIONAL CO., INC., (U.S. CL. 46). SN 78-904,914. PUB. 7-10-2007. FILED 6-9-2006.
- 3,297,858. **CHATAK (BLOCK FORM)**. ADVANCED FOODS NUTRITION BROKER LLC, MULTIPLE CLASS, (INT. CLS. 29, 30 AND 32), (U.S. CLS. 45, 46 AND 48). SN 78-905,729. PUB. 7-10-2007. FILED 6-12-2006.
- 3,297,865. **YONI TASTES THE WORLD (BLOCK FORM)**. NEPTUNE FOOD PRODUCTS (1990) LTD., MULTIPLE CLASS, (INT. CLS. 29 AND 30), (U.S. CL. 46). SN 78-906,157. PUB. 7-10-2007. FILED 6-12-2006.
- 3,297,903. **ULTRAPURE (BLOCK FORM)**. WORCESTER CREAMERIES CORP., (U.S. CL. 46). SN 78-910,878. PUB. 7-10-2007. FILED 6-19-2006.
- 3,297,909. **GREENBAG (BLOCK FORM)**. ROSANNA AKUTU, MULTIPLE CLASS, (INT. CLS. 29, 30, 32 AND 43), (U.S. CLS. 45, 46, 48, 100 AND 101). SN 78-911,930. PUB. 7-10-2007. FILED 6-20-2006.
- 3,297,942. **V FRESH THE VERY FINEST A.L. VERNA**

- COMPANY, INC. AND DESIGN.** A.L. VERNA COMPANY, INC., (U.S. CL. 46). SN 78-919,549. PUB. 7-10-2007. FILED 6-29-2006.
- 3,297,950. **AMERICA'S AT HOME SNACK SINCE 1914 AND DESIGN.** FRANKLIN CONNECTIONS, L.P., (U.S. CL. 46). SN 78-920,865. PUB. 2-6-2007. FILED 6-30-2006.
- 3,297,958 (*See Class 1 for this trademark*).
- 3,297,993. **JEFF FOXWORTHY (BLOCK FORM).** FOXWORTHY, JEFF, (U.S. CL. 46). SN 78-931,263. PUB. 7-10-2007. FILED 7-17-2006.
- 3,298,016. **IL NUMERATO AND DESIGN.** CARAPPELLI FIRENZE S.P.A., (U.S. CL. 46). SN 78-939,806. PUB. 7-10-2007. FILED 7-28-2006.
- 3,298,095. **MONTGOMERY INN WORLD FAMOUS THE RIBS KING AND DESIGN.** RIBS KING, INC., MULTIPLE CLASS, (INT. CLS. 29, 30, 35 AND 43), (U.S. CLS. 46, 100, 101 AND 102). SN 78-961,813. PUB. 7-10-2007. FILED 8-28-2006.
- 3,298,158. **COFCO AND DESIGN.** CHINA NATIONAL CEREALS, OILS & FOODSTUFFS IMPORT & EXPORT CORPORATION, MULTIPLE CLASS, (INT. CLS. 29, 30, 31, 32, 33 AND 36), (U.S. CLS. 1, 45, 46, 47, 48, 49, 100, 101 AND 102). SN 79-012,732. PUB. 7-10-2007. FILED 1-3-2005.
- 3,298,177. **TRATTORIA ALFREDO (BLOCK FORM).** LIDL STIFTUNG & CO. KG, MULTIPLE CLASS, (INT. CLS. 29 AND 30), (U.S. CL. 46). SN 79-018,642. PUB. 7-10-2007. FILED 11-9-2005.
- 3,298,201. **S SERRANO ESPAÑOL CONSORCIO DEL JAMÓN SERRANO ESPAÑOL AND DESIGN.** CONSORCIO DEL JAMÓN SERRANO ESPAÑOL, MULTIPLE CLASS, (INT. CLS. 29 AND 35), (U.S. CLS. 46, 100, 101 AND 102). SN 79-021,196. PUB. 7-10-2007. FILED 10-20-2005.

CLASS 30—STAPLE FOODS

- 3,296,039. **NOTTOLI (BLOCK FORM).** GEORGE NOTTOLI & SON, INC., MULTIPLE CLASS, (INT. CLS. 30 AND 43), (U.S. CLS. 46, 100 AND 101). SN 76-649,548. PUB. 7-10-2007. FILED 11-1-2005.
- 3,296,124. **COUNTRYSIDE (STYLIZED).** DAWN FOODS, INC., (U.S. CL. 46). SN 76-666,217. PUB. 7-10-2007. FILED 9-18-2006.
- 3,296,126. **COUNTRYSIDE (BLOCK FORM).** DAWN FOODS, INC., (U.S. CL. 46). SN 76-666,304. PUB. 7-10-2007. FILED 9-18-2006.
- 3,296,179. **LONESOME BULL AND DESIGN.** SALINAS, RAYMOND R., (U.S. CL. 46). SN 76-670,922. PUB. 7-10-2007. FILED 12-29-2006.
- 3,296,240. **SALAD ESSENTIALS AND DESIGN.** BARIATRIX NUTRITION INC., (U.S. CL. 46). SN 77-005,211. PUB. 7-10-2007. FILED 9-22-2006.
- 3,296,243 (*See Class 29 for this trademark*).
- 3,296,266. **"AS GOOD AS MOTHERS" FAMOUS SEASONED FLOUR AND DESIGN.** AS GOOD AS MOTHER'S INC., (U.S. CL. 46). SN 77-013,037. PUB. 7-10-2007. FILED 10-3-2006.
- 3,296,267. **MOTHER EARTH COFFEE CO. LLC (BLOCK FORM).** ROXANNE HUTTON, (U.S. CL. 46). SN 77-013,063. PUB. 7-10-2007. FILED 10-3-2006.
- 3,296,297 (*See Class 29 for this trademark*).
- 3,296,386. **CHOCOLATE CHIPPITY (BLOCK FORM).** THE PILLSBURY COMPANY, (U.S. CL. 46). SN 77-035,448. PUB. 7-10-2007. FILED 11-2-2006.
- 3,296,395. **TIMESSQCOFFEE AND DESIGN.** MCCracken, ROGER L., (U.S. CL. 46). SN 77-037,303. PUB. 7-10-2007. FILED 11-6-2006.
- 3,296,419. **GREEN FROG ROASTING CO. (BLOCK FORM).** GREEN FROG MARKET BERNARD, LLC, (U.S. CL. 46). SN 77-041,293. PUB. 7-10-2007. FILED 11-10-2006.
- 3,296,445. **LANIE LOU'S (BLOCK FORM).** LANIE LOU'S BROWNIES, LLC, (U.S. CL. 46). SN 77-044,765. PUB. 7-10-2007. FILED 11-15-2006.
- 3,296,454. **RUGEE (BLOCK FORM).** SAMANTHA B., INC., (U.S. CL. 46). SN 77-045,710. PUB. 7-10-2007. FILED 11-16-2006.
- 3,296,481. **TAMBELLINI (BLOCK FORM).** ICE LAND CORPORATION, (U.S. CL. 46). SN 77-049,866. PUB. 7-10-2007. FILED 11-22-2006.
- 3,296,492. **CODA COFFEE COMPANY (BLOCK FORM).** CODA COFFEE COMPANY, (U.S. CL. 46). SN 77-051,467. PUB. 7-10-2007. FILED 11-27-2006.
- 3,296,529. **53X11 COFFEE RIDE READY. AND DESIGN.** 53X11 COFFEE, LLC, (U.S. CL. 46). SN 77-055,698. PUB. 6-26-2007. FILED 12-1-2006.
- 3,296,555. **CILANTRO AND DESIGN.** CILANTRO TRADING INTERNATIONAL, LTD., (U.S. CL. 46). SN 77-058,480. PUB. 7-10-2007. FILED 12-6-2006.
- 3,296,590. **HABBY FLAKES AND DESIGN.** ROCKOW, BRUCE C., (U.S. CL. 46). SN 77-061,124. PUB. 7-10-2007. FILED 12-11-2006.
- 3,296,598. **BLACKBERRY MOON (BLOCK FORM).** ISI BRANDS, INC., (U.S. CL. 46). SN 77-061,392. PUB. 7-10-2007. FILED 12-11-2006.
- 3,296,658. **NOS NOT ORDINARY SAUCE (BLOCK FORM).** DANNY CASH UNLIMITED, LLC, (U.S. CL. 46). SN 77-064,002. PUB. 7-10-2007. FILED 12-14-2006.
- 3,296,738. **D'GARI AND DESIGN.** PRODUCTOS ALIMENTICIOS Y DIETETICOS, RELAMPAGO, S.A. DE C.V., (U.S. CL. 46). SN 77-068,520. PUB. 6-19-2007. FILED 12-20-2006.
- 3,296,748. **STAM (BLOCK FORM).** CHOCOLATERIE STAM USA, INC., (U.S. CL. 46). SN 77-071,606. PUB. 7-10-2007. FILED 12-27-2006.
- 3,296,852 (*See Class 16 for this trademark*).
- 3,296,880. **CANDY TOWN USA (BLOCK FORM).** CANDY TOWN USA, INC., MULTIPLE CLASS, (INT. CLS. 30 AND 35), (U.S. CLS. 46, 100, 101 AND 102). SN 77-087,302. PUB. 7-10-2007. FILED 1-20-2007.
- 3,296,881. **CANDY TOWN USA AND DESIGN.** CANDY TOWN USA, INC., MULTIPLE CLASS, (INT. CLS. 30 AND 35), (U.S. CLS. 46, 100, 101 AND 102). SN 77-087,314. PUB. 7-10-2007. FILED 1-20-2007.
- 3,296,885. **SUCKLEBUSTERS - TEXAS STYLE SAUCES & SEASONINGS (BLOCK FORM).** ARNOLD, DANNY H., (U.S. CL. 46). SN 77-087,451. PUB. 7-10-2007. FILED 1-21-2007.
- 3,297,065 (*See Class 11 for this trademark*).
- 3,297,118. **READI-BAKE BENEFIT AND DESIGN.** J&J SNACK FOODS CORP., (U.S. CL. 46). SN 77-110,630. PUB. 7-10-2007. FILED 2-19-2007.
- 3,297,132. **CRUNCH-A-TIZE ME CAP'N (BLOCK FORM).** THE QUAKER OATS COMPANY, (U.S. CL. 46). SN 77-117,996. PUB. 7-10-2007. FILED 2-28-2007.
- 3,297,139. **SIEBEL INSTITUTE OF TECHNOLOGY (BLOCK FORM).** THE SIEBEL INSTITUTE OF TECHNOLOGY, INC., (U.S. CL. 46). SN 77-120,823. PUB. 7-10-2007. FILED 3-2-2007.
- 3,297,164. **NOURISH ALL AREAS OF YOUR LIFE (BLOCK FORM).** SUPER BAKERY, INCORPORATED, (U.S. CL. 46). SN 77-141,207. PUB. 7-10-2007. FILED 3-27-2007.
- 3,297,240. **HELEN'S (BLOCK FORM).** WASSERMAN, HELEN, (U.S. CL. 46). SN 78-606,835. PUB. 7-10-2007. FILED 4-12-2005.
- 3,297,279. **HAUS SCHOKOLADE (BLOCK FORM).** SCHOKINAG CHOCOLATE NORTH AMERICA, INC., (U.S. CL. 46). SN 78-684,996. PUB. 7-10-2007. FILED 8-3-2005.
- 3,297,284. **CREMETORTES (BLOCK FORM).** WELLS' DAIRY, INC., (U.S. CL. 46). SN 78-695,439. PUB. 7-10-2007. FILED 8-18-2005.
- 3,297,292. **ROADS (BLOCK FORM).** AUGUST STORCK KG, (U.S. CL. 46). SN 78-702,606. PUB. 7-10-2007. FILED 8-29-2005.
- 3,297,338. **UVAFERM 43 (BLOCK FORM).** DANSTAR FERMENT AG, (U.S. CL. 46). SN 78-724,252. PUB. 7-10-2007. FILED 9-30-2005.
- 3,297,339. **NANCI'S FABULOUS FROZEN TREATS AND DESIGN.** WUDEL INC., (U.S. CL. 46). SN 78-724,428. PUB. 6-5-2007. FILED 9-30-2005.
- 3,297,340 (*See Class 29 for this trademark*).
- 3,297,345 (*See Class 3 for this trademark*).
- 3,297,362. **NATURE'S MIGHTY BITES AND DESIGN.** KIDS NEED US NOW, LLC, (U.S. CL. 46). SN 78-753,922. PUB. 7-10-2007. FILED 11-15-2005.
- 3,297,380. **AROMATICA ORGANICS AND DESIGN.** AROMATICA, INC., (U.S. CL. 46). SN 78-766,006. PUB. 7-10-2007.

- FILED 12-2-2005.
- 3,297,435. **FUD HORNO DE PIEDRA (BLOCK FORM)**, SIGMA ALIMENTOS, S.A. DE C.V., (U.S. CL. 46). SN 78-798,383. PUB. 7-10-2007. FILED 1-24-2006.
- 3,297,461. **COOKIE DOUGH BITES (BLOCK FORM)**, TASTE OF NATURE, INC., (U.S. CL. 46). SN 78-811,975. PUB. 7-10-2007. FILED 2-10-2006.
- 3,297,471. **INDY (BLOCK FORM)**, PRODUCTOS INDY SA DE CV, (U.S. CL. 46). SN 78-816,594. PUB. 7-10-2007. FILED 2-16-2006.
- 3,297,497 (*See Class 24 for this trademark*).
- 3,297,510. **PORTINI'S (BLOCK FORM)**, PORTINI'S INC., (U.S. CL. 46). SN 78-835,835. PUB. 7-10-2007. FILED 3-13-2006.
- 3,297,528. **PENDLETON (BLOCK FORM)**, PENDLETON WOOLEN MILLS, INC., (U.S. CL. 46). SN 78-842,174. PUB. 7-10-2007. FILED 3-21-2006.
- 3,297,602 (*See Class 29 for this trademark*).
- 3,297,650 (*See Class 29 for this trademark*).
- 3,297,662. **DIRTY RIBS (BLOCK FORM)**, DIRTY RIBS, LLC, (U.S. CL. 46). SN 78-872,085. PUB. 7-10-2007. FILED 4-28-2006.
- 3,297,680. **SANTA BARBARA SPICE COMPANY NESW AND DESIGN**, FULLER, JANE E. DBA SANTA BARBARA SPICE COMPANY, (U.S. CL. 46). SN 78-874,936. PUB. 7-10-2007. FILED 5-2-2006.
- 3,297,736. **CRISPA (BLOCK FORM)**, INTERNATIONAL GOLDEN FOODS, INC., (U.S. CL. 46). SN 78-885,542. PUB. 7-10-2007. FILED 5-17-2006.
- 3,297,756 (*See Class 29 for this trademark*).
- 3,297,858 (*See Class 29 for this trademark*).
- 3,297,865 (*See Class 29 for this trademark*).
- 3,297,892. **C AND DESIGN**, CHRISSEY'S SWEET TREATS CO., (U.S. CL. 46). SN 78-908,752. PUB. 7-10-2007. FILED 6-15-2006.
- 3,297,909 (*See Class 29 for this trademark*).
- 3,298,038. **FREY AND DESIGN**, FEDERATION OF MIGROS COOPERATIVES, (U.S. CL. 46). SN 78-947,715. PUB. 7-10-2007. FILED 8-8-2006.
- 3,298,048. **MISCELLANEOUS DESIGN**, AMERICAN FLAT-BREAD HOLDING COMPANY, (U.S. CL. 46). SN 78-950,388. PUB. 7-10-2007. FILED 8-11-2006.
- 3,298,057. **PRISCILA DO CERRADO COFFEE (BLOCK FORM)**, BLASER & WOLTERS SPECIALTY COFFEE TRADING CO., (U.S. CL. 46). SN 78-952,079. PUB. 7-10-2007. FILED 8-15-2006.
- 3,298,058. **AMISH COUNTRY POPCORN AND DESIGN**, BRIAN LEHMAN, (U.S. CL. 46). SN 78-952,368. PUB. 7-10-2007. FILED 8-15-2006.
- 3,298,066. **SUPER WHOLESOME (BLOCK FORM)**, RICHMOND BAKING CO., (U.S. CL. 46). SN 78-952,820. PUB. 7-10-2007. FILED 8-15-2006.
- 3,298,095 (*See Class 29 for this trademark*).
- 3,298,119. **HOLEY DONUTS! (BLOCK FORM)**, HOLEY DONUTS HOLDING CORP., (U.S. CL. 46). SN 78-965,877. PUB. 7-10-2007. FILED 9-1-2006.
- 3,298,132. **STANTON'S OWN (BLOCK FORM)**, HEPLER'S TOWN & COUNTRY ENTERPRISES, INC., DBA STANTON MILLING COMPANY, (U.S. CL. 46). SN 78-970,306. PUB. 7-10-2007. FILED 9-8-2006.
- 3,298,135. **TUGUSTO CHEF (BLOCK FORM)**, TUGUSTO FOODS, INC., (U.S. CL. 46). SN 78-971,338. PUB. 7-10-2007. FILED 9-11-2006.
- 3,298,158 (*See Class 29 for this trademark*).
- 3,298,174 (*See Class 5 for this trademark*).
- 3,298,177 (*See Class 29 for this trademark*).
- 3,298,271. **CONDECO (BLOCK FORM)**, EVA OLSSON, MULTIPLE CLASS, (INT. CLS. 30, 32 AND 43), (U.S. CLS. 45, 46, 48, 100 AND 101). SN 79-026,474. PUB. 7-10-2007. FILED 6-13-2006.
- 3,298,274. **LE 5 STAGIONI AND DESIGN**, AGUGIARO & FIGNA MOLINI S.P.A., (U.S. CL. 46). SN 79-026,790. PUB. 7-10-2007. FILED 3-7-2006.
- 3,298,300 (*See Class 5 for this trademark*).

CLASS 31—NATURAL AGRICULTURAL PRODUCTS

- 3,296,106. **AMAZING CAT LITTER (BLOCK FORM)**, CHOO CHOO IMPORTS, LLC, (U.S. CLS. 1 AND 46). SN 76-664,012. PUB. 7-10-2007. FILED 8-2-2006.
- 3,296,110. **NEW HARVEST ORGANICS (BLOCK FORM)**, NEW HARVEST ORGANICS, LLC, (U.S. CLS. 1 AND 46). SN 76-664,698. PUB. 7-10-2007. FILED 8-17-2006.
- 3,296,147. **TRAIN-ME! TRAINING REWARD (BLOCK FORM)**, CARDINAL LABORATORIES, INC., (U.S. CLS. 1 AND 46). SN 76-668,555. PUB. 7-10-2007. FILED 11-6-2006.
- 3,296,201. **THE RIGHT CHOICE (BLOCK FORM)**, NATURIFE FARMS, LLC, (U.S. CLS. 1 AND 46). SN 76-671,875. PUB. 7-10-2007. FILED 1-26-2007.
- 3,296,324 (*See Class 29 for this trademark*).
- 3,296,326 (*See Class 29 for this trademark*).
- 3,296,343. **HUTCHBUSTER (BLOCK FORM)**, AG PARTNERS COOP, (U.S. CLS. 1 AND 46). SN 77-028,871. PUB. 7-10-2007. FILED 10-25-2006.
- 3,296,382. **WAGGIN TRAIN BRAND JERKY LINKS (BLOCK FORM)**, ALAN LEE DISTRIBUTORS, (U.S. CLS. 1 AND 46). SN 77-034,631. PUB. 7-10-2007. FILED 11-1-2006.
- 3,296,383. **WAGGIN' TRAIN BRAND JERKY STICKS (BLOCK FORM)**, ALAN LEE DISTRIBUTORS, INC., (U.S. CLS. 1 AND 46). SN 77-034,656. PUB. 7-10-2007. FILED 11-1-2006.
- 3,296,588. **TICKLEME PLANT (BLOCK FORM)**, CHIPKIN, LAWRENCE I, (U.S. CLS. 1 AND 46). SN 77-061,089. PUB. 7-10-2007. FILED 12-11-2006.
- 3,296,655 (*See Class 29 for this trademark*).
- 3,296,671. **TOMAHAWK (BLOCK FORM)**, YAKIMA CHIEF RANCHES, L.L.C., (U.S. CLS. 1 AND 46). SN 77-064,312. PUB. 7-10-2007. FILED 12-14-2006.
- 3,296,732. **BALLANTINE AND DESIGN**, BALLANTINE PRODUCE CO., INC., (U.S. CLS. 1 AND 46). SN 77-067,424. PUB. 7-10-2007. FILED 12-19-2006.
- 3,297,142. **TRACK-PRO (STYLIZED)**, GOOD PET PRODUCTS, LTD., (U.S. CLS. 1 AND 46). SN 77-123,753. PUB. 7-10-2007. FILED 3-6-2007.
- 3,297,186 (*See Class 16 for this trademark*).
- 3,297,238 (*See Class 1 for this trademark*).
- 3,297,405 (*See Class 3 for this trademark*).
- 3,297,422. **MILLS BROS. (BLOCK FORM)**, MILLS BROS. INTERNATIONAL, INC., (U.S. CLS. 1 AND 46). SN 78-792,536. PUB. 7-10-2007. FILED 1-16-2006.
- 3,297,490. **MISCELLANEOUS DESIGN**, THE LITTLE POTATO COMPANY LTD, (U.S. CLS. 1 AND 46). SN 78-826,431. PUB. 7-10-2007. FILED 3-1-2006.
- 3,297,538. **OPAL (BLOCK FORM)**, SCHNEIDER BILL, MULTIPLE CLASS, (INT. CLS. 31 AND 44), (U.S. CLS. 1, 46, 100 AND 101). SN 78-846,591. PUB. 7-10-2007. FILED 3-27-2006.
- 3,297,781. **O2 LIMITED (BLOCK FORM)**, TEXAS FARM PRODUCTS HOLDING COMPANY, (U.S. CLS. 1 AND 46). SN 78-892,638. PUB. 7-10-2007. FILED 5-25-2006.
- 3,297,803. **FRESCO AND DESIGN**, AJ TRUCCO, INC., (U.S. CLS. 1 AND 46). SN 78-897,713. PUB. 7-10-2007. FILED 6-1-2006.
- 3,297,877. **FRUITALY (BLOCK FORM)**, COMPAGNIA ITALIANA DELLA FRUTTA S.P.A., (U.S. CLS. 1 AND 46). SN 78-907,274. PUB. 7-10-2007. FILED 6-13-2006.
- 3,298,126. **EL DULCE (BLOCK FORM)**, NPK PLUS, INC., (U.S. CLS. 1 AND 46). SN 78-969,049. PUB. 7-10-2007. FILED 9-7-2006.
- 3,298,158 (*See Class 29 for this trademark*).
- 3,298,174 (*See Class 5 for this trademark*).
- 3,298,252. **ROSALINA (BLOCK FORM)**, KNAAP LICENTIES BV, (U.S. CLS. 1 AND 46). SN 79-025,504. PUB. 7-10-2007. FILED 6-2-2006.
- 3,298,307 (*See Class 5 for this trademark*).
- 3,298,323 (*See Class 5 for this trademark*).

CLASS 32—LIGHT BEVERAGES

- 3,296,001. **POLAR BEAR NATURAL SPRING WATER SODIUM-FREE NON-CARBONATED AND DESIGN**, POLAR BEAR WATER COMPANY, (U.S. CLS. 45, 46 AND 48). SN

76-622,537. PUB. 7-10-2007. FILED 11-30-2004.
 3,296,009. **IRON ENERGY AND DESIGN. IRON HORSE BEVERAGES, INC.** (U.S. CLS. 45, 46 AND 48). SN 76-636,313. PUB. 7-10-2007. FILED 4-18-2005.
 3,296,020. **BALANCE (BLOCK FORM). HARRISON BURNET PTY LTD.,** (U.S. CLS. 45, 46 AND 48). SN 76-645,195. PUB. 7-10-2007. FILED 8-18-2005.
 3,296,061. **KINDER (BLOCK FORM). FERRERO S.P.A.,** (U.S. CLS. 45, 46 AND 48). SN 76-658,345. PUB. 7-10-2007. FILED 4-12-2006.
 3,296,074 (*See Class 14 for this trademark*).
 3,296,375 (*See Class 21 for this trademark*).
 3,296,944. **INTA JUICE (BLOCK FORM). INTA JUICE ENTERPRISES, INC.,** MULTIPLE CLASS, (INT. CLS. 32, 35 AND 43), (U.S. CLS. 45, 46, 48, 100, 101 AND 102). SN 77-090,468. PUB. 7-10-2007. FILED 1-24-2007.
 3,297,189. **COORS EDGE (BLOCK FORM). COORS GLOBAL PROPERTIES, INC.,** (U.S. CLS. 45, 46 AND 48). SN 78-430,273. PUB. 7-10-2007. FILED 6-4-2004.
 3,297,263. **EX DRINKS AND DESIGN. GOSLING, ALISTAIR M./AL,** (U.S. CLS. 45, 46 AND 48). SN 78-642,886. PUB. 7-10-2007. FILED 6-3-2005.
 3,297,345 (*See Class 3 for this trademark*).
 3,297,549. **KAJA FRUIT INFUSIONS AND DESIGN. KAJA, INC.,** (U.S. CLS. 45, 46 AND 48). SN 78-851,108. PUB. 7-10-2007. FILED 3-31-2006.
 3,297,551. **FUEGO ENERGY DRINK (BLOCK FORM). MILARDO, GIANLUCA, A.** (U.S. CLS. 45, 46 AND 48). SN 78-852,093. PUB. 7-10-2007. FILED 4-2-2006.
 3,297,653. **LIPOCAROTENES (BLOCK FORM). NSE PRODUCTS, INC.,** (U.S. CLS. 45, 46 AND 48). SN 78-871,152. PUB. 7-10-2007. FILED 4-27-2006.
 3,297,705 (*See Class 29 for this trademark*).
 3,297,717. **IST AND ONLY WATER DEDICATED TO ELIMINATING OBESITY IN AMERICA (BLOCK FORM). LOCKE-ADDISON, P. S., AND LOCKE, WILLIAM R., JR.** (U.S. CLS. 45, 46 AND 48). SN 78-882,898. PUB. 7-10-2007. FILED 5-12-2006.
 3,297,745. **UNITED DISTRIBUTORS INC. WATER. PURE AND SIMPLE. AND DESIGN. UNITED DISTRIBUTORS, INC.,** (U.S. CLS. 45, 46 AND 48). SN 78-886,507. PUB. 4-3-2007. FILED 5-18-2006.
 3,297,789. **CHICANITAS (BLOCK FORM). SALSAS CASTILLO S.A. DE C.V.,** (U.S. CLS. 45, 46 AND 48). SN 78-894,799. PUB. 7-10-2007. FILED 5-27-2006.
 3,297,807. **SHAKE-A-SODA (BLOCK FORM). CHEEBURGER CHEEBURGER RESTAURANTS, INC.,** (U.S. CLS. 45, 46 AND 48). SN 78-898,752. PUB. 7-10-2007. FILED 6-2-2006.
 3,297,858 (*See Class 29 for this trademark*).
 3,297,909 (*See Class 29 for this trademark*).
 3,298,158 (*See Class 29 for this trademark*).
 3,298,196. **ERDINGER HEFE-WEIZEN DARK AND DESIGN. ERDINGER WEIBBRÄU FRANZ BROMBACH, MULTIPLE CLASS, (INT. CLS. 32, 33 AND 43),** (U.S. CLS. 45, 46, 47, 48, 49, 100 AND 101). SN 79-020,607. PUB. 7-10-2007. FILED 11-21-2005.
 3,298,197. **GEBREU DEM BAYERISCHEN REINHEITSGEBOT VON 1516 AUS BAYERN ERDINGER WEISSBRAU ERDINGER HEFE-WEIZEN NON ALCOHOLIC CONTAINS LESS THAN 0.5% ALCOHOL BY VOLUME PRODUCT OF GERMANY MALT BEVERAGE NET CONTENTS 1 PINT 9 FL.OZ. AND DESIGN. ERDINGER WEIBBRÄU FRANZ BROMBACH, MULTIPLE CLASS, (INT. CLS. 32, 33 AND 43),** (U.S. CLS. 45, 46, 47, 48, 49, 100 AND 101). SN 79-020,609. PUB. 7-10-2007. FILED 11-21-2005.
 3,298,214 (*See Class 3 for this trademark*).
 3,298,237. **LEJAY (BLOCK FORM). LEJAY LAGOUTE, MULTIPLE CLASS, (INT. CLS. 32 AND 33),** (U.S. CLS. 45, 46, 47, 48 AND 49). SN 79-024,667. PUB. 7-10-2007. FILED 4-27-2006.
 3,298,271 (*See Class 30 for this trademark*).
 3,298,289. **GRAPETISER 100% PURE PLEASURE AND DESIGN. SABMILLER INTERNATIONAL B.V.,** (U.S. CLS. 45, 46 AND 48). SN 79-027,414. PUB. 7-10-2007. FILED 7-20-2006.
 3,298,290. **PEARTISER (BLOCK FORM). SABMILLER INTERNATIONAL B.V.,** (U.S. CLS. 45, 46 AND 48). SN 79-027,415. PUB. 7-10-2007. FILED 7-20-2006.
 3,298,296. **APPLETISER 100% PURE PLEASURE AND DESIGN. SABMILLER INTERNATIONAL B.V.,** (U.S. CLS. 45,

46 AND 48). SN 79-027,613. PUB. 7-10-2007. FILED 7-20-2006.
 3,298,336 (*See Class 21 for this trademark*).

CLASS 33—WINES AND SPIRITS

3,296,011 (*See Class 21 for this trademark*).
 3,296,068. **TARTAN ROYAL (STYLIZED). SAFEWAY INC.,** (U.S. CLS. 47 AND 49). SN 76-659,107. PUB. 7-10-2007. FILED 4-26-2006.
 3,296,137. **TARTAN ROYAL (BLOCK FORM). SAFEWAY INC.,** (U.S. CLS. 47 AND 49). SN 76-667,348. PUB. 7-10-2007. FILED 10-12-2006.
 3,296,351. **DON FELIX (BLOCK FORM). DESTILADORA DE LOS ALTOS S.A. DE C.V.,** (U.S. CLS. 47 AND 49). SN 77-030,982. PUB. 7-10-2007. FILED 10-27-2006.
 3,296,487. **MOST WANTED (BLOCK FORM). HIGH PLAINS INC.,** (U.S. CLS. 47 AND 49). SN 77-050,748. PUB. 7-10-2007. FILED 11-26-2006.
 3,296,518. **HACIENDA ESTIPAC (BLOCK FORM). DESTILADORA HACIENDA SANTA MARIA, S.A. DE C.V.,** (U.S. CLS. 47 AND 49). SN 77-054,586. PUB. 7-10-2007. FILED 11-30-2006.
 3,296,603. **ANGELS TEARS (BLOCK FORM). GRANDE PROVENCE PROPERTIES (PTY) LIMITED,** (U.S. CLS. 47 AND 49). SN 77-061,620. PUB. 7-10-2007. FILED 12-11-2006.
 3,296,631. **COLOMA (BLOCK FORM). SOCIEDAD EXPORTADORA FINANCIERA VENEZOLANA (SOEXVE),** (U.S. CLS. 47 AND 49). SN 77-063,086. PUB. 7-10-2007. FILED 12-13-2006.
 3,296,723. **POTTER'S (BLOCK FORM). FRANK LIN DISTILLERS PRODUCTS, LTD.,** (U.S. CLS. 47 AND 49). SN 77-065,680. PUB. 7-10-2007. FILED 12-15-2006.
 3,297,007. **PALOCITRO (BLOCK FORM). STONE VILLA WINE CELLARS, INC.,** (U.S. CLS. 47 AND 49). SN 77-092,047. PUB. 7-10-2007. FILED 1-26-2007.
 3,297,033. **RUSKOVA (BLOCK FORM). ANSON IMPORTS, LTD. CO.,** (U.S. CLS. 47 AND 49). SN 77-092,762. PUB. 7-10-2007. FILED 1-26-2007.
 3,297,091. **GENTLEMAN JACK AND DESIGN. JACK DANIEL'S PROPERTIES, INC.,** (U.S. CLS. 47 AND 49). SN 77-103,133. PUB. 7-10-2007. FILED 2-8-2007.
 3,297,092. **GENTLEMAN JACK RARE TENNESSEE WHISKEY AND DESIGN. JACK DANIEL'S PROPERTIES, INC.,** (U.S. CLS. 47 AND 49). SN 77-103,157. PUB. 7-10-2007. FILED 2-8-2007.
 3,297,171. **CHRISTMAS ROSE (BLOCK FORM). STONE VILLA WINE CELLARS, INC.,** (U.S. CLS. 47 AND 49). SN 77-152,512. PUB. 7-10-2007. FILED 4-10-2007.
 3,297,179. **MISCELLANEOUS DESIGN. GRÄFLICH VON HARDENBERG'SCHE KORNBRENNEREI GMBH & CO. KG,** (U.S. CLS. 47 AND 49). SN 78-273,938. PUB. 4-3-2007. FILED 7-14-2003.
 3,297,191. **KRAKUS EXCLUSIVE AND DESIGN. KOMPANIA SPIRYTUSOWA "WRATISLAVIA" POLMOS WROCLAW SPOLKA AKCYJNA,** (U.S. CLS. 47 AND 49). SN 78-433,210. PUB. 7-10-2007. FILED 6-10-2004.
 3,297,227. **WATERFORD VINEYARDS (BLOCK FORM). WATERFORD VINEYARDS, LLC,** (U.S. CLS. 47 AND 49). SN 78-580,107. PUB. 7-25-2006. FILED 3-4-2005.
 3,297,322. **SECRET CLONE (BLOCK FORM). COSENTINO SIGNATURE WINERIES,** (U.S. CLS. 47 AND 49). SN 78-716,826. PUB. 7-10-2007. FILED 9-20-2005.
 3,297,593. **CHERRYHOG (BLOCK FORM). GRÄFLICH VON HARDENBERG'SCHE KORNBRENNEREI GMBH & CO. KG,** (U.S. CLS. 47 AND 49). SN 78-861,836. PUB. 7-10-2007. FILED 4-14-2006.
 3,297,808. **RAKA AND DESIGN. PIETER GERHARDUS VERSTER DREYER,** (U.S. CLS. 47 AND 49). SN 78-898,768. PUB. 7-10-2007. FILED 6-2-2006.
 3,297,840. **BRANDOLINI (BLOCK FORM). BRANDINO BRANDOLINI D'ADDA,** (U.S. CLS. 47 AND 49). SN 78-903,074. PUB. 7-10-2007. FILED 6-7-2006.
 3,297,849 (*See Class 9 for this trademark*).
 3,297,850 (*See Class 9 for this trademark*).
 3,297,959. **THE HEREDAD COLLECTION AND DESIGN. SEGURA VIUDAS, S.A.,** MULTIPLE CLASS, (INT. CLS.

- 33 AND 35), (U.S. CLS. 47, 49, 100, 101 AND 102). SN 78-923,416. PUB. 7-10-2007. FILED 7-6-2006.
- 3,297,982. **MISCELLANEOUS DESIGN**. VIGNERONS CATALANS EN ROUSSILLON, (U.S. CLS. 47 AND 49). SN 78-929,203. PUB. 7-10-2007. FILED 7-13-2006.
- 3,298,109. **HUI AND DESIGN**. CHUNGBUKSOJU CO., LTD., (U.S. CLS. 47 AND 49). SN 78-963,763. PUB. 7-10-2007. FILED 8-30-2006.
- 3,298,118. **EL MAYOR (STYLIZED)**. LUXCO, INC., (U.S. CLS. 47 AND 49). SN 78-965,262. PUB. 7-10-2007. FILED 8-31-2006.
- 3,298,141. **IBIS AND DESIGN**. LARSEN - LE COGNAC DES VIKINGS S.A., (U.S. CLS. 47 AND 49). SN 78-973,492. PUB. 7-10-2007. FILED 9-13-2006.
- 3,298,158 (*See Class 29 for this trademark*).
- 3,298,196 (*See Class 32 for this trademark*).
- 3,298,197 (*See Class 32 for this trademark*).
- 3,298,237 (*See Class 32 for this trademark*).
- 3,298,261. **REDARK AND DESIGN**. PHILIP HARMANDJIEV, (U.S. CLS. 47 AND 49). SN 79-026,002. PUB. 7-10-2007. FILED 5-19-2006.
- 3,298,301. **GOLD CASTELLBLANCH (BLOCK FORM)**. CASTELLBLANCH, S.A., (U.S. CLS. 47 AND 49). SN 79-027,670. PUB. 7-10-2007. FILED 6-12-2006.
- 3,298,304. **DBZX AND DESIGN**. MATRIX, (U.S. CLS. 47 AND 49). SN 79-027,770. PUB. 7-10-2007. FILED 7-28-2006.
- 3,298,328. **CHATEAU DE COGNAC (STYLIZED)**. CHATEAU DE COGNAC S.A.; SOCIÉTÉ ANONYME, (U.S. CLS. 47 AND 49). SN 79-029,166. PUB. 7-10-2007. FILED 8-16-2006.
- 3,298,376. **MARQUÉS DE REQUENA AND DESIGN**. TORRE ORIA, S.L., (U.S. CLS. 47 AND 49). SN 79-032,629. PUB. 7-10-2007. FILED 5-12-2006.
- 3,298,377. **FRANZ REH (BLOCK FORM)**. REH KENDERMANN GMBH WEINKELLEREI, (U.S. CLS. 47 AND 49). SN 79-032,650. PUB. 7-10-2007. FILED 11-22-2006.

CLASS 34—SMOKERS' ARTICLES

- 3,297,987. **DON CARLOS EDICION DE ANIVERSARIO (BLOCK FORM)**. FUENTE MARKETING LTD., (U.S. CLS. 2, 8, 9 AND 17). SN 78-930,638. PUB. 7-10-2007. FILED 7-17-2006.
- 3,298,340. **L&B LAMBERT & BUTLER AND DESIGN**. IMPERIAL TOBACCO LIMITED, (U.S. CLS. 2, 8, 9 AND 17). SN 79-029,698. PUB. 7-10-2007. FILED 9-25-2006.

SERVICE MARKS

CLASS 35—ADVERTISING AND BUSINESS

- 3,295,970. **SEAL-IT AND DESIGN**. SEAL-IT, INC., (U.S. CLS. 100, 101 AND 102). SN 76-205,408. PUB. 7-10-2007. FILED 2-5-2001.
- 3,295,974. **BENCHMARK MEDICAL, INC.**. BENCHMARK MEDICAL, INC., MULTIPLE CLASS, (INT. CLS. 35 AND 44), (U.S. CLS. 100, 101 AND 102). SN 76-435,530. PUB. 10-21-2003. FILED 7-25-2002.
- 3,295,975 (*See Class 9 for this trademark*).
- 3,295,984. **OUTERBANKSOUTFITTERS.COM AND DESIGN**. RITZ CAMERA CENTERS, INC., (U.S. CLS. 100, 101 AND 102). SN 76-578,953. PUB. 7-10-2007. FILED 3-3-2004.
- 3,295,987 (*See Class 14 for this trademark*).
- 3,295,990. **HALDEX (BLOCK FORM)**. HALDEX AB, (U.S. CLS. 100, 101 AND 102). SN 76-598,252. PUB. 7-10-2007. FILED 6-21-2004.
- 3,296,004. **GUARANTEED PRE-PLAYED AND DESIGN**. MOVIE GALLERY US, LLC, (U.S. CLS. 100, 101 AND 102). SN 76-626,166. PUB. 7-10-2007. FILED 12-28-2004.
- 3,296,019. **YOUNG AUDIENCES ARTS CARD (BLOCK FORM)**. YOUNG AUDIENCES, INC., (U.S. CLS. 100, 101 AND 102). SN 76-644,553. PUB. 7-10-2007. FILED 8-8-2005.
- 3,296,024. **ADORAMA (BLOCK FORM)**. ADORAMA, INC., MULTIPLE CLASS, (INT. CLS. 35 AND 40), (U.S. CLS. 100, 101, 102, 103 AND 106). SN 76-645,877. PUB. 7-10-2007. FILED 8-30-2005.
- 3,296,030. **SENECA ALLEGANY CASINO AND DESIGN**. SENECA GAMING CORPORATION, MULTIPLE CLASS, (INT. CLS. 35, 41 AND 43), (U.S. CLS. 100, 101, 102 AND 107). SN 76-647,520. PUB. 7-10-2007. FILED 9-26-2005.
- 3,296,031. **JOHN 17:23 FELLOWSHIP (BLOCK FORM)**. BARNABAS MINISTRIES, INC., (U.S. CLS. 100, 101 AND 102). SN 76-647,538. PUB. 7-10-2007. FILED 9-27-2005.
- 3,296,037. **MISCELLANEOUS DESIGN**. PORTUGUESE WATER DOG CLUB OF AMERICA, INC., MULTIPLE CLASS, (INT. CLS. 35 AND 44), (U.S. CLS. 100, 101 AND 102). SN 76-648,831. PUB. 7-10-2007. FILED 10-19-2005.
- 3,296,041. **DSI (BLOCK FORM)**. DAVID SALES, INC., (U.S. CLS. 100, 101 AND 102). SN 76-649,788. PUB. 7-10-2007. FILED 11-4-2005.
- 3,296,045 (*See Class 19 for this trademark*).
- 3,296,047. **THE EXCHANGE (BLOCK FORM)**. J.S. MUSIC CORPORATION, (U.S. CLS. 100, 101 AND 102). SN 76-652,763. PUB. 7-10-2007. FILED 12-27-2005.
- 3,296,053. **CPG AND DESIGN**. CONTINENTAL PROMOTION GROUP, INC., (U.S. CLS. 100, 101 AND 102). SN 76-656,545. PUB. 7-10-2007. FILED 3-7-2006.
- 3,296,055. **BROKERBIN.COM THE B2B HARDWARE EXCHANGE AND DESIGN**. BROKER EXCHANGE NETWORK, LLC, (U.S. CLS. 100, 101 AND 102). SN 76-657,135. PUB. 7-10-2007. FILED 3-23-2006.
- 3,296,073. **NORTH AMERICA'S LEADING TRUCK PARTS NETWORK (BLOCK FORM)**. VIPAR HEAVY DUTY, INC., (U.S. CLS. 100, 101 AND 102). SN 76-660,160. PUB. 7-10-2007. FILED 5-17-2006.
- 3,296,074 (*See Class 14 for this trademark*).
- 3,296,080. **LUCIDA STAFFING GROUP (BLOCK FORM)**. LUCIDA STAFFING GROUP LLC, (U.S. CLS. 100, 101 AND 102). SN 76-661,037. PUB. 7-10-2007. FILED 6-5-2006.
- 3,296,085. **RESHIP (BLOCK FORM)**. MANNA FREIGHT SYSTEMS, INC., (U.S. CLS. 100, 101 AND 102). SN 76-661,730. PUB. 7-10-2007. FILED 6-16-2006.
- 3,296,086. **WJ BOOKSTORE AND DESIGN**. T. W. WANG, INC., (U.S. CLS. 100, 101 AND 102). SN 76-661,778. PUB. 7-10-2007. FILED 6-19-2006.
- 3,296,096. **FULL SPECTRUM REWARDS (STYLIZED)**. REWARDSNOW, INC., (U.S. CLS. 100, 101 AND 102). SN 76-662,877. PUB. 7-10-2007. FILED 7-11-2006.
- 3,296,097. **DOWNTOWN AND DESIGN**. DOWNTOWN FORD LINCOLN MERCURY, INC., MULTIPLE CLASS, (INT. CLS. 35, 37 AND 39), (U.S. CLS. 100, 101, 102, 103, 105 AND 106). SN 76-663,193. PUB. 7-10-2007. FILED 7-17-2006.
- 3,296,103. **THE HCA FOUNDATION (BLOCK FORM)**. C/HCA, INC., MULTIPLE CLASS, (INT. CLS. 35, 36 AND 41), (U.S. CLS. 100, 101, 102 AND 107). SN 76-663,690. PUB. 7-10-2007. FILED 7-26-2006.
- 3,296,104. **THE HCA FOUNDATION SERVING. LEADING. SUPPORTING. (BLOCK FORM)**. C/HCA, INC., MULTIPLE CLASS, (INT. CLS. 35, 36 AND 41), (U.S. CLS. 100, 101, 102 AND 107). SN 76-663,692. PUB. 7-10-2007. FILED 7-26-2006.
- 3,296,109. **MANGOMOBILE (BLOCK FORM)**. MANGO LLC, MULTIPLE CLASS, (INT. CLS. 35, 38 AND 41), (U.S. CLS. 100, 101, 102, 104 AND 107). SN 76-664,648. PUB. 7-10-2007. FILED 8-16-2006.
- 3,296,111. **ISAVE.COM (STYLIZED)**. ISAVE.COM, INC., MULTIPLE CLASS, (INT. CLS. 35 AND 42), (U.S. CLS. 100, 101 AND 102). SN 76-664,728. PUB. 7-10-2007. FILED 8-17-2006.
- 3,296,112 (*See Class 16 for this trademark*).
- 3,296,114. **MISCELLANEOUS DESIGN**. ATTENTUS MEDICAL SALES, INC., (U.S. CLS. 100, 101 AND 102). SN 76-664,983. PUB. 7-10-2007. FILED 8-17-2006.
- 3,296,117 (*See Class 25 for this trademark*).
- 3,296,135. **SOYODO (BLOCK FORM)**. SONG, RUHUA, (U.S. CLS. 100, 101 AND 102). SN 76-667,230. PUB. 7-10-2007. FILED 10-10-2006.
- 3,296,138. **WORKING DIFFERENTLY REVOLUTIONIZING RETIREMENT FOR INDIVIDUALS AND EMPLOYERS AND DESIGN**. WORKING DIFFERENTLY LLC, (U.S. CLS. 100, 101 AND 102). SN 76-667,607. PUB. 7-10-2007. FILED 10-13-2006.
- 3,296,142. **THE COIN VAULT (BLOCK FORM)**. SHOP AT

- HOME, LLC, MULTIPLE CLASS, (INT. CLS. 35 AND 41), (U.S. CLS. 100, 101, 102 AND 107). SN 76-668,171. PUB. 7-10-2007. FILED 10-27-2006.
- 3,296,145. **PHARMACY BENEFIT MANAGEMENT INSTITUTE (BLOCK FORM)**. PHARMACY BENEFIT MANAGEMENT INSTITUTE, LP, (U.S. CLS. 100, 101 AND 102). SN 76-668,505. PUB. 7-10-2007. FILED 11-6-2006.
- 3,296,151. **IMPLICIT (BLOCK FORM)**. IMPLICIT RESOURCES LIMITED, MULTIPLE CLASS, (INT. CLS. 35 AND 42), (U.S. CLS. 100, 101 AND 102). SN 76-668,983. PUB. 7-10-2007. FILED 11-14-2006.
- 3,296,156. **PHYSICAL, MENTAL & FINANCIAL WELLNESS (BLOCK FORM)**. WELLNESS INTERNATIONAL NETWORK, LTD., (U.S. CLS. 100, 101 AND 102). SN 76-669,887. PUB. 7-10-2007. FILED 12-4-2006.
- 3,296,189. **PAP-FOR (BLOCK FORM)**. KRAUSE, EDWARD J., III, (U.S. CLS. 100, 101 AND 102). SN 76-671,767. PUB. 7-10-2007. FILED 1-24-2007.
- 3,296,190. **DUNN LUMBER BUILDING FRIENDS SINCE 1907 SAVE AND DESIGN**. DUNN LUMBER CO., INC., (U.S. CLS. 100, 101 AND 102). SN 76-671,781. PUB. 7-10-2007. FILED 1-25-2007.
- 3,296,199. **RAFFLEPARTNER AND DESIGN**. RMD, INC., (U.S. CLS. 100, 101 AND 102). SN 76-671,836. PUB. 7-10-2007. FILED 1-25-2007.
- 3,296,204. **EVERYONE'S A LUCKY DOG AT AARON'S (BLOCK FORM)**. AARON INVESTMENT COMPANY, MULTIPLE CLASS, (INT. CLS. 35, 36, 37, 39, 41, 42, 43 AND 45), (U.S. CLS. 100, 101, 102, 103, 105, 106 AND 107). SN 76-671,965. PUB. 7-10-2007. FILED 1-29-2007.
- 3,296,205. **CREATING COMMUNITIES OF INNOVATION (BLOCK FORM)**. ASSOCIATION OF UNIVERSITY RESEARCH PARKS, (U.S. CLS. 100, 101 AND 102). SN 76-671,975. PUB. 7-10-2007. FILED 1-29-2007.
- 3,296,206. **MISCELLANEOUS DESIGN**. ASSOCIATION OF UNIVERSITY RESEARCH PARKS, (U.S. CLS. 100, 101 AND 102). SN 76-671,976. PUB. 7-10-2007. FILED 1-29-2007.
- 3,296,207. **AURP (BLOCK FORM)**. ASSOCIATION OF UNIVERSITY RESEARCH PARKS, (U.S. CLS. 100, 101 AND 102). SN 76-671,977. PUB. 7-10-2007. FILED 1-29-2007.
- 3,296,222 (*See Class 16 for this trademark*).
- 3,296,226. **LENDINGBRIDGE AND DESIGN**. ACCREDITED HOME LENDERS, INC., (U.S. CLS. 100, 101 AND 102). SN 77-002,301. PUB. 4-3-2007. FILED 9-19-2006.
- 3,296,227. **RAWOLUTION (BLOCK FORM)**. AMSDEN, MATTHEW, MULTIPLE CLASS, (INT. CLS. 35 AND 39), (U.S. CLS. 100, 101, 102 AND 105). SN 77-002,872. PUB. 7-10-2007. FILED 9-20-2006.
- 3,296,235. **B.A.C.A. BIKERS AGAINST CHIL ABUSE AND DESIGN**. BIKERS AGAINST CHILD ABUSE, (U.S. CLS. 100, 101 AND 102). SN 77-004,160. PUB. 7-10-2007. FILED 9-21-2006.
- 3,296,237. **GASP (BLOCK FORM)**. MILDLY DELIRIOUS DESIGN INC., (U.S. CLS. 100, 101 AND 102). SN 77-005,082. PUB. 7-10-2007. FILED 9-22-2006.
- 3,296,238. **NAIL HOUSE (BLOCK FORM)**. HICKORY SPRINGS MANUFACTURING COMPANY, (U.S. CLS. 100, 101 AND 102). SN 77-005,100. PUB. 7-10-2007. FILED 9-22-2006.
- 3,296,254. **TARGETED MEDIA INC. A TIME INC. COMPANY (BLOCK FORM)**. TIME INC., (U.S. CLS. 100, 101 AND 102). SN 77-010,307. PUB. 7-10-2007. FILED 9-29-2006.
- 3,296,257. **TAG AND DESIGN**. TAG, INC., (U.S. CLS. 100, 101 AND 102). SN 77-011,338. PUB. 7-10-2007. FILED 10-1-2006.
- 3,296,258. **ALTER EGO AND DESIGN**. BOWKER, MARC, (U.S. CLS. 100, 101 AND 102). SN 77-011,545. PUB. 7-10-2007. FILED 10-2-2006.
- 3,296,261. **DIGGYACTIVE (BLOCK FORM)**. DIGGYWOOD INC., (U.S. CLS. 100, 101 AND 102). SN 77-012,007. PUB. 7-10-2007. FILED 10-2-2006.
- 3,296,280. **EAGLE PASS AND DESIGN**. EAGLE PASS CHAMBER OF COMMERCE, (U.S. CLS. 100, 101 AND 102). SN 77-016,073. PUB. 7-10-2007. FILED 10-6-2006.
- 3,296,281. **QUIETAGENT (BLOCK FORM)**. STAFFCV, INC., (U.S. CLS. 100, 101 AND 102). SN 77-016,409. PUB. 7-10-2007. FILED 10-7-2006.
- 3,296,283. **ESTATIONER STORE (BLOCK FORM)**. ESTATIONER, LLC, (U.S. CLS. 100, 101 AND 102). SN 77-016,612. PUB. 7-10-2007. FILED 10-9-2006.
- 3,296,289. **GREAT AMERICAN RIVALRY SERIES (BLOCK FORM)**. IHIGH, INC., (U.S. CLS. 100, 101 AND 102). SN 77-018,333. PUB. 7-10-2007. FILED 10-11-2006.
- 3,296,290. **GREAT AMERICAN RIVALRY SERIES AND DESIGN**. IHIGH, INC., (U.S. CLS. 100, 101 AND 102). SN 77-018,334. PUB. 7-10-2007. FILED 10-11-2006.
- 3,296,293. **THRIFTY WHITE PHARMACY (BLOCK FORM)**. THRIFTY DRUG STORES, INC., MULTIPLE CLASS, (INT. CLS. 35, 40 AND 41), (U.S. CLS. 100, 101, 102, 103, 106 AND 107). SN 77-018,614. PUB. 7-10-2007. FILED 10-11-2006.
- 3,296,313. **CARPLEX (BLOCK FORM)**. CARPLEX, MULTIPLE CLASS, (INT. CLS. 35 AND 36), (U.S. CLS. 100, 101 AND 102). SN 77-024,593. PUB. 7-10-2007. FILED 10-19-2006.
- 3,296,319. **L&W STONE CORPORATION (BLOCK FORM)**. L&W STONE CORPORATION, MULTIPLE CLASS, (INT. CLS. 35 AND 40), (U.S. CLS. 100, 101, 102, 103 AND 106). SN 77-025,431. PUB. 7-10-2007. FILED 10-19-2006.
- 3,296,325. **MY PET ... NATURALLY AND DESIGN**. EQUINE ENTERPRISES, INC, (U.S. CLS. 100, 101 AND 102). SN 77-026,327. PUB. 7-10-2007. FILED 10-20-2006.
- 3,296,328. **EREINSURE (BLOCK FORM)**. EREINSURE.COM, INC., (U.S. CLS. 100, 101 AND 102). SN 77-026,961. PUB. 7-10-2007. FILED 10-23-2006.
- 3,296,339. **RSA (BLOCK FORM)**. MICHAEL R. SAGE, (U.S. CLS. 100, 101 AND 102). SN 77-028,329. PUB. 7-10-2007. FILED 10-24-2006.
- 3,296,346. **INFINITE IMPRESSIONS (BLOCK FORM)**. NICHOLS, KIM A., (U.S. CLS. 100, 101 AND 102). SN 77-029,966. PUB. 7-10-2007. FILED 10-26-2006.
- 3,296,348. **EAUCTION DEPOT (STYLIZED)**. EAUCTION DEPOT, LLC, (U.S. CLS. 100, 101 AND 102). SN 77-030,259. PUB. 6-26-2007. FILED 10-26-2006.
- 3,296,350. **EXCEED SALES (BLOCK FORM)**. ELISA CIARAME TARO, (U.S. CLS. 100, 101 AND 102). SN 77-030,774. PUB. 7-10-2007. FILED 10-27-2006.
- 3,296,352. **BITTERSWEET BUTTERFLY (BLOCK FORM)**. WARNER, NINA D., AND WARNER, TIMOTHY W., (U.S. CLS. 100, 101 AND 102). SN 77-031,250. PUB. 7-10-2007. FILED 10-27-2006.
- 3,296,353. **BEST DISTRIBUTING CO. (BLOCK FORM)**. BEACON ROOFING SUPPLY, INC., (U.S. CLS. 100, 101 AND 102). SN 77-031,279. PUB. 7-10-2007. FILED 10-27-2006.
- 3,296,354. **BEST DISTRIBUTING CO. AND DESIGN**. BEACON ROOFING SUPPLY, INC., (U.S. CLS. 100, 101 AND 102). SN 77-031,308. PUB. 7-10-2007. FILED 10-27-2006.
- 3,296,355. **P AND DESIGN**. BEACON ROOFING SUPPLY, INC., (U.S. CLS. 100, 101 AND 102). SN 77-031,433. PUB. 7-10-2007. FILED 10-27-2006.
- 3,296,356. **ROOF DEPOT AND DESIGN**. BEACON ROOFING SUPPLY, INC., (U.S. CLS. 100, 101 AND 102). SN 77-031,456. PUB. 7-10-2007. FILED 10-27-2006.
- 3,296,357. **SHELTER DISTRIBUTION, INC. (BLOCK FORM)**. BEACON ROOFING SUPPLY, INC., (U.S. CLS. 100, 101 AND 102). SN 77-031,472. PUB. 7-10-2007. FILED 10-27-2006.
- 3,296,358. **SHELTER DISTRIBUTION, INC. AND DESIGN**. BEACON ROOFING SUPPLY, INC., (U.S. CLS. 100, 101 AND 102). SN 77-031,483. PUB. 7-10-2007. FILED 10-27-2006.
- 3,296,361. **VNSNY COMMUNITY CONNECTIONS TIME-BANK (BLOCK FORM)**. VISITING NURSE SERVICE OF NEW YORK, INC., (U.S. CLS. 100, 101 AND 102). SN 77-031,767. PUB. 7-10-2007. FILED 10-29-2006.
- 3,296,370. **DELIVERING UPTIME (BLOCK FORM)**. INOC, LLC, (U.S. CLS. 100, 101 AND 102). SN 77-032,932. PUB. 7-10-2007. FILED 10-31-2006.
- 3,296,371. **REKINDLE THE PASSION WITH INTIMATE FASHION (BLOCK FORM)**. LOVER'S LANE I.P., LTD., (U.S. CLS. 100, 101 AND 102). SN 77-033,266. PUB. 7-10-2007. FILED 10-31-2006.
- 3,296,378. **P3 PLATINUM PERFORMANCE PROGRAM TRANSPORTATION WITH CONFIDENCE AND DESIGN**. TRANSPORTATION INTERMEDIARIES ASSOCIATION, MULTIPLE CLASS, (INT. CLS. 35, 39 AND 42), (U.S. CLS. 100, 101, 102 AND 105). SN 77-034,074. PUB. 7-10-2007. FILED 11-1-2006.
- 3,296,380. **BILL'S GHOST AND SPIRITS ESTABLISHED 1982 AND DESIGN**. BILL'S GHOST & SPIRITS LLC, (U.S. CLS. 100, 101 AND 102). SN 77-034,430. PUB. 7-10-2007. FILED 11-

- 1-2006.
- 3,296,384. **THE NATIONAL AEROSPACE LEADERSHIP INITIATIVE (NALI) (BLOCK FORM)**. CONNECTICUT CENTER FOR ADVANCED TECHNOLOGY, INC., MULTIPLE CLASS, (INT. CLS. 35, 41 AND 42), (U.S. CLS. 100, 101, 102 AND 107). SN 77-034,945. PUB. 7-10-2007. FILED 11-2-2006.
- 3,296,385. **SOUTHERN ROOF CENTER (BLOCK FORM)**. BEACON ROOFING SUPPLY, INC., (U.S. CLS. 100, 101 AND 102). SN 77-035,203. PUB. 7-10-2007. FILED 11-2-2006.
- 3,296,396. **GEMCOM, LLC AND DESIGN**. GEMCOM, LLC, (U.S. CLS. 100, 101 AND 102). SN 77-037,643. PUB. 6-26-2007. FILED 11-6-2006.
- 3,296,398. **NANOSPEED (BLOCK FORM)**. NANOSPEED, LLC, (U.S. CLS. 100, 101 AND 102). SN 77-037,684. PUB. 7-10-2007. FILED 11-6-2006.
- 3,296,410. **CAKE (BLOCK FORM)**. CAKE, LLC, MULTIPLE CLASS, (INT. CLS. 35 AND 41), (U.S. CLS. 100, 101, 102 AND 107). SN 77-040,377. PUB. 7-10-2007. FILED 11-9-2006.
- 3,296,413. **THERE'S NOTHING WRONG WITH THE CARTRIDGE...IT'S JUST EMPTY! (BLOCK FORM)**. INKTONE, INC., MULTIPLE CLASS, (INT. CLS. 35 AND 37), (U.S. CLS. 100, 101, 102, 103 AND 106). SN 77-040,961. PUB. 7-10-2007. FILED 11-9-2006.
- 3,296,418. **SOURCING AT MAGIC (BLOCK FORM)**. MEN'S APPAREL GUILD IN CALIFORNIA, INC., MULTIPLE CLASS, (INT. CLS. 35 AND 41), (U.S. CLS. 100, 101, 102 AND 107). SN 77-041,147. PUB. 7-10-2007. FILED 11-10-2006.
- 3,296,420. **RESORTSANDLODGES.COM AND DESIGN**. TRAVELNET SOLUTIONS, INC., (U.S. CLS. 100, 101 AND 102). SN 77-041,375. PUB. 6-26-2007. FILED 11-10-2006.
- 3,296,422. **COLUMBUS UNDERGROUND (BLOCK FORM)**. WALKER EVANS, (U.S. CLS. 100, 101 AND 102). SN 77-041,531. PUB. 7-10-2007. FILED 11-10-2006.
- 3,296,425 (*See Class 9 for this trademark*).
- 3,296,426. **MISCELLANEOUS DESIGN**. NAMI LOUISVILLE, INC., (U.S. CLS. 100, 101 AND 102). SN 77-041,768. PUB. 7-10-2007. FILED 11-10-2006.
- 3,296,427 (*See Class 9 for this trademark*).
- 3,296,437. **WINEACCESS (BLOCK FORM)**. WINE ACCESS, INC., (U.S. CLS. 100, 101 AND 102). SN 77-043,800. PUB. 7-10-2007. FILED 11-14-2006.
- 3,296,448. **CUSHION CONNECTION (BLOCK FORM)**. CUSHION CONNECTION, INC., (U.S. CLS. 100, 101 AND 102). SN 77-044,906. PUB. 7-10-2007. FILED 11-15-2006.
- 3,296,456. **CAREERSTORE (BLOCK FORM)**. FPS TRAINING CORP., (U.S. CLS. 100, 101 AND 102). SN 77-046,038. PUB. 7-10-2007. FILED 11-16-2006.
- 3,296,459. **EXTENDED PRESENCE OUTSOURCED SALES PROFESSIONALS AND DESIGN**. EXTENDED PRESENCE TECHNOLOGY BROKERAGE, LLC, (U.S. CLS. 100, 101 AND 102). SN 77-046,804. PUB. 6-26-2007. FILED 11-17-2006.
- 3,296,468. **LANGUAGE WORKS (BLOCK FORM)**. THE LANGUAGE WORKS, INC., MULTIPLE CLASS, (INT. CLS. 35 AND 41), (U.S. CLS. 100, 101, 102 AND 107). SN 77-047,646. PUB. 7-10-2007. FILED 11-20-2006.
- 3,296,472 (*See Class 9 for this trademark*).
- 3,296,475. **LOW FLYING BRANDS (BLOCK FORM)**. KILGANON INC., (U.S. CLS. 100, 101 AND 102). SN 77-048,664. PUB. 7-10-2007. FILED 11-21-2006.
- 3,296,483. **MEDICAL PRACTICE PROFITS (BLOCK FORM)**. GARDNER, JOHN H. (U.S. CLS. 100, 101 AND 102). SN 77-050,378. PUB. 7-10-2007. FILED 11-24-2006.
- 3,296,490. **MYSTIC COAST & COUNTRY TRAVEL INDUSTRY ASSOCIATION AND DESIGN**. MYSTIC COAST & COUNTRY TRAVEL INDUSTRY ASSOCIATION, INC., (U.S. CLS. 100, 101 AND 102). SN 77-051,074. PUB. 7-10-2007. FILED 11-27-2006.
- 3,296,493 (*See Class 14 for this trademark*).
- 3,296,500. **HEADLINE NEWS HN AND DESIGN**. HEADLINE NEWS, INC., (U.S. CLS. 100, 101 AND 102). SN 77-052,753. PUB. 6-26-2007. FILED 11-29-2006.
- 3,296,505. **MADE IN CHINA MADE EASY (STYLIZED)**. TEAM LOGISTIC SERVICES, INC., (U.S. CLS. 100, 101 AND 102). SN 77-053,364. PUB. 7-10-2007. FILED 11-29-2006.
- 3,296,512. **VIRTUAL GURU (BLOCK FORM)**. ATLAS ISLAND MEDIA, INC., (U.S. CLS. 100, 101 AND 102). SN 77-053,955. PUB. 7-10-2007. FILED 11-30-2006.
- 3,296,521. **1 IN 3 AND DESIGN**. CREDIT UNION ASSOCIATION OF COLORADO, (U.S. CLS. 100, 101 AND 102). SN 77-054,823. PUB. 6-26-2007. FILED 12-1-2006.
- 3,296,526. **FACTORY DIRECT PREMIUMS AND DESIGN**. FACTORY DIRECT PREMIUMS, LLC, (U.S. CLS. 100, 101 AND 102). SN 77-055,245. PUB. 7-10-2007. FILED 12-1-2006.
- 3,296,533. **FASTORDERFROM.COM AND DESIGN**. MEETINGS & EVENTS INTERNATIONAL, INC., MULTIPLE CLASS, (INT. CLS. 35 AND 36), (U.S. CLS. 100, 101 AND 102). SN 77-056,255. PUB. 7-10-2007. FILED 12-4-2006.
- 3,296,541. **JLS GLOBAL AND DESIGN**. JLS GLOBAL, LLC, (U.S. CLS. 100, 101 AND 102). SN 77-056,977. PUB. 7-10-2007. FILED 12-5-2006.
- 3,296,546. **COBBLESTONE CONSULTING (BLOCK FORM)**. COBBLESTONE CONSULTING, INC., (U.S. CLS. 100, 101 AND 102). SN 77-057,431. PUB. 7-10-2007. FILED 12-5-2006.
- 3,296,547. **MISCELLANEOUS DESIGN**. BRAIN INJURY ASSOCIATION OF AMERICA, MULTIPLE CLASS, (INT. CLS. 35 AND 41), (U.S. CLS. 100, 101, 102 AND 107). SN 77-057,485. PUB. 6-26-2007. FILED 12-5-2006.
- 3,296,552. **GOODSFORGOD AND DESIGN**. GOODS FOR GOOD, INC., (U.S. CLS. 100, 101 AND 102). SN 77-058,230. PUB. 7-10-2007. FILED 12-6-2006.
- 3,296,553. **PRINCETONONE UNIFIED SOLUTIONS FOR A TALENTED WORLD. AND DESIGN**. PRINCETON SEARCH LLC, (U.S. CLS. 100, 101 AND 102). SN 77-058,308. PUB. 6-26-2007. FILED 12-6-2006.
- 3,296,557. **INTIMACY AND DESIGN**. INTIMACY MANAGEMENT COMPANY LLC, (U.S. CLS. 100, 101 AND 102). SN 77-058,746. PUB. 6-26-2007. FILED 12-7-2006.
- 3,296,559. **PESG AND DESIGN**. PROFESSIONAL EMPLOYER'S SERVICES GROUP, LLC, DBA PROFESSIONAL EDUCATIONAL SERVICES GROUP, LLC, (U.S. CLS. 100, 101 AND 102). SN 77-058,970. PUB. 7-10-2007. FILED 12-7-2006.
- 3,296,580. **IP SCORECARD (BLOCK FORM)**. NEXT STEPS RESEARCH, LLC, MULTIPLE CLASS, (INT. CLS. 35, 36 AND 42), (U.S. CLS. 100, 101 AND 102). SN 77-060,423. PUB. 7-10-2007. FILED 12-8-2006.
- 3,296,581. **AD.MERSION (BLOCK FORM)**. ZOOM MEDIA METRICS, LLC, (U.S. CLS. 100, 101 AND 102). SN 77-060,457. PUB. 7-10-2007. FILED 12-8-2006.
- 3,296,607. **A AGRILIANCE AND DESIGN**. AGRILIANCE LLC., MULTIPLE CLASS, (INT. CLS. 35 AND 42), (U.S. CLS. 100, 101 AND 102). SN 77-061,958. PUB. 7-10-2007. FILED 12-12-2006.
- 3,296,611. **CLEVELAND AUTO SHOW AND DESIGN**. GREATER CLEVELAND AUTOMOBILE DEALERS ASSOCIATION, (U.S. CLS. 100, 101 AND 102). SN 77-062,165. PUB. 7-10-2007. FILED 12-12-2006.
- 3,296,612. **WHERE KASHRUT AND QUALITY ARE #1 (BLOCK FORM)**. HUNGARIAN KOSHER FOODS, INC., (U.S. CLS. 100, 101 AND 102). SN 77-062,297. PUB. 7-10-2007. FILED 12-12-2006.
- 3,296,613. **MISCELLANEOUS DESIGN**. MOON, SANG HEUM, (U.S. CLS. 100, 101 AND 102). SN 77-062,429. PUB. 6-26-2007. FILED 12-12-2006.
- 3,296,619. **MISCELLANEOUS DESIGN**. THE BRIAN MADDEN COMPANY, LLC, MULTIPLE CLASS, (INT. CLS. 35, 38, 41 AND 42), (U.S. CLS. 100, 101, 102, 104 AND 107). SN 77-062,875. PUB. 7-10-2007. FILED 12-12-2006.
- 3,296,620. **TULIP TOY GALLERY (BLOCK FORM)**. SMART GIRL SQUARED, INC., (U.S. CLS. 100, 101 AND 102). SN 77-062,916. PUB. 7-10-2007. FILED 12-12-2006.
- 3,296,621. **KITTERY TRADING POST (BLOCK FORM)**. KEVIN, INC., (U.S. CLS. 100, 101 AND 102). SN 77-062,966. PUB. 7-10-2007. FILED 12-13-2006.
- 3,296,628. **FURNITURE FAIR (BLOCK FORM)**. O.K.I. FURNITURE FAIR, INC., (U.S. CLS. 100, 101 AND 102). SN 77-063,026. PUB. 7-10-2007. FILED 12-13-2006.
- 3,296,642. **CETALUS AND DESIGN**. CETALUS LLC, MULTIPLE CLASS, (INT. CLS. 35 AND 45), (U.S. CLS. 100, 101 AND 102). SN 77-063,582. PUB. 7-10-2007. FILED 12-13-2006.
- 3,296,643. **YOUR LOVE MAKES MY HEART BEAT AND DESIGN**. WACKY BEAR FACTORY, (U.S. CLS. 100, 101 AND 102). SN 77-063,604. PUB. 7-10-2007. FILED 12-13-2006.
- 3,296,645. **ORDER CORNER (BLOCK FORM)**. LONE STAR MEALS, INC., DBA ORDERCORNER, (U.S. CLS. 100, 101 AND 102). SN 77-063,704. PUB. 7-10-2007. FILED 12-13-2006.

- 3,296,652. **GREENCURRENTS (BLOCK FORM)**. DTE ENERGY COMPANY, (U.S. CLS. 100, 101 AND 102). SN 77-063,932. PUB. 7-10-2007. FILED 12-14-2006.
- 3,296,659. **VOZ LATINO (BLOCK FORM)**. STIMSON, DRAKE, (U.S. CLS. 100, 101 AND 102). SN 77-064,008. PUB. 7-10-2007. FILED 12-14-2006.
- 3,296,660. **OMNILEVER (BLOCK FORM)**. TIGRAN, PETROSYAN, (U.S. CLS. 100, 101 AND 102). SN 77-064,044. PUB. 7-10-2007. FILED 12-14-2006.
- 3,296,674 (*See Class 9 for this trademark*).
- 3,296,675. **MISCELLANEOUS DESIGN**. CORPORATE DINING, INC., (U.S. CLS. 100, 101 AND 102). SN 77-064,415. PUB. 7-10-2007. FILED 12-14-2006.
- 3,296,680. **LIFE IS IN YOUR HANDS (BLOCK FORM)**. THE BLOOD AND TISSUE CENTER OF CENTRAL TEXAS, MULTIPLE CLASS, (INT. CLS. 35 AND 44), (U.S. CLS. 100, 101 AND 102). SN 77-064,507. PUB. 7-10-2007. FILED 12-14-2006.
- 3,296,681. **LICENSE TO SELL (BLOCK FORM)**. CORPORATE SPORT, INC., (U.S. CLS. 100, 101 AND 102). SN 77-064,533. PUB. 7-10-2007. FILED 12-14-2006.
- 3,296,688. **ROPEWORKS AND DESIGN**. ROPEWORKS INDUSTRIAL GROUP, INC., MULTIPLE CLASS, (INT. CLS. 35 AND 41), (U.S. CLS. 100, 101, 102 AND 107). SN 77-064,693. PUB. 7-10-2007. FILED 12-14-2006.
- 3,296,689. **POOLDAWG AND DESIGN**. BILLIARD EXCHANGE, INC., DBA POOLDAWG, (U.S. CLS. 100, 101 AND 102). SN 77-064,715. PUB. 7-10-2007. FILED 12-14-2006.
- 3,296,690. **WAY TO GROW (BLOCK FORM)**. INNIS, COREY A, (U.S. CLS. 100, 101 AND 102). SN 77-064,724. PUB. 7-10-2007. FILED 12-14-2006.
- 3,296,695. **CERTES (BLOCK FORM)**. CERTES FINANCIAL PROS, (U.S. CLS. 100, 101 AND 102). SN 77-064,807. PUB. 7-10-2007. FILED 12-14-2006.
- 3,296,697. **DOING WELL BY DOING GOOD (BLOCK FORM)**. TIM SEXTON, (U.S. CLS. 100, 101 AND 102). SN 77-064,827. PUB. 7-10-2007. FILED 12-14-2006.
- 3,296,698. **I.M. HOME (BLOCK FORM)**. I.M. HOME FURNITURE INC., (U.S. CLS. 100, 101 AND 102). SN 77-064,845. PUB. 7-10-2007. FILED 12-14-2006.
- 3,296,701 (*See Class 9 for this trademark*).
- 3,296,704. **P PASSIONATE MUSIC & FILM | CULTURE | LIFESTYLE AND DESIGN**. PASSIONATE ENTERTAINMENT, INC., (U.S. CLS. 100, 101 AND 102). SN 77-065,074. PUB. 7-10-2007. FILED 12-15-2006.
- 3,296,707. **DESIGN YOUR LOOK...LOVE OUR PRICE (BLOCK FORM)**. AMERICAN BLIND AND WALLPAPER FACTORY, INC., (U.S. CLS. 100, 101 AND 102). SN 77-065,111. PUB. 7-10-2007. FILED 12-15-2006.
- 3,296,711. **CA CAPPELLEN & ASSOCIATES (STYLIZED)**. CAPPELLEN & ASSOCIATES, (U.S. CLS. 100, 101 AND 102). SN 77-065,452. PUB. 7-10-2007. FILED 12-15-2006.
- 3,296,712. **FOR HOTELIERS, BY HOTELIERS. (BLOCK FORM)**. ADVANTIS HOSPITALITY ALLIANCE L.L.C., (U.S. CLS. 100, 101 AND 102). SN 77-065,500. PUB. 7-10-2007. FILED 12-15-2006.
- 3,296,735. **EXTREME ACHIEVERS (BLOCK FORM)**. STANTON ROYCE, MULTIPLE CLASS, (INT. CLS. 35 AND 41), (U.S. CLS. 100, 101, 102 AND 107). SN 77-067,984. PUB. 7-10-2007. FILED 12-19-2006.
- 3,296,740 (*See Class 16 for this trademark*).
- 3,296,741 (*See Class 16 for this trademark*).
- 3,296,742 (*See Class 16 for this trademark*).
- 3,296,743. **YOU BID. YOU WIN. GUARANTEED. (BLOCK FORM)**. WONBID LLC, (U.S. CLS. 100, 101 AND 102). SN 77-069,498. PUB. 7-10-2007. FILED 12-21-2006.
- 3,296,758. **SYMPLEGADES (BLOCK FORM)**. SYMPLEGADES INC., (U.S. CLS. 100, 101 AND 102). SN 77-073,721. PUB. 7-10-2007. FILED 12-29-2006.
- 3,296,769. **HOMELAND HEROES SERVING THOSE WHO SERVED (BLOCK FORM)**. PILKINGTON, ROBERT, R. AND PILKINGTON, DENISE, L., (U.S. CLS. 100, 101 AND 102). SN 77-075,919. PUB. 7-10-2007. FILED 1-4-2007.
- 3,296,776. **PROJECT CHILDSAFE (BLOCK FORM)**. NATIONAL SHOOTING SPORTS FOUNDATION, INC., (U.S. CLS. 100, 101 AND 102). SN 77-076,869. PUB. 7-10-2007. FILED 1-5-2007.
- 3,296,782. **MIGHTY MOOSE (BLOCK FORM)**. COULTER, KEVIN, (U.S. CLS. 100, 101 AND 102). SN 77-077,382. PUB. 7-10-2007. FILED 1-5-2007.
- 3,296,786. **DIAMONDWORLD (BLOCK FORM)**. PATEL, MANESH, (U.S. CLS. 100, 101 AND 102). SN 77-078,492. PUB. 7-10-2007. FILED 1-8-2007.
- 3,296,787. **ENETFAST (BLOCK FORM)**. E-NET ADVERTISING, LLC, (U.S. CLS. 100, 101 AND 102). SN 77-078,545. PUB. 7-10-2007. FILED 1-9-2007.
- 3,296,804. **EL PASO SADDLEBLANKET 6926 GATEWAY EAST EL PASO, TEXAS 79915 AND DESIGN**. EL PASO SADDLEBLANKET COMPANY, L.P., (U.S. CLS. 100, 101 AND 102). SN 77-080,339. PUB. 7-10-2007. FILED 1-11-2007.
- 3,296,806. **MISCELLANEOUS DESIGN**. GAME FANATIX LLC, (U.S. CLS. 100, 101 AND 102). SN 77-080,393. PUB. 7-10-2007. FILED 1-10-2007.
- 3,296,807. **ABUNDANCE BY DESIGN (BLOCK FORM)**. ROCKY MOUNTAIN INSTITUTE, (U.S. CLS. 100, 101 AND 102). SN 77-080,619. PUB. 7-10-2007. FILED 1-11-2007.
- 3,296,809. **PASSIONATELY COMMITTED (BLOCK FORM)**. NUCARA MANAGEMENT GROUP, (U.S. CLS. 100, 101 AND 102). SN 77-080,818. PUB. 7-10-2007. FILED 1-11-2007.
- 3,296,812. **HOW ARE YOU MANAGING? (BLOCK FORM)**. J.H. COHN, LLP, MULTIPLE CLASS, (INT. CLS. 35 AND 36), (U.S. CLS. 100, 101 AND 102). SN 77-081,162. PUB. 7-10-2007. FILED 1-11-2007.
- 3,296,816. **GASBUDDY (BLOCK FORM)**. GASBUDDY ORGANIZATION INC, (U.S. CLS. 100, 101 AND 102). SN 77-082,630. PUB. 7-10-2007. FILED 1-13-2007.
- 3,296,822. **E2COMPUTERS (BLOCK FORM)**. E2COMPUTERS LLC, (U.S. CLS. 100, 101 AND 102). SN 77-083,357. PUB. 7-10-2007. FILED 1-15-2007.
- 3,296,838. **SCOPE OF LEADERSHIP (BLOCK FORM)**. ALPINE LINK CORPORATION, MULTIPLE CLASS, (INT. CLS. 35 AND 41), (U.S. CLS. 100, 101, 102 AND 107). SN 77-084,564. PUB. 7-10-2007. FILED 1-17-2007.
- 3,296,850. **ARE YOU OK WITH THAT? (BLOCK FORM)**. CLEARWAY MINNESOTA, (U.S. CLS. 100, 101 AND 102). SN 77-085,363. PUB. 7-10-2007. FILED 1-18-2007.
- 3,296,854. **WISCONSIN MILK MARKETING BOARD WISCONSIN DAIRY PRODUCERS AND DESIGN**. WISCONSIN MILK MARKETING BOARD, INC., MULTIPLE CLASS, (INT. CLS. 35 AND 41), (U.S. CLS. 100, 101, 102 AND 107). SN 77-085,557. PUB. 7-10-2007. FILED 1-18-2007.
- 3,296,855. **ER (BLOCK FORM)**. ORGANIC FOODS EXPRESS, INC., (U.S. CLS. 100, 101 AND 102). SN 77-085,584. PUB. 7-10-2007. FILED 1-18-2007.
- 3,296,860. **ORGANIZATION HEALTH CHECK (BLOCK FORM)**. CS L.L.C., (U.S. CLS. 100, 101 AND 102). SN 77-085,988. PUB. 7-10-2007. FILED 1-18-2007.
- 3,296,867. **HYPERBRIEF (BLOCK FORM)**. JAMES DECRESCENZO REPORTING, LLC, (U.S. CLS. 100, 101 AND 102). SN 77-086,400. PUB. 7-10-2007. FILED 1-19-2007.
- 3,296,872. **WD PARTNERS (BLOCK FORM)**. WD PARTNERS, INC., MULTIPLE CLASS, (INT. CLS. 35, 37 AND 42), (U.S. CLS. 100, 101, 102, 103 AND 106). SN 77-086,880. PUB. 7-10-2007. FILED 1-19-2007.
- 3,296,876. **PERSONNEL ONE AND DESIGN**. EMPLOYMENT SOLUTIONS MANAGEMENT, INC., (U.S. CLS. 100, 101 AND 102). SN 77-087,156. PUB. 7-10-2007. FILED 1-19-2007.
- 3,296,879. **KUTTER'S (BLOCK FORM)**. KUTTER'S FURNITURE STORE, INC., (U.S. CLS. 100, 101 AND 102). SN 77-087,176. PUB. 7-10-2007. FILED 1-19-2007.
- 3,296,880 (*See Class 30 for this trademark*).
- 3,296,881 (*See Class 30 for this trademark*).
- 3,296,893. **SHE HASIT (BLOCK FORM)**. RODGERS, SHEILA, (U.S. CLS. 100, 101 AND 102). SN 77-087,694. PUB. 7-10-2007. FILED 1-22-2007.
- 3,296,898. **SITE4HIRE (BLOCK FORM)**. SITE4HIRE.COM, INC., (U.S. CLS. 100, 101 AND 102). SN 77-087,912. PUB. 7-10-2007. FILED 1-22-2007.
- 3,296,904. **WINE, DINE & DEMO (BLOCK FORM)**. PEPCOM INC., (U.S. CLS. 100, 101 AND 102). SN 77-088,616. PUB. 7-10-2007. FILED 1-23-2007.
- 3,296,911. **APOLLO PAPER CO. (BLOCK FORM)**. AMCOR LIMITED, (U.S. CLS. 100, 101 AND 102). SN 77-088,807. PUB. 7-10-2007. FILED 1-23-2007.
- 3,296,912. **THE HERO'S WELCOME (BLOCK FORM)**. INTELLIGENCE NAVIGATORS CORP., (U.S. CLS. 100, 101

- AND 102). SN 77-088,808. PUB. 7-10-2007. FILED 1-23-2007.
- 3,296,915. **DORIGNAC'S (BLOCK FORM)**. DORIGNAC'S FOOD CENTER, L.L.C., (U.S. CLS. 100, 101 AND 102). SN 77-088,893. PUB. 7-10-2007. FILED 1-23-2007.
- 3,296,939. **JIMMY BEANS WOOL ENDLESS POSSIBILITIES. (BLOCK FORM)**. JIMMYS WOOL, LLC, (U.S. CLS. 100, 101 AND 102). SN 77-090,144. PUB. 7-10-2007. FILED 1-24-2007.
- 3,296,943. **FIT IN. STAND OUT. (BLOCK FORM)**. THE WET SEAL, INC., (U.S. CLS. 100, 101 AND 102). SN 77-090,438. PUB. 7-10-2007. FILED 1-24-2007.
- 3,296,944 (*See Class 32 for this trademark*).
- 3,296,949. **INFOMAT (BLOCK FORM)**. REDDING, COURTNEY LYNN, (U.S. CLS. 100, 101 AND 102). SN 77-090,711. PUB. 7-10-2007. FILED 1-25-2007.
- 3,296,950. **MISCELLANEOUS DESIGN**. FENCE WAREHOUSE, INC., (U.S. CLS. 100, 101 AND 102). SN 77-090,762. PUB. 7-10-2007. FILED 1-25-2007.
- 3,296,951. **INTA JUICE AND DESIGN**. INTA JUICE ENTERPRISES, INC., MULTIPLE CLASS, (INT. CLS. 35 AND 43), (U.S. CLS. 100, 101 AND 102). SN 77-090,812. PUB. 7-10-2007. FILED 1-25-2007.
- 3,296,952. **PROJECTWORLD (BLOCK FORM)**. INSTITUTE FOR INTERNATIONAL RESEARCH, INC., (U.S. CLS. 100, 101 AND 102). SN 77-090,848. PUB. 7-10-2007. FILED 1-25-2007.
- 3,296,955. **BLUE STEEL STUDIO (BLOCK FORM)**. BLUE STEEL STUDIO, LLC, (U.S. CLS. 100, 101 AND 102). SN 77-090,932. PUB. 7-10-2007. FILED 1-25-2007.
- 3,296,963. **BE-OUR-GUEST.NET AND DESIGN**. BE-OUR-GUEST NETWORK, INC., (U.S. CLS. 100, 101 AND 102). SN 77-091,161. PUB. 7-10-2007. FILED 1-25-2007.
- 3,296,967. **LEADMINDER (BLOCK FORM)**. CARGILL CONSULTING GROUP, INC., (U.S. CLS. 100, 101 AND 102). SN 77-091,182. PUB. 7-10-2007. FILED 1-25-2007.
- 3,296,968. **REACH OUT & COOK! (BLOCK FORM)**. BINARY ENGINEERING SOFTWARE, INC, (U.S. CLS. 100, 101 AND 102). SN 77-091,189. PUB. 7-10-2007. FILED 1-25-2007.
- 3,296,970. **GOOZEX (BLOCK FORM)**. GOOZEX, INC., (U.S. CLS. 100, 101 AND 102). SN 77-091,228. PUB. 7-10-2007. FILED 1-25-2007.
- 3,296,972. **FORESTENSE (BLOCK FORM)**. IMAGETREE CORPORATION, (U.S. CLS. 100, 101 AND 102). SN 77-091,262. PUB. 7-10-2007. FILED 1-25-2007.
- 3,296,975. **GARAN-BEADAGIO (BLOCK FORM)**. JOHNSON, ANNA K., (U.S. CLS. 100, 101 AND 102). SN 77-091,322. PUB. 7-10-2007. FILED 1-25-2007.
- 3,296,983. **DYSCERN (BLOCK FORM)**. DYSCERN, LLC, MULTIPLE CLASS, (INT. CLS. 35 AND 37), (U.S. CLS. 100, 101, 102, 103 AND 106). SN 77-091,559. PUB. 7-10-2007. FILED 1-25-2007.
- 3,296,999. **GRIN (BLOCK FORM)**. GRINGO VENTURES, LLC, (U.S. CLS. 100, 101 AND 102). SN 77-091,709. PUB. 7-10-2007. FILED 1-26-2007.
- 3,297,004. **LAND THE RAINMAKER (BLOCK FORM)**. INTELLIGENCE NAVIGATORS CORP., (U.S. CLS. 100, 101 AND 102). SN 77-091,990. PUB. 7-10-2007. FILED 1-26-2007.
- 3,297,011. **SHOEMONEY (BLOCK FORM)**. SHOEMONEY MEDIA GROUP, INC., (U.S. CLS. 100, 101 AND 102). SN 77-092,124. PUB. 7-10-2007. FILED 1-26-2007.
- 3,297,013. **LE BELLE (BLOCK FORM)**. LE BELLE INTERNATIONAL, INC., (U.S. CLS. 100, 101 AND 102). SN 77-092,141. PUB. 7-10-2007. FILED 1-26-2007.
- 3,297,015. **NO CREDIT? DON'T SWEAT IT! (BLOCK FORM)**. NACIONAL NAME HOLDING, LLC, MULTIPLE CLASS, (INT. CLS. 35, 36 AND 37), (U.S. CLS. 100, 101, 102, 103 AND 106). SN 77-092,169. PUB. 7-10-2007. FILED 1-26-2007.
- 3,297,016. **MATERIAL (BLOCK FORM)**. REYES, DAVID G, (U.S. CLS. 100, 101 AND 102). SN 77-092,198. PUB. 7-10-2007. FILED 1-26-2007.
- 3,297,025. **HEARTH, PATIO & BARBECUE EXPO AND DESIGN**. HEARTH, PATIO & BARBECUE ASSOCIATION, (U.S. CLS. 100, 101 AND 102). SN 77-092,512. PUB. 7-10-2007. FILED 1-26-2007.
- 3,297,027 (*See Class 16 for this trademark*).
- 3,297,029. **FANMAIL (BLOCK FORM)**. HYPERDRIVE INTERACTIVE, LTD., (U.S. CLS. 100, 101 AND 102). SN 77-092,587. PUB. 7-10-2007. FILED 1-26-2007.
- 3,297,030. **FANMAIL AND DESIGN**. HYPERDRIVE INTERACTIVE, LTD., (U.S. CLS. 100, 101 AND 102). SN 77-092,632. PUB. 7-10-2007. FILED 1-26-2007.
- 3,297,031. **MERVYNS (BLOCK FORM)**. MERVYN'S BRANDS, LLC, (U.S. CLS. 100, 101 AND 102). SN 77-092,678. PUB. 7-10-2007. FILED 1-26-2007.
- 3,297,032. **YOUVEGOTCLAIMS (BLOCK FORM)**. AUTOMATED COLLECTION CONTROL, INC., (U.S. CLS. 100, 101 AND 102). SN 77-092,745. PUB. 7-10-2007. FILED 1-26-2007.
- 3,297,035. **JIMMY BEANS WOOL (BLOCK FORM)**. JIMMYS WOOL, LLC, (U.S. CLS. 100, 101 AND 102). SN 77-092,994. PUB. 7-10-2007. FILED 1-28-2007.
- 3,297,036. **ENDLESS POSSIBILITIES (BLOCK FORM)**. JIMMYS WOOL, LLC, (U.S. CLS. 100, 101 AND 102). SN 77-092,998. PUB. 7-10-2007. FILED 1-28-2007.
- 3,297,050. **ALABAMA LAUNCHPAD (BLOCK FORM)**. ALABAMA LAUNCHPAD, (U.S. CLS. 100, 101 AND 102). SN 77-093,849. PUB. 7-10-2007. FILED 1-29-2007.
- 3,297,059. **GOOZEX YOUR GAME TRADING COMMUNITY (BLOCK FORM)**. GOOZEX, INC., (U.S. CLS. 100, 101 AND 102). SN 77-095,654. PUB. 7-10-2007. FILED 1-31-2007.
- 3,297,070. **RMI (BLOCK FORM)**. ROCKY MOUNTAIN INSTITUTE, (U.S. CLS. 100, 101 AND 102). SN 77-098,779. PUB. 7-10-2007. FILED 2-4-2007.
- 3,297,075. **Q QUALIGENCE (STYLIZED)**. QUALIGENCE, INC., (U.S. CLS. 100, 101 AND 102). SN 77-100,090. PUB. 7-10-2007. FILED 2-6-2007.
- 3,297,077. **FINEKRAFT (BLOCK FORM)**. FINEKRAFT, INC., (U.S. CLS. 100, 101 AND 102). SN 77-100,441. PUB. 7-10-2007. FILED 2-6-2007.
- 3,297,088. **VIP COSTUMES (BLOCK FORM)**. LETIANNA TRADING COMPANY, LLC, (U.S. CLS. 100, 101 AND 102). SN 77-102,844. PUB. 7-10-2007. FILED 2-8-2007.
- 3,297,089. **SHOP AT HOME CARPETS BRINGING THE STORE TO YOUR DOOR AND DESIGN**. MCCOY, WADE, (U.S. CLS. 100, 101 AND 102). SN 77-102,877. PUB. 7-10-2007. FILED 2-8-2007.
- 3,297,099. **GLASS.NET AND DESIGN**. QUALITYSMITH, INC., (U.S. CLS. 100, 101 AND 102). SN 77-105,292. PUB. 7-10-2007. FILED 2-12-2007.
- 3,297,104. **SEEING WHAT'S POSSIBLE (BLOCK FORM)**. THE CHICAGO LIGHTHOUSE FOR PEOPLE WHO ARE BLIND OR VISUALLY IMPAIRED, MULTIPLE CLASS, (INT. CLS. 35, 38, 41 AND 44), (U.S. CLS. 100, 101, 102, 104 AND 107). SN 77-105,862. PUB. 7-10-2007. FILED 2-13-2007.
- 3,297,111. **ONE CALL FITS ALL (BLOCK FORM)**. PFIZER INC., (U.S. CLS. 100, 101 AND 102). SN 77-108,225. PUB. 7-10-2007. FILED 2-15-2007.
- 3,297,124. **TIME TO PLAY! (BLOCK FORM)**. TARGET BRANDS, INC., (U.S. CLS. 100, 101 AND 102). SN 77-114,317. PUB. 7-10-2007. FILED 2-23-2007.
- 3,297,149. **RFI DIRECT (BLOCK FORM)**. THOMAS PUBLISHING COMPANY, (U.S. CLS. 100, 101 AND 102). SN 77-128,199. PUB. 7-10-2007. FILED 3-12-2007.
- 3,297,152. **KNIGHTSBRIDGE (BLOCK FORM)**. HEWLETT-PACKARD DEVELOPMENT COMPANY, L.P., MULTIPLE CLASS, (INT. CLS. 35, 37 AND 42), (U.S. CLS. 100, 101, 102, 103 AND 106). SN 77-132,444. PUB. 7-10-2007. FILED 3-15-2007.
- 3,297,156. **LUMBER LIQUIDATORS HARDWOOD FLOORING FOR LESS! AND DESIGN**. LUMBER LIQUIDATORS, INC., (U.S. CLS. 100, 101 AND 102). SN 77-135,059. PUB. 7-10-2007. FILED 3-20-2007.
- 3,297,169. **BROAD STREET DIGITAL (BLOCK FORM)**. ARBNET-THEXCHANGE, INC., (U.S. CLS. 100, 101 AND 102). SN 77-149,904. PUB. 7-10-2007. FILED 4-5-2007.
- 3,297,175. **ASP (STYLIZED)**. SHKLAREK, ALON, (U.S. CLS. 100, 101 AND 102). SN 78-090,657. PUB. 7-10-2007. FILED 10-29-2001.
- 3,297,180. **MONSTER WORLDWIDE (BLOCK FORM)**. MONSTER (CALIFORNIA), INC., MULTIPLE CLASS, (INT. CLS. 35, 36, 37, 42, 43, 44 AND 45), (U.S. CLS. 100, 101, 102, 103 AND 106). SN 78-328,861. PUB. 12-5-2006. FILED 11-17-2003.
- 3,297,185. **MAVERIK (BLOCK FORM)**. MAVERIK, INC, (U.S. CLS. 100, 101 AND 102). SN 78-379,330. PUB. 7-10-2007. FILED 3-5-2004.
- 3,297,188. **MISCELLANEOUS DESIGN**. COLEMAN, CHRIS-

- NA A., (U.S. CLS. 100, 101 AND 102), SN 78-425,341. PUB. 4-11-2006. FILED 5-26-2004.
- 3,297,192. **MYOFFICE (BLOCK FORM)**. MYCAREER SOLUTIONS, L.L.C., (U.S. CLS. 100, 101 AND 102), SN 78-441,629. PUB. 7-10-2007. FILED 6-25-2004.
- 3,297,196. **EQUITY MARKETING (BLOCK FORM)**. EMAK WORLDWIDE, INC., (U.S. CLS. 100, 101 AND 102), SN 78-474,435. PUB. 7-10-2007. FILED 8-26-2004.
- 3,297,199. **SCOTIAMOCATTA (BLOCK FORM)**. THE BANK OF NOVA SCOTIA, MULTIPLE CLASS, (INT. CLS. 35 AND 36), (U.S. CLS. 100, 101 AND 102), SN 78-492,079. PUB. 7-10-2007. FILED 9-30-2004.
- 3,297,203. **LOFTS CANAL SIDE.COM URBAN LIVING REDEFINED AND DESIGN**. KIRON, MULTIPLE CLASS, (INT. CLS. 35, 36, 37 AND 42), (U.S. CLS. 100, 101, 102, 103 AND 106), SN 78-497,813. PUB. 7-10-2007. FILED 10-11-2004.
- 3,297,204. **LOFTS CANAL SIDE URBAN LIVING REDEFINED AND DESIGN**. KIRON, MULTIPLE CLASS, (INT. CLS. 35, 36, 37 AND 42), (U.S. CLS. 100, 101, 102, 103 AND 106), SN 78-497,843. PUB. 7-10-2007. FILED 10-11-2004.
- 3,297,205 (*See Class 9 for this trademark*).
- 3,297,213. **QWEST SOLUTIONS CENTER (BLOCK FORM)**. QWEST COMMUNICATIONS INTERNATIONAL INC., (U.S. CLS. 100, 101 AND 102), SN 78-530,030. PUB. 7-10-2007. FILED 12-9-2004.
- 3,297,214. **WINGS FINANCIAL ADVISORS (BLOCK FORM)**. WINGS FINANCIAL FEDERAL CREDIT UNION, MULTIPLE CLASS, (INT. CLS. 35 AND 36), (U.S. CLS. 100, 101 AND 102), SN 78-541,966. PUB. 7-10-2007. FILED 1-4-2005.
- 3,297,215. **A-D (BLOCK FORM)**. AFFILIATED INDEPENDENT DISTRIBUTORS, INC., (U.S. CLS. 100, 101 AND 102), SN 78-554,651. PUB. 7-10-2007. FILED 1-26-2005.
- 3,297,221. **FINESSE DIAMONDS CORP. (BLOCK FORM)**. FINESSE DIAMOND CORPORATION, (U.S. CLS. 100, 101 AND 102), SN 78-569,765. PUB. 7-10-2007. FILED 2-17-2005.
- 3,297,235. **MAGIC CASH (BLOCK FORM)**. JACOBS ENTERTAINMENT, INC., (U.S. CLS. 100, 101 AND 102), SN 78-593,514. PUB. 7-10-2007. FILED 3-23-2005.
- 3,297,236. **MISCELLANEOUS DESIGN**. MAURICE 9TH EARL SPENCER, CHARLES EDWARD, (U.S. CLS. 100, 101 AND 102), SN 78-593,602. PUB. 7-10-2007. FILED 3-23-2005.
- 3,297,249. **RR AND DESIGN**. ROBSON COMMUNITIES, INC., MULTIPLE CLASS, (INT. CLS. 35, 41 AND 43), (U.S. CLS. 100, 101, 102 AND 107), SN 78-623,052. PUB. 4-3-2007. FILED 5-4-2005.
- 3,297,253. **BRUNI GLASS PACKAGING (BLOCK FORM)**. BRUNI GLASS PACKAGING, INC., MULTIPLE CLASS, (INT. CLS. 35 AND 40), (U.S. CLS. 100, 101, 102, 103 AND 106), SN 78-630,667. PUB. 7-10-2007. FILED 5-16-2005.
- 3,297,260 (*See Class 16 for this trademark*).
- 3,297,268. **STAFFLOGIX (BLOCK FORM)**. STAFFLOGIX CORPORATION, MULTIPLE CLASS, (INT. CLS. 35 AND 42), (U.S. CLS. 100, 101 AND 102), SN 78-653,974. PUB. 7-10-2007. FILED 6-20-2005.
- 3,297,273. **U.S. RECORDINGS (BLOCK FORM)**. U.S. RECORDINGS, INC., MULTIPLE CLASS, (INT. CLS. 35, 38 AND 42), (U.S. CLS. 100, 101, 102 AND 104), SN 78-677,808. PUB. 7-10-2007. FILED 7-25-2005.
- 3,297,276. **AUTOMATION TECHNOLOGY EXPO (BLOCK FORM)**. CANON COMMUNICATIONS LLC, (U.S. CLS. 100, 101 AND 102), SN 78-682,991. PUB. 7-10-2007. FILED 8-1-2005.
- 3,297,277. **TOP GUN (BLOCK FORM)**. HOD, AYAL, (U.S. CLS. 100, 101 AND 102), SN 78-683,067. PUB. 12-27-2005. FILED 8-1-2005.
- 3,297,282. **FAME US TALENT COMPETITION AND DESIGN**. MARGHERITIS, SHELLI KAY, (U.S. CLS. 100, 101 AND 102), SN 78-691,121. PUB. 7-10-2007. FILED 8-11-2005.
- 3,297,286. **FRONTIER NUTRITION ONE SOURCE - A WORLD OF NUTRITION AND DESIGN**. FRONTIER NUTRITION INCORPORATED, (U.S. CLS. 100, 101 AND 102), SN 78-697,036. PUB. 2-13-2007. FILED 8-21-2005.
- 3,297,287. **EMIRATES SKYCARGO (BLOCK FORM)**. EMIRATES CORPORATION, MULTIPLE CLASS, (INT. CLS. 35 AND 39), (U.S. CLS. 100, 101, 102 AND 105), SN 78-697,439. PUB. 7-10-2007. FILED 8-22-2005.
- 3,297,288. **IDENTITY GUARD (BLOCK FORM)**. INTERSECTIONS INC., MULTIPLE CLASS, (INT. CLS. 35, 36 AND 45), (U.S. CLS. 100, 101 AND 102), SN 78-700,063. PUB. 7-10-2007. FILED 8-25-2005.
- 3,297,290. **IDENTITY GUARD AND DESIGN**. INTERSECTIONS INC., MULTIPLE CLASS, (INT. CLS. 35, 36 AND 45), (U.S. CLS. 100, 101 AND 102), SN 78-702,238. PUB. 7-10-2007. FILED 8-29-2005.
- 3,297,295. **MILLERS DECORATIVE PLUMBING & HARDWARE AND DESIGN**. MILLER, DEBRA, (U.S. CLS. 100, 101 AND 102), SN 78-703,828. PUB. 7-10-2007. FILED 8-30-2005.
- 3,297,298 (*See Class 25 for this trademark*).
- 3,297,312. **HTS AND DESIGN**. HTS, LLC, MULTIPLE CLASS, (INT. CLS. 35, 37 AND 41), (U.S. CLS. 100, 101, 102, 103, 106 AND 107), SN 78-710,642. PUB. 7-10-2007. FILED 9-11-2005.
- 3,297,316. **SPOTLIGHT ADS (BLOCK FORM)**. ADMISSION CORPORATION, (U.S. CLS. 100, 101 AND 102), SN 78-712,092. PUB. 7-10-2007. FILED 9-13-2005.
- 3,297,324. **THE MAR KET AT HOM FURNITURE AND DESIGN**. HOM FURNITURE, INC., (U.S. CLS. 100, 101 AND 102), SN 78-718,387. PUB. 7-10-2007. FILED 9-22-2005.
- 3,297,327. **LAW FIRM PRO BONO CHALLENGE (BLOCK FORM)**. PRO BONO INSTITUTE, (U.S. CLS. 100, 101 AND 102), SN 78-719,333. PUB. 7-10-2007. FILED 9-23-2005.
- 3,297,329. **CRAZY STEREO AND DESIGN**. ASSAD, BECKER Q., MULTIPLE CLASS, (INT. CLS. 35 AND 37), (U.S. CLS. 100, 101, 102, 103 AND 106), SN 78-720,083. PUB. 7-10-2007. FILED 9-25-2005.
- 3,297,331. **LIVE FREE AND RIDE (BLOCK FORM)**. SEACOAST HARLEY-DAVIDSON, INC., (U.S. CLS. 100, 101 AND 102), SN 78-720,704. PUB. 7-10-2007. FILED 9-26-2005.
- 3,297,332. **YOGA 360 WELLNESS STUDIO (BLOCK FORM)**. YOGA 360 INC., MULTIPLE CLASS, (INT. CLS. 35, 41 AND 44), (U.S. CLS. 100, 101, 102 AND 107), SN 78-721,116. PUB. 7-10-2007. FILED 9-27-2005.
- 3,297,347. **PP (STYLIZED)**. EXEL INC., MULTIPLE CLASS, (INT. CLS. 35, 39, 40 AND 42), (U.S. CLS. 100, 101, 102, 103, 105 AND 106), SN 78-730,598. PUB. 7-10-2007. FILED 10-11-2005.
- 3,297,348. **POWER PACKAGING (BLOCK FORM)**. EXEL INC., MULTIPLE CLASS, (INT. CLS. 35, 39, 40 AND 42), (U.S. CLS. 100, 101, 102, 103, 105 AND 106), SN 78-730,797. PUB. 7-10-2007. FILED 10-11-2005.
- 3,297,351. **HEY BABY (BLOCK FORM)**. HEY BABY, INC., (U.S. CLS. 100, 101 AND 102), SN 78-733,830. PUB. 7-10-2007. FILED 10-14-2005.
- 3,297,353. **THE BISON GROUP AND DESIGN**. THE BISON GROUP, MULTIPLE CLASS, (INT. CLS. 35 AND 41), (U.S. CLS. 100, 101, 102 AND 107), SN 78-740,510. PUB. 7-10-2007. FILED 10-26-2005.
- 3,297,366. **REGATTA (BLOCK FORM)**. ALLIANCE TRADING, INC., (U.S. CLS. 100, 101 AND 102), SN 78-755,961. PUB. 7-10-2007. FILED 11-17-2005.
- 3,297,368. **NORTHSTAR CERAMICS (BLOCK FORM)**. NORTHSTAR CERAMIC TRADING, LLC, (U.S. CLS. 100, 101 AND 102), SN 78-757,260. PUB. 7-10-2007. FILED 11-18-2005.
- 3,297,370. **PASSDAWORD (BLOCK FORM)**. SAM MOULTRIE, II, (U.S. CLS. 100, 101 AND 102), SN 78-758,725. PUB. 7-10-2007. FILED 11-21-2005.
- 3,297,378. **QUEENSPLACE (BLOCK FORM)**. ALEXANDERS, DAVID, (U.S. CLS. 100, 101 AND 102), SN 78-765,330. PUB. 7-10-2007. FILED 12-2-2005.
- 3,297,384. **AQUATIC CENTER (BLOCK FORM)**. AQUATIC CENTER INC., MULTIPLE CLASS, (INT. CLS. 35 AND 39), (U.S. CLS. 100, 101, 102 AND 105), SN 78-767,231. PUB. 7-10-2007. FILED 12-6-2005.
- 3,297,387. **POP ON POINT OF PURCHASE ONLINE NETWORK AND DESIGN**. SALADYGA, KEVIN, (U.S. CLS. 100, 101 AND 102), SN 78-768,460. PUB. 7-10-2007. FILED 12-7-2005.
- 3,297,388 (*See Class 16 for this trademark*).
- 3,297,392 (*See Class 9 for this trademark*).
- 3,297,397. **SENSIBLE WEDDINGS (BLOCK FORM)**. LI TEACH, INC., (U.S. CLS. 100, 101 AND 102), SN 78-778,310. PUB. 7-10-2007. FILED 12-21-2005.
- 3,297,398 (*See Class 9 for this trademark*).
- 3,297,403. **PVP (BLOCK FORM)**. PATRIOT EQUITIES, L.P., MULTIPLE CLASS, (INT. CLS. 35 AND 36), (U.S. CLS. 100,

- 101 AND 102). SN 78-782,349. PUB. 7-10-2007. FILED 12-29-2005.
- 3,297,404. **P3 (BLOCK FORM)**. PATRIOT EQUITIES, L.P., MULTIPLE CLASS, (INT. CLS. 35 AND 36), (U.S. CLS. 100, 101 AND 102). SN 78-782,404. PUB. 7-10-2007. FILED 12-29-2005.
- 3,297,413. **DPL (BLOCK FORM)**. REDEMPTION PLUS, (U.S. CLS. 100, 101 AND 102). SN 78-787,794. PUB. 7-10-2007. FILED 1-9-2006.
- 3,297,425 (*See Class 1 for this trademark*).
- 3,297,426. **WINDSOR PLYWOOD (BLOCK FORM)**. WINDSOR PLYWOOD NORTHWEST, INC., (U.S. CLS. 100, 101 AND 102). SN 78-793,748. PUB. 7-10-2007. FILED 1-18-2006.
- 3,297,427 (*See Class 1 for this trademark*).
- 3,297,428 (*See Class 9 for this trademark*).
- 3,297,429 (*See Class 9 for this trademark*).
- 3,297,430 (*See Class 9 for this trademark*).
- 3,297,447. **YOUR MISSION IS OUR PASSION (BLOCK FORM)**. EVENT 360, INC., MULTIPLE CLASS, (INT. CLS. 35, 36 AND 41), (U.S. CLS. 100, 101, 102 AND 107). SN 78-805,754. PUB. 7-10-2007. FILED 2-2-2006.
- 3,297,449. **EYESHARE (BLOCK FORM)**. SORENSEN ASSOCIATES INC, (U.S. CLS. 100, 101 AND 102). SN 78-806,022. PUB. 7-10-2007. FILED 2-2-2006.
- 3,297,456. **COMMERCIAL LENDING EASY AS RESIDENTIAL (BLOCK FORM)**. SILVER HILL FINANCIAL, LLC, (U.S. CLS. 100, 101 AND 102). SN 78-810,064. PUB. 7-10-2007. FILED 2-8-2006.
- 3,297,457. **CLEAR COMMERCIAL LENDING EASY AS RESIDENTIAL (BLOCK FORM)**. SILVER HILL FINANCIAL, LLC, (U.S. CLS. 100, 101 AND 102). SN 78-810,318. PUB. 7-10-2007. FILED 2-8-2006.
- 3,297,459. **CLEAR COMMERCIAL LENDING EASY AS RESIDENTIAL (STYLIZED)**. SILVER HILL FINANCIAL, LLC, (U.S. CLS. 100, 101 AND 102). SN 78-810,343. PUB. 7-10-2007. FILED 2-8-2006.
- 3,297,472. **PROTECTOR PLUS REGISTRATION PROGRAM (BLOCK FORM)**. ROY, SPEED & ROSS LTD., MULTIPLE CLASS, (INT. CLS. 35 AND 40), (U.S. CLS. 100, 101, 102, 103 AND 106). SN 78-818,130. PUB. 7-10-2007. FILED 2-17-2006.
- 3,297,474. **THEGLOBEANDMAIL.COM (BLOCK FORM)**. CTVGLOBEMEDIA PUBLISHING INC./PUBLICATIONS CTVGLOBEMEDIA INC., MULTIPLE CLASS, (INT. CLS. 35 AND 41), (U.S. CLS. 100, 101, 102 AND 107). SN 78-820,115. PUB. 7-10-2007. FILED 2-21-2006.
- 3,297,487. **BRANDMINE (BLOCK FORM)**. MRA ADVERTISING/PRODUCTION SUPPORT SERVICES, INC., (U.S. CLS. 100, 101 AND 102). SN 78-826,255. PUB. 7-10-2007. FILED 3-1-2006.
- 3,297,493. **THE COMPLETE TILE COLLECTION (BLOCK FORM)**. THE COMPLETE TILE COLLECTION, LLC, (U.S. CLS. 100, 101 AND 102). SN 78-829,283. PUB. 7-10-2007. FILED 3-4-2006.
- 3,297,515. **S STAFFORD AND DESIGN**. STAFFORD DEVELOPMENT COMPANY, MULTIPLE CLASS, (INT. CLS. 35 AND 37), (U.S. CLS. 100, 101, 102, 103 AND 106). SN 78-838,486. PUB. 7-10-2007. FILED 3-16-2006.
- 3,297,518. **GOLDEN ORCHARD (BLOCK FORM)**. GOLDEN ORCHARD FRANCHISING, INC., (U.S. CLS. 100, 101 AND 102). SN 78-839,254. PUB. 7-10-2007. FILED 3-16-2006.
- 3,297,519. **GOLDEN ORCHARD AND DESIGN**. GOLDEN ORCHARD FRANCHISING, INC., (U.S. CLS. 100, 101 AND 102). SN 78-839,285. PUB. 7-10-2007. FILED 3-16-2006.
- 3,297,521. **SET THE HOOK! (BLOCK FORM)**. CARR SPECIALTY BAITS, INC., (U.S. CLS. 100, 101 AND 102). SN 78-840,311. PUB. 7-10-2007. FILED S.R. 3-17-2006; AM. P.R. 5-25-2007.
- 3,297,524. **EDUCATIONATLAS.COM (BLOCK FORM)**. LOVELESS, BECTON, (U.S. CLS. 100, 101 AND 102). SN 78-841,529. PUB. 7-10-2007. FILED 3-20-2006.
- 3,297,525 (*See Class 9 for this trademark*).
- 3,297,527 (*See Class 25 for this trademark*).
- 3,297,529 (*See Class 16 for this trademark*).
- 3,297,542. **LINCOLN ELECTRIC AND DESIGN**. THE LINCOLN ELECTRIC COMPANY, (U.S. CLS. 100, 101 AND 102). SN 78-847,529. PUB. 7-10-2007. FILED 3-28-2006.
- 3,297,543. **TEXAS WIDE OPEN FOR BUSINESS AND DESIGN**. OFFICE OF THE GOVERNOR, STATE OF TEXAS, MULTIPLE CLASS, (INT. CLS. 35 AND 36), (U.S. CLS. 100, 101 AND 102). SN 78-848,232. PUB. 7-10-2007. FILED 3-28-2006.
- 3,297,547. **BEST DOCTORS AND DESIGN**. BEST DOCTORS, INC., (U.S. CLS. 100, 101 AND 102). SN 78-850,451. PUB. 7-10-2007. FILED 3-30-2006.
- 3,297,556. **PIVOTPOINT SOLUTIONS AND DESIGN**. PIVOTPOINT SOLUTIONS, (U.S. CLS. 100, 101 AND 102). SN 78-852,517. PUB. 11-28-2006. FILED 4-3-2006.
- 3,297,558. **STERICYCLE EXPERT RECALL (BLOCK FORM)**. STERICYCLE, INC., (U.S. CLS. 100, 101 AND 102). SN 78-852,918. PUB. 7-10-2007. FILED 4-3-2006.
- 3,297,564. **LUNAMETRICS (BLOCK FORM)**. LUNAMETRICS, LLC, MULTIPLE CLASS, (INT. CLS. 35 AND 42), (U.S. CLS. 100, 101 AND 102). SN 78-855,488. PUB. 7-10-2007. FILED 4-6-2006.
- 3,297,573. **PIH (BLOCK FORM)**. PARTNERS IN HEALTH, A NONPROFIT CORPORATION, MULTIPLE CLASS, (INT. CLS. 35, 41, 42, 44 AND 45), (U.S. CLS. 100, 101, 102 AND 107). SN 78-857,650. PUB. 7-10-2007. FILED 4-10-2006.
- 3,297,580. **BALLROOM DANCE TEACHERS COLLEGE (BLOCK FORM)**. JARMOLOW, DIANE, MULTIPLE CLASS, (INT. CLS. 35 AND 41), (U.S. CLS. 100, 101, 102 AND 107). SN 78-858,961. PUB. 7-10-2007. FILED 4-11-2006.
- 3,297,581. **MISCELLANEOUS DESIGN**. SVI, LLC, (U.S. CLS. 100, 101 AND 102). SN 78-859,181. PUB. 7-10-2007. FILED 4-11-2006.
- 3,297,590. **CARGAS (BLOCK FORM)**. CARGAS SYSTEMS, INC., MULTIPLE CLASS, (INT. CLS. 35 AND 42), (U.S. CLS. 100, 101 AND 102). SN 78-861,548. PUB. 7-10-2007. FILED 4-14-2006.
- 3,297,594. **ARTIZAN (BLOCK FORM)**. ARTIZAN INTERNET SERVICES, LLC, MULTIPLE CLASS, (INT. CLS. 35 AND 42), (U.S. CLS. 100, 101 AND 102). SN 78-861,847. PUB. 7-10-2007. FILED 4-14-2006.
- 3,297,596. **ARTIZAN AND DESIGN**. ARTIZAN INTERNET SERVICES, LLC, MULTIPLE CLASS, (INT. CLS. 35 AND 42), (U.S. CLS. 100, 101 AND 102). SN 78-861,865. PUB. 7-10-2007. FILED 4-14-2006.
- 3,297,597. **ACTIVE 20-30 INTERNATIONAL AND DESIGN**. ACTIVE 20-30 USA & CANADA, MULTIPLE CLASS, (INT. CLS. 35, 36 AND 41), (U.S. CLS. 100, 101, 102 AND 107). SN 78-861,994. PUB. 7-10-2007. FILED 4-14-2006.
- 3,297,598. **ACTIVE 20-30 (BLOCK FORM)**. ACTIVE 20-30 USA & CANADA, MULTIPLE CLASS, (INT. CLS. 35, 36 AND 41), (U.S. CLS. 100, 101, 102 AND 107). SN 78-862,002. PUB. 7-10-2007. FILED 4-14-2006.
- 3,297,600. **ZENGO WIRELESS AND DESIGN**. BANKS, KHALISHA T., (U.S. CLS. 100, 101 AND 102). SN 78-862,278. PUB. 4-17-2007. FILED 4-15-2006.
- 3,297,601. **DAILYBLOWOUTS.COM (BLOCK FORM)**. RAWDIN, RICH S., (U.S. CLS. 100, 101 AND 102). SN 78-862,381. PUB. 7-10-2007. FILED 4-16-2006.
- 3,297,603. **TEAMCONNECTION AND DESIGN**. TEAM CONNECTION, INC., (U.S. CLS. 100, 101 AND 102). SN 78-862,611. PUB. 7-10-2007. FILED 4-17-2006.
- 3,297,618. **WHATEVERLIFE (BLOCK FORM)**. WHATEVERLIFE, INC., MULTIPLE CLASS, (INT. CLS. 35, 41 AND 42), (U.S. CLS. 100, 101, 102 AND 107). SN 78-863,882. PUB. 7-10-2007. FILED 4-18-2006.
- 3,297,634. **BLUEBLASTMEDIA (BLOCK FORM)**. YPG MEDIA, LLC, (U.S. CLS. 100, 101 AND 102). SN 78-867,630. PUB. 7-10-2007. FILED 4-24-2006.
- 3,297,636. **CPC CHILDREN'S PERSONAL CONDUCT BODY & MIND AND DESIGN**. TAEKWORLD, (U.S. CLS. 100, 101 AND 102). SN 78-868,140. PUB. 7-10-2007. FILED 4-24-2006.
- 3,297,637. **MPCRUDE (BLOCK FORM)**. M P MATHEWS LC, (U.S. CLS. 100, 101 AND 102). SN 78-868,700. PUB. 7-10-2007. FILED 4-25-2006.
- 3,297,644. **AIRSPEED (BLOCK FORM)**. THE LEADING EDGE GROUP, LLC, MULTIPLE CLASS, (INT. CLS. 35, 36, 37, 39 AND 42), (U.S. CLS. 100, 101, 102, 103, 105 AND 106). SN 78-869,771. PUB. 7-10-2007. FILED 4-26-2006.
- 3,297,646 (*See Class 9 for this trademark*).
- 3,297,669. **ZOODANGO (BLOCK FORM)**. ZOODANGO INC, MULTIPLE CLASS, (INT. CLS. 35, 41 AND 45), (U.S. CLS. 100, 101, 102 AND 107). SN 78-872,781. PUB. 7-10-2007. FILED 4-29-2006.

- 3,297,671. **LUNAMETRICS AND DESIGN**. LUNAMETRICS, LLC, MULTIPLE CLASS, (INT. CLS. 35 AND 42), (U.S. CLS. 100, 101 AND 102). SN 78-872,865. PUB. 7-10-2007. FILED 4-29-2006.
- 3,297,674. **MISCELLANEOUS DESIGN**. COMPTEL, (U.S. CLS. 100, 101 AND 102). SN 78-873,410. PUB. 7-10-2007. FILED 5-1-2006.
- 3,297,677. **IMPACT MOBILE MEDIA (BLOCK FORM)**. IMPACT MOBILE MEDIA, LLC, (U.S. CLS. 100, 101 AND 102). SN 78-873,948. PUB. 7-10-2007. FILED 5-1-2006.
- 3,297,678 (*See Class 25 for this trademark*).
- 3,297,692. **ISLAND GROWN MARTHA'S VINEYARD AND DESIGN**. ALICE J. BERLOW, D/B/A THE ISLAND GROWN INITIATIVE, (U.S. CLS. 100, 101 AND 102). SN 78-877,049. PUB. 7-10-2007. FILED 5-4-2006.
- 3,297,709. **THE BRAIN ANEURYSM FOUNDATION (BLOCK FORM)**. THE BRAIN ANEURYSM FOUNDATION, INC., MULTIPLE CLASS, (INT. CLS. 35, 36 AND 41), (U.S. CLS. 100, 101, 102 AND 107). SN 78-880,793. PUB. 7-10-2007. FILED 5-10-2006.
- 3,297,713. **YVES BÉHAR (BLOCK FORM)**. BÉHAR, YVES, MULTIPLE CLASS, (INT. CLS. 35 AND 42), (U.S. CLS. 100, 101 AND 102). SN 78-881,979. PUB. 7-10-2007. FILED 5-11-2006.
- 3,297,757 (*See Class 9 for this trademark*).
- 3,297,762. **INCREASING REVENUE IR AND DESIGN**. INCREASING REVENUE, INC., MULTIPLE CLASS, (INT. CLS. 35 AND 41), (U.S. CLS. 100, 101, 102 AND 107). SN 78-888,682. PUB. 7-10-2007. FILED 5-22-2006.
- 3,297,769. **NATURE'S PROMISE (BLOCK FORM)**. AHOLD LICENSING SA, (U.S. CLS. 100, 101 AND 102). SN 78-889,886. PUB. 7-10-2007. FILED 5-26-2006.
- 3,297,773 (*See Class 10 for this trademark*).
- 3,297,783. **SETDEPO (BLOCK FORM)**. SET DEPO, LLC, MULTIPLE CLASS, (INT. CLS. 35, 41 AND 42), (U.S. CLS. 100, 101, 102 AND 107). SN 78-893,592. PUB. 7-10-2007. FILED 5-25-2006.
- 3,297,784. **THE EVOLUTION OF DEPOSITION MANAGEMENT (BLOCK FORM)**. SET DEPO, LLC, MULTIPLE CLASS, (INT. CLS. 35, 41 AND 42), (U.S. CLS. 100, 101, 102 AND 107). SN 78-893,597. PUB. 7-10-2007. FILED 5-25-2006.
- 3,297,806. **ENCHANTRESS BOUTIQUE AND DESIGN**. SPILSBURY BRITTA, (U.S. CLS. 100, 101 AND 102). SN 78-898,724. PUB. 7-10-2007. FILED 6-1-2006.
- 3,297,810. **CRYSTAL COMPASS AND DESIGN**. CRYSTAL COMPASS CONSULTING, LLC, MULTIPLE CLASS, (INT. CLS. 35 AND 36), (U.S. CLS. 100, 101 AND 102). SN 78-899,584. PUB. 7-10-2007. FILED 6-2-2006.
- 3,297,815. **BLUE & CREAM (BLOCK FORM)**. SUDACK, MARK, (U.S. CLS. 100, 101 AND 102). SN 78-900,491. PUB. 7-10-2007. FILED 6-5-2006.
- 3,297,822. **MISCELLANEOUS DESIGN**. MEDIMETRIX GROUP, INC., MULTIPLE CLASS, (INT. CLS. 35, 41 AND 44), (U.S. CLS. 100, 101, 102 AND 107). SN 78-901,428. PUB. 7-10-2007. FILED 6-6-2006.
- 3,297,833. **MAGIC CITY CIGARS (BLOCK FORM)**. LAURENCIO, WALDO, (U.S. CLS. 100, 101 AND 102). SN 78-902,632. PUB. 7-10-2007. FILED 6-7-2006.
- 3,297,841. **RGA (BLOCK FORM)**. RUBBER & GASKET COMPANY OF AMERICA, INC., MULTIPLE CLASS, (INT. CLS. 35, 37 AND 40), (U.S. CLS. 100, 101, 102, 103 AND 106). SN 78-903,124. PUB. 7-10-2007. FILED 6-7-2006.
- 3,297,842. **RGA AN EMPLOYEE OWNED COMPANY AND DESIGN**. RUBBER & GASKET COMPANY OF AMERICA, INC., MULTIPLE CLASS, (INT. CLS. 35, 37 AND 40), (U.S. CLS. 100, 101, 102, 103 AND 106). SN 78-903,472. PUB. 7-10-2007. FILED 6-8-2006.
- 3,297,848 (*See Class 9 for this trademark*).
- 3,297,854. **EPERITUS (BLOCK FORM)**. EPERITUS, LLC, MULTIPLE CLASS, (INT. CLS. 35, 36, 37 AND 42), (U.S. CLS. 100, 101, 102, 103 AND 106). SN 78-905,055. PUB. 7-10-2007. FILED 6-9-2006.
- 3,297,857. **FASA (BLOCK FORM)**. FASHION ACCESSORIES SHIPPERS ASSOCIATION, INC., (U.S. CLS. 100, 101 AND 102). SN 78-905,723. PUB. 7-10-2007. FILED 6-12-2006.
- 3,297,867. **VOX (BLOCK FORM)**. VOX, INCORPORATED, (U.S. CLS. 100, 101 AND 102). SN 78-906,300. PUB. 7-10-2007. FILED 6-12-2006.
- 3,297,884. **AMBASSADORS FOR CHILDREN (BLOCK FORM)**. AMBASSADORS FOR CHILDREN, (U.S. CLS. 100, 101 AND 102). SN 78-907,673. PUB. 7-10-2007. FILED 6-14-2006.
- 3,297,885. **AMBASSADORS FOR CHILDREN AND DESIGN**. AMBASSADORS FOR CHILDREN, (U.S. CLS. 100, 101 AND 102). SN 78-907,678. PUB. 7-10-2007. FILED 6-14-2006.
- 3,297,886. **RR ROCKIT RANCH PRODUCTIONS (STYLIZED)**. ROCKIT RANCH PRODUCTIONS, INC., MULTIPLE CLASS, (INT. CLS. 35 AND 41), (U.S. CLS. 100, 101, 102 AND 107). SN 78-907,904. PUB. 7-10-2007. FILED 6-14-2006.
- 3,297,890. **T3 (BLOCK FORM)**. ANDERSON PERFORMANCE IMPROVEMENT COMPANY, LTD., (U.S. CLS. 100, 101 AND 102). SN 78-908,378. PUB. 7-10-2007. FILED 6-14-2006.
- 3,297,896. **FLEXITY SOLUTIONS (BLOCK FORM)**. FLEXITY SOLUTIONS INC., MULTIPLE CLASS, (INT. CLS. 35, 36 AND 42), (U.S. CLS. 100, 101 AND 102). SN 78-909,647. PUB. 7-10-2007. FILED 6-15-2006.
- 3,297,897. **F FLEXITY SOLUTIONS AND DESIGN**. FLEXITY SOLUTIONS INC., MULTIPLE CLASS, (INT. CLS. 35, 36 AND 42), (U.S. CLS. 100, 101 AND 102). SN 78-909,649. PUB. 7-10-2007. FILED 6-15-2006.
- 3,297,901. **RENTBUREAU (BLOCK FORM)**. RENTBUREAU, LLC, (U.S. CLS. 100, 101 AND 102). SN 78-910,672. PUB. 7-10-2007. FILED 6-17-2006.
- 3,297,905. **MECHANICAL SERVICE CONTRACTORS OF AMERICA MSCA AND DESIGN**. MECHANICAL CONTRACTORS ASSOCIATION OF AMERICA, INC., (U.S. CLS. 100, 101 AND 102). SN 78-911,202. PUB. 7-10-2007. FILED 6-19-2006.
- 3,297,907. **CHARTING THE RETURN PATH TO YOUR WORLD (BLOCK FORM)**. BACKCHANNELMEDIA, INC., (U.S. CLS. 100, 101 AND 102). SN 78-911,559. PUB. 7-10-2007. FILED 6-19-2006.
- 3,297,910. **AAT COMMUNICATIONS A SUBSIDIARY OF SBA COMMUNICATIONS CORPORATION AND DESIGN**. AAT COMMUNICATIONS CORP., MULTIPLE CLASS, (INT. CLS. 35, 37 AND 38), (U.S. CLS. 100, 101, 102, 103, 104 AND 106). SN 78-912,078. PUB. 7-10-2007. FILED 6-20-2006.
- 3,297,911. **FIGURE AT SEA (BLOCK FORM)**. CSPE, LLC, (U.S. CLS. 100, 101 AND 102). SN 78-912,242. PUB. 7-10-2007. FILED 6-20-2006.
- 3,297,912. **3D AND DESIGN**. BACKCHANNELMEDIA, INC., (U.S. CLS. 100, 101 AND 102). SN 78-912,499. PUB. 7-10-2007. FILED 6-20-2006.
- 3,297,913. **ETSY (BLOCK FORM)**. ETSY, INC., (U.S. CLS. 100, 101 AND 102). SN 78-912,570. PUB. 7-10-2007. FILED 6-20-2006.
- 3,297,916. **GALERIE D'ORSAY (BLOCK FORM)**. GALERIE D'ORSAY, LLC, (U.S. CLS. 100, 101 AND 102). SN 78-913,712. PUB. 7-10-2007. FILED 6-21-2006.
- 3,297,920 (*See Class 20 for this trademark*).
- 3,297,926. **EXCLAMATION, WITH A POINT (BLOCK FORM)**. CLEAR!BLUE HOLDINGS, LLC, (U.S. CLS. 100, 101 AND 102). SN 78-916,904. PUB. 7-10-2007. FILED 6-26-2006.
- 3,297,934. **NTS NAIL TECHNICIANS SUPPLY AND DESIGN**. NAIL TECH SUPPLY, INC., (U.S. CLS. 100, 101 AND 102). SN 78-918,784. PUB. 7-10-2007. FILED 6-28-2006.
- 3,297,943. **GO GALERIE D'ORSAY THE FINEST IN MASTER WORKS AND DESIGN**. GALERIE D'ORSAY, (U.S. CLS. 100, 101 AND 102). SN 78-919,572. PUB. 7-10-2007. FILED 6-29-2006.
- 3,297,947. **KMART (BLOCK FORM)**. KMART OF MICHIGAN, INC., (U.S. CLS. 100, 101 AND 102). SN 78-920,275. PUB. 7-10-2007. FILED 6-29-2006.
- 3,297,948. **EIP EARNED INCOME PROGRAM (BLOCK FORM)**. GLOBAL DIRECT SALES LLC, (U.S. CLS. 100, 101 AND 102). SN 78-920,654. PUB. 7-10-2007. FILED 6-30-2006.
- 3,297,949. **DPFUNDER AND DESIGN**. GLOBAL DIRECT SALES LLC, (U.S. CLS. 100, 101 AND 102). SN 78-920,678. PUB. 7-10-2007. FILED 6-30-2006.
- 3,297,951. **POPS POPS POPS (STYLIZED)**. GENERAL HOLDINGS, LLC, (U.S. CLS. 100, 101 AND 102). SN 78-921,096. PUB. 2-6-2007. FILED 6-30-2006.
- 3,297,955. **PROJECT HOME AGAIN (BLOCK FORM)**. MECHANICAL CONTRACTORS ASSOCIATION OF AMERICA, INC., (U.S. CLS. 100, 101 AND 102). SN 78-922,669.

- PUB. 7-10-2007. FILED 7-5-2006.
 3,297,959 (*See Class 33 for this trademark*).
 3,297,971. **ODELL'S (BLOCK FORM)**, ODELL'S, (U.S. CLS. 100, 101 AND 102). SN 78-926,175. PUB. 7-10-2007. FILED 7-10-2006.
 3,297,973. **THE ULTIMATE RECRUITING EXPERIENCE (BLOCK FORM)**, ROUSH, GAVIN, (U.S. CLS. 100, 101 AND 102). SN 78-926,290. PUB. 7-10-2007. FILED 7-10-2006.
 3,297,974. **I'M A SUPERFIT KID AND DESIGN**, IAN'S NATURAL FOODS, INC., MULTIPLE CLASS, (INT. CLS. 35 AND 41), (U.S. CLS. 100, 101, 102 AND 107). SN 78-926,608. PUB. 7-10-2007. FILED 7-11-2006.
 3,297,978. **PROFUSION CONSULTING (BLOCK FORM)**, PROFUSION CONSULTING, MULTIPLE CLASS, (INT. CLS. 35, 36 AND 42), (U.S. CLS. 100, 101 AND 102). SN 78-928,050. PUB. 7-10-2007. FILED 7-12-2006.
 3,297,979. **PROFUSION CONSULTING AND DESIGN**, PROFUSION CONSULTING, MULTIPLE CLASS, (INT. CLS. 35, 36 AND 42), (U.S. CLS. 100, 101 AND 102). SN 78-928,077. PUB. 7-10-2007. FILED 7-12-2006.
 3,298,000. **GODDESS NIGHT OUT (BLOCK FORM)**, PATERNO IMPORTS, LTD., D/B/A PATERNO WINES INTERNATIONAL, (U.S. CLS. 100, 101 AND 102). SN 78-933,169. PUB. 7-10-2007. FILED 7-19-2006.
 3,298,012. **VILLAGE HOMES (BLOCK FORM)**, VILLAGE HOMES OF COLORADO, INC., MULTIPLE CLASS, (INT. CLS. 35, 36, 37, 41 AND 42), (U.S. CLS. 100, 101, 102, 103, 106 AND 107). SN 78-936,240. PUB. 7-10-2007. FILED 7-24-2006.
 3,298,022. **MISCELLANEOUS DESIGN**, BRAZOS ELECTRIC POWER COOPERATIVE, INC., MULTIPLE CLASS, (INT. CLS. 35, 39 AND 40), (U.S. CLS. 100, 101, 102, 103, 105 AND 106). SN 78-940,906. PUB. 7-10-2007. FILED 7-31-2006.
 3,298,028. **MISCELLANEOUS DESIGN**, APPLE INC., MULTIPLE CLASS, (INT. CLS. 35 AND 41), (U.S. CLS. 100, 101, 102 AND 107). SN 78-943,482. PUB. 7-10-2007. FILED 8-2-2006.
 3,298,037 (*See Class 9 for this trademark*).
 3,298,041. **FRCH DESIGN WORLDWIDE (BLOCK FORM)**, FRCH DESIGN WORLDWIDE-CINCINNATI, INC., MULTIPLE CLASS, (INT. CLS. 35, 37, 42 AND 45), (U.S. CLS. 100, 101, 102, 103 AND 106). SN 78-948,649. PUB. 7-10-2007. FILED 8-9-2006.
 3,298,046. **SYSTEMIC SMARTS (BLOCK FORM)**, JOSEPH, TAYLERE M, MULTIPLE CLASS, (INT. CLS. 35 AND 41), (U.S. CLS. 100, 101, 102 AND 107). SN 78-949,749. PUB. 7-10-2007. FILED 8-10-2006.
 3,298,047. **WORDS PEOPLE READ (BLOCK FORM)**, ALL WRITE PUBLISHING, LLC, DBA ALLWRITE INK, (U.S. CLS. 100, 101 AND 102). SN 78-949,881. PUB. 7-10-2007. FILED 8-10-2006.
 3,298,049. **POCKET EXPRESS (BLOCK FORM)**, HAND-MARK, INC., MULTIPLE CLASS, (INT. CLS. 35 AND 38), (U.S. CLS. 100, 101, 102 AND 104). SN 78-950,434. PUB. 7-10-2007. FILED 8-11-2006.
 3,298,050. **APL (STYLIZED)**, AMATEUR POKER LEAGUE, INC., MULTIPLE CLASS, (INT. CLS. 35 AND 41), (U.S. CLS. 100, 101, 102 AND 107). SN 78-950,487. PUB. 7-10-2007. FILED 8-11-2006.
 3,298,081. **SUSTAINABLE STYLE FOUNDATION (BLOCK FORM)**, SUSTAINABLE STYLE FOUNDATION, MULTIPLE CLASS, (INT. CLS. 35 AND 42), (U.S. CLS. 100, 101 AND 102). SN 78-957,466. PUB. 7-10-2007. FILED 8-22-2006.
 3,298,084. **AMERICAN HEALTH NETWORK AND DESIGN**, AMERICAN HEALTH NETWORK, INC., MULTIPLE CLASS, (INT. CLS. 35 AND 44), (U.S. CLS. 100, 101 AND 102). SN 78-958,883. PUB. 7-10-2007. FILED 8-23-2006.
 3,298,085. **BRAVOSOLUTION (BLOCK FORM)**, BRAVOSOLUTION S.P.A., (U.S. CLS. 100, 101 AND 102). SN 78-959,268. PUB. 7-10-2007. FILED 8-24-2006.
 3,298,090. **ORGAN DONORS LIVE ON BOB SWANSON GIVE A LIFE FOUNDATION (BLOCK FORM)**, BOB SWANSON GIVE A LIFE FOUNDATION, INC., (U.S. CLS. 100, 101 AND 102). SN 78-960,543. PUB. 7-10-2007. FILED 8-25-2006.
 3,298,092. **MERRY GARDENERS (BLOCK FORM)**, MERRY GARDENERS, (U.S. CLS. 100, 101 AND 102). SN 78-961,052. PUB. 7-10-2007. FILED 8-25-2006.
 3,298,095 (*See Class 29 for this trademark*).
 3,298,096. **PLANNING IS POWER (BLOCK FORM)**, PLANNED PARENTHOOD OF NEW YORK CITY, INC., (U.S. CLS. 100, 101 AND 102). SN 78-962,289. PUB. 7-10-2007. FILED 8-28-2006.
 3,298,103. **BECK AG AND DESIGN**, BECK AG, INC., (U.S. CLS. 100, 101 AND 102). SN 78-962,850. PUB. 6-5-2007. FILED 8-29-2006.
 3,298,106. **GEA . GLOBAL ENVELOPE ALLIANCE . INCREASING THE VALUE & VOLUME OF MAIL AND DESIGN**, ENVELOPE MANUFACTURERS ASSOCIATION, (U.S. CLS. 100, 101 AND 102). SN 78-963,473. PUB. 7-10-2007. FILED 8-30-2006.
 3,298,110. **AMMACHI PUBLICATIONS (BLOCK FORM)**, MATA AMRITANANDAMAYI CENTER, (U.S. CLS. 100, 101 AND 102). SN 78-963,924. PUB. 7-10-2007. FILED 8-30-2006.
 3,298,111. **MA (STYLIZED)**, MACROECONOMIC ADVISERS, L.L.C., MULTIPLE CLASS, (INT. CLS. 35 AND 36), (U.S. CLS. 100, 101 AND 102). SN 78-963,955. PUB. 7-10-2007. FILED 8-30-2006.
 3,298,114. **JERKS AT WORK AND DESIGN**, LLOYD, KENNETH L., (U.S. CLS. 100, 101 AND 102). SN 78-964,281. PUB. 7-10-2007. FILED 8-30-2006.
 3,298,123. **WATERVILLE, OHIO ON THE BANKS OF HISTORY AND DESIGN**, VILLAGE OF WATERVILLE, (U.S. CLS. 100, 101 AND 102). SN 78-967,322. PUB. 5-8-2007. FILED 9-5-2006.
 3,298,138 (*See Class 16 for this trademark*).
 3,298,147 (*See Class 14 for this trademark*).
 3,298,151. **DRIVEUSA (BLOCK FORM)**, INOFIN, MULTIPLE CLASS, (INT. CLS. 35, 37 AND 39), (U.S. CLS. 100, 101, 102, 103, 105 AND 106). SN 78-978,755. PUB. 9-6-2005. FILED 7-2-2004.
 3,298,152 (*See Class 16 for this trademark*).
 3,298,160 (*See Class 20 for this trademark*).
 3,298,161. **LINEAR SOURCE (BLOCK FORM)**, CLARIANT AG, MULTIPLE CLASS, (INT. CLS. 35 AND 38), (U.S. CLS. 100, 101, 102 AND 104). SN 79-014,807. PUB. 7-10-2007. FILED 8-3-2005.
 3,298,162 (*See Class 9 for this trademark*).
 3,298,165. **MX THE MANUFACTURING EXCELLENCE AWARDS AND DESIGN**, THE INSTITUTION OF MECHANICAL ENGINEERS, MULTIPLE CLASS, (INT. CLS. 35 AND 41), (U.S. CLS. 100, 101, 102 AND 107). SN 79-016,274. PUB. 7-10-2007. FILED 5-3-2005.
 3,298,166 (*See Class 9 for this trademark*).
 3,298,167 (*See Class 7 for this trademark*).
 3,298,173 (*See Class 9 for this trademark*).
 3,298,178 (*See Class 9 for this trademark*).
 3,298,184. **FAST STRATEGY CENTER AND DESIGN**, WERY PHILIPPE, MULTIPLE CLASS, (INT. CLS. 35 AND 38), (U.S. CLS. 100, 101, 102 AND 104). SN 79-019,129. PUB. 7-10-2007. FILED 11-21-2005.
 3,298,189. **SUEZ ENVIRONNEMENT (STYLIZED)**, SUEZ ENVIRONNEMENT, MULTIPLE CLASS, (INT. CLS. 35, 37, 39 AND 42), (U.S. CLS. 100, 101, 102, 103, 105 AND 106). SN 79-019,534. PUB. 7-10-2007. FILED 8-26-2005.
 3,298,190. **SUEZ ENVIRONMENT (STYLIZED)**, SUEZ ENVIRONNEMENT, MULTIPLE CLASS, (INT. CLS. 35, 37, 39 AND 42), (U.S. CLS. 100, 101, 102, 103, 105 AND 106). SN 79-019,535. PUB. 7-10-2007. FILED 8-26-2005.
 3,298,193. **ONDEO INDUSTRIAL SOLUTIONS SUEZ AND DESIGN**, SUEZ ENVIRONNEMENT, MULTIPLE CLASS, (INT. CLS. 35, 37, 39 AND 42), (U.S. CLS. 100, 101, 102, 103, 105 AND 106). SN 79-019,599. PUB. 7-10-2007. FILED 8-26-2005.
 3,298,201 (*See Class 29 for this trademark*).
 3,298,213. **URALSIB (BLOCK FORM)**, OPEN JOINT STOCK COMPANY; "BANK URALSIB", MULTIPLE CLASS, (INT. CLS. 35 AND 36), (U.S. CLS. 100, 101 AND 102). SN 79-022,629. PUB. 7-10-2007. FILED 12-23-2005.
 3,298,220. **RETECASA (STYLIZED)**, RETECASA S.P.A., MULTIPLE CLASS, (INT. CLS. 35 AND 36), (U.S. CLS. 100, 101 AND 102). SN 79-023,222. PUB. 7-10-2007. FILED 3-29-2006.
 3,298,235. **ALYSSA (BLOCK FORM)**, ALYSSA YACHT CHARTER & BROKER AG, MULTIPLE CLASS, (INT. CLS. 35, 36 AND 39), (U.S. CLS. 100, 101, 102 AND 105). SN 79-024,541. PUB. 7-10-2007. FILED 5-2-2006.
 3,298,240 (*See Class 9 for this trademark*).
 3,298,242 (*See Class 18 for this trademark*).

- 3,298,247. **ECO SECURITIES AND DESIGN**. ECOSECURITIES GROUP LIMITED, MULTIPLE CLASS, (INT. CLS. 35, 36, 42 AND 44), (U.S. CLS. 100, 101 AND 102). SN 79-025,017. PUB. 7-10-2007. FILED 5-18-2006.
- 3,298,283. **RENO (BLOCK FORM)**. RENO SCHUHCENTRUM GMBH, (U.S. CLS. 100, 101 AND 102). SN 79-027,072. PUB. 7-10-2007. FILED 2-22-2006.
- 3,298,286 (*See Class 16 for this trademark*).
- 3,298,295 (*See Class 16 for this trademark*).
- 3,298,302 (*See Class 18 for this trademark*).
- 3,298,320. **HESPERION (BLOCK FORM)**. HESPERION LTD., MULTIPLE CLASS, (INT. CLS. 35 AND 42), (U.S. CLS. 100, 101 AND 102). SN 79-028,618. PUB. 7-10-2007. FILED 8-29-2006.
- 3,298,321. **H AND DESIGN**. HESPERION LTD., MULTIPLE CLASS, (INT. CLS. 35 AND 42), (U.S. CLS. 100, 101 AND 102). SN 79-028,670. PUB. 7-10-2007. FILED 8-29-2006.
- 3,298,329. **MISCELLANEOUS DESIGN**. KÜHNE + NAGEL INTERNATIONAL AG, MULTIPLE CLASS, (INT. CLS. 35, 36 AND 39), (U.S. CLS. 100, 101, 102 AND 105). SN 79-029,209. PUB. 7-10-2007. FILED 3-3-2006.
- 3,298,333. **AQUABROWSER (BLOCK FORM)**. MEDIALAB SOLUTIONS B.V., MULTIPLE CLASS, (INT. CLS. 35 AND 42), (U.S. CLS. 100, 101 AND 102). SN 79-029,319. PUB. 7-10-2007. FILED 3-29-2006.
- 3,298,334. **AQUABROWSER SEARCH, DISCOVER, REFINE. (BLOCK FORM)**. MEDIALAB SOLUTIONS B.V., MULTIPLE CLASS, (INT. CLS. 35 AND 42), (U.S. CLS. 100, 101 AND 102). SN 79-029,320. PUB. 7-10-2007. FILED 3-29-2006.
- 3,298,339 (*See Class 9 for this trademark*).
- 3,298,344 (*See Class 1 for this trademark*).
- 3,298,351. **SQOOPS WELCOME TO THE OTHER SITE (STYLIZED)**. SQOOPS GMBH, MULTIPLE CLASS, (INT. CLS. 35, 38 AND 41), (U.S. CLS. 100, 101, 102, 104 AND 107). SN 79-030,810. PUB. 7-10-2007. FILED 4-5-2006.
- 3,298,374. **LE VIGNE DEL LAZIO AND DESIGN**. ASSOCIAZIONE "LE VIGNE DEL LAZIO", (U.S. CLS. 100, 101 AND 102). SN 79-032,552. PUB. 7-10-2007. FILED 10-27-2005.
- 3,298,395 (*See Class 9 for this trademark*).
-
- CLASS 36—INSURANCE AND FINANCIAL**
- 3,296,017. **LIVESTRONG AND DESIGN**. LANCE ARMSTRONG FOUNDATION, INC., (U.S. CLS. 100, 101 AND 102). SN 76-644,417. PUB. 6-26-2007. FILED 8-5-2005.
- 3,296,033. **THE OMNI GROUP (BLOCK FORM)**. OMNI FINANCIAL GROUP, INC., MULTIPLE CLASS, (INT. CLS. 36 AND 42), (U.S. CLS. 100, 101 AND 102). SN 76-647,974. PUB. 7-10-2007. FILED 10-3-2005.
- 3,296,034. **MISCELLANEOUS DESIGN**. THE ALDEN B. DOW AND VADA B. DOW CREATIVITY FOUNDATION, DBA THE ALDEN AND VADA DOW FAMILY FOUNDATIONS, (U.S. CLS. 100, 101 AND 102). SN 76-648,112. PUB. 7-10-2007. FILED 10-7-2005.
- 3,296,063. **HEALTHWEB (BLOCK FORM)**. THE TRIZETTO GROUP, INC., (U.S. CLS. 100, 101 AND 102). SN 76-658,594. PUB. 7-10-2007. FILED 4-17-2006.
- 3,296,072. **MISCELLANEOUS DESIGN**. BABSON CAPITAL MANAGEMENT LLC, (U.S. CLS. 100, 101 AND 102). SN 76-660,143. PUB. 7-10-2007. FILED 5-17-2006.
- 3,296,076. **THE CHESAPEAKE LIFE INSURANCE COMPANY (BLOCK FORM)**. THE CHESAPEAKE LIFE INSURANCE COMPANY, (U.S. CLS. 100, 101 AND 102). SN 76-660,534. PUB. 7-10-2007. FILED 5-24-2006.
- 3,296,090. **MANN MERCHANT PROCESSING SYSTEMS AND DESIGN**. MANN MERCHANT PROCESSING SYSTEMS, LLC, (U.S. CLS. 100, 101 AND 102). SN 76-662,200. PUB. 5-22-2007. FILED 6-27-2006.
- 3,296,103 (*See Class 35 for this trademark*).
- 3,296,104 (*See Class 35 for this trademark*).
- 3,296,107. **THE FILIPPIS FOUNDATION AND DESIGN**. THE FILIPPIS FOUNDATION, (U.S. CLS. 100, 101 AND 102). SN 76-664,428. PUB. 7-10-2007. FILED 8-10-2006.
- 3,296,122. **MYNUTRIKIDS.COM (STYLIZED)**. MORIARTY, PAUL, MULTIPLE CLASS, (INT. CLS. 36 AND 44), (U.S. CLS. 100, 101 AND 102). SN 76-666,062. PUB. 7-10-2007. FILED 9-14-2006.
- 3,296,136. **ANDORRA CREDIT REPAIR AND DESIGN**. ANDORRA CREDIT REPAIR, CORP., (U.S. CLS. 100, 101 AND 102). SN 76-667,322. PUB. 7-10-2007. FILED 10-12-2006.
- 3,296,148. **HEALTHY PEOPLE AND DESIGN**. THE LOOMIS COMPANY, MULTIPLE CLASS, (INT. CLS. 36 AND 44), (U.S. CLS. 100, 101 AND 102). SN 76-668,633. PUB. 7-10-2007. FILED 11-7-2006.
- 3,296,182. **RICHSA (BLOCK FORM)**. RICHARDSON & ASSOCIATES, INC., (U.S. CLS. 100, 101 AND 102). SN 76-671,216. PUB. 7-10-2007. FILED 1-10-2007.
- 3,296,197. **WD WESTERN DENTAL AND DESIGN**. WESTERN DENTAL SERVICES, INC., (U.S. CLS. 100, 101 AND 102). SN 76-671,834. PUB. 7-10-2007. FILED 1-25-2007.
- 3,296,204 (*See Class 35 for this trademark*).
- 3,296,212. **ZIP CASH (BLOCK FORM)**. NORTH TEXAS TOLLWAY AUTHORITY, (U.S. CLS. 100, 101 AND 102). SN 76-672,815. PUB. 7-10-2007. FILED 2-15-2007.
- 3,296,216. **SAFE AND SECURE PAYMENTS ON THE GO! (BLOCK FORM)**. PLANET GROUP, INC., (U.S. CLS. 100, 101 AND 102). SN 76-673,865. PUB. 7-10-2007. FILED 3-2-2007.
- 3,296,224. **PENSON FINANCIAL FUTURES (BLOCK FORM)**. PENSON WORLDWIDE, INC., (U.S. CLS. 100, 101 AND 102). SN 77-001,669. PUB. 7-10-2007. FILED 9-18-2006.
- 3,296,251. **AMERICAS INSURANCE ADVISORS AND DESIGN**. BULLOCK, KATHERINE, W, (U.S. CLS. 100, 101 AND 102). SN 77-009,252. PUB. 7-10-2007. FILED 9-28-2006.
- 3,296,272. **BIG BRAIN (BLOCK FORM)**. PENNSYLVANIA HIGHER EDUCATION ASSISTANCE AGENCY (PHEAA), AN AGENCY OF THE COMMONWEALTH OF PENNSYLVANIA, (U.S. CLS. 100, 101 AND 102). SN 77-014,269. PUB. 7-10-2007. FILED 10-5-2006.
- 3,296,277. **MISCELLANEOUS DESIGN**. MEADOWOOD MALL LLC, (U.S. CLS. 100, 101 AND 102). SN 77-015,369. PUB. 7-10-2007. FILED 10-6-2006.
- 3,296,303. **FREEZIN' FOR A REASON (BLOCK FORM)**. CAMP SUNSHINE AT SEBAGO LAKE, INC., (U.S. CLS. 100, 101 AND 102). SN 77-022,458. PUB. 7-10-2007. FILED 10-17-2006.
- 3,296,313 (*See Class 35 for this trademark*).
- 3,296,318. **TURN TO BLUE (BLOCK FORM)**. BLUE CROSS AND BLUE SHIELD ASSOCIATION, (U.S. CLS. 100, 101 AND 102). SN 77-025,327. PUB. 7-10-2007. FILED 10-19-2006.
- 3,296,342. **AMERICAN HEARTLAND CABINS OF HOCKING HILLS OHIO (BLOCK FORM)**. COOK, CAROLINE J, AND COOK, DOUGLAS, (U.S. CLS. 100, 101 AND 102). SN 77-028,834. PUB. 7-10-2007. FILED 10-25-2006.
- 3,296,387. **GET RETIREMENT RIGHT (BLOCK FORM)**. UNITED OF OMAHA LIFE INSURANCE COMPANY, (U.S. CLS. 100, 101 AND 102). SN 77-035,947. PUB. 7-10-2007. FILED 11-3-2006.
- 3,296,388. **THE REAL ESTATE-XCHANGE ON THE CUTTING EDGE OF TODAY'S MARKETPLACE AND DESIGN**. THE REAL ESTATE-XCHANGE INC., (U.S. CLS. 100, 101 AND 102). SN 77-035,951. PUB. 7-10-2007. FILED 11-3-2006.
- 3,296,442. **MISCELLANEOUS DESIGN**. K2 ADVISORS L.L.C., (U.S. CLS. 100, 101 AND 102). SN 77-044,492. PUB. 7-10-2007. FILED 11-15-2006.
- 3,296,451. **ANGELHEALTHCARE INVESTORS, LLC (STYLIZED)**. ANGELHEALTHCARE INVESTORS, LLC, (U.S. CLS. 100, 101 AND 102). SN 77-045,227. PUB. 7-10-2007. FILED 11-16-2006.
- 3,296,452. **S SEMBLER AND DESIGN**. THE SEMBLER COMPANY, MULTIPLE CLASS, (INT. CLS. 36 AND 37), (U.S. CLS. 100, 101, 102, 103 AND 106). SN 77-045,297. PUB. 7-10-2007. FILED 11-16-2006.
- 3,296,461. **RE/MAX (BLOCK FORM)**. RE/MAX INTERNATIONAL, INC., (U.S. CLS. 100, 101 AND 102). SN 77-046,919. PUB. 7-10-2007. FILED 11-17-2006.
- 3,296,467. **CPEA'S BLOODHOUNDS FOR AMERICA PROGRAM AND DESIGN**. CHILD PROTECTION EDUCATION OF AMERICA, INC., (U.S. CLS. 100, 101 AND 102). SN 77-047,533. PUB. 7-10-2007. FILED 11-20-2006.
- 3,296,493 (*See Class 14 for this trademark*).
- 3,296,496. **DAVESFAVS (BLOCK FORM)**. DAVESFAVS.COM, INC., (U.S. CLS. 100, 101 AND 102). SN 77-052,058. PUB. 7-10-2007. FILED 11-28-2006.
- 3,296,520. **EURO-IN (BLOCK FORM)**. AMERICAN EXPRESS

- MARKETING & DEVELOPMENT CORP., (U.S. CLS. 100, 101 AND 102). SN 77-054,728. PUB. 7-10-2007. FILED 12-1-2006.
- 3,296,533 (*See Class 35 for this trademark*).
- 3,296,537. **ELIST REALTY (STYLIZED)**. CHARLES HORN, (U.S. CLS. 100, 101 AND 102). SN 77-056,618. PUB. 6-26-2007. FILED 12-4-2006.
- 3,296,551. **LONG TERM CARE WORKERS HEALTH TRUST FUND AND DESIGN**. LONG TERM CARE WORKERS HEALTH TRUST FUND, (U.S. CLS. 100, 101 AND 102). SN 77-058,175. PUB. 7-10-2007. FILED 12-6-2006.
- 3,296,574. **FEEDBACK NETWORK AND DESIGN**. FEEDBACKNETWORK, LLC, (U.S. CLS. 100, 101 AND 102). SN 77-060,130. PUB. 7-10-2007. FILED 12-8-2006.
- 3,296,580 (*See Class 35 for this trademark*).
- 3,296,586. **FIRST STEP AND DESIGN**. FIRST STEP LLC, (U.S. CLS. 100, 101 AND 102). SN 77-060,764. PUB. 7-10-2007. FILED S.R. 12-9-2006; AM. P.R. 4-10-2007.
- 3,296,609. **QUALITY LIFE REVERSE MORTGAGE AND DESIGN**. ESTABLISHED MORTGAGE PROFESSIONALS, INC., DBA QUALITY LIFE REVERSE MORTGAGE, (U.S. CLS. 100, 101 AND 102). SN 77-062,105. PUB. 7-10-2007. FILED 12-12-2006.
- 3,296,630. **CONDOSUPERCENTER (STYLIZED)**. ZILBERT REALTY GROUP, INC., (U.S. CLS. 100, 101 AND 102). SN 77-063,080. PUB. 7-10-2007. FILED 12-13-2006.
- 3,296,633. **ZILBERT REALTY GROUP AND DESIGN**. ZILBERT REALTY GROUP, INC., (U.S. CLS. 100, 101 AND 102). SN 77-063,103. PUB. 7-10-2007. FILED 12-13-2006.
- 3,296,634. **MLSGATEWAY (BLOCK FORM)**. MLSOK.COM, INC., (U.S. CLS. 100, 101 AND 102). SN 77-063,105. PUB. 7-10-2007. FILED 12-13-2006.
- 3,296,635. **EXPECT THE BEST (BLOCK FORM)**. LIBERTY NATIONAL BANK, (U.S. CLS. 100, 101 AND 102). SN 77-063,335. PUB. 7-10-2007. FILED 12-13-2006.
- 3,296,653. **TOYS FOR BIGGER BOYS (BLOCK FORM)**. DENNIS PUBLISHING, INC., (U.S. CLS. 100, 101 AND 102). SN 77-063,949. PUB. 7-10-2007. FILED 12-14-2006.
- 3,296,656. **THE NEW WAY TO AGE CAMPAIGN AND DESIGN**. PRESBYTERIAN VILLAGES OF MICHIGAN FOUNDATION, (U.S. CLS. 100, 101 AND 102). SN 77-063,990. PUB. 7-10-2007. FILED 12-14-2006.
- 3,296,679. **QSG (BLOCK FORM)**. QUANTITATIVE SERVICES GROUP LLC, (U.S. CLS. 100, 101 AND 102). SN 77-064,501. PUB. 7-10-2007. FILED 12-14-2006.
- 3,296,706. **WORLD'S FAIR (BLOCK FORM)**. WORLD'S FAIR CAPTIAL, INC., (U.S. CLS. 100, 101 AND 102). SN 77-065,104. PUB. 7-10-2007. FILED 12-15-2006.
- 3,296,730. **THE RIGHT BAIL BOND TAKES AN EMPIRE (BLOCK FORM)**. EMPIRE BONDING AGENCY INC., (U.S. CLS. 100, 101 AND 102). SN 77-066,580. PUB. 7-10-2007. FILED 12-18-2006.
- 3,296,736. **BLACKOAK (BLOCK FORM)**. JOHN FOX, (U.S. CLS. 100, 101 AND 102). SN 77-067,987. PUB. 7-10-2007. FILED 12-19-2006.
- 3,296,752. **APARTMENT REALTY ADVISORS (BLOCK FORM)**. APARTMENT REALTY ADVISORS, INC., (U.S. CLS. 100, 101 AND 102). SN 77-072,691. PUB. 7-10-2007. FILED 12-28-2006.
- 3,296,759. **ANGELS AMONG US (BLOCK FORM)**. ANGELS AMONG US, INC., (U.S. CLS. 100, 101 AND 102). SN 77-074,086. PUB. 7-10-2007. FILED 1-2-2007.
- 3,296,772. **LW LIFESETTLEWARE AND DESIGN**. INVESCOR, LTD., (U.S. CLS. 100, 101 AND 102). SN 77-076,248. PUB. 7-10-2007. FILED 1-4-2007.
- 3,296,811. **LAPS FOR CF (BLOCK FORM)**. LAPS FOR CF FOUNDATION INC, (U.S. CLS. 100, 101 AND 102). SN 77-080,962. PUB. 7-10-2007. FILED 1-11-2007.
- 3,296,812 (*See Class 35 for this trademark*).
- 3,296,814. **MISCELLANEOUS DESIGN**. THOMPSON, MARSHA M., AND THOMPSON, FITZROY, (U.S. CLS. 100, 101 AND 102). SN 77-081,605. PUB. 7-10-2007. FILED 1-12-2007.
- 3,296,834. **SILVERTON ARMOR PROTECTION (BLOCK FORM)**. SILVERTON MARINE CORPORATION, (U.S. CLS. 100, 101 AND 102). SN 77-084,433. PUB. 7-10-2007. FILED 1-17-2007.
- 3,296,842. **ALLODIUM INVESTMENT CONSULTANTS (BLOCK FORM)**. ALLODIUM INVESTMENT CONSULTANTS, LLC, (U.S. CLS. 100, 101 AND 102). SN 77-084,714. PUB. 7-10-2007. FILED 1-17-2007.
- 3,296,894. **PIMA FCU AND DESIGN**. PIMA FEDERAL CREDIT UNION, (U.S. CLS. 100, 101 AND 102). SN 77-087,718. PUB. 7-10-2007. FILED 1-22-2007.
- 3,296,903. **VETERANS SELECT (STYLIZED)**. MILLER, LINDA, AND RUGER, CHET, AND ROBERTS, SCOTT, (U.S. CLS. 100, 101 AND 102). SN 77-088,481. PUB. 7-10-2007. FILED 1-22-2007.
- 3,296,905. **QUAL-O-METER (BLOCK FORM)**. FIRST NLC FINANCIAL SERVICES, LLC, (U.S. CLS. 100, 101 AND 102). SN 77-088,617. PUB. 7-10-2007. FILED 1-23-2007.
- 3,296,906. **QUAL-O-METER HARD EASY AND DESIGN**. FIRST NLC FINANCIAL SERVICES, LLC, (U.S. CLS. 100, 101 AND 102). SN 77-088,623. PUB. 7-10-2007. FILED 1-23-2007.
- 3,296,933. **HMO HEALTH OHIO AND DESIGN**. MEDICAL MUTUAL OF OHIO, (U.S. CLS. 100, 101 AND 102). SN 77-089,843. PUB. 7-10-2007. FILED 1-24-2007.
- 3,296,937. **GALEN PARTNERS AND DESIGN**. GALEN MANAGEMENT, L.L.C., (U.S. CLS. 100, 101 AND 102). SN 77-089,977. PUB. 7-10-2007. FILED 1-24-2007.
- 3,296,938. **GALEN PARTNERS (BLOCK FORM)**. GALEN MANAGEMENT, L.L.C., (U.S. CLS. 100, 101 AND 102). SN 77-089,979. PUB. 7-10-2007. FILED 1-24-2007.
- 3,296,954. **CHERRY POCKET (BLOCK FORM)**. CHERRY POCKET FISH CAMP, (U.S. CLS. 100, 101 AND 102). SN 77-090,908. PUB. 7-10-2007. FILED 1-25-2007.
- 3,296,957. **WE'RE HERE WHEN LIFE HAPPENS (BLOCK FORM)**. CITIZENS FINANCIAL GROUP, INC., (U.S. CLS. 100, 101 AND 102). SN 77-090,993. PUB. 7-10-2007. FILED 1-25-2007.
- 3,296,966. **HOPE IS WHERE THE HEART IS (BLOCK FORM)**. RICH IN LOVE CHARITY, INC., (U.S. CLS. 100, 101 AND 102). SN 77-091,178. PUB. 7-10-2007. FILED 1-25-2007.
- 3,296,982. **BRI (BLOCK FORM)**. BROOKS, MICHAEL A., (U.S. CLS. 100, 101 AND 102). SN 77-091,519. PUB. 7-10-2007. FILED 1-25-2007.
- 3,297,015 (*See Class 35 for this trademark*).
- 3,297,023. **MISCELLANEOUS DESIGN**. GIBRALTAR, LLC, MULTIPLE CLASS, (INT. CLS. 36 AND 37), (U.S. CLS. 100, 101, 102, 103 AND 106). SN 77-092,460. PUB. 7-10-2007. FILED 1-26-2007.
- 3,297,034. **BENCOM YOUR EMPLOYEE BENEFIT SOLUTION AND DESIGN**. BENCOM LLC, (U.S. CLS. 100, 101 AND 102). SN 77-092,867. PUB. 7-10-2007. FILED 1-27-2007.
- 3,297,040. **YOU MATTER MORE (BLOCK FORM)**. BANGOR SAVINGS BANK, (U.S. CLS. 100, 101 AND 102). SN 77-093,247. PUB. 7-10-2007. FILED 1-29-2007.
- 3,297,045. **ACE WESTCHESTER SPECIALTY GROUP (BLOCK FORM)**. ACE LIMITED, (U.S. CLS. 100, 101 AND 102). SN 77-093,572. PUB. 7-10-2007. FILED 1-29-2007.
- 3,297,055. **RAPIFONE (BLOCK FORM)**. LATIN NODE INC., MULTIPLE CLASS, (INT. CLS. 36 AND 38), (U.S. CLS. 100, 101, 102 AND 104). SN 77-094,091. PUB. 7-10-2007. FILED 1-29-2007.
- 3,297,056. **UFUCU (BLOCK FORM)**. UNIVERSITY FEDERAL CREDIT UNION, (U.S. CLS. 100, 101 AND 102). SN 77-094,734. PUB. 7-10-2007. FILED 1-30-2007.
- 3,297,057. **FINANCIAL FASHION HOUSE (BLOCK FORM)**. CINNAMON MCCANN, (U.S. CLS. 100, 101 AND 102). SN 77-095,138. PUB. 7-10-2007. FILED 1-30-2007.
- 3,297,073. **CATERING FOR THE CURE (BLOCK FORM)**. THE SUSAN G. KOMEN BREAST CANCER FOUNDATION, INC., (U.S. CLS. 100, 101 AND 102). SN 77-099,006. PUB. 7-10-2007. FILED 2-5-2007.
- 3,297,095. **JUST LEND (BLOCK FORM)**. PORTICO HOLDINGS, LLC, (U.S. CLS. 100, 101 AND 102). SN 77-104,473. PUB. 7-10-2007. FILED 2-10-2007.
- 3,297,096. **JUST LEND AND DESIGN**. PORTICO HOLDINGS, LLC, (U.S. CLS. 100, 101 AND 102). SN 77-104,478. PUB. 7-10-2007. FILED 2-10-2007.
- 3,297,167. **BENCOM (BLOCK FORM)**. BENCOM LLC, (U.S. CLS. 100, 101 AND 102). SN 77-147,063. PUB. 7-10-2007. FILED 4-3-2007.
- 3,297,178. **TRADITION**. CORE COMMUNITIES, LLC, MULTIPLE CLASS, (INT. CLS. 36 AND 37), (U.S. CLS. 100, 101, 102, 103 AND 106). SN 78-194,953. PUB. 3-23-2004. FILED 12-

- 16-2002.
 3,297,180 (*See Class 35 for this trademark*).
 3,297,187. **FIRST FOR A REASON (BLOCK FORM)**. FIRST FRANKLIN FINANCIAL CORPORATION, (U.S. CLS. 100, 101 AND 102). SN 78-401,954. PUB. 1-25-2005. FILED 4-14-2004.
 3,297,190. **ENGAGE HSA SOLUTION (BLOCK FORM)**. ASSOCIATED BANC-CORP, (U.S. CLS. 100, 101 AND 102). SN 78-430,965. PUB. 7-10-2007. FILED 6-7-2004.
 3,297,194. **CAPITAL E FINANCIAL GROUP AND DESIGN**. CAPITAL E (BERMUDA) LTD., (U.S. CLS. 100, 101 AND 102). SN 78-458,875. PUB. 7-5-2005. FILED 7-29-2004.
 3,297,197. **EXCLUSIVE ONE (BLOCK FORM)**. SERNA, TONY, (U.S. CLS. 100, 101 AND 102). SN 78-480,336. PUB. 7-10-2007. FILED 9-8-2004.
 3,297,199 (*See Class 35 for this trademark*).
 3,297,200. **MANCHESTER UNITED (BLOCK FORM)**. MANCHESTER UNITED LIMITED, MULTIPLE CLASS, (INT. CLS. 36, 38 AND 41), (U.S. CLS. 100, 101, 102, 104 AND 107). SN 78-493,169. PUB. 7-10-2007. FILED 10-1-2004.
 3,297,203 (*See Class 35 for this trademark*).
 3,297,204 (*See Class 35 for this trademark*).
 3,297,214 (*See Class 35 for this trademark*).
 3,297,217. **RX GOLD PLAN (BLOCK FORM)**. THE SELECT COMPANY, INC., (U.S. CLS. 100, 101 AND 102). SN 78-558,512. PUB. 7-10-2007. FILED 2-2-2005.
 3,297,257. **APARTMENT SOLUTIONS (BLOCK FORM)**. APARTMENT SOLUTIONS, INC., (U.S. CLS. 100, 101 AND 102). SN 78-634,811. PUB. 7-10-2007. FILED 5-23-2005.
 3,297,258. **LIST FOR KIDS (BLOCK FORM)**. DEPENA, BOLIVAR J., (U.S. CLS. 100, 101 AND 102). SN 78-635,705. PUB. 7-10-2007. FILED 5-24-2005.
 3,297,278. **PRAXELL AND DESIGN**. PRAXELL, INC., (U.S. CLS. 100, 101 AND 102). SN 78-683,178. PUB. 7-10-2007. FILED 8-1-2005.
 3,297,288 (*See Class 35 for this trademark*).
 3,297,289. **THREE SPRINGS AND DESIGN**. GF PROPERTIES GROUP, LLC, MULTIPLE CLASS, (INT. CLS. 36 AND 37), (U.S. CLS. 100, 101, 102, 103 AND 106). SN 78-700,363. PUB. 7-10-2007. FILED 8-25-2005.
 3,297,290 (*See Class 35 for this trademark*).
 3,297,301. **BPS (BLOCK FORM)**. PAY RENT, BUILD CREDIT, INC., (U.S. CLS. 100, 101 AND 102). SN 78-707,515. PUB. 7-10-2007. FILED 9-6-2005.
 3,297,308. **FIRST CHOICE BROKERS (BLOCK FORM)**. FIRST CHOICE BROKERS, (U.S. CLS. 100, 101 AND 102). SN 78-710,086. PUB. 7-10-2007. FILED S.R. 9-9-2005; AM. P.R. 3-1-2007.
 3,297,358. **BREAKFREE! (BLOCK FORM)**. CHITTENDEN TRUST COMPANY, (U.S. CLS. 100, 101 AND 102). SN 78-745,530. PUB. 7-10-2007. FILED 11-2-2005.
 3,297,403 (*See Class 35 for this trademark*).
 3,297,404 (*See Class 35 for this trademark*).
 3,297,424. **PAYMENT REPORTING BUILDS CREDIT (BLOCK FORM)**. PAY RENT, BUILD CREDIT, INC., (U.S. CLS. 100, 101 AND 102). SN 78-792,693. PUB. 7-10-2007. FILED 1-17-2006.
 3,297,447 (*See Class 35 for this trademark*).
 3,297,458. **CLEAR COMMERCIAL LENDING EASY AS RESIDENTIAL (STYLIZED)**. SILVER HILL FINANCIAL, LLC, (U.S. CLS. 100, 101 AND 102). SN 78-810,334. PUB. 7-10-2007. FILED 2-8-2006.
 3,297,464 (*See Class 9 for this trademark*).
 3,297,467. **APPROVED.COM (BLOCK FORM)**. CAPITAL MORTGAGE SERVICES, INC., (U.S. CLS. 100, 101 AND 102). SN 78-814,900. PUB. 7-10-2007. FILED 2-14-2006.
 3,297,485. **PROFESSIONAL UNDERWRITERS LIABILITY INSURANCE COMPANY (BLOCK FORM)**. THE DOCTORS COMPANY, (U.S. CLS. 100, 101 AND 102). SN 78-824,175. PUB. 7-10-2007. FILED 2-27-2006.
 3,297,511. **WORLD RISK SOLUTIONS, LTD. AND DESIGN**. WORLD RISK SOLUTIONS, LTD., (U.S. CLS. 100, 101 AND 102). SN 78-835,956. PUB. 7-10-2007. FILED 3-13-2006.
 3,297,516. **STAFFORD PROPERTIES AND DESIGN**. STAFFORD DEVELOPMENT COMPANY, MULTIPLE CLASS, (INT. CLS. 36 AND 37), (U.S. CLS. 100, 101, 102, 103 AND 106). SN 78-838,599. PUB. 7-10-2007. FILED 3-16-2006.
 3,297,520. **SIAN (BLOCK FORM)**. MCZ/CENTRUM FLORIDA XIX, L.L.C., MULTIPLE CLASS, (INT. CLS. 36 AND 37), (U.S. CLS. 100, 101, 102, 103 AND 106). SN 78-839,992. PUB. 7-10-2007. FILED 3-17-2006.
 3,297,530. **MINTO AND DESIGN**. MINTO HOLDINGS INC., MULTIPLE CLASS, (INT. CLS. 36 AND 37), (U.S. CLS. 100, 101, 102, 103 AND 106). SN 78-843,225. PUB. 7-10-2007. FILED 3-22-2006.
 3,297,541. **INTERDEPENDENT FINANCIAL ADVISOR (BLOCK FORM)**. SWENSON ANDERSON ASSOCIATES, INC., (U.S. CLS. 100, 101 AND 102). SN 78-847,328. PUB. 7-10-2007. FILED 3-27-2006.
 3,297,543 (*See Class 35 for this trademark*).
 3,297,585. **ZIG ZAG BAIL BONDS (BLOCK FORM)**. HUBBARD, GLEN K., (U.S. CLS. 100, 101 AND 102). SN 78-869,506. PUB. 7-10-2007. FILED 4-12-2006.
 3,297,597 (*See Class 35 for this trademark*).
 3,297,598 (*See Class 35 for this trademark*).
 3,297,624. **LB LOCALBILLING AND DESIGN**. LOCAL BILLING SOLUTIONS LIMITED, (U.S. CLS. 100, 101 AND 102). SN 78-865,561. PUB. 7-10-2007. FILED 4-20-2006.
 3,297,644 (*See Class 35 for this trademark*).
 3,297,647. **PRINCIPAL AND DESIGN**. PRINCIPAL FINANCIAL SERVICES, INC., (U.S. CLS. 100, 101 AND 102). SN 78-869,793. PUB. 7-10-2007. FILED 4-26-2006.
 3,297,679. **PIRA ENERGY GROUP (BLOCK FORM)**. PETROLEUM INDUSTRY RESEARCH ASSOCIATES, INC., DBA PIRA ENERGY GROUP, (U.S. CLS. 100, 101 AND 102). SN 78-874,458. PUB. 7-10-2007. FILED 5-2-2006.
 3,297,695. **ARIMA (BLOCK FORM)**. ARIMA CAPITAL, LLC, (U.S. CLS. 100, 101 AND 102). SN 78-878,139. PUB. 7-10-2007. FILED 5-5-2006.
 3,297,696. **ARIMA CAPITAL AND DESIGN**. ARIMA CAPITAL, LLC, (U.S. CLS. 100, 101 AND 102). SN 78-878,184. PUB. 7-10-2007. FILED 5-5-2006.
 3,297,709 (*See Class 35 for this trademark*).
 3,297,757 (*See Class 9 for this trademark*).
 3,297,765. **TAKE A BITE OUT OF AUTISM (BLOCK FORM)**. TIMOTHY SCHOOL DEVELOPMENT FUND, INC., (U.S. CLS. 100, 101 AND 102). SN 78-889,108. PUB. 7-10-2007. FILED 5-22-2006.
 3,297,767. **ENTERPRISE TRUST (BLOCK FORM)**. ENTERPRISE FINANCIAL SERVICES CORP., (U.S. CLS. 100, 101 AND 102). SN 78-889,291. PUB. 7-10-2007. FILED 5-22-2006.
 3,297,785. **MERGERMARKET AND DESIGN**. MERGERMARKET LIMITED, (U.S. CLS. 100, 101 AND 102). SN 78-893,787. PUB. 7-10-2007. FILED 5-26-2006.
 3,297,798. **KNIGHT AND DESIGN**. KNIGHT MANAGEMENT INSURANCE SERVICES, LLC, (U.S. CLS. 100, 101 AND 102). SN 78-896,413. PUB. 7-10-2007. FILED 5-30-2006.
 3,297,810 (*See Class 35 for this trademark*).
 3,297,811. **BANGLADESH ASSOCIATION OF AMERICA, INC. (BAAI) (BLOCK FORM)**. BANGLADESH ASSOCIATION OF AMERICA, INC., (U.S. CLS. 100, 101 AND 102). SN 78-899,748. PUB. 4-3-2007. FILED 6-2-2006.
 3,297,816. **AIRT (BLOCK FORM)**. ALTERNATIVE INVESTMENT RESEARCH AND TECHNOLOGIES LLC, (U.S. CLS. 100, 101 AND 102). SN 78-900,647. PUB. 7-10-2007. FILED 6-5-2006.
 3,297,817. **HUNGER TO HOPE (BLOCK FORM)**. THE RUSS REID COMPANY, INCORPORATED, (U.S. CLS. 100, 101 AND 102). SN 78-900,818. PUB. 7-10-2007. FILED 6-5-2006.
 3,297,836. **PORTFOLIO STRESS TEST (BLOCK FORM)**. CAMARDA FINANCIAL ADVISORS, INC., (U.S. CLS. 100, 101 AND 102). SN 78-902,797. PUB. 7-10-2007. FILED 6-7-2006.
 3,297,837. **IC FEDERAL CREDIT UNION YOUR MONEY. YOUR LIFE. ALL TOGETHER NOW. AND DESIGN**. I-C FEDERAL CREDIT UNION, (U.S. CLS. 100, 101 AND 102). SN 78-902,804. PUB. 7-10-2007. FILED 6-7-2006.
 3,297,854 (*See Class 35 for this trademark*).
 3,297,861. **THE FOURTH PROFESSION (BLOCK FORM)**. PROFESSIONAL LIABILITY MANAGEMENT OF AMERICA, INC., (U.S. CLS. 100, 101 AND 102). SN 78-905,867. PUB. 7-10-2007. FILED 6-12-2006.
 3,297,863. **CONSUMERCENTS (BLOCK FORM)**. AAA FAIR CREDIT FOUNDATION, MULTIPLE CLASS, (INT. CLS. 36 AND 41), (U.S. CLS. 100, 101, 102 AND 107). SN 78-906,104. PUB. 7-10-2007. FILED 6-12-2006.

- 3,297,864. **CONSUMERCENTS AND DESIGN.** AAA FAIR CREDIT FOUNDATION, MULTIPLE CLASS, (INT. CLS. 36 AND 41), (U.S. CLS. 100, 101, 102 AND 107). SN 78-906,142. PUB. 7-10-2007. FILED 6-12-2006.
- 3,297,866. **FINANCIAL KNOWLEDGE IS POWER (BLOCK FORM).** AAA FAIR CREDIT FOUNDATION, (U.S. CLS. 100, 101 AND 102). SN 78-906,225. PUB. 7-10-2007. FILED 6-12-2006.
- 3,297,880 (*See Class 16 for this trademark.*).
- 3,297,894. **MISCELLANEOUS DESIGN.** THE OFFICER DOWN MEMORIAL PAGE, INC., MULTIPLE CLASS, (INT. CLS. 36 AND 45), (U.S. CLS. 100, 101 AND 102). SN 78-908,953. PUB. 7-10-2007. FILED 6-15-2006.
- 3,297,896 (*See Class 35 for this trademark.*).
- 3,297,897 (*See Class 35 for this trademark.*).
- 3,297,898. **VRGATEWAY (BLOCK FORM).** VRGATEWAY, INC., (U.S. CLS. 100, 101 AND 102). SN 78-910,024. PUB. 7-10-2007. FILED 6-16-2006.
- 3,297,899. **ESA FOUNDATION AND DESIGN.** ESA'S FOUNDATION, (U.S. CLS. 100, 101 AND 102). SN 78-910,478. PUB. 7-10-2007. FILED 6-16-2006.
- 3,297,904 (*See Class 16 for this trademark.*).
- 3,297,919. **PEAPACK GLADSTONE BANK FOUNDED 1921 AND DESIGN.** PEAPACK GLADSTONE BANK, (U.S. CLS. 100, 101 AND 102). SN 78-915,142. PUB. 7-10-2007. FILED 6-23-2006.
- 3,297,928. **A PENNY A DAY KEEPS POVERTY AWAY (BLOCK FORM).** GARBER ESTHER, AND PYRES PIVOR, (U.S. CLS. 100, 101 AND 102). SN 78-917,356. PUB. 7-10-2007. FILED 6-26-2006.
- 3,297,953. **DEALER EQUITY PLUS (BLOCK FORM).** CNA NATIONAL WARRANTY CORPORATION, (U.S. CLS. 100, 101 AND 102). SN 78-921,422. PUB. 7-10-2007. FILED 6-30-2006.
- 3,297,954. **MAPSNG (BLOCK FORM).** BLUEMARK, LLC, MULTIPLE CLASS, (INT. CLS. 36 AND 42), (U.S. CLS. 100, 101 AND 102). SN 78-922,606. PUB. 7-10-2007. FILED 7-5-2006.
- 3,297,960. **ALPHA ADVANTAGE (BLOCK FORM).** BARCLAYS GLOBAL INVESTORS, N.A., MULTIPLE CLASS, (INT. CLS. 36 AND 41), (U.S. CLS. 100, 101, 102 AND 107). SN 78-924,044. PUB. 7-10-2007. FILED 7-6-2006.
- 3,297,965. **COST RECOVERY SOLUTIONS (BLOCK FORM).** SMITH, GERARD A., (U.S. CLS. 100, 101 AND 102). SN 78-924,929. PUB. 7-10-2007. FILED 7-7-2006.
- 3,297,972. **MYRENTAL (BLOCK FORM).** MYRENTAL INCORPORATED, (U.S. CLS. 100, 101 AND 102). SN 78-926,246. PUB. 7-10-2007. FILED 7-10-2006.
- 3,297,978 (*See Class 35 for this trademark.*).
- 3,297,979 (*See Class 35 for this trademark.*).
- 3,297,983. **MISCELLANEOUS DESIGN.** CREST FINANCIAL STRATEGIES LTD., (U.S. CLS. 100, 101 AND 102). SN 78-929,795. PUB. 7-10-2007. FILED 7-14-2006.
- 3,297,997. **.R.F.C. U. AND DESIGN.** REDSTONE FEDERAL CREDIT UNION COOPERATIVE SAVINGS AND LOAN CORPORATION, (U.S. CLS. 100, 101 AND 102). SN 78-932,525. PUB. 7-10-2007. FILED 7-19-2006.
- 3,298,001. **MARES THE REAL ESTATE STORE AND DESIGN.** MARKET AREA REAL ESTATE SERVICES, INC., (U.S. CLS. 100, 101 AND 102). SN 78-934,011. PUB. 7-10-2007. FILED 7-20-2006.
- 3,298,003. **MARES THE REAL ESTATE STORE AND DESIGN.** MARKET AREA REAL ESTATE SERVICES, INC., (U.S. CLS. 100, 101 AND 102). SN 78-934,041. PUB. 7-10-2007. FILED 7-20-2006.
- 3,298,012 (*See Class 35 for this trademark.*).
- 3,298,017. **S CHINA MINSHENG BANKING CORP., LTD. AND DESIGN.** CHINA MINSHENG BANKING CORP., LTD., (U.S. CLS. 100, 101 AND 102). SN 78-939,973. PUB. 7-10-2007. FILED 7-28-2006.
- 3,298,040. **GIVING USA FOUNDATION AND DESIGN.** GIVING USA FOUNDATION, INC., (U.S. CLS. 100, 101 AND 102). SN 78-947,740. PUB. 7-10-2007. FILED 8-8-2006.
- 3,298,051. **RESERVESOFT (BLOCK FORM).** HUGHES RESERVES AND ASSET MANAGEMENT INC., MULTIPLE CLASS, (INT. CLS. 36 AND 42), (U.S. CLS. 100, 101 AND 102). SN 78-950,678. PUB. 7-10-2007. FILED 8-11-2006.
- 3,298,052. **RAYZOR RANCH TOWN CENTER (BLOCK FORM).** ALLEGIANCE HILLVIEW, LP, MULTIPLE CLASS, (INT. CLS. 36 AND 37), (U.S. CLS. 100, 101, 102, 103 AND 106). SN 78-950,679. PUB. 7-10-2007. FILED 8-11-2006.
- 3,298,053. **RAYZOR RANCH TOWN CENTER AND DESIGN.** ALLEGIANCE HILLVIEW, LP, MULTIPLE CLASS, (INT. CLS. 36 AND 37), (U.S. CLS. 100, 101, 102, 103 AND 106). SN 78-950,693. PUB. 7-10-2007. FILED 8-11-2006.
- 3,298,060. **SANKATY (BLOCK FORM).** SANKATY ADVISORS, LLC, (U.S. CLS. 100, 101 AND 102). SN 78-952,384. PUB. 7-10-2007. FILED 8-15-2006.
- 3,298,061. **SANKATY ADVISORS (BLOCK FORM).** SANKATY ADVISORS, LLC, (U.S. CLS. 100, 101 AND 102). SN 78-952,400. PUB. 7-10-2007. FILED 8-15-2006.
- 3,298,062. **SANKATY ADVISORS AND DESIGN.** SANKATY ADVISORS, LLC, (U.S. CLS. 100, 101 AND 102). SN 78-952,408. PUB. 7-10-2007. FILED 8-15-2006.
- 3,298,063. **SANKATY CREDIT OPPORTUNITIES (BLOCK FORM).** SANKATY ADVISORS, LLC, (U.S. CLS. 100, 101 AND 102). SN 78-952,624. PUB. 7-10-2007. FILED 8-15-2006.
- 3,298,064. **COPS (BLOCK FORM).** SANKATY ADVISORS, LLC, (U.S. CLS. 100, 101 AND 102). SN 78-952,631. PUB. 7-10-2007. FILED 8-15-2006.
- 3,298,065. **PROSPECT HARBOR (BLOCK FORM).** SANKATY ADVISORS, LLC, (U.S. CLS. 100, 101 AND 102). SN 78-952,639. PUB. 7-10-2007. FILED 8-15-2006.
- 3,298,091. **USA HOMEBUYERS SELL THE RIGHT WAY. FAST. AND DESIGN.** USA HOMEBUYERS, INC., (U.S. CLS. 100, 101 AND 102). SN 78-960,992. PUB. 7-10-2007. FILED S.R. 8-25-2006; AM. P.R. 5-7-2007.
- 3,298,099. **IT'S LIKE STRAIGHT A'S FOR YOUR MONEY. (BLOCK FORM).** CLASS ACT FEDERAL CREDIT UNION, (U.S. CLS. 100, 101 AND 102). SN 78-962,747. PUB. 7-10-2007. FILED 8-29-2006.
- 3,298,105. **CLASS ACT + FEDERAL CREDIT UNION (STYLIZED).** CLASS ACT CREDIT UNION, (U.S. CLS. 100, 101 AND 102). SN 78-963,467. PUB. 7-10-2007. FILED 8-30-2006.
- 3,298,111 (*See Class 35 for this trademark.*).
- 3,298,117. **PERSONAL ATTENTION. POWERFUL RESOURCES. (BLOCK FORM).** VISION FINANCIAL MARKETS LLC, (U.S. CLS. 100, 101 AND 102). SN 78-965,019. PUB. 7-10-2007. FILED 8-31-2006.
- 3,298,138 (*See Class 16 for this trademark.*).
- 3,298,158 (*See Class 29 for this trademark.*).
- 3,298,162 (*See Class 9 for this trademark.*).
- 3,298,166 (*See Class 9 for this trademark.*).
- 3,298,167 (*See Class 7 for this trademark.*).
- 3,298,213 (*See Class 35 for this trademark.*).
- 3,298,215. **EXANE TEMPLIERS FUND (BLOCK FORM).** EXANE, (U.S. CLS. 100, 101 AND 102). SN 79-022,700. PUB. 7-10-2007. FILED 1-20-2006.
- 3,298,220 (*See Class 35 for this trademark.*).
- 3,298,222. **EXANE MICROMEGAS FUND (BLOCK FORM).** EXANE, (U.S. CLS. 100, 101 AND 102). SN 79-023,796. PUB. 7-10-2007. FILED 1-20-2006.
- 3,298,235 (*See Class 35 for this trademark.*).
- 3,298,238. **M-SUP (BLOCK FORM).** SUMITOMO MITSUI BANKING CORPORATION,; SINGAPORE BRANCH, (U.S. CLS. 100, 101 AND 102). SN 79-024,670. PUB. 7-10-2007. FILED 5-3-2006.
- 3,298,247 (*See Class 35 for this trademark.*).
- 3,298,286 (*See Class 16 for this trademark.*).
- 3,298,303. **GES CREDIT AND DESIGN.** CASTELLARNAU REBULL, TIRS, (U.S. CLS. 100, 101 AND 102). SN 79-027,758. PUB. 7-10-2007. FILED 6-8-2006.
- 3,298,329 (*See Class 35 for this trademark.*).

CLASS 37—CONSTRUCTION AND REPAIR

- 3,296,012 (*See Class 11 for this trademark.*).
- 3,296,097 (*See Class 35 for this trademark.*).
- 3,296,158. **ACCEPT NOTHING LESS. (BLOCK FORM).** HANDYMAN MATTERS, INC., (U.S. CLS. 100, 103 AND 106). SN 76-670,156. PUB. 7-10-2007. FILED 12-11-2006.
- 3,296,203. **AQUABOND (STYLIZED).** ERGON, LLC, (U.S. CLS. 100, 103 AND 106). SN 76-671,925. PUB. 7-10-2007.

- FILED 1-29-2007.
 3,296,204 (*See Class 35 for this trademark*).
 3,296,307. **CIA CLEAN INDOOR AIR ALLIANCE AND DESIGN.** CLOCKWORK HOME SERVICES, INC., (U.S. CLS. 100, 103 AND 106). SN 77-023,907. PUB. 7-10-2007. FILED 10-18-2006.
 3,296,308. **MARGARET'S CLEANERS (BLOCK FORM).** MARGARET'S DRY CLEANING, INC., (U.S. CLS. 100, 103 AND 106). SN 77-023,979. PUB. 7-10-2007. FILED 10-18-2006.
 3,296,309. **MARGARET'S CLEANERS AND DESIGN.** MARGARET'S DRY CLEANING, INC., (U.S. CLS. 100, 103 AND 106). SN 77-024,070. PUB. 7-10-2007. FILED 10-18-2006.
 3,296,312. **CLEAN BY MAIL AND DESIGN.** MARGARET'S DRY CLEANING, INC., (U.S. CLS. 100, 103 AND 106). SN 77-024,420. PUB. 7-10-2007. FILED 10-18-2006.
 3,296,316. **LEGACY GOWN PRESERVATION (BLOCK FORM).** MARGARET'S DRY CLEANING, INC., (U.S. CLS. 100, 103 AND 106). SN 77-025,205. PUB. 7-10-2007. FILED 10-19-2006.
 3,296,317. **LEGACY GOWN PRESERVATION AND DESIGN.** MARGARET'S DRY CLEANING, INC., (U.S. CLS. 100, 103 AND 106). SN 77-025,251. PUB. 7-10-2007. FILED 10-19-2006.
 3,296,336 (*See Class 7 for this trademark*).
 3,296,364. **BUMPERDOC (BLOCK FORM).** BUMPERDOC, INC., (U.S. CLS. 100, 103 AND 106). SN 77-032,007. PUB. 7-10-2007. FILED 10-30-2006.
 3,296,374. **THE COOPERATIVE BUILDING OUTLET DIY WITH ON-SITE TRAINING & SUPERVISION AND DESIGN.** NOVO ENTERPRISES INCORPORATED, (U.S. CLS. 100, 103 AND 106). SN 77-033,745. PUB. 7-10-2007. FILED 10-31-2006.
 3,296,379. **ESQUIRE CLEANERS (BLOCK FORM).** SM2, INC., (U.S. CLS. 100, 103 AND 106). SN 77-034,198. PUB. 7-10-2007. FILED 11-1-2006.
 3,296,394. **MY FAVORITE CLEANERS (BLOCK FORM).** KINZIE & COMPANY, INC., MULTIPLE CLASS, (INT. CLS. 37 AND 40), (U.S. CLS. 100, 103 AND 106). SN 77-037,232. PUB. 7-10-2007. FILED 11-6-2006.
 3,296,404. **DREAM. DESIGN. DEVELOP (BLOCK FORM).** OKLAHOMA DEVELOPMENT GROUP, L.L.C., (U.S. CLS. 100, 103 AND 106). SN 77-038,573. PUB. 7-10-2007. FILED 11-7-2006.
 3,296,413 (*See Class 35 for this trademark*).
 3,296,424. **ALL EASTERN IOWA SEAMLESS GUTTER "WE GO TO ANY LENGTH" PROUD TO BE AN AMERICAN AND DESIGN.** ALL EASTERN IOWA GUTTER, INC., MULTIPLE CLASS, (INT. CLS. 37 AND 40), (U.S. CLS. 100, 103 AND 106). SN 77-041,640. PUB. 7-10-2007. FILED 11-10-2006.
 3,296,452 (*See Class 36 for this trademark*).
 3,296,453. **PP PLAZA PROPERTIES DEVELOPERS / MANAGERS AND DESIGN.** PLAZA PROPERTIES, INC., (U.S. CLS. 100, 103 AND 106). SN 77-045,414. PUB. 7-10-2007. FILED 11-16-2006.
 3,296,458. **WILKINSON (BLOCK FORM).** WILKINSON CORPORATION, (U.S. CLS. 100, 103 AND 106). SN 77-046,597. PUB. 7-10-2007. FILED 11-17-2006.
 3,296,480. **FORTIFIEDSTRUCTURES GROUP LLC AND DESIGN.** FORTIFIED STRUCTURES GROUP LLC, (U.S. CLS. 100, 103 AND 106). SN 77-049,742. PUB. 7-10-2007. FILED 11-22-2006.
 3,296,535. **BOB'S REEDVILLE PLUMBING PLUMBING PROBLEMS SOLVED AND DESIGN.** BOB'S REEDVILLE PLUMBING, LLC, (U.S. CLS. 100, 103 AND 106). SN 77-056,483. PUB. 7-10-2007. FILED 12-4-2006.
 3,296,545. **C.P. MORGAN (BLOCK FORM).** C.P. MORGAN COMMUNITIES, L.P., (U.S. CLS. 100, 103 AND 106). SN 77-057,430. PUB. 7-10-2007. FILED 12-5-2006.
 3,296,608. **SUMMER RAIN (BLOCK FORM).** SUMMER RAIN SPRINKLER SYSTEMS, INC., (U.S. CLS. 100, 103 AND 106). SN 77-062,026. PUB. 7-10-2007. FILED 12-12-2006.
 3,296,853. **COOL GEEKS YOUR PERSONAL COMPUTER REPAIR TECHS. AND DESIGN.** COOL GEEKS, INC., (U.S. CLS. 100, 103 AND 106). SN 77-085,554. PUB. 7-10-2007. FILED 1-18-2007.
 3,296,872 (*See Class 35 for this trademark*).
 3,296,900. **MIKE AND DESIGN.** ABSOLUTE MOLE CONTROL, LLC, (U.S. CLS. 100, 103 AND 106). SN 77-088,230. PUB. 7-10-2007. FILED 1-22-2007.
 3,296,983 (*See Class 35 for this trademark*).
 3,297,001. **DEFINITIVE DETAILING (BLOCK FORM).** DEFINITIVE DETAILING, LLC, (U.S. CLS. 100, 103 AND 106). SN 77-091,759. PUB. 7-10-2007. FILED 1-26-2007.
 3,297,015 (*See Class 35 for this trademark*).
 3,297,023 (*See Class 36 for this trademark*).
 3,297,060. **AMERICA'S CHOICE FOR HOME SECURITY (BLOCK FORM).** GUARDIAN ALARMS, INC., (U.S. CLS. 100, 103 AND 106). SN 77-096,063. PUB. 7-10-2007. FILED 1-31-2007.
 3,297,152 (*See Class 35 for this trademark*).
 3,297,178 (*See Class 36 for this trademark*).
 3,297,180 (*See Class 35 for this trademark*).
 3,297,203 (*See Class 35 for this trademark*).
 3,297,204 (*See Class 35 for this trademark*).
 3,297,246. **CADATA (BLOCK FORM).** THE CADATA CORPORATION, INC., (U.S. CLS. 100, 103 AND 106). SN 78-615,100. PUB. 10-24-2006. FILED 4-22-2005.
 3,297,289 (*See Class 36 for this trademark*).
 3,297,312 (*See Class 35 for this trademark*).
 3,297,329 (*See Class 35 for this trademark*).
 3,297,406. **BUG MUGGER (BLOCK FORM).** MOLINA, DAVID K., (U.S. CLS. 100, 103 AND 106). SN 78-783,105. PUB. 8-29-2006. FILED 12-30-2005.
 3,297,495. **CRAFTSMAN COTTAGES AND DESIGN.** CRAFTSMAN COTTAGES, INC., (U.S. CLS. 100, 103 AND 106). SN 78-830,943. PUB. 7-10-2007. FILED 3-7-2006.
 3,297,508. **THE HANDY GUY AND DESIGN.** THE HANDY GUY, INC., (U.S. CLS. 100, 103 AND 106). SN 78-834,591. PUB. 7-10-2007. FILED 3-10-2006.
 3,297,515 (*See Class 35 for this trademark*).
 3,297,516 (*See Class 36 for this trademark*).
 3,297,520 (*See Class 36 for this trademark*).
 3,297,525 (*See Class 9 for this trademark*).
 3,297,530 (*See Class 36 for this trademark*).
 3,297,545. **AUTO REJUVENATOR (BLOCK FORM).** AUTO REJUVENATOR, INC., (U.S. CLS. 100, 103 AND 106). SN 78-849,398. PUB. 7-10-2007. FILED S.R. 3-29-2006; AM. P.R. 6-6-2007.
 3,297,561. **VILLAS BY THE SEA AND DESIGN.** MINTO HOLDINGS INC., (U.S. CLS. 100, 103 AND 106). SN 78-854,452. PUB. 7-10-2007. FILED 4-5-2006.
 3,297,562. **OLYMPIA AND DESIGN.** MINTO HOLDINGS INC., (U.S. CLS. 100, 103 AND 106). SN 78-854,493. PUB. 7-10-2007. FILED 4-5-2006.
 3,297,606 (*See Class 9 for this trademark*).
 3,297,617. **STV AND DESIGN.** TELEVENTURE.TV, LLC, (U.S. CLS. 100, 103 AND 106). SN 78-863,778. PUB. 7-10-2007. FILED 4-18-2006.
 3,297,619. **CLEANTOPIA (BLOCK FORM).** GROVER, JEFF, (U.S. CLS. 100, 103 AND 106). SN 78-863,966. PUB. 7-10-2007. FILED 4-18-2006.
 3,297,644 (*See Class 35 for this trademark*).
 3,297,649. **DYMAXION (BLOCK FORM).** MITCHELL DRILLING CONTRACTORS PTY LTD, MULTIPLE CLASS, (INT. CLS. 37 AND 42), (U.S. CLS. 100, 101, 103 AND 106). SN 78-870,063. PUB. 7-10-2007. FILED 4-26-2006.
 3,297,666. **RELIANCE (BLOCK FORM).** RELIANCE PLUMBING, SEWER, & DRAINAGE, INC., (U.S. CLS. 100, 103 AND 106). SN 78-872,292. PUB. 7-10-2007. FILED 4-28-2006.
 3,297,683. **ACCU-BLADE (BLOCK FORM).** OKAY INDUSTRIES, INC., (U.S. CLS. 100, 103 AND 106). SN 78-875,745. PUB. 7-10-2007. FILED 5-3-2006.
 3,297,701. **JEFF THE PLUMBER (BLOCK FORM).** JEFF THE PLUMBER, INC., (U.S. CLS. 100, 103 AND 106). SN 78-878,724. PUB. 7-10-2007. FILED 5-8-2006.
 3,297,726. **VERTICAL ACCESS (BLOCK FORM).** DIEBOLT, KENT SLADE, MULTIPLE CLASS, (INT. CLS. 37 AND 42), (U.S. CLS. 100, 101, 103 AND 106). SN 78-884,254. PUB. 7-10-2007. FILED 5-16-2006.
 3,297,749. **A NEW WAY OF BUILDING (BLOCK FORM).** AYTON, ANTHONY, (U.S. CLS. 100, 103 AND 106). SN 78-886,967. PUB. 7-10-2007. FILED 5-18-2006.
 3,297,829. **ALPHA ECOLOGICAL PEST CONTROL THE GREEN APPROACH AND DESIGN.** ALPHA PEST CONTROL INCORPORATED, (U.S. CLS. 100, 103 AND 106). SN 78-902,322. PUB. 7-10-2007. FILED 6-6-2006.

- 3,297,841 (*See Class 35 for this trademark.*)
 3,297,842 (*See Class 35 for this trademark.*)
 3,297,854 (*See Class 35 for this trademark.*)
 3,297,889. **THINK WELTY. (BLOCK FORM).** WELTY BUILDING COMPANY LTD. MULTIPLE CLASS, (INT. CLS. 37 AND 42), (U.S. CLS. 100, 101, 103 AND 106). SN 78-908,143. PUB. 7-10-2007. FILED 6-14-2006.
 3,297,910 (*See Class 35 for this trademark.*)
 3,298,007. **MAKO TECHNOLOGIES AND DESIGN.** MAKO TECHNOLOGIES, INC., MULTIPLE CLASS, (INT. CLS. 37, 39, 41 AND 42), (U.S. CLS. 100, 101, 103, 105, 106 AND 107). SN 78-935,212. PUB. 7-10-2007. FILED 7-21-2006.
 3,298,012 (*See Class 35 for this trademark.*)
 3,298,031 (*See Class 6 for this trademark.*)
 3,298,041 (*See Class 35 for this trademark.*)
 3,298,052 (*See Class 36 for this trademark.*)
 3,298,053 (*See Class 36 for this trademark.*)
 3,298,071. **BRI ROOFING & SHEET METAL (BLOCK FORM).** BRI ROOFING & SHEET METAL, INC., (U.S. CLS. 100, 103 AND 106). SN 78-954,211. PUB. 7-10-2007. FILED 8-17-2006.
 3,298,137. **PQS AND DESIGN.** PQS CONSTRUCTION, INC., (U.S. CLS. 100, 103 AND 106). SN 78-972,276. PUB. 7-10-2007. FILED 9-12-2006.
 3,298,145. **HOUSE CALL (BLOCK FORM).** FUMIGATION UNLIMITED, INC., MULTIPLE CLASS, (INT. CLS. 37 AND 42), (U.S. CLS. 100, 101, 103 AND 106). SN 78-974,517. PUB. 7-10-2007. FILED 9-14-2006.
 3,298,151 (*See Class 35 for this trademark.*)
 3,298,160 (*See Class 20 for this trademark.*)
 3,298,166 (*See Class 9 for this trademark.*)
 3,298,167 (*See Class 7 for this trademark.*)
 3,298,188 (*See Class 11 for this trademark.*)
 3,298,189 (*See Class 35 for this trademark.*)
 3,298,190 (*See Class 35 for this trademark.*)
 3,298,191. **ONDEO SUEZ AND DESIGN.** SUEZ ENVIRONNEMENT, MULTIPLE CLASS, (INT. CLS. 37, 39, 40 AND 42), (U.S. CLS. 100, 101, 103, 105 AND 106). SN 79-019,536. PUB. 7-10-2007. FILED 8-26-2005.
 3,298,193 (*See Class 35 for this trademark.*)
 3,298,316 (*See Class 7 for this trademark.*)
 3,298,326 (*See Class 6 for this trademark.*)
-
- CLASS 38—COMMUNICATION**
- 3,295,975 (*See Class 9 for this trademark.*)
 3,296,109 (*See Class 35 for this trademark.*)
 3,296,165. **CAMPALUMNI.COM AND DESIGN.** CAMPALUMNI.COM LLC, (U.S. CLS. 100, 101 AND 104). SN 76-670,485. PUB. 7-10-2007. FILED 12-18-2006.
 3,296,191 (*See Class 9 for this trademark.*)
 3,296,192 (*See Class 9 for this trademark.*)
 3,296,210. **LA MEGA SE PEGA (BLOCK FORM).** SPANISH BROADCASTING SYSTEM, INC, (U.S. CLS. 100, 101 AND 104). SN 76-672,442. PUB. 7-10-2007. FILED 2-8-2007.
 3,296,305. **YONJA (BLOCK FORM).** YONJA, LLC, MULTIPLE CLASS, (INT. CLS. 38 AND 41), (U.S. CLS. 100, 101, 104 AND 107). SN 77-023,723. PUB. 7-10-2007. FILED 10-18-2006.
 3,296,321 (*See Class 9 for this trademark.*)
 3,296,344. **HARMONICA (BLOCK FORM).** VOXPATH NETWORKS, INC., (U.S. CLS. 100, 101 AND 104). SN 77-029,251. PUB. 7-10-2007. FILED 10-25-2006.
 3,296,360. **MANO (BLOCK FORM).** VIPERA GMBH, (U.S. CLS. 100, 101 AND 104). SN 77-031,714. PUB. 7-10-2007. FILED 10-29-2006.
 3,296,390. **VSGI HOW DO YOU COMMUNICATE? AND DESIGN.** VISUAL SYSTEMS GROUP, INC. DBA VSGI, (U.S. CLS. 100, 101 AND 104). SN 77-036,196. PUB. 7-10-2007. FILED 11-3-2006.
 3,296,443. **SPIVOT (BLOCK FORM).** SPIVOT LLC, MULTIPLE CLASS, (INT. CLS. 38 AND 42), (U.S. CLS. 100, 101 AND 104). SN 77-044,515. PUB. 7-10-2007. FILED 11-15-2006.
 3,296,497 (*See Class 9 for this trademark.*)
 3,296,527. **SOCIALMAIL (BLOCK FORM).** ARCHITEL HOLDINGS LLC, (U.S. CLS. 100, 101 AND 104). SN 77-055,585. PUB. 7-10-2007. FILED 12-1-2006.
 3,296,579. **MODTV (BLOCK FORM).** KAREN MORRISON, MULTIPLE CLASS, (INT. CLS. 38 AND 41), (U.S. CLS. 100, 101, 104 AND 107). SN 77-060,295. PUB. 7-10-2007. FILED 12-8-2006.
 3,296,582. **T3 AND DESIGN.** T3 TELECOM SOFTWARE, INC., (U.S. CLS. 100, 101 AND 104). SN 77-060,499. PUB. 7-10-2007. FILED 12-8-2006.
 3,296,589. **MODTV: FASHION NETWORK (BLOCK FORM).** KAREN MORRISON, (U.S. CLS. 100, 101 AND 104). SN 77-061,098. PUB. 7-10-2007. FILED 12-11-2006.
 3,296,610. **LILY PAD (BLOCK FORM).** LILY PAD USA, LLC, (U.S. CLS. 100, 101 AND 104). SN 77-062,118. PUB. 7-10-2007. FILED 12-12-2006.
 3,296,619 (*See Class 35 for this trademark.*)
 3,296,693. **GROUPTIVITY (BLOCK FORM).** APPMAIL LLC, (U.S. CLS. 100, 101 AND 104). SN 77-064,752. PUB. 7-10-2007. FILED 12-14-2006.
 3,296,701 (*See Class 9 for this trademark.*)
 3,296,771. **VIEWPOINTE (BLOCK FORM).** VIEWPOINTE ARCHIVE SERVICES LLC, MULTIPLE CLASS, (INT. CLS. 38 AND 39), (U.S. CLS. 100, 101, 104 AND 105). SN 77-076,155. PUB. 7-10-2007. FILED 1-4-2007.
 3,296,978. **ACCUCONFERENCE (BLOCK FORM).** TALK-PATH LLC, (U.S. CLS. 100, 101 AND 104). SN 77-091,395. PUB. 7-10-2007. FILED 1-25-2007.
 3,297,017. **FEEDLION (BLOCK FORM).** SURVOL INTERACTIVE TECHNOLOGIES, (U.S. CLS. 100, 101 AND 104). SN 77-092,202. PUB. 7-10-2007. FILED 1-26-2007.
 3,297,055 (*See Class 36 for this trademark.*)
 3,297,094. **CAPTIVIEW AND DESIGN.** CAPTIVIEW, INC., (U.S. CLS. 100, 101 AND 104). SN 77-104,227. PUB. 7-10-2007. FILED 2-9-2007.
 3,297,104 (*See Class 35 for this trademark.*)
 3,297,200 (*See Class 36 for this trademark.*)
 3,297,205 (*See Class 9 for this trademark.*)
 3,297,273 (*See Class 35 for this trademark.*)
 3,297,296. **COMMUNITY VOICE MAIL AND DESIGN.** COMMUNITY VOICE MAIL NATIONAL OFFICE, (U.S. CLS. 100, 101 AND 104). SN 78-704,706. PUB. 7-10-2007. FILED 8-31-2005.
 3,297,300. **COMMUNITY VOICE MAIL (BLOCK FORM).** COMMUNITY VOICE MAIL NATIONAL OFFICE, (U.S. CLS. 100, 101 AND 104). SN 78-707,145. PUB. 7-10-2007. FILED 9-6-2005.
 3,297,388 (*See Class 16 for this trademark.*)
 3,297,396. **DISCOVERY CHANNEL RADIO (BLOCK FORM).** DISCOVERY COMMUNICATIONS, INC., MULTIPLE CLASS, (INT. CLS. 38 AND 41), (U.S. CLS. 100, 101, 104 AND 107). SN 78-777,942. PUB. 7-10-2007. FILED 12-21-2005.
 3,297,425 (*See Class 1 for this trademark.*)
 3,297,440. **ATLANTIC SEAPORTS AND DESIGN.** SHANNON FOYNES PORT COMPANY, MULTIPLE CLASS, (INT. CLS. 38 AND 39), (U.S. CLS. 100, 101, 104 AND 105). SN 78-800,870. PUB. 7-10-2007. FILED 1-27-2006.
 3,297,496. **CLICK...CLICK. DOCUMENTS DONE! (BLOCK FORM).** AUTOMATED LEGAL SYSTEMS, INC., (U.S. CLS. 100, 101 AND 104). SN 78-831,042. PUB. 7-10-2007. FILED 3-7-2006.
 3,297,570. **LEADER DIALOG (BLOCK FORM).** LEADER TECHNOLOGIES, INC., (U.S. CLS. 100, 101 AND 104). SN 78-857,170. PUB. 7-10-2007. FILED 4-8-2006.
 3,297,577. **MISCELLANEOUS DESIGN.** NINTENDO CO., LTD., (U.S. CLS. 100, 101 AND 104). SN 78-858,336. PUB. 7-10-2007. FILED 4-10-2006.
 3,297,608. **MISCELLANEOUS DESIGN.** BELL SOUTH INTELLECTUAL PROPERTY CORPORATION, MULTIPLE CLASS, (INT. CLS. 38 AND 45), (U.S. CLS. 100, 101 AND 104). SN 78-862,939. PUB. 7-10-2007. FILED 4-17-2006.
 3,297,648. **POKERSTRATEGY AND DESIGN.** POKER STRATEGY.DE PUBLISHING LTD., MULTIPLE CLASS, (INT. CLS. 38 AND 41), (U.S. CLS. 100, 101, 104 AND 107). SN 78-869,979. PUB. 7-10-2007. FILED 4-26-2006.
 3,297,707 (*See Class 9 for this trademark.*)
 3,297,739. **SATLABS AND DESIGN.** SATLABS GROUP EEIG, (U.S. CLS. 100, 101 AND 104). SN 78-885,994. PUB. 7-10-2007. FILED 5-17-2006.
 3,297,772 (*See Class 9 for this trademark.*)
 3,297,847 (*See Class 9 for this trademark.*)
 3,297,910 (*See Class 35 for this trademark.*)

- 3,298,006. **POLITIPUNK (BLOCK FORM)**. NOAH ROBISON-COX, (U.S. CLS. 100, 101 AND 104). SN 78-934,568. PUB. 7-10-2007. FILED 7-21-2006.
- 3,298,037 (*See Class 9 for this trademark*).
- 3,298,049 (*See Class 35 for this trademark*).
- 3,298,160 (*See Class 20 for this trademark*).
- 3,298,161 (*See Class 35 for this trademark*).
- 3,298,166 (*See Class 9 for this trademark*).
- 3,298,173 (*See Class 9 for this trademark*).
- 3,298,178 (*See Class 9 for this trademark*).
- 3,298,184 (*See Class 35 for this trademark*).
- 3,298,186 (*See Class 9 for this trademark*).
- 3,298,230 (*See Class 9 for this trademark*).
- 3,298,251. **MIXI (STYLIZED)**. MIXI, INC., MULTIPLE CLASS, (INT. CLS. 38 AND 45), (U.S. CLS. 100, 101 AND 104). SN 79-025,452. PUB. 7-10-2007. FILED 3-17-2006.
- 3,298,268 (*See Class 9 for this trademark*).
- 3,298,286 (*See Class 16 for this trademark*).
- 3,298,308 (*See Class 9 for this trademark*).
- 3,298,309 (*See Class 9 for this trademark*).
- 3,298,310 (*See Class 9 for this trademark*).
- 3,298,311 (*See Class 9 for this trademark*).
- 3,298,312 (*See Class 9 for this trademark*).
- 3,298,313 (*See Class 9 for this trademark*).
- 3,298,332 (*See Class 9 for this trademark*).
- 3,298,351 (*See Class 35 for this trademark*).
- 3,298,371. **POPSCAN AND DESIGN**. SENSATIONAL AG, MULTIPLE CLASS, (INT. CLS. 38 AND 42), (U.S. CLS. 100, 101 AND 104). SN 79-032,251. PUB. 7-10-2007. FILED 10-30-2006.

CLASS 39—TRANSPORTATION AND STORAGE

- 3,296,097 (*See Class 35 for this trademark*).
- 3,296,188. **A FIRST-CLASS MOVE (BLOCK FORM)**. A FIRST-CLASS MOVE LLC, MULTIPLE CLASS, (INT. CLS. 39 AND 45), (U.S. CLS. 100, 101 AND 105). SN 76-671,724. PUB. 7-10-2007. FILED 1-23-2007.
- 3,296,204 (*See Class 35 for this trademark*).
- 3,296,227 (*See Class 35 for this trademark*).
- 3,296,236. **MTR WESTERN (STYLIZED)**. MERIDIAN TRANSPORTATION RESOURCES, LLC, MULTIPLE CLASS, (INT. CLS. 39 AND 41), (U.S. CLS. 100, 101, 105 AND 107). SN 77-004,505. PUB. 7-10-2007. FILED 9-21-2006.
- 3,296,241. **FAIR WIND (BLOCK FORM)**. FAIR WIND, INC., (U.S. CLS. 100 AND 105). SN 77-005,535. PUB. 7-10-2007. FILED 9-22-2006.
- 3,296,255. **EQUINE AMBULATORY SERVICE AND DESIGN**. DANIEL, JERRY, (U.S. CLS. 100 AND 105). SN 77-010,908. PUB. 7-10-2007. FILED 9-29-2006.
- 3,296,330. **ATLAS ACCEL (BLOCK FORM)**. ATLAS INVESTMENT COMPANY, INC., (U.S. CLS. 100 AND 105). SN 77-027,225. PUB. 7-10-2007. FILED 10-23-2006.
- 3,296,378 (*See Class 35 for this trademark*).
- 3,296,629. **UNCHARTED OUTPOSTS (BLOCK FORM)**. UNCHARTED OUTPOSTS, INC., (U.S. CLS. 100 AND 105). SN 77-063,071. PUB. 7-10-2007. FILED 12-13-2006.
- 3,296,646. **BUSHTRACKS (BLOCK FORM)**. BUSHTRACKS AFRICAN EXPEDITIONS, INC., (U.S. CLS. 100 AND 105). SN 77-063,739. PUB. 7-10-2007. FILED 12-13-2006.
- 3,296,728. **YOU DESERVE EXTRA SPACE (BLOCK FORM)**. EXTRA SPACE STORAGE LLC, (U.S. CLS. 100 AND 105). SN 77-066,565. PUB. 7-10-2007. FILED 12-18-2006.
- 3,296,771 (*See Class 38 for this trademark*).
- 3,296,907. **ANOTHER 9 (BLOCK FORM)**. SAVVY NETWORKS, INC., MULTIPLE CLASS, (INT. CLS. 39 AND 42), (U.S. CLS. 100, 101 AND 105). SN 77-088,638. PUB. 7-10-2007. FILED 1-23-2007.
- 3,296,976. **CARIBBEANWEDDINGS.COM (BLOCK FORM)**. CARIBBEAN WEDDINGS, INC., (U.S. CLS. 100 AND 105). SN 77-091,326. PUB. 7-10-2007. FILED 1-25-2007.
- 3,297,079. **OCEAN EXPRESS (BLOCK FORM)**. GATEWAY TO L.A., INC., (U.S. CLS. 100 AND 105). SN 77-100,693. PUB. 7-10-2007. FILED 2-6-2007.
- 3,297,087. **CARS WITH A CONSCIENCE (BLOCK FORM)**. ZIPCAR, INC., (U.S. CLS. 100 AND 105). SN 77-102,706. PUB. 7-10-2007. FILED 2-8-2007.
- 3,297,113. **CLASSIC AUSTRALIA & NEW ZEALAND (BLOCK FORM)**. EXPEDIA, INC., MULTIPLE CLASS, (INT. CLS. 39 AND 43), (U.S. CLS. 100, 101 AND 105). SN 77-108,282. PUB. 7-10-2007. FILED 2-15-2007.
- 3,297,212. **CERYX (BLOCK FORM)**. CERYX INC., MULTIPLE CLASS, (INT. CLS. 39 AND 42), (U.S. CLS. 100, 101 AND 105). SN 78-528,912. PUB. 7-10-2007. FILED 12-8-2004.
- 3,297,223. **ACI ASSOCIATED COURIERS INC. AND DESIGN**. ASSOCIATED COURIERS, INC., (U.S. CLS. 100 AND 105). SN 78-573,560. PUB. 7-10-2007. FILED 2-23-2005.
- 3,297,287 (*See Class 35 for this trademark*).
- 3,297,309. **MISCELLANEOUS DESIGN**. SOUTHWEST AIRLINES CO., (U.S. CLS. 100 AND 105). SN 78-710,120. PUB. 7-10-2007. FILED 9-9-2005.
- 3,297,347 (*See Class 35 for this trademark*).
- 3,297,348 (*See Class 35 for this trademark*).
- 3,297,384 (*See Class 35 for this trademark*).
- 3,297,405 (*See Class 3 for this trademark*).
- 3,297,440 (*See Class 38 for this trademark*).
- 3,297,507. **PAYDELAY (BLOCK FORM)**. RESERVATIONSYSTEM.COM, INC., MULTIPLE CLASS, (INT. CLS. 39 AND 43), (U.S. CLS. 100, 101 AND 105). SN 78-834,571. PUB. 7-10-2007. FILED 3-10-2006.
- 3,297,514. **CHANGING WHAT'S POSSIBLE (BLOCK FORM)**. FEDERAL EXPRESS CORPORATION, (U.S. CLS. 100 AND 105). SN 78-837,771. PUB. 7-10-2007. FILED 3-15-2006.
- 3,297,575 (*See Class 20 for this trademark*).
- 3,297,614. **123LOADBOARD (BLOCK FORM)**. LOZZO MANAGEMENT INC., (U.S. CLS. 100 AND 105). SN 78-863,538. PUB. 7-10-2007. FILED 4-18-2006.
- 3,297,642. **DOUBLEVAULT (BLOCK FORM)**. DOUBLEVAULT TECHNOLOGIES, INC., MULTIPLE CLASS, (INT. CLS. 39 AND 42), (U.S. CLS. 100, 101 AND 105). SN 78-869,660. PUB. 7-10-2007. FILED 4-26-2006.
- 3,297,644 (*See Class 35 for this trademark*).
- 3,297,673. **ROUTE SCOUT (BLOCK FORM)**. TILTON ASSOCIATES GIS, INC., (U.S. CLS. 100 AND 105). SN 78-873,293. PUB. 7-10-2007. FILED 5-1-2006.
- 3,297,782. **LA JOLLA KAYAK AND DESIGN**. LA JOLLA KAYAK & COMPANY LLC, (U.S. CLS. 100 AND 105). SN 78-892,846. PUB. 7-10-2007. FILED 5-25-2006.
- 3,297,812. **CAREFLITE AND DESIGN**. CAREFLITE, (U.S. CLS. 100 AND 105). SN 78-900,152. PUB. 4-3-2007. FILED 6-5-2006.
- 3,297,851 (*See Class 9 for this trademark*).
- 3,298,007 (*See Class 37 for this trademark*).
- 3,298,022 (*See Class 35 for this trademark*).
- 3,298,023. **AMERICAN RESCUE DOG ASSOCIATION, INC. (BLOCK FORM)**. AMERICAN RESCUE DOG ASSOCIATION, INC., (U.S. CLS. 100 AND 105). SN 78-941,368. PUB. 7-10-2007. FILED 7-31-2006.
- 3,298,024. **ARDA (BLOCK FORM)**. AMERICAN RESCUE DOG ASSOCIATION, INC., (U.S. CLS. 100 AND 105). SN 78-941,498. PUB. 7-10-2007. FILED 7-31-2006.
- 3,298,029. **DONGBUTOUR (BLOCK FORM)**. COURTESY TRAVEL, INC., (U.S. CLS. 100 AND 105). SN 78-943,862. PUB. 7-10-2007. FILED 8-3-2006.
- 3,298,030. **BULLZEYE PIZZA (BLOCK FORM)**. OMEGA 1, LLC, MULTIPLE CLASS, (INT. CLS. 39 AND 43), (U.S. CLS. 100, 101 AND 105). SN 78-944,034. PUB. 7-10-2007. FILED 8-3-2006.
- 3,298,069. **THE PROMISE OF TOMORROW (BLOCK FORM)**. CELGENE CORPORATION, MULTIPLE CLASS, (INT. CLS. 39 AND 44), (U.S. CLS. 100, 101 AND 105). SN 78-953,651. PUB. 7-10-2007. FILED 8-16-2006.
- 3,298,100. **RPM AND DESIGN**. ABF FREIGHT SYSTEM, INC., (U.S. CLS. 100 AND 105). SN 78-962,798. PUB. 7-10-2007. FILED 8-29-2006.
- 3,298,101. **RPM (BLOCK FORM)**. ABF FREIGHT SYSTEM, INC., (U.S. CLS. 100 AND 105). SN 78-962,806. PUB. 7-10-2007. FILED 8-29-2006.
- 3,298,151 (*See Class 35 for this trademark*).
- 3,298,152 (*See Class 16 for this trademark*).
- 3,298,160 (*See Class 20 for this trademark*).
- 3,298,167 (*See Class 7 for this trademark*).
- 3,298,188 (*See Class 11 for this trademark*).

3,298,189 (*See Class 35 for this trademark.*)
 3,298,190 (*See Class 35 for this trademark.*)
 3,298,191 (*See Class 37 for this trademark.*)
 3,298,193 (*See Class 35 for this trademark.*)
 3,298,214 (*See Class 3 for this trademark.*)
 3,298,235 (*See Class 35 for this trademark.*)
 3,298,329 (*See Class 35 for this trademark.*)
 3,298,353 (*See Class 25 for this trademark.*)

CLASS 40—MATERIAL TREATMENT

3,296,024 (*See Class 35 for this trademark.*)
 3,296,293 (*See Class 35 for this trademark.*)
 3,296,319 (*See Class 35 for this trademark.*)
 3,296,394 (*See Class 37 for this trademark.*)
 3,296,424 (*See Class 37 for this trademark.*)
 3,296,473. **MEQUATIONS WE ARE SUM ONE AND DESIGN.** SUOS, SAKANEL, AND SUOS, SORONIT, (U.S. CLS. 100, 103 AND 106). SN 77-048,364. PUB. 7-10-2007. FILED 11-21-2006.
 3,296,493 (*See Class 14 for this trademark.*)
 3,296,717. **MISCELLANEOUS DESIGN.** AL'S CABINETS, INC., (U.S. CLS. 100, 103 AND 106). SN 77-065,574. PUB. 7-10-2007. FILED 12-15-2006.
 3,296,774. **OFS (BLOCK FORM).** FURUKAWA ELECTRIC NORTH AMERICA, INC., (U.S. CLS. 100, 103 AND 106). SN 77-076,666. PUB. 7-10-2007. FILED 1-5-2007.
 3,296,789. **NIEDWICK MACHINE PRECISION MANUFACTURING M AND DESIGN.** THE NIEDWICK CORPORATION, (U.S. CLS. 100, 103 AND 106). SN 77-078,913. PUB. 7-10-2007. FILED 1-9-2007.
 3,296,808. **RED LINE GRAPHICS INCORPORATED YOUR IMAGE. DEFINED. AND DESIGN.** RED LINE GRAPHICS, INC., (U.S. CLS. 100, 103 AND 106). SN 77-080,637. PUB. 7-10-2007. FILED 1-11-2007.
 3,296,813. **ART IS MAGIC (BLOCK FORM).** TAMIAN, RICHARD, (U.S. CLS. 100, 103 AND 106). SN 77-081,529. PUB. 7-10-2007. FILED 1-11-2007.
 3,296,817. **RAY GRIFFITHS (BLOCK FORM).** RAY GRIFFITHS INC, MULTIPLE CLASS, (INT. CLS. 40 AND 42), (U.S. CLS. 100, 101, 103 AND 106). SN 77-083,046. PUB. 7-10-2007. FILED 1-15-2007.
 3,296,828. **G II AND DESIGN.** GEMINI INDUSTRIES, INC., (U.S. CLS. 100, 103 AND 106). SN 77-083,961. PUB. 7-10-2007. FILED 1-16-2007.
 3,297,022. **FLEXAN AND DESIGN.** THE FLEXAN CORPORATION, (U.S. CLS. 100, 103 AND 106). SN 77-092,433. PUB. 7-10-2007. FILED 1-26-2007.
 3,297,028. **PAPER OR PLASTIC? EITHER WAY, WE'LL PRINT IT! (BLOCK FORM).** DIGITAL VISION RESOURCES GROUP, LLC, (U.S. CLS. 100, 103 AND 106). SN 77-092,569. PUB. 7-10-2007. FILED 1-26-2007.
 3,297,053. **GRINS 2 GO (BLOCK FORM).** GRINS 2 GO, INC., MULTIPLE CLASS, (INT. CLS. 40 AND 41), (U.S. CLS. 100, 101, 103, 106 AND 107). SN 77-093,994. PUB. 7-10-2007. FILED 1-29-2007.
 3,297,054. **GRINS 2 GO AND DESIGN.** GRINS 2 GO, INC., MULTIPLE CLASS, (INT. CLS. 40 AND 41), (U.S. CLS. 100, 101, 103, 106 AND 107). SN 77-094,008. PUB. 7-10-2007. FILED 1-29-2007.
 3,297,206 (*See Class 1 for this trademark.*)
 3,297,232. **ANCHOR FABRICATION (BLOCK FORM).** ANCHOR FABRICATION PARTNERSHIP, LTD., MULTIPLE CLASS, (INT. CLS. 40 AND 42), (U.S. CLS. 100, 101, 103 AND 106). SN 78-591,280. PUB. 7-10-2007. FILED 3-21-2005.
 3,297,234. **ANCHOR FABRICATION AND DESIGN.** ANCHOR FABRICATION PARTNERSHIP, LTD., MULTIPLE CLASS, (INT. CLS. 40 AND 42), (U.S. CLS. 100, 101, 103 AND 106). SN 78-593,118. PUB. 7-10-2007. FILED 3-23-2005.
 3,297,253 (*See Class 35 for this trademark.*)
 3,297,347 (*See Class 35 for this trademark.*)
 3,297,348 (*See Class 35 for this trademark.*)
 3,297,441 (*See Class 16 for this trademark.*)
 3,297,472 (*See Class 35 for this trademark.*)
 3,297,592. **N AND DESIGN.** NEWLAND TECHNOLOGY PRODUCTS AMERICA INC., (U.S. CLS. 100, 103 AND

106). SN 78-861,788. PUB. 7-10-2007. FILED 4-14-2006.
 3,297,595. **SUNSCOPE (BLOCK FORM).** SUN COAST MERCHANTS CORPORATION, (U.S. CLS. 100, 103 AND 106). SN 78-861,851. PUB. 7-10-2007. FILED 4-14-2006.
 3,297,606 (*See Class 9 for this trademark.*)
 3,297,612. **XIMEDICA (BLOCK FORM).** XIMEDICA, LLC, MULTIPLE CLASS, (INT. CLS. 40 AND 42), (U.S. CLS. 100, 101, 103 AND 106). SN 78-863,402. PUB. 7-10-2007. FILED 4-18-2006.
 3,297,613. **XL COLOR (BLOCK FORM).** XL COLOR CORP., (U.S. CLS. 100, 103 AND 106). SN 78-863,492. PUB. 7-10-2007. FILED 4-18-2006.
 3,297,841 (*See Class 35 for this trademark.*)
 3,297,842 (*See Class 35 for this trademark.*)
 3,297,874. **HOW IMPRESSIVE! (BLOCK FORM).** KNUTSON, KRISTINE, (U.S. CLS. 100, 103 AND 106). SN 78-907,126. PUB. 7-10-2007. FILED 6-13-2006.
 3,298,022 (*See Class 35 for this trademark.*)
 3,298,070. **E-WORLD RECYCLERS (BLOCK FORM).** E-WORLD RECYCLERS, LLC, (U.S. CLS. 100, 103 AND 106). SN 78-953,752. PUB. 4-3-2007. FILED 8-16-2006.
 3,298,160 (*See Class 20 for this trademark.*)
 3,298,188 (*See Class 11 for this trademark.*)
 3,298,191 (*See Class 37 for this trademark.*)
 3,298,326 (*See Class 6 for this trademark.*)

CLASS 41—EDUCATION AND ENTERTAINMENT

3,295,971 (*See Class 9 for this trademark.*)
 3,295,975 (*See Class 9 for this trademark.*)
 3,296,005. **MISCELLANEOUS DESIGN.** KARLE, AMY, (U.S. CLS. 100, 101 AND 107). SN 76-628,010. PUB. 7-10-2007. FILED 1-14-2005.
 3,296,028. **PROFITMAX (BLOCK FORM).** PROFITMAX COUNTER TRAINING, INC., (U.S. CLS. 100, 101 AND 107). SN 76-646,519. PUB. 7-10-2007. FILED 9-9-2005.
 3,296,030 (*See Class 35 for this trademark.*)
 3,296,036 (*See Class 16 for this trademark.*)
 3,296,046 (*See Class 9 for this trademark.*)
 3,296,048. **MY SAFE ZONE (BLOCK FORM).** GLOBAL SAFE ZONE, INC., (U.S. CLS. 100, 101 AND 107). SN 76-653,538. PUB. 7-10-2007. FILED 1-17-2006.
 3,296,067. **BULLY MIC RECORDS AND DESIGN.** STARKS, ANDRE P., (U.S. CLS. 100, 101 AND 107). SN 76-659,055. PUB. 7-10-2007. FILED 4-25-2006.
 3,296,070. **ROCK SOLID (BLOCK FORM).** SLIPPERY ROCK UNIVERSITY OF PENNSYLVANIA, A UNIT OF THE STATE SYSTEM OF HIGHER EDUCATION, (U.S. CLS. 100, 101 AND 107). SN 76-659,223. PUB. 7-10-2007. FILED 4-27-2006.
 3,296,078. **FAMILYLIFE THIS WEEK (BLOCK FORM).** FLTI, MULTIPLE CLASS, (INT. CLS. 41 AND 45), (U.S. CLS. 100, 101 AND 107). SN 76-660,739. PUB. 7-10-2007. FILED 5-30-2006.
 3,296,079. **FAMILYLIFE SUNDAY NIGHTS (BLOCK FORM).** FLTI, MULTIPLE CLASS, (INT. CLS. 41 AND 45), (U.S. CLS. 100, 101 AND 107). SN 76-660,744. PUB. 7-10-2007. FILED 5-30-2006.
 3,296,095. **BLOGASANA (BLOCK FORM).** DO, LOAN, (U.S. CLS. 100, 101 AND 107). SN 76-662,804. PUB. 7-10-2007. FILED 7-10-2006.
 3,296,103 (*See Class 35 for this trademark.*)
 3,296,104 (*See Class 35 for this trademark.*)
 3,296,109 (*See Class 35 for this trademark.*)
 3,296,112 (*See Class 16 for this trademark.*)
 3,296,121. **HAPKIYUDO (BLOCK FORM).** PARK, MOON SOON, (U.S. CLS. 100, 101 AND 107). SN 76-665,992. PUB. 7-10-2007. FILED 9-13-2006.
 3,296,130. **RABBIT'S REVIEWS (BLOCK FORM).** EX SITU MARKETING INC., (U.S. CLS. 100, 101 AND 107). SN 76-666,703. PUB. 7-10-2007. FILED 9-28-2006.
 3,296,131. **JIMMY RANE CHARITY GOLF TOURNAMENT R AND DESIGN.** JIMMY RANE FOUNDATION, (U.S. CLS. 100, 101 AND 107). SN 76-666,782. PUB. 7-10-2007. FILED 9-29-2006.

- 3,296,140. **CURRENT BIOGRAPHY (BLOCK FORM)**. THE H.W. WILSON COMPANY, (U.S. CLS. 100, 101 AND 107). SN 76-667,977. PUB. 7-10-2007. FILED 10-24-2006.
- 3,296,142 (*See Class 35 for this trademark*).
- 3,296,143. **MONEY FOR A SONG! (BLOCK FORM)**. BELLE-TIERE, GENE, (U.S. CLS. 100, 101 AND 107). SN 76-668,273. PUB. 7-10-2007. FILED 10-30-2006.
- 3,296,155. **HOOGLAND CENTER FOR TEACHER EXCELLENCE (BLOCK FORM)**. HILLSDALE COLLEGE, (U.S. CLS. 100, 101 AND 107). SN 76-669,700. PUB. 7-10-2007. FILED 11-30-2006.
- 3,296,167. **KIDCREATE (BLOCK FORM)**. LARA SCHINKEL-OLSON INC., (U.S. CLS. 100, 101 AND 107). SN 76-670,537. PUB. 7-10-2007. FILED 12-19-2006.
- 3,296,168. **H.O.G. (BLOCK FORM)**. H-D MICHIGAN, INC., (U.S. CLS. 100, 101 AND 107). SN 76-670,549. PUB. 7-10-2007. FILED 12-19-2006.
- 3,296,183 (*See Class 9 for this trademark*).
- 3,296,187. **AMERICA'S #1 SAILING SCHOOL (BLOCK FORM)**. OFFSHORE SAILING SCHOOL LTD., (U.S. CLS. 100, 101 AND 107). SN 76-671,662. PUB. 7-10-2007. FILED 1-22-2007.
- 3,296,204 (*See Class 35 for this trademark*).
- 3,296,220 (*See Class 16 for this trademark*).
- 3,296,230 (*See Class 16 for this trademark*).
- 3,296,231 (*See Class 16 for this trademark*).
- 3,296,232. **A-SPIRE UNIVERSITY (BLOCK FORM)**. A-SPIRE FINANCIAL CORPORATION, (U.S. CLS. 100, 101 AND 107). SN 77-003,334. PUB. 4-3-2007. FILED 9-20-2006.
- 3,296,236 (*See Class 39 for this trademark*).
- 3,296,246. **AU A-SPIRE UNIVERSITY AND DESIGN**. A-SPIRE FINANCIAL CORPORATION, (U.S. CLS. 100, 101 AND 107). SN 77-008,062. PUB. 4-3-2007. FILED 9-26-2006.
- 3,296,265. **EXTREME SCHOOLHOUSE (BLOCK FORM)**. EXTREME LEARNING, INC., (U.S. CLS. 100, 101 AND 107). SN 77-012,878. PUB. 7-10-2007. FILED 10-3-2006.
- 3,296,270. **SOUTH 70 (BLOCK FORM)**. TWO LANE ROAD, INC., (U.S. CLS. 100, 101 AND 107). SN 77-013,310. PUB. 7-10-2007. FILED 10-4-2006.
- 3,296,271. **TENJUNE (BLOCK FORM)**. BASEMENT MANAGER, LLC, MULTIPLE CLASS, (INT. CLS. 41 AND 43), (U.S. CLS. 100, 101 AND 107). SN 77-014,106. PUB. 7-10-2007. FILED 10-4-2006.
- 3,296,282. **KNOWLEDGE ACADEMIES (BLOCK FORM)**. SAGE LEADERSHIP PARTNERS, INC., (U.S. CLS. 100, 101 AND 107). SN 77-016,444. PUB. 7-10-2007. FILED 10-8-2006.
- 3,296,284. **MARTS ON WHEELS (BLOCK FORM)**. MARTZ, VERNILLYN, (U.S. CLS. 100, 101 AND 107). SN 77-017,107. PUB. 7-10-2007. FILED 10-9-2006.
- 3,296,293 (*See Class 35 for this trademark*).
- 3,296,294. **MISCELLANEOUS DESIGN**. LION'S HEART CHRISTIAN MINISTRIES, INC., MULTIPLE CLASS, (INT. CLS. 41 AND 45), (U.S. CLS. 100, 101 AND 107). SN 77-019,147. PUB. 7-10-2007. FILED 10-11-2006.
- 3,296,305 (*See Class 38 for this trademark*).
- 3,296,311. **MISCELLANEOUS DESIGN**. US OPEN SWING DANCE CHAMPIONSHIPS, INC., (U.S. CLS. 100, 101 AND 107). SN 77-024,390. PUB. 7-10-2007. FILED 10-18-2006.
- 3,296,315. **AVEDA INSTITUTE (BLOCK FORM)**. AVEDA CORPORATION, (U.S. CLS. 100, 101 AND 107). SN 77-025,118. PUB. 7-10-2007. FILED 10-19-2006.
- 3,296,321 (*See Class 9 for this trademark*).
- 3,296,333. **NOTHING BUT NET (BLOCK FORM)**. MCDONALD'S CORPORATION, (U.S. CLS. 100, 101 AND 107). SN 77-027,806. PUB. 7-10-2007. FILED 10-24-2006.
- 3,296,335. **TDI (BLOCK FORM)**. THERAPY DOGS INTERNATIONAL, INC., MULTIPLE CLASS, (INT. CLS. 41 AND 45), (U.S. CLS. 100, 101 AND 107). SN 77-028,081. PUB. 7-10-2007. FILED 10-24-2006.
- 3,296,363. **PMTV (BLOCK FORM)**. CROSSWIND PROJECT MANAGEMENT INC., (U.S. CLS. 100, 101 AND 107). SN 77-031,972. PUB. 7-10-2007. FILED 10-30-2006.
- 3,296,366 (*See Class 25 for this trademark*).
- 3,296,373. **SEATTLE CHAMBER MUSIC SOCIETY (BLOCK FORM)**. SEATTLE CHAMBER MUSIC FESTIVAL, DBA SEATTLE CHAMBER MUSIC SOCIETY, (U.S. CLS. 100, 101 AND 107). SN 77-033,655. PUB. 7-10-2007. FILED 10-31-2006.
- 3,296,381 (*See Class 9 for this trademark*).
- 3,296,384 (*See Class 35 for this trademark*).
- 3,296,409. **VALENTE (BLOCK FORM)**. BERTELLI VALENTE, (U.S. CLS. 100, 101 AND 107). SN 77-040,029. PUB. 7-10-2007. FILED 11-8-2006.
- 3,296,410 (*See Class 35 for this trademark*).
- 3,296,411. **MISCELLANEOUS DESIGN**. LOTT-GIDI, LINDA, (U.S. CLS. 100, 101 AND 107). SN 77-040,394. PUB. 7-10-2007. FILED 11-9-2006.
- 3,296,415. **LEGACY INTERACTIVE (BLOCK FORM)**. LEGACY INTERACTIVE, INC., (U.S. CLS. 100, 101 AND 107). SN 77-041,058. PUB. 7-10-2007. FILED 11-9-2006.
- 3,296,417. **LEGACY GAMES (BLOCK FORM)**. LEGACY INTERACTIVE, INC., (U.S. CLS. 100, 101 AND 107). SN 77-041,066. PUB. 7-10-2007. FILED 11-9-2006.
- 3,296,418 (*See Class 35 for this trademark*).
- 3,296,425 (*See Class 9 for this trademark*).
- 3,296,427 (*See Class 9 for this trademark*).
- 3,296,435. **SOULSONG PUBLISHING REACHING EVERY CHILD AND DESIGN**. FLETTER, SHARON, (U.S. CLS. 100, 101 AND 107). SN 77-043,415. PUB. 7-10-2007. FILED 11-14-2006.
- 3,296,436. **DOROTHY ROSE 13 (BLOCK FORM)**. MCCULLOUGH, PATRICIA, (U.S. CLS. 100, 101 AND 107). SN 77-043,732. PUB. 7-10-2007. FILED 11-14-2006.
- 3,296,450. **THE NEEDLES (BLOCK FORM)**. THE NEEDLES, (U.S. CLS. 100, 101 AND 107). SN 77-045,007. PUB. 7-10-2007. FILED 11-15-2006.
- 3,296,462. **MISCELLANEOUS DESIGN**. FLINT CREEK WILDLIFE REHABILITATION, MULTIPLE CLASS, (INT. CLS. 41 AND 44), (U.S. CLS. 100, 101 AND 107). SN 77-046,934. PUB. 7-10-2007. FILED 11-17-2006.
- 3,296,465 (*See Class 9 for this trademark*).
- 3,296,468 (*See Class 35 for this trademark*).
- 3,296,482 (*See Class 6 for this trademark*).
- 3,296,499. **WORLD OILMAN'S POKER TOURNAMENT WOPT AND DESIGN**. CORNERSTONE ACQUISITION & MANAGEMENT COMPANY LLC, (U.S. CLS. 100, 101 AND 107). SN 77-052,467. PUB. 7-10-2007. FILED 11-28-2006.
- 3,296,501. **BODY & SPIRIT (BLOCK FORM)**. THREE ANGELS BROADCASTING NETWORK, INC., (U.S. CLS. 100, 101 AND 107). SN 77-053,022. PUB. 7-10-2007. FILED 11-29-2006.
- 3,296,513. **SLOWLUTIONS (BLOCK FORM)**. COMPOSED LIFE SERVICES, PLLC, (U.S. CLS. 100, 101 AND 107). SN 77-053,961. PUB. 7-10-2007. FILED 11-30-2006.
- 3,296,538. **SOMEDAY STARTS TODAY. (STYLIZED)**. COLUMBIA COLLEGE, (U.S. CLS. 100, 101 AND 107). SN 77-056,655. PUB. 7-10-2007. FILED 12-4-2006.
- 3,296,539. **BREAKING THE SOUND BARRIER (BLOCK FORM)**. CAROLINA EAR RESEARCH INSTITUTE, THE, (U.S. CLS. 100, 101 AND 107). SN 77-056,818. PUB. 7-10-2007. FILED 12-4-2006.
- 3,296,547 (*See Class 35 for this trademark*).
- 3,296,548. **MOONGAMERS (BLOCK FORM)**. ALLEN, LINDA, (U.S. CLS. 100, 101 AND 107). SN 77-057,518. PUB. 7-10-2007. FILED 12-5-2006.
- 3,296,560. **MISCELLANEOUS DESIGN**. INFANTSEE4D, (U.S. CLS. 100, 101 AND 107). SN 77-059,041. PUB. 6-26-2007. FILED 12-7-2006.
- 3,296,565. **ANTIX AND DESIGN**. NUNEZ, MICHULA, (U.S. CLS. 100, 101 AND 107). SN 77-059,652. PUB. 7-10-2007. FILED 12-7-2006.
- 3,296,577. **THE MIND WHISPERER (BLOCK FORM)**. MCBEE, DANIEL, (U.S. CLS. 100, 101 AND 107). SN 77-060,239. PUB. 7-10-2007. FILED 12-8-2006.
- 3,296,579 (*See Class 38 for this trademark*).
- 3,296,585. **ROUND AND BROWN (BLOCK FORM)**. RK NETMEDIA, INC., (U.S. CLS. 100, 101 AND 107). SN 77-060,747. PUB. 7-10-2007. FILED 12-9-2006.
- 3,296,614. **HEALTH FOR A LIFETIME (BLOCK FORM)**. THREE ANGELS BROADCASTING NETWORK, INC., (U.S. CLS. 100, 101 AND 107). SN 77-062,435. PUB. 7-10-2007. FILED 12-12-2006.
- 3,296,615. **ESN (BLOCK FORM)**. ENGINEERING SERVICES NETWORK, INC., (U.S. CLS. 100, 101 AND 107). SN 77-062,530. PUB. 7-10-2007. FILED 12-12-2006.
- 3,296,616. **SHOULDER TO SHOULDER (BLOCK FORM)**.

- ENGINEERING SERVICES NETWORK, INC., (U.S. CLS. 100, 101 AND 107). SN 77-062,583. PUB. 7-10-2007. FILED 12-12-2006.
- 3,296,617. **TEEN PATHWAYS (BLOCK FORM)**. THREE ANGELS BROADCASTING NETWORK, INC., (U.S. CLS. 100, 101 AND 107). SN 77-062,654. PUB. 7-10-2007. FILED 12-12-2006.
- 3,296,619 (*See Class 35 for this trademark*).
- 3,296,622. **WAVLENGTH (BLOCK FORM)**. MINNESOTA PUBLIC RADIO, (U.S. CLS. 100, 101 AND 107). SN 77-062,992. PUB. 7-10-2007. FILED 12-13-2006.
- 3,296,623. **ORIGINATION (BLOCK FORM)**. ORIGINATION, INC., (U.S. CLS. 100, 101 AND 107). SN 77-062,997. PUB. 7-10-2007. FILED 12-13-2006.
- 3,296,624. **ORIGINATION, INC. THE NATION THAT CATERS TO YOUTH AND DESIGN**. ORIGINATION, INC., (U.S. CLS. 100, 101 AND 107). SN 77-062,998. PUB. 7-10-2007. FILED 12-13-2006.
- 3,296,641. **SOULFUL VOICES (BLOCK FORM)**. GOSPEL MUSIC CHANNEL, LLC, (U.S. CLS. 100, 101 AND 107). SN 77-063,543. PUB. 7-10-2007. FILED 12-13-2006.
- 3,296,648. **EVERYONE'S A MIRACLE (BLOCK FORM)**. THE LILI CLAIRE FOUNDATION, (U.S. CLS. 100, 101 AND 107). SN 77-063,749. PUB. 7-10-2007. FILED 12-13-2006.
- 3,296,650. **THE GAS HOUSE GORILLAS (BLOCK FORM)**. FINK, RICHARD J. (U.S. CLS. 100, 101 AND 107). SN 77-063,777. PUB. 7-10-2007. FILED 12-13-2006.
- 3,296,654. **ADULTELTE (BLOCK FORM)**. COLOSSUS MEDIA CORPORATION, (U.S. CLS. 100, 101 AND 107). SN 77-063,962. PUB. 7-10-2007. FILED 12-14-2006.
- 3,296,657. **"CAPTURING YOUR LIFE, ONE FRAME AT A TIME." (BLOCK FORM)**. JOEY, (U.S. CLS. 100, 101 AND 107). SN 77-063,993. PUB. 7-10-2007. FILED 12-14-2006.
- 3,296,664. **AT AFFORDABLE TICKETS AND DESIGN**. AFFORDABLE TICKET SERVICE, INC., (U.S. CLS. 100, 101 AND 107). SN 77-064,150. PUB. 7-10-2007. FILED 12-14-2006.
- 3,296,665. **SIM RLF (BLOCK FORM)**. SOCIETY FOR INFORMATION MANAGEMENT, (U.S. CLS. 100, 101 AND 107). SN 77-064,152. PUB. 7-10-2007. FILED 12-14-2006.
- 3,296,667. **EYERONIX (BLOCK FORM)**. EYERONIX, LLC, (U.S. CLS. 100, 101 AND 107). SN 77-064,165. PUB. 7-10-2007. FILED 12-14-2006.
- 3,296,668. **FIRSTROUND KNOCKOUT IRKO (BLOCK FORM)**. SIMONI, DANIEL, (U.S. CLS. 100, 101 AND 107). SN 77-064,186. PUB. 7-10-2007. FILED 12-14-2006.
- 3,296,672. **MISCELLANEOUS DESIGN**. SUGAR RHYTHM DANCE, (U.S. CLS. 100, 101 AND 107). SN 77-064,323. PUB. 7-10-2007. FILED 12-14-2006.
- 3,296,674 (*See Class 9 for this trademark*).
- 3,296,688 (*See Class 35 for this trademark*).
- 3,296,692 (*See Class 16 for this trademark*).
- 3,296,694. **CAPTAIN STABBIN (BLOCK FORM)**. RK NETMEDIA, INC., (U.S. CLS. 100, 101 AND 107). SN 77-064,781. PUB. 7-10-2007. FILED 12-14-2006.
- 3,296,701 (*See Class 9 for this trademark*).
- 3,296,718. **DOLLARS & SENSE (BLOCK FORM)**. MONDAY, CURTIS R., (U.S. CLS. 100, 101 AND 107). SN 77-065,576. PUB. 7-10-2007. FILED 12-15-2006.
- 3,296,721. **ZUMBA GOLD (BLOCK FORM)**. ZUMBA FITNESS, LLC, (U.S. CLS. 100, 101 AND 107). SN 77-065,660. PUB. 7-10-2007. FILED 12-15-2006.
- 3,296,725. **GSR (STYLIZED)**. GRAND SIERRA OPERATING CORP., (U.S. CLS. 100, 101 AND 107). SN 77-065,865. PUB. 7-10-2007. FILED 12-16-2006.
- 3,296,727. **SOUL TRACKS (BLOCK FORM)**. CHRISTOPHER LUKE RIZIK, (U.S. CLS. 100, 101 AND 107). SN 77-066,416. PUB. 7-10-2007. FILED 12-18-2006.
- 3,296,735 (*See Class 35 for this trademark*).
- 3,296,739. **BACK TO NATURE (BLOCK FORM)**. THREE ANGELS BROADCASTING NETWORK, INC., (U.S. CLS. 100, 101 AND 107). SN 77-068,786. PUB. 7-10-2007. FILED 12-20-2006.
- 3,296,742 (*See Class 16 for this trademark*).
- 3,296,750. **PASADENA ATHLETIC CLUB (BLOCK FORM)**. PASADENA ATHLETIC OPERATING CLUB, (U.S. CLS. 100, 101 AND 107). SN 77-072,484. PUB. 7-10-2007. FILED 12-28-2006.
- 3,296,751 (*See Class 16 for this trademark*).
- 3,296,761. **GOJIMANIA (BLOCK FORM)**. FREELIFE INTERNATIONAL HOLDINGS, LLC, (U.S. CLS. 100, 101 AND 107). SN 77-074,558. PUB. 6-5-2007. FILED 1-2-2007.
- 3,296,765. **SUBCAT (BLOCK FORM)**. SUBCAT MUSIC STUDIOS, (U.S. CLS. 100, 101 AND 107). SN 77-075,091. PUB. 7-10-2007. FILED 1-3-2007.
- 3,296,768 (*See Class 9 for this trademark*).
- 3,296,773. **APPA INSTITUTE FOR FACILITIES MANAGEMENT AND DESIGN**. APPA, (U.S. CLS. 100, 101 AND 107). SN 77-076,650. PUB. 7-10-2007. FILED 1-5-2007.
- 3,296,775. **SUPERVISOR'S TOOLKIT NUTS AND BOLTS OF FACILITIES SUPERVISION AND DESIGN**. APPA, (U.S. CLS. 100, 101 AND 107). SN 77-076,682. PUB. 7-10-2007. FILED 1-5-2007.
- 3,296,777 (*See Class 16 for this trademark*).
- 3,296,778 (*See Class 16 for this trademark*).
- 3,296,779. **DROCK SPARGO (BLOCK FORM)**. GUZMAN, RENE, (U.S. CLS. 100, 101 AND 107). SN 77-077,097. PUB. 7-10-2007. FILED 1-5-2007.
- 3,296,780 (*See Class 16 for this trademark*).
- 3,296,796. **MYESI AND DESIGN**. ESI INTERNATIONAL, (U.S. CLS. 100, 101 AND 107). SN 77-079,573. PUB. 7-10-2007. FILED 1-10-2007.
- 3,296,801. **BAY TO BREAKERS (BLOCK FORM)**. ANSCHUTZ 12K COMPANY, (U.S. CLS. 100, 101 AND 107). SN 77-079,862. PUB. 7-10-2007. FILED 1-10-2007.
- 3,296,803. **HOOPLA TEAM (BLOCK FORM)**. EMMERICH, ROXANNE, (U.S. CLS. 100, 101 AND 107). SN 77-080,290. PUB. 7-10-2007. FILED 1-10-2007.
- 3,296,805. **PERMISSION TO BE EXTRAORDINARY (BLOCK FORM)**. EMMERICH, ROXANNE, (U.S. CLS. 100, 101 AND 107). SN 77-080,349. PUB. 7-10-2007. FILED 1-10-2007.
- 3,296,815. **SETTING CAPTIVES FREE (BLOCK FORM)**. SETTING CAPTIVES FREE, (U.S. CLS. 100, 101 AND 107). SN 77-081,662. PUB. 7-10-2007. FILED 1-12-2007.
- 3,296,824. **ART OF STRENGTH (BLOCK FORM)**. PUNCH INC., (U.S. CLS. 100, 101 AND 107). SN 77-083,414. PUB. 7-10-2007. FILED 1-16-2007.
- 3,296,827. **ARCHKIDECTURE (BLOCK FORM)**. COWAN, JULIE R., (U.S. CLS. 100, 101 AND 107). SN 77-083,725. PUB. 7-10-2007. FILED 1-16-2007.
- 3,296,838 (*See Class 35 for this trademark*).
- 3,296,844. **RIGHTBIRD (BLOCK FORM)**. WILD BIRDS UNLIMITED INC, (U.S. CLS. 100, 101 AND 107). SN 77-084,887. PUB. 7-10-2007. FILED 1-17-2007.
- 3,296,847. **INFLATABLELAND (BLOCK FORM)**. SAVONA, ROBERT C., AND SAVONA, CYNTHIA B., (U.S. CLS. 100, 101 AND 107). SN 77-085,048. PUB. 7-10-2007. FILED 1-17-2007.
- 3,296,854 (*See Class 35 for this trademark*).
- 3,296,859. **AWARD CENTRAL (BLOCK FORM)**. REED ELSEVIER PROPERTIES INC., (U.S. CLS. 100, 101 AND 107). SN 77-085,837. PUB. 7-10-2007. FILED 1-18-2007.
- 3,296,864. **ECLECTIQUE (BLOCK FORM)**. HEFFERNAN, BRIAN D., (U.S. CLS. 100, 101 AND 107). SN 77-086,317. PUB. 7-10-2007. FILED 1-19-2007.
- 3,296,875. **NUTTIEST PLAY OF THE YEAR (BLOCK FORM)**. BLUE DIAMOND GROWERS, (U.S. CLS. 100, 101 AND 107). SN 77-087,002. PUB. 7-10-2007. FILED 1-19-2007.
- 3,296,883. **KINGDOM MILLIONAIRE (BLOCK FORM)**. EAGAN, CATHERINE, AND DR. J. VICTOR EAGAN, (U.S. CLS. 100, 101 AND 107). SN 77-087,427. PUB. 7-10-2007. FILED 1-21-2007.
- 3,296,887. **AUTOMOTOPHOTO (BLOCK FORM)**. ANDREW L WHEELER, (U.S. CLS. 100, 101 AND 107). SN 77-087,487. PUB. 7-10-2007. FILED 1-21-2007.
- 3,296,913. **EXPORT COMPLIANCE TRAINING INSTITUTE AND DESIGN**. BLACK, SENGERS & ASSOCIATES, (U.S. CLS. 100, 101 AND 107). SN 77-088,850. PUB. 7-10-2007. FILED 1-23-2007.
- 3,296,918. **HOSTILE OMISH (BLOCK FORM)**. HOSTILE OMISH, INC., (U.S. CLS. 100, 101 AND 107). SN 77-089,055. PUB. 7-10-2007. FILED 1-23-2007.
- 3,296,919. **THE LOOPHOLE (BLOCK FORM)**. MINNESOTA PUBLIC RADIO, (U.S. CLS. 100, 101 AND 107). SN 77-089,061. PUB. 7-10-2007. FILED 1-23-2007.
- 3,296,928. **NURSE TO PATIENT (BLOCK FORM)**. VIRTUAL MEETING STRATEGIES, INC., (U.S. CLS. 100, 101 AND

- 107). SN 77-089,608. PUB. 7-10-2007. FILED 1-24-2007.
- 3,296,934. **LOOPCAST (BLOCK FORM)**. MINNESOTA PUBLIC RADIO, (U.S. CLS. 100, 101 AND 107). SN 77-089,850. PUB. 7-10-2007. FILED 1-24-2007.
- 3,296,940. **BOYS SPEAK OUT (BLOCK FORM)**. BOYS SPEAK OUT, INC., (U.S. CLS. 100, 101 AND 107). SN 77-090,150. PUB. 7-10-2007. FILED 1-24-2007.
- 3,296,964. **WOUND CARE EDUCATION INSTITUTE AND DESIGN**. WOUND CARE EDUCATION INSTITUTE, (U.S. CLS. 100, 101 AND 107). SN 77-091,162. PUB. 7-10-2007. FILED 1-25-2007.
- 3,296,989. **MUSIC MILL (BLOCK FORM)**. BURWEN, PETER, (U.S. CLS. 100, 101 AND 107). SN 77-091,589. PUB. 7-10-2007. FILED 1-25-2007.
- 3,296,993. **GIRLS GO OUTSIDE (BLOCK FORM)**. GIRLS GO OUTSIDE, (U.S. CLS. 100, 101 AND 107). SN 77-091,595. PUB. 7-10-2007. FILED 1-25-2007.
- 3,296,997. **THE BUREAU (BLOCK FORM)**. THE BUREAU, LLC, (U.S. CLS. 100, 101 AND 107). SN 77-091,637. PUB. 7-10-2007. FILED 1-25-2007.
- 3,297,010. **JACKSON HOLE (BLOCK FORM)**. JACKSON HOLE MOUNTAIN RESORT CORPORATION, (U.S. CLS. 100, 101 AND 107). SN 77-092,083. PUB. 7-10-2007. FILED 1-26-2007.
- 3,297,014. **ARTNEWS (BLOCK FORM)**. ARTNEWS, LLC, (U.S. CLS. 100, 101 AND 107). SN 77-092,145. PUB. 7-10-2007. FILED 1-26-2007.
- 3,297,020. **WINNING IS GRAND (BLOCK FORM)**. MARY KAY INC., (U.S. CLS. 100, 101 AND 107). SN 77-092,341. PUB. 7-10-2007. FILED 1-26-2007.
- 3,297,027 (See Class 16 for this trademark).
- 3,297,038. **THE FRIENDLY BRIEFS (BLOCK FORM)**. CAMPUS CURRENT, INC., MULTIPLE CLASS, (INT. CLS. 41 AND 45), (U.S. CLS. 100, 101 AND 107). SN 77-093,074. PUB. 7-10-2007. FILED 1-28-2007.
- 3,297,047. **PARENT PASSAGES (BLOCK FORM)**. JOHNSON ELIZABETH M, (U.S. CLS. 100, 101 AND 107). SN 77-093,638. PUB. 7-10-2007. FILED 1-29-2007.
- 3,297,053 (See Class 40 for this trademark).
- 3,297,054 (See Class 40 for this trademark).
- 3,297,067. **K9 CORE +A (BLOCK FORM)**. K9 CORE CONSULTING & TRAINING, LLC, (U.S. CLS. 100, 101 AND 107). SN 77-097,651. PUB. 7-10-2007. FILED 2-2-2007.
- 3,297,069. **PLAYBOY CLUB AND DESIGN**. PLAYBOY ENTERPRISES INTERNATIONAL, INC., MULTIPLE CLASS, (INT. CLS. 41 AND 43), (U.S. CLS. 100, 101 AND 107). SN 77-098,326. PUB. 7-10-2007. FILED 2-2-2007.
- 3,297,072. **SURVIVOR OUTWIT OUTPLAY OUTLAST FIJI AND DESIGN**. SURVIVOR PRODUCTIONS, LLC, (U.S. CLS. 100, 101 AND 107). SN 77-098,976. PUB. 7-10-2007. FILED 2-5-2007.
- 3,297,104 (See Class 35 for this trademark).
- 3,297,106. **HELPING PEOPLE THRIVE (BLOCK FORM)**. CONTINENTAL HEALTH PROMOTION, INC., MULTIPLE CLASS, (INT. CLS. 41 AND 44), (U.S. CLS. 100, 101 AND 107). SN 77-107,081. PUB. 7-10-2007. FILED 2-14-2007.
- 3,297,112. **SAUERKRAUT357 (BLOCK FORM)**. RUNSTADLER, DREW, (U.S. CLS. 100, 101 AND 107). SN 77-108,261. PUB. 7-10-2007. FILED 2-15-2007.
- 3,297,129. **PREPOINT (BLOCK FORM)**. ANCILLARY CARE MANAGEMENT, INC., MULTIPLE CLASS, (INT. CLS. 41 AND 44), (U.S. CLS. 100, 101 AND 107). SN 77-115,898. PUB. 7-10-2007. FILED 2-26-2007.
- 3,297,135. **REAL PEOPLE, SIMPLE IDEAS (BLOCK FORM)**. THE PILLSBURY COMPANY, (U.S. CLS. 100, 101 AND 107). SN 77-119,426. PUB. 7-10-2007. FILED 3-1-2007.
- 3,297,145. **PLAYBOY COMEDY AND DESIGN**. PLAYBOY ENTERPRISES INTERNATIONAL, INC., (U.S. CLS. 100, 101 AND 107). SN 77-125,829. PUB. 7-10-2007. FILED 3-8-2007.
- 3,297,150. **THE DEAL (BLOCK FORM)**. THE DEAL, LLC, (U.S. CLS. 100, 101 AND 107). SN 77-128,433. PUB. 7-10-2007. FILED 3-12-2007.
- 3,297,154 (See Class 25 for this trademark).
- 3,297,176 (See Class 16 for this trademark).
- 3,297,193 (See Class 9 for this trademark).
- 3,297,200 (See Class 36 for this trademark).
- 3,297,206 (See Class 1 for this trademark).
- 3,297,216. **CAMELOT FILMS (BLOCK FORM)**. ATWELL, ROBERT P., (U.S. CLS. 100, 101 AND 107). SN 78-558,249. PUB. 7-10-2007. FILED 2-1-2005.
- 3,297,230 (See Class 25 for this trademark).
- 3,297,237 (See Class 9 for this trademark).
- 3,297,243 (See Class 9 for this trademark).
- 3,297,244 (See Class 9 for this trademark).
- 3,297,249 (See Class 35 for this trademark).
- 3,297,250. **PANORAMA AND DESIGN**. PANORAMA SOFTWARE (BARBADOS) LTD., MULTIPLE CLASS, (INT. CLS. 41 AND 42), (U.S. CLS. 100, 101 AND 107). SN 78-623,130. PUB. 7-10-2007. FILED 5-4-2005.
- 3,297,251. **PANORAMA (BLOCK FORM)**. PANORAMA SOFTWARE (BARBADOS) LTD., MULTIPLE CLASS, (INT. CLS. 41 AND 42), (U.S. CLS. 100, 101 AND 107). SN 78-623,147. PUB. 7-10-2007. FILED 5-4-2005.
- 3,297,260 (See Class 16 for this trademark).
- 3,297,265 (See Class 9 for this trademark).
- 3,297,280. **QUALIFIED LAWYERS TRANSFER TEST (BLOCK FORM)**. SOLAW INTERNATIONAL, INC., (U.S. CLS. 100, 101 AND 107). SN 78-686,045. PUB. 7-10-2007. FILED 8-4-2005.
- 3,297,281. **LIFE CAPTURED BEAUTIFULLY (BLOCK FORM)**. HEATHER BOOKOUT PHOTOGRAPHY, (U.S. CLS. 100, 101 AND 107). SN 78-690,783. PUB. 7-10-2007. FILED 8-11-2005.
- 3,297,305 (See Class 7 for this trademark).
- 3,297,312 (See Class 35 for this trademark).
- 3,297,323. **DIRT MOTORSPORTS (BLOCK FORM)**. DIRT MOTORSPORTS, INC., (U.S. CLS. 100, 101 AND 107). SN 78-718,268. PUB. 7-10-2007. FILED 9-22-2005.
- 3,297,325 (See Class 16 for this trademark).
- 3,297,332 (See Class 35 for this trademark).
- 3,297,343. **BROOKLYN HEIGHTS MONTESSORI SCHOOL (BLOCK FORM)**. BROOKLYN HEIGHTS MONTESSORI SCHOOL, (U.S. CLS. 100, 101 AND 107). SN 78-728,117. PUB. 7-10-2007. FILED 10-6-2005.
- 3,297,353 (See Class 35 for this trademark).
- 3,297,359. **PRACTICAL MONEY SKILLS FOR LIFE (BLOCK FORM)**. VISA INTERNATIONAL SERVICE ASSOCIATION, (U.S. CLS. 100, 101 AND 107). SN 78-749,863. PUB. 7-10-2007. FILED 11-8-2005.
- 3,297,367. **INTEGRATED MOVEMENT THERAPY (BLOCK FORM)**. THE SAMARYA CENTER, (U.S. CLS. 100, 101 AND 107). SN 78-756,516. PUB. 7-10-2007. FILED 11-17-2005.
- 3,297,381 (See Class 9 for this trademark).
- 3,297,383. **THE TRUFFLEMAN (BLOCK FORM)**. FREDERICK MOSTERT, MULTIPLE CLASS, (INT. CLS. 41 AND 43), (U.S. CLS. 100, 101 AND 107). SN 78-767,011. PUB. 7-10-2007. FILED 12-5-2005.
- 3,297,388 (See Class 16 for this trademark).
- 3,297,396 (See Class 38 for this trademark).
- 3,297,405 (See Class 3 for this trademark).
- 3,297,407. **OLD SKOOL CAFE (BLOCK FORM)**. GOINES, TERESA JEAN, MULTIPLE CLASS, (INT. CLS. 41 AND 43), (U.S. CLS. 100, 101 AND 107). SN 78-783,713. PUB. 7-10-2007. FILED 1-2-2006.
- 3,297,410. **ZANMASTER (BLOCK FORM)**. GREEN, JAMES E., (U.S. CLS. 100, 101 AND 107). SN 78-785,328. PUB. 7-10-2007. FILED 1-5-2006.
- 3,297,423. **GREAT X SCAPE AND DESIGN**. HUGHES, DANIEL, (U.S. CLS. 100, 101 AND 107). SN 78-792,612. PUB. 7-10-2007. FILED 1-16-2006.
- 3,297,427 (See Class 1 for this trademark).
- 3,297,437 (See Class 9 for this trademark).
- 3,297,447 (See Class 35 for this trademark).
- 3,297,452. **DIVINE BALANCE AND DESIGN**. DIVINE BALANCE, INC., (U.S. CLS. 100, 101 AND 107). SN 78-807,973. PUB. 7-10-2007. FILED 2-6-2006.
- 3,297,454 (See Class 25 for this trademark).
- 3,297,463. **HAMMER (BLOCK FORM)**. THE ARMAND HAMMER MUSEUM OF ART AND CULTURAL CENTER, INC., (U.S. CLS. 100, 101 AND 107). SN 78-812,639. PUB. 7-10-2007. FILED 2-10-2006.
- 3,297,473. **THE MATRIX (BLOCK FORM)**. MARION, SHAWN, (U.S. CLS. 100, 101 AND 107). SN 78-818,258. PUB. 7-10-2007. FILED 2-18-2006.
- 3,297,474 (See Class 35 for this trademark).

- 3,297,484 (*See Class 9 for this trademark*).
- 3,297,498. **THE VICTORY COACH (BLOCK FORM)**. TOP-NOTCH COMMUNICATIONS GROUP, LLC., (U.S. CLS. 100, 101 AND 107). SN 78-831,202. PUB. 7-10-2007. FILED 3-7-2006.
- 3,297,504. **BLUE ZONES (BLOCK FORM)**. QUEST NETWORK, INC., (U.S. CLS. 100, 101 AND 107). SN 78-833,856. PUB. 7-10-2007. FILED 3-9-2006.
- 3,297,505. **FYI FILM YOUR ISSUE (BLOCK FORM)**. FILM YOUR ISSUE, LTD., (U.S. CLS. 100, 101 AND 107). SN 78-833,977. PUB. 7-10-2007. FILED 3-10-2006.
- 3,297,506 (*See Class 25 for this trademark*).
- 3,297,526. **EGC EVERGREEN COPYRIGHTS AND DESIGN**. EVERGREEN COPYRIGHT ACQUISITIONS, LLC, (U.S. CLS. 100, 101 AND 107). SN 78-842,127. PUB. 7-10-2007. FILED 3-21-2006.
- 3,297,537. **EMERSON (BLOCK FORM)**. EMERSON COLLEGE, (U.S. CLS. 100, 101 AND 107). SN 78-846,509. PUB. 7-10-2007. FILED 3-27-2006.
- 3,297,550. **GOLDEN GULCH CASINO (BLOCK FORM)**. GOLDEN MARDI GRAS, INC., (U.S. CLS. 100, 101 AND 107). SN 78-851,715. PUB. 7-10-2007. FILED 3-31-2006.
- 3,297,553. **BETTER BASKETBALL (BLOCK FORM)**. BETTER BASKETBALL, INC., (U.S. CLS. 100, 101 AND 107). SN 78-852,150. PUB. 7-10-2007. FILED 4-2-2006.
- 3,297,555. **JLI JEWISH LEARNING INSTITUTE AND DESIGN**. THE JEWISH LEARNING INSTITUTE, (U.S. CLS. 100, 101 AND 107). SN 78-852,494. PUB. 7-10-2007. FILED 4-3-2006.
- 3,297,563. **CINEMASTAR (BLOCK FORM)**. CINEMASTAR LUXURY THEATERS, INC., (U.S. CLS. 100, 101 AND 107). SN 78-855,109. PUB. 7-10-2007. FILED 4-5-2006.
- 3,297,568 (*See Class 9 for this trademark*).
- 3,297,573 (*See Class 35 for this trademark*).
- 3,297,578. **MISCELLANEOUS DESIGN**. NINTENDO CO., LTD., (U.S. CLS. 100, 101 AND 107). SN 78-858,345. PUB. 7-10-2007. FILED 4-10-2006.
- 3,297,580 (*See Class 35 for this trademark*).
- 3,297,589. **FREE GEEK (BLOCK FORM)**. FREE GEEK INC., (U.S. CLS. 100, 101 AND 107). SN 78-861,435. PUB. 7-10-2007. FILED 4-13-2006.
- 3,297,597 (*See Class 35 for this trademark*).
- 3,297,598 (*See Class 35 for this trademark*).
- 3,297,604. **CATWALK TELEVISION (BLOCK FORM)**. CATWALK TELEVISION NETWORK, (U.S. CLS. 100, 101 AND 107). SN 78-862,646. PUB. 7-10-2007. FILED 4-17-2006.
- 3,297,605. **NIGHTSURF PICTURES (BLOCK FORM)**. HACKSHAW, TIRSA, (U.S. CLS. 100, 101 AND 107). SN 78-862,671. PUB. 7-10-2007. FILED 4-17-2006.
- 3,297,618 (*See Class 35 for this trademark*).
- 3,297,621. **WBI (STYLIZED)**. SAN FERNANDO BEAUTY ACADEMY, (U.S. CLS. 100, 101 AND 107). SN 78-864,332. PUB. 7-10-2007. FILED 4-19-2006.
- 3,297,629. **MAYDAY (BLOCK FORM)**. MAYDAY, (U.S. CLS. 100, 101 AND 107). SN 78-866,480. PUB. 7-10-2007. FILED 4-21-2006.
- 3,297,635 (*See Class 16 for this trademark*).
- 3,297,643. **HEALTHY CHURCH DNA (BLOCK FORM)**. REDIEHS, GLEN H., AND WEBB, LARRY E., (U.S. CLS. 100, 101 AND 107). SN 78-869,744. PUB. 7-10-2007. FILED 4-26-2006.
- 3,297,645. **DISCERN PLUS (BLOCK FORM)**. REDIEHS, GLEN H., AND WEBB, LARRY E., (U.S. CLS. 100, 101 AND 107). SN 78-869,773. PUB. 7-10-2007. FILED 4-26-2006.
- 3,297,646 (*See Class 9 for this trademark*).
- 3,297,648 (*See Class 38 for this trademark*).
- 3,297,669 (*See Class 35 for this trademark*).
- 3,297,670 (*See Class 9 for this trademark*).
- 3,297,672. **SCORES ON THE FOURS (BLOCK FORM)**. COMCAST SPORTSNET PHILADELPHIA, L.P., (U.S. CLS. 100, 101 AND 107). SN 78-873,125. PUB. 7-10-2007. FILED 5-1-2006.
- 3,297,704. **SHOWCASE OF HOMES (BLOCK FORM)**. JOHN T. NOTHNAGLE, INC., (U.S. CLS. 100, 101 AND 107). SN 78-879,738. PUB. 7-10-2007. FILED 5-9-2006.
- 3,297,709 (*See Class 35 for this trademark*).
- 3,297,711 (*See Class 16 for this trademark*).
- 3,297,712 (*See Class 16 for this trademark*).
- 3,297,714 (*See Class 25 for this trademark*).
- 3,297,718. **KDOQI KIDNEY DISEASE OUTCOMES QUALITY INITIATIVE NATIONAL KIDNEY FOUNDATION AND DESIGN**. NATIONAL KIDNEY FOUNDATION, INC., (U.S. CLS. 100, 101 AND 107). SN 78-883,143. PUB. 7-10-2007. FILED 5-15-2006.
- 3,297,720. **RAISING MALAWI ORPHAN CARE INITIATIVE AND DESIGN**. KABBALAH CENTRE INTERNATIONAL, INC., (U.S. CLS. 100, 101 AND 107). SN 78-883,273. PUB. 7-10-2007. FILED 5-15-2006.
- 3,297,721. **RAISING MALAWI ORPHAN CARE INITIATIVE (BLOCK FORM)**. KABBALAH CENTRE INTERNATIONAL, INC., (U.S. CLS. 100, 101 AND 107). SN 78-883,275. PUB. 7-10-2007. FILED 5-15-2006.
- 3,297,723. **ANTIBALAS (BLOCK FORM)**. MARTIN PERNA, (U.S. CLS. 100, 101 AND 107). SN 78-883,668. PUB. 7-10-2007. FILED 5-15-2006.
- 3,297,724. **FOOD SAFETY SUMMIT EXPO & CONFERENCE (BLOCK FORM)**. ASCEND MEDIA PROFESSIONAL SERVICES, LLC, (U.S. CLS. 100, 101 AND 107). SN 78-883,670. PUB. 7-10-2007. FILED 5-15-2006.
- 3,297,727. **INK (BLOCK FORM)**. INTERACTIVE NEIGHBORHOOD FOR KIDS, INC., (U.S. CLS. 100, 101 AND 107). SN 78-884,327. PUB. 7-10-2007. FILED 5-16-2006.
- 3,297,728. **INK AND DESIGN**. INTERACTIVE NEIGHBORHOOD FOR KIDS, INC., (U.S. CLS. 100, 101 AND 107). SN 78-884,348. PUB. 7-10-2007. FILED 5-16-2006.
- 3,297,748. **WOODLAND PUBLISHING AND DESIGN**. WOODLAND PUBLISHING, INC., (U.S. CLS. 100, 101 AND 107). SN 78-886,768. PUB. 7-10-2007. FILED 5-18-2006.
- 3,297,757 (*See Class 9 for this trademark*).
- 3,297,762 (*See Class 35 for this trademark*).
- 3,297,768. **ENTRÉE VOUS HOW DINNER GETS DONE. AND DESIGN**. ENTRÉE VOUS, MULTIPLE CLASS, (INT. CLS. 41 AND 43), (U.S. CLS. 100, 101 AND 107). SN 78-889,770. PUB. 7-10-2007. FILED 5-23-2006.
- 3,297,778. **TALBOT (BLOCK FORM)**. BIOLA UNIVERSITY, INC., (U.S. CLS. 100, 101 AND 107). SN 78-891,924. PUB. 7-10-2007. FILED 5-24-2006.
- 3,297,779. **BETTER TOGETHER (BLOCK FORM)**. CASEY FAMILY PROGRAMS, MULTIPLE CLASS, (INT. CLS. 41 AND 45), (U.S. CLS. 100, 101 AND 107). SN 78-892,063. PUB. 7-10-2007. FILED 5-24-2006.
- 3,297,783 (*See Class 35 for this trademark*).
- 3,297,784 (*See Class 35 for this trademark*).
- 3,297,790. **SHAREDEVENTS (BLOCK FORM)**. SHARED INSIGHTS US, LLC, (U.S. CLS. 100, 101 AND 107). SN 78-895,271. PUB. 7-10-2007. FILED 5-29-2006.
- 3,297,796 (*See Class 9 for this trademark*).
- 3,297,800 (*See Class 9 for this trademark*).
- 3,297,822 (*See Class 35 for this trademark*).
- 3,297,830. **FORESIGHT (BLOCK FORM)**. FORE-SIGHT, LLC, (U.S. CLS. 100, 101 AND 107). SN 78-902,478. PUB. 7-10-2007. FILED 6-7-2006.
- 3,297,839 (*See Class 9 for this trademark*).
- 3,297,846 (*See Class 9 for this trademark*).
- 3,297,855. **COLLINS COLLEGE (BLOCK FORM)**. AL COLLINS GRAPHIC DESIGN SCHOOL, LTD., (U.S. CLS. 100, 101 AND 107). SN 78-905,093. PUB. 7-10-2007. FILED 6-9-2006.
- 3,297,856. **EVOLUTION AND DESIGN**. EVOLUTION FILM & TAPE, INC, (U.S. CLS. 100, 101 AND 107). SN 78-905,401. PUB. 7-10-2007. FILED 6-10-2006.
- 3,297,863 (*See Class 36 for this trademark*).
- 3,297,864 (*See Class 36 for this trademark*).
- 3,297,873. **THE HARKER SCHOOL (BLOCK FORM)**. THE HARKER SCHOOL, (U.S. CLS. 100, 101 AND 107). SN 78-907,100. PUB. 7-10-2007. FILED 6-13-2006.
- 3,297,878 (*See Class 16 for this trademark*).
- 3,297,879. **HARKER (BLOCK FORM)**. THE HARKER SCHOOL, (U.S. CLS. 100, 101 AND 107). SN 78-907,337. PUB. 7-10-2007. FILED 6-13-2006.
- 3,297,880 (*See Class 16 for this trademark*).
- 3,297,886 (*See Class 35 for this trademark*).
- 3,297,915. **M AND DESIGN**. CLARK, CHARLES K., (U.S. CLS. 100, 101 AND 107). SN 78-913,442. PUB. 7-10-2007. FILED 6-21-2006.
- 3,297,925. **THE PUPPETHEADS (BLOCK FORM)**. SPEARS,

- GARY BRUCE, (U.S. CLS. 100, 101 AND 107). SN 78-916,267. PUB. 7-10-2007. FILED 6-25-2006.
- 3,297,927. **THE ZEN OF SINGING ...THE SPIRITUAL PATH TO FINDING YOUR VOICE. AND DESIGN.** MCCARTHY, NORA A., (U.S. CLS. 100, 101 AND 107). SN 78-917,289. PUB. 7-10-2007. FILED 6-26-2006.
- 3,297,935. **DWYER (BLOCK FORM).** THE NEW YORK RACING ASSOCIATION INC., (U.S. CLS. 100, 101 AND 107). SN 78-918,943. PUB. 7-10-2007. FILED 6-28-2006.
- 3,297,937. **ALFRED G. VANDERBILT (BLOCK FORM).** THE NEW YORK RACING ASSOCIATION INC., (U.S. CLS. 100, 101 AND 107). SN 78-918,961. PUB. 7-10-2007. FILED 6-28-2006.
- 3,297,938. **A.P. SMITHWICK MEMORIAL (BLOCK FORM).** THE NEW YORK RACING ASSOCIATION INC., (U.S. CLS. 100, 101 AND 107). SN 78-918,979. PUB. 7-10-2007. FILED 6-28-2006.
- 3,297,939. **SARANAC (BLOCK FORM).** THE NEW YORK RACING ASSOCIATION INC., (U.S. CLS. 100, 101 AND 107). SN 78-918,997. PUB. 7-10-2007. FILED 6-28-2006.
- 3,297,940. **SANFORD (BLOCK FORM).** THE NEW YORK RACING ASSOCIATION INC., (U.S. CLS. 100, 101 AND 107). SN 78-919,002. PUB. 7-10-2007. FILED 6-28-2006.
- 3,297,941. **BERNARD BARUCH (BLOCK FORM).** THE NEW YORK RACING ASSOCIATION INC., (U.S. CLS. 100, 101 AND 107). SN 78-919,014. PUB. 7-10-2007. FILED 6-28-2006.
- 3,297,960 (*See Class 36 for this trademark.*).
- 3,297,968. **BLACK PEARLS (BLOCK FORM).** ROBINSON, DEE, (U.S. CLS. 100, 101 AND 107). SN 78-925,316. PUB. 7-10-2007. FILED 7-10-2006.
- 3,297,969. **CAFEPRESS CONNECT (BLOCK FORM).** CAFEPRESS.COM, INC., (U.S. CLS. 100, 101 AND 107). SN 78-926,154. PUB. 7-10-2007. FILED 7-10-2006.
- 3,297,974 (*See Class 35 for this trademark.*).
- 3,297,981 (*See Class 16 for this trademark.*).
- 3,297,989. **PODFACTORY (BLOCK FORM).** PRIMITIVE, INC., (U.S. CLS. 100, 101 AND 107). SN 78-930,908. PUB. 7-10-2007. FILED 7-17-2006.
- 3,297,992. **PINNACLE RECORDS (BLOCK FORM).** PINNACLE RECORDS LLC, (U.S. CLS. 100, 101 AND 107). SN 78-931,160. PUB. 7-10-2007. FILED 7-17-2006.
- 3,298,007 (*See Class 37 for this trademark.*).
- 3,298,008. **LUCIDIAN (BLOCK FORM).** BREWER, FARON C., (U.S. CLS. 100, 101 AND 107). SN 78-935,340. PUB. 7-10-2007. FILED 7-21-2006.
- 3,298,011. **CADDIE CONCIERGE (BLOCK FORM).** CADDIE MASTER ENTERPRISES, INC., MULTIPLE CLASS, (INT. CLS. 41 AND 45), (U.S. CLS. 100, 101 AND 107). SN 78-936,067. PUB. 7-10-2007. FILED 7-24-2006.
- 3,298,012 (*See Class 35 for this trademark.*).
- 3,298,015. **NJASFAA AND DESIGN.** NEW JERSEY ASSOCIATION OF STUDENT FINANCIAL AID ADMINISTRATORS, INC., (U.S. CLS. 100, 101 AND 107). SN 78-939,758. PUB. 7-10-2007. FILED 7-28-2006.
- 3,298,018. **TIMES TOPICS (BLOCK FORM).** NEW YORK TIMES COMPANY, THE, (U.S. CLS. 100, 101 AND 107). SN 78-940,072. PUB. 7-10-2007. FILED 7-28-2006.
- 3,298,025 (*See Class 16 for this trademark.*).
- 3,298,028 (*See Class 35 for this trademark.*).
- 3,298,046 (*See Class 35 for this trademark.*).
- 3,298,050 (*See Class 35 for this trademark.*).
- 3,298,068. **POKER RIDE (BLOCK FORM).** WATERLEAF LIMITED, (U.S. CLS. 100, 101 AND 107). SN 78-953,253. PUB. 7-10-2007. FILED 8-16-2006.
- 3,298,076. **CONCEPT360 (BLOCK FORM).** ZELENY GROUP, LLC, DBA CONCEPT 360, MULTIPLE CLASS, (INT. CLS. 41 AND 42), (U.S. CLS. 100, 101 AND 107). SN 78-956,734. PUB. 7-10-2007. FILED 8-21-2006.
- 3,298,077. **HOME MEETS WORK (BLOCK FORM).** SAFETY SOLUTION CONSULTANTS, INC., (U.S. CLS. 100, 101 AND 107). SN 78-956,863. PUB. 7-10-2007. FILED 8-21-2006.
- 3,298,086. **MISCELLANEOUS DESIGN.** STEVEN A. BLANCHARD, (U.S. CLS. 100, 101 AND 107). SN 78-959,831. PUB. 7-10-2007. FILED 8-24-2006.
- 3,298,089. **CAMP CAMBRIDGE (BLOCK FORM).** FISHER, LAWRENCE, AND EPSTEIN, LESLEY, (U.S. CLS. 100, 101 AND 107). SN 78-960,156. PUB. 7-10-2007. FILED 8-24-2006.
- 3,298,102. **MISCELLANEOUS DESIGN.** IN MY SHOES, INC., (U.S. CLS. 100, 101 AND 107). SN 78-962,846. PUB. 7-10-2007. FILED 8-29-2006.
- 3,298,124. **MY DREAM ACADEMY AND DESIGN.** GRAVIXX CORPORATION, MULTIPLE CLASS, (INT. CLS. 41 AND 43), (U.S. CLS. 100, 101 AND 107). SN 78-967,572. PUB. 7-10-2007. FILED 9-5-2006.
- 3,298,125. **HEALTHCARE SPEAKERS NETWORK AND DESIGN.** TILLER GROUP, INC., (U.S. CLS. 100, 101 AND 107). SN 78-967,823. PUB. 7-10-2007. FILED 9-6-2006.
- 3,298,130. **HONEY HUSH SEMINAR (BLOCK FORM).** WILLIAMS, ROZALIA CECELIA, (U.S. CLS. 100, 101 AND 107). SN 78-970,193. PUB. 7-10-2007. FILED 9-8-2006.
- 3,298,143. **HORSESHOE PITCHING CAPITAL OF THE WORLD (BLOCK FORM).** DARKE COUNTY HORSESHOE CLUB, INC., (U.S. CLS. 100, 101 AND 107). SN 78-973,611. PUB. 7-10-2007. FILED 9-13-2006.
- 3,298,150. **CENTER FOR RELIGIOUS INQUIRY (BLOCK FORM).** ST. BARTHOLOMEW'S CHURCH IN THE CITY OF NEW YORK, (U.S. CLS. 100, 101 AND 107). SN 78-978,442. PUB. 7-10-2007. FILED 4-7-2006.
- 3,298,152 (*See Class 16 for this trademark.*).
- 3,298,165 (*See Class 35 for this trademark.*).
- 3,298,166 (*See Class 9 for this trademark.*).
- 3,298,168 (*See Class 16 for this trademark.*).
- 3,298,169 (*See Class 9 for this trademark.*).
- 3,298,178 (*See Class 9 for this trademark.*).
- 3,298,186 (*See Class 9 for this trademark.*).
- 3,298,199 (*See Class 5 for this trademark.*).
- 3,298,214 (*See Class 3 for this trademark.*).
- 3,298,218 (*See Class 5 for this trademark.*).
- 3,298,225 (*See Class 9 for this trademark.*).
- 3,298,230 (*See Class 9 for this trademark.*).
- 3,298,236 (*See Class 16 for this trademark.*).
- 3,298,268 (*See Class 9 for this trademark.*).
- 3,298,273 (*See Class 10 for this trademark.*).
- 3,298,286 (*See Class 16 for this trademark.*).
- 3,298,332 (*See Class 9 for this trademark.*).
- 3,298,351 (*See Class 35 for this trademark.*).
- 3,298,375. **LENOARMI AND DESIGN.** NOEMI SURIOL PUIGVERT, (U.S. CLS. 100, 101 AND 107). SN 79-032,622. PUB. 7-10-2007. FILED 7-31-2006.
- 3,298,380 (*See Class 9 for this trademark.*).
- 3,298,390. **M MAF CLUB (STYLIZED).** SHARM HOLDING, LLC, (U.S. CLS. 100, 101 AND 107). SN 79-034,132. PUB. 7-10-2007. FILED 3-17-2006.

CLASS 42—SCIENTIFIC, COMPUTER AND LEGAL SERVICES

- 3,295,969. **BENCHMARK.** INDEPENDENT PHYSICAL THERAPY, (U.S. CLS. 100 AND 101). SN 76-205,043. PUB. 11-6-2001. FILED 2-5-2001.
- 3,295,983 (*See Class 9 for this trademark.*).
- 3,295,998. **MENTORPRO AND DESIGN.** NATIONAL MENTORING PARTNERSHIP, INC./ MENTOR, (U.S. CLS. 100 AND 101). SN 76-617,693. PUB. 7-10-2007. FILED 10-22-2004.
- 3,296,033 (*See Class 36 for this trademark.*).
- 3,296,043. **POLICYWARE (BLOCK FORM).** SKYWIRE SOFTWARE, LLC, (U.S. CLS. 100 AND 101). SN 76-650,493. PUB. 7-10-2007. FILED 11-17-2005.
- 3,296,101. **IW AND DESIGN.** INTEGWARE, INC., (U.S. CLS. 100 AND 101). SN 76-663,639. PUB. 7-10-2007. FILED 7-25-2006.
- 3,296,111 (*See Class 35 for this trademark.*).
- 3,296,127. **DISC (BLOCK FORM).** INTERNATIONAL DIGITAL ENTERPRISE ALLIANCE, INC., (U.S. CLS. 100 AND 101). SN 76-666,306. PUB. 7-10-2007. FILED 9-18-2006.
- 3,296,139. **SPORE-WISE (BLOCK FORM).** STERI CHECK SYSTEMS, INC., (U.S. CLS. 100 AND 101). SN 76-667,715. PUB. 7-10-2007. FILED 10-19-2006.
- 3,296,146. **SCI SOLUTIONS (BLOCK FORM).** SCI SOLUTIONS, DBA SCHEDULING.COM, (U.S. CLS. 100 AND 101). SN 76-668,519. PUB. 7-10-2007. FILED 11-6-2006.
- 3,296,151 (*See Class 35 for this trademark.*).
- 3,296,153. **WEBDEB (BLOCK FORM).** WEBDEB, INC., (U.S. CLS. 100 AND 101). SN 76-669,126. PUB. 7-10-2007. FILED

- 11-13-2006.
 3,296,161. **SPINDUSTRY (BLOCK FORM)**. SPINDUSTRY SYSTEMS INCORPORATED, (U.S. CLS. 100 AND 101). SN 76-670,383. PUB. 7-10-2007. FILED 12-15-2006.
 3,296,204 (*See Class 35 for this trademark*).
 3,296,250. **VIRTUAL AVAILABILITY (BLOCK FORM)**. CHAMPION SOLUTIONS GROUP, INC., (U.S. CLS. 100 AND 101). SN 77-008,948. PUB. 7-10-2007. FILED 9-27-2006.
 3,296,253. **LOGICFORCE (BLOCK FORM)**. LOGICFORCE CONSULTING, LLC, (U.S. CLS. 100 AND 101). SN 77-009,753. PUB. 7-10-2007. FILED 9-28-2006.
 3,296,306. **TIMEMD (BLOCK FORM)**. TIME M.D., INC., (U.S. CLS. 100 AND 101). SN 77-023,827. PUB. 7-10-2007. FILED 10-18-2006.
 3,296,336 (*See Class 7 for this trademark*).
 3,296,347. **SCHOOL DOWNLOAD LIBRARY AND DESIGN**. DIGITAL LIBRARY RESERVE, INC., (U.S. CLS. 100 AND 101). SN 77-030,081. PUB. 7-10-2007. FILED 10-26-2006.
 3,296,378 (*See Class 35 for this trademark*).
 3,296,384 (*See Class 35 for this trademark*).
 3,296,392. **RESTORATION R E S O U R C E S AND DESIGN**. RESTORATION RESOURCES, (U.S. CLS. 100 AND 101). SN 77-036,461. PUB. 7-10-2007. FILED 11-3-2006.
 3,296,402. **THE FUTURE VALUE OF BUSINESS (BLOCK FORM)**. LUCRUM, INC., (U.S. CLS. 100 AND 101). SN 77-038,405. PUB. 7-10-2007. FILED 11-7-2006.
 3,296,423 (*See Class 9 for this trademark*).
 3,296,443 (*See Class 38 for this trademark*).
 3,296,497 (*See Class 9 for this trademark*).
 3,296,506 (*See Class 9 for this trademark*).
 3,296,516. **RACE ARE WE SO DIFFERENT? AND DESIGN**. AMERICAN ANTHROPOLOGICAL ASSOCIATION, (U.S. CLS. 100 AND 101). SN 77-054,497. PUB. 7-10-2007. FILED 11-30-2006.
 3,296,530. **B BESTECH AND DESIGN**. BESTECH, A DIVISION OF BOUDREAU-ESPLEY-PITRE CORPORATION, (U.S. CLS. 100 AND 101). SN 77-056,044. PUB. 7-10-2007. FILED 12-3-2006.
 3,296,540. **BRANDLETTERING (BLOCK FORM)**. BELL, CAROLYN JILL, (U.S. CLS. 100 AND 101). SN 77-056,868. PUB. 7-10-2007. FILED 12-5-2006.
 3,296,550. **PIXTORIE (BLOCK FORM)**. PICTORIE, LLC, (U.S. CLS. 100 AND 101). SN 77-057,933. PUB. 7-10-2007. FILED 12-6-2006.
 3,296,570. **COMPETENCY BUILDER (BLOCK FORM)**. GETABSTRACT LTD (SWITZERLAND), (U.S. CLS. 100 AND 101). SN 77-060,001. PUB. 7-10-2007. FILED 12-8-2006.
 3,296,580 (*See Class 35 for this trademark*).
 3,296,591. **PROVIDING A CLEAR DIRECTION (BLOCK FORM)**. RAJKOWSKI HANSMEIER, LTD., (U.S. CLS. 100 AND 101). SN 77-061,178. PUB. 7-10-2007. FILED 12-11-2006.
 3,296,604. **RESULTSONDEMAND (BLOCK FORM)**. SUM TOTAL SYSTEMS, INC., (U.S. CLS. 100 AND 101). SN 77-061,676. PUB. 7-10-2007. FILED 12-11-2006.
 3,296,607 (*See Class 35 for this trademark*).
 3,296,619 (*See Class 35 for this trademark*).
 3,296,666. **FRANKLIN'S KITE AND DESIGN**. FRANKLIN'S KITE, (U.S. CLS. 100 AND 101). SN 77-064,162. PUB. 7-10-2007. FILED 12-14-2006.
 3,296,670. **SUTIN THAYER & BROWNE (BLOCK FORM)**. SUTIN, THAYER & BROWNE, (U.S. CLS. 100 AND 101). SN 77-064,230. PUB. 7-10-2007. FILED 12-14-2006.
 3,296,709. **DELIVERING ON THE PROMISE OF PERSONALIZED MEDICINE (BLOCK FORM)**. GENITOPE CORPORATION, (U.S. CLS. 100 AND 101). SN 77-065,298. PUB. 7-10-2007. FILED 12-15-2006.
 3,296,737. **APPLE ACCREDITED PROFESSIONAL PRE-SCHOOL LEARNING ENVIRONMENT AND DESIGN**. THE FLORIDA ASSOCIATION OF CHILD CARE MANAGEMENT, INC., (U.S. CLS. 100 AND 101). SN 77-068,392. PUB. 7-10-2007. FILED 12-20-2006.
 3,296,744. **DESIGNLOUNGE (BLOCK FORM)**. DESIGNLOUNGE, INC., (U.S. CLS. 100 AND 101). SN 77-069,729. PUB. 7-10-2007. FILED 12-21-2006.
 3,296,746. **DRTANDEM (BLOCK FORM)**. DANIEL J. PRINZING, (U.S. CLS. 100 AND 101). SN 77-070,942. PUB. 7-10-2007. FILED 12-23-2006.
 3,296,753. **INTALGENT (BLOCK FORM)**. INTALGENT TECHNOLOGIES, LLC, (U.S. CLS. 100 AND 101). SN 77-073,059. PUB. 7-10-2007. FILED 12-29-2006.
 3,296,754 (*See Class 9 for this trademark*).
 3,296,755. **BRIGHTDOOR (BLOCK FORM)**. BRIGHTDOOR SYSTEMS, INC., (U.S. CLS. 100 AND 101). SN 77-073,382. PUB. 7-10-2007. FILED 12-29-2006.
 3,296,756. **OUT OF THE BOX DESIGNS (BLOCK FORM)**. OTB ARCHITECTURAL ELEMENTS, INC., (U.S. CLS. 100 AND 101). SN 77-073,386. PUB. 7-10-2007. FILED 12-29-2006.
 3,296,757. **SHMOOZE (BLOCK FORM)**. KORET COMMUNICATIONS, LTD., (U.S. CLS. 100 AND 101). SN 77-073,585. PUB. 7-10-2007. FILED 12-29-2006.
 3,296,760. **ANYWHERE NETWORK (BLOCK FORM)**. YANKEE GROUP RESEARCH, INC., (U.S. CLS. 100 AND 101). SN 77-074,206. PUB. 7-10-2007. FILED 1-2-2007.
 3,296,795. **RULE THE WEB (BLOCK FORM)**. THE REAL TIME MATRIX CORPORATION, (U.S. CLS. 100 AND 101). SN 77-079,531. PUB. 7-10-2007. FILED 1-10-2007.
 3,296,817 (*See Class 40 for this trademark*).
 3,296,823. **HIGHRISE (BLOCK FORM)**. 37SIGNALS, LLC, (U.S. CLS. 100 AND 101). SN 77-083,372. PUB. 7-10-2007. FILED 1-16-2007.
 3,296,831 (*See Class 16 for this trademark*).
 3,296,865. **EVOLVING ARTS (BLOCK FORM)**. MCWILLIAMS, STEPHANIE, (U.S. CLS. 100 AND 101). SN 77-086,353. PUB. 7-10-2007. FILED 1-19-2007.
 3,296,866. **LICKENBROCK (BLOCK FORM)**. LICKENBROCK TECHNOLOGIES, LLC, (U.S. CLS. 100 AND 101). SN 77-086,373. PUB. 7-10-2007. FILED 1-19-2007.
 3,296,868. **ARCHITECTS OF THE USER EXPERIENCE (BLOCK FORM)**. NAVIGATIONARTS, LLC, (U.S. CLS. 100 AND 101). SN 77-086,567. PUB. 7-10-2007. FILED 1-19-2007.
 3,296,872 (*See Class 35 for this trademark*).
 3,296,892. **GLOBALSTEM AND DESIGN**. GLOBALSTEM, INCORPORATED, (U.S. CLS. 100 AND 101). SN 77-087,682. PUB. 7-10-2007. FILED 1-22-2007.
 3,296,895. **BAZAARVOICE AND DESIGN**. BAZAARVOICE, INC., (U.S. CLS. 100 AND 101). SN 77-087,792. PUB. 7-10-2007. FILED 1-22-2007.
 3,296,907 (*See Class 39 for this trademark*).
 3,296,908. **CELL DESIGN (BLOCK FORM)**. CELL DESIGN LLC, MULTIPLE CLASS, (INT. CLS. 42 AND 44), (U.S. CLS. 100 AND 101). SN 77-088,748. PUB. 7-10-2007. FILED 1-23-2007.
 3,296,910. **WR WORLDWIDEREACTION.COM (BLOCK FORM)**. VIRTUAL REACTION INCORPORATED, (U.S. CLS. 100 AND 101). SN 77-088,779. PUB. 7-10-2007. FILED 1-23-2007.
 3,296,942. **ZHIBIT ART LIVES HERE AND DESIGN**. ZHIBIT LLC, (U.S. CLS. 100 AND 101). SN 77-090,432. PUB. 7-10-2007. FILED 1-24-2007.
 3,296,947. **PURELY PATRICIA (BLOCK FORM)**. FOX, PATRICIA, (U.S. CLS. 100 AND 101). SN 77-090,702. PUB. 7-10-2007. FILED 1-25-2007.
 3,297,019. **APPFACOR (BLOCK FORM)**. THEIKOS INC., (U.S. CLS. 100 AND 101). SN 77-092,319. PUB. 7-10-2007. FILED 1-26-2007.
 3,297,042. **KEYSTONE (BLOCK FORM)**. KEYSTONE SOFTWARE, INC., (U.S. CLS. 100 AND 101). SN 77-093,365. PUB. 7-10-2007. FILED 1-29-2007.
 3,297,044. **NELEVEN (BLOCK FORM)**. NELEVEN, INC., (U.S. CLS. 100 AND 101). SN 77-093,559. PUB. 7-10-2007. FILED 1-29-2007.
 3,297,046. **DEALERFIRE (BLOCK FORM)**. NELEVEN, INC., (U.S. CLS. 100 AND 101). SN 77-093,586. PUB. 7-10-2007. FILED 1-29-2007.
 3,297,076. **E3 (STYLIZED)**. ENERGY-ENVIRONMENT-ECONOMICS, L.L.C., (U.S. CLS. 100 AND 101). SN 77-100,226. PUB. 7-10-2007. FILED 2-6-2007.
 3,297,080. **WHOLE BRAIN CREATIVE (BLOCK FORM)**. WHOLE BRAIN CREATIVES, INC., (U.S. CLS. 100 AND 101). SN 77-100,762. PUB. 7-10-2007. FILED 2-6-2007.
 3,297,086. **LI LICKENBROCK (STYLIZED)**. LICKENBROCK TECHNOLOGIES, LLC, (U.S. CLS. 100 AND 101). SN 77-101,797. PUB. 7-10-2007. FILED 2-7-2007.
 3,297,152 (*See Class 35 for this trademark*).
 3,297,180 (*See Class 35 for this trademark*).

- 3,297,195 (*See Class 9 for this trademark*).
 3,297,201. **PHYTOSOME BIOAVAILABLE AND DESIGN**. INDENA S.P.A., (U.S. CLS. 100 AND 101). SN 78-494,169. PUB. 7-10-2007. FILED 10-4-2004.
 3,297,203 (*See Class 35 for this trademark*).
 3,297,204 (*See Class 35 for this trademark*).
 3,297,205 (*See Class 9 for this trademark*).
 3,297,206 (*See Class 1 for this trademark*).
 3,297,212 (*See Class 39 for this trademark*).
 3,297,218. **MISCELLANEOUS DESIGN**. MILLER THOMSON LLP, (U.S. CLS. 100 AND 101). SN 78-560,240. PUB. 7-10-2007. FILED 2-3-2005.
 3,297,226 (*See Class 9 for this trademark*).
 3,297,229 (*See Class 9 for this trademark*).
 3,297,232 (*See Class 40 for this trademark*).
 3,297,234 (*See Class 40 for this trademark*).
 3,297,243 (*See Class 9 for this trademark*).
 3,297,250 (*See Class 41 for this trademark*).
 3,297,251 (*See Class 41 for this trademark*).
 3,297,268 (*See Class 35 for this trademark*).
 3,297,273 (*See Class 35 for this trademark*).
 3,297,275 (*See Class 9 for this trademark*).
 3,297,293. **IPTRADE (BLOCK FORM)**. IPTRADE, INC., (U.S. CLS. 100 AND 101). SN 78-703,289. PUB. 7-10-2007. FILED 8-30-2005.
 3,297,303 (*See Class 9 for this trademark*).
 3,297,305 (*See Class 7 for this trademark*).
 3,297,311 (*See Class 9 for this trademark*).
 3,297,334 (*See Class 1 for this trademark*).
 3,297,335. **EASYFLIGHT (BLOCK FORM)**. THE PRESS OF OHIO, INC., (U.S. CLS. 100 AND 101). SN 78-722,196. PUB. 7-10-2007. FILED 9-28-2005.
 3,297,347 (*See Class 35 for this trademark*).
 3,297,348 (*See Class 35 for this trademark*).
 3,297,355. **ZWEAVE (BLOCK FORM)**. ZWEAVE, INC., (U.S. CLS. 100 AND 101). SN 78-742,869. PUB. 7-10-2007. FILED 10-28-2005.
 3,297,374. **TECTONIC OUTDOORS (BLOCK FORM)**. TECTONIC OUTDOORS, LLC, (U.S. CLS. 100 AND 101). SN 78-762,673. PUB. 7-10-2007. FILED 11-29-2005.
 3,297,382. **COMMISSION ON FIRE ACCREDITATION INTERNATIONAL AND DESIGN**. CENTER FOR PUBLIC SAFETY EXCELLENCE, INC., (U.S. CLS. 100 AND 101). SN 78-766,941. PUB. 7-10-2007. FILED 12-5-2005.
 3,297,395 (*See Class 9 for this trademark*).
 3,297,398 (*See Class 9 for this trademark*).
 3,297,412. **INTEGRAL SOLUTIONS GROUP (BLOCK FORM)**. J M SMITH CORPORATION, (U.S. CLS. 100 AND 101). SN 78-787,714. PUB. 7-10-2007. FILED 1-9-2006.
 3,297,414. **TRANS4MINE (BLOCK FORM)**. SANDVIK TAMROCK OY, (U.S. CLS. 100 AND 101). SN 78-787,938. PUB. 7-10-2007. FILED 1-9-2006.
 3,297,416. **I INTEGRAL SOLUTIONS GROUP AND DESIGN**. J M SMITH CORPORATION, (U.S. CLS. 100 AND 101). SN 78-788,459. PUB. 7-10-2007. FILED 1-10-2006.
 3,297,427 (*See Class 1 for this trademark*).
 3,297,428 (*See Class 9 for this trademark*).
 3,297,429 (*See Class 9 for this trademark*).
 3,297,430 (*See Class 9 for this trademark*).
 3,297,436 (*See Class 9 for this trademark*).
 3,297,460. **T-MOBILE HOMESITE (BLOCK FORM)**. DEUTSCHE TELEKOM AG, (U.S. CLS. 100 AND 101). SN 78-811,328. PUB. 7-10-2007. FILED 2-9-2006.
 3,297,489. **EYEONINVENTORY AND DESIGN**. BOOKSTORE MANAGER, INC., (U.S. CLS. 100 AND 101). SN 78-826,273. PUB. 7-10-2007. FILED 3-1-2006.
 3,297,500. **SALESHAWK AND DESIGN**. XFI CORPORATION, (U.S. CLS. 100 AND 101). SN 78-832,523. PUB. 7-10-2007. FILED 3-8-2006.
 3,297,501. **GATE.COM (BLOCK FORM)**. AFFINITY INTERNET, INC., (U.S. CLS. 100 AND 101). SN 78-832,574. PUB. 7-10-2007. FILED 3-8-2006.
 3,297,509 (*See Class 16 for this trademark*).
 3,297,512 (*See Class 9 for this trademark*).
 3,297,523. **OPENELOQUENCE (BLOCK FORM)**. MARXMEIER SOFTWARE AG, (U.S. CLS. 100 AND 101). SN 78-841,491. PUB. 7-10-2007. FILED 3-20-2006.
 3,297,525 (*See Class 9 for this trademark*).
 3,297,564 (*See Class 35 for this trademark*).
 3,297,571. **BREAK OUT OF THE BULB (BLOCK FORM)**. SPRIEGEL, ANDREW R., (U.S. CLS. 100 AND 101). SN 78-857,182. PUB. 7-10-2007. FILED 4-8-2006.
 3,297,573 (*See Class 35 for this trademark*).
 3,297,575 (*See Class 20 for this trademark*).
 3,297,582 (*See Class 6 for this trademark*).
 3,297,583. **FORCENET AND DESIGN**. DEPARTMENT OF THE NAVY, AN AGENCY OF THE UNITED STATES, AS REPRESENTED BY THE SPACE AND NAVAL WARFARE SYSTEMS COMMAND, (U.S. CLS. 100 AND 101). SN 78-860,294. PUB. 7-10-2007. FILED 4-12-2006.
 3,297,590 (*See Class 35 for this trademark*).
 3,297,594 (*See Class 35 for this trademark*).
 3,297,596 (*See Class 35 for this trademark*).
 3,297,612 (*See Class 40 for this trademark*).
 3,297,618 (*See Class 35 for this trademark*).
 3,297,620. **WEDDING COMPASS (BLOCK FORM)**. GAUSE, GEOFFREY W., (U.S. CLS. 100 AND 101). SN 78-864,067. PUB. 7-10-2007. FILED 4-18-2006.
 3,297,642 (*See Class 39 for this trademark*).
 3,297,644 (*See Class 35 for this trademark*).
 3,297,646 (*See Class 9 for this trademark*).
 3,297,649 (*See Class 37 for this trademark*).
 3,297,659 (*See Class 9 for this trademark*).
 3,297,665 (*See Class 9 for this trademark*).
 3,297,671 (*See Class 35 for this trademark*).
 3,297,713 (*See Class 35 for this trademark*).
 3,297,726 (*See Class 37 for this trademark*).
 3,297,733. **ENERGYNET (BLOCK FORM)**. NEW POWER TECHNOLOGIES, (U.S. CLS. 100 AND 101). SN 78-885,074. PUB. 7-10-2007. FILED 5-16-2006.
 3,297,746. **DRESS CODE (BLOCK FORM)**. DRESS CODE LLC, (U.S. CLS. 100 AND 101). SN 78-886,517. PUB. 7-10-2007. FILED 5-18-2006.
 3,297,755. **CUUL (BLOCK FORM)**. C.U.U.L., INC., (U.S. CLS. 100 AND 101). SN 78-887,695. PUB. 7-10-2007. FILED 5-19-2006.
 3,297,757 (*See Class 9 for this trademark*).
 3,297,770. **MISCELLANEOUS DESIGN**. PROTATECH, LLC, (U.S. CLS. 100 AND 101). SN 78-890,006. PUB. 7-10-2007. FILED 5-23-2006.
 3,297,775. **CLICKY'S WEB WORLD (BLOCK FORM)**. NATIONAL CENTER FOR MISSING AND EXPLOITED CHILDREN, (U.S. CLS. 100 AND 101). SN 78-891,651. PUB. 7-10-2007. FILED 5-24-2006.
 3,297,783 (*See Class 35 for this trademark*).
 3,297,784 (*See Class 35 for this trademark*).
 3,297,788. **AMAZING STAGING (BLOCK FORM)**. REEDER, MONA L., DBA AMAZING STAGING, (U.S. CLS. 100 AND 101). SN 78-894,766. PUB. 7-10-2007. FILED 5-26-2006.
 3,297,820. **COOL IT! (BLOCK FORM)**. NATIONAL WILDLIFE FEDERATION, (U.S. CLS. 100 AND 101). SN 78-901,371. PUB. 7-10-2007. FILED 6-6-2006.
 3,297,854 (*See Class 35 for this trademark*).
 3,297,872. **SHARED HEALTH CLINICAL HEALTH RECORD (BLOCK FORM)**. BLUECROSS BLUESHIELD OF TENNESSEE, INC., (U.S. CLS. 100 AND 101). SN 78-906,850. PUB. 7-10-2007. FILED 6-14-2006.
 3,297,881. **BE PROLIFIC (BLOCK FORM)**. BRANDIMATION, INC., (U.S. CLS. 100 AND 101). SN 78-907,634. PUB. 7-10-2007. FILED 6-14-2006.
 3,297,882. **FORMVIEW (BLOCK FORM)**. BRANDIMATION, INC., (U.S. CLS. 100 AND 101). SN 78-907,650. PUB. 7-10-2007. FILED 6-14-2006.
 3,297,883. **BETWEEN PRODUCTS AND PEOPLE (BLOCK FORM)**. BRANDIMATION INC., (U.S. CLS. 100 AND 101). SN 78-907,655. PUB. 7-10-2007. FILED 6-14-2006.
 3,297,889 (*See Class 37 for this trademark*).
 3,297,896 (*See Class 35 for this trademark*).
 3,297,897 (*See Class 35 for this trademark*).
 3,297,908. **REMEMBERWELL.NET (BLOCK FORM)**. SWAIN HEATHER CLAIRE, MULTIPLE CLASS, (INT. CLS. 42 AND 45), (U.S. CLS. 100 AND 101). SN 78-911,564. PUB. 7-10-2007. FILED 6-19-2006.
 3,297,931. **SHAREDHEALTH TRANSFORMING CARE AND DESIGN**. BLUECROSS BLUESHIELD OF TENNESSEE, INC., (U.S. CLS. 100 AND 101). SN 78-918,072. PUB. 7-10-

2007. FILED 6-27-2006.
- 3,297,944. **CTSS GROUP AND DESIGN**. CORPORATE AND TRANSPORTATION SECURITY SOLUTIONS LLC, MULTIPLE CLASS, (INT. CLS. 42 AND 45), (U.S. CLS. 100 AND 101). SN 78-919,874. PUB. 7-10-2007. FILED 6-29-2006.
- 3,297,945. **CTSS GROUP (BLOCK FORM)**. CORPORATE AND TRANSPORTATION SECURITY SOLUTIONS LLC, MULTIPLE CLASS, (INT. CLS. 42 AND 45), (U.S. CLS. 100 AND 101). SN 78-919,880. PUB. 7-10-2007. FILED 6-29-2006.
- 3,297,954 (*See Class 36 for this trademark*).
- 3,297,977. **WEBVALENCE (BLOCK FORM)**. CROUCH MARTIN D., (U.S. CLS. 100 AND 101). SN 78-927,720. PUB. 7-10-2007. FILED 7-12-2006.
- 3,297,978 (*See Class 35 for this trademark*).
- 3,297,979 (*See Class 35 for this trademark*).
- 3,297,991. **ICANL (BLOCK FORM)**. INTERSOCIETAL COMMISSION FOR THE ACCREDITATION OF NUCLEAR MEDICINE/NUCLEAR CARDIOLOGY LABORATORIES, (U.S. CLS. 100 AND 101). SN 78-930,988. PUB. 7-10-2007. FILED 7-17-2006.
- 3,298,007 (*See Class 37 for this trademark*).
- 3,298,009. **WEBPOTW (BLOCK FORM)**. INTERNATIONAL ENVIRONMENTAL ASSOCIATES, INC., (U.S. CLS. 100 AND 101). SN 78-935,736. PUB. 7-10-2007. FILED 7-24-2006.
- 3,298,012 (*See Class 35 for this trademark*).
- 3,298,021. **TRANSMI AND DESIGN**. JOHNSTON TECHNOLOGY E.I.R.L., (U.S. CLS. 100 AND 101). SN 78-940,673. PUB. 7-10-2007. FILED 7-30-2006.
- 3,298,041 (*See Class 35 for this trademark*).
- 3,298,051 (*See Class 36 for this trademark*).
- 3,298,059. **ADVANCED TECHNOLOGY FOR A CLEANER FUTURE (BLOCK FORM)**. ESW TECHNOLOGIES, INC., (U.S. CLS. 100 AND 101). SN 78-952,380. PUB. 7-10-2007. FILED 8-15-2006.
- 3,298,076 (*See Class 41 for this trademark*).
- 3,298,081 (*See Class 35 for this trademark*).
- 3,298,083. **BLACK MOUNTAIN ROYALTY AND DESIGN**. BLACK MOUNTAIN ROYALTY LP, (U.S. CLS. 100 AND 101). SN 78-958,175. PUB. 7-10-2007. FILED 8-23-2006.
- 3,298,097. **FOR JUSTICE NOW (BLOCK FORM)**. ANDERSON & BOUTWELL, ATTYS AT LAW, (U.S. CLS. 100 AND 101). SN 78-962,604. PUB. 7-10-2007. FILED 8-29-2006.
- 3,298,112. **LAB TESTS ONLINE (BLOCK FORM)**. AMERICAN ASSOCIATION FOR CLINICAL CHEMISTRY, INC., (U.S. CLS. 100 AND 101). SN 78-964,033. PUB. 7-10-2007. FILED 8-30-2006.
- 3,298,127. **MISCELLANEOUS DESIGN**. GUY CARPENTER & COMPANY, INC., (U.S. CLS. 100 AND 101). SN 78-969,436. PUB. 7-10-2007. FILED 9-7-2006.
- 3,298,142. **DIBBLE ENGINEERING (BLOCK FORM)**. DIBBLE & ASSOCIATES CONSULTING ENGINEERS, (U.S. CLS. 100 AND 101). SN 78-973,607. PUB. 7-10-2007. FILED 9-13-2006.
- 3,298,145 (*See Class 37 for this trademark*).
- 3,298,149 (*See Class 9 for this trademark*).
- 3,298,160 (*See Class 20 for this trademark*).
- 3,298,162 (*See Class 9 for this trademark*).
- 3,298,166 (*See Class 9 for this trademark*).
- 3,298,169 (*See Class 9 for this trademark*).
- 3,298,172 (*See Class 10 for this trademark*).
- 3,298,173 (*See Class 9 for this trademark*).
- 3,298,188 (*See Class 11 for this trademark*).
- 3,298,189 (*See Class 35 for this trademark*).
- 3,298,190 (*See Class 35 for this trademark*).
- 3,298,191 (*See Class 37 for this trademark*).
- 3,298,193 (*See Class 35 for this trademark*).
- 3,298,216 (*See Class 9 for this trademark*).
- 3,298,218 (*See Class 5 for this trademark*).
- 3,298,240 (*See Class 9 for this trademark*).
- 3,298,247 (*See Class 35 for this trademark*).
- 3,298,268 (*See Class 9 for this trademark*).
- 3,298,292 (*See Class 14 for this trademark*).
- 3,298,320 (*See Class 35 for this trademark*).
- 3,298,321 (*See Class 35 for this trademark*).
- 3,298,330 (*See Class 1 for this trademark*).
- 3,298,333 (*See Class 35 for this trademark*).
- 3,298,334 (*See Class 35 for this trademark*).
- 3,298,339 (*See Class 9 for this trademark*).
- 3,298,347 (*See Class 9 for this trademark*).
- 3,298,355. **SPONTANIA AND DESIGN**. DIALCOM NETWORKS S.L., (U.S. CLS. 100 AND 101). SN 79-031,051. PUB. 7-10-2007. FILED 6-22-2006.
- 3,298,359 (*See Class 5 for this trademark*).
- 3,298,362 (*See Class 9 for this trademark*).
- 3,298,371 (*See Class 38 for this trademark*).
- 3,298,373 (*See Class 9 for this trademark*).
- 3,298,381 (*See Class 9 for this trademark*).
- 3,298,383. **SCHUBRA (BLOCK FORM)**. SCHULTZE & BRAUN GMBH, (U.S. CLS. 100 AND 101). SN 79-033,276. PUB. 7-10-2007. FILED 6-12-2006.
- 3,298,385 (*See Class 6 for this trademark*).
-
- CLASS 43—HOTEL AND RESTAURANT SERVICES**
- 3,296,030 (*See Class 35 for this trademark*).
- 3,296,039 (*See Class 30 for this trademark*).
- 3,296,059. **LAKEWAY (BLOCK FORM)**. BEHRINGER HARVARD LAKEWAY, L.P., (U.S. CLS. 100 AND 101). SN 76-658,062. PUB. 7-10-2007. FILED 4-10-2006.
- 3,296,074 (*See Class 14 for this trademark*).
- 3,296,087. **MISCELLANEOUS DESIGN**. FIVE O'CLOCK OF MILWAUKEE, LLC, (U.S. CLS. 100 AND 101). SN 76-662,145. PUB. 7-10-2007. FILED 6-26-2006.
- 3,296,088. **FIVE O'CLOCK STEAKHOUSE (BLOCK FORM)**. FIVE O'CLOCK OF MILWAUKEE, LLC, (U.S. CLS. 100 AND 101). SN 76-662,146. PUB. 7-10-2007. FILED 6-26-2006.
- 3,296,171. **TRAMONTI (BLOCK FORM)**. LSMS, INC., (U.S. CLS. 100 AND 101). SN 76-670,825. PUB. 7-10-2007. FILED 12-22-2006.
- 3,296,185. **MISCELLANEOUS DESIGN**. WINGS ON THE GO, INC., (U.S. CLS. 100 AND 101). SN 76-671,397. PUB. 7-10-2007. FILED 1-16-2007.
- 3,296,204 (*See Class 35 for this trademark*).
- 3,296,271 (*See Class 41 for this trademark*).
- 3,296,327. **WINGS AND DESIGN**. WING IT, LLC, (U.S. CLS. 100 AND 101). SN 77-026,722. PUB. 7-10-2007. FILED 10-23-2006.
- 3,296,362. **MAHOGANY PRIME STEAK HOUSE (STYLIZED)**. ASSET MANAGEMENT GROUP, L.L.C., (U.S. CLS. 100 AND 101). SN 77-031,916. PUB. 7-10-2007. FILED 10-30-2006.
- 3,296,365. **JJ JIMMY JOHN'S GOURMET SANDWICHES SINCE 1983 AND DESIGN**. JIMMY JOHN'S ENTERPRISES, LLC, (U.S. CLS. 100 AND 101). SN 77-032,323. PUB. 7-10-2007. FILED 10-30-2006.
- 3,296,397. **VOYAGERS CROSSING (BLOCK FORM)**. SHOREQUEST, LLC, (U.S. CLS. 100 AND 101). SN 77-037,657. PUB. 7-10-2007. FILED 11-6-2006.
- 3,296,406. **SOUVLAKI MEDITERRANEAN & AMERICAN FOOD AND DESIGN**. WILLIAMS, JOHN D., AND WILLIAMS, NANCY D., (U.S. CLS. 100 AND 101). SN 77-039,559. PUB. 7-10-2007. FILED 11-8-2006.
- 3,296,412. **BUTTERFLY (BLOCK FORM)**. SALTFLY, LLC, (U.S. CLS. 100 AND 101). SN 77-040,651. PUB. 7-10-2007. FILED 11-9-2006.
- 3,296,432. **INFINITY BAY (BLOCK FORM)**. HAWAII HIDEAWAYS INC., (U.S. CLS. 100 AND 101). SN 77-042,987. PUB. 7-10-2007. FILED 11-13-2006.
- 3,296,438. **WILSON'S (BLOCK FORM)**. WILSON'S ICE CREAM PARLOR, INC., (U.S. CLS. 100 AND 101). SN 77-043,872. PUB. 7-10-2007. FILED 11-14-2006.
- 3,296,460. **WILKINSON (BLOCK FORM)**. WILKINSON CORPORATION, (U.S. CLS. 100 AND 101). SN 77-046,854. PUB. 7-10-2007. FILED 11-17-2006.
- 3,296,542. **FRESH VALUE MEAL (BLOCK FORM)**. DOCTOR'S ASSOCIATES INC., (U.S. CLS. 100 AND 101). SN 77-057,079. PUB. 7-10-2007. FILED 12-5-2006.
- 3,296,562. **PAPA GINO'S PIZZERIA AND DESIGN**. PAPA GINO'S, INC., (U.S. CLS. 100 AND 101). SN 77-059,369. PUB. 7-10-2007. FILED 12-7-2006.
- 3,296,639. **BODHI'S (BLOCK FORM)**. FREEMAN, RICHARD B., (U.S. CLS. 100 AND 101). SN 77-063,498. PUB. 7-10-2007. FILED 12-13-2006.
- 3,296,655 (*See Class 29 for this trademark*).

- 3,296,662. **SHARE THE KITCHEN (BLOCK FORM)**. GREEN, LYNN H., (U.S. CLS. 100 AND 101). SN 77-064,071. PUB. 7-10-2007. FILED 12-14-2006.
- 3,296,710. **WE'VE GOT IT ALL! (BLOCK FORM)**. KARL KUCERIS AND RUSSELL HERTRICH, DBA USA SUBS, (U.S. CLS. 100 AND 101). SN 77-065,394. PUB. 7-10-2007. FILED 12-15-2006.
- 3,296,719. **DAVIS STREET FISH MARKET (BLOCK FORM)**. CLEAN PLATE CLUB, LLC, (U.S. CLS. 100 AND 101). SN 77-065,608. PUB. 7-10-2007. FILED 12-15-2006.
- 3,296,845. **SPITONY'S PIZZA (BLOCK FORM)**. C J SPITONY'S INC., (U.S. CLS. 100 AND 101). SN 77-084,911. PUB. 7-10-2007. FILED 1-17-2007.
- 3,296,944 (*See Class 32 for this trademark*).
- 3,296,945. **INTA JUICE FRUIT SMOOTHIES AND DESIGN**. INTA JUICE ENTERPRISES, INC., (U.S. CLS. 100 AND 101). SN 77-090,473. PUB. 7-10-2007. FILED 1-24-2007.
- 3,296,951 (*See Class 35 for this trademark*).
- 3,296,960. **TRISTAN (BLOCK FORM)**. TRISTAN RESTAURANT, LLC, (U.S. CLS. 100 AND 101). SN 77-091,085. PUB. 7-10-2007. FILED 1-25-2007.
- 3,297,005. **PUSATERI'S THIN CHICAGO PIZZA (BLOCK FORM)**. PUSATERI, INC., (U.S. CLS. 100 AND 101). SN 77-092,003. PUB. 7-10-2007. FILED 1-26-2007.
- 3,297,041. **ZORN'S LONG ISLAND'S FAVORITE TAKEOUT QUALITY & SERVICE SINCE 1940 (STYLIZED)**. ZORN'S POULTRY FARMS, INC., (U.S. CLS. 100 AND 101). SN 77-093,303. PUB. 7-10-2007. FILED 1-29-2007.
- 3,297,061 (*See Class 16 for this trademark*).
- 3,297,068. **GETTIN' TOGETHER OVER GATTI'S (BLOCK FORM)**. MR. GATTI'S, LP, (U.S. CLS. 100 AND 101). SN 77-097,683. PUB. 7-10-2007. FILED 2-2-2007.
- 3,297,069 (*See Class 41 for this trademark*).
- 3,297,108. **WAKE UP ON THE BRIGHT SIDE (BLOCK FORM)**. LA QUINTA WORLDWIDE, L.L.C., (U.S. CLS. 100 AND 101). SN 77-107,528. PUB. 7-10-2007. FILED 2-14-2007.
- 3,297,113 (*See Class 39 for this trademark*).
- 3,297,176 (*See Class 16 for this trademark*).
- 3,297,180 (*See Class 35 for this trademark*).
- 3,297,181. **THE COFFEE FACTORY AND DESIGN**. THE COFFEE FACTORY, S.A. DE C.V., (U.S. CLS. 100 AND 101). SN 78-365,596. PUB. 7-10-2007. FILED 2-10-2004.
- 3,297,184. **32 THIRTY TWO (STYLIZED)**. SECURITY ATLANTIC LEASING, LLC, (U.S. CLS. 100 AND 101). SN 78-378,930. PUB. 7-10-2007. FILED 3-4-2004.
- 3,297,249 (*See Class 35 for this trademark*).
- 3,297,274. **PERRY'S STEAKHOUSE & GRILLE AND DESIGN**. CHRISTOPHER V. PERRY FAMILY LIMITED PARTNERSHIP, (U.S. CLS. 100 AND 101). SN 78-682,346. PUB. 7-10-2007. FILED 8-1-2005.
- 3,297,350. **THE JAZZ CORNER AND DESIGN**. THE JAZZ CORNER, INC., (U.S. CLS. 100 AND 101). SN 78-732,195. PUB. 7-10-2007. FILED 10-12-2005.
- 3,297,383 (*See Class 41 for this trademark*).
- 3,297,405 (*See Class 3 for this trademark*).
- 3,297,407 (*See Class 41 for this trademark*).
- 3,297,420. **THE DEN (BLOCK FORM)**. MAGNUM RESTAURANT & ENTERTAINMENT GROUP, (U.S. CLS. 100 AND 101). SN 78-790,654. PUB. 7-10-2007. FILED 1-12-2006.
- 3,297,462. **CASA JAVA (BLOCK FORM)**. VILLA HOLDING, LLC, (U.S. CLS. 100 AND 101). SN 78-812,535. PUB. 7-10-2007. FILED 2-10-2006.
- 3,297,491. **PURPLE FEET WINE BOUTIQUE & TASTING ROOM AND DESIGN**. BEPE ENTERPRISES, LLC, (U.S. CLS. 100 AND 101). SN 78-827,771. PUB. 7-10-2007. FILED 3-2-2006.
- 3,297,507 (*See Class 39 for this trademark*).
- 3,297,544. **KNOCKOUT (BLOCK FORM)**. KO PIZZERIA, INC., (U.S. CLS. 100 AND 101). SN 78-848,441. PUB. 7-10-2007. FILED 3-28-2006.
- 3,297,587. **SHULTZIE'S SUBS UNLIMITED PLUS (BLOCK FORM)**. SUBS, INC., (U.S. CLS. 100 AND 101). SN 78-860,934. PUB. 7-10-2007. FILED 4-13-2006.
- 3,297,602 (*See Class 29 for this trademark*).
- 3,297,609. **CERTIFIED CAMP COUNSELORS (BLOCK FORM)**. CAMP BOW WOW DISTRIBUTION LLC, (U.S. CLS. 100 AND 101). SN 78-863,059. PUB. 7-10-2007. FILED 4-17-2006.
- 3,297,656. **J. B. MACK AND DESIGN**. JB MACK LLC, (U.S. CLS. 100 AND 101). SN 78-871,198. PUB. 7-10-2007. FILED 4-27-2006.
- 3,297,698. **VIVOLI CAFÉ AND DESIGN**. A & D FIRENZE, INC. D/B/A, VIVOLI CAFÉ & TRATTORIA, (U.S. CLS. 100 AND 101). SN 78-878,452. PUB. 7-10-2007. FILED 5-8-2006.
- 3,297,768 (*See Class 41 for this trademark*).
- 3,297,888. **STARTCOOKING.COM (BLOCK FORM)**. KATHY MAISTER'S START COOKING LLC, (U.S. CLS. 100 AND 101). SN 78-908,084. PUB. 7-10-2007. FILED 6-14-2006.
- 3,297,909 (*See Class 29 for this trademark*).
- 3,297,924. **NACHO MAMA'S (BLOCK FORM)**. NACHO MAMA'S, INC., (U.S. CLS. 100 AND 101). SN 78-915,942. PUB. 7-10-2007. FILED 6-23-2006.
- 3,297,956. **RANDOM ACTS OF PIE-NESS (BLOCK FORM)**. VICORP RESTAURANTS, INC., (U.S. CLS. 100 AND 101). SN 78-922,788. PUB. 7-10-2007. FILED 7-5-2006.
- 3,298,030 (*See Class 39 for this trademark*).
- 3,298,033. **3 WAYS TO WING IT (BLOCK FORM)**. WING-STREET, LLC, (U.S. CLS. 100 AND 101). SN 78-945,038. PUB. 7-10-2007. FILED 8-4-2006.
- 3,298,054. **MISCELLANEOUS DESIGN**. RIO'S PET SPA & BOARDING, INC., (U.S. CLS. 100 AND 101). SN 78-950,937. PUB. 7-10-2007. FILED 8-12-2006.
- 3,298,067. **SCREAMING MOOSE GRILL AND DESIGN**. SCREAMING MOOSE GRILL, (U.S. CLS. 100 AND 101). SN 78-952,854. PUB. 4-3-2007. FILED 8-15-2006.
- 3,298,095 (*See Class 29 for this trademark*).
- 3,298,115. **GLENMOOR AND DESIGN**. LIFE CARE ST.JOHNS, INC., DBA GLENMOOR, MULTIPLE CLASS, (INT. CLS. 43 AND 44), (U.S. CLS. 100 AND 101). SN 78-964,863. PUB. 7-10-2007. FILED 8-31-2006.
- 3,298,124 (*See Class 41 for this trademark*).
- 3,298,129. **THE DUBLIN PUB AND DESIGN**. SPRINGFIELD PUB, INC., (U.S. CLS. 100 AND 101). SN 78-970,141. PUB. 7-10-2007. FILED 9-8-2006.
- 3,298,152 (*See Class 16 for this trademark*).
- 3,298,196 (*See Class 32 for this trademark*).
- 3,298,197 (*See Class 32 for this trademark*).
- 3,298,236 (*See Class 16 for this trademark*).
- 3,298,271 (*See Class 30 for this trademark*).

CLASS 44—MEDICAL, BEAUTY AND AGRICULTURAL SERVICES

- 3,295,974 (*See Class 35 for this trademark*).
- 3,296,002 (*See Class 3 for this trademark*).
- 3,296,023. **RED CARPET SMILE (BLOCK FORM)**. GOLUB-EVANS, JEFFREY, (U.S. CLS. 100 AND 101). SN 76-645,622. PUB. 7-10-2007. FILED 8-26-2005.
- 3,296,037 (*See Class 35 for this trademark*).
- 3,296,046 (*See Class 9 for this trademark*).
- 3,296,122 (*See Class 36 for this trademark*).
- 3,296,144. **BEVERLY HILLS ANTI-AGING CENTER (BLOCK FORM)**. UZZI REISS, M.D., INC., (U.S. CLS. 100 AND 101). SN 76-668,435. PUB. 7-10-2007. FILED 11-2-2006.
- 3,296,148 (*See Class 36 for this trademark*).
- 3,296,184. **WWW.MYDADDYSNORES.COM (STYLIZED)**. ROTHSTEIN, NANCY, (U.S. CLS. 100 AND 101). SN 76-671,346. PUB. 7-10-2007. FILED 1-12-2007.
- 3,296,186. **RADNET, INC. AND DESIGN**. RADNET, INC., (U.S. CLS. 100 AND 101). SN 76-671,533. PUB. 7-10-2007. FILED 1-19-2007.
- 3,296,194. **WESTERN DENTAL CENTERS AND DESIGN**. WESTERN DENTAL SERVICES, INC., (U.S. CLS. 100 AND 101). SN 76-671,821. PUB. 7-10-2007. FILED 1-25-2007.
- 3,296,198. **WD WESTERN DENTAL AND DESIGN**. WESTERN DENTAL SERVICES, INC., (U.S. CLS. 100 AND 101). SN 76-671,835. PUB. 7-10-2007. FILED 1-25-2007.
- 3,296,263. **IN YOUR FACE TATTOOZ (BLOCK FORM)**. CLIFFTON D. MAY, (U.S. CLS. 100 AND 101). SN 77-012,128. PUB. 7-10-2007. FILED 10-2-2006.
- 3,296,310. **OLIVERA (BLOCK FORM)**. OLIVERA WEIGHT MANAGEMENT S.C., (U.S. CLS. 100 AND 101). SN 77-024,226. PUB. 7-10-2007. FILED 10-18-2006.
- 3,296,376. **HOSPICE OF CHATTANOOGA (BLOCK FORM)**.

- HOSPICE OF CHATTANOOGA, INC., MULTIPLE CLASS, (INT. CLS. 44 AND 45), (U.S. CLS. 100 AND 101). SN 77-033,782. PUB. 7-10-2007. FILED 10-31-2006.
- 3,296,389. **BARK 'N BUBBLES PREMIER SELF-SERVICE DOG WASH AND DESIGN.** BARK 'N BUBBLES DOG WASH, LLC, (U.S. CLS. 100 AND 101). SN 77-036,079. PUB. 7-10-2007. FILED 11-3-2006.
- 3,296,462 (*See Class 41 for this trademark.*).
- 3,296,494. **PAWDEROSA (BLOCK FORM).** SOLAY, LORI L., AND FALKELL, PHILIP C., MULTIPLE CLASS, (INT. CLS. 44 AND 45), (U.S. CLS. 100 AND 101). SN 77-051,900. PUB. 7-10-2007. FILED 11-28-2006.
- 3,296,502. **PP+ PODIATRY PLUS COMPREHENSIVE FOOT CARE WITH A PERSONAL TOUCH AND DESIGN.** GARY J. HOBERMAN, D.P.M. & ASSOCIATES, S.C., (U.S. CLS. 100 AND 101). SN 77-053,105. PUB. 6-26-2007. FILED 11-29-2006.
- 3,296,517. **SPEAKING OF SEX AND DESIGN.** PLANNED PARENTHOOD OF WESTERN WASHINGTON, (U.S. CLS. 100 AND 101). SN 77-054,572. PUB. 7-10-2007. FILED 11-30-2006.
- 3,296,532. **TRUE NORTH WILDERNESS PROGRAM (BLOCK FORM).** MAVES, TYLER A. AND BAREFOOT, MADHUR II E, (U.S. CLS. 100 AND 101). SN 77-056,125. PUB. 7-10-2007. FILED 12-4-2006.
- 3,296,549. **DEVENU (BLOCK FORM).** MIDWEST MEDICAL AESTHETICS, LLC, (U.S. CLS. 100 AND 101). SN 77-057,697. PUB. 7-10-2007. FILED 12-5-2006.
- 3,296,592. **IF YOU LOVE YOUR SKIN, BUT NOT THOSE HAIRS, UNIK.WAX CENTER IS FOR YOU (BLOCK FORM).** UKW HOLDING COMPANY, (U.S. CLS. 100 AND 101). SN 77-061,203. PUB. 7-10-2007. FILED 12-11-2006.
- 3,296,661. **PAWDEROSA AND DESIGN.** SOLAY, LORI L., AND FALKELL, PHILLIP C., MULTIPLE CLASS, (INT. CLS. 44 AND 45), (U.S. CLS. 100 AND 101). SN 77-064,060. PUB. 7-10-2007. FILED 12-14-2006.
- 3,296,680 (*See Class 35 for this trademark.*).
- 3,296,683. **MISCELLANEOUS DESIGN.** FAMILY ORTHODONTICS, INC., (U.S. CLS. 100 AND 101). SN 77-064,536. PUB. 7-10-2007. FILED 12-14-2006.
- 3,296,686. **KEEP APOPTOSIS ALIVE. (BLOCK FORM).** GEN-TA INCORPORATED, (U.S. CLS. 100 AND 101). SN 77-064,618. PUB. 7-10-2007. FILED 12-14-2006.
- 3,296,691. **COMMUNICATIVE BALANCING (BLOCK FORM).** SCHAEFFER, DWIGHT L., (U.S. CLS. 100 AND 101). SN 77-064,746. PUB. 7-10-2007. FILED 12-14-2006.
- 3,296,696. **MISCELLANEOUS DESIGN.** HOLMES, FAITH L, (U.S. CLS. 100 AND 101). SN 77-064,812. PUB. 7-10-2007. FILED 12-14-2006.
- 3,296,700. **EXPECTING MOTHERS, EXPECTING MORE (BLOCK FORM).** WADDELL, ROBERT CHRISTOPHER, (U.S. CLS. 100 AND 101). SN 77-064,937. PUB. 7-10-2007. FILED 12-15-2006.
- 3,296,720. **GET IN. GET OUT. GET BETTER. (BLOCK FORM).** INTERMOUNTAIN HEALTH CARE, INC., (U.S. CLS. 100 AND 101). SN 77-065,651. PUB. 7-10-2007. FILED 12-15-2006.
- 3,296,770. **JETSETTER SPA ENJOY THE JOURNEY AND DESIGN.** JETSETTER SPA, INC., (U.S. CLS. 100 AND 101). SN 77-076,147. PUB. 7-10-2007. FILED 1-4-2007.
- 3,296,781. **AUTISTICSOLUTIONS (BLOCK FORM).** LEMKE, NANCY LU, (U.S. CLS. 100 AND 101). SN 77-077,304. PUB. 7-10-2007. FILED 1-5-2007.
- 3,296,819. **G GENEZEN TOTAL INFUSION SOLUTIONS AND DESIGN.** GENEZEN HEALTHCARE, INC., (U.S. CLS. 100 AND 101). SN 77-083,221. PUB. 7-10-2007. FILED 1-15-2007.
- 3,296,874. **SAINT THOMAS HEALTH SERVICES AND DESIGN.** SAINT THOMAS HEALTH SERVICES, (U.S. CLS. 100 AND 101). SN 77-086,939. PUB. 7-10-2007. FILED 1-19-2007.
- 3,296,908 (*See Class 42 for this trademark.*).
- 3,296,932. **K KELSEY-SEYBOLD CLINIC AND DESIGN.** KELSEY-SEYBOLD MEDICAL GROUP, P.A., (U.S. CLS. 100 AND 101). SN 77-089,759. PUB. 7-10-2007. FILED 1-24-2007.
- 3,297,104 (*See Class 35 for this trademark.*).
- 3,297,106 (*See Class 41 for this trademark.*).
- 3,297,129 (*See Class 41 for this trademark.*).
- 3,297,141. **WHERE THE LOSER IS THE WINNER (BLOCK FORM).** KEITH MARZ, (U.S. CLS. 100 AND 101). SN 77-122,816. PUB. 7-10-2007. FILED 3-5-2007.
- 3,297,180 (*See Class 35 for this trademark.*).
- 3,297,243 (*See Class 9 for this trademark.*).
- 3,297,303 (*See Class 9 for this trademark.*).
- 3,297,325 (*See Class 16 for this trademark.*).
- 3,297,332 (*See Class 35 for this trademark.*).
- 3,297,344. **SMILECITY DENTAL AND DESIGN.** SMILECITY DENTAL, (U.S. CLS. 100 AND 101). SN 78-729,379. PUB. 7-10-2007. FILED 10-7-2005.
- 3,297,405 (*See Class 3 for this trademark.*).
- 3,297,445. **BELOVED GOD GOD SWEET GOD WE LOVE YOU GOD GOD BLESSED GOD AND DESIGN.** SLOANE, LESLIE, (U.S. CLS. 100 AND 101). SN 78-803,795. PUB. 7-10-2007. FILED 1-31-2006.
- 3,297,465. **GILA RUT SALON (STYLIZED).** DAVIS, KERI, (U.S. CLS. 100 AND 101). SN 78-814,225. PUB. 7-10-2007. FILED 2-14-2006.
- 3,297,484 (*See Class 9 for this trademark.*).
- 3,297,522. **THE DENVER CLINIC FOR EXTREMITIES AT RISK AND DESIGN.** THE INSTITUTE FOR LIMB PRESERVATION, (U.S. CLS. 100 AND 101). SN 78-840,343. PUB. 4-3-2007. FILED 3-17-2006.
- 3,297,538 (*See Class 31 for this trademark.*).
- 3,297,540. **GEORGIA ENHANCED CARE AND DESIGN.** GEORGIA DEPARTMENT OF COMMUNITY HEALTH, (U.S. CLS. 100 AND 101). SN 78-846,854. PUB. 7-10-2007. FILED 3-27-2006.
- 3,297,573 (*See Class 35 for this trademark.*).
- 3,297,610. **CERTIFIED CAMP COUNSELORS (BLOCK FORM).** CAMP BOW WOW DISTRIBUTION LLC, (U.S. CLS. 100 AND 101). SN 78-863,066. PUB. 7-10-2007. FILED 4-17-2006.
- 3,297,616. **COLUMBIA NEUROSURGICAL (BLOCK FORM).** COLUMBIA NEUROSURGICAL ASSOCIATES, L.L.C., (U.S. CLS. 100 AND 101). SN 78-863,771. PUB. 7-10-2007. FILED 4-18-2006.
- 3,297,630 (*See Class 5 for this trademark.*).
- 3,297,640. **RIGHT SIZE KIDS (BLOCK FORM).** DUROCHER, LYNN, (U.S. CLS. 100 AND 101). SN 78-869,049. PUB. 7-10-2007. FILED 4-25-2006.
- 3,297,657. **MISCELLANEOUS DESIGN.** THE NEW YORK AND PRESBYTERIAN HOSPITAL, (U.S. CLS. 100 AND 101). SN 78-871,331. PUB. 7-10-2007. FILED 4-27-2006.
- 3,297,658. **MISCELLANEOUS DESIGN.** THE NEW YORK AND PRESBYTERIAN HOSPITAL, (U.S. CLS. 100 AND 101). SN 78-871,337. PUB. 7-10-2007. FILED 4-27-2006.
- 3,297,663. **MUNSTER MEDICAL CENTER (BLOCK FORM).** FAMILY CARE CENTER OF INDIANA, L.L.C., (U.S. CLS. 100 AND 101). SN 78-872,119. PUB. 7-10-2007. FILED 4-28-2006.
- 3,297,687. **CONTACTO MEDICO (BLOCK FORM).** OPTURA, LLC, (U.S. CLS. 100 AND 101). SN 78-876,244. PUB. 7-10-2007. FILED 5-4-2006.
- 3,297,689. **SELF IMAGES (BLOCK FORM).** SHANTILAL N. PATEL, (U.S. CLS. 100 AND 101). SN 78-876,793. PUB. 7-10-2007. FILED 5-4-2006.
- 3,297,737. **PEACE OF MIND PET SERVICES (BLOCK FORM).** KAREN A. HUGHES, (U.S. CLS. 100 AND 101). SN 78-885,609. PUB. 7-10-2007. FILED 5-17-2006.
- 3,297,787 (*See Class 3 for this trademark.*).
- 3,297,822 (*See Class 35 for this trademark.*).
- 3,297,860. **ANGEL FARMS (BLOCK FORM).** ANGEL FARMS MINISTRIES, A CORPORATION SOLE, (U.S. CLS. 100 AND 101). SN 78-905,782. PUB. 7-10-2007. FILED 6-12-2006.
- 3,297,870. **HOPE PRACTICED HERE (BLOCK FORM).** HAUSER, ROSS A., AND HAUSER, MARION A., (U.S. CLS. 100 AND 101). SN 78-906,737. PUB. 7-10-2007. FILED 6-13-2006.
- 3,297,914. **GO GREEN! AND DESIGN.** WILLIAM D. DEVENNEY, (U.S. CLS. 100 AND 101). SN 78-913,343. PUB. 7-10-2007. FILED 6-21-2006.
- 3,297,923. **BROOKS HEALTH SPA (BLOCK FORM).** GENESIS HEALTH, INC., (U.S. CLS. 100 AND 101). SN 78-915,783. PUB. 7-10-2007. FILED 6-23-2006.
- 3,297,980. **ICON LASIK (BLOCK FORM).** THE EYE ACADEMY OF AMERICA, LTD., (U.S. CLS. 100 AND 101). SN 78-928,530. PUB. 7-10-2007. FILED 7-13-2006.
- 3,298,043. **ORTHOPROOFUSA (BLOCK FORM).** VIRTUAL

CAST, LLC, (U.S. CLS. 100 AND 101). SN 78-948,864. PUB. 7-10-2007. FILED 8-9-2006.
 3,298,069 (*See Class 39 for this trademark*).
 3,298,078. **HEALING HOLOGRAMS (BLOCK FORM)**. HEALING HOLOGRAMS, INC., (U.S. CLS. 100 AND 101). SN 78-956,882. PUB. 7-10-2007. FILED 8-21-2006.
 3,298,084 (*See Class 35 for this trademark*).
 3,298,115 (*See Class 43 for this trademark*).
 3,298,152 (*See Class 16 for this trademark*).
 3,298,218 (*See Class 5 for this trademark*).
 3,298,247 (*See Class 35 for this trademark*).
 3,298,265 (*See Class 3 for this trademark*).
 3,298,273 (*See Class 10 for this trademark*).
 3,298,330 (*See Class 1 for this trademark*).
 3,298,345 (*See Class 3 for this trademark*).
 3,298,359 (*See Class 5 for this trademark*).

CLASS 45—PERSONAL SERVICES

3,295,986. **IC3 INTERNET CRIME COMPLAINT CENTER AND DESIGN**. NATIONAL WHITE COLLAR CRIME CENTER, (U.S. CLS. 100 AND 101). SN 76-581,623. PUB. 7-10-2007. FILED 3-17-2004.
 3,296,078 (*See Class 41 for this trademark*).
 3,296,079 (*See Class 41 for this trademark*).
 3,296,099. **PARTYKARMA (BLOCK FORM)**. PARTYKARMA, INC., (U.S. CLS. 100 AND 101). SN 76-663,246. PUB. 7-10-2007. FILED 7-17-2006.
 3,296,166. **BIBLEINFO.COM (BLOCK FORM)**. IT IS WRITTEN, INC., (U.S. CLS. 100 AND 101). SN 76-670,515. PUB. 7-10-2007. FILED 12-18-2006.
 3,296,181. **CARTER LAW FIRM, P.S. AND DESIGN**. CARTER LAW FIRM, P.S., (U.S. CLS. 100 AND 101). SN 76-671,052. PUB. 7-10-2007. FILED 1-5-2007.
 3,296,188 (*See Class 39 for this trademark*).
 3,296,204 (*See Class 35 for this trademark*).
 3,296,287. **GOD IS IN CLEVELAND AND DESIGN**. EPISCOPAL WEST SIDE SHARED MINISTRY, (U.S. CLS. 100 AND 101). SN 77-018,108. PUB. 7-10-2007. FILED 10-10-2006.
 3,296,294 (*See Class 41 for this trademark*).
 3,296,299. **SECURING A WORLD OF INFORMATION (BLOCK FORM)**. VIDEOOP LLC, (U.S. CLS. 100 AND 101). SN 77-021,759. PUB. 7-10-2007. FILED 10-16-2006.
 3,296,302. **FRENZOO (BLOCK FORM)**. FRENZOO LTD, (U.S. CLS. 100 AND 101). SN 77-022,363. PUB. 7-10-2007. FILED 10-16-2006.
 3,296,321 (*See Class 9 for this trademark*).
 3,296,335 (*See Class 41 for this trademark*).
 3,296,376 (*See Class 44 for this trademark*).
 3,296,476. **EXFILEZ.COM 69 AND DESIGN**. NAPPYVISION, LLC, (U.S. CLS. 100 AND 101). SN 77-048,998. PUB. 7-10-2007. FILED 11-21-2006.
 3,296,494 (*See Class 44 for this trademark*).
 3,296,528. **ADVANTIA (BLOCK FORM)**. MICHAEL W. STARKWEATHER, P.C., (U.S. CLS. 100 AND 101). SN 77-055,588. PUB. 7-10-2007. FILED 12-1-2006.
 3,296,534. **PRAIRIE SHIELD (BLOCK FORM)**. PRAIRIE SHIELD REGIONAL ALLIANCE, (U.S. CLS. 100 AND 101). SN 77-056,344. PUB. 7-10-2007. FILED 12-4-2006.
 3,296,567. **COUNSEL TO THOSE WHO SHAPE OUR FUTURE (BLOCK FORM)**. HILL WALLACK LLP, (U.S. CLS. 100 AND 101). SN 77-059,924. PUB. 7-10-2007. FILED 12-8-2006.
 3,296,642 (*See Class 35 for this trademark*).
 3,296,661 (*See Class 44 for this trademark*).
 3,296,699. **RAINBOWCHRISTIANS (BLOCK FORM)**. CANON, JUSTIN RUSSELL, (U.S. CLS. 100 AND 101). SN 77-064,881. PUB. 7-10-2007. FILED 12-15-2006.
 3,296,726. **GSR (STYLIZED)**. GRAND SIERRA OPERATING CORP., (U.S. CLS. 100 AND 101). SN 77-065,870. PUB. 7-10-2007. FILED 12-16-2006.
 3,296,749. **DINNER AND A MODEL (BLOCK FORM)**. SOCS-GOLDMANKRUZ, LLC, (U.S. CLS. 100 AND 101). SN 77-072,272. PUB. 7-10-2007. FILED 12-27-2006.
 3,296,856. **KIT-N-SIT WATCHES YOUR KAT AT HOME AND DESIGN**. KIT-N-SIT LLC, (U.S. CLS. 100 AND 101). SN 77-085,702. PUB. 7-10-2007. FILED 1-18-2007.
 3,296,959. **MISCELLANEOUS DESIGN**. WAVEMARKET, INC., (U.S. CLS. 100 AND 101). SN 77-091,059. PUB. 7-10-2007. FILED 1-25-2007.
 3,296,971. **FLIRT ALERT (BLOCK FORM)**. HDVE, LLC, (U.S. CLS. 100 AND 101). SN 77-091,229. PUB. 7-10-2007. FILED 1-25-2007.
 3,297,012. **WE DO BUSINESS BRAWLS (BLOCK FORM)**. KAUFMAN, DAVID Z., (U.S. CLS. 100 AND 101). SN 77-092,131. PUB. 7-10-2007. FILED 1-26-2007.
 3,297,026. **ONE* (BLOCK FORM)**. ONE SPOKANE, (U.S. CLS. 100 AND 101). SN 77-092,530. PUB. 7-10-2007. FILED 1-26-2007.
 3,297,038 (*See Class 41 for this trademark*).
 3,297,125. **MIGENTE.COM (BLOCK FORM)**. COMMUNITY CONNECT INC., (U.S. CLS. 100 AND 101). SN 77-114,482. PUB. 7-10-2007. FILED 2-23-2007.
 3,297,126. **MG MIGENTE.COM AND DESIGN**. COMMUNITY CONNECT INC., (U.S. CLS. 100 AND 101). SN 77-114,619. PUB. 7-10-2007. FILED 2-23-2007.
 3,297,127. **BLACKPLANET.COM (BLOCK FORM)**. COMMUNITY CONNECT INC., (U.S. CLS. 100 AND 101). SN 77-114,677. PUB. 7-10-2007. FILED 2-23-2007.
 3,297,144. **SMART (BLOCK FORM)**. PRO TECH MONITORING, INC., (U.S. CLS. 100 AND 101). SN 77-124,302. PUB. 7-10-2007. FILED 3-7-2007.
 3,297,180 (*See Class 35 for this trademark*).
 3,297,288 (*See Class 35 for this trademark*).
 3,297,290 (*See Class 35 for this trademark*).
 3,297,302. **RED TEAM INVESTIGATIONS (BLOCK FORM)**. RED TEAM INVESTIGATIONS, (U.S. CLS. 100 AND 101). SN 78-708,330. PUB. 7-10-2007. FILED 9-7-2005.
 3,297,450. **PLOWPOINT (BLOCK FORM)**. PLOWPOINT, INC, (U.S. CLS. 100 AND 101). SN 78-806,162. PUB. 7-10-2007. FILED 2-3-2006.
 3,297,451. **SHEPHERD CARE (BLOCK FORM)**. PLOWPOINT, INC, (U.S. CLS. 100 AND 101). SN 78-806,243. PUB. 7-10-2007. FILED 2-3-2006.
 3,297,494 (*See Class 9 for this trademark*).
 3,297,534. **OFF DUTY OFFICERS, INC. (BLOCK FORM)**. OFF DUTY OFFICERS, INC., (U.S. CLS. 100 AND 101). SN 78-844,915. PUB. 7-10-2007. FILED 3-23-2006.
 3,297,573 (*See Class 35 for this trademark*).
 3,297,608 (*See Class 38 for this trademark*).
 3,297,669 (*See Class 35 for this trademark*).
 3,297,670 (*See Class 9 for this trademark*).
 3,297,710. **FINAL DISPOSITIONS (BLOCK FORM)**. SCHINDEL, JOHN B., (U.S. CLS. 100 AND 101). SN 78-881,504. PUB. 7-10-2007. FILED 5-11-2006.
 3,297,711 (*See Class 16 for this trademark*).
 3,297,779 (*See Class 41 for this trademark*).
 3,297,793. **THE REDEEMED CHRISTIAN CHURCH OF GOD AND DESIGN**. THE REDEEMED CHRISTIAN CHURCH OF GOD, N.A., INC., (U.S. CLS. 100 AND 101). SN 78-895,616. PUB. 7-10-2007. FILED 5-30-2006.
 3,297,875. **HOW IMPRESSIVE! (BLOCK FORM)**. KNUTSON, KRISTINE, (U.S. CLS. 100 AND 101). SN 78-907,139. PUB. 7-10-2007. FILED 6-13-2006.
 3,297,894 (*See Class 36 for this trademark*).
 3,297,908 (*See Class 42 for this trademark*).
 3,297,936 (*See Class 16 for this trademark*).
 3,297,944 (*See Class 42 for this trademark*).
 3,297,945 (*See Class 42 for this trademark*).
 3,297,966. **CLUB M.A.W. ENCOURAGING EQUIPPING AND CONNECTING MOTHERS AND WIVES AND DESIGN**. STEINHAUSER, MICHELE L, (U.S. CLS. 100 AND 101). SN 78-925,071. PUB. 7-10-2007. FILED 7-8-2006.
 3,298,011 (*See Class 41 for this trademark*).
 3,298,041 (*See Class 35 for this trademark*).
 3,298,080. **TELL THE STORY OF A LIFETIME (BLOCK FORM)**. STEWART ENTERPRISES, INC., (U.S. CLS. 100 AND 101). SN 78-957,335. PUB. 7-10-2007. FILED 8-22-2006.
 3,298,108. **NIGHTLIGHT (BLOCK FORM)**. NIGHTLIGHT CHRISTIAN ADOPTIONS, (U.S. CLS. 100 AND 101). SN 78-963,629. PUB. 7-10-2007. FILED 8-30-2006.
 3,298,133. **ALL IN A ROW (BLOCK FORM)**. ALL IN A ROW, LLC, (U.S. CLS. 100 AND 101). SN 78-970,559. PUB. 7-10-2007. FILED 9-8-2006.
 3,298,140. **ANDREWS INTERNATIONAL (BLOCK FORM)**.

ANDREWS INTERNATIONAL, INC., (U.S. CLS. 100 AND 101). SN 78-973,173. PUB. 7-10-2007. FILED 9-13-2006. 3,298,251 (*See Class 38 for this trademark*).

3,298,350. **REDHOTPIE (BLOCK FORM)**. JETPLACE PTY LTD, (U.S. CLS. 100 AND 101). SN 79-030,576. PUB. 7-10-2007. FILED 9-14-2006.

* * * * *

SECTION 2.—PRIOR UNITED STATES CLASSIFICATION

CERTIFICATION MARKS

CLASS A—GOODS

3,296,902. **KAUA'I MADE AND DESIGN.** COUNTY OF KAUAI, MULTIPLE CLASS, (U.S. CLS. A AND B), SN 77-088,399. PUB. 7-10-2007. FILED 1-22-2007.

3,297,439. **V AND DESIGN.** VAAD HOEIR OF ST. LOUIS, MULTIPLE CLASS, (U.S. CLS. A AND B), SN 78-800,686. PUB. 7-10-2007. FILED 1-27-2006.

3,296,013. **CERTIFIED MEDICAL OFFICE MANAGER (CMOM) (BLOCK FORM).** ASSISTEX, INC., SN 76-638,998. PUB. 7-10-2007. FILED 5-19-2005.

3,296,102. **BTS (BLOCK FORM).** SOCIETY OF CABLE TELECOMMUNICATIONS ENGINEERS, INC., SN 76-663,684. PUB. 7-10-2007. FILED 7-24-2006.

3,296,902 (*See Class A for this trademark*).

3,297,439 (*See Class A for this trademark*).

3,297,774. **CERTIFIED COPC 2000 VMO AND DESIGN.** CUSTOMER OPERATIONS PERFORMANCE CENTER INC., SN 78-891,370. PUB. 7-10-2007. FILED 5-24-2006.

CLASS B—SERVICES

* * * * *

TRADEMARK REGISTRATIONS ISSUED UNDER SECTION 1(d)

The following marks have registered on the Principal Register pursuant to the intent-to-use provisions of Section 1(d) of the Trademark Act of 1946, as amended.

SECTION 1.— INTERNATIONAL CLASSIFICATION

The short titles associated below with the international class numbers are terms designed merely for quick identification and are not an official part of the international classification. The full names of international classes are given in section 6.1 of the trademark rules of practice.

The designation "U.S. Cl." appearing in this section refers to the U.S. class in effect prior to Sep. 1, 1973 rather than the international class which applies to applications filed on or after that date. For adoption of international classification see notice in the OFFICIAL GAZETTE of Jun. 26, 1973 (911 O.G. TM 210).

Application in more than one class

3,298,405. PETROSYS SOLUTIONS, INC., BELLAIRE, TX. SN 75-881,565. PUB. 7-18-2006, FILED 12-28-1999.

3,298,406. INFORMATIONSTEKNIK SCANDINAVIA A/S, DK-2450 COPENHAGEN SV, DENMARK. SN 75-901,993. PUB. 4-4-2006, FILED 1-24-2000.

PSI TECHNOLOGY

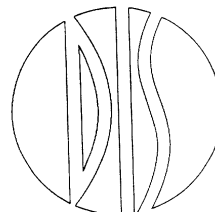

NO CLAIM IS MADE TO THE EXCLUSIVE RIGHT TO USE "TECHNOLOGY", APART FROM THE MARK AS SHOWN.

CLASS 37—CONSTRUCTION AND REPAIR

FOR INSTALLATION OF COMPUTERS, COMPUTER NETWORKS, DATA CENTERS AND COMPUTER SYSTEMS (U.S. CLS. 100, 103 AND 106).
FIRST USE 4-20-2000; IN COMMERCE 8-25-2000.

CLASS 42—SCIENTIFIC, COMPUTER AND LEGAL SERVICES

FOR IMPLEMENTATION OF COMPUTERS, COMPUTER NETWORKS, DATA CENTERS AND COMPUTER SYSTEMS; COMPUTER CONSULTING RELATED TO PERFORMANCE ANALYSIS, OPERATING SYSTEMS, SYSTEM MANAGEMENT, HIGH AVAILABILITY DESIGN, STORAGE SYSTEM DESIGN, DATA BACKUP, DISASTER RECOVERY, COMPUTERS, COMPUTER NETWORKS AND COMPUTER SYSTEMS (U.S. CLS. 100 AND 101).
FIRST USE 4-20-2000; IN COMMERCE 8-25-2000.

CLASS 35—ADVERTISING AND BUSINESS

FOR PROFESSIONAL BUSINESS MANAGEMENT CONSULTATION IN THE FIELD OF LANGUAGE INTERPRETATION; SECRETARIAL SERVICES IN THE FIELD OF LANGUAGE INTERPRETATION; PROVIDING LANGUAGE INTERPRETATION TECHNOLOGY TO THIRD PARTIES, NAMELY, RENTAL OF LANGUAGE INTERPRETATION APPARATUS AND INSTRUMENTS (U.S. CLS. 100, 101 AND 102).
FIRST USE 0-0-1974; IN COMMERCE 0-0-1974.

CLASS 38—COMMUNICATION

FOR RENTAL OF COMMUNICATIONS APPARATUS AND INSTRUMENTS (U.S. CLS. 100, 101 AND 104).
FIRST USE 0-0-1974; IN COMMERCE 0-0-1974.

CLASS 41—EDUCATION AND ENTERTAINMENT

FOR RENTAL OF ELECTRONIC AUDIO AND VISUAL EQUIPMENT FOR USE IN EDUCATIONAL CONFERENCES, CONGRESSES, SEMINARS, FORUMS, SYMPOSIUMS AND WORKSHOPS IN THE FIELD OF LANGUAGE INTERPRETATION (U.S. CLS. 100, 101 AND 107).
FIRST USE 0-0-1974; IN COMMERCE 0-0-1974.

CLASS 42—SCIENTIFIC, COMPUTER AND LEGAL SERVICES

FOR COMPUTER PROGRAMMING FOR OTHERS IN THE FIELD OF LANGUAGE INTERPRETATION TECHNOLOGY; RENTAL OF COMPUTER HARDWARE AND COMPUTER SOFTWARE TO OTHERS IN THE FIELD OF LANGUAGE INTERPRETATION TECHNOLOGY; MAINTENANCE, UPDATING AND DESIGN OF COMPUTER SOFTWARE FOR OTHERS IN THE FIELD OF LANGUAGE INTERPRETATION TECHNOLOGY; COMPUTER SYSTEMS ANALYSIS FOR OTHERS IN THE FIELD OF LANGUAGE INTERPRETATION TECHNOLOGY; TECHNICAL ASSISTANCE IN CONNECTION WITH CONFERENCES, NAMELY, TECHNICAL CONSULTATION RELATING TO FACILITIES, AUDIO-VISUAL EQUIPMENT AND SOUND SYSTEMS FOR CONFERENCES, CONGRESSES, SEMINARS, FORUMS, SYMPOSIUMS AND WORKSHOPS REQUIRING COMMUNICATION OR INTERPRETATION SERVICES ALL IN THE FIELD OF LANGUAGE INTERPRETATION; INTERPRETATION SERVICES, NAMELY, PROVIDING LANGUAGE INTERPRETERS FOR CONFERENCES, CONGRESSES, SEMINARS, FORUMS, SYMPOSIUMS AND WORKSHOPS (U.S. CLS. 100 AND 101).
FIRST USE 0-0-1974; IN COMMERCE 0-0-1974.

3,298,407. AMERICAN HOMESTAR CORPORATION, LEAGUE CITY, TX. SN 76-013,792. PUB. 1-6-2004, FILED 3-21-2000.

HOMESTAR**CLASS 35—ADVERTISING AND BUSINESS**

FOR RETAIL STORE SERVICES FEATURING MODULAR, MANUFACTURED AND MOBILE HOMES (U.S. CLS. 100, 101 AND 102).
FIRST USE 3-5-2007; IN COMMERCE 3-5-2007.

CLASS 40—MATERIAL TREATMENT

FOR MANUFACTURE OF MODULAR, MANUFACTURED AND MOBILE HOMES TO THE ORDER AND SPECIFICATION OF OTHERS (U.S. CLS. 100, 103 AND 106).
FIRST USE 3-5-2007; IN COMMERCE 3-5-2007.

3,298,409. SWEET ENTERTAINMENT GROUP, WEST VANCOUVER, BRITISH COLUMBIA, CANADA. SN 76-183,600. PUB. 10-5-2004, FILED 12-19-2000.



NO CLAIM IS MADE TO THE EXCLUSIVE RIGHT TO USE "ENTERTAINMENT GROUP", APART FROM THE MARK AS SHOWN.

CLASS 35—ADVERTISING AND BUSINESS

FOR ONLINE RETAIL STORE SERVICES FEATURING PHOTOGRAPHS, MOTION PICTURE FILMS AND PRERECORDED VIDEO TAPES IN THE FIELD OF ADULT ENTERTAINMENT (U.S. CLS. 100, 101 AND 102).
FIRST USE 4-8-2000; IN COMMERCE 4-8-2000.

CLASS 41—EDUCATION AND ENTERTAINMENT

FOR ENTERTAINMENT SERVICES, NAMELY, PROVIDING A WEBSITE FEATURING PHOTOGRAPHS, MOVIES AND VIDEOS IN THE FIELD OF ADULT ENTERTAINMENT (U.S. CLS. 100, 101 AND 107).
FIRST USE 5-15-1998; IN COMMERCE 5-15-1998.

3,298,410. SYNTHES, WEST CHESTER, PA. SN 76-215,040. PUB. 7-11-2006, FILED 2-23-2001.

VERTEFILL**CLASS 5—PHARMACEUTICALS**

FOR SURGICAL IMPLANTS COMPRISED FROM BIOLOGICAL TISSUE, NAMELY BONES AND BONE-BASED MATERIALS AND HUMAN OR ANIMAL BASED ALLOGRAFTS AND ALLOGRAFT-BASED MATERIALS, FOR IMPLANTATION IN ORTHOPEDIC AND SPINE SURGERY (U.S. CLS. 6, 18, 44, 46, 51 AND 52).
FIRST USE 6-25-2002; IN COMMERCE 6-25-2002.

CLASS 10—MEDICAL APPARATUS

FOR SURGICAL IMPLANTS COMPRISED FROM NON-BIOLOGICAL OR ARTIFICIAL MATERIALS FOR IMPLANTATION IN ORTHOPEDIC AND SPINE SURGERY; SURGICAL INSTRUMENTS FOR HARVESTING AUTOGRAFT DURING ORTHOPEDIC PROCEDURES (U.S. CLS. 26, 39 AND 44).
FIRST USE 6-25-2002; IN COMMERCE 6-25-2002.

3,298,414. HEADSPROUT, INC., SEATTLE, WA. SN 76-348,017. PUB. 12-23-2003, FILED 12-10-2001.

FLEXIPHONICS**CLASS 9—ELECTRICAL AND SCIENTIFIC APPARATUS**

FOR EDUCATIONAL SOFTWARE FOR CHILDREN; EDUCATIONAL SOFTWARE FOR ADULTS FEATURING INSTRUCTION IN READING, SOFTWARE FEATURING INSTRUCTION IN READING, AND INSTRUCTION MANUALS AND WORKBOOKS SOLD AS A UNIT WITH THE AFORESAID GOODS (U.S. CLS. 21, 23, 26, 36 AND 38).
FIRST USE 3-13-2007; IN COMMERCE 3-13-2007.

CLASS 16—PAPER GOODS AND PRINTED MATTER

FOR BOOKS, LEARNING GUIDES, WORKBOOKS, TEACHER GUIDES, ALL FEATURING GAMES AND INSTRUCTION IN ADULT AND CHILDHOOD EDUCATION, READING SKILLS, EDUCATIONAL TESTING (U.S. CLS. 2, 5, 22, 23, 29, 37, 38 AND 50).
FIRST USE 3-13-2007; IN COMMERCE 3-13-2007.

CLASS 41—EDUCATION AND ENTERTAINMENT

FOR EDUCATIONAL SERVICES AND EDUCATIONAL TESTING SERVICES, NAMELY PROVIDING CLASSES, SEMINARS, WORKSHOPS, TRAINING PROGRAMS AND STUDENT DEVELOPMENT PROGRAMS ON-LINE OVER A NETWORK, AND BY A GLOBAL COMPUTER NETWORK, FEATURING INSTRUCTION IN ADULT AND CHILDHOOD EDUCATION, READING SKILLS, EDUCATIONAL TESTING (U.S. CLS. 100, 101 AND 107).
FIRST USE 3-13-2007; IN COMMERCE 3-13-2007.

3,298,415. ACUITY BRANDS, INC., ATLANTA, GA. SN 76-351,886. PUB. 6-3-2003, FILED 12-20-2001.

CLASS 1—CHEMICALS

FOR CHEMICAL PREPARATION USED TO REMOVE DIRT, GREASE, OIL, MINERAL DEPOSITS AND SCALE FROM REFRIGERATION UNIT COOLING COILS; CHEMICAL PREPARATIONS FOR MELTING ICE ON STAIRS, WALKWAYS, DRIVEWAYS AND THE LIKE; CHEMICAL PREPARATION FOR MAKING LAWN CARE COMPOST; ANTIFREEZE FOR USE ON AUTOMOBILE WINDSHIELDS; SOIL CONDITIONERS, NAMELY, STERILANTS FOR AGRICULTURAL, DOMESTIC OR HORTICULTURAL USE; FUEL TANK ADDITIVES; MOLD RELEASE COMPOUNDS FOR USE IN A WIDE VARIETY OF INDUSTRIES; ASPHALT RELEASE AGENTS; CHEMICAL PREPARATION IN THE NATURE OF AN ACTIVATED PEAT MOSS USED TO ABSORB OIL, GREASE, DIRT, AND CARBON DEPOSITS FOR INSTITUTIONAL, INDUSTRIAL, COMMERCIAL AND DOMESTIC USE (U.S. CLS. 1, 5, 6, 10, 26 AND 46).
FIRST USE 7-1-2006; IN COMMERCE 7-1-2006.

CLASS 2—PAINTS

FOR PAINTS AND SEALANTS FOR INDUSTRIAL AND INSTITUTIONAL USE; NAMELY, FLUORESCENT PAINTS FOR FACTORY FLOORS; FLOOR AND SURFACE SEALER COATINGS FOR INDUSTRIAL AND INSTITUTIONAL USE; SEALERS FOR TILE, TERRAZZO, VINYL TILE, CORK, WOOD AND CONCRETE; FLOOR VARNISH; PAINT PRIMERS (U.S. CLS. 6, 11 AND 16).
FIRST USE 7-1-2006; IN COMMERCE 7-1-2006.

CLASS 3—COSMETICS AND CLEANING PREPARATIONS

FOR GENERAL PURPOSE CLEANERS; DEGREASING PREPARATIONS FOR ALL PURPOSE USE; RADIATOR CLEANERS; HOT VAT METAL CLEANERS AND DEGREASERS FOR ALL PURPOSE USE; PAINT STRIPPER, PAINT REMOVER, AND RUST STRIPPERS FOR INDUSTRIAL AND INSTITUTIONAL USE; SEPTIC TANK, DRAIN AND SEWER OPENERS AND CLEANERS; CERAMIC TILE CLEANERS; BATHROOM FIXTURE CLEANERS; MILDEW CLEANERS; KITCHEN CLEANERS; HAND SOAPS AND CLEANERS AND CREAMS; GLASS CLEANERS; CONCRETE, STONE AND MASONRY CLEANERS; LAUNDRY SOAPS AND DETERGENTS; LAUNDRY BLEACH; FABRIC SOFTENER COMPOUNDS; CARPET CLEANERS AND PRE-SPOTTERS; CARPET SOAPS; CLEANERS FOR USE ON AUTOMOBILE WINDSHIELDS; CLEANERS AND POLISHES FOR WOOD, METAL, AND PAINTED SURFACE; LIQUID SWEEPING COMPOUNDS; TIRE AND RUBBER MAT DRESSINGS; TIRE CLEANERS; FLOOR POLISHES; FLOOR FINISHES; FLOOR WAXES; FLOOR CLEANERS; FLOOR SEALERS; FLOOR WAX REMOVER; PORCELAIN CLEANERS; MARBLE CLEANERS;

FABRIC CLEANERS; RUG CLEANERS; ALUMINUM CLEANERS; ASPHALT AND TAR REMOVER; CONCRETE REMOVERS; VEHICLE DRYING AGENTS; VEHICLE PROTECTIVE COATINGS, WAXES, AND POLISHES; VEHICLE DETERGENTS AND SHAMPOOS; VEHICLE RAIN REPELLANT AND GLASS TREATMENT; POLISHING AGENTS, NAMELY, VINYL, RUBBER AND LEATHER DRESSINGS; BODY SOAP; HAIR SHAMPOO; STOVE AND OVEN CLEANERS; HOSPITAL SOAPS; DISHWASHING CLEANERS AND DETERGENTS; ELECTRICAL EQUIPMENT AEROSOL CLEANER AND LUBRICANT; SPOT, MARK, AND STAIN REMOVER; STEAM CLEANING COMPOSITIONS FOR INSTITUTIONAL, INDUSTRIAL, COMMERCIAL AND DOMESTIC USE WITH A WIDE VARIETY OF GOODS IN VARIOUS INDUSTRIAL; CREAM PASTE CLEANERS FOR PORCELAIN AND VITREOUS CHINA; WALL AND WOODWORK CLEANER; AIRCRAFT AND AUTOMOTIVE CLEANERS AND DEGREASERS AND PARTS CLEANING COMPOSITIONS FOR INSTITUTIONAL, INDUSTRIAL, COMMERCIAL AND DOMESTIC USE WITH A WIDE VARIETY OF GOODS IN VARIOUS INDUSTRIES; PARTS STIPPLING/CLEANING PREPARATION FOR CLEANING OIL, GREASE, DIRT, AND CARBON DEPOSITS; CHEMICAL SOLVENTS FOR CLEANING AND DEGREASING; AND CHEMICAL PREPARATIONS FOR UNCLOGGING PIPES AND SEPTIC TANK CLEANING (U.S. CLS. 1, 4, 6, 50, 51 AND 52).
FIRST USE 7-1-2006; IN COMMERCE 7-1-2006.

CLASS 4—LUBRICANTS AND FUELS

FOR LUBRICANTS AND FUELS, NAMELY, ABSORBENT COMPOSITIONS FOR ABSORBING SPILLS FROM FLOORS IN THE FORM OF POWDERS AND GRANULES; ALL PURPOSE PENETRATES, LUBRICANTS, AND ANTI-SEIZE COMPOUNDS; SPILL TREATMENTS NAMELY ABSORBENTS FOR LIQUIDS (U.S. CLS. 1, 6 AND 15).
FIRST USE 7-1-2006; IN COMMERCE 7-1-2006.

CLASS 5—PHARMACEUTICALS

FOR PREPARATIONS FOR KILLING WEEDS FOR COMMERCIAL, INDUSTRIAL, INSTITUTIONAL AND DOMESTIC USE; FLEA CONTROLLER DEVICES, NAMELY, TOPICAL FLEA PREPARATIONS, FLEA SPRAY FOR HOMES AND YARDS, FLEA SHAMPOO; FLEA CONCENTRATE, FLEA FOGGER, FLEA KILLER FOR CARPETS AND FURNITURE, FLEA TRAPS; HERBICIDES; INSECTICIDES; RODENTICIDES; VERMICIDES FOR AGRICULTURAL, INSTITUTIONAL, INDUSTRIAL, DOMESTIC USE; INSECT REPELLANT; DISINFECTANTS FOR DISHES, FLOORS, GLASS, AND UTENSILS HAND SANITIZERS; CARPET SANITIZERS; ALL PURPOSE DISINFECTANTS AND SANITIZERS FOR DOMESTIC, INSTITUTIONAL AND INDUSTRIAL USE; GROUND CONTROL CHEMICALS, NAMELY, SELECTIVE AND NON SELECTIVE WEED KILLERS AND BRUSH KILLERS (U.S. CLS. 6, 18, 44, 46, 51 AND 52).
FIRST USE 7-1-2006; IN COMMERCE 7-1-2006.

CLASS 7—MACHINERY

FOR POWER OPERATED INDUSTRIAL AND COMMERCIAL CLEANING EQUIPMENT; NAMELY, SPRAYERS, FOG SPRAYERS, STEAM CLEANING MACHINES, PRESSURE WASHERS, AND AIR AGITATION CLEANERS AND PUMPS FOR USE IN CONNECTION THEREWITH; STEAM CLEANERS; VACUUM CLEANERS; CARPET CLEANING AND SHAMPOOING MACHINES; FLOOR CLEANING AND POLISHING MACHINES AND PARTS THEREWITH (U.S. CLS. 13, 19, 21, 23, 31, 34 AND 35).
FIRST USE 7-1-2006; IN COMMERCE 7-1-2006.

CLASS 9—ELECTRICAL AND SCIENTIFIC APPARATUS

FOR SOUND AND ELECTROMAGNETIC WAVE RECEIVERS AND TRANSMITTERS; FLEXIBLE WIRING SYSTEMS AND COMPONENTS; NAMELY, FLEXIBLE BRANCH CIRCUITS, ATTACHMENT PLUGS, RECEPTACLES, CONNECTORS AND FITTINGS; EMERGENCY LIGHTING UNIT INVERTERS; ELECTRICAL LIGHTING CONTROLS; ELECTRICAL DIMMING CONTROLLERS AND LIGHT SWITCHES FOR ELECTRIC FIXTURES; DIMMING UNITS COMPRISED OF CABINETS, CONTROL STATIONS AND WIRING FOR CONTROL OF ELECTRICAL LIGHTING FIXTURES AND ELECTRIC LOADS; ELECTRONIC SENSING DEVICES, NAMELY, ULTRASONIC OCCUPANCY SENSORS AND RANGE EXTENDERS FOR LIGHTING ENERGY MANAGEMENT; LIGHTING CONTROL SYSTEMS, COMPRISED OF DIMMERS, LOW VOLTAGE SWITCHES, PROGRAMMABLE LIGHTING CONTROLLERS, LIGHTING ENERGY MANAGEMENT OCCUPANCY SENSORS AND TIMERS, AND RANGE EXTENDERS FOR ENERGY MANAGEMENT (U.S. CLS. 21, 23, 26, 36 AND 38).
FIRST USE 7-1-2006; IN COMMERCE 7-1-2006.

CLASS 11—ENVIRONMENTAL CONTROL APPARATUS

FOR ELECTRIC LIGHTING FIXTURES; ELECTRIC LINEAR MODULAR LIGHTING SYSTEMS COMPRISED OF PLUG-IN RELOCATABLE MODULAR WIRING COMPONENTS; EMERGENCY LIGHTING FIXTURES AND SYSTEMS COMPRISED OF EXIT SIGNS, EMERGENCY LIGHT UNITS, BACK UP POWER BATTERY PACKS, AND COMBINATIONS THEREOF; BATTERY POWERED LIGHTING FIXTURES; ELECTRIC LIGHTING TRACK UNITS; HARDWARE FOR MOUNTING AND HANGING ELECTRICAL LIGHTING FIXTURES; LED REPLACEMENT LIGHT EMITTING DIODE TUBES; ALUMINUM, STEEL AND FIBERGLASS FIXTURE POLES FOR ELECTRIC LIGHTING; WATER PUMPS; DRUM FAUCETS; AND LIGHT FIXTURE LENSES SOLD AS COMPONENTS OF LIGHTING EQUIPMENT (U.S. CLS. 13, 21, 23, 31 AND 34).
FIRST USE 7-1-2006; IN COMMERCE 7-1-2006.

CLASS 17—RUBBER GOODS

FOR AEROSOL GASKET FORMING COMPOSITIONS; ADHESIVE SEALANTS FOR GENERAL USE; ANTI-RUST CAULKING SEALANTS; NON-SLIP ADHESIVE FILM FOR BRAKES; AND ABSORBENT PADS AND PILLOWS FOR COLLECTION, CONTAINMENT AND ABSORPTION OF SPILLS (U.S. CLS. 1, 5, 12, 13, 35 AND 50).
FIRST USE 7-1-2006; IN COMMERCE 7-1-2006.

CLASS 21—HOUSEWARES AND GLASS

FOR MANUALLY OPERATED CLEANING EQUIPMENT AND ACCESSORIES; NAMELY, BROOMS, DUSTPANS, SCRUBBING BRUSHES, DUST MOPS, WET MOPS, MOP HANDLES, SPONGE MOPS, SQUEEGEES FOR HOUSEHOLD USE, DISPENSERS FOR FLOOR WAX, BUCKETS, MOP WRINGERS, CLEANING SPONGES, SCOURING PADS, PLASTIC JANITORIAL MATS, WIPING CLOTHS, STEEL WOOL, CHAMOIS SKINS, SOAP AND CHEMICAL DISPENSERS, TOWEL AND SANITARY NAPKIN DISPENSERS, HOUSEHOLD GLOVES FOR CLEANING; MICE AND RAT TRAPS; PAILS AND PARTS THEREFORE; AND WASTE RECEPTACLES (U.S. CLS. 2, 13, 23, 29, 30, 33, 40 AND 50).
FIRST USE 8-0-2006; IN COMMERCE 8-0-2006.

3,298,416. ALL ACCESS APPAREL, INC., MONTEBELLO, CA. SN 76-355,792. PUB. 2-4-2003, FILED 1-3-2002.

SELF ESTEEM

OWNER OF U.S. REG. NO. 2,311,586.

CLASS 9—ELECTRICAL AND SCIENTIFIC APPARATUS

FOR SUNGLASSES (U.S. CLS. 21, 23, 26, 36 AND 38).
FIRST USE 1-0-2006; IN COMMERCE 1-0-2006.

CLASS 18—LEATHER GOODS

FOR PURSES, HANDBAGS, BACKPACKS, FANNY PACKS, TOTE BAGS, COSMETIC CASES SOLD EMPTY, TOILETRY CASES SOLD EMPTY, COIN PURSES AND WALLETS (U.S. CLS. 1, 2, 3, 22 AND 41).
FIRST USE 8-0-2003; IN COMMERCE 8-0-2003.

3,298,419. TMW SYSTEMS, INC., BEACHWOOD, OH. SN 76-372,602. PUB. 1-13-2004, FILED 2-21-2002.

TMW

CLASS 35—ADVERTISING AND BUSINESS

FOR BUSINESS CONSULTATION SERVICES CONCERNING THE ADOPTION OF TRANSPORTATION MANAGEMENT SOFTWARE SYSTEMS BY INDIVIDUAL TRANSPORTATION BUSINESSES; DATA PROCESSING SERVICES, NAMELY, COMPUTERIZED INTEGRATION OF TRANSPORTATION DATA FOR OTHERS; AND BUSINESS MANAGEMENT CONSULTING SERVICES IN THE FIELDS OF ORDER MANAGEMENT, WAREHOUSE MANAGEMENT, LOGISTICS MANAGEMENT, MERCHANDISING MANAGEMENT, TRANSPORTATION MANAGEMENT, CUSTOMER SERVICES MANAGEMENT, ACCOUNTING MANAGEMENT, DATA REPORTING AND ELECTRONIC DATA INTERCHANGE (U.S. CLS. 100, 101 AND 102).
FIRST USE 1-1-1990; IN COMMERCE 1-1-1990.

CLASS 42—SCIENTIFIC, COMPUTER AND LEGAL SERVICES

FOR TECHNOLOGY SERVICES FOR THE TRANSPORTATION INDUSTRY, NAMELY, DESIGNING, IMPLEMENTING AND UPDATING COMPUTER SOFTWARE SYSTEMS THAT PROVIDE ON-LINE STATUS INFORMATION FOR A PARTICULAR ORDER OF GOODS OR SERVICES; CONSULTING SERVICES RELATED TO DESIGN AND IMPLEMENTATION OF COMPUTER HARDWARE AND SOFTWARE SYSTEMS FOR MAKING ORDER STATUS VISIBLE ON-LINE AND FOR PROVIDING EVENT-DRIVEN DATABASES IN REAL- OR NEAR-REAL TIME (U.S. CLS. 100 AND 101).
FIRST USE 1-1-1990; IN COMMERCE 1-1-1990.

3,298,420. VIRGIN ENTERPRISES LIMITED, LONDON W8 7AR, ENGLAND. SN 76-373,019. PUB. 3-23-2004, FILED 2-19-2002.

VIRGIN

CLASS 35—ADVERTISING AND BUSINESS

FOR BUSINESS INCENTIVE SERVICES, NAMELY, OFFERING PLANS TO EMPLOYERS INCLUDING MOTIVATIONAL SCHEMES, GIFT CERTIFICATES AND OTHER REWARDS FOR EMPLOYEES, MANAGEMENT OF INCENTIVE PROGRAMS, EVENTS AND SCHEMES FOR OTHERS (U.S. CLS. 100, 101 AND 102).
FIRST USE 3-0-2006; IN COMMERCE 4-0-2006.

CLASS 36—INSURANCE AND FINANCIAL

FOR DEBIT CARD SERVICES (U.S. CLS. 100, 101 AND 102).
FIRST USE 8-0-2006; IN COMMERCE 8-0-2006.

3,298,421. VIRGIN ENTERPRISES LIMITED, LONDON W8 7AR, ENGLAND. SN 76-373,020. PUB. 3-23-2004, FILED 2-19-2002.

CLASS 35—ADVERTISING AND BUSINESS

FOR BUSINESS INCENTIVE SERVICES, NAMELY, OFFERING PLANS TO EMPLOYERS INCLUDING MOTIVATIONAL SCHEMES, GIFT CERTIFICATES AND OTHER REWARDS FOR EMPLOYEES, MANAGEMENT OF INCENTIVE PROGRAMS, EVENTS AND SCHEMES FOR OTHERS (U.S. CLS. 100, 101 AND 102).
FIRST USE 3-0-2006; IN COMMERCE 4-0-2006.

CLASS 36—INSURANCE AND FINANCIAL

FOR DEBIT CARD SERVICES (U.S. CLS. 100, 101 AND 102).
FIRST USE 8-0-2006; IN COMMERCE 8-0-2006.

3,298,430. PARK B. SMITH, INC., NEW YORK, NY. SN 76-463,924. PUB. 6-29-2004, FILED 11-4-2002.

**CLASS 20—FURNITURE AND ARTICLES NOT OTHERWISE CLASSIFIED**

FOR PILLOWS, DECORATIVE PILLOWS AND CHAIR PADS (U.S. CLS. 2, 13, 22, 25, 32 AND 50).
FIRST USE 10-25-2006; IN COMMERCE 10-25-2006.

CLASS 21—HOUSEWARES AND GLASS

FOR BATHROOM ACCESSORIES, NAMELY TUMBLERS AND TOOTHBRUSH HOLDERS; SOAP DISH, LOTION DISPENSER; SOAP DISPENSER; TRASH CONTAINER FOR HOUSEHOLD USE; WASTEBASKETS; VOITIVE CANDLEHOLDERS NOT OF PRECIOUS METAL AND CANDLEHOLDERS NOT OF PRECIOUS METAL (U.S. CLS. 2, 13, 23, 29, 30, 33, 40 AND 50).
FIRST USE 10-25-2006; IN COMMERCE 10-25-2006.

CLASS 24—FABRICS

FOR COMFORTERS; BLANKET THROWS; AFGHANS; COVERLETS; BED SHEETS; PILLOW CASES; DUVETS; SHAMS; DUST RUFFLES; UNFITTED FABRIC FURNITURE COVERS; SHOWER CURTAINS; WINDOW TREATMENTS, NAMELY DRAPERIES, CURTAINS, FABRIC VALENCES, CURTAIN PANELS AND TIE-BACKS; TABLE LINENS, NAMELY PLACEMATS MADE OF FABRIC AND NAPKINS MADE OF FABRIC; KITCHEN TOWELS; POT HOLDERS; AND OVEN MITS (U.S. CLS. 42 AND 50).
FIRST USE 10-25-2006; IN COMMERCE 10-25-2006.

CLASS 27—FLOOR COVERINGS

FOR RUGS (U.S. CLS. 19, 20, 37, 42 AND 50).
FIRST USE 10-25-2006; IN COMMERCE 10-25-2006.

3,298,436. THE BETHEL PERFORMING ARTS CENTER, LLC, LIBERTY, NY. SN 76-495,917. PUB. 12-9-2003, FILED 3-10-2003.

BETHEL WOODS

NO CLAIM IS MADE TO THE EXCLUSIVE RIGHT TO USE "BETHEL", APART FROM THE MARK AS SHOWN.

CLASS 16—PAPER GOODS AND PRINTED MATTER

FOR PAPER GOODS AND PRINTED MATTER, NAMELY, PAMPHLETS, MAGAZINES, INSTRUCTIONAL AND INFORMATIVE LITERATURE IN THE FIELDS OF MUSIC AND ENTERTAINMENT AND CULTURE; CARDS, NAMELY, ANNOUNCEMENT, BLANK, BUSINESS, NOTE, STATIONERY, WRITING PAPER AND ENVELOPES (U.S. CLS. 2, 5, 22, 23, 29, 37, 38 AND 50).
FIRST USE 6-15-2006; IN COMMERCE 6-15-2006.

CLASS 18—LEATHER GOODS

FOR HANDBAGS, TOTE BAGS (U.S. CLS. 1, 2, 3, 22 AND 41).
FIRST USE 8-26-2005; IN COMMERCE 8-26-2005.

CLASS 21—HOUSEWARES AND GLASS

FOR COFFEE MUGS (U.S. CLS. 2, 13, 23, 29, 30, 33, 40 AND 50).
FIRST USE 7-19-2004; IN COMMERCE 7-19-2004.

CLASS 25—CLOTHING

FOR CLOTHING, NAMELY, T-SHIRTS, SWEATSHIRTS, SHIRTS, TOPS, AND OTHER APPAREL, NAMELY, SWEATERS, JACKETS, WIND-RESISTANT JACKETS; HEADGEAR, NAMELY, HATS, CAPS (U.S. CLS. 22 AND 39).
FIRST USE 7-22-2006; IN COMMERCE 7-22-2006.

CLASS 35—ADVERTISING AND BUSINESS

FOR PROMOTING THE EVENTS AND CONCERTS OF OTHERS; FARMERS MARKETS (U.S. CLS. 100, 101 AND 102).

FIRST USE 5-8-2006; IN COMMERCE 5-8-2006.

CLASS 38—COMMUNICATION

FOR PROVIDING ON-LINE ELECTRONIC INTERACTIVE FORUMS AND BULLETIN BOARDS FOR CHATTING, MESSAGING, AND EXCHANGING INFORMATION ABOUT A PERFORMING ARTS CENTER VIA COMPUTER NETWORKS AND THE INTERNET (U.S. CLS. 100, 101 AND 104).

FIRST USE 5-3-2006; IN COMMERCE 5-3-2006.

CLASS 41—EDUCATION AND ENTERTAINMENT

FOR EDUCATION AND ENTERTAINMENT SERVICES, NAMELY, LIVE ENTERTAINMENT-AND-MUSIC FESTIVALS AND ENTERTAINMENT-AND-MUSIC EVENTS INVOLVING ORCHESTRAS, CHAMBER MUSIC GROUPS, SOLO ARTISTS, ROCK 'N ROLL, JAZZ, COUNTRY, AND BLUE GRASS GROUPS, AND OTHER MUSIC GROUPS AND NAMELY, ENTERTAINMENT IN THE NATURE OF DANCE, CULTURAL PERFORMANCES AND ACTIVITIES, NAMELY, PLAYS, LIVE MUSIC, LECTURES PROVIDING ON-LINE INFORMATION ON ENTERTAINMENT, MUSIC, AND CULTURAL EVENTS AND ENTERTAINERS VIA COMPUTER INFORMATION NETWORKS AND WEB SITES AND THE INTERNET RELATING TO THE FOREGOING; EDUCATION AND ENTERTAINMENT, NAMELY, CONCERT BOOKING, PROVIDING FACILITIES FOR RECREATION ACTIVITIES AND NATURE STUDIES AND ENJOYMENT (U.S. CLS. 100, 101 AND 107).

FIRST USE 8-26-2006; IN COMMERCE 8-26-2006.

CLASS 43—HOTEL AND RESTAURANT SERVICES

FOR PROVIDING CONCERT AND PERFORMANCE HALL FACILITIES FOR OTHERS; PERFORMING ARTS CENTER (U.S. CLS. 100 AND 101).

FIRST USE 5-0-2006; IN COMMERCE 5-0-2006.

3,298,438. MERCURY BUSINESS SERVICES, INC., BOSTON, MA. SN 76-498,247. PUB. 7-6-2004, FILED 3-17-2003.

MERCURYSHIP

CLASS 9—ELECTRICAL AND SCIENTIFIC APPARATUS

FOR COMPUTER SOFTWARE FOR USE IN FACILITATING AND SCHEDULING THE TRACKING, PICKUP, DELIVERY AND RECEIPT OF GOODS AT COMMERCIAL AND RESIDENTIAL LOCATIONS, TRACKING ORDERS AND DELIVERIES, VERIFYING ORDERS AND PAYMENTS, PROVIDING REMOTE NOTIFICATION OF DELIVERIES, AND STORING CUSTOMER INFORMATION (U.S. CLS. 21, 23, 26, 36 AND 38).

FIRST USE 10-31-2005; IN COMMERCE 10-31-2005.

CLASS 35—ADVERTISING AND BUSINESS

FOR PROVIDING SHIPPING AND TRACKING INFORMATION OF PACKAGES VIA A GLOBAL COMPUTER NETWORK, NAMELY, FACILITATING AND SCHEDULING THE TRACKING, PICKUP, DELIVERY AND RECEIPT OF GOODS AT COMMERCIAL AND RESIDENTIAL LOCATIONS, TRACKING ORDERS AND DELIVERIES, VERIFYING ORDERS AND PAYMENTS, PROVIDING REMOTE NOTIFICATION OF DELIVERIES, AND STORING CUSTOMER INFORMATION (U.S. CLS. 100, 101 AND 102).

FIRST USE 10-31-2005; IN COMMERCE 10-31-2005.

3,298,448. NANHAI ARCHIE DECORATIVE HARDWARE CO., LTD. OF FOSHAN, FOSHAN CITY, GUANGDONG, CHINA. SN 76-543,263. PUB. 10-12-2004, FILED 9-8-2003.

 **ARCHIE**

PRIORITY CLAIMED UNDER SEC. 44(D) ON CHINA APPLICATION NO. 300031508, FILED 6-12-2003, REG. NO. 300031508, DATED 6-12-2003, EXPIRES 6-12-2013.

CLASS 6—METAL GOODS

FOR ALLOYS OF COMMON METAL, NAMELY, ALLOYS USED FOR CASTING, METAL ALLOYS FOR FURTHER MANUFACTURING; TUBING OF METAL; PIPES AND FITTINGS THEREFORE; BRACKETS FOR HANDLING LOADS; FITTINGS FOR BUILDING AND CONSTRUCTION; DOORS; WINDOWS; ALUMINUM-PLASTIC BOARDS WITH ALUMINUM AS PRIMARY MATERIAL; BANDS FOR FASTENING ITEMS TOGETHER; BOLTS; WINDOW FITTINGS; NON-ELECTRIC DOOR CLOSERS; CLOTHES HOOKS; DOOR HANDLES; DOOR BOLTS; HINGES; RUNNERS FOR SLIDING DOORS; FITTINGS FOR FURNITURE; HARDWARE; NON-ELECTRIC LOCKS; SAFES; PULLEYS OTHER THAN FOR MACHINES; TANKS FOR STORAGE; NON-LUMINOUS AND NON-MECHANICAL SIGNBOARDS; BELLS FOR ANIMALS; SOLDERING WIRE; IDENTIFICATION BRACELETS FOR USE IN HOSPITALS; TREE PROTECTORS (U.S. CLS. 2, 12, 13, 14, 23, 25 AND 50).

FIRST USE 4-15-2003; IN COMMERCE 5-10-2004.

CLASS 21—HOUSEWARES AND GLASS

FOR UTENSILS FOR HOUSEHOLD PURPOSES, NAMELY, POT AND PAN SCRAPERS, ROLLING PINS, SPATULAS, TURNERS, WHISKS, DISHES, NOT OF PRECIOUS METAL; DISHES, POTS AND JARS MADE OF GLASS; WORKS OF ART MADE FROM PORCELAIN, TERRACOTTA, OR GLASS, NAMELY, STATUES, SCULPTURES; DRINKING VESSELS; PAPER TOWEL DISPENSERS MADE OF METAL OTHER THAN FIXED; TOILET PAPER HOLDERS; SOAP DISPENSERS; DISHES FOR SOAP; SOAP HOLDERS; CLOTHING STRETCHERS; TOILET UTENSILS, NAMELY TOILET BRUSHES TOILET BRUSH HOLDERS; SCRUBBING BRUSHES; TOOTHBRUSHES; TOOTHPICK HOLDERS, NOT OF PRECIOUS METAL; PERFUME SPRAYERS SOLD EMPTY; VACUUM BOTTLES; HOUSEHOLD SCOURING TOOLS, NAMELY, SCOURING SPONGES, SAUCEPAN SCOURERS INCLUDING METAL; CAGES FOR HOUSEHOLD PETS (U.S. CLS. 2, 13, 23, 29, 30, 33, 40 AND 50).

FIRST USE 4-15-2003; IN COMMERCE 5-10-2004.

3,298,449. WESTERN NEW YORK PUBLIC BROADCASTING ASSOCIATION, BUFFALO, NY. SN 76-547,750. PUB. 7-26-2005, FILED 9-29-2003.

THINKBRIGHT

CLASS 16—PAPER GOODS AND PRINTED MATTER

FOR PRINTED INSTRUCTIONAL, EDUCATIONAL, AND TEACHING MATERIALS FOR THE TRAINING OF EDUCATORS (U.S. CLS. 2, 5, 22, 23, 29, 37, 38 AND 50).

FIRST USE 7-0-2003; IN COMMERCE 7-0-2003.

CLASS 38—COMMUNICATION

FOR TELEVISION BROADCASTING; DIGITAL MULTICASTING; BROADCASTING PROGRAMS VIA A GLOBAL COMPUTER NETWORK; VIDEO BROADCASTING (U.S. CLS. 100, 101 AND 104).

FIRST USE 10-0-2003; IN COMMERCE 10-0-2003.

CLASS 41—EDUCATION AND ENTERTAINMENT

FOR EDUCATION SERVICES, NAMELY, CONDUCTING SEMINARS, CONFERENCES, AND WORKSHOPS IN THE FIELD OF TRAINING FOR EDUCATORS (U.S. CLS. 100, 101 AND 107).

FIRST USE 7-0-2003; IN COMMERCE 7-0-2003.

CLASS 42—SCIENTIFIC, COMPUTER AND LEGAL SERVICES

FOR PROVIDING TEMPORARY USE OF NON-DOWNLOADABLE EDUCATIONAL SOFTWARE VIA A GLOBAL COMPUTER NETWORK (U.S. CLS. 100 AND 101).

FIRST USE 10-0-2003; IN COMMERCE 10-0-2003.

CLASS 35—ADVERTISING AND BUSINESS

FOR DOCUMENT PREPARATION, CONSULTING AND ADVOCACY SERVICES IN THE FIELD OF PREVENTING AND ASSISTING WITH REPAIRING AND PREVENTING DAMAGE CAUSED BY LOSS OR COMPROMISE OF IDENTIFICATION INFORMATION AND DAMAGE TO CREDIT STATUS; CARD-REGISTRATION SERVICES IN THE NATURE OF CREDIT- AND DEBIT-CARD-NOTIFICATION AND CANCELLATION SERVICES FOR LOST OR STOLEN CARDS AND NOTIFICATION SERVICES; PROVIDING CREDIT-MONITORING SERVICES; PROVIDING CONSUMER-ALERT INFORMATION TO CONSUMERS, NOTIFICATION TO CONSUMERS OF CREDIT AND FRAUD INFORMATION, AND ASSISTANCE TO CONSUMERS IN NOTIFICATION OF RELEVANT INSTITUTIONS, BUSINESSES, AND AGENCIES IN THE EVENT OF A LOSS OR COMPROMISE OF IDENTIFICATION OR LOST OR STOLEN CREDIT CARDS, DRIVERS' LICENSES, PASSPORTS, AIRLINE TICKETS AND OTHER PERSONAL-IDENTITY DATA OR DOCUMENTS; REFERRALS OF VICTIMS TO APPROPRIATE LAW ENFORCEMENT AND REGULATORY AGENCIES; REFERRALS AND CONSULTING IN THE FIELD OF INSURANCE AGAINST CONSUMER AND CREDIT FRAUD; AND PRODUCT MARKETING SERVICES, AND CONSULTING SERVICES IN THE FIELD OF PRODUCT MARKETING (U.S. CLS. 100, 101 AND 102).

FIRST USE 8-28-2003; IN COMMERCE 8-28-2003.

CLASS 45—PERSONAL SERVICES

FOR CONSULTING SERVICES IN THE FIELDS OF INTERNET AND E-MAIL SECURITY AND FRAUD PREVENTION (U.S. CLS. 100 AND 101).

FIRST USE 8-28-2003; IN COMMERCE 8-28-2003.

3,298,461. FALKENSTEIN, LYNDIA, PORTLAND, OR. SN 76-586,563. PUB. 8-15-2006, FILED 4-13-2004.

RETIRESMILING

THE MARK CONSISTS OF STANDARD CHARACTERS WITHOUT CLAIM TO ANY PARTICULAR FONT, STYLE, SIZE, OR COLOR.

CLASS 16—PAPER GOODS AND PRINTED MATTER

FOR TRAINING MANUALS CONTAINING EDUCATIONAL INFORMATION AND MATERIALS FOR AIDING BUSINESSES IN ACHIEVING FOCUS TO INCREASE SALES, PROFITS, AND PRODUCTIVITY, AND/FOR AIDING INDIVIDUALS IN ACHIEVING FOCUS FOR CHARACTER DEVELOPMENT, ALTERNATIVE CAREERPLANNING, WORK/LIFE BALANCE, AND FINANCIAL PLANNING BY IDENTIFYING OPPORTUNITIES AND STRENGTHS (U.S. CLS. 2, 5, 22, 23, 29, 37, 38 AND 50).

FIRST USE 0-0-1997; IN COMMERCE 0-0-1997.

3,298,451. IDENTITY THEFT 911, LLC, SCOTTSDALE, AZ. SN 76-552,247. PUB. 1-10-2006, FILED 9-30-2003.

ID THEFT 911

NO CLAIM IS MADE TO THE EXCLUSIVE RIGHT TO USE "ID THEFT", APART FROM THE MARK AS SHOWN.

CLASS 41—EDUCATION AND ENTERTAINMENT

FOR EDUCATIONAL SERVICES, NAMELY, CONDUCTING CLASSES, WORKSHOPS, AND SEMINARS IN THE FIELD OF AIDING BUSINESSES IN ACHIEVING FOCUS TO INCREASE SALES, PROFITS, AND PRODUCTIVITY, AND/OR FOR AIDING INDIVIDUALS IN ACHIEVING FOCUS FOR CHARACTER-DEVELOPMENT, ALTERNATIVE CAREER PLANNING, WORK/LIFE BALANCE, AND FINANCIAL PLANNING BY IDENTIFYING OPPORTUNITIES AND STRENGTHS (U.S. CLS. 100, 101 AND 107).

FIRST USE 0-0-1997; IN COMMERCE 0-0-1997.

3,298,465. LUCASFILM LTD., SAN FRANCISCO, CA. SN 76-596,915. PUB. 7-12-2005, FILED 6-14-2004.



THE MARK CONSISTS OF A STYLIZED LETTER H WITH A WINDOW DESIGN.

3,298,464. HEALTH CRAFT, INC., TAMPA, FL. SN 76-595,553. PUB. 5-16-2006, FILED 6-4-2004.

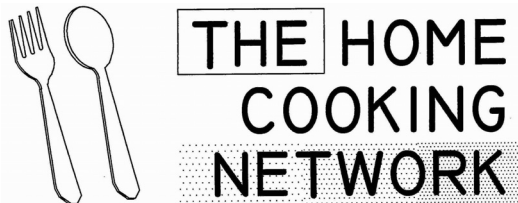

NO CLAIM IS MADE TO THE EXCLUSIVE RIGHT TO USE "HOME COOKING NETWORK", APART FROM THE MARK AS SHOWN.

THE STIPLING IS A FEATURE OF THE MARK.

CLASS 16—PAPER GOODS AND PRINTED MATTER

FOR MAGAZINES ON THE TOPIC OF MOTION PICTURE FILMS AND SCIENCE FICTION (U.S. CLS. 2, 5, 22, 23, 29, 37, 38 AND 50).

FIRST USE 9-0-2004; IN COMMERCE 9-0-2004.

CLASS 41—EDUCATION AND ENTERTAINMENT

FOR ENTERTAINMENT SERVICES, NAMELY, PROVIDING ONLINE INFORMATION, ARTICLES, MUSIC, IMAGES, FILM, INTERACTIVE INTERVIEWS AND COMMENTARY ABOUT MOTION PICTURE FILMS AND SCIENCE FICTION; PROVIDING ONLINE MAGAZINES AND NEWSLETTERS ABOUT MOTION PICTURE FILMS AND SCIENCE FICTION; FAN CLUB SERVICES (U.S. CLS. 100, 101 AND 107).

FIRST USE 6-10-2003; IN COMMERCE 6-10-2003.

CLASS 35—ADVERTISING AND BUSINESS

FOR PROVIDING A WEBSITE FEATURING INFORMATION ABOUT SHOPPING TIPS GEARED SPECIFICALLY TO THE HOME COOK VIA A GLOBAL COMPUTER NETWORK (U.S. CLS. 100, 101 AND 102).

FIRST USE 2-15-2004; IN COMMERCE 2-15-2004.

3,298,472. AMERICA'S COMMUNITY BANKERS, WASHINGTON, DC. SN 76-606,452. PUB. 12-13-2005, FILED 8-11-2004.

CLASS 41—EDUCATION AND ENTERTAINMENT

FOR ENTERTAINMENT SERVICES IN THE NATURE OF ONGOING RADIO AND TELEVISION PROGRAMS IN THE FIELD OF COOKING AND CULINARY ARTS, FITNESS AND NUTRITION; PRODUCTION OF RADIO AND TELEVISION PROGRAMS; DISTRIBUTION OF RADIO AND TELEVISION PROGRAMS FOR OTHERS (U.S. CLS. 100, 101 AND 107).

FIRST USE 2-15-2004; IN COMMERCE 2-15-2004.

LEVERAGE. ACCESS. EXPERTISE.

THE MARK CONSISTS OF STANDARD CHARACTERS WITHOUT CLAIM TO ANY PARTICULAR FONT, STYLE, SIZE, OR COLOR.

CLASS 43—HOTEL AND RESTAURANT SERVICES

FOR PROVIDING A WEBSITE FEATURING INFORMATION ABOUT RECIPES, COOKING TECHNIQUES AND METHODS GEARED SPECIFICALLY TO THE HOME COOK VIA A GLOBAL COMPUTER NETWORK (U.S. CLS. 100 AND 101).

FIRST USE 2-15-2004; IN COMMERCE 2-15-2004.

CLASS 16—PAPER GOODS AND PRINTED MATTER

FOR INFORMATION BULLETINS, BOOKS AND MAGAZINES IN THE FIELD OF FINANCE, FINANCIAL MANAGEMENT, BANKING AND BUSINESS FOR FINANCIAL INSTITUTIONS (U.S. CLS. 2, 5, 22, 23, 29, 37, 38 AND 50).

FIRST USE 4-30-2004; IN COMMERCE 4-30-2004.

CLASS 35—ADVERTISING AND BUSINESS

FOR BUSINESS SUPPORT SERVICES, NAMELY PROVIDING FINANCIAL AND BANKING PRODUCTS AND SERVICES TO FINANCIAL INSTITUTIONS THAT MAY THEN BE RE-OFFERED BY THOSE FINANCIAL INSTITUTIONS; NEGOTIATING MEMBER-ADVANTAGED BANKING AND FINANCIAL PROGRAMS FOR OFFER BY OTHERS; BUSINESS INFORMATION SERVICES, NAMELY, ENDORSING PRODUCTS AND SERVICES IN THE FINANCIAL INDUSTRY TO FINANCIAL INSTITUTIONS; ASSOCIATION SERVICES, NAMELY PROMOTING THE INTERESTS OF THE FINANCIAL INSTITUTIONS INDUSTRY (U.S. CLS. 100, 101 AND 102).

FIRST USE 4-30-2004; IN COMMERCE 4-30-2004.

CLASS 36—INSURANCE AND FINANCIAL

FOR MORTGAGE BANKING, BROKERAGE AND LENDING; MORTGAGE PROCUREMENT FOR OTHERS, BANKING SERVICES; AND FINANCIAL SERVICES, NAMELY FINANCIAL CONSULTATION (U.S. CLS. 100, 101 AND 102).

FIRST USE 4-30-2004; IN COMMERCE 4-30-2004.

CLASS 41—EDUCATION AND ENTERTAINMENT

FOR EDUCATIONAL SERVICES FOR PERSONNEL OF FINANCIAL INSTITUTIONS, NAMELY CONDUCTING SEMINARS AND WORKSHOPS, AND DISTRIBUTION OF PUBLICATIONS IN CONNECTION THEREWITH, IN THE FIELD OF FINANCIAL, MARKETING AND MANAGEMENT OPERATIONS OF FINANCIAL INSTITUTIONS (U.S. CLS. 100, 101 AND 107).

FIRST USE 4-30-2004; IN COMMERCE 4-30-2004.

3,298,487. EXELON CORPORATION, PHILADELPHIA, PA. SN 76-615,666. PUB. 1-10-2006, FILED 10-7-2004.



NO CLAIM IS MADE TO THE EXCLUSIVE RIGHT TO USE "COMMUNITY", APART FROM THE MARK AS SHOWN.

CLASS 35—ADVERTISING AND BUSINESS

FOR PROVIDING A WEBSITE ENABLING EMPLOYEES TO IDENTIFY VOLUNTEER OPPORTUNITIES WITH EDUCATIONAL, CULTURAL, ENVIRONMENTAL, AND COMMUNITY AND NEIGHBORHOOD DEVELOPMENT PROGRAMS; ORGANIZING AND CONDUCTING VOLUNTEER PROGRAMS FOR EDUCATIONAL, CULTURAL, ENVIRONMENT, AND COMMUNITY AND NEIGHBORHOOD DEVELOPMENT PROGRAMS (U.S. CLS. 100, 101 AND 102).

FIRST USE 12-0-2004; IN COMMERCE 12-0-2004.

CLASS 36—INSURANCE AND FINANCIAL

FOR CORPORATE CITIZENSHIP PROGRAM, NAMELY, FINANCIAL SPONSORSHIP OF EDUCATIONAL, CULTURAL, ENVIRONMENTAL, AND COMMUNITY AND NEIGHBORHOOD DEVELOPMENT PROGRAMS (U.S. CLS. 100, 101 AND 102).

FIRST USE 12-0-2004; IN COMMERCE 12-0-2004.

3,298,488. ENERGY AND PROPULSION SYSTEMS, ASBESTOS (QUEBEC), CANADA. SN 76-615,744. PUB. 1-3-2006, FILED 10-14-2004.

BionX

CLASS 9—ELECTRICAL AND SCIENTIFIC APPARATUS

FOR ENERGY MANAGEMENT SYSTEM, NAMELY, AN ELECTRIC MOTOR, GENERATOR, ELECTRONIC CIRCUITRY AND CONTROL PANEL, SOLD AS A KIT, FOR MONITORING AND CONTROLLING THE PROVIDING OF PROPULSION ENERGY TO VEHICLES PROPORTIONAL TO USER DEMANDS, AND FOR CHARGING A BATTERY (U.S. CLS. 21, 23, 26, 36 AND 38).

FIRST USE 9-0-2004; IN COMMERCE 9-0-2004.

CLASS 12—VEHICLES

FOR VEHICLES, NAMELY, BICYCLES, POWERED OR ASSISTED BY AN ENERGY MANAGEMENT SYSTEM, NAMELY, AN ELECTRIC MOTOR, GENERATOR, ELECTRONIC CIRCUITRY AND CONTROL PANEL, FOR MONITORING AND CONTROLLING THE PROVIDING OF PROPULSION ENERGY PROPORTIONAL TO USER DEMANDS, AND FOR CHARGING A BATTERY (U.S. CLS. 19, 21, 23, 31, 35 AND 44).

FIRST USE 9-0-2004; IN COMMERCE 9-0-2004.

3,298,492. ERA DESIGN, LTD., BROOKLYN, NY. SN 76-621,831. PUB. 1-17-2006, FILED 11-22-2004.

LZ NEW YORK

NO CLAIM IS MADE TO THE EXCLUSIVE RIGHT TO USE "NEW YORK", APART FROM THE MARK AS SHOWN.

CLASS 6—METAL GOODS

FOR METAL KEY CHAINS; METAL PILLBOXES (U.S. CLS. 2, 12, 13, 14, 23, 25 AND 50).

FIRST USE 10-13-2004; IN COMMERCE 10-13-2004.

CLASS 9—ELECTRICAL AND SCIENTIFIC APPARATUS

FOR SUNGLASSES AND EYEGLASSES (U.S. CLS. 21, 23, 26, 36 AND 38).

FIRST USE 10-13-2004; IN COMMERCE 10-13-2004.

CLASS 14—JEWELRY

FOR JEWELRY, NAMELY, WATCHES, EARRINGS, RINGS, BRACELETS, NECKLACES, CHARMS, PENDANTS, BROOCHES, PINS, TOE RINGS AND MINI CLOCKS; CIGARETTE CASES OF PRECIOUS METAL; PRECIOUS METAL PILLBOXES (U.S. CLS. 2, 27, 28 AND 50).

FIRST USE 10-13-2004; IN COMMERCE 10-13-2004.

CLASS 16—PAPER GOODS AND PRINTED MATTER

FOR PENS AND DESKTOP BUSINESS CARD HOLDERS (U.S. CLS. 2, 5, 22, 23, 29, 37, 38 AND 50).
FIRST USE 10-13-2004; IN COMMERCE 10-13-2004.

3,298,496. YUKI SHARONI BEAUTY & LIFESTYLE, INC., BEVERLY HILLS, CA. SN 76-625,110. PUB. 2-28-2006, FILED 12-20-2004.

CLASS 18—LEATHER GOODS

FOR HANDBAGS; BUSINESS CARD CASES (U.S. CLS. 1, 2, 3, 22 AND 41).
FIRST USE 10-13-2004; IN COMMERCE 10-13-2004.

YUKI SHARONI**CLASS 20—FURNITURE AND ARTICLES NOT OTHERWISE CLASSIFIED**

FOR PERSONAL COMPACT MIRRORS AND PLASTIC PILLBOXES (U.S. CLS. 2, 13, 22, 25, 32 AND 50).
FIRST USE 10-13-2004; IN COMMERCE 10-13-2004.

THE MARK CONSISTS OF STANDARD CHARACTERS WITHOUT CLAIM TO ANY PARTICULAR FONT, STYLE, SIZE, OR COLOR.

CLASS 26—FANCY GOODS

FOR HAIR CLIPS, HAIR BANDS AND BARRETTES (U.S. CLS. 37, 39, 40, 42 AND 50).
FIRST USE 10-13-2004; IN COMMERCE 10-13-2004.

CLASS 25—CLOTHING

FOR SHOES, BELTS, SHIRTS, TANK TOPS, PANTS, SHORTS, SKIRTS, SOCKS, UNDERWEAR, HATS (U.S. CLS. 22 AND 39).
FIRST USE 4-13-2007; IN COMMERCE 4-13-2007.

3,298,495. GARDINER, WALTER, ELLENVILLE, NY. SN 76-624,571. PUB. 3-14-2006, FILED 12-15-2004.

CLASS 44—MEDICAL, BEAUTY AND AGRICULTURAL SERVICES

FOR BEAUTY SALONS, COSMETIC AND COLOR ANALYSIS, COSMETICIAN SERVICES, HAIR CUTTING, HAIR STYLING, HAIRDRESSING SALONS, HAIRDRESSING SERVICES, SKIN CARE SALONS (U.S. CLS. 100 AND 101).
FIRST USE 5-1-1990; IN COMMERCE 5-1-1990.



3,298,497. EXCELLUS HEALTH PLAN, INC., ROCHESTER, NY. SN 76-625,637. PUB. 7-19-2005, FILED 12-27-2004.

UNIVERA INNOVATIONS**CLASS 8—HAND TOOLS**

FOR CUTLERY, NAMELY POCKET, HUNTING, FISHING, OUTDOORS, CAMPING, KITCHEN, COLLECTORS AND UTILITY KNIVES, KNIFE POUCHES, SOFT CASES FOR KNIVES, NAMELY, KNIFE ROLLS (U.S. CLS. 23, 28 AND 44).
FIRST USE 3-1-2005; IN COMMERCE 3-1-2005.

THE MARK CONSISTS OF STANDARD CHARACTERS WITHOUT CLAIM TO ANY PARTICULAR FONT, STYLE, SIZE, OR COLOR.
OWNER OF U.S. REG. NOS. 2,368,062 AND 2,810,659.

CLASS 35—ADVERTISING AND BUSINESS

FOR RETAIL STORE SERVICES, MAIL ORDER CATALOG SERVICES, WHOLESALE DISTRIBUTORSHIP SERVICES AND WHOLESALE STORE SERVICES IN THE FIELD OF CUTLERY, FEATURING POCKET, HUNTING, FISHING, OUTDOORS, CAMPING, KITCHEN, COLLECTORS AND UTILITY KNIVES, BELT BUCKLES, LETTER OPENERS, HATS, AND KNIFE ACCESSORIES, NAMELY, KNIFE POUCHES, KNIFE PACKS, KNIFE SHEATHS, AND SOFT CASES FOR KNIVES, NAMELY KNIFE ROLLS (U.S. CLS. 100, 101 AND 102).
FIRST USE 3-1-2005; IN COMMERCE 3-1-2005.

CLASS 36—INSURANCE AND FINANCIAL

FOR UNDERWRITING AND ADMINISTRATION OF PREPAID HEALTH CARE PLANS (U.S. CLS. 100, 101 AND 102).
FIRST USE 10-28-2004; IN COMMERCE 10-28-2004.

CLASS 44—MEDICAL, BEAUTY AND AGRICULTURAL SERVICES

FOR HEALTH CARE IN THE NATURE OF HEALTH CARE MAINTENANCE ORGANIZATIONS (U.S. CLS. 100 AND 101).
FIRST USE 10-28-2004; IN COMMERCE 10-28-2004.

3,298,507. BROWN, ERIC, CEDARHURST, NY. SN 76-632,419. PUB. 6-6-2006, FILED 3-1-2005.

3,298,515. SAFEWAY INC., PLEASANTON, CA. SN 76-634,293. PUB. 3-6-2007, FILED 3-24-2005.

THE DO-NOTS

THE MARK CONSISTS OF STANDARD CHARACTERS WITHOUT CLAIM TO ANY PARTICULAR FONT, STYLE, SIZE, OR COLOR.

CLASS 16—PAPER GOODS AND PRINTED MATTER

FOR PRINTED PUBLICATIONS, NAMELY, BOOKS AND BOOKLETS FOR CHILDREN FEATURING ANIMATED CARTOONS; MAGAZINES, BOOKS AND BOOKLETS FOR CHILDREN FEATURING ANIMATED CHARACTERS; PICTURE BOOKS, CHILDREN'S AND ANIMATED BOOKS, CHILDREN'S AND ANIMATED MAGAZINES (U.S. CLS. 2, 5, 22, 23, 29, 37, 38 AND 50).
FIRST USE 12-1-2006; IN COMMERCE 12-1-2006.

CLASS 41—EDUCATION AND ENTERTAINMENT

FOR ENTERTAINMENT SERVICES, NAMELY, PROVIDING A WEB SITE FEATURING ANIMATION AND PROVIDING ONLINE ENTERTAINMENT IN THE NATURE OF ANIMATED CARTOONS VIA THE INTERNET (U.S. CLS. 100, 101 AND 107).
FIRST USE 12-1-2006; IN COMMERCE 12-1-2006.

3,298,510. SCHWARTZ, DALE, LONGMONT, CO. SN 76-633,435. PUB. 12-20-2005, FILED 3-16-2005.

PINSTRIPES

THE MARK CONSISTS OF STANDARD CHARACTERS WITHOUT CLAIM TO ANY PARTICULAR FONT, STYLE, SIZE, OR COLOR.

CLASS 41—EDUCATION AND ENTERTAINMENT

FOR ENTERTAINMENT SERVICES, NAMELY, PROVIDING FACILITIES FOR BOWLING AND/OR BOCCE (U.S. CLS. 100, 101 AND 107).
FIRST USE 2-0-2006; IN COMMERCE 2-0-2006.

CLASS 43—HOTEL AND RESTAURANT SERVICES

FOR RESTAURANT SERVICES (U.S. CLS. 100 AND 101).
FIRST USE 2-0-2006; IN COMMERCE 2-0-2006.



NO CLAIM IS MADE TO THE EXCLUSIVE RIGHT TO USE "ORGANICS", APART FROM THE MARK AS SHOWN.

THE COLOR(S) ORANGE, YELLOW, GREEN, BLUE AND WHITE IS/ARE CLAIMED AS A FEATURE OF THE MARK.

THE COLOR ORANGE APPEARS ON THE LEFT SIDE OF THE O. THE COLOR YELLOW APPEARS IN THE CENTER OF THE O. THE COLOR GREEN APPEARS TO THE RIGHT OF THE O. THE COLOR BLUE APPEARS IN THE O. THE COLOR BLACK APPEARS IN THE RECTANGLE BEHIND THE TERM ORGANICS. THE COLOR WHITE APPEARS IN THE TERM ORGANICS.

CLASS 29—MEATS AND PROCESSED FOODS

FOR SEMI-SWEET CHOCOLATE BAKING CHIPS, PEANUT BUTTER, FRUIT PRESERVES, FLAVORED AND UNFLAVORED SOY BEVERAGES USED AS A MILK SUBSTITUTE, MILK, SOY MILK, YOGURT, FRUIT FLAVORED LOW FAT YOGURT, CHEESE, BUTTER, EGGS, APPLE SAUCE, CANNED WHOLE TOMATOES, CANNED DICED TOMATOES, TOMATO PASTE, PROCESSED BLACK BEANS, PROCESSED PINTO BEANS, PROCESSED KIDNEY BEANS, PROCESSED GARBANZO BEANS, CHICKEN BROTH, VEGETABLE BROTH, FROZEN FRENCH FRIED POTATOES, FROZEN FRUIT, FROZEN VEGETABLES, GARDEN SALADS, EXTRA VIRGIN OLIVE OIL (U.S. CL. 46).
FIRST USE 3-10-2007; IN COMMERCE 3-10-2007.

CLASS 30—STAPLE FOODS

FOR CHOCOLATE TRUFFLES, TOMATO SAUCE, FROZEN ENTREES, NAMELY BLACK BEAN ENCHILADAS, BEAN AND CHEESE BURRITOS, CHEESE ENCHILADAS, MACARONI AND CHEESE DINNER, CHEESE RAVIOLI, WILD MUSHROOM AND CHEESE RAVIOLI, CHEESE LASAGNA, CHEESE QUESADILLAS, COLD BREAKFAST CEREAL, HOT BREAKFAST CEREAL, INSTANT OATMEAL, BREAD, COOKIES, GRAHAM CRACKERS, CRACKERS, PRETZELS, PRETZEL RODS, CHEESE PUFFS, CHEESE CURLS, CORN TORTILLA CHIPS, MICROWAVE POPCORN, BALSAMIC VINEGAR, SALAD DRESSINGS, MUSTARD, MAPLE SYRUP; TEA, BEVERAGES MADE OF TEA, COFFEE, FLAVORED COFFEE, ICE CREAM, MACARONI AND CHEESE, PASTA, PASTA SAUCES, NAMELY MARINARA, TOMATO BASIL, ROASTED GARLIC, AND MUSHROOM; SALSA (U.S. CL. 46).
FIRST USE 3-9-2007; IN COMMERCE 3-9-2007.

CLASS 31—NATURAL AGRICULTURAL PRODUCTS

FOR FRESH FRUIT, FRESH VEGETABLES, FRESH BABY PEELED CARROTS (U.S. CLS. 1 AND 46).
FIRST USE 7-9-2006; IN COMMERCE 7-9-2006.

CLASS 32—LIGHT BEVERAGES

FOR FRUIT-FLAVORED JUICES, NAMELY CRANBERRY JUICE COCKTAIL, APPLE JUICE, BLUEBERRY JUICE, ORANGE JUICE, GRAPE JUICE, LEMONADE, BERRY PUNCH (U.S. CLS. 45, 46 AND 48).

FIRST USE 3-8-2007; IN COMMERCE 3-8-2007.

3,298,552. MAD DOG ATHLETICS, INC., VENICE, CA. SN 76-646,620. PUB. 8-1-2006, FILED 9-12-2005.

SPINNING

THE MARK CONSISTS OF STANDARD CHARACTERS WITHOUT CLAIM TO ANY PARTICULAR FONT, STYLE, SIZE, OR COLOR.

OWNER OF U.S. REG. NOS. 2,003,922, 2,424,295, AND OTHERS.

CLASS 9—ELECTRICAL AND SCIENTIFIC APPARATUS

FOR COMPUTER SOFTWARE FOR TRACKING INDIVIDUAL OUTPUT IN THE FIELD OF EXERCISE AND FITNESS, COMPUTER SOFTWARE FOR PULMONARY AND CARDIOVASCULAR ANALYSIS, COMPUTERS, HANDHELD COMPUTERS, MICROCOMPUTERS, PERSONAL COMPUTERS, COMPUTER HARDWARE, COMPUTER PERIPHERALS, COMPUTER TERMINALS (U.S. CLS. 21, 23, 26, 36 AND 38).

FIRST USE 3-31-2006; IN COMMERCE 3-31-2006.

CLASS 16—PAPER GOODS AND PRINTED MATTER

FOR COMPUTER PROGRAM MANUALS FOR USE IN THE FIELD OF EXERCISE AND FITNESS, COMPUTER PROGRAM MANUALS FOR USE IN THE FIELD OF PULMONARY AND CARDIOVASCULAR ANALYSIS (U.S. CLS. 2, 5, 22, 23, 29, 37, 38 AND 50).

FIRST USE 3-31-2006; IN COMMERCE 3-31-2006.

3,298,553. G&D TRANSPORTATION, INC., MORTON, IL. SN 76-646,652. PUB. 7-18-2006, FILED 9-13-2005.

SMART.EFFICIENT.LOGISTICS.

THE MARK CONSISTS OF STANDARD CHARACTERS WITHOUT CLAIM TO ANY PARTICULAR FONT, STYLE, SIZE, OR COLOR.

CLASS 35—ADVERTISING AND BUSINESS

FOR SUPPLY CHAIN, LOGISTIC AND REVERSE LOGISTIC SERVICES, NAMELY, INVENTORY MANAGEMENT AND PRODUCT AND INVENTORY DEMAND FORECASTING, PROCUREMENT OF INVENTORY AND ORDER FULFILLMENT FOR OTHERS; BUSINESS CONSULTING SERVICES REGARDING THE DESIGN, DEVELOPMENT AND INTEGRATION OF DISTRIBUTION SYSTEMS AND SOLUTIONS; BUSINESS INFORMATION MANAGEMENT SERVICES REGARDING ORDER SHIPMENT AND LIFT TRACING, BUSINESS OPERATIONS PERFORMANCE REPORTING, DATA ENTRY FOR TRANSPORTATION AND SHIPPING INFORMATION, MATERIAL RECEIVING AND SEQUENCING AND PREPARING SHIPPING DOCUMENTS AND INVOICES OVER COMPUTER NETWORKS, INTRANETS AND THE INTERNET; INVENTORY MANAGEMENT IN THE FIELD OF LOGISTICAL TRANSPORTATION SERVICES (U.S. CLS. 100, 101 AND 102).

FIRST USE 11-11-2006; IN COMMERCE 11-11-2006.

CLASS 37—CONSTRUCTION AND REPAIR

FOR CLEANING, REPAIRING AND MAINTAINING SHIPPING CONTAINERS FOR OTHERS (U.S. CLS. 100, 103 AND 106).

FIRST USE 11-11-2006; IN COMMERCE 11-11-2006.

CLASS 39—TRANSPORTATION AND STORAGE

FOR FREIGHT HANDLING, TRANSPORTATION, DISTRIBUTION AND SHIPPING TRANSPORTATION SERVICES BY TRUCK AND OTHER OVER THE ROAD VEHICLES; CROSS DOCKING WAREHOUSE SERVICES, NAMELY, RECEIPT, STORAGE, SEQUENCING AND DISTRIBUTION OF PRIME PRODUCTS FOR OTHERS; WAREHOUSE STORAGE SERVICES FOR MANAGING SHIPPING CONTAINERS INCLUDING INBOUND RECEIPT, STORAGE AND REDISTRIBUTION OF SHIPPING CONTAINERS FOR OTHERS; EXPORT CARGO HANDLING CONSOLIDATION SERVICES, NAMELY CONSOLIDATION OF CONTAINER AND TRAILER LOADS FOR INTERNATIONAL DISTRIBUTION AND COORDINATION OF DISTRIBUTION OF FREIGHT DESTINED FOR FOREIGN COUNTRIES; WAREHOUSING SERVICES, NAMELY, STORAGE, SEQUENCING, PACKAGING, KITTING, SUB-ASSEMBLY, DISTRIBUTION, PICK-UP AND PACKING FOR SHIPMENT OF GOODS AND OTHER FREIGHT FOR OTHERS; TRANSPORTATION BROKERAGE SERVICES FOR OTHERS AND FREIGHT FORWARDING (U.S. CLS. 100 AND 105).

FIRST USE 11-11-2006; IN COMMERCE 11-11-2006.

CLASS 40—MATERIAL TREATMENT

FOR ASSEMBLY OF SHIPPING CONTAINERS FOR OTHERS INCLUDING TARPING AND UNTARPING THE SAME; CUSTOM MANUFACTURING AND FINISHING OF HEAVY EARTH-MOVING AND WELDING EQUIPMENT, LAND VEHICLES ENGINE DRESSES, TESTED LAND VEHICLE ENGINES AND MACHINES FOR MOVING AND HANDLING MATERIAL FOR OTHERS, INCLUDING PARTS PAINTING (U.S. CLS. 100, 103 AND 106).

FIRST USE 11-11-2006; IN COMMERCE 11-11-2006.

3,298,554. G&D TRANSPORTATION, INC., MORTON, IL. SN
76-646,653. PUB. 7-18-2006, FILED 9-13-2005.



CLASS 35—ADVERTISING AND BUSINESS

FOR SUPPLY CHAIN, LOGISTIC AND REVERSE LOGISTIC SERVICES, NAMELY, INVENTORY MANAGEMENT AND PRODUCT AND INVENTORY DEMAND FORECASTING, PROCUREMENT OF INVENTORY AND ORDER FULFILLMENT FOR OTHERS; BUSINESS CONSULTING SERVICES REGARDING THE DESIGN, DEVELOPMENT AND INTEGRATION OF DISTRIBUTION SYSTEMS AND SOLUTIONS; BUSINESS INFORMATION MANAGEMENT SERVICES REGARDING ORDER SHIPMENT AND LIFT TRACING, BUSINESS OPERATIONS PERFORMANCE REPORTING, DATA ENTRY FOR TRANSPORTATION AND SHIPPING INFORMATION, MATERIAL RECEIVING AND SEQUENCING AND PREPARING SHIPPING DOCUMENTS AND INVOICES OVER COMPUTER NETWORKS, INTRANETS AND THE INTERNET; INVENTORY MANAGEMENT IN THE FIELD OF LOGISTICAL TRANSPORTATION SERVICES (U.S. CLS. 100, 101 AND 102).

FIRST USE 11-11-2006; IN COMMERCE 11-11-2006.

CLASS 37—CONSTRUCTION AND REPAIR

FOR CLEANING, REPAIRING AND MAINTAINING SHIPPING CONTAINERS FOR OTHERS (U.S. CLS. 100, 103 AND 106).

FIRST USE 11-11-2006; IN COMMERCE 11-11-2006.

CLASS 39—TRANSPORTATION AND STORAGE

FOR FREIGHT HANDLING, TRANSPORTATION, DISTRIBUTION AND SHIPPING TRANSPORTATION SERVICES BY TRUCK AND OTHER OVER THE ROAD VEHICLES; CROSS DOCKING WAREHOUSE SERVICES, NAMELY, RECEIPT, STORAGE, SEQUENCING AND DISTRIBUTION OF PRIME PRODUCTS FOR OTHERS; WAREHOUSE STORAGE SERVICES FOR MANAGING SHIPPING CONTAINERS INCLUDING INBOUND RECEIPT, STORAGE AND REDISTRIBUTION OF SHIPPING CONTAINERS FOR OTHERS; EXPORT CARGO HANDLING CONSOLIDATION SERVICES, NAMELY CONSOLIDATION OF CONTAINER AND TRAILER LOADS FOR INTERNATIONAL DISTRIBUTION AND COORDINATION OF DISTRIBUTION OF FREIGHT DESTINED FOR FOREIGN COUNTRIES; WAREHOUSING SERVICES, NAMELY, STORAGE, SEQUENCING, PACKAGING, KITTING, SUB-ASSEMBLY, DISTRIBUTION, PICK-UP AND PACKING FOR SHIPMENT OF GOODS AND OTHER FREIGHT FOR OTHERS; TRANSPORTATION BROKERAGE SERVICES FOR OTHERS AND FREIGHT FORWARDING (U.S. CLS. 100 AND 105).

FIRST USE 11-11-2006; IN COMMERCE 11-11-2006.

CLASS 40—MATERIAL TREATMENT

FOR ASSEMBLY OF SHIPPING CONTAINERS FOR OTHERS INCLUDING TARPING AND UNTARPING THE SAME; CUSTOM MANUFACTURING AND FINISHING OF HEAVY EARTH-MOVING AND WELDING EQUIPMENT, LAND VEHICLES ENGINE DRESSES, TESTED LAND VEHICLE ENGINES AND MACHINES FOR MOVING AND HANDLING MATERIAL FOR OTHERS, INCLUDING PARTS PAINTING (U.S. CLS. 100, 103 AND 106).

FIRST USE 11-11-2006; IN COMMERCE 11-11-2006.

3,298,555. G&D TRANSPORTATION, INC., MORTON, IL. SN
76-646,654. PUB. 7-18-2006, FILED 9-13-2005.

G&D INTEGRATED

THE MARK CONSISTS OF STANDARD CHARACTERS WITHOUT CLAIM TO ANY PARTICULAR FONT, STYLE, SIZE, OR COLOR.

NO CLAIM IS MADE TO THE EXCLUSIVE RIGHT TO USE "INTEGRATED", APART FROM THE MARK AS SHOWN.

CLASS 35—ADVERTISING AND BUSINESS

FOR SUPPLY CHAIN, LOGISTIC AND REVERSE LOGISTIC SERVICES, NAMELY, INVENTORY MANAGEMENT AND PRODUCT AND INVENTORY DEMAND FORECASTING, PROCUREMENT OF INVENTORY AND ORDER FULFILLMENT FOR OTHERS; BUSINESS CONSULTING SERVICES REGARDING THE DESIGN, DEVELOPMENT AND INTEGRATION OF DISTRIBUTION SYSTEMS AND SOLUTIONS; BUSINESS INFORMATION MANAGEMENT SERVICES REGARDING ORDER SHIPMENT AND LIFT TRACING, BUSINESS OPERATIONS PERFORMANCE REPORTING, DATA ENTRY FOR TRANSPORTATION AND SHIPPING INFORMATION, MATERIAL RECEIVING AND SEQUENCING AND PREPARING SHIPPING DOCUMENTS AND INVOICES OVER COMPUTER NETWORKS, INTRANETS AND THE INTERNET; INVENTORY MANAGEMENT IN THE FIELD OF LOGISTICAL TRANSPORTATION SERVICES (U.S. CLS. 100, 101 AND 102).

FIRST USE 11-11-2006; IN COMMERCE 11-11-2006.

CLASS 37—CONSTRUCTION AND REPAIR

FOR CLEANING, REPAIRING AND MAINTAINING SHIPPING CONTAINERS FOR OTHERS (U.S. CLS. 100, 103 AND 106).

FIRST USE 11-11-2006; IN COMMERCE 11-11-2006.

CLASS 39—TRANSPORTATION AND STORAGE

FOR FREIGHT HANDLING, TRANSPORTATION, DISTRIBUTION AND SHIPPING TRANSPORTATION SERVICES BY TRUCK AND OTHER OVER THE ROAD VEHICLES; CROSS DOCKING WAREHOUSE SERVICES, NAMELY, RECEIPT, STORAGE, SEQUENCING AND DISTRIBUTION OF PRIME PRODUCTS FOR OTHERS; WAREHOUSE STORAGE SERVICES FOR MANAGING SHIPPING CONTAINERS INCLUDING INBOUND RECEIPT, STORAGE AND REDISTRIBUTION OF SHIPPING CONTAINERS FOR OTHERS; EXPORT CARGO HANDLING CONSOLIDATION SERVICES, NAMELY CONSOLIDATION OF CONTAINER AND TRAILER LOADS FOR INTERNATIONAL DISTRIBUTION AND COORDINATION OF DISTRIBUTION OF FREIGHT DESTINED FOR FOREIGN COUNTRIES; WAREHOUSING SERVICES, NAMELY, STORAGE, SEQUENCING, PACKAGING, KITTING, SUB-ASSEMBLY, DISTRIBUTION, PICK-UP AND PACKING FOR SHIPMENT OF GOODS AND OTHER FREIGHT FOR OTHERS; TRANSPORTATION BROKERAGE SERVICES FOR OTHERS AND FREIGHT FORWARDING (U.S. CLS. 100 AND 105).

FIRST USE 11-11-2006; IN COMMERCE 11-11-2006.

CLASS 40—MATERIAL TREATMENT

FOR ASSEMBLY OF SHIPPING CONTAINERS FOR OTHERS INCLUDING TARPING AND UNTARPING THE SAME; CUSTOM MANUFACTURING AND FINISHING OF HEAVY EARTH-MOVING AND WELDING EQUIPMENT, LAND VEHICLES ENGINE DRESSES, TESTED LAND VEHICLE ENGINES AND MACHINES FOR MOVING AND HANDLING MATERIAL FOR OTHERS, INCLUDING PARTS PAINTING (U.S. CLS. 100, 103 AND 106).

FIRST USE 11-11-2006; IN COMMERCE 11-11-2006.

3,298,598. THE WILLIAM WARREN GROUP, INC., DBA THE WILLIAM WARREN GROUP, SANTA MONICA, CA. SN 76-662,242. PUB. 2-6-2007, FILED 6-28-2006.

STORMAN

THE MARK CONSISTS OF STANDARD CHARACTERS WITHOUT CLAIM TO ANY PARTICULAR FONT, STYLE, SIZE, OR COLOR.

CLASS 28—TOYS AND SPORTING GOODS

FOR PLAYTHINGS, NAMELY TOY ACTION FIGURES AND ACCESSORIES THEREFOR, TOY FIGURES (U.S. CLS. 22, 23, 38 AND 50).

FIRST USE 3-1-2006; IN COMMERCE 3-1-2006.

CLASS 39—TRANSPORTATION AND STORAGE

FOR STORAGE SERVICES TO THE PUBLIC IN CONNECTION WITH SELF-STORAGE WAREHOUSE FACILITIES (U.S. CLS. 100 AND 105).

FIRST USE 3-1-2006; IN COMMERCE 3-1-2006.

3,298,602. NINJAI GANG, LLC, KAILUA, HI. SN 76-976,961. PUB. 1-28-2003, FILED 7-19-2001.

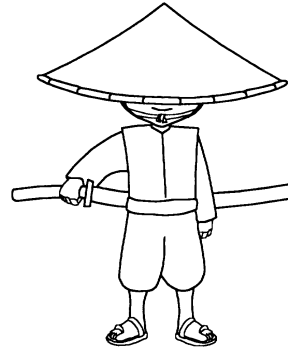
**CLASS 16—PAPER GOODS AND PRINTED MATTER**

FOR DECALS AND CARTOON PRINTS (U.S. CLS. 2, 5, 22, 23, 29, 37, 38 AND 50).

FIRST USE 11-14-2001; IN COMMERCE 11-14-2001.

CLASS 25—CLOTHING

FOR MEN'S, WOMEN'S AND CHILDREN'S CLOTHING, NAMELY, T-SHIRTS (U.S. CLS. 22 AND 39).

FIRST USE 12-27-2001; IN COMMERCE 12-27-2001.

3,298,604. BROWN, BRUCE A., GAVIOTO, CA. SN 76-978,567. PUB. 2-21-2006, FILED 5-17-2005.

ENDLESS SUMMER

THE MARK CONSISTS OF STANDARD CHARACTERS WITHOUT CLAIM TO ANY PARTICULAR FONT, STYLE, SIZE, OR COLOR.

OWNER OF U.S. REG. NOS. 1,220,076 AND 1,669,526.

CLASS 6—METAL GOODS

FOR NON-LUMINOUS AND NON-MECHANICAL METAL SIGNS (U.S. CLS. 2, 12, 13, 14, 23, 25 AND 50).

FIRST USE 1-0-2004; IN COMMERCE 1-0-2004.

CLASS 9—ELECTRICAL AND SCIENTIFIC APPARATUS

FOR ELECTRIC WALL SWITCH PLATES, THERMOMETERS (U.S. CLS. 21, 23, 26, 36 AND 38).

FIRST USE 1-0-2004; IN COMMERCE 1-0-2004.

CLASS 11—ENVIRONMENTAL CONTROL APPARATUS

FOR LAMP SHADES, LAMPS (U.S. CLS. 13, 21, 23, 31 AND 34).

FIRST USE 1-0-2005; IN COMMERCE 1-0-2005.

CLASS 14—JEWELRY

FOR JEWELRY, NAMELY BRACELETS, EARRINGS, NECKLACES; CLOCKS, PENDANTS (U.S. CLS. 2, 27, 28 AND 50).

FIRST USE 8-18-2004; IN COMMERCE 8-18-2004.

CLASS 16—PAPER GOODS AND PRINTED MATTER

FOR STICKERS, CALENDARS, POSTERS, MEMBERSHIP CARDS, NAMELY CUSTOMER SHOPPING PREFERENCE CARDS MADE OF PAPER, COASTERS MADE OF PAPER (U.S. CLS. 2, 5, 22, 23, 29, 37, 38 AND 50).
FIRST USE 12-0-1999; IN COMMERCE 12-0-1999.

CLASS 18—LEATHER GOODS

FOR TOTE BAGS (U.S. CLS. 1, 2, 3, 22 AND 41).
FIRST USE 9-10-2006; IN COMMERCE 9-10-2006.

CLASS 21—HOUSEWARES AND GLASS

FOR CUPS, MUGS; TABLEWARE, NAMELY DRINKING GLASSES (U.S. CLS. 2, 13, 23, 29, 30, 33, 40 AND 50).
FIRST USE 6-15-2001; IN COMMERCE 6-15-2001.

CLASS 24—FABRICS

FOR FABRICS, NAMELY COTTON, NYLON, CHEMILLE, NON-WOVEN TEXTILE, AND POLYESTER; TOWELS, CURTAINS, TABLECLOTHS, BED SHEETS, PILLOW CASES, COMFORTERS, TABLE LINEN, NAMELY, NAPKINS, PLACE MATS (U.S. CLS. 42 AND 50).
FIRST USE 7-11-2004; IN COMMERCE 7-11-2004.

CLASS 25—CLOTHING

FOR SWEAT SHIRTS (U.S. CLS. 22 AND 39).
FIRST USE 8-2-2005, JUNE, 1979.; IN COMMERCE 8-2-2005, JUNE, 1979..

CLASS 28—TOYS AND SPORTING GOODS

FOR VOLLEY BALLS, TOY AUTOMOBILES; SURFBOARDS (U.S. CLS. 22, 23, 38 AND 50).
FIRST USE 3-0-2004; IN COMMERCE 3-0-2004.

CLASS 32—LIGHT BEVERAGES

FOR BEER (U.S. CLS. 45, 46 AND 48).
FIRST USE 3-1-2005; IN COMMERCE 3-1-2005.

3,298,605. BROWN, BRUCE A., GAVIOTO, CA. SN 76-978,588.
PUB. 2-14-2006, FILED 5-17-2005.



OWNER OF U.S. REG. NOS. 1,220,076 AND 1,669,526.

CLASS 6—METAL GOODS

FOR NON-LUMINOUS AND NON-MECHANICAL METAL SIGNS (U.S. CLS. 2, 12, 13, 14, 23, 25 AND 50).
FIRST USE 1-31-2004; IN COMMERCE 1-31-2004.

CLASS 9—ELECTRICAL AND SCIENTIFIC APPARATUS

FOR ELECTRIC WALL SWITCH PLATES, THERMOMETERS (U.S. CLS. 21, 23, 26, 36 AND 38).
FIRST USE 1-31-2004; IN COMMERCE 1-31-2004.

CLASS 11—ENVIRONMENTAL CONTROL APPARATUS

FOR LAMPSHADES, LAMPS (U.S. CLS. 13, 21, 23, 31 AND 34).
FIRST USE 1-31-2005; IN COMMERCE 1-31-2005.

CLASS 14—JEWELRY

FOR JEWELRY, NAMELY BRACELETS, EARRINGS, NECKLACES; CLOCKS, PENDANTS (U.S. CLS. 2, 27, 28 AND 50).
FIRST USE 1-31-2005; IN COMMERCE 1-31-2005.

CLASS 16—PAPER GOODS AND PRINTED MATTER

FOR STICKERS, CALENDARS, POSTERS, MEMBERSHIP CARDS, NAMELY CUSTOMER SHOPPING PREFERENCE CARDS MADE OF PAPER, COASTERS MADE OF PAPER (U.S. CLS. 2, 5, 22, 23, 29, 37, 38 AND 50).
FIRST USE 12-31-1999; IN COMMERCE 12-31-1999.

CLASS 18—LEATHER GOODS

FOR TOTE BAGS (U.S. CLS. 1, 2, 3, 22 AND 41).
FIRST USE 9-10-2006; IN COMMERCE 9-10-2006.

CLASS 21—HOUSEWARES AND GLASS

FOR CUPS, MUGS, TABLEWARE, NAMELY DRINKING GLASSES (U.S. CLS. 2, 13, 23, 29, 30, 33, 40 AND 50).
FIRST USE 6-15-2001; IN COMMERCE 6-15-2001.

CLASS 24—FABRICS

FOR FABRICS, NAMELY COTTON, NYLON, CHEMILLE, NON-WOVEN TEXTILE, AND POLYESTER; TOWELS; CURTAINS; TABLECLOTHS; BED SHEETS; PILLOW CASES; COMFORTERS; TABLE LINEN, NAMELY, NAPKINS, AND PLACE MATS (U.S. CLS. 42 AND 50).
FIRST USE 10-31-2004; IN COMMERCE 10-31-2004.

CLASS 25—CLOTHING

FOR SWEAT SHIRTS (U.S. CLS. 22 AND 39).
FIRST USE 8-2-2005, JUNE, 1979.; IN COMMERCE 8-2-2005.

CLASS 28—TOYS AND SPORTING GOODS

FOR VOLLEY BALLS, TOY AUTOMOBILES; SURFBOARDS (U.S. CLS. 22, 23, 38 AND 50).
FIRST USE 3-31-2004; IN COMMERCE 3-31-2004.

CLASS 32—LIGHT BEVERAGES

FOR BEER (U.S. CLS. 45, 46 AND 48).
FIRST USE 3-1-2005; IN COMMERCE 3-1-2005.

3,298,642. UNITED ARTISTS CORPORATION, LOS ANGELES, CA. AND DANJAQ, LLC, SANTA MONICA, CA. SN 78-147,583. PUB. 6-15-2004, FILED 7-25-2002.

CHITTY CHITTY BANG BANG

CLASS 16—PAPER GOODS AND PRINTED MATTER

FOR STATIONERY; PAPER CUT-OUT FIGURES; PICTURES; POSTERS; MOUNTED AND UNMOUNTED PHOTOGRAPHS; PUBLICATIONS, NAMELY, SOUVENIR PROGRAMS CONCERNING THEATRICAL PRODUCTIONS; FICTIONAL NOVELS AND SHORT STORY BOOKS; PAPER BANNERS; DECALS; AND BLANK PAPER (U.S. CLS. 2, 5, 22, 23, 29, 37, 38 AND 50).
FIRST USE 4-28-2005; IN COMMERCE 4-28-2005.

CLASS 21—HOUSEWARES AND GLASS

FOR LUNCH BOXES; MUGS, AND BEVERAGE GLASSWARE (U.S. CLS. 2, 13, 23, 29, 30, 33, 40 AND 50).
FIRST USE 4-28-2005; IN COMMERCE 4-28-2005.

CLASS 28—TOYS AND SPORTING GOODS

FOR ACTION FIGURE TOYS AND ACCESSORIES THEREFOR; ACTION FIGURES; HOBBY CRAFT DOLL AND FIGURINE KITS; WIND-UP TOYS; MECHANICAL TOYS; DOLLS AND PUPPETS AND ACCESSORIES THEREFOR; STUFFED AND PLUSH TOYS; MUSICAL TOYS; TOY CARS, TRUCKS AND OTHER TOY VEHICLES; MODEL CARS; MUSIC BOX TOYS (U.S. CLS. 22, 23, 38 AND 50).
FIRST USE 4-28-2005; IN COMMERCE 4-28-2005.

3,298,643. VALSPAR SOURCING, INC., MINNEAPOLIS, MN. SN 78-155,131. PUB. 9-9-2003, FILED 8-16-2002.

NEXTERRA

CLASS 1—CHEMICALS

FOR ARTIFICIAL RESINS USED IN THE MANUFACTURE OF COMPOSITE ARTICLES (U.S. CLS. 1, 5, 6, 10, 26 AND 46).
FIRST USE 9-29-2006; IN COMMERCE 9-29-2006.

CLASS 2—PAINTS

FOR GEL COATS FOR USE ON COMPOSITE ARTICLES (U.S. CLS. 6, 11 AND 16).
FIRST USE 9-29-2006; IN COMMERCE 9-29-2006.

3,298,650. DRUMM, ROCHELLE, IVINE, CA. SN 78-169,469. PUB. 3-23-2004, FILED 9-30-2002.

BABYCHIX

CLASS 16—PAPER GOODS AND PRINTED MATTER

FOR PAPER GOODS AND PRINTED MATTER, NAMELY, GIFT CARDS, OCCASION CARDS (U.S. CLS. 2, 5, 22, 23, 29, 37, 38 AND 50).
FIRST USE 3-6-2007; IN COMMERCE 3-6-2007.

CLASS 24—FABRICS

FOR GIFT BASKETS MADE OF PLASTICS CONTAINING BABY AND CHILDREN'S PRODUCTS AND ACCESSORIES NAMELY, CLOTHING, NAMELY, T-SHIRTS (U.S. CLS. 42 AND 50).
FIRST USE 3-1-2007; IN COMMERCE 3-6-2007.

CLASS 25—CLOTHING

FOR CLOTHING, FOR BABIES AND CHILDREN, NAMELY, SHIRTS (U.S. CLS. 22 AND 39).
FIRST USE 3-1-2007; IN COMMERCE 3-6-2007.

CLASS 45—PERSONAL SERVICES

FOR PREPARATION OF CUSTOMIZED GIFT BASKETS WITH SELECTED ITEMS REGARDING A BABY OR CHILDREN'S THEME (U.S. CLS. 100 AND 101).
FIRST USE 3-1-2007; IN COMMERCE 3-6-2007.

3,298,654. APPLE INC., CUPERTINO, CA. SN 78-179,083. PUB. 12-23-2003, FILED 10-28-2002.

.MAC

PRIORITY CLAIMED UNDER SEC. 44(D) ON ERP CMNTY TM OFC APPLICATION NO. 002698884, FILED 5-16-2002.

PRIORITY CLAIMED UNDER SEC. 44(D) ON ERP CMNTY TM OFC APPLICATION NO. 002698884, FILED 5-16-2002.

PRIORITY CLAIMED UNDER SEC. 44(D) ON ERP CMNTY TM OFC APPLICATION NO. 002698884, FILED 5-16-2002.

PRIORITY CLAIMED UNDER SEC. 44(D) ON ERP CMNTY TM OFC APPLICATION NO. 002698884, FILED 5-16-2002.

PRIORITY CLAIMED UNDER SEC. 44(D) ON ERP CMNTY TM OFC APPLICATION NO. 002698884, FILED 5-16-2002.

PRIORITY CLAIMED UNDER SEC. 44(D) ON ERP CMNTY TM OFC APPLICATION NO. 002698884, FILED 5-16-2002.

OWNER OF U.S. REG. NOS. 1,964,391, 1,968,965, AND 2,076,153.

CLASS 9—ELECTRICAL AND SCIENTIFIC APPARATUS

FOR COMPUTER SOFTWARE FOR SYNCHRONIZATION OF DATA BETWEEN COMPUTERS, HANDHELD ELECTRONIC DEVICES, AND ONLINE ACCOUNTS; COMPUTER SCREEN SAVER SOFTWARE; SOFTWARE FOR COMPUTER SYSTEM BACKUP, SOFTWARE FOR ACCESS TO AND MANAGEMENT OF ELECTRONIC PERSONAL CALENDARS (U.S. CLS. 21, 23, 26, 36 AND 38).

FIRST USE 7-17-2002; IN COMMERCE 7-17-2002.

CLASS 38—COMMUNICATION

FOR ELECTRONIC TRANSMISSION OF DATA, IMAGES, AUDIO, VIDEO AND DOCUMENTS, INCLUDING TEXT, CARDS, LETTERS, MESSAGES, MAIL, ANIMATIONS, AND ELECTRONIC MAIL, OVER GLOBAL COMMUNICATIONS NETWORKS; ELECTRONIC MAIL SERVICES; COMMUNICATION SERVICES ENABLING COMPUTER USERS TO EXCHANGE MESSAGES AND FILES OVER THE INTERNET (U.S. CLS. 100, 101 AND 104).

FIRST USE 7-17-2002; IN COMMERCE 7-17-2002.

CLASS 39—TRANSPORTATION AND STORAGE

FOR ELECTRONIC STORAGE OF DATA, IMAGES, DOCUMENTS, SOFTWARE AND STORAGE OF ELECTRONIC MEDIA, INCLUDING IMAGES, TEXT, AUDIO, AND VIDEO DATA (U.S. CLS. 100 AND 105).

FIRST USE 7-17-2002; IN COMMERCE 7-17-2002.

CLASS 41—EDUCATION AND ENTERTAINMENT

FOR TRAINING IN THE USE AND OPERATION OF COMPUTERS, COMPUTER PERIPHERALS, AND COMPUTER SOFTWARE (U.S. CLS. 100, 101 AND 107).

FIRST USE 5-10-2003; IN COMMERCE 5-10-2003.

CLASS 42—SCIENTIFIC, COMPUTER AND LEGAL SERVICES

FOR UPDATING OF COMPUTER SOFTWARE; HOSTING THE WEB SITES OF OTHERS ON A COMPUTER SERVER FOR A GLOBAL COMPUTER NETWORK; PROVIDING TEMPORARY USE OF ON-LINE NON-DOWNLOADABLE SOFTWARE FOR ELECTRONIC MAIL, FOR ACCESS TO AND MANAGEMENT OF CONTACT INFORMATION, FOR ACCESS TO AND MANAGEMENT OF ELECTRONIC PERSONAL CALENDARS, FOR ACCESS TO AND MANAGEMENT OF WEB BROWSER BOOKMARK LISTS, FOR WEB SITE DESIGN, CREATION AND PUBLISHING, FOR SHARING FILES, IMAGES, AND MOVIES ON THE INTERNET, FOR CREATING AND DELIVERING ELECTRONIC GREETING CARDS, AND FOR COMPUTER TRAINING (U.S. CLS. 100 AND 101).

FIRST USE 7-17-2002; IN COMMERCE 7-17-2002.

3,298,657. MEDIAMOST INTERNATIONAL, INC., NEW YORK, NY. SN 78-189,806. PUB. 3-1-2005, FILED 11-29-2002.

**CLASS 9—ELECTRICAL AND SCIENTIFIC APPARATUS**

FOR MOTION PICTURE FILMS, SOUND FILMS, CINEMATOGRAPHIC FILMS AND PHOTOGRAPHIC FILMS FEATURING COMEDY, DRAMA, ADVENTURE, ACTION, DOCUMENTARIES, CARTOONS, ANIMATION, ROMANCE, SPORTS, LEISURE, SCIENCE AND TECHNOLOGY, TRAVEL, RELIGION, MUSIC, NATURE, LIVE CONCERTS AND EVENTS, HISTORY, SCIENCE FICTION, FICTION, NON-FICTION, HEALTH, NATURAL HISTORY, GEOGRAPHY, BIOLOGY, CULTURE, ENTERTAINMENT, INSTRUCTION, AND OTHER TOPICS OF GENERAL INTEREST; ELECTRONIC PUBLICATIONS, NAMELY, PROGRAMMING GUIDES, FEATURING INFORMATION ON TELEVISION PROGRAMS, NEWS, COMEDY, DRAMA, FILM, ACTION, ADVENTURE, DOCUMENTARIES, LAW, CRIME, CARTOONS, ANIMATION, GAMES, ROMANCE, SPORTS, LEISURE, SCIENCE AND TECHNOLOGY, TRAVEL, RECREATIONAL ACTIVITIES, RELIGION, MUSIC, FOOD AND COOKING, NATURE, EXERCISE AND FITNESS, LIVE CONCERTS AND EVENTS, HISTORY, SCIENCE FICTION, FICTION, NON-FICTION, INTERVIEWS, CURRENT AFFAIRS, HEALTH, NATURAL HISTORY, SOCIAL ISSUES, GEOGRAPHY, HISTORY, BIOLOGY, POLITICS, ARTS, ONLINE CONTENT, WEATHER, CULTURE, ENTERTAINMENT, INSTRUCTION, OTHER TOPICS OF GENERAL INTEREST AND DOWNLOADABLE SOUND RECORDINGS FEATURING MUSIC (U.S. CLS. 21, 23, 26, 36 AND 38).

FIRST USE 1-0-2003; IN COMMERCE 1-0-2003.

CLASS 16—PAPER GOODS AND PRINTED MATTER

FOR PRINTED MATTER, NAMELY, GUIDES, FEATURING OR RELATING TO TELEVISION PROGRAMS AND SCHEDULES (U.S. CLS. 2, 5, 22, 23, 29, 37, 38 AND 50).

FIRST USE 1-0-2003; IN COMMERCE 1-0-2003.

CLASS 35—ADVERTISING AND BUSINESS

FOR DISSEMINATION OF ADVERTISING FOR OTHERS VIA TELEVISION, THE INTERNET, AND ELECTRONIC PUBLICATIONS; PREPARATION, DISSEMINATION AND UPDATING OF ONLINE ADVERTISING FOR OTHERS; PROVIDING TELEVISION ADVERTISING FOR OTHERS; PRODUCTION OF TELEVISION COMMERCIALS; TELEVISION ADVERTISING; INTERACTIVE RETAIL SERVICES PROVIDED VIA TELEVISION FEATURING GENERAL MERCHANDISE (U.S. CLS. 100, 101 AND 102).

FIRST USE 1-0-2003; IN COMMERCE 1-0-2003.

CLASS 38—COMMUNICATION

FOR INTERNET, SATELLITE, CABLE TELEVISION, CABLE TELEVISION BROADCASTING; SATELLITE BROADCASTING; SATELLITE TRANSMISSION; CABLE TELEVISION TRANSMISSION; VIDEO-ON-DEMAND TRANSMISSION SERVICES; ELECTRONIC BROADCASTING AND TRANSMISSION OF TEXT, SOUND, IMAGES, VIA THE INTERNET; TRANSMISSION OF DIGITAL INFORMATION AND DATA; TRANSMISSION OF AUDIO, VIDEO, STILL AND MOVING IMAGES AND DATA IN REAL AND DELAYED TIME; AUDIO/VIDEO STREAMING VIA THE INTERNET (U.S. CLS. 100, 101 AND 104).

FIRST USE 1-0-2003; IN COMMERCE 1-0-2003.

CLASS 41—EDUCATION AND ENTERTAINMENT

FOR ENTERTAINMENT IN THE NATURE OF ONGOING TELEVISION PROGRAMS FEATURING NEWS, COMEDY, DRAMA, FILM, ACTION, ADVENTURE, DOCUMENTARIES, LAW, CRIME, CARTOONS, ANIMATION, GAMES, ROMANCE, SPORTS, LEISURE, SCIENCE AND TECHNOLOGY, TRAVEL, RECREATIONAL ACTIVITIES, RELIGION, MUSIC, FOOD AND COOKING, NATURE, EXERCISE AND FITNESS, LIVE CONCERTS AND EVENTS, HISTORY, SCIENCE FICTION, FICTION, NON-FICTION, INTERVIEWS, CURRENT AFFAIRS, HEALTH, NATURAL HISTORY, SOCIAL ISSUES, MATHEMATICS, GEOGRAPHY, HISTORY, BIOLOGY, POLITICS, ARTS, ON-LINE CONTENT, WEATHER, CULTURE, ENTERTAINMENT, INSTRUCTION, AND OTHER TOPICS OF GENERAL INTEREST; PRODUCTION OF TELEVISION AND RADIO PROGRAMS; ENTERTAINMENT SERVICES, NAMELY, PROVIDING ON-LINE ENTERTAINMENT SERVICES IN THE FORM OF A WEBSITE FEATURING NEWS, COMEDY, DRAMA, FILM, ACTION, ADVENTURE, DOCUMENTARIES, LAW, CRIME, CARTOONS, ANIMATION, GAMES, ROMANCE, SPORTS, LEISURE, SCIENCE AND TECHNOLOGY, TRAVEL, RECREATIONAL ACTIVITIES, RELIGION, MUSIC, FOOD AND COOKING, NATURE, EXERCISE AND FITNESS, LIVE CONCERTS AND EVENTS, HISTORY, SCIENCE FICTION, FICTION, NON-FICTION, INTERVIEWS, CURRENT AFFAIRS, HEALTH, NATURAL HISTORY, SOCIAL ISSUES, GEOGRAPHY, HISTORY, BIOLOGY, POLITICS, ARTS, ON-LINE CONTENT, WEATHER, AND CULTURE; PRODUCTION OF SOUND AND VIDEO RECORDINGS, MOTION PICTURE FILMS, TELEVISION AND RADIO SHOWS; ENTERTAINMENT SERVICES, NAMELY, PROVIDING PRERECORDED MUSIC INFORMATION IN THE FIELD OF MUSIC AND COMMENTARY AND ARTICLES ABOUT MUSIC VIA THE INTERNET; NEWS AGENCY SERVICES, NAMELY, GATHERING AND DISSEMINATION OF NEWS; NEWS REPORTING SERVICES; PROVISION OF RADIO AND TELEVISION CREWS FOR PRODUCTION SERVICES FOR OUTSIDE LOCATIONS; ONLINE PUBLICATIONS, NAMELY, ELECTRONIC PROGRAM GUIDES FOR BROADCAST, CABLE AND SATELLITE TELEVISION PROGRAMMING; DISTRIBUTION OF TELEVISION PROGRAMMING TO CABLE, TERRESTRIAL OR SATELLITE TELEVISION SYSTEMS (U.S. CLS. 100, 101 AND 107).

FIRST USE 1-0-2003; IN COMMERCE 1-0-2003.

3,298,664. BRAVO SPORTS, CYPRESS, CA. SN 78-213,106. PUB. 4-11-2006, FILED 2-10-2003.

HYPER

OWNER OF U.S. REG. NOS. 2,105,944 AND 2,107,919.

CLASS 18—LEATHER GOODS

FOR HOCKEY BACKPACKS (U.S. CLS. 1, 2, 3, 22 AND 41).
FIRST USE 7-0-1999; IN COMMERCE 1-31-2000.

CLASS 25—CLOTHING

FOR HOCKEY APPAREL, NAMELY, HOCKEY JERSEYS AND HOCKEY PANTS (U.S. CLS. 22 AND 39).
FIRST USE 7-0-1999; IN COMMERCE 1-31-2000.

CLASS 28—TOYS AND SPORTING GOODS

FOR HOCKEY APPAREL, NAMELY, HOCKEY GOALIE PADS, PROTECTIVE PADDING FOR SKATING (U.S. CLS. 22, 23, 38 AND 50).
FIRST USE 7-0-1999; IN COMMERCE 1-31-2000.

3,298,668. THE ADMINISTRATORS OF THE TULANE EDUCATIONAL FUND, NEW ORLEANS, LA. SN 78-228,374. PUB. 7-12-2005, FILED 3-21-2003.

TULANE

OWNER OF U.S. REG. NOS. 1,915,719, 2,737,647, AND 2,743,096.

CLASS 35—ADVERTISING AND BUSINESS

FOR CONDUCTING RESEARCH AND EXPERIMENTS FOR OTHERS IN THE FIELD OF BUSINESS (U.S. CLS. 100, 101 AND 102).

FIRST USE 0-0-1914; IN COMMERCE 0-0-1914.

CLASS 42—SCIENTIFIC, COMPUTER AND LEGAL SERVICES

FOR CONDUCTING SCIENTIFIC RESEARCH, SCIENTIFIC TESTING, AND LABORATORY EXPERIMENTS FOR OTHERS IN THE FIELDS OF ENGINEERING, ARCHITECTURE, LAW, AND SOCIAL WORK; CONDUCTING SCIENTIFIC RESEARCH, SCIENTIFIC TESTING, AND LABORATORY EXPERIMENTS FOR OTHERS IN THE FIELDS OF LIBERAL ARTS AND SCIENCES, NAMELY, ANTHROPOLOGY, ART, CELL AND MOLECULAR BIOLOGY, ECOLOGY AND EVOLUTIONARY BIOLOGY, CHEMISTRY, CLASSICAL STUDIES, COMMUNICATION, EARTH AND ENVIRONMENTAL SCIENCES, ECONOMICS, ENGLISH, FRENCH AND ITALIAN, GERMANIC AND SLAVIC STUDIES, HISTORY, MATHEMATICS, MUSIC, PHILOSOPHY, PHYSICS, POLITICAL SCIENCE, PSYCHOLOGY, SOCIOLOGY, SPANISH AND PORTUGUESE, AND THEATER AND DANCE; CONDUCTING MEDICAL RESEARCH, CLINICAL TESTING, AND LABORATORY EXPERIMENTS IN THE FIELDS OF MEDICINE, PUBLIC HEALTH, AND TROPICAL MEDICINE (U.S. CLS. 100 AND 101).

FIRST USE 0-0-1884; IN COMMERCE 0-0-1884.

CLASS 44—MEDICAL, BEAUTY AND AGRICULTURAL SERVICES

FOR PROVIDING HOSPITAL, MEDICAL, AND HEALTH CARE SERVICES; CONDUCTING MEDICAL TESTING IN THE FIELDS OF PUBLIC HEALTH AND TROPICAL MEDICINE (U.S. CLS. 100 AND 101).

FIRST USE 0-0-1884; IN COMMERCE 0-0-1884.

CLASS 45—PERSONAL SERVICES

FOR CONDUCTING RESEARCH, TESTING, AND EXPERIMENTS FOR OTHERS IN THE FIELD OF SOCIAL WORK, EXCEPT FOR SCIENTIFIC AND LABORATORY RESEARCH, SCIENTIFIC AND LABORATORY TESTING, AND SCIENTIFIC AND LABORATORY EXPERIMENTS (U.S. CLS. 100 AND 101).

FIRST USE 0-0-1927; IN COMMERCE 0-0-1927.

3,298,693. KIDZ BOP LLC, NEW YORK, NY. SN 78-301,749. PUB. 7-6-2004, FILED 9-17-2003.

KIDZ BOP

OWNER OF U.S. REG. NO. 2,538,339.

NO CLAIM IS MADE TO THE EXCLUSIVE RIGHT TO USE "KIDS", APART FROM THE MARK AS SHOWN.

CLASS 16—PAPER GOODS AND PRINTED MATTER

FOR PUBLICATIONS, NAMELY, MAGAZINES, COMIC BOOKS, PROGRAMS, BOOKS AND MUSIC BOOKS, ALL FEATURING MUSIC (U.S. CLS. 2, 5, 22, 23, 29, 37, 38 AND 50).

FIRST USE 12-31-2005; IN COMMERCE 12-31-2005.

CLASS 25—CLOTHING

FOR CLOTHING, NAMELY, T-SHIRTS, SWEAT-SHIRTS, TANK TOPS, SHIRTS, HATS, CAPS (U.S. CLS. 22 AND 39).

FIRST USE 4-3-2006; IN COMMERCE 4-3-2006.

CLASS 28—TOYS AND SPORTING GOODS

FOR TOYS AND GAMES, NAMELY, TOY MUSICAL INSTRUMENTS, TOY MICROPHONES (U.S. CLS. 22, 23, 38 AND 50).

FIRST USE 7-4-2005; IN COMMERCE 7-4-2005.

3,298,706. CONTRACT FREIGHTERS, INC., JOPLIN, MO. SN 78-319,789. PUB. 7-5-2005, FILED 10-28-2003.

WE DELIVER ALL FREIGHT AS PROMISED**CLASS 35—ADVERTISING AND BUSINESS**

FOR COMPUTERIZED TRACKING AND LOCATING OF FREIGHT IN TRANSIT; PROVIDING TRUCKING AND FREIGHT TRANSPORTATION LISTINGS, AND EMPLOYMENT LISTINGS BY MEANS OF A GLOBAL COMPUTER NETWORK, PHONE, FAX, OR EMAIL; FREIGHT TRANSPORTATION MANAGEMENT AND LOGISTICS SERVICES; PROVIDING SHIPMENT INFORMATION VIA A GLOBAL COMPUTER NETWORK, PHONE, FAX, OR EMAIL FOR TRACING THE LOCATION AND STATUS OF SHIPPED CARGO; PROVIDING RATE INFORMATION FOR SHIPPING VIA A GLOBAL COMPUTER NETWORK, PHONE, FAX, OR EMAIL; SCHEDULING AND BOOKING FREIGHT SHIPMENTS VIA A GLOBAL COMPUTER NETWORK, PHONE, FAX, OR EMAIL FOR USERS OF TRANSPORTATION SERVICES; PROMOTING PUBLIC AWARENESS OF THE NEED FOR TRAFFIC SAFETY AND SAFE DRIVING PRACTICES INVOLVING TRUCKS AND OTHER MOTORISTS THROUGH THE DISTRIBUTION OF VISUAL AIDS AND PRINTED MATTER (U.S. CLS. 100, 101 AND 102).

FIRST USE 3-0-2006; IN COMMERCE 3-0-2006.

CLASS 39—TRANSPORTATION AND STORAGE

FOR FREIGHT SERVICES, NAMELY, HANDLING AND HAULING CARGO BY TRUCK; TRUCK AND TRAILER LEASING SERVICES; LEASING OF TRANSPORTATION AND TRUCKING FACILITIES; PROVIDING INFORMATION IN THE FIELD OF FREIGHT TRANSPORTATION AND SHIPPING, ABOUT DELIVERY, BOOKING, CARGO, LOADS, AND FREIGHT CONTRACTORS AND DRIVERS BY MEANS OF A GLOBAL COMPUTER NETWORK, PHONE, FAX, OR EMAIL (U.S. CLS. 100 AND 105).

FIRST USE 3-0-2006; IN COMMERCE 3-0-2006.

3,298,702. DINUBILE, NICHOLAS A., HAVERTOWN, PA. SN 78-315,920. PUB. 7-27-2004, FILED 10-20-2003.

FRAMEWORK**CLASS 9—ELECTRICAL AND SCIENTIFIC APPARATUS**

FOR PRERECORDED AUDIO TAPES, COMPACT DISCS AND PRERECORDED VIDEO TAPES FEATURING HEALTH, FITNESS, EXERCISE, WELLNESS, SPORTS MEDICINE, AGING, NUTRITION AND NUTRITIONAL SUPPLEMENT INFORMATION AND ADVICE (U.S. CLS. 21, 23, 26, 36 AND 38).

FIRST USE 12-1-2006; IN COMMERCE 12-1-2006.

CLASS 16—PAPER GOODS AND PRINTED MATTER

FOR EDUCATIONAL MATERIALS, NAMELY A SERIES OF BOOKS, MAGAZINES, AND INFORMATIONAL BROCHURES IN THE FIELDS OF HEALTH, FITNESS, EXERCISE, WELLNESS, SPORTS MEDICINE, AGING, NUTRITION AND NUTRITIONAL SUPPLEMENTS (U.S. CLS. 2, 5, 22, 23, 29, 37, 38 AND 50).

FIRST USE 7-1-2005; IN COMMERCE 7-1-2005.

3,298,720. BEVERLY HILLS PET HOTELS, INC., CLEVELAND, OH. SN 78-353,811. PUB. 6-28-2005, FILED 1-19-2004.

THE BARKLEY PET HOTEL & DAY SPA

THE MARK CONSISTS OF STANDARD CHARACTERS WITHOUT CLAIM TO ANY PARTICULAR FONT, STYLE, SIZE, OR COLOR.

NO CLAIM IS MADE TO THE EXCLUSIVE RIGHT TO USE "PET HOTEL & DAY SPA", APART FROM THE MARK AS SHOWN.

CLASS 43—HOTEL AND RESTAURANT SERVICES

FOR PET BOARDING SERVICES, KENNELING SERVICES INCLUDING BOTH CAGED AND CAGE-FREE DAILY AND OVERNIGHT PET LODGING SERVICES (U.S. CLS. 100 AND 101).

FIRST USE 3-20-2007; IN COMMERCE 3-20-2007.

CLASS 44—MEDICAL, BEAUTY AND AGRICULTURAL SERVICES

FOR PET GROOMING SERVICES, PET SALON SERVICES, AND PET NAIL CLIPPING, BATHING, AND HAIR-STYLING SERVICES; PET DAY CARE SERVICES; PET SITTING SERVICES AND PET WALKING SERVICES; PET THERAPY SERVICES, NAMELY, HYDROTHERAPY, SWIMMING THERAPY, MASSOTHERAPY, AROMATHERAPY, AND ACUPUNCTURE, HORSE WHISPERING, AND DOG WHISPERING (U.S. CLS. 100 AND 101).

FIRST USE 3-20-2007; IN COMMERCE 3-20-2007.

3,298,728. THQ INC., AGOURA HILLS, CA. SN 78-367,391. PUB. 2-28-2006, FILED 2-12-2004.

COMPANY OF HEROES

THE MARK CONSISTS OF STANDARD CHARACTERS WITHOUT CLAIM TO ANY PARTICULAR FONT, STYLE, SIZE, OR COLOR.

CLASS 9—ELECTRICAL AND SCIENTIFIC APPARATUS

FOR VIDEO GAMES, NAMELY, VIDEO GAME SOFTWARE FOR PLAY ON PERSONAL COMPUTERS; VIDEO GAMES ON DVDS, CD-ROMS, COMPACT DISCS, AND DOWNLOADABLE COMPUTER PROGRAMS PROVIDED THROUGH THE INTERNET AND A COMMUNICATION NETWORK FOR USE WITH MOBILE PHONES AND WIRELESS DEVICES; PRE-RECORDED COMPACT DISCS, PRE-RECORDED DVDS, FEATURING CHARACTERS, SCENES, DIALOGUE AND OTHER CONTENT FROM THE VIDEO GAME SOFTWARE (U.S. CLS. 21, 23, 26, 36 AND 38).

FIRST USE 9-12-2006; IN COMMERCE 9-12-2006.

CLASS 42—SCIENTIFIC, COMPUTER AND LEGAL SERVICES

FOR PROVIDING TEMPORARY USE OF NON-DOWNLOADABLE COMPUTER GAME PROGRAMS PROVIDED THROUGH THE INTERNET AND A COMMUNICATIONS NETWORK FOR USE WITH MOBILE PHONES AND WIRELESS DEVICES (U.S. CLS. 100 AND 101).

FIRST USE 1-15-2007; IN COMMERCE 1-15-2007.

3,298,732. SAM BISER PRESS, INC., LOS ANGELES, CA. SN 78-373,372. PUB. 12-28-2004, FILED 2-24-2004.

BEYOND THE HEALERS' BOOKS

THE MARK CONSISTS OF STANDARD CHARACTERS WITHOUT CLAIM TO ANY PARTICULAR FONT, STYLE, SIZE, OR COLOR.

CLASS 41—EDUCATION AND ENTERTAINMENT

FOR ON-LINE PUBLICATION OF INSTRUCTIONAL, EDUCATIONAL, AND TEACHING MATERIALS IN THE FIELD OF HEALTH CARE, HERBAL MEDICINE, PERSONAL AWARENESS, SELF-IMPROVEMENT AND NATURAL HEALING (U.S. CLS. 100, 101 AND 107).

FIRST USE 1-27-2004; IN COMMERCE 1-27-2004.

CLASS 44—MEDICAL, BEAUTY AND AGRICULTURAL SERVICES

FOR PROVIDING HEALTH AND MEDICAL INFORMATION IN THE FIELD OF HEALTH CARE, NATURAL HEALING, HERBAL MEDICINE, NUTRITION AND DIETITIAN SERVICES (U.S. CLS. 100 AND 101).

FIRST USE 1-27-2004; IN COMMERCE 1-27-2004.

3,298,736. UNITED PENTECOSTAL CHURCH INTERNATIONAL, INC., HAZELWOOD, MO. SN 78-378,916. PUB. 6-13-2006, FILED 3-4-2004.

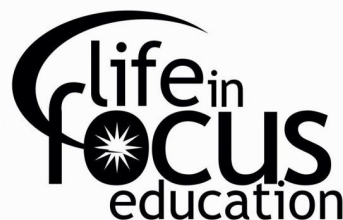

NO CLAIM IS MADE TO THE EXCLUSIVE RIGHT TO USE "EDUCATION", APART FROM THE MARK AS SHOWN.

THE MARK CONSISTS OF THE WORDS "LIFE IN" ON THE FIRST LINE BEGIN ABOVE THE "O" IN THE WORD "FOCUS" ON THE SECOND LINE, WITH THE WORD "EDUCATION" ON THE THIRD LINE STARTING UNDER THE "O" IN THE WORD "FOCUS" AND ENDING WITH THE "N" OF EDUCATION ALIGNED TO THE RIGHT OF THE "S" IN THE WORD "FOCUS." ALL LETTERS ARE IN LOWER CASE. A CURVING SWOOSH STARTS ABOVE THE "E" IN LIFE AND CURVES UP, AROUND AND THEN DOWN TO FORM THE CROSS OF THE "F" IN THE WORD "FOCUS" AND ENDS IN A WHITE STARBURST IN THE CENTER OF THE "O" IN THE WORD "FOCUS".

CLASS 9—ELECTRICAL AND SCIENTIFIC APPARATUS

FOR PRERECORDED AUDIO AND VIDEO MEDIA, NAMELY, AUDIOTAPES, VIDEOTAPES AND COMPACT DISCS PRESENTING EDUCATIONAL, INSPIRATIONAL, MOTIVATIONAL AND FAITH-BASED COMMUNITY PROGRAMS, MUSIC AND MESSAGES FOR TRAINING OTHERS IN THE FIELDS OF ALCOHOL AND DRUG EDUCATION, EMPLOYMENT DEVELOPMENT, ANGER MANAGEMENT, COMPUTER TRAINING, PARENTING SKILLS, FINANCIAL MANAGEMENT, MENTORING, HEALTH EDUCATION, RELATIONSHIP BUILDING, CULTURAL INTEGRATION AND ASSIMILATION, AND LIFE SKILL TRAINING FOR INCARCERATED INDIVIDUALS (U.S. CLS. 21, 23, 26, 36 AND 38).

FIRST USE 4-0-2004; IN COMMERCE 4-0-2004.

CLASS 16—PAPER GOODS AND PRINTED MATTER

FOR TRAINING MANUALS, TEACHING GUIDES, STUDENT WORKBOOKS, SELF-TEACHING GUIDES, PRINTED FORMS, AND TEACHING CHARTS IN THE FIELDS OF ALCOHOL AND DRUG EDUCATION, EMPLOYMENT DEVELOPMENT, ANGER MANAGEMENT, COMPUTER TRAINING, PARENTING SKILLS, FINANCIAL MANAGEMENT, MENTORING, HEALTH EDUCATION, RELATIONSHIP BUILDING, CULTURAL INTEGRATION AND ASSIMILATION, AND LIFE SKILL TRAINING FOR INCARCERATED INDIVIDUALS (U.S. CLS. 2, 5, 22, 23, 29, 37, 38 AND 50).

FIRST USE 4-0-2004; IN COMMERCE 4-0-2004.

CLASS 41—EDUCATION AND ENTERTAINMENT

FOR EDUCATIONAL SERVICES PRESENTED THROUGH SEMINARS, ONE-ON-ONE TEACHING AND SUPPORT GROUPS IN THE FIELDS OF ALCOHOL AND DRUG EDUCATION, EMPLOYMENT TRAINING, ANGER MANAGEMENT, COMPUTER TRAINING, PARENTING SKILLS, FINANCIAL MANAGEMENT, MENTORING, HEALTH EDUCATION, RELATIONSHIP BUILDING, CULTURAL INTEGRATION AND ASSIMILATION, LIFE SKILL TRAINING FOR INCARCERATED INDIVIDUALS, AND CAREER COUNSELING (U.S. CLS. 100, 101 AND 107).

FIRST USE 4-0-2004; IN COMMERCE 4-0-2004.

CLASS 45—PERSONAL SERVICES

FOR COUNSELING THROUGH FAITH-BASED COMMUNITY SUPPORT GROUPS IN THE FIELDS OF ALCOHOL RECOVERY, PERSONAL RELATIONSHIPS AND PERSONAL MOTIVATION (U.S. CLS. 100 AND 101).

FIRST USE 4-0-2004; IN COMMERCE 4-0-2004.

3,298,738. UNITED PENTECOSTAL CHURCH INTERNATIONAL, INC., HAZELWOOD, MO. SN 78-378,933. PUB. 6-13-2006, FILED 3-4-2004.

**LIFE IN FOCUS
EDUCATION**

THE MARK CONSISTS OF STANDARD CHARACTERS WITHOUT CLAIM TO ANY PARTICULAR FONT, STYLE, SIZE, OR COLOR.

NO CLAIM IS MADE TO THE EXCLUSIVE RIGHT TO USE "EDUCATION", APART FROM THE MARK AS SHOWN.

CLASS 9—ELECTRICAL AND SCIENTIFIC APPARATUS

FOR PRERECORDED AUDIO AND VIDEO MEDIA, NAMELY, AUDIOTAPES, VIDEOTAPES AND COMPACT DISCS PRESENTING EDUCATIONAL, INSPIRATIONAL, MOTIVATIONAL AND FAITH-BASED COMMUNITY PROGRAMS, MUSIC AND MESSAGES FOR TRAINING OTHERS IN THE FIELDS OF ALCOHOL AND DRUG EDUCATION, EMPLOYMENT DEVELOPMENT, ANGER MANAGEMENT, COMPUTER TRAINING, PARENTING SKILLS, FINANCIAL MANAGEMENT, MENTORING, HEALTH EDUCATION, RELATIONSHIP BUILDING, CULTURAL INTEGRATION AND ASSIMILATION, AND LIFE SKILL TRAINING FOR INCARCERATED INDIVIDUALS (U.S. CLS. 21, 23, 26, 36 AND 38).

FIRST USE 4-0-2004; IN COMMERCE 4-0-2004.

CLASS 16—PAPER GOODS AND PRINTED MATTER

FOR TRAINING MANUALS, TEACHING GUIDES, STUDENT WORKBOOKS, SELF-TEACHING GUIDES, PRINTED FORMS, AND TEACHING CHARTS IN THE FIELDS OF ALCOHOL AND DRUG EDUCATION, EMPLOYMENT DEVELOPMENT, ANGER MANAGEMENT, COMPUTER TRAINING, PARENTING SKILLS, FINANCIAL MANAGEMENT, MENTORING, HEALTH EDUCATION, RELATIONSHIP BUILDING, CULTURAL INTEGRATION AND ASSIMILATION, AND LIFE SKILL TRAINING FOR INCARCERATED INDIVIDUALS (U.S. CLS. 2, 5, 22, 23, 29, 37, 38 AND 50).

FIRST USE 4-0-2004; IN COMMERCE 4-0-2004.

CLASS 41—EDUCATION AND ENTERTAINMENT

FOR EDUCATIONAL SERVICES PRESENTED THROUGH SEMINARS, ONE-ON-ONE TEACHING AND SUPPORT GROUPS IN THE FIELDS OF ALCOHOL AND DRUG EDUCATION, EMPLOYMENT TRAINING, ANGER MANAGEMENT, COMPUTER TRAINING, PARENTING SKILLS, FINANCIAL MANAGEMENT, MENTORING, HEALTH EDUCATION, RELATIONSHIP BUILDING, CULTURAL INTEGRATION AND ASSIMILATION, LIFE SKILL TRAINING FOR INCARCERATED INDIVIDUALS, AND CAREER COUNSELING (U.S. CLS. 100, 101 AND 107).

FIRST USE 4-0-2004; IN COMMERCE 4-0-2004.

CLASS 45—PERSONAL SERVICES

FOR COUNSELING THROUGH FAITH-BASED COMMUNITY SUPPORT GROUPS IN THE FIELDS OF ALCOHOL RECOVERY, PERSONAL RELATIONSHIPS AND PERSONAL MOTIVATION (U.S. CLS. 100 AND 101).

FIRST USE 4-0-2004; IN COMMERCE 4-0-2004.

3,298,740. ADVANCED HAIR STUDIO (EUROPE) LTD, DUBLIN 2, IRELAND. SN 78-381,232. PUB. 2-21-2006, FILED 3-9-2004.



NO CLAIM IS MADE TO THE EXCLUSIVE RIGHT TO USE "HAIR STUDIO", APART FROM THE MARK AS SHOWN.

CLASS 16—PAPER GOODS AND PRINTED MATTER

FOR PRINTED MATTER, NAMELY, BROCHURES, MANUALS, NEWSLETTERS, PRINTED INSTRUCTIONAL, EDUCATIONAL AND TEACHING MATERIALS, AND PRINTED VISUALS IN THE NATURE OF PROMOTIONAL MATERIAL, POINT OF SALE POSTERS, POINT OF SALE PRINTED FORMS IN THE NATURE OF CONTRACTS, PRE-PRINTED ADVERTISEMENTS FOR NEWSPAPERS, MAGAZINES AND PAMPHLETS, PRINTED ADVERTISEMENTS FOR NEWSPAPERS AND MAGAZINES, AND ADVERTISING POSTERS AND LEAFLETS, ALL IN THE FIELDS OF HAIR PIECES, WIGS, FALSE HAIR, HAIR FASTENERS, HAIR NETS, HAIRDRESSING AND STYLING SERVICES AND SERVICES IN CONNECTION WITH FIXING HAIR PIECES TO THE HEADS OF HUMAN BEINGS (U.S. CLS. 2, 5, 22, 23, 29, 37, 38 AND 50).

FIRST USE 0-0-1986; IN COMMERCE 0-0-1986.

CLASS 26—FANCY GOODS

FOR HAIR PIECES, WIGS AND TOUPEES (U.S. CLS. 37, 39, 40, 42 AND 50).

FIRST USE 0-0-1986; IN COMMERCE 0-0-1986.

3,298,748. USA MARKETING, LLC, OAKLAND, CA. SN 78-387,907. PUB. 9-6-2005, FILED 3-19-2004.

FANIMATION

THE MARK CONSISTS OF STANDARD CHARACTERS WITHOUT CLAIM TO ANY PARTICULAR FONT, STYLE, SIZE, OR COLOR.

CLASS 35—ADVERTISING AND BUSINESS

FOR ADVERTISING SERVICES, NAMELY, ADVERTISING AGENCIES; PREPARATION AND REALIZATION OF MEDIA AND ADVERTISING PLANS AND CONCEPTS; PREPARING AUDIO-VISUAL PRESENTATIONS FOR USE IN ADVERTISING; PROMOTING THE GOODS AND SERVICES OF OTHERS BY DISTRIBUTING ADVERTISING MATERIALS THROUGH A VARIETY OF METHODS (U.S. CLS. 100, 101 AND 102).

FIRST USE 7-1-2006; IN COMMERCE 7-1-2006.

CLASS 41—EDUCATION AND ENTERTAINMENT

FOR ENTERTAINMENT SERVICES IN THE NATURE OF CARD STUNTS PERFORMANCES AT LARGE PUBLIC EVENTS (U.S. CLS. 100, 101 AND 107).

FIRST USE 2-1-2004; IN COMMERCE 2-1-2004.

3,298,762. ON TOP OF THE WORLD COMMUNITIES, INC., OCALA, FL. SN 78-416,281. PUB. 1-3-2006, FILED 5-10-2004.

A DESTINATION YOU CALL HOME

THE MARK CONSISTS OF STANDARD CHARACTERS WITHOUT CLAIM TO ANY PARTICULAR FONT, STYLE, SIZE, OR COLOR.

CLASS 37—CONSTRUCTION AND REPAIR

FOR CONSTRUCTION PLANNING, PLANNING AND LAYING OUT OF RESIDENTIAL COMMUNITIES; REAL ESTATE DEVELOPMENT (U.S. CLS. 100, 103 AND 106).

FIRST USE 11-3-2004; IN COMMERCE 11-3-2004.

CLASS 41—EDUCATION AND ENTERTAINMENT

FOR PROVIDING INDOOR AND OUTDOOR RECREATIONAL FACILITIES (U.S. CLS. 100, 101 AND 107).

FIRST USE 11-3-2004; IN COMMERCE 11-3-2004.

3,298,769. INTELITRAC, INC., GERMANTOWN, MD. SN 78-428,647. PUB. 6-28-2005, FILED 6-2-2004.

DATABASE FARM

THE MARK CONSISTS OF STANDARD CHARACTERS WITHOUT CLAIM TO ANY PARTICULAR FONT, STYLE, SIZE, OR COLOR.

NO CLAIM IS MADE TO THE EXCLUSIVE RIGHT TO USE "DATABASE", APART FROM THE MARK AS SHOWN.

CLASS 9—ELECTRICAL AND SCIENTIFIC APPARATUS

FOR COMPUTER HARDWARE AND SOFTWARE, FOR PROVIDING LARGE AMOUNTS OF COMPUTER MEMORY FOR RAPID SEARCHING, ACCESS, AND BACKUP OF LARGE DATABASES (U.S. CLS. 21, 23, 26, 36 AND 38).

FIRST USE 12-6-2005; IN COMMERCE 12-6-2005.

CLASS 42—SCIENTIFIC, COMPUTER AND LEGAL SERVICES

FOR HARDWARE DESIGN AND SOFTWARE PROGRAMMING SERVICES, FOR PROVIDING LARGE AMOUNTS OF COMPUTER MEMORY FOR RAPID SEARCHING, ACCESS AND BACKUP OF LARGE DATABASES (U.S. CLS. 100 AND 101).

FIRST USE 12-6-2005; IN COMMERCE 12-6-2005.

3,298,776. MCKINNON INFORMATION SYSTEMS, INC., NEPEAN, ONTARIO, CANADA. SN 78-440,458. PUB. 7-18-2006, FILED 6-24-2004.

YOU CAN'T THINK WITH YOUR TOOL BELT ON

THE MARK CONSISTS OF STANDARD CHARACTERS WITHOUT CLAIM TO ANY PARTICULAR FONT, STYLE, SIZE, OR COLOR.

CLASS 9—ELECTRICAL AND SCIENTIFIC APPARATUS

FOR PRERECORDED AUDIO CASSETTES AND VIDEO TAPES, CD'S AND DVD'S FEATURING RECORDINGS OF SEMINARS AND TALKS IN THE FIELD OF PUBLIC SPEAKING, BUSINESS CONSULTING, MOTIVATION, MARKETING AND MANAGEMENT AND SELF IMPROVEMENT; DOWNLOADABLE ELECTRONIC PUBLICATIONS IN THE NATURE OF NEWSLETTERS CONCERNING BUSINESS IMPROVEMENT, MOTIVATION AND SELF IMPROVEMENT (U.S. CLS. 21, 23, 26, 36 AND 38).

FIRST USE 11-30-2003; IN COMMERCE 11-30-2003.

CLASS 16—PAPER GOODS AND PRINTED MATTER

FOR PRINTED NEWSLETTERS CONCERNING BUSINESS IMPROVEMENT, MOTIVATION AND SELF IMPROVEMENT (U.S. CLS. 2, 5, 22, 23, 29, 37, 38 AND 50).

FIRST USE 4-10-2007; IN COMMERCE 4-10-2007.

CLASS 41—EDUCATION AND ENTERTAINMENT

FOR EDUCATION SERVICES, NAMELY, PROVIDING SEMINARS IN THE FIELD OF PUBLIC SPEAKING, BUSINESS CONSULTING, MOTIVATION, MARKETING, MANAGEMENT AND SELF IMPROVEMENT; PROVIDING ON-LINE PUBLICATIONS IN THE NATURE OF ELECTRONIC NEWSLETTERS IN THE FIELD OF PUBLIC SPEAKING, BUSINESS CONSULTING, MOTIVATION, MARKETING AND MANAGEMENT AND SELF IMPROVEMENT; PROVIDING NEWSLETTERS IN THE FIELD OF PUBLIC SPEAKING, BUSINESS CONSULTING, MOTIVATION, MARKETING AND MANAGEMENT AND SELF IMPROVEMENT VIA E-MAIL (U.S. CLS. 100, 101 AND 107).

FIRST USE 11-30-2003; IN COMMERCE 11-30-2003.

3,298,780. SNAKE ALLEY CUSTOMS, INC., LAKE BARRINGTON, IL. SN 78-446,285. PUB. 12-20-2005, FILED 7-6-2004.

SNAKE ALLEY CUSTOMS

THE MARK CONSISTS OF STANDARD CHARACTERS WITHOUT CLAIM TO ANY PARTICULAR FONT, STYLE,

SIZE, OR COLOR.

NO CLAIM IS MADE TO THE EXCLUSIVE RIGHT TO USE "CUSTOMS", APART FROM THE MARK AS SHOWN.

CLASS 12—VEHICLES

FOR MOTORCYCLES (U.S. CLS. 19, 21, 23, 31, 35 AND 44).

FIRST USE 5-15-2004; IN COMMERCE 5-15-2004.

CLASS 40—MATERIAL TREATMENT

FOR CUSTOM MANUFACTURING OF MOTORCYCLES (U.S. CLS. 100, 103 AND 106).

FIRST USE 5-15-2004; IN COMMERCE 5-15-2004.

3,298,785. ARCADIS CORPORATE SERVICES, INC., HIGHLANDS RANCH, CO. SN 78-451,854. PUB. 2-28-2006, FILED 7-16-2004.

FIND & FIX

THE MARK CONSISTS OF STANDARD CHARACTERS WITHOUT CLAIM TO ANY PARTICULAR FONT, STYLE, SIZE, OR COLOR.

CLASS 37—CONSTRUCTION AND REPAIR

FOR CONSTRUCTION PLANNING, MONITORING, MANAGEMENT AND SUPERVISION; CONSULTING REGARDING SEWER, PIPE, PIPELINE AND MANHOLE REPAIR; REPAIR, REHABILITATION AND RENOVATION OF SEWERS, PIPES, PIPELINES AND MANHOLES; TRENCHLESS REPAIR OF SEWERS, PIPES, PIPELINES AND MANHOLES; CURED-IN-PLACE AND POINT REPAIR OF SEWERS, PIPES, PIPELINES AND MANHOLES (U.S. CLS. 100, 103 AND 106).

FIRST USE 10-15-2002; IN COMMERCE 10-15-2002.

CLASS 42—SCIENTIFIC, COMPUTER AND LEGAL SERVICES

FOR LOCATING AND MAPPING OF SEWERS, PIPES, PIPELINES AND MANHOLES TO A PHYSICAL LOCATION, GEOGRAPHIC INFORMATION SYSTEMS (GIS) AND GLOBAL POSITIONING SYSTEMS (GPS); GATHERING, REVIEWING, ANALYZING AND REPORTING DATA REGARDING SEWERS, PIPES, PIPELINES AND MANHOLES; ENGINEERING REGARDING SEWER, PIPE, PIPELINE AND MANHOLE REPAIR; INSPECTION AND EVALUATION OF SEWERS, PIPES, PIPELINES AND MANHOLES; TRENCHLESS INSPECTION AND EVALUATION OF SEWERS, PIPES, PIPELINES AND MANHOLES; INFRASTRUCTURE ASSET MANAGEMENT SERVICES, NAMELY, INVESTIGATING, ASSESSING, CREATING REMEDIATION STRATEGIES AND CREATING MAINTENANCE PLANS FOR MUNICIPALITY, CITY AND COUNTY INFRASTRUCTURE ASSETS, NAMELY, SEWERS, PIPES, PIPELINES, WATER TREATMENT FACILITIES, WATER FACILITIES AND MANHOLES (U.S. CLS. 100 AND 101).

FIRST USE 10-15-2002; IN COMMERCE 10-15-2002.

3,298,787. FREIGHTLINER LLC, PORTLAND, OR. SN 78-453,283. PUB. 7-5-2005, FILED 7-20-2004.

RUN SMART

THE MARK CONSISTS OF STANDARD CHARACTERS WITHOUT CLAIM TO ANY PARTICULAR FONT, STYLE, SIZE, OR COLOR.

CLASS 35—ADVERTISING AND BUSINESS

FOR MOTOR VEHICLE DEALERSHIP SERVICES (U.S. CLS. 100, 101 AND 102).
FIRST USE 11-15-2004; IN COMMERCE 11-15-2004.

CLASS 37—CONSTRUCTION AND REPAIR

FOR VEHICLE REPAIR AND MAINTENANCE SERVICES (U.S. CLS. 100, 103 AND 106).
FIRST USE 11-15-2004; IN COMMERCE 11-15-2004.

3,298,790. SWISSLIGHT, LLC, BALTIMORE, MD. SN 78-456,502. PUB. 6-28-2005, FILED 7-26-2004.

MR. JULY

THE MARK CONSISTS OF STANDARD CHARACTERS WITHOUT CLAIM TO ANY PARTICULAR FONT, STYLE, SIZE, OR COLOR.

THE NAME MR. JULY IN THE MARK DOES NOT IDENTIFY A LIVING INDIVIDUAL.

CLASS 14—JEWELRY

FOR JEWELRY, WATCHES AND CLOCKS (U.S. CLS. 2, 27, 28 AND 50).
FIRST USE 2-13-2007; IN COMMERCE 2-13-2007.

CLASS 25—CLOTHING

FOR CLOTHING, NAMELY, SHIRTS, T-SHIRTS, JERSEYS, PANTS, TOPS, BOTTOMS, SUITS, BLAZERS, SWEATERS, JACKETS, COATS, ANORAKS, SWEATSHIRTS, SWEATPANTS, SHORTS, SKIRTS, DRESSES, LOUNGEWEAR, FOOTWEAR, SOCKS, HOSIERY, HEADWEAR, BANDANAS, BELTS, GLOVES, SCARVES (U.S. CLS. 22 AND 39).

FIRST USE 2-13-2007; IN COMMERCE 2-13-2007.

3,298,792. FREE SPIRIT PUBLISHING INC., MINNEAPOLIS, MN. SN 78-458,323. PUB. 12-20-2005, FILED 7-28-2004.

BULLY FREE

THE MARK CONSISTS OF STANDARD CHARACTERS WITHOUT CLAIM TO ANY PARTICULAR FONT, STYLE, SIZE, OR COLOR.

CLASS 9—ELECTRICAL AND SCIENTIFIC APPARATUS

FOR PRERECORDED COMPACT DISCS FEATURING INFORMATION, FORMS, CHECKLISTS, SURVEYS, HANDOUTS, AND LETTERS RELATED TO BULLYING, TEASING, MEANNESS AND OTHER INAPPROPRIATE BEHAVIOR (U.S. CLS. 21, 23, 26, 36 AND 38).

FIRST USE 8-0-2003; IN COMMERCE 8-0-2003.

CLASS 16—PAPER GOODS AND PRINTED MATTER

FOR PRINTED MATERIALS, NAMELY, A SERIES OF BOOKS, WORKBOOKS, POSTERS, HANDOUTS, AND CATALOGS FEATURING INFORMATION RELATED TO BULLYING, TEASING, MEANNESS AND OTHER INAPPROPRIATE BEHAVIOR (U.S. CLS. 2, 5, 22, 23, 29, 37, 38 AND 50).

FIRST USE 0-0-1999; IN COMMERCE 0-0-1999.

3,298,793. CAPTARA CORPORATION, SAN FRANCISCO, CA. SN 78-458,460. PUB. 1-24-2006, FILED 7-28-2004.

CAPTARA

THE MARK CONSISTS OF STANDARD CHARACTERS WITHOUT CLAIM TO ANY PARTICULAR FONT, STYLE, SIZE, OR COLOR.

THE FOREIGN WORDING IN THE MARK TRANSLATES INTO ENGLISH AS "(THAT) IT CATCHES".

CLASS 35—ADVERTISING AND BUSINESS

FOR PROVIDING A MARKETPLACE FOR FINANCIAL SERVICES BY WHICH PARTIES SEEKING OR PROVIDING FINANCING CAN LOCATE ONE ANOTHER AND COME TOGETHER VIA A GLOBAL COMPUTER NETWORK TO TRANSACT BUSINESS (U.S. CLS. 100, 101 AND 102).

FIRST USE 5-1-2000; IN COMMERCE 5-1-2000.

CLASS 36—INSURANCE AND FINANCIAL

FOR FINANCIAL SERVICES, NAMELY, PROVIDING ADVICE TO ENTERPRISES IN OBTAINING FINANCING FOR CAPITAL EXPENDITURES; PROVIDING FINANCIAL ADVICE TO ENTERPRISES IN PLANNING, SOURCING, EXECUTION, AND MANAGEMENT OF CAPITAL EXPENDITURE FINANCING AND IN CREATING PROCESSES TO OPTIMIZE THE PLANNING, SOURCING, EXECUTION AND MANAGEMENT OF CAPITAL EXPENDITURE FINANCING (U.S. CLS. 100, 101 AND 102).

FIRST USE 5-1-2000; IN COMMERCE 5-1-2000.

3,298,798. EASTWAY FAIR COMPANY LIMITED, TORTOLA, BR. VIRGIN ISLANDS. SN 78-460,036. PUB. 6-20-2006, FILED 7-31-2004.

3,298,797. SILVER SUMMIT DEVELOPMENT GROUP, INC., ROSWELL, GA. SN 78-459,403. PUB. 6-13-2006, FILED 7-30-2004.



NO CLAIM IS MADE TO THE EXCLUSIVE RIGHT TO USE "DEVELOPMENT GROUP", APART FROM THE MARK AS SHOWN.

THE MARK CONSISTS OF THE WORDS SILVER SUMMIT DEVELOPMENT GROUP POSITIONED TO THE RIGHT OF AND BELOW THE OUTLINE OF A PARTIAL SECTIONAL VIEW OF A HOUSE ADJOINING A LARGER PARTIAL SECTIONAL VIEW OF ANOTHER HOUSE.

CLASS 36—INSURANCE AND FINANCIAL

FOR REAL ESTATE BROKERAGE (U.S. CLS. 100, 101 AND 102).

FIRST USE 7-21-2004; IN COMMERCE 7-30-2004.

CLASS 37—CONSTRUCTION AND REPAIR

FOR REAL ESTATE SERVICES, NAMELY, REAL ESTATE DEVELOPMENT; RESIDENTIAL AND COMMERCIAL BUILDING CONSTRUCTION; CONSTRUCTION MANAGEMENT, CONSTRUCTION CONSULTING (U.S. CLS. 100, 103 AND 106).

FIRST USE 10-11-2004; IN COMMERCE 11-17-2004.

ONE + SYSTEM

THE MARK CONSISTS OF STANDARD CHARACTERS WITHOUT CLAIM TO ANY PARTICULAR FONT, STYLE, SIZE, OR COLOR.

CLASS 7—MACHINERY

FOR POWER TOOLS, NAMELY, BAND SAWS, CIRCULAR SAWS, JIG SAWS, TILE SAWS, TRIM SAWS, RECIPROCATING SAWS, SPIRAL SAWS, POWER-OPERATED SAWS, ROUTERS, GRINDERS, BURRS, REAMERS, SANDERS, BUFFERS, POLISHERS, POWER OPERATED NAILING GUNS, DRILLS, HAMMER-DRILLS, DRILL PRESSES, IMPACT DRIVERS, POWER STAPLERS, POWER OPERATED SCREWDRIVERS, POWER CAULK GUNS, POWER OPERATED LAWN AND GARDEN STRING TRIMMERS, POWER OPERATED GRASS/WEED TRIMMERS, LAWN AND GARDEN EDGERS, POWER OPERATED CULTIVATORS, POWER OPERATED LAWN AND GARDEN TILLERS, POWER BLOWERS FOR LAWN DEBRIS, ELECTRIC CHAINSAWS, POWER OPERATED PRUNERS, POWER OPERATED SHEARS, POWER OPERATED SPRAYERS, VACUUM CLEANERS POWER TOOL ACCESSORIES, NAMELY, KITS CONSISTING PRIMARILY OF ONE OR MORE POWER TOOLS, NAMELY, DRILLS, IMPACT DRIVERS, CIRCULAR SAWS, RECIPROCATING SAWS, JIG SAWS, CHAIN SAWS, SANDERS, AND/OR HANDHELD VACUUM CLEANERS, SPECIALLY DESIGNED BATTERY PACKS AND BATTERY CHARGERS (U.S. CLS. 13, 19, 21, 23, 31, 34 AND 35).

FIRST USE 9-30-2004; IN COMMERCE 9-30-2004.

CLASS 9—ELECTRICAL AND SCIENTIFIC APPARATUS

FOR BATTERIES AND BATTERY CHARGERS (U.S. CLS. 21, 23, 26, 36 AND 38).

FIRST USE 9-30-2004; IN COMMERCE 9-30-2004.

3,298,799. SPORTSWEAVE, MORGANTOWN, WV. SN 78-460,116. PUB. 11-8-2005, FILED 8-1-2004.

3,298,805. KERKHOFF, DEAN, COVINA, CA. SN 78-462,595. PUB. 6-28-2005, FILED 8-5-2004.

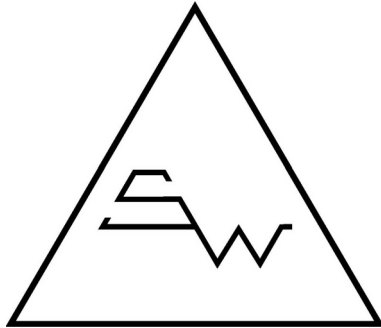

CLASS 38—COMMUNICATION

FOR BROADCASTING PROGRAMS FEATURING TEAM AND INDIVIDUAL ATHLETIC PERFORMANCES VIA A GLOBAL COMPUTER NETWORK (U.S. CLS. 100, 101 AND 104).
FIRST USE 5-1-2004; IN COMMERCE 8-1-2004.

CLASS 41—EDUCATION AND ENTERTAINMENT

FOR PROVIDING SPORTS AND RECREATIONAL ACTIVITIES INFORMATION VIA A GLOBAL COMPUTER NETWORK, NAMELY, PROVIDING ON-LINE SPORTS AND RECREATIONAL ACTIVITIES INFORMATION, SCORES, TEAM AND INDIVIDUAL STATISTICS, SCHEDULES AND NEWS (U.S. CLS. 100, 101 AND 107).
FIRST USE 5-1-2004; IN COMMERCE 8-1-2004.

3,298,800. SPORTSWEAVE, MORGANTOWN, WV. SN 78-460,117. PUB. 11-8-2005, FILED 8-1-2004.

SportsWeave

THE MARK CONSISTS OF STANDARD CHARACTERS WITHOUT CLAIM TO ANY PARTICULAR FONT, STYLE, SIZE, OR COLOR.

CLASS 38—COMMUNICATION

FOR BROADCASTING PROGRAMS FEATURING TEAM AND INDIVIDUAL ATHLETIC PERFORMANCES VIA A GLOBAL COMPUTER NETWORK (U.S. CLS. 100, 101 AND 104).
FIRST USE 5-1-2004; IN COMMERCE 8-1-2004.

CLASS 41—EDUCATION AND ENTERTAINMENT

FOR PROVIDING SPORTS AND RECREATIONAL ACTIVITIES INFORMATION VIA A GLOBAL COMPUTER NETWORK, NAMELY, PROVIDING ON-LINE SPORTS AND RECREATIONAL ACTIVITIES INFORMATION, SCORES, TEAM AND INDIVIDUAL STATISTICS, SCHEDULES AND NEWS (U.S. CLS. 100, 101 AND 107).
FIRST USE 5-1-2004; IN COMMERCE 8-1-2004.

CHIQUI THING

THE MARK CONSISTS OF STANDARD CHARACTERS WITHOUT CLAIM TO ANY PARTICULAR FONT, STYLE, SIZE, OR COLOR.
THE ENGLISH TRANSLATION OF THE WORD "CHIQUI" IN THE MARK IS "LITTLE".

CLASS 14—JEWELRY

FOR JEWELRY (U.S. CLS. 2, 27, 28 AND 50).
FIRST USE 3-12-2007; IN COMMERCE 3-12-2007.

CLASS 18—LEATHER GOODS

FOR PURSES AND HANDBAGS (U.S. CLS. 1, 2, 3, 22 AND 41).
FIRST USE 3-12-2007; IN COMMERCE 3-12-2007.

CLASS 25—CLOTHING

FOR APPAREL, NAMELY T-SHIRTS, SOCKS, HATS, SWEATSHIRTS, JACKETS, SHORTS, PANTS, SWEATERS, TOPS AND SWIMSUITS (U.S. CLS. 22 AND 39).
FIRST USE 3-12-2007; IN COMMERCE 3-12-2007.

3,298,814. LONGEVITY MEDICAL CLINIC, INC., KIRKLAND, WA. SN 78-472,297. PUB. 12-20-2005, FILED 8-24-2004.



Longevity
MEDICAL
CLINIC

NO CLAIM IS MADE TO THE EXCLUSIVE RIGHT TO USE "MEDICAL CLINIC", APART FROM THE MARK AS SHOWN.

THE COLOR(S) BLACK AND BRONZE IS/ARE CLAIMED AS A FEATURE OF THE MARK.

THE MARK CONSISTS IN PART OF A STYLIZED LEAF WITH THE LOWER HALF IN BRONZE, ON A BLACK BACKGROUND WITH A BRONZE BORDER. THE WORD LONGEVITY APPEARS IN BLACK BELOW, WITH THE WORDS MEDICAL CLINIC IN BRONZE BELOW THAT.

CLASS 5—PHARMACEUTICALS

FOR NUTRITIONAL SUPPLEMENTS AND HORMONES FOR USE IN ANTI-AGING MEDICAL THERAPY SERVICES (U.S. CLS. 6, 18, 44, 46, 51 AND 52).
FIRST USE 10-26-2004; IN COMMERCE 10-26-2004.

CLASS 44—MEDICAL, BEAUTY AND AGRICULTURAL SERVICES

FOR ANTI-AGING MEDICAL THERAPY SERVICES USING NATURAL SUPPLEMENTS AND HORMONE REPLACEMENT THERAPY (U.S. CLS. 100 AND 101).
FIRST USE 10-26-2004; IN COMMERCE 10-26-2004.

3,298,821. ASSOCIATION OF AMERICAN MEDICAL COLLEGES, WASHINGTON, DC. SN 78-476,462. PUB. 8-8-2006, FILED 8-31-2004.

**TOMORROW'S
DOCTORS,
TOMORROW'S CURES**

THE MARK CONSISTS OF STANDARD CHARACTERS WITHOUT CLAIM TO ANY PARTICULAR FONT, STYLE, SIZE, OR COLOR.

CLASS 16—PAPER GOODS AND PRINTED MATTER

FOR PUBLICATIONS, NAMELY, MONTHLY MAGAZINES ON THE SUBJECTS OF MEDICAL EDUCATION AND TRAINING, BIOMEDICAL RESEARCH AND HEALTH SERVICES; AND MAGAZINES, NEWSLETTERS, REPORTS, AND GUIDEBOOKS ON THE SUBJECTS OF CAREER PLANNING FOR MEDICAL STUDENTS (U.S. CLS. 2, 5, 22, 23, 29, 37, 38 AND 50).
FIRST USE 1-0-2005; IN COMMERCE 1-0-2005.

CLASS 35—ADVERTISING AND BUSINESS

FOR ASSOCIATION SERVICES, NAMELY, PROMOTING THE INTERESTS OF MEDICAL SCHOOLS AND TEACHING HOSPITALS AND PROMOTING MEDICAL EDUCATION, MEDICAL RESEARCH AND HEALTH CARE THROUGH THE IMPROVEMENT OF MEDICAL SCHOOLS AND TEACHING HOSPITALS; PROVIDING AN ONLINE COMPUTER DATABASE FOR USE IN EMPLOYMENT, HIRING, RECRUITING, PLACEMENT, AND CAREER NETWORKING BY MEDICAL PROFESSIONALS; COMPUTERIZED RESIDENCY APPLICATION SERVICES FOR MEDICAL SCHOOL GRADUATES APPLYING FOR RESIDENCY POSITIONS; DATA PROCESSING SERVICES FOR THE APPLICATION OF PROSPECTIVE MEDICAL STUDENTS FOR ADMISSION TO DESIGNATED MEDICAL SCHOOLS; PROVIDING CAREER INFORMATION TO MEDICAL STUDENTS VIA THE INTERNET (U.S. CLS. 100, 101 AND 102).
FIRST USE 4-0-2004; IN COMMERCE 4-0-2004.

CLASS 36—INSURANCE AND FINANCIAL

FOR FINANCIAL SERVICES, NAMELY, ARRANGING LOAN SERVICES FOR MEDICAL SCHOOL STUDENTS (U.S. CLS. 100, 101 AND 102).
FIRST USE 1-0-2005; IN COMMERCE 1-0-2005.

CLASS 41—EDUCATION AND ENTERTAINMENT

FOR PROVIDING ONLINE INFORMATION IN THE FIELD OF MEDICAL PROFESSIONAL EDUCATIONAL PROGRAMS AND MEDICAL EDUCATION; PREPARATION, ADMINISTRATION, AND ANALYSIS OF STANDARDIZED TESTS TO ASSESS MASTERY OF BASIC CONCEPTS IN BIOLOGY, CHEMISTRY, PHYSICS, FACILITY WITH PROBLEM SOLVING, CRITICAL THINKING AND WRITING SKILLS; CAREER COUNSELING SERVICES FEATURING CAREER PLANNING FOR MEDICAL STUDENTS (U.S. CLS. 100, 101 AND 107).
FIRST USE 4-0-2004; IN COMMERCE 4-0-2004.

CLASS 42—SCIENTIFIC, COMPUTER AND LEGAL SERVICES

FOR PROVIDING TEMPORARY USE OF ONLINE NONDOWNLOADABLE SOFTWARE FOR USE IN THE ADMINISTRATIVE MANAGEMENT OF DATA REGARDING CAREER PLANNING AND PREPARATION, MEDICAL EDUCATION, AND RELATED MEDICAL PROFESSIONAL ACTIVITIES (U.S. CLS. 100 AND 101).
FIRST USE 4-0-2004; IN COMMERCE 4-0-2004.

3,298,838. DEMAND ENTERTAINMENT, INC., SANTA MONICA, CA. SN 78-482,816. PUB. 12-27-2005, FILED 9-13-2004.

GRAB

THE MARK CONSISTS OF STANDARD CHARACTERS WITHOUT CLAIM TO ANY PARTICULAR FONT, STYLE, SIZE, OR COLOR.

CLASS 9—ELECTRICAL AND SCIENTIFIC APPARATUS

FOR DOWNLOADABLE COMPUTER GAME SOFTWARE FOR USE IN CONNECTING TO AND PROVIDING INDIVIDUALS ACCESS TO PLAY SINGLE PLAYER AND MULTIPLAYER ONLINE GAMES (U.S. CLS. 21, 23, 26, 36 AND 38).
FIRST USE 10-0-2004; IN COMMERCE 10-0-2004.

CLASS 41—EDUCATION AND ENTERTAINMENT

FOR ENTERTAINMENT SERVICES, NAMELY, PROVIDING NON-DOWNLOADABLE ONLINE COMPUTER GAMES AND PROVIDING INFORMATION TO END USERS CONCERNING ACCESSING AND PLAYING ONLINE COMPUTER GAMES VIA A GLOBAL COMPUTER NETWORK (U.S. CLS. 100, 101 AND 107).
FIRST USE 10-0-2004; IN COMMERCE 10-0-2004.

3,298,849. WOOTEN, CHARLES RANDOLPH, VENICE, CA.
SN 78-495,057. PUB. 1-10-2006, FILED 10-5-2004.

THE BLOODY LOVELIES

THE MARK CONSISTS OF STANDARD CHARACTERS WITHOUT CLAIM TO ANY PARTICULAR FONT, STYLE, SIZE, OR COLOR.

CLASS 9—ELECTRICAL AND SCIENTIFIC APPARATUS

FOR PRE-RECORDED CDS FEATURING MUSIC AND SOUND RECORDINGS (U.S. CLS. 21, 23, 26, 36 AND 38).
FIRST USE 9-1-1996; IN COMMERCE 10-6-2004.

CLASS 25—CLOTHING

FOR T-SHIRTS (U.S. CLS. 22 AND 39).
FIRST USE 9-1-1996; IN COMMERCE 10-6-2004.

CLASS 41—EDUCATION AND ENTERTAINMENT

FOR ENTERTAINMENT, NAMELY LIVE PERFORMANCES BY A POP-ROCK MUSICAL BAND (U.S. CLS. 100, 101 AND 107).
FIRST USE 9-1-1996; IN COMMERCE 10-6-2004.

3,298,851. HEALTH NEW ENGLAND, INC., SPRINGFIELD, MA. SN 78-498,302. PUB. 3-7-2006, FILED 10-12-2004.



Health New England How Can We Help?

OWNER OF U.S. REG. NOS. 1,426,061 AND 1,426,062.
NO CLAIM IS MADE TO THE EXCLUSIVE RIGHT TO USE "HEALTH", APART FROM THE MARK AS SHOWN.
SEC. 2(F) AS TO "NEW ENGLAND".

CLASS 36—INSURANCE AND FINANCIAL

FOR MEDICAL INSURANCE, NAMELY UNDERWRITING (U.S. CLS. 100, 101 AND 102).
FIRST USE 3-0-2005; IN COMMERCE 3-0-2005.

CLASS 44—MEDICAL, BEAUTY AND AGRICULTURAL SERVICES

FOR HEALTH MAINTENANCE SERVICES, NAMELY, OPERATING A HEALTH MAINTENANCE ORGANIZATION WHICH ADDRESSES HEALTH AND MEDICAL CARE FOR ITS MEMBERS THROUGH A NETWORK OF SELECTED HEALTH CARE PROVIDERS (U.S. CLS. 100 AND 101).

FIRST USE 3-0-2005; IN COMMERCE 3-0-2005.

3,298,852. UGURTEKS TEKSTIL ÜRÜNLERİ TİCARET VE SANAYİ ANONİM ŞİRKETİ, GÜNGÖREN, İSTANBUL, TURKEY. SN 78-498,997. PUB. 9-5-2006, FILED 10-13-2004.



PRIORITY CLAIMED UNDER SEC. 44(D) ON TURKEY APPLICATION NO. 2004/28856, FILED 9-9-2004.

NO CLAIM IS MADE TO THE EXCLUSIVE RIGHT TO USE "LINEN", APART FROM THE MARK AS SHOWN.

THE COLOR(S) BLACK, GRAY AND WHITE IS/ARE CLAIMED AS A FEATURE OF THE MARK.

THE MARK CONSISTS OF A BLACK BACKGROUND, A GRAY AND WHITE CHANDELIER, THE WORDS LINEN IS MY LUXURY IN WHITE AND THE WORDS RAISON D'ETERE IN A COLOR LIGHTER THAN BLACK.

THE ENGLISH TRANSLATION OF THE WORD RAISON D'ETERE IN THE MARK IS REASON TO BE.

CLASS 25—CLOTHING

FOR CLOTHING FOR MEN, WOMEN AND CHILDREN, NAMELY, PANTS, JEANS, JACKETS, SHIRTS, SHORTS, TOPS, COATS, SKIRTS, VESTS, DRESSES AND BLOUSES, SPORT CLOTHES NAMELY, SWEAT PANTS, SHORTS, SWEATSHIRTS, T-SHIRTS, TOPS, WOVEN PANTS, WOVEN SHIRTS, WOVEN JACKETS, KNIT TOPS, SWEATERS, COATS, SKIRTS, DENIM, DENIM PANTS, VESTS, KNIT, DRESSES, CARDIGANS AND BLOUSES MADE IN WHOLE OR IN SIGNIFICANT PART OF LINEN (U.S. CLS. 22 AND 39).
FIRST USE 11-0-2005; IN COMMERCE 1-0-2006.

CLASS 26—FANCY GOODS

FOR LACES FOR CLOTHING, EMBROIDERY FOR CLOTHING, FABRIC APPLIQUES FOR CLOTHING, RIBBONS FOR CLOTHING, BRAIDS FOR CLOTHING, CLOTH PATCHES, NAMELY, LETTERS AND NUMBERS FOR CLOTHING, ALL MADE IN WHOLE OR IN SIGNIFICANT PART OF LINEN (U.S. CLS. 37, 39, 40, 42 AND 50).

FIRST USE 11-0-2005; IN COMMERCE 1-0-2006.

3,298,855. BATES COMMUNICATIONS, INC., WELLESLEY, MA. SN 78-503,621. PUB. 2-28-2006, FILED 10-21-2004.

3,298,858. DIAGEO IRELAND, DUBLIN 8, IRELAND. SN 78-504,422. PUB. 1-24-2006, FILED 10-22-2004.

SPEAK LIKE A CEO

THE MARK CONSISTS OF STANDARD CHARACTERS WITHOUT CLAIM TO ANY PARTICULAR FONT, STYLE, SIZE, OR COLOR.

CLASS 16—PAPER GOODS AND PRINTED MATTER

FOR PRINTED PUBLICATIONS, NAMELY, BOOKS, WORKBOOKS, AND ARTICLES IN THE FIELD OF LEADERSHIP AND COMMUNICATIONS (U.S. CLS. 2, 5, 22, 23, 29, 37, 38 AND 50).
FIRST USE 4-1-2005; IN COMMERCE 4-1-2005.

CLASS 35—ADVERTISING AND BUSINESS

FOR BUSINESS MANAGEMENT CONSULTATION IN THE FIELD OF EXECUTIVE COACHING AND LEADERSHIP DEVELOPMENT (U.S. CLS. 100, 101 AND 102).
FIRST USE 6-1-2005; IN COMMERCE 6-1-2005.

3,298,856. CARNIVAL CORPORATION, MIAMI, FL. SN 78-503,875. PUB. 10-25-2005, FILED 10-21-2004.

CCL

THE MARK CONSISTS OF STANDARD CHARACTERS WITHOUT CLAIM TO ANY PARTICULAR FONT, STYLE, SIZE, OR COLOR.

CLASS 39—TRANSPORTATION AND STORAGE

FOR TRAVEL AGENCY SERVICES, NAMELY, MAKING RESERVATIONS AND BOOKINGS FOR TRANSPORTATION (U.S. CLS. 100 AND 105).
FIRST USE 6-30-2006; IN COMMERCE 6-30-2006.

CLASS 43—HOTEL AND RESTAURANT SERVICES

FOR TRAVEL AGENCY SERVICES, NAMELY, MAKING RESERVATIONS AND BOOKING FOR TEMPORARY LODGING (U.S. CLS. 100 AND 101).
FIRST USE 6-30-2006; IN COMMERCE 6-30-2006.

SURGER

THE MARK CONSISTS OF STANDARD CHARACTERS WITHOUT CLAIM TO ANY PARTICULAR FONT, STYLE, SIZE, OR COLOR.

CLASS 9—ELECTRICAL AND SCIENTIFIC APPARATUS

FOR PLATFORM SURFACE THAT EMITS ULTRASOUND WAVES THAT INDUCE FROTHING IN BEER (U.S. CLS. 21, 23, 26, 36 AND 38).
FIRST USE 2-27-2006; IN COMMERCE 10-31-2006.

CLASS 32—LIGHT BEVERAGES

FOR BEERS; STOUT (U.S. CLS. 45, 46 AND 48).
FIRST USE 2-27-2006; IN COMMERCE 10-31-2006.

3,298,862. SHAYNE, WILLIAM C., NEW YORK, NY. SN 78-506,532. PUB. 1-10-2006, FILED 10-27-2004.

EXIMIDO

THE MARK CONSISTS OF STANDARD CHARACTERS WITHOUT CLAIM TO ANY PARTICULAR FONT, STYLE, SIZE, OR COLOR.

CLASS 35—ADVERTISING AND BUSINESS

FOR BUSINESS CONSULTING SERVICES IN THE FIELDS OF IMPORTING, EXPORTING, SHIPPING AND PURCHASE AND SALE OF GOODS AND SERVICES; COMPUTERIZED ONLINE ORDERING SERVICE FEATURING EDUCATIONAL MATERIALS, NAMELY, VIDEO, AUDIO, SOFTWARE, PRINT AND ELECTRONIC PRODUCTS; PROVIDING ONLINE COMMERCIAL DIRECTORY SERVICES IN THE FIELD OF EDUCATIONAL MATERIALS, NAMELY, VIDEO, AUDIO, SOFTWARE, PRINT AND ELECTRONIC PRODUCTS; AND DISSEMINATION OF ADVERTISING FOR OTHERS VIA AN ONLINE ELECTRONIC COMMUNICATIONS NETWORK (U.S. CLS. 100, 101 AND 102).
FIRST USE 11-2-2006; IN COMMERCE 11-2-2006.

CLASS 42—SCIENTIFIC, COMPUTER AND LEGAL SERVICES

FOR REVIEW OF THE STANDARDS AND PRACTICES OF OTHERS TO ASSURE COMPLIANCE WITH BUSINESS AND INTERNATIONAL TRADE REGULATIONS AND LAWS; PROVIDING COMPUTER SEARCH ENGINES FOR OBTAINING DATA IN THE FIELD OF EDUCATIONAL MATERIALS, NAMELY, VIDEO, AUDIO, SOFTWARE, PRINT AND ELECTRONIC PRODUCTS (U.S. CLS. 100 AND 101).

FIRST USE 11-2-2006; IN COMMERCE 11-2-2006.

3,298,872. PROVADO TECHNOLOGIES, INC., GAINESVILLE, FL. SN 78-518,719. PUB. 1-31-2006, FILED 11-17-2004.

PROVADO
TECHNOLOGIES, INC.

3,298,866. CITY OF LOS ANGELES, LOS ANGELES, CA. SN 78-513,901. PUB. 7-4-2006, FILED 11-9-2004.

**LOS ANGELES
TRIATHLON**

THE MARK CONSISTS OF STANDARD CHARACTERS WITHOUT CLAIM TO ANY PARTICULAR FONT, STYLE, SIZE, OR COLOR.

OWNER OF U.S. REG. NOS. 2,850,496, 2,947,073, AND OTHERS.

NO CLAIM IS MADE TO THE EXCLUSIVE RIGHT TO USE "TRIATHLON", APART FROM THE MARK AS SHOWN.

SEC. 2(F).

CLASS 25—CLOTHING

FOR CLOTHING, NAMELY T-SHIRTS, SWEATSHIRTS, TANK TOPS, AND HATS (U.S. CLS. 22 AND 39).
FIRST USE 9-10-2000; IN COMMERCE 9-10-2000.

CLASS 41—EDUCATION AND ENTERTAINMENT

FOR ATHLETIC AND SPORTING EVENT SERVICES, NAMELY, ARRANGING, ORGANIZING, STAGING AND OPERATING TRIATHLON RACES (U.S. CLS. 100, 101 AND 107).

FIRST USE 9-10-2000; IN COMMERCE 9-10-2000.

NO CLAIM IS MADE TO THE EXCLUSIVE RIGHT TO USE "TECHNOLOGIES, INC.", APART FROM THE MARK AS SHOWN.

THE ENGLISH TRANSLATION OF THE WORDING "PROVADO" IS "PROVEN".

CLASS 35—ADVERTISING AND BUSINESS

FOR VALUE-ADDED RESELLER SERVICES, NAMELY, DISTRIBUTORSHIP SERVICES IN THE FIELD OF TELECOMMUNICATIONS HARDWARE AND SOFTWARE (U.S. CLS. 100, 101 AND 102).

FIRST USE 3-28-2005; IN COMMERCE 4-29-2005.

CLASS 37—CONSTRUCTION AND REPAIR

FOR CUSTOM INSTALLATION OF TELECOMMUNICATIONS AND COMPUTER NETWORK CABLING; MAINTENANCE AND REPAIR OF TELECOMMUNICATION SYSTEMS; MAINTENANCE OF VOICEMAIL SYSTEMS, NAMELY, MAKING MOVES, ADDS, AND CHANGES TO VOICEMAIL SYSTEMS (U.S. CLS. 100, 103 AND 106).

FIRST USE 3-28-2005; IN COMMERCE 4-29-2005.

CLASS 42—SCIENTIFIC, COMPUTER AND LEGAL SERVICES

FOR DESIGN AND IMPLEMENTATION OF TELECOMMUNICATION SYSTEMS, NAMELY, VOICE OVER IP SYSTEMS, CALL CENTER SYSTEMS, VOICE AND UNIFIED MESSAGING SYSTEMS, VIDEO CONFERENCING SYSTEMS, AUDIO AND MULTIMEDIA CONFERENCING SYSTEMS, AND CALL RECORDING SYSTEMS; CUSTOM DESIGN OF TELECOMMUNICATIONS AND COMPUTER NETWORK CABLING; COMPUTER CONSULTING SERVICES; COMPUTER SOFTWARE DEVELOPMENT AND COMPUTER SOFTWARE CONSULTATION; COMPUTER SOFTWARE DEVELOPMENT AND COMPUTER SOFTWARE CONSULTATION IN THE FIELDS OF BUSINESS MANAGEMENT, LOGISTICS, CALL-TAKING, RESERVATIONS PROCESSING, ROUTING, DISPATCHING, AND BILLING (U.S. CLS. 100 AND 101).

FIRST USE 3-28-2005; IN COMMERCE 4-29-2005.

3,298,877. ECARDIO DIAGNOSTICS, LLC, THE WOODLANDS, TX. SN 78-522,080. PUB. 3-6-2007, FILED 11-23-2004.

eCARDIO

THE MARK CONSISTS OF STANDARD CHARACTERS WITHOUT CLAIM TO ANY PARTICULAR FONT, STYLE, SIZE, OR COLOR.

CLASS 38—COMMUNICATION

FOR PROVISION OF ACCESS TO MEDICAL DATA AND DOCUMENTS STORED ELECTRONICALLY IN CENTRAL FILES FOR REMOTE CONSULTATION BY MEDICAL PROFESSIONALS; TRANSMISSION OF MEDICAL PATIENT CARDIAC INFORMATION (U.S. CLS. 100, 101 AND 104).

FIRST USE 1-1-2005; IN COMMERCE 1-1-2005.

CLASS 44—MEDICAL, BEAUTY AND AGRICULTURAL SERVICES

FOR MEDICAL SERVICES, NAMELY, PROVIDING CARDIAC ARRHYTHMIA MONITORING AND DIAGNOSTIC SERVICES FOR PATIENTS AND REPORTING RESULTS TO PHYSICIANS AND HOSPITALS, AND PROVIDING MEDICAL INFORMATION IN THE NATURE OF ELECTRONIC MEDICAL REPORTS (U.S. CLS. 100 AND 101).

FIRST USE 8-31-2004; IN COMMERCE 8-31-2004.

3,298,880. NATURE'S SUNSHINE PRODUCTS, INC., PROVO, UT. SN 78-522,995. PUB. 5-9-2006, FILED 11-24-2004.

MAXXYLITOL

THE MARK CONSISTS OF STANDARD CHARACTERS WITHOUT CLAIM TO ANY PARTICULAR FONT, STYLE, SIZE, OR COLOR.

CLASS 3—COSMETICS AND CLEANING PREPARATIONS

FOR PERSONAL CARE PRODUCTS, NAMELY, COSMETICS; ORAL HEALTH PRODUCTS, NAMELY, TOOTHPASTE, NON-MEDICATED MOUTH WASH AND MOUTH SPRAY, NON-MEDICATED TEETHING GEL FOR ADULTS AND CHILDREN (U.S. CLS. 1, 4, 6, 50, 51 AND 52).

FIRST USE 5-14-2005; IN COMMERCE 5-14-2005.

CLASS 5—PHARMACEUTICALS

FOR NASAL SPRAY PREPARATIONS; HOMEOPATHIC AND OTHER NONPRESCRIPTION REMEDIES, NAMELY, DECONGESTANT NASAL SPRAYS, NASAL SPRAY FOR USE IN THE TREATMENT OF FLU, AND ALLERGY RELIEF (U.S. CLS. 6, 18, 44, 46, 51 AND 52).

FIRST USE 5-14-2005; IN COMMERCE 5-14-2005.

3,298,882. MCCARNEY, KEVIN T., DBA POQUITO MAS, NORTH HOLLYWOOD, CA. SN 78-523,809. PUB. 11-29-2005, FILED 11-29-2004.

NATURE'S GRILL

THE MARK CONSISTS OF STANDARD CHARACTERS WITHOUT CLAIM TO ANY PARTICULAR FONT, STYLE, SIZE, OR COLOR.

OWNER OF U.S. REG. NO. 2,201,508.

NO CLAIM IS MADE TO THE EXCLUSIVE RIGHT TO USE "GRILL", APART FROM THE MARK AS SHOWN.

CLASS 16—PAPER GOODS AND PRINTED MATTER

FOR COOKBOOKS (U.S. CLS. 2, 5, 22, 23, 29, 37, 38 AND 50).

FIRST USE 6-1-2006; IN COMMERCE 6-1-2006.

CLASS 30—STAPLE FOODS

FOR BURRITOS CONSISTING PRIMARILY OF VEGETABLES, BEANS, MEATS, POULTRY OR SEAFOOD; QUESADILLAS CONSISTING PRIMARILY OF VEGETABLES, BEANS, MEATS, POULTRY OR SEAFOOD; AND TACOS CONSISTING PRIMARILY OF VEGETABLES, BEANS, MEATS, POULTRY OR SEAFOOD (U.S. CL. 46).

FIRST USE 6-15-2003; IN COMMERCE 6-15-2003.

3,298,883. MENDIVE, SUSIE, NEW YORK, NY. SN 78-525,165. PUB. 7-18-2006, FILED 12-1-2004.



CLASS 16—PAPER GOODS AND PRINTED MATTER

FOR PAPER GOODS AND ACCESSORIES FOR HOME LIVING, ENTERTAINMENT, SLEEPING, BATHING, WORKING, PLAYING AND FASHION, NAMELY, FOLDERS AND HANGING FILE BOXES, NESTING OR STORAGE BOXES, NOTEBOOKS, MAGAZINE FILES, TRAYS OF PAPER, COASTERS AND BOXES, ALL MADE OF PAPER (U.S. CLS. 2, 5, 22, 23, 29, 37, 38 AND 50).

FIRST USE 10-1-2005; IN COMMERCE 12-31-2005.

CLASS 27—FLOOR COVERINGS

FOR NON-TEXTILE WALL HANGINGS, NAMELY, WALLPAPER (U.S. CLS. 19, 20, 37, 42 AND 50).

FIRST USE 10-1-2005; IN COMMERCE 12-31-2005.

3,298,886. BOLTUN CORPORATION, TAINAN HSIEN, TAIWAN. SN 78-526,430. PUB. 1-17-2006, FILED 12-3-2004.



OWNER OF U.S. REG. NO. 2,743,105.

CLASS 7—MACHINERY

FOR METAL PROCESS PRESSES, NAMELY, METAL EXTRUSION PRESSES; THREADING MACHINES, FORGING MACHINES, SCREW CAP EXTRUSION MOLDING MACHINES, TUNGSTEN STEEL PUNCHING PRESSES FOR METAL WORKING, ROLL THREADING MACHINES, MULTI-PURPOSE METAL PROCESSING MACHINES, NAMELY, METAL BROACHING AND BOARING MACHINES; INJECTION MOLDING MACHINES FOR SCREWS, SWAGING MACHINES FOR BENDING OF METAL; ENGINE BEARINGS FOR VEHICLES (U.S. CLS. 13, 19, 21, 23, 31, 34 AND 35).

FIRST USE 11-1-2006; IN COMMERCE 11-1-2006.

CLASS 12—VEHICLES

FOR CARS, MOTORCYCLES, ELECTRIC VEHICLES, NAMELY, ELECTRIC CARS AND ELECTRIC LOCOMOTIVES; STEEL WHEEL RIMS FOR VEHICLES, AXLE BEARINGS FOR LAND, AIR AND WATER VEHICLES, CLUTCHES FOR LAND, AIR AND WATER VEHICLES, CLUTCH COVERS FOR LAND, AIR AND WATER VEHICLES, CLUTCH DISKS FOR LAND, AIR AND WATER VEHICLES, ALUMINUM WHEEL RIMS FOR VEHICLES (U.S. CLS. 19, 21, 23, 31, 35 AND 44).

FIRST USE 11-1-2006; IN COMMERCE 11-1-2006.

3,298,890. DONALD J. TRUMP, NEW YORK, NY. SN 78-530,787. PUB. 7-4-2006, FILED 12-10-2004.



NO CLAIM IS MADE TO THE EXCLUSIVE RIGHT TO USE "TOWER TAMPA" AND "SIGNATURE PROPERTY", APART FROM THE MARK AS SHOWN.

THE NAME "DONALD J. TRUMP" IDENTIFIES A LIVING INDIVIDUAL WHOSE CONSENT IS OF RECORD.

CLASS 36—INSURANCE AND FINANCIAL

FOR REAL ESTATE SERVICES, NAMELY, LISTING, LEASING, AND MANAGING RESIDENTIAL PROPERTY INCLUDING CONDOMINIUMS (U.S. CLS. 100, 101 AND 102).

FIRST USE 12-0-2004; IN COMMERCE 12-0-2004.

CLASS 37—CONSTRUCTION AND REPAIR

FOR REAL ESTATE DEVELOPMENT OF RESIDENTIAL PROPERTY INCLUDING CONDOMINIUMS (U.S. CLS. 100, 103 AND 106).

FIRST USE 12-0-2004; IN COMMERCE 12-0-2004.

3,298,898. ABLE PLANET, INCORPORATED, WHEAT RIDGE, CO. SN 78-537,289. PUB. 6-27-2006, FILED 12-22-2004.

IT IS POSSIBLE.

THE MARK CONSISTS OF STANDARD CHARACTERS WITHOUT CLAIM TO ANY PARTICULAR FONT, STYLE, SIZE, OR COLOR.

CLASS 9—ELECTRICAL AND SCIENTIFIC APPARATUS

FOR TECHNOLOGICAL DEVICES FOR IMPROVING ACOUSTIC CLARITY AND AUDIO TRANSMISSION AND RECEPTION FOR ASSISTING PERSONS WITH SENSORY OR COGNITIVE IMPAIRMENTS, NAMELY, ADAPTED STEREO HEADPHONES, ADAPTED TELEPHONES, ADAPTED HANDS-FREE CORDLESS TELEPHONE UNITS, AND ADAPTED COMPUTER-TELEPHONE HEADSET UNITS; ELECTRONIC DEVICES FOR ASSISTING PERSONS WITH SENSORY OR COGNITIVE IMPAIRMENTS, NAMELY, STEREO AUDIO AMPLIFICATION UNITS, AND RADIO AUDIO AMPLIFICATION UNITS; ELECTRONIC UNITS FOR MINIMIZING OR ELIMINATING ELECTROMAGNETIC AUDIO INTERFERENCES; VOICE OVER INTERNET PROTOCOL TELEPHONES, EMERGENCY TELEPHONES, AND PAY PHONES, ALL ADAPTED FOR ASSISTING PERSONS WITH SENSORY OR COGNITIVE IMPAIRMENTS (U.S. CLS. 21, 23, 26, 36 AND 38).

FIRST USE 0-0-2004; IN COMMERCE 0-0-2004.

CLASS 10—MEDICAL APPARATUS

FOR TECHNOLOGICAL DEVICES FOR ASSISTING PERSONS WITH SENSORY OR COGNITIVE IMPAIRMENTS, NAMELY, HEARING AIDS, HEARING IMPLANT SYSTEMS COMPOSED OF ARTIFICIAL MATERIALS (U.S. CLS. 26, 39 AND 44).

FIRST USE 3-15-2007; IN COMMERCE 3-15-2007.

3,298,901. LANG, SIEGFRIED A., 66117 SAARBRUECKEN, FED REP GERMANY. SN 78-540,035. PUB. 1-17-2006, FILED 12-30-2004.

FERTAN

THE MARK CONSISTS OF STANDARD CHARACTERS WITHOUT CLAIM TO ANY PARTICULAR FONT, STYLE, SIZE, OR COLOR.

CLASS 2—PAINTS

FOR RUST PREVENTING PREPARATIONS IN THE NATURE OF COATINGS; METAL PROTECTING PREPARATIONS, NAMELY, RUST PRESERVATIVES IN THE NATURE OF COATINGS (U.S. CLS. 6, 11 AND 16).

FIRST USE 1-2-1980; IN COMMERCE 6-24-2003.

CLASS 3—COSMETICS AND CLEANING PREPARATIONS

FOR RUST REMOVING PREPARATIONS (U.S. CLS. 1, 4, 6, 50, 51 AND 52).

FIRST USE 1-2-1980; IN COMMERCE 6-24-2003.

3,298,911. VA INVEST, MOSCOW, RUSSIAN FED.. SN 78-548,898. PUB. 6-6-2006, FILED 1-18-2005.

VITRINA

THE MARK CONSISTS OF STANDARD CHARACTERS WITHOUT CLAIM TO ANY PARTICULAR FONT, STYLE, SIZE, OR COLOR.

THE NON-LATIN CHARACTER(S) IN THE MARK TRANSLITERATES INTO VITRINA, AND THIS MEANS GLASS WINDOW IN ENGLISH.

CLASS 16—PAPER GOODS AND PRINTED MATTER

FOR ADHESIVE BANDS FOR STATIONERY OR HOUSEHOLD PURPOSES, ADVERTISEMENT BOARDS OF PAPER OR CARDBOARD, ANNOUNCEMENT CARDS, ARCHITECTS' MODELS, BAGS OF PAPER OR PLASTICS FOR PACKAGING; BOOKS AND BOOKLETS IN THE FIELD OF ADVERTISING; BOOKMARKERS, BOTTLE WRAPPERS OF CARDBOARD OR PAPER, BOXES OF CARDBOARD OR PAPER, CALENDARS, CARDBOARD; CATALOGS IN THE FIELD OF ADVERTISING; CLIPBOARDS, COMIC BOOKS, CONICAL PAPER BAGS, BOOK COVERS, DECALCOMANIAS, DRAWING PADS, ENGRAVINGS, ENVELOPES, ETCHINGS, FLAGS OF PAPER, FOLDERS FOR PAPERS, PRINTED FORMS, FOUNTAIN PENS, GRAPHIC PRINTS, GRAPHIC PRINT REPRESENTATIONS, GRAPHIC ART REPRODUCTIONS, GREETING CARDS, GUMMED CLOTH FOR BOOKBINDING, GUMMED TAPE FOR STATIONERY; HANDBOOKS AND MANUALS IN THE FIELD OF ADVERTISING; PAPER LABELS NOT OF TEXTILE, LEDGER BOOKS, LITHOGRAPHIC WORKS OF ART, LOOSE-LEAF BINDERS, MUSICAL GREETING CARDS, NEWSPAPERS, NOTE BOOKS; OFFICE REQUISITES EXCEPT FURNITURE, NAMELY, STAPLERS, PENS, FILES, LOOSE-LEAF BINDERS, FOLDERS, DOCUMENT CASES, PAPER CASES; PACKING PAPER, WRITING PADS; PAMPHLETS IN THE FIELD OF ADVERTISING; PAPER BOWS, PAPER RIBBONS, PENCILS; PERIODICALS IN THE FIELD OF ADVERTISING; PHOTO-ENGRAVINGS, PHOTOGRAPH STANDS, PHOTOGRAPHS, PICTURES, PLACARDS OF PAPER OR CARDBOARD, PLASTIC CLING FILM NOT FOR COMMERCIAL OR INDUSTRIAL PURPOSES, PLASTIC FILM FOR FOOD WRAPPING FOR HOUSEHOLD USE, POSTCARDS, POSTERS; PRINTED MATTER, NAMELY, PRINTED LABELS, PRINTED CALENDARS; PRINTED PUBLICATIONS, NAMELY, BOOKS, BOOKLETS, BROCHURES, MAGAZINES IN THE FIELD OF ADVERTISING; PRINTED TIMETABLES, ENGRAVINGS, PROSPECTUSES, SEALS, SHEETS OF RECLAIMED CELLULOSE FOR WRAPPING NOT FOR COMMERCIAL OR INDUSTRIAL USE, SIGNBOARDS OF PAPER OR CARDBOARD, STANDS FOR PENS AND PENCILS, STATIONERY, STENCILS, STICKERS; TRANSPARENCIES, WRAPPING PAPER, WRITING OR DRAWING BOOKS, WRITING PAPER (U.S. CLS. 2, 5, 22, 23, 29, 37, 38 AND 50).

FIRST USE 5-27-2006; IN COMMERCE 5-27-2006.

CLASS 35—ADVERTISING AND BUSINESS

FOR ADVERTISING AND MARKETING, ADVERTISING AGENCIES, DIRECT MAIL ADVERTISING, CONDUCTING MARKETING STUDIES, BILLING, BUSINESS APPRAISALS, BUSINESS INFORMATION IN THE FIELD OF ADVERTISING, BUSINESS INVESTIGATIONS, BUSINESS MANAGEMENT ASSISTANCE, BUSINESS MANAGEMENT CONSULTANCY, BUSINESS MANAGEMENT OF PERFORMING ARTISTS, BUSINESS ORGANIZATION CONSULTANCY, COMMERCIAL INFORMATION AGENCIES, COMMERCIAL AND INDUSTRIAL MANAGEMENT ASSISTANCE, DISSEMINATION OF ADVERTISING MATTER, DISTRIBUTION OF SAMPLES, ECONOMIC FORECASTING, MARKET RESEARCH, MODELING FOR ADVERTISING OR SALES PROMOTION, ON-LINE ADVERTISING ON A COMPUTER NETWORK, ORGANIZATION OF EXHIBITS FOR COMMERCIAL OR ADVERTISING PURPOSES, NAMELY, WHOLESALE OR RETAIL TRADERS, ORGANIZATION OF TRADE FAIRS FOR COMMERCIAL OR ADVERTISING PURPOSES, NAMELY, WHOLESALE OR RETAIL TRADERS, PROFESSIONAL BUSINESS CONSULTANCY, PUBLICATION OF PUBLICITY TEXTS, PUBLICITY MATERIAL RENTAL, ADVERTISING SERVICES OF A RADIO ADVERTISING AGENCY, RENTAL OF ADVERTISING SPACE, AGENCIES FOR ADVERTISING TIME, SALES PROMOTION, SHOP WINDOW DRESSING ARRANGEMENT SERVICES, TELEVISION ADVERTISING FOR OTHERS, UPDATING OF ADVERTISING TEXT, WORD PROCESSING (U.S. CLS. 100, 101 AND 102).

FIRST USE 5-27-2006; IN COMMERCE 5-27-2006.

CLASS 36—INSURANCE AND FINANCIAL

FOR CAPITAL INVESTMENT CONSULTATION (U.S. CLS. 100, 101 AND 102).

FIRST USE 5-27-2006; IN COMMERCE 5-27-2006.

CLASS 41—EDUCATION AND ENTERTAINMENT

FOR EDUCATIONAL SERVICES, NAMELY, ARRANGING AND CONDUCTING CONFERENCES, SEMINARS, AND WORKSHOPS IN THE FIELD OF ADVERTISING; NIGHT CLUB SERVICES, CORRESPONDENCE SCHOOLS, INFORMATION ON EDUCATION; EDUCATIONAL SERVICES, NAMELY, PROVIDING SEMINARS, COURSES, CONFERENCES IN THE FIELD OF ADVERTISING; PARTY PLANNING, PHOTOGRAPHIC REPORTING; PRACTICAL TRAINING IN THE FIELD OF RELAXATION, RECREATION ACTIVITY; PROVIDING FACILITIES FOR RECREATIONAL ACTIVITIES; PROVIDING ON-LINE PUBLICATIONS, NAMELY, ELECTRONIC BROCHURES IN THE FIELD OF ADVERTISING VIA A GLOBAL COMPUTER NETWORK; PUBLICATION OF BOOKS, PUBLICATION OF ELECTRONIC BOOKS AND JOURNALS VIA A GLOBAL COMPUTER NETWORK, PUBLICATION OF TEXTS, PROVIDING RECREATIONAL INFORMATION IN THE FIELD OF LEISURE; SCRIPTWRITING SERVICES, VIDEO TAPE EDITING, VOCATIONAL GUIDANCE (U.S. CLS. 100, 101 AND 107).

FIRST USE 5-27-2006; IN COMMERCE 5-27-2006.

CLASS 42—SCIENTIFIC, COMPUTER AND LEGAL SERVICES

FOR ARCHITECTURAL CONSULTATION, DRESS DESIGNING, DESIGN OF INTERIOR DÉCOR, GRAPHIC ARTS DESIGNING, INDUSTRIAL DESIGN, LITIGATION CONSULTANCY SERVICES, PACKAGING DESIGN FOR OTHERS, SURVEYING (U.S. CLS. 100 AND 101).

FIRST USE 5-27-2006; IN COMMERCE 5-27-2006.

3,298,940. GOOD HURT, LLC, LOS ANGELES, CA. SN 78-566,072. PUB. 3-7-2006, FILED 2-11-2005.

PRESCRIPTION COCKTAILS

THE MARK CONSISTS OF STANDARD CHARACTERS WITHOUT CLAIM TO ANY PARTICULAR FONT, STYLE, SIZE, OR COLOR.

NO CLAIM IS MADE TO THE EXCLUSIVE RIGHT TO USE "COCKTAILS", APART FROM THE MARK AS SHOWN.

CLASS 41—EDUCATION AND ENTERTAINMENT

FOR ENTERTAINMENT, NAMELY, NIGHTCLUBS FEATURING MUSIC AND DANCING (U.S. CLS. 100, 101 AND 107).

FIRST USE 1-10-2004; IN COMMERCE 1-10-2004.

CLASS 43—HOTEL AND RESTAURANT SERVICES

FOR PROVIDING FOOD AND DRINK IN A NIGHT-CLUB AND BAR (U.S. CLS. 100 AND 101).

FIRST USE 1-10-2004; IN COMMERCE 1-10-2004.

3,298,941. SAINT-GOBAIN PERFORMANCE PLASTICS CORPORATION, AURORA, OH. SN 78-566,837. PUB. 6-20-2006, FILED 2-14-2005.

BDF

THE MARK CONSISTS OF STANDARD CHARACTERS WITHOUT CLAIM TO ANY PARTICULAR FONT, STYLE, SIZE, OR COLOR.

CLASS 9—ELECTRICAL AND SCIENTIFIC APPARATUS

FOR SILICONE AND PLASTIC TUBING FOR USE IN LABORATORY MARKETS (U.S. CLS. 21, 23, 26, 36 AND 38).

FIRST USE 3-22-2005; IN COMMERCE 3-22-2005.

CLASS 10—MEDICAL APPARATUS

FOR FLEXIBLE TUBING FOR MEDICAL AND PHARMACEUTICAL APPLICATIONS, NAMELY, SILICONE TUBING AND PLASTIC TUBING FOR USE IN FLUID TRANSFER IN THE PHARMACEUTICAL AND MEDICAL MARKETS (U.S. CLS. 26, 39 AND 44).

FIRST USE 3-22-2005; IN COMMERCE 3-22-2005.

3,298,952. RAGHORN, INC., KNOX, IN. SN 78-569,871. PUB. 6-27-2006, FILED 2-17-2005.

3,298,966. HISPANIC YELLOW PAGES OF AMERICA, INC., CHICAGO, IL. SN 78-574,510. PUB. 2-13-2007, FILED 2-24-2005.

RAGHORN'S INDIANA OUTDOOR NEWS

THE MARK CONSISTS OF STANDARD CHARACTERS WITHOUT CLAIM TO ANY PARTICULAR FONT, STYLE, SIZE, OR COLOR.

OWNER OF U.S. REG. NO. 1,987,300.

NO CLAIM IS MADE TO THE EXCLUSIVE RIGHT TO USE "INDIANA OUTDOOR NEWS", APART FROM THE MARK AS SHOWN.

CLASS 16—PAPER GOODS AND PRINTED MATTER

FOR MAGAZINE DEVOTED TO OUTDOOR INTERESTS WITHIN THE STATE OF INDIANA (U.S. CLS. 2, 5, 22, 23, 29, 37, 38 AND 50).

FIRST USE 4-30-2004; IN COMMERCE 4-30-2004.

CLASS 41—EDUCATION AND ENTERTAINMENT

FOR PROVIDING AN ON-LINE MAGAZINE AND INFORMATION IN THE FIELD OF OUTDOOR NEWS (U.S. CLS. 100, 101 AND 107).

FIRST USE 4-30-2004; IN COMMERCE 4-30-2004.

3,298,962. INTERMOLECULAR, INC., SANTA CLARA, CA. SN 78-573,252. PUB. 8-1-2006, FILED 2-23-2005.

INTERMOLECULAR

THE MARK CONSISTS OF STANDARD CHARACTERS WITHOUT CLAIM TO ANY PARTICULAR FONT, STYLE, SIZE, OR COLOR.

CLASS 7—MACHINERY

FOR SEMICONDUCTOR MANUFACTURING MACHINES, NAMELY, COMBINATION CLEANING AND PROCESSING UNITS USED IN THE PROCESSING OF MATERIALS FOR THE MANUFACTURE OF SEMICONDUCTORS (U.S. CLS. 13, 19, 21, 23, 31, 34 AND 35).

FIRST USE 3-13-2006; IN COMMERCE 3-13-2006.

CLASS 11—ENVIRONMENTAL CONTROL APPARATUS

FOR SEMICONDUCTOR PROCESSING FURNACES FOR PROCESSING SEMICONDUCTOR ARTICLES, SUCH AS SEMICONDUCTOR WAFERS, SUBSTRATES, DISKS AND PANELS; APPARATUS FOR RINSING AND DRYING WAFERS (U.S. CLS. 13, 21, 23, 31 AND 34).

FIRST USE 3-13-2006; IN COMMERCE 3-13-2006.



NO CLAIM IS MADE TO THE EXCLUSIVE RIGHT TO USE "INFO", APART FROM THE MARK AS SHOWN.

THE NAME(S), PORTRAIT(S), AND/OR SIGNATURE(S) SHOWN IN THE MARK DOES NOT IDENTIFY A PARTICULAR LIVING INDIVIDUAL.

THE ENGLISH TRANSLATION OF THE SPANISH WORD "DON" IN THE MARK IS "SIR OR MR".

CLASS 41—EDUCATION AND ENTERTAINMENT

FOR TELEPHONE INFORMATION LINE PROVIDING INFORMATION IN THE FIELD OF CURRENT EVENTS, ENTERTAINMENT AND SPORTS NEWS (U.S. CLS. 100, 101 AND 107).

FIRST USE 7-31-2004; IN COMMERCE 7-31-2004.

CLASS 42—SCIENTIFIC, COMPUTER AND LEGAL SERVICES

FOR TELEPHONE INFORMATION LINE PROVIDING INFORMATION IN THE FIELD OF WEATHER AND LEGAL NEWS (U.S. CLS. 100 AND 101).

FIRST USE 7-31-2004; IN COMMERCE 7-31-2004.

3,298,974. COMPASS BANCSHARES, INC., BIRMINGHAM, AL. SN 78-578,231. PUB. 12-20-2005, FILED 3-2-2005.

COMPASS IDENTITY SAFE

THE MARK CONSISTS OF STANDARD CHARACTERS WITHOUT CLAIM TO ANY PARTICULAR FONT, STYLE, SIZE, OR COLOR.

OWNER OF U.S. REG. NOS. 1,604,027, 1,894,328, AND OTHERS.

NO CLAIM IS MADE TO THE EXCLUSIVE RIGHT TO USE "IDENTITY", APART FROM THE MARK AS SHOWN.

CLASS 36—INSURANCE AND FINANCIAL

FOR INSURANCE AND FINANCIAL AND BANKING SERVICES, NAMELY, PROVIDING IDENTITY THEFT EXPENSE REIMBURSEMENT INSURANCE AGENCY SERVICES; CREDIT CONSULTATION, NAMELY, PROVIDING ASSISTANCE IN RESTORING AND ANALYZING CREDIT AND OBTAINING REIMBURSEMENT OF COSTS ASSOCIATED WITH IDENTITY THEFT; PROVIDING FINANCIAL INFORMATION REPORTING TO CREDIT BUREAUS; PROVIDING FINANCIAL REGISTRY SERVICES, NAMELY, ONLINE CREDIT, DEBIT AND CHARGE CARD REGISTRY THAT PROTECTS CUSTOMERS FROM UNAUTHORIZED CHARGE AND NOTIFIES CARD ISSUERS ABOUT CHANGES NEEDED TO CONSUMERS' ACCOUNTS; AND, PROVIDING CUSTOMERS WITH EMERGENCY FUNDS (U.S. CLS. 100, 101 AND 102).

FIRST USE 10-0-2005; IN COMMERCE 10-0-2005.

CLASS 45—PERSONAL SERVICES

FOR PROVIDING IDENTITY THEFT INFORMATION TO CREDIT BUREAUS (U.S. CLS. 100 AND 101).
FIRST USE 10-0-2005; IN COMMERCE 10-0-2005.

3,298,978. D'FIRO DESIGN INC., LAFAYETTE, CA. SN 78-580,991. PUB. 7-4-2006, FILED 3-4-2005.

ELEGANT DESIGN FOR
HEALTHY OUTDOOR
LIVING

THE MARK CONSISTS OF STANDARD CHARACTERS WITHOUT CLAIM TO ANY PARTICULAR FONT, STYLE, SIZE, OR COLOR.

CLASS 18—LEATHER GOODS

FOR PATIO UMBRELLAS (U.S. CLS. 1, 2, 3, 22 AND 41).
FIRST USE 5-1-2004; IN COMMERCE 5-1-2004.

CLASS 20—FURNITURE AND ARTICLES NOT OTHERWISE CLASSIFIED

FOR PATIO FURNITURE AND OUTDOOR FURNITURE (U.S. CLS. 2, 13, 22, 25, 32 AND 50).
FIRST USE 5-1-2004; IN COMMERCE 5-1-2004.

3,298,980. D'FIRO DESIGN, INC., LAFAYETTE, CA. SN 78-580,996. PUB. 7-4-2006, FILED 3-5-2005.



THE COLOR(S) ORANGE, GRAY AND BLACK IS/ARE CLAIMED AS A FEATURE OF THE MARK.
THE COLOR BLACK APPEARS IN THE LETTERING.
THE COLOR ORANGE APPEARS IN THE CIRCLE DESIGN

AND THE COLOR GRAY APPEARS IN THE OUTLINE OF THE LETTERING.

CLASS 18—LEATHER GOODS

FOR PATIO UMBRELLAS (U.S. CLS. 1, 2, 3, 22 AND 41).
FIRST USE 5-1-2004; IN COMMERCE 5-1-2004.

CLASS 20—FURNITURE AND ARTICLES NOT OTHERWISE CLASSIFIED

FOR PATIO FURNITURE, OUTDOOR FURNITURE (U.S. CLS. 2, 13, 22, 25, 32 AND 50).
FIRST USE 5-1-2004; IN COMMERCE 5-1-2004.

3,298,981. WATERWORKS, INC., DANBURY, CT. SN 78-582,532. PUB. 7-11-2006, FILED 3-8-2005.

WATERWORKS

THE MARK CONSISTS OF STANDARD CHARACTERS WITHOUT CLAIM TO ANY PARTICULAR FONT, STYLE, SIZE, OR COLOR.

CLASS 24—FABRICS

FOR HOME FURNISHING FABRICS, NAMELY, WOVEN FABRICS; PRINTED FABRIC FOR HOME DECORATING (U.S. CLS. 42 AND 50).
FIRST USE 8-1-2006; IN COMMERCE 8-1-2006.

CLASS 26—FANCY GOODS

FOR LACE TRIMMINGS, CANVAS TRIMMINGS (U.S. CLS. 37, 39, 40, 42 AND 50).
FIRST USE 8-1-2006; IN COMMERCE 8-1-2006.

3,298,982. GOTV NETWORKS, INC., SHERMAN OAKS, CA. SN 78-583,177. PUB. 7-18-2006, FILED 3-8-2005.



THE MARK CONSISTS OF STANDARD CHARACTERS WITHOUT CLAIM TO ANY PARTICULAR FONT, STYLE, SIZE, OR COLOR.

CLASS 38—COMMUNICATION

FOR TELEVISION BROADCASTING VIA A WIRELESS NETWORK; INTERACTIVE TELEVISION BROADCASTING VIA A WIRELESS NETWORK; PROVIDING TRANSMISSION OF NEWS VIA A WIRELESS NETWORK; PROVIDING ENTERTAINMENT VIA A WIRELESS NETWORK, NAMELY, ELECTRONIC TRANSMISSION OF ENTERTAINMENT MEDIA CONTENT; TELEVISION BROADCASTING AND TRANSMISSION BETWEEN WIRELESS DEVICES AND COMPUTER NETWORKS VIA A WIRELESS NETWORK (U.S. CLS. 100, 101 AND 104).

FIRST USE 4-1-2005; IN COMMERCE 4-1-2005.

CLASS 41—EDUCATION AND ENTERTAINMENT

FOR PRODUCTION OF TELEVISION PROGRAMS TO BE DISTRIBUTED VIA A WIRELESS NETWORK; PRODUCTION OF INTERACTIVE TELEVISION PROGRAMS TO BE DISTRIBUTED VIA A WIRELESS NETWORK; ENTERTAINMENT SERVICES, NAMELY, PROVIDING TELEVISION PROGRAMS IN THE FIELDS OF ENTERTAINMENT, GENERAL NEWS, CURRENT EVENTS, SPORTS, WEATHER, REVIEWS, SHOPPING AND HOROSCOPES VIA A WIRELESS NETWORK; ENTERTAINMENT IN THE NATURE OF TELEVISION NEWS SHOWS VIA A WIRELESS NETWORK; ENTERTAINMENT SERVICES, NAMELY, PROVIDING TELEVISION PROGRAMS IN THE FIELD OF NEWS IN THE NATURE OF CURRENT EVENT REPORTING VIA A WIRELESS NETWORK; ENTERTAINMENT IN THE NATURE OF TELEVISION NEWS SHOWS VIA A WIRELESS NETWORK; ENTERTAINMENT SERVICES, NAMELY, PROVIDING TELEVISION PROGRAMS IN THE FIELD OF ENTERTAINMENT INFORMATION VIA A WIRELESS NETWORK; PROVIDING INFORMATION IN THE FIELDS OF TELEVISION ENTERTAINMENT PROGRAMMING AND THE TELEVISION ENTERTAINMENT INDUSTRY VIA A WIRELESS NETWORK (U.S. CLS. 100, 101 AND 107).

FIRST USE 4-1-2005; IN COMMERCE 4-1-2005.

3,298,983. SPORTS ON DEMAND LLC, BETHPAGE, NY. SN 78-583,622. PUB. 7-4-2006, FILED 3-9-2005.

YOU GOT GAME. ON DEMAND.

THE MARK CONSISTS OF STANDARD CHARACTERS WITHOUT CLAIM TO ANY PARTICULAR FONT, STYLE, SIZE, OR COLOR.

NO CLAIM IS MADE TO THE EXCLUSIVE RIGHT TO USE "ON DEMAND", APART FROM THE MARK AS SHOWN.

CLASS 38—COMMUNICATION

FOR VIDEO ON DEMAND TRANSMISSION SERVICES; CABLE TELEVISION BROADCASTING SERVICES (U.S. CLS. 100, 101 AND 104).

FIRST USE 4-30-2005; IN COMMERCE 4-30-2005.

CLASS 41—EDUCATION AND ENTERTAINMENT

FOR ENTERTAINMENT SERVICES, NAMELY, AN ON-GOING VIDEO ON DEMAND TELEVISION PROGRAM IN THE FIELD OF SPORTS EDUCATION AND COACHING; CABLE TELEVISION PROGRAMMING SERVICES; SPORTS CAMP (U.S. CLS. 100, 101 AND 107).

FIRST USE 4-30-2005; IN COMMERCE 4-30-2005.

3,298,986. C. L. SWANSON CORPORATION, MADISON, WI. SN 78-585,814. PUB. 12-27-2005, FILED 3-11-2005.

BETTER-4-YOU

THE MARK CONSISTS OF STANDARD CHARACTERS WITHOUT CLAIM TO ANY PARTICULAR FONT, STYLE, SIZE, OR COLOR.

CLASS 35—ADVERTISING AND BUSINESS

FOR VENDING MACHINE SERVICES (U.S. CLS. 100, 101 AND 102).

FIRST USE 11-8-2004; IN COMMERCE 11-8-2004.

CLASS 43—HOTEL AND RESTAURANT SERVICES

FOR CATERING AND CONTRACT FOOD SERVICES (U.S. CLS. 100 AND 101).

FIRST USE 11-8-2004; IN COMMERCE 11-8-2004.

3,298,989. ALASKA STRUCTURES, INC., ANCHORAGE, AK. SN 78-588,690. PUB. 5-16-2006, FILED 3-16-2005.

BLU-MED

THE MARK CONSISTS OF STANDARD CHARACTERS WITHOUT CLAIM TO ANY PARTICULAR FONT, STYLE, SIZE, OR COLOR.

CLASS 35—ADVERTISING AND BUSINESS

FOR TRANSPORTATION LOGISTIC SERVICES, NAMELY, ARRANGING THE TRANSPORTATION OF GOODS FOR OTHERS IN THE NATURE OF ARRANGING SHIPPING AND TRANSPORTING OF SUPPLIES, EQUIPMENT, AND OTHER GOODS IN RESPONSE TO DISASTERS AND EMERGENCIES (U.S. CLS. 100, 101 AND 102).

FIRST USE 4-30-2005; IN COMMERCE 4-30-2005.

CLASS 42—SCIENTIFIC, COMPUTER AND LEGAL SERVICES

FOR TECHNICAL CONSULTING SERVICES REGARDING THE DESIGN AND IMPLEMENTATION OF MOBILE MEDICAL, HOSPITAL, AND SURGICAL TREATMENT FACILITIES FOR USE IN EMERGENCY AND DISASTER RESPONSE (U.S. CLS. 100 AND 101).

FIRST USE 4-30-2005; IN COMMERCE 4-30-2005.

3,298,994. HARRELL, VALERIE J., SYLMAR, CA. SN 78-589,696. PUB. 6-27-2006, FILED 3-17-2005.

3,298,993. BVG RESORT HOMES, INC., TAMPA, FL. SN 78-589,506. PUB. 7-11-2006, FILED 3-17-2005.

**DICK HARRELL
PERFORMANCE
CENTER**

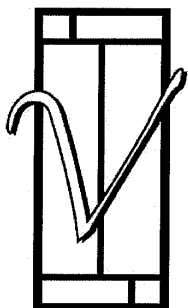

THE MARK CONSISTS OF A STYLIZED LETTER "V" IN FRONT OF A VERTICALLY POSITIONED RECTANGLE.

CLASS 36—INSURANCE AND FINANCIAL

FOR BROKERAGE AND MANAGEMENT OF VACATION PROPERTIES; FINANCIAL INVESTMENT IN THE FIELD OF REAL ESTATE; REAL ESTATE EQUITY SHARING, NAMELY, MANAGING AND ARRANGING FOR OWNERSHIP AND TRANSIENT USE OF REAL ESTATE BY MULTIPLE INVESTORS; REAL ESTATE MANAGEMENT IN THE FIELD OF RENTAL PROPERTIES; REAL ESTATE SERVICES, NAMELY, MEMBERSHIP VACATION CLUB SERVICES IN THE NATURE OF FORMATION AND OPERATION OF EQUITY INTERESTS IN VACATION PROPERTIES (U.S. CLS. 100, 101 AND 102).

FIRST USE 7-23-2005; IN COMMERCE 7-23-2005.

CLASS 43—HOTEL AND RESTAURANT SERVICES

FOR RESORT LODGING SERVICES (U.S. CLS. 100 AND 101).

FIRST USE 7-23-2003; IN COMMERCE 7-23-2003.

CLASS 45—PERSONAL SERVICES

FOR CONCIERGE SERVICES FOR OTHERS COMPRISED OF MAKING REQUESTED PERSONAL ARRANGEMENTS AND RESERVATIONS AND PROVIDING CUSTOMER-SPECIFIC INFORMATION TO MEET INDIVIDUAL NEEDS RENDERED TOGETHER IN A TEMPORARY LIVING RESIDENTIAL ENVIRONMENT (U.S. CLS. 100 AND 101).

FIRST USE 7-23-2005; IN COMMERCE 7-23-2005.

THE MARK CONSISTS OF STANDARD CHARACTERS WITHOUT CLAIM TO ANY PARTICULAR FONT, STYLE, SIZE, OR COLOR.

OWNER OF U.S. REG. NOS. 2,777,803 AND 2,785,805.

NO CLAIM IS MADE TO THE EXCLUSIVE RIGHT TO USE "PERFORMANCE CENTER", APART FROM THE MARK AS SHOWN.

THE MARK DOES NOT IDENTIFY A LIVING INDIVIDUAL

CLASS 6—METAL GOODS

FOR METAL COMMEMORATIVE EMBLEMS, METAL COMMEMORATIVE LICENSE PLATES, AND METAL KEY CHAINS (U.S. CLS. 2, 12, 13, 14, 23, 25 AND 50).

FIRST USE 5-12-2004; IN COMMERCE 5-12-2004.

CLASS 16—PAPER GOODS AND PRINTED MATTER

FOR POSTERS, DECALS, STICKERS AND PHOTOGRAPHS (U.S. CLS. 2, 5, 22, 23, 29, 37, 38 AND 50).

FIRST USE 1-1-1965; IN COMMERCE 1-1-1965.

CLASS 25—CLOTHING

FOR CLOTHING, NAMELY SHIRTS, HATS, AND JACKETS (U.S. CLS. 22 AND 39).

FIRST USE 7-2-2004; IN COMMERCE 7-2-2004.

CLASS 37—CONSTRUCTION AND REPAIR

FOR REPAIR AND MAINTENANCE OF RACING AUTOMOBILES (U.S. CLS. 100, 103 AND 106).

FIRST USE 12-31-1969; IN COMMERCE 12-31-1969.

CLASS 41—EDUCATION AND ENTERTAINMENT

FOR ENTERTAINMENT SERVICES, NAMELY, ARRANGING AND CONDUCTING AUTOMOBILE RACES, AND RELATED EXHIBITIONS AND DISPLAYS (U.S. CLS. 100, 101 AND 107).

FIRST USE 12-31-1969; IN COMMERCE 10-21-2005.

3,299,003. LSN, INC., ATLANTA, GA. SN 78-592,065. PUB. 11-14-2006, FILED 3-22-2005.

3,299,006. OLIVIA W. DESIGNS LLC, NEW YORK, NY. SN 78-592,552. PUB. 7-4-2006, FILED 3-22-2005.

KEEMEE

ON THE GO

THE MARK CONSISTS OF STANDARD CHARACTERS WITHOUT CLAIM TO ANY PARTICULAR FONT, STYLE, SIZE, OR COLOR.

CLASS 14—JEWELRY

FOR JEWELRY (U.S. CLS. 2, 27, 28 AND 50).
FIRST USE 10-22-2005; IN COMMERCE 3-1-2006.

CLASS 35—ADVERTISING AND BUSINESS

FOR WHOLESALE, RETAIL STORE AND ON-LINE RETAIL STORE SERVICES FEATURING JEWELRY AND FASHION ACCESSORIES (U.S. CLS. 100, 101 AND 102).

FIRST USE 10-22-2005; IN COMMERCE 3-1-2006.

THE MARK CONSISTS OF STANDARD CHARACTERS WITHOUT CLAIM TO ANY PARTICULAR FONT, STYLE, SIZE, OR COLOR.

CLASS 35—ADVERTISING AND BUSINESS

FOR PROVIDING INFORMATION IN THE NATURE OF ADVERTISER SUPPORTED CONTESTS AND SWEEPSTAKES TO WIRELESS DEVICES (U.S. CLS. 100, 101 AND 102).

FIRST USE 4-1-2005; IN COMMERCE 4-1-2005.

CLASS 39—TRANSPORTATION AND STORAGE

FOR PROVIDING INFORMATION IN THE NATURE OF TRAFFIC REPORTING TO WIRELESS DEVICES (U.S. CLS. 100 AND 105).

FIRST USE 4-1-2005; IN COMMERCE 4-1-2005.

CLASS 41—EDUCATION AND ENTERTAINMENT

FOR PROVIDING INFORMATION IN THE NATURE OF CURRENT EVENT TYPE NEWS AND SPORTS NEWS TO WIRELESS DEVICES (U.S. CLS. 100, 101 AND 107).

FIRST USE 4-1-2005; IN COMMERCE 4-1-2005.

CLASS 42—SCIENTIFIC, COMPUTER AND LEGAL SERVICES

FOR PROVIDING INFORMATION IN THE NATURE OF WEATHER FORECASTING TO WIRELESS DEVICES (U.S. CLS. 100 AND 101).

FIRST USE 4-1-2005; IN COMMERCE 4-1-2005.

3,299,009. RBC MINISTRIES, GRAND RAPIDS, MI. SN 78-593,482. PUB. 7-11-2006, FILED 3-23-2005.



OWNER OF U.S. REG. NOS. 1,647,241, 2,634,847, AND OTHERS.

NO CLAIM IS MADE TO THE EXCLUSIVE RIGHT TO USE "MINISTRIES", APART FROM THE MARK AS SHOWN.

THE STIPPLING IS FOR SHADING PURPOSES ONLY.

CLASS 9—ELECTRICAL AND SCIENTIFIC APPARATUS

FOR AUDIO AND VISUAL RECORDINGS, NAMELY, VIDEO AND AUDIO RECORDINGS FEATURING RELIGIOUS MUSIC, LECTURES, HISTORIES AND DISCUSSIONS ON RELIGIOUS SUBJECTS, AND VIDEO AND AUDIO RECORDINGS FOR BIBLE STUDY, RELIGIOUS EDUCATION AND INSTRUCTION (U.S. CLS. 21, 23, 26, 36 AND 38).

FIRST USE 7-1-2005; IN COMMERCE 7-1-2005.

CLASS 16—PAPER GOODS AND PRINTED MATTER

FOR PRINTED PUBLICATIONS, NAMELY, DEVOTIONAL GUIDES, RELIGIOUS INSPIRATIONAL BOOKS AND BOOKLETS, RELIGIOUS PAMPHLETS, RELIGIOUS SHEET MUSIC AND MUSIC BOOKS, PERIODICALS RELATING TO RELIGIOUS SUBJECTS, SPORTS AND RELIGIOUS MAGAZINES (U.S. CLS. 2, 5, 22, 23, 29, 37, 38 AND 50).

FIRST USE 7-1-2005; IN COMMERCE 7-1-2005.

CLASS 41—EDUCATION AND ENTERTAINMENT

FOR EDUCATIONAL AND ENTERTAINMENT SERVICES, NAMELY, RELIGIOUS RADIO AND TELEVISION PROGRAMS, RADIO PROGRAMS FEATURING PHONE IN, INTERVIEWS, AND SPORTS NEWS, PERFORMANCES OF RELIGIOUS MUSIC BY SINGING GROUPS, CONDUCTING SEMINARS IN THE FIELD OF RELIGION AND THEOLOGY, PROVIDING INFORMATION IN THE FIELD OF RELIGIOUS EDUCATION VIA A GLOBAL COMPUTER NETWORK AND PUBLISHING BOOKS, BOOKLETS, PRINTED MUSIC, AND RELATED AUDIO AND VIDEO RECORDINGS OF OTHERS (U.S. CLS. 100, 101 AND 107).

FIRST USE 7-1-2005; IN COMMERCE 7-1-2005.

3,299,016. NIPPON POLYURETHANE INDUSTRY CO., LTD., TOKYO, JAPAN. SN 78-595,056. PUB. 1-24-2006, FILED 3-25-2005.

QRYSTHANE

THE MARK CONSISTS OF STANDARD CHARACTERS WITHOUT CLAIM TO ANY PARTICULAR FONT, STYLE, SIZE, OR COLOR.

CLASS 1—CHEMICALS

FOR UNPROCESSED PLASTICS; UNPROCESSED SYNTHETIC RESINS AS RAW MATERIALS IN THE FORM OF POWDERS, LIQUIDS, OR PASTES; AND UNPROCESSED POLYURETHANE RESINS (U.S. CLS. 1, 5, 6, 10, 26 AND 46).

FIRST USE 9-28-2006; IN COMMERCE 9-28-2006.

CLASS 17—RUBBER GOODS

FOR SEMI-PROCESSED PLASTIC, SYNTHETIC RESINS, AND POLYURETHANE RESINS IN THE FORM OF BARS, BLOCKS, PELLETS, RODS, SHEETS, AND TUBES FOR USE IN MANUFACTURING (U.S. CLS. 1, 5, 12, 13, 35 AND 50).

FIRST USE 9-28-2006; IN COMMERCE 9-28-2006.

3,299,019. SPARTON CORPORATION, JACKSON, MI. SN 78-595,637. PUB. 7-4-2006, FILED 3-25-2005.

SPARTON MEDICAL SYSTEMS

THE MARK CONSISTS OF STANDARD CHARACTERS WITHOUT CLAIM TO ANY PARTICULAR FONT, STYLE, SIZE, OR COLOR.

OWNER OF U.S. REG. NOS. 1,355,220 AND 1,358,965.

NO CLAIM IS MADE TO THE EXCLUSIVE RIGHT TO USE "MEDICAL SYSTEMS", APART FROM THE MARK AS SHOWN.

CLASS 40—MATERIAL TREATMENT

FOR CUSTOM MANUFACTURING OF ELECTRONIC MEDICAL DEVICES FOR OTHERS; CONTRACT MANUFACTURING OF ELECTRONIC MEDICAL DEVICES FOR OTHERS; PROTOTYPE MANUFACTURING OF ELECTRONIC MEDICAL DEVICES FOR OTHERS; AND CONSULTATION PROVIDED WITH ANY OF THE AFORESAID SERVICES (U.S. CLS. 100, 103 AND 106).

FIRST USE 3-0-2005; IN COMMERCE 3-0-2005.

CLASS 42—SCIENTIFIC, COMPUTER AND LEGAL SERVICES

FOR PRODUCT RESEARCH AND DEVELOPMENT; PROTOTYPE RESEARCH AND DEVELOPMENT; DESIGN, TESTING, ANALYSIS, AND EVALUATION OF NEW PRODUCTS AND THEIR DEVELOPMENT; ENGINEERING; ENGINEERING ANALYSIS, MODELING, AND SIMULATIONS; TESTING, ANALYSIS, AND EVALUATION OF PRODUCTS FOR THE PURPOSE OF CERTIFICATION; TESTING, ANALYSIS, AND EVALUATION OF PRODUCTS FOR THE PURPOSE OF GOVERNMENTAL AGENCY APPROVAL; SOFTWARE DESIGN AND DEVELOPMENT, BUT EXCLUDING SOFTWARE DESIGN AND SUPPORT SERVICES RELATED TO INTEGRATED CIRCUITS; AND CONSULTATION PROVIDED FOR ANY OF THE AFORESAID SERVICES (U.S. CLS. 100 AND 101).

FIRST USE 3-0-2005; IN COMMERCE 3-0-2005.

3,299,020. SPARTON CORPORATION, JACKSON, MI. SN 78-595,638. PUB. 7-4-2006, FILED 3-25-2005.



OWNER OF U.S. REG. NOS. 1,355,220 AND 1,358,965.

NO CLAIM IS MADE TO THE EXCLUSIVE RIGHT TO USE "MEDICAL SYSTEMS", APART FROM THE MARK AS SHOWN.

THE MARK CONSISTS OF A DOUBLE HELIX AND THE WORDS "SPARTON MEDICAL SYSTEMS".

CLASS 40—MATERIAL TREATMENT

FOR CUSTOM MANUFACTURING OF ELECTRONIC MEDICAL DEVICES FOR OTHERS; CONTRACT MANUFACTURING OF ELECTRONIC MEDICAL DEVICES FOR OTHERS; PROTOTYPE MANUFACTURING OF ELECTRONIC MEDICAL DEVICES FOR OTHERS; AND CONSULTATION PROVIDED WITH ANY OF THE AFORESAID SERVICES (U.S. CLS. 100, 103 AND 106).
FIRST USE 3-0-2005; IN COMMERCE 3-0-2005.

CLASS 42—SCIENTIFIC, COMPUTER AND LEGAL SERVICES

FOR PRODUCT RESEARCH AND DEVELOPMENT; PROTOTYPE RESEARCH AND DEVELOPMENT; DESIGN, TESTING; ANALYSIS, AND EVALUATION OF NEW PRODUCTS AND THEIR DEVELOPMENT; ENGINEERING; ENGINEERING ANALYSIS, MODELING, AND SIMULATIONS; TESTING, ANALYSIS, AND EVALUATION OF PRODUCTS FOR THE PURPOSE OF CERTIFICATION; TESTING, ANALYSIS, AND EVALUATION OF PRODUCTS FOR THE PURPOSE OF GOVERNMENTAL AGENCY APPROVAL; SOFTWARE DESIGN AND DEVELOPMENT, BUT EXCLUDING SOFTWARE DESIGN AND SUPPORT SERVICES RELATED TO INTEGRATED CIRCUITS; AND CONSULTATION PROVIDED FOR ANY OF THE AFORESAID SERVICES (U.S. CLS. 100 AND 101).
FIRST USE 3-0-2005; IN COMMERCE 3-0-2005.

3,299,026. PATTERSON WHITTAKER ARCHITECTURAL PROFILES, LLC, SEATTLE, WA. SN 78-597,085. PUB. 7-4-2006, FILED 3-29-2005.

**PATTERSON
WHITTAKER**

THE MARK CONSISTS OF STANDARD CHARACTERS WITHOUT CLAIM TO ANY PARTICULAR FONT, STYLE, SIZE, OR COLOR.

CLASS 19—NON-METALLIC BUILDING MATERIALS

FOR NON-METAL BUILDING MATERIALS, NAMELY, PLASTIC PROFILES, ARCHITECTURAL ARCHES, KEYSTONES MADE OF STONE, ARTIFICIAL STONE AND RECONSTITUTED STONE, DOOR CASINGS NOT OF METAL, DOOR FRAMES NOT OF METAL, DOOR JAMBS NOT OF METAL, DOOR PANELS NOT OF METAL, NON-METAL DOOR UNITS, NON-METAL WINDOW CASEMENTS, NON-METAL WINDOW FRAMES, NON-METAL WINDOW SILLS, NON-METAL WINDOWS, NON-METAL CHIMNEY CAPS, PRE-FABRICATED NONMETAL ARCHITECTURAL COLUMNS, PILASTERS, NON-METAL CORNICES, CORBELS, CROWNS, DECORATIVE COVES, NON-METAL MANTELS FOR FIREPLACES, QUOINS, PARAPETS, NON-METAL RAILINGS FOR STAIRWAYS, WAINSCOT CAPS AND CHAIR RAILS, WALL CAPS, AND WALL PANELS, NON-METAL BUILDING MATERIAL, NAMELY FASCIA (U.S. CLS. 1, 12, 33 AND 50).
FIRST USE 2-0-2003; IN COMMERCE 2-0-2003.

CLASS 20—FURNITURE AND ARTICLES NOT OTHERWISE CLASSIFIED

FOR PICTURE AND MIRROR FRAMES NOT OF PRECIOUS METAL (U.S. CLS. 2, 13, 22, 25, 32 AND 50).
FIRST USE 2-0-2003; IN COMMERCE 2-0-2003.

3,299,028. ZDOCS, INC., SALT LAKE CITY, UT. SN 78-597,754. PUB. 7-4-2006, FILED 3-29-2005.

ZDOCS

THE MARK CONSISTS OF STANDARD CHARACTERS WITHOUT CLAIM TO ANY PARTICULAR FONT, STYLE, SIZE, OR COLOR.

CLASS 35—ADVERTISING AND BUSINESS

FOR COPYING OF DOCUMENTS, NAMELY, BOOKS, POSTERS, BROCHURES, AND OTHER DOCUMENTS (U.S. CLS. 100, 101 AND 102).
FIRST USE 7-20-2005; IN COMMERCE 7-20-2005.

CLASS 40—MATERIAL TREATMENT

FOR PRINTING OF BOOKS, POSTERS, BROCHURES, AND OTHER DOCUMENTS (U.S. CLS. 100, 103 AND 106).
FIRST USE 7-20-2005; IN COMMERCE 7-20-2005.

3,299,033. SCHOOL LOOP, INC., BURLINGAME, CA. SN 78-599,721. PUB. 7-4-2006, FILED 3-31-2005.

**ARE YOU IN THE
LOOP?**

THE MARK CONSISTS OF STANDARD CHARACTERS WITHOUT CLAIM TO ANY PARTICULAR FONT, STYLE, SIZE, OR COLOR.

CLASS 38—COMMUNICATION

FOR PROVIDING ONLINE CHAT ROOMS AND ELECTRONIC BULLETIN BOARDS FOR TRANSMISSION OF MESSAGES AMONG PARENTS, TEACHERS, SCHOOL OFFICIALS AND STUDENTS (U.S. CLS. 100, 101 AND 104).
FIRST USE 9-30-2004; IN COMMERCE 9-30-2004.

CLASS 41—EDUCATION AND ENTERTAINMENT

FOR PROVIDING NEWSLETTER UPDATES TO PARENTS AND STUDENTS ABOUT HOMEWORK ASSIGNMENTS VIA ELECTRONIC MAIL; PROVIDING A WEB SITE FEATURING INFORMATION ABOUT HOMEWORK ASSIGNMENTS AND OTHER SCHOOL AND CLASSROOM INFORMATION FOR PARENTS AND STUDENTS (U.S. CLS. 100, 101 AND 107).

FIRST USE 9-30-2004; IN COMMERCE 9-30-2004.

3,299,040. REASON PICTURES LLC, WEST HOLLYWOOD, CA. SN 78-600,474. PUB. 7-25-2006, FILED 4-1-2005.

CLASS 42—SCIENTIFIC, COMPUTER AND LEGAL SERVICES

FOR WEB SITE HOSTING SERVICES FOR OTHERS; APPLICATION SERVICE PROVIDER (ASP), NAMELY, HOSTING COMPUTER SOFTWARE APPLICATIONS FOR USE BY OTHERS (U.S. CLS. 100 AND 101).

FIRST USE 9-30-2004; IN COMMERCE 9-30-2004.



CLASS 36—INSURANCE AND FINANCIAL

FOR MOTION PICTURE AND TELEVISION PROGRAM FINANCING SERVICES (U.S. CLS. 100, 101 AND 102).

FIRST USE 5-7-2004; IN COMMERCE 5-7-2004.

3,299,035. CUNNINGHAM LINDSEY U.S., INC., SCHAMBURG, IL. SN 78-600,300. PUB. 8-8-2006, FILED 4-1-2005.

CLASS 41—EDUCATION AND ENTERTAINMENT

FOR ENTERTAINMENT SERVICES, NAMELY, MOTION PICTURE PRODUCTION AND DISTRIBUTION, AND PRODUCTION OF TELEVISION PROGRAMS (U.S. CLS. 100, 101 AND 107).

FIRST USE 5-7-2007; IN COMMERCE 5-7-2007.

3,299,044. GTES, LLC, BLAINE, WA. SN 78-601,242. PUB. 7-25-2006, FILED 4-4-2005.

ESRS

SHERLOC

THE MARK CONSISTS OF STANDARD CHARACTERS WITHOUT CLAIM TO ANY PARTICULAR FONT, STYLE, SIZE, OR COLOR.

CLASS 35—ADVERTISING AND BUSINESS

FOR FISHERIES MANAGEMENT (U.S. CLS. 100, 101 AND 102).

FIRST USE 1-1-2002; IN COMMERCE 1-1-2002.

THE MARK CONSISTS OF STANDARD CHARACTERS WITHOUT CLAIM TO ANY PARTICULAR FONT, STYLE, SIZE, OR COLOR.

CLASS 40—MATERIAL TREATMENT

FOR MOLD REMEDIATION, PETROLEUM SPILL REMEDIATION AND CHEMICAL REMEDIATION (U.S. CLS. 100, 103 AND 106).

FIRST USE 1-1-2002; IN COMMERCE 1-1-2002.

CLASS 9—ELECTRICAL AND SCIENTIFIC APPARATUS

FOR COMMUNICATIONS HARDWARE AND APPLICATION SOFTWARE FOR LOCATING ASSETS, PEOPLE, AND ANIMALS (U.S. CLS. 21, 23, 26, 36 AND 38).

FIRST USE 12-31-2005; IN COMMERCE 12-31-2005.

CLASS 42—SCIENTIFIC, COMPUTER AND LEGAL SERVICES

FOR ENGINEERING SERVICES RELATED TO COMMUNICATIONS HARDWARE AND APPLICATION SOFTWARE FOR LOCATING ASSETS, PEOPLE, AND ANIMALS (U.S. CLS. 100 AND 101).

FIRST USE 12-31-2005; IN COMMERCE 12-31-2005.

3,299,054. MCNEILL DESIGNS LLC, WILMINGTON, DE. SN 78-604,752. PUB. 7-4-2006, FILED 4-8-2005.

YOU'VE BEEN SENTENCED!

THE MARK CONSISTS OF STANDARD CHARACTERS WITHOUT CLAIM TO ANY PARTICULAR FONT, STYLE, SIZE, OR COLOR.

CLASS 28—TOYS AND SPORTING GOODS

FOR EQUIPMENT AND MATERIALS SOLD AS A UNIT FOR PLAYING BOARD GAMES AND CARD GAMES; HAND HELD UNITS FOR PLAYING ELECTRONIC GAMES; QUESTION SETS FOR BOARD GAMES (U.S. CLS. 22, 23, 38 AND 50).

FIRST USE 5-5-2005; IN COMMERCE 5-5-2005.

CLASS 41—EDUCATION AND ENTERTAINMENT

FOR ENTERTAINMENT SERVICES, NAMELY, PROVIDING AN INTERACTIVE ON-LINE COMPUTER GAME (U.S. CLS. 100, 101 AND 107).

FIRST USE 3-19-2007; IN COMMERCE 3-19-2007.

3,299,060. URBAN HELPERS, LLC, ARLINGTON, VA. SN 78-606,264. PUB. 8-8-2006, FILED 4-11-2005.



NO CLAIM IS MADE TO THE EXCLUSIVE RIGHT TO USE "HELPER", APART FROM THE MARK AS SHOWN.

THE COLORS BLACK, RED AND WHITE CLAIMED AS A FEATURE OF THE MARK.

THE COLOR RED APPEARS IN THE WORDS URBAN,

HELPERS AND TIME, AND THE HAT AND DOG APPEAR IN THE COLOR RED. THE COLOR BLACK APPEARS IN THE WORDS WORKING HARD TO GIVE YOU AND THE ELLIPSIS, THE CLOCK, THE PAIL, THE BROOM, THE STAR, THE TOOL BELT, AND THE STICK FIGURE. THE COLOR WHITE APPEARS IN THE FACE OF THE CLOCK, THE TOOL BELT, THE HAMMER, PAINT BRUSH AND PICK THAT ARE PART OF THE TOOL BELT, THE BELT BUCKLE AND IN THE BACKGROUND OF THE MARK.

CLASS 35—ADVERTISING AND BUSINESS

FOR APPOINTMENT SCHEDULING SERVICES, NAMELY, SCHEDULING APPOINTMENTS FOR HOME CLEANING, LAWN MAINTENANCE, SNOW AND LEAF REMOVAL, CAR MAINTENANCE AND WASHING, AND GENERAL HOME MAINTENANCE AND REPAIR (U.S. CLS. 100, 101 AND 102).

FIRST USE 1-1-2005; IN COMMERCE 1-1-2005.

CLASS 36—INSURANCE AND FINANCIAL

FOR PROVIDING CUSTOMER SPECIFIC INFORMATION IN THE FIELD OF REAL ESTATE (U.S. CLS. 100, 101 AND 102).

FIRST USE 1-1-2005; IN COMMERCE 1-1-2005.

CLASS 44—MEDICAL, BEAUTY AND AGRICULTURAL SERVICES

FOR PET WALKING SERVICES (U.S. CLS. 100 AND 101).

FIRST USE 1-1-2005; IN COMMERCE 1-1-2005.

CLASS 45—PERSONAL SERVICES

FOR ORGANIZATIONAL SERVICES FOR HOME OR PERSONAL PURPOSES, NAMELY, ORGANIZING PERSONAL SCHEDULES, ORGANIZING RESIDENTIAL LIVING SPACES, CLOSETS, KITCHENS, BATHROOMS, LIVING ROOMS, BEDROOMS, GARAGES, STORAGE ROOMS, ATTICS, BASEMENTS, SITTING ROOMS, FOYERS, PATIOS, WINDOW SPACES, AND OFFICES; RUNNING ERRANDS FOR OTHERS, NAMELY, PERSONAL LAUNDRY AND MAIL DROP OFF AND PICK UP; HOUSE SITTING; PERSONAL SHOPPING FOR OTHERS, NAMELY, BUYING GROCERIES AND GIFTS (U.S. CLS. 100 AND 101).

FIRST USE 1-1-2005; IN COMMERCE 1-1-2005.

3,299,071. MALEK, MARTIN, BROOKLYN, NY. SN 78-609,405. PUB. 7-11-2006, FILED 4-15-2005.



THE COLOR GRAY IS INTENDED TO INDICATE SHADING OR CONTRAST ONLY.

THE MARK CONSISTS OF THE FIGURE OF A PERSON WHO IS WALKING.

CLASS 18—LEATHER GOODS

FOR HANDBAGS, ALL-PURPOSE SPORTS BAGS, BRIEFCASES, SUITCASES, KNAPSACKS, WAISTPACKS, BACKPACKS, POCKET BOOKS, PURSES, ATTACHE CASES, WALLETS, SHOE BAGS FOR TRAVEL (U.S. CLS. 1, 2, 3, 22 AND 41).

FIRST USE 3-6-2007; IN COMMERCE 3-6-2007.

CLASS 25—CLOTHING

FOR CLOTHING, NAMELY SHIRTS, PANTS, SHORTS, JACKETS, WARM-UP SUITS, JOGGING SUITS, SOCKS, SWIMWEAR, SKIRTS, SWEATERS, UNDERWEAR, HEADWEAR, CAPS, VISORS, HATS, HEADBANDS, SWEATBANDS, SLEEPWEAR, SCARVES, TIES, GLOVES AND WRISTBANDS; FOOTWEAR, SHOES AND SNEAKERS (U.S. CLS. 22 AND 39).

FIRST USE 3-6-2007; IN COMMERCE 3-6-2007.

CLASS 28—TOYS AND SPORTING GOODS

FOR EXERCISING MACHINES, NAMELY, WEIGHT LIFTING MACHINES, STATIONARY EXERCISE BICYCLES, ELLIPTICAL MACHINES, STAIR-STEPPING MACHINES AND TREADMILLS; TOYS AND PLAYTHINGS, NAMELY, ACTION FIGURES, PLUSH TOYS, AND TOY VEHICLES; GAMES, NAMELY, BOARD GAMES; DOLLS; SKATEBOARDS; ICE SKATES; ROLLER SKATES; IN-LINE SKATES; PLAYGROUND BALLS; SOCCER EQUIPMENT, NAMELY, SOCCER BALLS; BASEBALL EQUIPMENT, NAMELY, BASEBALL BATS, BASEBALLS, BASEBALL MITTS AND BASEBALL GLOVES; BASKETBALL EQUIPMENT, NAMELY, BASKETBALLS AND BACKBOARD FOR BASKETBALL; HOCKEY EQUIPMENT, NAMELY, FIELD HOCKEY BALLS, HOCKEY STICKS, HOCKEY GLOVES AND HOCKEY PUCKS; AND FOOTBALL EQUIPMENT, NAMELY, FOOTBALLS (U.S. CLS. 22, 23, 38 AND 50).

FIRST USE 3-6-2007; IN COMMERCE 3-6-2007.

3,299,096. ASSOCIATED PRODUCT TECHNOLOGIES, INC., KENILWORTH, NJ. SN 78-620,964. PUB. 7-18-2006, FILED 5-2-2005.

SMOOTHX

THE MARK CONSISTS OF STANDARD CHARACTERS WITHOUT CLAIM TO ANY PARTICULAR FONT, STYLE, SIZE, OR COLOR.

CLASS 3—COSMETICS AND CLEANING PREPARATIONS

FOR COLLOIDAL OATMEAL NON-MEDICATED BATH TREATMENTS; SKIN SOAPS; COSMETIC CREAMS FOR SKIN CARE; NON-MEDICATED SKIN CARE PREPARATIONS; NON-MEDICATED SKIN CREAMS; SKIN CLEANSERS; SKIN CLEANSING CREAM; SKIN CLEANSING LOTION; SKIN CONDITIONERS; SKIN MOISTURIZERS (U.S. CLS. 1, 4, 6, 50, 51 AND 52).

FIRST USE 2-1-2007; IN COMMERCE 2-1-2007.

CLASS 5—PHARMACEUTICALS

FOR MEDICATED BATH PREPARATIONS; MEDICATED BATH SALTS; MEDICATED LOTIONS FOR SKIN; MEDICATED SKIN CARE PREPARATIONS; MEDICATED SKIN CREAMS (U.S. CLS. 6, 18, 44, 46, 51 AND 52).

FIRST USE 2-1-2007; IN COMMERCE 2-1-2007.

3,299,109. MOEN INCORPORATED, NORTH OLMSTED, OH. SN 78-626,293. PUB. 7-18-2006, FILED 5-10-2005.

CABRINA

THE MARK CONSISTS OF STANDARD CHARACTERS WITHOUT CLAIM TO ANY PARTICULAR FONT, STYLE, SIZE, OR COLOR.

CLASS 6—METAL GOODS

FOR METAL ROBE HOOKS (U.S. CLS. 2, 12, 13, 14, 23, 25 AND 50).

FIRST USE 7-1-2005; IN COMMERCE 7-1-2005.

CLASS 21—HOUSEWARES AND GLASS

FOR BATH ACCESSORIES, NAMELY TOWEL BARS, TOWEL RINGS, TOILET TISSUE HOLDERS (U.S. CLS. 2, 13, 23, 29, 30, 33, 40 AND 50).

FIRST USE 7-1-2005; IN COMMERCE 7-1-2005.

3,299,110. MOEN INCORPORATED, NORTH OLMSTED, OH. SN 78-626,298. PUB. 7-18-2006, FILED 5-10-2005.

STONY RIDGE

THE MARK CONSISTS OF STANDARD CHARACTERS WITHOUT CLAIM TO ANY PARTICULAR FONT, STYLE, SIZE, OR COLOR.

CLASS 6—METAL GOODS

FOR METAL ROBE HOOKS (U.S. CLS. 2, 12, 13, 14, 23, 25 AND 50).

FIRST USE 7-1-2006; IN COMMERCE 7-1-2006.

CLASS 21—HOUSEWARES AND GLASS

FOR BATH ACCESSORIES, NAMELY, TOWEL BARS, TOWEL RINGS, TOILET TISSUE HOLDERS (U.S. CLS. 2, 13, 23, 29, 30, 33, 40 AND 50).

FIRST USE 7-1-2006; IN COMMERCE 7-1-2006.

3,299,123. CONAIR CORPORATION, STAMFORD, CT. SN 78-634,254. PUB. 2-28-2006, FILED 5-20-2005.

TOURMALINE 5000

THE MARK CONSISTS OF STANDARD CHARACTERS WITHOUT CLAIM TO ANY PARTICULAR FONT, STYLE, SIZE, OR COLOR.

NO CLAIM IS MADE TO THE EXCLUSIVE RIGHT TO

USE "TOURMALINE", APART FROM THE MARK AS SHOWN.

CLASS 9—ELECTRICAL AND SCIENTIFIC APPARATUS

FOR HAIR APPLIANCES, NAMELY ELECTRIC CURLING IRONS, STRAIGHTENERS AND HOT BRUSHES (U.S. CLS. 21, 23, 26, 36 AND 38).

FIRST USE 8-1-2005; IN COMMERCE 8-1-2005.

CLASS 11—ENVIRONMENTAL CONTROL APPARATUS

FOR HAIR APPLIANCES, NAMELY HAIR DRYERS (U.S. CLS. 13, 21, 23, 31 AND 34).

FIRST USE 8-1-2005; IN COMMERCE 8-1-2005.

3,299,130. RESHAPING THE WORLD LLC, WEST BALDWIN, ME. SN 78-637,092. PUB. 3-7-2006, FILED 5-25-2005.

reshaping the world

THE MARK CONSISTS OF STANDARD CHARACTERS WITHOUT CLAIM TO ANY PARTICULAR FONT, STYLE, SIZE, OR COLOR.

CLASS 16—PAPER GOODS AND PRINTED MATTER

FOR GREETING CARDS; MESSAGE CARDS LAMINATED IN PLASTIC; POSTCARDS; CALENDARS; DESK CALENDARS; POCKET CALENDARS; PRINTED CALENDARS; WALL CALENDARS; CALENDAR DESK PADS; STATIONERY; STATIONERY WRITING PAPER AND ENVELOPES; BUMPER STICKERS; STICKERS; PAPER TAGS; CARDBOARD HANG TAGS; PAMPHLETS, FLIERS, AND PRINTED INSTRUCTIONAL, EDUCATIONAL, AND TEACHING MATERIALS USED IN CONNECTION WITH THE FIELDS OF MEDITATION, MINDFULNESS, METAPHYSICAL DEVELOPMENT, CHANNELING, SPIRITUAL DEVELOPMENT, SPIRITUAL GROWTH, SPIRITUAL PRACTICES, YOGA, MARTIAL ARTS, NEW AGE PHILOSOPHY, ART, DANCE, MOVEMENT, WRITING, MUSIC, PSYCHOTHERAPY, COUNSELING, GROUP PROCESS, BREATHING, BREATHWORK, EXERCISE, ENERGY WORK, CRYSTAL AND STONE HEALING, PSYCHIC AND MEDIUM DEVELOPMENT, SOUND HEALING, WELL-BEING, WELLNESS, TRANSPERSONAL WORK, HEALING ARTS, SELF-HELP, TRANSFORMATIONAL WORK, SELF-DEVELOPMENT, SELF-IMPROVEMENT, SELF-FULFILLMENT, SELF-KNOWLEDGE, SELF-AWARENESS, SELF-ACCEPTANCE, SELF-RESPONSIBILITY, PERSONAL GROWTH, CREATIVE PROCESS, IMAGINATION, METAPHOR AND MEANING, NARRATIVE WORK, OUTDOOR EDUCATION, AND CHILD AND FAMILY DEVELOPMENT; POSTERS; MOUNTED POSTERS; UNMOUNTED POSTERS; PRINTED PAPER SIGNS; PAPER FLAGS; PAPER BANNERS; ART PRINTS; COLOR PRINTS; LITHOGRAPHIC PRINTS; PHOTOGRAPHIC PRINTS; PICTORIAL PRINTS; BOOKS AND MAGAZINES PERTAINING TO THE FIELDS OF MEDITATION, MINDFULNESS, METAPHYSICAL DEVELOPMENT, CHANNELING, SPIRITUAL DEVELOPMENT, SPIRITUAL GROWTH, SPIRITUAL PRACTICES, YOGA, MARTIAL ARTS, NEW AGE PHILOSOPHY, ART, DANCE, MOVEMENT, WRITING, MUSIC, PSYCHOTHERAPY, COUNSELING, GROUP PROCESS, BREATHING, BREATHWORK, EXERCISE, ENERGY WORK, CRYSTAL AND STONE HEALING, PSYCHIC AND MEDIUM DEVELOPMENT, SOUND HEALING, WELL-BEING, WELLNESS, TRANSPERSONAL WORK,

HEALING ARTS, SELF-HELP, TRANSFORMATIONAL WORK, SELF-DEVELOPMENT, SELF-IMPROVEMENT, SELF-FULFILLMENT, SELF-KNOWLEDGE, SELF-AWARENESS, SELF-ACCEPTANCE, SELF-RESPONSIBILITY, PERSONAL GROWTH, CREATIVE PROCESS, IMAGINATION, METAPHOR AND MEANING, NARRATIVE WORK, OUTDOOR EDUCATION, AND CHILD AND FAMILY DEVELOPMENT; NOTE PADS; PAPER NAPKINS; PAPER TABLE CLOTHS; PAPER MATS; PAPER PLACEMATS; TABLE MATS OF PAPER; PENS; PENCILS; PEN AND PENCIL CASES AND BOXES; PAPER BAGS AND SACKS; PAPER GIFT BAGS; FABRIC GIFT BAGS AND SACKS; WRAPPING PAPER; GIFT WRAPPING PAPER; TOILET PAPER; FACIAL TISSUES; TISSUE PAPER; FOLDERS; FILE FOLDERS; PAPER FOLDERS; ENVELOPES; CARDBOARD BOXES; PAPER BOXES; STATIONERY BOXES; ADDRESS LABELS; ADHESIVE LABELS; PHOTOGRAPHS; PHOTOGRAPH ALBUMS; TEMPORARY TATTOOS; PLASTIC OR PAPER BAGS FOR MERCHANDISE PACKAGING; PAPER POUCHES FOR PACKAGING; AND PAPER MAIL POUCHES (U.S. CLS. 2, 5, 22, 23, 29, 37, 38 AND 50).

FIRST USE 9-1-2005; IN COMMERCE 9-1-2005.

CLASS 25—CLOTHING

FOR WRISTBANDS; HATS; BASEBALL CAPS; HEAD BANDS; EAR MUFFS; SCARVES; NECKTIES, MITTENS; GLOVES; T-SHIRTS; SHIRTS; TURTLENECKS; SWEATERS; SWEATSHIRTS; BLOUSES; VESTS; TANK TOPS; CAMISOLES; COATS; JACKETS; FLEECE PULLOVERS; BELTS; SKIRTS; PANTS; DRESSES; KILTS; LEG WARMERS; SWEATPANTS; WATERPROOF PANTS; WIND RESISTANT PANTS; SHORTS; CAPRI PANTS; BATHING SUITS; SHOES; SOCKS; SNEAKERS; SANDALS; SLIPPERS; TIGHTS; BANDANAS; CHILDREN'S AND INFANTS' CLOTH BIBS; AND CHILDREN'S AND INFANTS' SHOES AND BOOTS (U.S. CLS. 22 AND 39).

FIRST USE 9-1-2005; IN COMMERCE 9-1-2005.

CLASS 41—EDUCATION AND ENTERTAINMENT

FOR EDUCATIONAL AND ENTERTAINMENT SERVICES, NAMELY, CONDUCTING CLASSES, COURSES, SEMINARS, CONFERENCES, WORKSHOPS, SUMMER CAMPS, LIVE MUSICAL CONCERTS AND CULTURAL ACTIVITIES IN THE FIELDS OF MEDITATION, MINDFULNESS, METAPHYSICAL DEVELOPMENT, CHANNELING, SPIRITUAL DEVELOPMENT, SPIRITUAL GROWTH, SPIRITUAL PRACTICES, YOGA, MARTIAL ARTS, NEW AGE PHILOSOPHY, ART, DANCE, MOVEMENT, WRITING, MUSIC, PSYCHOTHERAPY, COUNSELING, GROUP PROCESS, BREATHING, BREATHWORK, EXERCISE, ENERGY WORK, CRYSTAL AND STONE HEALING, PSYCHIC AND MEDIUM DEVELOPMENT, SOUND HEALING, WELL-BEING, WELLNESS, TRANSPERSONAL WORK, HEALING ARTS, SELF-HELP, TRANSFORMATIONAL WORK, SELF-DEVELOPMENT, SELF-IMPROVEMENT, SELF-FULFILLMENT, SELF-KNOWLEDGE, SELF-AWARENESS, SELF-ACCEPTANCE, SELF-RESPONSIBILITY, PERSONAL GROWTH, CREATIVE PROCESS, IMAGINATION, METAPHOR AND MEANING, NARRATIVE WORK, OUTDOOR EDUCATION, AND CHILD AND FAMILY DEVELOPMENT; AND DISTRIBUTING COURSE MATERIALS IN CONNECTION THEREWITH (U.S. CLS. 100, 101 AND 107).

FIRST USE 9-1-2005; IN COMMERCE 9-1-2005.

3,299,141. STEMCELLS, INC., PALO ALTO, CA. SN 78-640,635. PUB. 7-11-2006, FILED 5-31-2005.

HuCNS-SC

THE MARK CONSISTS OF STANDARD CHARACTERS WITHOUT CLAIM TO ANY PARTICULAR FONT, STYLE, SIZE, OR COLOR.

CLASS 1—CHEMICALS

FOR BIOLOGICAL CELL SUSPENSION, NAMELY, A COMPOSITION OF EXPANDED HUMAN NEURAL STEM AND PROGENITOR CELLS DERIVED FROM HUMAN CENTRAL NERVOUS SYSTEM TISSUE FOR SCIENTIFIC RESEARCH (U.S. CLS. 1, 5, 6, 10, 26 AND 46).

FIRST USE 11-13-2006; IN COMMERCE 11-13-2006.

CLASS 5—PHARMACEUTICALS

FOR BIOLOGICAL CELL SUSPENSION, NAMELY, A COMPOSITION OF EXPANDED HUMAN NEURAL STEM AND PROGENITOR CELLS DERIVED FROM HUMAN CENTRAL NERVOUS SYSTEM TISSUE FOR CLINICAL USE AS A CELLULAR THERAPEUTIC (U.S. CLS. 6, 18, 44, 46, 51 AND 52).

FIRST USE 11-13-2006; IN COMMERCE 11-13-2006.

3,299,151. O-SAN INTERNATIONAL, INC., LAWRENCEVILLE, GA. SN 78-645,902. PUB. 6-27-2006, FILED 6-8-2005.

365 NUTRITION

THE MARK CONSISTS OF STANDARD CHARACTERS WITHOUT CLAIM TO ANY PARTICULAR FONT, STYLE, SIZE, OR COLOR.

NO CLAIM IS MADE TO THE EXCLUSIVE RIGHT TO USE "NUTRITION", APART FROM THE MARK AS SHOWN.

CLASS 5—PHARMACEUTICALS

FOR DIETARY SUPPLEMENTS, VITAMINS; NUTRITIONAL SHAKES FOR USE AS A MEAL SUBSTITUTE (U.S. CLS. 6, 18, 44, 46, 51 AND 52).

FIRST USE 9-30-2006; IN COMMERCE 9-30-2006.

CLASS 35—ADVERTISING AND BUSINESS

FOR RETAIL STORES FEATURING HEALTH FOODS, DIETARY SUPPLEMENTS, VITAMINS, COSMETICS, BODY CARE, AROMATHERAPY PRODUCTS, DRINKING WATER, NUTRITIONAL BEVERAGES AND SPORTS DRINKS; ONLINE RETAIL STORE FEATURING HEALTH FOODS, DIETARY SUPPLEMENTS, VITAMINS, COSMETICS, BODY CARE, AROMATHERAPY PRODUCTS, DRINKING WATER, NUTRITIONAL BEVERAGES AND SPORTS DRINKS; MAIL ORDER SERVICES FEATURING HEALTH FOODS, DIETARY SUPPLEMENTS, VITAMINS, COSMETICS, BODY CARE, AROMATHERAPY PRODUCTS, DRINKING WATER, NUTRITIONAL BEVERAGES AND SPORTS DRINKS (U.S. CLS. 100, 101 AND 102).

FIRST USE 9-30-2005; IN COMMERCE 9-30-2006.

3,299,154. NEUSTAT, PAULA, NEW CITY, NY. SN 78-646,710. PUB. 1-3-2006, FILED 6-8-2005.

Furniture Topper

THE MARK CONSISTS OF STANDARD CHARACTERS WITHOUT CLAIM TO ANY PARTICULAR FONT, STYLE, SIZE, OR COLOR.

NO CLAIM IS MADE TO THE EXCLUSIVE RIGHT TO USE "FURNITURE", APART FROM THE MARK AS SHOWN.

CLASS 20—FURNITURE AND ARTICLES NOT OTHERWISE CLASSIFIED

FOR FITTED FABRIC FURNITURE COVERS, CUSHIONS (U.S. CLS. 2, 13, 22, 25, 32 AND 50).

FIRST USE 9-20-2005; IN COMMERCE 11-15-2006.

CLASS 24—FABRICS

FOR UNFITTED FABRIC FURNITURE COVERS, COVERS FOR CUSHIONS (U.S. CLS. 42 AND 50).

FIRST USE 9-20-2005; IN COMMERCE 11-15-2006.

3,299,160. HEALTH-LETE, LLC, POTOMAC FALLS, VA. SN 78-650,185. PUB. 7-11-2006, FILED 6-14-2005.

HEALTH-LETE

THE MARK CONSISTS OF STANDARD CHARACTERS WITHOUT CLAIM TO ANY PARTICULAR FONT, STYLE, SIZE, OR COLOR.

CLASS 25—CLOTHING

FOR CLOTHING, NAMELY, CAPS AND SHIRTS (U.S. CLS. 22 AND 39).

FIRST USE 2-20-2006; IN COMMERCE 2-20-2006.

CLASS 41—EDUCATION AND ENTERTAINMENT

FOR CONDUCTING SEMINARS IN THE FIELD OF HEALTH, NUTRITION, EXERCISE AND WELLNESS; ARRANGING AND CONDUCTING HEALTH AND FITNESS PROGRAMS DESIGNED TO ENCOURAGE HABIT-FORMING FITNESS AND NUTRITION REGIMENS; AND EXERCISE AND FITNESS COUNSELING (U.S. CLS. 100, 101 AND 107).

FIRST USE 2-20-2006; IN COMMERCE 2-20-2006.

CLASS 44—MEDICAL, BEAUTY AND AGRICULTURAL SERVICES

FOR HEALTH CARE COUNSELING SERVICES IN THE FIELDS OF NUTRITION COUNSELING, MEDICAL HEALTH COUNSELING AND WELLNESS COUNSELING (U.S. CLS. 100 AND 101).

FIRST USE 2-20-2006; IN COMMERCE 2-20-2006.

3,299,179. FOX ENTERPRISES, INC., FORT MYERS, FL. SN 78-658,150. PUB. 7-11-2006, FILED 6-24-2005.

**CLASS 9—ELECTRICAL AND SCIENTIFIC APPARATUS**

FOR ACTIVE ELECTRONIC COMPONENTS AND PASSIVE ELECTRONIC COMPONENTS, NAMELY, QUARTZ CRYSTALS, MICROPROCESSOR CRYSTALS, CRYSTAL CLOCK OSCILLATORS, OSCILLATORS, TEMPERATURE COMPENSATED CRYSTAL OSCILLATORS, VOLTAGE CONTROLLED CRYSTAL OSCILLATORS, OVEN CONTROLLED CRYSTAL OSCILLATORS, CRYSTAL FILTERS, CERAMIC RESONATORS, VOLTAGE CONTROLLED OSCILLATORS, PHASED LOCKED LOOPS, APPLICATION SPECIFIC INTEGRATED CIRCUITS, FREQUENCY TRANSLATORS, BAW RESONATORS, BAW OSCILLATORS, SAW RESONATORS, SAW OSCILLATORS, FREQUENCY GENERATING DEVICES AND FREQUENCY CONTROLLING DEVICES (U.S. CLS. 21, 23, 26, 36 AND 38).

FIRST USE 6-15-2006; IN COMMERCE 6-15-2006.

3,299,161. MR. GATTI'S, L.P., AUSTIN, TX. SN 78-651,536. PUB. 7-25-2006, FILED 6-15-2005.

**CLASS 40—MATERIAL TREATMENT**

FOR CUSTOM MANUFACTURE OF ACTIVE ELECTRONIC COMPONENTS AND PASSIVE ELECTRONIC COMPONENTS, NAMELY, QUARTZ CRYSTALS, MICROPROCESSOR CRYSTALS, CRYSTAL CLOCK OSCILLATORS, OSCILLATORS, TEMPERATURE COMPENSATED CRYSTAL OSCILLATORS, VOLTAGE CONTROLLED CRYSTAL OSCILLATORS, OVEN CONTROLLED CRYSTAL OSCILLATORS, CRYSTAL FILTERS, CERAMIC RESONATORS, VOLTAGE CONTROLLED OSCILLATORS, PHASED LOCKED LOOPS, APPLICATION SPECIFIC INTEGRATED CIRCUITS, FREQUENCY TRANSLATORS, BAW (BULK ACOUSTIC WAVE) RESONATORS, BAW OSCILLATORS, SAW (SURFACE ACOUSTIC WAVE) RESONATORS, SAW OSCILLATORS, FREQUENCY GENERATING DEVICES, FREQUENCY CONTROLLING DEVICES AND THE PROGRAMMABILITY THEREOF (U.S. CLS. 100, 103 AND 106).

FIRST USE 6-15-2006; IN COMMERCE 6-15-2006.

OWNER OF U.S. REG. NOS. 2,289,368, 2,312,385, AND OTHERS.

THE MARK CONSISTS OF THE WORDS GATTI-TOWN EAT UP THE FUN! IN STYLIZED FORM WITH THE LETTER W IN THE SHAPE OF A FORK HOLDING SPAGHETTI.

3,299,180. FRED MEYER STORES, INC., PORTLAND, OR. SN 78-659,294. PUB. 1-10-2006, FILED 6-27-2005.

GLACIER'S EDGE**CLASS 41—EDUCATION AND ENTERTAINMENT**

FOR ENTERTAINMENT SERVICES IN THE NATURE OF INDOOR AMUSEMENT COMPLEXES (U.S. CLS. 100, 101 AND 107).

FIRST USE 7-17-2005; IN COMMERCE 7-17-2005.

THE MARK CONSISTS OF STANDARD CHARACTERS WITHOUT CLAIM TO ANY PARTICULAR FONT, STYLE, SIZE, OR COLOR.

OWNER OF U.S. REG. NOS. 1,745,232, 2,671,596, AND OTHERS.

CLASS 43—HOTEL AND RESTAURANT SERVICES

FOR RESTAURANT AND CARRY-OUT SERVICES (U.S. CLS. 100 AND 101).

FIRST USE 7-17-2005; IN COMMERCE 7-17-2005.

CLASS 7—MACHINERY

FOR COMPRESSED AIR PUMPS (U.S. CLS. 13, 19, 21, 23, 31, 34 AND 35).

FIRST USE 5-31-2006; IN COMMERCE 5-31-2006.

CLASS 9—ELECTRICAL AND SCIENTIFIC APPARATUS

FOR SUNGLASSES (U.S. CLS. 21, 23, 26, 36 AND 38).
FIRST USE 9-30-2006; IN COMMERCE 9-30-2006.

CLASS 11—ENVIRONMENTAL CONTROL APPARATUS

FOR COMBINATION PORTABLE FANS AND LAMPS, CAMP LANTERNS, GAS CAMPING TABLE LAMPS, BATTERY POWERED FLUORESCENT LANTERNS, HANGING BATTERY OPERATED CAMP LIGHTS, MINI LAMPS, HEADLIGHT LAMPS, FLOATABLE CAMP LAMPS, GAS LANTERNS, PROPANE CAMP STOVES, SINGLE MANTLE GAS LANTERNS, PORTABLE WATER SHOWERS, REPLACEMENT GLASS LANTERN GLOBES AND COMBINATION PACKS COMPRISED OF A LANTERN, FLASHLIGHT AND HEADLIGHT (U.S. CLS. 13, 21, 23, 31 AND 34).

FIRST USE 8-31-2006; IN COMMERCE 8-31-2006.

CLASS 20—FURNITURE AND ARTICLES NOT OTHERWISE CLASSIFIED

FOR INFLATABLE MATS AND PILLOWS, CAMP COTS, AIR MATTRESSES FOR CAMPING WITH BUILT IN PUMP, CAMP BEDS, SEATS, FOLDING STADIUM SEATS AND FOLDING TABLES WITH FOLDING CHAIRS, NON-METAL TENT STAKES (U.S. CLS. 2, 13, 22, 25, 32 AND 50).

FIRST USE 8-31-2006; IN COMMERCE 8-31-2006.

3,299,202. ASIA OIL SEALS CO., LTD., FUH HSING HSIANG, TAIWAN. SN 78-665,893. PUB. 7-18-2006, FILED 7-7-2005.

ASA

THE MARK CONSISTS OF STANDARD CHARACTERS WITHOUT CLAIM TO ANY PARTICULAR FONT, STYLE, SIZE, OR COLOR.

CLASS 7—MACHINERY

FOR RUBBER OIL SEALS FOR AUTOMOBILES OR PARTS OF MACHINES, PLASTIC OIL SEALS FOR AUTOMOBILES OR PARTS OF MACHINES, GASKETS FOR AUTOMOBILES, PACKING RINGS, SEAL RINGS AND OIL RINGS AS MACHINE PARTS (U.S. CLS. 13, 19, 21, 23, 31, 34 AND 35).

FIRST USE 2-19-2000; IN COMMERCE 2-19-2000.

CLASS 17—RUBBER GOODS

FOR RUBBER OIL SEALS, PLASTIC OIL SEALS, RUBBER PACKINGS FOR FORMING SEALS; GASKETS FOR PIPES AND PLUMBING (U.S. CLS. 1, 5, 12, 13, 35 AND 50).

FIRST USE 2-19-2000; IN COMMERCE 2-19-2000.

3,299,210. BRINTON, DAVID, NORTH HOLLYWOOD, CA. SN 78-669,681. PUB. 6-13-2006, FILED 7-13-2005.

**CLASS 9—ELECTRICAL AND SCIENTIFIC APPARATUS**

FOR PRERECORDED DVDS FEATURING METHODS OF INCREASING THE PERFORMANCE OF ALL LEVELS OF ATHLETES AND COACHES, FROM RECREATIONAL TO PROFESSIONAL, IN ROAD CYCLING, TRACK CYCLING, MOUNTAIN BIKING, AND TRIATHLON; DOWNLOADABLE DVD RECORDINGS FEATURING EDUCATIONAL MATERIALS FOR INCREASING THE PERFORMANCE OF ALL LEVELS OF ATHLETES AND COACHES, FROM RECREATIONAL TO PROFESSIONAL, IN ROAD CYCLING, TRACK CYCLING, MOUNTAIN BIKING, AND TRIATHLON (U.S. CLS. 21, 23, 26, 36 AND 38).

FIRST USE 3-5-2007; IN COMMERCE 3-5-2007.

CLASS 16—PAPER GOODS AND PRINTED MATTER

FOR EDUCATIONAL MATERIALS, NAMELY MANUALS AND HANDBOOKS FOR INCREASING THE PERFORMANCE OF ALL LEVELS OF ATHLETES AND COACHES, FROM RECREATIONAL TO PROFESSIONAL, IN ROAD CYCLING, TRACK CYCLING, MOUNTAIN BIKING, AND TRIATHLON (U.S. CLS. 2, 5, 22, 23, 29, 37, 38 AND 50).

FIRST USE 3-5-2007; IN COMMERCE 3-5-2007.

CLASS 41—EDUCATION AND ENTERTAINMENT

FOR EDUCATIONAL SERVICES, NAMELY CONDUCTING CLASSES, SEMINARS, CLINICS, WORKSHOPS, AND ONE-ON-ONE TRAINING TO INCREASE THE PERFORMANCE OF ALL LEVELS OF ATHLETES AND COACHES, FROM RECREATIONAL TO PROFESSIONAL, IN ROAD CYCLING, TRACK CYCLING, MOUNTAIN BIKING, AND TRIATHLON; ON-LINE PUBLICATION OF EDUCATIONAL MATERIALS FOR INCREASING THE PERFORMANCE OF ALL LEVELS OF ATHLETES AND COACHES, FROM RECREATIONAL TO PROFESSIONAL, IN ROAD CYCLING, TRACK CYCLING, MOUNTAIN BIKING, AND TRIATHLON (U.S. CLS. 100, 101 AND 107).

FIRST USE 3-5-2007; IN COMMERCE 3-5-2007.

3,299,224. DILIGENT TECHNOLOGIES CORPORATION, FRAMINGHAM, MA. SN 78-675,925. PUB. 7-18-2006, FILED 7-22-2005.

PROTECTIER

THE MARK CONSISTS OF STANDARD CHARACTERS WITHOUT CLAIM TO ANY PARTICULAR FONT, STYLE, SIZE, OR COLOR.

CLASS 9—ELECTRICAL AND SCIENTIFIC APPARATUS

FOR COMPUTER SOFTWARE FOR DATA PROTECTION, NAMELY, DISK-BASED DATA PROTECTION FOR DATA STORAGE, DATA BACKUP AND RECOVERY, AND DATA STORAGE REGULATORY COMPLIANCE; COMPUTER SOFTWARE FOR DATA STORAGE VIRTUALIZATION; COMPUTER SOFTWARE FOR EMULATING TAPE STORAGE DEVICES WITH DISK STORAGE DEVICES IN HETEROGENEOUS SYSTEMS ENVIRONMENTS FOR DATA STORAGE; COMPUTER SOFTWARE FOR ANALYZING AND REPORTING ON DATA STORAGE, BACKUP AND RECOVERY NEEDS; COMPUTER SOFTWARE FOR THE DESIGN, SELECTION, INSTALLATION, IMPLEMENTATION, AND USE OF COMPUTER HARDWARE AND SOFTWARE SYSTEMS RELATING TO DATA PROTECTION, STORAGE, BACKUP AND RECOVERY; COMPUTER HARDWARE AND COMPUTER PERIPHERALS; COMPUTER MEMORY HARDWARE; COMPUTER STORAGE HARDWARE; COMPUTER NETWORKING HARDWARE; COMPUTER HARDWARE AND SOFTWARE, SERVERS, SWITCHES, HUBS AND PERIPHERALS FOR COMMUNICATION, CONTROL, MANAGEMENT AND TRANSMISSION OF DATA AND INFORMATION AMONG SERVERS, STORAGE DEVICES, AND COMPUTER PERIPHERALS ATTACHED TO A COMPUTER NETWORK; COMPUTER HARDWARE, NAMELY, AN EMULATION COMPUTER SERVER FOR EMULATING TAPE STORAGE DEVICES WITH DISK STORAGE DEVICES FOR DATA STORAGE (U.S. CLS. 21, 23, 26, 36 AND 38).
FIRST USE 6-20-2005; IN COMMERCE 6-20-2005.

CLASS 42—SCIENTIFIC, COMPUTER AND LEGAL SERVICES

FOR COMPUTER SERVICES FOR DATA PROTECTION, NAMELY COMPUTER SOFTWARE DESIGN AND DEVELOPMENT FOR DISK-BASED DATA PROTECTION, DATA STORAGE, DATA BACKUP AND RECOVERY, AND DATA STORAGE REGULATORY COMPLIANCE; COMPUTER PROJECT DESIGN AND COMPUTER ARCHITECTURE DESIGN, NAMELY, DESIGN OF COMPUTER HARDWARE AND COMPUTER SOFTWARE, COMMUNICATIONS HARDWARE AND SOFTWARE, AND COMPUTER NETWORKS FOR OTHERS; IMPLEMENTATION AND INTEGRATION OF DISK-BASED DATA PROTECTION, DATA STORAGE, DATA BACKUP AND RECOVERY, AND DATA STORAGE REGULATORY COMPLIANCE COMPUTER SOFTWARE FOR COMPUTER SYSTEMS AND NETWORKS; DESIGN, DEVELOPMENT AND CUSTOMIZATION OF COMPUTER HARDWARE AND SOFTWARE FOR OTHERS; INTEGRATION OF COMPUTER SYSTEMS AND NETWORKS; COMPUTER HARDWARE DEVELOPMENT; MAINTENANCE OF COMPUTER SOFTWARE; TECHNICAL SUPPORT SERVICES, NAMELY, TROUBLESHOOTING OF COMPUTER HARDWARE AND SOFTWARE PROBLEMS; CONSULTING SERVICES IN THE FIELD OF DESIGN, SELECTION, IMPLEMENTATION AND USE OF COMPUTER HARDWARE AND SOFTWARE SYSTEMS FOR OTHERS (U.S. CLS. 100 AND 101).
FIRST USE 6-20-2005; IN COMMERCE 6-20-2005.

3,299,238. PETERS JR., JAMES C., CORDOVA, TN. SN 78-681,903. PUB. 2-21-2006, FILED 7-29-2005.

Christ Is Alive

THE MARK CONSISTS OF STANDARD CHARACTERS WITHOUT CLAIM TO ANY PARTICULAR FONT, STYLE, SIZE, OR COLOR.

CLASS 14—JEWELRY

FOR JEWELRY (U.S. CLS. 2, 27, 28 AND 50).
FIRST USE 12-31-2002; IN COMMERCE 12-31-2004.

CLASS 25—CLOTHING

FOR CLOTHING NAMELY, BELTS, BLOUSES, CAPS, HOODS, INFANT AND TODDLER ONE PIECE CLOTHING, JERSEYS, MANTLES, MUFFLERS, SHIRTS, SHIRTS, SHORT SETS, SHOULDER WRAPS, SWADDLING CLOTHES, SWEATSHIRTS, T-SHIRTS, TIES, TOPS, UNDERARM CLOTHING SHIELDS, PERSPIRATION ABSORBENT UNDERWEAR CLOTHING, AND WRAPS; PARTS OF CLOTHING, NAMELY, GUSSETS FOR TIGHTS, GUSSETS FOR STOCKINGS, GUSSETS FOR BATHING SUITS, GUSSETS FOR UNDERWEAR, GUSSETS FOR LEOTARDS AND GUSSETS FOR FOOTLETS; SHOULDER PADS FOR CLOTHING; CLOTH BIBS, AND CLOTH DIAPERS (U.S. CLS. 22 AND 39).
FIRST USE 12-31-2002; IN COMMERCE 12-31-2004.

3,299,240. SPECKOZ, INC., ALPHARETTA, GA. SN 78-682,426. PUB. 7-25-2006, FILED 8-1-2005.

Z-PRO

THE MARK CONSISTS OF STANDARD CHARACTERS WITHOUT CLAIM TO ANY PARTICULAR FONT, STYLE, SIZE, OR COLOR.

CLASS 5—PHARMACEUTICALS

FOR CHEMICAL PESTICIDES AND PEST DETECTION KITS, SAID KITS COMPRISED OF PHEROMONE AND PHEROMONE TRAPS FOR CRAWLING AND FLYING INSECT PESTS, PORTABLE FIELD MICROSCOPES, HAND LENS, FORCEPS, BRUSHES, COLLECTION VIALS, AND INSECT LABELS, ALL FOR USE BY PEST CONTROL PROFESSIONALS; AIR FRESHENERS (U.S. CLS. 6, 18, 44, 46, 51 AND 52).
FIRST USE 3-0-2006; IN COMMERCE 3-0-2006.

CLASS 11—ENVIRONMENTAL CONTROL APPARATUS

FOR DISPENSING UNITS FOR AIR FRESHENERS (U.S. CLS. 13, 21, 23, 31 AND 34).
FIRST USE 3-0-2006; IN COMMERCE 3-0-2006.

3,299,241. PINPOINT TRACKING SOLUTIONS, LLC, PA-COIMA, CA. SN 78-682,684. PUB. 6-20-2006, FILED 8-1-2005.



THE MARK CONSISTS OF A CIRCLE WITH A CURVED DESIGN ABOVE THE TOP LEFT SIDE FOLLOWED BY THE WORD "ECOTRAC" WITH A "." ABOVE THE "E".

CLASS 9—ELECTRICAL AND SCIENTIFIC APPARATUS

FOR VEHICLE LOCATOR AND RECOVERY DEVICE HAVING A GLOBAL POSITIONING SYSTEMS (GPS) RECEIVER AND A WIRELESS TELECOMMUNICATIONS TRANSMITTER (U.S. CLS. 21, 23, 26, 36 AND 38).
FIRST USE 7-25-2005; IN COMMERCE 7-25-2005.

CLASS 45—PERSONAL SERVICES

FOR TRACKING, LOCATING AND MONITORING OF VEHICLES FOR SECURITY PURPOSES THROUGH MOBILE VEHICLE LOCATOR DEVICES (U.S. CLS. 100 AND 101).
FIRST USE 7-25-2005; IN COMMERCE 7-25-2005.

3,299,259. BOUMA, SARIAN S., ANNAPOLIS, MD. SN 78-693,262. PUB. 7-11-2006, FILED 8-16-2005.

SIANNA MYSTIQUE

THE MARK CONSISTS OF STANDARD CHARACTERS WITHOUT CLAIM TO ANY PARTICULAR FONT, STYLE, SIZE, OR COLOR.

CLASS 3—COSMETICS AND CLEANING PREPARATIONS

FOR COSMETICS, BATH PRODUCTS, NAMELY, SOAPS, LOTIONS, CREAMS, AND BUTTERS, BATH GEL, BATH BEADS, BATH CRYSTALS AND BATH SALTS (U.S. CLS. 1, 4, 6, 50, 51 AND 52).
FIRST USE 6-0-2006; IN COMMERCE 6-0-2006.

CLASS 25—CLOTHING

FOR WEARING APPAREL, NAMELY, SHIRTS, HATS, SWEAT SUITS, RUNNING SUITS, SLEEPWEAR, LOUNGEWEAR AND ROBES (U.S. CLS. 22 AND 39).
FIRST USE 7-0-2006; IN COMMERCE 7-0-2006.

3,299,265. COMPUPAY, INC., MIRAMAR, FL. SN 78-696,637. PUB. 7-18-2006, FILED 8-19-2005.

INNOVATION PAYS

THE MARK CONSISTS OF STANDARD CHARACTERS WITHOUT CLAIM TO ANY PARTICULAR FONT, STYLE, SIZE, OR COLOR.

CLASS 35—ADVERTISING AND BUSINESS

FOR COMPUTERIZED PAYROLL PREPARATION SERVICES; WEB-BASED PAYROLL PREPARATION SERVICES; ADMINISTRATION OF BUSINESS PAYROLL FOR OTHERS (U.S. CLS. 100, 101 AND 102).
FIRST USE 10-1-2005; IN COMMERCE 10-1-2005.

CLASS 36—INSURANCE AND FINANCIAL

FOR PAYROLL TAX DEBITING SERVICES (U.S. CLS. 100, 101 AND 102).
FIRST USE 10-1-2005; IN COMMERCE 10-1-2005.

3,299,273. ALLURENT, INC., CAMBRIDGE, MA. SN 78-698,616. PUB. 1-16-2007, FILED 8-23-2005.

ALLURENT

THE MARK CONSISTS OF STANDARD CHARACTERS WITHOUT CLAIM TO ANY PARTICULAR FONT, STYLE, SIZE, OR COLOR.

CLASS 41—EDUCATION AND ENTERTAINMENT

FOR COMPUTER EDUCATION TRAINING SERVICES (U.S. CLS. 100, 101 AND 107).
FIRST USE 5-2-2006; IN COMMERCE 5-2-2006.

CLASS 42—SCIENTIFIC, COMPUTER AND LEGAL SERVICES

FOR CUSTOM DESIGN, DEVELOPMENT AND IMPLEMENTATION OF COMPUTER PROGRAMS FOR OTHERS; COMPUTER SERVICES, NAMELY, PROVIDING COMPUTER CONSULTING SERVICES; TECHNICAL SUPPORT SERVICES, NAMELY, TROUBLESHOOTING OF COMPUTER HARDWARE AND SOFTWARE PROBLEMS (U.S. CLS. 100 AND 101).
FIRST USE 11-1-2005; IN COMMERCE 11-1-2005.

3,299,277. FERNANDEZ, MICHAEL ANTHONY, AUSTIN, TX. SN 78-700,556. PUB. 5-23-2006, FILED 8-25-2005.



THE MARK CONSISTS OF A VINTAGE STYLE MICROPHONE THAT HAS THE WORD "HOODFELLA" SPELLED OUT IN A CURSIVE SCRIPT USING THE CORD. THE LETTERS "H" AND "F" ARE BUILT INTO THE CENTER OF THE MICROPHONE GRILLE.

CLASS 9—ELECTRICAL AND SCIENTIFIC APPARATUS

FOR AUDIO CASSETTES FEATURING MUSIC AND ENTERTAINMENT BY MUSICAL ARTISTS AND GROUPS; AUDIO DIGITAL TAPES FEATURING MUSIC AND ENTERTAINMENT BY MUSICAL ARTISTS AND GROUPS; AUDIO DISCS FEATURING MUSIC AND ENTERTAINMENT BY MUSICAL ARTISTS AND GROUPS; AUDIO RECORDINGS FEATURING MUSIC AND ENTERTAINMENT BY MUSICAL ARTISTS AND GROUPS; AUDIO TAPES FEATURING MUSIC AND ENTERTAINMENT BY MUSICAL ARTISTS AND GROUPS; DOWNLOADABLE MUSICAL SOUND RECORDINGS; DOWNLOADABLE RING TONES, GRAPHICS AND MUSIC VIA A GLOBAL COMPUTER NETWORK AND WIRELESS DEVICES; DOWNLOADABLE VIDEO RECORDINGS FEATURING MUSIC AND ENTERTAINMENT INCLUDING LIVE PERFORMANCES, INTERVIEWS, APPEARANCES AND MUSIC VIDEOS BY MUSICAL ARTISTS AND GROUPS; ELECTRONIC PUBLICATIONS, NAMELY, WEB SITES AND WEB MAGAZINES FEATURING INFORMATION REGARDING PERFORMANCES OF MUSICAL ARTISTS WITH AND WITHOUT SOUND CLIPS RECORDED ON COMPUTER MEDIA; MUSICAL SOUND RECORDINGS; MUSICAL VIDEO RECORDINGS; PHONOGRAPH RECORDS FEATURING MUSIC AND ENTERTAINMENT BY MUSICAL ARTISTS AND GROUPS; PRE-RECORDED CD'S, VIDEO TAPES, LASER DISKS AND DVD'S FEATURING MUSIC AND ENTERTAINMENT INCLUDING LIVE PERFORMANCES, INTERVIEWS, APPEARANCES AND MUSIC VIDEOS BY MUSICAL ARTISTS AND GROUPS; PRERECORDED AUDIO CASSETTES FEATURING MUSIC AND ENTERTAINMENT BY MUSICAL ARTISTS AND GROUPS; PRERECORDED AUDIO TAPES FEATURING MUSIC AND ENTERTAINMENT BY MUSICAL ARTISTS AND GROUPS; PRERECORDED DIGITAL AUDIO TAPE FEATURING MUSIC AND ENTERTAINMENT BY MUSICAL ARTISTS AND GROUPS; PRERECORDED VIDEO CASSETTES FEATURING MUSIC AND ENTERTAINMENT INCLUDING LIVE PERFORMANCES, INTERVIEWS, APPEARANCES AND MUSIC VIDEOS BY MUSICAL ARTISTS AND GROUPS; PRERECORDED VIDEO TAPES FEATURING MUSIC AND ENTERTAINMENT INCLUDING LIVE PERFORMANCES, INTERVIEWS, APPEARANCES AND MUSIC VIDEOS BY MUSICAL ARTISTS AND GROUPS; SOUND RECORDINGS FEATURING MUSIC AND ENTERTAINMENT BY MUSICAL ARTISTS AND GROUPS; VIDEO RECORDINGS FEATURING MUSIC AND ENTERTAINMENT INCLUDING LIVE PERFORMANCES, INTERVIEWS, APPEARANCES AND MUSIC VIDEOS BY MUSICAL ARTISTS AND GROUPS; VIDEO TAPES FEATURING MUSIC AND ENTERTAINMENT INCLUDING LIVE PERFORMANCES, INTERVIEWS, APPEARANCES AND MUSIC VIDEOS BY MUSICAL ARTISTS AND GROUPS; VISUAL RECORDINGS AND AUDIO VISUAL RECORDINGS FEATURING MUSIC AND ANIMATION (U.S. CLS. 21, 23, 26, 36 AND 38).

FIRST USE 7-7-2005; IN COMMERCE 2-1-2006.

CLASS 41—EDUCATION AND ENTERTAINMENT

FOR AUDIO RECORDING AND PRODUCTION; CONDUCTING ENTERTAINMENT EXHIBITIONS IN THE NATURE OF TELEVISION SHOWS, SPORTS EVENTS, FASHION SHOWS, GAME SHOWS, MUSIC SHOWS, AWARD SHOWS AND COMEDY SHOWS BEFORE LIVE AUDIENCES WHICH ARE ALL BROADCAST LIVE OR TAPED FOR LATER BROADCAST AND MUSIC FESTIVALS, CAR SHOWS AND OTHER ORGANIZED FUNCTIONS, BOTH INDOOR AND OUTDOOR; ENTERTAINMENT IN THE NATURE OF ON-GOING TELEVISION PROGRAMS IN THE FIELD OF MUSIC AND ENTERTAINMENT; ENTERTAINMENT IN THE NATURE OF VISUAL AND AUDIO PERFORMANCES, AND MUSICAL, VARIETY, NEWS AND COMEDY SHOWS; ENTERTAINMENT IN THE NATURE OF LIVE CONCERTS AND PERFORMANCES BY MUSICAL ARTISTS AND GROUPS; ENTERTAINMENT NAMELY, LIVE PERFORMANCES BY A MUSICAL BAND; ENTERTAINMENT NAMELY, PRODUCTION OF MUSICAL PERFORMANCES, MUSIC VIDEOS AND AUDIO RECORDING; ENTERTAINMENT SERVICES, NAMELY, PROVIDING A RADIO PROGRAM IN THE FIELD OF MUSIC AND ENTERTAINMENT VIA A GLOBAL COM-

PUTER NETWORK; ENTERTAINMENT SERVICES, NAMELY, PROVIDING A WEB SITE FEATURING MUSICAL PERFORMANCES, MUSICAL VIDEOS, RELATED FILM CLIPS, PHOTOGRAPHS, AND OTHER MULTIMEDIA MATERIALS; ENTERTAINMENT SERVICES, NAMELY, PROVIDING ON-LINE REVIEWS OF MUSIC, MUSICAL ARTISTS AND MUSIC VIDEOS; ENTERTAINMENT SERVICES, NAMELY, PROVIDING PRERECORDED MUSIC, INFORMATION IN THE FIELD OF MUSIC, AND COMMENTARY AND ARTICLES ABOUT MUSIC, ALL ON-LINE VIA A GLOBAL COMPUTER NETWORK; ENTERTAINMENT, NAMELY A CONTINUING MUSIC AND ENTERTAINMENT SHOW BROADCAST OVER TELEVISION, SATELLITE, AUDIO, AND VIDEO MEDIA; ENTERTAINMENT, NAMELY LIVE MUSIC CONCERTS; ENTERTAINMENT, NAMELY LIVE PERFORMANCES BY MUSICAL BANDS; MUSIC PRODUCTION SERVICES; MUSIC PUBLISHING SERVICES; ORGANIZING EXHIBITIONS FOR THE PROMOTION OF MUSIC AND THE ARTS; PRESENTATION OF MUSICAL PERFORMANCE; RADIO ENTERTAINMENT PRODUCTION; RECORD MASTER PRODUCTION; RECORD PRODUCTION; RECORDING STUDIOS; SOUND RECORDING STUDIOS (U.S. CLS. 100, 101 AND 107).

FIRST USE 7-7-2005; IN COMMERCE 6-3-2006.

3,299,293. THE QUADRANT CORPORATION, BELLEVUE, WA. SN 78-705,133. PUB. 5-16-2006, FILED 9-1-2005.

TAHOMA MEADOW

THE MARK CONSISTS OF STANDARD CHARACTERS WITHOUT CLAIM TO ANY PARTICULAR FONT, STYLE, SIZE, OR COLOR.

CLASS 36—INSURANCE AND FINANCIAL

FOR REAL ESTATE BROKERAGE SERVICES (U.S. CLS. 100, 101 AND 102).

FIRST USE 1-26-2006; IN COMMERCE 1-26-2006.

CLASS 37—CONSTRUCTION AND REPAIR

FOR RESIDENTIAL BUILDING CONSTRUCTION AND REAL ESTATE DEVELOPMENT SERVICES (U.S. CLS. 100, 103 AND 106).

FIRST USE 1-26-2006; IN COMMERCE 1-26-2006.

3,299,298. PUBLIUS PRESS, INC., LOOKOUT MOUNTAIN, TN. SN 78-708,228. PUB. 6-6-2006, FILED 9-7-2005.

THE PATRIOT POST

THE MARK CONSISTS OF STANDARD CHARACTERS WITHOUT CLAIM TO ANY PARTICULAR FONT, STYLE, SIZE, OR COLOR.

CLASS 9—ELECTRICAL AND SCIENTIFIC APPARATUS

FOR DOWNLOADABLE ELECTRONIC PUBLICATIONS IN THE NATURE OF NEWSLETTERS IN THE FIELD OF SURVEYS AND ANALYSES OF NEWS, POLICY, AND OPINION (U.S. CLS. 21, 23, 26, 36 AND 38).

FIRST USE 1-4-2006; IN COMMERCE 1-4-2006.

CLASS 16—PAPER GOODS AND PRINTED MATTER

FOR NEWSLETTERS IN THE FIELD OF SURVEYS AND ANALYSES OF NEWS, POLICY, AND OPINION (U.S. CLS. 2, 5, 22, 23, 29, 37, 38 AND 50).

FIRST USE 1-4-2006; IN COMMERCE 1-4-2006.

CLASS 41—EDUCATION AND ENTERTAINMENT

FOR PROVIDING NEWSLETTERS IN THE FIELD OF SURVEYS AND ANALYSES OF NEWS, POLICY, AND OPINION VIA E-MAIL, AND PROVIDING QUOTATIONS OF HISTORICAL FIGURES VIA E-MAIL (U.S. CLS. 100, 101 AND 107).

FIRST USE 1-4-2006; IN COMMERCE 1-4-2006.

3,299,300. MONTEFIORE MEDICAL CENTER, INC., BRONX, NY. SN 78-709,018. PUB. 12-5-2006, FILED 9-8-2005.



The Care Management Company

NO CLAIM IS MADE TO THE EXCLUSIVE RIGHT TO USE "CMO" AND "CARE MANAGEMENT COMPANY", APART FROM THE MARK AS SHOWN.

CLASS 35—ADVERTISING AND BUSINESS

FOR MANAGEMENT AND ADMINISTRATION SERVICES AND RECORDS MANAGEMENT SERVICES IN THE FIELD OF HEALTHCARE—NAMESLY, DOCUMENT INDEXING FOR OTHERS; MANAGEMENT OF COMPUTERIZED FILES; AND VERIFYING AND MONITORING THE CREDENTIALS OF DOCTORS AND OTHER MEDICAL PROFESSIONALS (U.S. CLS. 100, 101 AND 102).

FIRST USE 10-27-2005; IN COMMERCE 10-27-2005.

CLASS 44—MEDICAL, BEAUTY AND AGRICULTURAL SERVICES

FOR MANAGED HEALTH CARE SERVICES, NAMESLY, PROVIDING MEDICAL AND BEHAVIORAL CASE MANAGEMENT PROGRAMS, DISEASE MANAGEMENT AND HEALTH AND WELLNESS PROGRAM SERVICES, AND MENTAL HEALTH COUNSELING AND PSYCHOTHERAPY AS IT RELATES TO RELATIONSHIPS (U.S. CLS. 100 AND 101).

FIRST USE 10-27-2005; IN COMMERCE 10-27-2005.

3,299,301. MONTEFIORE MEDICAL CENTER, INC., BRONX, NY. SN 78-709,047. PUB. 11-21-2006, FILED 9-8-2005.

CMO CARE CONTINUITY

THE MARK CONSISTS OF STANDARD CHARACTERS WITHOUT CLAIM TO ANY PARTICULAR FONT, STYLE, SIZE, OR COLOR.

NO CLAIM IS MADE TO THE EXCLUSIVE RIGHT TO USE "CMO CARE", APART FROM THE MARK AS SHOWN.

CLASS 35—ADVERTISING AND BUSINESS

FOR MANAGEMENT AND ADMINISTRATION SERVICES AND RECORDS MANAGEMENT SERVICES IN THE FIELD OF HEALTHCARE—NAMESLY, DOCUMENT INDEXING FOR OTHERS; MANAGEMENT OF COMPUTERIZED FILES; AND VERIFYING AND MONITORING THE CREDENTIALS OF DOCTORS AND OTHER MEDICAL PROFESSIONALS (U.S. CLS. 100, 101 AND 102).

FIRST USE 10-27-2005; IN COMMERCE 10-27-2005.

CLASS 44—MEDICAL, BEAUTY AND AGRICULTURAL SERVICES

FOR MANAGED HEALTH CARE SERVICES, NAMESLY, PROVIDING MEDICAL AND BEHAVIORAL CASE MANAGEMENT PROGRAMS, DISEASE MANAGEMENT AND HEALTH AND WELLNESS PROGRAM SERVICES, AND MENTAL HEALTH COUNSELING AND PSYCHOTHERAPY AS IT RELATES TO RELATIONSHIPS (U.S. CLS. 100 AND 101).

FIRST USE 10-27-2005; IN COMMERCE 10-27-2005.

3,299,318. MAJESCOMASTEK, EDISON, NJ. SN 78-714,485. PUB. 9-19-2006, FILED 9-16-2005.

MAJESCOMASTEK

THE MARK CONSISTS OF STANDARD CHARACTERS WITHOUT CLAIM TO ANY PARTICULAR FONT, STYLE, SIZE, OR COLOR.

CLASS 35—ADVERTISING AND BUSINESS

FOR OUTSOURCING IN THE FIELDS OF BUSINESS PROCESS AND INFORMATION TECHNOLOGY (U.S. CLS. 100, 101 AND 102).

FIRST USE 10-30-2005; IN COMMERCE 10-30-2005.

CLASS 42—SCIENTIFIC, COMPUTER AND LEGAL SERVICES

FOR INFORMATION TECHNOLOGY CONSULTATION, NAMESLY, PROVIDING INFORMATION TECHNOLOGY (U.S. CLS. 100 AND 101).

FIRST USE 10-30-2005; IN COMMERCE 10-30-2005.

3,299,321. HONEYCUTT, RHODNEY, HICKORY, NC. SN 78-714,848. PUB. 5-30-2006, FILED 9-16-2005.

3,299,356. PRICELINE.COM INCORPORATED, NORWALK, CT. SN 78-723,279. PUB. 7-11-2006, FILED 9-29-2005.

ICEBABYS

THE MARK CONSISTS OF STANDARD CHARACTERS WITHOUT CLAIM TO ANY PARTICULAR FONT, STYLE, SIZE, OR COLOR.

CLASS 30—STAPLE FOODS

FOR CONES FOR ICE CREAM; EDIBLE FRUIT ICES; FLAVORED ICES; FROZEN YOGHURT; FRUIT ICE BAR; FRUIT ICES; ICE CREAM; ICE CREAM DRINKS; ICE CREAM MIXES; ICE CREAM POWDER; ICE CREAM SUBSTITUTE; ICE MILK; ICE MILK BARS; ICE-CREAM CAKES (U.S. CL. 46).

FIRST USE 5-24-2006; IN COMMERCE 5-24-2006.

CLASS 35—ADVERTISING AND BUSINESS

FOR CONCESSION STANDS FEATURING ICE CREAM, FROZEN DESSERTS, SNACKS, DRINKS, AND FAST FOOD; FOOD KIOSK SERVICES; STREET VENDOR SERVICES FEATURING ICE CREAM, FROZEN DESSERTS, SNACKS, DRINKS, AND FAST FOOD; VENDING IN THE FIELD OF ICE CREAM, FROZEN DESSERTS, SNACKS, DRINKS, AND FAST FOOD (U.S. CLS. 100, 101 AND 102).

FIRST USE 5-24-2006; IN COMMERCE 5-24-2006.

3,299,338. NORTHERN DIGITAL INC., WATERLOO, ONTARIO, CANADA. SN 78-719,101. PUB. 6-13-2006, FILED 9-23-2005.

POLARIS SPECTRA

THE MARK CONSISTS OF STANDARD CHARACTERS WITHOUT CLAIM TO ANY PARTICULAR FONT, STYLE, SIZE, OR COLOR.

OWNER OF U.S. REG. NOS. 2,080,194 AND 2,366,341.

CLASS 9—ELECTRICAL AND SCIENTIFIC APPARATUS

FOR OPTI-ELECTRICAL MOTION MEASUREMENT DEVICE (U.S. CLS. 21, 23, 26, 36 AND 38).

FIRST USE 7-12-2006; IN COMMERCE 7-12-2006.

CLASS 10—MEDICAL APPARATUS

FOR OPTI-ELECTRICAL MOTION MEASUREMENT DEVICES FOR USE IN COMPUTER ASSISTED MEDICAL THERAPY (U.S. CLS. 26, 39 AND 44).

FIRST USE 7-12-2006; IN COMMERCE 7-12-2006.

MORE WAYS TO SAVE

THE MARK CONSISTS OF STANDARD CHARACTERS WITHOUT CLAIM TO ANY PARTICULAR FONT, STYLE, SIZE, OR COLOR.

CLASS 39—TRANSPORTATION AND STORAGE

FOR TRAVEL AGENCY SERVICES, NAMELY, BOOKINGS FOR TRANSPORTATION FOR OTHERS VIA THE INTERNET (U.S. CLS. 100 AND 105).

FIRST USE 1-0-2006; IN COMMERCE 1-0-2006.

CLASS 40—MATERIAL TREATMENT

FOR PRINTING TICKETS AND CONFIRMATIONS FOR LODGING AND AIR TRAVEL RESERVATIONS FOR OTHERS (U.S. CLS. 100, 103 AND 106).

FIRST USE 1-0-2006; IN COMMERCE 1-0-2006.

CLASS 43—HOTEL AND RESTAURANT SERVICES

FOR TRAVEL AGENCY SERVICES, NAMELY, MAKING RESERVATIONS AND BOOKINGS FOR HOTELS AND OTHER TEMPORARY LODGINGS FOR OTHERS VIA THE INTERNET, AND BY MAIL, COURIER, TELEPHONE AND FACSIMILE TRANSMISSION (U.S. CLS. 100 AND 101).

FIRST USE 1-0-2006; IN COMMERCE 1-0-2006.

3,299,363. GARCIA-PEDROSO, GONZALO, MIAMI, FL. SN 78-725,339. PUB. 6-27-2006, FILED 10-3-2005.

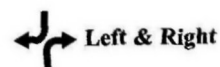

THE MARK CONSISTS OF AN UPSIDE DOWN ARROW POINTING TO THE LEFT WHEN VIEWED FROM TOP TO BOTTOM DIAGONALLY ADJACENT TO AN ARROW POINTING TO THE RIGHT WHEN VIEWED FROM BOTTOM TO TOP, ALL OF WHICH IS NEXT TO THE PHRASE "LEFT & RIGHT".

CLASS 18—LEATHER GOODS

FOR HANDBAGS (U.S. CLS. 1, 2, 3, 22 AND 41).

FIRST USE 12-27-2005; IN COMMERCE 12-27-2005.

CLASS 25—CLOTHING

FOR SHOES AND BELTS (U.S. CLS. 22 AND 39).

FIRST USE 11-30-2005; IN COMMERCE 11-30-2005.

3,299,371. THE BUXTON COMPANY, FORT WORTH, TX. SN 78-726,224. PUB. 7-11-2006, FILED 10-4-2005.

WITHOUT CLAIM TO ANY PARTICULAR FONT, STYLE, SIZE, OR COLOR.

SCOUT

THE MARK CONSISTS OF STANDARD CHARACTERS WITHOUT CLAIM TO ANY PARTICULAR FONT, STYLE, SIZE, OR COLOR.

CLASS 35—ADVERTISING AND BUSINESS

FOR ADVERTISING; PUBLIC RELATIONS; CONSULTATION IN THE FIELDS OF ADVERTISING AND PUBLIC RELATIONS; BUSINESS RESEARCH AND MARKET RESEARCH CONSULTATION; MEDIA RESEARCH, BUSINESS COMPETITIVE INTELLIGENCE AND BUSINESS COMMUNICATIONS STRATEGY ANALYSIS, AND BUSINESS PROGRAM DEVELOPMENT (U.S. CLS. 100, 101 AND 102).
FIRST USE 9-26-2001; IN COMMERCE 9-26-2001.

CLASS 35—ADVERTISING AND BUSINESS

FOR DATABASE MANAGEMENT, COLLATING AND ORGANIZING INFORMATION TO HELP COMPANIES AND INDIVIDUALS DETERMINE LOCATIONS FOR THEIR BUSINESSES (U.S. CLS. 100, 101 AND 102).
FIRST USE 5-24-2004; IN COMMERCE 5-24-2004.

CLASS 42—SCIENTIFIC, COMPUTER AND LEGAL SERVICES

FOR PRODUCT RESEARCH (U.S. CLS. 100 AND 101).
FIRST USE 9-26-2001; IN COMMERCE 9-26-2001.

CLASS 42—SCIENTIFIC, COMPUTER AND LEGAL SERVICES

FOR MAPPING (U.S. CLS. 100 AND 101).
FIRST USE 5-24-2004; IN COMMERCE 5-24-2004.

3,299,410. SIERRA HEALTHSTYLES LLC, TUCSON, AZ. SN 78-733,807. PUB. 7-4-2006, FILED 10-14-2005.

3,299,383. RIVER'S END HOLDINGS, LLC, HOPKINS, MN. SN 78-729,053. PUB. 8-1-2006, FILED 10-7-2005.

CENTER FOR LIFE IN BALANCE

RIVER'S END

THE MARK CONSISTS OF STANDARD CHARACTERS WITHOUT CLAIM TO ANY PARTICULAR FONT, STYLE, SIZE, OR COLOR.

THE MARK CONSISTS OF STANDARD CHARACTERS WITHOUT CLAIM TO ANY PARTICULAR FONT, STYLE, SIZE, OR COLOR.

OWNER OF U.S. REG. NOS. 2,114,500, 2,114,511, AND 3,005,365.

NO CLAIM IS MADE TO THE EXCLUSIVE RIGHT TO USE "CENTER", APART FROM THE MARK AS SHOWN.

OWNER OF U.S. REG. NOS. 2,293,644 AND 2,293,645.

CLASS 25—CLOTHING

FOR CLOTHING, NAMELY SHIRTS, PANTS, SHORTS, JACKETS, SWEATERS, AND CAPS (U.S. CLS. 22 AND 39).
FIRST USE 8-1-2006; IN COMMERCE 8-1-2006.

CLASS 35—ADVERTISING AND BUSINESS

FOR PROMOTING THE PUBLIC AWARENESS OF THE NEED FOR STRESS MANAGEMENT, SELF DISCOVERY AND WELLNESS OF BODY, MIND, AND SPIRIT (U.S. CLS. 100, 101 AND 102).
FIRST USE 4-14-2005; IN COMMERCE 4-14-2005.

CLASS 35—ADVERTISING AND BUSINESS

FOR WHOLESALE DISTRIBUTORSHIPS FEATURING CLOTHING AND APPAREL. (U.S. CLS. 100, 101 AND 102).
FIRST USE 2-0-2007; IN COMMERCE 2-0-2007.

CLASS 41—EDUCATION AND ENTERTAINMENT

FOR CONDUCTING WORKSHOPS, SEMINARS AND LECTURES IN THE FIELDS OF STRESS MANAGEMENT, SELF DISCOVERY, THE HEALTH AND WELLNESS OF THE BODY, MIND AND SPIRIT, FITNESS, NUTRITION, COOKING, WELLNESS, SEXUALITY, VITALITY, WOMEN'S HEALTH AND MOTHERHOOD, MOVEMENT, PERSONAL GROWTH, HEALING, YOGA, ADVENTURE, MEDITATION, ASTRONOMY, NATIVE AMERICAN CULTURE, BIKING, PHOTOGRAPHY, SWIMMING, GOLF, TENNIS, AND HORSE RIDING, AND DISTRIBUTING COURSE MATERIALS IN CONNECTION THEREWITH (U.S. CLS. 100, 101 AND 107).
FIRST USE 4-14-2005; IN COMMERCE 4-14-2005.

3,299,389. FIRST & 42ND, INC., NEW YORK, NY. SN 78-729,805. PUB. 6-27-2006, FILED 10-10-2005.

FIRST & 42ND

CLASS 43—HOTEL AND RESTAURANT SERVICES

FOR HEALTH RESORT SERVICES, NAMELY, PROVIDING FOOD AND LODGING THAT SPECIALIZE IN PROMOTING PATRONS' GENERAL HEALTH AND WELL-BEING (U.S. CLS. 100 AND 101).
FIRST USE 4-14-2005; IN COMMERCE 4-14-2005.

THE MARK CONSISTS OF STANDARD CHARACTERS

CLASS 44—MEDICAL, BEAUTY AND AGRICULTURAL SERVICES

FOR HEALTH SPA AND HEALTH CARE SERVICES FOR HEALTH AND WELLNESS OF THE MIND, BODY AND SPIRIT, NAMELY COSMETIC BODY CARE SERVICES; INTEGRATIVE MEDICAL SERVICES; MEDICAL CLINICS, CONSULTATIONS AND COUNSELING (U.S. CLS. 100 AND 101).

FIRST USE 4-14-2005; IN COMMERCE 4-14-2005.

3,299,423. CUBEWARE GMBH, ROSENHEIM, FED REP GERMANY. SN 78-735,473. PUB. 6-20-2006, FILED 10-18-2005.

cubeware

THE MARK CONSISTS OF STANDARD CHARACTERS WITHOUT CLAIM TO ANY PARTICULAR FONT, STYLE, SIZE, OR COLOR.

CLASS 41—EDUCATION AND ENTERTAINMENT

FOR ARRANGING AND CONDUCTING OF SEMINARS FOR ELECTRONIC DATA PROCESSING (U.S. CLS. 100, 101 AND 107).

FIRST USE 6-23-2005; IN COMMERCE 7-31-2005.

CLASS 42—SCIENTIFIC, COMPUTER AND LEGAL SERVICES

FOR DESIGN OF COMPUTER PROGRAMS FOR OTHERS, MAINTENANCE OF COMPUTER PROGRAMS AND SOFTWARE; UPDATING OF COMPUTER SOFTWARE; MAINTENANCE OF COMPUTER SOFTWARE (U.S. CLS. 100 AND 101).

FIRST USE 6-23-2005; IN COMMERCE 7-31-2005.

3,299,461. THE REGER GROUP, LLC, STAFFORD, VA. SN 78-738,900. PUB. 7-4-2006, FILED 10-24-2005.



OWNER OF U.S. REG. NOS. 3,010,307 AND 3,064,793.
NO CLAIM IS MADE TO THE EXCLUSIVE RIGHT TO USE "FAMILY OWNED BUSINESSES", APART FROM THE MARK AS SHOWN.

CLASS 35—ADVERTISING AND BUSINESS

FOR BUSINESS PROCESS RE-ENGINEERING SERVICES; BUSINESS MANAGEMENT CONSULTATION; ECONOMIC FORECASTING AND ANALYSIS; BUSINESS MANAGEMENT SERVICES, NAMELY, MANAGING LOGISTICS, REVERSE LOGISTICS, SUPPLY CHAIN SERVICES, SUPPLY CHAIN VISIBILITY AND SYNCHRONIZATION, SUPPLY AND DEMAND FORECASTING AND PRODUCT DISTRIBUTION PROCESSES FOR OTHERS; BUSINESS MANAGEMENT PLANNING; AND BUSINESS CONSULTING SERVICES RELATING TO PRODUCT DISTRIBUTION, OPERATIONS MANAGEMENT SERVICES, LOGISTICS, REVERSE LOGISTICS, SUPPLY CHAIN, AND PRODUCTION SYSTEMS AND DISTRIBUTION SOLUTIONS; MILITARY SCIENCE SERVICES, NAMELY, OPERATIONS MANAGEMENT SERVICES, LOGISTICS, REVERSE LOGISTICS, SUPPLY CHAIN, AND PRODUCTION SYSTEMS AND DISTRIBUTION SOLUTIONS; GOVERNMENT ORGANIZATION AND OPERATION CONSULTANCY; PROVIDING INFORMATION IN THE FIELD OF GOVERNMENT AFFAIRS (U.S. CLS. 100, 101 AND 102).

FIRST USE 6-23-2005; IN COMMERCE 6-23-2005.

CLASS 41—EDUCATION AND ENTERTAINMENT

FOR TRAINING SERVICES IN THE FIELDS OF SECURITY AND COUNTER-TERRORISM, NAMELY LEADERSHIP, TEAM BUILDING, COMMUNICATIONS, COMPUTER HARDWARE AND SOFTWARE, AND LOGISTICS (U.S. CLS. 100, 101 AND 107).

FIRST USE 6-23-2005; IN COMMERCE 6-23-2005.

CLASS 42—SCIENTIFIC, COMPUTER AND LEGAL SERVICES

FOR DESIGN AND TESTING OF NEW PRODUCTS FOR OTHERS IN THE SECURITY AND COUNTER-TERRORISM FIELDS; DESIGN FOR OTHERS IN THE FIELD OF SECURITY SYSTEMS AND COUNTER-TERRORISM DEVICES; RESEARCH AND DEVELOPMENT OF NEW PRODUCTS FOR OTHERS IN THE SECURITY AND COUNTER-TERRORISM FIELDS; AND COMPUTER SYSTEMS ANALYSIS IN THE AREA OF SECURITY AND COUNTER-TERRORISM; RESEARCH AND DEVELOPMENT AND PLANNING AND DESIGN OF SECURITY AND COUNTER-TERRORISM PLANS AND PROCEDURES FOR OTHERS (U.S. CLS. 100 AND 101).

FIRST USE 6-23-2005; IN COMMERCE 6-23-2005.

CLASS 45—PERSONAL SERVICES

FOR SECURITY SERVICES, NAMELY, TECHNICAL SURVEILLANCE, COUNTER-TERRORISM, PHYSICAL, CYBER, AND OPERATIONAL SECURITY ASSESSMENT, PLANNING, DEVELOPMENT, INTEGRATION AND IMPLEMENTATION; CONSULTING IN THE FIELDS OF NATIONAL SECURITY AND COUNTER-TERRORISM; AND REVIEW AND ANALYSIS OF OTHERS' SECURITY AND COUNTER-TERRORISM PLANS AND PROCEDURES; PROVIDING INFORMATION IN THE FIELD OF THE MILITARY, MILITARY TACTICS, AND STRATEGIES (U.S. CLS. 100 AND 101).

FIRST USE 6-23-2005; IN COMMERCE 6-23-2005.

3,299,463. HAMBORG, PETER MARK, HUNTINGTON BEACH, CA. SN 78-739,155. PUB. 6-27-2006, FILED 10-24-2005.

hamborgs

CLASS 25—CLOTHING

FOR BASEBALL CAPS; CAPS; SHORT-SLEEVED OR LONG-SLEEVED T-SHIRTS (U.S. CLS. 22 AND 39).

FIRST USE 11-0-2005; IN COMMERCE 11-0-2005.

CLASS 28—TOYS AND SPORTING GOODS

FOR SKATEBOARDS (U.S. CLS. 22, 23, 38 AND 50).
FIRST USE 11-0-2005; IN COMMERCE 11-0-2005.

3,299,464. WAVEFRONT TECHNOLOGY, INC., PARAMOUNT, CA. SN 78-739,316. PUB. 12-19-2006, FILED 10-24-2005.

TMD

THE MARK CONSISTS OF STANDARD CHARACTERS WITHOUT CLAIM TO ANY PARTICULAR FONT, STYLE, SIZE, OR COLOR.

CLASS 11—ENVIRONMENTAL CONTROL APPARATUS

FOR LIGHT DIFFUSERS (U.S. CLS. 13, 21, 23, 31 AND 34).
FIRST USE 11-1-2006; IN COMMERCE 11-1-2006.

CLASS 17—RUBBER GOODS

FOR PLASTIC, THERMOPLASTIC, AND POLYMERIC LIGHT-MANAGEMENT FILMS AND SHEETING USED TO ENHANCE AND CONTROL BRIGHTNESS, LIGHT DIRECTION, CONTRAST, VIEWABILITY OR POWER CONSUMPTION IN COMPUTER MONITOR SCREENS, DISPLAYS FOR LAPTOPS AND OTHER COMPUTERS, VIEWING SCREENS AND LARGE AND SMALL DISPLAYS FOR PHONES, PAGERS, AND OTHER HAND-HELD ELECTRONIC DEVICES, TELEVISION SET AND VIDEO MONITOR SCREENS, VIDEO DISPLAY TERMINALS, ELECTRONIC INSTRUMENTATION DISPLAYS, POINT-OF-PURCHASE MACHINE DISPLAYS, AND REAR PROJECTION SCREENS (U.S. CLS. 1, 5, 12, 13, 35 AND 50).
FIRST USE 11-1-2006; IN COMMERCE 11-1-2006.

3,299,468. STAPLES, SEAN, EL DORADO HILLS, CA. SN 78-739,695. PUB. 6-20-2006, FILED 10-25-2005.

SHINE

THE MARK CONSISTS OF STANDARD CHARACTERS WITHOUT CLAIM TO ANY PARTICULAR FONT, STYLE, SIZE, OR COLOR.

CLASS 15—MUSICAL INSTRUMENTS

FOR CUSTOM BUILT DRUMS (U.S. CLS. 2, 21 AND 36).
FIRST USE 2-1-2005; IN COMMERCE 2-1-2005.

CLASS 25—CLOTHING

FOR CLOTHING, NAMELY, T-SHIRTS, HATS, SHOES, GLOVES, PANTS, SHORTS, BEANIES, VISORS, WRIST SWEAT BANDS, SPORTS JERSEYS, TRACK SUITS, JACKETS, BELTS, SOCKS, SWEATSHIRTS, HOODIES, CASUAL SPORT SHIRTS (U.S. CLS. 22 AND 39).
FIRST USE 1-1-2005; IN COMMERCE 1-1-2005.

3,299,476. LARRY H. MILLER BASEBALL, INC., SANDY, UT. SN 78-741,191. PUB. 11-14-2006, FILED 10-26-2005.



THE MARK CONSISTS OF BUMBLE BEE WEARING BASEBALL CAP AND HOLDING BASEBALL BAT.

CLASS 21—HOUSEWARES AND GLASS

FOR BEVERAGE CONTAINERS, NAMELY, DRINKING GLASSES, CUPS AND MUGS (U.S. CLS. 2, 13, 23, 29, 30, 33, 40 AND 50).
FIRST USE 10-27-2005; IN COMMERCE 10-27-2005.

CLASS 25—CLOTHING

FOR CLOTHING, NAMELY, CAPS, HATS, HEADWEAR, SHIRTS, T-SHIRTS, TURTLENECKS, SHORTS, PANTS, BASEBALL UNIFORMS, JERSEYS, SWEATSHIRTS, SWEATPANTS, SLEEPWEAR, JACKETS, FOOTWEAR, SOCKS (U.S. CLS. 22 AND 39).
FIRST USE 10-27-2005; IN COMMERCE 10-27-2005.

3,299,485. BSH HOME APPLIANCES CORPORATION, HUNTINGTON BEACH, CA. SN 78-742,692. PUB. 7-4-2006, FILED 10-28-2005.

DLX SERIES

THE MARK CONSISTS OF STANDARD CHARACTERS WITHOUT CLAIM TO ANY PARTICULAR FONT, STYLE, SIZE, OR COLOR.

NO CLAIM IS MADE TO THE EXCLUSIVE RIGHT TO USE "SERIES", APART FROM THE MARK AS SHOWN.

CLASS 7—MACHINERY

FOR CLOTHES WASHING MACHINES AND MACHINE PARTS THEREOF (U.S. CLS. 13, 19, 21, 23, 31, 34 AND 35).
FIRST USE 4-1-2005; IN COMMERCE 4-1-2005.

CLASS 11—ENVIRONMENTAL CONTROL APPARATUS

FOR CLOTHES DRYERS THAT SPIN AND TUMBLE, AND PARTS THEREOF (U.S. CLS. 13, 21, 23, 31 AND 34).
FIRST USE 4-1-2005; IN COMMERCE 4-1-2005.

3,299,495. STERLING PUBLISHING CO., INC., NEW YORK, NY. SN 78-744,260. PUB. 12-12-2006, FILED 11-1-2005.

CREATE WITH THE DESIGNERS

THE MARK CONSISTS OF STANDARD CHARACTERS WITHOUT CLAIM TO ANY PARTICULAR FONT, STYLE, SIZE, OR COLOR.

CLASS 9—ELECTRICAL AND SCIENTIFIC APPARATUS

FOR SERIES OF PRE-RECORDED INTERACTIVE DVDS, COMPACT DISCS AND COMPUTER CD-ROMS FEATURING INFORMATION ON HANDICRAFT AND HOBBY SUBJECTS (U.S. CLS. 21, 23, 26, 36 AND 38).
FIRST USE 6-30-2006; IN COMMERCE 6-30-2006.

CLASS 16—PAPER GOODS AND PRINTED MATTER

FOR SERIES OF INSTRUCTIONAL BOOKS ON HANDICRAFT AND HOBBY SUBJECTS (U.S. CLS. 2, 5, 22, 23, 29, 37, 38 AND 50).
FIRST USE 6-30-2006; IN COMMERCE 6-30-2006.

3,299,499. MOBILEJAM, LLC, KENMORE, WA. SN 78-744,639. PUB. 7-4-2006, FILED 11-1-2005.

PARTY'S AT MY HOUSE

THE MARK CONSISTS OF STANDARD CHARACTERS WITHOUT CLAIM TO ANY PARTICULAR FONT, STYLE, SIZE, OR COLOR.

CLASS 38—COMMUNICATION

FOR COMMUNICATIONS SERVICES, NAMELY, TRANSMITTING STREAMED SOUND AND AUDIO-VISUAL RECORDINGS VIA THE INTERNET; ELECTRONIC VOICE MESSAGING, NAMELY, THE RECORDING AND SUBSEQUENT TRANSMISSION OF VOICE MESSAGES BY TELEPHONE; NETWORK CONFERENCING SERVICES; PROVIDING ON-LINE CHAT ROOMS AND ELECTRONIC BULLETIN BOARDS FOR TRANSMISSION OF MESSAGES AMONG USERS IN THE FIELD OF GENERAL INTEREST; PROVIDING ON-LINE CHAT ROOMS FOR TRANSMISSION OF MESSAGES AMONG COMPUTER USERS CONCERNING TOPICS IN THE FIELD OF MATCHMAKING AND DATING; PROVIDING TELEPHONE CONFERENCING SERVICES; TELECOMMUNICATION SERVICES, NAMELY, LOCAL AND LONG DISTANCE TRANSMISSION OF VOICE, DATA, GRAPHICS BY MEANS OF TELEPHONE, TELEGRAPHIC, CABLE, AND SATELLITE TRANSMISSIONS; TRANSMISSION OF SOUND, VIDEO AND INFORMATION; VIDEO TELECONFERENCING; WEB CONFERENCING SERVICES (U.S. CLS. 100, 101 AND 104).
FIRST USE 3-26-2007; IN COMMERCE 3-26-2007.

CLASS 45—PERSONAL SERVICES

FOR DATING SERVICES; MATCHMAKING SERVICES; WEB SITE SERVICES FEATURING ON-LINE DATING CLUB (U.S. CLS. 100 AND 101).
FIRST USE 3-26-2007; IN COMMERCE 3-26-2007.

3,299,521. MELIE BIANCO ACCESSORIES, INC., LOS ANGELES, CA. SN 78-748,715. PUB. 7-18-2006, FILED 11-7-2005.

MELIE

THE MARK CONSISTS OF STANDARD CHARACTERS WITHOUT CLAIM TO ANY PARTICULAR FONT, STYLE, SIZE, OR COLOR.

THE NAME MELIE DOES NOT IDENTIFY A LIVING INDIVIDUAL.

CLASS 14—JEWELRY

FOR JEWELRY (U.S. CLS. 2, 27, 28 AND 50).
FIRST USE 1-5-2007; IN COMMERCE 1-5-2007.

CLASS 25—CLOTHING

FOR MEN'S, WOMEN'S, BOY'S, AND GIRL'S CLOTHING, NAMELY, SHOES, BOOTS, KNIT AND WOVEN SHIRTS; BLOUSES, KNIT AND WOVEN PANTS, SHORTS, AND JEANS; SWEATERS, JACKETS, VESTS, COATS, RAINWEAR, BELTS, HATS, GLOVES, SOCKS, FOOTWEAR, SANDALS, SCARVES, TIES, ASCOTS, AND NECKERCHIEFS; SUSPENDERS, CAPS, SUITS, BLAZERS, JACKETS, WIND RESISTANT JACKETS, SWEATSHIRTS, T-SHIRTS, TROUSERS, SHIRTS AND SPORTSHIRTS; PAJAMAS, HOSIERY, TANK TOPS, SWEATS, SLIPPERS, SNEAKERS, UNDERWEAR, DRESSES, SKIRTS, PANTS, AND HEADWEAR; VESTS, SPORT SHIRTS, SWIMWEAR, JOGGING SUITS, UNDERWEAR, LINGERIE, TEE SHIRTS, STOCKINGS, TIGHTS, ROBES, PAJAMAS, UNDERSHIRTS, LEGGINGS, PANTIES, BRAS, AND TEDDIES (U.S. CLS. 22 AND 39).

FIRST USE 1-5-2007; IN COMMERCE 1-5-2007.

3,299,528. TITLE INSURANCE NATIONAL INFORMATION EXCHANGE, LLC, EVANSTON, IL. SN 78-750,240. PUB. 7-11-2006, FILED 11-9-2005.

3,299,539. CASTELLA IMPORTS, INC., HAUPPAUGE, NY. SN 78-752,083. PUB. 2-6-2007, FILED 11-11-2005.

TINIX

REGAL

THE MARK CONSISTS OF STANDARD CHARACTERS WITHOUT CLAIM TO ANY PARTICULAR FONT, STYLE, SIZE, OR COLOR.

THE MARK CONSISTS OF STANDARD CHARACTERS WITHOUT CLAIM TO ANY PARTICULAR FONT, STYLE, SIZE, OR COLOR.

CLASS 36—INSURANCE AND FINANCIAL

FOR REAL ESTATE ACQUISITION SERVICES; PROVIDING INFORMATION IN THE FIELD OF REAL ESTATE BY MEANS OF A WEB SITE (U.S. CLS. 100, 101 AND 102).
FIRST USE 7-4-2006; IN COMMERCE 7-4-2006.

CLASS 2—PAINTS

FOR FOOD COLORS FOR DOMESTIC USE (U.S. CLS. 6, 11 AND 16).
FIRST USE 12-15-1967; IN COMMERCE 12-15-1967.

CLASS 42—SCIENTIFIC, COMPUTER AND LEGAL SERVICES

FOR REAL ESTATE CLOSING SERVICES (U.S. CLS. 100 AND 101).
FIRST USE 7-4-2006; IN COMMERCE 7-4-2006.

CLASS 30—STAPLE FOODS

FOR FOOD EXTRACTS USED AS FLAVORING (U.S. CL. 46).
FIRST USE 12-15-1967; IN COMMERCE 12-15-1967.

CLASS 45—PERSONAL SERVICES

FOR FRAUD DETECTION AND FRAUD REDUCTION SERVICES IN THE FIELD OF TITLE INSURANCE; FRAUD DETECTION AND FRAUD REDUCTION SERVICES IN THE FIELD OF MORTGAGE LENDING (U.S. CLS. 100 AND 101).
FIRST USE 7-4-2006; IN COMMERCE 7-4-2006.

3,299,564. QUEENSTAMP COMPANY LIMITED, ROAD TOWN, TORTOLA, BR. VIRGIN ISLANDS. SN 78-754,756. PUB. 11-14-2006, FILED 11-16-2005.

3,299,533. LAND O'LAKES PURINA FEED LLC, SHOREVIEW, MN. SN 78-750,974. PUB. 8-29-2006, FILED 11-10-2005.

RANGELAND RATION MANAGER



THE MARK CONSISTS OF STANDARD CHARACTERS WITHOUT CLAIM TO ANY PARTICULAR FONT, STYLE, SIZE, OR COLOR.

NO CLAIM IS MADE TO THE EXCLUSIVE RIGHT TO USE "PRINT", APART FROM THE MARK AS SHOWN.

OWNER OF U.S. REG. NO. 3,085,192.
NO CLAIM IS MADE TO THE EXCLUSIVE RIGHT TO USE "RATION MANAGER", APART FROM THE MARK AS SHOWN.

CLASS 5—PHARMACEUTICALS

FOR MEDICATED ANIMAL FEED (U.S. CLS. 6, 18, 44, 46, 51 AND 52).
FIRST USE 5-1-2006; IN COMMERCE 5-1-2006.

CLASS 2—PAINTS

FOR TONER FOR PRINTERS; TONER CARTRIDGES; PRINTERS INK; INKJET PRINTER INK; COLORANTS FOR USE IN THE MANUFACTURE OF PRINTING INK; PRINTING INKS, COATINGS, PIGMENTS AND DISPERSIONS FOR USE IN THE GRAPHIC ARTS INDUSTRY; PRINTER INK CARTRIDGES; INK JET CARTRIDGES FILLED; INKJET PRINTER CARTRIDGES; INKJET PRINTER CLEANING CARTRIDGES; REFILL INK KITS COMPRISED OF BOTTLES OF INK, INK JET CARTRIDGE DRILL, POWDER AND LIQUID IMAGING TONER AND INKS; INKJET PRINTER CLEANING CARTRIDGES (U.S. CLS. 6, 11 AND 16).
FIRST USE 10-22-2005; IN COMMERCE 10-22-2005.

CLASS 31—NATURAL AGRICULTURAL PRODUCTS

FOR ANIMAL FEED (U.S. CLS. 1 AND 46).
FIRST USE 5-1-2006; IN COMMERCE 5-1-2006.

CLASS 9—ELECTRICAL AND SCIENTIFIC APPARATUS

FOR COMPUTER PARTS, ACCESSORIES AND PERIPHERALS, NAMELY COMPUTER MOUSE, LOUDSPEAKERS, PRINTERS FOR USE WITH COMPUTERS; COMPUTER CLEANING CARTRIDGES; PRINTER EQUIPMENTS AND ACCESSORIES, NAMELY EMPTY INK CARTRIDGES FOR INK-JET PRINTERS, CLIPS FOR CLAMPING INK CARTRIDGES, AND INKJET PRINTERS; COMPONENTS FOR LASER TONER CARTRIDGES, NAMELY, REPLACEMENT DRUMS AND ROLLERS (U.S. CLS. 21, 23, 26, 36 AND 38).

FIRST USE 10-22-2005; IN COMMERCE 10-22-2005.

CLASS 16—PAPER GOODS AND PRINTED MATTER

FOR PRINTER PAPERS; THERMAL PAPERS; PAPER COMPUTER DISK LABELS; COMPUTER PRINTER PAPERS; BLANK PAPER LABELS; ENVELOPES; PLASTIC AND PAPER INKJET TRANSPARENCY; INK RIBBONS; PRINTER RIBBONS; PRINTING ACCESSORIES AND PARTS, NAMELY DUPLICATING INK, AND INK RIBBON CASSETTES FOR COMPUTER PRINTERS; STATIONERY (U.S. CLS. 2, 5, 22, 23, 29, 37, 38 AND 50).

FIRST USE 10-22-2005; IN COMMERCE 10-22-2005.

CLASS 25—CLOTHING

FOR CLOTHING, NAMELY, PLAYER UNIFORMS, FOOTWEAR, CHEERLEADER UNIFORMS, REPLICAS UNIFORM SHIRTS, WOOL HATS, PAINTER CAPS, BASEBALL CAPS, VISORS, HEADBANDS, WRISTBANDS, SHIRTS, TANK TOPS, JERSEY TOPS, SWEATPANTS, SWEATSHIRTS AND TEESHIRTS (U.S. CLS. 22 AND 39).

FIRST USE 1-1-2006; IN COMMERCE 1-1-2007.

CLASS 28—TOYS AND SPORTING GOODS

FOR TOYS AND SPORTING GOODS, NAMELY, STUFFED ANIMALS, BASEBALLS, BASEBALL BATS, BASEBALL BATTING TEES, BATTING GRIPS, BATTING GLOVES, BEAN BAGS, TOY BANKS, BASEBALL MITTS, CHRISTMAS TREE ORNAMENTS, AND PLAYING CARDS (U.S. CLS. 22, 23, 38 AND 50).

FIRST USE 1-1-2006; IN COMMERCE 1-1-2007.

CLASS 41—EDUCATION AND ENTERTAINMENT

FOR ENTERTAINMENT SERVICES IN THE NATURE OF BASEBALL EXHIBITIONS (U.S. CLS. 100, 101 AND 107).

FIRST USE 1-1-2006; IN COMMERCE 1-1-2007.

3,299,576. AUGUSTA PROFESSIONAL BASEBALL LLC, BALTIMORE, MD. SN 78-756,712. PUB. 2-13-2007, FILED 11-18-2005.



NO CLAIM IS MADE TO THE EXCLUSIVE RIGHT TO USE "AUGUSTA", APART FROM THE MARK AS SHOWN. THE COLOR(S) WHITE, BLACK, GREY, ORANGE AND GREEN IS/ARE CLAIMED AS A FEATURE OF THE MARK.

THE MARK CONSISTS OF A BEE WITH AN ORANGE AND BLACK BODY OUTLINED IN GREY, WHITE EYES AND WINGS OUTLINED IN BLACK AND GREY, WEARING A GREEN JACKET WITH GREY BUTTONS AND HOLDING TWO GREY BASEBALL BATS. THE WORD "AUGUSTA" IN ORANGE LETTERS AND THE WORD "GREENJACKETS" IN WHITE LETTERS APPEAR ACROSS THE FRONT OF THE BEE'S BODY. TWO GREY GOLF CLUBS WITH GREEN HANDLES APPEAR BELOW THE WORD "GREENJACKETS".

CLASS 16—PAPER GOODS AND PRINTED MATTER

FOR PAPER GOODS AND PRINTED MATERIALS, NAMELY BUMPER STICKERS, GAME TICKETS, DECALS, MEMO PADS, NOTE PAPER, BASEBALL CARDS, EVENT PROGRAMS, MAGAZINES FEATURING BASEBALL AND SPORTS, COLORING BOOKS, POSTCARDS, PAPER PENNANTS AND CALENDARS (U.S. CLS. 2, 5, 22, 23, 29, 37, 38 AND 50).

FIRST USE 1-1-2006; IN COMMERCE 1-1-2007.

3,299,584. UNITED PARCEL SERVICE OF AMERICA, INC., ATLANTA, GA. SN 78-758,402. PUB. 4-11-2006, FILED 11-21-2005.

UPS FREIGHT

THE MARK CONSISTS OF STANDARD CHARACTERS WITHOUT CLAIM TO ANY PARTICULAR FONT, STYLE, SIZE, OR COLOR.

OWNER OF U.S. REG. NOS. 514,285, 735,064, AND OTHERS.

NO CLAIM IS MADE TO THE EXCLUSIVE RIGHT TO USE "FREIGHT", APART FROM THE MARK AS SHOWN.

CLASS 9—ELECTRICAL AND SCIENTIFIC APPARATUS

FOR SOFTWARE FOR USE IN PREPARING AND PRINTING SHIPPING DOCUMENTS AND INVOICES AND TRACKING SHIPPED PACKAGES AND FREIGHT, AND FOR LOGISTICS PLANNING AND SUPPLY CHAIN MANAGEMENT SOLUTIONS (U.S. CLS. 21, 23, 26, 36 AND 38).

FIRST USE 5-1-2006; IN COMMERCE 5-1-2006.

CLASS 35—ADVERTISING AND BUSINESS

FOR COMPUTERIZED TRACKING AND TRACING OF PACKAGES AND FREIGHT IN TRANSIT, NAMELY, PROVIDING COMPUTERIZED INFORMATION ON DOMESTIC AND INTERNATIONAL TRANSPORTATION AND DELIVERY SERVICES (U.S. CLS. 100, 101 AND 102).

FIRST USE 5-1-2006; IN COMMERCE 5-1-2006.

CLASS 39—TRANSPORTATION AND STORAGE

FOR FREIGHT FORWARDING; TRANSPORTATION AND DELIVERY OF PERSONAL PROPERTY BY AIR, RAIL, BOAT AND MOTOR VEHICLE; WAREHOUSING, STORAGE, PACKING, DELIVERY AND RETURNS WITH RESPECT TO THE TRANSPORTATION AND DELIVERY OF PERSONAL PROPERTY (U.S. CLS. 100 AND 105).

FIRST USE 5-1-2006; IN COMMERCE 5-1-2006.

3,299,603. CONAIR CORPORATION, STAMFORD, CT. SN 78-763,869. PUB. 5-23-2006, FILED 11-30-2005.

WARING

THE MARK CONSISTS OF STANDARD CHARACTERS WITHOUT CLAIM TO ANY PARTICULAR FONT, STYLE, SIZE, OR COLOR.

OWNER OF U.S. REG. NOS. 605,403, 605,699, AND 2,843,844.

3,299,592. WINGERT, KERSTIN OLIVIA, PHOENIX, AZ. AND WINGERT, WILLIAM BRITTON, PHOENIX, AZ. SN 78-762,286. PUB. 1-23-2007, FILED 11-29-2005.

SOUVIA

THE MARK CONSISTS OF STANDARD CHARACTERS WITHOUT CLAIM TO ANY PARTICULAR FONT, STYLE, SIZE, OR COLOR.

CLASS 35—ADVERTISING AND BUSINESS

FOR RETAIL STORE SERVICES FEATURING TEA, HERBAL TEA, TEA-BASED BEVERAGES, HERBAL TEA-BASED BEVERAGES, TISANE-BASED BEVERAGES, LOOSE TEA, LOOSE HERBAL TEA, LOOSE TEA WITH FRUIT FLAVORING, LOOSE HERBAL TEA WITH FRUIT FLAVORING, TEA-BASED BEVERAGES WITH FRUIT FLAVORING, HERBAL TEA-BASED BEVERAGES WITH FRUIT FLAVORING, TEA BAGS, TEAWARE, NAMELY, TEAPOTS, TEACUPS, TEA SAUCERS, TEA PLATES, TEA INFUSERS NOT OF PRECIOUS METAL, TEA SCOOPS, TEA BAG HOLDERS, FOODS INCORPORATING TEA AS AN INGREDIENT, NAMELY, PASTRIES, BREADS, BAKED GOODS, SAUCES, MARINADES; COMPUTERIZED ON LINE ORDERING SERVICES FEATURING TEA, HERBAL TEA, TEA-BASED BEVERAGES, HERBAL TEA-BASED BEVERAGES, TISANE-BASED BEVERAGES, LOOSE TEA, LOOSE HERBAL TEA, LOOSE TEA WITH FRUIT FLAVORING, LOOSE HERBAL TEA WITH FRUIT FLAVORING, TEA-BASED BEVERAGES WITH FRUIT FLAVORING, HERBAL TEA-BASED BEVERAGES WITH FRUIT FLAVORING, TEA BAGS, TEAPOTS, TEACUPS, TEA SAUCERS, TEA PLATES, TEA INFUSERS NOT OF PRECIOUS METAL, TEA SCOOPS, TEA BAG HOLDERS, AND FOODS INCORPORATING TEA AS AN INGREDIENT, NAMELY, PASTRIES, BREADS, BAKED GOODS, SAUCES, MARINADES; RETAIL STORE SERVICES FEATURING TEA, BAKED GOODS, AND BEVERAGES FOR CONSUMPTION ON OR OFF THE PREMISES (U.S. CLS. 100, 101 AND 102).

FIRST USE 5-1-2005; IN COMMERCE 5-1-2005.

CLASS 41—EDUCATION AND ENTERTAINMENT

FOR EDUCATIONAL SERVICES, NAMELY, CONDUCTING CLASSES, SEMINARS, CONFERENCES, AND WORKSHOPS FOR OTHERS IN THE FIELDS OF TEA, TEA TASTING, TEA BREWING, COOKING WITH TEA, TEA FLIGHT TASTING; DEVELOPMENT AND DISSEMINATION OF EDUCATIONAL MATERIALS FOR OTHERS IN THE FIELDS OF TEA, TEA TASTING, TEA BREWING, COOKING WITH TEA, TEA FLIGHT TASTING (U.S. CLS. 100, 101 AND 107).

FIRST USE 5-1-2005; IN COMMERCE 5-1-2005.

CLASS 7—MACHINERY

FOR ELECTRIC COFFEE GRINDERS; ELECTRIC FOOD BLENDERS; ELECTRIC JUICE EXTRACTORS; JUICE EXTRACTORS; JUICE MACHINES (U.S. CLS. 13, 19, 21, 23, 31, 34 AND 35).

FIRST USE 1-1-1952; IN COMMERCE 1-1-1952.

CLASS 11—ENVIRONMENTAL CONTROL APPARATUS

FOR ELECTRIC COFFEE MAKERS; ELECTRIC COFFEE PERCOLATORS; ELECTRIC COFFEE POTS (U.S. CLS. 13, 21, 23, 31 AND 34).

FIRST USE 1-1-1952; IN COMMERCE 1-1-1952.

3,299,604. NUMARA SOFTWARE, INC., TAMPA, FL. SN 78-764,325. PUB. 8-15-2006, FILED 12-1-2005.

NUMARA

THE MARK CONSISTS OF STANDARD CHARACTERS WITHOUT CLAIM TO ANY PARTICULAR FONT, STYLE, SIZE, OR COLOR.

CLASS 9—ELECTRICAL AND SCIENTIFIC APPARATUS

FOR COMPUTER SOFTWARE FOR USE IN THE FIELD OF HELP DESK MANAGEMENT, NAMELY COMPUTER SOFTWARE FOR TRACKING AND MANAGING INFORMATION TECHNOLOGY SUPPORT REQUESTS AND INCIDENT REPORTS FROM USERS AND FOR TRACKING AND MANAGING TECHNOLOGY EQUIPMENT SUPPORT HISTORIES AND SUPPORT COST REPORTING; COMPUTER SOFTWARE FOR USE IN THE FIELD OF INFORMATION TECHNOLOGY ASSET MANAGEMENT, NAMELY COMPUTER SOFTWARE FOR TRACKING, MANAGING AND AUDITING COMPUTER SOFTWARE LICENSES AND COMPLIANCE AND FOR TRACKING AND MANAGING INFORMATION ON COMPUTER HARDWARE ASSETS, LEASE, USER, VENDOR, INSTALLATION AND SYSTEM CONFIGURATION, ASSET PURCHASING AND INSTALLATION AND DEPLOYMENT OF COMPUTER SOFTWARE AND SOFTWARE UPDATES BY LOCAL OR REMOTE MEANS (U.S. CLS. 21, 23, 26, 36 AND 38).

FIRST USE 12-12-2005; IN COMMERCE 12-12-2005.

CLASS 42—SCIENTIFIC, COMPUTER AND LEGAL SERVICES

FOR INSTALLATION AND MAINTENANCE OF COMPUTER SOFTWARE FOR USE IN THE FIELD OF HELP DESK MANAGEMENT; INSTALLATION AND MAINTENANCE OF COMPUTER SOFTWARE FOR USE IN THE FIELD OF INFORMATION TECHNOLOGY ASSET MANAGEMENT (U.S. CLS. 100 AND 101).

FIRST USE 12-12-2005; IN COMMERCE 12-12-2005.

3,299,625. FGE LLC, PHOENIX, AZ. SN 78-768,664. PUB. 9-26-2006, FILED 12-7-2005.

Licensed to Blow

THE MARK CONSISTS OF STANDARD CHARACTERS WITHOUT CLAIM TO ANY PARTICULAR FONT, STYLE, SIZE, OR COLOR.

CLASS 9—ELECTRICAL AND SCIENTIFIC APPARATUS

FOR MOTION PICTURE FILMS ABOUT ADULT ENTERTAINMENT; PRE-RECORDED CD'S, VIDEO TAPES, LASER DISKS AND DVD'S FEATURING ADULT ENTERTAINMENT (U.S. CLS. 21, 23, 26, 36 AND 38).

FIRST USE 12-29-2005; IN COMMERCE 12-29-2005.

CLASS 41—EDUCATION AND ENTERTAINMENT

FOR ENTERTAINMENT IN THE NATURE OF AN ADULT ENTERTAINMENT WEBSITE (U.S. CLS. 100, 101 AND 107).

FIRST USE 12-29-2005; IN COMMERCE 12-29-2005.

3,299,631. NUMARA SOFTWARE, INC., TAMPA, FL. SN 78-769,966. PUB. 11-28-2006, FILED 12-9-2005.



NO CLAIM IS MADE TO THE EXCLUSIVE RIGHT TO USE "SOFTWARE", APART FROM THE MARK AS SHOWN.

THE MARK CONSISTS OF THE WORD NUMARA, WITH A CURVED LINE BEGINNING BELOW THE WORD AND CONTINUING UPWARDS THROUGH THE LETTERS ARA, PLUS THE WORD SOFTWARE.

CLASS 9—ELECTRICAL AND SCIENTIFIC APPARATUS

FOR COMPUTER SOFTWARE FOR USE IN THE FIELD OF HELP DESK MANAGEMENT, NAMELY COMPUTER SOFTWARE FOR TRACKING AND MANAGING INFORMATION TECHNOLOGY SUPPORT REQUESTS AND INCIDENT REPORTS FROM USERS AND FOR TRACKING AND MANAGING TECHNOLOGY EQUIPMENT SUPPORT HISTORIES AND SUPPORT COST REPORTING; COMPUTER SOFTWARE FOR USE IN THE FIELD OF INFORMATION TECHNOLOGY ASSET MANAGEMENT, NAMELY COMPUTER SOFTWARE FOR TRACKING, MANAGING AND AUDITING COMPUTER SOFTWARE LICENSES AND COMPLIANCE AND FOR TRACKING AND MANAGING INFORMATION ON COMPUTER HARDWARE ASSETS, LEASE, USER, VENDOR, INSTALLATION AND SYSTEM CONFIGURATION, ASSET PURCHASING AND INSTALLATION AND DEPLOYMENT OF COMPUTER SOFTWARE AND SOFTWARE UPDATES BY LOCAL OR REMOTE MEANS (U.S. CLS. 21, 23, 26, 36 AND 38).

FIRST USE 12-12-2005; IN COMMERCE 12-12-2005.

CLASS 42—SCIENTIFIC, COMPUTER AND LEGAL SERVICES

FOR INSTALLATION AND MAINTENANCE OF COMPUTER SOFTWARE FOR USE IN THE FIELD OF HELP DESK MANAGEMENT; INSTALLATION AND MAINTENANCE OF COMPUTER SOFTWARE FOR USE IN THE FIELD OF INFORMATION TECHNOLOGY ASSET MANAGEMENT (U.S. CLS. 100 AND 101).

FIRST USE 12-12-2005; IN COMMERCE 12-12-2005.

3,299,687. M2 VENTURES LLC, SACHSE, TX. SN 78-785,058. PUB. 1-9-2007, FILED 1-4-2006.

PERFECT SCENTS

THE MARK CONSISTS OF STANDARD CHARACTERS WITHOUT CLAIM TO ANY PARTICULAR FONT, STYLE, SIZE, OR COLOR.

NO CLAIM IS MADE TO THE EXCLUSIVE RIGHT TO USE "SCENTS", APART FROM THE MARK AS SHOWN.

CLASS 3—COSMETICS AND CLEANING PREPARATIONS

FOR NON-MEDICATED GROOMING PREPARATIONS FOR PETS, NAMELY WATER-BASED ODOR REPELLING SOLUTIONS SPRAYED ON ANIMALS USING A HAND-HELD BRUSH (U.S. CLS. 1, 4, 6, 50, 51 AND 52).

FIRST USE 12-2-2005; IN COMMERCE 2-15-2006.

CLASS 21—HOUSEWARES AND GLASS

FOR ANIMAL GROOMING BRUSHES, ELECTRIC BRUSHES FOR GROOMING ANIMALS, AND DEVICES FOR GROOMING PETS AND ANIMALS COMPRISED OF A BUILT-IN BRUSH HEAD AND DISPENSER OR SPRAYER FOR DISPENSING NON-MEDICATED PREPARATIONS FOR PET GROOMING, SAID DEVICE SOLD EMPTY (U.S. CLS. 2, 13, 23, 29, 30, 33, 40 AND 50).

FIRST USE 12-2-2005; IN COMMERCE 2-15-2006.

3,299,688. THE REGER GROUP, LLC, STAFFORD, VA. SN 78-785,665. PUB. 7-4-2006, FILED 1-5-2006.



OWNER OF U.S. REG. NOS. 3,010,307 AND 3,064,793. NO CLAIM IS MADE TO THE EXCLUSIVE RIGHT TO USE "GROUP", APART FROM THE MARK AS SHOWN.

CLASS 35—ADVERTISING AND BUSINESS

FOR INFORMATION IN THE FIELD OF GOVERNMENT AFFAIRS; GOVERNMENT ORGANIZATION AND OPERATION CONSULTANCY (U.S. CLS. 100, 101 AND 102).
FIRST USE 10-4-2004; IN COMMERCE 12-20-2004.

CLASS 41—EDUCATION AND ENTERTAINMENT

FOR TRAINING SERVICES IN THE FIELD OF DEFENSE AND OTHER MILITARY SCIENCES; ARRANGING PROFESSIONAL WORKSHOP AND TRAINING COURSES (U.S. CLS. 100, 101 AND 107).
FIRST USE 10-4-2004; IN COMMERCE 12-20-2004.

CLASS 42—SCIENTIFIC, COMPUTER AND LEGAL SERVICES

FOR RESEARCH IN THE FIELD OF INTELLIGENCE AND SECURITY (U.S. CLS. 100 AND 101).
FIRST USE 10-4-2004; IN COMMERCE 12-20-2004.

CLASS 45—PERSONAL SERVICES

FOR CONSULTING SERVICES IN THE FIELD OF NATIONAL SECURITY; PROVIDING INFORMATION IN THE FIELD OF THE MILITARY, MILITARY TACTICS AND STRATEGIES; MILITARY SCIENCE SERVICES, NAMELY, ANALYZING WAR STRATEGIES (U.S. CLS. 100 AND 101).
FIRST USE 10-4-2004; IN COMMERCE 12-20-2004.

3,299,729. NEUROCOM INTERNATIONAL, INC., CLACKAMAS, OR. SN 78-795,273. PUB. 10-31-2006, FILED 1-20-2006.

BALANCE MANAGER

THE MARK CONSISTS OF STANDARD CHARACTERS WITHOUT CLAIM TO ANY PARTICULAR FONT, STYLE, SIZE, OR COLOR.

OWNER OF U.S. REG. NO. 1,525,362. NO CLAIM IS MADE TO THE EXCLUSIVE RIGHT TO USE "BALANCE", APART FROM THE MARK AS SHOWN.

CLASS 9—ELECTRICAL AND SCIENTIFIC APPARATUS

FOR COMPUTER SOFTWARE FOR ASSESSING AND TREATING BALANCE AND MOBILITY DISORDERS (U.S. CLS. 21, 23, 26, 36 AND 38).
FIRST USE 2-15-2007; IN COMMERCE 2-15-2007.

CLASS 10—MEDICAL APPARATUS

FOR MEDICAL APPARATUS, NAMELY, DYNAMIC AND STATIC COMPUTERIZED FORCE PLATFORMS FOR ASSESSING AND TREATING BALANCE AND MOBILITY DISORDERS (U.S. CLS. 26, 39 AND 44).
FIRST USE 4-3-2006; IN COMMERCE 4-3-2006.

3,299,745. MOEN INCORPORATED, NORTH OLMSTED, OH. SN 78-799,070. PUB. 7-4-2006, FILED 1-25-2006.

SAVVY

THE MARK CONSISTS OF STANDARD CHARACTERS WITHOUT CLAIM TO ANY PARTICULAR FONT, STYLE, SIZE, OR COLOR.

CLASS 6—METAL GOODS

FOR METAL ROBE HOOKS (U.S. CLS. 2, 12, 13, 14, 23, 25 AND 50).
FIRST USE 4-24-2006; IN COMMERCE 4-24-2006.

CLASS 11—ENVIRONMENTAL CONTROL APPARATUS

FOR FAUCETS, NAMELY LAVATORY FAUCETS, KITCHEN FAUCETS, BAR SINK FAUCETS, ROMAN TUB FAUCETS, FAUCET HANDLES, FAUCET VALVES; SHOWER AND TUB FIXTURES, NAMELY TUB SPOUTS, SHOWER HEADS, SHOWER HEAD SPRAYERS, HAND HELD SHOWERS; SHOWER VALVES, TUB/SHOWER VALVES, TUB/SHOWER DIVERTER VALVES; PLUMBING ACCESSORIES, NAMELY KITCHEN SINK SPRAYERS; BIDETS AND PARTS THEREFOR; TOILET TANK LEVERS (U.S. CLS. 13, 21, 23, 31 AND 34).
FIRST USE 4-24-2006; IN COMMERCE 4-24-2006.

CLASS 21—HOUSEWARES AND GLASS

FOR KITCHEN AND BATHROOM ACCESSORIES AND FIXTURES, NAMELY, TOWEL BARS, TOWEL RINGS (U.S. CLS. 2, 13, 23, 29, 30, 33, 40 AND 50).
FIRST USE 4-24-2006; IN COMMERCE 4-24-2006.

3,299,747. SWEET REXIE'S LLC, NORWALK, CT. SN 78-799,379. PUB. 1-30-2007, FILED 1-25-2006.



NO CLAIM IS MADE TO THE EXCLUSIVE RIGHT TO USE "SWEET", APART FROM THE MARK AS SHOWN.

THE COLOR(S) GREEN, BLUE, PINK, RED AND BLACK IS/ARE CLAIMED AS A FEATURE OF THE MARK.

THE COLOR GREEN APPEARS IN THE MIDDLE CIRCLE, THE COLOR BLUE APPEARS IN THE FIRST RING FROM THE MIDDLE CIRCLE, THE COLOR PINK APPEARS IN THE SECOND RING FROM THE MIDDLE CIRCLE, THE COLOR RED APPEARS IN THE OUTER RING AND THE COLOR BLACK APPEARS IN THE LINING OF THE RINGS AND THE WORDING "SWEET REXIE'S".

THE MARK CONSISTS OF A CIRCULAR CENTER, WHICH IS ENCLOSED BY A RING, WHICH IS THEN ENCLOSED BY ANOTHER RING, WHICH IS THEN ENCLOSED BY A FINAL RING, EACH WITH A LINEAR BORDER, AND WITH THE LITERAL ELEMENT OF THE MARK, "SWEET REXIE'S" IN A CIRCULAR PATTERN WITHIN ONE OR MORE OF THE CIRCULAR CENTER AND THE RINGS.

CLASS 30—STAPLE FOODS

FOR BAKERY DESSERTS; BAKERY GOODS; BAKERY PRODUCTS; BAKERY PRODUCTS, NAMELY SWEET BAKERY GOODS; CANDIES; CANDY; CANDY BARS; CANDY CAKE DECORATIONS; CANDY COATED APPLES; CANDY COATED POPCORN; CANDY DECORATIONS FOR CAKES; CANDY MINTS; CANDY WITH CARAMEL; CANDY WITH COCOA; CHOCOLATE; CHOCOLATE BARS; CHOCOLATE CANDIES; CHOCOLATE CHIPS; CHOCOLATE COVERED NUTS; CHOCOLATE FONDUE; CHOCOLATE MOUSSE; CHOCOLATE PASTES; CHOCOLATE POWDER; CHOCOLATE SYRUP; CHOCOLATE TOPPING; CHOCOLATE TRUFFLES; COOKIE MIXES; COOKIES; FOOD PACKAGE COMBINATIONS CONSISTING PRIMARILY OF BREAD, CRACKERS AND/OR COOKIES; GIFT BASKETS CONTAINING CANDY; MILK CHOCOLATE; MIXES FOR BAKERY GOODS; PEPPERMINT CANDY; SNACK MIX CONSISTING PRIMARILY OF CRACKERS, PRETZELS, CANDIED NUTS AND/OR POPPED POPCORN; STARCH-BASED CANDIES; SUGARLESS CANDIES (U.S. CL. 46).

FIRST USE 10-16-2006; IN COMMERCE 10-16-2006.

CLASS 35—ADVERTISING AND BUSINESS

FOR RETAIL CANDY STORES; RETAIL CLOTHING BOUTIQUES; RETAIL GIFT SHOPS; RETAIL JEWELRY STORES; RETAIL SHOPS FEATURING TOYS, GAMES, CHILDREN'S CLOTHING, AND COSTUME JEWELRY (U.S. CLS. 100, 101 AND 102).

FIRST USE 12-8-2004; IN COMMERCE 12-8-2004.

CLASS 41—EDUCATION AND ENTERTAINMENT

FOR ENTERTAINMENT SERVICES, NAMELY, CONDUCTING PARTIES; PARTY PLANNING; PARTY PLANNING CONSULTATION; SPECIAL EVENT PLANNING; SPECIAL EVENT PLANNING CONSULTATION (U.S. CLS. 100, 101 AND 107).

FIRST USE 12-8-2004; IN COMMERCE 12-8-2004.

CLASS 43—HOTEL AND RESTAURANT SERVICES

FOR CATERING; CATERING FOR THE PROVISION OF FOOD AND BEVERAGES; CATERING OF FOOD AND DRINKS (U.S. CLS. 100 AND 101).

FIRST USE 12-8-2004; IN COMMERCE 12-8-2004.

3,299,770. SWINMURN, NICK, HENDERSON, NV. SN 78-808,775. PUB. 10-10-2006, FILED 2-7-2006.

STAGR

THE MARK CONSISTS OF STANDARD CHARACTERS WITHOUT CLAIM TO ANY PARTICULAR FONT, STYLE, SIZE, OR COLOR.

CLASS 18—LEATHER GOODS

FOR LEATHER GOODS AND PERSONAL ACCESSORIES, NAMELY, LEATHER BAGS, HANDBAGS, ATTACHE CASES, SUITCASES, LUGGAGE, TRUNKS, TRAVELING BAGS AND SPORTS BAGS, RUCKSACKS, BEAUTY CASES, NAMELY, TOILETRY CASES SOLD EMPTY, KEY CASES, BRIEFCASES, PURSES, WALLETS, UMBRELLAS, PARASOLS, AND WALKING STICKS (U.S. CLS. 1, 2, 3, 22 AND 41).

FIRST USE 11-1-2006; IN COMMERCE 11-1-2006.

CLASS 25—CLOTHING

FOR CLOTHES, NAMELY, TOPS, DRESSES, GOWNS, SHIRTS, T-SHIRTS, SPORT SHIRTS, POLO SHIRTS, PULLOVERS, BLOUSES, COATS, SWEATERS, SWEATSHIRTS, BOTTOMS, SHORTS, TROUSERS, SLACKS, PANTS, JEANS, SKIRTS, OVERALLS, JUMPERS, COVERALLS, ROMPERS, BODY SUITS, JOGGING SUITS, SWEAT SUITS, BATHING SUITS, PLAY SUITS, CARDIGANS, VESTS, JACKETS, SWIMWEAR, SLEEPWEAR, PAJAMAS, UNDERWEAR, BRIEFS, UNDERPANTS, BOXER SHORTS, UNDERSHIRTS, RAINWEAR, SOCKS, TIGHTS, LEOTARDS, LEGGINGS, SUSPENDERS, NECKTIES, SCARVES, GLOVES, MITTENS; FOOTWEAR NAMELY, BOOTS, SHOES, SANDALS, SLIPPERS, ATHLETIC FOOTWEAR, CASUAL FOOTWEAR; HEADWEAR NAMELY HATS, CAPS, HEAD BANDS, AND BERETS; FASHION ACCESSORIES NAMELY, SCARVES, WRAPS, AND BELTS (U.S. CLS. 22 AND 39).

FIRST USE 11-1-2006; IN COMMERCE 11-1-2006.

3,299,771. REMINGTON DIRECT, LP, FORT WORTH, TX. SN 78-808,992. PUB. 10-10-2006, FILED 2-7-2006.

3,299,794. FALLON, TIMOTHY R., BARKSDALE, TX. SN 78-816,270. PUB. 10-24-2006, FILED 2-16-2006.

MIRACLE FRUITS OF THE WORLD

THE MARK CONSISTS OF STANDARD CHARACTERS WITHOUT CLAIM TO ANY PARTICULAR FONT, STYLE, SIZE, OR COLOR.

NO CLAIM IS MADE TO THE EXCLUSIVE RIGHT TO USE FRUITS, APART FROM THE MARK AS SHOWN.

CLASS 5—PHARMACEUTICALS

FOR VITAMINS, MINERAL SUPPLEMENTS, DIETARY SUPPLEMENTS, HERBAL SUPPLEMENTS, NUTRITIONAL SUPPLEMENTS, NUTRITIONALLY FORTIFIED JUICE BEVERAGES (U.S. CLS. 6, 18, 44, 46, 51 AND 52).

FIRST USE 2-16-2007; IN COMMERCE 2-16-2007.

CLASS 32—LIGHT BEVERAGES

FOR FRUIT JUICES, FRUIT BEVERAGES IN THE NATURE OF FORTIFIED FRUIT JUICE (U.S. CLS. 45, 46 AND 48).

FIRST USE 2-16-2007; IN COMMERCE 2-16-2007.

3,299,778. LIN, JAY W., S. EL MONTE, CA. SN 78-810,321. PUB. 9-12-2006, FILED 2-8-2006.

WEBTAC

THE MARK CONSISTS OF STANDARD CHARACTERS WITHOUT CLAIM TO ANY PARTICULAR FONT, STYLE, SIZE, OR COLOR.

CLASS 13—FIREARMS

FOR FIREARMS, GOODS FOR FIREARMS, NAMELY HOLSTERS AND MAGAZINE POUCHES (U.S. CLS. 2 AND 9).

FIRST USE 3-11-2006; IN COMMERCE 3-11-2006.

CLASS 21—HOUSEWARES AND GLASS

FOR WATERBAGS NAMELY, INSULATED WATER BACKPACKS AND CAMEL BAGS FOR CARRYING WATER (U.S. CLS. 2, 13, 23, 29, 30, 33, 40 AND 50).

FIRST USE 3-11-2006; IN COMMERCE 3-11-2006.

CLASS 25—CLOTHING

FOR CLOTHING, NAMELY, VESTS (U.S. CLS. 22 AND 39).

FIRST USE 3-11-2006; IN COMMERCE 3-11-2006.

BECAUSE WE'VE BEEN THERE

THE MARK CONSISTS OF STANDARD CHARACTERS WITHOUT CLAIM TO ANY PARTICULAR FONT, STYLE, SIZE, OR COLOR.

CLASS 39—TRANSPORTATION AND STORAGE

FOR OUTDOOR OUTFITTING SERVICES, NAMELY, ARRANGING AND CONDUCTING HUNTING AND FISHING EXPEDITIONS (U.S. CLS. 100 AND 105).

FIRST USE 2-10-2005; IN COMMERCE 2-10-2005.

CLASS 41—EDUCATION AND ENTERTAINMENT

FOR RECREATIONAL SERVICES, NAMELY, PROVIDING HUNTING PRESERVES (U.S. CLS. 100, 101 AND 107).

FIRST USE 2-10-2005; IN COMMERCE 2-10-2005.

3,299,816. DUNBAR ARMORED, INC., HUNT VALLEY, MD. SN 78-822,515. PUB. 12-19-2006, FILED 2-24-2006.

Dunbar *Vault-Trak*

OWNER OF U.S. REG. NOS. 2,108,425, 2,804,671, AND OTHERS.

THE COLORS RED, WHITE, AND BLACK ARE CLAIMED AS A FEATURE OF THE MARK.

THE COLOR RED APPEARS IN THE TERM DUNBAR, THE COLOR WHITE APPEARS IN THE SHOOTING STAR DESIGN THAT RUNS THROUGH THE TERM DUNBAR AND THE COLOR BLACK APPEARS IN THE TERMS VAULT-TRAK. THE MARK IS PRESENTED ON A TRANSPARENT BACKGROUND AND NO OTHER COLORS ARE CLAIMED.

CLASS 35—ADVERTISING AND BUSINESS

FOR COMPUTERIZED TRACKING AND TRACING OF PACKAGES IN TRANSIT VIA INTRANET AND INTERNET; COMPUTERIZED TRACKING AND TRACING OF PACKAGES IN TRANSIT, NAMELY, SHIPMENTS OF MONEY FROM PICKUP TO DELIVERY TO A PROCESSING CENTER FOR TRANSACTION CONFIRMATION AND PROCESSING, IN REAL-TIME VIA A WIRELESS COMPUTER NETWORK (U.S. CLS. 100, 101 AND 102).

FIRST USE 6-1-2005; IN COMMERCE 6-1-2005.

CLASS 39—TRANSPORTATION AND STORAGE

FOR ARMORED CAR TRANSPORT TO TRANSPORT MONEY AND VALUABLES (U.S. CLS. 100 AND 105).

FIRST USE 6-5-2005; IN COMMERCE 6-5-2005.

3,299,817. DUCTSMART, LLC, RENTON, WA. SN 78-822,785. PUB. 11-21-2006, FILED 2-24-2006.

DUCTSMART

THE MARK CONSISTS OF STANDARD CHARACTERS WITHOUT CLAIM TO ANY PARTICULAR FONT, STYLE, SIZE, OR COLOR.

CLASS 7—MACHINERY

FOR BRUSHES BEING PARTS OF OR FOR USE WITH A DUCT, PIPE AND TUBE CLEANING MACHINE (U.S. CLS. 13, 19, 21, 23, 31, 34 AND 35). FIRST USE 5-31-2006; IN COMMERCE 5-31-2006.

CLASS 37—CONSTRUCTION AND REPAIR

FOR CLEANING OF TUBES, PIPES, VENTS, AND DUCTS IN BUILDINGS (U.S. CLS. 100, 103 AND 106). FIRST USE 2-27-2007; IN COMMERCE 2-27-2007.

3,299,825. RNB ENTERTAINMENT GROUP, INC., SAN FRANCISCO, CA. SN 78-826,612. PUB. 10-24-2006, FILED 3-1-2006.



CLASS 9—ELECTRICAL AND SCIENTIFIC APPARATUS

FOR CDS AND DVDS FEATURING MUSICAL PERFORMANCES (U.S. CLS. 21, 23, 26, 36 AND 38). FIRST USE 6-1-2006; IN COMMERCE 8-29-2006.

CLASS 41—EDUCATION AND ENTERTAINMENT

FOR MUSIC PRODUCTION SERVICES (U.S. CLS. 100, 101 AND 107). FIRST USE 6-1-2006; IN COMMERCE 8-29-2006.

3,299,829. CELLCO PARTNERSHIP, DBA VERIZON WIRELESS, BASKING RIDGE, NJ. SN 78-827,152. PUB. 8-29-2006, FILED 3-2-2006.

CONECTATE CON TU PASION

THE MARK CONSISTS OF STANDARD CHARACTERS WITHOUT CLAIM TO ANY PARTICULAR FONT, STYLE, SIZE, OR COLOR.
THE ENGLISH TRANSLATION OF CONECTATE CON TU

PASION IS CONNECT WITH YOUR PASSION.

CLASS 38—COMMUNICATION

FOR WIRELESS TELEPHONE COMMUNICATION SERVICES (U.S. CLS. 100, 101 AND 104). FIRST USE 4-25-2006; IN COMMERCE 4-25-2006.

CLASS 41—EDUCATION AND ENTERTAINMENT

FOR SPORTS NEWS REPORTING SERVICES (U.S. CLS. 100, 101 AND 107). FIRST USE 4-25-2006; IN COMMERCE 4-25-2006.

3,299,844. ETIENNE AIGNER, INC., NEW YORK, NY. SN 78-833,319. PUB. 8-29-2006, FILED 3-9-2006.



OWNER OF U.S. REG. NOS. 2,243,918, 2,306,420, AND OTHERS.

THE NAME ETIENNE DOES NOT IDENTIFY A LIVING INDIVIDUAL.

CLASS 18—LEATHER GOODS

FOR HANDBAGS, WALLETS, TOTE BAGS AND BACKPACKS (U.S. CLS. 1, 2, 3, 22 AND 41). FIRST USE 9-21-2006; IN COMMERCE 9-21-2006.

CLASS 25—CLOTHING

FOR BELTS (U.S. CLS. 22 AND 39). FIRST USE 9-21-2006; IN COMMERCE 9-21-2006.

3,299,860. BFS BRANDS, LLC, NASHVILLE, TN. SN 78-837,908. PUB. 10-24-2006, FILED 3-15-2006.



OWNER OF U.S. REG. NOS. 140,804, 1,387,468, AND OTHERS.

NO CLAIM IS MADE TO THE EXCLUSIVE RIGHT TO USE "AUTO CARE" AND "SINCE 1926", APART FROM THE MARK AS SHOWN.

THE COLOR(S) RED, BLUE AND WHITE IS/ARE CLAIMED AS A FEATURE OF THE MARK.

THE MARK CONSISTS OF THE COLOR RED APPEARS AS THE BACKGROUND OF THE WORDING FIRESTONE

COMPLETE AUTO CARE, WHICH IS ALL IN WHITE, AND THE COLOR BLUE APPEARS UNDERNEATH THE RED PORTION, AS THE BACKGROUND OF THE WORDING "SINCE 1926," WHICH IS IN WHITE; THE WORD FIRESTONE IS STYLIZED.

CLASS 35—ADVERTISING AND BUSINESS

FOR RETAIL TIRE AND AUTOMOBILE PARTS AND ACCESSORIES STORE (U.S. CLS. 100, 101 AND 102).
FIRST USE 6-30-2005; IN COMMERCE 10-31-2005.

CLASS 37—CONSTRUCTION AND REPAIR

FOR AUTOMOTIVE SERVICES, NAMELY, AUTOMOBILE REPAIR AND MAINTENANCE (U.S. CLS. 100, 103 AND 106).
FIRST USE 6-30-2005; IN COMMERCE 10-31-2006.

3,299,861. BFS BRANDS, LLC, NASHVILLE, TN. SN 78-837,964. PUB. 9-5-2006, FILED 3-15-2006.

FIRESTONE COMPLETE AUTO CARE

THE MARK CONSISTS OF STANDARD CHARACTERS WITHOUT CLAIM TO ANY PARTICULAR FONT, STYLE, SIZE, OR COLOR.

OWNER OF U.S. REG. NOS. 140,804, 1,387,468, AND OTHERS.

NO CLAIM IS MADE TO THE EXCLUSIVE RIGHT TO USE "AUTO CARE", APART FROM THE MARK AS SHOWN.

CLASS 35—ADVERTISING AND BUSINESS

FOR RETAIL TIRE AND AUTOMOBILE PARTS AND ACCESSORIES STORE (U.S. CLS. 100, 101 AND 102).
FIRST USE 6-30-2005; IN COMMERCE 10-31-2005.

CLASS 37—CONSTRUCTION AND REPAIR

FOR AUTOMOTIVE SERVICES, NAMELY, AUTOMOBILE REPAIR AND MAINTENANCE (U.S. CLS. 100, 103 AND 106).
FIRST USE 6-30-2005; IN COMMERCE 10-31-2005.

3,299,877. FELLOWSHIP CHURCH, GRAPEVINE, TX. SN 78-845,733. PUB. 10-31-2006, FILED 3-24-2006.



THE MARK CONSISTS OF A STYLIZED VERSION OF THE WORD "ELEVATE" WITH MOUNTAINS AND CLOUDS IN THE BACKGROUND AND A DEPICTION OF AN ELEVATOR UNDER THE WORD.

CLASS 9—ELECTRICAL AND SCIENTIFIC APPARATUS

FOR PRE-RECORDED CD'S, VIDEO TAPES, LASER DISKS AND DVD'S FEATURING RELIGIOUS SUBJECT MATTER (U.S. CLS. 21, 23, 26, 36 AND 38).

FIRST USE 3-31-2006; IN COMMERCE 3-31-2006.

CLASS 16—PAPER GOODS AND PRINTED MATTER

FOR CHILDREN'S ACTIVITY BOOKS; CHILDREN'S BOOKS; CHILDREN'S STORYBOOKS; PRINTED INSTRUCTIONAL, EDUCATIONAL, AND TEACHING MATERIALS IN THE FIELD OF RELIGION; PRINTED TEACHING ACTIVITY GUIDES IN THE FIELD OF RELIGION; WORKBOOKS DIRECTED TO RELIGION (U.S. CLS. 2, 5, 22, 23, 29, 37, 38 AND 50).

FIRST USE 3-31-2006; IN COMMERCE 3-31-2006.

CLASS 45—PERSONAL SERVICES

FOR EVANGELISTIC AND MINISTERIAL SERVICES (U.S. CLS. 100 AND 101).

FIRST USE 3-31-2006; IN COMMERCE 3-31-2006.

3,299,878. FELLOWSHIP CHURCH, GRAPEVINE, TX. SN 78-845,798. PUB. 10-31-2006, FILED 3-24-2006.

Elevate

THE MARK CONSISTS OF STANDARD CHARACTERS WITHOUT CLAIM TO ANY PARTICULAR FONT, STYLE, SIZE, OR COLOR.

CLASS 9—ELECTRICAL AND SCIENTIFIC APPARATUS

FOR PRE-RECORDED CD'S, VIDEO TAPES, LASER DISKS AND DVD'S FEATURING RELIGIOUS SUBJECT MATTER (U.S. CLS. 21, 23, 26, 36 AND 38).

FIRST USE 3-31-2006; IN COMMERCE 3-31-2006.

CLASS 16—PAPER GOODS AND PRINTED MATTER

FOR CHILDREN'S ACTIVITY BOOKS; CHILDREN'S BOOKS; CHILDREN'S STORYBOOKS; PRINTED INSTRUCTIONAL, EDUCATIONAL, AND TEACHING MATERIALS IN THE FIELD OF RELIGION; PRINTED TEACHING ACTIVITY GUIDES IN THE FIELD OF RELIGION; WORKBOOKS DIRECTED TO RELIGION (U.S. CLS. 2, 5, 22, 23, 29, 37, 38 AND 50).

FIRST USE 3-31-2006; IN COMMERCE 3-31-2006.

CLASS 45—PERSONAL SERVICES

FOR EVANGELISTIC AND MINISTERIAL SERVICES (U.S. CLS. 100 AND 101).

FIRST USE 3-31-2006; IN COMMERCE 3-31-2006.

3,299,884. PFIZER ENTERPRISES SARL, LUXEMBOURG, LUXEMBOURG. SN 78-849,654. PUB. 12-5-2006, FILED 3-30-2006.

3,299,909. BLUE J INTERNATIONAL INC., S. EL MONTE, CA. SN 78-859,154. PUB. 12-5-2006, FILED 4-11-2006.

PETALS PLAN EACH DAY
THROUGH ACTIVE LIVING AND
SUPPORT

KWA

THE MARK CONSISTS OF STANDARD CHARACTERS WITHOUT CLAIM TO ANY PARTICULAR FONT, STYLE, SIZE, OR COLOR.

THE MARK CONSISTS OF STANDARD CHARACTERS WITHOUT CLAIM TO ANY PARTICULAR FONT, STYLE, SIZE, OR COLOR.

CLASS 16—PAPER GOODS AND PRINTED MATTER

FOR PRINTED VISUALS IN THE NATURE OF MANUALS, BOOKLETS, LEAFLETS, BROCHURES, DISPLAYS AND POSTERS FEATURING INFORMATION ON THE SUBJECT OF ONCOLOGY (U.S. CLS. 2, 5, 23, 29, 37, 38 AND 50).

FIRST USE 9-0-2006; IN COMMERCE 9-0-2006.

CLASS 13—FIREARMS

FOR FIREARMS, NAMELY REPLICA FIREARMS (U.S. CLS. 2 AND 9).

FIRST USE 8-10-2002; IN COMMERCE 8-10-2002.

CLASS 44—MEDICAL, BEAUTY AND AGRICULTURAL SERVICES

FOR PROVIDING HEALTH INFORMATION (U.S. CLS. 100 AND 101).

FIRST USE 5-0-2006; IN COMMERCE 5-0-2006.

CLASS 28—TOYS AND SPORTING GOODS

FOR TOYS AND SPORTING GOODS, NAMELY, AIR-SOFT GUNS, TOY GUNS, TOY MODEL AND REPLICA WEAPONS, PAINTBALL GUNS (U.S. CLS. 22, 23, 38 AND 50).

FIRST USE 8-10-2002; IN COMMERCE 8-10-2002.

3,299,896. AP ED VENTURES, LLC, FISHER ISLAND, FL. SN 78-855,911. PUB. 2-6-2007, FILED 4-6-2006.

3,299,951. NATIONAL BREAST CANCER COALITION, WASHINGTON, DC. SN 78-874,469. PUB. 1-23-2007, FILED 5-2-2006.

TEACHADE

WO(MEN) WHO GET IT RIGHT

THE MARK CONSISTS OF STANDARD CHARACTERS WITHOUT CLAIM TO ANY PARTICULAR FONT, STYLE, SIZE, OR COLOR.

THE MARK CONSISTS OF STANDARD CHARACTERS WITHOUT CLAIM TO ANY PARTICULAR FONT, STYLE, SIZE, OR COLOR.

CLASS 38—COMMUNICATION

FOR PROVIDING ON-LINE DISCUSSION FORUMS FOR TRANSMISSION OF MESSAGES AMONG COMPUTER USERS IN THE FIELD OF EDUCATION (U.S. CLS. 100, 101 AND 104).

FIRST USE 7-4-2006; IN COMMERCE 7-4-2006.

CLASS 36—INSURANCE AND FINANCIAL

FOR CHARITABLE FUND RAISING SERVICES (U.S. CLS. 100, 101 AND 102).

FIRST USE 9-29-2006; IN COMMERCE 9-29-2006.

CLASS 41—EDUCATION AND ENTERTAINMENT

FOR PROVIDING EDUCATIONAL CONTENT, INFORMATION, COMMENTARY AND REVIEW IN THE FIELD OF EDUCATION; PROVIDING AN EDUCATIONAL RESOURCE WEBSITE WHICH FEATURES EDUCATIONAL CONTENT AND INFORMATION IN THE FIELD OF EDUCATION, EDUCATIONAL RESOURCE ASSESSMENT, COMMENTARY AND REVIEW (U.S. CLS. 100, 101 AND 107).

FIRST USE 7-4-2006; IN COMMERCE 7-4-2006.

CLASS 41—EDUCATION AND ENTERTAINMENT

FOR ORGANIZING AND CONDUCTING AWARD CEREMONIES IN THE FIELD OF BREAST CANCER AWARENESS; PROVIDING AWARDS THAT RECOGNIZE ACCOMPLISHMENTS OF INDIVIDUALS AND ORGANIZATIONS IN ORDER TO INCREASE PUBLIC AWARENESS OF BREAST CANCER (U.S. CLS. 100, 101 AND 107).

FIRST USE 9-29-2006; IN COMMERCE 9-29-2006.

3,299,989. AERO DESIGN AND MANUFACTURING COMPANY, INC., DULUTH, MN. SN 78-885,585. PUB. 12-19-2006, FILED 5-17-2006.

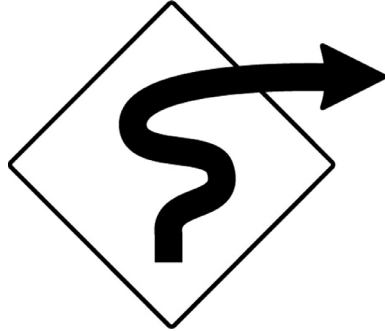

THE MARK CONSISTS OF DIAMOND SHAPE WITH CURVED ARROW INSIDE COMING OUT OF THE RIGHT SIDE.

CLASS 16—PAPER GOODS AND PRINTED MATTER

FOR VINYL STICKERS (U.S. CLS. 2, 5, 22, 23, 29, 37, 38 AND 50).
FIRST USE 8-4-2006; IN COMMERCE 8-4-2006.

CLASS 25—CLOTHING

FOR HATS, MICROFIBER SHIRTS, T-SHIRTS AND FLEECE JACKETS (U.S. CLS. 22 AND 39).
FIRST USE 8-4-2006; IN COMMERCE 8-4-2006.

CLASS 39—TRANSPORTATION AND STORAGE

FOR ARRANGING AND CONDUCTING MOTOR-CYCLE TOURS FOR OTHERS (U.S. CLS. 100 AND 105).
FIRST USE 8-4-2006; IN COMMERCE 8-4-2006.

CLASS 7—MACHINERY

FOR BLANKING PRESSES; BRUSHES BEING PARTS OF OR FOR USE WITH PRINTING PRESSES; DRILLING MACHINES AND PARTS THEREFOR; INDUSTRIAL MACHINE PRESSES; MACHINE PARTS NAMELY, BEARINGS AND BUSHINGS; MACHINE PARTS NAMELY, BLADES; MACHINE PARTS NAMELY, FLEXIBLE SHAFT COUPLINGS; MACHINE PARTS NAMELY, GRINDSTONES; MACHINE PARTS NAMELY, HOODS; MACHINE PARTS, NAMELY, BEARING HOUSINGS; MACHINE PARTS, NAMELY, BEARING INSERTS; MACHINE PARTS, NAMELY, CYLINDERS; MACHINE PARTS, NAMELY, MOLDS FOR USE IN THE MANUFACTURE OF PRINTING PRESS PARTS; MACHINE PARTS, NAMELY, ROLLER BEARINGS; POWER TOOLS, NAMELY, DRILL PRESSES; PRINTING PLATES; PRINTING PRESSES; PRINTING PRESSES FOR CERAMIC MATERIAL; PRINTING ROLLERS; PUNCHING PRESSES; ROLLERS FOR ROTARY PRINTING MACHINES (U.S. CLS. 13, 19, 21, 23, 31, 34 AND 35).
FIRST USE 4-1-2007; IN COMMERCE 4-1-2007.

CLASS 35—ADVERTISING AND BUSINESS

FOR DISTRIBUTORSHIPS IN THE FIELD OF PRINTING PRESS AND PRINTING PRESS PARTS; PROMOTING THE SALE OF GOODS AND SERVICES OF OTHERS THROUGH THE DISTRIBUTION OF PRINTED MATERIAL AND PROMOTIONAL CONTESTS; WHOLESALE DISTRIBUTORSHIPS FEATURING PRINTING PRESS AND PRINTING PRESS PARTS (U.S. CLS. 100, 101 AND 102).
FIRST USE 4-1-2007; IN COMMERCE 4-1-2007.

3,299,999. PANTONE, INC., CARLSTADT, NJ. SN 78-888,759. PUB. 3-27-2007, FILED 5-22-2006.

THE COLOR OF IDEAS

THE MARK CONSISTS OF STANDARD CHARACTERS WITHOUT CLAIM TO ANY PARTICULAR FONT, STYLE, SIZE, OR COLOR.
NO CLAIM IS MADE TO THE EXCLUSIVE RIGHT TO USE "COLOR", APART FROM THE MARK AS SHOWN.

CLASS 35—ADVERTISING AND BUSINESS

FOR SPECIFYING COLORS FOR CORPORATE IDENTIFICATION PROGRAMS BY PROVIDING COLOR ANALYSIS FOR MATCHING AGAINST STANDARDS FOR A COLOR, INCLUDING ITS STRENGTH, TONE AND TRANSPARENCY, TO THE ORDER AND/OR SPECIFICATION OF OTHERS; RECOMMENDING COLOR PALETTES FOR NEW PRODUCTS AND SERVICES BASED ON COLOR TRENDS AND USAGE; PROVIDING COLOR AND TREND INFORMATION IN THE FIELDS OF FASHION, BEAUTY, HOME AND PRODUCT INFORMATION RELATED THERETO; PROMOTING THE STUDY OF THE PSYCHOLOGY OF COLOR AND SOCIETAL COLOR TRENDS (U.S. CLS. 100, 101 AND 102).
FIRST USE 10-23-2006; IN COMMERCE 10-23-2006.

3,299,998. PRINTER'S REPAIR PARTS, INC., FRANKLIN PARK, IL. SN 78-887,713. PUB. 1-16-2007, FILED 5-19-2006.

P.R.P

THE MARK CONSISTS OF STANDARD CHARACTERS WITHOUT CLAIM TO ANY PARTICULAR FONT, STYLE, SIZE, OR COLOR.
OWNER OF U.S. REG. NO. 2,094,548.

CLASS 42—SCIENTIFIC, COMPUTER AND LEGAL SERVICES

FOR DEVELOPING CUSTOMIZED STANDARDS TO ASSURE COLOR CONSISTENCY AND ACCURACY IN THE REPRODUCTION AND SPECIFICATION OF COLORS; SPECIFYING AND VERIFYING COLOR AS USED BY PRINTERS AND GRAPHIC ARTISTS IN MANY AREAS OF DESIGN, NAMELY GRAPHIC DESIGN, INDUSTRIAL DESIGN, ARCHITECTURE AND INTERIOR DESIGN, COSMETICS AND FASHION DESIGN; PROVIDING INFORMATION IN THE FIELD OF COLOR REPRODUCTION TECHNOLOGY, DIGITAL WORKFLOW, COLOR CONSISTENCY IN WORKFLOW AND PRODUCT INTERFACE (U.S. CLS. 100 AND 101).
FIRST USE 10-23-2006; IN COMMERCE 10-23-2006.

3,300,026. ENLOIT ENTERPRISES, LLC, NORWALK, CT. SN 78-900,471. PUB. 1-16-2007, FILED 6-5-2006.

JESUS IS MY SPOTTER

THE MARK CONSISTS OF STANDARD CHARACTERS WITHOUT CLAIM TO ANY PARTICULAR FONT, STYLE, SIZE, OR COLOR.

CLASS 35—ADVERTISING AND BUSINESS

FOR ON-LINE RETAIL STORE SERVICES FEATURING DOWNLOADABLE PRE-RECORDED MUSIC AND VIDEO (U.S. CLS. 100, 101 AND 102).
FIRST USE 4-9-2005; IN COMMERCE 4-9-2005.

CLASS 41—EDUCATION AND ENTERTAINMENT

FOR ENTERTAINMENT SERVICES, NAMELY, LIVE MUSIC CONCERTS (U.S. CLS. 100, 101 AND 107).
FIRST USE 4-9-2005; IN COMMERCE 4-9-2005.

3,300,070. VOGAN CONSULTING SERVICES, INC., MALVERN, PA. SN 78-913,100. PUB. 1-23-2007, FILED 6-21-2006.



THE MARK CONSISTS OF STYLIZED TEXT AND AN ABSTRACT BARBERSHOP AWNING.

CLASS 9—ELECTRICAL AND SCIENTIFIC APPARATUS

FOR ELECTRONIC PUBLICATIONS, NAMELY, GUIDES FEATURING MANAGEMENT AND LEADERSHIP DEVELOPMENT RECORDED ON COMPUTER MEDIA (U.S. CLS. 21, 23, 26, 36 AND 38).
FIRST USE 6-8-2006; IN COMMERCE 6-8-2006.

CLASS 16—PAPER GOODS AND PRINTED MATTER

FOR PRINTED GUIDES FOR MANAGEMENT AND LEADERSHIP DEVELOPMENT (U.S. CLS. 2, 5, 22, 23, 29, 37, 38 AND 50).
FIRST USE 6-8-2006; IN COMMERCE 6-8-2006.

CLASS 35—ADVERTISING AND BUSINESS

FOR BUSINESS MANAGEMENT AND CONSULTATION (U.S. CLS. 100, 101 AND 102).
FIRST USE 6-8-2006; IN COMMERCE 6-8-2006.

3,300,080. VPI CORP., WILMINGTON, DE. SN 78-916,754. PUB. 1-23-2007, FILED 6-26-2006.

HANDI-WARE

THE MARK CONSISTS OF STANDARD CHARACTERS WITHOUT CLAIM TO ANY PARTICULAR FONT, STYLE, SIZE, OR COLOR.

CLASS 8—HAND TOOLS

FOR CUTLERY (U.S. CLS. 23, 28 AND 44).
FIRST USE 7-31-2006; IN COMMERCE 7-31-2006.

CLASS 21—HOUSEWARES AND GLASS

FOR BEVERAGE GLASSWARE, DISHES AND PLATES, CUPS, BOWLS AND MUGS (U.S. CLS. 2, 13, 23, 29, 30, 33, 40 AND 50).
FIRST USE 6-30-2007; IN COMMERCE 6-30-2007.

3,300,082. FLAME RESISTANT GARMENTS, INC., HAMMOND, IN. SN 78-917,671. PUB. 2-13-2007, FILED 6-27-2006.

CODERED

THE MARK CONSISTS OF STANDARD CHARACTERS WITHOUT CLAIM TO ANY PARTICULAR FONT, STYLE, SIZE, OR COLOR.

CLASS 35—ADVERTISING AND BUSINESS

FOR ELECTRONIC CATALOG SERVICES IN THE FIELD OF SAFETY SUPPLIES AND EQUIPMENT (U.S. CLS. 100, 101 AND 102).
FIRST USE 6-0-2006; IN COMMERCE 6-0-2006.

CLASS 37—CONSTRUCTION AND REPAIR

FOR RENTAL AND REPAIR OF SAFETY EQUIPMENT (U.S. CLS. 100, 103 AND 106).
FIRST USE 11-8-2004; IN COMMERCE 11-8-2004.

CLASS 39—TRANSPORTATION AND STORAGE

FOR RESCUE SERVICES (U.S. CLS. 100 AND 105).
FIRST USE 11-8-2004; IN COMMERCE 11-8-2004.

3,300,112. GOAT FUNCTION LLC, BOULDER, CO. SN 78-926,684. PUB. 2-20-2007, FILED 7-11-2006.

CLASS 41—EDUCATION AND ENTERTAINMENT

FOR TRAINING SERVICES IN THE FIELD OF SAFETY (U.S. CLS. 100, 101 AND 107).
FIRST USE 11-8-2004; IN COMMERCE 11-8-2004.

Scapegoat

THE MARK CONSISTS OF STANDARD CHARACTERS WITHOUT CLAIM TO ANY PARTICULAR FONT, STYLE, SIZE, OR COLOR.

3,300,101. DUNNE, MARTHA S, CORONADO, CA. SN 78-922,642. PUB. 2-13-2007, FILED 7-5-2006.

IdeoLingo

THE MARK CONSISTS OF STANDARD CHARACTERS WITHOUT CLAIM TO ANY PARTICULAR FONT, STYLE, SIZE, OR COLOR.

CLASS 18—LEATHER GOODS

FOR MEN'S AND WOMEN'S LUGGAGE; BACKPACKS; MESSENGER BAGS; DUFFEL BAGS; CARRY-ON BAGS; HANDBAGS; SHOULDER BAGS; TOTE BAGS; BRIEFCASES; ROLLING LUGGAGE AND BAGS (U.S. CLS. 1, 2, 3, 22 AND 41).
FIRST USE 8-1-2004; IN COMMERCE 10-15-2006.

CLASS 9—ELECTRICAL AND SCIENTIFIC APPARATUS

FOR DECORATIVE MAGNETS (U.S. CLS. 21, 23, 26, 36 AND 38).
FIRST USE 8-1-2006; IN COMMERCE 6-17-2007.

CLASS 25—CLOTHING

FOR MEN'S AND WOMEN'S APPAREL AND CLOTHING, NAMELY, KNIT TOPS, T-SHIRTS, WOVEN SHIRTS, LONG SLEEVE PULLOVERS, FULL ZIP HOODED SHIRTS AND SWEATSHIRTS, PERFORMANCE AND CASUAL PANTS; CASUAL OUTERWEAR, NAMELY, WATERPROOF JACKETS, INSULATED JACKETS, WATERPROOF AND INSULATED JACKETS, PERFORMANCE PANTS; MEN'S AND WOMEN'S FOOTWEAR; CASUAL FOOTWEAR FROM LEATHER, SYNTHETICS, NATURAL FIBERS; ATHLETIC FOOTWEAR FROM SYNTHETIC, NYLON, POLYESTER, AND OTHER MATERIALS; SHOES AND BOOTS (U.S. CLS. 22 AND 39).
FIRST USE 8-1-2004; IN COMMERCE 10-15-2006.

CLASS 16—PAPER GOODS AND PRINTED MATTER

FOR FLASH CARDS; PRINTED EDUCATIONAL MATERIAL, NAMELY, TEACHING TILES (U.S. CLS. 2, 5, 22, 23, 29, 37, 38 AND 50).
FIRST USE 8-1-2006; IN COMMERCE 6-17-2007.

3,300,114. REGIS, INC., MINNEAPOLIS, MN. SN 78-926,903. PUB. 2-20-2007, FILED 7-11-2006.

3,300,109. PFAU, MARIANNE RICHERT, SAN DIEGO, CA. SN 78-925,052. PUB. 2-20-2007, FILED 7-8-2006.

TOUTES SUITES

THE MARK CONSISTS OF STANDARD CHARACTERS WITHOUT CLAIM TO ANY PARTICULAR FONT, STYLE, SIZE, OR COLOR.

WHAT MAKES A MAKEOVER

THE MARK CONSISTS OF STANDARD CHARACTERS WITHOUT CLAIM TO ANY PARTICULAR FONT, STYLE, SIZE, OR COLOR.

CLASS 9—ELECTRICAL AND SCIENTIFIC APPARATUS

FOR SOUND RECORDINGS FEATURING MUSIC (U.S. CLS. 21, 23, 26, 36 AND 38).
FIRST USE 6-1-2007; IN COMMERCE 6-6-2007.

CLASS 41—EDUCATION AND ENTERTAINMENT

FOR SWEEPSTAKE SERVICES; SWEEPSTAKE SERVICES PROVIDED OVER A GLOBAL COMPUTER NETWORK (U.S. CLS. 100, 101 AND 107).
FIRST USE 8-0-2006; IN COMMERCE 8-0-2006.

CLASS 41—EDUCATION AND ENTERTAINMENT

FOR ENTERTAINMENT, NAMELY LIVE MUSIC CONCERTS (U.S. CLS. 100, 101 AND 107).
FIRST USE 6-0-2006; IN COMMERCE 5-13-2007.

CLASS 44—MEDICAL, BEAUTY AND AGRICULTURAL SERVICES

FOR HAIR CUTTING; HAIR STYLING; HAIRDRESSING SERVICES (U.S. CLS. 100 AND 101).
FIRST USE 8-0-2006; IN COMMERCE 8-0-2006.

3,300,134. AUDIO AND VIDEO LABS, INC., PENNSAUKEN, NJ. SN 78-932,475. PUB. 3-13-2007, FILED 7-19-2006.

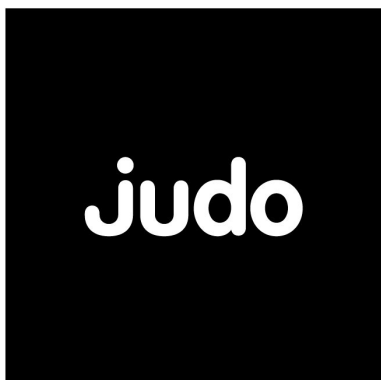

THE MARK CONSISTS OF THE WORD "JUDO" FORMED IN A DARK BACKGROUND.

CLASS 35—ADVERTISING AND BUSINESS

FOR ADVERTISING AND MARKETING; ADVERTISING, MARKETING AND PROMOTION SERVICES; BUSINESS CONSULTATION AND MANAGEMENT REGARDING MARKETING ACTIVITIES AND LAUNCHING OF NEW PRODUCTS; BUSINESS MARKETING CONSULTING SERVICES; BUSINESS MARKETING SERVICES; DEVELOPMENT OF MARKETING STRATEGIES AND CONCEPTS; ELECTRONIC COMMERCE SERVICES, NAMELY PROVIDING INFORMATION PRODUCTS VIA TELECOMMUNICATION NETWORKS FOR ADVERTISING AND SALES PURPOSES; GENERAL BUSINESS MERCHANDISING SERVICES, NAMELY, MARKETING; INFORMATION MANAGEMENT SERVICES, NAMELY, SHIPMENT PROCESSING, PREPARING SHIPPING DOCUMENTS AND INVOICES, TRACKING DOCUMENTS, PACKAGES AND FREIGHT OVER COMPUTER NETWORKS, INTRANETS AND INTERNETS; ORDER FULFILLMENT SERVICES; PROMOTION AND MARKETING SERVICES AND RELATED CONSULTING; PROVIDING BUSINESS MARKETING INFORMATION (U.S. CLS. 100, 101 AND 102).
FIRST USE 5-30-2007; IN COMMERCE 5-30-2007.

CLASS 40—MATERIAL TREATMENT

FOR CUSTOMIZED PRINTING OF COMPANY NAMES AND LOGOS FOR PROMOTIONAL AND ADVERTISING PURPOSES ON THE GOODS OF OTHERS; DESIGN PRINTING FOR OTHERS; DESKTOP PUBLISHING FOR OTHERS; DIGITAL ON-DEMAND PRINTING SERVICES OF BOOKS AND OTHER DOCUMENTS; LETTERPRESS PRINTING; LITHOGRAPHIC PRINTING; OFFSET PRINTING; PATTERN PRINTING; PHOTOGRAPHIC PRINTING; PHOTOGRAPHIC SLIDE AND/OR PRINT PROCESSING; PHOTOGRAVURE PRINTING; PORTRAIT PRINTING; PRINTING; PRINTING OF ADVERTISING MATTER; PRINTING OF BOOKS; PRINTING OF PATTERNS ON TEXTILES; SCREEN PRINTING; SILK SCREEN PRINTING; STATIONERY PRINTING SERVICES (U.S. CLS. 100, 103 AND 106).
FIRST USE 5-30-2007; IN COMMERCE 5-30-2007.

CLASS 42—SCIENTIFIC, COMPUTER AND LEGAL SERVICES

FOR APPLICATION SERVICE PROVIDER (ASP), NAMELY, HOSTING COMPUTER SOFTWARE APPLICATIONS OF OTHERS; DESIGN, CREATION, HOSTING AND MAINTENANCE OF INTERNET SITES FOR THIRD PARTIES; DESIGN, CREATION, HOSTING, MAINTENANCE OF WEBSITES FOR OTHERS; HOSTING OF DIGITAL CONTENT ON THE INTERNET; WEB SITE HOSTING SERVICES (U.S. CLS. 100 AND 101).
FIRST USE 5-30-2007; IN COMMERCE 5-30-2007.

3,300,153. STURM FOODS, INC., MANAWA, WI. SN 78-943,966. PUB. 3-27-2007, FILED 8-3-2006.

VILLA RICA

THE MARK CONSISTS OF STANDARD CHARACTERS WITHOUT CLAIM TO ANY PARTICULAR FONT, STYLE, SIZE, OR COLOR.

THE FOREIGN WORDING IN THE MARK TRANSLATES INTO ENGLISH AS RICH.

CLASS 30—STAPLE FOODS

FOR OAT BASED POWDERED DRINK MIXES; HOT COCOA MIX; CAPPUCINO MIX; INSTANT OATMEAL; PROCESSED OATS (U.S. CL. 46).
FIRST USE 11-30-2006; IN COMMERCE 11-30-2006.

CLASS 32—LIGHT BEVERAGES

FOR FRUIT FLAVORED POWDERED DRINK MIXES FOR USE IN MAKING FRUIT FLAVORED BEVERAGES (U.S. CLS. 45, 46 AND 48).
FIRST USE 11-30-2006; IN COMMERCE 11-30-2006.

3,300,155. CORPORATE SCREENING SERVICES, INC., CLEVELAND, OH. SN 78-944,258. PUB. 12-12-2006, FILED 8-3-2006.



OWNER OF U.S. REG. NO. 2,212,600.
NO CLAIM IS MADE TO THE EXCLUSIVE RIGHT TO USE "CORPORATE SCREENING", APART FROM THE MARK AS SHOWN.

CLASS 35—ADVERTISING AND BUSINESS

FOR BUSINESS INVESTIGATIONS (U.S. CLS. 100, 101 AND 102).
FIRST USE 9-0-2006; IN COMMERCE 9-0-2006.

CLASS 45—PERSONAL SERVICES

FOR BACKGROUND INVESTIGATION AND PRE-EMPLOYMENT BACKGROUND SCREENING SERVICES (U.S. CLS. 100 AND 101).
FIRST USE 9-0-2006; IN COMMERCE 9-0-2006.

3,300,198. BOARD OF DIRECTORS, GREATER KELLY DEVELOPMENT AUTHORITY, SAN ANTONIO, TX. SN 78-972,670. PUB. 1-2-2007, FILED 9-12-2006.



NO CLAIM IS MADE TO THE EXCLUSIVE RIGHT TO USE "PORT SAN ANTONIO", APART FROM THE MARK AS SHOWN.

THE COLOR(S) GREY AND RED IS/ARE CLAIMED AS A FEATURE OF THE MARK.

THE COLOR GREY APPEARS IN THE WORDING "PORT SAN ANTONIO" AND THE COLOR RED APPEARS AS THE CURVED BANDS.

CLASS 35—ADVERTISING AND BUSINESS

FOR PROMOTING THE ECONOMIC DEVELOPMENT OF TERMINAL FACILITIES FOR SHIPMENT OF GOODS BY OTHERS, NATIONALLY AND INTERNATIONALLY, UTILIZING RAIL, AIR AND TRUCKING (U.S. CLS. 100, 101 AND 102).

FIRST USE 3-2-2007; IN COMMERCE 3-2-2007.

CLASS 39—TRANSPORTATION AND STORAGE

FOR OPERATING FACILITIES, NAMELY, THE RENTAL OF DOCKS, TERMINALS AND WAREHOUSES FOR THE SHIPMENT OF GOODS, NATIONALLY AND INTERNATIONALLY, UTILIZING RAIL, AIR AND TRUCKING (U.S. CLS. 100 AND 105).

FIRST USE 3-2-2007; IN COMMERCE 3-2-2007.

3,300,199. FEEL ME GEAR, INC., VANCOUVER, B.C., CANADA. SN 78-976,323. PUB. 7-11-2006, FILED 8-13-2004.

FEEL ME

THE MARK CONSISTS OF STANDARD CHARACTERS WITHOUT CLAIM TO ANY PARTICULAR FONT, STYLE, SIZE, OR COLOR.

CLASS 9—ELECTRICAL AND SCIENTIFIC APPARATUS

FOR MUSIC SOUND RECORDINGS ON COMPACT DISCS (U.S. CLS. 21, 23, 26, 36 AND 38).

FIRST USE 7-1-2005; IN COMMERCE 9-20-2005.

CLASS 35—ADVERTISING AND BUSINESS

FOR ON-LINE RETAIL STORE SERVICES FEATURING MUSIC RECORDINGS ON COMPACT DISCS AND DOWNLOADABLE PRE-RECORDED MUSIC (U.S. CLS. 100, 101 AND 102).

FIRST USE 12-30-2005; IN COMMERCE 12-30-2005.

3,300,200. WANI, DAVID, NEWPORT BEACH, CA. SN 78-977,867. PUB. 2-27-2007, FILED 2-23-2006.

TWENTY4SEVEN HOTELS

THE MARK CONSISTS OF STANDARD CHARACTERS WITHOUT CLAIM TO ANY PARTICULAR FONT, STYLE, SIZE, OR COLOR.

NO CLAIM IS MADE TO THE EXCLUSIVE RIGHT TO USE "HOTELS", APART FROM THE MARK AS SHOWN.

CLASS 35—ADVERTISING AND BUSINESS

FOR HOTEL, RESORT, SPA, RESTAURANT, AND BAR MANAGEMENT FOR OTHERS (U.S. CLS. 100, 101 AND 102).

FIRST USE 11-10-2006; IN COMMERCE 2-15-2007.

CLASS 36—INSURANCE AND FINANCIAL

FOR INVESTMENT SERVICES, NAMELY REAL ESTATE INVESTMENT FOR HOTELS, RESORTS, SPAS, RESTAURANTS AND BARS, MARKETED TO INVESTORS IN COMMERCIAL REAL ESTATE (U.S. CLS. 100, 101 AND 102).

FIRST USE 11-10-2006; IN COMMERCE 2-15-2007.

3,300,204. SANTICA USA, INC., BOCA RATON, FL. SN 78-978,590. PUB. 7-18-2006, FILED 5-18-2005.

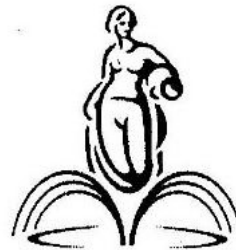

THE MARK CONSISTS OF A DRAWING OF A WOMAN CARRYING WATER HOVERING ABOVE A WATER FOUNTAIN.

CLASS 3—COSMETICS AND CLEANING PREPARATIONS

FOR SKIN CARE PREPARATIONS, NAMELY LOTIONS, BODY CREAMS, FACE CREAMS, SKIN EMOLLIENTS, SKIN TONERS, ASTRINGENTS, AND MASQUES; NON-MEDICATED COSMECEUTICALS, NAMELY, SKIN CREAMS AND FACIAL PREPARATIONS (U.S. CLS. 1, 4, 6, 50, 51 AND 52).

FIRST USE 1-30-2007; IN COMMERCE 1-30-2007.

CLASS 5—PHARMACEUTICALS

FOR DIETARY SUPPLEMENTS (U.S. CLS. 6, 18, 44, 46, 51 AND 52).

FIRST USE 5-30-2004; IN COMMERCE 5-30-2004.

3,300,213. CTG ATHLETICS LLC, BRONX, NY. SN 78-978,693. PUB. 8-15-2006, FILED 3-23-2005.

VERDERO

THE MARK CONSISTS OF STANDARD CHARACTERS WITHOUT CLAIM TO ANY PARTICULAR FONT, STYLE, SIZE, OR COLOR.

CLASS 25—CLOTHING

FOR FOOTWEAR; SPORT FOOTWEAR, ATHLETIC FOOTWEAR, CLEATED FOOTWEAR AND TURF FOOTWEAR (U.S. CLS. 22 AND 39).
FIRST USE 9-0-2006; IN COMMERCE 9-0-2006.

CLASS 28—TOYS AND SPORTING GOODS

FOR ATHLETIC GLOVES (U.S. CLS. 22, 23, 38 AND 50).
FIRST USE 9-0-2006; IN COMMERCE 9-0-2006.

3,300,221. SIERRA HEALTHSTYLES LLC, TUSCON, AZ. SN 78-978,750. PUB. 9-12-2006, FILED 10-7-2004.



OWNER OF U.S. REG. NO. 2,195,695.

CLASS 14—JEWELRY

FOR JEWELRY (U.S. CLS. 2, 27, 28 AND 50).
FIRST USE 1-0-2007; IN COMMERCE 1-0-2007.

CLASS 21—HOUSEWARES AND GLASS

FOR PLASTIC SPORTS BOTTLES SOLD EMPTY; COFFEE AND BEVERAGE STIRRERS (U.S. CLS. 2, 13, 23, 29, 30, 33, 40 AND 50).
FIRST USE 1-0-2007; IN COMMERCE 1-0-2007.

CLASS 43—HOTEL AND RESTAURANT SERVICES

FOR RESORT HOTELS AND LODGING, RESTAURANT AND BAR SERVICES (U.S. CLS. 100 AND 101).
FIRST USE 1-0-2007; IN COMMERCE 1-0-2007.

3,300,223. NEW KINGDOMS, LLC, MYRTLE BEACH, SC. SN 78-978,765. PUB. 8-29-2006, FILED 1-12-2005.



CLASS 21—HOUSEWARES AND GLASS

FOR MUGS (U.S. CLS. 2, 13, 23, 29, 30, 33, 40 AND 50).
FIRST USE 8-0-2006; IN COMMERCE 8-0-2006.

CLASS 25—CLOTHING

FOR CLOTHING, NAMELY, TOPS, CAPES, BELTS; COSTUMES FOR HALLOWEEN, MASQUERADE AND FOR USE IN ROLE-PLAYING; AND HEADWEAR (U.S. CLS. 22 AND 39).
FIRST USE 6-0-2005; IN COMMERCE 6-0-2005.

CLASS 28—TOYS AND SPORTING GOODS

FOR TOYS AND PLAYTHINGS, NAMELY, WANDS AND DECORATIVE TOPPERS FOR WANDS, TOY RUNES IN THE NATURE OF A PLAY MAGICAL CHARM, PLUSH TOY ANIMALS AND ACCESSORIES THEREFOR; CHRISTMAS TREE ORNAMENTS; GAME PIECES, NAMELY, TOY WANDS, TOY COMPASSES, TOY KEYS AND DECORATIVE TOPPERS FOR WANDS, TOY RUNES IN THE NATURE OF A PLAY MAGICAL CHARM, AND OTHER FANTASY, ADVENTURE, WIZARDRY OR MAGIC ITEMS THAT INTERFACE WITH LIVE, INTERACTIVE GAMES, NAMELY, HAND-HELD TOY WEAPONS, ALL OF WHICH ARE OFFERED AT OR IN CONNECTION WITH APPLICANT'S ENTERTAINMENT AND AMUSEMENT CENTERS, AND SPECIFICALLY EXCLUDING THREE DIMENSIONAL TOY PUZZLE CUBES THAT UNFOLD TO REVEAL CUSTOMIZED GRAPHICS AND DESIGNS (U.S. CLS. 22, 23, 38 AND 50).
FIRST USE 6-0-2005; IN COMMERCE 6-0-2005.

CLASS 41—EDUCATION AND ENTERTAINMENT

FOR ENTERTAINMENT SERVICES FOR CHILDREN, NAMELY, LIVE, INTERACTIVE ELECTRONIC GAMES, CHILDREN'S ENTERTAINMENT AND AMUSEMENT CENTERS, NAMELY, INTERACTIVE PLAY AREAS, AMUSEMENT AND THEME PARK SERVICES, ARCADE SERVICE; LIVE ENTERTAINMENT IN THE NATURE OF AN INTERACTIVE GAME (U.S. CLS. 100, 101 AND 107).
FIRST USE 6-0-2005; IN COMMERCE 6-0-2005.

3,300,234. XCEL HOLDINGS, LLC, SCOTTSDALE, AZ. SN 78-978,818. PUB. 6-6-2006, FILED 3-14-2005.

CLASS 9—ELECTRICAL AND SCIENTIFIC APPARATUS

FOR INSTRUCTIONAL AND INTERACTIVE MULTI-MEDIA SOFTWARE IN THE FIELDS OF SALES, BUSINESS, PERSONAL DEVELOPMENT, SALES TEAM BUILDING AND BUSINESS TEAM BUILDING SOFTWARE; AND AUDIO AND VIDEO RECORDINGS IN THE FIELDS OF SALES, BUSINESS, PERSONAL DEVELOPMENT, SALES TEAM BUILDING AND BUSINESS TEAM BUILDING (U.S. CLS. 21, 23, 26, 36 AND 38). FIRST USE 6-1-2001; IN COMMERCE 6-1-2006.

CLASS 16—PAPER GOODS AND PRINTED MATTER

FOR EDUCATIONAL BOOKS AND COLUMNS IN THE FIELD OF SALES, BUSINESS, PERSONAL DEVELOPMENT, SALES TEAM BUILDING AND BUSINESS TEAM BUILDING (U.S. CLS. 2, 5, 22, 23, 29, 37, 38 AND 50). FIRST USE 6-1-2001; IN COMMERCE 6-1-2006.

CLASS 41—EDUCATION AND ENTERTAINMENT

FOR EDUCATIONAL AND TRAINING SERVICES, NAMELY, CONDUCTING CLASSES, SEMINARS, CONFERENCES AND DIAGNOSTIC EDUCATIONAL TESTING IN THE FIELD OF SALES, BUSINESS, PERSONAL DEVELOPMENT, SALES TEAM BUILDING AND BUSINESS TEAM BUILDING; AND PROVIDING NEWSLETTERS IN THE FIELD OF SALES, BUSINESS, PERSONAL DEVELOPMENT, SALES TEAM BUILDING AND BUSINESS TEAM BUILDING VIA E-MAIL (U.S. CLS. 100, 101 AND 107). FIRST USE 6-1-2001; IN COMMERCE 6-1-2006.

Little Voice Management

THE MARK CONSISTS OF STANDARD CHARACTERS WITHOUT CLAIM TO ANY PARTICULAR FONT, STYLE, SIZE, OR COLOR.

NO CLAIM IS MADE TO THE EXCLUSIVE RIGHT TO USE "MANAGEMENT", APART FROM THE MARK AS SHOWN.

* * * * *

SECTION 2.— INTERNATIONAL CLASSIFICATION

The short titles associated below with the international class numbers are terms designed merely for quick identification and are not an official part of the international classification. The full names of international classes are given in section 6.1 of the trademark rules of practice.

The designation "U.S. Cl." appearing in this section refers to the U.S. class in effect prior to Sep. 1, 1973 rather than the international class which applies to applications filed on or after that date. For adoption of international classification see notice in the OFFICIAL GAZETTE of Jun. 26, 1973 (911 O.G. TM 210).

Application in one class

CLASS 1—CHEMICALS

3,298,576. FBC INDUSTRIES, INC., SCHAUMBERG, IL. SN 76-654,710. PUB. 1-16-2007, FILED 2-7-2006.

WHEYPRO

THE MARK CONSISTS OF STANDARD CHARACTERS WITHOUT CLAIM TO ANY PARTICULAR FONT, STYLE, SIZE, OR COLOR.

FOR CHEMICALS USED IN INDUSTRY, NAMELY, SEQUESTERING AGENTS CONSISTING OF MIXTURES OF PHOSPHATES (U.S. CLS. 1, 5, 6, 10, 26 AND 46).
FIRST USE 7-1-2006; IN COMMERCE 7-1-2006.

CLASS 1—(Continued).

3,298,619. SPECIALTY MINERALS (MICHIGAN) INC., BINGHAM FARMS, MI. SN 77-013,331. PUB. 3-13-2007, FILED 10-4-2006.

XCS

THE MARK CONSISTS OF STANDARD CHARACTERS WITHOUT CLAIM TO ANY PARTICULAR FONT, STYLE, SIZE, OR COLOR.

FOR COMPOSITE MINERAL COMPOSED PRIMARILY OF SILICON DIOXIDE AND ALUMINA FOR USE AS A BASIC RAW MATERIAL IN GLASSMAKING (U.S. CLS. 1, 5, 6, 10, 26 AND 46).
FIRST USE 2-23-2007; IN COMMERCE 2-23-2007.

3,298,590. AQUATHIN CORP., POMPANO BEACH, FL. SN 76-658,941. PUB. 12-5-2006, FILED 4-24-2006.

MEGACHAR

THE MARK CONSISTS OF STANDARD CHARACTERS WITHOUT CLAIM TO ANY PARTICULAR FONT, STYLE, SIZE, OR COLOR.

FOR GRANULAR ACTIVATED CARBON IN THE NATURE OF FILTERING MATERIALS FOR PURIFYING WATER IN DOMESTIC, COMMERCIAL OR INDUSTRIAL APPLICATIONS (U.S. CLS. 1, 5, 6, 10, 26 AND 46).
FIRST USE 6-30-1984; IN COMMERCE 6-30-1984.

3,298,676. GEO. PFAU'S SONS COMPANY, INC., JEFFERSONVILLE, IN. SN 78-249,751. PUB. 12-30-2003, FILED 5-15-2003.

PEAK TECH

FOR ANTI-OXIDANTS FOR USE IN FATS, OIL, AND ANIMAL FEEDS (U.S. CLS. 1, 5, 6, 10, 26 AND 46).
FIRST USE 1-0-2007; IN COMMERCE 1-0-2007.

CLASS 1—(Continued).

3,298,794. TERRAFUSION, INC., BRENTWOOD, CA. SN 78-458,710. PUB. 6-28-2005, FILED 7-29-2004.

CLASS 1—(Continued).

3,299,050. GE HEALTHCARE UK LIMITED, BUCKINGHAMSHIRE, UNITED KINGDOM. SN 78-603,660. PUB. 10-3-2006, FILED 4-7-2005.

ECL PLEX

CA MAX

THE MARK CONSISTS OF STANDARD CHARACTERS WITHOUT CLAIM TO ANY PARTICULAR FONT, STYLE, SIZE, OR COLOR.

PRIORITY CLAIMED UNDER SEC. 44(D) ON ERPNCMNTY TM OFC APPLICATION NO. 004320289, FILED 3-3-2005.

OWNER OF U.S. REG. NOS. 2,830,827 AND 2,830,828. NO CLAIM IS MADE TO THE EXCLUSIVE RIGHT TO USE "ECL", APART FROM THE MARK AS SHOWN.

FOR CHEMILUMINESCENCE DETECTION AGENT AND PROTEIN MOLECULAR WEIGHT MARKS FOR USE IN WESTERN BLOTTING; CHEMICALS AND CHEMICAL REAGENTS FOR USE IN SCIENCE AND RESEARCH; CHEMICAL PREPARATIONS FOR SCIENTIFIC PURPOSES; CHEMICAL SUBSTANCES FOR ANALYSES IN LABORATORIES FOR SCIENCE AND RESEARCH USE; CHEMICAL REAGENTS AND PREPARATIONS FOR USE IN THE LABELING AND DETECTION OF NUCLEIC ACIDS AND PROTEINS; NON-RADIOACTIVE CHEMICAL REAGENTS AND PREPARATIONS FOR USE IN THE LABELING AND DETECTION OF IMMOBILIZED NUCLEIC ACIDS AND PROTEINS (U.S. CLS. 1, 5, 6, 10, 26 AND 46).

FIRST USE 7-31-2005; IN COMMERCE 7-31-2005.

3,299,164. LIFELINE CELL TECHNOLOGY, LLC, WALKERSVILLE, MD. SN 78-653,067. PUB. 3-21-2006, FILED 6-17-2005.

FibroLife

THE MARK CONSISTS OF STANDARD CHARACTERS WITHOUT CLAIM TO ANY PARTICULAR FONT, STYLE, SIZE, OR COLOR.

FOR NON TOXIC, NON CAUSTIC NATURAL CONCRETE ADDITIVE AND AN ADDITIVE FOR MASONRY AND BRICKS (U.S. CLS. 1, 5, 6, 10, 26 AND 46).

FIRST USE 2-1-2007; IN COMMERCE 2-1-2007.

THE MARK CONSISTS OF STANDARD CHARACTERS WITHOUT CLAIM TO ANY PARTICULAR FONT, STYLE, SIZE, OR COLOR.

FOR MEDIA FOR CELL CULTURES IN LIQUID FORM, FOR SCIENTIFIC USE (U.S. CLS. 1, 5, 6, 10, 26 AND 46).

FIRST USE 6-17-2005; IN COMMERCE 1-6-2006.

CLASS 1—(Continued).

3,299,254. REGENESIS BIOREMEDIATION PRODUCTS, SAN CLEMENTE, CA. SN 78-690,794. PUB. 5-23-2006, FILED 8-11-2005.

HRC ADVANCED

THE MARK CONSISTS OF STANDARD CHARACTERS WITHOUT CLAIM TO ANY PARTICULAR FONT, STYLE, SIZE, OR COLOR.

OWNER OF U.S. REG. NOS. 2,307,482, 2,989,634, AND OTHERS.

FOR CHEMICALS FOR USE IN THE DECONTAMINATION OF SITES POLLUTED BY TOXIC WASTE SUCH AS OIL, HEAVY METALS, AND ANY OTHER ORGANIC OR INORGANIC MATERIAL (U.S. CLS. 1, 5, 6, 10, 26 AND 46).

FIRST USE 11-4-2005; IN COMMERCE 11-4-2005.

3,299,291. CORN PRODUCTS INTERNATIONAL, INC., WESTCHESTER, IL. SN 78-703,671. PUB. 1-10-2006, FILED 8-30-2005.

FARMAL

THE MARK CONSISTS OF STANDARD CHARACTERS WITHOUT CLAIM TO ANY PARTICULAR FONT, STYLE, SIZE, OR COLOR.

FOR UNMODIFIED STARCHES FROM WHITE CORN OR MAIZE USED AS INGREDIENTS FOR PHARMACEUTICAL PRODUCTS (U.S. CLS. 1, 5, 6, 10, 26 AND 46).

FIRST USE 1-26-2007; IN COMMERCE 1-26-2007.

3,299,427. MICHEL MERCIER PRODUCTS, DBA M.M.P., INC., SOUTH PLAINFIELD, NJ. SN 78-735,898. PUB. 1-16-2007, FILED 10-19-2005.

EDICOL

THE MARK CONSISTS OF STANDARD CHARACTERS WITHOUT CLAIM TO ANY PARTICULAR FONT, STYLE, SIZE, OR COLOR.

FOR CHEMICALS, NAMELY ETHOXYDIGLYCOL, FOR USE IN THE MANUFACTURE OF COSMETIC, PERSONAL CARE AND PHARMACEUTICAL PRODUCTS (U.S. CLS. 1, 5, 6, 10, 26 AND 46).

FIRST USE 5-16-1987; IN COMMERCE 5-16-1987.

CLASS 1—(Continued).

3,299,466. CARGILL, INCORPORATED, WAYZATA, MN. SN 78-739,628. PUB. 6-27-2006, FILED 10-25-2005.

SWEETDESIGN

THE MARK CONSISTS OF STANDARD CHARACTERS WITHOUT CLAIM TO ANY PARTICULAR FONT, STYLE, SIZE, OR COLOR.

FOR ARTIFICIAL SWEETENERS (U.S. CLS. 1, 5, 6, 10, 26 AND 46).

FIRST USE 7-27-2006; IN COMMERCE 7-27-2006.

3,299,563. PANOMICS, INC., FREMONT, CA. SN 78-754,684. PUB. 7-4-2006, FILED 11-15-2005.

PROCARTA

THE MARK CONSISTS OF STANDARD CHARACTERS WITHOUT CLAIM TO ANY PARTICULAR FONT, STYLE, SIZE, OR COLOR.

FOR BIOLOGICAL REAGENT FOR RESEARCH AND LABORATORY USE, NAMELY REAGENTS USED FOR PROTEIN EXPRESSION PROFILING (U.S. CLS. 1, 5, 6, 10, 26 AND 46).

FIRST USE 7-13-2006; IN COMMERCE 12-11-2006.

3,299,601. LOVELAND PRODUCTS, INC., GREELEY, CO. SN 78-763,653. PUB. 2-13-2007, FILED 11-30-2005.

VALIDATE

THE MARK CONSISTS OF STANDARD CHARACTERS WITHOUT CLAIM TO ANY PARTICULAR FONT, STYLE, SIZE, OR COLOR.

FOR SEED AND PLANT GROWTH HORMONES AND FERTILIZER ADDITIVES FOR AGRICULTURAL AND HORTICULTURAL USE (U.S. CLS. 1, 5, 6, 10, 26 AND 46).

FIRST USE 3-14-2006; IN COMMERCE 3-14-2006.

CLASS 1—(Continued).

3,299,602. LOVELAND PRODUCTS, INC., GREELEY, CO. SN 78-763,661. PUB. 2-13-2007, FILED 11-30-2005.

CLASS 1—(Continued).

3,299,633. MISSISSIPPI VALLEY AG, LLC, CLARKSVILLE, TN. SN 78-770,177. PUB. 8-29-2006, FILED 12-9-2005.

RADIATE

STRIVE

THE MARK CONSISTS OF STANDARD CHARACTERS WITHOUT CLAIM TO ANY PARTICULAR FONT, STYLE, SIZE, OR COLOR.

FOR SEED AND PLANT GROWTH HORMONES AND FERTILIZER ADDITIVES FOR AGRICULTURAL AND HORTICULTURAL USE (U.S. CLS. 1, 5, 6, 10, 26 AND 46).
FIRST USE 3-14-2006; IN COMMERCE 3-14-2006.

THE MARK CONSISTS OF STANDARD CHARACTERS WITHOUT CLAIM TO ANY PARTICULAR FONT, STYLE, SIZE, OR COLOR.

FOR PLANT GROWTH REGULATORS FOR AGRICULTURAL USE (U.S. CLS. 1, 5, 6, 10, 26 AND 46).
FIRST USE 5-0-2006; IN COMMERCE 5-0-2006.

3,299,620. HERCULES INCORPORATED, WILMINGTON, DE. SN 78-768,188. PUB. 5-9-2006, FILED 12-7-2005.

3,299,634. MISSISSIPPI VALLEY AG, LLC, CLARKSVILLE, TN. SN 78-770,184. PUB. 8-29-2006, FILED 12-9-2005.

ADVANTAGE

AMASS

THE MARK CONSISTS OF STANDARD CHARACTERS WITHOUT CLAIM TO ANY PARTICULAR FONT, STYLE, SIZE, OR COLOR.

OWNER OF U.S. REG. NO. 1,731,963.
FOR FOAM CONTROL AGENTS USED IN THE PULP AND PAPER INDUSTRY (U.S. CLS. 1, 5, 6, 10, 26 AND 46).
FIRST USE 3-22-2006; IN COMMERCE 3-22-2006.

THE MARK CONSISTS OF STANDARD CHARACTERS WITHOUT CLAIM TO ANY PARTICULAR FONT, STYLE, SIZE, OR COLOR.

FOR PLANT GROWTH REGULATORS FOR AGRICULTURAL USE (U.S. CLS. 1, 5, 6, 10, 26 AND 46).
FIRST USE 5-0-2006; IN COMMERCE 5-0-2006.

3,299,632. MISSISSIPPI VALLEY AG, LLC, CLARKSVILLE, TN. SN 78-770,159. PUB. 8-29-2006, FILED 12-9-2005.

3,299,705. HALLIBURTON ENERGY SERVICES, INC., CARROLLTON, TX. SN 78-788,351. PUB. 7-25-2006, FILED 1-10-2006.

MVAGRO

INNOVERT

THE MARK CONSISTS OF STANDARD CHARACTERS WITHOUT CLAIM TO ANY PARTICULAR FONT, STYLE, SIZE, OR COLOR.

FOR PLANT GROWTH REGULATORS FOR AGRICULTURAL USE (U.S. CLS. 1, 5, 6, 10, 26 AND 46).
FIRST USE 5-0-2006; IN COMMERCE 5-0-2006.

THE MARK CONSISTS OF STANDARD CHARACTERS WITHOUT CLAIM TO ANY PARTICULAR FONT, STYLE, SIZE, OR COLOR.

FOR DRILLING MUDS AND CHEMICAL ADDITIVES USED IN OIL AND GAS WELL DRILLING OPERATIONS (U.S. CLS. 1, 5, 6, 10, 26 AND 46).
FIRST USE 12-31-2005; IN COMMERCE 12-31-2005.

CLASS 1—(Continued).

3,299,741. JONES-HAMILTON CO., WALBRIDGE, OH. SN 78-798,306. PUB. 9-12-2006, FILED 1-24-2006.



OWNER OF U.S. REG. NO. 2,968,235.
NO CLAIM IS MADE TO THE EXCLUSIVE RIGHT TO USE "BY" AND "CO.", APART FROM THE MARK AS SHOWN.

THE MARK CONSISTS OF TWO CONCENTRIC CIRCLES SUPERIMPOSED OVER A STYLIZED ANIMAL PAW PRINT.

FOR CHEMICAL ADDITIVES FOR USE IN THE MANUFACTURE OF PET FOODS (U.S. CLS. 1, 5, 6, 10, 26 AND 46).

FIRST USE 3-9-2007; IN COMMERCE 3-9-2007.

3,299,983. FRANKLIN INTERNATIONAL, INC., COLUMBUS, OH. SN 78-883,736. PUB. 1-16-2007, FILED 5-15-2006.

ACRYNAX

THE MARK CONSISTS OF STANDARD CHARACTERS WITHOUT CLAIM TO ANY PARTICULAR FONT, STYLE, SIZE, OR COLOR.

FOR HOT MELT ADHESIVES FOR INDUSTRIAL USE (U.S. CLS. 1, 5, 6, 10, 26 AND 46).

FIRST USE 3-13-2006; IN COMMERCE 3-13-2006.

CLASS 1—(Continued).

3,300,180. INDOPCO, INC., DBA NATIONAL STARCH AND CHEMICAL COMPANY, BRIDGEWATER, NJ. SN 78-957,189. PUB. 3-6-2007, FILED 8-22-2006.

N-DURANCE

THE MARK CONSISTS OF STANDARD CHARACTERS WITHOUT CLAIM TO ANY PARTICULAR FONT, STYLE, SIZE, OR COLOR.

FOR ADHESIVES FOR USE IN THE MANUFACTURE OF MILLWORK AND WOOD BONDING APPLICATIONS (U.S. CLS. 1, 5, 6, 10, 26 AND 46).

FIRST USE 5-24-2007; IN COMMERCE 5-24-2007.

CLASS 2—PAINTS

3,298,791. ROAD SERVICES INTERNATIONAL LTD., BURLINGTON, ONTARIO, CANADA. SN 78-456,751. PUB. 6-28-2005, FILED 7-26-2004.

PERMAMARK

THE MARK CONSISTS OF STANDARD CHARACTERS WITHOUT CLAIM TO ANY PARTICULAR FONT, STYLE, SIZE, OR COLOR.

FOR REFLECTIVE PAINTS AND COATINGS FOR USE IN ROAD AND SIDEWALK PAVEMENT MARKING (U.S. CLS. 6, 11 AND 16).

FIRST USE 12-1-1975; IN COMMERCE 3-31-2006.

3,298,957. EXTERIOR WOOD RESTORATION, INC., CICERO, IN. SN 78-572,007. PUB. 7-11-2006, FILED 2-22-2005.

Timber OX

THE MARK CONSISTS OF STANDARD CHARACTERS WITHOUT CLAIM TO ANY PARTICULAR FONT, STYLE, SIZE, OR COLOR.

NO CLAIM IS MADE TO THE EXCLUSIVE RIGHT TO USE "TIMBER", APART FROM THE MARK AS SHOWN.

FOR WOOD TREATMENT PRODUCTS IN THE NATURE OF WOOD PRESERVATIVE, WOOD PRESERVATIVE STAIN, WOOD CONDITIONER, WOOD STAIN (U.S. CLS. 6, 11 AND 16).

FIRST USE 7-31-2004; IN COMMERCE 1-28-2006.

CLASS 2—(Continued).

3,299,172. PALEO BOND, INC., ST. PAUL, MN. SN 78-655,370.
PUB. 8-1-2006, FILED 6-21-2005.

PRE-SERVE

THE MARK CONSISTS OF STANDARD CHARACTERS WITHOUT CLAIM TO ANY PARTICULAR FONT, STYLE, SIZE, OR COLOR.

FOR LIQUID PENETRANTS AND SEALANTS TO PROVIDE PROTECTION FOR NATURAL AND MAN-MADE STONE, NAMELY, LIMESTONE, SANDSTONE, SEDIMENTARY ROCK, CALCAREOUS ROCK, FOSSIL TRACKWAYS, GRAVESTONE MARKERS, TOMB-STONES, HAND-CARVED STATUARY AND ARCHITECTURAL FACADES (U.S. CLS. 6, 11 AND 16).
FIRST USE 11-8-2005; IN COMMERCE 11-8-2005.

CLASS 2—(Continued).

3,299,577. PPG ARCHITECTURAL FINISHES, INC., PITTSBURGH, PA. SN 78-756,853. PUB. 7-11-2006, FILED 11-18-2005.

COLOR VISIONS

THE MARK CONSISTS OF STANDARD CHARACTERS WITHOUT CLAIM TO ANY PARTICULAR FONT, STYLE, SIZE, OR COLOR.

NO CLAIM IS MADE TO THE EXCLUSIVE RIGHT TO USE "COLOR", APART FROM THE MARK AS SHOWN.

FOR COATING COMPOSITIONS IN THE NATURE OF PAINT, NAMELY, WET PAINT SAMPLES (U.S. CLS. 6, 11 AND 16).
FIRST USE 3-24-2006; IN COMMERCE 3-24-2006.

3,299,368. SENSIENT COLORS INC., MILWAUKEE, WI. SN 78-725,845. PUB. 6-20-2006, FILED 10-4-2005.

SENSIJET

THE MARK CONSISTS OF STANDARD CHARACTERS WITHOUT CLAIM TO ANY PARTICULAR FONT, STYLE, SIZE, OR COLOR.

OWNER OF U.S. REG. NO. 2,982,199.
FOR COLORANTS USED IN THE MANUFACTURE OF INKS; INKS COMPRISED OF COLORS, FRAGRANCES AND FLAVORS TO BE USED IN INKJET PRINTING (U.S. CLS. 6, 11 AND 16).
FIRST USE 6-21-2004; IN COMMERCE 6-21-2004.

3,299,578. PPG ARCHITECTURAL FINISHES, INC., PITTSBURGH, PA. SN 78-756,858. PUB. 7-11-2006, FILED 11-18-2005.

GRAND DISTINCTION

THE MARK CONSISTS OF STANDARD CHARACTERS WITHOUT CLAIM TO ANY PARTICULAR FONT, STYLE, SIZE, OR COLOR.

FOR COATING COMPOSITIONS IN THE NATURE OF PAINT FOR ARCHITECTURAL APPLICATIONS (U.S. CLS. 6, 11 AND 16).
FIRST USE 2-7-2006; IN COMMERCE 2-7-2006.

3,299,536. THE GLIDDEN COMPANY, STRONGSVILLE, OH. SN 78-751,284. PUB. 6-27-2006, FILED 11-10-2005.

LIFEMASTER

THE MARK CONSISTS OF STANDARD CHARACTERS WITHOUT CLAIM TO ANY PARTICULAR FONT, STYLE, SIZE, OR COLOR.

OWNER OF U.S. REG. NOS. 1,818,328 AND 1,820,367.
FOR COATINGS IN THE NATURE OF PAINTS (U.S. CLS. 6, 11 AND 16).
FIRST USE 4-11-2006; IN COMMERCE 4-11-2006.

3,299,641. THE GLIDDEN COMPANY, STRONGSVILLE, OH. SN 78-771,816. PUB. 6-27-2006, FILED 12-13-2005.

QUIET SPACES

THE MARK CONSISTS OF STANDARD CHARACTERS WITHOUT CLAIM TO ANY PARTICULAR FONT, STYLE, SIZE, OR COLOR.

FOR COATINGS IN THE NATURE OF PAINT (U.S. CLS. 6, 11 AND 16).
FIRST USE 5-1-2006; IN COMMERCE 5-1-2006.

CLASS 2—(Continued).

3,299,642. THE GLIDDEN COMPANY, STRONGSVILLE, OH.
SN 78-771,817. PUB. 6-27-2006, FILED 12-13-2005.

CLASS 2—(Continued).

3,299,677. THE SHERWIN-WILLIAMS COMPANY, CLEVELAND, OH. SN 78-781,436. PUB. 7-18-2006, FILED 12-28-2005.

ACTIVE SPACES

THE MARK CONSISTS OF STANDARD CHARACTERS WITHOUT CLAIM TO ANY PARTICULAR FONT, STYLE, SIZE, OR COLOR.
FOR COATINGS IN THE NATURE OF PAINT (U.S. CLS. 6, 11 AND 16).
FIRST USE 5-1-2006; IN COMMERCE 5-1-2006.

PROGREEN

THE MARK CONSISTS OF STANDARD CHARACTERS WITHOUT CLAIM TO ANY PARTICULAR FONT, STYLE, SIZE, OR COLOR.
FOR CLEAR AND PIGMENTED COATINGS USED IN THE NATURE OF PAINT (U.S. CLS. 6, 11 AND 16).
FIRST USE 3-2-2007; IN COMMERCE 3-2-2007.

3,299,643. THE GLIDDEN COMPANY, STRONGSVILLE, OH.
SN 78-771,818. PUB. 6-27-2006, FILED 12-13-2005.

CLASS 3—COSMETICS AND CLEANING PREPARATIONS

3,298,423. AUSTRALIAN GOLD, INC., INDIANAPOLIS, IN.
SN 76-403,642. PUB. 3-13-2007, FILED 5-3-2002.

ELEGANT SPACES

THE MARK CONSISTS OF STANDARD CHARACTERS WITHOUT CLAIM TO ANY PARTICULAR FONT, STYLE, SIZE, OR COLOR.
FOR COATINGS IN THE NATURE OF PAINT (U.S. CLS. 6, 11 AND 16).
FIRST USE 5-1-2006; IN COMMERCE 5-1-2006.

SEX POT

FOR SUNTANNING PREPARATIONS (U.S. CLS. 1, 4, 6, 50, 51 AND 52).
FIRST USE 11-5-2002; IN COMMERCE 11-5-2002.

3,299,644. THE GLIDDEN COMPANY, STRONGSVILLE, OH.
SN 78-771,819. PUB. 6-27-2006, FILED 12-13-2005.

3,298,429. SUNSCIENCE, INC., MIAMI, FL. SN 76-456,317.
PUB. 12-30-2003, FILED 9-30-2002.

CASUAL SPACES

THE MARK CONSISTS OF STANDARD CHARACTERS WITHOUT CLAIM TO ANY PARTICULAR FONT, STYLE, SIZE, OR COLOR.
FOR COATINGS IN THE NATURE OF PAINT (U.S. CLS. 6, 11 AND 16).
FIRST USE 5-1-2006; IN COMMERCE 5-1-2006.

SUNWELL

FOR SKIN CARE PREPARATIONS AND COSMETICS, NAMELY MOISTURIZER, TONER, CLEANSER, NIGHT CREAM, NON-MEDICATED SKIN SERUMS, SKIN LIGHTENER, FACIAL MASK, SOAP FOR FACE AND BODY, OILS FOR FACE AND BODY, BATH OIL, GEL FOR FACE AND BODY, SHOWER GEL, LIPSTICK, POWDER FOR FACE AND BODY, BLUSH, MASCARA, EYE SHADOW, FOUNDATION, CONCEALER, WRINKLE REMOVER, BATH FOAM, BATH SALTS, BRONZING POWDER; NON-MEDICATED SUNCARE PREPARATIONS, NAMELY NON-MEDICATED SUNSCREEN CREAM, NON-MEDICATED SUNSCREEN LOTION, NON-MEDICATED SUNSCREEN OIL, NON-MEDICATED SUNSCREEN STICKS, NON-MEDICATED SUN TAN LOTION FOR THE FACE AND BODY, NON-MEDICATED ULTRA-VIOLET PROTECTION LOTIONS, NON-MEDICATED SUN BLOCK, NON-MEDICATED SUNBURN CARE CREAM, NON-MEDICATED SUNBURN CARE LOTION, NON-MEDICATED SUNBURN CARE SPRAYS, NON-MEDICATED SELF TANNER CREAM AND LOTION, NON-MEDICATED SELF TANNER SPRAY; HAIR CARE PREPARATIONS, NAMELY SHAMPOO, CONDITIONER, HAIR LIGHTENER, HAIR MASKS, NON-MEDICATED HAIR SERUMS, HAIR SPRAY (U.S. CLS. 1, 4, 6, 50, 51 AND 52).
FIRST USE 11-6-2006; IN COMMERCE 11-6-2006.

CLASS 3—(Continued).

3,298,466. HANSON HONG BIOMEDICAL CO., LTD., TAIPEI CITY, TAIWAN. SN 76-602,337. PUB. 9-12-2006, FILED 7-14-2004.

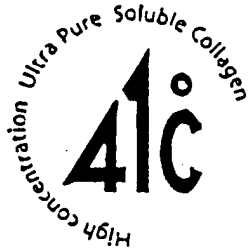

NO CLAIM IS MADE TO THE EXCLUSIVE RIGHT TO USE "41C HIGH CONCENTRATION ULTRA PURE SOLUBLE COLLAGEN", APART FROM THE MARK AS SHOWN.

FOR COSMETICS; HAIR WAVING PREPARATIONS; HAIR COLORANTS; HAIR LOTIONS; HAIR SHAMPOOS; BODY CLEANSING PREPARATIONS; DETERGENTS FOR CLOTHING, BATHROOMS AND KITCHENS; POLISHES IN THE FORMS OF WAX, POWDER OR LIQUID FOR FLOORS, AUTOMOBILES AND UTENSILS; PERFUMERY; ESSENTIAL OILS FOR PERSONAL USE; TOOTHPASTES, DENTIFRICES, NON-MEDICATED DENTAL RINSES; BLEACHING PREPARATIONS AND OTHER SUBSTANCES FOR LAUNDRY USE; CLEANING, POLISHING, SCOURING AND ABRASIVE PREPARATIONS; AND SOAPS (U.S. CLS. 1, 4, 6, 50, 51 AND 52).

FIRST USE 1-1-2000; IN COMMERCE 4-15-2005.

3,298,474. NU-WORLD CORPORATION, CARTERET, NJ. SN 76-606,836. PUB. 7-5-2005, FILED 8-13-2004.

SPORT PAINT

THE MARK CONSISTS OF STANDARD CHARACTERS WITHOUT CLAIM TO ANY PARTICULAR FONT, STYLE, SIZE, OR COLOR.

NO CLAIM IS MADE TO THE EXCLUSIVE RIGHT TO USE "SPORT", APART FROM THE MARK AS SHOWN.

FOR COSMETICS, NAMELY, NAIL POLISH, NAIL CARE PREPARATIONS, EYE SHADOW, LIPSTICK, LIP GLOSS, FACIAL MAKEUP, FRAGRANCES, NAMELY PERFUMES AND COLOGNES, MASCARA, NON-MEDICATED SKIN CARE PREPARATIONS, HAIR CARE PREPARATIONS, SHAMPOO, HAIR COLORING, AND HAIR STYLING PREPARATIONS (U.S. CLS. 1, 4, 6, 50, 51 AND 52).

FIRST USE 10-0-2005; IN COMMERCE 10-0-2005.

CLASS 3—(Continued).

3,298,627. GAP (APPAREL), LLC, SAN FRANCISCO, CA. SN 77-031,056. PUB. 1-16-2007, FILED 10-27-2006.

MOONWALK

THE MARK CONSISTS OF STANDARD CHARACTERS WITHOUT CLAIM TO ANY PARTICULAR FONT, STYLE, SIZE, OR COLOR.

FOR BATH GEL; BATH OIL; BATH SALTS; BODY CREAM; BODY LOTION; BODY SCRUB; BODY SPRAYS; HAND LOTIONS (U.S. CLS. 1, 4, 6, 50, 51 AND 52).

FIRST USE 4-29-2007; IN COMMERCE 4-29-2007.

3,298,628. GAP (APPAREL), LLC, SAN FRANCISCO, CA. SN 77-031,080. PUB. 1-16-2007, FILED 10-27-2006.

RAINCHECK

THE MARK CONSISTS OF STANDARD CHARACTERS WITHOUT CLAIM TO ANY PARTICULAR FONT, STYLE, SIZE, OR COLOR.

FOR BATH GEL; BATH OILS; BATH SALTS; BODY CREAMS; BODY LOTION; BODY SCRUB; BODY SPRAYS; HAND LOTIONS (U.S. CLS. 1, 4, 6, 50, 51 AND 52).

FIRST USE 4-29-2007; IN COMMERCE 4-29-2007.

3,298,629. GAP (APPAREL), LLC, SAN FRANCISCO, CA. SN 77-031,094. PUB. 1-16-2007, FILED 10-27-2006.

SUGARSNAP

THE MARK CONSISTS OF STANDARD CHARACTERS WITHOUT CLAIM TO ANY PARTICULAR FONT, STYLE, SIZE, OR COLOR.

FOR BATH GEL; BATH OIL; BATH SALTS; BODY CREAM; BODY LOTION; BODY SCRUB; BODY SPRAYS; HAND LOTIONS (U.S. CLS. 1, 4, 6, 50, 51 AND 52).

FIRST USE 4-29-2007; IN COMMERCE 4-29-2007.

CLASS 3—(Continued).

3,298,630. GAP (APPAREL), LLC, SAN FRANCISCO, CA. SN 77-031,105. PUB. 1-16-2007, FILED 10-27-2006.

PEACETRAIN

THE MARK CONSISTS OF STANDARD CHARACTERS WITHOUT CLAIM TO ANY PARTICULAR FONT, STYLE, SIZE, OR COLOR.

FOR BATH GEL; BATH OIL; BATH SALTS; BODY CREAM; BODY LOTION; BODY OIL; BODY SCRUB; BODY SPRAYS; HAND LOTIONS (U.S. CLS. 1, 4, 6, 50, 51 AND 52).

FIRST USE 4-29-2007; IN COMMERCE 4-29-2007.

3,298,631. GAP (APPAREL), LLC, SAN FRANCISCO, CA. SN 77-031,116. PUB. 1-16-2007, FILED 10-27-2006.

SUNNYSIDE

THE MARK CONSISTS OF STANDARD CHARACTERS WITHOUT CLAIM TO ANY PARTICULAR FONT, STYLE, SIZE, OR COLOR.

FOR BATH GEL; BATH OIL; BATH SALTS; BODY CREAM; BODY LOTION; BODY SCRUB; BODY SPRAYS; HAND LOTIONS (U.S. CLS. 1, 4, 6, 50, 51 AND 52).

FIRST USE 4-29-2007; IN COMMERCE 4-29-2007.

3,298,632. GAP (APPAREL), LLC, SAN FRANCISCO, CA. SN 77-032,551. PUB. 1-16-2007, FILED 10-30-2006.

NIGHTFALL

THE MARK CONSISTS OF STANDARD CHARACTERS WITHOUT CLAIM TO ANY PARTICULAR FONT, STYLE, SIZE, OR COLOR.

FOR BATH GEL; BATH OIL; BATH SALTS; BODY CREAM; BODY LOTION; BODY SCRUB; BODY SPRAYS; HAND LOTIONS (U.S. CLS. 1, 4, 6, 50, 51 AND 52).

FIRST USE 4-29-2007; IN COMMERCE 4-29-2007.

CLASS 3—(Continued).

3,298,655. MULLINS, AIMEE, NEW YORK, NY. SN 78-185,312. PUB. 6-17-2003, FILED 11-14-2002.

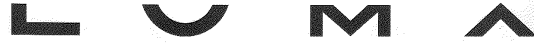

FOR LIPSTICK, LIP LINER PENCILS, LIP GLOSS, FOUNDATION, BLUSH, PRESSED POWDER, LOOSE POWDER, MASCARA, EYE LINER, EYE PENCILS, MAKEUP BRUSHES, EYE SHADOW, UNDER-EYE COVER, SOAP, CLEANSING LOTION, TONER, ASTRINGENT FOR COSMETIC PURPOSES, EYE MAKEUP REMOVER, FACIAL MASKS, EYE CREAM, FACIAL AND BODY TREATMENT CREAM, COVER-UP BLEMISH LOTION, SHAVE CREAM, FACIAL SCRUB, BODY POLISHER, NAMELY, EXFOLIANT, NAIL POLISH, BODY LOTION, SUNSCREEN, NAMELY, MOISTURIZING SUNSCREEN, GEL, SPRAY, SELF-TANNING, BRONZING AND TINTED FORMULAS, AND SKIN MOISTURIZER (U.S. CLS. 1, 4, 6, 50, 51 AND 52).

FIRST USE 1-5-2006; IN COMMERCE 6-28-2006.

3,298,685. MARK LEES SKIN CARE, INC., PENSACOLA, FL. SN 78-287,610. PUB. 7-12-2005, FILED 8-14-2003.

MARK LEES

Science...Made Beautiful

THE MARK CONSISTS OF STANDARD CHARACTERS WITHOUT CLAIM TO ANY PARTICULAR FONT, STYLE, SIZE, OR COLOR.

OWNER OF U.S. REG. NO. 2,132,830.

FOR SKIN CARE PRODUCTS, NAMELY, SKIN CLEANSER, SKIN TONER, SKIN CREAM, SKIN LOTION, SKIN MASK GEL, MAKE-UP FOUNDATION, POWDER AND BLUSH (U.S. CLS. 1, 4, 6, 50, 51 AND 52).

FIRST USE 3-17-2007; IN COMMERCE 3-17-2007.

3,298,711. EXCELDA MANUFACTURING COMPANY, BRIGHTON, MI. SN 78-335,233. PUB. 6-14-2005, FILED 12-2-2003.

SUPREME MARINE

THE MARK CONSISTS OF STANDARD CHARACTERS WITHOUT CLAIM TO ANY PARTICULAR FONT, STYLE, SIZE, OR COLOR.

NO CLAIM IS MADE TO THE EXCLUSIVE RIGHT TO USE MARINE, APART FROM THE MARK AS SHOWN.

FOR WAXES, POLISHES, AND CLEANERS FOR SHIPS, BOATS, AND PERSONAL WATERCRAFT (U.S. CLS. 1, 4, 6, 50, 51 AND 52).

FIRST USE 1-10-2005; IN COMMERCE 2-15-2005.

CLASS 3—(Continued).

3,298,763. COLGATE-PALMOLIVE COMPANY, NEW YORK, NY. SN 78-418,734. PUB. 6-21-2005, FILED 5-14-2004.

CLASS 3—(Continued).

3,298,803. RECTORSEAL CORPORATION, HOUSTON, TX. SN 78-462,053. PUB. 11-29-2005, FILED 8-4-2004.

SCRUB BUSTER

BLUE MAGIC THE MAGIC IS IN THE RESULTS

THE MARK CONSISTS OF STANDARD CHARACTERS WITHOUT CLAIM TO ANY PARTICULAR FONT, STYLE, SIZE, OR COLOR.

FOR DETERGENTS (U.S. CLS. 1, 4, 6, 50, 51 AND 52). FIRST USE 2-26-2007; IN COMMERCE 2-26-2007.

THE MARK CONSISTS OF STANDARD CHARACTERS WITHOUT CLAIM TO ANY PARTICULAR FONT, STYLE, SIZE, OR COLOR.

OWNER OF U.S. REG. NO. 1,393,685.

FOR CLEANING AND FINISHING PREPARATIONS FOR VEHICLES, NAMELY POLISHING CREAMS AND LIQUIDS, GLOSS AND PAINT SEALANTS, WHEEL CLEANERS, WHEEL BRIGHTENERS, TIRE SHINE, ROAD TAR REMOVER AND BUG GEL, PLASTIC AND PLEXIGLASS CLEANERS, AND CONVERTIBLE TOP CLEANERS (U.S. CLS. 1, 4, 6, 50, 51 AND 52). FIRST USE 2-3-2004; IN COMMERCE 2-3-2004.

3,298,786. TOMJAI ENTERPRISES CORP., MIAMI, FL. SN 78-452,716. PUB. 6-20-2006, FILED 7-19-2004.

3,298,809. VICTORIA'S SECRET STORES BRAND MANAGEMENT, INC., REYNOLDSBURG, OH. SN 78-466,928. PUB. 7-5-2005, FILED 8-13-2004.

MJ MAGIC

SO IN LOVE

THE MARK CONSISTS OF STANDARD CHARACTERS WITHOUT CLAIM TO ANY PARTICULAR FONT, STYLE, SIZE, OR COLOR.

FOR BEAUTY AND SKIN CARE PRODUCTS, NAMELY, SOAPS AND PERSONAL CLEANSING PRODUCTS NAMELY BODY WASH, SKIN LOTIONS, SKIN CREAMS, SKIN MOISTURIZING LOTIONS AND CREAMS; COSMETICS, NAMELY, NONMEDICATED SKIN SOAPS AND SKIN LOTIONS AND CREAMS FOR DEPIGMENTATION OF THE SKIN (U.S. CLS. 1, 4, 6, 50, 51 AND 52).

FIRST USE 9-4-2004; IN COMMERCE 9-4-2004.

THE MARK CONSISTS OF STANDARD CHARACTERS WITHOUT CLAIM TO ANY PARTICULAR FONT, STYLE, SIZE, OR COLOR.

FOR PERSONAL CARE PRODUCTS, NAMELY, BATH BEADS, BODY GLITTER, BODY MIST, BODY WASH, COLOGNE, CREAM FOR THE BODY, CREAM FOR THE HANDS, FRAGRANT BODY SPLASH, FRAGRANT BODY MIST, LOTION FOR THE BODY, LOTION FOR THE FACE, LOTION FOR THE FEET, LOTION FOR THE HANDS, PERFUME, POWDER FOR THE BODY, SHOWER CREAM, SHOWER GEL, SKIN BRONZING CREAM, SOAP FOR THE BODY, SOAP FOR THE FACE, SOAP FOR THE HANDS (U.S. CLS. 1, 4, 6, 50, 51 AND 52).

FIRST USE 5-10-2005; IN COMMERCE 5-10-2005.

CLASS 3—(Continued).

3,298,816. COLGATE-PALMOLIVE COMPANY, NEW YORK, NY. SN 78-473,282. PUB. 7-19-2005, FILED 8-25-2004.

CLASS 3—(Continued).

3,298,896. SHISEIDO COMPANY, LTD., TOKYO, JAPAN. SN 78-535,363. PUB. 7-18-2006, FILED 12-20-2004.

PASSION OF FRUITS

THE MARK CONSISTS OF STANDARD CHARACTERS WITHOUT CLAIM TO ANY PARTICULAR FONT, STYLE, SIZE, OR COLOR.

FOR ALL PURPOSE HOUSEHOLD CLEANERS WITH DEODORIZING PROPERTIES (U.S. CLS. 1, 4, 6, 50, 51 AND 52).

FIRST USE 6-0-2005; IN COMMERCE 6-0-2005.

3,298,842. COTY US LLC, NEW YORK, NY. SN 78-488,637. PUB. 12-6-2005, FILED 9-23-2004.



NO CLAIM IS MADE TO THE EXCLUSIVE RIGHT TO USE "ORGANICS" AND "WILD HONEY", APART FROM THE MARK AS SHOWN.

FOR SOAPS; PERFUMERY; ESSENTIAL OILS FOR PERSONAL USE; COSMETICS; HAIR LOTIONS (U.S. CLS. 1, 4, 6, 50, 51 AND 52).

FIRST USE 7-1-2005; IN COMMERCE 7-1-2005.

3,298,893. WHOLEMADE, INC., NEWTON, IA. SN 78-532,131. PUB. 10-17-2006, FILED 12-14-2004.

WHOLEMADE

FOR NON-MEDICATED SKIN CARE PREPARATIONS, HAIR CARE PREPARATIONS, AND BODY CARE PREPARATIONS (U.S. CLS. 1, 4, 6, 50, 51 AND 52).

FIRST USE 10-0-2004; IN COMMERCE 10-0-2004.

EXPRESS REPAIR

THE MARK CONSISTS OF STANDARD CHARACTERS WITHOUT CLAIM TO ANY PARTICULAR FONT, STYLE, SIZE, OR COLOR.

NO CLAIM IS MADE TO THE EXCLUSIVE RIGHT TO USE "REPAIR", APART FROM THE MARK AS SHOWN.

FOR NON-MEDICATED SKIN CARE PREPARATIONS; HAIR CARE PREPARATIONS; BODY CARE PRODUCTS, NAMELY, BODY SOAPS, BODY CREAMS, BODY LOTIONS, BODY POWDERS, NON-MEDICATED DEODORANTS AND ANTI-PERSPIRANTS; NON-MEDICATED SUNCARE PRODUCTS, NAMELY, SUNSCREEN CREAMS AND/OR FOAMS, SUN BLOCK AND SUN TANNING PREPARATIONS; NON-MEDICATED PREPARATIONS TO PROTECT THE SKIN FROM THE SUN; NAMELY, SUN CREAMS AND AFTER-SUN LOTIONS; BATH PRODUCTS, NAMELY, BATH BEADS, BATH FOAM, BATH GELS, BATH LOTION, BATH OIL, BATH POWDER, AND NON-MEDICATED BATH SALTS; PERFUME, COLOGNE, COSMETICS AND MAKEUP (U.S. CLS. 1, 4, 6, 50, 51 AND 52).

FIRST USE 9-1-2005; IN COMMERCE 9-1-2005.

3,298,903. BIGELOW MERCHANDISING, LLC, COLUMBUS, OH. SN 78-544,342. PUB. 7-11-2006, FILED 1-8-2005.

PILOT'S POMADE

THE MARK CONSISTS OF STANDARD CHARACTERS WITHOUT CLAIM TO ANY PARTICULAR FONT, STYLE, SIZE, OR COLOR.

NO CLAIM IS MADE TO THE EXCLUSIVE RIGHT TO USE "POMADE", APART FROM THE MARK AS SHOWN.

FOR PERSONAL CARE PRODUCTS, NAMELY HAIR POMADE (U.S. CLS. 1, 4, 6, 50, 51 AND 52).

FIRST USE 2-16-2006; IN COMMERCE 2-16-2006.

CLASS 3—(Continued).

3,298,904. BALMAIN S.A., PARIS, FRANCE. SN 78-545,518.
PUB. 1-10-2006, FILED 1-11-2005.



OWNER OF FRANCE REG. NO. 033247615, DATED 9-25-2003, EXPIRES 9-25-2013.

FOR PERFUMES; EAU DE TOILETTE AND EAU DE COLOGNE; ESSENTIAL OILS FOR PERSONAL USE; GELS, DEODORANTS FOR PERSONAL USE; AFTER-SHAVE LOTIONS, PREPARATIONS FOR THE HAIR, NOT FOR MEDICAL PURPOSES, NAMELY SHAMPOOS (U.S. CLS. 1, 4, 6, 50, 51 AND 52).

FIRST USE 4-19-2006; IN COMMERCE 4-19-2006.

3,298,936. BAYLISS, DONNA M., BIGGS, CA. SN 78-563,971.
PUB. 5-30-2006, FILED 2-9-2005.

**BLOSSOMS IN A
BOTTLE**

THE MARK CONSISTS OF STANDARD CHARACTERS WITHOUT CLAIM TO ANY PARTICULAR FONT, STYLE, SIZE, OR COLOR.

FOR PERSONAL CARE PRODUCTS, NAMELY AROMATHERAPY PRODUCTS IN THE NATURE OF CREAMS, LOTIONS, OILS AND SPRITZES, COSMETICS, HAIR CARE PRODUCTS IN THE NATURE OF SHAMPOOS, CONDITIONERS, STYLING GELS AND MOISTURIZERS, BODY LOTIONS, SKIN MOISTURIZERS; BODY, HAND AND FACE CREAMS; PERSONAL DEODORANTS, FACIAL MASKS, SKIN TONERS, NAIL POLISH, NAIL POLISH REMOVER, MAKEUP REMOVER, PERFUME, COLOGNE, TOOTHPASTE, MOUTHWASH, SHAVING CREAM, AFTER SHAVE LOTION, SUNSCREEN CREAM; BABY CARE PRODUCTS, NAMELY BABY SHAMPOO, BABY LOTION, PRE-MOISTENED COSMETIC BABY WIPES, BABY CREAMS, BABY POWDER; HOUSEHOLD CARE PRODUCTS, NAMELY ALL-PURPOSE CLEANERS, FURNITURE POLISHES; AIR FRESHENERS, DEODORANT FOR BODY CARE; LAUNDRY PRODUCTS, NAMELY LAUNDRY DETERGENT, FABRIC SOFTENER, SCENTED LINEN WATER, AND WRINKLE REDUCERS; DEODORANTS FOR CLOTHING AND TEXTILES (U.S. CLS. 1, 4, 6, 50, 51 AND 52).

FIRST USE 4-30-2005; IN COMMERCE 4-30-2005.

CLASS 3—(Continued).

3,298,970. LUSTER PRODUCTS, INC., CHICAGO, IL. SN 78-576,654. PUB. 6-20-2006, FILED 2-28-2005.

YOU CONTROL

THE MARK CONSISTS OF STANDARD CHARACTERS WITHOUT CLAIM TO ANY PARTICULAR FONT, STYLE, SIZE, OR COLOR.

NO CLAIM IS MADE TO THE EXCLUSIVE RIGHT TO USE "CONTROL", APART FROM THE MARK AS SHOWN. FOR NON-MEDICATED HAIR CARE PREPARATIONS (U.S. CLS. 1, 4, 6, 50, 51 AND 52).

FIRST USE 11-0-2005; IN COMMERCE 11-0-2005.

3,298,971. LUSTER PRODUCTS, INC., CHICAGO, IL. SN 78-576,670. PUB. 6-20-2006, FILED 2-28-2005.

YOU GLOSS

THE MARK CONSISTS OF STANDARD CHARACTERS WITHOUT CLAIM TO ANY PARTICULAR FONT, STYLE, SIZE, OR COLOR.

NO CLAIM IS MADE TO THE EXCLUSIVE RIGHT TO USE "GLOSS", APART FROM THE MARK AS SHOWN. FOR NON-MEDICATED HAIR CARE PREPARATIONS (U.S. CLS. 1, 4, 6, 50, 51 AND 52).

FIRST USE 11-0-2005; IN COMMERCE 11-0-2005.

CLASS 3—(Continued).

3,298,972. LUSTER PRODUCTS, INC., CHICAGO, IL. SN 78-576,675. PUB. 6-20-2006, FILED 2-28-2005.

CLASS 3—(Continued).

3,299,008. TY-KENN PRODUCTS COMPANY, INC., PLANO, TX. SN 78-593,468. PUB. 12-27-2005, FILED 3-23-2005.

YOU REPAIR

THE MARK CONSISTS OF STANDARD CHARACTERS WITHOUT CLAIM TO ANY PARTICULAR FONT, STYLE, SIZE, OR COLOR.

NO CLAIM IS MADE TO THE EXCLUSIVE RIGHT TO USE "REPAIR", APART FROM THE MARK AS SHOWN. FOR NON-MEDICATED HAIR CARE PREPARATIONS (U.S. CLS. 1, 4, 6, 50, 51 AND 52).

FIRST USE 11-0-2005; IN COMMERCE 11-0-2005.

Simply Stylin'

THE MARK CONSISTS OF STANDARD CHARACTERS WITHOUT CLAIM TO ANY PARTICULAR FONT, STYLE, SIZE, OR COLOR.

FOR HAIR CARE PRODUCTS, NAMELY, SHAMPOOS, CONDITIONERS, HAIR GELS, MOUSSES, AND HAIR STYLING SPRAY (U.S. CLS. 1, 4, 6, 50, 51 AND 52).

FIRST USE 2-8-2007; IN COMMERCE 2-8-2007.

3,298,997. THE PROCTER & GAMBLE COMPANY, CINCINNATI, OH. SN 78-590,210. PUB. 12-13-2005, FILED 3-18-2005.

3,299,056. PERFORMANCE BRANDS, INC., SUNRISE, FL. SN 78-605,019. PUB. 7-11-2006, FILED 4-8-2005.

VITANIACIN

THE MARK CONSISTS OF STANDARD CHARACTERS WITHOUT CLAIM TO ANY PARTICULAR FONT, STYLE, SIZE, OR COLOR.

OWNER OF U.S. REG. NOS. 2,460,415, 2,540,913, AND 2,667,284.

FOR INGREDIENT CONTAINING VITAMINS AND PRO-VITAMINS USED AS A COMPONENT IN SKIN MOISTURIZERS, SKIN CLEANSERS AND SKIN LOTIONS (U.S. CLS. 1, 4, 6, 50, 51 AND 52).

FIRST USE 1-31-2003; IN COMMERCE 1-31-2003.

BLUE JEAN GIRL

THE MARK CONSISTS OF STANDARD CHARACTERS WITHOUT CLAIM TO ANY PARTICULAR FONT, STYLE, SIZE, OR COLOR.

NO CLAIM IS MADE TO THE EXCLUSIVE RIGHT TO USE "GIRL", APART FROM THE MARK AS SHOWN.

FOR SUNTAN PRODUCTS, NAMELY TANNING LOTIONS, TANNING GELS AND TANNING OILS (U.S. CLS. 1, 4, 6, 50, 51 AND 52).

FIRST USE 9-28-2005; IN COMMERCE 9-28-2005.

CLASS 3—(Continued).

3,299,057. PERFORMANCE BRANDS, INC., SUNRISE, FL. SN 78-605,049. PUB. 1-10-2006, FILED 4-8-2005.

AMERICAN BRONZE

THE MARK CONSISTS OF STANDARD CHARACTERS WITHOUT CLAIM TO ANY PARTICULAR FONT, STYLE, SIZE, OR COLOR.

FOR SUNTAN PRODUCTS, NAMELY TANNING LOTIONS, TANNING GELS AND TANNING OILS (U.S. CLS. 1, 4, 6, 50, 51 AND 52).

FIRST USE 3-1-2007; IN COMMERCE 3-1-2007.

CLASS 3—(Continued).

3,299,132. PERRINE, INC., LAS VEGAS, NV. SN 78-637,333. PUB. 7-11-2006, FILED 5-25-2005.

LAS VEGAS GARDEN COLLECTIONS

THE MARK CONSISTS OF STANDARD CHARACTERS WITHOUT CLAIM TO ANY PARTICULAR FONT, STYLE, SIZE, OR COLOR.

NO CLAIM IS MADE TO THE EXCLUSIVE RIGHT TO USE "LAS VEGAS" AND "COLLECTIONS", APART FROM THE MARK AS SHOWN.

FOR TOILETRIES, NAMELY, EYE LOTIONS, AGE RETARDANT LOTION, AGE SPOT REDUCING CREAMS, ANTI-WRINKLE CREAM, WRINKLE RESISTANT CREAM; AFTER-SHAVE LOTIONS, LOTIONS FOR BEARDS, SHAVING LOTION; AFTER-SUN LOTIONS, COSMETIC SUNTAN LOTIONS, SUN CARE LOTIONS, SELF-TANNING PREPARATIONS; SKIN LOTION, SKIN CREAM, LOTIONS FOR FACE AND BODY CARE; TONING LOTION FOR THE FACE, BODY AND HANDS; BODY LOTION, BEAUTY LOTIONS, LOTIONS FOR CELLULITE REDUCTION, NON-MEDICATED STIMULATING LOTIONS FOR THE SKIN, SKIN CLEANSING LOTION, STYLING LOTIONS, NIGHT CREAM, PERFUMED TALCUM POWDER, SKIN CLARIFIERS, SKIN LIGHTENERS, TOPICAL SKIN SPRAYS FOR COSMETIC PURPOSES, HAIR CONDITIONER, HAIR CARE LOTIONS, HAIR LOTIONS, HAIR DRESSINGS FOR MEN, HAIR SHAMPOO, TOILET SOAP, BATH SOAP, BODY CLEANSING SCRUB, ANTIBACTERIAL SKIN SOAPS, ANTI-BACTERIAL SOAP; BATH AND SHOWER GEL; NON-MEDICATED BATH SALTS, NON-MEDICATED MUSCLE SOAK, BATH LOTION, BATHING LOTIONS, BATH CRYSTALS, BATH POWDER, BUBBLE BATH; MASSAGE GEL; FACE LOTIONS; FACE MILK AND LOTIONS, FACIAL LOTION; AROMATHERAPY LOTIONS, PERFUME, EAU DE PERFUME, COLOGNE, EAU DE COLOGNE, COLOGNE WATER, LIQUID PERFUMES, PERFUME OILS, PERFUME OILS FOR THE MANUFACTURE OF COSMETIC PREPARATIONS; AROMATHERAPY CREAMS, AROMATHERAPY LOTIONS, AROMATHERAPY OILS, AROMATHERAPY PILLOWS COMPRISING POTPOURRI IN FABRIC CONTAINERS, POTPOURRI, ROOM FRAGRANCES, SCENTED OILS USED TO PRODUCE AROMAS WHEN HEATED, SACHETS, BODY SPRAYS, NAMELY WATER IN ATOMIZED CONTAINERS USED TO PRODUCE A COOLING EFFECT; FRAGRANCE EMITTING WICKS FOR ROOM FRAGRANCE, INCENSE, PERFUMING SACHETS, BABY LOTION, NON-MEDICATED DIAPER RASH OINTMENTS AND LOTIONS, BABY HAIR CONDITIONER; HAND LOTIONS (U.S. CLS. 1, 4, 6, 50, 51 AND 52).

FIRST USE 2-20-2007; IN COMMERCE 2-20-2007.

3,299,058. IES ENTERPRISES, INC., NEW YORK, NY. SN 78-605,553. PUB. 6-27-2006, FILED 4-9-2005.

NUTRA-OIL

THE MARK CONSISTS OF STANDARD CHARACTERS WITHOUT CLAIM TO ANY PARTICULAR FONT, STYLE, SIZE, OR COLOR.

FOR PERSONAL CARE PRODUCTS, NAMELY, NON-MEDICATED SKIN CLEANSERS (U.S. CLS. 1, 4, 6, 50, 51 AND 52).

FIRST USE 12-8-2006; IN COMMERCE 12-8-2006.

3,299,088. S&G HAMPTON SUN LLC, NEW YORK, NY. SN 78-615,766. PUB. 7-4-2006, FILED 4-25-2005.

Privet Bloom

THE MARK CONSISTS OF STANDARD CHARACTERS WITHOUT CLAIM TO ANY PARTICULAR FONT, STYLE, SIZE, OR COLOR.

NO CLAIM IS MADE TO THE EXCLUSIVE RIGHT TO USE "PRIVET", APART FROM THE MARK AS SHOWN.

FOR PERFUME (U.S. CLS. 1, 4, 6, 50, 51 AND 52).
FIRST USE 2-15-2007; IN COMMERCE 2-15-2007.

CLASS 3—(Continued).

3,299,134. LAURICE EL BADRY RAHME LTD., DBA LAURICE & CO., NEW YORK, NY. SN 78-638,761. PUB. 9-5-2006, FILED 5-27-2005.

MAKING SCENTS OF NEW YORK

THE MARK CONSISTS OF STANDARD CHARACTERS WITHOUT CLAIM TO ANY PARTICULAR FONT, STYLE, SIZE, OR COLOR.
FOR FRAGRANCES, NAMELY PERFUMES (U.S. CLS. 1, 4, 6, 50, 51 AND 52).
FIRST USE 2-0-2003; IN COMMERCE 2-0-2003.

3,299,135. JANE & COMPANY, LLC, BALTIMORE, MD. SN 78-638,822. PUB. 2-7-2006, FILED 5-27-2005.

BE PURE

THE MARK CONSISTS OF STANDARD CHARACTERS WITHOUT CLAIM TO ANY PARTICULAR FONT, STYLE, SIZE, OR COLOR.
FOR COSMETICS (U.S. CLS. 1, 4, 6, 50, 51 AND 52).
FIRST USE 12-16-2006; IN COMMERCE 12-16-2006.

3,299,157. SHAMBAN, AVA T., SANTA MONICA, CA. SN 78-648,092. PUB. 7-4-2006, FILED 6-10-2005.

AVA  MD

NO CLAIM IS MADE TO THE EXCLUSIVE RIGHT TO USE "MD" AND THE CADUCEUS DESIGN, APART FROM THE MARK AS SHOWN.
FOR NONMEDICATED SKIN-CARE PREPARATIONS (U.S. CLS. 1, 4, 6, 50, 51 AND 52).
FIRST USE 4-21-2006; IN COMMERCE 4-21-2006.

CLASS 3—(Continued).

3,299,162. S. C. JOHNSON & SON, INC., RACINE, WI. SN 78-651,843. PUB. 2-28-2006, FILED 6-16-2005.

CRYSTAL RAIN

THE MARK CONSISTS OF STANDARD CHARACTERS WITHOUT CLAIM TO ANY PARTICULAR FONT, STYLE, SIZE, OR COLOR.
FOR ALL PURPOSE GLASS AND SURFACE CLEANER FOR HOUSEHOLD USE (U.S. CLS. 1, 4, 6, 50, 51 AND 52).
FIRST USE 12-11-2006; IN COMMERCE 12-11-2006.

3,299,182. L'OREAL, PARIS, FRANCE. SN 78-659,688. PUB. 10-10-2006, FILED 6-28-2005.

STYLE INFUSING

THE MARK CONSISTS OF STANDARD CHARACTERS WITHOUT CLAIM TO ANY PARTICULAR FONT, STYLE, SIZE, OR COLOR.
FOR HAIR SHAMPOOS AND CONDITIONERS (U.S. CLS. 1, 4, 6, 50, 51 AND 52).
FIRST USE 6-0-2006; IN COMMERCE 6-0-2006.

3,299,199. NZYMSYS I.P., INC., MILLERSVILLE, MD. SN 78-664,555. PUB. 12-12-2006, FILED 7-6-2005.

OCEANIC

THE MARK CONSISTS OF STANDARD CHARACTERS WITHOUT CLAIM TO ANY PARTICULAR FONT, STYLE, SIZE, OR COLOR.
FOR PRODUCTS, NAMELY, ALL-PURPOSE CLEANERS FOR CLEANING AND DECONTAMINATING SURFACES OF COMMON COMMERCIAL AND RESIDENTIAL BUILDING MATERIALS AND INDOOR SURFACES (U.S. CLS. 1, 4, 6, 50, 51 AND 52).
FIRST USE 1-5-2006; IN COMMERCE 1-5-2006.

CLASS 3—(Continued).

3,299,245. TENAX USA, LLC, CHARLOTTE, NC. SN 78-684,842. PUB. 12-19-2006, FILED 8-3-2005.

CLASS 3—(Continued).

3,299,284. PERRINE, INC., LAS VEGAS, NV. SN 78-701,956. PUB. 5-9-2006, FILED 8-27-2005.

LUSTRO ITALIANO

THE MARK CONSISTS OF STANDARD CHARACTERS WITHOUT CLAIM TO ANY PARTICULAR FONT, STYLE, SIZE, OR COLOR.

THE ENGLISH TRANSLATION OF THE WORDING LUSTRO ITALIANO IN THE MARK IS ITALIAN LUSTER OR ITALIAN BRILLIANCE.

FOR CLEANING PREPARATIONS FOR CLEANING AND POLISHING STONE SURFACES (U.S. CLS. 1, 4, 6, 50, 51 AND 52).

FIRST USE 7-1-2005; IN COMMERCE 9-1-2005.

GARDEN COLLECTIONS

THE MARK CONSISTS OF STANDARD CHARACTERS WITHOUT CLAIM TO ANY PARTICULAR FONT, STYLE, SIZE, OR COLOR.

NO CLAIM IS MADE TO THE EXCLUSIVE RIGHT TO USE "COLLECTIONS", APART FROM THE MARK AS SHOWN.

FOR TOILETRIES, NAMELY, EYE LOTIONS, SACHET-LIKE EYE PILLOWS CONTAINING FRAGRANCES; AGE RETARDANT LOTION, AGE SPOT REDUCING CREAMS, ANTI-WRINKLE CREAM, WRINKLE RESISTANT CREAM; AFTER-SHAVE LOTIONS, LOTIONS FOR BEARDS, SHAVING LOTION; AFTERSUN LOTIONS, COSMETIC SUNTAN LOTIONS, SUN CARE LOTIONS, SELF-TANNING PREPARATIONS; SKIN LOTION, SKIN CREAM, LOTIONS FOR FACE AND BODY CARE; TONING LOTION FOR THE FACE, BODY AND HANDS; BODY LOTION, BEAUTY LOTIONS, LOTIONS FOR CELLULITE REDUCTION, NON-MEDICATED STIMULATING LOTIONS FOR THE SKIN, SKIN CLEANSING LOTION, STYLING LOTIONS, NIGHT CREAM, PERFUMED TALCUM POWDER, SKIN CLARIFIERS, SKIN LIGHTENERS, TOPICAL SKIN SPRAYS FOR COSMETIC PURPOSES, HAIR CONDITIONER, HAIR CARE LOTIONS, HAIR LOTIONS, HAIR DRESSINGS FOR MEN, HAIR SHAMPOO; TOILET SOAP, BATH SOAP, BODY CLEANSING SCRUB, ANTI-BACTERIAL SKIN SOAPS, ANTI-BACTERIAL SOAP; BATH AND SHOWER GEL; NON-MEDICATED BATH SALTS, NON-MEDICATED MUSCLE SOAK, BATH LOTION, BATHING LOTIONS, BATH CRYSTALS, BATH POWDER, BUBBLE BATH; MASSAGE GEL; FACE LOTIONS; FACE MILK AND LOTIONS, FACIAL LOTION; AROMATHERAPY LOTIONS, PERFUME, EAU DE PERFUME, COLOGNE, EAU DE COLOGNE, COLOGNE WATER, LIQUID PERFUMES, PERFUME OILS, PERFUME OILS FOR THE MANUFACTURE OF COSMETIC PREPARATIONS; AROMATHERAPY CREAMS, AROMATHERAPY LOTIONS, AROMATHERAPY OILS, AROMATHERAPY PILLOWS COMPRISING POTPOURRI IN FABRIC CONTAINERS, POTPOURRI, ROOM FRAGRANCES, SCENTED OILS USED TO PRODUCE AROMAS WHEN HEATED, SACHETS, BODY SPRAYS, NAMELY, WATER IN ATOMIZED CONTAINERS USED TO PRODUCE A COOLING EFFECT; FRAGRANCE EMITTING WICKS FOR ROOM FRAGRANCE, INCENSE, PERFUMING SACHETS; BABY LOTION, NON-MEDICATED DIAPER RASH OINTMENTS AND LOTIONS, BABY HAIR CONDITIONER; HAND LOTIONS (U.S. CLS. 1, 4, 6, 50, 51 AND 52).

FIRST USE 4-5-2007; IN COMMERCE 4-5-2007.

3,299,255. AUSTRALIAN GOLD, INC., INDIANAPOLIS, IN. SN 78-691,660. PUB. 7-18-2006, FILED 8-12-2005.

FOREVER CLEAN

THE MARK CONSISTS OF STANDARD CHARACTERS WITHOUT CLAIM TO ANY PARTICULAR FONT, STYLE, SIZE, OR COLOR.

FOR NON-MEDICATED PRE-MOISTENED TOWELLETES IMPREGNATED WITH SANITIZING PREPARATIONS FOR BODY CLEANSING (U.S. CLS. 1, 4, 6, 50, 51 AND 52).

FIRST USE 11-1-2005; IN COMMERCE 11-1-2005.

CLASS 3—(Continued).

3,299,292. PERIO, INC., DUBLIN, OH. SN 78-704,692. PUB. 12-19-2006, FILED 8-31-2005.

BARZ

THE MARK CONSISTS OF STANDARD CHARACTERS WITHOUT CLAIM TO ANY PARTICULAR FONT, STYLE, SIZE, OR COLOR.

FOR AFTER-SHAVE BALMS; AFTER-SHAVE CREAMS; AFTER-SHAVE EMULSIONS; AFTER-SHAVE GEL; AFTER-SHAVE LOTIONS; BODY SPRAYS; SHOWER AND BATH GEL (U.S. CLS. 1, 4, 6, 50, 51 AND 52).

FIRST USE 2-16-2007; IN COMMERCE 2-16-2007.

CLASS 3—(Continued).

3,299,348. ENCHANTÉ ACCESSORIES INC., NEW YORK, NY. SN 78-721,348. PUB. 6-6-2006, FILED 9-27-2005.

BODY RAVES

THE MARK CONSISTS OF STANDARD CHARACTERS WITHOUT CLAIM TO ANY PARTICULAR FONT, STYLE, SIZE, OR COLOR.

NO CLAIM IS MADE TO THE EXCLUSIVE RIGHT TO USE "BODY", APART FROM THE MARK AS SHOWN.

FOR BODY POWDER; BODY SPRAYS; COSMETICS; FACE AND BODY CREAMS; FACE AND BODY LOTIONS; ROOM FRAGRANCES; SHOWER GELS (U.S. CLS. 1, 4, 6, 50, 51 AND 52).

FIRST USE 8-0-2006; IN COMMERCE 8-0-2006.

3,299,317. LUCKY 11, INC., FRISCO, TX. SN 78-713,984. PUB. 6-6-2006, FILED 9-15-2005.

LUCKY 11

THE MARK CONSISTS OF STANDARD CHARACTERS WITHOUT CLAIM TO ANY PARTICULAR FONT, STYLE, SIZE, OR COLOR.

FOR BODY LOTION; HAIR CONDITIONER; HAIR CREAMS; HAIR GEL; HAIR MOUSSE; HAIR POMADES; HAIR SHAMPOO; HAIR SPRAY; SHOWER AND BATH GEL (U.S. CLS. 1, 4, 6, 50, 51 AND 52).

FIRST USE 2-2-2006; IN COMMERCE 2-2-2006.

3,299,351. L'OREAL USA CREATIVE, INC., NEW YORK, NY. SN 78-722,315. PUB. 11-21-2006, FILED 9-28-2005.

PERFECT PERFORMANCE TECHNOLOGY

THE MARK CONSISTS OF STANDARD CHARACTERS WITHOUT CLAIM TO ANY PARTICULAR FONT, STYLE, SIZE, OR COLOR.

NO CLAIM IS MADE TO THE EXCLUSIVE RIGHT TO USE "TECHNOLOGY", APART FROM THE MARK AS SHOWN.

FOR HAIR CARE AND NON-MEDICATED HAIR TREATMENT PREPARATIONS (U.S. CLS. 1, 4, 6, 50, 51 AND 52).

FIRST USE 4-1-2006; IN COMMERCE 4-1-2006.

3,299,347. ENCHANTÉ ACCESSORIES INC., NEW YORK, NY. SN 78-721,227. PUB. 6-6-2006, FILED 9-27-2005.

BODY PRESERVES

THE MARK CONSISTS OF STANDARD CHARACTERS WITHOUT CLAIM TO ANY PARTICULAR FONT, STYLE, SIZE, OR COLOR.

NO CLAIM IS MADE TO THE EXCLUSIVE RIGHT TO USE "BODY", APART FROM THE MARK AS SHOWN.

FOR BODY POWDER; BODY SPRAYS; COSMETICS; FACE AND BODY CREAMS; FACE AND BODY LOTIONS; ROOM FRAGRANCES; SHOWER GELS (U.S. CLS. 1, 4, 6, 50, 51 AND 52).

FIRST USE 8-0-2006; IN COMMERCE 8-0-2006.

3,299,378. MAMA MIO LTD., LONDON, W1F 8DN, UNITED KINGDOM. SN 78-727,822. PUB. 7-4-2006, FILED 10-6-2005.

BOOB TUBE

THE MARK CONSISTS OF STANDARD CHARACTERS WITHOUT CLAIM TO ANY PARTICULAR FONT, STYLE, SIZE, OR COLOR.

FOR SKIN CARE AND BODY CARE PRODUCTS, NAMELY, MOISTURIZERS, BODY OILS AND MASSAGE OILS; NON-MEDICATED SKIN CARE AND BODY CARE PRODUCTS FOR PREVENTING STRETCH MARKS, NAMELY, MOISTURIZERS, BODY OILS AND MASSAGE OILS (U.S. CLS. 1, 4, 6, 50, 51 AND 52).

FIRST USE 10-0-2005; IN COMMERCE 10-0-2005.

CLASS 3—(Continued).

3,299,386. TANTOWEL U.S., LAS VEGAS, NV. SN 78-729,301. PUB. 7-4-2006, FILED 10-7-2005.

ON THE GLOW

THE MARK CONSISTS OF STANDARD CHARACTERS WITHOUT CLAIM TO ANY PARTICULAR FONT, STYLE, SIZE, OR COLOR.
FOR SKIN MOISTURIZING LOTIONS AND SUNSCREEN CREAMS (U.S. CLS. 1, 4, 6, 50, 51 AND 52).
FIRST USE 12-1-2005; IN COMMERCE 12-1-2005.

3,299,399. SAMY MARK, INC., MIAMI, FL. SN 78-731,287. PUB. 12-19-2006, FILED 10-12-2005.

GET CURLS

THE MARK CONSISTS OF STANDARD CHARACTERS WITHOUT CLAIM TO ANY PARTICULAR FONT, STYLE, SIZE, OR COLOR.
FOR HAIR CARE PREPARATIONS (U.S. CLS. 1, 4, 6, 50, 51 AND 52).
FIRST USE 12-29-2005; IN COMMERCE 12-29-2005.

3,299,434. MODELS PREFER, LTD., WATERBURY, CT. SN 78-736,322. PUB. 6-27-2006, FILED 10-19-2005.

BRUSH ON BRILLIANCE

THE MARK CONSISTS OF STANDARD CHARACTERS WITHOUT CLAIM TO ANY PARTICULAR FONT, STYLE, SIZE, OR COLOR.
NO CLAIM IS MADE TO THE EXCLUSIVE RIGHT TO USE "BRUSH ON", APART FROM THE MARK AS SHOWN.
FOR COSMETICS (U.S. CLS. 1, 4, 6, 50, 51 AND 52).
FIRST USE 2-16-2007; IN COMMERCE 2-16-2007.

CLASS 3—(Continued).

3,299,478. HOLYFIELD, LOUISE, DALLAS, TX. SN 78-741,578. PUB. 6-27-2006, FILED 10-27-2005.

YOU ARE NEVER TO YOUNG TO AVOID A WRINKLE

THE MARK CONSISTS OF STANDARD CHARACTERS WITHOUT CLAIM TO ANY PARTICULAR FONT, STYLE, SIZE, OR COLOR.
FOR FACIAL SKIN CARE PRODUCTS, NAMELY, FACIAL LOTIONS, FACIAL CLEANSERS, FACIAL SCRUBBING FOAM; BODY CARE PREPARATIONS, NAMELY, BODY LOTION, BODY CLEANSER, BODY SCRUBBING FOAM (U.S. CLS. 1, 4, 6, 50, 51 AND 52).
FIRST USE 3-1-2007; IN COMMERCE 3-1-2007.

3,299,488. ELLIE D, LLC, MCLEAN, VA. SN 78-742,959. PUB. 1-23-2007, FILED 10-28-2005.

ELLIE

THE MARK CONSISTS OF STANDARD CHARACTERS WITHOUT CLAIM TO ANY PARTICULAR FONT, STYLE, SIZE, OR COLOR.
FOR PERFUME (U.S. CLS. 1, 4, 6, 50, 51 AND 52).
FIRST USE 1-24-2007; IN COMMERCE 1-24-2007.

3,299,506. ARAMIS INC., NEW YORK, NY. SN 78-746,161. PUB. 7-18-2006, FILED 11-3-2005.

ROOT POWER

THE MARK CONSISTS OF STANDARD CHARACTERS WITHOUT CLAIM TO ANY PARTICULAR FONT, STYLE, SIZE, OR COLOR.
FOR HAIR CARE PREPARATIONS (U.S. CLS. 1, 4, 6, 50, 51 AND 52).
FIRST USE 5-31-2006; IN COMMERCE 5-31-2006.

CLASS 3—(Continued).

3,299,510. SCRUPLES PROFESSIONAL SALON PRODUCTS, INC., LAKEVILLE, MN. SN 78-746,707. PUB. 8-22-2006, FILED 11-3-2005.

POWER BLONDE

THE MARK CONSISTS OF STANDARD CHARACTERS WITHOUT CLAIM TO ANY PARTICULAR FONT, STYLE, SIZE, OR COLOR.

NO CLAIM IS MADE TO THE EXCLUSIVE RIGHT TO USE "BLONDE", APART FROM THE MARK AS SHOWN, FOR HAIR CARE PRODUCTS, NAMELY, HAIR LIGHTENERS (U.S. CLS. 1, 4, 6, 50, 51 AND 52).
FIRST USE 5-18-2006; IN COMMERCE 5-18-2006.

3,299,517. ASPEN BENEFITS GROUP, L.L.C., LAS VEGAS, NV. SN 78-747,759. PUB. 8-1-2006, FILED 11-4-2005.

ACNERECOVERY

THE MARK CONSISTS OF STANDARD CHARACTERS WITHOUT CLAIM TO ANY PARTICULAR FONT, STYLE, SIZE, OR COLOR.

FOR SKIN CLEANSERS, FACIAL CREAMS AND LOTIONS, SKIN MOISTURIZERS, FACIAL SCRUBS (U.S. CLS. 1, 4, 6, 50, 51 AND 52).
FIRST USE 2-2-2006; IN COMMERCE 2-2-2006.

3,299,542. HOLYFIELD, LOUISE, DALLAS, TX. SN 78-752,244. PUB. 6-27-2006, FILED 11-11-2005.

POREFORM

THE MARK CONSISTS OF STANDARD CHARACTERS WITHOUT CLAIM TO ANY PARTICULAR FONT, STYLE, SIZE, OR COLOR.

FOR FACIAL MASK (U.S. CLS. 1, 4, 6, 50, 51 AND 52).
FIRST USE 3-1-2007; IN COMMERCE 3-1-2007.

CLASS 3—(Continued).

3,299,544. COSMETIC DERMATOLOGY, INC., MIAMI, FL. SN 78-752,489. PUB. 7-18-2006, FILED 11-11-2005.

LASER A-PEEL

THE MARK CONSISTS OF STANDARD CHARACTERS WITHOUT CLAIM TO ANY PARTICULAR FONT, STYLE, SIZE, OR COLOR.

FOR SKIN CREAMS, SKIN LOTIONS, SKIN MOISTURIZERS, SKIN EMOLLIENTS, SKIN MASKS, SKIN SCRUBS, EXFOLIATES, SKIN CLEANSERS, SKIN TONERS, SKIN GELS, SHAVE GELS, SUN SCREENS AND SUN BLOCK PREPARATIONS (U.S. CLS. 1, 4, 6, 50, 51 AND 52).

FIRST USE 6-1-2006; IN COMMERCE 6-1-2006.

3,299,555. MANZIONE, JOHN JOSEPH, BAY SHORE, NY. SN 78-754,422. PUB. 7-18-2006, FILED 11-15-2005.

CLICK & GO!

THE MARK CONSISTS OF STANDARD CHARACTERS WITHOUT CLAIM TO ANY PARTICULAR FONT, STYLE, SIZE, OR COLOR.

FOR ARTIFICIAL NAILS (U.S. CLS. 1, 4, 6, 50, 51 AND 52).

FIRST USE 11-15-2006; IN COMMERCE 11-15-2006.

3,299,598. NEUTROGENA CORPORATION, LOS ANGELES, CA. SN 78-763,310. PUB. 1-9-2007, FILED 11-30-2005.

HELIOSOL

THE MARK CONSISTS OF STANDARD CHARACTERS WITHOUT CLAIM TO ANY PARTICULAR FONT, STYLE, SIZE, OR COLOR.

FOR FACIAL AND BODY SUNCARE PREPARATIONS, NAMELY, SUN SCREEN (U.S. CLS. 1, 4, 6, 50, 51 AND 52).

FIRST USE 7-28-2006; IN COMMERCE 7-28-2006.

CLASS 3—(Continued).

3,299,629. WELLNESS FORMULATIONS, LLC, HAZLETON, PA. SN 78-769,614. PUB. 12-5-2006, FILED 12-8-2005.

Dermal ReNu

THE MARK CONSISTS OF STANDARD CHARACTERS WITHOUT CLAIM TO ANY PARTICULAR FONT, STYLE, SIZE, OR COLOR.

NO CLAIM IS MADE TO THE EXCLUSIVE RIGHT TO USE "DERMAL", APART FROM THE MARK AS SHOWN. FOR NON-MEDICATED SKIN CARE PREPARATIONS (U.S. CLS. 1, 4, 6, 50, 51 AND 52). FIRST USE 3-15-2006; IN COMMERCE 3-15-2006.

3,299,640. LANCOME PARFUMS ET BEAUTE & CIE, PARIS, FRANCE. SN 78-771,169. PUB. 12-12-2006, FILED 12-12-2005.

MILLE & UNE ROSES

THE MARK CONSISTS OF STANDARD CHARACTERS WITHOUT CLAIM TO ANY PARTICULAR FONT, STYLE, SIZE, OR COLOR.

THE ENGLISH TRANSLATION OF "MILLE & UNE" IS "THOUSAND AND ONE". FOR PERFUMES (U.S. CLS. 1, 4, 6, 50, 51 AND 52). FIRST USE 4-0-2006; IN COMMERCE 4-0-2006.

3,299,652. REVLON CONSUMER PRODUCTS CORPORATION, NEW YORK, NY. SN 78-774,408. PUB. 7-25-2006, FILED 12-15-2005.

JUST BITTEN

THE MARK CONSISTS OF STANDARD CHARACTERS WITHOUT CLAIM TO ANY PARTICULAR FONT, STYLE, SIZE, OR COLOR.

FOR COSMETICS; MAKEUP (U.S. CLS. 1, 4, 6, 50, 51 AND 52). FIRST USE 10-25-2006; IN COMMERCE 10-25-2006.

CLASS 3—(Continued).

3,299,699. NAMASTE LABORATORIES, L.L.C., BLUE ISLAND, IL. SN 78-787,882. PUB. 3-20-2007, FILED 1-9-2006.

FLEXIBILITY

THE MARK CONSISTS OF STANDARD CHARACTERS WITHOUT CLAIM TO ANY PARTICULAR FONT, STYLE, SIZE, OR COLOR.

FOR HAIR CARE PREPARATIONS (U.S. CLS. 1, 4, 6, 50, 51 AND 52). FIRST USE 12-7-2006; IN COMMERCE 12-7-2006.

3,299,758. KANE ENTERPRISES, INC., LA HABRA, CA. SN 78-802,953. PUB. 7-11-2006, FILED 1-31-2006.

Serious Naturals

THE MARK CONSISTS OF STANDARD CHARACTERS WITHOUT CLAIM TO ANY PARTICULAR FONT, STYLE, SIZE, OR COLOR.

NO CLAIM IS MADE TO THE EXCLUSIVE RIGHT TO USE "NATURALS", APART FROM THE MARK AS SHOWN. FOR ALL PURPOSE CLEANING PREPARATIONS; SOAPS; PERFUMERY. ESSENTIAL OILS, COSMETICS, HAIR LOTIONS; SHAMPOOS (U.S. CLS. 1, 4, 6, 50, 51 AND 52). FIRST USE 3-1-2006; IN COMMERCE 3-1-2006.

3,299,782. PERIO, INC., DUBLIN, OH. SN 78-810,879. PUB. 12-19-2006, FILED 2-9-2006.

BARZ

THE MARK CONSISTS OF STANDARD CHARACTERS WITHOUT CLAIM TO ANY PARTICULAR FONT, STYLE, SIZE, OR COLOR.

FOR DEODORANTS AND ANTIPERSPIRANTS; SHAVING BALM; SHAVING CREAM; SHAVING GEL (U.S. CLS. 1, 4, 6, 50, 51 AND 52). FIRST USE 2-16-2007; IN COMMERCE 2-16-2007.

CLASS 3—(Continued).

3,299,840. DYNAMIS THERAPEUTICS, INC., ELKINS PARK, PA. SN 78-831,123. PUB. 10-24-2006, FILED 3-7-2006.

CLASS 3—(Continued).

3,299,858. COLGATE-PALMOLIVE COMPANY, NEW YORK, NY. SN 78-837,023. PUB. 6-6-2006, FILED 3-14-2006.

SUPLAMINE

THE MARK CONSISTS OF STANDARD CHARACTERS WITHOUT CLAIM TO ANY PARTICULAR FONT, STYLE, SIZE, OR COLOR.

FOR CHEMICAL ADDITIVE SOLD AS A COMPONENT INGREDIENT OF FACE AND BODY CREAMS (U.S. CLS. 1, 4, 6, 50, 51 AND 52).

FIRST USE 3-3-2006; IN COMMERCE 3-3-2006.

FRESH BLAST

THE MARK CONSISTS OF STANDARD CHARACTERS WITHOUT CLAIM TO ANY PARTICULAR FONT, STYLE, SIZE, OR COLOR.

FOR DISH WASHING DETERGENTS (U.S. CLS. 1, 4, 6, 50, 51 AND 52).

FIRST USE 2-26-2007; IN COMMERCE 2-26-2007.

3,299,845. LANCOME PARFUMS ET BEAUTE & CIE, PARIS, FRANCE. SN 78-833,600. PUB. 2-27-2007, FILED 3-9-2006.

3,299,874. DEPASQUALE, CARMEN, FAIR LAWN, NJ. SN 78-845,208. PUB. 10-31-2006, FILED 3-24-2006.

UV EXPERT 20

THE MARK CONSISTS OF STANDARD CHARACTERS WITHOUT CLAIM TO ANY PARTICULAR FONT, STYLE, SIZE, OR COLOR.

OWNER OF U.S. REG. NO. 2,359,784.

NO CLAIM IS MADE TO THE EXCLUSIVE RIGHT TO USE "UV" AND "20", APART FROM THE MARK AS SHOWN.

FOR SUNSCREEN, NAMELY, MILKS, CREAMS, GELS AND OILS (U.S. CLS. 1, 4, 6, 50, 51 AND 52).

FIRST USE 3-19-2007; IN COMMERCE 3-19-2007.

SUNCURES

THE MARK CONSISTS OF STANDARD CHARACTERS WITHOUT CLAIM TO ANY PARTICULAR FONT, STYLE, SIZE, OR COLOR.

FOR SUNSCREEN PREPARATIONS FOR THE FACE AND BODY (U.S. CLS. 1, 4, 6, 50, 51 AND 52).

FIRST USE 5-31-2006; IN COMMERCE 5-31-2006.

3,299,857. COLGATE-PALMOLIVE COMPANY, NEW YORK, NY. SN 78-837,017. PUB. 6-6-2006, FILED 3-14-2006.

3,299,885. THE PROCTER & GAMBLE COMPANY, CINCINNATI, OH. SN 78-849,700. PUB. 11-14-2006, FILED 3-30-2006.

CITRUS BLAST

THE MARK CONSISTS OF STANDARD CHARACTERS WITHOUT CLAIM TO ANY PARTICULAR FONT, STYLE, SIZE, OR COLOR.

NO CLAIM IS MADE TO THE EXCLUSIVE RIGHT TO USE "CITRUS", APART FROM THE MARK AS SHOWN.

FOR DISHWASHING DETERGENTS (U.S. CLS. 1, 4, 6, 50, 51 AND 52).

FIRST USE 2-26-2007; IN COMMERCE 2-26-2007.

SHOWTIME

THE MARK CONSISTS OF STANDARD CHARACTERS WITHOUT CLAIM TO ANY PARTICULAR FONT, STYLE, SIZE, OR COLOR.

FOR BODY WASH, BODY SPRAY, DEODORANT AND ANTIPERSPIRANT (U.S. CLS. 1, 4, 6, 50, 51 AND 52).

FIRST USE 6-19-2006; IN COMMERCE 6-19-2006.

CLASS 3—(Continued).

3,299,901. REVLOX CONSUMER PRODUCTS CORPORATION, NEW YORK, NY. SN 78-856,924. PUB. 10-10-2006, FILED 4-7-2006.

GOLDEN AFFAIR

THE MARK CONSISTS OF STANDARD CHARACTERS WITHOUT CLAIM TO ANY PARTICULAR FONT, STYLE, SIZE, OR COLOR.

FOR COSMETICS; MAKE-UP (U.S. CLS. 1, 4, 6, 50, 51 AND 52).

FIRST USE 10-25-2006; IN COMMERCE 10-25-2006.

3,299,914. L'OREAL USA CREATIVE, INC., NEW YORK, NY. SN 78-861,565. PUB. 2-13-2007, FILED 4-14-2006.

SPRING MOUSSE

THE MARK CONSISTS OF STANDARD CHARACTERS WITHOUT CLAIM TO ANY PARTICULAR FONT, STYLE, SIZE, OR COLOR.

OWNER OF U.S. REG. NO. 2,927,024.

NO CLAIM IS MADE TO THE EXCLUSIVE RIGHT TO USE "MOUSSE", APART FROM THE MARK AS SHOWN.

FOR HAIR STYLING PREPARATION (U.S. CLS. 1, 4, 6, 50, 51 AND 52).

FIRST USE 11-0-2006; IN COMMERCE 11-0-2006.

3,299,925. THEOCHEM LABORATORIES, INC., TAMPA, FL. SN 78-864,654. PUB. 12-12-2006, FILED 4-19-2006.

Nutra-Max

THE MARK CONSISTS OF STANDARD CHARACTERS WITHOUT CLAIM TO ANY PARTICULAR FONT, STYLE, SIZE, OR COLOR.

FOR ALL-PURPOSE CLEANERS (U.S. CLS. 1, 4, 6, 50, 51 AND 52).

FIRST USE 11-1-2006; IN COMMERCE 11-1-2006.

CLASS 3—(Continued).

3,299,944. ONE WORLD NETWORKS INTEGRATED TECHNOLOGIES, INC., LOS ANGELES, CA. SN 78-871,557. PUB. 10-31-2006, FILED 4-27-2006.

REJUVAFIRM

THE MARK CONSISTS OF STANDARD CHARACTERS WITHOUT CLAIM TO ANY PARTICULAR FONT, STYLE, SIZE, OR COLOR.

FOR SKIN CARE PRODUCTS, NAMELY, NON-MEDICATED SKIN SERUM; COSMETIC CREAMS FOR SKIN CARE; NON-MEDICATED SKIN CREAMS; SKIN MOISTURIZER; WRINKLE REDUCING SKIN CARE PREPARATIONS; FACE CREAMS; SKIN CLARIFIERS; WRINKLE RESISTING CREAM; ANTI-AGING CREAM; ANTI-WRINKLE CREAM; BEAUTY SERUMS (U.S. CLS. 1, 4, 6, 50, 51 AND 52).

FIRST USE 10-13-2006; IN COMMERCE 10-13-2006.

3,299,955. JAFER LIMITED, HAMILTON, BERMUDA. SN 78-875,399. PUB. 11-21-2006, FILED 5-3-2006.



OWNER OF U.S. REG. NOS. 1,241,758, 2,960,802, AND OTHERS.

NO CLAIM IS MADE TO THE EXCLUSIVE RIGHT TO USE "KIDS", APART FROM THE MARK AS SHOWN.

THE MARK CONSISTS OF SIDE BY SIDE DEPICTIONS OF A GLOBE, A FLOWER, A GIRL RUNNING HOLDING A BALL AND A CAT.

FOR FRAGRANCES FOR PERSONAL USE, TOILET WATER, COLOGNE (U.S. CLS. 1, 4, 6, 50, 51 AND 52).

FIRST USE 3-31-2006; IN COMMERCE 1-31-2007.

3,299,956. JAFER LIMITED, HAMILTON, BERMUDA. SN 78-875,418. PUB. 11-14-2006, FILED 5-3-2006.



OWNER OF U.S. REG. NOS. 1,241,758, 2,974,522, AND OTHERS.

NO CLAIM IS MADE TO THE EXCLUSIVE RIGHT TO USE "KIDS", APART FROM THE MARK AS SHOWN.

THE MARK CONSISTS OF SIDE BY SIDE DEPICTIONS OF A GLOBE, A FISH WITH BUBBLES ABOVE IT, A BOY ON A SURFBOARD AND A DOG.

FOR FRAGRANCES FOR PERSONAL USE, TOILET WATER, COLOGNE (U.S. CLS. 1, 4, 6, 50, 51 AND 52).

FIRST USE 3-31-2006; IN COMMERCE 1-31-2007.

CLASS 3—(Continued).

3,300,010. FLAGEOLI, LTD., LAS VEGAS, NV. SN 78-894,452. PUB. 1-2-2007, FILED 5-26-2006.

CLASS 3—(Continued).

3,300,032. DIRECT HOLDINGS AMERICAS, INCORPORATED, FAIRFAX, VA. SN 78-903,058. PUB. 1-16-2007, FILED 6-7-2006.

ProMinerals

THE MARK CONSISTS OF STANDARD CHARACTERS WITHOUT CLAIM TO ANY PARTICULAR FONT, STYLE, SIZE, OR COLOR.

FOR FOUNDATION; LOOSE FACE POWDER (U.S. CLS. 1, 4, 6, 50, 51 AND 52).
FIRST USE 6-28-2006; IN COMMERCE 6-28-2006.



3,300,013. IT'S YOURS INC., BOWIE, MD. SN 78-896,456. PUB. 1-2-2007, FILED 5-30-2006.

It's Yours!

THE MARK CONSISTS OF STANDARD CHARACTERS WITHOUT CLAIM TO ANY PARTICULAR FONT, STYLE, SIZE, OR COLOR.

FOR HAIR LOTIONS; HAIR RINSES (U.S. CLS. 1, 4, 6, 50, 51 AND 52).
FIRST USE 7-30-2006; IN COMMERCE 11-30-2006.

NO CLAIM IS MADE TO THE EXCLUSIVE RIGHT TO USE "STAIN", APART FROM THE MARK AS SHOWN.

THE MARK CONSISTS OF A HUMAN FACE SURROUNDED BY BUBBLES, ORIENTED ABOVE THE WORDS "STAIN PAL". THE HUMAN FACE, THE BUBBLES, AND THE WORDS APPEAR IN A FIELD OF STARS.

FOR STAIN REMOVER (U.S. CLS. 1, 4, 6, 50, 51 AND 52).

FIRST USE 7-18-2006; IN COMMERCE 7-18-2006.

3,300,014. SARATI INTERNATIONAL, LTD, LOS FRESNOS, TX. SN 78-896,841. PUB. 1-23-2007, FILED 5-31-2006.

Skin Sweet

THE MARK CONSISTS OF STANDARD CHARACTERS WITHOUT CLAIM TO ANY PARTICULAR FONT, STYLE, SIZE, OR COLOR.

NO CLAIM IS MADE TO THE EXCLUSIVE RIGHT TO USE "SKIN", APART FROM THE MARK AS SHOWN.

FOR PERSONAL CARE PRODUCTS FOR SKIN HEALTH AND RENEWAL, NAMELY FACIAL AND BODY PRODUCTS NAMELY ANTI-AGING, CLEANSING, MOISTURIZING LOTIONS, CREAMS, AND SERUMS (U.S. CLS. 1, 4, 6, 50, 51 AND 52).
FIRST USE 5-1-2005; IN COMMERCE 5-1-2005.

3,300,041. LANESE, MIKI, ORANGE, CA. SN 78-904,388. PUB. 1-16-2007, FILED 6-8-2006.

HOTTIEDOTS!

THE MARK CONSISTS OF STANDARD CHARACTERS WITHOUT CLAIM TO ANY PARTICULAR FONT, STYLE, SIZE, OR COLOR.

FOR PEEL AND STICK BEAUTY MARKS (U.S. CLS. 1, 4, 6, 50, 51 AND 52).

FIRST USE 1-1-2007; IN COMMERCE 1-1-2007.

CLASS 3—(Continued).

3,300,050. ADVANCE MERCHANDISING COMPANY, INC., ROANOKE, VA. SN 78-909,001. PUB. 2-13-2007, FILED 6-15-2006.

PROFESSIONAL'S FAVORITE NO
MORE DUST

THE MARK CONSISTS OF STANDARD CHARACTERS WITHOUT CLAIM TO ANY PARTICULAR FONT, STYLE, SIZE, OR COLOR.
OWNER OF U.S. REG. NOS. 3,146,103, 3,161,951, AND OTHERS.

FOR CLEANING PREPARATIONS FOR VEHICLES, NAMELY AUTOMOTIVE WHEEL CLEANERS TO REMOVE BRAKE DUST, DIRT, OIL, GREASE AND GRIME (U.S. CLS. 1, 4, 6, 50, 51 AND 52).

FIRST USE 7-24-2006; IN COMMERCE 7-24-2006.

3,300,051. THANE INTERNATIONAL, INC., LA QUINTA, CA. SN 78-909,524. PUB. 1-23-2007, FILED 6-15-2006.

LOOK FLAWLESS NOT FAKE

THE MARK CONSISTS OF STANDARD CHARACTERS WITHOUT CLAIM TO ANY PARTICULAR FONT, STYLE, SIZE, OR COLOR.

FOR COSMETICS; FOUNDATION MAKE-UP (U.S. CLS. 1, 4, 6, 50, 51 AND 52).

FIRST USE 8-9-2006; IN COMMERCE 8-9-2006.

3,300,052. THANE INTERNATIONAL, INC., LA QUINTA, CA. SN 78-909,531. PUB. 1-23-2007, FILED 6-15-2006.

SWIRL GLIDE AND GLOW

THE MARK CONSISTS OF STANDARD CHARACTERS WITHOUT CLAIM TO ANY PARTICULAR FONT, STYLE, SIZE, OR COLOR.

FOR COSMETICS; FOUNDATION MAKE-UP (U.S. CLS. 1, 4, 6, 50, 51 AND 52).

FIRST USE 8-9-2006; IN COMMERCE 8-9-2006.

CLASS 3—(Continued).

3,300,083. AUSTRALIAN GOLD, INC., INDIANAPOLIS, IN. SN 78-918,166. PUB. 11-21-2006, FILED 6-27-2006.

TAP THAT

THE MARK CONSISTS OF STANDARD CHARACTERS WITHOUT CLAIM TO ANY PARTICULAR FONT, STYLE, SIZE, OR COLOR.

FOR SKIN CARE PREPARATIONS, NAMELY, NON-MEDICATED INDOOR AND OUTDOOR TANNING PREPARATIONS (U.S. CLS. 1, 4, 6, 50, 51 AND 52).

FIRST USE 6-16-2006; IN COMMERCE 6-16-2006.

3,300,089. SPPC PARIS BLEU SAS, PARIS, FRANCE. SN 78-918,831. PUB. 1-30-2007, FILED 6-28-2006.

SECRET FLOWERS

THE MARK CONSISTS OF STANDARD CHARACTERS WITHOUT CLAIM TO ANY PARTICULAR FONT, STYLE, SIZE, OR COLOR.

FOR PERFUMERY (U.S. CLS. 1, 4, 6, 50, 51 AND 52).

FIRST USE 7-0-1996; IN COMMERCE 1-18-2007.

3,300,161. SOULSTICE SPA, INC., SAUSALITO, CA. SN 78-945,592. PUB. 3-27-2007, FILED 8-4-2006.

soulstice
everyday spa

NO CLAIM IS MADE TO THE EXCLUSIVE RIGHT TO USE "SPA", APART FROM THE MARK AS SHOWN.

THE COLORS BLACK AND GRAY ARE CLAIMED AS A FEATURE OF THE MARK.

THE COLOR BLACK APPEARS IN THE WORD "SOULSTICE" AND THE COLOR GRAY APPEARS IN THE WORDS "EVERYDAY SPA".

FOR BODY AND BEAUTY CARE PREPARATIONS (U.S. CLS. 1, 4, 6, 50, 51 AND 52).

FIRST USE 5-1-2006; IN COMMERCE 10-15-2006.

CLASS 3—(Continued).

3,300,181. BEAUTYBANK INC., NEW YORK, NY. SN 78-957,579. PUB. 2-13-2007, FILED 8-22-2006.

SMOOTH 365

THE MARK CONSISTS OF STANDARD CHARACTERS WITHOUT CLAIM TO ANY PARTICULAR FONT, STYLE, SIZE, OR COLOR.

FOR NON-MEDICATED SKIN CARE PREPARATIONS (U.S. CLS. 1, 4, 6, 50, 51 AND 52).
FIRST USE 5-15-2007; IN COMMERCE 5-15-2007.

CLASS 3—(Continued).

3,300,224. EBEL INTERNATIONAL LTD., HAMILTON, BER-MUDA. SN 78-978,768. PUB. 5-9-2006, FILED 2-3-2005.

REGRESSION

THE MARK CONSISTS OF STANDARD CHARACTERS WITHOUT CLAIM TO ANY PARTICULAR FONT, STYLE, SIZE, OR COLOR.

FOR PERSONAL CARE PRODUCTS, NAMELY, ANTI-WRINKLE CREAMS, ANTI-AGING CREAMS, SKIN MOISTURIZERS, EYE CREAMS, BODY AND FACE LOTIONS (U.S. CLS. 1, 4, 6, 50, 51 AND 52).
FIRST USE 8-0-2003; IN COMMERCE 9-13-2005.

CLASS 4—LUBRICANTS AND FUELS

3,299,575. CHEVRON U.S.A. INC., SAN RAMON, CA. SN 78-756,026. PUB. 7-18-2006, FILED 11-17-2005.

3,300,220. EBEL INTERNATIONAL LTD., HAMILTON, BER-MUDA. SN 78-978,749. PUB. 8-29-2006, FILED 2-9-2005.

HIPERCUT

THE MARK CONSISTS OF STANDARD CHARACTERS WITHOUT CLAIM TO ANY PARTICULAR FONT, STYLE, SIZE, OR COLOR.

FOR METALWORKING FLUIDS, NAMELY WATER-SOLUBLE OILS WITH LUBRICATING AND COOLING PROPERTIES (U.S. CLS. 1, 6 AND 15).
FIRST USE 4-1-2006; IN COMMERCE 4-1-2006.

3,299,600. LUMETIQUE, INC., STUDIO CITY, CA. SN 78-763,638. PUB. 8-29-2006, FILED 11-30-2005.

MITHYKA

EBEL

FOR COSMETICS, NAMELY, FRAGRANCES, COLOGNE, EAU DE PARFUM, EAU DE TOILETTE, PERFUMED LOTIONS (U.S. CLS. 1, 4, 6, 50, 51 AND 52).
FIRST USE 0-0-2004; IN COMMERCE 10-4-2005.

ECOWOOD WICK

THE MARK CONSISTS OF STANDARD CHARACTERS WITHOUT CLAIM TO ANY PARTICULAR FONT, STYLE, SIZE, OR COLOR.

NO CLAIM IS MADE TO THE EXCLUSIVE RIGHT TO USE "WICK", APART FROM THE MARK AS SHOWN.
FOR CANDLES, CANDLE WICKS (U.S. CLS. 1, 6 AND 15).
FIRST USE 11-15-2005; IN COMMERCE 12-1-2005.

CLASS 4—(Continued).

3,299,711. PITTNER, VANESSA R., WICHITA FALLS, TX. SN 78-790,421. PUB. 9-5-2006, FILED 1-12-2006.

CORNERSTONE CANDLE

THE MARK CONSISTS OF STANDARD CHARACTERS WITHOUT CLAIM TO ANY PARTICULAR FONT, STYLE, SIZE, OR COLOR.

NO CLAIM IS MADE TO THE EXCLUSIVE RIGHT TO USE "CANDLE", APART FROM THE MARK AS SHOWN. FOR CANDLES (U.S. CLS. 1, 6 AND 15).
FIRST USE 1-29-2007; IN COMMERCE 3-24-2007.

3,299,722. IMPERIAL CANDLE COMPANY, LLC, CLEVELAND, GA. SN 78-793,800. PUB. 9-26-2006, FILED 1-18-2006.

JENNI ORIGINALS

THE MARK CONSISTS OF STANDARD CHARACTERS WITHOUT CLAIM TO ANY PARTICULAR FONT, STYLE, SIZE, OR COLOR.

NO CLAIM IS MADE TO THE EXCLUSIVE RIGHT TO USE "ORIGINALS", APART FROM THE MARK AS SHOWN. FOR CANDLES, BOTANICAL CANDLES, DECORATIVE CANDLES, FRAGRANCE CANDLES (U.S. CLS. 1, 6 AND 15).
FIRST USE 3-1-2007; IN COMMERCE 3-1-2007.

3,299,746. BOIS B.S.L. ÉNERGIE INC., MONT-JOLI, CANADA. SN 78-799,088. PUB. 10-17-2006, FILED 1-25-2006.



THE MARK CONSISTS OF THE WORDING "SMARTLOG" APPEARING TO THE RIGHT OF A POLYGON CONTAINING A DEPICTION OF FLAMES THAT FORM A STYLIZED LETTER "S".

FOR FIREWOOD LOGS MADE OF HIGH-DENSITY WOOD SAWDUST AND SHAVINGS, WHICH CAN BE BURNED FOR ENERGY (U.S. CLS. 1, 6 AND 15).
FIRST USE 3-20-2006; IN COMMERCE 7-12-2006.

CLASS 4—(Continued).

3,299,753. LACERENZA, D. MATTHEW, STAMFORD, CT. SN 78-801,132. PUB. 10-3-2006, FILED 1-27-2006.

SPORTSLYK

THE MARK CONSISTS OF STANDARD CHARACTERS WITHOUT CLAIM TO ANY PARTICULAR FONT, STYLE, SIZE, OR COLOR.

FOR ALL-PURPOSE LUBRICANTS FOR MACHINES, GUNS, AND SPORTS EQUIPMENT (U.S. CLS. 1, 6 AND 15).
FIRST USE 1-1-2007; IN COMMERCE 3-1-2007.

3,299,835. FIBER BY-PRODUCTS CORP., GOSHEN, IN. SN 78-829,773. PUB. 10-24-2006, FILED 3-6-2006.

PROPELLET

THE MARK CONSISTS OF STANDARD CHARACTERS WITHOUT CLAIM TO ANY PARTICULAR FONT, STYLE, SIZE, OR COLOR.

FOR WOOD PELLETS FOR FUEL (U.S. CLS. 1, 6 AND 15).
FIRST USE 11-1-2006; IN COMMERCE 11-1-2006.

3,299,929. M-X AG, LLC, DANVILLE, IL. SN 78-865,831. PUB. 12-5-2006, FILED 4-20-2006.

BLAZE BRIGHT

THE MARK CONSISTS OF STANDARD CHARACTERS WITHOUT CLAIM TO ANY PARTICULAR FONT, STYLE, SIZE, OR COLOR.

FOR SHELLED CORN FOR FUEL (U.S. CLS. 1, 6 AND 15).
FIRST USE 4-0-2006; IN COMMERCE 10-18-2006.

CLASS 5—PHARMACEUTICALS

CLASS 5—(Continued).

3,298,411. MEDPOINTE HEALTHCARE INC., SOMERSET, NJ. SN 76-305,709. PUB. 4-15-2003, FILED 8-28-2001.

medPointe

FOR PHARMACEUTICALS TO TREAT HUMANS, NAMELY, PREPARATIONS USED TO TREAT ALLERGIES, RESPIRATORY ILLNESSES, COUGHS AND COLDS, EPILEPSY, CENTRAL NERVOUS SYSTEM DISORDERS, GASTRO-INTESTINAL, CANAL AND SKELETAL DISORDERS, CONDITIONS OF MENOPAUSE, PEDIATRIC INFECTIONS, AND DISEASES OF THE AGED (U.S. CLS. 6, 18, 44, 46, 51 AND 52).

FIRST USE 7-0-2003; IN COMMERCE 7-0-2003.

CLASS 5—(Continued).

3,298,512. SIGMA-TAU HEALTHSCIENCE, INC., NEW YORK, NY. SN 76-634,190. PUB. 8-8-2006, FILED 3-23-2005.

AMINOCARNITINE

THE MARK CONSISTS OF STANDARD CHARACTERS WITHOUT CLAIM TO ANY PARTICULAR FONT, STYLE, SIZE, OR COLOR.

FOR NUTRITIONAL SUPPLEMENTS (U.S. CLS. 6, 18, 44, 46, 51 AND 52).

FIRST USE 2-17-2006; IN COMMERCE 2-17-2006.

3,298,457. BIOKEMIKAL S.A. DE C.V., SANTO TOMÁS, SAN SALVADOR, EL SALVADOR. SN 76-575,834. PUB. 7-12-2005, FILED 2-17-2004.

DAYASUPRIL BIOKEMICAL

THE MARK CONSISTS OF STANDARD CHARACTERS WITHOUT CLAIM TO ANY PARTICULAR FONT, STYLE, SIZE, OR COLOR.

NO CLAIM IS MADE TO THE EXCLUSIVE RIGHT TO USE "BIOCHEMICAL", APART FROM THE MARK AS SHOWN.

FOR DIETARY SUPPLEMENTS (U.S. CLS. 6, 18, 44, 46, 51 AND 52).

FIRST USE 1-15-2007; IN COMMERCE 1-15-2007.

3,298,513. SIGMA-TAU HEALTHSCIENCE, INC., NEW YORK, NY. SN 76-634,191. PUB. 12-27-2005, FILED 3-23-2005.

NUTRACEUTICALS FOR LIFE

THE MARK CONSISTS OF STANDARD CHARACTERS WITHOUT CLAIM TO ANY PARTICULAR FONT, STYLE, SIZE, OR COLOR.

NO CLAIM IS MADE TO THE EXCLUSIVE RIGHT TO USE NUTRACEUTICALS, APART FROM THE MARK AS SHOWN.

FOR NUTRITIONAL SUPPLEMENTS (U.S. CLS. 6, 18, 44, 46, 51 AND 52).

FIRST USE 2-17-2006; IN COMMERCE 2-17-2006.

3,298,498. WORLD HEALTH PRODUCTS, LLC, STAMFORD, CT. SN 76-626,192. PUB. 10-25-2005, FILED 12-28-2004.

JET FUEL

THE MARK CONSISTS OF STANDARD CHARACTERS WITHOUT CLAIM TO ANY PARTICULAR FONT, STYLE, SIZE, OR COLOR.

FOR NUTRITIONAL SUPPLEMENTS, NAMELY, WEIGHT LOSS PILLS AND ENERGY AND WEIGHT LOSS DRINKS AND MIXES (U.S. CLS. 6, 18, 44, 46, 51 AND 52).

FIRST USE 3-7-2005; IN COMMERCE 3-7-2005.

3,298,514. SIGMA-TAU HEALTHSCIENCE, INC., NEW YORK, NY. SN 76-634,194. PUB. 12-27-2005, FILED 3-23-2005.

L-TAURO

THE MARK CONSISTS OF STANDARD CHARACTERS WITHOUT CLAIM TO ANY PARTICULAR FONT, STYLE, SIZE, OR COLOR.

FOR NUTRITIONAL SUPPLEMENTS (U.S. CLS. 6, 18, 44, 46, 51 AND 52).

FIRST USE 2-17-2006; IN COMMERCE 2-17-2006.

CLASS 5—(Continued).

3,298,519. WESTWAY FEED PRODUCTS, INC., TOMBALL, TX. SN 76-635,470. PUB. 7-18-2006, FILED 4-11-2005.



THE MARK CONSISTS IN PART OF A COW AT A FEED BIN. FOR MEDICATED FEED SUPPLEMENTS FOR LIVESTOCK (U.S. CLS. 6, 18, 44, 46, 51 AND 52). FIRST USE 4-9-2007; IN COMMERCE 4-9-2007.

3,298,589. A & B INGREDIENTS, INC., FAIRFIELD, NJ. SN 76-658,922. PUB. 12-12-2006, FILED 4-24-2006.

CYTOGUARD

THE MARK CONSISTS OF STANDARD CHARACTERS WITHOUT CLAIM TO ANY PARTICULAR FONT, STYLE, SIZE, OR COLOR.

FOR ANTIMICROBIAL AND BACTERIOSTATIC COMPOSITIONS TO BE USED FOR PRESERVATION AND/OR DISINFECTION OF FOOD AND FEEDSTUFFS, COSMETICS, ORAL CARE PRODUCTS, DEODORANTS, PERSONAL CARE PRODUCTS AND CLEANING PRODUCTS (U.S. CLS. 6, 18, 44, 46, 51 AND 52). FIRST USE 10-27-2006; IN COMMERCE 10-27-2006.

3,298,636. BLOCK DRUG COMPANY, INC., WEST TRENTON, NJ. SN 77-042,196. PUB. 3-6-2007, FILED 11-13-2006.



OWNER OF U.S. REG. NOS. 500,423, 1,649,912, AND OTHERS. FOR ANALGESIC PREPARATIONS (U.S. CLS. 6, 18, 44, 46, 51 AND 52). FIRST USE 2-28-2006; IN COMMERCE 2-28-2006.

CLASS 5—(Continued).

3,298,649. TWENTIETH CENTURY FOX FILM CORPORATION, LOS ANGELES, CA. SN 78-167,086. PUB. 11-18-2003, FILED 9-23-2002.

THE SIMPSONS

SEC. 2(F). FOR AIR FRESHENERS (U.S. CLS. 6, 18, 44, 46, 51 AND 52). FIRST USE 3-1-2004; IN COMMERCE 3-1-2004.

3,298,660. NSA, LLC, COLLIERVILLE, TN. SN 78-204,135. PUB. 9-26-2006, FILED 1-16-2003.

VINEYARD BLEND

NO CLAIM IS MADE TO THE EXCLUSIVE RIGHT TO USE "BLEND", APART FROM THE MARK AS SHOWN. FOR NUTRITIONAL SUPPLEMENT TABLETS (U.S. CLS. 6, 18, 44, 46, 51 AND 52). FIRST USE 11-0-2001; IN COMMERCE 11-0-2001.

3,298,675. TECH INTERNATIONAL, INC., DBA HEALTH TECH, ALPHARETTA, GA. SN 78-246,674. PUB. 1-13-2004, FILED 5-7-2003.

TUBE-O-LUBE

FOR SEXUAL LUBRICANT (U.S. CLS. 6, 18, 44, 46, 51 AND 52). FIRST USE 3-15-2007; IN COMMERCE 3-15-2007.

3,298,688. SVENSKA ÖRTMEDICINSKA INSTITUTET AB, 413 05 GÖTEBORG, SWEDEN. SN 78-298,824. PUB. 1-18-2005, FILED 9-10-2003.



NO CLAIM IS MADE TO THE EXCLUSIVE RIGHT TO USE "SWEDISH HERBAL INSTITUTE", APART FROM THE MARK AS SHOWN. FOR FOOD SUPPLEMENTS IN THE FORM OF VITAMINS AND MINERALS; HERBAL SUPPLEMENTS FOR MEDICAL PURPOSES (U.S. CLS. 6, 18, 44, 46, 51 AND 52). FIRST USE 6-1-2006; IN COMMERCE 7-1-2006.

CLASS 5—(Continued).

3,298,735. AHD INTERNATIONAL, LLC, ATLANTA, GA. SN 78-376,074. PUB. 1-18-2005, FILED 3-1-2004.

PREDEX

THE MARK CONSISTS OF STANDARD CHARACTERS WITHOUT CLAIM TO ANY PARTICULAR FONT, STYLE, SIZE, OR COLOR.

FOR DIETARY SUPPLEMENT INGREDIENTS, NAMELY DIOSMIN FROM ORANGE PEELS (U.S. CLS. 6, 18, 44, 46, 51 AND 52).

FIRST USE 9-1-2006; IN COMMERCE 9-1-2006.

CLASS 5—(Continued).

3,298,767. ALTANA, INC., MELVILLE, NY. SN 78-427,682. PUB. 7-12-2005, FILED 6-1-2004.

MURICIN

THE MARK CONSISTS OF STANDARD CHARACTERS WITHOUT CLAIM TO ANY PARTICULAR FONT, STYLE, SIZE, OR COLOR.

FOR PRESCRIPTION ONLY ANTI-BIOTIC OINTMENT FOR THE TREATMENT OF TOPICAL INFECTIONS IN CATS AND DOGS (U.S. CLS. 6, 18, 44, 46, 51 AND 52).

FIRST USE 3-9-2007; IN COMMERCE 3-9-2007.

3,298,811. NUTRITHERAPEUTICS INC, TAMPA, FL. SN 78-470,672. PUB. 7-12-2005, FILED 8-20-2004.

NUTRASTEM

THE MARK CONSISTS OF STANDARD CHARACTERS WITHOUT CLAIM TO ANY PARTICULAR FONT, STYLE, SIZE, OR COLOR.

FOR NUTRITIONAL SUPPLEMENT (U.S. CLS. 6, 18, 44, 46, 51 AND 52).

FIRST USE 7-1-2006; IN COMMERCE 7-1-2006.

3,298,745. PINKUS, MICHAEL R., CLEARWATER, FL. SN 78-383,425. PUB. 12-28-2004, FILED 3-12-2004.

Roll Away Pain

3,298,812. HELENA HOLDING COMPANY, WILMINGTON, DE. SN 78-471,612. PUB. 1-18-2005, FILED 8-23-2004.

SAURUS

THE MARK CONSISTS OF STANDARD CHARACTERS WITHOUT CLAIM TO ANY PARTICULAR FONT, STYLE, SIZE, OR COLOR.

FOR TOPICAL ANALGESICS (U.S. CLS. 6, 18, 44, 46, 51 AND 52).

FIRST USE 3-2-2005; IN COMMERCE 3-2-2005.

THE MARK CONSISTS OF STANDARD CHARACTERS WITHOUT CLAIM TO ANY PARTICULAR FONT, STYLE, SIZE, OR COLOR.

FOR INSECTICIDES FOR USE IN AGRICULTURE (U.S. CLS. 6, 18, 44, 46, 51 AND 52).

FIRST USE 12-0-2006; IN COMMERCE 12-0-2006.

CLASS 5—(Continued).

3,298,867. KENSEY NASH CORPORATION, EXTON, PA. SN 78-514,377. PUB. 3-7-2006, FILED 11-10-2004.

BIOBLANKET

THE MARK CONSISTS OF STANDARD CHARACTERS WITHOUT CLAIM TO ANY PARTICULAR FONT, STYLE, SIZE, OR COLOR.

FOR BIOLOGICAL CONNECTIVE TISSUE INTENDED FOR SUBSEQUENT IMPLANTATION, NAMELY, A HIGH DENSITY COLLAGEN MESH OF BIOLOGICAL TISSUE FOR THE PURPOSES OF SURGICALLY REPAIRING TISSUE IN A LIVING BEING (U.S. CLS. 6, 18, 44, 46, 51 AND 52).

FIRST USE 9-15-2004; IN COMMERCE 9-15-2004.

3,298,894. CELL US TRADEMARK LTD., MISSISSAUGA, ONTARIO, CANADA. SN 78-534,398. PUB. 1-23-2007, FILED 12-17-2004.

CREA-EDGE

THE MARK CONSISTS OF STANDARD CHARACTERS WITHOUT CLAIM TO ANY PARTICULAR FONT, STYLE, SIZE, OR COLOR.

FOR FOOD SUPPLEMENTS FOR BODY BUILDING, FOOD AND SPORT NUTRITIONAL SUPPLEMENTS FOR STRENGTH AND PERFORMANCE ENHANCEMENT; POWDERED NUTRITIONAL SUPPLEMENT DRINK MIX; MEAL REPLACEMENT SHAKES; CREATINE BLEND FOR USE AS AN INGREDIENT FOR NUTRITIONAL SUPPLEMENTS, VITAMIN FORTIFIED BEVERAGES (U.S. CLS. 6, 18, 44, 46, 51 AND 52).

FIRST USE 3-0-2005; IN COMMERCE 3-0-2005.

3,298,905. WESTERN HOLDINGS, CHEYENNE, WY. SN 78-547,328. PUB. 5-23-2006, FILED 1-13-2005.

NOVEX BIOTECH

THE MARK CONSISTS OF STANDARD CHARACTERS WITHOUT CLAIM TO ANY PARTICULAR FONT, STYLE,

CLASS 5—(Continued).

SIZE, OR COLOR.

NO CLAIM IS MADE TO THE EXCLUSIVE RIGHT TO USE "BIOTECH", APART FROM THE MARK AS SHOWN. FOR DIETARY SUPPLEMENTS (U.S. CLS. 6, 18, 44, 46, 51 AND 52).

FIRST USE 11-28-2005; IN COMMERCE 11-28-2005.

3,298,959. BODY WISE INTERNATIONAL, LLC, TUSTIN, CA. SN 78-572,669. PUB. 6-20-2006, FILED 2-22-2005.

BW365

THE MARK CONSISTS OF STANDARD CHARACTERS WITHOUT CLAIM TO ANY PARTICULAR FONT, STYLE, SIZE, OR COLOR.

FOR DIETARY AND NUTRITIONAL SUPPLEMENTS; MEAL REPLACEMENT SHAKES; APPETITE SUPPRESSANTS (U.S. CLS. 6, 18, 44, 46, 51 AND 52).

FIRST USE 1-1-2005; IN COMMERCE 2-15-2005.

3,298,977. T J SMITH & NEPHEW LIMITED, HULL, UNITED KINGDOM. SN 78-579,990. PUB. 7-11-2006, FILED 3-4-2005.

LEUKOSTRIP

THE MARK CONSISTS OF STANDARD CHARACTERS WITHOUT CLAIM TO ANY PARTICULAR FONT, STYLE, SIZE, OR COLOR.

FOR WOUND CLOSURE STRIPS (U.S. CLS. 6, 18, 44, 46, 51 AND 52).

FIRST USE 4-0-2001; IN COMMERCE 4-0-2001.

CLASS 5—(Continued).

3,298,984. MISC US TRADEMARK LTD., MISSISSAUGA, ONTARIO, CANADA. SN 78-584,917. PUB. 8-8-2006, FILED 3-10-2005.

SMARTBURN

THE MARK CONSISTS OF STANDARD CHARACTERS WITHOUT CLAIM TO ANY PARTICULAR FONT, STYLE, SIZE, OR COLOR.

FOR FOOD SUPPLEMENTS FOR BODY BUILDING, STRENGTH AND PERFORMANCE ENHANCEMENT; NUTRITIONAL SUPPLEMENTS (U.S. CLS. 6, 18, 44, 46, 51 AND 52).

FIRST USE 8-0-2005; IN COMMERCE 8-0-2005.

3,299,010. WALCO INTERNATIONAL, INC., WESTLAKE, TX. SN 78-593,519. PUB. 7-4-2006, FILED 3-23-2005.

RANCH PACK

THE MARK CONSISTS OF STANDARD CHARACTERS WITHOUT CLAIM TO ANY PARTICULAR FONT, STYLE, SIZE, OR COLOR.

NO CLAIM IS MADE TO THE EXCLUSIVE RIGHT TO USE "PACK", APART FROM THE MARK AS SHOWN.

FOR KIT CONTAINING CATTLE VACCINES AND SUPPLEMENTS FOR USE BY CATTLE FARMERS (U.S. CLS. 6, 18, 44, 46, 51 AND 52).

FIRST USE 2-21-2006; IN COMMERCE 2-21-2006.

CLASS 5—(Continued).

3,299,105. S. C. JOHNSON & SON, INC., RACINE, WI. SN 78-624,765. PUB. 6-20-2006, FILED 5-6-2005.



OWNER OF U.S. REG. NOS. 1,594,843, 1,596,048, AND 2,169,628.

FOR INSECT REPELLENTS (U.S. CLS. 6, 18, 44, 46, 51 AND 52).

FIRST USE 12-14-2006; IN COMMERCE 12-14-2006.

3,299,106. S. C. JOHNSON & SON, INC., RACINE, WI. SN 78-624,775. PUB. 6-20-2006, FILED 5-6-2005.



OWNER OF U.S. REG. NOS. 1,594,843, 2,169,628, AND OTHERS.

THE COLOR(S) WHITE AND ORANGE IS/ARE CLAIMED AS A FEATURE OF THE MARK.

THE MARK CONSISTS OF THE WORD OFF IN WHITE INSIDE AN ORANGE CIRCLE WITH A WHITE EXCLAMATION MARK.

FOR INSECT REPELLENTS (U.S. CLS. 6, 18, 44, 46, 51 AND 52).

FIRST USE 12-14-2006; IN COMMERCE 12-14-2006.

3,299,111. NUTRI-ENERGETICS SYSTEMS LTD., LILLIPUT, POOLE, UNITED KINGDOM. SN 78-626,309. PUB. 2-14-2006, FILED 5-10-2005.

ENERGETIC INTEGRATOR

CLASS 5—(Continued).

THE MARK CONSISTS OF STANDARD CHARACTERS WITHOUT CLAIM TO ANY PARTICULAR FONT, STYLE, SIZE, OR COLOR.

FOR MINERAL SUPPLEMENTS (U.S. CLS. 6, 18, 44, 46, 51 AND 52).

FIRST USE 3-14-2007; IN COMMERCE 3-14-2007.

CLASS 5—(Continued).

3,299,189. AMERIFIT NUTRITION, INC., BLOOMFIELD, CT. SN 78-661,798. PUB. 10-17-2006, FILED 6-30-2005.

ESTROVEN MENOPAUSE TEST

THE MARK CONSISTS OF STANDARD CHARACTERS WITHOUT CLAIM TO ANY PARTICULAR FONT, STYLE, SIZE, OR COLOR.

NO CLAIM IS MADE TO THE EXCLUSIVE RIGHT TO USE "MENOPAUSE TEST", APART FROM THE MARK AS SHOWN.

FOR TEST KITS FOR DETERMINING HORMONE LEVELS FOR HOME USE (U.S. CLS. 6, 18, 44, 46, 51 AND 52).

FIRST USE 5-15-2005; IN COMMERCE 5-15-2005.

3,299,145. ARYSTA LIFESCIENCE NORTH AMERICA CORPORATION, CARY, NC. SN 78-641,670. PUB. 1-24-2006, FILED 6-1-2005.

CAPTAN PRO

THE MARK CONSISTS OF STANDARD CHARACTERS WITHOUT CLAIM TO ANY PARTICULAR FONT, STYLE, SIZE, OR COLOR.

NO CLAIM IS MADE TO THE EXCLUSIVE RIGHT TO USE "CAPTAN", APART FROM THE MARK AS SHOWN.

FOR FUNGICIDES FOR USE IN AGRICULTURE AND HORTICULTURE (U.S. CLS. 6, 18, 44, 46, 51 AND 52).

FIRST USE 6-1-2006; IN COMMERCE 6-1-2006.

3,299,247. HAI, JOSHUA H., ORANGE, CA. SN 78-685,248. PUB. 7-11-2006, FILED 8-3-2005.

HCT LIPIDS - HAYCO

THE MARK CONSISTS OF STANDARD CHARACTERS WITHOUT CLAIM TO ANY PARTICULAR FONT, STYLE, SIZE, OR COLOR.

NO CLAIM IS MADE TO THE EXCLUSIVE RIGHT TO USE "HCT LIPIDS", APART FROM THE MARK AS SHOWN.

FOR DIETARY SUPPLEMENT, AIDS IN MAINTAINING HEALTHY CHOLESTEROL LEVELS NATURALLY (U.S. CLS. 6, 18, 44, 46, 51 AND 52).

FIRST USE 8-3-2005; IN COMMERCE 8-3-2005.

3,299,156. MWI VETERINARY SUPPLY CO., MERIDIAN, ID. SN 78-647,476. PUB. 9-5-2006, FILED 6-9-2005.

VETRIMEC

THE MARK CONSISTS OF STANDARD CHARACTERS WITHOUT CLAIM TO ANY PARTICULAR FONT, STYLE, SIZE, OR COLOR.

FOR VETERINARY PHARMACEUTICALS, NAMELY, VETERINARY ANTHELMINTICS, ALL CONTAINING IVERMECTIN AS THE ACTIVE INGREDIENT, FOR BOVINE AND EQUINE USE (U.S. CLS. 6, 18, 44, 46, 51 AND 52).

FIRST USE 8-3-2005; IN COMMERCE 8-3-2005.

3,299,263. PERFORMANCE HORSE NUTRITION, LLC, WEISER, ID. SN 78-696,088. PUB. 12-26-2006, FILED 8-19-2005.

HOOF AID

THE MARK CONSISTS OF STANDARD CHARACTERS WITHOUT CLAIM TO ANY PARTICULAR FONT, STYLE, SIZE, OR COLOR.

NO CLAIM IS MADE TO THE EXCLUSIVE RIGHT TO USE "HOOF", APART FROM THE MARK AS SHOWN.

FOR ANIMAL FEED SUPPLEMENTS, NAMELY A NUTRITIONAL HOOF SUPPLEMENT FOR HORSES (U.S. CLS. 6, 18, 44, 46, 51 AND 52).

FIRST USE 2-28-2006; IN COMMERCE 2-28-2006.

CLASS 5—(Continued).

3,299,276. ARYSTA LIFESCIENCE NORTH AMERICA CORPORATION, CARY, NC. SN 78-699,844. PUB. 1-24-2006, FILED 8-24-2005.

Captan Pro

NO CLAIM IS MADE TO THE EXCLUSIVE RIGHT TO USE "CAPTAN", APART FROM THE MARK AS SHOWN, FOR FUNGICIDES FOR USE IN AGRICULTURE AND HORTICULTURE (U.S. CLS. 6, 18, 44, 46, 51 AND 52).
FIRST USE 6-1-2006; IN COMMERCE 6-1-2006.

CLASS 5—(Continued).

3,299,354. BIO-LAB, INC., LAWRENCEVILLE, GA. SN 78-722,902. PUB. 6-27-2006, FILED 9-29-2005.

POOL PODS

THE MARK CONSISTS OF STANDARD CHARACTERS WITHOUT CLAIM TO ANY PARTICULAR FONT, STYLE, SIZE, OR COLOR.

NO CLAIM IS MADE TO THE EXCLUSIVE RIGHT TO USE "POOL", APART FROM THE MARK AS SHOWN, FOR SANITIZING TABLET FOR RECREATIONAL POOLS (U.S. CLS. 6, 18, 44, 46, 51 AND 52).
FIRST USE 10-1-2005; IN COMMERCE 3-16-2006.

3,299,299. PROLONG PHARMACEUTICALS, INC., MONMOUTH JUNCTION, NJ. SN 78-708,605. PUB. 12-5-2006, FILED 9-7-2005.

EPEG

THE MARK CONSISTS OF STANDARD CHARACTERS WITHOUT CLAIM TO ANY PARTICULAR FONT, STYLE, SIZE, OR COLOR.
FOR ERYTHROPOIETIN HORMONES (U.S. CLS. 6, 18, 44, 46, 51 AND 52).
FIRST USE 6-0-2005; IN COMMERCE 12-0-2005.

3,299,312. TAKEDA PHARMACEUTICAL COMPANY LIMITED, CHUO-KU, OSAKA, JAPAN. SN 78-711,899. PUB. 9-12-2006, FILED 9-13-2005.

DUETACT

THE MARK CONSISTS OF STANDARD CHARACTERS WITHOUT CLAIM TO ANY PARTICULAR FONT, STYLE, SIZE, OR COLOR.
FOR PHARMACEUTICAL PREPARATIONS FOR THE TREATMENT OF DIABETIC DISEASE (U.S. CLS. 6, 18, 44, 46, 51 AND 52).
FIRST USE 8-17-2006; IN COMMERCE 8-17-2006.

3,299,403. WRIGHT SALES, GRANDVILLE, MI. SN 78-731,841. PUB. 7-25-2006, FILED 10-12-2005.

AIRBEADS

THE MARK CONSISTS OF STANDARD CHARACTERS WITHOUT CLAIM TO ANY PARTICULAR FONT, STYLE, SIZE, OR COLOR.

FOR DECORATIVE HANGING AIR FRESHENER FOR NAMELY, AUTOMOBILE, HOME AND OFFICE (U.S. CLS. 6, 18, 44, 46, 51 AND 52).
FIRST USE 12-8-2004; IN COMMERCE 10-5-2005.

3,299,416. NUTRITEL FOOD TECHNOLOGIES INC., CALEDON EAST, ONTARIO, CANADA. SN 78-734,491. PUB. 6-20-2006, FILED 10-17-2005.

SoWell

THE MARK CONSISTS OF STANDARD CHARACTERS WITHOUT CLAIM TO ANY PARTICULAR FONT, STYLE, SIZE, OR COLOR.

FOR MEAL REPLACEMENT NUTRITION BARS, MEAL REPLACEMENT POWDERS, AND MEAL REPLACEMENT AND DIETARY SUPPLEMENT DRINKS AND DRINK MIXES (U.S. CLS. 6, 18, 44, 46, 51 AND 52).
FIRST USE 3-1-2006; IN COMMERCE 11-1-2006.

CLASS 5—(Continued).

3,299,425. NUTRAGENETICS, HERMOSA BEACH, CA. SN 78-735,767. PUB. 6-20-2006, FILED 10-18-2005.

HEALTH-RITE

THE MARK CONSISTS OF STANDARD CHARACTERS WITHOUT CLAIM TO ANY PARTICULAR FONT, STYLE, SIZE, OR COLOR.

FOR DIETARY SUPPLEMENTS (U.S. CLS. 6, 18, 44, 46, 51 AND 52).

FIRST USE 12-0-2006; IN COMMERCE 3-6-2007.

3,299,443. ISAGRO USA, INC., DURHAM, NC. SN 78-737,309. PUB. 7-18-2006, FILED 10-20-2005.

STRADA

THE MARK CONSISTS OF STANDARD CHARACTERS WITHOUT CLAIM TO ANY PARTICULAR FONT, STYLE, SIZE, OR COLOR.

THE FOREIGN WORDING IN THE MARK TRANSLATES INTO ENGLISH AS STREET, ROAD OR WAY.

FOR HERBICIDES (U.S. CLS. 6, 18, 44, 46, 51 AND 52).

FIRST USE 3-16-2007; IN COMMERCE 3-16-2007.

3,299,451. NUTRITION & FITNESS, INC., FAYETTEVILLE, NC. SN 78-737,934. PUB. 2-6-2007, FILED 10-21-2005.

TRANSDERMIS

THE MARK CONSISTS OF STANDARD CHARACTERS WITHOUT CLAIM TO ANY PARTICULAR FONT, STYLE, SIZE, OR COLOR.

FOR TOPICAL OINTMENT CONTAINING EMU OIL FOR USE IN REDUCING THE APPEARANCE OF SCARS (U.S. CLS. 6, 18, 44, 46, 51 AND 52).

FIRST USE 5-25-2006; IN COMMERCE 5-25-2006.

CLASS 5—(Continued).

3,299,470. 4LIFE TRADEMARKS, LLC, SANDY, UT. SN 78-740,294. PUB. 7-11-2006, FILED 10-25-2005.

BIOGENISTEIN ULTRA

THE MARK CONSISTS OF STANDARD CHARACTERS WITHOUT CLAIM TO ANY PARTICULAR FONT, STYLE, SIZE, OR COLOR.

OWNER OF U.S. REG. NO. 2,415,791.

FOR DIETARY AND NUTRITIONAL SUPPLEMENTS; VITAMIN, MINERAL AND HERBAL SUPPLEMENTS; DIETARY SUPPLEMENTS, NAMELY, IMMUNE FACTOR PREPARATIONS TO ENHANCE AND STIMULATE THE IMMUNE SYSTEM (U.S. CLS. 6, 18, 44, 46, 51 AND 52).

FIRST USE 3-1-2006; IN COMMERCE 3-1-2006.

3,299,497. CHERRY, JENNIFER J., SAINT LOUIS, MO. SN 78-744,326. PUB. 7-4-2006, FILED 11-1-2005.

BIOVENE

THE MARK CONSISTS OF STANDARD CHARACTERS WITHOUT CLAIM TO ANY PARTICULAR FONT, STYLE, SIZE, OR COLOR.

FOR DIETARY AND NUTRITIONAL SUPPLEMENT (U.S. CLS. 6, 18, 44, 46, 51 AND 52).

FIRST USE 1-0-2006; IN COMMERCE 1-0-2006.

3,299,505. SCHERING-PLOUGH HEALTHCARE PRODUCTS, INC., MEMPHIS, TN. SN 78-746,035. PUB. 7-11-2006, FILED 11-3-2005.

DUAL ACTION FREEZE AWAY

THE MARK CONSISTS OF STANDARD CHARACTERS WITHOUT CLAIM TO ANY PARTICULAR FONT, STYLE, SIZE, OR COLOR.

OWNER OF U.S. REG. NOS. 2,909,077 AND 2,911,554.

FOR PHARMACEUTICAL PREPARATIONS FOR USE IN THE REMOVAL OF WARTS (U.S. CLS. 6, 18, 44, 46, 51 AND 52).

FIRST USE 2-28-2006; IN COMMERCE 2-28-2006.

CLASS 5—(Continued).

3,299,515. AMBATI, BALAMURALI, AUGUSTA, GA. AND AMBATI, JAYAKRISHNA, AUGUSTA, GA. SN 78-747,321. PUB. 7-18-2006, FILED 11-4-2005.

iVeena

THE MARK CONSISTS OF STANDARD CHARACTERS WITHOUT CLAIM TO ANY PARTICULAR FONT, STYLE, SIZE, OR COLOR.

FOR ANTI-DIABETIC PHARMACEUTICALS, CARDIOVASCULAR PHARMACEUTICALS, DRUG DELIVERY AGENTS CONSISTING OF COMPOUNDS THAT FACILITATE DELIVERY OF A WIDE RANGE OF PHARMACEUTICALS, OCULAR PHARMACEUTICALS, PHARMACEUTICAL PREPARATIONS FOR USE IN CHEMOTHERAPY, PHARMACEUTICAL PREPARATIONS FOR THE TREATMENT OF MACULAR DEGENERATION, CORNEAL NEOVASCULARIZATION, DIABETIC RETINOPATHY, CANCER, STROKE, HEART DISEASE, WOUND HEALING; PHARMACEUTICAL PREPARATIONS, NAMELY, A DRUG DELIVERY SYSTEM COMPRISING POLYMER-BASED ORAL TABLETS FOR THE CONTINUOUS RELEASE OF A WIDE VARIETY OF THERAPEUTIC AGENTS, PHARMACEUTICAL PREPARATIONS ACTING ON THE CENTRAL NERVOUS SYSTEM, PHARMACEUTICAL PREPARATIONS FOR OCULAR OR INTRAOCULAR SURGERY, PHARMACEUTICAL PREPARATIONS FOR TREATING DIABETES, PHARMACEUTICAL PREPARATIONS FOR WOUNDS, PHARMACEUTICAL PRODUCTS FOR OPHTHALMOLOGICAL USE, PLANT EXTRACTS FOR MEDICAL, VETERINARY AND PHARMACEUTICAL PURPOSES (U.S. CLS. 6, 18, 44, 46, 51 AND 52).

FIRST USE 3-6-2007; IN COMMERCE 3-6-2007.

3,299,518. ASPEN BENEFITS GROUP, L.L.C., LAS VEGAS, NV. SN 78-747,770. PUB. 8-1-2006, FILED 11-4-2005.

ACNERECOVERY

THE MARK CONSISTS OF STANDARD CHARACTERS WITHOUT CLAIM TO ANY PARTICULAR FONT, STYLE, SIZE, OR COLOR.

FOR ACNE MEDICATIONS; ACNE TREATMENT PREPARATIONS; MEDICATED ACNE TREATMENT PREPARATIONS, NAMELY, ANTIBIOTIC CLEANSERS AND ANTI-INFLAMMATORY, ANTIBIOTIC AND KERATOLYTIC LOTIONS, CREAMS; CHEMICAL SKIN PEELS; MEDICATED CREAMS FOR SPOT TREATMENT OF ACNE; ACNE TREATMENT KITS, NAMELY, KITS CONTAINING ANTIBIOTIC CLEANSERS AND ANTI-INFLAMMATORY, ANTIBIOTIC AND KERATOLYTIC LOTIONS, AND CREAMS (U.S. CLS. 6, 18, 44, 46, 51 AND 52).

FIRST USE 2-2-2006; IN COMMERCE 2-2-2006.

CLASS 5—(Continued).

3,299,565. DOBBS, NATHAN F., ORMOND BEACH, FL. SN 78-754,768. PUB. 8-1-2006, FILED 11-16-2005.

Stopeespots

THE MARK CONSISTS OF STANDARD CHARACTERS WITHOUT CLAIM TO ANY PARTICULAR FONT, STYLE, SIZE, OR COLOR.

FOR DISINFECTANTS FOR TOILETS (U.S. CLS. 6, 18, 44, 46, 51 AND 52).

FIRST USE 3-31-2007; IN COMMERCE 3-31-2007.

3,299,574. CANICA DESIGN INC., ALMONTE, ONTARIO, CANADA. SN 78-755,884. PUB. 7-4-2006, FILED 11-17-2005.

DynaStretch

THE MARK CONSISTS OF STANDARD CHARACTERS WITHOUT CLAIM TO ANY PARTICULAR FONT, STYLE, SIZE, OR COLOR.

FOR SURGICAL TAPE, NAMELY, NON-INVASIVE SURGICAL BANDAGE FOR USE IN PRE-OPERATIVE SKIN EXPANSION (U.S. CLS. 6, 18, 44, 46, 51 AND 52).

FIRST USE 8-29-2006; IN COMMERCE 8-29-2006.

3,299,596. INFO MARKETING GROUP INC., SANTA MONICA, CA. SN 78-762,661. PUB. 8-15-2006, FILED 11-29-2005.

Natural Health

PHARMACEUTICALS

NO CLAIM IS MADE TO THE EXCLUSIVE RIGHT TO USE NATURAL HEALTH AND PHARMACEUTICALS, APART FROM THE MARK AS SHOWN.

THE MARK CONSISTS OF WORDS SEPARATED BY LINE AND LEAF.

FOR PHARMACEUTICALS FOR APPETITE SUPPRESSION, DIET, AND WEIGHT LOSS (U.S. CLS. 6, 18, 44, 46, 51 AND 52).

FIRST USE 1-17-2007; IN COMMERCE 1-17-2007.

CLASS 5—(Continued).

3,299,670. BAYER HEALTHCARE LLC, PITTSBURGH, PA.
SN 78-778,794. PUB. 7-25-2006, FILED 12-21-2005.

BREEZE

THE MARK CONSISTS OF STANDARD CHARACTERS WITHOUT CLAIM TO ANY PARTICULAR FONT, STYLE, SIZE, OR COLOR.

OWNER OF U.S. REG. NO. 2,815,718.

FOR MEDICAL DIAGNOSTIC REAGENTS FOR THE ANALYSIS OF BODY FLUIDS (U.S. CLS. 6, 18, 44, 46, 51 AND 52).

FIRST USE 12-22-2006; IN COMMERCE 12-22-2006.

3,299,698. NDS NUTRITIONAL PRODUCTS, INC., LAVISTA, NE. SN 78-787,859. PUB. 10-10-2006, FILED 1-9-2006.

Omega Cuts

THE MARK CONSISTS OF STANDARD CHARACTERS WITHOUT CLAIM TO ANY PARTICULAR FONT, STYLE, SIZE, OR COLOR.

NO CLAIM IS MADE TO THE EXCLUSIVE RIGHT TO USE "OMEGA", APART FROM THE MARK AS SHOWN.

FOR NUTRITIONAL AND DIETARY SUPPLEMENTS (U.S. CLS. 6, 18, 44, 46, 51 AND 52).

FIRST USE 1-13-2006; IN COMMERCE 1-13-2006.

3,299,716. RIDLEY U.S. HOLDINGS, INC., MANKATO, MN. SN 78-791,203. PUB. 8-8-2006, FILED 1-13-2006.

WEATHERALL

THE MARK CONSISTS OF STANDARD CHARACTERS WITHOUT CLAIM TO ANY PARTICULAR FONT, STYLE, SIZE, OR COLOR.

FOR ANIMAL FEED SUPPLEMENTS, NAMELY WEATHER RESISTANT MINERAL SUPPLEMENTS FOR LIVESTOCK (U.S. CLS. 6, 18, 44, 46, 51 AND 52).

FIRST USE 2-19-2007; IN COMMERCE 2-19-2007.

CLASS 5—(Continued).

3,299,735. GAIA HERBS, INC., BREVARD, NC. SN 78-795,814. PUB. 9-26-2006, FILED 1-20-2006.

QUICK DEFENSE

THE MARK CONSISTS OF STANDARD CHARACTERS WITHOUT CLAIM TO ANY PARTICULAR FONT, STYLE, SIZE, OR COLOR.

FOR HERBAL, NUTRITIONAL AND DIETARY SUPPLEMENTS (U.S. CLS. 6, 18, 44, 46, 51 AND 52).

FIRST USE 9-1-2006; IN COMMERCE 9-1-2006.

3,299,756. CREATION'S GARDEN NATURAL PRODUCTS, INC., VALENCIA, CA. SN 78-802,252. PUB. 1-16-2007, FILED 1-30-2006.



THE COLOR(S) RED AND GRAY IS/ARE CLAIMED AS A FEATURE OF THE MARK.

THE COLOR RED IS PART OF THE LETTER R AND THE COLOR GRAY IS IN THE REMAINDER OF THE WORD CHOLESTACOR WITH ONLY PART OF THE LETTER R APPEARING IN GRAY.

FOR DIETARY SUPPLEMENTS, MEAL REPLACEMENT DRINKS; MEAL REPLACEMENT AND DIETARY SUPPLEMENT DRINK MIXES; MEAL REPLACEMENT POWDERS; AND DIETARY MEAL REPLACEMENT BARS; MINERAL SUPPLEMENTS NUTRITIONAL ADDITIVES FOR USE IN FOODS; BEVERAGES, AND NUTRACEUTICALS FOR USE AS A DIETARY SUPPLEMENT (U.S. CLS. 6, 18, 44, 46, 51 AND 52).

FIRST USE 5-1-2005; IN COMMERCE 5-1-2006.

3,299,761. AMERICAN LABORATORIES, INC., OMAHA, NE. SN 78-804,403. PUB. 9-26-2006, FILED 2-1-2006.

AMERI-FLEX

THE MARK CONSISTS OF STANDARD CHARACTERS WITHOUT CLAIM TO ANY PARTICULAR FONT, STYLE, SIZE, OR COLOR.

FOR DIETARY SUPPLEMENTS (U.S. CLS. 6, 18, 44, 46, 51 AND 52).

FIRST USE 11-9-2005; IN COMMERCE 4-28-2006.

CLASS 5—(Continued).

3,299,795. WESTERN HOLDINGS, LLC, CHEYENNE, WY.
SN 78-816,316. PUB. 9-12-2006, FILED 2-16-2006.

OSTEOVAL CARBONATE FORTE

THE MARK CONSISTS OF STANDARD CHARACTERS WITHOUT CLAIM TO ANY PARTICULAR FONT, STYLE, SIZE, OR COLOR.

NO CLAIM IS MADE TO THE EXCLUSIVE RIGHT TO USE "CARBONATE", APART FROM THE MARK AS SHOWN.

FOR DIETARY SUPPLEMENTS (U.S. CLS. 6, 18, 44, 46, 51 AND 52).

FIRST USE 3-31-2006; IN COMMERCE 3-31-2006.

CLASS 5—(Continued).

3,299,850. JAMSHIDI, ANITA, GREAT FALLS, VA. SN 78-836,380. PUB. 10-24-2006, FILED 3-14-2006.

UTTERLY YOURS

THE MARK CONSISTS OF STANDARD CHARACTERS WITHOUT CLAIM TO ANY PARTICULAR FONT, STYLE, SIZE, OR COLOR.

OWNER OF U.S. REG. NO. 3,020,882.
FOR BREAST-NURSING PADS (U.S. CLS. 6, 18, 44, 46, 51 AND 52).

FIRST USE 3-31-2006; IN COMMERCE 3-31-2006.

3,299,804. JAZZ PHARMACEUTICALS, INC., PALO ALTO, CA. SN 78-818,704. PUB. 8-1-2006, FILED 2-20-2006.

WAKE UP TO THE DIFFERENCE

THE MARK CONSISTS OF STANDARD CHARACTERS WITHOUT CLAIM TO ANY PARTICULAR FONT, STYLE, SIZE, OR COLOR.

FOR PHARMACEUTICAL PREPARATIONS FOR USE IN THE TREATMENT OF SLEEP DISORDERS; PHARMACEUTICAL PREPARATIONS FOR THE TREATMENT OF DISEASES OF THE CENTRAL NERVOUS SYSTEM AND A VARIETY OF CONDITIONS, SYMPTOMS, AND DISEASES, NAMELY, NARCOLEPSY, FIBROMYALGIA, INSOMNIA AND MYOSITIS (U.S. CLS. 6, 18, 44, 46, 51 AND 52).

FIRST USE 3-6-2006; IN COMMERCE 3-6-2006.

3,299,868. GAIA HERBS, INC., BREVARD, NC. SN 78-841,263. PUB. 10-10-2006, FILED 3-20-2006.

RESPIRATORY DEFENSE

THE MARK CONSISTS OF STANDARD CHARACTERS WITHOUT CLAIM TO ANY PARTICULAR FONT, STYLE, SIZE, OR COLOR.

NO CLAIM IS MADE TO THE EXCLUSIVE RIGHT TO USE "RESPIRATORY", APART FROM THE MARK AS SHOWN.

FOR HERBAL, NUTRITIONAL AND DIETARY SUPPLEMENTS (U.S. CLS. 6, 18, 44, 46, 51 AND 52).

FIRST USE 5-31-2006; IN COMMERCE 5-31-2006.

3,299,833. GAIA HERBS, INC., BREVARD, NC. SN 78-828,649. PUB. 9-12-2006, FILED 3-3-2006.

MAITAKE DEFENSE

THE MARK CONSISTS OF STANDARD CHARACTERS WITHOUT CLAIM TO ANY PARTICULAR FONT, STYLE, SIZE, OR COLOR.

NO CLAIM IS MADE TO THE EXCLUSIVE RIGHT TO USE "MAITAKE", APART FROM THE MARK AS SHOWN.

FOR HERBAL, NUTRITIONAL AND DIETARY SUPPLEMENTS CONTAINING MAITAKE (U.S. CLS. 6, 18, 44, 46, 51 AND 52).

FIRST USE 9-1-2006; IN COMMERCE 9-1-2006.

3,299,869. MARTEK BIOSCIENCES CORPORATION, COLUMBIA, MD. SN 78-841,713. PUB. 10-24-2006, FILED 3-20-2006.

GORMACKISIN

THE MARK CONSISTS OF STANDARD CHARACTERS WITHOUT CLAIM TO ANY PARTICULAR FONT, STYLE, SIZE, OR COLOR.

FOR PHARMACEUTICAL PRODUCTS AND PREPARATIONS FOR THE TREATMENT OF INFLAMMATION AND DISEASES RELATED TO INFLAMMATION (U.S. CLS. 6, 18, 44, 46, 51 AND 52).

FIRST USE 12-18-2006; IN COMMERCE 12-18-2006.

CLASS 5—(Continued).

3,299,871. DERMAVANCE PHARMACEUTICAL INC., MALVERN, PA. SN 78-844,660. PUB. 11-7-2006, FILED 3-23-2006.

Vivelif

THE MARK CONSISTS OF STANDARD CHARACTERS WITHOUT CLAIM TO ANY PARTICULAR FONT, STYLE, SIZE, OR COLOR.
FOR PHARMACEUTICAL PREPARATIONS FOR USE IN DERMATOLOGY (U.S. CLS. 6, 18, 44, 46, 51 AND 52).
FIRST USE 6-13-2006; IN COMMERCE 9-19-2006.

3,299,873. JMM LLC, 342 DYER AVE, RI. SN 78-845,088. PUB. 11-14-2006, FILED 3-24-2006.

Durasex

THE MARK CONSISTS OF STANDARD CHARACTERS WITHOUT CLAIM TO ANY PARTICULAR FONT, STYLE, SIZE, OR COLOR.
FOR HERBAL SUPPLEMENTS (U.S. CLS. 6, 18, 44, 46, 51 AND 52).
FIRST USE 11-17-2004; IN COMMERCE 11-17-2004.

3,299,915. LEADING EDGE MARKETING, INC., NASSAU, NEW PROVIDENCE, BAHAMAS. SN 78-862,972. PUB. 11-21-2006, FILED 4-17-2006.

VigRX Plus

THE MARK CONSISTS OF STANDARD CHARACTERS WITHOUT CLAIM TO ANY PARTICULAR FONT, STYLE, SIZE, OR COLOR.
FOR DIETARY SUPPLEMENTS; HERBAL SUPPLEMENTS; NUTRACEUTICALS FOR USE AS A DIETARY SUPPLEMENT (U.S. CLS. 6, 18, 44, 46, 51 AND 52).
FIRST USE 1-1-2006; IN COMMERCE 3-1-2006.

CLASS 5—(Continued).

3,299,917. OMS INVESTMENTS, INC., LOS ANGELES, CA. SN 78-863,064. PUB. 11-28-2006, FILED 4-17-2006.

TOTALKILL

THE MARK CONSISTS OF STANDARD CHARACTERS WITHOUT CLAIM TO ANY PARTICULAR FONT, STYLE, SIZE, OR COLOR.
FOR INSECTICIDES, PESTICIDES, AND HERBICIDES FOR DOMESTIC USE (U.S. CLS. 6, 18, 44, 46, 51 AND 52).
FIRST USE 3-1-2007; IN COMMERCE 3-1-2007.

3,299,950. BLOCK DRUG COMPANY, INC., WEST TRENTON, NJ. SN 78-874,380. PUB. 11-14-2006, FILED 5-2-2006.

GOODY'S COUNTRY

THE MARK CONSISTS OF STANDARD CHARACTERS WITHOUT CLAIM TO ANY PARTICULAR FONT, STYLE, SIZE, OR COLOR.
OWNER OF U.S. REG. NOS. 527,865, 1,601,822, AND OTHERS.
FOR ANALGESICS (U.S. CLS. 6, 18, 44, 46, 51 AND 52).
FIRST USE 11-30-2005; IN COMMERCE 11-30-2005.

3,300,040. PREVENT PRO PRODUCTS, DBA INVETEK, INC., TUSTIN, CA. SN 78-904,287. PUB. 1-30-2007, FILED 6-8-2006.

MetaFizz

FOR VITAMIN SUPPLEMENTS; MINERAL SUPPLEMENTS; DIETARY SUPPLEMENTS; HERBAL DIETARY SUPPLEMENTS; NUTRACEUTICALS FOR USE AS A DIETARY SUPPLEMENT; AND NUTRITIONALLY FORTIFIED BEVERAGES (U.S. CLS. 6, 18, 44, 46, 51 AND 52).
FIRST USE 0-0-2006; IN COMMERCE 4-24-2007.

CLASS 5—(Continued).

3,300,053. CHOPRA, RAJ K., WESTBURY, NY. SN 78-909,611.
PUB. 1-9-2007, FILED 6-15-2006.

ROBUST-Q

THE MARK CONSISTS OF STANDARD CHARACTERS WITHOUT CLAIM TO ANY PARTICULAR FONT, STYLE, SIZE, OR COLOR.
FOR NUTRITIONAL SUPPLEMENTS (U.S. CLS. 6, 18, 44, 46, 51 AND 52).
FIRST USE 5-2-2007; IN COMMERCE 5-2-2007.

3,300,060. PRIME LIFE FIBERS, INC., DURHAM, NC. SN 78-911,387. PUB. 2-6-2007, FILED 6-19-2006.

PRIME LIFE FIBERS

THE MARK CONSISTS OF STANDARD CHARACTERS WITHOUT CLAIM TO ANY PARTICULAR FONT, STYLE, SIZE, OR COLOR.
NO CLAIM IS MADE TO THE EXCLUSIVE RIGHT TO USE "FIBERS", APART FROM THE MARK AS SHOWN.
FOR INCONTINENCE GARMENTS (U.S. CLS. 6, 18, 44, 46, 51 AND 52).
FIRST USE 5-15-2007; IN COMMERCE 5-15-2007.

3,300,118. ULTIMATE FORMULATIONS, INC., CITY OF INDUSTRY, CA. SN 78-927,831. PUB. 2-13-2007, FILED 7-12-2006.

Q-Best

THE MARK CONSISTS OF STANDARD CHARACTERS WITHOUT CLAIM TO ANY PARTICULAR FONT, STYLE, SIZE, OR COLOR.
FOR VITAMINS, ENZYMES FOR DIETARY SUPPLEMENT USE, HERBAL SUPPLEMENTS, HEALTH FOOD SUPPLEMENTS, NUTRITIONAL SUPPLEMENTS (U.S. CLS. 6, 18, 44, 46, 51 AND 52).
FIRST USE 3-12-2007; IN COMMERCE 3-12-2007.

CLASS 5—(Continued).

3,300,125. LEE, YONG H., NORTHRIDGE, CA. SN 78-930,695.
PUB. 2-20-2007, FILED 7-17-2006.

BIOTAMIN

THE MARK CONSISTS OF STANDARD CHARACTERS WITHOUT CLAIM TO ANY PARTICULAR FONT, STYLE, SIZE, OR COLOR.
FOR DIET SUPPLEMENT FOR IMPROVED BODY ENERGY AND FUNCTION (U.S. CLS. 6, 18, 44, 46, 51 AND 52).
FIRST USE 1-1-2007; IN COMMERCE 1-1-2007.

3,300,130. GLANBIA PLC, KILKENNY, IRELAND. SN 78-931,715. PUB. 11-21-2006, FILED 7-18-2006.



OWNER OF U.S. REG. NO. 2,077,943.
FOR WHEY PROTEIN AND PEPTIDES FOR USE AS A NUTRITIONAL INGREDIENT IN FOOD AND DIETARY SUPPLEMENTS (U.S. CLS. 6, 18, 44, 46, 51 AND 52).
FIRST USE 10-31-2006; IN COMMERCE 10-31-2006.

3,300,144. ARISTA NUTRACEUTICALS, INC., FALLON, NV. SN 78-938,525. PUB. 3-13-2007, FILED 7-27-2006.

CARDIO GOLD

THE MARK CONSISTS OF STANDARD CHARACTERS WITHOUT CLAIM TO ANY PARTICULAR FONT, STYLE, SIZE, OR COLOR.
NO CLAIM IS MADE TO THE EXCLUSIVE RIGHT TO USE "CARDIO", APART FROM THE MARK AS SHOWN.
FOR DIETARY AND NUTRITIONAL SUPPLEMENTS (U.S. CLS. 6, 18, 44, 46, 51 AND 52).
FIRST USE 11-2-2006; IN COMMERCE 11-2-2006.

CLASS 5—(Continued).

3,300,160. NATURAL ORGANICS INC., MELVILLE, NY. SN 78-945,011. PUB. 2-13-2007, FILED 8-4-2006.

ULTRA SKINNY MINI COUNTDOWN

THE MARK CONSISTS OF STANDARD CHARACTERS WITHOUT CLAIM TO ANY PARTICULAR FONT, STYLE, SIZE, OR COLOR.

OWNER OF U.S. REG. NO. 2,942,717. FOR DIETARY SUPPLEMENT (U.S. CLS. 6, 18, 44, 46, 51 AND 52). FIRST USE 7-31-2006; IN COMMERCE 10-9-2006.

CLASS 5—(Continued).

3,300,194. BRITEAGE CORPORATION, LAGUNA HILLS, CA. SN 78-969,587. PUB. 1-16-2007, FILED 9-7-2006.

BriteSHIELD

THE MARK CONSISTS OF STANDARD CHARACTERS WITHOUT CLAIM TO ANY PARTICULAR FONT, STYLE, SIZE, OR COLOR.

FOR NUTRITIONAL SUPPLEMENTS (U.S. CLS. 6, 18, 44, 46, 51 AND 52). FIRST USE 7-1-2006; IN COMMERCE 11-1-2006.

3,300,176. LEE, YONG H., NORTHRIDGE, CA. SN 78-955,905. PUB. 2-20-2007, FILED 8-19-2006.

CURINE

THE MARK CONSISTS OF STANDARD CHARACTERS WITHOUT CLAIM TO ANY PARTICULAR FONT, STYLE, SIZE, OR COLOR.

FOR DIETARY SUPPLEMENT TO HELP RELIEVE DISORDERS OF THE KIDNEYS AND UTERUS (U.S. CLS. 6, 18, 44, 46, 51 AND 52). FIRST USE 1-1-2007; IN COMMERCE 1-1-2007.

3,300,196. BRITEAGE CORPORATION, LAGUNA HILLS, CA. SN 78-970,650. PUB. 1-16-2007, FILED 9-8-2006.

BriteSMART

3,300,183. VITAMIN SHOPPE INDUSTRIES INC., NORTH BERGEN, NJ. SN 78-959,324. PUB. 3-6-2007, FILED 8-24-2006.

PRO-PUDDING

THE MARK CONSISTS OF STANDARD CHARACTERS WITHOUT CLAIM TO ANY PARTICULAR FONT, STYLE, SIZE, OR COLOR.

FOR VITAMIN, DIETARY AND NUTRITIONAL SUPPLEMENTS, NAMELY, A PROTEIN POWDER PUDDING MIX (U.S. CLS. 6, 18, 44, 46, 51 AND 52). FIRST USE 4-30-2006; IN COMMERCE 4-30-2006.

THE MARK CONSISTS OF STYLIZED TEXT OF THE WORDING BRITESMART.

FOR NUTRITIONAL SUPPLEMENTS (U.S. CLS. 6, 18, 44, 46, 51 AND 52). FIRST USE 7-1-2006; IN COMMERCE 11-1-2006.

CLASS 5—(Continued).

3,300,217. ALEXION PHARMACEUTICALS, INC., CHESTER, CT. SN 78-978,719. PUB. 12-13-2005, FILED 3-18-2005.

SOLIRIS

THE MARK CONSISTS OF STANDARD CHARACTERS WITHOUT CLAIM TO ANY PARTICULAR FONT, STYLE, SIZE, OR COLOR.

FOR PHARMACEUTICAL AND MEDICINAL PREPARATIONS AND SUBSTANCES FOR USE IN THE TREATMENT OF HEMATOLOGICAL DISEASES AND DISORDERS (U.S. CLS. 6, 18, 44, 46, 51 AND 52).
FIRST USE 3-16-2007; IN COMMERCE 4-2-2007.

3,300,229. NEREUS PHARMACEUTICALS, INC., SAN DIEGO, CA. SN 78-978,802. PUB. 10-4-2005, FILED 11-23-2004.



FOR PHARMACEUTICAL PREPARATIONS FOR THE TREATMENT OF CANCER (U.S. CLS. 6, 18, 44, 46, 51 AND 52).

FIRST USE 5-8-2006; IN COMMERCE 5-8-2006.

CLASS 6—METAL GOODS**CLASS 6—(Continued).**

3,298,445. INTERLINE BRANDS, INC., JACKSONVILLE, FL. SN 76-540,309. PUB. 6-8-2004, FILED 8-26-2003.

**WHEN IT COMES TO
KEEPING CRITTERS OUT OF
CHIMNEYS, WE'RE
ANIMALS!**

FOR METAL CHIMNEY CAPS (U.S. CLS. 2, 12, 13, 14, 23, 25 AND 50).
FIRST USE 12-3-2005; IN COMMERCE 12-31-2006.

3,298,577. SIDMAS INCORPORATED, IRVINE, CA. SN 76-654,967. PUB. 10-24-2006, FILED 2-13-2006.

RETRO-STUD

THE MARK CONSISTS OF STANDARD CHARACTERS WITHOUT CLAIM TO ANY PARTICULAR FONT, STYLE, SIZE, OR COLOR.

FOR METAL HOLLOW WALL FASTENERS AND FASTENING ANCHORS (U.S. CLS. 2, 12, 13, 14, 23, 25 AND 50).

FIRST USE 8-20-2006; IN COMMERCE 8-20-2006.

3,298,593. WASHERS, INC., DBA ALPHA STAMPING COMPANY, LIVONIA, MI. SN 76-659,624. PUB. 10-17-2006, FILED 5-5-2006.

VALULOK

THE MARK CONSISTS OF STANDARD CHARACTERS WITHOUT CLAIM TO ANY PARTICULAR FONT, STYLE, SIZE, OR COLOR.

FOR METAL FASTENERS, NAMELY CLUSTERS OF NUTS AND BOLTS (U.S. CLS. 2, 12, 13, 14, 23, 25 AND 50).

FIRST USE 3-5-2007; IN COMMERCE 3-5-2007.

CLASS 6—(Continued).

3,298,625. PRIMESOURCE BUILDING PRODUCTS, INC., CARROLLTON, TX. SN 77-027,688. PUB. 3-20-2007, FILED 10-24-2006.

CLASS 6—(Continued).

3,298,775. PERMAR SYSTEMS, INC., WOLCOTT, NY. SN 78-436,783. PUB. 10-18-2005, FILED 6-17-2004.



Post Blazers

THE MARK CONSISTS OF STANDARD CHARACTERS WITHOUT CLAIM TO ANY PARTICULAR FONT, STYLE, SIZE, OR COLOR.
FOR NON-LUMINOUS, NON-MECHANICAL METAL SIGNS (U.S. CLS. 2, 12, 13, 14, 23, 25 AND 50).
FIRST USE 2-26-2007; IN COMMERCE 2-26-2007.

OWNER OF U.S. REG. NOS. 2,953,644, 2,953,709, AND 3,032,141.
FOR METAL CORNER BEAD FOR USE IN BUILDING CONSTRUCTION (U.S. CLS. 2, 12, 13, 14, 23, 25 AND 50).
FIRST USE 2-1-2007; IN COMMERCE 2-1-2007.

3,298,913. CTB IP, INC., WILMINGTON, DE. SN 78-549,429. PUB. 10-25-2005, FILED 1-18-2005.

FULL SWEEP

THE MARK CONSISTS OF STANDARD CHARACTERS WITHOUT CLAIM TO ANY PARTICULAR FONT, STYLE, SIZE, OR COLOR.
FOR METAL ANCHOR FOR USE WITH GRAIN BINS (U.S. CLS. 2, 12, 13, 14, 23, 25 AND 50).
FIRST USE 3-3-2007; IN COMMERCE 3-3-2007.

3,298,765. TRUTH HARDWARE CORPORATION, OWATONNA, MN. SN 78-421,793. PUB. 11-28-2006, FILED 5-19-2004.

ENCORE

3,299,046. HUGHES, DAVID R., LITITZ, PA. SN 78-601,869. PUB. 1-3-2006, FILED 4-5-2005.

GARRETT-BUCHANAN

THE MARK CONSISTS OF STANDARD CHARACTERS WITHOUT CLAIM TO ANY PARTICULAR FONT, STYLE, SIZE, OR COLOR.
FOR WINDOW HARDWARE MADE PRIMARILY OF METAL, NAMELY, BRACKETS, TRACKS, LATCHES, LOCKS, KNOBS, HANDLES, HINGES, OPERATORS, AND LEVERSETS, SOLD EXCLUSIVELY TO MANUFACTURERS (U.S. CLS. 2, 12, 13, 14, 23, 25 AND 50).
FIRST USE 3-31-2005; IN COMMERCE 3-31-2005.

THE MARK CONSISTS OF STANDARD CHARACTERS WITHOUT CLAIM TO ANY PARTICULAR FONT, STYLE, SIZE, OR COLOR.
FOR METAL PIGGY BANKS (U.S. CLS. 2, 12, 13, 14, 23, 25 AND 50).
FIRST USE 11-30-2005; IN COMMERCE 11-30-2006.

CLASS 6—(Continued).

3,299,200. TREE ISLAND WIRE (USA), INC., FONTANA, CA. SN 78-664,799. PUB. 11-21-2006, FILED 7-6-2005.

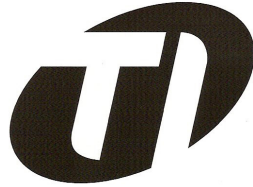

FOR BRIGHT CARBON STEEL WIRE; MERCHANT WIRE; VINEYARD WIRE; NAILS; WELDED WIRE FABRIC; CONSTRUCTION AND FENCING STAPLES; ANNEALED WIRE; AND STRAPPING WIRE (U.S. CLS. 2, 12, 13, 14, 23, 25 AND 50).
FIRST USE 3-17-2006; IN COMMERCE 3-17-2006.

3,299,393. THE STEEL NETWORK, INC., RALEIGH, NC. SN 78-730,497. PUB. 6-13-2006, FILED 10-11-2005.

TightStrap

THE MARK CONSISTS OF STANDARD CHARACTERS WITHOUT CLAIM TO ANY PARTICULAR FONT, STYLE, SIZE, OR COLOR.

FOR CONSTRUCTION ELEMENTS MADE OF METAL, NAMELY, BRACING MEMBERS FOR WALL SECTIONS (U.S. CLS. 2, 12, 13, 14, 23, 25 AND 50).
FIRST USE 5-0-2006; IN COMMERCE 5-0-2006.

3,299,395. CALIFORNIA EXPANDED METAL PRODUCTS COMPANY, DBA CEMCO CORPORATION, CITY OF INDUSTRY, CA. SN 78-730,655. PUB. 7-4-2006, FILED 10-11-2005.

FIRESTIK

THE MARK CONSISTS OF STANDARD CHARACTERS WITHOUT CLAIM TO ANY PARTICULAR FONT, STYLE, SIZE, OR COLOR.

FOR METAL BUILDING MATERIALS FOR BUILDING CONSTRUCTION, NAMELY, STEEL FRAMING WITH INTUMESCENT STRIPS SOLD AS A UNIT (U.S. CLS. 2, 12, 13, 14, 23, 25 AND 50).
FIRST USE 8-3-2006; IN COMMERCE 8-3-2006.

CLASS 6—(Continued).

3,299,398. CALIFORNIA EXPANDED METAL PRODUCTS COMPANY, DBA CEMCO CORPORATION, CITY OF INDUSTRY, CA. SN 78-731,184. PUB. 7-4-2006, FILED 10-11-2005.



FOR METAL BUILDING MATERIALS FOR BUILDING CONSTRUCTION, NAMELY, STEEL FRAMING WITH INTUMESCENT STRIPS SOLD AS A UNIT (U.S. CLS. 2, 12, 13, 14, 23, 25 AND 50).
FIRST USE 8-3-2006; IN COMMERCE 8-3-2006.

3,299,404. C&W DESIGN, LLC, PITTSBURGH, PA. SN 78-732,719. PUB. 7-4-2006, FILED 10-13-2005.

THE PURSE ESCORT

THE MARK CONSISTS OF STANDARD CHARACTERS WITHOUT CLAIM TO ANY PARTICULAR FONT, STYLE, SIZE, OR COLOR.

NO CLAIM IS MADE TO THE EXCLUSIVE RIGHT TO USE "PURSE", APART FROM THE MARK AS SHOWN.

FOR DECORATIVE METAL HOOK DESIGNED TO ATTACH TO A TABLE, FOR THE PURPOSE OF HANGING PURSES, HANDBAGS, SCARVES, HATS, AND SHOPPING BAGS NEXT TO THE USER (U.S. CLS. 2, 12, 13, 14, 23, 25 AND 50).
FIRST USE 9-1-2006; IN COMMERCE 9-1-2006.

CLASS 6—(Continued).

3,299,456. EVERETT, PERRY L., LAKE OSWEGO, OR. AND GOLDEN, THAYNE J., LAKE OSWEGO, OR. SN 78-738,161. PUB. 10-3-2006, FILED 10-21-2005.

CLASS 6—(Continued).

3,299,867. EATON CORPORATION, CLEVELAND, OH. SN 78-841,163. PUB. 10-24-2006, FILED 3-20-2006.

LINE BOSS

THE MARK CONSISTS OF STANDARD CHARACTERS WITHOUT CLAIM TO ANY PARTICULAR FONT, STYLE, SIZE, OR COLOR.

FOR METAL CLAMPING AND UNCLAMPING LOCKING MECHANISM FOR ROPES, NAMELY, FOR MOUNTAINEERING (U.S. CLS. 2, 12, 13, 14, 23, 25 AND 50).

FIRST USE 11-9-2006; IN COMMERCE 11-9-2006.

SURE-MATE

THE MARK CONSISTS OF STANDARD CHARACTERS WITHOUT CLAIM TO ANY PARTICULAR FONT, STYLE, SIZE, OR COLOR.

FOR METAL COUPLING FOR HYDRAULIC FLUID PIPES AND LINES (U.S. CLS. 2, 12, 13, 14, 23, 25 AND 50).

FIRST USE 2-21-2007; IN COMMERCE 2-21-2007.

3,299,660. JIAN SHUN KING TRADING CO., LTD., TAINAN CITY, TAIWAN. SN 78-775,603. PUB. 10-10-2006, FILED 12-17-2005.

COMFO

THE MARK CONSISTS OF STANDARD CHARACTERS WITHOUT CLAIM TO ANY PARTICULAR FONT, STYLE, SIZE, OR COLOR.

FOR METAL SAFES; SAFE DEPOSIT BOXES; METAL FIRE RESISTANT SAFES (U.S. CLS. 2, 12, 13, 14, 23, 25 AND 50).

FIRST USE 7-25-2006; IN COMMERCE 12-7-2006.

3,299,908. QUALITY EDGE, INC., MIDDLETOWN, OH. SN 78-858,852. PUB. 11-21-2006, FILED 4-11-2006.

GUARDIAN PLUS

THE MARK CONSISTS OF STANDARD CHARACTERS WITHOUT CLAIM TO ANY PARTICULAR FONT, STYLE, SIZE, OR COLOR.

OWNER OF U.S. REG. NO. 2,824,056.
FOR METAL GUTTER GUARDS (U.S. CLS. 2, 12, 13, 14, 23, 25 AND 50).

FIRST USE 10-0-2006; IN COMMERCE 10-0-2006.

3,299,811. UNITED GENERAL SUPPLY CO., INC., HOUSTON, TX. SN 78-820,029. PUB. 8-1-2006, FILED 2-21-2006.

TEXAN STUFF

THE MARK CONSISTS OF STANDARD CHARACTERS WITHOUT CLAIM TO ANY PARTICULAR FONT, STYLE, SIZE, OR COLOR.

NO CLAIM IS MADE TO THE EXCLUSIVE RIGHT TO USE "TEXAN", APART FROM THE MARK AS SHOWN.

FOR METAL MAIL BOXES; METAL DOOR HARDWARE, NAMELY, KNOBS, LOCKS, HANDLES, LEVERS, KNOCKERS; METAL SCULPTURES, METAL DECORATIVE WALL ORNAMENTS; METAL DECORATIVE BOXES; METAL KEY RINGS; METAL ORNAMENTAL WINDMILLS (U.S. CLS. 2, 12, 13, 14, 23, 25 AND 50).

FIRST USE 0-0-2006; IN COMMERCE 0-0-2006.

3,299,923. DRIVES INCORPORATED, FULTON, IL. SN 78-864,478. PUB. 12-12-2006, FILED 4-19-2006.

EXC

THE MARK CONSISTS OF STANDARD CHARACTERS WITHOUT CLAIM TO ANY PARTICULAR FONT, STYLE, SIZE, OR COLOR.

FOR METAL CHAINS FOR USE WITH CONVEYORS (U.S. CLS. 2, 12, 13, 14, 23, 25 AND 50).

FIRST USE 3-22-2006; IN COMMERCE 3-22-2006.

CLASS 6—(Continued).

3,300,076. ASPEN PET PRODUCTS, INC., DENVER, CO. SN 78-915,987. PUB. 12-26-2006, FILED 6-23-2006.

STAY!

THE MARK CONSISTS OF STANDARD CHARACTERS WITHOUT CLAIM TO ANY PARTICULAR FONT, STYLE, SIZE, OR COLOR.

FOR METAL CLASPS FOR ANIMAL TIE-OUT STAKE (U.S. CLS. 2, 12, 13, 14, 23, 25 AND 50).
FIRST USE 9-29-2006; IN COMMERCE 9-29-2006.

3,300,121. PACIFIC COAST WIRE ROPE & FITTINGS, INC., DBA FEENEY WIRE ROPE & RIGGING, OAKLAND, CA. SN 78-928,723. PUB. 2-27-2007, FILED 7-13-2006.

SOMERSET

THE MARK CONSISTS OF STANDARD CHARACTERS WITHOUT CLAIM TO ANY PARTICULAR FONT, STYLE, SIZE, OR COLOR.

FOR SUPPORTS FOR CLIMBING PLANTS, VEGETABLE PLANTS, AND GARDEN PLANTS MADE OF METAL (U.S. CLS. 2, 12, 13, 14, 23, 25 AND 50).
FIRST USE 9-1-2006; IN COMMERCE 9-1-2006.

3,300,182. PEERLESS INDUSTRIES, INC., MELROSE PARK, IL. SN 78-957,684. PUB. 3-13-2007, FILED 8-22-2006.

Return-to-Zero

THE MARK CONSISTS OF STANDARD CHARACTERS WITHOUT CLAIM TO ANY PARTICULAR FONT, STYLE, SIZE, OR COLOR.

FOR METAL SWIVEL MECHANISM SOLD AS A COMPONENT PART OF METAL AUDIO, VIDEO AND COMPUTER WALL AND CEILING MOUNTS (U.S. CLS. 2, 12, 13, 14, 23, 25 AND 50).
FIRST USE 5-17-2006; IN COMMERCE 5-17-2006.

CLASS 7—MACHINERY**CLASS 7—(Continued).**

3,298,413. TOYO ROSHI KABUSHIKI KAISHA, CHUO-KU, TOKYO, 103-0023, JAPAN. SN 76-320,656. PUB. 8-8-2006, FILED 10-3-2001.

ADVANTEC

OWNER OF U.S. REG. NOS. 1,605,195, 2,220,960, AND OTHERS.

FOR STIRRING MACHINES FOR INDUSTRIAL USE; FILTERING MACHINES AND FILTERS BEING PART OF MACHINES FOR INDUSTRIAL USE IN THE FIELD OF CHEMICAL MANUFACTURING, SEMICONDUCTORS, BEVERAGES AND FOODS (U.S. CLS. 13, 19, 21, 23, 31, 34 AND 35).
FIRST USE 9-9-2004; IN COMMERCE 9-9-2004.

3,298,434. FAIRLANE PRODUCTS INC., FRASER, MI. SN 76-486,437. PUB. 11-11-2003, FILED 1-28-2003.

ACCU-THRUST

FOR HOLDING DEVICE, NAMELY, THRUST SCREWS, FOR HOLDING PRODUCTS FOR MACHINING AND ASSEMBLY (U.S. CLS. 13, 19, 21, 23, 31, 34 AND 35).

FIRST USE 4-22-2003; IN COMMERCE 4-22-2003.

3,298,452. IRONMAN MACHINE INC., CHANHASSEN, MN. SN 76-554,021. PUB. 6-20-2006, FILED 10-6-2003.

ROOF RAPTOR

NO CLAIM IS MADE TO THE EXCLUSIVE RIGHT TO USE "ROOF", APART FROM THE MARK AS SHOWN.

FOR ROOFING TEAR-OFF MACHINES (U.S. CLS. 13, 19, 21, 23, 31, 34 AND 35).
FIRST USE 2-28-2004; IN COMMERCE 2-28-2004.

CLASS 7—(Continued).

3,298,467. AUTOMATE TECHNOLOGIES LLC, RIVERHEAD, NY. SN 76-602,564. PUB. 7-11-2006, FILED 7-16-2004.



OWNER OF U.S. REG. NOS. 2,214,088 AND 2,215,978.
NO CLAIM IS MADE TO THE EXCLUSIVE RIGHT TO USE "SMART SEAL", APART FROM THE MARK AS SHOWN.

SEC. 2(F) AUTOMATE.
FOR HEAT SEALING MACHINES FOR INDUSTRIAL USE TO APPLY METAL FOIL SAFETY SEALS TO BOTTLES, JARS AND OTHER RECEPTACLES THAT CAN BE SEALED BY HEAT INDUCTION (U.S. CLS. 13, 19, 21, 23, 31, 34 AND 35).

FIRST USE 8-1-2003; IN COMMERCE 8-1-2003.

3,298,473. LINTEC KABUSHIKI KAISHA, TA LINTEC CORPORATION, ITABASHI-KU, TOKYO, JAPAN. SN 76-606,455. PUB. 7-5-2005, FILED 8-11-2004.

L-VIS

THE MARK CONSISTS OF STANDARD CHARACTERS WITHOUT CLAIM TO ANY PARTICULAR FONT, STYLE, SIZE, OR COLOR.

FOR PRINTER-EQUIPPED LABELING MACHINES (U.S. CLS. 13, 19, 21, 23, 31, 34 AND 35).

FIRST USE 1-16-2004; IN COMMERCE 8-29-2006.

CLASS 7—(Continued).

3,298,527. LEAR BAYLOR, INC., GARDEN GROVE, CA. SN 76-637,806. PUB. 1-24-2006, FILED 5-4-2005.

LECTRIC

THE MARK CONSISTS OF STANDARD CHARACTERS WITHOUT CLAIM TO ANY PARTICULAR FONT, STYLE, SIZE, OR COLOR.

FOR ELECTRIC PROPULSION SYSTEM COMPRISED OF AN ELECTRIC MOTOR AND CONTROLLER FOR WATERCRAFT (U.S. CLS. 13, 19, 21, 23, 31, 34 AND 35).
FIRST USE 10-23-2006; IN COMMERCE 10-23-2006.

3,298,541. THE E. H. WACHS COMPANY, WHEELING, IL. SN 76-643,285. PUB. 8-1-2006, FILED 7-21-2005.

WAVE

THE MARK CONSISTS OF STANDARD CHARACTERS WITHOUT CLAIM TO ANY PARTICULAR FONT, STYLE, SIZE, OR COLOR.

FOR AUTOMATED VALVE TURNING EQUIPMENT, NAMELY, VALVE TURNING MACHINES FOR USE BY A WATER SYSTEM (U.S. CLS. 13, 19, 21, 23, 31, 34 AND 35).

FIRST USE 7-28-2005; IN COMMERCE 7-28-2005.

3,298,564. WEDGELOCK EQUIPMENT LIMITED, UPPER HUTT, NEW ZEALAND. SN 76-649,139. PUB. 6-27-2006, FILED 10-25-2005.

WEDGELOCK

THE MARK CONSISTS OF STANDARD CHARACTERS WITHOUT CLAIM TO ANY PARTICULAR FONT, STYLE, SIZE, OR COLOR.

FOR HITCHES FOR EARTH MOVING EQUIPMENT ENABLING FITTINGS TO BE ADDED AND REMOVED QUICKLY; EARTH MOVING ATTACHMENTS NAMELY BUCKETS, GRABS, CLAMPS (U.S. CLS. 13, 19, 21, 23, 31, 34 AND 35).

FIRST USE 4-0-1994; IN COMMERCE 10-0-2006.

CLASS 7—(Continued).

3,298,606. CHURCH & DWIGHT COMPANY, GREEN RIVER, WY. SN 76-978,591. PUB. 1-24-2006, FILED 4-15-2005.

ARM & HAMMER

THE MARK CONSISTS OF STANDARD CHARACTERS WITHOUT CLAIM TO ANY PARTICULAR FONT, STYLE, SIZE, OR COLOR.

OWNER OF U.S. REG. NOS. 930,654, 2,678,903, AND OTHERS.

FOR VACUUM CLEANER BAGS, FILTERS FOR VACUUM CLEANERS (U.S. CLS. 13, 19, 21, 23, 31, 34 AND 35).

FIRST USE 8-17-2005; IN COMMERCE 8-17-2005.

3,298,609. SPP HOLDING CORPORATION, WEST CHICAGO, IL. SN 77-004,356. PUB. 3-13-2007, FILED 9-21-2006.

Klean-A-Tron

THE MARK CONSISTS OF STANDARD CHARACTERS WITHOUT CLAIM TO ANY PARTICULAR FONT, STYLE, SIZE, OR COLOR.

FOR SWIMMING POOL SWEEPERS (U.S. CLS. 13, 19, 21, 23, 31, 34 AND 35).

FIRST USE 3-16-2007; IN COMMERCE 3-16-2007.

3,298,623. AUBURN CONSOLIDATED INDUSTRIES, INC., AUBURN, NE. SN 77-024,283. PUB. 2-6-2007, FILED 10-18-2006.

A RIDE LIKE NO OTHER.

THE MARK CONSISTS OF STANDARD CHARACTERS WITHOUT CLAIM TO ANY PARTICULAR FONT, STYLE, SIZE, OR COLOR.

FOR LAWN MOWERS (U.S. CLS. 13, 19, 21, 23, 31, 34 AND 35).

FIRST USE 1-24-2007; IN COMMERCE 1-24-2007.

CLASS 7—(Continued).

3,298,633. HALLIBURTON ENERGY SERVICES, INC., CARROLLTON, TX. SN 77-039,380. PUB. 2-20-2007, FILED 11-8-2006.

QUADPACK

THE MARK CONSISTS OF STANDARD CHARACTERS WITHOUT CLAIM TO ANY PARTICULAR FONT, STYLE, SIZE, OR COLOR.

FOR EARTH BORING EQUIPMENT, NAMELY, DRILL BITS, CORING BITS, AND REPLACEMENT PARTS THEREFOR (U.S. CLS. 13, 19, 21, 23, 31, 34 AND 35).

FIRST USE 11-30-2006; IN COMMERCE 11-30-2006.

3,298,667. M & M MACHINERY SALES, LLC, GASTONIA, NC. SN 78-224,844. PUB. 6-22-2004, FILED 3-12-2003.

METRAFEED

FOR TEXTILE MACHINERY, NAMELY, CARD FEEDERS (U.S. CLS. 13, 19, 21, 23, 31, 34 AND 35).

FIRST USE 2-20-2007; IN COMMERCE 2-20-2007.

3,298,697. VALIANT CORPORATION, WINDSOR, ONTARIO, CANADA. SN 78-310,182. PUB. 1-18-2005, FILED 10-7-2003.

VALU-FLEX

FOR FRAMING MACHINE FOR USE IN THE MANUFACTURE OF AUTOMOTIVE VEHICLES WHICH HOLDS AUTOMOTIVE BODY COMPONENT PARTS AT PREDETERMINED POSITIONS PRIOR TO SECURING THE COMPONENTS (U.S. CLS. 13, 19, 21, 23, 31, 34 AND 35).

FIRST USE 1-16-1995; IN COMMERCE 1-16-1995.

3,298,698. VALIANT CORPORATION, WINDSOR, ONTARIO, CANADA. SN 78-310,198. PUB. 1-18-2005, FILED 10-7-2003.

GEO-POD

FOR FRAMING MACHINE FOR USE IN THE MANUFACTURE OF AUTOMOTIVE VEHICLES WHICH HOLDS AUTOMOTIVE BODY COMPONENT PARTS AT PREDETERMINED POSITIONS PRIOR TO SECURING THE COMPONENTS (U.S. CLS. 13, 19, 21, 23, 31, 34 AND 35).

FIRST USE 12-20-2006; IN COMMERCE 12-20-2006.

CLASS 7—(Continued).

3,298,733. DADCO, INC., PLYMOUTH, MI. SN 78-375,224. PUB. 11-30-2004, FILED 2-27-2004.

ULTRAPAK

THE MARK CONSISTS OF STANDARD CHARACTERS WITHOUT CLAIM TO ANY PARTICULAR FONT, STYLE, SIZE, OR COLOR.

FOR MACHINE PARTS, NAMELY, SEAL AND BEARING HOUSINGS SOLD AS AN INTEGRAL COMPONENT OF PISTON RODS OF PNEUMATIC CYLINDERS AND SPRINGS WITH COMPRESSED GAS (U.S. CLS. 13, 19, 21, 23, 31, 34 AND 35).

FIRST USE 3-8-2004; IN COMMERCE 3-8-2004.



3,298,739. ATLAS COPCO TOOLS AB, STOCKHOLM, SWEDEN. SN 78-380,051. PUB. 7-12-2005, FILED 3-8-2004.

PULSOR

THE MARK CONSISTS OF STANDARD CHARACTERS WITHOUT CLAIM TO ANY PARTICULAR FONT, STYLE, SIZE, OR COLOR.

FOR POWER TOOLS, NAMELY IMPULSE NUT RUNNERS AND IMPULSE WRENCHES (U.S. CLS. 13, 19, 21, 23, 31, 34 AND 35).

FIRST USE 9-1-2005; IN COMMERCE 9-1-2005.



3,298,831. AB ORWAK, SAVSJO, SWEDEN. SN 78-479,278. PUB. 12-20-2005, FILED 9-7-2004.

LITTLE ELEPHANT

THE MARK CONSISTS OF STANDARD CHARACTERS WITHOUT CLAIM TO ANY PARTICULAR FONT, STYLE, SIZE, OR COLOR.

FOR WASTE COMPACTORS AND BALERS FOR RECYCLING (U.S. CLS. 13, 19, 21, 23, 31, 34 AND 35).

FIRST USE 5-31-2005; IN COMMERCE 11-23-2005.

CLASS 7—(Continued).

3,298,888. FLORACRAFT CORPORATION, LUDINGTON, MI. SN 78-530,615. PUB. 9-6-2005, FILED 12-10-2004.

STYROCUTTER

THE MARK CONSISTS OF STANDARD CHARACTERS WITHOUT CLAIM TO ANY PARTICULAR FONT, STYLE, SIZE, OR COLOR.

FOR ELECTRIC HAND TOOL FOR CUTTING PLASTIC FOAM (U.S. CLS. 13, 19, 21, 23, 31, 34 AND 35).

FIRST USE 2-20-2007; IN COMMERCE 2-20-2007.



3,298,973. HALLIBURTON ENERGY SERVICES, INC., CARROLLTON, TX. SN 78-577,335. PUB. 11-29-2005, FILED 3-1-2005.

Z3

THE MARK CONSISTS OF STANDARD CHARACTERS WITHOUT CLAIM TO ANY PARTICULAR FONT, STYLE, SIZE, OR COLOR.

FOR EARTH BORING EQUIPMENT FOR USE IN OIL AND GAS DRILLING OPERATIONS, NAMELY, DRILL BITS, CORING BITS, HOLE ENLARGEMENT TOOL, AND REAMERS (U.S. CLS. 13, 19, 21, 23, 31, 34 AND 35).

FIRST USE 5-30-2005; IN COMMERCE 5-30-2005.

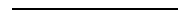

3,299,068. WHITE CAP CONSTRUCTION SUPPLY, INC., COSTA MESA, CA. SN 78-607,719. PUB. 1-10-2006, FILED 4-13-2005.

BLACK MARLIN

THE MARK CONSISTS OF STANDARD CHARACTERS WITHOUT CLAIM TO ANY PARTICULAR FONT, STYLE, SIZE, OR COLOR.

FOR BLADES, CORD, WIRE (U.S. CLS. 13, 19, 21, 23, 31, 34 AND 35).

FIRST USE 4-0-1996; IN COMMERCE 4-0-1996.

CLASS 7—(Continued).

3,299,081. TITAN TOOL, INC., OAKLAND, NJ. SN 78-614,156.
PUB. 1-10-2006, FILED 4-21-2005.

POWRTEX

THE MARK CONSISTS OF STANDARD CHARACTERS WITHOUT CLAIM TO ANY PARTICULAR FONT, STYLE, SIZE, OR COLOR.

FOR POWER OPERATED TEXTURE SPRAYERS (U.S. CLS. 13, 19, 21, 23, 31, 34 AND 35).

FIRST USE 11-17-2006; IN COMMERCE 11-17-2006.

3,299,084. ERMANCO INCORPORATED, SPRING LAKE, MI.
SN 78-614,761. PUB. 1-17-2006, FILED 4-22-2005.

XCELSORT

THE MARK CONSISTS OF STANDARD CHARACTERS WITHOUT CLAIM TO ANY PARTICULAR FONT, STYLE, SIZE, OR COLOR.

FOR CONVEYOR SORTATION MECHANISMS (U.S. CLS. 13, 19, 21, 23, 31, 34 AND 35).

FIRST USE 2-28-2007; IN COMMERCE 2-28-2007.

3,299,116. GLASER, DONALD J., EMPORIA, KS. SN 78-627,430. PUB. 10-10-2006, FILED 5-11-2005.

GraverMach

THE MARK CONSISTS OF STANDARD CHARACTERS WITHOUT CLAIM TO ANY PARTICULAR FONT, STYLE, SIZE, OR COLOR.

FOR ENGRAVING MACHINES, ELECTRIC, PNEUMATIC ENGRAVING TOOLS, AND PARTS THEREOF (U.S. CLS. 13, 19, 21, 23, 31, 34 AND 35).

FIRST USE 9-13-2005; IN COMMERCE 11-18-2005.

CLASS 7—(Continued).

3,299,183. EMERSON ELECTRIC CO., ST. LOUIS, MO. SN 78-659,914. PUB. 9-5-2006, FILED 6-28-2005.

EVOLUTION COMPACT

THE MARK CONSISTS OF STANDARD CHARACTERS WITHOUT CLAIM TO ANY PARTICULAR FONT, STYLE, SIZE, OR COLOR.

NO CLAIM IS MADE TO THE EXCLUSIVE RIGHT TO USE "COMPACT", APART FROM THE MARK AS SHOWN.

FOR FOOD WASTE DISPOSERS, GARBAGE DISPOSALS, AND REPLACEMENT PARTS THEREFOR; SPLASH BAFFLES FOR USE WITH GARBAGE DISPOSALS (U.S. CLS. 13, 19, 21, 23, 31, 34 AND 35).

FIRST USE 5-15-2006; IN COMMERCE 5-15-2006.

3,299,187. STOWE WOODWARD LLC, YOUNGSVILLE, NC.
SN 78-660,699. PUB. 6-6-2006, FILED 6-29-2005.

COVERFLEX

THE MARK CONSISTS OF STANDARD CHARACTERS WITHOUT CLAIM TO ANY PARTICULAR FONT, STYLE, SIZE, OR COLOR.

FOR MACHINE PARTS, NAMELY, POLYMERIC COVERS FOR SUPERCALENDER ROLLS AND POLYMERIC COVERS FOR OTHER INDUSTRIAL ROLLS, FOR USE IN THE PAPERMAKING AND PRINT INDUSTRIES (U.S. CLS. 13, 19, 21, 23, 31, 34 AND 35).

FIRST USE 12-5-2005; IN COMMERCE 12-5-2005.

3,299,230. EMERSON ELECTRIC CO., ST. LOUIS, MO. SN 78-678,658. PUB. 9-5-2006, FILED 7-26-2005.

EVOLUTION ESSENTIAL

THE MARK CONSISTS OF STANDARD CHARACTERS WITHOUT CLAIM TO ANY PARTICULAR FONT, STYLE, SIZE, OR COLOR.

FOR FOOD WASTE DISPOSERS, GARBAGE DISPOSALS AND REPLACEMENT PARTS THEREFOR; SPLASH BAFFLES FOR USE WITH GARBAGE DISPOSALS (U.S. CLS. 13, 19, 21, 23, 31, 34 AND 35).

FIRST USE 5-15-2006; IN COMMERCE 5-15-2006.

CLASS 7—(Continued).

3,299,306. COMPONENTS PLUS, LLC, HARTLAND, WI. SN 78-710,627. PUB. 12-5-2006, FILED 9-11-2005.



FOR COMPONENTS FOR LAWN AND GARDEN TILLING MACHINES AND FARM IMPLEMENTS, NAMELY TILLER TINES AND CUTTER BARS; COMPONENTS FOR LAWN MOWERS, NAMELY MOWER BLADES; COMPONENTS FOR DISC HARROWS, NAMELY TINES AND DISCS; AND LASER HARDENED MOWER BLADES (U.S. CLS. 13, 19, 21, 23, 31, 34 AND 35).

FIRST USE 10-9-2006; IN COMMERCE 10-9-2006.

CLASS 7—(Continued).

3,299,438. SUNLUXE ENTERPRISES LIMITED, WANCHAI, HONG KONG. SN 78-736,791. PUB. 6-27-2006, FILED 10-20-2005.

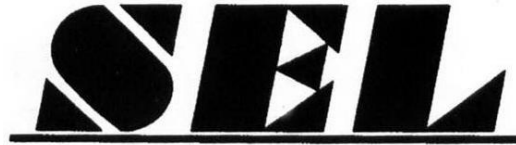

THE MARK CONSISTS OF THE WORD SEL. FOR COFFEE EXTRACTING MACHINES; DISH WASHING MACHINES; WASHING MACHINES FOR CLOTHES; ELECTRIC WAX-POLISHING MACHINES FOR HOUSEHOLD PURPOSES; ELECTRIC MOTORS FOR MACHINES; ENGINES AND MOTORS FOR THE GENERATION OF ELECTRICITY; MOTORS FOR BOATS; IGNITION DEVICES FOR MOTORS OF LAND VEHICLES; ELECTRONIC IGNITIONS FOR VEHICLES; IGNITION PARTS FOR INTERNAL COMBUSTION ENGINES NAMELY, CONDENSERS AND POINTS; TRACTOR TOWED AGRICULTURAL IMPLEMENTS, NAMELY, PLOWS, MOWERS, HARVESTERS; METALWORKING MACHINE TOOLS; POLISHING MACHINES FOR USE IN GRINDING AND POLISHING METAL, WOOD, CERAMICS AND PLASTICS; WOOD SAWING MACHINES; WOOD DRILLING MACHINES; INJECTION PLASTIC MOLDING MACHINES; DRILLING MACHINES; POWER DRILL BITS; ELECTRIC HAMMERS; ELECTRIC HAND-HELD DRILLS; ELECTRIC KNIVES; ELECTRIC LAWNMOWERS; ELECTRIC PLANERS; HAND-HELD PNEUMATIC DRILLS; HAND-HELD PNEUMATIC HAMMERS; MECHANICALLY OPERATED HAND-HELD CRIMPERS; POWER-OPERATED SCREWDRIVERS; POWER-DRIVEN WRENCHES; TOOL BITS FOR MACHINES; VACUUM CLEANERS; REGULATORS BEING PARTS OF MACHINES; PULLEYS BEING PARTS OF MACHINES; MACHINE PARTS NAMELY, BEARINGS AND BUSHINGS; DRIVES FOR VACUUM PUMPS (U.S. CLS. 13, 19, 21, 23, 31, 34 AND 35).

FIRST USE 1-11-2007; IN COMMERCE 1-11-2007.

3,299,421. MIDWEST FASTENERS, INC., MIAMISBURG, OH. SN 78-735,292. PUB. 7-4-2006, FILED 10-18-2005.

EAGLE

THE MARK CONSISTS OF STANDARD CHARACTERS WITHOUT CLAIM TO ANY PARTICULAR FONT, STYLE, SIZE, OR COLOR.
FOR ELECTRIC WELDING MACHINES, NAMELY CAPACITOR DISCHARGE STUD WELDERS (U.S. CLS. 13, 19, 21, 23, 31, 34 AND 35).
FIRST USE 2-15-2006; IN COMMERCE 2-15-2006.

3,299,448. WATER TECH, LLC, EAST BRUNSWICK, NJ. SN 78-737,661. PUB. 7-18-2006, FILED 10-20-2005.

CATFISH

THE MARK CONSISTS OF STANDARD CHARACTERS WITHOUT CLAIM TO ANY PARTICULAR FONT, STYLE, SIZE, OR COLOR.
FOR SWIMMING POOL CLEANERS, IN THE NATURE OF A VACUUM-TYPE UNIT (U.S. CLS. 13, 19, 21, 23, 31, 34 AND 35).
FIRST USE 1-1-2007; IN COMMERCE 1-1-2007.

CLASS 7—(Continued).

3,299,482. WARNKEZ, LLC, STOVER, MO. SN 78-742,272.
PUB. 7-4-2006, FILED 10-28-2005.

WARNKEZ

THE MARK CONSISTS OF STANDARD CHARACTERS WITHOUT CLAIM TO ANY PARTICULAR FONT, STYLE, SIZE, OR COLOR.

FOR TRACTOR-TOWED AGRICULTURAL IMPLEMENTS, NAMELY, PLOWS FOR CUTTING TRENCHES FOR INSERTION OF A DIVIDING WALL AND INCORPORATING AN APPARATUS FOR DISPENSING AND INSTALLING THE WALL-FORMING MATERIAL (U.S. CLS. 13, 19, 21, 23, 31, 34 AND 35).

FIRST USE 11-17-2005; IN COMMERCE 11-17-2005.

3,299,547. ZONGSHEN INDUSTRIAL GROUP CO., LTD.,
CHONGQING, CHINA. SN 78-753,481. PUB. 10-17-2006,
FILED 11-14-2005.



OWNER OF U.S. REG. NO. 2,773,830.
FOR ENGINES NOT FOR LAND VEHICLES; GASOLINE ENGINES NOT FOR LAND VEHICLES; ELECTRIC GENERATORS; SUCTION PUMPS; LAWNMOWERS; AGRICULTURAL MACHINES, NAMELY, CULTIVATORS, HARVESTERS, DISK HARROWS, SEEDERS; POWER-OPERATED SAWS; POWER-OPERATED LAWN AND GARDEN TOOLS, NAMELY, CULTIVATORS; POWER-OPERATED LAWN AND GARDEN TILLERS; BOAT ENGINES; POWER-OPERATED GRASS/WEED TRIMMERS; INDUSTRIAL MACHINE PRESSES; WASHING MACHINES FOR HOUSEHOLD PURPOSES (U.S. CLS. 13, 19, 21, 23, 31, 34 AND 35).

FIRST USE 12-0-1999; IN COMMERCE 4-25-2006.

CLASS 7—(Continued).

3,299,556. ECHO, INCORPORATED, LAKE ZURICH, IL. SN 78-754,526. PUB. 8-29-2006, FILED 11-15-2005.

FOR LASER CUT HEDGE CLIPPER BLADES USED IN CONNECTION WITH OUTDOOR GAS POWER EQUIPMENT (U.S. CLS. 13, 19, 21, 23, 31, 34 AND 35).

FIRST USE 8-1-2005; IN COMMERCE 8-1-2005.

3,299,557. ECHO, INCORPORATED, LAKE ZURICH, IL. SN 78-754,538. PUB. 8-29-2006, FILED 11-15-2005.

RAZOR EDGE

THE MARK CONSISTS OF STANDARD CHARACTERS WITHOUT CLAIM TO ANY PARTICULAR FONT, STYLE, SIZE, OR COLOR.

FOR LASER CUT HEDGE CLIPPER BLADES USED IN CONNECTION WITH OUTDOOR GAS POWER EQUIPMENT (U.S. CLS. 13, 19, 21, 23, 31, 34 AND 35).

FIRST USE 8-1-2005; IN COMMERCE 8-1-2005.

3,299,627. JETSTREAM OF HOUSTON, LLP, HOUSTON, TX. SN 78-769,086. PUB. 10-17-2006, FILED 12-8-2005.

MAX ARMSTRONG

THE MARK CONSISTS OF STANDARD CHARACTERS WITHOUT CLAIM TO ANY PARTICULAR FONT, STYLE, SIZE, OR COLOR.

THE NAME(S), PORTRAIT(S), AND/OR SIGNATURE(S) SHOWN IN THE MARK DOES NOT IDENTIFY A PARTICULAR LIVING INDIVIDUAL.

FOR POWER TOOLS PARTS, NAMELY, AN AIR-OPERATED ASSIST ARM FOR USE WITH THE CONTROL GUNS USED IN HIGH PRESSURE WATER BLASTING (U.S. CLS. 13, 19, 21, 23, 31, 34 AND 35).

FIRST USE 7-21-2005; IN COMMERCE 8-21-2006.

CLASS 7—(Continued).

3,299,679. SOLEIL TOOL INDUSTRIES CORP., WUCHI, TAICHUNG COUNTY, TAIWAN. SN 78-782,347. PUB. 10-17-2006, FILED 12-29-2005.



THE ENGLISH TRANSLATION OF "SOLEIL" IS "SUN." FOR CHAIN SAWS, CIRCULAR SAWS FOR WOODWORKING, ELECTRIC CHAIN SAWS, WOODWORKING SAW-TOOTH SETTING MACHINES, POWER TOOLS, NAMELY, CIRCULAR SAWS, PORTABLE SAW MILLS, CHAINS FOR CHAIN SAWS, BLADES FOR POWER SAWS (U.S. CLS. 13, 19, 21, 23, 31, 34 AND 35). FIRST USE 12-7-2005; IN COMMERCE 5-20-2006.

3,299,724. JANOME SEWING MACHINE CO., LTD., TOKYO, JAPAN. SN 78-794,091. PUB. 7-11-2006, FILED 1-18-2006.

SEWPRECISE

THE MARK CONSISTS OF STANDARD CHARACTERS WITHOUT CLAIM TO ANY PARTICULAR FONT, STYLE, SIZE, OR COLOR. FOR SEWING MACHINES (U.S. CLS. 13, 19, 21, 23, 31, 34 AND 35). FIRST USE 6-0-2006; IN COMMERCE 7-0-2006.

3,299,913. SMARTPOOL INCORPORATED, LAKEWOOD, NJ. SN 78-861,540. PUB. 12-5-2006, FILED 4-14-2006.

BLUE STREAK

THE MARK CONSISTS OF STANDARD CHARACTERS WITHOUT CLAIM TO ANY PARTICULAR FONT, STYLE, SIZE, OR COLOR. FOR COMMERCIAL AND INDUSTRIAL AS WELL AS RESIDENTIAL ROBOTS FOR CLEANING SWIMMING POOLS (U.S. CLS. 13, 19, 21, 23, 31, 34 AND 35). FIRST USE 1-31-2007; IN COMMERCE 1-31-2007.

CLASS 7—(Continued).

3,299,948. SYLMARK HOLDINGS LIMITED, DUBLIN 2, IRELAND. SN 78-873,527. PUB. 11-21-2006, FILED 5-1-2006.

SHAKE 'N TAKE

THE MARK CONSISTS OF STANDARD CHARACTERS WITHOUT CLAIM TO ANY PARTICULAR FONT, STYLE, SIZE, OR COLOR. FOR ELECTRIC FOOD BLENDERS (U.S. CLS. 13, 19, 21, 23, 31, 34 AND 35). FIRST USE 8-31-2006; IN COMMERCE 8-31-2006.

3,300,023. H-P PRODUCTS, INC., LOUISVILLE, OH. SN 78-899,542. PUB. 1-9-2007, FILED 6-2-2006.

WEBS-B-GONE

THE MARK CONSISTS OF STANDARD CHARACTERS WITHOUT CLAIM TO ANY PARTICULAR FONT, STYLE, SIZE, OR COLOR. FOR WANDS FOR USE WITH CENTRAL VACUUM SYSTEMS (U.S. CLS. 13, 19, 21, 23, 31, 34 AND 35). FIRST USE 5-9-2007; IN COMMERCE 5-9-2007.

3,300,137. GRACO MINNESOTA INC., MINNEAPOLIS, MN. SN 78-933,193. PUB. 2-13-2007, FILED 7-19-2006.

APEX

THE MARK CONSISTS OF STANDARD CHARACTERS WITHOUT CLAIM TO ANY PARTICULAR FONT, STYLE, SIZE, OR COLOR. FOR ELECTRIC PUMPS FOR TRANSFERRING OIL AND HYDRAULIC FLUID (U.S. CLS. 13, 19, 21, 23, 31, 34 AND 35). FIRST USE 11-1-2006; IN COMMERCE 11-1-2006.

CLASS 7—(Continued).

3,300,171. GRACO MINNESOTA INC., MINNEAPOLIS, MN.
SN 78-951,200. PUB. 2-13-2007, FILED 8-14-2006.

E-FLO

THE MARK CONSISTS OF STANDARD CHARACTERS WITHOUT CLAIM TO ANY PARTICULAR FONT, STYLE, SIZE, OR COLOR.

FOR ELECTRIC POWERED PUMPS FOR PUMPING COATING MATERIAL, NAMELY, PAINTS, ADHESIVES, AND OTHER FLUIDS FOR INDUSTRIAL USE (U.S. CLS. 13, 19, 21, 23, 31, 34 AND 35).

FIRST USE 2-2-2007; IN COMMERCE 2-2-2007.

CLASS 8—(Continued).

3,298,489. WAHL CLIPPER CORPORATION, STERLING, IL.
SN 76-616,941. PUB. 12-20-2005, FILED 10-20-2004.

PERFORMER

THE MARK CONSISTS OF STANDARD CHARACTERS WITHOUT CLAIM TO ANY PARTICULAR FONT, STYLE, SIZE, OR COLOR.

FOR ELECTRIC HAIR CARE PRODUCTS, NAMELY, TRIMMERS; ELECTRIC HAIR CARE PRODUCTS, CLIPPERS (U.S. CLS. 23, 28 AND 44).

FIRST USE 8-0-1999; IN COMMERCE 8-0-1999.

3,300,205. CHURCH & DWIGHT COMPANY, GREEN RIVER, WY. SN 78-978,591. PUB. 1-24-2006, FILED 4-15-2005.

3,298,820. THE BEECHIE COMPANY, LLC, GIG HARBOR, WA. SN 78-476,348. PUB. 10-4-2005, FILED 8-31-2004.



NANO KNIVES

THE MARK CONSISTS OF STANDARD CHARACTERS WITHOUT CLAIM TO ANY PARTICULAR FONT, STYLE, SIZE, OR COLOR.

NO CLAIM IS MADE TO THE EXCLUSIVE RIGHT TO USE "KNIVES", APART FROM THE MARK AS SHOWN.

FOR CUTLERY; CUTLERY NAMELY, CAMPING CUTLERY; TABLEWARE NAMELY, KNIVES, FORKS AND SPOONS; KNIVES; BAGEL SLICERS; BUTCHER KNIVES; CARPET KNIVES; CARVING KNIVES; CHEF KNIVES; CLEAVERS; DIVING KNIVES; FISHING KNIVES AND FISHING SLICING KITCHEN KNIVES; KITCHEN KNIVES; FIXED BLADE KNIVES; FOLDING KNIVES; HUNTING KNIVES; PARING KNIVES; PEN KNIVES; POCKET KNIVES; PRUNING KNIVES; PUTTY KNIVES; RAZOR KNIVES; SCALING KNIVES; SPORT KNIVES; STEAK KNIVES; TABLE KNIVES; THIN-BLADED KITCHEN KNIVES; THROWING KNIVES; UTILITY KNIVES; VEGETABLE KNIVES; WHITTILING KNIVES; WORKING KNIVES, RAZOR BLADES; AND BLADES FOR ALL THE AFOREMENTIONED KNIVES (U.S. CLS. 23, 28 AND 44).

FIRST USE 2-1-2007; IN COMMERCE 2-16-2007.

OWNER OF U.S. REG. NOS. 1,835,893, 2,388,462, AND OTHERS.

FOR VACUUM CLEANER BAGS, FILTERS FOR VACUUM CLEANERS (U.S. CLS. 13, 19, 21, 23, 31, 34 AND 35).

FIRST USE 8-17-2005; IN COMMERCE 8-17-2005.

CLASS 8—HAND TOOLS

CLASS 8—(Continued).

3,298,884. VIAGGIO, INC., ORLANDO, FL. SN 78-525,379. PUB. 9-27-2005, FILED 12-1-2004.

File Cozy

THE MARK CONSISTS OF STANDARD CHARACTERS WITHOUT CLAIM TO ANY PARTICULAR FONT, STYLE, SIZE, OR COLOR.
NO CLAIM IS MADE TO THE EXCLUSIVE RIGHT TO USE "FILE", APART FROM THE MARK AS SHOWN.
FOR NAIL FILE CARRYING CASE (U.S. CLS. 23, 28 AND 44).
FIRST USE 9-1-2004; IN COMMERCE 12-1-2004.

3,298,955. EASCO HAND TOOLS, INC., SIMSBURY, CT. SN 78-571,760. PUB. 7-4-2006, FILED 2-21-2005.

SURFACE DRIVE PLUS

THE MARK CONSISTS OF STANDARD CHARACTERS WITHOUT CLAIM TO ANY PARTICULAR FONT, STYLE, SIZE, OR COLOR.
OWNER OF U.S. REG. NO. 1,892,568.
NO CLAIM IS MADE TO THE EXCLUSIVE RIGHT TO USE "DRIVE PLUS", APART FROM THE MARK AS SHOWN.
FOR HAND TOOLS, NAMELY WRENCHES (U.S. CLS. 23, 28 AND 44).
FIRST USE 4-30-2005; IN COMMERCE 4-30-2005.

3,298,960. STURM, RUGER AND CO., INC., SOUTHPORT, CT. SN 78-573,159. PUB. 7-18-2006, FILED 2-23-2005.

RUGER

THE MARK CONSISTS OF STANDARD CHARACTERS WITHOUT CLAIM TO ANY PARTICULAR FONT, STYLE, SIZE, OR COLOR.

CLASS 8—(Continued).

OWNER OF U.S. REG. NOS. 618,055, 2,064,693, AND OTHERS.
SEC. 2(F).
FOR POCKETKNIVES AND HUNTING KNIVES (U.S. CLS. 23, 28 AND 44).
FIRST USE 10-29-2004; IN COMMERCE 10-29-2004.

3,299,067. VILLANI, EMILIO M., LONDON, ONTARIO, CANADA. SN 78-607,615. PUB. 1-17-2006, FILED 4-13-2005.

ONE SHOT SHOVEL

THE MARK CONSISTS OF STANDARD CHARACTERS WITHOUT CLAIM TO ANY PARTICULAR FONT, STYLE, SIZE, OR COLOR.
NO CLAIM IS MADE TO THE EXCLUSIVE RIGHT TO USE "SHOVEL", APART FROM THE MARK AS SHOWN.
FOR HAND TOOLS, NAMELY, GARDEN SHOVELS (U.S. CLS. 23, 28 AND 44).
FIRST USE 4-5-2007; IN COMMERCE 4-5-2007.

3,299,369. ALCAS CORPORATION, OLEAN, NY. SN 78-725,899. PUB. 2-13-2007, FILED 10-4-2005.



OWNER OF U.S. REG. NOS. 1,048,431, 1,083,221, AND OTHERS.
THE MARK CONSISTS OF THE HEAD OF A DOG.
FOR KNIVES, NAMELY SPORT KNIVES, HUNTING KNIVES, FISHING KNIVES, POCKET KNIVES, SURVIVAL KNIVES, FOLDING KNIVES, UTILITY KNIVES AND COMBAT KNIVES (U.S. CLS. 23, 28 AND 44).
FIRST USE 6-11-2007; IN COMMERCE 6-11-2007.

3,299,385. AMARILLO HARDWARE COMPANY, AMARILLO, TX. SN 78-729,150. PUB. 10-24-2006, FILED 10-7-2005.

E-Z READ

THE MARK CONSISTS OF STANDARD CHARACTERS WITHOUT CLAIM TO ANY PARTICULAR FONT, STYLE,

CLASS 8—(Continued).

SIZE, OR COLOR.

OWNER OF U.S. REG. NO. 2,093,141.
FOR MANUALLY OPERATED HAND TOOLS,
NAMESLY, SOCKET SETS, SOCKET WRENCHES AND
SCREWDRIVERS (U.S. CLS. 23, 28 AND 44).
FIRST USE 10-0-2006; IN COMMERCE 10-0-2006.

3,299,583. CLARK & ASSOCIATES, INC., SANTA FE
SPRINGS, CA. SN 78-757,602. PUB. 3-6-2007, FILED 11-18-
2005.

RED TOP

THE MARK CONSISTS OF STANDARD CHARACTERS
WITHOUT CLAIM TO ANY PARTICULAR FONT, STYLE,
SIZE, OR COLOR.

FOR MANUAL DRILL BITS, HAND TOOLS, NAMESLY,
WRENCHES, SOCKETS SETS AND UTILITY KNIVES
(U.S. CLS. 23, 28 AND 44).

FIRST USE 8-30-2005; IN COMMERCE 8-30-2005.

3,299,834. AMES TRUE TEMPER PROPERTIES, INC., WIL-
MINGTON, DE. SN 78-829,742. PUB. 9-26-2006, FILED 3-6-
2006.

THE SCOUT

THE MARK CONSISTS OF STANDARD CHARACTERS
WITHOUT CLAIM TO ANY PARTICULAR FONT, STYLE,
SIZE, OR COLOR.

FOR SHOVELS (U.S. CLS. 23, 28 AND 44).

FIRST USE 1-31-2007; IN COMMERCE 1-31-2007.

3,300,018. WAHL CLIPPER CORPORATION, STERLING, IL.
SN 78-897,755. PUB. 1-2-2007, FILED 6-1-2006.

DEFINITIONS

THE MARK CONSISTS OF STANDARD CHARACTERS
WITHOUT CLAIM TO ANY PARTICULAR FONT, STYLE,
SIZE, OR COLOR.

OWNER OF U.S. REG. NO. 3,133,613.
FOR ELECTRIC HAIR TRIMMERS (U.S. CLS. 23, 28
AND 44).

FIRST USE 8-0-2006; IN COMMERCE 8-0-2006.

CLASS 8—(Continued).

3,300,022. JP PLAN, SANTA ANA, CA. SN 78-899,487. PUB. 1-
16-2007, FILED 6-2-2006.

JP PLAN

THE MARK CONSISTS OF STANDARD CHARACTERS
WITHOUT CLAIM TO ANY PARTICULAR FONT, STYLE,
SIZE, OR COLOR.

FOR HAIR CUTTING SCISSORS (U.S. CLS. 23, 28 AND
44).

FIRST USE 4-13-2006; IN COMMERCE 4-13-2006.

3,300,154. NUPLA CORPORATION, SUN VALLEY, CA. SN
78-944,250. PUB. 3-20-2007, FILED 8-3-2006.

HANDI-HAMMER

THE MARK CONSISTS OF STANDARD CHARACTERS
WITHOUT CLAIM TO ANY PARTICULAR FONT, STYLE,
SIZE, OR COLOR.

FOR HAND TOOLS NAMESLY, HAMMERS; HAND
TOOLS NAMESLY, ICE PICKS; HAND TOOLS NAMESLY,
PUNCHES; HAND TOOLS, NAMESLY, AUTOMOBILE
SHEET METAL DENT REPAIR TOOL; HAND TOOLS,
NAMESLY, RAMMERS (U.S. CLS. 23, 28 AND 44).

FIRST USE 6-29-2007; IN COMMERCE 6-29-2007.

3,300,187. E. MISHAN & SONS, INC., NEW YORK, NY. SN 78-
963,512. PUB. 12-26-2006, FILED 8-30-2006.

BONZAI CHOPPER

THE MARK CONSISTS OF STANDARD CHARACTERS
WITHOUT CLAIM TO ANY PARTICULAR FONT, STYLE,
SIZE, OR COLOR.

NO CLAIM IS MADE TO THE EXCLUSIVE RIGHT TO
USE "CHOPPER", APART FROM THE MARK AS SHOWN.
FOR HAND-OPERATED CHOPPERS (U.S. CLS. 23, 28
AND 44).

FIRST USE 1-11-2007; IN COMMERCE 1-11-2007.

CLASS 8—(Continued).

3,300,188. AMERICAN SAFETY RAZOR COMPANY, CEDAR KNOLLS, NJ. SN 78-964,615. PUB. 2-6-2007, FILED 8-31-2006.

Bikini

OWNER OF U.S. REG. NO. 3,151,675.
NO CLAIM IS MADE TO THE EXCLUSIVE RIGHT TO USE "BIKINI", APART FROM THE MARK AS SHOWN.
FOR RAZORS AND RAZOR BLADES (U.S. CLS. 23, 28 AND 44).
FIRST USE 5-31-2005; IN COMMERCE 5-31-2005.

CLASS 9—ELECTRICAL AND SCIENTIFIC APPARATUS

3,298,399. STERLING SOFTWARE, INC., ISLANDIA, NY. SN 74-668,096. PUB. 11-21-1995, FILED 5-1-1995.

VISION:SIXTY

FOR COMPUTER PROGRAM WHICH PROVIDES A FIXED-FORM REPORT GENERATOR AND AN EXTENDED MAINFRAME UTILITY PROGRAM AND PRINTED INSTRUCTIONAL MANUALS, THEREFOR, SOLD AS A UNIT (U.S. CLS. 21, 23, 26, 36 AND 38).
FIRST USE 12-31-2001; IN COMMERCE 12-31-2001.

3,298,402. MACK, JAY, HENDERSON, NV. SN 75-838,963. PUB. 1-18-2005, FILED 11-2-1999.

WEBWEAR

FOR WEARABLE COMPUTER HARDWARE AND COMPUTER SOFTWARE, NAMELY, MICRO PROCESSOR-POWERED COMPUTERS AND SOFTWARE FOR USE THEREWITH IN SPEECH RECOGNITION, HANDS FREE OR KEYED DATA ENTRY, DATA STORAGE, RETRIEVAL AND PROCESSING, OR COMMUNICATION IN THE FIELD OF MOBILE COMPUTING (U.S. CLS. 21, 23, 26, 36 AND 38).
FIRST USE 3-26-2007; IN COMMERCE 3-26-2007.

CLASS 9—(Continued).

3,298,404. MACK, JAY, HENDERSON, NV. SN 75-845,350. PUB. 10-30-2001, FILED 12-1-1999.

INTELLIWEAR

FOR WEARABLE COMPUTER HARDWARE AND COMPUTER SOFTWARE, NAMELY, WEARABLE MICRO PROCESSOR-POWERED COMPUTERS AND ASSOCIATED SOFTWARE USED FOR HANDS FREE DATA ENTRY, DATA STORAGE, DATA RETRIEVAL AND DATA PROCESSING, AND USED FOR ELECTRONIC MESSAGING AND FOR CONNECTING TO THE INTERNET (U.S. CLS. 21, 23, 26, 36 AND 38).
FIRST USE 3-18-2007; IN COMMERCE 3-18-2007.

3,298,437. ZAHOUREK SYSTEMS, INCORPORATED, LOVELAND, CO. SN 76-497,647. PUB. 6-29-2004, FILED 3-17-2003.

MYOLOGIK

FOR EDUCATIONAL AND INSTRUCTIONAL VIDEOS, COMPUTER SOFTWARE, AND DOWNLOADABLE INTERNET-BASED SOFTWARE FEATURING INSTRUCTION IN THE FIELDS OF ZOOLOGY, BIOLOGY, ANATOMY, PHYSIOLOGY, KINESIOLOGY, PHYSICS, AND PSYCHOLOGY (U.S. CLS. 21, 23, 26, 36 AND 38).
FIRST USE 8-31-2004; IN COMMERCE 8-31-2004.

3,298,439. DCE APRILIS, INC., MIDLAND, MI. SN 76-499,094. PUB. 10-21-2003, FILED 3-20-2003.

DHD

FOR HOLOGRAPHIC RECORDING MATERIAL, NAMELY, GLASS OR PLASTIC SUBSTRATES CONTAINING PHOTOPOLYMER SYSTEMS COMPRISED OF A MIXTURE OF CHEMICALS, OF A CLASS CAPABLE OF UNDERGOING CATIONIC RING-OPENING POLYMERIZATION, FOR USE IN THE FIELD OF HOLOGRAPHIC DATA STORAGE (U.S. CLS. 21, 23, 26, 36 AND 38).
FIRST USE 11-20-2006; IN COMMERCE 11-20-2006.

CLASS 9—(Continued).

3,298,443. ACCUBALANCE CORPORATION, ST. HELENA, CA. SN 76-522,184. PUB. 2-3-2004, FILED 6-12-2003.



THE MARK CONSISTS OF THE COMPOUND WORD, "ACCUBALANCE", CONSISTING OF TWO PARTS, "ACCU" AND "BALANCE". EACH PART IS ENCLOSED BY ITS OWN RECTANGLE. THE FIRST PART, "ACCU", IS DEPICTED WITH WHITE LETTERING AND A RED BACKGROUND WITHIN ITS RECTANGLE. THE SECOND PART, "BALANCE", IS DEPICTED WITH RED LETTERING AND A WHITE BACKGROUND WITHIN ITS RECTANGLE. THE OVERALL BORDER ENCOMPASSING BOTH RECTANGLES IS DEPICTED IN NAVY BLUE".

FOR ELECTRONIC PERSONAL ORGANIZER FOR BANKING TRANSACTION ACCOUNT MANAGEMENT (U.S. CLS. 21, 23, 26, 36 AND 38).

FIRST USE 5-11-2004; IN COMMERCE 11-2-2004.

CLASS 9—(Continued).

3,298,454. MICHELIN NORTH AMERICA, INC., GREENVILLE, SC. SN 76-566,368. PUB. 9-27-2005, FILED 12-12-2003.



THE MARK CONSISTS OF STANDARD CHARACTERS WITHOUT CLAIM TO ANY PARTICULAR FONT, STYLE, SIZE, OR COLOR.

FOR MICROPROCESSOR WITH MEMORY AND TRANSMITTER, RECEIVER AND DISPLAY FOR PROVIDING INFORMATION ON THE TEMPERATURE AND PRESSURE IN A PNEUMATIC TIRE (U.S. CLS. 21, 23, 26, 36 AND 38).

FIRST USE 8-0-2006; IN COMMERCE 8-0-2006.

3,298,453. PREMIER FARNELL CORP., INDEPENDENCE, OH. SN 76-566,295. PUB. 8-30-2005, FILED 12-19-2003.



FOR AUDIO/VIDEO AND COMPUTER/NETWORK BULK ELECTRICAL WIRE, TERMINATED CABLES AND CONNECTORS; AUDIO EQUIPMENT, NAMELY, PROFESSIONALLY AND PERMANENTLY INSTALLED, IN-WALL AND IN-CEILING SPEAKERS ASSOCIATED WITH HOME THEATER SURROUND SOUND AND WHOLE HOUSE AUDIO SYSTEMS, SUBWOOFERS, HEADSETS, AND VIDEO PROCESSORS AND CONVERTERS TO DISTRIBUTE, REPEAT AND COVERT VIDEO SIGNALS, AND PARTS THEREFOR (U.S. CLS. 21, 23, 26, 36 AND 38).

FIRST USE 4-12-2004; IN COMMERCE 4-12-2004.

3,298,462. KS2 TECHNOLOGIES, INC., GRAPEVINE, TX. SN 76-589,322. PUB. 6-14-2005, FILED 4-29-2004.



THE MARK CONSISTS OF STANDARD CHARACTERS WITHOUT CLAIM TO ANY PARTICULAR FONT, STYLE, SIZE, OR COLOR.

FOR COMPUTER SOFTWARE AND SOFTWARE TOOLS THAT ENABLE USERS TO RETRIEVE DATA FROM DATA SOURCES FOR USE IN REPORTING ON FRONT END USER APPLICATION SOFTWARE (U.S. CLS. 21, 23, 26, 36 AND 38).

FIRST USE 1-16-2003; IN COMMERCE 1-29-2003.

CLASS 9—(Continued).

3,298,463. NET INTEGRATION TECHNOLOGIES INC., MARKHAM L3R 9Z6, ONTARIO, CANADA. SN 76-591,719. PUB. 5-23-2006, FILED 5-11-2004.

NITIX

THE MARK CONSISTS OF STANDARD CHARACTERS WITHOUT CLAIM TO ANY PARTICULAR FONT, STYLE, SIZE, OR COLOR.

PRIORITY CLAIMED UNDER SEC. 44(D) ON CANADA APPLICATION NO. 1,198,171, FILED 11-26-2003, REG. NO. 653639, DATED 11-25-2005, EXPIRES 11-25-2020.

FOR AUTONOMIC LINUX COMPUTER NETWORK OPERATING SYSTEM SOFTWARE (U.S. CLS. 21, 23, 26, 36 AND 38).

FIRST USE 1-0-2004; IN COMMERCE 1-0-2004.



3,298,469. CHECKPOINT SYSTEMS, INC., THOROFARE, NJ. SN 76-603,134. PUB. 7-26-2005, FILED 7-20-2004.

CHECKPASS

THE MARK CONSISTS OF STANDARD CHARACTERS WITHOUT CLAIM TO ANY PARTICULAR FONT, STYLE, SIZE, OR COLOR.

FOR LIBRARY AUTOMATION SYSTEM COMPRISED OF COMPUTER HARDWARE AND COMPUTER SOFTWARE FOR LIBRARY SERVICES, NAMELY, SCHEDULING OF PATRON COMPUTER TIME, CIRCULATION CONTROL, CATALOGING, INVENTORY, PRINT JOBS, PAYMENTS OF LIBRARY FEES AND FINES, AND TO OTHERWISE CONTROL OPERATION OF A LIBRARY (U.S. CLS. 21, 23, 26, 36 AND 38).

FIRST USE 8-31-2004; IN COMMERCE 8-31-2004.

CLASS 9—(Continued).

3,298,491. CAMBRIDGE RESEARCH & INSTRUMENTATION, INC., WOBURN, MA. SN 76-617,945. PUB. 10-10-2006, FILED 10-21-2004.

MAESTRO

THE MARK CONSISTS OF STANDARD CHARACTERS WITHOUT CLAIM TO ANY PARTICULAR FONT, STYLE, SIZE, OR COLOR.

FOR LABORATORY EQUIPMENT, NAMELY DIGITAL IMAGING SYSTEMS COMPRISING AN ILLUMINATOR, A DIGITAL CAMERA, OPTICAL INTERFERENCE FILTERS AND A TUNABLE FILTER, USED FOR FLUORESCENCE OPTICAL IMAGING OF SAMPLES, AND COMPUTER SOFTWARE FOR USE IN OPERATING THE DIGITAL IMAGING SYSTEM, OR INTERPRETING THE IMAGES OBTAINED THEREBY, COMPUTERS, AND ADAPTORS FOR LENSES AND MICROSCOPES, ALL OF THE FOREGOING SOLD SEPARATELY OR AS A UNIT FOR FLUORESCENCE OPTICAL IMAGING (U.S. CLS. 21, 23, 26, 36 AND 38).

FIRST USE 8-31-2004; IN COMMERCE 8-31-2004.



3,298,494. STEHAGER, TORBJÖRN V, S-134 65 INGARÖ, SWEDEN. SN 76-623,685. PUB. 10-25-2005, FILED 12-8-2004.

ROXOR

THE MARK CONSISTS OF THE STYLIZED LETTERS ROXOR.

FOR SUNGLASSES (U.S. CLS. 21, 23, 26, 36 AND 38).

FIRST USE 0-0-2004; IN COMMERCE 1-0-2006.



3,298,505. NANOGEOMETRY RESEARCH INC., KAWASAKI, KANAGAWA 213-0012, JAPAN. SN 76-631,043. PUB. 5-2-2006, FILED 2-16-2005.

INNOVATION TO REALITY

THE MARK CONSISTS OF STANDARD CHARACTERS WITHOUT CLAIM TO ANY PARTICULAR FONT, STYLE, SIZE, OR COLOR.

FOR SEMICONDUCTOR TESTERS; ELECTRIC METERS FOR INSPECTING SEMICONDUCTORS AND FOR TESTING INTEGRATED CIRCUITS; MAGNETIC METERS, NAMELY, VOLTMETERS, CHRONOMETERS, DYNAMETERS AND SOUND LEVEL METERS AND VOLTAGE AND AMPERAGE TESTERS AND PROBES FOR TESTING INTEGRATED CIRCUITS; ELECTRON MICROSCOPES (U.S. CLS. 21, 23, 26, 36 AND 38).

FIRST USE 11-1-2006; IN COMMERCE 11-1-2006.

CLASS 9—(Continued).

3,298,509. SONY COMPUTER ENTERTAINMENT AMERICA INC., FOSTER CITY, CA. SN 76-632,988. PUB. 6-27-2006, FILED 3-7-2005.

HOT SHOTS GOLF: OPEN TEE

THE MARK CONSISTS OF STANDARD CHARACTERS WITHOUT CLAIM TO ANY PARTICULAR FONT, STYLE, SIZE, OR COLOR.

OWNER OF U.S. REG. NOS. 2,269,770, 2,987,686, AND OTHERS.

FOR COMPUTER GAME SOFTWARE AND VIDEO GAME SOFTWARE (U.S. CLS. 21, 23, 26, 36 AND 38).

FIRST USE 5-3-2005; IN COMMERCE 5-3-2005.

3,298,511. ULTRA-SCAN CORPORATION, AMHERST, NY. SN 76-633,474. PUB. 6-27-2006, FILED 3-14-2005.

TouchLink

THE MARK CONSISTS OF STANDARD CHARACTERS WITHOUT CLAIM TO ANY PARTICULAR FONT, STYLE, SIZE, OR COLOR.

FOR BIOMETRIC IDENTIFICATION SYSTEMS COMPRISING FINGERPRINT SCANNERS AND ASSOCIATED SOFTWARE FOR IDENTIFICATION OF INDIVIDUALS FOR DISPENSING MEDICATION (U.S. CLS. 21, 23, 26, 36 AND 38).

FIRST USE 4-0-2005; IN COMMERCE 9-30-2005.

3,298,525. STEWART & STEVENSON LLC, HOUSTON, TX. SN 76-636,489. PUB. 7-4-2006, FILED 4-11-2005.

DAQPAQ

THE MARK CONSISTS OF STANDARD CHARACTERS WITHOUT CLAIM TO ANY PARTICULAR FONT, STYLE, SIZE, OR COLOR.

FOR DATA PROCESSORS AND SIGNAL PROCESSORS (U.S. CLS. 21, 23, 26, 36 AND 38).

FIRST USE 12-0-2004; IN COMMERCE 3-0-2005.

CLASS 9—(Continued).

3,298,533. TEKSOUTH CORPORATION, GARDENDALE, AL. SN 76-639,279. PUB. 2-14-2006, FILED 5-23-2005.

SWIFT

THE MARK CONSISTS OF STANDARD CHARACTERS WITHOUT CLAIM TO ANY PARTICULAR FONT, STYLE, SIZE, OR COLOR.

OWNER OF U.S. REG. NO. 2,861,452.

FOR PERSONAL COMPUTER AND COMPUTER SERVER SOFTWARE, NAMELY A SOFTWARE UTILITY FOR TRANSFERRING FILES ACROSS A NETWORK, NAMELY SOFTWARE THAT SECURELY AND EFFICIENTLY TRANSFERS DATA FILES FROM ONE LOCATION TO ANOTHER OVER A COMMUNICATIONS LINK, SUCH AS A GLOBAL COMMUNICATIONS NETWORK, EXCLUDING TELECOMMUNICATION SOLUTIONS FOR THE SECURE TRANSFER OF MESSAGES AND FILES OF FINANCIAL TRANSACTIONS (U.S. CLS. 21, 23, 26, 36 AND 38).

FIRST USE 5-30-2002; IN COMMERCE 5-30-2002.

3,298,534. TEKSOUTH CORPORATION, GARDENDALE, AL. SN 76-639,281. PUB. 2-14-2006, FILED 5-23-2005.



OWNER OF U.S. REG. NO. 2,861,452.

FOR PERSONAL COMPUTER AND COMPUTER SERVER SOFTWARE, NAMELY A SOFTWARE UTILITY FOR TRANSFERRING FILES ACROSS A NETWORK, NAMELY SOFTWARE THAT SECURELY AND EFFICIENTLY TRANSFERS DATA FILES FROM ONE LOCATION TO ANOTHER OVER A COMMUNICATIONS LINK, SUCH AS A GLOBAL COMMUNICATIONS NETWORK, EXCLUDING TELECOMMUNICATION SOLUTIONS FOR THE SECURE TRANSFER OF MESSAGES AND FILES OF FINANCIAL TRANSACTIONS (U.S. CLS. 21, 23, 26, 36 AND 38).

FIRST USE 5-30-2002; IN COMMERCE 5-30-2002.

3,298,539. TEHUTI NETWORKS LTD., HIERZLIYA 46105, ISRAEL. SN 76-642,374. PUB. 8-1-2006, FILED 7-6-2005.

TEHUTI NETWORKS

CLASS 9—(Continued).

THE MARK CONSISTS OF STANDARD CHARACTERS WITHOUT CLAIM TO ANY PARTICULAR FONT, STYLE, SIZE, OR COLOR.

NO CLAIM IS MADE TO THE EXCLUSIVE RIGHT TO USE "NETWORKS", APART FROM THE MARK AS SHOWN.

FOR COMPUTER HARDWARE, NAMELY, COMPUTER CHIPS, COMPUTER CARDS, NAMELY NETWORK INTERFACE CARDS ALSO KNOWN AS COMPUTER NETWORK ADAPTERS, COMPUTER DATA PROCESSORS, COMPUTER ACCELERATOR BOARDS, AND COMPUTER SOFTWARE FOR ETHERNET TRAFFIC ACCELERATION (U.S. CLS. 21, 23, 26, 36 AND 38).

FIRST USE 4-0-2003; IN COMMERCE 4-0-2003.

3,298,557. HANVON CORPORATION, IRVINE, CA. SN 76-647,753. PUB. 6-20-2006, FILED 9-30-2005.

HANVON

THE MARK CONSISTS OF STANDARD CHARACTERS WITHOUT CLAIM TO ANY PARTICULAR FONT, STYLE, SIZE, OR COLOR.

FOR COMPUTER DRAWING TABLETS AND COMPUTER WRITING TABLETS AND RELATED SOFTWARE; COMPUTER CARD READERS AND OPTICAL CHARACTER RECOGNITION HARDWARE AND RELATED SOFTWARE (U.S. CLS. 21, 23, 26, 36 AND 38).

FIRST USE 1-25-2006; IN COMMERCE 1-25-2006.

3,298,585. PRAVATA, GEORGE, BROOKLYN, NY. AND PRAVATA, LOURDES, BROOKLYN, NY. SN 76-658,651. PUB. 11-28-2006, FILED 4-18-2006.

SILLYBOYZ

THE MARK CONSISTS OF STANDARD CHARACTERS WITHOUT CLAIM TO ANY PARTICULAR FONT, STYLE, SIZE, OR COLOR.

FOR PRESSURE GAUGES AND PRESSURE SWITCHES FOR CALIBRATING PAINT BALL GUNS (U.S. CLS. 21, 23, 26, 36 AND 38).

FIRST USE 5-15-2006; IN COMMERCE 5-15-2006.

CLASS 9—(Continued).

3,298,596. J.A. WOOLLAM CO., INC., LINCOLN, NE. SN 76-660,926. PUB. 1-16-2007, FILED 6-1-2006.

GLOBALDYNE

THE MARK CONSISTS OF STANDARD CHARACTERS WITHOUT CLAIM TO ANY PARTICULAR FONT, STYLE, SIZE, OR COLOR.

FOR EQUIPMENT, NAMELY, ELLIPSOMETER BASED APPARATUS FOR MEASURING THICKNESS AND OPTICAL PROPERTIES OF SEMICONDUCTOR, DISK DRIVE, MAGNETIC DATA STORAGE MEDIA, OPTICAL DATA STORAGE MEDIA, THIN FILMS AND MULTIPLE LAYER FILMS ON SUBSTRATES AND COATINGS, INCLUDING TEMPERATURE CAUSED EFFECTS, AND COMPUTER PROGRAMS NECESSARY FOR CONTROLLING THE ELLIPSOMETER BASED APPARATUS AND FOR ANALYZING ACQUIRED ELLIPSO-METRIC DATA (U.S. CLS. 21, 23, 26, 36 AND 38).

FIRST USE 12-12-2003; IN COMMERCE 12-12-2003.

3,298,600. J.A. WOOLLAM CO., INC., LINCOLN, NE. SN 76-663,973. PUB. 1-16-2007, FILED 8-1-2006.

COMPLETEEASE

FOR EQUIPMENT, NAMELY, ELLIPSOMETER BASED APPARATUS FOR MEASURING THICKNESS AND OPTICAL PROPERTIES OF SEMICONDUCTOR, DISK DRIVE, MAGNETIC MEDIA DATA STORAGE MEDIA, OPTICAL DATA STORAGE MEDIA, THIN FILMS AND MULTIPLE LAYER FILMS ON SUBSTRATES AND COATINGS, INCLUDING TEMPERATURE CAUSED EFFECTS, AND COMPUTER PROGRAMS NECESSARY FOR CONTROLLING THE ELLIPSOMETER BASED APPARATUS AND FOR ANALYZING ACQUIRED ELLIPSO-METRIC DATA (U.S. CLS. 21, 23, 26, 36 AND 38).

FIRST USE 6-1-2006; IN COMMERCE 12-14-2006.

3,298,639. FARADAY TECHNOLOGY CORPORATION, HSINCHU, TAIWAN. SN 78-119,580. PUB. 5-18-2004, FILED 4-4-2002.

FARADAY

FOR PRINTED CIRCUIT BOARDS; INTEGRATED CIRCUITS; SEMICONDUCTOR DEVICES; EMBEDDED MEMORY INTEGRATED CIRCUITS, NAMELY, EN-CODED CIRCUIT CARDS WITH PROGRAMMING USED FOR IN-SYSTEM PROGRAMMING TO PRESENT A COMPLETE SYSTEM ON CHIP; COMPUTER OPERATING SYSTEMS; SYSTEM DEVELOPMENT TOOLS, NAMELY, COMPIERS, ASSEMBLERS, AND LINKERS; COMPUTER SOFTWARE FOR USE IN CUSTOMIZING INTEGRATED CIRCUITS AND IN MANUFACTURING CUSTOMIZED INTEGRATED CIRCUITS, INTEGRATED CIRCUITS AND INTEGRATED CIRCUIT LAYOUTS; CENTRAL PROCESSING UNITS FOR COMPUTERS; MICROPROCESSOR UNITS FOR COMPUTERS; AND EMBEDDED CENTRAL PROCESSING UNITS FOR COMPUTERS (U.S. CLS. 21, 23, 26, 36 AND 38).

FIRST USE 6-0-1993; IN COMMERCE 10-0-1995.

CLASS 9—(Continued).

3,298,640. EPIWORKS, INC., CHAMPAIGN, IL. SN 78-122,584. PUB. 10-11-2005, FILED 4-18-2002.

EPIFET

OWNER OF U.S. REG. NO. 2,546,066.
FOR ELECTRONIC AND OPTOELECTRONIC COMPOUND SEMICONDUCTOR MATERIALS, NAMELY, EPITAXIAL WAFERS (U.S. CLS. 21, 23, 26, 36 AND 38).
FIRST USE 4-17-2001; IN COMMERCE 4-17-2001.

3,298,646. CLORE AUTOMOTIVE LLC, LEXENA, KS. SN 78-159,172. PUB. 12-16-2003, FILED 8-29-2002.

CHARGE IT!

NO CLAIM IS MADE TO THE EXCLUSIVE RIGHT TO USE "CHARGE", APART FROM THE MARK AS SHOWN.
FOR BATTERY RE-CHARGERS AND JUMP STARTERS FOR AUTOMOBILE BATTERIES (U.S. CLS. 21, 23, 26, 36 AND 38).
FIRST USE 3-8-2007; IN COMMERCE 3-8-2007.

3,298,669. VIACOM INTERNATIONAL INC., NEW YORK, NY. SN 78-233,515. PUB. 7-6-2004, FILED 4-3-2003.

SAVE THE MUSIC

OWNER OF U.S. REG. NOS. 2,165,655 AND 2,213,342.
FOR THEATRICAL OR MUSICAL SOUND RECORDINGS; THEATRICAL OR MUSICAL VIDEO RECORDINGS; SUNGLASSES, HAND HELD VIDEO GAME CARTRIDGES, GAME CARTRIDGES FOR COMPUTER VIDEO GAMES AND INSTRUCTIONAL MANUALS SOLD AS A UNIT; CD ROM GAME MACHINES FOR USE WITH TELEVISION SETS (U.S. CLS. 21, 23, 26, 36 AND 38).
FIRST USE 3-1-2007; IN COMMERCE 3-1-2007.

3,298,673. WESTINGHOUSE ELECTRIC CORPORATION, NEW YORK, NY. SN 78-243,717. PUB. 12-16-2003, FILED 4-30-2003.

WESTINGHOUSE

OWNER OF U.S. REG. NO. 2,354,296.
FOR COMPUTER CABLES AND ELECTRICAL NETWORKING SUPPLIES, NAMELY, WIRES, CABLES, PLUG AND RECEPTACLE ASSEMBLIES, COUPLERS, COMPUTER MOUSE, DVD DISC DRIVES FOR COMPUTERS; NAMELY DIGITAL, PLASMA, AND LIQUID DISPLAY UNIVERSAL, STANDS AND MOUNTING BRACKETS; DVD PLAYERS AND RECORDERS, TELEVISION TUNER CARDS FOR COMPUTERS, DVD PLAYER/RECORDER, TELEVISION, AND REMOTE CONTROL APPARATUS (U.S. CLS. 21, 23, 26, 36 AND 38).
FIRST USE 9-1-2004; IN COMMERCE 9-1-2004.

CLASS 9—(Continued).

3,298,674. VERTICAL CIRCUITS, INC., SCOTTS VALLEY, CA. SN 78-244,094. PUB. 1-6-2004, FILED 4-30-2003.

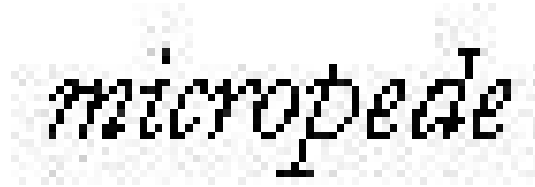

FOR MULTIPLE SEMICONDUCTOR VERTICALLY STACKED DIE ASSEMBLY (U.S. CLS. 21, 23, 26, 36 AND 38).
FIRST USE 3-9-2007; IN COMMERCE 3-9-2007.

3,298,689. FIBERLINK COMMUNICATIONS CORPORATION, BLUE BELL, PA. SN 78-300,479. PUB. 12-28-2004, FILED 9-15-2003.

ACTIVE TRANSPORT NOTIFICATION

NO CLAIM IS MADE TO THE EXCLUSIVE RIGHT TO USE TRANSPORT NOTIFICATION, APART FROM THE MARK AS SHOWN.
FOR SOFTWARE FOR THE DETECTION, RECOGNITION AND USE OF WIFI, CELLULAR, MODEM, ETHERNET AND OTHER CONNECTION DEVICES AND SIGNALS (U.S. CLS. 21, 23, 26, 36 AND 38).
FIRST USE 11-10-2003; IN COMMERCE 11-10-2003.

3,298,696. THERMACUT, INC., CLAREMONT, NH. SN 78-309,011. PUB. 6-22-2004, FILED 10-3-2003.

EX-TRAFIRE

FOR ELECTRIC ARC PLASMA CUTTING AND ELECTRIC ARC WELDING TORCHES AND REPLACEMENT PARTS FOR PLASMA CUTTING AND WELDING TORCHES (U.S. CLS. 21, 23, 26, 36 AND 38).
FIRST USE 3-31-2006; IN COMMERCE 3-31-2006.

3,298,705. DAYSTAR TECHNOLOGIES, INC., HALFMOON, NY. SN 78-316,713. PUB. 2-8-2005, FILED 10-21-2003.

DAYSTAR

FOR SOLAR CELLS AND PHOTOVOLTAIC SOLAR MODULES (U.S. CLS. 21, 23, 26, 36 AND 38).
FIRST USE 1-22-1999; IN COMMERCE 1-22-1999.

CLASS 9—(Continued).

3,298,708. FORUM SYSTEMS, SANDY, UT. SN 78-330,505. PUB. 3-28-2006, FILED 11-20-2003.

CLASS 9—(Continued).

3,298,722. DISNEY ENTERPRISES, INC., BURBANK, CA. SN 78-356,697. PUB. 6-28-2005, FILED 1-23-2004.

SSL IS NOT ENOUGH

THE MARK CONSISTS OF STANDARD CHARACTERS WITHOUT CLAIM TO ANY PARTICULAR FONT, STYLE, SIZE, OR COLOR.

NO CLAIM IS MADE TO THE EXCLUSIVE RIGHT TO USE "SSL", APART FROM THE MARK AS SHOWN.

FOR COMPUTER HARDWARE AND SOFTWARE FOR MONITORING AND MAINTAINING SECURED DATA ACROSS THE WORLD-WIDE WEB OR OTHER COMPUTER NETWORK (U.S. CLS. 21, 23, 26, 36 AND 38).

FIRST USE 5-5-2006; IN COMMERCE 5-5-2006.



3,298,712. DITECH NETWORKS, INC., MOUNTAIN VIEW, CA. SN 78-336,059. PUB. 7-5-2005, FILED 12-3-2003.

CHICKEN LITTLE

THE MARK CONSISTS OF STANDARD CHARACTERS WITHOUT CLAIM TO ANY PARTICULAR FONT, STYLE, SIZE, OR COLOR.

FOR COMPACT DISCS FEATURING MUSIC AND STORIES FOR CHILDREN; DIGITAL VIDEO DISCS FEATURING ANIMATED CHILDREN'S ADVENTURE AND COMEDY MOVIES AND MUSIC; COMPUTER GAME PROGRAMS, AND MOTION PICTURE FILMS IN THE FIELD OF ANIMATED CHILDREN'S COMEDY AND ADVENTURE (U.S. CLS. 21, 23, 26, 36 AND 38).

FIRST USE 6-9-2006; IN COMMERCE 6-9-2006.



3,298,727. IGT, RENO, NV. SN 78-367,312. PUB. 8-3-2004, FILED 2-12-2004.

VQA

THE MARK CONSISTS OF STANDARD CHARACTERS WITHOUT CLAIM TO ANY PARTICULAR FONT, STYLE, SIZE, OR COLOR.

FOR TELECOMMUNICATIONS EQUIPMENT, NAMELY, ECHO CANCELLERS AND VOICE QUALITY ASSURANCE EQUIPMENT, NAMELY COMPUTER HARDWARE FOR USE IN CIRCUIT-SWITCHED, PACKET-SWITCHED, WIRELESS AND WIRELINE NETWORKS; COMPUTER SOFTWARE TO CONTROL AND IMPROVE TELECOMMUNICATIONS EQUIPMENT SOUND QUALITY (U.S. CLS. 21, 23, 26, 36 AND 38).

FIRST USE 12-12-2006; IN COMMERCE 12-12-2006.

KLONDIKE TREASURE

THE MARK CONSISTS OF STANDARD CHARACTERS WITHOUT CLAIM TO ANY PARTICULAR FONT, STYLE, SIZE, OR COLOR.

FOR GAMING MACHINES, NAMELY, SLOT MACHINES WITH OR WITHOUT VIDEO OUTPUT, VIDEO LOTTERY TERMINALS, GAMING MACHINES FOR PLAY OF AN INTERACTIVE, ELECTRONIC BINGO GAME (U.S. CLS. 21, 23, 26, 36 AND 38).

FIRST USE 6-29-2006; IN COMMERCE 7-26-2006.

CLASS 9—(Continued).

3,298,730. ESTIMATION, INC., LINTHICUM HEIGHTS, MD.
SN 78-371,054. PUB. 8-1-2006, FILED 2-20-2004.



THE MARK CONSISTS OF STYLIZED LETTERS EIL FOR COMPUTER SOFTWARE FOR USE IN THE CONSTRUCTION INDUSTRY FOR DEVELOPING AND GENERATING ESTIMATES AND BIDS IN THE CONSTRUCTION INDUSTRY (U.S. CLS. 21, 23, 26, 36 AND 38).

FIRST USE 5-1-2003; IN COMMERCE 5-1-2003.

3,298,752. IGT, RENO, NV. SN 78-399,079. PUB. 1-11-2005,
FILED 4-8-2004.

DOUBLE STARS

THE MARK CONSISTS OF STANDARD CHARACTERS WITHOUT CLAIM TO ANY PARTICULAR FONT, STYLE, SIZE, OR COLOR.

OWNER OF U.S. REG. NO. 2,704,309.
FOR GAMING MACHINES, NAMELY, DEVICES WHICH ACCEPT A WAGER AND COMPONENTS THEREFOR, NAMELY, CONTROLLERS, DISPLAYS, BUTTON PANELS, BOLSTERS, ELECTRICAL WIRING, AND COMPUTER HARDWARE AND SOFTWARE ASSOCIATED THEREWITH (U.S. CLS. 21, 23, 26, 36 AND 38).

FIRST USE 7-28-2005; IN COMMERCE 8-15-2005.

CLASS 9—(Continued).

3,298,754. IGT, RENO, NV. SN 78-402,268. PUB. 1-4-2005,
FILED 4-15-2004.

BUT WAIT! WIN MORE!

THE MARK CONSISTS OF STANDARD CHARACTERS WITHOUT CLAIM TO ANY PARTICULAR FONT, STYLE, SIZE, OR COLOR.

FOR GAMING MACHINES, NAMELY, DEVICES WHICH ACCEPT A WAGER AND COMPONENTS THEREFOR, NAMELY, CONTROLLERS, DISPLAYS, BUTTON PANELS, BOLSTERS, ELECTRICAL WIRING, AND COMPUTER HARDWARE AND SOFTWARE ASSOCIATED THEREWITH (U.S. CLS. 21, 23, 26, 36 AND 38).

FIRST USE 4-26-2006; IN COMMERCE 4-26-2006.

3,298,759. TUMBLEWEED SOFTWARE, INC., FORT WORTH, TX. SN 78-412,753. PUB. 2-15-2005, FILED 5-4-2004.

ZOOMCARD

THE MARK CONSISTS OF STANDARD CHARACTERS WITHOUT CLAIM TO ANY PARTICULAR FONT, STYLE, SIZE, OR COLOR.

FOR PRE-PAID MAGNETICALLY ENCODED DEBIT CARDS (U.S. CLS. 21, 23, 26, 36 AND 38).

FIRST USE 6-1-2005; IN COMMERCE 6-1-2005.

3,298,773. PRESTOLITE WIRE CORPORATION, SOUTH-FIELD, MI. SN 78-433,320. PUB. 7-5-2005, FILED 6-10-2004.

PRESTOMAX

THE MARK CONSISTS OF STANDARD CHARACTERS WITHOUT CLAIM TO ANY PARTICULAR FONT, STYLE, SIZE, OR COLOR.

FOR ELECTRICAL WIRE AND CABLE (U.S. CLS. 21, 23, 26, 36 AND 38).

FIRST USE 10-0-2006; IN COMMERCE 10-0-2006.

CLASS 9—(Continued).

3,298,806. SILVERBACK TECHNOLOGIES, INC., RENO, NV.
SN 78-462,909. PUB. 12-13-2005, FILED 8-5-2004.

CLASS 9—(Continued).

3,298,822. ARTISENT, INC., BOSTON, MA. SN 78-477,992.
PUB. 2-21-2006, FILED 9-2-2004.

R3D3

THE MARK CONSISTS OF STANDARD CHARACTERS WITHOUT CLAIM TO ANY PARTICULAR FONT, STYLE, SIZE, OR COLOR.

FOR WIRELESS COMMUNICATIONS EQUIPMENT, NAMELY ANTENNAS, MODULAR MAST SYSTEMS COMPRISED OF A BASE, A SUPPORT MAST, AND CONNECTORS FOR SUPPORTING SYSTEM COMPONENTS SUCH AS ANTENNAS, POWER SOURCES, AND TELECOMMUNICATION SENSORS; MOBILE ANTENNA SYSTEMS COMPRISED OF ANTENNAS FOR WIRELESS COMMUNICATION APPARATUS, AND MOUNTING DEVICES FOR CAMERAS (U.S. CLS. 21, 23, 26, 36 AND 38).

FIRST USE 10-28-2006; IN COMMERCE 10-28-2006.



3,298,808. CABOT SAFETY INTERMEDIATE CORPORATION, NEWARK, DE. SN 78-465,485. PUB. 7-5-2005, FILED 8-11-2004.

M-TAC

THE MARK CONSISTS OF STANDARD CHARACTERS WITHOUT CLAIM TO ANY PARTICULAR FONT, STYLE, SIZE, OR COLOR.

FOR GAS MASKS; RESPIRATORS, NOT FOR MEDICAL USE (U.S. CLS. 21, 23, 26, 36 AND 38).

FIRST USE 7-0-2006; IN COMMERCE 7-0-2006.

THE MARK CONSISTS OF TWO CONCENTRIC CIRCLES, WITH THE OUTER CIRCLE BEING THINNER THAN THE INNER CIRCLE. THE INSIDE CIRCLE IS BROKEN WITH OPEN SPACES IN BOTH THE HORIZONTAL AND VERTICAL PLANES, FORMING AN INVERSE TARGET "CROSS-HAIRS" RESULT. INSIDE BOTH CIRCLES IS AN ABSTRACT, FORK-LIKE IMAGE WITH BOTH HORIZONTAL AND ANGULAR LINES IN THE SAME VALUE AS THE TWO OUTER CONCENTRIC CIRCLES. LASTLY, THERE IS THE WORD HALO WHICH EXISTS BELOW THE MORE RIGHT PORTION OF THE HORIZONTAL LINES IN THE ABSTRACT, FORK-LIKE IMAGE.

FOR EXTERNAL PERIMETER COMPONENT MOLDED ONTO PROTECTIVE HELMETS FOR USE BY MILITARY AND LAW ENFORCEMENT, SERVING AS A MOUNTING BASE FOR DETACHABLE DEVICES SUCH AS PROTECTIVE FACE MASK, HEAD PHONES, CAMERAS AND LIGHTS (U.S. CLS. 21, 23, 26, 36 AND 38).

FIRST USE 2-2-2007; IN COMMERCE 2-2-2007.

CLASS 9—(Continued).

3,298,823. ADVANCED CHIP ENGINEERING TECHNOLOGY INC., HSINCHU HSIEN, TAIWAN. SN 78-478,344. PUB. 1-3-2006, FILED 9-3-2004.

CLASS 9—(Continued).

3,298,826. ADVANCED CHIP ENGINEERING TECHNOLOGY INC., HSINCHU HSIEN, TAIWAN. SN 78-479,249. PUB. 1-3-2006, FILED 9-7-2004.

AMEBA-CSP

LGA

THE MARK CONSISTS OF STANDARD CHARACTERS WITHOUT CLAIM TO ANY PARTICULAR FONT, STYLE, SIZE, OR COLOR.

FOR FLASH MEMORY CARD; FLOATING-POINT OPERATION COMPUTER CHIP; BLANK ELECTRONIC CHIP CARDS, BLANK SMART CARDS; ENCODED ELECTRONIC CHIP CARDS, NAMELY, SMART CARDS CONTAINING PROGRAMMING FOR STORING PERSONAL DATA, NAMELY PERSONAL IDENTIFICATION, BANK INFORMATION OR HEALTH DATA; INTEGRATED CIRCUITS; MEMORY CARDS, COMPUTER HARDWARE; MICRO-CIRCUITS FOR SILICON CHIPS; MICRO-PROCESSORS UNIT CHIPS; STRUCTURE SEMICONDUCTOR WAFERS; RAM (RANDOM ACCESS MEMORY) CARD; ROM (READ ONLY MEMORY) CHIPS; SEMICONDUCTOR MEMORY UNITS; SEMICONDUCTOR CHIPS; SEMICONDUCTOR POWER ELEMENTS; SEMICONDUCTOR DEVICES; SILICON CHIPS; SILICON WAFERS; ULSI (ULTRA LARGE SCALE INTEGRATED) CHIPS; VLSI (VERY LARGE SCALE INTEGRATED) CHIPS; SILICON WAFERS; AND ELECTRONIC COMPONENTS, NAMELY COPPER WAFERS, POTASSIUM ARSENIDE WAFERS (U.S. CLS. 21, 23, 26, 36 AND 38).

FIRST USE 10-4-2006; IN COMMERCE 10-4-2006.

NO CLAIM IS MADE TO THE EXCLUSIVE RIGHT TO USE "LGA", APART FROM THE MARK AS SHOWN.

FOR FLASH MEMORY CARD; FLOATING-POINT OPERATION COMPUTER CHIP; BLANK ELECTRONIC CHIP CARDS, BLANK SMART CARDS; ENCODED ELECTRONIC CHIP CARDS, NAMELY, SMART CARDS CONTAINING PROGRAMMING FOR STORING PERSONAL DATA, NAMELY PERSONAL IDENTIFICATION, BANK INFORMATION OR HEALTH DATA; INTEGRATED CIRCUITS; MEMORY CARDS, COMPUTER HARDWARE; MICRO-CIRCUITS FOR SILICON CHIPS; MICRO-PROCESSORS UNIT CHIPS; STRUCTURE SEMICONDUCTOR WAFERS; RAM (RANDOM ACCESS MEMORY) CARD; ROM (READ ONLY MEMORY) CHIPS; SEMICONDUCTOR MEMORY UNITS; SEMICONDUCTOR CHIPS; SEMICONDUCTOR POWER ELEMENTS; SEMICONDUCTOR DEVICES; SILICON CHIPS; SILICON WAFERS; ULSI (ULTRA LARGE SCALE INTEGRATED) CHIPS; VLSI (VERY LARGE SCALE INTEGRATED) CHIPS; SILICON WAFERS; AND ELECTRONIC COMPONENTS, NAMELY COPPER WAFERS, POTASSIUM ARSENIDE WAFERS (U.S. CLS. 21, 23, 26, 36 AND 38).

FIRST USE 10-11-2006; IN COMMERCE 10-11-2006.

CLASS 9—(Continued).

3,298,827. ADVANCED CHIP ENGINEERING TECHNOLOGY INC., HSINCHU HSIEN, TAIWAN. SN 78-479,250. PUB. 1-3-2006, FILED 9-7-2004.

CLASS 9—(Continued).

3,298,828. ADVANCED CHIP ENGINEERING TECHNOLOGY INC., HSINCHU HSIEN, TAIWAN. SN 78-479,251. PUB. 1-3-2006, FILED 9-7-2004.



NO CLAIM IS MADE TO THE EXCLUSIVE RIGHT TO USE "SiP", APART FROM THE MARK AS SHOWN.

FOR FLASH MEMORY CARD; FLOATING-POINT OPERATION COMPUTER CHIP; BLANK ELECTRONIC CHIP CARDS, BLANK SMART CARDS; ENCODED ELECTRONIC CHIP CARDS, NAMELY, SMART CARDS CONTAINING PROGRAMMING FOR STORING PERSONAL DATA, NAMELY PERSONAL IDENTIFICATION, BANK INFORMATION OR HEALTH DATA; INTEGRATED CIRCUITS; MEMORY CARDS, COMPUTER HARDWARE; MICRO-CIRCUITS FOR SILICON CHIPS; MICRO-PROCESSORS UNIT CHIPS; STRUCTURE SEMICONDUCTOR WAFERS; RAM (RANDOM ACCESS MEMORY) CARD; ROM (READ ONLY MEMORY) CHIPS; SEMICONDUCTOR MEMORY UNITS; SEMICONDUCTOR CHIPS; SEMICONDUCTOR POWER ELEMENTS; SEMICONDUCTOR DEVICES; SILICON CHIPS; SILICON WAFERS; ULSI (ULTRA LARGE SCALE INTEGRATED) CHIPS; VLSI (VERY LARGE SCALE INTEGRATED) CHIPS; SILICON WAFERS; AND ELECTRONIC COMPONENTS, NAMELY COPPER WAFERS, POTASSIUM ARSENIDE WAFERS (U.S. CLS. 21, 23, 26, 36 AND 38).

FIRST USE 8-30-2006; IN COMMERCE 8-30-2006.

NO CLAIM IS MADE TO THE EXCLUSIVE RIGHT TO USE "BGA", APART FROM THE MARK AS SHOWN.

FOR FLASH MEMORY CARD; FLOATING-POINT OPERATION COMPUTER CHIP; BLANK ELECTRONIC CHIP CARDS, BLANK SMART CARDS; ENCODED ELECTRONIC CHIP CARDS, NAMELY, SMART CARDS CONTAINING PROGRAMMING FOR STORING PERSONAL DATA, NAMELY PERSONAL IDENTIFICATION, BANK INFORMATION OR HEALTH DATA; INTEGRATED CIRCUITS; MEMORY CARDS, COMPUTER HARDWARE; MICRO-CIRCUITS FOR SILICON CHIPS; MICRO-PROCESSORS UNIT CHIPS; STRUCTURE SEMICONDUCTOR WAFERS; RAM (RANDOM ACCESS MEMORY) CARD; ROM (READ ONLY MEMORY) CHIPS; SEMICONDUCTOR MEMORY UNITS; SEMICONDUCTOR CHIPS; SEMICONDUCTOR POWER ELEMENTS; SEMICONDUCTOR DEVICES; SILICON CHIPS; SILICON WAFERS; ULSI (ULTRA LARGE SCALE INTEGRATED) CHIPS; VLSI (VERY LARGE SCALE INTEGRATED) CHIPS; SILICON WAFERS; AND ELECTRONIC COMPONENTS, NAMELY COPPER WAFERS, POTASSIUM ARSENIDE WAFERS (U.S. CLS. 21, 23, 26, 36 AND 38).

FIRST USE 7-26-2006; IN COMMERCE 7-26-2006.

CLASS 9—(Continued).

3,298,829. ADVANCED CHIP ENGINEERING TECHNOLOGY INC., HSINCHU HSIEN, TAIWAN. SN 78-479,267. PUB. 1-3-2006, FILED 9-7-2004.

CLASS 9—(Continued).

3,298,830. ADVANCED CHIP ENGINEERING TECHNOLOGY INC., HSINCHU HSIEN, TAIWAN. SN 78-479,268. PUB. 1-3-2006, FILED 9-7-2004.

AMEBA-SIP**AMEBA-BGA**

THE MARK CONSISTS OF STANDARD CHARACTERS WITHOUT CLAIM TO ANY PARTICULAR FONT, STYLE, SIZE, OR COLOR.

FOR FLASH MEMORY CARD; FLOATING-POINT OPERATION COMPUTER CHIP; BLANK ELECTRONIC CHIP CARDS, BLANK SMART CARDS; ENCODED ELECTRONIC CHIP CARDS, NAMELY, SMART CARDS CONTAINING PROGRAMMING FOR STORING PERSONAL DATA, NAMELY PERSONAL IDENTIFICATION, BANK INFORMATION OR HEALTH DATA; INTEGRATED CIRCUITS; MEMORY CARDS, COMPUTER HARDWARE; MICRO-CIRCUITS FOR SILICON CHIPS; MICRO-PROCESSORS UNIT CHIPS; STRUCTURE SEMICONDUCTOR WAFERS; RAM (RANDOM ACCESS MEMORY) CARD; ROM (READ ONLY MEMORY) CHIPS; SEMICONDUCTOR MEMORY UNITS; SEMICONDUCTOR CHIPS; SEMICONDUCTOR POWER ELEMENTS; SEMICONDUCTOR DEVICES; SILICON CHIPS; SILICON WAFERS; ULSI (ULTRA LARGE SCALE INTEGRATED) CHIPS; VLSI (VERY LARGE SCALE INTEGRATED) CHIPS; SILICON WAFERS; AND ELECTRONIC COMPONENTS, NAMELY COPPER WAFERS, POTASSIUM ARSENIDE WAFERS (U.S. CLS. 21, 23, 26, 36 AND 38).

FIRST USE 8-30-2006; IN COMMERCE 8-30-2006.

THE MARK CONSISTS OF STANDARD CHARACTERS WITHOUT CLAIM TO ANY PARTICULAR FONT, STYLE, SIZE, OR COLOR.

FOR FLASH MEMORY CARD; FLOATING-POINT OPERATION COMPUTER CHIP; BLANK ELECTRONIC CHIP CARDS, BLANK SMART CARDS; ENCODED ELECTRONIC CHIP CARDS, NAMELY, SMART CARDS CONTAINING PROGRAMMING FOR STORING PERSONAL DATA, NAMELY, PERSONAL IDENTIFICATION, BANK INFORMATION OR HEALTH DATA; INTEGRATED CIRCUITS; MEMORY CARDS, COMPUTER HARDWARE; MICRO-CIRCUITS FOR SILICON CHIPS; MICRO-PROCESSORS UNIT CHIPS; STRUCTURE SEMICONDUCTOR WAFERS; RAM (RANDOM ACCESS MEMORY) CARD; ROM (READ ONLY MEMORY) CHIPS; SEMICONDUCTOR MEMORY UNITS; SEMICONDUCTOR CHIPS; SEMICONDUCTOR POWER ELEMENTS; SEMICONDUCTOR DEVICES; SILICON CHIPS; SILICON WAFERS; ULSI (ULTRA LARGE SCALE INTEGRATED) CHIPS; VLSI (VERY LARGE SCALE INTEGRATED) CHIPS; SILICON WAFERS; AND ELECTRONIC COMPONENTS, NAMELY, COPPER WAFERS, POTASSIUM ARSENIDE WAFERS (U.S. CLS. 21, 23, 26, 36 AND 38).

FIRST USE 7-26-2006; IN COMMERCE 7-26-2006.

CLASS 9—(Continued).

3,298,833. ADVANCED CHIP ENGINEERING TECHNOLOGY INC., HSINCHU HSIEN, TAIWAN. SN 78-479,937. PUB. 1-3-2006, FILED 9-8-2004.

AMEBA-LGA

THE MARK CONSISTS OF STANDARD CHARACTERS WITHOUT CLAIM TO ANY PARTICULAR FONT, STYLE, SIZE, OR COLOR.

FOR FLASH MEMORY CARD; FLOATING-POINT OPERATION COMPUTER CHIP; BLANK ELECTRONIC CHIP CARDS, BLANK SMART CARDS; ENCODED ELECTRONIC CHIP CARDS, NAMELY, SMART CARDS CONTAINING PROGRAMMING FOR STORING PERSONAL DATA, NAMELY PERSONAL IDENTIFICATION, BANK INFORMATION OR HEALTH DATA; INTEGRATED CIRCUITS; MEMORY CARDS, COMPUTER HARDWARE; MICRO-CIRCUITS FOR SILICON CHIPS; MICRO-PROCESSORS UNIT CHIPS; STRUCTURE SEMICONDUCTOR WAFERS; RAM (RANDOM ACCESS MEMORY) CARD; ROM (READ ONLY MEMORY) CHIPS; SEMICONDUCTOR MEMORY UNITS; SEMICONDUCTOR CHIPS; SEMICONDUCTOR POWER ELEMENTS; SEMICONDUCTOR DEVICES; SILICON CHIPS; SILICON WAFERS; ULSI (ULTRA LARGE SCALE INTEGRATED) CHIPS; VLSI (VERY LARGE SCALE INTEGRATED) CHIPS; SILICON WAFERS; AND ELECTRONIC COMPONENTS, NAMELY, COPPER WAFERS, POTASSIUM ARSENIDE WAFERS (U.S. CLS. 21, 23, 26, 36 AND 38).

FIRST USE 10-11-2006; IN COMMERCE 10-11-2006.

3,298,844. XEROX CORPORATION, STAMFORD, CT. SN 78-490,911. PUB. 1-10-2006, FILED 9-28-2004.

SMART KIT

THE MARK CONSISTS OF STANDARD CHARACTERS WITHOUT CLAIM TO ANY PARTICULAR FONT, STYLE, SIZE, OR COLOR.

NO CLAIM IS MADE TO THE EXCLUSIVE RIGHT TO USE "KIT", APART FROM THE MARK AS SHOWN.

FOR PARTS FOR LASER PRINTERS, COMPUTER PRINTERS, PHOTOCOPIERS, AND OPTICAL CHARACTER RECOGNITION (OCR) SCANNERS, NAMELY FUSER, XEROGRAPHIC/PRINT MODULE, OZONE FILTER, AND TONER CARTRIDGE (U.S. CLS. 21, 23, 26, 36 AND 38).

FIRST USE 10-1-2004; IN COMMERCE 10-1-2004.

CLASS 9—(Continued).

3,298,865. SAFETY HELMETS CANADA, INC., MEMPHIS, TN. SN 78-511,949. PUB. 4-11-2006, FILED 11-5-2004.

FUEL

THE MARK CONSISTS OF STANDARD CHARACTERS WITHOUT CLAIM TO ANY PARTICULAR FONT, STYLE, SIZE, OR COLOR.

FOR MOTORCYCLE HELMETS; SPEAKERS, AMPLIFIERS AND SIGNAL PROCESSORS FOR CUSTOM AUTOMOTIVE AUDIO SYSTEMS (U.S. CLS. 21, 23, 26, 36 AND 38).

FIRST USE 9-8-2005; IN COMMERCE 9-8-2005.

3,298,870. FULL COMPASS SYSTEMS, LTD., MIDDLETON, WI. SN 78-517,484. PUB. 10-3-2006, FILED 11-16-2004.

CLONE TONE

THE MARK CONSISTS OF STANDARD CHARACTERS WITHOUT CLAIM TO ANY PARTICULAR FONT, STYLE, SIZE, OR COLOR.

FOR BLANK AUDIO AND VIDEO TAPE CASSETTES; COMPUTER HARDWARE AND SOFTWARE FOR AUDIO, VIDEO, COMMUNICATIONS, AND MULTIMEDIA PRODUCTION AND MANAGEMENT (U.S. CLS. 21, 23, 26, 36 AND 38).

FIRST USE 3-7-1978; IN COMMERCE 10-13-2004.

CLASS 9—(Continued).

3,298,871. WILCOXON RESEARCH, INC., GERMANTOWN, MD. SN 78-517,784. PUB. 5-2-2006, FILED 11-16-2004.

CLASS 9—(Continued).

3,298,891. NAMCO BANDAI GAMES INC., OTA-KU, TOKYO, JAPAN. SN 78-531,641. PUB. 7-25-2006, FILED 12-13-2004.

VibeLink

THE MARK CONSISTS OF STANDARD CHARACTERS WITHOUT CLAIM TO ANY PARTICULAR FONT, STYLE, SIZE, OR COLOR.

FOR INDUSTRIAL SENSOR NETWORK, NAMELY, SOFTWARE USED TO DISPLAY THE PROCESSED DATA OUTPUT FROM VIBRATION SENSORS (U.S. CLS. 21, 23, 26, 36 AND 38).

FIRST USE 7-13-2005; IN COMMERCE 7-13-2005.

LUMINES

THE MARK CONSISTS OF STANDARD CHARACTERS WITHOUT CLAIM TO ANY PARTICULAR FONT, STYLE, SIZE, OR COLOR.

PRIORITY CLAIMED UNDER SEC. 44(D) ON JAPAN APPLICATION NO. 2004-068452, FILED 7-23-2004.

FOR COMPUTER PROGRAMS FOR USE IN OPERATING INTERACTIVE GAMES ON MULTIMEDIA DEVICES, VIDEO GAME MACHINES (U.S. CLS. 21, 23, 26, 36 AND 38).

FIRST USE 12-12-2004; IN COMMERCE 3-24-2005.

3,298,876. SYNAPSIS TECHNOLOGY, INC., SPRING HOUSE, PA. SN 78-521,953. PUB. 3-28-2006, FILED 11-23-2004.

3,298,892. NAMCO BANDAI GAMES INC., OTA-KU, TOKYO, JAPAN. SN 78-531,651. PUB. 7-25-2006, FILED 12-13-2004.

EMARS

THE MARK CONSISTS OF STANDARD CHARACTERS WITHOUT CLAIM TO ANY PARTICULAR FONT, STYLE, SIZE, OR COLOR.

FOR REGULATORY COMPLIANCE MANAGEMENT AND REPORTING SOFTWARE (U.S. CLS. 21, 23, 26, 36 AND 38).

FIRST USE 8-5-2004; IN COMMERCE 8-5-2004.

METEOS

THE MARK CONSISTS OF STANDARD CHARACTERS WITHOUT CLAIM TO ANY PARTICULAR FONT, STYLE, SIZE, OR COLOR.

PRIORITY CLAIMED UNDER SEC. 44(D) ON JAPAN APPLICATION NO. 2004-070184, FILED 7-29-2004.

FOR COMPUTER PROGRAMS FOR USE IN OPERATING INTERACTIVE GAMES ON MULTIMEDIA DEVICES, PRE-RECORDED PROGRAMS FOR GAMES WITH LIQUID CRYSTAL DISPLAYS (U.S. CLS. 21, 23, 26, 36 AND 38).

FIRST USE 3-10-2005; IN COMMERCE 6-27-2005.

CLASS 9—(Continued).

3,298,902. FIRST AUDIO MANUFACTURING (HONG KONG) LIMITED, KOWLOON, HONG KONG. SN 78-542,759. PUB. 6-6-2006, FILED 1-5-2005.

CLASS 9—(Continued).

3,298,914. WI-TRONIX, LLC, BOLINGBROOK, IL. SN 78-549,679. PUB. 3-21-2006, FILED 1-19-2005.

DJ-TECH

WI-TRONIX

THE MARK CONSISTS OF STANDARD CHARACTERS WITHOUT CLAIM TO ANY PARTICULAR FONT, STYLE, SIZE, OR COLOR.

FOR COMPUTER SOFTWARE FOR COLLECTION, STORAGE, ANALYSIS AND PRESENTATION OF DATA OBTAINED FROM LOCOMOTIVES FOR CONTROL AND MONITORING OF BOTH INTEGRATED AND NON-INTEGRATED ELECTRONIC SYSTEMS AND DEVICES, NAMELY, TRACTION CONTROL SYSTEM, ENGINE, BRAKING SYSTEM, OPERATOR ALERTING AND SAFETY WARNING SYSTEM, TRANSMISSION FLUID LEVEL MONITORING SYSTEM, ENGINE TEMPERATURE CONTROL SYSTEM AND SHOCK ABSORBERS (U.S. CLS. 21, 23, 26, 36 AND 38).

FIRST USE 2-15-2005; IN COMMERCE 2-15-2005.

3,298,915. WI-TRONIX, LLC, BOLINGBROOK, IL. SN 78-549,684. PUB. 3-28-2006, FILED 1-19-2005.



THE MARK CONSISTS OF STANDARD CHARACTERS WITHOUT CLAIM TO ANY PARTICULAR FONT, STYLE, SIZE, OR COLOR.

FOR APPARATUS FOR RECORDING, TRANSMISSION OR REPRODUCTION OF SOUND AND IMAGES; AMPLIFIERS; MP3 PLAYERS; PORTABLE RADIO CASSETTE PLAYERS; DIGITAL AUDIO TAPE RECORDERS AND PLAYERS; SING-ALONG COMPACT DISC PLAYERS AND RECORDERS; PORTABLE AUDIO COMPACT DISC PLAYERS, CASSETTE PLAYERS; LOUDSPEAKERS; HORNS FOR LOUDSPEAKERS; LOUDSPEAKER CABINETS; SOUND MIXERS; STEREO EQUALIZERS; STEREO TUNERS; RADIOS; MICROPHONES; SOUND AND/OR VIDEO RECORDING MEDIA IN THE FORM OF DISCS AND TAPES, NAMELY, BLANK DVDS, CDS, COMPUTER DISCS, AUDIO TAPES, VIDEO TAPES; AUDIO SPEAKERS; REMOTE CONTROLLER, HEADPHONES, EARPHONES AND CABLES FOR USE WITH AUDIO AND VIDEO APPARATUS (U.S. CLS. 21, 23, 26, 36 AND 38).

FIRST USE 4-23-2007; IN COMMERCE 4-23-2007.

THE COLOR(S) ORANGE AND PURPLE IS/ARE CLAIMED AS A FEATURE OF THE MARK.

THE COLOR ORANGE APPEARS IN THE LETTERS W,I,R,O,N,I, THE HYPHEN AND THE OVAL DESIGN. THE COLOR PURPLE APPEARS IN THE LETTERS T AND X.

THE MARK CONSISTS OF STYLIZED WORD WI-TRONIX WITH STYLIZED LETTER T AND THE LETTER X INCLUDED AS PART OF A CIRCLE.

FOR COMPUTER SOFTWARE FOR COLLECTION, STORAGE, ANALYSIS AND PRESENTATION OF DATA OBTAINED FROM LOCOMOTIVES FOR CONTROL AND MONITORING OF BOTH INTEGRATED AND NON-INTEGRATED ELECTRONIC SYSTEMS AND DEVICES, NAMELY, TRACTION CONTROL SYSTEM, ENGINE, BRAKING SYSTEM, OPERATOR ALERTING AND SAFETY WARNING SYSTEM, TRANSMISSION FLUID LEVEL MONITORING SYSTEM, ENGINE TEMPERATURE CONTROL SYSTEM AND SHOCK ABSORBERS (U.S. CLS. 21, 23, 26, 36 AND 38).

FIRST USE 2-15-2005; IN COMMERCE 2-15-2005.

CLASS 9—(Continued).

3,298,916. SILICON LABORATORIES INC., AUSTIN, TX. SN 78-550,376. PUB. 2-21-2006, FILED 1-19-2005.

SILABS

THE MARK CONSISTS OF STANDARD CHARACTERS WITHOUT CLAIM TO ANY PARTICULAR FONT, STYLE, SIZE, OR COLOR.

FOR INTEGRATED CIRCUITS; COMPUTERS; SEMI-CONDUCTORS; MODEMS; INTEGRATED RADIO FREQUENCY TRANSCEIVERS, SYNTHESIZERS AND TUNERS; AND TRANSMITTERS OF ELECTRONIC SIGNALS (U.S. CLS. 21, 23, 26, 36 AND 38).

FIRST USE 2-19-2007; IN COMMERCE 2-19-2007.

CLASS 9—(Continued).

3,298,946. POLYPOWER TECH. CO., LTD, HSICHIH CITY, TAIPEI HSIEN, TAIWAN. SN 78-568,042. PUB. 8-29-2006, FILED 2-15-2005.

POLYPOWER

FOR COMPUTER INTERFACE CARDS; NETWORK INTERFACE CARDS; MODEMS; COMPUTER NETWORK HUBS AND ROUTERS; COMMUNICATION HUBS; GATEWAY ROUTERS IN THE NATURE OF COMPUTER CONTROL HARDWARE, NAMELY FOR TRANSMITTING AND RECEIVING DATA OVER COMPUTER NETWORKS, NAMELY, VOICE OVER INTERNET PROTOCOL, LOCAL AREA NETWORK, WIDE LOCAL AREA NETWORK, VIRTUAL PRIVATE NETWORK, DIGITAL SUBSCRIBER LINE, AND WIRELESS TELECOMMUNICATIONS NETWORKS; NETWORK COMMUNICATION EQUIPMENT, NAMELY, OPTICAL CABLES (U.S. CLS. 21, 23, 26, 36 AND 38).

FIRST USE 5-20-2005; IN COMMERCE 1-20-2006.

3,298,923. POWER COMMUNICATION TECHNOLOGY CO., LTD., TAIPEI, TAIWAN. SN 78-555,905. PUB. 6-20-2006, FILED 1-28-2005.

PRIORITY CLAIMED UNDER SEC. 44(D) ON TAIWAN APPLICATION NO. 093034907, FILED 7-28-2004.

FOR SWITCHING-SIGNAL ELECTRICAL CONNECTORS; TELECOMMUNICATION CABLES; SIGNAL PROCESSORS; MICRO PROCESSORS; COMPUTER CENTRAL PROCESSING UNITS; ELECTRIC WIRES; ELECTRIC CABLES; ELECTRICAL SIGNAL SWITCHES FOR PERSONAL USE ON COMPUTERS; MULTI-COMPUTER POWER CONTROLLERS; COMPUTER NETWORKING HARDWARE; CABLES AND FIBERS FOR THE TRANSMISSION OF IMAGE AND SOUND; COMPUTER NETWORKING HUBS, SWITCHES AND ROUTERS; COMPUTER MONITORS; KEYBOARDS; COMPUTER MOUSE, NAMELY TRACKBALLS; AUDIO SPEAKERS; COMPUTER CABLES; AUTO KEYBOARD, VIDEO AND MOUSE SWITCHES; AND AUTOMATIC POWER SWITCHES (U.S. CLS. 21, 23, 26, 36 AND 38).

FIRST USE 2-1-2005; IN COMMERCE 2-1-2005.

3,298,948. LERNER, IRA S., NEW YORK, NY. SN 78-568,191. PUB. 10-10-2006, FILED 2-16-2005.

I STUDIO

THE MARK CONSISTS OF STANDARD CHARACTERS WITHOUT CLAIM TO ANY PARTICULAR FONT, STYLE, SIZE, OR COLOR.

NO CLAIM IS MADE TO THE EXCLUSIVE RIGHT TO USE "STUDIO", APART FROM THE MARK AS SHOWN.

FOR EYEWEAR, NAMELY, OPHTHALMIC FRAMES; PRESCRIPTION AND NON-PRESCRIPTION EYEGLASSES; SUNGLASSES; PROTECTIVE EYEWEAR; CLIP-ON LENS ATTACHMENTS; MAGNETIC EYEWEAR, NAMELY, EYEWEAR THAT UTILIZES MAGNETS TO SECURE A SECONDARY LENS OR LENSES TO A PRIMARY PAIR OF EYEGLASSES OR SUNGLASSES; GOGGLES FOR SPORTS (U.S. CLS. 21, 23, 26, 36 AND 38).

FIRST USE 5-10-2005; IN COMMERCE 1-15-2006.

CLASS 9—(Continued).

3,298,954. SWANSON TOOL COMPANY, INC., FRANKFORD, IL. SN 78-570,438. PUB. 6-6-2006, FILED 2-18-2005.

PRO-CAST

THE MARK CONSISTS OF STANDARD CHARACTERS WITHOUT CLAIM TO ANY PARTICULAR FONT, STYLE, SIZE, OR COLOR.

FOR HAND TOOLS, NAMELY, LASER, PLUMB AND SPIRIT LEVELS (U.S. CLS. 21, 23, 26, 36 AND 38).
FIRST USE 5-1-2005; IN COMMERCE 5-1-2005.

3,298,963. SARCOS INVESTMENTS LC, SALT LAKE CITY, UT. SN 78-573,648. PUB. 6-13-2006, FILED 2-23-2005.

XOS

THE MARK CONSISTS OF STANDARD CHARACTERS WITHOUT CLAIM TO ANY PARTICULAR FONT, STYLE, SIZE, OR COLOR.

FOR ROBOTIC MAN AMPLIFIER SYSTEMS, NAMELY ROBOTIC EXOSKELETON SUITS WORN BY HUMANS FOR THE PURPOSE OF ENHANCING THE STRENGTH AND ENDURANCE OF THE PERSON WEARING THE SUIT; PERSONNEL AMPLIFICATION SYSTEMS, NAMELY ROBOTIC EXOSKELETON SUITS WORN BY MILITARY PERSONNEL AND OTHERS IN COMBATIVE AND DANGEROUS ENVIRONMENTS FOR ENHANCING THE ENDURANCE AND STRENGTH OF THE PERSON WEARING THE SUIT (U.S. CLS. 21, 23, 26, 36 AND 38).

FIRST USE 2-0-2005; IN COMMERCE 2-0-2006.

3,298,964. SPX CORPORATION, CHARLOTTE, NC. SN 78-574,192. PUB. 11-15-2005, FILED 2-24-2005.

DF FIRST

THE MARK CONSISTS OF STANDARD CHARACTERS WITHOUT CLAIM TO ANY PARTICULAR FONT, STYLE, SIZE, OR COLOR.

CLASS 9—(Continued).

NO CLAIM IS MADE TO THE EXCLUSIVE RIGHT TO USE "DF", APART FROM THE MARK AS SHOWN.

FOR COMPUTER HARDWARE AND SOFTWARE USED FOR RADIO SIGNAL INTERCEPT, COLLECTION AND DIRECTION FINDING WITHIN FREQUENCY RANGE 0.1 MHZ TO 3 GHZ; RECEIVERS AND PROCESSORS FOR USE IN SUCH SIGNAL PROCESSING SYSTEMS (U.S. CLS. 21, 23, 26, 36 AND 38).

FIRST USE 8-17-2004; IN COMMERCE 8-17-2004.

3,298,985. INTEGRA5 COMMUNICATIONS, INC., BURLINGTON, MA. SN 78-585,177. PUB. 12-13-2005, FILED 3-11-2005.

UNIPC

THE MARK CONSISTS OF STANDARD CHARACTERS WITHOUT CLAIM TO ANY PARTICULAR FONT, STYLE, SIZE, OR COLOR.

FOR COMPUTER HARDWARE AND SOFTWARE INTEGRATING VOICE TELEPHONY, CALLER ID, CALL HISTORY AND VOICE-MAIL MESSAGE WAITING FOR OPERATION ON A PERSONAL COMPUTER (U.S. CLS. 21, 23, 26, 36 AND 38).

FIRST USE 8-11-2006; IN COMMERCE 3-12-2007.

3,299,001. POST GLOVER RESISTORS, INC., ERLANGER, KY. SN 78-591,212. PUB. 6-27-2006, FILED 3-21-2005.

POST GLOVER RESISTORS

THE MARK CONSISTS OF STANDARD CHARACTERS WITHOUT CLAIM TO ANY PARTICULAR FONT, STYLE, SIZE, OR COLOR.

OWNER OF U.S. REG. NO. 2,900,240.

NO CLAIM IS MADE TO THE EXCLUSIVE RIGHT TO USE "RESISTORS", APART FROM THE MARK AS SHOWN.

FOR ELECTRICAL INDUSTRIAL EQUIPMENT, NAMELY, POWER RESISTORS FOR USE IN NEUTRAL GROUNDING, GROUND FAULT FINDING, GROUND FAULT INDICATION, GROUND FAULT MONITORING, HARMONIC FILTERING, AND ELECTRICAL LOAD BANKS (U.S. CLS. 21, 23, 26, 36 AND 38).

FIRST USE 1-1-1980; IN COMMERCE 1-1-1980.

CLASS 9—(Continued).

3,299,017. DC COMICS, NEW YORK, NY. SN 78-595,124. PUB. 12-27-2005, FILED 3-25-2005.

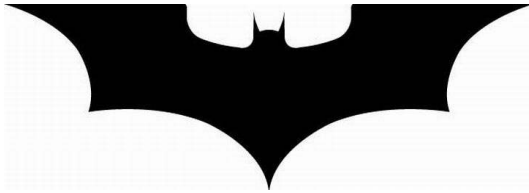

THE MARK CONSISTS OF DESIGN OF BAT.
FOR MOTION PICTURE FILMS FEATURING COMEDY, DRAMA, ACTION, ADVENTURE AND/OR ANIMATION, AND MOTION PICTURE FILMS FOR BROADCAST ON TELEVISION FEATURING COMEDY, DRAMA, ACTION, ADVENTURE AND/OR ANIMATION; AUDIO TAPES, AUDIO-VIDEO TAPES, AUDIO VIDEO CASSETTES, AUDIO VIDEO DISCS, AND DIGITAL VERSATILE DISCS FEATURING MUSIC, COMEDY, DRAMA, ACTION, ADVENTURE, AND/OR ANIMATION; CD ROM COMPUTER GAME DISCS; SHORT MOTION PICTURE FILM CASSETTES FEATURING COMEDY, DRAMA, ACTION, ADVENTURE AND/OR ANIMATION TO BE USED WITH HAND-HELD VIEWERS OR PROJECTORS; MOUSE PADS; SUNGLASSES AND CASES THEREFORE; AUDIO TAPES AND BOOKLETS SOLD AS A UNIT FEATURING COMEDY, DRAMA, ACTION, ADVENTURE, ANIMATION AND MUSIC INFORMATION; COMPUTER PROGRAMS, NAMELY, SOFTWARE LINKING DIGITIZED VIDEO AND AUDIO MEDIA TO A GLOBAL COMPUTER INFORMATION NETWORK; GAME EQUIPMENT SOLD AS A UNIT FOR PLAYING A PARLOR-TYPE COMPUTER GAME; VIDEO AND COMPUTER GAME PROGRAMS; VIDEO GAME CARTRIDGES AND CASSETTES; CELLULAR TELEPHONE ACCESSORIES, NAMELY, HANDS-FREE ACCESSORIES, CELLULAR TELEPHONE COVERS AND CELLULAR TELEPHONE FACE COVERS; AND DECORATIVE MAGNETS (U.S. CLS. 21, 23, 26, 36 AND 38).

FIRST USE 6-15-2005; IN COMMERCE 6-15-2005.

3,299,018. TOSHIBA AMERICA CONSUMER PRODUCTS, L.L.C., WAYNE, NJ. SN 78-595,319. PUB. 7-25-2006, FILED 3-25-2005.

CUSTOM SERIES

THE MARK CONSISTS OF STANDARD CHARACTERS WITHOUT CLAIM TO ANY PARTICULAR FONT, STYLE, SIZE, OR COLOR.

NO CLAIM IS MADE TO THE EXCLUSIVE RIGHT TO USE "SERIES", APART FROM THE MARK AS SHOWN.

FOR TELEVISIONS; VIDEO MONITORS (U.S. CLS. 21, 23, 26, 36 AND 38).

FIRST USE 5-28-2005; IN COMMERCE 5-28-2005.

CLASS 9—(Continued).

3,299,023. HERMAN MILLER, INC., ZEELAND, MI. SN 78-596,799. PUB. 3-14-2006, FILED 3-29-2005.

**SONARE
TECHNOLOGIES**

THE MARK CONSISTS OF STANDARD CHARACTERS WITHOUT CLAIM TO ANY PARTICULAR FONT, STYLE, SIZE, OR COLOR.

NO CLAIM IS MADE TO THE EXCLUSIVE RIGHT TO USE "TECHNOLOGIES", APART FROM THE MARK AS SHOWN.

FOR ELECTRONIC AND TELECOMMUNICATIONS APPARATUS FOR SOUND PRIVACY (U.S. CLS. 21, 23, 26, 36 AND 38).

FIRST USE 9-1-2005; IN COMMERCE 9-1-2005.

3,299,031. CWW-USA, LLC, MIAMI, FL. SN 78-599,286. PUB. 7-18-2006, FILED 3-31-2005.

BLU
P R O D U C T S

NO CLAIM IS MADE TO THE EXCLUSIVE RIGHT TO USE "PRODUCTS", APART FROM THE MARK AS SHOWN.

FOR CELLULAR TELEPHONE ACCESSORIES, NAMELY, ANTENNAE, BATTERIES, CHARGERS, CIGARETTE LIGHTER ADAPTERS, POWER CORDS, AUDIO ADAPTERS, CARRY CASES, AND BELT CLIPS (U.S. CLS. 21, 23, 26, 36 AND 38).

FIRST USE 1-5-2005; IN COMMERCE 1-5-2005.

CLASS 9—(Continued).

3,299,042. HELP-YOUR-SELF, INC., WASHINGTON, DC. SN 78-600,928. PUB. 7-11-2006, FILED 4-4-2005.

CLASS 9—(Continued).

3,299,076. REVOLT AMPS, LTD., CHICAGO, IL. SN 78-612,402. PUB. 11-14-2006, FILED 4-19-2005.

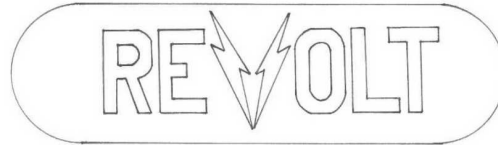

SeeMeSafely

THE MARK CONSISTS OF EACH SIDE OF THE "V" IS THE SHAPE OF A LIGHTNING BOLT.
FOR GUITAR AMPLIFIERS (U.S. CLS. 21, 23, 26, 36 AND 38).
FIRST USE 2-17-2005; IN COMMERCE 10-26-2005.

3,299,080. ACTIVISION PUBLISHING, INC., SANTA MONICA, CA. SN 78-613,665. PUB. 1-10-2006, FILED 4-21-2005.

THE MARK CONSISTS OF STANDARD CHARACTERS WITHOUT CLAIM TO ANY PARTICULAR FONT, STYLE, SIZE, OR COLOR.
FOR SAFETY EQUIPMENT, NAMELY, BATTERY-OPERATED BEACON LIGHTS FOR VISIBILITY PURPOSES THAT CAN BE AFFIXED AND REMOVED FROM VARIOUS DEVICES (U.S. CLS. 21, 23, 26, 36 AND 38).
FIRST USE 3-29-2007; IN COMMERCE 3-29-2007.

GUITAR HERO

THE MARK CONSISTS OF STANDARD CHARACTERS WITHOUT CLAIM TO ANY PARTICULAR FONT, STYLE, SIZE, OR COLOR.
NO CLAIM IS MADE TO THE EXCLUSIVE RIGHT TO USE "GUITAR", APART FROM THE MARK AS SHOWN.
FOR INTERACTIVE VIDEO GAME COMPRISED OF A CARTRIDGE OR DVD SOLD AS A UNIT WITH AN ELECTRONIC GUITAR APPARATUS (U.S. CLS. 21, 23, 26, 36 AND 38).
FIRST USE 5-0-2005; IN COMMERCE 11-8-2005.

3,299,074. SALETNIK, PAULA, CAVE CREEK, AZ. SN 78-611,814. PUB. 9-12-2006, FILED 4-19-2005.

3,299,085. COULTER, WILLIAM WICKERT, TAKOMA PARK, MD. SN 78-614,785. PUB. 9-12-2006, FILED 4-22-2005.

PISTOL PACKIN PAULA

BILLY COULTER

THE MARK CONSISTS OF STANDARD CHARACTERS WITHOUT CLAIM TO ANY PARTICULAR FONT, STYLE, SIZE, OR COLOR.
THE NAME PISTOL PACKING PAULA IDENTIFIES A LIVING INDIVIDUAL WHOSE CONSENT IS OF RECORD.
FOR PRE-RECORDED FILM, DVDS, VIDEOTAPE, FEATURING STUNT RIDING, GUN HANDLING, AND HORSE RIDING (U.S. CLS. 21, 23, 26, 36 AND 38).
FIRST USE 10-30-2006; IN COMMERCE 10-30-2006.

THE MARK CONSISTS OF STANDARD CHARACTERS WITHOUT CLAIM TO ANY PARTICULAR FONT, STYLE, SIZE, OR COLOR.
THE NAME BILLY COULTER IDENTIFIES A LIVING INDIVIDUAL WHOSE CONSENT IS OF RECORD.
FOR SERIES OF PRERECORDED COMPACT DISCS FEATURING MUSIC (U.S. CLS. 21, 23, 26, 36 AND 38).
FIRST USE 12-1-2006; IN COMMERCE 12-1-2006.

CLASS 9—(Continued).

3,299,099. MAKEMUSIC, INC., EDEN PRAIRIE, MN. SN 78-621,407. PUB. 1-24-2006, FILED 5-2-2005.

makemusic

OWNER OF U.S. REG. NOS. 2,717,685 AND 2,882,913.
FOR COMPUTER SOFTWARE FOR COMPOSING,
PERFORMING, PUBLISHING, ARRANGING AND
PRINTING MUSIC (U.S. CLS. 21, 23, 26, 36 AND 38).
FIRST USE 6-22-2005; IN COMMERCE 6-22-2005.

3,299,112. ACTORIS SOFTWARE, INCORPORATED, ESCON-
DIDO, CA. SN 78-626,373. PUB. 6-20-2006, FILED 5-10-2005.

Actoris

THE MARK CONSISTS OF STANDARD CHARACTERS
WITHOUT CLAIM TO ANY PARTICULAR FONT, STYLE,
SIZE, OR COLOR.
FOR COMPUTER SOFTWARE USED IN THE FIELD
OF RESTAURANT AND/OR RETAIL MANAGEMENT,
NAMELY, MANAGEMENT OF STAFFING SCHEDULES
AND INVENTORY (U.S. CLS. 21, 23, 26, 36 AND 38).
FIRST USE 9-1-2002; IN COMMERCE 9-1-2002.

3,299,120. ACTION GAMING, INC., LAS VEGAS, NV. SN 78-
632,538. PUB. 7-25-2006, FILED 5-18-2005.

VIDEO POKER FOR WINNERS

THE MARK CONSISTS OF STANDARD CHARACTERS
WITHOUT CLAIM TO ANY PARTICULAR FONT, STYLE,
SIZE, OR COLOR.
NO CLAIM IS MADE TO THE EXCLUSIVE RIGHT TO
USE "VIDEO POKER", APART FROM THE MARK AS
SHOWN.
FOR COMPUTER SOFTWARE FOR TEACHING PLAY
OF VIDEO POKER (U.S. CLS. 21, 23, 26, 36 AND 38).
FIRST USE 11-30-2006; IN COMMERCE 11-30-2006.

CLASS 9—(Continued).

3,299,129. PEARLE, INC., MASON, OH. SN 78-636,287. PUB. 8-
1-2006, FILED 5-24-2005.

BELLISSIMA

THE MARK CONSISTS OF STANDARD CHARACTERS
WITHOUT CLAIM TO ANY PARTICULAR FONT, STYLE,
SIZE, OR COLOR.

THE FOREIGN WORDING IN THE MARK TRANSLATES
INTO ENGLISH AS "MOST BEAUTIFUL".
FOR EYEGLASSES, SUNGLASSES AND EYEWEAR
ACCESSORIES, NAMELY, EYEGLASS CASES (U.S.
CLS. 21, 23, 26, 36 AND 38).
FIRST USE 1-31-2004; IN COMMERCE 1-31-2004.

3,299,142. HERITAGE MEDCALL, INC., TAMPA, FL. SN 78-
641,006. PUB. 10-3-2006, FILED 6-1-2005.

Sentry Legacy

THE MARK CONSISTS OF STANDARD CHARACTERS
WITHOUT CLAIM TO ANY PARTICULAR FONT, STYLE,
SIZE, OR COLOR.

FOR EMERGENCY CALL SYSTEMS COMPRISED OF
INTERCOMS, LOUDSPEAKERS, TWO-WAY RADIOS,
EMERGENCY CALL PULL CORDS, WIRELESS RE-
MOTE CALL PENDANTS, SMOKE DETECTORS, SE-
CURITY ALARM, DOME LIGHTS, AND STROBE
LIGHTS FOR MONITORING AND ANNUNCIATING
FIRE ALARMS, DOOR MONITORING, SECURITY
AND WANDER ALARMS WITH USE IN ASSISTED
LIVING FACILITIES, CONDOMINIUMS, APARTMENTS
AND SENIOR HOUSING (U.S. CLS. 21, 23, 26, 36 AND
38).
FIRST USE 6-1-2004; IN COMMERCE 7-1-2004.

CLASS 9—(Continued).

3,299,150. SENSOPTICS LIMITED, BRISTOL, UNITED KINGDOM. SN 78-645,130. PUB. 3-20-2007, FILED 6-7-2005.

Cobalt

THE MARK CONSISTS OF STANDARD CHARACTERS WITHOUT CLAIM TO ANY PARTICULAR FONT, STYLE, SIZE, OR COLOR.

FOR FIBER-OPTIC SENSOR TECHNOLOGY AND PRODUCTS, NAMELY, VIBRATION SENSORS, ACOUSTIC SENSORS AND PROXIMITY SENSORS FOR PERIMETER SECURITY, BORDER SECURITY, PIPELINE PROTECTION, PROTECTION OF FIBER-OPTIC TELECOMMUNICATIONS CABLES AND SURVEILLANCE (U.S. CLS. 21, 23, 26, 36 AND 38).
FIRST USE 10-21-2005; IN COMMERCE 11-29-2005.

3,299,152. RAYTHEON COMPANY, WALTHAM, MA. SN 78-646,110. PUB. 7-18-2006, FILED 6-8-2005.

RAYTHEON ADAPTIVE MISSION PROFILER

THE MARK CONSISTS OF STANDARD CHARACTERS WITHOUT CLAIM TO ANY PARTICULAR FONT, STYLE, SIZE, OR COLOR.

NO CLAIM IS MADE TO THE EXCLUSIVE RIGHT TO USE "ADAPTIVE MISSION PROFILER", APART FROM THE MARK AS SHOWN.

FOR COMPUTER SOFTWARE IN THE FIELD OF COMPUTER SIMULATIONS FOR USE IN A DISTRIBUTED SIMULATION HAVING A PLURALITY OF SIMULATION ELEMENTS, WHICH PROVIDES A COMMUNICATION INTERFACE STRUCTURE FOR MESSAGING BETWEEN THE SIMULATION ELEMENTS, AND WHICH PROVIDES A PERFORMANCE ANALYSIS OF THE SIMULATION ELEMENTS AND OF THE DISTRIBUTED SIMULATION (U.S. CLS. 21, 23, 26, 36 AND 38).
FIRST USE 11-4-2005; IN COMMERCE 7-28-2006.

3,299,153. KEIBERG INTERNATIONAL INC., WINNIPEG, MANITOBA, CANADA. SN 78-646,526. PUB. 6-20-2006, FILED 6-8-2005.

LINE ALERT

THE MARK CONSISTS OF STANDARD CHARACTERS WITHOUT CLAIM TO ANY PARTICULAR FONT, STYLE, SIZE, OR COLOR.

CLASS 9—(Continued).

NO CLAIM IS MADE TO THE EXCLUSIVE RIGHT TO USE "LINE", APART FROM THE MARK AS SHOWN.

FOR MULTI-COLOURED SAFETY MARKERS IMPLANTED INTO THE GROUND DESIGNED TO INDICATE THE PROXIMITY OF UNDERGROUND OBJECTS (U.S. CLS. 21, 23, 26, 36 AND 38).
FIRST USE 3-2-2007; IN COMMERCE 3-2-2007.

3,299,170. GENERAL ELECTRIC COMPANY, SCHNECTADY, NY. SN 78-653,936. PUB. 9-26-2006, FILED 6-20-2005.

HD-FLOW

THE MARK CONSISTS OF STANDARD CHARACTERS WITHOUT CLAIM TO ANY PARTICULAR FONT, STYLE, SIZE, OR COLOR.

FOR COMPUTER SOFTWARE FOR USE WITH ULTRASOUND MEDICAL IMAGING APPARATUS TO DEPICT AND DISPLAY BLOOD VESSELS (U.S. CLS. 21, 23, 26, 36 AND 38).
FIRST USE 12-31-2005; IN COMMERCE 12-31-2005.

3,299,173. TOUCHTABLE, INC., PASADENA, CA. SN 78-655,466. PUB. 3-21-2006, FILED 6-21-2005.

TOUCHSHARE

THE MARK CONSISTS OF STANDARD CHARACTERS WITHOUT CLAIM TO ANY PARTICULAR FONT, STYLE, SIZE, OR COLOR.

FOR SOFTWARE THAT FACILITATES THE SHARING OF GEOGRAPHICAL INFORMATION SYSTEMS' DATA ACROSS A NETWORK, ALLOWING COLLABORATION BETWEEN GROUPS AND INDIVIDUALS AT MULTIPLE GEOGRAPHIC LOCATIONS (U.S. CLS. 21, 23, 26, 36 AND 38).
FIRST USE 9-30-2005; IN COMMERCE 9-30-2005.

CLASS 9—(Continued).

3,299,192. PACIFIC ACCUENERGY TECHNOLOGY CO., LTD. EL SEGUNDO, CA. SN 78-662,311. PUB. 3-6-2007, FILED 7-1-2005.

Accuenergy

THE MARK CONSISTS OF STANDARD CHARACTERS WITHOUT CLAIM TO ANY PARTICULAR FONT, STYLE, SIZE, OR COLOR.

FOR ELECTRIC METERS, ELECTRIC METERS FOR USE IN MEASURING ELECTRIC PARAMETERS IN THE FIELD OF POWER DISTRIBUTING SYSTEM (U.S. CLS. 21, 23, 26, 36 AND 38).

FIRST USE 1-7-2004; IN COMMERCE 1-7-2004.

3,299,214. MATSUSHITA ELECTRIC INDUSTRIAL CO., LTD., OSAKA, JAPAN. SN 78-672,140. PUB. 7-4-2006, FILED 7-18-2005.

MotionSD STUDIO

THE MARK CONSISTS OF STANDARD CHARACTERS WITHOUT CLAIM TO ANY PARTICULAR FONT, STYLE, SIZE, OR COLOR.

NO CLAIM IS MADE TO THE EXCLUSIVE RIGHT TO USE "STUDIO", APART FROM THE MARK AS SHOWN.

FOR COMPUTER SOFTWARE FOR EDITING MOTION PICTURES (U.S. CLS. 21, 23, 26, 36 AND 38).

FIRST USE 10-15-2005; IN COMMERCE 11-30-2005.

CLASS 9—(Continued).

3,299,217. ATEN INTERNATIONAL CO., LTD., TAIPEI, TAIWAN. SN 78-674,084. PUB. 7-18-2006, FILED 7-20-2005.

KVMP

THE MARK CONSISTS OF STANDARD CHARACTERS WITHOUT CLAIM TO ANY PARTICULAR FONT, STYLE, SIZE, OR COLOR.

FOR COMPUTER PERIPHERALS; COMPUTER PERIPHERALS FOR ACCESSING AND CONTROLLING MULTIPLE COMPUTERS AND SERVERS WITH A SINGLE KEYBOARD, MONITOR AND MOUSE; COMPUTER PERIPHERALS FOR ALLOWING A PLURALITY OF USERS TO INDEPENDENTLY ACCESS AND CONTROL A PLURALITY OF COMPUTERS AND SERVERS FROM A PLURALITY OF KEYBOARDS, MONITORS AND MICE; COMPUTER PERIPHERALS FOR REMOTE ACCESS AND CONTROL OF COMPUTERS AND SERVERS; VIDEO TRANSMISSION APPARATUS, NAMELY, SPLITTER FOR DISPLAYING THE OUTPUT FROM A SINGLE COMPUTER ON MULTIPLE MONITORS; COMPUTER PERIPHERAL HARDWARE FOR TRANSMITTING KEYBOARD, MONITOR, MOUSE, AUDIO AND SERIAL DATA SIGNALS OVER A DISTANCE; COMPUTER NETWORKING HARDWARE; INTERFACE CARDS FOR DATA PROCESSING EQUIPMENT IN THE FORM OF PRINTED CIRCUITS; DATA SWITCHING APPARATUS, NAMELY, ETHERNET SWITCHES AND COMPUTER NETWORK SWITCHES; DATA TRANSFER EQUIPMENT, NAMELY, DATA PROCESSORS, MODEMS, COMPUTER NETWORK HUBS, SWITCHES AND ROUTERS; CABLE SPLITTERS AND TELEPHONE-ACTIVATED POWER SWITCHES, NAMELY, CABLES AND COMPUTER HARDWARE FOR LINKING COMPUTERS WITH PERIPHERALS, KEYBOARDS, VIDEO DISPLAY MONITORS AND MICE; COMPUTER HARDWARE, NAMELY, DISPLAY TERMINALS, MONITORS AND INTERFACE CARDS AND COMPUTER OPERATING SOFTWARE; COMPUTER HARDWARE AND ASSOCIATED SOFTWARE FOR ON-SCREEN PROGRAMMING OF COMPUTER PERIPHERALS; COMPUTER PERIPHERALS HARDWARE FOR TRANSMITTING KEYBOARD, MOUSE AND VIDEO SIGNALS BETWEEN A LOCAL COMPUTER AND A REMOTE COMPUTER OVER A COMPUTER COMMUNICATIONS LINK; COMPUTER CABINETS TO HOUSE COMPUTER NETWORK SERVERS AND RELATED COMPUTER EQUIPMENT; RACKS FOR MOUNTING COMPUTER EQUIPMENT; POWER SWITCHES; COMMUNICATION HUBS; VIDEO TRANSMISSION SWITCH APPARATUS TO SWITCH THE VIDEO OUTPUT FROM A PLURALITY OF COMPUTERS; CONVERTER; AND COMPUTER PERIPHERALS FOR MONITORING ENVIRONMENT IN SERVER ROOM (U.S. CLS. 21, 23, 26, 36 AND 38).

FIRST USE 10-1-2003; IN COMMERCE 10-1-2003.

3,299,218. MULTIMEDIA GAMES, INC., AUSTIN, TX. SN 78-674,446. PUB. 6-13-2006, FILED 7-20-2005.

Win Zone

THE MARK CONSISTS OF STANDARD CHARACTERS WITHOUT CLAIM TO ANY PARTICULAR FONT, STYLE,

CLASS 9—(Continued).

SIZE, OR COLOR.

NO CLAIM IS MADE TO THE EXCLUSIVE RIGHT TO USE "WIN", APART FROM THE MARK AS SHOWN.

FOR LOTTERY GAMING MACHINES AND TERMINALS; INTERACTIVE LOTTERY VIDEO GAMES OF VIRTUAL REALITY COMPRISED OF LOTTERY GAMING MACHINES AND SOFTWARE (U.S. CLS. 21, 23, 26, 36 AND 38).

FIRST USE 9-14-2005; IN COMMERCE 9-14-2005.

3,299,219. PEARLE, INC., MASON, OH. SN 78-674,504. PUB. 3-28-2006, FILED 7-20-2005.

DVIATIONS

THE MARK CONSISTS OF STANDARD CHARACTERS WITHOUT CLAIM TO ANY PARTICULAR FONT, STYLE, SIZE, OR COLOR.

FOR EYEGLASS CASES; EYEGLASSES; SUNGLASSES (U.S. CLS. 21, 23, 26, 36 AND 38).

FIRST USE 12-31-2005; IN COMMERCE 12-31-2005.

3,299,244. E2INTERACTIVE, INC., DBA E2INTERACTIVE, INC., ATLANTA, GA. SN 78-684,422. PUB. 6-27-2006, FILED 8-3-2005.

PAYMENT ZONE

THE MARK CONSISTS OF STANDARD CHARACTERS WITHOUT CLAIM TO ANY PARTICULAR FONT, STYLE, SIZE, OR COLOR.

NO CLAIM IS MADE TO THE EXCLUSIVE RIGHT TO USE "PAYMENT", APART FROM THE MARK AS SHOWN.

FOR ELECTRONIC AND COMPUTERIZED SYSTEM COMPRISED OF COMPUTER HARDWARE AND OPERATING SOFTWARE THAT ALLOW USERS TO PERFORM ELECTRONIC BUSINESS TRANSACTIONS, NAMELY PAYMENTS FOR GOODS AND/OR SERVICES; ELECTRONIC AND MAGNETIC CARDS FOR USE IN CONNECTION WITH ELECTRONIC BUSINESS TRANSACTIONS, NAMELY PAYMENTS FOR GOODS AND/OR SERVICES (U.S. CLS. 21, 23, 26, 36 AND 38).

FIRST USE 11-0-2006; IN COMMERCE 11-0-2006.

CLASS 9—(Continued).

3,299,250. SCIENTIFIC GAMES ROYALTY CORPORATION, ALPHARETTA, GA. SN 78-686,583. PUB. 7-11-2006, FILED 8-5-2005.

BetJet

THE MARK CONSISTS OF STANDARD CHARACTERS WITHOUT CLAIM TO ANY PARTICULAR FONT, STYLE, SIZE, OR COLOR.

FOR MODULAR WAGERING TERMINAL SYSTEMS COMPRISING TELLER OPERATED AND SELF-SERVICE WAGERING TERMINALS; MODULAR WAGERING TERMINAL SYSTEMS FOR USE IN PRINTING WAGER TICKETS AND REDEEMING WINNING TICKETS; HARDWARE AND SOFTWARE MODULES FOR USE IN MULTIPLE WAGERING SYSTEM CONFIGURATIONS (U.S. CLS. 21, 23, 26, 36 AND 38).

FIRST USE 7-31-2006; IN COMMERCE 7-31-2006.

3,299,252. AEROPOSTALE WEST, INC., WAYNE, NJ. SN 78-690,075. PUB. 8-29-2006, FILED 8-10-2005.

JIMMY'Z

THE MARK CONSISTS OF STANDARD CHARACTERS WITHOUT CLAIM TO ANY PARTICULAR FONT, STYLE, SIZE, OR COLOR.

OWNER OF U.S. REG. NOS. 1,411,390 AND 1,490,256. FOR SUNGLASSES (U.S. CLS. 21, 23, 26, 36 AND 38).

FIRST USE 7-31-2005; IN COMMERCE 7-31-2005.

3,299,258. VAUGHAN, KIRK, PORT ORCHARD, WA. SN 78-692,649. PUB. 5-30-2006, FILED 8-15-2005.

alr
ascenté records

NO CLAIM IS MADE TO THE EXCLUSIVE RIGHT TO USE "RECORDS", APART FROM THE MARK AS SHOWN.

THE ENGLISH TRANSLATION OF THE FOREIGN WORDING "ASCENTE" IS "ASCENT".

FOR MUSICAL SOUND RECORDINGS (U.S. CLS. 21, 23, 26, 36 AND 38).

FIRST USE 4-17-2006; IN COMMERCE 5-1-2006.

CLASS 9—(Continued).

3,299,262. FOODHANDLER, INC., RENO, NV. SN 78-695,814.
PUB. 7-11-2006, FILED 8-18-2005.

FORMFLEX

THE MARK CONSISTS OF STANDARD CHARACTERS WITHOUT CLAIM TO ANY PARTICULAR FONT, STYLE, SIZE, OR COLOR.

FOR DISPOSABLE PROTECTIVE GLOVES FOR INDUSTRIAL USE (U.S. CLS. 21, 23, 26, 36 AND 38).
FIRST USE 11-17-2005; IN COMMERCE 2-8-2007.

CLASS 9—(Continued).

3,299,269. GLOBAL EMERGENCY RESOURCES, LLC, EVANS, GA. SN 78-698,110. PUB. 10-31-2006, FILED 8-23-2005.

M-CIMS

THE MARK CONSISTS OF STANDARD CHARACTERS WITHOUT CLAIM TO ANY PARTICULAR FONT, STYLE, SIZE, OR COLOR.

FOR COMPUTER SOFTWARE FOR USE IN THE FIELD OF MEDICAL EMERGENCY MANAGEMENT TO TRACK PERSONNEL AND EQUIPMENT RESOURCES IN A REAL-TIME, LIVE ENVIRONMENT (U.S. CLS. 21, 23, 26, 36 AND 38).

FIRST USE 8-4-2005; IN COMMERCE 8-5-2005.

3,299,290. IPTRADE, INC., NEWTON, MA. SN 78-703,303.
PUB. 10-17-2006, FILED 8-30-2005.

3,299,266. JAWALAPERSAD, BIDJAI K., NEW YORK, NY.
SN 78-697,117. PUB. 7-25-2006, FILED 8-22-2005.



NO CLAIM IS MADE TO THE EXCLUSIVE RIGHT TO USE "RECORDS", APART FROM THE MARK AS SHOWN.

THE COLORS ORANGE, BLACK AND WHITE ARE CLAIMED AS A FEATURE OF THE MARK.

THE MARK CONSISTS OF THE DESIGN ELEMENT OF A COMPACT DISC WITHIN A CIRCULAR SAW BLADE. THE BLADE APPEARS IN BLACK, THE RING JUST INSIDE THE BLADE APPEARS IN WHITE, AND THE AREA INSIDE THE RING APPEARS IN SIX ALTERNATING SECTIONS OF BLACK AND ORANGE, WITH A TOTAL OF THREE OF EACH. ONE OF THE ORANGE SECTIONS CONTAINS A DESIGN OF AN OIL DRILLING RIG, WHICH APPEARS IN WHITE. THE VERY CENTER OF THE DISC APPEARS IN WHITE. BELOW THE DESIGN ELEMENT, THE WORD "TURMOIL" APPEARS IN BLACK, AND THE WORD "RECORDS" APPEARS IN ORANGE.

FOR SOUND RECORDINGS FEATURING MUSIC, NAMELY, PHONOGRAPH RECORDS, PRE-RECORDED AUDIO TAPES, ENHANCED CD'S, COMPACT DISCS, PRE-RECORDED VIDEOTAPES, PRE-RECORDED VIDEOCASSETTES, PRE-RECORDED DIGITAL AUDIO TAPES, DVD'S, AND LASER DISCS FEATURING MUSIC (U.S. CLS. 21, 23, 26, 36 AND 38).

FIRST USE 3-25-2007; IN COMMERCE 3-25-2007.

INTELLIVIBE

THE MARK CONSISTS OF STANDARD CHARACTERS WITHOUT CLAIM TO ANY PARTICULAR FONT, STYLE, SIZE, OR COLOR.

FOR VIBRATION ANALYSIS AND SUPPRESSION SYSTEM COMPRISED OF COMPUTER HARDWARE, COMPUTER SOFTWARE, FIRMWARE AND ACTIVE MATERIAL COMPONENTS, NAMELY PIEZO CERAMICS, FOR USE IN CONNECTION WITH HIGH PRECISION MACHINERY AND EQUIPMENT FOR SEMICONDUCTOR, MICRO AND NANO-DEVICE MANUFACTURING, AND FOR USE IN CONNECTION WITH TRANSPORTATION DEVICES, NAMELY AUTOMOBILES AND AIRCRAFT (U.S. CLS. 21, 23, 26, 36 AND 38).
FIRST USE 7-7-2006; IN COMMERCE 7-7-2006.

3,299,304. NOVA GAMING, LLC, GREENVILLE, SC. SN 78-710,477. PUB. 7-18-2006, FILED 9-9-2005.

PILE O PENNIES

THE MARK CONSISTS OF STANDARD CHARACTERS WITHOUT CLAIM TO ANY PARTICULAR FONT, STYLE, SIZE, OR COLOR.

FOR COMPUTER SOFTWARE FOR USE IN ASSOCIATION WITH GAMING MACHINES; GAMING MACHINES (U.S. CLS. 21, 23, 26, 36 AND 38).

FIRST USE 4-25-2006; IN COMMERCE 4-25-2006.

CLASS 9—(Continued).

3,299,325. STAPLES THE OFFICE SUPERSTORE, LLC, FRAMINGHAM, MA. SN 78-716,608. PUB. 6-20-2006, FILED 9-20-2005.

SPINDEX

THE MARK CONSISTS OF STANDARD CHARACTERS WITHOUT CLAIM TO ANY PARTICULAR FONT, STYLE, SIZE, OR COLOR.

FOR DIVIDERS FOR USE WITH STORAGE RACKS THAT HOLD A STACK OF CDS OR DVDS (U.S. CLS. 21, 23, 26, 36 AND 38).

FIRST USE 9-0-2006; IN COMMERCE 9-0-2006.

3,299,352. VIRGIN MOBILE USA, LLC, WARREN, NJ. SN 78-722,576. PUB. 2-13-2007, FILED 9-28-2005.

SWITCH _ BACK

THE MARK CONSISTS OF STANDARD CHARACTERS WITHOUT CLAIM TO ANY PARTICULAR FONT, STYLE, SIZE, OR COLOR.

FOR MOBILE TELEPHONES; TELEPHONES; MOD-EMS; BATTERIES; BATTERY CHARGERS; AND MOBILE TELEPHONE ACCESSORIES, NAMELY CIGARETTE LIGHTER ADAPTERS, DASHBOARD MOUNTS, HANDS-FREE HEADSETS, CARRYING CASES, AND BELT CLIPS; PERSONAL DIGITAL ASSISTANTS (U.S. CLS. 21, 23, 26, 36 AND 38).

FIRST USE 4-30-2006; IN COMMERCE 4-30-2006.

3,299,366. LEAF NETWORKS, LLC, SCOTTSDALE, AZ. SN 78-725,622. PUB. 5-30-2006, FILED 10-3-2005.

Leaf Networks

THE MARK CONSISTS OF STANDARD CHARACTERS WITHOUT CLAIM TO ANY PARTICULAR FONT, STYLE, SIZE, OR COLOR.

NO CLAIM IS MADE TO THE EXCLUSIVE RIGHT TO USE "NETWORKS", APART FROM THE MARK AS SHOWN.

FOR COMMUNICATIONS SOFTWARE FOR CONNECTING COMPUTER NETWORKS (U.S. CLS. 21, 23, 26, 36 AND 38).

FIRST USE 12-19-2006; IN COMMERCE 12-19-2006.

CLASS 9—(Continued).

3,299,384. THE A.H. EMERY COMPANY, SEYMOUR, CT. SN 78-729,112. PUB. 7-4-2006, FILED 10-7-2005.

PERMACELL

THE MARK CONSISTS OF STANDARD CHARACTERS WITHOUT CLAIM TO ANY PARTICULAR FONT, STYLE, SIZE, OR COLOR.

FOR WEIGHING EQUIPMENT, NAMELY, SCALES, ELECTRONIC AND HYDRAULIC LOAD CELLS, INSTRUMENTATION FOR WEIGHING EQUIPMENT, NAMELY, DIGITAL INDICATORS AND PRINTERS FOR DISPLAYING AND RECORDING INFORMATION FROM WEIGHING EQUIPMENT AND COMPUTER SOFTWARE FOR OPERATING WEIGHING EQUIPMENT (U.S. CLS. 21, 23, 26, 36 AND 38).

FIRST USE 1-31-2006; IN COMMERCE 1-31-2006.

3,299,400. SANDISK CORPORATION, MILPITAS, CA. SN 78-731,321. PUB. 1-24-2006, FILED 10-12-2005.

CRUZER CROSSFIRE

THE MARK CONSISTS OF STANDARD CHARACTERS WITHOUT CLAIM TO ANY PARTICULAR FONT, STYLE, SIZE, OR COLOR.

OWNER OF U.S. REG. NO. 2,754,118.
FOR USB FLASH DRIVE (U.S. CLS. 21, 23, 26, 36 AND 38).

FIRST USE 12-15-2005; IN COMMERCE 12-15-2005.

3,299,417. THE FINEST ACCESSORIES, INC., NORTH BEND, WA. SN 78-734,634. PUB. 9-26-2006, FILED 10-17-2005.

MOBILE LUXE

THE MARK CONSISTS OF STANDARD CHARACTERS WITHOUT CLAIM TO ANY PARTICULAR FONT, STYLE, SIZE, OR COLOR.

NO CLAIM IS MADE TO THE EXCLUSIVE RIGHT TO USE "MOBILE", APART FROM THE MARK AS SHOWN.

FOR CHARMS AND ORNAMENTS FOR ATTACHMENT TO, COVERING OF, AND FOR USE IN CONNECTION WITH PERSONALIZING ITEMS, NAMELY, PHONES, COMPUTERS, PERSONAL DIGITAL ASSISTANTS, PERSONAL DATA ASSISTANTS, AND ELECTRONIC PERSONAL ORGANIZERS (U.S. CLS. 21, 23, 26, 36 AND 38).

FIRST USE 1-27-2005; IN COMMERCE 1-27-2005.

CLASS 9—(Continued).

3,299,418. INVITROGEN CORPORATION, CARLSBAD, CA.
SN 78-734,788. PUB. 6-20-2006, FILED 10-17-2005.

CLASS 9—(Continued).

3,299,493. AAMP OF FLORIDA, INC., CLEARWATER, FL.
SN 78-744,152. PUB. 2-6-2007, FILED 11-1-2005.

UTYPE

THE MARK CONSISTS OF STANDARD CHARACTERS WITHOUT CLAIM TO ANY PARTICULAR FONT, STYLE, SIZE, OR COLOR.

FOR COMPUTER SOFTWARE FOR ANALYZING NUCLEIC ACID SEQUENCING RESULTS (U.S. CLS. 21, 23, 26, 36 AND 38).

FIRST USE 10-0-2005; IN COMMERCE 10-0-2005.

PERIPHERAL

3,299,444. STERLING METS. L.P., FLUSHING, NY. SN 78-737,335. PUB. 7-11-2006, FILED 10-20-2005.



OWNER OF U.S. REG. NOS. 250,040, 1,530,538, AND OTHERS.

FOR ELECTRICAL AND SCIENTIFIC APPARATUS, NAMELY, RADIOS; PRE-RECORDED VIDEOTAPES RELATING TO BASEBALL; PRE-RECORDED VIDEODISCS RELATING TO BASEBALL; PRE-RECORDED AUDIO DISCS RELATING TO BASEBALL; COMPACT DISC CASES; CASES FOR PERSONAL DIGITAL ASSISTANTS, CELL PHONE ACCESSORIES, NAMELY, CASES AND FACE PLATE COVERS; BINOCULARS; CALCULATORS; PHOTOGRAPHIC CAMERAS; ELECTRIC SUNGLASSES; DECORATIVE MAGNETS; PROTECTIVE HELMETS, VIDEO AND COMPUTER GAME CARTRIDGES, VIDEO AND COMPUTER GAME DISCS, VIDEO AND COMPUTER GAME CASSETTES AND VIDEO GAME CONTROLLERS; COMPUTER ACCESSORIES, NAMELY, MOUSE PADS COMPUTER GAME PROGRAMS (U.S. CLS. 21, 23, 26, 36 AND 38).

FIRST USE 10-9-1984; IN COMMERCE 10-9-1984.

THE MARK CONSISTS OF STANDARD CHARACTERS WITHOUT CLAIM TO ANY PARTICULAR FONT, STYLE, SIZE, OR COLOR.

OWNER OF U.S. REG. NO. 2,153,385.

FOR FULL LINE OF SECURITY DEVICES FOR AUTOMOBILES, NAMELY, DATABUS DOORLOCK INTERFACES, KEYLESS ENTRY SYSTEMS COMPRISED OF REMOTE CONTROLS TO OPEN AND CLOSE DOORS, ELECTRONIC TIMERS; NOISE CONTROL DEVICES FOR AUTOMOBILES, NAMELY, ANTENNA GROUND LOOP ISOLATORS, CHOKE FILTERS, FILTERING CAPACITORS, POWER LEAD FILTERS; CELL PHONE DEVICES FOR AUTOMOBILES, NAMELY, TELECOMMUNICATION EXCHANGERS, CELL PHONE INTERFACES, CHARGE CORDS, DOORLOCK INTERFACES; PORTABLE-ELECTRONICS INTERFACES FOR AUTOMOBILES, NAMELY, MP3 PLAYER CORDS, MP3 PLAYER INTERFACING, MP3 PLAYER TRANSMITTERS, MP3 PLAYER INTERFACES, PERSONAL DIGITAL ASSISTANTS INTERFACES, PORTABLE VIDEO PLAYER INTERFACING; AUDIO/VISUAL DEVICES FOR AUTOMOBILES, NAMELY, VIDEO PROCESSORS, DVD CHANGER INTERFACING, DVD INTERFACING, GAME SYSTEM INTERFACES, IN-CAR ENTERTAINMENT SYSTEM INTERFACING, LCD VIDEO MONITOR INTERFACING, NAVIGATION INTERFACES, NAVIGATION SYSTEM INTERFACING, RADIO FREQUENCY AUDIO/VIDEO RECEIVERS, RADIO FREQUENCY AUDIO/VIDEO TRANSMITTERS, RADIO FREQUENCY VIDEO RECEIVERS, RADIO FREQUENCY VIDEO TRANSMITTERS, VIDEO CABLES, VIDEO SIGNAL AMPLIFIERS, VIDEO SIGNAL DISTRIBUTION PRODUCTS FOR AUTOMOBILES, NAMELY, VIDEO SIGNAL SWITCHERS; SYSTEM CONTROL INTERFACES FOR AUTOMOBILES, NAMELY, ALL-IN-ONE TRIGGERS, DATABUS INTERFACES, IR REPEATERS, IR TRANSMITTERS, LOW VOLTAGE TRIGGERS, PULSE GENERATORS, STEERING WHEEL INTERFACES, TIMERS; AUDIO/VISUAL TOOLS FOR AUTOMOBILES, NAMELY, DATA ANALYZERS; RADIO REMOVAL TOOLS FOR AUTOMOBILES, NAMELY, FREQUENCY SPLITTERS, ELECTRIC LINE FILTERS, SIGNAL ANALYZERS (U.S. CLS. 21, 23, 26, 36 AND 38).

FIRST USE 4-3-2003; IN COMMERCE 4-3-2003.

CLASS 9—(Continued).

3,299,524. ROBOTOLZ LIMITED, KWUN TONG, KOW-
LOON, HONG KONG. SN 78-749,584. PUB. 7-18-2006,
FILED 11-8-2005.

CROSSLINER

THE MARK CONSISTS OF STANDARD CHARACTERS
WITHOUT CLAIM TO ANY PARTICULAR FONT, STYLE,
SIZE, OR COLOR.

FOR SURVEYING APPARATUS, NAMELY, AN
ALIGNMENT TOOL USING A LASER FOR DETERMIN-
ING ELEVATION LEVELS (U.S. CLS. 21, 23, 26, 36 AND
38).

FIRST USE 9-0-2002; IN COMMERCE 9-0-2002.

3,299,525. ROBOTOLZ LIMITED, KWUN TONG, KOW-
LOON, HONG KONG. SN 78-749,612. PUB. 7-18-2006,
FILED 11-8-2005.

ROBOLASER

THE MARK CONSISTS OF STANDARD CHARACTERS
WITHOUT CLAIM TO ANY PARTICULAR FONT, STYLE,
SIZE, OR COLOR.

OWNER OF U.S. REG. NO. 2,231,068.
FOR SURVEYING APPARATUS, NAMELY, AN
ALIGNMENT TOOL USING A LASER FOR DETERMIN-
ING ELEVATION LEVELS (U.S. CLS. 21, 23, 26, 36 AND
38).

FIRST USE 8-0-2000; IN COMMERCE 8-0-2000.

3,299,527. WSO2, INC., SHARON, MA. SN 78-750,226. PUB. 9-
5-2006, FILED 11-9-2005.



THE MARK CONSISTS OF THE LETTERS WSO, WITH
THE NUMBER 2 POSITIONED AFTER THE LETTER O AS A
SUBSCRIPT. WITHIN THE LETTER O, THERE IS A ZIG-
ZAG DESIGN THAT SIMULATES A PULSE OR HEART-
BEAT.

FOR COMPUTER SOFTWARE FOR BUILDING, DE-
PLOYING, SECURING AND MANAGING THE COM-
MUNICATIONS AND INTERACTIONS BETWEEN TWO
OR MORE COMPUTERS, COMPUTER SERVERS, AND/
OR OTHER COMPUTING DEVICES THAT CONNECT
TO A NETWORK (U.S. CLS. 21, 23, 26, 36 AND 38).

FIRST USE 7-0-2005; IN COMMERCE 7-0-2005.

CLASS 9—(Continued).

3,299,540. NIKSUN, INC., MONMOUTH JUNCTION, NJ. SN
78-752,232. PUB. 7-11-2006, FILED 11-11-2005.

INTELLIDEFEND

THE MARK CONSISTS OF STANDARD CHARACTERS
WITHOUT CLAIM TO ANY PARTICULAR FONT, STYLE,
SIZE, OR COLOR.

FOR COMPUTER HARDWARE AND SOFTWARE FOR
MONITORING COMMUNICATIONS AND NETWORKS;
COMPUTER HARDWARE AND SOFTWARE FOR USE
IN COMPUTER NETWORK SECURITY, MONITORING
USAGE, POLICY MONITORING AND COMPLIANCE
MONITORING; COMPUTER HARDWARE AND SOFT-
WARE FOR RECORDING NETWORK TRAFFIC FOR
LAWFUL INTERCEPT, WIRE-TAPPING, FILTERING,
RECONSTRUCTING TRAFFIC, AND COMMUNICA-
TIONS ACTIVITY MONITORING (U.S. CLS. 21, 23, 26,
36 AND 38).

FIRST USE 1-19-2007; IN COMMERCE 1-19-2007.

3,299,543. BACOU-DALLOZ EYE & FACE PROTECTION,
INC., SMITHFIELD, RI. SN 78-752,339. PUB. 7-18-2006,
FILED 11-11-2005.

UVEX PROTÉGÉ

THE MARK CONSISTS OF STANDARD CHARACTERS
WITHOUT CLAIM TO ANY PARTICULAR FONT, STYLE,
SIZE, OR COLOR.

FOR SAFETY EYEWEAR (U.S. CLS. 21, 23, 26, 36 AND
38).

FIRST USE 11-29-2006; IN COMMERCE 11-29-2006.

CLASS 9—(Continued).

3,299,558. TRANSACT TECHNOLOGIES, INC., WALLINGFORD, CT. SN 78-754,554. PUB. 7-11-2006, FILED 11-15-2005.

EPIC 430

THE MARK CONSISTS OF STANDARD CHARACTERS WITHOUT CLAIM TO ANY PARTICULAR FONT, STYLE, SIZE, OR COLOR.

FOR SYSTEM AND GAMING DEVICES, NAMELY, AN ATTACHMENT FOR A GAMING DEVICE OR MACHINE, NAMELY, A COMPUTER PERIPHERAL COMPRISED OF A CURRENCY, COUPON, TICKET, CARD OR VOUCHER DEVICE FOR USE IN THE ISSUANCE OR REDEMPTION OF CASHLESS GAMING COUPONS, TICKETS, CARDS, VOUCHERS, OR OTHER FORMATS IN CONNECTION WITH THE OPERATION OF GAMING DEVICES OR MACHINES (U.S. CLS. 21, 23, 26, 36 AND 38).

FIRST USE 1-11-2006; IN COMMERCE 11-15-2006.

3,299,559. TRANSACT TECHNOLOGIES, INC., WALLINGFORD, CT. SN 78-754,564. PUB. 7-11-2006, FILED 11-15-2005.

EPIC 630

THE MARK CONSISTS OF STANDARD CHARACTERS WITHOUT CLAIM TO ANY PARTICULAR FONT, STYLE, SIZE, OR COLOR.

FOR SYSTEM AND GAMING DEVICES, NAMELY, AN ATTACHMENT FOR A GAMING DEVICE OR MACHINE, NAMELY, A COMPUTER PERIPHERAL COMPRISED OF A CURRENCY, COUPON, TICKET, CARD OR VOUCHER DEVICE FOR USE IN THE ISSUANCE OR REDEMPTION OF CASHLESS GAMING COUPONS, TICKETS, CARDS, VOUCHERS, OR OTHER FORMATS IN CONNECTION WITH THE OPERATION OF GAMING DEVICES OR MACHINES (U.S. CLS. 21, 23, 26, 36 AND 38).

FIRST USE 9-13-2005; IN COMMERCE 9-20-2005.

CLASS 9—(Continued).

3,299,560. CEMAPHORE SYSTEMS, INC., SAN MATEO, CA. SN 78-754,574. PUB. 7-18-2006, FILED 11-15-2005.

DR DONE RIGHT

THE MARK CONSISTS OF STANDARD CHARACTERS WITHOUT CLAIM TO ANY PARTICULAR FONT, STYLE, SIZE, OR COLOR.

FOR COMPUTER SOFTWARE AND HARDWARE IN THE FIELD OF COMMUNICATIONS FOR ENHANCING THE SPEED, RELIABILITY, AND RECOVERABILITY OF MESSAGING SYSTEMS (U.S. CLS. 21, 23, 26, 36 AND 38).

FIRST USE 9-29-2006; IN COMMERCE 9-29-2006.

3,299,561. CEMAPHORE SYSTEMS, INC., SAN MATEO, CA. SN 78-754,576. PUB. 7-25-2006, FILED 11-15-2005.



NO CLAIM IS MADE TO THE EXCLUSIVE RIGHT TO USE "SYSTEMS", APART FROM THE MARK AS SHOWN.

FOR COMPUTER SOFTWARE AND HARDWARE IN THE FIELD OF COMMUNICATIONS FOR ENHANCING THE SPEED, RELIABILITY, AND RECOVERABILITY OF MESSAGING SYSTEMS (U.S. CLS. 21, 23, 26, 36 AND 38).

FIRST USE 9-29-2006; IN COMMERCE 9-29-2006.

CLASS 9—(Continued).

3,299,586. INFOCUS CORPORATION, WILSONVILLE, OR. SN 78-758,893. PUB. 6-27-2006, FILED 11-22-2005.

PLAY BIG

THE MARK CONSISTS OF STANDARD CHARACTERS WITHOUT CLAIM TO ANY PARTICULAR FONT, STYLE, SIZE, OR COLOR.

FOR AUDIO AND VIDEO PROJECTORS; MULTIMEDIA PROJECTORS; PICTURE PROJECTORS; HOME THEATRE PROJECTORS; GAMING PROJECTORS; DIGITAL PROJECTORS AND PARTS THEREFOR, AND CONNECTIVITY EQUIPMENT THEREFOR, NAMELY, ELECTRICAL CONNECTORS AND CABLES AND RELATED ITEMS FOR CONNECTIVITY PURPOSES; COMPUTER SOFTWARE FOR USE TO ENABLE TRANSMISSION AND DISPLAY OF IMAGES ON A PROJECTOR (U.S. CLS. 21, 23, 26, 36 AND 38).

FIRST USE 1-4-2006; IN COMMERCE 1-4-2006.

3,299,593. ID INTERACTIVE LLC, DELRAY BEACH, FL. SN 78-762,318. PUB. 10-17-2006, FILED 11-29-2005.

CLAWS & PAWS

THE MARK CONSISTS OF STANDARD CHARACTERS WITHOUT CLAIM TO ANY PARTICULAR FONT, STYLE, SIZE, OR COLOR.

FOR GAMING MACHINES, NAMELY, DEVICES WHICH ACCEPT A WAGER, AND COMPUTER SOFTWARE FOR GAMING MACHINES (U.S. CLS. 21, 23, 26, 36 AND 38).

FIRST USE 3-1-2006; IN COMMERCE 4-28-2006.

3,299,597. REVERA INCORPORATED, SUNNYVALE, CA. SN 78-762,824. PUB. 8-1-2006, FILED 11-29-2005.

VERAFLEX

THE MARK CONSISTS OF STANDARD CHARACTERS WITHOUT CLAIM TO ANY PARTICULAR FONT, STYLE, SIZE, OR COLOR.

FOR METROLOGY SYSTEMS COMPRISED OF COMPUTER HARDWARE AND X-RAY EQUIPMENT FOR MEASURING PHYSICAL COMPOSITION AND THICKNESS OF THIN FILMS, FOR USE IN THE SEMICONDUCTOR MANUFACTURING PROCESS (U.S. CLS. 21, 23, 26, 36 AND 38).

FIRST USE 10-0-2005; IN COMMERCE 10-0-2005.

CLASS 9—(Continued).

3,299,609. GENERAL ELECTRIC COMPANY, SCHENECTADY, NY. SN 78-765,364. PUB. 6-27-2006, FILED 12-2-2005.

VOLUMERAD

THE MARK CONSISTS OF STANDARD CHARACTERS WITHOUT CLAIM TO ANY PARTICULAR FONT, STYLE, SIZE, OR COLOR.

FOR SOFTWARE FOR PROCESSING DIGITAL IMAGES OF THE ANATOMY FOR DIAGNOSIS AND TREATMENT (U.S. CLS. 21, 23, 26, 36 AND 38).

FIRST USE 1-31-2006; IN COMMERCE 1-31-2006.

3,299,613. SITIME CORPORATION, SUNNYVALE, CA. SN 78-766,851. PUB. 4-18-2006, FILED 12-5-2005.

SIRES

THE MARK CONSISTS OF STANDARD CHARACTERS WITHOUT CLAIM TO ANY PARTICULAR FONT, STYLE, SIZE, OR COLOR.

FOR ELECTRONIC DEVICES FOR MEASURING, TESTING AND GENERATING ELECTRONIC AND ELECTRICAL TIMING OR CLOCK SIGNALS IN SILICON SEMICONDUCTOR CHIPS AND SIGNAL CONDITIONING CIRCUITRY, NAMELY, ELECTROMECHANICAL OSCILLATORS; SEMICONDUCTORS, SILICON WAFERS, PACKAGED OSCILLATORS, CLOCK CHIPS, AND TIMING CHIPS (U.S. CLS. 21, 23, 26, 36 AND 38).

FIRST USE 2-15-2007; IN COMMERCE 2-15-2007.

3,299,630. BLADE NETWORK TECHNOLOGIES, INC., SANTA CLARA, CA. SN 78-769,806. PUB. 11-21-2006, FILED 12-8-2005.

BLADE NETWORK TECHNOLOGIES

THE MARK CONSISTS OF STANDARD CHARACTERS WITHOUT CLAIM TO ANY PARTICULAR FONT, STYLE, SIZE, OR COLOR.

NO CLAIM IS MADE TO THE EXCLUSIVE RIGHT TO USE "NETWORK TECHNOLOGIES", APART FROM THE MARK AS SHOWN.

FOR NETWORK INTERFACE MODULES FOR SERVERS (U.S. CLS. 21, 23, 26, 36 AND 38).

FIRST USE 2-13-2006; IN COMMERCE 2-13-2006.

CLASS 9—(Continued).

3,299,648. HEATHROW SCIENTIFIC LLC, VERNON HILLS, IL. SN 78-773,166. PUB. 8-29-2006, FILED 12-14-2005.

ONERACK

THE MARK CONSISTS OF STANDARD CHARACTERS WITHOUT CLAIM TO ANY PARTICULAR FONT, STYLE, SIZE, OR COLOR.

FOR LABORATORY EQUIPMENT, NAMELY, TEST TUBE RACKS (U.S. CLS. 21, 23, 26, 36 AND 38).

FIRST USE 1-0-2006; IN COMMERCE 8-0-2006.

3,299,649. BATTERIES PLUS, LLC, HARTLAND, WI. SN 78-773,460. PUB. 8-29-2006, FILED 12-14-2005.

WERKER

THE MARK CONSISTS OF STANDARD CHARACTERS WITHOUT CLAIM TO ANY PARTICULAR FONT, STYLE, SIZE, OR COLOR.

OWNER OF U.S. REG. NO. 2,943,090.

THE ENGLISH TRANSLATION OF THE WORD WERKER IN THE MARK IS WORKER.

FOR BATTERY CHARGERS (U.S. CLS. 21, 23, 26, 36 AND 38).

FIRST USE 11-11-2005; IN COMMERCE 11-11-2005.

3,299,665. ELECTRONIC THEATRE CONTROLS, INC., MIDDLETON, WI. SN 78-777,102. PUB. 8-15-2006, FILED 12-20-2005.

EOS

THE MARK CONSISTS OF STANDARD CHARACTERS WITHOUT CLAIM TO ANY PARTICULAR FONT, STYLE, SIZE, OR COLOR.

FOR ELECTRIC LIGHTING CONTROL CONSOLES (U.S. CLS. 21, 23, 26, 36 AND 38).

FIRST USE 12-7-2006; IN COMMERCE 12-7-2006.

CLASS 9—(Continued).

3,299,685. SONOA SYSTEMS, INC., SUNNYVALE, CA. SN 78-784,199. PUB. 9-5-2006, FILED 1-3-2006.

SONOA

THE MARK CONSISTS OF STANDARD CHARACTERS WITHOUT CLAIM TO ANY PARTICULAR FONT, STYLE, SIZE, OR COLOR.

FOR COMPUTER HARDWARE AND SOFTWARE FOR INTERCONNECTING, MANAGING, SECURING AND OPERATING LOCAL AND WIDE AREA NETWORKS AND TELEPHONY SYSTEMS, NAMELY ROUTERS, GATEWAYS, SWITCHES, PORT ADAPTERS, AND OTHER COMMUNICATION DEVICES, AND SOFTWARE USED IN THE OPERATION AND MANAGEMENT THEREOF (U.S. CLS. 21, 23, 26, 36 AND 38).

FIRST USE 6-1-2005; IN COMMERCE 1-15-2007.

3,299,691. EPOK, INC., BETHESDA, MD. SN 78-786,161. PUB. 2-6-2007, FILED 1-6-2006.

EPOK ISE

THE MARK CONSISTS OF STANDARD CHARACTERS WITHOUT CLAIM TO ANY PARTICULAR FONT, STYLE, SIZE, OR COLOR.

OWNER OF U.S. REG. NOS. 3,024,314 AND 3,024,328.

NO CLAIM IS MADE TO THE EXCLUSIVE RIGHT TO USE "ISE", APART FROM THE MARK AS SHOWN.

FOR COMPUTER SOFTWARE FOR USE IN THE SECURE EXCHANGE AND TRANSMISSION OF INFORMATION AND DATA OVER COMPUTER NETWORKS (U.S. CLS. 21, 23, 26, 36 AND 38).

FIRST USE 1-6-2006; IN COMMERCE 4-30-2006.

3,299,692. ID INTERACTIVE LLC, DELRAY BEACH, FL. SN 78-786,203. PUB. 10-17-2006, FILED 1-6-2006.

MAGIC HANDS

THE MARK CONSISTS OF STANDARD CHARACTERS WITHOUT CLAIM TO ANY PARTICULAR FONT, STYLE, SIZE, OR COLOR.

FOR GAMING MACHINES, NAMELY, DEVICES WHICH ACCEPT A WAGER, AND COMPUTER SOFTWARE ASSOCIATED THEREWITH (U.S. CLS. 21, 23, 26, 36 AND 38).

FIRST USE 8-28-2006; IN COMMERCE 9-22-2006.

CLASS 9—(Continued).

3,299,693. ID INTERACTIVE LLC, DELRAY BEACH, FL. SN 78-786,206. PUB. 10-17-2006, FILED 1-6-2006.

TIME QUEST

THE MARK CONSISTS OF STANDARD CHARACTERS WITHOUT CLAIM TO ANY PARTICULAR FONT, STYLE, SIZE, OR COLOR.

FOR GAMING MACHINES, NAMELY, DEVICES WHICH ACCEPT A WAGER, AND COMPUTER SOFTWARE ASSOCIATED THEREWITH (U.S. CLS. 21, 23, 26, 36 AND 38).

FIRST USE 10-4-2006; IN COMMERCE 11-8-2006.

CLASS 9—(Continued).

3,299,708. LEE, RAYMOND C., SACRAMENTO, CA. AND WONG, KENNY, SACRAMENTO, CA. SN 78-789,308. PUB. 8-29-2006, FILED 1-11-2006.

KARDESIGN

THE MARK CONSISTS OF STANDARD CHARACTERS WITHOUT CLAIM TO ANY PARTICULAR FONT, STYLE, SIZE, OR COLOR.

FOR AUDIO EQUIPMENT FOR VEHICLES, NAMELY, SPEAKERS AND SPEAKER HOUSINGS (U.S. CLS. 21, 23, 26, 36 AND 38).

FIRST USE 4-1-2006; IN COMMERCE 4-1-2006.

3,299,717. MILLION VOICES FOUNDATION, DALLAS, TX. SN 78-791,523. PUB. 9-12-2006, FILED 1-13-2006.

MILLION VOICES

THE MARK CONSISTS OF STANDARD CHARACTERS WITHOUT CLAIM TO ANY PARTICULAR FONT, STYLE, SIZE, OR COLOR.

NO CLAIM IS MADE TO THE EXCLUSIVE RIGHT TO USE "VOICES", APART FROM THE MARK AS SHOWN.

FOR MUSICAL SOUND RECORDINGS (U.S. CLS. 21, 23, 26, 36 AND 38).

FIRST USE 12-19-2006; IN COMMERCE 12-19-2006.

3,299,718. AGRIZAP, INC., VENTURA, CA. SN 78-791,949. PUB. 10-24-2006, FILED 1-14-2006.

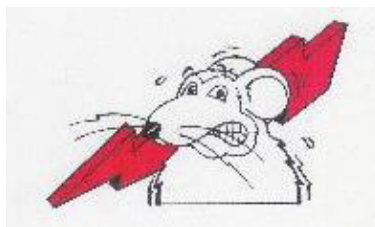

THE COLOR(S) BLACK, RED AND WHITE IS/ARE CLAIMED AS A FEATURE OF THE MARK.

THE COLOR BLACK APPEARS IN THE OUTLINE OF THE ENTIRE DESIGN, IN THE HEAD FEATURES OF THE RODENT AND IN THE SWEAT FALLING FROM THE RODENT. THE COLOR RED APPEARS IN THE BOLT DESIGN. THE COLOR WHITE APPEARS IN THE BODY OF THE RODENT.

FOR ELECTRONIC RODENT CONTROL DEVICE (U.S. CLS. 21, 23, 26, 36 AND 38).

FIRST USE 1-1-1999; IN COMMERCE 1-1-1999.

3,299,707. HONEYWELL INTERNATIONAL INC., MORRISTOWN, NJ. SN 78-789,219. PUB. 3-6-2007, FILED 1-11-2006.



OWNER OF U.S. REG. NOS. 300,644, 1,826,828, AND OTHERS.

NO CLAIM IS MADE TO THE EXCLUSIVE RIGHT TO USE "FIRE CONTROL INSTRUMENTS", APART FROM THE MARK AS SHOWN.

FOR FIRE ALARM, POLICE SIGNALLING AND EMERGENCY EVACUATION DEVICES, NAMELY, FIRE ALARM CONTROL PANELS, HOUSING FOR ELECTRONIC BOARDS, ELECTRONIC CARD MODULES, NETWORK CARDS, AUDIO COMMAND CENTERS, AUDIO TRANSDUCERS, SMOKE DETECTORS, HEAT DETECTORS, IONIZATION PLUG-IN DETECTORS, PHOTO ELECTRONIC PLUG-IN DETECTORS, SMOKE SENSORS, THERMAL SENSORS, ELECTRIC SWITCHES, ALARM PULL STATIONS, AUDIBLE AND VISIBLE NOTIFICATION APPLIANCES, STROBES, SIRENS, BELLS, HORNS, SPEAKERS, ENUNCIATORS, LCD PANELS, LED PANELS, POWER DISTRIBUTION UNITS, ELECTRIC POWER SUPPLIES, BATTERY CHARGERS, BATTERIES AND EMERGENCY PERSONNEL TELEPHONES (U.S. CLS. 21, 23, 26, 36 AND 38).

FIRST USE 8-31-2005; IN COMMERCE 9-30-2006.

CLASS 9—(Continued).

3,299,720. NAMCO BANDAI GAMES AMERICA INC., CYPRESS, CA. SN 78-793,425. PUB. 8-8-2006, FILED 1-17-2006.

ULTIMATE NINJA

THE MARK CONSISTS OF STANDARD CHARACTERS WITHOUT CLAIM TO ANY PARTICULAR FONT, STYLE, SIZE, OR COLOR.

FOR COMPUTER GAME PROGRAMS; VIDEO GAME CARTRIDGES (U.S. CLS. 21, 23, 26, 36 AND 38).
FIRST USE 6-26-2006; IN COMMERCE 6-26-2006.

3,299,726. ECHEF, LLC, LINCOLN, NE. SN 78-794,870. PUB. 11-28-2006, FILED 1-19-2006.

eCHEF

THE MARK CONSISTS OF STANDARD CHARACTERS WITHOUT CLAIM TO ANY PARTICULAR FONT, STYLE, SIZE, OR COLOR.

FOR COMPUTER SOFTWARE FOR CREATING SEARCHABLE DATABASES OF INFORMATION AND DATA; COMPUTER SOFTWARE FOR THE COLLECTION, EDITING, ORGANIZING, MODIFYING, BOOK MARKING, TRANSMISSION, STORAGE AND SHARING OF DATA AND INFORMATION; COMPUTER SOFTWARE FOR RECIPE MANAGEMENT AND A RECIPE DATABASE (U.S. CLS. 21, 23, 26, 36 AND 38).
FIRST USE 8-1-2006; IN COMMERCE 8-1-2006.

3,299,773. ID INTERACTIVE LLC, DELRAY BEACH, FL. SN 78-809,233. PUB. 10-17-2006, FILED 2-7-2006.

MOUSE TO MARS

THE MARK CONSISTS OF STANDARD CHARACTERS WITHOUT CLAIM TO ANY PARTICULAR FONT, STYLE, SIZE, OR COLOR.

FOR GAMING MACHINES, NAMELY, DEVICES WHICH ACCEPT A WAGER, AND COMPUTER SOFTWARE ASSOCIATED THEREWITH (U.S. CLS. 21, 23, 26, 36 AND 38).
FIRST USE 11-10-2006; IN COMMERCE 12-15-2006.

CLASS 9—(Continued).

3,299,774. ID INTERACTIVE LLC, DELRAY BEACH, FL. SN 78-809,237. PUB. 10-17-2006, FILED 2-7-2006.

BALLS-O-BUCKS

THE MARK CONSISTS OF STANDARD CHARACTERS WITHOUT CLAIM TO ANY PARTICULAR FONT, STYLE, SIZE, OR COLOR.

FOR GAMING MACHINES, NAMELY, DEVICES WHICH ACCEPT A WAGER, AND COMPUTER SOFTWARE ASSOCIATED THEREWITH (U.S. CLS. 21, 23, 26, 36 AND 38).
FIRST USE 9-26-2006; IN COMMERCE 10-31-2006.

3,299,783. BALLY GAMING INTERNATIONAL, INC., LAS VEGAS, NV. SN 78-811,062. PUB. 9-19-2006, FILED 2-9-2006.

SAND DOLLARS

THE MARK CONSISTS OF STANDARD CHARACTERS WITHOUT CLAIM TO ANY PARTICULAR FONT, STYLE, SIZE, OR COLOR.

FOR GAMING DEVICES, NAMELY SLOT MACHINES, WITH OR WITHOUT VIDEO OUTPUT (U.S. CLS. 21, 23, 26, 36 AND 38).
FIRST USE 9-15-2006; IN COMMERCE 9-15-2006.

3,299,787. REDCART SOLUTIONS, LLC, NEW BRIGHTON, MN. SN 78-813,633. PUB. 12-12-2006, FILED 2-13-2006.

RedCart

THE MARK CONSISTS OF STANDARD CHARACTERS WITHOUT CLAIM TO ANY PARTICULAR FONT, STYLE, SIZE, OR COLOR.

FOR COMPUTER SOFTWARE FOR ONLINE PROOFING, ORDERING, PHOTO GALLERY CREATION, PRODUCT AND PRICE MANAGEMENT, ORDER MANAGEMENT, AND DISCOUNT AND PROMOTION FEATURES, ALL RELATED TO PHOTOGRAPHS AND ELECTRONIC IMAGES (U.S. CLS. 21, 23, 26, 36 AND 38).
FIRST USE 12-20-2006; IN COMMERCE 12-20-2006.

CLASS 9—(Continued).

3,299,807. MCILHENNY COMPANY, AVERY ISLAND, LA. SN 78-819,057. PUB. 8-1-2006, FILED 2-20-2006.

CHEZ TABASCO

THE MARK CONSISTS OF STANDARD CHARACTERS WITHOUT CLAIM TO ANY PARTICULAR FONT, STYLE, SIZE, OR COLOR.

OWNER OF U.S. REG. NOS. 3,015,104 AND 3,015,107. THE FOREIGN WORDING IN THE MARK TRANSLATES INTO ENGLISH AS HOUSE OF. FOR GAMING MACHINES (U.S. CLS. 21, 23, 26, 36 AND 38).

FIRST USE 11-14-2006; IN COMMERCE 11-14-2006.

3,299,810. BALLY GAMING INTERNATIONAL, INC., LAS VEGAS, NV. SN 78-819,915. PUB. 9-19-2006, FILED 2-21-2006.

GOLDEN MONKEY

THE MARK CONSISTS OF STANDARD CHARACTERS WITHOUT CLAIM TO ANY PARTICULAR FONT, STYLE, SIZE, OR COLOR.

FOR GAMING DEVICES, NAMELY SLOT MACHINES, WITH OR WITHOUT VIDEO OUTPUT (U.S. CLS. 21, 23, 26, 36 AND 38).

FIRST USE 3-7-2007; IN COMMERCE 3-7-2007.

3,299,812. MERCHANTWAREHOUSE.COM, INC., BOSTON, MA. SN 78-820,507. PUB. 10-24-2006, FILED 2-22-2006.

MERCHANTWARE

THE MARK CONSISTS OF STANDARD CHARACTERS WITHOUT CLAIM TO ANY PARTICULAR FONT, STYLE, SIZE, OR COLOR.

FOR SOFTWARE FOR FACILITATING CREDIT-CARD TRANSACTIONS, NAMELY, SOFTWARE TO ALLOW USERS TO PERFORM ELECTRONIC BUSINESS TRANSACTIONS VIA A GLOBAL COMPUTER NETWORK (U.S. CLS. 21, 23, 26, 36 AND 38).

FIRST USE 5-19-2006; IN COMMERCE 5-19-2006.

CLASS 9—(Continued).

3,299,823. APPLE INC., CUPERTINO, CA. SN 78-825,435. PUB. 1-9-2007, FILED 2-28-2006.

PHOTO BOOTH

THE MARK CONSISTS OF STANDARD CHARACTERS WITHOUT CLAIM TO ANY PARTICULAR FONT, STYLE, SIZE, OR COLOR.

PRIORITY CLAIMED UNDER SEC. 44(D) ON NEW ZEALAND APPLICATION NO. 735024, FILED 9-1-2005.

FOR COMPUTER SOFTWARE USED FOR IMAGE EDITING, IMAGE ACQUISITION, AND IMAGE VIEWING (U.S. CLS. 21, 23, 26, 36 AND 38).

FIRST USE 10-12-2005; IN COMMERCE 10-12-2005.

3,299,827. THE CEDARVILLE UNIVERSITY, CEDARVILLE, OH. SN 78-826,868. PUB. 10-24-2006, FILED 3-1-2006.



THE COLORS GREEN, BLACK, AND WHITE ARE CLAIMED AS A FEATURE OF THE MARK.

THE MARK CONSISTS OF THE WORD "RE:VIEW" WITHIN A BLACK OUTLINED RECTANGLE WITH ROUNDED EDGES. THE "VIEW" PORTION OF THE WORD IS IN GREEN WHILE THE "RE:" IS IN BLACK. THE WORD IS FEATURED AGAINST A WHITE BACKGROUND WITHIN THE RECTANGLE AND IS ORIENTED TOWARD THE RIGHT SIDE OF THE RECTANGLE. ON THE LEFT HAND SIDE OF THE RECTANGLE, THERE IS A BLOCK OF GREEN WITH SMALLER WHITE BLOCKS IN VERTICAL PATTERNS INSIDE OF IT.

FOR PRE-RECORDED CDS AND DVDS FEATURING EDUCATIONAL CURRICULUMS (U.S. CLS. 21, 23, 26, 36 AND 38).

FIRST USE 9-10-2006; IN COMMERCE 9-10-2006.

CLASS 9—(Continued).

3,299,849. HEATHROW SCIENTIFIC LLC, VERNON HILLS, IL. SN 78-835,344. PUB. 9-12-2006, FILED 3-13-2006.

ROTA-RACK

THE MARK CONSISTS OF STANDARD CHARACTERS WITHOUT CLAIM TO ANY PARTICULAR FONT, STYLE, SIZE, OR COLOR.

OWNER OF U.S. REG. NO. 2,883,293.
FOR LABORATORY EQUIPMENT, NAMELY, TEST TUBE RACKS (U.S. CLS. 21, 23, 26, 36 AND 38).
FIRST USE 10-1-2006; IN COMMERCE 12-1-2006.

3,299,855. IP HOLDINGS, LLC, VANCOUVER, WA. SN 78-836,782. PUB. 1-30-2007, FILED 3-14-2006.

Digital Fusion

THE MARK CONSISTS OF STANDARD CHARACTERS WITHOUT CLAIM TO ANY PARTICULAR FONT, STYLE, SIZE, OR COLOR.

NO CLAIM IS MADE TO THE EXCLUSIVE RIGHT TO USE "DIGITAL", APART FROM THE MARK AS SHOWN.
FOR LIGHTING BALLAST FOR IGNITION AND CONTROL OF HORTICULTURE GROW LIGHTS (U.S. CLS. 21, 23, 26, 36 AND 38).

FIRST USE 4-11-2006; IN COMMERCE 1-1-2007.

3,299,865. LUNAR EXPLORER, LLC, RAHWAY, NY. SN 78-840,510. PUB. 1-23-2007, FILED 3-17-2006.

Lunar Explorer

THE MARK CONSISTS OF STANDARD CHARACTERS WITHOUT CLAIM TO ANY PARTICULAR FONT, STYLE, SIZE, OR COLOR.

NO CLAIM IS MADE TO THE EXCLUSIVE RIGHT TO USE "LUNAR", APART FROM THE MARK AS SHOWN.

FOR COMPUTER SOFTWARE INTERACTIVE SIMULATION OF THE MOON (U.S. CLS. 21, 23, 26, 36 AND 38).
FIRST USE 10-27-2004; IN COMMERCE 11-16-2006.

CLASS 9—(Continued).

3,299,872. VINCULUM COMMUNICATIONS, INC., SAN DIEGO, CA. SN 78-844,734. PUB. 10-31-2006, FILED 3-23-2006.

VINTALK

THE MARK CONSISTS OF STANDARD CHARACTERS WITHOUT CLAIM TO ANY PARTICULAR FONT, STYLE, SIZE, OR COLOR.

FOR TELECOMMUNICATIONS AND DATA NETWORKING HARDWARE, NAMELY DEVICES FOR TRANSPORTING AND AGGREGATING VOICE, DATA, AND VIDEO COMMUNICATIONS ACROSS MULTIPLE NETWORK INFRASTRUCTURES AND COMMUNICATIONS PROTOCOLS (U.S. CLS. 21, 23, 26, 36 AND 38).
FIRST USE 3-11-2006; IN COMMERCE 3-11-2006.

3,299,886. TRANSITIONS OPTICAL, INC., PINELLAS PARK, FL. SN 78-850,178. PUB. 7-11-2006, FILED 3-30-2006.

ACTIVATED BY TRANSITIONS

THE MARK CONSISTS OF STANDARD CHARACTERS WITHOUT CLAIM TO ANY PARTICULAR FONT, STYLE, SIZE, OR COLOR.

FOR EYEGLASS LENSES AND LENS BLANKS (U.S. CLS. 21, 23, 26, 36 AND 38).

FIRST USE 3-24-2006; IN COMMERCE 3-24-2006.

3,299,905. GREAT BUILDERS SOLUTIONS INC., TORONTO, ONTARIO, CANADA. SN 78-858,065. PUB. 11-21-2006, FILED 4-10-2006.

DYNAMIC BUILDER

THE MARK CONSISTS OF STANDARD CHARACTERS WITHOUT CLAIM TO ANY PARTICULAR FONT, STYLE, SIZE, OR COLOR.

NO CLAIM IS MADE TO THE EXCLUSIVE RIGHT TO USE "BUILDER", APART FROM THE MARK AS SHOWN.

FOR DATABASE MANAGEMENT COMPUTER SOFTWARE FOR USE IN CONSTRUCTION PROJECTS, NAMELY, SOFTWARE FOR JOB COST ESTIMATING, SCHEDULING, WARRANTY ANALYSES, SALES, CLIENT MANAGEMENT, SELECTION OF CONSTRUCTION OPTIONS, PURCHASING, MARKETING, LAND DEVELOPMENT, MODELING AND DESIGN, BUDGETING, FINANCING, FORECASTING, AND ACCOUNTING (U.S. CLS. 21, 23, 26, 36 AND 38).

FIRST USE 3-28-2007; IN COMMERCE 3-28-2007.

CLASS 9—(Continued).

3,299,906. THE MCGRAW-HILL COMPANIES, INC., NEW YORK, NY. SN 78-858,176. PUB. 12-5-2006, FILED 4-10-2006.

GRAPHING CALCULATOR EASY FILES

THE MARK CONSISTS OF STANDARD CHARACTERS WITHOUT CLAIM TO ANY PARTICULAR FONT, STYLE, SIZE, OR COLOR.

NO CLAIM IS MADE TO THE EXCLUSIVE RIGHT TO USE GRAPHING CALCULATOR, APART FROM THE MARK AS SHOWN.

FOR CD-ROMS AND DOWNLOADABLE COMPUTER SOFTWARE FEATURING A SUPPLEMENTAL MATH PROGRAM FOR TEACHERS AND STUDENTS IN GRADES 6-12 (U.S. CLS. 21, 23, 26, 36 AND 38).

FIRST USE 11-0-2005; IN COMMERCE 11-0-2005.

3,299,920. NSI AUDIO INC, SAN JOSE, CA. SN 78-863,945. PUB. 11-28-2006, FILED 4-18-2006.

AudioBank

THE MARK CONSISTS OF STANDARD CHARACTERS WITHOUT CLAIM TO ANY PARTICULAR FONT, STYLE, SIZE, OR COLOR.

FOR AUDIO EQUIPMENT FOR VEHICLES, NAMELY, STEREOS, SPEAKERS, AMPLIFIERS, EQUALIZERS, CROSSOVERS AND SPEAKER HOUSINGS (U.S. CLS. 21, 23, 26, 36 AND 38).

FIRST USE 8-1-2006; IN COMMERCE 8-1-2006.

3,299,921. NSI AUDIO INC, SAN JOSE, CA. SN 78-864,022. PUB. 11-28-2006, FILED 4-18-2006.

AudioTek

THE MARK CONSISTS OF STANDARD CHARACTERS WITHOUT CLAIM TO ANY PARTICULAR FONT, STYLE, SIZE, OR COLOR.

FOR AUDIO EQUIPMENT FOR VEHICLES, NAMELY, STEREOS, SPEAKERS, AMPLIFIERS, EQUALIZERS, CROSSOVERS AND SPEAKER HOUSINGS (U.S. CLS. 21, 23, 26, 36 AND 38).

FIRST USE 8-1-2006; IN COMMERCE 8-1-2006.

CLASS 9—(Continued).

3,299,927. ESCHATONE RECORDS, LLC, NEW YORK, NY. SN 78-865,309. PUB. 11-21-2006, FILED 4-19-2006.



THE MARK CONSISTS OF LOWERCASE "E" INSIDE STYLIZED "OMEGA" SYMBOL.

FOR AUDIO RECORDINGS FEATURING MUSIC; DOWNLOADABLE MUSICAL SOUND RECORDINGS; DOWNLOADABLE VIDEO RECORDINGS FEATURING MUSIC; MUSICAL SOUND RECORDINGS; MUSICAL VIDEO RECORDINGS; PRE-RECORDED CD'S, VIDEO TAPES, LASER DISKS AND DVD'S FEATURING MUSIC; SOUND RECORDINGS FEATURING MUSIC; VIDEO RECORDINGS FEATURING MUSIC (U.S. CLS. 21, 23, 26, 36 AND 38).

FIRST USE 10-1-2006; IN COMMERCE 10-10-2006.

3,299,928. ESCHATONE RECORDS, LLC, NEW YORK, NY. SN 78-865,322. PUB. 11-21-2006, FILED 4-19-2006.

Eschatone

THE MARK CONSISTS OF STANDARD CHARACTERS WITHOUT CLAIM TO ANY PARTICULAR FONT, STYLE, SIZE, OR COLOR.

FOR AUDIO RECORDINGS FEATURING MUSIC; DOWNLOADABLE MUSICAL SOUND RECORDINGS; DOWNLOADABLE VIDEO RECORDINGS FEATURING MUSIC; MUSICAL SOUND RECORDINGS; MUSICAL VIDEO RECORDINGS; PRE-RECORDED CD'S, VIDEO TAPES, LASER DISKS AND DVD'S FEATURING MUSIC; SOUND RECORDINGS FEATURING MUSIC; VIDEO RECORDINGS FEATURING MUSIC (U.S. CLS. 21, 23, 26, 36 AND 38).

FIRST USE 10-1-2006; IN COMMERCE 10-10-2006.

CLASS 9—(Continued).

3,299,939. CDMDATA, INC., SCOTTSDALE, AZ. SN 78-869,374. PUB. 11-28-2006, FILED 4-25-2006.

DIGITALLOT

THE MARK CONSISTS OF STANDARD CHARACTERS WITHOUT CLAIM TO ANY PARTICULAR FONT, STYLE, SIZE, OR COLOR.

OWNER OF U.S. REG. NO. 2,881,942.
FOR COMPUTER SOFTWARE FOR UPLOADING, DOWNLOADING, PROCESSING, ORGANIZING, VIEWING, PRINTING AND SEARCHING OF VEHICLE INFORMATION (U.S. CLS. 21, 23, 26, 36 AND 38).
FIRST USE 1-20-1999; IN COMMERCE 5-10-1999.

3,299,945. DENISON, SHERILL, CLEARWATER, FL. SN 78-871,622. PUB. 12-5-2006, FILED 4-27-2006.

Tri-Ped

THE MARK CONSISTS OF STANDARD CHARACTERS WITHOUT CLAIM TO ANY PARTICULAR FONT, STYLE, SIZE, OR COLOR.

FOR WEIGHTED DEVICE THAT STABILIZES THE LEGS OF TRIPODS (U.S. CLS. 21, 23, 26, 36 AND 38).
FIRST USE 1-1-2006; IN COMMERCE 1-1-2007.

3,299,961. ADDICT LTD., SOUTHAMPTON, UNITED KINGDOM. SN 78-877,109. PUB. 12-5-2006, FILED 5-4-2006.

ADDICT

THE MARK CONSISTS OF STANDARD CHARACTERS WITHOUT CLAIM TO ANY PARTICULAR FONT, STYLE, SIZE, OR COLOR.

FOR COMPACT DISK STORAGE WALLETS; COMPUTER BAGS; PRERECORDED COMPACT DISCS FEATURING MUSIC; ANTI-DAZZLE GOGGLES; GOGGLES FOR SKIING; GOGGLES FOR SNOWBOARDING (U.S. CLS. 21, 23, 26, 36 AND 38).
FIRST USE 12-31-2000; IN COMMERCE 12-31-2001.

CLASS 9—(Continued).

3,299,968. GRANSTAFF, BRETT, CARTHAGE, TN. SN 78-878,792. PUB. 1-2-2007, FILED 5-8-2006.

BLACKJACK MECHANIC

THE MARK CONSISTS OF STANDARD CHARACTERS WITHOUT CLAIM TO ANY PARTICULAR FONT, STYLE, SIZE, OR COLOR.

NO CLAIM IS MADE TO THE EXCLUSIVE RIGHT TO USE "BLACKJACK", APART FROM THE MARK AS SHOWN.

FOR INSTRUCTIONAL DVDS FEATURING SEMINARS ABOUT BLACKJACK STRATEGIES; INSTRUCTIONAL DVDS FEATURING BLACKJACK STRATEGIES (U.S. CLS. 21, 23, 26, 36 AND 38).
FIRST USE 7-1-2006; IN COMMERCE 7-1-2006.

3,299,969. KAMMS CONSULTING, LLC, VENTNOR CITY, NJ. SN 78-878,922. PUB. 12-19-2006, FILED 5-8-2006.

INGLÉS EN EL TRABAJO

THE MARK CONSISTS OF STANDARD CHARACTERS WITHOUT CLAIM TO ANY PARTICULAR FONT, STYLE, SIZE, OR COLOR.

NO CLAIM IS MADE TO THE EXCLUSIVE RIGHT TO USE "INGLES", APART FROM THE MARK AS SHOWN.

THE FOREIGN WORDING IN THE MARK TRANSLATES INTO ENGLISH AS ENGLISH ON THE JOB.

FOR COMPACT DISCS FEATURING JOB SPECIFIC LANGUAGE LEARNING (U.S. CLS. 21, 23, 26, 36 AND 38).
FIRST USE 8-10-2006; IN COMMERCE 8-10-2006.

3,299,977. COMMSCOPE, INC. OF NORTH CAROLINA, HICKORY, NC. SN 78-882,086. PUB. 11-28-2006, FILED 5-12-2006.

CONNECTED BY COMMSCOPE!

THE MARK CONSISTS OF STANDARD CHARACTERS WITHOUT CLAIM TO ANY PARTICULAR FONT, STYLE, SIZE, OR COLOR.

OWNER OF U.S. REG. NOS. 898,651, 3,124,082, AND OTHERS.

FOR COMMUNICATIONS CABLES, NAMELY, FIBER OPTIC, TWISTED PAIR AND COAXIAL CABLES, AND HYBRIDS THEREOF, AND CONNECTORS THEREFOR (U.S. CLS. 21, 23, 26, 36 AND 38).
FIRST USE 8-1-2006; IN COMMERCE 8-1-2006.

CLASS 9—(Continued).

3,300,008. PROMEDIA TECHNOLOGIES, INC., ONTARIO, CA. SN 78-893,879. PUB. 2-6-2007, FILED 5-26-2006.

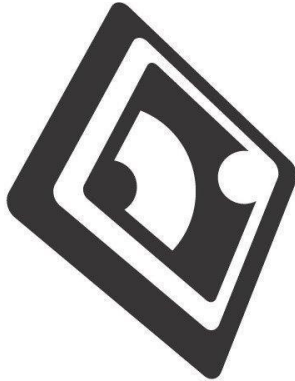

FOR COMPUTER MONITORS; HOME THEATER PRODUCTS, NAMELY, LCD; LIQUID CRYSTAL DISPLAY PROJECTORS; LIQUID CRYSTAL DISPLAYS (U.S. CLS. 21, 23, 26, 36 AND 38).
FIRST USE 5-4-2007; IN COMMERCE 5-4-2007.

CLASS 9—(Continued).

3,300,024. NASH, JOEL H, NEW YORK, NY. SN 78-900,075. PUB. 1-2-2007, FILED 6-4-2006.

Fit Pack

THE MARK CONSISTS OF STANDARD CHARACTERS WITHOUT CLAIM TO ANY PARTICULAR FONT, STYLE, SIZE, OR COLOR.

NO CLAIM IS MADE TO THE EXCLUSIVE RIGHT TO USE "PACK", APART FROM THE MARK AS SHOWN.

FOR DVDS FEATURING A SERIES OF CLASSES PROVIDING INSTRUCTION ON SOME OR ALL OF: AEROBICS, GENERAL EXERCISE, RESISTANCE TRAINING, STRETCHING, BALANCE POSITIONS, LIFE INSTRUCTION, MUSIC, MOTIVATION, DIETING AND WEIGHT MANAGEMENT, NUTRITION AND HEALTH; PRE-RECORDED CD'S, VIDEO TAPES, LASER DISKS AND DVD'S FEATURING A SERIES OF CLASSES PROVIDING INSTRUCTION ON SOME OR ALL OF: AEROBICS, GENERAL EXERCISE, RESISTANCE TRAINING, STRETCHING, BALANCE POSITIONS, LIFE INSTRUCTION, MUSIC, MOTIVATION, DIETING AND WEIGHT MANAGEMENT, NUTRITION AND HEALTH (U.S. CLS. 21, 23, 26, 36 AND 38).

FIRST USE 11-0-2006; IN COMMERCE 11-0-2006.

3,300,039. ROWE TECHNOLOGIES, INC, GOLDEN, CO. SN 78-904,205. PUB. 1-16-2007, FILED 6-8-2006.

VERIDeposit

THE MARK CONSISTS OF THE LETTER V IS CAPITALIZED AND THE D IS CAPITALIZED.

FOR COMPUTER COMMUNICATIONS SOFTWARE TO ALLOW CUSTOMERS TO ACCESS BANK ACCOUNT INFORMATION AND TRANSACT BANK BUSINESS (U.S. CLS. 21, 23, 26, 36 AND 38).

FIRST USE 4-10-2007; IN COMMERCE 4-10-2007.

3,300,019. ATLUS U.S.A., INC., IRVINE, CA. SN 78-898,276. PUB. 1-9-2007, FILED 6-1-2006.

ODIN SPHERE

THE MARK CONSISTS OF STANDARD CHARACTERS WITHOUT CLAIM TO ANY PARTICULAR FONT, STYLE, SIZE, OR COLOR.

FOR VIDEO AND COMPUTER GAME PROGRAMS, CARTRIDGES AND DISCS AND INSTRUCTION MANUALS SOLD AS A UNIT (U.S. CLS. 21, 23, 26, 36 AND 38).

FIRST USE 5-22-2007; IN COMMERCE 5-22-2007.

3,300,056. ONDA, HIDEKI FRANCIS, TOKYO, JAPAN. SN 78-910,814. PUB. 1-23-2007, FILED 6-18-2006.

AquaTune

THE MARK CONSISTS OF STANDARD CHARACTERS WITHOUT CLAIM TO ANY PARTICULAR FONT, STYLE, SIZE, OR COLOR.

FOR AUDIO SPEAKER ENCLOSURES; AUDIO SPEAKERS; PROTECTIVE CARRYING CASES FOR PORTABLE MUSIC PLAYERS NAMELY MP3 PLAYERS (U.S. CLS. 21, 23, 26, 36 AND 38).

FIRST USE 6-9-2006; IN COMMERCE 6-9-2006.

CLASS 9—(Continued).

3,300,061. W3I HOLDINGS, LLC, SARTELL, MN. SN 78-911,684. PUB. 2-13-2007, FILED 6-19-2006.

YOURSREEN

THE MARK CONSISTS OF STANDARD CHARACTERS WITHOUT CLAIM TO ANY PARTICULAR FONT, STYLE, SIZE, OR COLOR.

FOR DOWNLOADABLE SOFTWARE FOR DELIVERING, DISPLAYING, BROWSING, VIEWING, REVIEWING, CREATING, EDITING AND MANAGING ELECTRONIC WALLPAPERS, SCREENSAVERS, THEMES, SKINS, WIDGETS, ICONS, CURSORS, RING TONES, GAMES, VIDEOS, PHOTOGRAPHS, DIGITAL FILES, DESKTOP ENHANCEMENTS AND ENTERTAINMENT (U.S. CLS. 21, 23, 26, 36 AND 38).

FIRST USE 7-9-2006; IN COMMERCE 7-9-2006.

3,300,062. PATIENT CARE TECHNOLOGY SYSTEMS, LLC., MISSION VIEJO, CA. SN 78-911,770. PUB. 2-20-2007, FILED 6-19-2006.

Amelior Tracker

THE MARK CONSISTS OF STANDARD CHARACTERS WITHOUT CLAIM TO ANY PARTICULAR FONT, STYLE, SIZE, OR COLOR.

OWNER OF U.S. REG. NOS. 2,656,679, 3,146,710, AND 3,149,838.

NO CLAIM IS MADE TO THE EXCLUSIVE RIGHT TO USE "TRACKER", APART FROM THE MARK AS SHOWN.

FOR COMPUTER SOFTWARE FOR TRACKING AND COMMUNICATING THE LOCATION AND MEDICAL TREATMENT STATUS OF PATIENTS, AND THE LOCATION OF MEDICAL STAFF AND MOBILE MEDICAL EQUIPMENT IN A HEALTHCARE FACILITY (U.S. CLS. 21, 23, 26, 36 AND 38).

FIRST USE 8-1-2006; IN COMMERCE 8-1-2006.

CLASS 9—(Continued).

3,300,063. HIDEKI FRANCIS ONDA, TOKYO, JAPAN. SN 78-911,828. PUB. 1-23-2007, FILED 6-19-2006.

TuneRemote

THE MARK CONSISTS OF STANDARD CHARACTERS WITHOUT CLAIM TO ANY PARTICULAR FONT, STYLE, SIZE, OR COLOR.

FOR PROTECTIVE CARRYING CASES FOR PORTABLE MUSIC PLAYERS NAMELY MP3 PLAYERS; REMOTE CONTROLS FOR STEREO, RADIO, TELEVISION, COMPUTER, MP3 PLAYER (U.S. CLS. 21, 23, 26, 36 AND 38).

FIRST USE 7-13-2006; IN COMMERCE 7-13-2006.

3,300,064. ZETEC, INC., SNOQUALMIE, WA. SN 78-911,914. PUB. 2-13-2007, FILED 6-20-2006.

ECVision

THE MARK CONSISTS OF STANDARD CHARACTERS WITHOUT CLAIM TO ANY PARTICULAR FONT, STYLE, SIZE, OR COLOR.

FOR COMPUTER PROGRAMS FOR EDDY CURRENT INSPECTION FOR DEFECTS IN HEAT EXCHANGERS AND PIPES (U.S. CLS. 21, 23, 26, 36 AND 38).

FIRST USE 2-28-2007; IN COMMERCE 2-28-2007.

3,300,074. MNICHKO, VIATCHESLAV, SARASOTA, FL. SN 78-915,037. PUB. 2-13-2007, FILED 6-22-2006.

Mpraxis

THE MARK CONSISTS OF STANDARD CHARACTERS WITHOUT CLAIM TO ANY PARTICULAR FONT, STYLE, SIZE, OR COLOR.

FOR COMPUTER SOFTWARE FOR AUTOMATED DATA COLLECTION (U.S. CLS. 21, 23, 26, 36 AND 38).

FIRST USE 7-6-2006; IN COMMERCE 5-22-2007.

CLASS 9—(Continued).

3,300,093. GROVES, WILLIAM A, DORAL, FL. SN 78-919,487.
PUB. 2-13-2007, FILED 6-29-2006.

ROMAT

THE MARK CONSISTS OF STANDARD CHARACTERS WITHOUT CLAIM TO ANY PARTICULAR FONT, STYLE, SIZE, OR COLOR.

FOR ARM RESTS FOR USE WITH COMPUTERS; BACKUP DRIVES FOR COMPUTERS; BIOS (BASIC INPUT OUTPUT SYSTEM) COMPUTER PROGRAMS; BIOS (BASIC INPUT/OUTPUT SYSTEM) COMPUTER PROGRAM; BLANK COMPUTER DISCS; BLANK DISCS FOR COMPUTERS; BLANK FLOPPY COMPUTER DISCS; BLANK HARD COMPUTER DISCS; BLANK MAGNETIC COMPUTER TAPES; BLANK TAPES FOR STORAGE OF COMPUTER DATA; CAR NAVIGATION COMPUTERS; CD DRIVES FOR COMPUTERS; CENTRAL PROCESSING UNITS (CPU); COMMUNICATIONS COMPUTERS; COMMUNICATIONS SERVERS; COMPUTER ACCELERATOR BOARD; COMPUTER BUFFERS; COMPUTER CABLES; COMPUTER CAMERAS; COMPUTER CARD ADAPTER; COMPUTER CARRYING CASES; COMPUTER CENTRAL PROCESSING UNITS; COMPUTER CHASSIS; COMPUTER CHIPS; COMPUTER CHIPSET FOR USE IN TRANSMITTING DATA TO AND FROM A CENTRAL PROCESSING UNIT; COMPUTER COLOR PRINTER USING HEAT SENSITIVE DRY PRINTING PROCESS; COMPUTER COMPONENT TESTING AND CALIBRATING EQUIPMENT; COMPUTER CURSOR CONTROL DEVICES, NAMELY, COMPUTER MOUSE; COMPUTER CURSOR CONTROL DEVICES, NAMELY, DIGITIZER TABLETS; COMPUTER CURSOR CONTROL DEVICES, NAMELY, LIGHT PENS; COMPUTER CURSOR CONTROL DEVICES, NAMELY, TOUCH PADS; COMPUTER CURSOR CONTROL DEVICES, NAMELY, TRACKBALLS; COMPUTER DISC DRIVES; COMPUTER DOCKING STATION; COMPUTER EXPANSION BOARDS; COMPUTER FAX MODEM CARDS; COMPUTER GAME CARTRIDGES; COMPUTER GAME CASSETTES; COMPUTER GAME DISCS; COMPUTER GAME EQUIPMENT CONTAINING MEMORY DEVICES NAMELY, DISCS; COMPUTER GAME JOYSTICKS; COMPUTER GAME PROGRAMS; COMPUTER GAME SOFTWARE; COMPUTER GAME TAPES; COMPUTER GRAPHICS BOARDS; COMPUTER GRAPHICS SOFTWARE; COMPUTER HARD DISCS; COMPUTER HARDWARE; COMPUTER HARDWARE FOR TELECOMMUNICATIONS; COMPUTER HEAT SINKS; COMPUTER INTERFACE BOARDS; COMPUTER JOYSTICKS; COMPUTER KEYBOARDS; COMPUTER KEYPADS; COMPUTER MEMORIES; COMPUTER MEMORY HARDWARE; COMPUTER MONITOR FRAMES; COMPUTER MONITORS; COMPUTER MOUSE; COMPUTER MOUSE, NAMELY, TOUCHPADS; COMPUTER MOUSE, NAMELY, TRACKBALLS; COMPUTER NETWORK ADAPTERS; COMPUTER NETWORK HUBS, SWITCHES AND ROUTERS; COMPUTER NETWORKING HARDWARE; COMPUTER PARALLEL PORTS; COMPUTER PERIPHERALS; COMPUTER PRINTERS; COMPUTER SCREEN FILTERS; COMPUTER SERIAL PORTS; COMPUTER STORAGE DEVICES, NAMELY, FLASH DRIVES; COMPUTER STORAGE DEVICES, NAMELY, JUMP DRIVES; COMPUTER STORAGE DEVICES, NAMELY, THUMB DRIVES; COMPUTER STYLUS; COMPUTER TERMINALS; COMPUTERS; DESKTOP COMPUTERS; DUST COVERS FOR COMPUTERS; ELECTRONIC COMPUTERS; FLOPPY DISCS DRIVES; FRAMES FOR ATTACHMENT TO COMPUTER MONITORS; GATEWAY ROUTERS IN THE NATURE OF COMPUTER CONTROL HARDWARE; HANDHELD COMPUTERS; HANDHELD PERSONAL COMPUTERS; HARD DISCS FOR COMPUTERS; HARD DRIVES FOR COMPUTERS; HEADSETS FOR USE WITH COMPUTERS; HEAT SINKS FOR USE IN COMPUTERS; INTERNAL COOLING FANS

CLASS 9—(Continued).

FOR COMPUTERS; LAN (LOCAL AREA NETWORK) ACCESS POINTS FOR CONNECTING NETWORK COMPUTER USERS; LAN (LOCAL AREA NETWORK) COMPUTER CARDS FOR CONNECTING PORTABLE COMPUTER DEVICES TO COMPUTER NETWORKS; LAPTOP COMPUTERS; MEMORY CARDS; MICRO-COMPUTER; MICRO-COMPUTERS; MICROCHIPS; MICROPROCESSORS; MOBILE COMPUTERS; MOBILE COMPUTING AND OPERATING PLATFORMS CONSISTING OF DATA TRANSCEIVERS, WIRELESS NETWORKS AND GATEWAYS FOR COLLECTION AND MANAGEMENT OF DATA; NOTEBOOK COMPUTERS; PERSONAL COMPUTERS; PERSONAL DIGITAL ASSISTANT COMPUTERS; POCKET COMPUTERS FOR NOTE-TAKING; REMOTE CURSOR CONTROLS FOR COMPUTERS; TABLET COMPUTER; UNFILLED INK CARTRIDGES FOR PHOTOCOPY MACHINES OR COMPUTER PRINTERS; WIRELESS COMPUTER PERIPHERALS; WRIST RESTS FOR COMPUTER MOUSE USERS; WRIST RESTS FOR USE WITH COMPUTERS (U.S. CLS. 21, 23, 26, 36 AND 38).

FIRST USE 5-29-2007; IN COMMERCE 5-29-2007.

3,300,110. IOZ LLC, PACIFIC PALISADES, CA. SN 78-925,197.
PUB. 2-13-2007, FILED 7-9-2006.

ZEROPHILIA

THE MARK CONSISTS OF STANDARD CHARACTERS WITHOUT CLAIM TO ANY PARTICULAR FONT, STYLE, SIZE, OR COLOR.

FOR DOWNLOADABLE MOTION PICTURES AND TV SHOWS ABOUT THE FICTIONAL GENETIC CONDITION "ZEROPHILIA" CREATED BY MARTIN CURLAND OR THE MOTION PICTURE ENTITLED "ZEROPHILIA" WRITTEN BY MARTIN CURLAND; DOWNLOADABLE MULTIMEDIA FILE CONTAINING ARTWORK, TEXT, AUDIO, VIDEO, GAMES, AND INTERNET WEB LINKS RELATING TO THE MOTION PICTURE ENTITLED "ZEROPHILIA" WRITTEN BY MARTIN CURLAND OR THE FICTIONAL GENETIC CONDITION "ZEROPHILIA" CREATED BY MARTIN CURLAND; DVDS FEATURING THE MOTION PICTURE ENTITLED "ZEROPHILIA" WRITTEN BY MARTIN CURLAND; MOTION PICTURE FILMS ABOUT THE FICTIONAL GENETIC CONDITION "ZEROPHILIA" CREATED BY MARTIN CURLAND; PRE-RECORDED CD'S, VIDEO TAPES, LASER DISKS AND DVD'S FEATURING THE MOTION PICTURE ENTITLED "ZEROPHILIA" WRITTEN BY MARTIN CURLAND OR RELATING TO THE FICTIONAL GENETIC CONDITION "ZEROPHILIA" CREATED BY MARTIN CURLAND (U.S. CLS. 21, 23, 26, 36 AND 38).

FIRST USE 2-20-2007; IN COMMERCE 2-20-2007.

CLASS 9—(Continued).

3,300,120. CANSEL SURVEY EQUIPMENT INC., BURNABY, BRITISH COLUMBIA, CANADA. SN 78-928,449. PUB. 2-27-2007, FILED 7-13-2006.

Linesite

THE MARK CONSISTS OF STANDARD CHARACTERS WITHOUT CLAIM TO ANY PARTICULAR FONT, STYLE, SIZE, OR COLOR.

FOR SURVEYORS' LEVELS; THEODOLITES; TRIPODS (U.S. CLS. 21, 23, 26, 36 AND 38).

FIRST USE 5-31-2007; IN COMMERCE 5-31-2007.

3,300,127. SPACECRAFT COMPONENTS CORP., NORTH LAS VEGAS, NV. SN 78-931,161. PUB. 1-30-2007, FILED 7-17-2006.



FOR ELECTRICAL CONNECTORS (U.S. CLS. 21, 23, 26, 36 AND 38).

FIRST USE 6-1-2006; IN COMMERCE 6-1-2006.

3,300,138. ATLAS U.S.A., INC., IRVINE, CA. SN 78-933,574. PUB. 1-9-2007, FILED 7-20-2006.

SUPER ROBOT TAISEN

THE MARK CONSISTS OF STANDARD CHARACTERS WITHOUT CLAIM TO ANY PARTICULAR FONT, STYLE, SIZE, OR COLOR.

FOR VIDEO AND COMPUTER GAME PROGRAMS, CARTRIDGES AND INSTRUCTION MANUALS SOLD AS A UNIT (U.S. CLS. 21, 23, 26, 36 AND 38).

FIRST USE 8-8-2006; IN COMMERCE 8-8-2006.

CLASS 9—(Continued).

3,300,147. TWO TECHNOLOGIES, INC., HORSHAM, PA. SN 78-939,980. PUB. 3-13-2007, FILED 7-28-2006.

EYE.SEE

THE MARK CONSISTS OF STANDARD CHARACTERS WITHOUT CLAIM TO ANY PARTICULAR FONT, STYLE, SIZE, OR COLOR.

FOR COMPUTER SOFTWARE FOR USE IN BAR CODE READERS AND TO ENABLE ANALYSIS OF COLORED INKS AND BAR CODES; COMPUTER SOFTWARE FOR USE IN HAND-HELD DATA PROCESSORS (U.S. CLS. 21, 23, 26, 36 AND 38).

FIRST USE 10-0-2006; IN COMMERCE 10-0-2006.

3,300,148. TWO TECHNOLOGIES, INC., HORSHAM, PA. SN 78-939,986. PUB. 3-13-2007, FILED 7-28-2006.

EYE.D

THE MARK CONSISTS OF STANDARD CHARACTERS WITHOUT CLAIM TO ANY PARTICULAR FONT, STYLE, SIZE, OR COLOR.

FOR COMPUTER SOFTWARE FOR USE IN BAR CODE READERS AND TO ENABLE ANALYSIS OF COLORED INKS AND BAR CODES; COMPUTER SOFTWARE FOR USE IN HAND-HELD DATA PROCESSORS (U.S. CLS. 21, 23, 26, 36 AND 38).

FIRST USE 10-0-2006; IN COMMERCE 10-0-2006.

CLASS 9—(Continued).

3,300,157. THE CENTER FOR ORGANIZATIONAL EXCELLENCE, INC., ROCKVILLE, MD. SN 78-944,314. PUB. 3-20-2007, FILED 8-3-2006.

GoalOwner

THE MARK CONSISTS OF STANDARD CHARACTERS WITHOUT CLAIM TO ANY PARTICULAR FONT, STYLE, SIZE, OR COLOR.

FOR COMPUTER SOFTWARE FOR MANAGING ORGANIZATIONAL PERFORMANCE SYSTEMS; COMPUTER SOFTWARE FOR MANAGING ORGANIZATIONAL PERFORMANCE SYSTEMS THAT MAY BE DOWNLOADED FROM A GLOBAL COMPUTER NETWORK; COMPUTER SOFTWARE THAT PROVIDES REAL-TIME, INTEGRATED BUSINESS MANAGEMENT INTELLIGENCE BY COMBINING INFORMATION FROM VARIOUS DATABASES AND PRESENTING IT IN AN EASY-TO-UNDERSTAND USER INTERFACE; DATABASE MANAGEMENT SOFTWARE FOR MANAGING ORGANIZATIONAL PERFORMANCE SYSTEMS; DOWNLOADABLE SOFTWARE FOR MANAGING ORGANIZATIONAL PERFORMANCE SYSTEMS; EDUCATIONAL SOFTWARE FEATURING INSTRUCTION IN MANAGING ORGANIZATIONAL PERFORMANCE SYSTEMS (U.S. CLS. 21, 23, 26, 36 AND 38).

FIRST USE 6-19-2007; IN COMMERCE 6-19-2007.

3,300,179. FANUC LTD, YAMANASHI, JAPAN. SN 78-957,171. PUB. 1-23-2007, FILED 8-22-2006.

NCGuidePro

THE MARK CONSISTS OF STANDARD CHARACTERS WITHOUT CLAIM TO ANY PARTICULAR FONT, STYLE, SIZE, OR COLOR.

FOR COMPUTER SOFTWARE, NAMELY SOFTWARE FOR USE IN SIMULATING OPERATIONS OF COMPUTER NUMERICAL CONTROLLERS AND PROGRAMMABLE LOGIC CONTROLLERS FOR MONITORING MACHINING PROGRAMS AND/OR DEBUGGING SEQUENCE PROGRAMS (U.S. CLS. 21, 23, 26, 36 AND 38).

FIRST USE 9-13-2006; IN COMMERCE 12-21-2006.

CLASS 9—(Continued).

3,300,184. FOOD QUALITY SENSOR INTERNATIONAL, LEXINGTON, MA. SN 78-959,583. PUB. 3-6-2007, FILED 8-24-2006.

Never Guess Again

THE MARK CONSISTS OF STANDARD CHARACTERS WITHOUT CLAIM TO ANY PARTICULAR FONT, STYLE, SIZE, OR COLOR.

FOR HANDHELD ELECTRONIC SENSOR THAT DETERMINES THE FRESHNESS OF FOOD (U.S. CLS. 21, 23, 26, 36 AND 38).

FIRST USE 10-31-2006; IN COMMERCE 10-31-2006.

3,300,214. AMERICAN SUPERCONDUCTOR CORPORATION, WESTBOROUGH, MA. SN 78-978,698. PUB. 9-20-2005, FILED 6-11-2004.

POWERED BY AMSC

THE MARK CONSISTS OF STANDARD CHARACTERS WITHOUT CLAIM TO ANY PARTICULAR FONT, STYLE, SIZE, OR COLOR.

FOR SUPERCONDUCTOR ELECTRIC/ELECTRICAL WIRES; REELS FOR SUPERCONDUCTOR ELECTRIC WIRES; ELECTRICAL POWER CONVERTERS; SYNCHRONOUS CONDENSERS; SUPERCONDUCTOR ELECTRICAL CURRENT CONDUCTORS; ELECTRICAL POWER STORAGE AND POWER QUALITY EQUIPMENT AND SYSTEMS, NAMELY, VOLTAGE RESTORERS USED FOR UTILITY VOLTAGE REGULATION; VOLTAGE RESTORERS PRIMARILY USED FOR VOLTAGE SAG PROTECTION FOR COMMERCIAL AND INDUSTRIAL FACILITIES AND/OR CRITICAL LOADS; ELECTRICAL POWER QUALITY EQUIPMENT AND SYSTEMS FOR USE IN TRANSMISSION AND DISTRIBUTION POWER GRID APPLICATIONS, NAMELY, SYNCHRONOUS CONDENSERS CAPABLE OF GENERATING OR ABSORBING REACTIVE POWER USED TO ENSURE RELIABLE FLOW OF ELECTRICITY THROUGH AC POWER GRIDS (U.S. CLS. 21, 23, 26, 36 AND 38).

FIRST USE 6-12-2006; IN COMMERCE 6-12-2006.

CLASS 9—(Continued).

3,300,227. MIRACLE REMOTE, LLC, RIDGEFIELD, NJ. SN 78-978,800. PUB. 9-26-2006, FILED 6-22-2005.

MIRACLE REMOTE

THE MARK CONSISTS OF STANDARD CHARACTERS WITHOUT CLAIM TO ANY PARTICULAR FONT, STYLE, SIZE, OR COLOR.

NO CLAIM IS MADE TO THE EXCLUSIVE RIGHT TO USE "REMOTE", APART FROM THE MARK AS SHOWN.

FOR CONSUMER REMOTE CONTROL UNITS FOR TELEVISIONS (U.S. CLS. 21, 23, 26, 36 AND 38).

FIRST USE 10-30-2005; IN COMMERCE 3-8-2006.

CLASS 10—(Continued).

3,298,521. CINCINNATI SUB-ZERO PRODUCTS, INC., CINCINNATI, OH. SN 76-635,545. PUB. 1-3-2006, FILED 4-8-2005.



Penguin Cold Therapy

CLASS 10—MEDICAL APPARATUS

3,298,483. HEAD-SO-ROUND, LLC, EAST GRAND RAPIDS, MI. SN 76-613,795. PUB. 1-10-2006, FILED 9-28-2004.

SLEEPSHAPER

THE MARK CONSISTS OF STANDARD CHARACTERS WITHOUT CLAIM TO ANY PARTICULAR FONT, STYLE, SIZE, OR COLOR.

FOR ORTHOPEDIC APPARATUS FOR PREVENTING POSITIONAL PLAGIOCEPHALY (U.S. CLS. 26, 39 AND 44).

FIRST USE 10-7-2004; IN COMMERCE 10-7-2004.

NO CLAIM IS MADE TO THE EXCLUSIVE RIGHT TO USE "COLD THERAPY", APART FROM THE MARK AS SHOWN.

FOR ELECTRONICALLY OPERATED PORTABLE COOLING SYSTEM FOR LOCALIZED COLD THERAPEUTIC TREATMENT COMPOSED OF A PUMP AND ASSOCIATED COLD THERAPY PAD (U.S. CLS. 26, 39 AND 44).

FIRST USE 3-1-2007; IN COMMERCE 3-1-2007.

3,298,522. TACTILE TECHNOLOGIES, INC., LAS VEGAS, NV. SN 76-635,937. PUB. 1-10-2006, FILED 4-13-2005.

ILS

3,298,517. ACCURAY INCORPORATED, SUNNYVALE, CA. SN 76-635,461. PUB. 8-8-2006, FILED 4-11-2005.

XSIGHT

THE MARK CONSISTS OF STANDARD CHARACTERS WITHOUT CLAIM TO ANY PARTICULAR FONT, STYLE, SIZE, OR COLOR.

FOR COMPONENT OF RADIOSURGERY AND RADIOTHERAPY MEDICAL APPARATUS CONSISTING OF ROBOTIC LINEAR ACCELERATOR AND PATIENT POSITION APPARATUS USED FOR THE PRECISE, FULL-BODY DELIVERY OF THERAPEUTIC X-RAYS, NAMELY APPARATUS AND SOFTWARE FOR TRACKING AND DELIVERING TREATMENT BY MEANS OF BONE STRUCTURE AND WITHOUT THE NEED FOR SURGICAL IMPLANTS (U.S. CLS. 26, 39 AND 44).

FIRST USE 5-6-2005; IN COMMERCE 5-6-2005.

THE MARK CONSISTS OF STANDARD CHARACTERS WITHOUT CLAIM TO ANY PARTICULAR FONT, STYLE, SIZE, OR COLOR.

FOR DENTAL IMPLANT NAVIGATION SYSTEM CONSISTING OF A COMPUTED TOMOGRAPHY (CT) APPARATUS AND COMPUTER SOFTWARE FOR USE IN LOCATING THE APPROPRIATE PLACE TO PUT A DENTAL IMPLANT IN THE MOUTH OF A PATIENT (U.S. CLS. 26, 39 AND 44).

FIRST USE 3-30-2007; IN COMMERCE 3-30-2007.

CLASS 10—(Continued).

3,298,719. ARTHROCARE CORPORATION, SUNNYVALE, CA. SN 78-352,665. PUB. 9-13-2005, FILED 1-15-2004.

CLASS 10—(Continued).

3,298,795. MEDTRONIC, INC., MINNEAPOLIS, MN. SN 78-458,988. PUB. 7-5-2005, FILED 7-29-2004.

PARAGON T2

ORTHONAV

THE MARK CONSISTS OF STANDARD CHARACTERS WITHOUT CLAIM TO ANY PARTICULAR FONT, STYLE, SIZE, OR COLOR.

OWNER OF U.S. REG. NO. 2,936,945.
FOR MEDICAL DEVICE FOR USE HAVING TEMPERATURE INDICATING FUNCTION, NAMELY, ELECTROSURGICAL PROBE, WAND AND INSTRUMENT USED TO ABLATE, REMOVE OR OTHERWISE MODIFY TISSUE IN ORTHOPEDIC SURGICAL PROCEDURES (U.S. CLS. 26, 39 AND 44).
FIRST USE 12-23-2003; IN COMMERCE 12-23-2003.

THE MARK CONSISTS OF STANDARD CHARACTERS WITHOUT CLAIM TO ANY PARTICULAR FONT, STYLE, SIZE, OR COLOR.

FOR SURGICAL NAVIGATION EQUIPMENT USED IN ORTHOPEDIC SURGERY (U.S. CLS. 26, 39 AND 44).
FIRST USE 5-13-2005; IN COMMERCE 5-13-2005.

3,298,753. BARRY JOEL KAPLAN, INC., SAN DIEGO, CA. SN 78-399,697. PUB. 1-25-2005, FILED 4-9-2004.

3,298,804. DIAGNOSTICS FOR THE REAL WORLD LIMITED, SUNNYVALE, CA. SN 78-462,481. PUB. 7-5-2005, FILED 8-5-2004.

DR. JOEL KAPLAN

FIRSTBURST

THE MARK CONSISTS OF STANDARD CHARACTERS WITHOUT CLAIM TO ANY PARTICULAR FONT, STYLE, SIZE, OR COLOR.

THE NAME "DR. JOEL KAPLAN" IDENTIFIES A LIVING INDIVIDUAL WHOSE CONSENT IS OF RECORD.
FOR ADULT THEMED CONSUMER MERCHANDISE, NAMELY, DILDOS, LOVE DOLLS, BENWA BALLS, ARTIFICIAL VAGINAS AND PENISES, PENIS ENLARGERS, AND PACIFIERS FOR USE BY ADULTS; VIBRATORS AND STIMULATORS (U.S. CLS. 26, 39 AND 44).
FIRST USE 1-1-2006; IN COMMERCE 1-1-2006.

THE MARK CONSISTS OF STANDARD CHARACTERS WITHOUT CLAIM TO ANY PARTICULAR FONT, STYLE, SIZE, OR COLOR.

FOR LIQUID AND URINE SAMPLE COLLECTION DEVICE CONSISTING OF A FUNNEL, VALVE AND TUBE, FOR CLINICAL, MEDICAL OR HOME USE (U.S. CLS. 26, 39 AND 44).
FIRST USE 3-15-2007; IN COMMERCE 3-15-2007.

CLASS 10—(Continued).

3,298,817. SAINT-GOBAIN PERFORMANCE PLASTICS CORPORATION, AURORA, OH. SN 78-474,161. PUB. 7-12-2005, FILED 8-26-2004.

SIL-MED

THE MARK CONSISTS OF STANDARD CHARACTERS WITHOUT CLAIM TO ANY PARTICULAR FONT, STYLE, SIZE, OR COLOR.

OWNER OF U.S. REG. NO. 2,525,209.

FOR SILICONE MEDICAL APPARATUS, NAMELY, SURGICAL DRAINS, SUCTION RESERVOIRS, VASCULAR TIES, VESSEL LOOPS, INFUSION SLEEVES, TEST CHAMBERS, STERILIZATION TRAYS, U-CONNECTORS, TUBING AND CORRUGATED SHEETS (U.S. CLS. 26, 39 AND 44).

FIRST USE 12-23-1975; IN COMMERCE 0-0-1997.

3,298,843. FUNFACTORY USA, INC., BURBANK, CA. SN 78-488,884. PUB. 1-24-2006, FILED 9-23-2004.

SINNFLUT

THE MARK CONSISTS OF STANDARD CHARACTERS WITHOUT CLAIM TO ANY PARTICULAR FONT, STYLE, SIZE, OR COLOR.

FOR ELECTRIC AND NON-ELECTRIC MASSAGE APPARATUS AND ADULT SEXUAL AIDS MADE OF SILICONE AND OTHER PLASTICS, NAMELY, VIBRATORS, ARTIFICIAL PENISES (U.S. CLS. 26, 39 AND 44).
FIRST USE 10-1-2005; IN COMMERCE 10-1-2005.

CLASS 10—(Continued).

3,298,847. WAVELIGHT LASER TECHNOLOGIE AG, ERLANGEN, FED REP GERMANY. SN 78-492,333. PUB. 7-18-2006, FILED 9-30-2004.

PROMISE OF LIGHT

THE MARK CONSISTS OF STANDARD CHARACTERS WITHOUT CLAIM TO ANY PARTICULAR FONT, STYLE, SIZE, OR COLOR.

PRIORITY CLAIMED UNDER SEC. 44(D) ON ERPNTY TM OFC APPLICATION NO. 004054557, FILED 9-30-2004, REG. NO. 004054557, DATED 11-18-2005, EXPIRES 9-30-2014.

FOR MEDICAL APPARATUS AND INSTRUMENTS, NAMELY MEASURING EQUIPMENT FOR SKIN THICKNESS, ULTRAVIOLET LAMP THERAPEUTIC INSTRUMENTS FOR MEDICAL PURPOSES, LIGHT EMITTING THERAPEUTIC INSTRUMENTS FOR MEDICAL PURPOSES, INFRARED LAMP THERAPEUTIC INSTRUMENTS FOR MEDICAL PURPOSES, INSTRUMENT STANDS, INSTRUMENT TABLES, ARMCHAIRS FOR MEDICAL PURPOSES, BEDS SPECIALLY MADE FOR MEDICAL PURPOSES; LASER AND PERIPHERAL SYSTEMS, NAMELY LASERS FOR MEDICAL AND COSMETIC PURPOSES, LASER SCANNERS FOR MEDICAL AND COSMETIC PURPOSES, LASER BEAM GUIDING DEVICES FOR MEDICAL AND COSMETIC PURPOSES AND THEIR COMPONENTS (U.S. CLS. 26, 39 AND 44).
FIRST USE 3-30-2007; IN COMMERCE 3-30-2007.

3,298,889. SAMSUNG AMERICA, INC., RIDGEFIELD PARK, NJ. SN 78-530,699. PUB. 1-17-2006, FILED 12-10-2004.

HEALTHY LIVING

THE MARK CONSISTS OF STANDARD CHARACTERS WITHOUT CLAIM TO ANY PARTICULAR FONT, STYLE, SIZE, OR COLOR.

OWNER OF U.S. REG. NO. 2,402,926.

FOR NEBULIZERS FOR RESPIRATORY THERAPY; NEBULIZER KITS FOR RESPIRATORY THERAPY COMPOSED OF REPLACEMENT NEBULIZERS, AIR TUBES AND FILTERS (U.S. CLS. 26, 39 AND 44).
FIRST USE 3-0-2006; IN COMMERCE 3-0-2006.

CLASS 10—(Continued).

3,298,949. ELI LILLY AND COMPANY, INDIANAPOLIS, IN. SN 78-569,425. PUB. 12-27-2005, FILED 2-17-2005.

CLASS 10—(Continued).

3,299,168. CIMEX MEDICAL INNOVATIONS, L.C., COVINGTON, LA. SN 78-653,542. PUB. 10-17-2006, FILED 6-17-2005.

HUMAPEN MEMOIR

THE MARK CONSISTS OF STANDARD CHARACTERS WITHOUT CLAIM TO ANY PARTICULAR FONT, STYLE, SIZE, OR COLOR.

OWNER OF U.S. REG. NO. 2,767,043.
FOR INSULIN DELIVERY DEVICES, NAMELY, SYRINGES (U.S. CLS. 26, 39 AND 44).
FIRST USE 1-15-2007; IN COMMERCE 1-15-2007.



3,298,951. GOOD LIFE, LLC, JACKSONVILLE, OR. SN 78-569,523. PUB. 7-4-2006, FILED 2-17-2005.

SNORE ENDER

OWNER OF U.S. REG. NO. 2,739,342.
THE MARK CONSISTS OF A HALF CIRCLE WHICH SYMBOLIZES THE LETTER C HAVING FIRST AND SECOND ENDS, WITH A SMALLER SOLID CIRCLE SITUATED MEDIANLY THEREBETWEEN.

FOR MEDICAL DEVICES, NAMELY, HAND-HELD CRYOSURGICAL INSTRUMENTS AND TIPS THEREFORE; CRYOSURGICAL COOLING STATIONS (U.S. CLS. 26, 39 AND 44).
FIRST USE 7-27-2005; IN COMMERCE 7-27-2005.

THE MARK CONSISTS OF STANDARD CHARACTERS WITHOUT CLAIM TO ANY PARTICULAR FONT, STYLE, SIZE, OR COLOR.

NO CLAIM IS MADE TO THE EXCLUSIVE RIGHT TO USE SNORE, APART FROM THE MARK AS SHOWN.
FOR ANTI-SNORING DEVICES, NAMELY, SENORS (U.S. CLS. 26, 39 AND 44).
FIRST USE 4-1-2003; IN COMMERCE 4-1-2003.

3,299,231. CLIFFORD J. RUDDLE, D.D.S., A.P.C., SANTA BARBARA, CA. SN 78-679,797. PUB. 5-30-2006, FILED 7-27-2005.

3,299,029. CONCORDIA MANUFACTURING, LLC, COVENTRY, RI. SN 78-597,861. PUB. 1-10-2006, FILED 3-30-2005.

BIOFELT**ENDOACTIVATOR**

THE MARK CONSISTS OF STANDARD CHARACTERS WITHOUT CLAIM TO ANY PARTICULAR FONT, STYLE, SIZE, OR COLOR.

FOR NON-WOVEN MESH FELT SUBSTRATES FOR USE IN THE REPLACEMENT AND GRAFTING OF BIOLOGIC TISSUE IN THE FIELD OF BIOMEDICAL TEXTILE ENGINEERING (U.S. CLS. 26, 39 AND 44).
FIRST USE 11-29-2006; IN COMMERCE 11-29-2006.

THE MARK CONSISTS OF STANDARD CHARACTERS WITHOUT CLAIM TO ANY PARTICULAR FONT, STYLE, SIZE, OR COLOR.

FOR DENTAL INSTRUMENTS FOR USE IN ROOT CANAL PROCEDURES, NAMELY, HANDPIECES AND ENDODONTIC TIPS FOR THE HANDPIECES (U.S. CLS. 26, 39 AND 44).
FIRST USE 10-26-2005; IN COMMERCE 10-26-2005.

CLASS 10—(Continued).

3,299,249. MICRUS ENDOVASCULAR CORPORATION, SAN JOSE, CA. SN 78-686,021. PUB. 1-10-2006, FILED 8-4-2005.

COURIER

THE MARK CONSISTS OF STANDARD CHARACTERS WITHOUT CLAIM TO ANY PARTICULAR FONT, STYLE, SIZE, OR COLOR.

FOR MEDICAL AND SURGICAL DEVICES, NAMELY, MICROCATHETERS FOR THE TREATMENT OF VASCULAR ANOMALIES (U.S. CLS. 26, 39 AND 44).

FIRST USE 3-28-2006; IN COMMERCE 3-28-2006.

3,299,270. ENVISION IMPLANTS, LLC, COVINGTON, LA. SN 78-698,369. PUB. 10-24-2006, FILED 8-23-2005.

ENVISION

THE MARK CONSISTS OF STANDARD CHARACTERS WITHOUT CLAIM TO ANY PARTICULAR FONT, STYLE, SIZE, OR COLOR.

FOR BREAST IMPLANT SIZING KIT CONTAINING A MEASURING DEVICE, SAMPLE IMPLANTS OF VARYING SIZES, SPORTS BRA FOR TESTING VARIOUS IMPLANT SIZES ON THE INDIVIDUAL, AND INFORMATION ON THE PROPER USE OF THE KIT AND SELECTION OF BREAST IMPLANTS PROVIDED IN PRINT AND ON DVD (U.S. CLS. 26, 39 AND 44).

FIRST USE 4-24-2006; IN COMMERCE 4-24-2006.

CLASS 10—(Continued).

3,299,361. AMBISEA TECHNOLOGY CORP., LTD, HONG KONG, HONG KONG. SN 78-724,756. PUB. 8-1-2006, FILED 10-1-2005.

AMBISEA

THE MARK CONSISTS OF STANDARD CHARACTERS WITHOUT CLAIM TO ANY PARTICULAR FONT, STYLE, SIZE, OR COLOR.

FOR APPARATUS FOR CLINICAL DIAGNOSIS; BLOOD PRESSURE MEASURING APPARATUS; BLOOD PRESSURE MONITORS; FETAL PULSE MONITORS; HEART MONITORS; HEARTBEAT MEASURING APPARATUS; MEDICAL DIAGNOSTIC APPARATUS, ANALYTICAL APPARATUS FOR MEDICAL PURPOSES AND BLOOD PRESSURE MEASURING APPARATUS; MEDICAL INSTRUMENT FOR CARDIOVASCULAR DIAGNOSTICS; PULSE RATE MONITORS; ULTRASONIC MEDICAL DIAGNOSTIC APPARATUS; ULTRASONIC DIAGNOSTIC APPARATUS (U.S. CLS. 26, 39 AND 44).

FIRST USE 10-1-2003; IN COMMERCE 4-19-2004.

3,299,367. STERIS INC., TEMECULA, CA. SN 78-725,796. PUB. 6-13-2006, FILED 10-4-2005.

CMAX

THE MARK CONSISTS OF STANDARD CHARACTERS WITHOUT CLAIM TO ANY PARTICULAR FONT, STYLE, SIZE, OR COLOR.

OWNER OF U.S. REG. NO. 2,725,122.
FOR SURGICAL AND MEDICAL APPARATUS, NAMELY POWERED OPERATING TABLES AND STRUCTURAL PARTS THEREFOR (U.S. CLS. 26, 39 AND 44).

FIRST USE 4-30-2005; IN COMMERCE 4-30-2005.

CLASS 10—(Continued).

3,299,489. UNION SURGICAL, LLC, PHILADELPHIA, PA. SN 78-743,672. PUB. 7-11-2006, FILED 10-31-2005.

T-Pin

THE MARK CONSISTS OF STANDARD CHARACTERS WITHOUT CLAIM TO ANY PARTICULAR FONT, STYLE, SIZE, OR COLOR.

FOR CANNULATED AND NON-CANNULATED ORTHOPEDIC SCREWS AND PINS; ORTHOPEDIC BONE SCREWS; DRILLING JIGS FOR SURGICAL APPLICATIONS; SURGICAL APPARATUS AND INSTRUMENTS, NAMELY, ORTHOPEDIC FIXATION DEVICES USED IN ORTHOPEDIC SURGERY, SURGICAL HAND TOOLS FOR INSERTING, REMOVING, AND MODIFYING ORTHOPEDIC SCREWS AND PINS (U.S. CLS. 26, 39 AND 44).

FIRST USE 1-1-2006; IN COMMERCE 1-1-2006.

3,299,501. ATRICURE INC., WEST CHESTER, OH. SN 78-745,068. PUB. 6-27-2006, FILED 11-2-2005.

ENDO-XCR

THE MARK CONSISTS OF STANDARD CHARACTERS WITHOUT CLAIM TO ANY PARTICULAR FONT, STYLE, SIZE, OR COLOR.

FOR MEDICAL DEVICES, NAMELY SURGICAL DEVICES THAT FACILITATE THE IDENTIFICATION, SEPARATION OR ABLATION OF BIOLOGIC TISSUES (U.S. CLS. 26, 39 AND 44).

FIRST USE 12-13-2005; IN COMMERCE 12-13-2005.

3,299,502. ATRICURE INC., WEST CHESTER, OH. SN 78-745,077. PUB. 6-27-2006, FILED 11-2-2005.

ENDO-XCL

THE MARK CONSISTS OF STANDARD CHARACTERS WITHOUT CLAIM TO ANY PARTICULAR FONT, STYLE, SIZE, OR COLOR.

FOR MEDICAL DEVICES, NAMELY SURGICAL DEVICES THAT FACILITATE THE IDENTIFICATION, SEPARATION OR ABLATION OF BIOLOGIC TISSUES (U.S. CLS. 26, 39 AND 44).

FIRST USE 12-13-2005; IN COMMERCE 12-13-2005.

CLASS 10—(Continued).

3,299,507. ENGELMAN, IAN K., SCARBOROUGH, ME. SN 78-746,347. PUB. 7-18-2006, FILED 11-3-2005.

JACOB

THE MARK CONSISTS OF STANDARD CHARACTERS WITHOUT CLAIM TO ANY PARTICULAR FONT, STYLE, SIZE, OR COLOR.

FOR ORTHOTIC JOINTS FOR ORTHOPEDIC BRACES (U.S. CLS. 26, 39 AND 44).

FIRST USE 3-30-2006; IN COMMERCE 3-30-2006.

3,299,538. MINNTECH CORPORATION, MINNEAPOLIS, MN. SN 78-751,866. PUB. 7-25-2006, FILED 11-11-2005.

SCOPE BUDDY

THE MARK CONSISTS OF STANDARD CHARACTERS WITHOUT CLAIM TO ANY PARTICULAR FONT, STYLE, SIZE, OR COLOR.

NO CLAIM IS MADE TO THE EXCLUSIVE RIGHT TO USE "SCOPE", APART FROM THE MARK AS SHOWN.

FOR PUMP THAT FLUSHES CLEANING AND RINSING SOLUTIONS THROUGH THE CHANNELS OF AN ENDOSCOPE (U.S. CLS. 26, 39 AND 44).

FIRST USE 10-1-2006; IN COMMERCE 10-1-2006.

3,299,595. ABBOTT LABORATORIES, ABBOTT PARK, IL. SN 78-762,620. PUB. 7-11-2006, FILED 11-29-2005.

ALPHATRAK

THE MARK CONSISTS OF STANDARD CHARACTERS WITHOUT CLAIM TO ANY PARTICULAR FONT, STYLE, SIZE, OR COLOR.

FOR BLOOD GLUCOSE MONITORS FOR VETERINARY USE (U.S. CLS. 26, 39 AND 44).

FIRST USE 2-16-2006; IN COMMERCE 2-16-2006.

CLASS 10—(Continued).

3,299,628. HOSPIRA, INC., LAKE FOREST, IL. SN 78-769,599. PUB. 1-23-2007, FILED 12-8-2005.

VISIV

THE MARK CONSISTS OF STANDARD CHARACTERS WITHOUT CLAIM TO ANY PARTICULAR FONT, STYLE, SIZE, OR COLOR.

FOR PLASTIC CONTAINERS FOR INJECTABLE MEDICATIONS AND/OR DILUENTS SOLD EMPTY (U.S. CLS. 26, 39 AND 44).

FIRST USE 7-31-2006; IN COMMERCE 7-31-2006.

CLASS 10—(Continued).

3,299,805. HEINZ KURZ GMBH MEDIZINTECHNIK, DUSSELINGEN, FED REP GERMANY. SN 78-818,820. PUB. 10-10-2006, FILED 2-20-2006.

IBP

THE MARK CONSISTS OF STANDARD CHARACTERS WITHOUT CLAIM TO ANY PARTICULAR FONT, STYLE, SIZE, OR COLOR.

FOR PROSTHESES FOR PURPOSE OF REPLACING MISSING, DAMAGED OR DEFORMED AUDITORY OSSICLES; IMPLANTS COMPRISING ARTIFICIAL MATERIALS (U.S. CLS. 26, 39 AND 44).

FIRST USE 9-0-2006; IN COMMERCE 9-0-2006.

3,299,678. BECKER, PAUL F., STUART, FL. SN 78-782,050. PUB. 9-5-2006, FILED 12-28-2005.

sleep on command

THE MARK CONSISTS OF STANDARD CHARACTERS WITHOUT CLAIM TO ANY PARTICULAR FONT, STYLE, SIZE, OR COLOR.

NO CLAIM IS MADE TO THE EXCLUSIVE RIGHT TO USE "SLEEP", APART FROM THE MARK AS SHOWN.

FOR APPARATUS FOR MAGNET THERAPY (U.S. CLS. 26, 39 AND 44).

FIRST USE 1-15-2006; IN COMMERCE 3-1-2007.

3,299,904. AMERICAN ORTHODONTICS CORPORATION, SHEBOYGAN, WI. SN 78-857,981. PUB. 12-5-2006, FILED 4-10-2006.

ROLLO

THE MARK CONSISTS OF STANDARD CHARACTERS WITHOUT CLAIM TO ANY PARTICULAR FONT, STYLE, SIZE, OR COLOR.

FOR ORTHODONTIC TOOTH BANDS (U.S. CLS. 26, 39 AND 44).

FIRST USE 1-0-2006; IN COMMERCE 1-0-2006.

3,299,690. ASPIRATION MEDICAL TECHNOLOGY, LLC., DAVIE, FL. SN 78-786,130. PUB. 9-5-2006, FILED 1-6-2006.

FOODDIVURZN

THE MARK CONSISTS OF STANDARD CHARACTERS WITHOUT CLAIM TO ANY PARTICULAR FONT, STYLE, SIZE, OR COLOR.

FOR MEDICAL AND SURGICAL APPARATUS AND INSTRUMENTS FOR CONTROLLING OBESITY IN THE NATURE OF AN ASPIRATION DEVICE AND A SHUNT (U.S. CLS. 26, 39 AND 44).

FIRST USE 3-7-2007; IN COMMERCE 3-7-2007.

3,300,002. PERVASIS THERAPEUTICS, INC., CAMBRIDGE, MA. SN 78-890,223. PUB. 2-13-2007, FILED 5-23-2006.

VASCUGEL

THE MARK CONSISTS OF STANDARD CHARACTERS WITHOUT CLAIM TO ANY PARTICULAR FONT, STYLE, SIZE, OR COLOR.

FOR IMPLANTS CONSISTING OF ARTIFICIAL MATERIALS (U.S. CLS. 26, 39 AND 44).

FIRST USE 7-31-2006; IN COMMERCE 7-31-2006.

CLASS 10—(Continued).

3,300,027. VECTOR SURGICAL, LLC, OCONOMOWOC, WI. SN 78-900,740. PUB. 1-9-2007, FILED 6-5-2006.

CLASS 11—(Continued).

3,298,459. ELECTROLUX HOME PRODUCTS, INC., CLEVELAND, OH. SN 76-582,832. PUB. 2-1-2005, FILED 3-24-2004.

CORRECTCLIPS

EXPRESS ICE

THE MARK CONSISTS OF STANDARD CHARACTERS WITHOUT CLAIM TO ANY PARTICULAR FONT, STYLE, SIZE, OR COLOR.

FOR MEDICAL DEVICE USED TO MARK TISSUE DURING AND/OR AFTER SURGERY (U.S. CLS. 26, 39 AND 44).

FIRST USE 7-0-2006; IN COMMERCE 7-0-2006.

THE MARK CONSISTS OF STANDARD CHARACTERS WITHOUT CLAIM TO ANY PARTICULAR FONT, STYLE, SIZE, OR COLOR.

NO CLAIM IS MADE TO THE EXCLUSIVE RIGHT TO USE "ICE", APART FROM THE MARK AS SHOWN.

FOR ICE MAKING MACHINES, SOLD AS AN INTEGRAL COMPONENT OF REFRIGERATORS, FREEZERS AND COMBINATION REFRIGERATOR/FREEZERS (U.S. CLS. 13, 21, 23, 31 AND 34).

FIRST USE 8-0-2004; IN COMMERCE 8-0-2004.

3,300,124. NATURE BRIGHT COMPANY, IRVINE, CA. SN 78-930,468. PUB. 1-2-2007, FILED 7-16-2006.

3,298,471. FOREST ENERGY CORPORATION, INC., SHOW LOW, AZ. SN 76-606,114. PUB. 12-20-2005, FILED 8-6-2004.

Bright Light. Brighter Future.



THE MARK CONSISTS OF STANDARD CHARACTERS WITHOUT CLAIM TO ANY PARTICULAR FONT, STYLE, SIZE, OR COLOR.

FOR PHOTOTHERAPEUTIC APPARATUS FOR MEDICAL PURPOSES; PHOTOTHERAPEUTIC APPARATUS FOR MEDICAL PURPOSES, NAMELY A LED (LIGHT-EMITTING DIODE) LIGHT SOURCE FOR MEDICAL AND AESTHETIC SKIN TREATMENTS (U.S. CLS. 26, 39 AND 44).

FIRST USE 7-16-2006; IN COMMERCE 7-16-2006.

NO CLAIM IS MADE TO THE EXCLUSIVE RIGHT TO USE "ENERGY CORPORATION", APART FROM THE MARK AS SHOWN.

FOR PELLET AND WOOD BURNING STOVES; PELLET AND WOOD CHIP BURNING BOILERS; HVAC SYSTEMS COMPRISED OF FURNACES FOR HEATING AIR OR WATER, AIR CONDITIONING UNITS FOR COOLING AIR, AND ELECTRIC AIR HANDLING FANS (U.S. CLS. 13, 21, 23, 31 AND 34).

FIRST USE 12-1-2003; IN COMMERCE 12-1-2003.

CLASS 11—ENVIRONMENTAL CONTROL APPARATUS

CLASS 11—(Continued).

3,298,536. WRATE, LEONARD A., OCEANSIDE, CA. SN 76-641,588. PUB. 3-21-2006, FILED 6-24-2005.

SPLASHINATOR

FOR SPLASH GUARDS FOR USE WITH URINALS (U.S. CLS. 13, 21, 23, 31 AND 34).
FIRST USE 4-8-2007; IN COMMERCE 4-8-2007.

CLASS 11—(Continued).

3,298,998. HOMER TLC, INC., CLAYMONT, DE. SN 78-590,565. PUB. 7-11-2006, FILED 3-18-2005.

DAWSON

3,298,695. HUNTER FAN COMPANY, MEMPHIS, TN. SN 78-305,390. PUB. 6-15-2004, FILED 9-25-2003.

ISLAND BREEZE

OWNER OF U.S. REG. NOS. 1,756,672, 2,315,917, AND OTHERS.
FOR CEILING FANS (U.S. CLS. 13, 21, 23, 31 AND 34).
FIRST USE 12-24-2006; IN COMMERCE 12-24-2006.

THE MARK CONSISTS OF STANDARD CHARACTERS WITHOUT CLAIM TO ANY PARTICULAR FONT, STYLE, SIZE, OR COLOR.

FOR CEILING FANS AND ELECTRIC LIGHTING FIXTURES (U.S. CLS. 13, 21, 23, 31 AND 34).
FIRST USE 10-0-2004; IN COMMERCE 10-0-2004.

3,298,700. HATCO CORPORATION, MILWAUKEE, WI. SN 78-312,760. PUB. 6-22-2004, FILED 10-13-2003.

TOAST-MAX

FOR ELECTRIC CONVEYOR TOASTER FOR COMMERCIAL AND INSTITUTIONAL USE (U.S. CLS. 13, 21, 23, 31 AND 34).
FIRST USE 2-7-2007; IN COMMERCE 2-7-2007.

3,299,114. THE COLEMAN COMPANY, INC., WICHITA, KS. SN 78-626,568. PUB. 6-20-2006, FILED 5-10-2005.

PINNACLE

3,298,907. SPADARO, CARL, JACKSONVILLE, FL. SN 78-547,556. PUB. 10-25-2005, FILED 1-14-2005.

MAGNUM

THE MARK CONSISTS OF STANDARD CHARACTERS WITHOUT CLAIM TO ANY PARTICULAR FONT, STYLE, SIZE, OR COLOR.
FOR FIREPLACES (U.S. CLS. 13, 21, 23, 31 AND 34).
FIRST USE 1-1-2005; IN COMMERCE 3-1-2005.

FOR PROPANE FUELED LANTERNS AND STOVES FOR USE IN CAMPING AND OUTDOOR-RELATED ACTIVITIES; LIQUID GAS FUELED LANTERNS AND STOVES FOR USE IN CAMPING AND OUTDOOR-RELATED ACTIVITIES (U.S. CLS. 13, 21, 23, 31 AND 34).
FIRST USE 4-29-2006; IN COMMERCE 4-29-2006.

CLASS 11—(Continued).

3,299,147. CBG BIOTECH, LTD. CO., NAPLES, FL. SN 78-642,602. PUB. 10-3-2006, FILED 6-2-2005.

CLASS 11—(Continued).

3,299,229. HAMSAR DIVERSCO INC., BURLINGTON, ONTARIO, CANADA. SN 78-678,604. PUB. 7-11-2006, FILED 7-26-2005.

TechnoClean

THE MARK CONSISTS OF STANDARD CHARACTERS WITHOUT CLAIM TO ANY PARTICULAR FONT, STYLE, SIZE, OR COLOR.

FOR DISTILLATION UNITS, NAMELY CONCENTRATOR DISTILLATION AND RECYCLER DISTILLATION UNITS, FOR RECYCLING, REDUCING, CONCENTRATING, AND STERILIZING WASTE MATERIALS AND CHEMICALS (U.S. CLS. 13, 21, 23, 31 AND 34).
FIRST USE 5-5-2005; IN COMMERCE 5-26-2005.



3,299,185. METRO INDUSTRIES, INC., WILKES-BARRE, PA. SN 78-660,493. PUB. 7-4-2006, FILED 6-29-2005.

METRO C5

THE MARK CONSISTS OF STANDARD CHARACTERS WITHOUT CLAIM TO ANY PARTICULAR FONT, STYLE, SIZE, OR COLOR.

FOR ELECTRIC CABINETS USED TO CONTROL TEMPERATURE AND HUMIDITY FOR HEATING AND PROOFING FOOD GOODS (U.S. CLS. 13, 21, 23, 31 AND 34).

FIRST USE 11-0-2005; IN COMMERCE 11-0-2005.

NO CLAIM IS MADE TO THE EXCLUSIVE RIGHT TO USE "INC." OR THE WORDS "HEAVY DUTY ILLUMINATION", APART FROM THE MARK AS SHOWN.

FOR AUTOMOTIVE HEADLAMPS AND HEADLIGHTS; WORK LAMPS; WORK LIGHTS; AUXILIARY LAMPS AND LIGHTS FOR CARS, TRUCKS, SNOW PLOWS, OFF ROAD VEHICLES, FORKLIFES, EARTH MOVING, LOGGING MINING AND CONSTRUCTION VEHICLES AND EQUIPMENT; VEHICLE AND MARINE COMPONENTS AND PARTS, NAMELY, LIGHTS, LAMPS, AND LAMP BULBS (U.S. CLS. 13, 21, 23, 31 AND 34).

FIRST USE 2-1-2005; IN COMMERCE 12-1-2006.

3,299,186. METRO INDUSTRIES, INC., WILKES-BARRE, PA. SN 78-660,503. PUB. 8-1-2006, FILED 6-29-2005.

C5

THE MARK CONSISTS OF STANDARD CHARACTERS WITHOUT CLAIM TO ANY PARTICULAR FONT, STYLE, SIZE, OR COLOR.

FOR ELECTRIC CABINETS USED TO CONTROL TEMPERATURE AND HUMIDITY FOR HEATING AND PROOFING FOOD GOODS (U.S. CLS. 13, 21, 23, 31 AND 34).

FIRST USE 11-0-2005; IN COMMERCE 11-0-2005.

3,299,236. KOHLER CO., KOHLER, WI. SN 78-681,120. PUB. 11-28-2006, FILED 7-28-2005.

CIMARRON

THE MARK CONSISTS OF STANDARD CHARACTERS WITHOUT CLAIM TO ANY PARTICULAR FONT, STYLE, SIZE, OR COLOR.

FOR TOILETS, LAVATORIES, LAVATORY PEDESTALS AND FLUSH TRIP LEVERS (U.S. CLS. 13, 21, 23, 31 AND 34).

FIRST USE 10-0-2004; IN COMMERCE 10-0-2004.

CLASS 11—(Continued).

3,299,286. KING OF FANS, INC., FT. LAUDERDALE, FL. SN 78-702,367. PUB. 11-28-2006, FILED 8-29-2005.

BRIO

THE MARK CONSISTS OF STANDARD CHARACTERS WITHOUT CLAIM TO ANY PARTICULAR FONT, STYLE, SIZE, OR COLOR.

THE ENGLISH TRANSLATION OF THE WORD "BRIO" IS "ENTHUSIASTIC VIGOR, VIVACITY, VERVE".

FOR ENVIRONMENTAL CONTROL APPARATUS, NAMELY ELECTRIC FLOOR FANS AND REPLACEMENT PARTS THEREFOR; CIRCULATING FANS FOR DOMESTIC AND COMMERCIAL USE; PORTABLE ELECTRIC FANS, FIXTURES AND PARTS THEREFOR; FREESTANDING ELECTRIC FANS, FIXTURES AND PARTS THEREFOR; ELECTRIC DESK FANS, FIXTURES AND PARTS THEREFOR, EXCLUDING ELECTRIC LIGHTING FIXTURES (U.S. CLS. 13, 21, 23, 31 AND 34).
FIRST USE 12-1-2005; IN COMMERCE 12-1-2005.

3,299,414. CONTOURE INT, INC., SARASOTA, FL. SN 78-734,068. PUB. 11-7-2006, FILED 10-16-2005.

Contoure

THE MARK CONSISTS OF STANDARD CHARACTERS WITHOUT CLAIM TO ANY PARTICULAR FONT, STYLE, SIZE, OR COLOR.

THE FOREIGN WORDING IN THE MARK TRANSLATES INTO ENGLISH AS "CONTOUR."

FOR MICROWAVE OVENS FOR COOKING AND ELECTRIC COOKING STOVES, ALL FOR USE IN BOATS AND RECREATIONAL VEHICLES (U.S. CLS. 13, 21, 23, 31 AND 34).

FIRST USE 5-15-2006; IN COMMERCE 11-1-2006.

3,299,475. STANDEX INTERNATIONAL CORPORATION, SALEM, NH. SN 78-740,774. PUB. 2-20-2007, FILED 10-26-2005.

KOOL STAR

THE MARK CONSISTS OF STANDARD CHARACTERS WITHOUT CLAIM TO ANY PARTICULAR FONT, STYLE, SIZE, OR COLOR.

FOR PREFABRICATED INSULATED MODULAR PANEL, WALK-IN COLD STORAGE COMPARTMENT ROOMS (U.S. CLS. 13, 21, 23, 31 AND 34).

FIRST USE 11-15-2005; IN COMMERCE 11-15-2005.

CLASS 11—(Continued).

3,299,483. HUNTER FAN COMPANY, MEMPHIS, TN. SN 78-742,383. PUB. 6-27-2006, FILED 10-28-2005.

WELLESLEY

THE MARK CONSISTS OF STANDARD CHARACTERS WITHOUT CLAIM TO ANY PARTICULAR FONT, STYLE, SIZE, OR COLOR.

OWNER OF U.S. REG. NO. 2,729,348.

FOR VENTILATING BATH EXHAUST FANS (U.S. CLS. 13, 21, 23, 31 AND 34).

FIRST USE 4-27-2006; IN COMMERCE 4-27-2006.

3,299,530. SLANT/FIN CORPORATION, GREENVALE, NY. SN 78-750,527. PUB. 7-18-2006, FILED 11-9-2005.

BOBCAT

THE MARK CONSISTS OF STANDARD CHARACTERS WITHOUT CLAIM TO ANY PARTICULAR FONT, STYLE, SIZE, OR COLOR.

FOR GAS FIRED BOILERS (U.S. CLS. 13, 21, 23, 31 AND 34).

FIRST USE 1-12-2007; IN COMMERCE 1-12-2007.

3,299,537. TECH LIGHTING L.L.C., SKOKIE, IL. SN 78-751,450. PUB. 7-18-2006, FILED 11-10-2005.

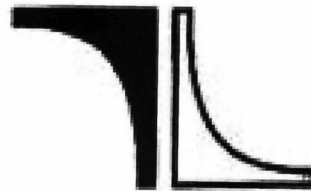

FOR ELECTRIC LIGHTING FIXTURES (U.S. CLS. 13, 21, 23, 31 AND 34).

FIRST USE 2-28-2006; IN COMMERCE 2-28-2006.

CLASS 11—(Continued).

3,299,594. BARBERAN, S.A., C/ GALILEO 3-9, SPAIN. SN 78-762,444. PUB. 8-1-2006, FILED 11-29-2005.

OPTIOVEN

THE COLOR(S) BLUE IS/ARE CLAIMED AS A FEATURE OF THE MARK.

THE MARK CONSISTS OF OPTIOVEN IN THE COLOR BLUE.

FOR INDUSTRIAL DRYERS FOR VARNISH COATED WOOD MOLDING (U.S. CLS. 13, 21, 23, 31 AND 34).

FIRST USE 10-25-2002; IN COMMERCE 6-20-2003.

3,299,637. MICHAEL KUANG, BURLINGAME, CA. SN 78-770,429. PUB. 8-29-2006, FILED 12-9-2005.

Kolusa

THE MARK CONSISTS OF STANDARD CHARACTERS WITHOUT CLAIM TO ANY PARTICULAR FONT, STYLE, SIZE, OR COLOR.

FOR DRAIN STRUCTURES FOR USE IN SPAS, STEAM ROOMS AND BATHS; EXHAUST HOODS FOR KITCHENS; FAUCET AERATORS; FAUCET SPRAYERS; FAUCETS; HAND HELD SHOWER HEADS; HAND SHOWERS; HAND-HELD SHOWERS; HEAT SINKS FOR USE IN HEATING, COOLING AND VENTILATING APPARATUS; KITCHEN SINK SPRAYERS; KITCHEN SINKS; LIGHTING FIXTURES; MIXER FAUCETS FOR WATER PIPES; PLUMBING FITTINGS NAMELY, SINK STRAINERS; PLUMBING FITTINGS, NAMELY, AERATORS FOR FAUCETS; PLUMBING FITTINGS, NAMELY, DRAINS; PLUMBING FITTINGS, NAMELY, FAUCET FILTERS; PLUMBING FITTINGS, NAMELY, SHOWER CONTROL VALVES; PLUMBING FIXTURES, NAMELY, SHOWER SPRAYERS; PLUMBING FIXTURES, NAMELY, SINK SPRAYERS; PLUMBING FIXTURES, NAMELY, SINK TRAPS; PLUMBING SUPPLIES, NAMELY SINK STRAINERS; SHOWER DOORS; SHOWER ENCLOSURES; SHOWER FAUCET EXTENSIONS; SHOWER HEAD SPRAYERS; SHOWER HEADS; SHOWER PANELS; SHOWER PLATFORMS; SHOWER STANDS; SHOWER TUBS; SHOWERS; SINGLE LEVER FIXTURES FOR LAVATORIES AND SINKS; SINKS; STEAM GENERATORS; STRAINERS FOR PLUMBING DRAINS; TAP WATER FAUCETS; WALL LIGHTS; WATER FAUCET SPOUT; WHIRLPOOL BATHS; WHIRLPOOL JETS; WHIRLPOOLS (U.S. CLS. 13, 21, 23, 31 AND 34).

FIRST USE 1-1-2006; IN COMMERCE 1-1-2006.

CLASS 11—(Continued).

3,299,666. MOEN INCORPORATED, NORTH OLMSTED, OH. SN 78-777,503. PUB. 7-4-2006, FILED 12-20-2005.

LANCELOT PROFESSIONAL

THE MARK CONSISTS OF STANDARD CHARACTERS WITHOUT CLAIM TO ANY PARTICULAR FONT, STYLE, SIZE, OR COLOR.

OWNER OF U.S. REG. NO. 125,600.

NO CLAIM IS MADE TO THE EXCLUSIVE RIGHT TO USE "PROFESSIONAL", APART FROM THE MARK AS SHOWN.

FOR SINKS (U.S. CLS. 13, 21, 23, 31 AND 34).

FIRST USE 5-1-2006; IN COMMERCE 5-1-2006.

3,299,700. NATURE BRIGHT COMPANY, IRVINE, CA. SN 78-787,923. PUB. 1-30-2007, FILED 1-9-2006.

wake up to light

THE MARK CONSISTS OF STANDARD CHARACTERS WITHOUT CLAIM TO ANY PARTICULAR FONT, STYLE, SIZE, OR COLOR.

FOR LAMPS (U.S. CLS. 13, 21, 23, 31 AND 34).

FIRST USE 5-6-2007; IN COMMERCE 5-6-2007.

3,299,725. MOEN INCORPORATED, NORTH OLMSTED, OH. SN 78-794,723. PUB. 7-4-2006, FILED 1-19-2006.

CHOICEFLO

THE MARK CONSISTS OF STANDARD CHARACTERS WITHOUT CLAIM TO ANY PARTICULAR FONT, STYLE, SIZE, OR COLOR.

FOR PLUMBING FITTINGS, NAMELY, FAUCET FILTERS; WATER FILTERS; WATER FILTER CARTRIDGES FOR DOMESTIC USE (U.S. CLS. 13, 21, 23, 31 AND 34).

FIRST USE 1-31-2006; IN COMMERCE 1-31-2006.

CLASS 11—(Continued).

3,299,744. WATERSAVER TECHNOLOGIES, LLC, LOUISVILLE, KY. SN 78-799,009. PUB. 9-12-2006, FILED 1-25-2006.

AQUS

THE MARK CONSISTS OF STANDARD CHARACTERS WITHOUT CLAIM TO ANY PARTICULAR FONT, STYLE, SIZE, OR COLOR.

FOR WATER CONSERVATION SYSTEM FOR LAVATORIES COMPRISING A WATER RESERVOIR, TOILET TANK FILL CONTROL UNIT, TUBING, AND ELECTRICAL WATER PUMP (U.S. CLS. 13, 21, 23, 31 AND 34).
FIRST USE 8-29-2006; IN COMMERCE 8-29-2006.

3,299,839. AQUA GENERAL, INC., HOUSTON, TX. SN 78-831,115. PUB. 1-23-2007, FILED 3-7-2006.



THE COLOR(S) BLACK, BLUE, LIGHT BLUE AND WHITE IS/ARE CLAIMED AS A FEATURE OF THE MARK. THE MARK CONSISTS OF THE FOLLOWING, THE WATER DROP IS IN BLUE ON TOP AND LIGHT BLUE AND WHITE ON THE BOTTOM PART OF THE DROP. THE GEOMETRIC SHAPE AROUND THE WATER DROP AND THE LETTERS "AQUAGUARD" ARE IN BLACK.

FOR TAP-WATER PURIFYING APPARATUS; WATER CONDITIONING UNITS; WATER PURIFICATION UNITS; WATER PURIFIERS; WATER PURIFYING APPARATUS; WATER PURIFYING UNITS, FOR POTABLE WATER FOR RESIDENTIAL AND COMMERCIAL USE; WATER SOFTENING UNITS (U.S. CLS. 13, 21, 23, 31 AND 34).

FIRST USE 5-1-2006; IN COMMERCE 6-1-2006.

CLASS 11—(Continued).

3,299,887. SOLAROASIS, LLC, RENO, NV. SN 78-850,750. PUB. 10-31-2006, FILED 3-31-2006.

Aqua-Bar NiteGlow

THE MARK CONSISTS OF STANDARD CHARACTERS WITHOUT CLAIM TO ANY PARTICULAR FONT, STYLE, SIZE, OR COLOR.

FOR AQUARIUM LIGHTS (U.S. CLS. 13, 21, 23, 31 AND 34).

FIRST USE 1-27-2007; IN COMMERCE 1-27-2007.

3,299,892. CHECKSON DIE CASTING & PRODUCT FACTORY LTD., SHATIN, HONG KONG. SN 78-853,067. PUB. 11-14-2006, FILED 4-4-2006.



FOR LAMPS; ARC LAMPS; BICYCLE LAMPS; CANDLE LAMPS; DISCHARGE LAMPS AND THEIR FITTINGS; FLUORESCENT LAMPS; GAS LAMPS; INCANDESCENT LAMPS; INFRARED LAMPS; LAMPS FOR OUTDOOR USE; LAMP WHOSE LIGHT CAN BE TURNED IN ALL DIRECTIONS; MERCURY LAMPS; OIL LAMPS; OVERHEAD LAMPS; SAFETY LAMPS FOR UNDERGROUND USE; SUN LAMPS; TANNING LAMPS; ULTRAVIOLET LAMPS NOT FOR MEDICAL PURPOSES; VEHICLE DYNAMO LAMPS; AQUARIUM LIGHTS; BACKUP LIGHTS FOR LAND VEHICLES; BICYCLE LIGHTS; DIVING LIGHTS; ELECTRIC HOLIDAY LIGHTS; ELECTRIC LIGHTS FOR CHRISTMAS TREES; ELECTRIC NIGHT LIGHTS; FRAGRANCE DISPENSING UNIT WHICH ALSO FEATURES A NIGHT LIGHT; HIGH INTENSITY SEARCH LIGHTS; KLIEG LIGHTS; LIGHTS FOR FIREARMS; LIGHTS FOR VEHICLES; PEN LIGHTS; POCKET SEARCH LIGHTS; REAR LIGHTS FOR VEHICLES; RUNNING LIGHTS FOR LAND VEHICLES; SOLAR LIGHT FIXTURES, NAMELY, INDOOR AND OUTDOOR SOLAR POWERED LIGHTING UNITS AND FIXTURES; TAIL LIGHTS FOR VEHICLES; WALL LIGHTS; CANDLE LANTERNS; ELECTRIC CHINESE LANTERNS; ELECTRIC LANTERNS; OIL LANTERNS; PORTABLE PAPER LANTERNS (CHOCHIN); STANDING PAPER LANTERNS (ANDON) (U.S. CLS. 13, 21, 23, 31 AND 34).

FIRST USE 4-4-2006; IN COMMERCE 4-4-2006.

CLASS 11—(Continued).

3,299,919. LACY, JARVIS, GRAND PRAIRIE, TX. SN 78-863,723. PUB. 11-28-2006, FILED 4-18-2006.



FOR VITAMIN C DECHLORINATING SHOWER FILTERS (U.S. CLS. 13, 21, 23, 31 AND 34).
FIRST USE 10-30-2004; IN COMMERCE 2-15-2005.

CLASS 12—(Continued).

3,298,400. MATSUI UNIVERSAL JOINT CORPORATION, SHINJUKU-KU, TOKYO, JAPAN. SN 75-446,477. PUB. 12-28-1999, FILED 3-9-1998.

URW

FOR AUTOMOBILE PARTS AND ACCESSORIES, NAMELY, BEARING SHAFTS, SHAFT JOINTS, SHAFT BEARINGS, POWER TRANSMISSIONS, SHOCK ABSORBERS, SPRINGS, BRAKE COMPONENTS, NAMELY, BRAKE MASTER CYLINDERS, BRAKE DRUMS, BRAKE SHOES, HYDRAULIC BRAKE HOSES, BRAKE ROTORS, BRAKE PADS, RETAINING CLIPS, BUSHINGS, O-RINGS AND ANTI-LOCK BRAKE SYSTEM ACTUATORS (U.S. CLS. 19, 21, 23, 31, 35 AND 44).
FIRST USE 11-9-2006; IN COMMERCE 11-9-2006.

3,300,215. AMERICAN VALVE, INC., GREENSBORO, NC. SN 78-978,708. PUB. 8-15-2006, FILED 12-21-2005.

3,298,455. AMERICAN CYCLE SYSTEMS INC., BALDWIN PARK, CA. SN 76-572,879. PUB. 7-12-2005, FILED 1-30-2004.

H2OTSTOP

CROSSFIRE

THE MARK CONSISTS OF STANDARD CHARACTERS WITHOUT CLAIM TO ANY PARTICULAR FONT, STYLE, SIZE, OR COLOR.
FOR SHOWER HEADS, HAND-HELD SPRAYERS FOR ATTACHING TO FAUCETS AND SHOWERS, TUB SPOUTS (U.S. CLS. 13, 21, 23, 31 AND 34).
FIRST USE 2-28-2007; IN COMMERCE 2-28-2007.

THE MARK CONSISTS OF STANDARD CHARACTERS WITHOUT CLAIM TO ANY PARTICULAR FONT, STYLE, SIZE, OR COLOR.
FOR BICYCLE WHEELS (U.S. CLS. 19, 21, 23, 31, 35 AND 44).
FIRST USE 4-29-2004; IN COMMERCE 4-29-2004.

3,300,216. AMERICAN VALVE, INC., GREENSBORO, NC. SN 78-978,716. PUB. 8-22-2006, FILED 12-21-2005.

3,298,508. TWIN VEE, INC., FORT PIERCE, FL. SN 76-632,505. PUB. 7-25-2006, FILED 3-2-2005.



FOR SHOWER HEADS, HAND-HELD SPRAYERS FOR ATTACHING TO FAUCETS AND SHOWERS, TUB SPOUTS (U.S. CLS. 13, 21, 23, 31 AND 34).
FIRST USE 2-28-2007; IN COMMERCE 2-28-2007.

OWNER OF U.S. REG. NO. 2,968,850.
NO CLAIM IS MADE TO THE EXCLUSIVE RIGHT TO USE "CATAMARANS", APART FROM THE MARK AS SHOWN.
SEC. 2(F) AS TO TWIN VEE.
FOR BOATS (U.S. CLS. 19, 21, 23, 31, 35 AND 44).
FIRST USE 10-31-2004; IN COMMERCE 10-31-2004.

CLASS 12—VEHICLES

CLASS 12—(Continued).

3,298,528. LEAR BAYLOR, INC., GARDEN GROVE, CA. SN 76-637,808. PUB. 1-24-2006, FILED 5-4-2005.

E-PROP

THE MARK CONSISTS OF STANDARD CHARACTERS WITHOUT CLAIM TO ANY PARTICULAR FONT, STYLE, SIZE, OR COLOR.

FOR PROPELLER FOR LOW RPM ELECTRIC BOAT PROPULSION (U.S. CLS. 19, 21, 23, 31, 35 AND 44). FIRST USE 10-23-2006; IN COMMERCE 10-23-2006.

3,298,549. THOMSON, KEVIN T., LYNN, NC. SN 76-645,533. PUB. 10-3-2006, FILED 8-24-2005.

HOGG HOOF

THE MARK CONSISTS OF STANDARD CHARACTERS WITHOUT CLAIM TO ANY PARTICULAR FONT, STYLE, SIZE, OR COLOR.

FOR BICYCLE AND MOTORCYCLE ACCESSORIES, NAMELY, KICKSTAND GROUND SUPPORT PAD (U.S. CLS. 19, 21, 23, 31, 35 AND 44). FIRST USE 11-6-2006; IN COMMERCE 11-6-2006.

3,298,572. KROEKER OFF ROAD ENGINEERING, INC., VALLEY CENTER, CA. SN 76-651,275. PUB. 11-7-2006, FILED 12-2-2005.

DESERT ASSAULT

THE MARK CONSISTS OF STANDARD CHARACTERS WITHOUT CLAIM TO ANY PARTICULAR FONT, STYLE, SIZE, OR COLOR.

FOR VEHICLE SUSPENSION SYSTEMS AND COMPONENTS (U.S. CLS. 19, 21, 23, 31, 35 AND 44). FIRST USE 2-15-2007; IN COMMERCE 2-15-2007.

CLASS 12—(Continued).

3,298,690. AMERICAN SPORTS LICENSING, INC., WILMINGTON, DE. SN 78-300,986. PUB. 1-4-2005, FILED 9-16-2003.

QUEST

FOR BOATS AND STRUCTURAL PARTS THEREFOR (U.S. CLS. 19, 21, 23, 31, 35 AND 44). FIRST USE 2-1-2007; IN COMMERCE 2-1-2007.

3,298,691. AMERICAN SPORTS LICENSING, INC., WILMINGTON, DE. SN 78-300,996. PUB. 12-28-2004, FILED 9-16-2003.



THE COLOR(S) BLACK, WHITE AND GRAY IS/ARE CLAIMED AS A FEATURE OF THE MARK.

THE COLOR WHITE APPEARS AS QUEST TEXT IN THE CENTER OF THE MARK. THE COLOR BLACK APPEARS AS A RECTANGLE SURROUNDING THE QUEST TEXT. THE COLOR GRAY APPEARS IN A STAR AND CIRCLE PATTERN SURROUNDING THE BLACK RECTANGLE.

FOR BOATS AND STRUCTURAL PARTS THEREFORE (U.S. CLS. 19, 21, 23, 31, 35 AND 44). FIRST USE 2-1-2007; IN COMMERCE 2-1-2007.

3,298,716. ASC INCORPORATED, SOUTHGATE, MI. SN 78-350,618. PUB. 2-1-2005, FILED 1-12-2004.

OWNER OF U.S. REG. NOS. 1,283,956, 2,023,944, AND OTHERS.

FOR CUSTOMIZED AUTOMOTIVE VEHICLES, NAMELY, CARS, TRUCKS AND VANS; SHOW VEHICLES, NAMELY, CARS, TRUCKS AND VANS; AUTOMOTIVE LAND VEHICLE BODIES AND STRUCTURAL, INTERIOR AND EXTERIOR PARTS THEREOF, NAMELY, ROOFS, ROOF SYSTEMS, NAMELY, CONVERTIBLE ROOFS, SUNROOFS, MOON ROOFS, VENTING SUNROOFS, VINYL TOPS, AUTOMOTIVE VEHICLE TONNEAU AND TRUNK DECK LIDS (U.S. CLS. 19, 21, 23, 31, 35 AND 44).

FIRST USE 1-4-2004; IN COMMERCE 1-4-2004.

CLASS 12—(Continued).

3,298,770. THE GOODYEAR TIRE & RUBBER COMPANY, AKRON, OH. SN 78-429,430. PUB. 7-5-2005, FILED 6-3-2004.

G622 RSD

THE MARK CONSISTS OF STANDARD CHARACTERS WITHOUT CLAIM TO ANY PARTICULAR FONT, STYLE, SIZE, OR COLOR.
FOR TIRES (U.S. CLS. 19, 21, 23, 31, 35 AND 44).
FIRST USE 6-20-2006; IN COMMERCE 6-20-2006.

3,298,789. DAIMLERCHRYSLER COMPANY LLC, AUBURN HILLS, MI. SN 78-453,998. PUB. 6-21-2005, FILED 7-21-2004.

SUPER BEE

THE MARK CONSISTS OF STANDARD CHARACTERS WITHOUT CLAIM TO ANY PARTICULAR FONT, STYLE, SIZE, OR COLOR.
FOR MOTOR VEHICLES, NAMELY AUTOMOBILES AND STRUCTURAL PARTS THEREOF (U.S. CLS. 19, 21, 23, 31, 35 AND 44).
FIRST USE 8-18-2006; IN COMMERCE 8-18-2006.

3,298,846. PEAKS ISLAND BOAT COMPANY, LLC, PORTLAND, ME. SN 78-492,227. PUB. 1-10-2006, FILED 9-30-2004.

PIBC

THE MARK CONSISTS OF STANDARD CHARACTERS WITHOUT CLAIM TO ANY PARTICULAR FONT, STYLE, SIZE, OR COLOR.
FOR BOATS AND STRUCTURAL PARTS THEREOF (U.S. CLS. 19, 21, 23, 31, 35 AND 44).
FIRST USE 2-0-2007; IN COMMERCE 3-19-2007.

CLASS 12—(Continued).

3,298,881. U.S.A AUTOSUN INTERNATIONAL GROUP LIMITED, MONGKOK, KOWLOON, HONG KONG. SN 78-523,201. PUB. 9-12-2006, FILED 11-26-2004.



愛 德 森

THE MARK CONSISTS OF A DESIGN ELEMENT COMPOSED OF AN ABSTRACT DRAWING OF FLYING WINGS SYMBOLIZING ENERGY AND HOPE AND THREE CHINESE CHARACTERS.
THE NON-LATIN CHARACTER(S) IN THE MARK TRANSLITERATES INTO AI; DE; SEN, AND THIS MEANS LOVE; ETHICS; FOREST IN ENGLISH.
FOR MOPEDS; MOTORCYCLES (U.S. CLS. 19, 21, 23, 31, 35 AND 44).
FIRST USE 12-14-2002; IN COMMERCE 2-8-2007.

3,298,968. RALLY MANUFACTURING, INC., MIAMI, FL. SN 78-576,534. PUB. 7-11-2006, FILED 2-28-2005.

XTREME FX

THE MARK CONSISTS OF STANDARD CHARACTERS WITHOUT CLAIM TO ANY PARTICULAR FONT, STYLE, SIZE, OR COLOR.
FOR AUTOMOBILE PARTS AND ACCESSORIES, NAMELY, WINDSHIELD WIPERS (U.S. CLS. 19, 21, 23, 31, 35 AND 44).
FIRST USE 5-23-2003; IN COMMERCE 5-23-2003.

3,299,053. WEDS CO., LTD., TOKYO, JAPAN. SN 78-604,551. PUB. 8-1-2006, FILED 4-8-2005.

WedsSport

PRIORITY CLAIMED UNDER SEC. 44(D) ON JAPAN APPLICATION NO. 2005018182, FILED 3-3-2005, REG. NO. 4910896, DATED 12-2-2005, EXPIRES 12-2-2015.
OWNER OF U.S. REG. NO. 1,374,701.
FOR VEHICLE WHEEL (U.S. CLS. 19, 21, 23, 31, 35 AND 44).
FIRST USE 4-0-1984; IN COMMERCE 7-0-2005.

CLASS 12—(Continued).

3,299,148. MDSA, LLC, NORCROSS, GA. SN 78-643,945. PUB. 3-27-2007, FILED 6-5-2005.



OWNER OF U.S. REG. NOS. 2,450,196, 2,823,994, AND OTHERS.

NO CLAIM IS MADE TO THE EXCLUSIVE RIGHT TO USE "AUTO PARTS", APART FROM THE MARK AS SHOWN.

THE COLOR(S) RED, BLACK, GRAY, AND WHITE IS/ ARE CLAIMED AS A FEATURE OF THE MARK.

THE MARK CONSISTS OF THE WORDS MIGHTY AUTO PARTS INSIDE A LOGO DESIGN. THE ROUNDED SHAPE ABOVE THE WORDS "MIGHTY AUTO PARTS" IS IN RED. THE WORDING "MIGHTY AUTO PARTS" AND THE ROUNDED SHAPE BELOW THIS WORDING ARE IN BLACK. TO THE RIGHT OF THE LOGO DESIGN IS THE WORD TECSELECT IN BLACK WITH WHITE AND GRAY BORDERING AROUND EACH LETTER.

FOR DISC BRAKES FOR LAND VEHICLES (U.S. CLS. 19, 21, 23, 31, 35 AND 44).

FIRST USE 4-0-2005; IN COMMERCE 4-0-2005.

3,299,307. GOODYEAR TIRE & RUBBER COMPANY, THE, AKRON, OH. SN 78-710,849. PUB. 12-26-2006, FILED 9-12-2005.

STILETTO

THE MARK CONSISTS OF STANDARD CHARACTERS WITHOUT CLAIM TO ANY PARTICULAR FONT, STYLE, SIZE, OR COLOR.

FOR TIRES, EXCLUDING BICYCLE TIRES (U.S. CLS. 19, 21, 23, 31, 35 AND 44).

FIRST USE 5-3-2006; IN COMMERCE 5-3-2006.

3,299,342. LUVERNE TRUCK EQUIPMENT, INC., BRANDON, SD. SN 78-720,308. PUB. 10-31-2006, FILED 9-26-2005.

MEGA STEP

THE MARK CONSISTS OF STANDARD CHARACTERS WITHOUT CLAIM TO ANY PARTICULAR FONT, STYLE, SIZE, OR COLOR.

NO CLAIM IS MADE TO THE EXCLUSIVE RIGHT TO USE "STEP", APART FROM THE MARK AS SHOWN.

FOR VEHICLE ACCESSORY, NAMELY SIDE ASSIST ENTRY STEP (U.S. CLS. 19, 21, 23, 31, 35 AND 44).

FIRST USE 9-0-2005; IN COMMERCE 9-0-2005.

CLASS 12—(Continued).

3,299,429. GIANT BICYCLE, INC., NEWBURY PARK, CA. SN 78-736,225. PUB. 6-27-2006, FILED 10-19-2005.

TRINITY

THE MARK CONSISTS OF STANDARD CHARACTERS WITHOUT CLAIM TO ANY PARTICULAR FONT, STYLE, SIZE, OR COLOR.

FOR BICYCLES AND STRUCTURAL PARTS THEREFOR (U.S. CLS. 19, 21, 23, 31, 35 AND 44).

FIRST USE 9-1-2005; IN COMMERCE 9-1-2005.

3,299,430. GIANT BICYCLE, INC., NEWBURY PARK, CA. SN 78-736,228. PUB. 7-4-2006, FILED 10-19-2005.

GLORY

THE MARK CONSISTS OF STANDARD CHARACTERS WITHOUT CLAIM TO ANY PARTICULAR FONT, STYLE, SIZE, OR COLOR.

FOR BICYCLES AND STRUCTURAL PARTS THEREFOR (U.S. CLS. 19, 21, 23, 31, 35 AND 44).

FIRST USE 9-1-2005; IN COMMERCE 9-1-2005.

3,299,431. GIANT BICYCLE, INC., NEWBURY PARK, CA. SN 78-736,238. PUB. 7-4-2006, FILED 10-19-2005.

ANTHEM

THE MARK CONSISTS OF STANDARD CHARACTERS WITHOUT CLAIM TO ANY PARTICULAR FONT, STYLE, SIZE, OR COLOR.

FOR BICYCLES AND STRUCTURAL PARTS THEREFOR (U.S. CLS. 19, 21, 23, 31, 35 AND 44).

FIRST USE 9-1-2005; IN COMMERCE 9-1-2005.

CLASS 12—(Continued).

3,299,582. GPX INTERNATIONAL TIRE CORPORATION, MALDEN, MA. SN 78-757,333. PUB. 7-18-2006, FILED 11-18-2005.

CLASS 12—(Continued).

3,299,801. INDUSTRIAS VASSALLO, INC., COTO LAUREL, PUERTO RICO. SN 78-817,545. PUB. 1-16-2007, FILED 2-17-2006.

AGRI STAR

THE MARK CONSISTS OF STANDARD CHARACTERS WITHOUT CLAIM TO ANY PARTICULAR FONT, STYLE, SIZE, OR COLOR.

FOR TIRES, TRACTOR TIRES, FARM IMPLEMENT TIRES (U.S. CLS. 19, 21, 23, 31, 35 AND 44).
FIRST USE 6-24-2005; IN COMMERCE 6-24-2005.

REBEL

THE MARK CONSISTS OF STANDARD CHARACTERS WITHOUT CLAIM TO ANY PARTICULAR FONT, STYLE, SIZE, OR COLOR.

FOR PADDLE-DRIVEN KAYAKS (U.S. CLS. 19, 21, 23, 31, 35 AND 44).
FIRST USE 3-20-2006; IN COMMERCE 3-20-2006.

3,299,754. STREKOZA INVENTURE, LLC., MAPLE CITY, MI. SN 78-801,141. PUB. 3-6-2007, FILED 1-27-2006.



THE MARK CONSISTS OF THE WORD THUNDERIDER IN STYLIZED FORM WITH LIGHTNING BOLTS DEPICTED BELOW THE WORD.

FOR BICYCLE PARTS, NAMELY, BICYCLE MUFFLERS THAT SIMULATE EXHAUST SOUNDS (U.S. CLS. 19, 21, 23, 31, 35 AND 44).

FIRST USE 12-8-2006; IN COMMERCE 12-8-2006.

3,299,837. LINKER METAL IND. CO., LTD., PUYAN TOWNSHIP, TAIWAN. SN 78-830,462. PUB. 10-24-2006, FILED 3-6-2006.

3,299,777. REAL CARBON FIBER, LLC, DAYTON, OH. SN 78-809,755. PUB. 9-26-2006, FILED 2-8-2006.

ALNOVA

Designed By Car Guys For
Car Guys

THE MARK CONSISTS OF STANDARD CHARACTERS WITHOUT CLAIM TO ANY PARTICULAR FONT, STYLE, SIZE, OR COLOR.

FOR LICENSE PLATE FRAMES (U.S. CLS. 19, 21, 23, 31, 35 AND 44).
FIRST USE 5-2-2006; IN COMMERCE 5-6-2006.

THE MARK CONSISTS OF STANDARD CHARACTERS WITHOUT CLAIM TO ANY PARTICULAR FONT, STYLE, SIZE, OR COLOR.

FOR BICYCLES AND STRUCTURAL PARTS THEREFORE (U.S. CLS. 19, 21, 23, 31, 35 AND 44).
FIRST USE 2-16-2007; IN COMMERCE 2-16-2007.

CLASS 12—(Continued).

3,299,936. AFFINIA GROUP, INC., ANN ARBOR, MI. SN 78-867,828. PUB. 1-2-2007, FILED 4-24-2006.

CLASS 12—(Continued).

3,300,016. GENMAR IP LLC, MINNEAPOLIS, MN. SN 78-896,919. PUB. 2-27-2007, FILED 5-31-2006.

SERVICE GRADE

THE MARK CONSISTS OF STANDARD CHARACTERS WITHOUT CLAIM TO ANY PARTICULAR FONT, STYLE, SIZE, OR COLOR.

FOR LAND VEHICLE BRAKE AND CLUTCH PARTS, NAMELY, BRAKE MASTER CYLINDERS; CLUTCH SLAVE CYLINDERS, BRAKE DRUMS, BRAKE CYLINDERS, BRAKE PADS, BRAKE SHOES, BRAKE ROTORS, BRAKE CALIPERS, BRAKE DISCS; BRAKE LINES FOR VEHICLES, BRAKE LININGS, BRAKE HARDWARE FOR VEHICLES, BRAKING SYSTEMS FOR VEHICLES, WHEEL CYLINDERS, BRAKE HOSES, BRAKE AND CLUTCH CABLES; CHASSIS PARTS FOR VEHICLES, NAMELY, CONTROL ARMS, BUSHINGS, SWAY BAR LINKS, SWAY BARS, FRAME MOUNTS, CV BOOTS, CV HALF SHAFT, CENTER LINKS, DRAG LINKS, COIL SPRINGS, STRUT MOUNT BEARING ASSEMBLIES, BALL JOINTS, TIE RODS; STEERING ASSEMBLY PARTS FOR LAND VEHICLES NAMELY, RACK AND PINION BOOT, ROD ADJUSTING SLEEVES, AND IDLER AND PITMAN ARMS (U.S. CLS. 19, 21, 23, 31, 35 AND 44).

FIRST USE 1-0-2007; IN COMMERCE 1-0-2007.

V-WING HULL

THE MARK CONSISTS OF STANDARD CHARACTERS WITHOUT CLAIM TO ANY PARTICULAR FONT, STYLE, SIZE, OR COLOR.

NO CLAIM IS MADE TO THE EXCLUSIVE RIGHT TO USE "HULL", APART FROM THE MARK AS SHOWN.

FOR BOATS AND STRUCTURAL PARTS THEREFOR (U.S. CLS. 19, 21, 23, 31, 35 AND 44).

FIRST USE 7-1-2006; IN COMMERCE 7-1-2006.

3,300,097. KOLCRAFT ENTERPRISES, INC., CHICAGO, IL. SN 78-920,555. PUB. 1-16-2007, FILED 6-30-2006.

3,300,015. GENMAR IP LLC, MINNEAPOLIS, MN. SN 78-896,915. PUB. 2-27-2007, FILED 5-31-2006.

Options

THE MARK CONSISTS OF STANDARD CHARACTERS WITHOUT CLAIM TO ANY PARTICULAR FONT, STYLE, SIZE, OR COLOR.

FOR STROLLERS FOR BABIES AND CHILDREN, BABY CARRIAGES (U.S. CLS. 19, 21, 23, 31, 35 AND 44).

FIRST USE 5-0-2005; IN COMMERCE 2-0-2006.

NO CLAIM IS MADE TO THE EXCLUSIVE RIGHT TO USE "HULL", APART FROM THE MARK AS SHOWN.

FOR BOATS AND STRUCTURAL PARTS THEREFOR (U.S. CLS. 19, 21, 23, 31, 35 AND 44).

FIRST USE 7-1-2006; IN COMMERCE 7-1-2006.

CLASS 13—FIREARMS

CLASS 13—(Continued).

3,298,587. UNITED STATES MARKETING CORPORATION, HUNTINGTON STATION, NY. SN 76-658,775. PUB. 2-20-2007, FILED 4-21-2006.

DANGEROUS GAME

THE MARK CONSISTS OF STANDARD CHARACTERS WITHOUT CLAIM TO ANY PARTICULAR FONT, STYLE, SIZE, OR COLOR.

FOR FIREARMS, NAMELY, PISTOLS, REVOLVERS, RIFLES, SHOTGUNS, CARBINES, AUTOMATIC CARBINES, AUTOMATIC GUNS, AUTOMATIC PISTOLS, AUTOMATIC RIFLES AND PARTS THEREFOR; BARREL REFLECTORS FOR FIREARMS; HOLSTERS; GUN CASES; CASE COVERS FOR FIREARMS; COVERS FOR FIREARMS; BUTT PLATES FOR SWIVELS FOR FIREARMS; TEST STANDS FOR FIREARMS; SUPPLEMENTAL CHAMBERS FOR FIREARMS; BIPODS AND TRIPODS AND STANDS FOR FIREARMS; NON-OPTICAL AND NON-TELESCOPIC GUN SIGHTS FOR FIREARMS; MAGAZINES FOR FIREARMS; SHOOTING BENCHES FOR FIREARMS; RIFLE AND PISTOL RESTS; GUN LOCKS; RECOIL PADS FOR FIREARMS; FIREARMS ACCESSORIES, NAMELY, GUN CLEANING BRUSHES, GUN CLEANING WIPING RODS, GUN CLEANING PULL THROUGHs, GUN CLEANING CLOSER CUPS BULLET AND SHELL EXTRACTORS, GUN COTTON NITRATED, WAD CUTTERS, GUN CLEANING DECAPPERS, GUN CLEANING PATCHES, CARTRIDGE BELTS, SHELL BELTS, SHOT BELTS, BLANK CARTRIDGE SHELL BELTS, BLANK CARTRIDGES, GUN CARTRIDGES, PISTOL CAPS, LOADING CLIPS FOR PISTOLS AND RIFLES, LOADING CLIPS FOR SMALL ARMS, PISTOL GRIPS, GRIPS FOR SMALL ARMS, GUN BARRELS, SIGHTING BASES FOR FIREARMS, GUN BELTS, GUN SNAPS AND GUN RINGS; AMMUNITION, SMALL ARMS AMMUNITION; AMMUNITION BAGS, WEAPON AIR PISTOLS, AIR RIFLES, WEAPON AIR SHOT AND WEAPON AIR PELLETS (U.S. CLS. 2 AND 9).
FIRST USE 6-1-2006; IN COMMERCE 6-1-2006.

3,298,614. B.J. ALAN COMPANY, YOUNGSTOWN, OH. SN 77-008,884. PUB. 3-6-2007, FILED 9-27-2006.

STORM WARNING

THE MARK CONSISTS OF STANDARD CHARACTERS WITHOUT CLAIM TO ANY PARTICULAR FONT, STYLE, SIZE, OR COLOR.

FOR FIREWORKS (U.S. CLS. 2 AND 9).
FIRST USE 3-30-2007; IN COMMERCE 3-30-2007.

CLASS 13—(Continued).

3,298,617. INGRAM ENTERPRISES, INC., SPRINGFIELD, MO. SN 77-010,831. PUB. 3-13-2007, FILED 9-29-2006.

ENOUGH SAID

THE MARK CONSISTS OF STANDARD CHARACTERS WITHOUT CLAIM TO ANY PARTICULAR FONT, STYLE, SIZE, OR COLOR.

FOR FIREWORKS IN SHELL FORMS (U.S. CLS. 2 AND 9).

FIRST USE 3-15-2007; IN COMMERCE 3-15-2007.

CLASS 14—JEWELRY

3,298,442. AMARU ENTERTAINMENT, INC., WEST HOLLYWOOD, CA. SN 76-521,239. PUB. 6-22-2004, FILED 6-2-2003.

2PAC

OWNER OF U.S. REG. NOS. 2,183,418, 2,763,817, AND OTHERS.

FOR JEWELRY (U.S. CLS. 2, 27, 28 AND 50).
FIRST USE 6-30-2006; IN COMMERCE 6-30-2006.

3,298,485. ASPEN DESIGNS, INC., NEW YORK, NY. SN 76-614,035. PUB. 1-10-2006, FILED 9-24-2004.

PLATINUM DREAMS

THE MARK CONSISTS OF STANDARD CHARACTERS WITHOUT CLAIM TO ANY PARTICULAR FONT, STYLE, SIZE, OR COLOR.

NO CLAIM IS MADE TO THE EXCLUSIVE RIGHT TO USE "PLATINUM", APART FROM THE MARK AS SHOWN. FOR JEWELRY PLATED IN PLATINUM (U.S. CLS. 2, 27, 28 AND 50).

FIRST USE 6-1-2005; IN COMMERCE 6-1-2005.

CLASS 14—(Continued).

3,298,601. NIKKEN, INC., IRVINE, CA. SN 76-664,996. PUB. 3-6-2007, FILED 8-22-2006.

TRIPHASE

THE MARK CONSISTS OF STANDARD CHARACTERS WITHOUT CLAIM TO ANY PARTICULAR FONT, STYLE, SIZE, OR COLOR.
FOR JEWELRY (U.S. CLS. 2, 27, 28 AND 50).
FIRST USE 9-0-2006; IN COMMERCE 9-0-2006.

3,298,721. YURMAN STUDIOS INC., NEW YORK, NY. SN 78-355,431. PUB. 7-12-2005, FILED 1-22-2004.

Cable Cage

THE MARK CONSISTS OF STANDARD CHARACTERS WITHOUT CLAIM TO ANY PARTICULAR FONT, STYLE, SIZE, OR COLOR.
OWNER OF U.S. REG. NOS. 1,658,160, 2,864,113, AND OTHERS.
FOR FINE JEWELRY, PRECIOUS STONES AND WATCHES (U.S. CLS. 2, 27, 28 AND 50).
FIRST USE 4-15-2004; IN COMMERCE 4-15-2004.

CLASS 14—(Continued).

3,298,749. CHILDRESS VINEYARDS, LLC, WELCOME, NC. SN 78-388,903. PUB. 6-28-2005, FILED 3-23-2004.



THE MARK CONSISTS OF A STYLIZED DESIGN OF THE LETTERS R AND C.
FOR WATCHES, WALL CLOCKS AND DESK CLOCKS; JEWELRY, BELT BUCKLES FOR CLOTHING MADE OF PRECIOUS METAL; DRESS PINS (U.S. CLS. 2, 27, 28 AND 50).
FIRST USE 3-15-2006; IN COMMERCE 3-15-2006.

3,298,928. MONICA RICH KOSANN PHOTOGRAPHY, LLC, NEW CANAAN, CT. SN 78-558,975. PUB. 7-18-2006, FILED 2-2-2005.

MONICA RICH KOSANN

THE MARK CONSISTS OF STANDARD CHARACTERS WITHOUT CLAIM TO ANY PARTICULAR FONT, STYLE, SIZE, OR COLOR.
OWNER OF U.S. REG. NOS. 2,837,936 AND 2,847,281.
THE NAME MONICA RICH KOSANN IDENTIFIES A LIVING INDIVIDUAL WHOSE CONSENT IS OF RECORD.
FOR JEWELRY (U.S. CLS. 2, 27, 28 AND 50).
FIRST USE 1-31-2004; IN COMMERCE 1-31-2004.

CLASS 14—(Continued).

3,298,950. LAU INTERNATIONAL, INC., MIAMI, FL. SN 78-569,521. PUB. 5-23-2006, FILED 2-17-2005.

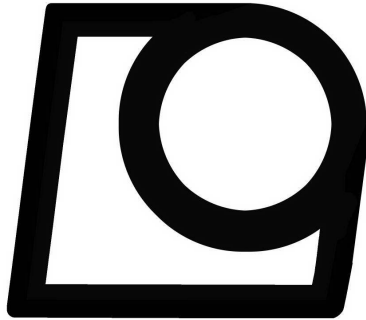

THE MARK CONSISTS OF A BOX WITH A SPHERE WITHIN THE RIGHT HAND CORNER OF THE BOX. FOR JEWELRY (U.S. CLS. 2, 27, 28 AND 50). FIRST USE 9-30-1991; IN COMMERCE 9-30-1991.

3,299,346. TAYLOR, BRIAN, BOUNTIFUL, UT. SN 78-720,619. PUB. 5-30-2006, FILED 9-26-2005.

PRO

THE MARK CONSISTS OF STANDARD CHARACTERS WITHOUT CLAIM TO ANY PARTICULAR FONT, STYLE, SIZE, OR COLOR. FOR JEWELRY (U.S. CLS. 2, 27, 28 AND 50). FIRST USE 10-0-2005; IN COMMERCE 10-0-2005.

3,299,365. ADINA DESIGN, INC., VAN NUYS, CA. SN 78-725,610. PUB. 8-29-2006, FILED 10-3-2005.

ADINA REYTER

THE MARK CONSISTS OF STANDARD CHARACTERS WITHOUT CLAIM TO ANY PARTICULAR FONT, STYLE, SIZE, OR COLOR. THE NAME(S), PORTRAIT(S), AND/OR SIGNATURE(S) SHOWN IN THE MARK IDENTIFIES ADINA REYTER, WHOSE CONSENT(S) TO REGISTER IS SUBMITTED. FOR JEWELRY, NAMELY RINGS, EARRINGS, BRACELETS, NECKLACES, PINS, AND BELT BUCKLES MADE OF PRECIOUS METAL (U.S. CLS. 2, 27, 28 AND 50). FIRST USE 1-0-2001; IN COMMERCE 1-0-2001.

CLASS 14—(Continued).

3,299,394. DIAMINTANGIBLES INTERNATIONAL, LTD., NASSAU, BAHAMAS. SN 78-730,595. PUB. 6-20-2006, FILED 10-11-2005.

RADIANT BRIDE

THE MARK CONSISTS OF STANDARD CHARACTERS WITHOUT CLAIM TO ANY PARTICULAR FONT, STYLE, SIZE, OR COLOR. FOR DIAMONDS (U.S. CLS. 2, 27, 28 AND 50). FIRST USE 1-18-2007; IN COMMERCE 1-18-2007.

3,299,432. INDOBUDI, LLC, EMERYVILLE, CA. SN 78-736,293. PUB. 6-20-2006, FILED 10-19-2005.

BALI KINGDOM

THE MARK CONSISTS OF STANDARD CHARACTERS WITHOUT CLAIM TO ANY PARTICULAR FONT, STYLE, SIZE, OR COLOR. NO CLAIM IS MADE TO THE EXCLUSIVE RIGHT TO USE "BALI", APART FROM THE MARK AS SHOWN. FOR JEWELRY (U.S. CLS. 2, 27, 28 AND 50). FIRST USE 1-2-2002; IN COMMERCE 2-19-2007.

3,299,437. MARTIN FLYER, INC., NEW YORK, NY. SN 78-736,417. PUB. 6-20-2006, FILED 10-19-2005.

FLYERFIT

THE MARK CONSISTS OF STANDARD CHARACTERS WITHOUT CLAIM TO ANY PARTICULAR FONT, STYLE, SIZE, OR COLOR. FOR RINGS (U.S. CLS. 2, 27, 28 AND 50). FIRST USE 10-0-2005; IN COMMERCE 10-0-2005.

CLASS 14—(Continued).

3,299,442. TARK ENTERPRISES LTD., HONG KONG, HONG KONG. SN 78-736,958. PUB. 8-22-2006, FILED 10-20-2005.

TARKON

THE MARK CONSISTS OF STANDARD CHARACTERS WITHOUT CLAIM TO ANY PARTICULAR FONT, STYLE, SIZE, OR COLOR.

FOR PRECIOUS METALS AND THEIR ALLOYS AND GOODS MADE OF PRECIOUS METALS OR COATED THEREWITH, NAMELY, CLOCKS, WATCHES, NECKLACES, RINGS, EARRINGS, AND BRACELETS; JEWELRY, PRECIOUS STONES; HOROLOGICAL AND CHRONOMETRIC INSTRUMENTS (U.S. CLS. 2, 27, 28 AND 50).

FIRST USE 1-31-2007; IN COMMERCE 1-31-2007.

3,299,446. STERLING METS, L.P., FLUSHING, NY. SN 78-737,370. PUB. 7-11-2006, FILED 10-20-2005.

Mets

OWNER OF U.S. REG. NOS. 1,528,814, 1,636,881, AND OTHERS.

FOR JEWELRY, NAMELY, BRACELETS, CHARMS, EARRINGS, RINGS, BELLY RINGS, NECKLACES, PENDANTS, WATCHES, COSTUME JEWELRY, RUBBER OR SILICONE BRACELETS AND/OR WRISTBANDS, MEDALLIONS, ORNAMENTAL METAL PINS, LAPEL PINS, CUFF LINKS, METAL BELT BUCKLES OF PRECIOUS METAL, MONEY CLIPS OF PRECIOUS METAL, PRECIOUS METAL KEY CHAINS, PRECIOUS METAL KEY RINGS, CLOCKS, WALL CLOCKS, ALARM CLOCKS, FOB WATCHES, CLOCK KEY CHAINS, AND NON-MONETARY COINS OF PRECIOUS METAL (U.S. CLS. 2, 27, 28 AND 50).

FIRST USE 0-0-1984; IN COMMERCE 0-0-1984.

CLASS 14—(Continued).

3,299,589. TYCOON INTERNATIONAL, INC., NEW YORK, NY. SN 78-760,913. PUB. 8-1-2006, FILED 11-25-2005.



THE COLOR(S) BLUE AND SILVER IS/ARE CLAIMED AS A FEATURE OF THE MARK.

THE COLOR BLUE APPEARS WITHIN THE STYLIZED LETTER "B" AND THE COLOR SILVER APPEARS WITHIN THE LETTERS "L", "E" AND "U".

THE ENGLISH TRANSLATION OF THE WORD BLEU IN THE MARK IS BLUE.

FOR COSTUME JEWELRY (U.S. CLS. 2, 27, 28 AND 50).

FIRST USE 10-0-2005; IN COMMERCE 12-0-2005.

3,299,590. JIANG, ZHONGJIE, NEWARK, DE. SN 78-761,033. PUB. 6-27-2006, FILED 11-26-2005.

iGold

THE MARK CONSISTS OF STANDARD CHARACTERS WITHOUT CLAIM TO ANY PARTICULAR FONT, STYLE, SIZE, OR COLOR.

FOR BRACELETS; CLOCKS; COLLECTIBLE COINS; FIGURES OF PRECIOUS METAL; FIGURINES OF PRECIOUS METAL; ITEMS MADE OF PRECIOUS METALS AND ITEMS MADE IN WHOLE OR IN PART OF PRECIOUS METALS, NAMELY DECORATIVE STICKERS, FLOWERS, GOLF BALLS, BASKETBALLS, HOCKEY PUCKS, BASEBALLS, FOOTBALLS, CAR MODELS, PHOTOGRAPHIC PICTURES, PAINTINGS, MEMORABLE PUBLICATIONS, AND COLLECTIBLE CARDS; JEWELRY; JEWELRY WATCHES; NECKLACES; SCULPTURES MADE OF PRECIOUS METAL; TIMEPIECES; WATCHES (U.S. CLS. 2, 27, 28 AND 50).

FIRST USE 3-1-2005; IN COMMERCE 3-1-2006.

CLASS 14—(Continued).

3,299,608. KOSS, KIMBERLY, L, MASON, OH. AND EHRS-
TINE, WILLIAM, H., MASON, OH. SN 78-765,355. PUB. 6-
27-2006, FILED 12-2-2005.

BELIEVER

THE MARK CONSISTS OF STANDARD CHARACTERS
WITHOUT CLAIM TO ANY PARTICULAR FONT, STYLE,
SIZE, OR COLOR.

FOR BEADS FOR USE IN THE MANUFACTURE OF
JEWELRY; BRACELETS; COSTUME JEWELRY; IDENTI-
FICATION BRACELETS; JEWELRY; JEWELRY BOXES
OF PRECIOUS METAL; JEWELRY CASES OF PRECIOUS
METAL; JEWELRY CHAINS; JEWELRY FINDINGS;
JEWELRY FOR THE HEAD; JEWELRY PINS FOR USE
ON HATS; JEWELRY WATCHES; JEWELRY, NAMELY,
AMULETS; JEWELRY, NAMELY, CROSSES; LAPEL
PINS; PINS BEING JEWELRY; RINGS BEING JEWELRY
(U.S. CLS. 2, 27, 28 AND 50).

FIRST USE 2-9-2006; IN COMMERCE 2-9-2006.

CLASS 14—(Continued).

3,299,902. NISEII CORPORATION, HACIENDA HEIGHTS,
CA. SN 78-857,019. PUB. 2-20-2007, FILED 4-7-2006.



Happy Jewelry Company

NO CLAIM IS MADE TO THE EXCLUSIVE RIGHT TO
USE "JEWELRY COMPANY", APART FROM THE MARK
AS SHOWN.

THE MARK CONSISTS OF AN EIGHT POINT STAR WITH
THE LETTERS HJC INSIDE THE STAR. EIGHT HEARTS
SURROUND THE STAR. THE WORDS HAPPY JEWELRY
COMPANY ARE BELOW THE STAR.

FOR JEWELRY (U.S. CLS. 2, 27, 28 AND 50).
FIRST USE 1-1-2007; IN COMMERCE 1-1-2007.

3,299,935. THE INITIAL SOURCE LLC, EAST HANOVER, NJ.
SN 78-867,625. PUB. 1-30-2007, FILED 4-23-2006.

Karat Kids

3,299,701. ERN ENTERPRISES, INC., PALATINE, IL. SN 78-
787,929. PUB. 8-29-2006, FILED 1-9-2006.

NO CLAIM IS MADE TO THE EXCLUSIVE RIGHT TO
USE "KARAT", APART FROM THE MARK AS SHOWN.

FOR JEWELRY (U.S. CLS. 2, 27, 28 AND 50).
FIRST USE 5-30-2006; IN COMMERCE 5-12-2006.

SKIN MINTS

3,300,004. STROKIN, LLC, CHASKA, MN. SN 78-892,523.
PUB. 10-24-2006, FILED 5-25-2006.

THE MARK CONSISTS OF STANDARD CHARACTERS
WITHOUT CLAIM TO ANY PARTICULAR FONT, STYLE,
SIZE, OR COLOR.

FOR NON-MONETARY METAL COINS AND MEDAL-
LIONS USED FOR EXCHANGING AMONG PLAYERS
DURING A GOLF GAME AS A RESULT OF WINNING A
HOLE (U.S. CLS. 2, 27, 28 AND 50).

FIRST USE 3-0-2007; IN COMMERCE 3-0-2007.

THE MARK CONSISTS OF STANDARD CHARACTERS
WITHOUT CLAIM TO ANY PARTICULAR FONT, STYLE,
SIZE, OR COLOR.

THE ENGLISH TRANSLATION OF VOLLMOND IS
"FULL MOON".

FOR WATCH WINDERS (U.S. CLS. 2, 27, 28 AND 50).
FIRST USE 5-31-2006; IN COMMERCE 5-31-2006.

VOLLMOND

CLASS 14—(Continued).

3,300,068. BEL-ORO INTERNATIONAL, INC., NEW YORK, NY. SN 78-912,430. PUB. 2-27-2007, FILED 6-20-2006.

Passione d'Oro

THE MARK CONSISTS OF STANDARD CHARACTERS WITHOUT CLAIM TO ANY PARTICULAR FONT, STYLE, SIZE, OR COLOR.

NO CLAIM IS MADE TO THE EXCLUSIVE RIGHT TO USE "D'ORO", APART FROM THE MARK AS SHOWN.

THE FOREIGN WORDING IN THE MARK TRANSLATES INTO ENGLISH AS PASSION OF GOLD.

FOR JEWELRY MADE WHOLLY OR SUBSTANTIALLY IN PART OF GOLD (U.S. CLS. 2, 27, 28 AND 50).

FIRST USE 9-1-2006; IN COMMERCE 9-1-2006.

3,300,095. BEL-ORO INTERNATIONAL, INC., NEW YORK, NY. SN 78-920,315. PUB. 2-27-2007, FILED 6-29-2006.

GLAM ROPE

THE MARK CONSISTS OF STANDARD CHARACTERS WITHOUT CLAIM TO ANY PARTICULAR FONT, STYLE, SIZE, OR COLOR.

NO CLAIM IS MADE TO THE EXCLUSIVE RIGHT TO USE "ROPE", APART FROM THE MARK AS SHOWN.

FOR JEWELRY (U.S. CLS. 2, 27, 28 AND 50).

FIRST USE 9-1-2006; IN COMMERCE 9-1-2006.

3,300,106. I-TEC ELECTRONICS INC., MIAMI, FL. SN 78-923,825. PUB. 3-13-2007, FILED 7-6-2006.

iRise

THE MARK CONSISTS OF STANDARD CHARACTERS WITHOUT CLAIM TO ANY PARTICULAR FONT, STYLE, SIZE, OR COLOR.

FOR ALARM CLOCKS; CLOCKS INCORPORATING RADIOS, AND CLOCKS WITH DOCKING STATION FOR PORTABLE ELECTRONIC AUDIO DEVICE, ALARM CLOCKS WITH DOCKING STATION FOR PORTABLE ELECTRONIC AUDIO DEVICE, CLOCKS INCORPORATING RADIOS WITH DOCKING STATION FOR PORTABLE ELECTRONIC AUDIO DEVICE (U.S. CLS. 2, 27, 28 AND 50).

FIRST USE 7-7-2006; IN COMMERCE 7-7-2006.

CLASS 14—(Continued).

3,300,108. D'ANGELO, KRISTEN M., TRABUCO CANYON, CA. AND COLE, VICKIE A., ORANGE, CA. SN 78-924,033. PUB. 2-20-2007, FILED 7-6-2006.

Winged Inspirations

THE MARK CONSISTS OF STANDARD CHARACTERS WITHOUT CLAIM TO ANY PARTICULAR FONT, STYLE, SIZE, OR COLOR.

FOR JEWELRY (U.S. CLS. 2, 27, 28 AND 50).

FIRST USE 5-1-2007; IN COMMERCE 5-1-2007.

CLASS 15—MUSICAL INSTRUMENTS

3,298,425. VELENO, JOHN, ST. PETERSBURG, FL. SN 76-408,050. PUB. 6-20-2006, FILED 5-14-2002.

THE ENGLISH TRANSLATION OF "VELENO" IS "VENOM" OR "POISON".

FOR GUITARS, BASS GUITARS, MINI GUITARS (U.S. CLS. 2, 21 AND 36).

FIRST USE 12-31-1972; IN COMMERCE 1-16-2007.

CLASS 15—(Continued).

3,298,504. FIRST ACT, INC., NEWTON, MA. SN 76-629,257.
PUB. 8-29-2006, FILED 1-25-2005.

LOLA

THE MARK CONSISTS OF STANDARD CHARACTERS WITHOUT CLAIM TO ANY PARTICULAR FONT, STYLE, SIZE, OR COLOR.

FOR MUSICAL INSTRUMENTS, NAMELY, GUITARS, AND PARTS AND ACCESSORIES FOR THE PLAYING OF, MAINTENANCE, REPAIR AND TRANSPORTATION OF GUITARS, NAMELY, GUITAR STRAPS, STRING WINDERS, GUITAR STRINGS, GUITAR PICKS, TUNERS FOR GUITARS, GUITAR STANDS, GUITAR CASES, SHEET MUSIC STANDS, CAPOS, GUITAR NECK STANDS, AND GUITAR SLIDES (U.S. CLS. 2, 21 AND 36).

FIRST USE 3-27-2006; IN COMMERCE 3-27-2006.

3,298,526. FIRST ACT., INC., BOSTON, MA. SN 76-637,705.
PUB. 6-20-2006, FILED 5-4-2005.



FOR MUSICAL INSTRUMENTS, NAMELY, PERCUSSION MUSICAL INSTRUMENTS, NAMELY, DRUMS, CYMBALS, TAMBOURINES, BONGOS, GUIROS, CASTANETS, SHAKERS AND JINGLE STICKS; STRINGED MUSICAL INSTRUMENTS, NAMELY, GUITARS, BANJOS, MANDOLINS, HARPS, DULCIMERS, VIOLINS AND MUSICAL INSTRUMENT ACCESSORIES, NAMELY DRUM STICKS, GUITAR STRAPS, STRING WINDERS, GUITAR PICKS, GUITAR NECK STANDS, GUITAR SLIDES, INSTRUMENTS CASES, SHEET MUSIC STANDS AND TUNERS FOR MUSICAL INSTRUMENTS (U.S. CLS. 2, 21 AND 36).

FIRST USE 6-11-2006; IN COMMERCE 6-11-2006.

CLASS 15—(Continued).

3,298,756. JANA BRUGAL, OMAR SALIM, SANTO DOMINGO, DOMINICAN REP. SN 78-405,264. PUB. 7-12-2005, FILED 4-20-2004.

THIRD WORLD GUITARS

THE MARK CONSISTS OF STANDARD CHARACTERS WITHOUT CLAIM TO ANY PARTICULAR FONT, STYLE, SIZE, OR COLOR.

NO CLAIM IS MADE TO THE EXCLUSIVE RIGHT TO USE "GUITARS", APART FROM THE MARK AS SHOWN. FOR ELECTRIC GUITARS (U.S. CLS. 2, 21 AND 36).
FIRST USE 10-10-2006; IN COMMERCE 10-10-2006.

3,299,550. STANNARD, JOHN, CLEARWATER, FL. SN 78-753,813. PUB. 7-18-2006, FILED 11-15-2005.

BOOMYWANG

THE MARK CONSISTS OF STANDARD CHARACTERS WITHOUT CLAIM TO ANY PARTICULAR FONT, STYLE, SIZE, OR COLOR.

FOR CYMBALS AND PERCUSSION INSTRUMENTS (U.S. CLS. 2, 21 AND 36).
FIRST USE 7-28-2006; IN COMMERCE 7-28-2006.

CLASS 16—PAPER GOODS AND PRINTED MATTER

3,298,408. NEWSTED, JASON, SAN FRANCISCO, CA. SN 76-044,025. PUB. 1-29-2002, FILED 5-8-2000.

ECHOBRAIN

FOR POSTERS, GREETING CARDS, DECALS, STICKERS (U.S. CLS. 2, 5, 22, 23, 29, 37, 38 AND 50).
FIRST USE 12-31-2001; IN COMMERCE 12-31-2001.

CLASS 16—(Continued).

3,298,435. GRUPO AZOR MEXICO, S.A. DE. C.V., INDUSTRIAL VALLEJO MEXICO, D.F. 02300, MEXICO. SN 76-492,482. PUB. 9-5-2006, FILED 2-26-2003.

PENOLOGY

FOR PERMANENT MARKERS, OVERHEAD PROJECTOR PENS, SPECIALTY MARKERS, WATER COLOR MARKERS, HIGHLIGHTERS, PENS, MARKERS, FELT-TIP PENS, ROLLER BALL PENS, GEL INK BALL POINT PENS (U.S. CLS. 2, 5, 22, 23, 29, 37, 38 AND 50).
FIRST USE 1-0-2007; IN COMMERCE 1-0-2007.

3,298,480. CONTEC, INC., SPARTANBURG, SC. SN 76-613,079. PUB. 1-16-2007, FILED 9-28-2004.

CONTEXT

THE MARK CONSISTS OF STANDARD CHARACTERS WITHOUT CLAIM TO ANY PARTICULAR FONT, STYLE, SIZE, OR COLOR.

FOR PAPER PRODUCTS, NAMELY, STATIONERY, BLANK WRITING PAPER, ALL HAVING RELATIVELY LOW PARTICLE AND LOW FIBER COUNTS, FOR USE IN CLEANROOM ENVIRONMENTS (U.S. CLS. 2, 5, 22, 23, 29, 37, 38 AND 50).

FIRST USE 12-31-2004; IN COMMERCE 12-31-2004.

3,298,490. WAKEFERN FOOD CORP., ELIZABETH, NJ. SN 76-617,285. PUB. 1-10-2006, FILED 10-22-2004.

LIVE RIGHT WITH SHOP RITE

THE MARK CONSISTS OF STANDARD CHARACTERS WITHOUT CLAIM TO ANY PARTICULAR FONT, STYLE, SIZE, OR COLOR.

OWNER OF U.S. REG. NOS. 1,867,239, 2,467,334, AND OTHERS.

FOR WRITING PAPER, CALENDARS, PAPER COFFEE FILTERS, PAPER TOWELS, PAPER NAPKINS, PAPER BAGS, TRASH CAN LINERS, TOILET TISSUE, FACIAL TISSUE, PERIODICALS PUBLISHED FOR CUSTOMERS AND EMPLOYEES ON THE SUBJECT OF HEALTH AND LIFESTYLE, DISPOSABLE DIAPERS (U.S. CLS. 2, 5, 22, 23, 29, 37, 38 AND 50).

FIRST USE 1-0-2005; IN COMMERCE 1-0-2005.

CLASS 16—(Continued).

3,298,499. CSORBA, JOHN, NORFOLK, VA. SN 76-626,517. PUB. 12-13-2005, FILED 12-30-2004.

OCEAN BEACH'S

THE MARK CONSISTS OF STANDARD CHARACTERS WITHOUT CLAIM TO ANY PARTICULAR FONT, STYLE, SIZE, OR COLOR.

FOR STICKERS AND DECALS (U.S. CLS. 2, 5, 22, 23, 29, 37, 38 AND 50).

FIRST USE 8-3-2006; IN COMMERCE 9-9-2006.

3,298,561. CENTRAL FLORIDA INVESTMENTS, INC., ORLANDO, FL. SN 76-648,760. PUB. 11-28-2006, FILED 10-14-2005.

♥MYRTLE BEACH

OWNER OF U.S. REG. NOS. 1,892,182, 2,524,340, AND OTHERS.

NO CLAIM IS MADE TO THE EXCLUSIVE RIGHT TO USE "MYRTLE BEACH", APART FROM THE MARK AS SHOWN.

FOR MAGAZINES DEALING WITH THE CITY OF MYRTLE BEACH, SOUTH CAROLINA AND TOURISM THEREIN WHICH PROVIDE INFORMATION REGARDING PERSONS, BUSINESSES, RESORTS, RESTAURANTS, ATTRACTIONS AND ACTIVITIES THEREIN; COUPONS FOR USE AT BUSINESSES, ENTERTAINMENT FACILITIES, ATTRACTIONS, RESORTS, ACTIVITIES AND RESTAURANTS; AND NOVELTY ITEMS AND SOUVENIRS, NAMELY, BUMPER STICKERS, JUMBO PAPER CLIPS AND PENS (U.S. CLS. 2, 5, 22, 23, 29, 37, 38 AND 50).

FIRST USE 7-0-2006; IN COMMERCE 7-0-2006.

3,298,580. LIFEWAY CHRISTIAN RESOURCES OF THE SOUTHERN BAPTIST CONVENTION, NASHVILLE, TN. SN 76-657,338. PUB. 11-21-2006, FILED 3-27-2006.

JUNGLE JAUNT

THE MARK CONSISTS OF STANDARD CHARACTERS WITHOUT CLAIM TO ANY PARTICULAR FONT, STYLE, SIZE, OR COLOR.

FOR PRINTED RELIGIOUS BOOKS, RELIGIOUS PAMPHLETS, RELIGIOUS MAGAZINES, RELIGIOUS NEWSLETTERS, RELIGIOUS BULLETINS, PRINTED RELIGIOUS TEACHING MATERIALS (U.S. CLS. 2, 5, 22, 23, 29, 37, 38 AND 50).

FIRST USE 2-0-2007; IN COMMERCE 2-0-2007.

CLASS 16—(Continued).

3,298,586. LIFEWAY CHRISTIAN RESOURCES OF THE SOUTHERN BAPTIST CONVENTION, NASHVILLE, TN. SN 76-658,771. PUB. 11-28-2006, FILED 4-20-2006.

ENGAGE 365

THE MARK CONSISTS OF STANDARD CHARACTERS WITHOUT CLAIM TO ANY PARTICULAR FONT, STYLE, SIZE, OR COLOR.

FOR CHURCH SUPPLY PRODUCTS FOR MARKETING AND COMMUNICATION PRODUCTS, NAMELY, CHURCH INDOOR-OUTDOOR PAPER BANNERS, WEEKLY BULLETINS CONCERNING CHURCH AND WORSHIP INFORMATION, POSTCARDS, PAPER DOORKNOB HANGERS, VISITOR CARDS (U.S. CLS. 2, 5, 22, 23, 29, 37, 38 AND 50).

FIRST USE 7-0-2006; IN COMMERCE 7-0-2006.

3,298,653. WARNOW, JOSETTE G., BERKELEY, CA. SN 78-170,030. PUB. 12-30-2003, FILED 10-2-2002.

TUTOR IN A BOOK

FOR TEXTBOOKS, PRINTED LESSONS, AND WORKBOOKS ON THE SUBJECT OF ALGEBRA AND GEOMETRY; STUDY GUIDES; CHARTS OF ANGLE; CIRCLE, TRIANGLE AND POLYGON FORMULAS AND DRAWINGS; GRAPH PAPER; FLASH CARDS; POSTERS; PENS; PENCILS; DRAWING RULERS; UNGRADUATED RULERS (U.S. CLS. 2, 5, 22, 23, 29, 37, 38 AND 50).

FIRST USE 10-15-2006; IN COMMERCE 3-10-2007.

3,298,679. ANDERSON, CATHERINE, KOCHAN, GERMANTOWN, MD. SN 78-257,955. PUB. 8-23-2005, FILED 6-4-2003.

JUST ORGANIZE YOUR STUFF

FOR FILING, INDEXING AND LABELING PRODUCTS, NAMELY, FILING LABELS, TABS, SLEEVE PROTECTORS, WORKBOOKS, WORKSHEETS, ENVELOPES AND PERSONAL JOURNALS (U.S. CLS. 2, 5, 22, 23, 29, 37, 38 AND 50).

FIRST USE 1-1-2006; IN COMMERCE 1-1-2006.

3,298,742. LONGO, ANDREW, NUTLEY, NJ. SN 78-381,358. PUB. 10-12-2004, FILED 3-10-2004.

**CLASS 16—(Continued).**

THE COLOR(S) BLUE TONES IS/ARE CLAIMED AS A FEATURE OF THE MARK.

THE MARK CONSISTS OF STYLIZED FONTS TO CREATE THE WORDS, "WHITTY WINDOWS". A RECTANGULAR IMAGE OF A PLASTIC BUMPER STICKER SLEEVE IS ALSO A PART OF THE MARK. THE COLOR(S) BLUE TONES ARE USED ON THE ENTIRE MARK TO GIVE THE ILLUSION OF PLASTIC.

FOR TRANSPARENT PLASTIC HOLDER FOR A BUMPER STICKER (U.S. CLS. 2, 5, 22, 23, 29, 37, 38 AND 50).

FIRST USE 3-10-2004; IN COMMERCE 10-29-2004.

3,298,771. LEADERSHIP NETWORK, DALLAS, TX. SN 78-431,925. PUB. 9-13-2005, FILED 6-8-2004.

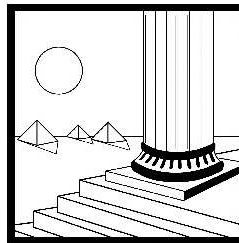
FOUNDATION**OF SUCCESS**

FOR PRINTED EDUCATIONAL MATERIAL, NAMELY BOOKS, NEWSLETTERS, WORKBOOKS, BROCHURES, BULLETINS, PAMPHLETS, GUIDES, AND WHITE PAPERS IN THE FIELDS OF RELIGION, SPIRITUALITY, AND PERSONAL DEVELOPMENT (U.S. CLS. 2, 5, 22, 23, 29, 37, 38 AND 50).

FIRST USE 9-0-2003; IN COMMERCE 9-0-2003.

3,298,774. PICTUREFLOW LLC, MELBOURNE, FL. SN 78-434,116. PUB. 11-14-2006, FILED 6-11-2004.

WHIBAL

THE MARK CONSISTS OF STANDARD CHARACTERS WITHOUT CLAIM TO ANY PARTICULAR FONT, STYLE, SIZE, OR COLOR.

FOR PRINTED CARDS CONSISTING OF A SERIES OF COLOR NEUTRAL CARDS TO BE USED FOR DETERMINING PROPER WHITE BALANCE AND COLOR ADJUSTMENT OF DIGITAL PHOTOGRAPHIC IMAGES (U.S. CLS. 2, 5, 22, 23, 29, 37, 38 AND 50).

FIRST USE 6-1-2004; IN COMMERCE 7-1-2004.

CLASS 16—(Continued).

3,298,796. INTERNATIONAL PAPER COMPANY, MEMPHIS, TN. SN 78-459,356. PUB. 1-24-2006, FILED 7-30-2004.

ZIP STRIP

THE MARK CONSISTS OF STANDARD CHARACTERS WITHOUT CLAIM TO ANY PARTICULAR FONT, STYLE, SIZE, OR COLOR.

NO CLAIM IS MADE TO THE EXCLUSIVE RIGHT TO USE STRIP, APART FROM THE MARK AS SHOWN.

FOR PAPER OR PLASTIC PULL STRIP INTEGRATED INTO PACKAGES OF PAPER WHICH ALLOW FOR OPENING (U.S. CLS. 2, 5, 22, 23, 29, 37, 38 AND 50).

FIRST USE 10-1-2004; IN COMMERCE 10-1-2004.

CLASS 16—(Continued).

3,298,859. THE UPPER DECK COMPANY, NORTH LAS VEGAS, NV. SN 78-504,647. PUB. 9-27-2005, FILED 10-22-2004.

KING OF THE COURT

THE MARK CONSISTS OF STANDARD CHARACTERS WITHOUT CLAIM TO ANY PARTICULAR FONT, STYLE, SIZE, OR COLOR.

FOR PHOTOGRAPHS AND TRADING CARDS (U.S. CLS. 2, 5, 22, 23, 29, 37, 38 AND 50).

FIRST USE 9-13-2006; IN COMMERCE 9-13-2006.

3,298,853. PASCUA YAQUI TRIBE, TUCSON, AZ. SN 78-501,917. PUB. 7-12-2005, FILED 10-19-2004.

PASCUA YAQUI TRIBE

THE MARK CONSISTS OF STANDARD CHARACTERS WITHOUT CLAIM TO ANY PARTICULAR FONT, STYLE, SIZE, OR COLOR.

FOR PUBLICATIONS, NAMELY NEWSPAPERS, NEWSLETTERS, PAMPHLETS, AND MAGAZINES FEATURING TRIBAL AND GENERAL NEWS AND INFORMATION (U.S. CLS. 2, 5, 22, 23, 29, 37, 38 AND 50).

FIRST USE 9-30-1978; IN COMMERCE 9-30-1978.

3,298,869. GROMICKO, NICK, BOULDER, CO. SN 78-516,528. PUB. 6-27-2006, FILED 11-13-2004.

Real Property Times

3,298,857. MEDIA EXPRESS CO. LTD., WARSAW, POLAND. SN 78-504,239. PUB. 9-6-2005, FILED 10-22-2004.



OWNER OF U.S. REG. NOS. 2,030,950 AND 2,158,241. THE COLOR(S) RED, WHITE AND YELLOW IS/ARE CLAIMED AS A FEATURE OF THE MARK.

THE MARK CONSISTS OF A TWO-LINE CAPTION IN A RED RECTANGULAR BACKGROUND; IN THE FIRST LINE CAPTION IN WHITE THE WORD "SUPER", IN THE SECOND LINE A SMALLER CAPTION "EXPRESS" IN A YELLOW COLOR.

FOR PRINTED PUBLICATIONS, NAMELY NEWSPAPERS, JOURNALS, MAGAZINES, NEWSLETTERS AND BOOKLETS FEATURING INFORMATION ABOUT POLITICAL, CULTURAL, SPORT, FINANCIAL AND SOCIOLOGICAL EVENTS (U.S. CLS. 2, 5, 22, 23, 29, 37, 38 AND 50).

FIRST USE 10-6-2004; IN COMMERCE 11-24-2006.

THE MARK CONSISTS OF STANDARD CHARACTERS WITHOUT CLAIM TO ANY PARTICULAR FONT, STYLE, SIZE, OR COLOR.

NO CLAIM IS MADE TO THE EXCLUSIVE RIGHT TO USE "REAL PROPERTY", APART FROM THE MARK AS SHOWN.

FOR NEWSPAPERS IN THE FIELD OF REAL PROPERTY (U.S. CLS. 2, 5, 22, 23, 29, 37, 38 AND 50).

FIRST USE 3-1-2005; IN COMMERCE 3-1-2005.

CLASS 16—(Continued).

3,298,878. ALERT-ALL CORP., NEW HOLLAND, PA. SN 78-522,714. PUB. 6-13-2006, FILED 11-24-2004.

CLASS 16—(Continued).

3,298,937. TARTA MARKETING, LLC, CHICAGO, IL. SN 78-564,423. PUB. 11-1-2005, FILED 2-10-2005.



OWNER OF U.S. REG. NOS. 2,008,531, 2,008,532, AND 3,000,000.

THE MARK CONSISTS OF AN OVAL SHAPE WITH THE WORDS "TOT FINDER" ABOVE A HEAD AND SHOULDER DRAWING OF A CHILD.

SEC. 2(F) AS TO "TOT FINDER".

FOR PRINTED MATERIALS, NAMELY, STICKERS TO BE USED AT PLACES WHERE CHILDREN, INVALIDS, AND OTHER HELPLESS PERSON MAY BE LOCATED AND IN NEED OF ASSISTANCE IN CASE OF EMERGENCY OR DISASTER AND BROCHURES FEATURING INSTRUCTION AND INFORMATION REGARDING WHAT TO DO IN CASE OF EMERGENCY OR DISASTER (U.S. CLS. 2, 5, 22, 23, 29, 37, 38 AND 50).
FIRST USE 4-30-2005; IN COMMERCE 4-30-2005.

TOPPERS BY TARTA

THE MARK CONSISTS OF STANDARD CHARACTERS WITHOUT CLAIM TO ANY PARTICULAR FONT, STYLE, SIZE, OR COLOR.

FOR GIFT WRAPPING PAPER; PAPER PACKAGE DECORATIONS; GIFT CARDS (U.S. CLS. 2, 5, 22, 23, 29, 37, 38 AND 50).

FIRST USE 9-13-2006; IN COMMERCE 9-13-2006.

3,298,992. GOALSGUY LEARNING SYSTEMS, INC., PALM HARBOR, FL. SN 78-589,441. PUB. 12-27-2005, FILED 3-17-2005.

3,298,922. ZAMBRANA, WILLIAM R., WEST ORANGE, NJ. SN 78-554,411. PUB. 1-10-2006, FILED 1-26-2005.

**GASP GENERALLY
ACCEPTED SUCCESS
PRINCIPLES**

Notable Quotes

THE MARK CONSISTS OF STANDARD CHARACTERS WITHOUT CLAIM TO ANY PARTICULAR FONT, STYLE, SIZE, OR COLOR.

FOR SERIES OF NON-FICTION BOOKS IN THE FIELD OF ENTERTAINMENT, SPORTS, SCIENCE, HISTORY, POLITICS AND THE ARTS (U.S. CLS. 2, 5, 22, 23, 29, 37, 38 AND 50).
FIRST USE 2-13-2006; IN COMMERCE 12-20-2006.

THE MARK CONSISTS OF STANDARD CHARACTERS WITHOUT CLAIM TO ANY PARTICULAR FONT, STYLE, SIZE, OR COLOR.

FOR SERIES OF BOOKS CONCERNING THE ACHIEVEMENT OF PERSONAL AND PROFESSIONAL GOALS (U.S. CLS. 2, 5, 22, 23, 29, 37, 38 AND 50).
FIRST USE 2-28-2006; IN COMMERCE 2-28-2006.

CLASS 16—(Continued).

3,299,012. MARVELOUS ENTERTAINMENT, INC., SHI-BUYA-KU, TOKYO, JAPAN. SN 78-594,112. PUB. 12-27-2005, FILED 3-24-2005.

GUNSLINGER GIRL

THE MARK CONSISTS OF STANDARD CHARACTERS WITHOUT CLAIM TO ANY PARTICULAR FONT, STYLE, SIZE, OR COLOR.

FOR PAPER WALL HANGINGS, NAMELY, PAPER WALL SCROLLS AND POSTERS (U.S. CLS. 2, 5, 22, 23, 29, 37, 38 AND 50).

FIRST USE 5-17-2005; IN COMMERCE 5-17-2005.

CLASS 16—(Continued).

3,299,075. AVODAH PUBLISHING, INC., KALISPELL, MT. SN 78-612,323. PUB. 1-10-2006, FILED 4-19-2005.

DISTINCTIVELY NORTHWEST LIVING

THE MARK CONSISTS OF STANDARD CHARACTERS WITHOUT CLAIM TO ANY PARTICULAR FONT, STYLE, SIZE, OR COLOR.

NO CLAIM IS MADE TO THE EXCLUSIVE RIGHT TO USE NORTHWEST, APART FROM THE MARK AS SHOWN. FOR GENERAL FEATURE MAGAZINE (U.S. CLS. 2, 5, 22, 23, 29, 37, 38 AND 50).

FIRST USE 9-20-2006; IN COMMERCE 9-21-2006.

3,299,059. CHARLES, STANLEY W., BALTIMORE, MD. SN 78-606,216. PUB. 4-18-2006, FILED 4-11-2005.

pressbox

THE MARK CONSISTS OF STANDARD CHARACTERS WITHOUT CLAIM TO ANY PARTICULAR FONT, STYLE, SIZE, OR COLOR.

FOR PRINTED PUBLICATIONS, NAMELY NEWSPAPERS, MAGAZINES AND NEWSLETTERS, FEATURING INFORMATION ABOUT SPORTS (U.S. CLS. 2, 5, 22, 23, 29, 37, 38 AND 50).

FIRST USE 4-1-2005; IN COMMERCE 6-1-2005.

3,299,079. ENTERPRISE NEWSMEDIA, LLC, QUINCY, MA. SN 78-613,521. PUB. 9-12-2006, FILED 4-21-2005.

TOWN COMMONS

THE MARK CONSISTS OF STANDARD CHARACTERS WITHOUT CLAIM TO ANY PARTICULAR FONT, STYLE, SIZE, OR COLOR.

FOR NEWSPAPER SECTIONS IN THE FIELD OF GENERAL, REGIONAL AND LOCAL INTEREST (U.S. CLS. 2, 5, 22, 23, 29, 37, 38 AND 50).

FIRST USE 4-5-2006; IN COMMERCE 4-5-2006.

3,299,065. THE FRAY LLC, THORNTON, CO. SN 78-607,409. PUB. 10-10-2006, FILED 4-12-2005.

THE FRAY

THE MARK CONSISTS OF STANDARD CHARACTERS WITHOUT CLAIM TO ANY PARTICULAR FONT, STYLE, SIZE, OR COLOR.

FOR POSTERS; STICKERS (U.S. CLS. 2, 5, 22, 23, 29, 37, 38 AND 50).

FIRST USE 6-1-2002; IN COMMERCE 6-1-2002.

3,299,118. BENNETT, LEEKAY, DELAWARE, OH. SN 78-630,388. PUB. 1-31-2006, FILED 5-16-2005.

Itty Bitty Ditties

THE MARK CONSISTS OF STANDARD CHARACTERS WITHOUT CLAIM TO ANY PARTICULAR FONT, STYLE, SIZE, OR COLOR.

FOR MINIATURE PAPER SHOPPING BAGS (U.S. CLS. 2, 5, 22, 23, 29, 37, 38 AND 50).

FIRST USE 9-8-2006; IN COMMERCE 9-8-2006.

CLASS 16—(Continued).

3,299,131. ELARAH, INC., TOLUCA LAKE, CA. SN 78-637,315. PUB. 7-11-2006, FILED 5-25-2005.

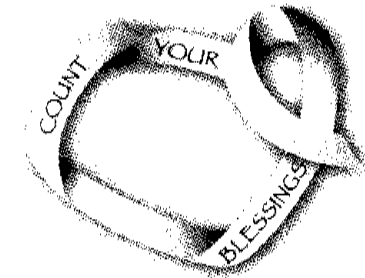

THE WORDS ARE IN THE COLOR BLACK. THE RIBBON IS OUTLINED IN BLACK WITH GRAY SHADING IN THE RIBBON AND WHITE COLOR IN THE RIBBON. THE RIBBON IS IN THE SHAPE OF A HEART.

FOR SOCIAL EXPRESSION PRODUCTS, SPECIFICALLY GREETING CARDS, BLANK JOURNALS AND CALENDARS (U.S. CLS. 2, 5, 22, 23, 29, 37, 38 AND 50).
FIRST USE 5-9-2005; IN COMMERCE 8-6-2006.

3,299,137. BUMGARNER, F. KEITH, BUFORD, GA. SN 78-639,880. PUB. 7-25-2006, FILED 5-31-2005.

THE FRAMED WORD

THE MARK CONSISTS OF STANDARD CHARACTERS WITHOUT CLAIM TO ANY PARTICULAR FONT, STYLE, SIZE, OR COLOR.

NO CLAIM IS MADE TO THE EXCLUSIVE RIGHT TO USE "FRAMED", APART FROM THE MARK AS SHOWN.

FOR PRINTED MATERIALS, NAMELY FRAMED ART IN THE NATURE OF PRINTS, PICTURES, PAINTINGS, MOUNTS AND ETCHINGS; PRINTED MATERIALS, NAMELY FRAMED SCRIPTURES (U.S. CLS. 2, 5, 22, 23, 29, 37, 38 AND 50).

FIRST USE 2-5-2007; IN COMMERCE 2-5-2007.

CLASS 16—(Continued).

3,299,176. CARDINAL BRANDS, INC., LAWRENCE, KS. SN 78-656,972. PUB. 12-5-2006, FILED 6-23-2005.

GOFOLIO

THE MARK CONSISTS OF STANDARD CHARACTERS WITHOUT CLAIM TO ANY PARTICULAR FONT, STYLE, SIZE, OR COLOR.

FOR ORGANIZATIONAL AND STORAGE PRODUCTS, NAMELY, EXPANDABLE FILE POCKETS AND FILE POCKETS FOR ORGANIZING AND STORING SCRAPBOOKING MATERIALS (U.S. CLS. 2, 5, 22, 23, 29, 37, 38 AND 50).

FIRST USE 6-1-2005; IN COMMERCE 6-1-2005.

3,299,181. UNION FOR REFORM JUDAISM, NEW YORK, NY. SN 78-659,642. PUB. 3-28-2006, FILED 6-28-2005.

DAVE DANGER ACTION KID

THE MARK CONSISTS OF STANDARD CHARACTERS WITHOUT CLAIM TO ANY PARTICULAR FONT, STYLE, SIZE, OR COLOR.

FOR COMIC STRIPS; COMIC STRIPS APPEARING IN MAGAZINES; PERIODICALS, MAGAZINES AND NEWSPAPERS, FEATURING STORIES, GAMES AND ACTIVITIES FOR CHILDREN (U.S. CLS. 2, 5, 22, 23, 29, 37, 38 AND 50).

FIRST USE 9-0-2005; IN COMMERCE 9-0-2005.

3,299,204. ORGANIZATIONAL DEVELOPMENT ASSOCIATES, INC., ATLANTA, GA. SN 78-667,159. PUB. 4-18-2006, FILED 7-11-2005.

BERKE PROFILE

THE MARK CONSISTS OF STANDARD CHARACTERS WITHOUT CLAIM TO ANY PARTICULAR FONT, STYLE, SIZE, OR COLOR.

NO CLAIM IS MADE TO THE EXCLUSIVE RIGHT TO USE "PROFILE", APART FROM THE MARK AS SHOWN.

FOR PRINTED REPORTS IN THE FIELD OF EMPLOYEE PROFILES, EMPLOYMENT TESTING, EMPLOYMENT SKILLS AND PSYCHOLOGICAL TESTS (U.S. CLS. 2, 5, 22, 23, 29, 37, 38 AND 50).

FIRST USE 5-1-2005; IN COMMERCE 7-1-2005.

CLASS 16—(Continued).

3,299,211. FUNIMATION PRODUCTIONS, LTD., FORT WORTH, TX. SN 78-671,482. PUB. 6-20-2006, FILED 7-15-2005.



OWNER OF U.S. REG. NO. 2,010,746.
NO CLAIM IS MADE TO THE EXCLUSIVE RIGHT TO USE "ENTERTAINMENT", APART FROM THE MARK AS SHOWN.

THE COLOR(S) RED, WHITE AND BLUE IS/ARE CLAIMED AS A FEATURE OF THE MARK.

THE MARK CONSISTS OF A LARGE BLUE QUADRILATERAL SHAPE CONTAINING A RED SUPERIMPOSED CIRCLE ON THE LEFT SIDE WITH A SMALL WHITE STAR ON THE LOWER RIGHT SIDE OF THE CIRCLE AND THE WORD FUNIMATION IN LARGE WHITE BLOCK LETTERS SUPERIMPOSED OVER THE CIRCLE AND THE QUADRILATERAL WITH THE WORD ENTERTAINMENT IN SMALLER WHITE BLOCK LETTERS SUPERIMPOSED OVER THE QUADRILATERAL UNDERNEATH THE WORD FUNIMATION.

FOR PAPER AND CARDBOARD GOODS, NAMELY, CARD GAME INSTRUCTION BOOKS, TRADING CARDS, POSTERS, POSTCARDS; RUBBER STAMPS; CHILDREN'S ACTIVITY BOOKS; CALENDARS, NAMELY WALL CALENDARS, COLOR PRINTS (U.S. CLS. 2, 5, 22, 23, 29, 37, 38 AND 50).

FIRST USE 7-1-2005; IN COMMERCE 7-1-2005.

3,299,215. UNITARIAN UNIVERSALIST ASSOCIATION, BOSTON, MA. SN 78-672,937. PUB. 7-4-2006, FILED 7-18-2005.



THE MARK CONSISTS OF A CHALICE DESIGN.
FOR JOURNALS IN THE FIELD OF RELIGION; SERIES OF FICTION AND NON-FICTION BOOKS ON A VARIETY OF TOPICS; PAMPHLETS IN THE FIELD OF RELIGION; PRINTED TEACHING MATERIALS IN THE FIELD OF RELIGIOUS EDUCATION (U.S. CLS. 2, 5, 22, 23, 29, 37, 38 AND 50).

FIRST USE 6-1-2005; IN COMMERCE 9-1-2005.

CLASS 16—(Continued).

3,299,256. PARIS BUSINESS PRODUCTS, INC., WESTAMP-
TON, NJ. SN 78-691,713. PUB. 1-10-2006, FILED 8-12-2005.

REVEAL

THE MARK CONSISTS OF STANDARD CHARACTERS WITHOUT CLAIM TO ANY PARTICULAR FONT, STYLE, SIZE, OR COLOR.

FOR NOTE BOOKS; ORGANIZERS FOR STATIONERY USE; PRESENTATION FOLDERS; STATIONERY FOLDERS (U.S. CLS. 2, 5, 22, 23, 29, 37, 38 AND 50).

FIRST USE 3-0-2006; IN COMMERCE 3-0-2006.

3,299,316. ENTERPRISE NEWSMEDIA, LLC, QUINCY, MA.
SN 78-713,911. PUB. 1-23-2007, FILED 9-15-2005.

SOUTH COAST HOMES

THE MARK CONSISTS OF STANDARD CHARACTERS WITHOUT CLAIM TO ANY PARTICULAR FONT, STYLE, SIZE, OR COLOR.

NO CLAIM IS MADE TO THE EXCLUSIVE RIGHT TO USE "HOMES", APART FROM THE MARK AS SHOWN.

FOR PRINTED PUBLICATIONS, NAMELY, NEWSPAPERS, NEWSPAPER INSERTS AND NEWSPAPER SECTIONS PRIMARILY RELATING TO MASSACHUSETTS (U.S. CLS. 2, 5, 22, 23, 29, 37, 38 AND 50).

FIRST USE 5-26-2005; IN COMMERCE 5-26-2005.

3,299,320. WMK HOLDINGS, INC., WILMINGTON, DE. SN
78-714,650. PUB. 1-2-2007, FILED 9-16-2005.

BEAR ESSENTIALS

THE MARK CONSISTS OF STANDARD CHARACTERS WITHOUT CLAIM TO ANY PARTICULAR FONT, STYLE, SIZE, OR COLOR.

FOR PAPER PRODUCTS, NAMELY DIAPERS, DISPOSABLE TRAINING PANTS AND DISPOSABLE WIPES NOT IMPREGNATED WITH CHEMICALS OR COMPOUNDS (U.S. CLS. 2, 5, 22, 23, 29, 37, 38 AND 50).

FIRST USE 1-1-2006; IN COMMERCE 1-1-2006.

CLASS 16—(Continued).

3,299,328. BOB DEMATTEIS CO., GRASS VALLEY, CA. SN 78-716,842. PUB. 6-20-2006, FILED 9-20-2005.

CLEAN-FILL

THE MARK CONSISTS OF STANDARD CHARACTERS WITHOUT CLAIM TO ANY PARTICULAR FONT, STYLE, SIZE, OR COLOR.

FOR PLASTIC BAGS FOR PACKAGING (U.S. CLS. 2, 5, 22, 23, 29, 37, 38 AND 50).

FIRST USE 3-1-2005; IN COMMERCE 3-1-2005.

CLASS 16—(Continued).

3,299,357. ROYAL CONSUMER INFORMATION PROUCTS, INC., SOMERSET, NJ. SN 78-723,294. PUB. 7-4-2006, FILED 9-29-2005.

PLATINUM SERIES

THE MARK CONSISTS OF STANDARD CHARACTERS WITHOUT CLAIM TO ANY PARTICULAR FONT, STYLE, SIZE, OR COLOR.

NO CLAIM IS MADE TO THE EXCLUSIVE RIGHT TO USE "SERIES", APART FROM THE MARK AS SHOWN.

FOR PAPER SHREDDERS (U.S. CLS. 2, 5, 22, 23, 29, 37, 38 AND 50).

FIRST USE 6-14-2006; IN COMMERCE 6-14-2006.

3,299,372. XEROX CORPORATION, STAMFORD, CT. SN 78-726,364. PUB. 6-27-2006, FILED 10-4-2005.

XEROX BUSINESS PLUS

THE MARK CONSISTS OF STANDARD CHARACTERS WITHOUT CLAIM TO ANY PARTICULAR FONT, STYLE, SIZE, OR COLOR.

OWNER OF U.S. REG. NOS. 525,717, 1,661,698, AND OTHERS.

NO CLAIM IS MADE TO THE EXCLUSIVE RIGHT TO USE "BUSINESS", APART FROM THE MARK AS SHOWN.

FOR COPYING PAPER, PRINTING PAPER, LAMINATED PAPER, REPRODUCTION PAPER (U.S. CLS. 2, 5, 22, 23, 29, 37, 38 AND 50).

FIRST USE 11-1-2005; IN COMMERCE 11-1-2005.

3,299,344. IEARTH ORGANIZATION LTD., COQUITLAM, BRITISH COLUMBIA, CANADA. SN 78-720,482. PUB. 2-6-2007, FILED 9-26-2005.



THE COLOR(S) CHARCOAL GREY, SILVER GREY, LIGHT GREY, AND WHITE IS/ARE CLAIMED AS A FEATURE OF THE MARK.

THE MARK CONSISTS OF THE WORDING IEARTH IN CHARCOAL GREY. THE SPHERE IS SHADED WITH COLORS SILVER AND GREY. THE WORDING IT'S IN YOUR HANDS APPEARS IN THE COLOR LIGHT GREY. A VERY FINE LIGHT GREY STROKE APPEARS AROUND THE PERIMETER OF THE SPHERE. THE WHITE COLOR APPEARS IN THE SPHERE WHERE THE SHADING DOES NOT APPEAR.

FOR GLOBES (U.S. CLS. 2, 5, 22, 23, 29, 37, 38 AND 50). FIRST USE 11-3-2005; IN COMMERCE 11-3-2005.

3,299,379. HASCO IA LIMITED, RENO, NV. SN 78-727,948. PUB. 6-20-2006, FILED 10-6-2005.

FirstFoto
Growing Family

OWNER OF U.S. REG. NOS. 1,986,995, 2,576,606, AND OTHERS.

FOR PORTRAIT PHOTOGRAPHS, NEWSLETTERS AND BROCHURES REGARDING PORTRAIT PHOTOGRAPHY, PAPER AND CARDBOARD PHOTOGRAPH HOLDERS AND PRESENTATION FOLDERS (U.S. CLS. 2, 5, 22, 23, 29, 37, 38 AND 50).

FIRST USE 9-0-2005; IN COMMERCE 9-0-2005.

CLASS 16—(Continued).

3,299,435. SCHOLASTIC INC., NEW YORK, NY. SN 78-736,336. PUB. 1-9-2007, FILED 10-19-2005.



OWNER OF U.S. REG. NOS. 1,567,119, 2,433,658, AND OTHERS.
FOR PENCILS, PENS, MARKERS AND CRAYONS (U.S. CLS. 2, 5, 22, 23, 29, 37, 38 AND 50).
FIRST USE 11-1-2002; IN COMMERCE 11-1-2002.

3,299,469. WORKMAN PUBLISHING CO., INC., NEW YORK, NY. SN 78-740,251. PUB. 7-11-2006, FILED 10-25-2005.

BAD DOG

THE MARK CONSISTS OF STANDARD CHARACTERS WITHOUT CLAIM TO ANY PARTICULAR FONT, STYLE, SIZE, OR COLOR.
FOR CALENDARS; GREETING CARDS (U.S. CLS. 2, 5, 22, 23, 29, 37, 38 AND 50).
FIRST USE 7-5-2006; IN COMMERCE 7-5-2006.

3,299,500. IBASIS, INC., BURLINGTON, MA. SN 78-745,015. PUB. 7-4-2006, FILED 11-1-2005.

WLDC

THE MARK CONSISTS OF STANDARD CHARACTERS WITHOUT CLAIM TO ANY PARTICULAR FONT, STYLE, SIZE, OR COLOR.
FOR PRE-PAID TELEPHONE CALLING CARDS, NOT MAGNETICALLY ENCODED (U.S. CLS. 2, 5, 22, 23, 29, 37, 38 AND 50).
FIRST USE 1-11-2007; IN COMMERCE 1-11-2007.

CLASS 16—(Continued).

3,299,535. ACCO BRANDS CORPORATION, LINCOLNSHIRE, IL. SN 78-751,146. PUB. 7-18-2006, FILED 11-10-2005.

COOL WAVES

THE MARK CONSISTS OF STANDARD CHARACTERS WITHOUT CLAIM TO ANY PARTICULAR FONT, STYLE, SIZE, OR COLOR.
FOR NOTEBOOKS; FOLDERS; PAPER AND PLASTIC REPORT COVERS; THREE RING BINDERS; AND INDEX TABS (U.S. CLS. 2, 5, 22, 23, 29, 37, 38 AND 50).
FIRST USE 5-31-2006; IN COMMERCE 5-31-2006.

3,299,568. BOXED BOOKS, INC., LAWRENCEVILLE, NJ. SN 78-755,174. PUB. 7-18-2006, FILED 11-16-2005.

TAX DEDUCTIONS A TO Z

THE MARK CONSISTS OF STANDARD CHARACTERS WITHOUT CLAIM TO ANY PARTICULAR FONT, STYLE, SIZE, OR COLOR.
NO CLAIM IS MADE TO THE EXCLUSIVE RIGHT TO USE "TAX DEDUCTIONS", APART FROM THE MARK AS SHOWN.
FOR SERIES OF NON-FICTION BOOKS IN THE FIELD OF TAXATION (U.S. CLS. 2, 5, 22, 23, 29, 37, 38 AND 50).
FIRST USE 12-1-2006; IN COMMERCE 12-1-2006.

3,299,569. BOXED BOOKS, INC., LAWRENCEVILLE, NJ. SN 78-755,202. PUB. 8-1-2006, FILED 11-16-2005.

This Book is Tax Deductible

THE MARK CONSISTS OF STANDARD CHARACTERS WITHOUT CLAIM TO ANY PARTICULAR FONT, STYLE, SIZE, OR COLOR.
FOR SERIES OF NON-FICTION BOOKS IN THE FIELD OF TAXATION (U.S. CLS. 2, 5, 22, 23, 29, 37, 38 AND 50).
FIRST USE 12-1-2006; IN COMMERCE 12-1-2006.

CLASS 16—(Continued).

3,299,573. AMERICAN SAILING ASSOCIATION, LOS ANGELES, CA. SN 78-755,842. PUB. 12-5-2006, FILED 11-17-2005.

BEARINGS

THE MARK CONSISTS OF STANDARD CHARACTERS WITHOUT CLAIM TO ANY PARTICULAR FONT, STYLE, SIZE, OR COLOR.

FOR PUBLICATIONS, NAMELY, A NEWSLETTER ON THE TOPICS OF SAILING AND SAILING INSTRUCTION (U.S. CLS. 2, 5, 22, 23, 29, 37, 38 AND 50).

FIRST USE 11-0-2005; IN COMMERCE 11-0-2005.

3,299,579. TAIYI PRECISION TECH CORP., TAIPEI HSIEN, TAIWAN. SN 78-757,027. PUB. 8-1-2006, FILED 11-18-2005.



OWNER OF U.S. REG. NOS. 2,569,184, 2,570,804, AND 2,696,982.

NO CLAIM IS MADE TO THE EXCLUSIVE RIGHT TO USE "PRECISION", APART FROM THE MARK AS SHOWN.

THE MARK CONSISTS OF THE WORDS "TAIYI PRECISION" OVERLYING A PAIR OF STYLIZED CHINESE CHARACTERS.

THE NON-LATIN CHARACTER(S) IN THE MARK TRANSLITERATES INTO TAI YI, AND THIS MEANS NOTHING IN ENGLISH.

FOR ART PRINTS; COLOR PRINTS; PLASTIC FILM NOT FOR INDUSTRIAL OR COMMERCIAL WRAPPING, NAMELY PLASTIC WRAPPING; PRINTED FORMS; PAINTINGS; PAPER BOXES; PAPER TAGS; PLASTIC SHEETS FOR WRITING, PRINTING, AND MARKING; SHIPPING LABELS; PHOTOGRAPHIC PRINTS (U.S. CLS. 2, 5, 22, 23, 29, 37, 38 AND 50).

FIRST USE 11-8-2005; IN COMMERCE 12-18-2005.

CLASS 16—(Continued).

3,299,668. UNITED STATES TELECOM ASSOCIATION, WASHINGTON, DC. SN 78-777,900. PUB. 12-5-2006, FILED 12-21-2005.

Communications Crossroads

THE MARK CONSISTS OF STANDARD CHARACTERS WITHOUT CLAIM TO ANY PARTICULAR FONT, STYLE, SIZE, OR COLOR.

NO CLAIM IS MADE TO THE EXCLUSIVE RIGHT TO USE "COMMUNICATIONS", APART FROM THE MARK AS SHOWN.

FOR PUBLICATIONS, NAMELY, MAGAZINES IN THE FIELD OF TELECOMMUNICATIONS, TELECOMMUNICATIONS LAW, TELECOMMUNICATIONS REGULATION, AND THE TELECOMMUNICATION INDUSTRY (U.S. CLS. 2, 5, 22, 23, 29, 37, 38 AND 50).

FIRST USE 3-0-2006; IN COMMERCE 3-0-2006.

3,299,697. VIRGIN COMICS, LLC, NEW YORK, NY. SN 78-787,672. PUB. 3-13-2007, FILED 1-9-2006.

DEVI

THE MARK CONSISTS OF STANDARD CHARACTERS WITHOUT CLAIM TO ANY PARTICULAR FONT, STYLE, SIZE, OR COLOR.

THE FOREIGN WORDING IN THE MARK TRANSLATES INTO ENGLISH AS MOTHER GODDESS.

FOR COMIC BOOKS (U.S. CLS. 2, 5, 22, 23, 29, 37, 38 AND 50).

FIRST USE 7-12-2006; IN COMMERCE 7-12-2006.

3,299,706. MARIELLEN RICH, POLAND, OH. SN 78-788,530. PUB. 9-12-2006, FILED 1-10-2006.

Angeloquent Creations by me

THE MARK CONSISTS OF STANDARD CHARACTERS WITHOUT CLAIM TO ANY PARTICULAR FONT, STYLE, SIZE, OR COLOR.

NO CLAIM IS MADE TO THE EXCLUSIVE RIGHT TO USE "CREATIONS", APART FROM THE MARK AS SHOWN.

FOR CUSTOM DESIGNED AND WRITTEN GREETING GIFT CARDS AND POSITIVE AFFIRMATION CARDS, NAMELY, MOTIVATIONAL CARDS (U.S. CLS. 2, 5, 22, 23, 29, 37, 38 AND 50).

FIRST USE 12-5-2006; IN COMMERCE 12-5-2006.

CLASS 16—(Continued).

3,299,709. VIRGIN COMICS, LLC, NEW YORK, NY. SN 78-789,765. PUB. 3-13-2007, FILED 1-11-2006.

CLASS 16—(Continued).

3,299,792. MEGAN USA, CORP., NEW YORK, NY. SN 78-815,651. PUB. 10-10-2006, FILED 2-15-2006.

SADHU

THE MARK CONSISTS OF STANDARD CHARACTERS WITHOUT CLAIM TO ANY PARTICULAR FONT, STYLE, SIZE, OR COLOR.

THE FOREIGN WORDING IN THE MARK TRANSLATES INTO ENGLISH AS MYSTIC.

FOR COMIC BOOKS (U.S. CLS. 2, 5, 22, 23, 29, 37, 38 AND 50).

FIRST USE 7-12-2006; IN COMMERCE 7-12-2006.

A TASTE OF CHIC

THE MARK CONSISTS OF STANDARD CHARACTERS WITHOUT CLAIM TO ANY PARTICULAR FONT, STYLE, SIZE, OR COLOR.

FOR GENERAL FEATURE MAGAZINES (U.S. CLS. 2, 5, 22, 23, 29, 37, 38 AND 50).

FIRST USE 12-23-2005; IN COMMERCE 5-1-2006.

3,299,751. P. H. GLATFELTER COMPANY, YORK, PA. SN 78-800,232. PUB. 7-18-2006, FILED 1-26-2006.

XCELERATOR

THE MARK CONSISTS OF STANDARD CHARACTERS WITHOUT CLAIM TO ANY PARTICULAR FONT, STYLE, SIZE, OR COLOR.

FOR PAPER (U.S. CLS. 2, 5, 22, 23, 29, 37, 38 AND 50).

FIRST USE 11-13-2006; IN COMMERCE 11-13-2006.

3,299,809. ACTIONPRO MEDIA PRODUCTIONS CORPORATION, BENTONVILLE, AR. SN 78-819,672. PUB. 10-31-2006, FILED 2-21-2006.

3,299,764. THE MCCALL PATTERN COMPANY, NEW YORK, NY. SN 78-805,303. PUB. 1-9-2007, FILED 2-2-2006.

479 GOLF

SEWING TODAY

THE MARK CONSISTS OF STANDARD CHARACTERS WITHOUT CLAIM TO ANY PARTICULAR FONT, STYLE, SIZE, OR COLOR.

NO CLAIM IS MADE TO THE EXCLUSIVE RIGHT TO USE "SEWING", APART FROM THE MARK AS SHOWN.

FOR MAGAZINES IN THE FIELD OF SEWING (U.S. CLS. 2, 5, 22, 23, 29, 37, 38 AND 50).

FIRST USE 7-31-2006; IN COMMERCE 7-31-2006.

THE MARK CONSISTS OF STANDARD CHARACTERS WITHOUT CLAIM TO ANY PARTICULAR FONT, STYLE, SIZE, OR COLOR.

NO CLAIM IS MADE TO THE EXCLUSIVE RIGHT TO USE "GOLF", APART FROM THE MARK AS SHOWN.

FOR MAGAZINES IN THE FIELD OF GOLF (U.S. CLS. 2, 5, 22, 23, 29, 37, 38 AND 50).

FIRST USE 7-17-2006; IN COMMERCE 7-17-2006.

CLASS 16—(Continued).

3,299,889. MUSTAFA, SAM A., HALEDON, NJ. SN 78-851,308. PUB. 11-14-2006, FILED 3-31-2006.



THE COLORS RED, GOLD, SILVER, WHITE, BLACK, AND GREEN ARE CLAIMED AS A FEATURE OF THE MARK.

THE COLOR RED APPEARS IN THE INNER CIRCLE OF THE MEDALLION AND ON THE BOW BETWEEN THE LAURELS; THE COLOR GOLD APPEARS IN THE CROWN, THE BEAK, THE WORDING SUUM CUIQUE, AND THE BAND OF THE MEDALLION; THE COLOR SILVER APPEARS IN THE INNER BAND OF THE MEDALLION AND THE OUTER BORDER OF THE MEDALLION; THE COLOR WHITE APPEARS IN THE EAGLE, THE OUTER BAND OF THE MEDALLION CONTAINING THE WORDING SUUM CUIQUE AND THE LAURELS, AND IN THE LEAVES; THE COLOR BLACK APPEARS IN THE WORDING MIGHT & REASON, IN THE BORDERS OF THE MEDALLION, THE BANDS OF THE MEDALLION, THE OUTLINE OF THE WORDING SUUM CUIQUE, THE OUTLINE AND FEATHERS OF THE EAGLE, AND THE OUTLINE OF THE LEAVES; AND THE COLOR GREEN APPEARS IN THE LEAVES.

THE FOREIGN WORDING IN THE MARK TRANSLATES INTO ENGLISH AS "TO EACH HIS OWN".

FOR MANUALS IN THE FIELD OF MINIATURE WARGAMING (U.S. CLS. 2, 5, 22, 23, 29, 37, 38 AND 50). FIRST USE 2-20-2007; IN COMMERCE 2-20-2007.

3,299,891. AMONES, TROY, ARCATA, CA. SN 78-852,372. PUB. 11-28-2006, FILED 4-3-2006.

In-School Ink

THE MARK CONSISTS OF STANDARD CHARACTERS WITHOUT CLAIM TO ANY PARTICULAR FONT, STYLE, SIZE, OR COLOR.

NO CLAIM IS MADE TO THE EXCLUSIVE RIGHT TO USE INK, APART FROM THE MARK AS SHOWN.

FOR COMIC BOOKS (U.S. CLS. 2, 5, 22, 23, 29, 37, 38 AND 50). FIRST USE 5-5-2006; IN COMMERCE 5-5-2006.

CLASS 16—(Continued).

3,299,894. THE MCGRAW-HILL COMPANIES, INC., NEW YORK, NY. SN 78-853,712. PUB. 11-21-2006, FILED 4-4-2006.

IN THE SPOTLIGHT

THE MARK CONSISTS OF STANDARD CHARACTERS WITHOUT CLAIM TO ANY PARTICULAR FONT, STYLE, SIZE, OR COLOR.

FOR SERIES OF READING AND LANGUAGE ARTS BOOKS FOR GRADES 6-12 (U.S. CLS. 2, 5, 22, 23, 29, 37, 38 AND 50).

FIRST USE 10-27-2005; IN COMMERCE 3-31-2006.

3,299,953. AMERICAN EXPRESS MARKETING & DEVELOPMENT CORP., NEW YORK, NY. SN 78-875,182. PUB. 12-5-2006, FILED 5-3-2006.

AROUND THE TABLE

THE MARK CONSISTS OF STANDARD CHARACTERS WITHOUT CLAIM TO ANY PARTICULAR FONT, STYLE, SIZE, OR COLOR.

FOR GENERAL FEATURE MAGAZINES (U.S. CLS. 2, 5, 22, 23, 29, 37, 38 AND 50).

FIRST USE 8-0-2006; IN COMMERCE 8-0-2006.

3,299,965. BOWERS, DANA N., CHICAGO, IL. SN 78-877,915. PUB. 12-12-2006, FILED 5-5-2006.

SHIMMER STUDIO

THE MARK CONSISTS OF STANDARD CHARACTERS WITHOUT CLAIM TO ANY PARTICULAR FONT, STYLE, SIZE, OR COLOR.

NO CLAIM IS MADE TO THE EXCLUSIVE RIGHT TO USE "STUDIO", APART FROM THE MARK AS SHOWN.

FOR STATIONERY; BLANK HAND BOUND JOURNALS (U.S. CLS. 2, 5, 22, 23, 29, 37, 38 AND 50). FIRST USE 12-1-2006; IN COMMERCE 12-1-2006.

CLASS 16—(Continued).

3,299,975. DMG FINANCIAL SERVICES, RIVERSIDE, CA. SN 78-880,907. PUB. 12-12-2006, FILED 5-10-2006.

Mark in the Margin

THE MARK CONSISTS OF STANDARD CHARACTERS WITHOUT CLAIM TO ANY PARTICULAR FONT, STYLE, SIZE, OR COLOR.

FOR GREETING CARDS (U.S. CLS. 2, 5, 22, 23, 29, 37, 38 AND 50).

FIRST USE 8-30-2006; IN COMMERCE 11-13-2006.

3,299,988. AERO DESIGN AND MANUFACTURING COMPANY, INC., DULUTH, MN. SN 78-885,584. PUB. 12-19-2006, FILED 5-17-2006.



OWNER OF U.S. REG. NO. 1,873,866.

THE MARK CONSISTS OF THE WORDS "AEROSTICH TOURS" COMBINED WITH A DIAMOND SHAPE WITH CURVED ARROW INSIDE COMING OUT OF THE RIGHT SIDE.

FOR VINYL STICKERS (U.S. CLS. 2, 5, 22, 23, 29, 37, 38 AND 50).

FIRST USE 8-4-2006; IN COMMERCE 8-4-2006.

3,299,995. NEXT STEP PUBLISHING, INC., VICTOR, NY. SN 78-887,237. PUB. 12-12-2006, FILED 5-18-2006.

your life, after high school
nextSTEP
 college careers life

OWNER OF U.S. REG. NOS. 2,222,157, 3,067,634, AND OTHERS.

NO CLAIM IS MADE TO THE EXCLUSIVE RIGHT TO USE "COLLEGE" AND "CAREERS" AND "LIFE", APART FROM THE MARK AS SHOWN.

THE MARK CONSISTS OF THE WORDING "YOUR LIFE, AFTER HIGH SCHOOL NEXTSTEP COLLEGE CAREERS LIFE."

FOR MAGAZINES FEATURING COLLEGE PLANNING, CAREER PLANNING, LIFE SKILLS, BRANDING, MARKETING AND ADVERTISING CONTENT (U.S. CLS. 2, 5, 22, 23, 29, 37, 38 AND 50).

FIRST USE 9-0-2005; IN COMMERCE 9-0-2005.

CLASS 16—(Continued).

3,299,997. NATIONAL ASSOCIATION OF PROFESSIONAL BASEBALL LEAGUES, INC., SAINT PETERSBURG, FL. SN 78-887,528. PUB. 12-26-2006, FILED 5-19-2006.



OWNER OF U.S. REG. NO. 1,916,594.

FOR PAPER GOODS AND PRINTED MATTER, NAMELY TRADING CARDS, POSTERS, STICKERS, PHOTOGRAPHS, DECALS, AND CATALOGS OF INTEREST TO BASEBALL FANS (U.S. CLS. 2, 5, 22, 23, 29, 37, 38 AND 50).

FIRST USE 8-26-2006; IN COMMERCE 8-26-2006.

3,300,005. DRAPER PRODUCTS, INC., APPLETON, WI. SN 78-892,769. PUB. 12-12-2006, FILED 5-25-2006.

BLUE RIBBON

THE MARK CONSISTS OF STANDARD CHARACTERS WITHOUT CLAIM TO ANY PARTICULAR FONT, STYLE, SIZE, OR COLOR.

FOR DISPOSABLE PUPPY/DOG HOUSE TRAINING PADS (U.S. CLS. 2, 5, 22, 23, 29, 37, 38 AND 50).

FIRST USE 8-3-2006; IN COMMERCE 8-3-2006.

3,300,011. RYLO, INC. SPEARFISH, SD. SN 78-895,442. PUB. 1-9-2007, FILED 5-30-2006.

Onzgo

THE MARK CONSISTS OF STANDARD CHARACTERS WITHOUT CLAIM TO ANY PARTICULAR FONT, STYLE, SIZE, OR COLOR.

FOR FILE BOXES FOR STORAGE OF BUSINESS AND PERSONAL RECORD (U.S. CLS. 2, 5, 22, 23, 29, 37, 38 AND 50).

FIRST USE 6-1-2007; IN COMMERCE 6-1-2007.

CLASS 16—(Continued).

3,300,100. FLEET RESERVE ASSOCIATION, ALEXANDRIA, VA. SN 78-921,025. PUB. 2-13-2007, FILED 6-30-2006.

FRA TODAY

THE MARK CONSISTS OF STANDARD CHARACTERS WITHOUT CLAIM TO ANY PARTICULAR FONT, STYLE, SIZE, OR COLOR.

FOR PRINTED MAGAZINES IN THE FIELD OF THE NAVY, MARINE AND COAST GUARD ARMED SERVICES AND RELATED MEMBERSHIP AND ALUMNI AFFAIRS (U.S. CLS. 2, 5, 22, 23, 29, 37, 38 AND 50).

FIRST USE 11-0-2006; IN COMMERCE 11-0-2006.

CLASS 16—(Continued).

3,300,131. BDA HOLDINGS, LLC, PHOENIX, AZ. SN 78-931,793. PUB. 3-6-2007, FILED 7-18-2006.



The Imaginative Child

NO CLAIM IS MADE TO THE EXCLUSIVE RIGHT TO USE "CHILD", APART FROM THE MARK AS SHOWN.

THE MARK CONSISTS OF STYLIZED TEXT AND AN DRAWING OF CHILD WITH A "THOUGHT BUBBLE" ABOVE THE CHILD'S HEAD.

FOR CHILDREN'S ACTIVITY BOOKS (U.S. CLS. 2, 5, 22, 23, 29, 37, 38 AND 50).

FIRST USE 10-15-2006; IN COMMERCE 10-15-2006.

3,300,116. SUNNY AMERICAS, INC., LOS ANGELES, CA. SN 78-927,129. PUB. 2-20-2007, FILED 7-11-2006.

LEFT OVERZ

THE MARK CONSISTS OF STANDARD CHARACTERS WITHOUT CLAIM TO ANY PARTICULAR FONT, STYLE, SIZE, OR COLOR.

FOR PLASTIC FOOD STORAGE BAGS FOR HOUSEHOLD USE (U.S. CLS. 2, 5, 22, 23, 29, 37, 38 AND 50).

FIRST USE 7-15-2006; IN COMMERCE 7-15-2006.

3,300,143. GOD'S GREATEST GIFT, LLC, MANCHESTER, MI. SN 78-936,949. PUB. 3-13-2007, FILED 7-25-2006.

God's Greatest Gift

THE MARK CONSISTS OF STANDARD CHARACTERS WITHOUT CLAIM TO ANY PARTICULAR FONT, STYLE, SIZE, OR COLOR.

FOR CHILDREN'S BOOKS (U.S. CLS. 2, 5, 22, 23, 29, 37, 38 AND 50).

FIRST USE 11-4-2006; IN COMMERCE 11-4-2006.

3,300,128. TADZINI DESIGN GROUP, LLC, TUCKAHOE, NY. SN 78-931,399. PUB. 3-13-2007, FILED 7-17-2006.

FLOWER WEB

NO CLAIM IS MADE TO THE EXCLUSIVE RIGHT TO USE "FLOWER", APART FROM THE MARK AS SHOWN.

FOR SELF-ADHESIVES FOR USE IN ARRANGING AND SEPARATING FLOWERS IN A VASE OR OTHER CONTAINER FOR HOUSEHOLD OR DOMESTIC PURPOSES (U.S. CLS. 2, 5, 22, 23, 29, 37, 38 AND 50).

FIRST USE 12-16-2005; IN COMMERCE 7-14-2006.

3,300,158. REDI-TAG CORPORATION, CYPRESS, CA. SN 78-944,505. PUB. 3-13-2007, FILED 8-3-2006.

REDI-BIND

THE MARK CONSISTS OF STANDARD CHARACTERS WITHOUT CLAIM TO ANY PARTICULAR FONT, STYLE, SIZE, OR COLOR.

FOR BINDERS (U.S. CLS. 2, 5, 22, 23, 29, 37, 38 AND 50).

FIRST USE 11-0-2006; IN COMMERCE 11-0-2006.

CLASS 16—(Continued).

3,300,159. REDI-TAG CORPORATION, CYPRESS, CA. SN 78-944,521. PUB. 3-13-2007, FILED 8-3-2006.

redi-bind

FOR BINDERS (U.S. CLS. 2, 5, 22, 23, 29, 37, 38 AND 50).

FIRST USE 11-0-2006; IN COMMERCE 11-0-2006.

3,300,169. STERLING PUBLISHING CO., INC., NEW YORK, NY. SN 78-950,056. PUB. 2-20-2007, FILED 8-11-2006.

ABSOLUTELY NASTY

THE MARK CONSISTS OF STANDARD CHARACTERS WITHOUT CLAIM TO ANY PARTICULAR FONT, STYLE, SIZE, OR COLOR.

FOR SERIES OF NON-FICTION BOOKS FEATURING PUZZLES, GAMES, CHALLENGING WORD GAMES AND CROSSWORDS; SYNDICATED NEWSPAPER COLUMNS FEATURING PUZZLES, GAMES, CHALLENGING WORD GAMES AND CROSSWORDS (U.S. CLS. 2, 5, 22, 23, 29, 37, 38 AND 50).

FIRST USE 3-31-2007; IN COMMERCE 3-31-2007.

3,300,210. MICROSOFT CORPORATION, REDMOND, WA. SN 78-978,669. PUB. 2-7-2006, FILED 5-12-2005.

XBOX 360

THE MARK CONSISTS OF STANDARD CHARACTERS WITHOUT CLAIM TO ANY PARTICULAR FONT, STYLE, SIZE, OR COLOR.

OWNER OF U.S. REG. NOS. 2,776,769 AND 2,817,709. FOR PUBLICATIONS, NAMELY, STRATEGY GUIDES, USER MANUALS, AND MAGAZINES ALL IN THE FIELD OF COMPUTER GAMES, SCIENCE FICTION, GAMES AND ENTERTAINMENT; PENS, NOTEBOOKS (U.S. CLS. 2, 5, 22, 23, 29, 37, 38 AND 50).

FIRST USE 12-0-2006; IN COMMERCE 12-0-2006.

CLASS 16—(Continued).

3,300,211. RHEUMINATIONS, INC., NEW YORK, NY. SN 78-978,684. PUB. 8-15-2006, FILED 11-11-2005.

DXLUPUS

THE MARK CONSISTS OF STANDARD CHARACTERS WITHOUT CLAIM TO ANY PARTICULAR FONT, STYLE, SIZE, OR COLOR.

FOR PRINTED EDUCATIONAL AND INFORMATIONAL MATERIALS IN THE FIELD OF LUPUS, NAMELY, BROCHURES, ARTICLES AND OTHER PRINTED MATERIALS (U.S. CLS. 2, 5, 22, 23, 29, 37, 38 AND 50).

FIRST USE 10-26-2002; IN COMMERCE 10-26-2002.

CLASS 17—RUBBER GOODS

3,298,500. PLIANT CORPORATION, SCHAUMBURG, IL. SN 76-628,019. PUB. 1-10-2006, FILED 1-14-2005.

R410

THE MARK CONSISTS OF STANDARD CHARACTERS WITHOUT CLAIM TO ANY PARTICULAR FONT, STYLE, SIZE, OR COLOR.

FOR PLASTIC STRETCH FILM WRAP FOR INDUSTRIAL AND COMMERCIAL PACKING USE (U.S. CLS. 1, 5, 12, 13, 35 AND 50).

FIRST USE 5-0-2006; IN COMMERCE 5-0-2006.

3,298,726. HUBER ENGINEERED WOODS LLC, CHARLOTTE, NC. SN 78-366,673. PUB. 6-20-2006, FILED 2-12-2004.



NO CLAIM IS MADE TO THE EXCLUSIVE RIGHT TO USE "TAPE", APART FROM THE MARK AS SHOWN.

FOR NON-METALLIC BUILDING MATERIAL, NAMELY CONSTRUCTION TAPE (U.S. CLS. 1, 5, 12, 13, 35 AND 50).

FIRST USE 1-14-2005; IN COMMERCE 1-14-2005.

CLASS 17—(Continued).

3,298,861. DIVERSIFIED FOAM PRODUCTS, INC., PENNSAUKEN, NJ. SN 78-506,023. PUB. 10-11-2005, FILED 10-26-2004.

COMBOFOAM

THE MARK CONSISTS OF STANDARD CHARACTERS WITHOUT CLAIM TO ANY PARTICULAR FONT, STYLE, SIZE, OR COLOR.

FOR SOUND ABSORBING FLOORING UNDERLAYMENT FOAM (U.S. CLS. 1, 5, 12, 13, 35 AND 50).
FIRST USE 1-2-2004; IN COMMERCE 1-2-2004.

3,299,196. CPFILMS INC., FIELDALE, VA. SN 78-662,988. PUB. 4-18-2006, FILED 7-1-2005.

SIDELIGHT SOLUTIONS

THE MARK CONSISTS OF STANDARD CHARACTERS WITHOUT CLAIM TO ANY PARTICULAR FONT, STYLE, SIZE, OR COLOR.

NO CLAIM IS MADE TO THE EXCLUSIVE RIGHT TO USE "SIDELIGHT", APART FROM THE MARK AS SHOWN.

FOR PLASTIC FILM THAT IS TINTED, LAMINATED, REFLECTIVE, OR EMBOSSED, FOR APPLICATION TO ARCHITECTURAL WINDOWS FOR HOME USE (U.S. CLS. 1, 5, 12, 13, 35 AND 50).
FIRST USE 8-11-2005; IN COMMERCE 3-27-2006.

3,299,267. INSULATION SOLUTIONS, INC., EAST PEORIA, IL. SN 78-697,329. PUB. 10-31-2006, FILED 8-22-2005.

VIPER

THE MARK CONSISTS OF STANDARD CHARACTERS WITHOUT CLAIM TO ANY PARTICULAR FONT, STYLE, SIZE, OR COLOR.

FOR VAPOR BARRIERS MADE OF POLYPROPYLENE FOR THE CONSTRUCTION INDUSTRY (U.S. CLS. 1, 5, 12, 13, 35 AND 50).
FIRST USE 5-15-2006; IN COMMERCE 5-15-2006.

CLASS 17—(Continued).

3,299,721. PREGIS INNOVATIVE PACKAGING INC., DEERFIELD, IL. SN 78-793,572. PUB. 8-1-2006, FILED 1-18-2006.

ASTRO-FOAM

THE MARK CONSISTS OF STANDARD CHARACTERS WITHOUT CLAIM TO ANY PARTICULAR FONT, STYLE, SIZE, OR COLOR.

FOR FOAM PLASTIC PACKAGING MATERIAL SOLD IN ROLL AND SHEET FORM (U.S. CLS. 1, 5, 12, 13, 35 AND 50).

FIRST USE 2-23-1987; IN COMMERCE 2-23-1987.

3,299,767. KNAUF INSULATION GMBH, SHELBYVILLE, IN. SN 78-806,757. PUB. 9-26-2006, FILED 2-3-2006.



THE MARK CONSISTS OF THE WORDS PERIMETER PLUS WITH A SERIES OF BENT ARROWS FORMING A SQUARE.

FOR FIBERGLASS BUILDING INSULATION (U.S. CLS. 1, 5, 12, 13, 35 AND 50).

FIRST USE 5-8-2006; IN COMMERCE 5-8-2006.

3,300,152. THE SHERWIN-WILLIAMS COMPANY, CLEVELAND, OH. SN 78-943,923. PUB. 2-27-2007, FILED 8-3-2006.

POWER HOUSE

THE MARK CONSISTS OF STANDARD CHARACTERS WITHOUT CLAIM TO ANY PARTICULAR FONT, STYLE, SIZE, OR COLOR.

FOR ADHESIVE SEALANT AND CAULKING COMPOUND (U.S. CLS. 1, 5, 12, 13, 35 AND 50).

FIRST USE 2-1-2007; IN COMMERCE 2-1-2007.

CLASS 18—LEATHER GOODS

CLASS 18—(Continued).

3,298,428. FITNESS QUEST, INC., ST. PETERSBURG, FL. SN 76-449,052. PUB. 12-13-2005, FILED 9-11-2002.

FIT BAG

NO CLAIM IS MADE TO THE EXCLUSIVE RIGHT TO USE "BAG", APART FROM THE MARK AS SHOWN. FOR COMBINATION ALL-PURPOSE SPORT BAG AND PURSE (U.S. CLS. 1, 2, 3, 22 AND 41). FIRST USE 3-1-2007; IN COMMERCE 3-1-2007.

3,298,476. GLO-JO TREASURES, LLC, MONTGOMERY, NY. SN 76-609,420. PUB. 7-12-2005, FILED 8-30-2004.

DINOLUGGAGE

THE MARK CONSISTS OF STANDARD CHARACTERS WITHOUT CLAIM TO ANY PARTICULAR FONT, STYLE, SIZE, OR COLOR. FOR CHILDS CARRYING BAG IN THE SHAPE OF A DINOSAUR (U.S. CLS. 1, 2, 3, 22 AND 41). FIRST USE 10-15-2006; IN COMMERCE 10-15-2006.

3,298,477. I DID IT, INC., FAR HILLS, NJ. SN 76-610,533. PUB. 7-12-2005, FILED 9-3-2004.

GLO N GO

THE MARK CONSISTS OF STANDARD CHARACTERS WITHOUT CLAIM TO ANY PARTICULAR FONT, STYLE, SIZE, OR COLOR. FOR PET LEASHES AND COLLARS (U.S. CLS. 1, 2, 3, 22 AND 41). FIRST USE 5-21-2004; IN COMMERCE 5-21-2004.

3,298,591. EASTSPORT INC., NEW YORK, NY. SN 76-658,993. PUB. 11-21-2006, FILED 4-24-2006.

BABY GOT BAG

THE MARK CONSISTS OF STANDARD CHARACTERS WITHOUT CLAIM TO ANY PARTICULAR FONT, STYLE, SIZE, OR COLOR. FOR BABY DIAPER BAGS, BABY DUFFEL BAGS, BABY BACKPACKS (U.S. CLS. 1, 2, 3, 22 AND 41). FIRST USE 9-1-2006; IN COMMERCE 9-1-2006.

CLASS 18—(Continued).

3,298,622. PGA TOUR, INC., PONTE VEDRA BEACH, FL. SN 77-017,449. PUB. 1-30-2007, FILED 10-10-2006.



OWNER OF U.S. REG. NOS. 1,523,862, 2,877,023, AND OTHERS. FOR GOLF UMBRELLAS, ATHLETIC BAGS, TOTE-BAGS, BRIEFCASES, LUGGAGE TAGS, CREDIT CARD CASES, WALLETS (U.S. CLS. 1, 2, 3, 22 AND 41). FIRST USE 5-1-2007; IN COMMERCE 5-1-2007.

3,298,663. LOXION KULCA MARKETING SERVICES CC, JOHANNESBURG, GAUTENG, SOUTH AFRICA. SN 78-212,693. PUB. 7-5-2005, FILED 2-10-2003.

LOXION KULCA

OWNER OF U.S. REG. NO. 2,576,573. THE NAME SHOWN IN THE MARK DOES NOT IDENTIFY A PARTICULAR LIVING INDIVIDUAL. FOR DUFFEL BAGS, HANDBAGS, SHOULDER BAGS, DOCUMENT BAGS AND WALLETS (U.S. CLS. 1, 2, 3, 22 AND 41). FIRST USE 3-27-2007; IN COMMERCE 3-27-2007.

3,298,694. TOTES ISOTONER CORPORATION, CINCINNATI, OH. SN 78-305,156. PUB. 9-26-2006, FILED 9-25-2003.

GRIPSTER

FOR UMBRELLAS (U.S. CLS. 1, 2, 3, 22 AND 41). FIRST USE 1-31-2004; IN COMMERCE 1-31-2004.

3,298,723. DISNEY ENTERPRISES, INC., BURBANK, CA. SN 78-356,712. PUB. 6-28-2005, FILED 1-23-2004.

CHICKEN LITTLE

THE MARK CONSISTS OF STANDARD CHARACTERS WITHOUT CLAIM TO ANY PARTICULAR FONT, STYLE, SIZE, OR COLOR. FOR BACKPACKS (U.S. CLS. 1, 2, 3, 22 AND 41). FIRST USE 6-9-2006; IN COMMERCE 6-9-2006.

CLASS 18—(Continued).

3,298,819. FRANCO, JOSEPH, BROOKLYN, NY. SN 78-475,826. PUB. 12-27-2005, FILED 8-30-2004.

CLASS 18—(Continued).

3,298,932. NLDA ASSOCIATES INC., GLENVIEW, IL. SN 78-561,063. PUB. 7-18-2006, FILED 2-4-2005.

PEACE ROCS

MOSAIC

THE MARK CONSISTS OF STANDARD CHARACTERS WITHOUT CLAIM TO ANY PARTICULAR FONT, STYLE, SIZE, OR COLOR.

FOR TRUNKS AND SUITCASES; BACKPACKS; RUCKSACKS, BAGS, NAMELY, BOOK BAGS, HANDBAGS, GARMENT BAGS FOR TRAVEL, TRAVEL BAGS, SCHOOL BAGS, BEACH BAGS, OVERNIGHT BAGS, CARRY-ON BAGS, GYM BAGS, DUFFLE BAGS, SHOULDER BAGS, DIAPER BAGS; BRIEFCASES; BILLFOLDS; WALLETS, POCKET WALLETS, PURSES; WAIST POUCHES; UMBRELLAS (U.S. CLS. 1, 2, 3, 22 AND 41).

FIRST USE 12-1-2006; IN COMMERCE 12-1-2006.

THE MARK CONSISTS OF STANDARD CHARACTERS WITHOUT CLAIM TO ANY PARTICULAR FONT, STYLE, SIZE, OR COLOR.

FOR LUGGAGE; LUGGAGE ACCESSORIES IN THE FORM OF CUBES AND FOLDERS FOR USE IN PACKING AND SEPARATING CONTENTS WITHIN LUGGAGE; BRIEFCASES; TRAVEL ACCESSORIES, NAMELY, TRAVEL BAGS, GARMENT BAGS, SHOE BAGS FOR TRAVEL, COSMETIC BAGS AND POUCHES SOLD EMPTY, TOILETRY KIT BAGS SOLD EMPTY; NONE OF THE AFORESAID GOODS ARE MADE WITH MOSAIC DESIGNS (U.S. CLS. 1, 2, 3, 22 AND 41).

FIRST USE 10-0-2005; IN COMMERCE 10-0-2005.

3,298,909. YAKIRA, LLC, NEW YORK, NY. SN 78-548,112. PUB. 5-9-2006, FILED 1-14-2005.

3,298,979. D'FIRO DESIGN, INC., LAFAYETTE, CA. SN 78-580,992. PUB. 7-4-2006, FILED 3-4-2005.

RED BY MARC ECKO

VIZOR

THE MARK CONSISTS OF STANDARD CHARACTERS WITHOUT CLAIM TO ANY PARTICULAR FONT, STYLE, SIZE, OR COLOR.

"MARC ECKO" IDENTIFIES A LIVING INDIVIDUAL WHOSE CONSENT IS OF RECORD.

FOR BAGS, NAMELY, HANDBAGS, BACKPACKS, MESSENGER BAGS; LEATHER KEY CHAINS; LEATHER WALLETS (U.S. CLS. 1, 2, 3, 22 AND 41).

FIRST USE 4-0-2005; IN COMMERCE 4-0-2005.

THE MARK CONSISTS OF STANDARD CHARACTERS WITHOUT CLAIM TO ANY PARTICULAR FONT, STYLE, SIZE, OR COLOR.

FOR PATIO UMBRELLAS (U.S. CLS. 1, 2, 3, 22 AND 41).

FIRST USE 3-1-2005; IN COMMERCE 3-1-2005.

CLASS 18—(Continued).

3,299,082. SCHNEIDER SADDLERY CO., INC., CHAGRIN FALLS, OH. SN 78-614,440. PUB. 6-6-2006, FILED 4-22-2005.

POLY-TECH

THE MARK CONSISTS OF STANDARD CHARACTERS WITHOUT CLAIM TO ANY PARTICULAR FONT, STYLE, SIZE, OR COLOR.

FOR EQUINE CLOTHING AND ANIMAL COVERS, NAMELY, COOLERS AND LINERS IN THE NATURE OF THOSE PROVIDING THERMAL INSULATION AND/OR WICKING FUNCTIONS FOR HORSES, AND BLANKETS FOR HORSES AND DOGS (U.S. CLS. 1, 2, 3, 22 AND 41).
FIRST USE 8-31-2005; IN COMMERCE 8-31-2005.

3,299,136. HIP DOGGIE INC., STUDIO CITY, CA. SN 78-639,771. PUB. 6-13-2006, FILED 5-31-2005.

Pimp Doggie

THE MARK CONSISTS OF STANDARD CHARACTERS WITHOUT CLAIM TO ANY PARTICULAR FONT, STYLE, SIZE, OR COLOR.

NO CLAIM IS MADE TO THE EXCLUSIVE RIGHT TO USE "DOGGIE", APART FROM THE MARK AS SHOWN.
FOR DOG CLOTHING (U.S. CLS. 1, 2, 3, 22 AND 41).
FIRST USE 6-30-2005; IN COMMERCE 6-30-2005.

3,299,159. HADLEY POLLET, LLC, CAMBRIDGE, MA. SN 78-649,158. PUB. 12-13-2005, FILED 6-13-2005.

HADLEY POLLET

THE MARK CONSISTS OF STANDARD CHARACTERS WITHOUT CLAIM TO ANY PARTICULAR FONT, STYLE, SIZE, OR COLOR.

THE NAME HADLEY POLLET IDENTIFIES A LIVING INDIVIDUAL WHOSE CONSENT IS OF RECORD.
FOR LUGGAGE, HANDBAGS, CANVAS TOTE BAGS AND WALLETS (U.S. CLS. 1, 2, 3, 22 AND 41).
FIRST USE 8-2-2002; IN COMMERCE 6-30-2005.

CLASS 18—(Continued).

3,299,390. PITTSBURGH ASSOCIATES, PITTSBURGH, PA. SN 78-729,870. PUB. 6-20-2006, FILED 10-10-2005.



OWNER OF U.S. REG. NOS. 1,539,239, 1,634,019, AND OTHERS.

FOR ATHLETIC BAGS, OVERNIGHT BAGS, BACK-PACKS, DUFFEL BAGS, TOTE BAGS, BEACH BAGS, KNAPSACKS, ATTACHE CASES, BRIEFCASES, PURSES, WALLETS, BILLFOLDS, FANNY PACKS, WAIST PACKS, COSMETIC CASES SOLD EMPTY, TOILETRY CASES SOLD EMPTY, BUSINESS CARD CASES, LUGGAGE, LUGGAGE TAGS, SUITCASES, UMBRELLAS, DOG COLLARS AND DOG LEASHES (U.S. CLS. 1, 2, 3, 22 AND 41).

FIRST USE 0-0-2001; IN COMMERCE 0-0-2001.

3,299,509. SALSTEIN, JASON, MIAMI, FL. AND CORONA, DANIELLE, CORAL GABLES, FL. SN 78-746,447. PUB. 7-18-2006, FILED 11-3-2005.

HUNTING SEASON

THE MARK CONSISTS OF STANDARD CHARACTERS WITHOUT CLAIM TO ANY PARTICULAR FONT, STYLE, SIZE, OR COLOR.

FOR HANDBAGS (U.S. CLS. 1, 2, 3, 22 AND 41).
FIRST USE 2-18-2007; IN COMMERCE 2-18-2007.

CLASS 18—(Continued).

3,299,619. STUDIO A.H. LLC, SAN FRANCISCO, CA. SN 78-768,065. PUB. 8-22-2006, FILED 12-7-2005.

TRUFFLE

THE MARK CONSISTS OF STANDARD CHARACTERS WITHOUT CLAIM TO ANY PARTICULAR FONT, STYLE, SIZE, OR COLOR.

FOR HANDBAGS, TOTE BAGS, AND FASHION ACCESSORIES, NAMELY, WALLETS (U.S. CLS. 1, 2, 3, 22 AND 41).

FIRST USE 11-15-2005; IN COMMERCE 1-0-2007.

CLASS 18—(Continued).

3,300,098. COASTAL PET PRODUCTS, INC., ALLIANCE, OH. SN 78-920,735. PUB. 2-20-2007, FILED 6-30-2006.

E-Z SNAP

THE MARK CONSISTS OF STANDARD CHARACTERS WITHOUT CLAIM TO ANY PARTICULAR FONT, STYLE, SIZE, OR COLOR.

FOR PET LEASH ACCESSORIES, NAMELY CLIPS FOR ATTACHING LEASHES TO PET COLLARS, HARNESSSES, AND/OR HEAD HALTERS (U.S. CLS. 1, 2, 3, 22 AND 41).

FIRST USE 1-2-2007; IN COMMERCE 1-2-2007.

3,299,659. VISAGE, INC., NEW YORK, NY. SN 78-775,430. PUB. 2-27-2007, FILED 12-16-2005.

VISAGE

THE MARK CONSISTS OF STANDARD CHARACTERS WITHOUT CLAIM TO ANY PARTICULAR FONT, STYLE, SIZE, OR COLOR.

THE FOREIGN WORDING IN THE MARK TRANSLATES INTO ENGLISH AS "FACE".

FOR LEATHER AND IMITATIONS OF LEATHER, AND GOODS MADE OF THESE MATERIALS AND NOT INCLUDED IN OTHER CLASSES, NAMELY, BAGS, HAND BAGS, PURSES, SHOULDER BAGS (U.S. CLS. 1, 2, 3, 22 AND 41).

FIRST USE 3-1-2007; IN COMMERCE 3-1-2007.

3,300,135. PUCHIBAG, INC., WEST HOLLYWOOD, CA. SN 78-932,749. PUB. 2-27-2007, FILED 7-19-2006.

PupSak

THE MARK CONSISTS OF STANDARD CHARACTERS WITHOUT CLAIM TO ANY PARTICULAR FONT, STYLE, SIZE, OR COLOR.

FOR ANIMAL CARRIERS (U.S. CLS. 1, 2, 3, 22 AND 41).

FIRST USE 3-1-2007; IN COMMERCE 5-1-2007.

3,300,033. BEACH, SHANNON, NORTH HOLLYWOOD, CA. SN 78-903,100. PUB. 1-23-2007, FILED 6-7-2006.

PUPPOOSE

THE MARK CONSISTS OF STANDARD CHARACTERS WITHOUT CLAIM TO ANY PARTICULAR FONT, STYLE, SIZE, OR COLOR.

FOR PET CARRIERS WORN ON THE BODY (U.S. CLS. 1, 2, 3, 22 AND 41).

FIRST USE 5-12-2006; IN COMMERCE 5-12-2006.

3,300,163. ASPEN PET PRODUCTS, INC., DENVER, CO. SN 78-947,456. PUB. 3-20-2007, FILED 8-8-2006.

ASPEN GOLD

THE MARK CONSISTS OF STANDARD CHARACTERS WITHOUT CLAIM TO ANY PARTICULAR FONT, STYLE, SIZE, OR COLOR.

OWNER OF U.S. REG. NOS. 2,159,992 AND 2,196,983. NO CLAIM IS MADE TO THE EXCLUSIVE RIGHT TO USE "GOLD", APART FROM THE MARK AS SHOWN.

FOR COLLARS FOR PETS (U.S. CLS. 1, 2, 3, 22 AND 41).

FIRST USE 4-20-2007; IN COMMERCE 4-20-2007.

CLASS 18—(Continued).

3,300,172. CARLSON, OAKLEY, SEATTLE, WA. AND REED, BRENDA, SEATTLE, WA. SN 78-951,831. PUB. 4-3-2007, FILED 8-14-2006.

CLASS 19—(Continued).

3,298,612. PRIMESOURCE BUILDING PRODUCTS, INC., CARROLLTON, TX. SN 77-008,567. PUB. 3-27-2007, FILED 9-27-2006.

DINGOLOPE

THE MARK CONSISTS OF STANDARD CHARACTERS WITHOUT CLAIM TO ANY PARTICULAR FONT, STYLE, SIZE, OR COLOR.

FOR BAGS FOR CARRYING PET ACCESSORIES (U.S. CLS. 1, 2, 3, 22 AND 41).

FIRST USE 11-1-2006; IN COMMERCE 11-1-2006.

GRIP-RITE

THE MARK CONSISTS OF STANDARD CHARACTERS WITHOUT CLAIM TO ANY PARTICULAR FONT, STYLE, SIZE, OR COLOR.

OWNER OF U.S. REG. NOS. 1,917,594, 2,995,884, AND 3,077,807.

FOR ROSIN SHEATHING PAPER USED FOR CONSTRUCTION PURPOSES (U.S. CLS. 1, 12, 33 AND 50).

FIRST USE 6-1-2007; IN COMMERCE 6-1-2007.

3,300,173. BOYT BRANDS, INC., IOWA FALLS, IA. SN 78-952,778. PUB. 4-10-2007, FILED 8-15-2006.

BOYT EDGE

THE MARK CONSISTS OF STANDARD CHARACTERS WITHOUT CLAIM TO ANY PARTICULAR FONT, STYLE, SIZE, OR COLOR.

OWNER OF U.S. REG. NO. 2,330,880.

FOR LUGGAGE (U.S. CLS. 1, 2, 3, 22 AND 41).

FIRST USE 4-19-2007; IN COMMERCE 4-25-2007.

3,298,613. PRIMESOURCE BUILDING PRODUCTS, INC., CARROLLTON, TX. SN 77-008,574. PUB. 3-27-2007, FILED 9-27-2006.

CLASS 19—NON-METALLIC BUILDING MATERIALS

3,298,468. ECMD, INC., NORTH WILKESBORO, NC. SN 76-602,931. PUB. 7-25-2006, FILED 7-16-2004.



KNOTWOOD

FOR NON-METALLIC BUILDING MATERIALS, NAMELY, PLASTIC SIMULATED WOOD (U.S. CLS. 1, 12, 33 AND 50).

FIRST USE 3-31-2005; IN COMMERCE 3-31-2005.

OWNER OF U.S. REG. NOS. 2,953,644, 2,953,709, AND 3,032,141.

FOR ROSIN SHEATHING PAPER USED FOR CONSTRUCTION PURPOSES (U.S. CLS. 1, 12, 33 AND 50).

FIRST USE 6-1-2007; IN COMMERCE 6-1-2007.

CLASS 19—(Continued).

3,298,715. SATIN FINISH HARDWOOD FLOORING LIMITED, WESTON, ONTARIO, CANADA. SN 78-345,636. PUB. 6-20-2006, FILED 12-25-2003.

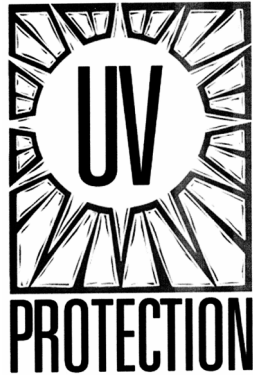

PRIORITY CLAIMED UNDER SEC. 44(D) ON CANADA APPLICATION NO. 1201285, FILED 12-8-2003, REG. NO. TMA635405, DATED 3-16-2005, EXPIRES 3-16-2020.

NO CLAIM IS MADE TO THE EXCLUSIVE RIGHT TO USE "UV PROTECTION", APART FROM THE MARK AS SHOWN.

THE LINING IS A FEATURE OF THE MARK AND DOES NOT INDICATE COLOR.

THE MARK CONSISTS OF AN ABSTRACT DRAWING. FOR PRE-FINISHED HARDWOOD FLOORING (U.S. CLS. 1, 12, 33 AND 50).

FIRST USE 8-24-2005; IN COMMERCE 8-24-2005.

3,298,724. TAPCO INTERNATIONAL CORPORATION, WIXOM, MI. SN 78-359,113. PUB. 12-27-2005, FILED 1-28-2004.

DISTINCTIVE CEDAR ACCENTS

THE MARK CONSISTS OF STANDARD CHARACTERS WITHOUT CLAIM TO ANY PARTICULAR FONT, STYLE, SIZE, OR COLOR.

NO CLAIM IS MADE TO THE EXCLUSIVE RIGHT TO USE "CEDAR ACCENT", APART FROM THE MARK AS SHOWN.

FOR NON-METAL RESIDENTIAL BUILDING PRODUCTS, NAMELY, SHUTTERS, SHINGLES, SIDING, PLASTIC TRIM (U.S. CLS. 1, 12, 33 AND 50).

FIRST USE 2-0-2007; IN COMMERCE 2-0-2007.

CLASS 19—(Continued).

3,298,741. JOHNSON, GARRETT, VIRGINIA BEACH, VA. SN 78-381,308. PUB. 12-21-2004, FILED 3-9-2004.

AIR REEF

THE MARK CONSISTS OF STANDARD CHARACTERS WITHOUT CLAIM TO ANY PARTICULAR FONT, STYLE, SIZE, OR COLOR.

NO CLAIM IS MADE TO THE EXCLUSIVE RIGHT TO USE "REEF", APART FROM THE MARK AS SHOWN.

FOR REEF STRUCTURE, NAMELY, AN ARTIFICIAL REEF FOR USE IN WAVE POOLS AND BODIES OF WATER TO MODIFY WAVES FOR RECREATIONAL PURPOSES (U.S. CLS. 1, 12, 33 AND 50).

FIRST USE 11-15-2006; IN COMMERCE 11-15-2006.

3,298,906. HENGSTONE HOLDINGS, INC., TORONTO, ONTARIO, CANADA. SN 78-547,551. PUB. 1-17-2006, FILED 1-14-2005.

COURTSTONE

THE MARK CONSISTS OF STANDARD CHARACTERS WITHOUT CLAIM TO ANY PARTICULAR FONT, STYLE, SIZE, OR COLOR.

FOR PAVING STONES AND RETAINING WALL BLOCKS MADE OF CONCRETE (U.S. CLS. 1, 12, 33 AND 50).

FIRST USE 3-31-2005; IN COMMERCE 3-31-2005.

3,299,066. FIBER COMPOSITES, LLC, NEW LONDON, NC. SN 78-607,484. PUB. 7-4-2006, FILED 4-13-2005.

PORTICO

THE MARK CONSISTS OF STANDARD CHARACTERS WITHOUT CLAIM TO ANY PARTICULAR FONT, STYLE, SIZE, OR COLOR.

FOR COMBINATION PLASTIC AND WOOD MATERIAL USED AS A WOOD SUBSTITUTE, IN THE FORM OF BOARDS, RAILS, SPINDLES, BALUSTERS, POSTS AND MOLDINGS (U.S. CLS. 1, 12, 33 AND 50).

FIRST USE 4-20-2005; IN COMMERCE 4-20-2005.

CLASS 19—(Continued).

3,299,069. SUR-LOC FLOORING SYSTEMS, LLC, CHARLESTOWN, WV. SN 78-607,983. PUB. 1-10-2006, FILED 4-13-2005.

DURA-TRAC

THE MARK CONSISTS OF STANDARD CHARACTERS WITHOUT CLAIM TO ANY PARTICULAR FONT, STYLE, SIZE, OR COLOR.

FOR NON-METAL PORTABLE FLOORING PANELS; REINFORCED PORTABLE FLOORING PANELS (U.S. CLS. 1, 12, 33 AND 50).

FIRST USE 10-10-2005; IN COMMERCE 10-10-2005.

3,299,102. VKR HOLDING A/S, 2970 HØRSHOLM, DENMARK. SN 78-623,228. PUB. 8-8-2006, FILED 5-4-2005.

SUN TUNNEL

THE MARK CONSISTS OF STANDARD CHARACTERS WITHOUT CLAIM TO ANY PARTICULAR FONT, STYLE, SIZE, OR COLOR.

OWNER OF U.S. REG. NO. 1,936,137.

FOR NON-METAL TUBULAR SKYLIGHTS (U.S. CLS. 1, 12, 33 AND 50).

FIRST USE 5-1-1994; IN COMMERCE 5-1-1994.

3,299,140. FINCIBEC S.P.A., 41049 SASSUOLO (MO), ITALY. SN 78-640,419. PUB. 7-25-2006, FILED 5-31-2005.

★★★★★
FINCIBEC

OWNER OF U.S. REG. NO. 2,104,844.
THE MARK CONSISTS OF FIVE STARS ABOVE THE WORD FINCIBEC IN STYLIZED LETTERING.

FOR CERAMIC TILES FOR FLOORING AND COVERINGS (U.S. CLS. 1, 12, 33 AND 50).

FIRST USE 0-0-1997; IN COMMERCE 0-0-1998.

CLASS 19—(Continued).

3,299,428. O'HAGIN'S, INC., ROHNERT PARK, CA. SN 78-736,216. PUB. 1-2-2007, FILED 10-19-2005.

Value Vent

THE MARK CONSISTS OF STANDARD CHARACTERS WITHOUT CLAIM TO ANY PARTICULAR FONT, STYLE, SIZE, OR COLOR.

NO CLAIM IS MADE TO THE EXCLUSIVE RIGHT TO USE "VENT", APART FROM THE MARK AS SHOWN.

FOR NON-METAL ROOF VENTS FOR HEATING, COOLING, AND VENTILATION IN RESIDENTIAL AND COMMERCIAL BUILDINGS (U.S. CLS. 1, 12, 33 AND 50).

FIRST USE 10-13-2006; IN COMMERCE 10-13-2006.

3,299,570. PLASTIC SAFETY SYSTEMS, INC., CLEVELAND, OH. SN 78-755,271. PUB. 7-18-2006, FILED 11-16-2005.

CRASHGARD

THE MARK CONSISTS OF STANDARD CHARACTERS WITHOUT CLAIM TO ANY PARTICULAR FONT, STYLE, SIZE, OR COLOR.

FOR CRASH BARRIERS OF PLASTIC FOR ROADS (U.S. CLS. 1, 12, 33 AND 50).

FIRST USE 3-9-2007; IN COMMERCE 3-9-2007.

3,299,610. MANNINGTON MILLS, INC., SALEM, NJ. SN 78-766,310. PUB. 11-14-2006, FILED 12-5-2005.

RAJA SLATE

THE MARK CONSISTS OF STANDARD CHARACTERS WITHOUT CLAIM TO ANY PARTICULAR FONT, STYLE, SIZE, OR COLOR.

NO CLAIM IS MADE TO THE EXCLUSIVE RIGHT TO USE "SLATE", APART FROM THE MARK AS SHOWN.

FOR LAMINATE FLOORING (U.S. CLS. 1, 12, 33 AND 50).

FIRST USE 12-15-2005; IN COMMERCE 12-15-2005.

CLASS 19—(Continued).

3,299,611. MANNINGTON MILLS, INC., SALEM, NJ. SN 78-766,313. PUB. 7-11-2006, FILED 12-5-2005.

PALERMO STONE

THE MARK CONSISTS OF STANDARD CHARACTERS WITHOUT CLAIM TO ANY PARTICULAR FONT, STYLE, SIZE, OR COLOR.
FOR LAMINATE FLOORING (U.S. CLS. 1, 12, 33 AND 50).
FIRST USE 12-15-2005; IN COMMERCE 12-15-2005.

3,299,723. SPECIALTY CONSTRUCTION BRANDS, INC., SAINT PAUL, MN. SN 78-793,846. PUB. 7-11-2006, FILED 1-18-2006.

ACCUCOLOR XT

THE MARK CONSISTS OF STANDARD CHARACTERS WITHOUT CLAIM TO ANY PARTICULAR FONT, STYLE, SIZE, OR COLOR.
OWNER OF U.S. REG. NO. 2,085,897.
FOR COLOR CONSISTENT, STAIN, MOLD AND CRACK RESISTANT PORTLAND CEMENT GROUT FOR INTERIOR AND EXTERIOR USE (U.S. CLS. 1, 12, 33 AND 50).
FIRST USE 6-30-2006; IN COMMERCE 6-30-2006.

3,299,760. MENARD, INC., EAU CLAIRE, WI. SN 78-803,471. PUB. 8-29-2006, FILED 1-31-2006.

FLOORS OF DISTINCTION

THE MARK CONSISTS OF STANDARD CHARACTERS WITHOUT CLAIM TO ANY PARTICULAR FONT, STYLE, SIZE, OR COLOR.
NO CLAIM IS MADE TO THE EXCLUSIVE RIGHT TO USE "FLOORS", APART FROM THE MARK AS SHOWN.
FOR WOOD FLOORING, NAMELY WOODEN FLOOR BOARDS AND PLANKS (U.S. CLS. 1, 12, 33 AND 50).
FIRST USE 3-15-2006; IN COMMERCE 3-15-2006.

CLASS 19—(Continued).

3,299,916. EASY GARDENER PRODUCTS, INC., WACO, TX. SN 78-863,045. PUB. 1-2-2007, FILED 4-17-2006.

WEED BLOCK ULTRA

THE MARK CONSISTS OF STANDARD CHARACTERS WITHOUT CLAIM TO ANY PARTICULAR FONT, STYLE, SIZE, OR COLOR.
OWNER OF U.S. REG. NOS. 1,408,576, 2,334,841, AND 3,121,605.
SEC. 2(F).
FOR GEOTEXTILES, NAMELY, FABRIC AND SHEETING FOR WEED PREVENTION IN NURSERIES, GREENHOUSES, AND LANDSCAPING (U.S. CLS. 1, 12, 33 AND 50).
FIRST USE 11-1-2006; IN COMMERCE 11-1-2006.

3,300,079. SPECIALTY CONSTRUCTION BRANDS, INC., SAINT PAUL, MN. SN 78-916,561. PUB. 2-6-2007, FILED 6-26-2006.

CHAPCO

THE MARK CONSISTS OF STANDARD CHARACTERS WITHOUT CLAIM TO ANY PARTICULAR FONT, STYLE, SIZE, OR COLOR.
OWNER OF U.S. REG. NO. 871,987.
FOR MORTARS, GROUTS, LATEX MODIFIED FLOOR PATCHING AND LEVELING COMPOUND AND CEMENT BASED SELF LEVELING FLOORING UNDERLAYMENT (U.S. CLS. 1, 12, 33 AND 50).
FIRST USE 5-1-2007; IN COMMERCE 5-1-2007.

3,300,086. STRONGWELL CORPORATION, BRISTOL, VA. SN 78-918,472. PUB. 2-20-2007, FILED 6-28-2006.

DURASHIELD HC

THE MARK CONSISTS OF STANDARD CHARACTERS WITHOUT CLAIM TO ANY PARTICULAR FONT, STYLE, SIZE, OR COLOR.
OWNER OF U.S. REG. NO. 1,647,454.
FOR NON-METALLIC BUILDING MATERIALS, NAMELY STRUCTURAL FIBERGLASS PANELS (U.S. CLS. 1, 12, 33 AND 50).
FIRST USE 5-7-2007; IN COMMERCE 5-7-2007.

CLASS 19—(Continued).

3,300,113. W.P. HICKMAN SYSTEMS, INC., SOLON, OH. SN 78-926,831. PUB. 2-20-2007, FILED 7-11-2006.

EASY LAP

THE MARK CONSISTS OF STANDARD CHARACTERS WITHOUT CLAIM TO ANY PARTICULAR FONT, STYLE, SIZE, OR COLOR.
FOR ASPHALT BASED ROOFING MASTICS (U.S. CLS. 1, 12, 33 AND 50).
FIRST USE 8-24-2006; IN COMMERCE 8-24-2006.

3,300,156. MANOS FABRIC INC., FORT LAUDERDALE, FL. SN 78-944,284. PUB. 3-27-2007, FILED 8-3-2006.

HURRITEX

THE MARK CONSISTS OF STANDARD CHARACTERS WITHOUT CLAIM TO ANY PARTICULAR FONT, STYLE, SIZE, OR COLOR.
FOR STORM AND HURRICANE SHUTTERS, NAMELY, NON-METAL EXTERIOR BUILDING SHUTTERS (U.S. CLS. 1, 12, 33 AND 50).
FIRST USE 1-8-2007; IN COMMERCE 4-30-2007.

3,300,202. WEYERHAEUSER COMPANY, FEDERAL WAY, WA. SN 78-978,294. PUB. 11-1-2005, FILED 4-19-2005.

FORRESTAR

THE MARK CONSISTS OF STANDARD CHARACTERS WITHOUT CLAIM TO ANY PARTICULAR FONT, STYLE, SIZE, OR COLOR.
FOR NON-METALLIC BUILDING MATERIALS, NAMELY, WOODEN VENEERS, PLYWOOD, FIBERBOARD, LUMBER, PARTICLE BOARD, ORIENTED STRAND BOARD, CORE STOCK AND CUT STOCK (U.S. CLS. 1, 12, 33 AND 50).
FIRST USE 10-31-2006; IN COMMERCE 12-11-2006.

CLASS 20—FURNITURE AND ARTICLES NOT OTHERWISE CLASSIFIED

CLASS 20—(Continued).

3,298,493. AMERICAN WOODMARK CORPORATION, WINCHESTER, VA. SN 76-623,670. PUB. 10-18-2005, FILED 12-8-2004.

YELLOWSTONE

THE MARK CONSISTS OF STANDARD CHARACTERS WITHOUT CLAIM TO ANY PARTICULAR FONT, STYLE, SIZE, OR COLOR.
OWNER OF U.S. REG. NO. 2,207,684.
FOR KITCHEN CABINETS AND BATHROOM CABINETS (U.S. CLS. 2, 13, 22, 25, 32 AND 50).
FIRST USE 9-4-1997; IN COMMERCE 9-4-1997.

3,298,680. PACIFIC COAST FEATHER COMPANY, SEATTLE, WA. SN 78-260,439. PUB. 10-18-2005, FILED 6-10-2003.

ALLERX

FOR PILLOWS (U.S. CLS. 2, 13, 22, 25, 32 AND 50).
FIRST USE 7-1-2003; IN COMMERCE 7-1-2003.

3,298,683. LUCKY LINE PRODUCTS, INC., SAN DIEGO, CA. SN 78-269,748. PUB. 8-3-2004, FILED 7-2-2003.

FLEX-O-LOC

FOR NON-METAL KEY RINGS (U.S. CLS. 2, 13, 22, 25, 32 AND 50).
FIRST USE 12-10-1974; IN COMMERCE 12-10-1974.

3,298,757. THE PHOENIX PRODUCT DESIGN GROUP LLC, ISSAQUAH, WA. SN 78-409,826. PUB. 9-27-2005, FILED 4-28-2004.

GRIZZ GRIP

THE MARK CONSISTS OF STANDARD CHARACTERS WITHOUT CLAIM TO ANY PARTICULAR FONT, STYLE, SIZE, OR COLOR.
NO CLAIM IS MADE TO THE EXCLUSIVE RIGHT TO USE "GRIP", APART FROM THE MARK AS SHOWN.
FOR JOINING AND ANCHORING CLIPS NOT OF METAL FOR USE WITH FLEXIBLE SHEETING MATERIALS INCLUDING TARPULINS (U.S. CLS. 2, 13, 22, 25, 32 AND 50).
FIRST USE 8-24-2004; IN COMMERCE 8-24-2004.

CLASS 20—(Continued).

3,298,860. GOLDEN TECHNOLOGIES, INC., OLD FORGE, PA. SN 78-505,664. PUB. 2-7-2006, FILED 10-25-2004.

CLASS 20—(Continued).

3,299,027. WHIRLPOOL PROPERTIES, INC., ST. JOSEPH, MI. SN 78-597,221. PUB. 8-1-2006, FILED 3-29-2005.

MAXI COMFORT

THE MARK CONSISTS OF STANDARD CHARACTERS WITHOUT CLAIM TO ANY PARTICULAR FONT, STYLE, SIZE, OR COLOR.

FOR TILT AND RECLINE MECHANISMS SOLD AS COMPONENT PARTS OF RECLINERS; TILT AND RECLINE MECHANISMS SOLD AS COMPONENT PARTS OF RECLINERS HAVING A LIFT ASSIST MECHANISM (U.S. CLS. 2, 13, 22, 25, 32 AND 50).
FIRST USE 1-0-2005; IN COMMERCE 1-0-2005.

GLADIATOR CADET

THE MARK CONSISTS OF STANDARD CHARACTERS WITHOUT CLAIM TO ANY PARTICULAR FONT, STYLE, SIZE, OR COLOR.

OWNER OF U.S. REG. NOS. 2,787,628, 2,787,629, AND 2,789,830.

FOR METAL SHELVES AND METAL STORAGE CABINETS; WORK BENCHES, WORKBENCH BACK-SPLASH WITH ELECTRICAL OUTLETS, WOOD WORKING SURFACES IN THE NATURE OF A TABLE TOP ON A STORAGE CABINET; WALL STORAGE PANELS IN THE NATURE OF SLOTTED WALL MOUNTED TOOL RACKS (U.S. CLS. 2, 13, 22, 25, 32 AND 50).
FIRST USE 7-10-2005; IN COMMERCE 7-10-2005.

3,299,005. KRUEGER INTERNATIONAL, INC., GREEN BAY, WI. SN 78-592,515. PUB. 12-20-2005, FILED 3-22-2005.

3,299,043. KIMBALL INTERNATIONAL, INC., JASPER, IN. SN 78-601,003. PUB. 7-11-2006, FILED 4-4-2005.

FLAT SCREEN GARAGE

THE MARK CONSISTS OF STANDARD CHARACTERS WITHOUT CLAIM TO ANY PARTICULAR FONT, STYLE, SIZE, OR COLOR.

NO CLAIM IS MADE TO THE EXCLUSIVE RIGHT TO USE "FLAT SCREEN", APART FROM THE MARK AS SHOWN.
FOR FURNITURE (U.S. CLS. 2, 13, 22, 25, 32 AND 50).
FIRST USE 9-1-2006; IN COMMERCE 9-1-2006.

MONTERREY

THE MARK CONSISTS OF STANDARD CHARACTERS WITHOUT CLAIM TO ANY PARTICULAR FONT, STYLE, SIZE, OR COLOR.

FOR OFFICE FURNITURE, NAMELY SEATING (U.S. CLS. 2, 13, 22, 25, 32 AND 50).
FIRST USE 10-11-2005; IN COMMERCE 10-11-2005.

CLASS 20—(Continued).

3,299,095. SAFCO PRODUCTS COMPANY, MINNEAPOLIS, MN. SN 78-620,707. PUB. 9-5-2006, FILED 5-2-2005.

GROOVE

THE MARK CONSISTS OF STANDARD CHARACTERS WITHOUT CLAIM TO ANY PARTICULAR FONT, STYLE, SIZE, OR COLOR.

FOR OFFICE FURNITURE, NAMELY, OFFICE CHAIRS (U.S. CLS. 2, 13, 22, 25, 32 AND 50).

FIRST USE 8-31-2006; IN COMMERCE 8-31-2006.

3,299,139. KOELLIKER ENTERPRISES, LLC, SPRING, TX. SN 78-640,236. PUB. 2-21-2006, FILED 5-31-2005.

YUR FRAMED

THE MARK CONSISTS OF STANDARD CHARACTERS WITHOUT CLAIM TO ANY PARTICULAR FONT, STYLE, SIZE, OR COLOR.

FOR NON PRECIOUS METAL MAGNETIC PICTURE FRAMES SUITABLE FOR ATTACHMENT TO ANY METAL SURFACE (U.S. CLS. 2, 13, 22, 25, 32 AND 50).

FIRST USE 5-17-2006; IN COMMERCE 11-28-2006.

3,299,332. SEALY TECHNOLOGY LLC, TRINITY, NC. SN 78-718,050. PUB. 6-20-2006, FILED 9-22-2005.

SEALY

THE MARK CONSISTS OF STANDARD CHARACTERS WITHOUT CLAIM TO ANY PARTICULAR FONT, STYLE, SIZE, OR COLOR.

OWNER OF U.S. REG. NOS. 426,168, 1,189,347, AND OTHERS.

FOR BED FRAMES (U.S. CLS. 2, 13, 22, 25, 32 AND 50). FIRST USE 12-21-2005; IN COMMERCE 12-21-2005.

CLASS 20—(Continued).

3,299,334. SEALY TECHNOLOGY LLC, TRINITY, NC. SN 78-718,282. PUB. 6-20-2006, FILED 9-22-2005.



OWNER OF U.S. REG. NOS. 426,168, 1,189,347, AND OTHERS.

THE MARK CONSISTS OF THE WORD SEALY WITHIN A BUTTERFLY-TYPE WINGED DESIGN.

FOR BED FRAMES (U.S. CLS. 2, 13, 22, 25, 32 AND 50). FIRST USE 12-21-2005; IN COMMERCE 12-21-2005.

3,299,387. HNI TECHNOLOGIES INC., MUSCATINE, IA. SN 78-729,429. PUB. 6-20-2006, FILED 10-8-2005.

RELATE

THE MARK CONSISTS OF STANDARD CHARACTERS WITHOUT CLAIM TO ANY PARTICULAR FONT, STYLE, SIZE, OR COLOR.

FOR FURNITURE (U.S. CLS. 2, 13, 22, 25, 32 AND 50). FIRST USE 3-27-2006; IN COMMERCE 8-10-2006.

3,299,402. BABY DELIGHT, INC., WOODBRIDGE, CA. SN 78-731,784. PUB. 2-13-2007, FILED 10-12-2005.

CUDDLE CUBBY

THE MARK CONSISTS OF STANDARD CHARACTERS WITHOUT CLAIM TO ANY PARTICULAR FONT, STYLE, SIZE, OR COLOR.

FOR AFTER-BATH CUSHIONED PADS, FOR USE BY INFANTS, BABIES, AND THE LIKE (U.S. CLS. 2, 13, 22, 25, 32 AND 50).

FIRST USE 11-14-2005; IN COMMERCE 11-14-2005.

CLASS 20—(Continued).

3,299,420. ANTENNA THEATRE, INC., SAUSALITO, CA. SN 78-734,871. PUB. 6-20-2006, FILED 10-17-2005.

CLASS 20—(Continued).

3,299,636. BERGE, RICK, FARIBAULT, MN. AND BERGE, LESLIE, FARIBAULT, MN. SN 78-770,393. PUB. 11-14-2006, FILED 12-9-2005.

SLOTOLOGY

THE MARK CONSISTS OF STANDARD CHARACTERS WITHOUT CLAIM TO ANY PARTICULAR FONT, STYLE, SIZE, OR COLOR.
FOR FURNITURE (U.S. CLS. 2, 13, 22, 25, 32 AND 50).
FIRST USE 6-0-2004; IN COMMERCE 11-0-2006.

3,299,531. DDC, INCORPORATED, LEAWOOD, KS. SN 78-750,544. PUB. 7-11-2006, FILED 11-9-2005.

PLANESHEETS

THE MARK CONSISTS OF STANDARD CHARACTERS WITHOUT CLAIM TO ANY PARTICULAR FONT, STYLE, SIZE, OR COLOR.
FOR FITTED FABRIC FURNITURE COVERS, NAMELY, FITTED PERSONAL COVERS FOR AIRLINE SEATS (U.S. CLS. 2, 13, 22, 25, 32 AND 50).
FIRST USE 12-9-2005; IN COMMERCE 12-9-2005.

THE ROAD OF LIFE

THE MARK CONSISTS OF STANDARD CHARACTERS WITHOUT CLAIM TO ANY PARTICULAR FONT, STYLE, SIZE, OR COLOR.
FOR FRAME TO CONTAIN PICTURES, PHOTOGRAPHS, WRITINGS, VERSE OR ART WORK (U.S. CLS. 2, 13, 22, 25, 32 AND 50).
FIRST USE 12-31-2006; IN COMMERCE 12-31-2006.

3,299,661. MCS INDUSTRIES, INC., EASTON, PA. SN 78-776,254. PUB. 10-31-2006, FILED 12-19-2005.

3,299,599. AMERICAN SEATING COMPANY, GRAND RAPIDS, MI. SN 78-763,517. PUB. 7-18-2006, FILED 11-30-2005.



MAJESTIC

THE MARK CONSISTS OF STANDARD CHARACTERS WITHOUT CLAIM TO ANY PARTICULAR FONT, STYLE, SIZE, OR COLOR.
FOR AUDITORIUM AND THEATER SEATING (U.S. CLS. 2, 13, 22, 25, 32 AND 50).
FIRST USE 12-0-2005; IN COMMERCE 12-0-2005.

NO CLAIM IS MADE TO THE EXCLUSIVE RIGHT TO USE "WALL", APART FROM THE MARK AS SHOWN.
THE COLOR(S) BLUE, PURPLE AND BLACK IS/ARE CLAIMED AS A FEATURE OF THE MARK.
THE MARK CONSISTS OF A BLACK WAVE DESIGN WITH THE WORD "WALL" APPEARING IN BLACK LETTERING ABOVE THE WAVE DESIGN IN A BLUE BACKGROUND AND THE WORD "SOLUTIONS" APPEARING IN BLACK LETTERING BELOW THE WAVE DESIGN IN A PURPLE BACKGROUND.
FOR DISPLAY CASES; FURNITURE FOR DISPLAYING GOODS; MIRRORS; PICTURE FRAMES; SHELVES; SHELVING AND COMPONENT PARTS THEREOF, NAMELY SHELVES AND BRACKETS SOLD AS A UNIT (U.S. CLS. 2, 13, 22, 25, 32 AND 50).
FIRST USE 8-17-2006; IN COMMERCE 8-17-2006.

CLASS 20—(Continued).

3,299,683. ANIMALS MATTER, INC., TORRANCE, CA. SN 78-783,428. PUB. 10-24-2006, FILED 12-31-2005.

ANIMALS MATTER

THE MARK CONSISTS OF STANDARD CHARACTERS WITHOUT CLAIM TO ANY PARTICULAR FONT, STYLE, SIZE, OR COLOR.

NO CLAIM IS MADE TO THE EXCLUSIVE RIGHT TO USE "ANIMALS", APART FROM THE MARK AS SHOWN. FOR BEDS FOR HOUSEHOLD PETS; CUSHIONS; DOG BEDS; FITTED FABRIC FURNITURE COVERS; FURNITURE; PET CUSHIONS; PET RAMP; PLAYHOUSES FOR PETS; PORTABLE BEDS FOR PETS (U.S. CLS. 2, 13, 22, 25, 32 AND 50).

FIRST USE 5-1-2003; IN COMMERCE 5-10-2003.

3,299,749. THE SHERWIN-WILLIAMS COMPANY, CLEVELAND, OH. SN 78-800,128. PUB. 7-18-2006, FILED 1-26-2006.

COLOR SIMPLICITY

THE MARK CONSISTS OF STANDARD CHARACTERS WITHOUT CLAIM TO ANY PARTICULAR FONT, STYLE, SIZE, OR COLOR.

NO CLAIM IS MADE TO THE EXCLUSIVE RIGHT TO USE "COLOR", APART FROM THE MARK AS SHOWN. FOR DISPLAY RACKS (U.S. CLS. 2, 13, 22, 25, 32 AND 50).

FIRST USE 3-27-2006; IN COMMERCE 3-27-2006.

3,299,779. ILLINOIS TOOL WORKS INC., GLENVIEW, IL. SN 78-810,377. PUB. 8-1-2006, FILED 2-8-2006.

DAHTI TECHNOLOGIES

THE MARK CONSISTS OF STANDARD CHARACTERS WITHOUT CLAIM TO ANY PARTICULAR FONT, STYLE, SIZE, OR COLOR.

NO CLAIM IS MADE TO THE EXCLUSIVE RIGHT TO USE "TECHNOLOGIES", APART FROM THE MARK AS SHOWN.

FOR COMFORT SEATING FOR FURNITURE AND COMFORT SEATING FOR STADIUM, AUDITORIUM, CINEMA AND THEATER SEATS (U.S. CLS. 2, 13, 22, 25, 32 AND 50).

FIRST USE 4-12-2004; IN COMMERCE 4-12-2004.

CLASS 20—(Continued).

3,299,828. KIMBALL INTERNATIONAL, INC., JASPER, IN. SN 78-827,044. PUB. 3-6-2007, FILED 3-2-2006.

BEO

THE MARK CONSISTS OF STANDARD CHARACTERS WITHOUT CLAIM TO ANY PARTICULAR FONT, STYLE, SIZE, OR COLOR.

FOR OFFICE FURNITURE, NAMELY, GUEST CHAIRS (U.S. CLS. 2, 13, 22, 25, 32 AND 50).

FIRST USE 8-1-2006; IN COMMERCE 8-1-2006.

3,299,846. WHITE, JULIE ANNE, MARSHFIELD HILLS, MA. SN 78-833,788. PUB. 10-31-2006, FILED 3-9-2006.

BED BOOTS

THE MARK CONSISTS OF STANDARD CHARACTERS WITHOUT CLAIM TO ANY PARTICULAR FONT, STYLE, SIZE, OR COLOR.

NO CLAIM IS MADE TO THE EXCLUSIVE RIGHT TO USE "BED", APART FROM THE MARK AS SHOWN.

FOR FURNITURE PARTS, NAMELY BED RISERS COMPRISED OF INDIVIDUAL SUPPORTS FOR PLACEMENT UNDER THE LEGS OF A BED FRAME TO RAISE THE HEIGHT OF THE FRAME (U.S. CLS. 2, 13, 22, 25, 32 AND 50).

FIRST USE 3-13-2006; IN COMMERCE 9-15-2006.

3,299,958. NIEN ADVANCED SOLUTIONS, SANTA FE SPRINGS, CA. SN 78-876,639. PUB. 12-12-2006, FILED 5-4-2006.

FORTUNA

THE MARK CONSISTS OF STANDARD CHARACTERS WITHOUT CLAIM TO ANY PARTICULAR FONT, STYLE, SIZE, OR COLOR.

THE ENGLISH TRANSLATION OF THE WORD FORTUNA IN THE MARK IS FORTUNE.

FOR INTERIOR WINDOW SHUTTERS (U.S. CLS. 2, 13, 22, 25, 32 AND 50).

FIRST USE 6-1-2006; IN COMMERCE 6-1-2006.

CLASS 20—(Continued).

3,300,003. THROCKMORTON, PAUL J, BOULDER, CO. SN 78-890,912. PUB. 1-2-2007, FILED 5-24-2006.

IFoundYourKeys.com

THE MARK CONSISTS OF STANDARD CHARACTERS WITHOUT CLAIM TO ANY PARTICULAR FONT, STYLE, SIZE, OR COLOR.

FOR PLASTIC KEY TAGS AND LABELS, NAMELY KEY TAGS AND LABELS THAT ASSIST IN THE RETURN OF LOST PROPERTY TO ITS OWNER (U.S. CLS. 2, 13, 22, 25, 32 AND 50).

FIRST USE 12-12-2006; IN COMMERCE 12-12-2006.

CLASS 21—(Continued).

3,298,562. HERITAGE MINT, LTD, SCOTTSDALE, AZ. SN 76-649,046. PUB. 2-13-2007, FILED 10-24-2005.

THE CHERRY TREE

FOR DINNERWARE (U.S. CLS. 2, 13, 23, 29, 30, 33, 40 AND 50).

FIRST USE 11-15-2005; IN COMMERCE 11-15-2005.

3,300,149. SAUDER MANUFACTURING COMPANY, ARCHBOLD, OH. SN 78-940,227. PUB. 3-13-2007, FILED 7-28-2006.

TREY

THE MARK CONSISTS OF STANDARD CHARACTERS WITHOUT CLAIM TO ANY PARTICULAR FONT, STYLE, SIZE, OR COLOR.

FOR CHAIRS (U.S. CLS. 2, 13, 22, 25, 32 AND 50).
FIRST USE 4-17-2007; IN COMMERCE 4-17-2007.

3,298,567. INGEAR CORPORATION, BUFFALO GROVE, IL. SN 76-649,430. PUB. 7-4-2006, FILED 10-31-2005.



FOR THERMAL INSULATED CONTAINERS FOR FOOD AND BEVERAGE (U.S. CLS. 2, 13, 23, 29, 30, 33, 40 AND 50).

FIRST USE 4-30-2006; IN COMMERCE 4-30-2006.

CLASS 21—HOUSEWARES AND GLASS

3,298,427. ORIGINAL CALIFORNIA CAR DUSTER COMPANY, INC., CHATSWORTH, CA. SN 76-439,290. PUB. 11-4-2003, FILED 8-7-2002.

The Original
CALIFORNIA
Dust Glove

OWNER OF U.S. REG. NOS. 2,085,125, 2,676,809, AND OTHERS.

NO CLAIM IS MADE TO THE EXCLUSIVE RIGHT TO USE "DUST GLOVE", APART FROM THE MARK AS SHOWN.

THE MARK CONSISTS OF THE WORDS "THE ORIGINAL CALIFORNIA DUST GLOVE" IN THE STYLIZED DESIGN, AS SHOWN IN THE DRAWING.

SEC. 2(F) AS TO "THE ORIGINAL CALIFORNIA".

FOR MOP TYPE CLEANING DEVICE WORN ON THE HAND TO REMOVE DIRT AND DUST (U.S. CLS. 2, 13, 23, 29, 30, 33, 40 AND 50).

FIRST USE 5-9-2006; IN COMMERCE 5-9-2006.

3,298,582. CLEANERS.TV, INC., TOMS RIVER, NJ. SN 76-658,177. PUB. 11-28-2006, FILED 4-11-2006.

EVERYTHING DUSTER

THE MARK CONSISTS OF STANDARD CHARACTERS WITHOUT CLAIM TO ANY PARTICULAR FONT, STYLE, SIZE, OR COLOR.

NO CLAIM IS MADE TO THE EXCLUSIVE RIGHT TO USE "DUSTER", APART FROM THE MARK AS SHOWN.
FOR HAND HELD HOUSEHOLD DUSTER (U.S. CLS. 2, 13, 23, 29, 30, 33, 40 AND 50).

FIRST USE 9-13-2006; IN COMMERCE 9-13-2006.

CLASS 21—(Continued).

3,298,584. LIFEWAY CHRISTIAN RESOURCES OF THE SOUTHERN BAPTIST CONVENTION, NASHVILLE, TN. SN 76-658,577. PUB. 11-28-2006, FILED 4-17-2006.

CLASS 21—(Continued).

3,299,061. THE DECOR CORPORATION PTY LTD, SCOR-ESBY, STATE OF VICTORIA, AUSTRALIA. SN 78-606,347. PUB. 9-19-2006, FILED 4-11-2005.

REMEMBRANCEWARE

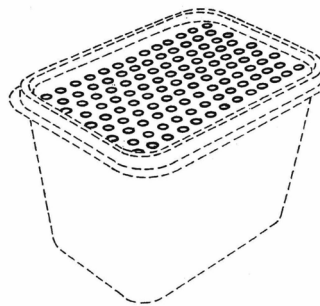

THE MARK CONSISTS OF STANDARD CHARACTERS WITHOUT CLAIM TO ANY PARTICULAR FONT, STYLE, SIZE, OR COLOR.

OWNER OF U.S. REG. NO. 2,137,691.
FOR COMMUNIONWARE, NAMELY, TRAYS, BREADPLATES, AND TRAY COVERS (U.S. CLS. 2, 13, 23, 29, 30, 33, 40 AND 50).
FIRST USE 1-0-2007; IN COMMERCE 1-0-2007.

THE MARK CONSISTS OF AN EVENLY SPACED PATTERN OF CIRCLES DETECTABLY RAISED FROM THE BACKGROUND SURFACE OF THE LID OF THE CONTAINER.

FOR PORTABLE CONTAINERS, WHOLLY OR PRE- DOMINANTLY OF PLASTIC, BUT NOT PRECIOUS METAL, FOR STORING HOUSEHOLD AND DOMESTIC GOODS (U.S. CLS. 2, 13, 23, 29, 30, 33, 40 AND 50).
FIRST USE 7-30-1999; IN COMMERCE 7-30-1999.

3,298,714. BOSTICK, CHARLES ROBERT II, GARDENA, CA. SN 78-337,313. PUB. 9-21-2004, FILED 12-5-2003.

3,299,324. IGNITE USA, LLC, CHICAGO, IL. SN 78-716,257. PUB. 9-12-2006, FILED 9-20-2005.

GROUNDS KEEPER

CONTIGO

THE MARK CONSISTS OF STANDARD CHARACTERS WITHOUT CLAIM TO ANY PARTICULAR FONT, STYLE, SIZE, OR COLOR.

FOR TRAY WITH POURING SPOUT (U.S. CLS. 2, 13, 23, 29, 30, 33, 40 AND 50).
FIRST USE 3-9-2007; IN COMMERCE 3-9-2007.

THE MARK CONSISTS OF STANDARD CHARACTERS WITHOUT CLAIM TO ANY PARTICULAR FONT, STYLE, SIZE, OR COLOR.

THE FOREIGN WORDING IN THE MARK TRANSLATES INTO ENGLISH AS "WITH YOU".

FOR BEVERAGE CONTAINERS, NAMELY MUGS, INSULATED CONTAINERS, AND DRINKING GLASSES (U.S. CLS. 2, 13, 23, 29, 30, 33, 40 AND 50).
FIRST USE 12-0-2005; IN COMMERCE 12-0-2005.

CLASS 21—(Continued).

3,299,514. SPORNETTE INTERNATIONAL INC, HOMEWOOD, IL. SN 78-747,311. PUB. 7-4-2006, FILED 11-4-2005.

VENTILATOR

THE MARK CONSISTS OF STANDARD CHARACTERS WITHOUT CLAIM TO ANY PARTICULAR FONT, STYLE, SIZE, OR COLOR.

FOR HAIR BRUSHES AND COMBS (U.S. CLS. 2, 13, 23, 29, 30, 33, 40 AND 50).

FIRST USE 5-0-2006; IN COMMERCE 5-0-2006.

3,299,657. NINGBO HUASHENG METAL PRODUCTS CO., LTD, ZHEJIANG, CHINA. SN 78-774,709. PUB. 8-8-2006, FILED 12-15-2005.

JUSTCOOK

FOR UTENSILS FOR HOUSEHOLD PURPOSES, NOT OF PRECIOUS METAL, NAMELY, FRYING PANS OF ALUMINUM, SOUP COOKING POTS OF STAINLESS STEEL, NON-STICK COOKING PANS, FRYING PANS OF UNWROUGHT IRON; NON-ELECTRIC PRESSURE COOKERS; PORCELAIN ENAMEL PLASTIC UTENSILS, NAMELY, BASINS BEING BOWLS, BOWLS, DISHES, POTS, CUPS; GLASSWARE FOR HOUSEHOLD PURPOSES, NAMELY, CUPS, DISHES, POTS (U.S. CLS. 2, 13, 23, 29, 30, 33, 40 AND 50).

FIRST USE 4-18-2000; IN COMMERCE 3-16-2004.

CLASS 21—(Continued).

3,299,712. NCP ENTERPRISES, LLC, SPRINGFIELD, OH. SN 78-790,544. PUB. 1-2-2007, FILED 1-12-2006.

Healthi-Pro

THE MARK CONSISTS OF STANDARD CHARACTERS WITHOUT CLAIM TO ANY PARTICULAR FONT, STYLE, SIZE, OR COLOR.

FOR BUCKETS, BRUSHES FOR WASHING AND CLEANING, BROOMS, CLOTHS FOR WIPING OR DUSTING, DUST PANS, MOPS, MOP HEADS, SQUEEGEES, CLEANING SPONGES, NON-ELECTRICAL CARPET AND HARDWOOD FLOOR SWEEPERS, AND SCOURING PADS (U.S. CLS. 2, 13, 23, 29, 30, 33, 40 AND 50).

FIRST USE 12-27-2005; IN COMMERCE 12-27-2005.

3,299,854. INTEX DIY INC., VILLA RICA, GA. SN 78-836,684. PUB. 11-7-2006, FILED 3-14-2006.

NEWCYCLED

THE MARK CONSISTS OF STANDARD CHARACTERS WITHOUT CLAIM TO ANY PARTICULAR FONT, STYLE, SIZE, OR COLOR.

FOR CLEANING RAGS (U.S. CLS. 2, 13, 23, 29, 30, 33, 40 AND 50).

FIRST USE 1-17-2007; IN COMMERCE 1-17-2007.

3,299,863. INTEX DIY INC., VILLA RICA, GA. SN 78-839,098. PUB. 10-24-2006, FILED 3-16-2006.

SCHMOPS

THE MARK CONSISTS OF STANDARD CHARACTERS WITHOUT CLAIM TO ANY PARTICULAR FONT, STYLE, SIZE, OR COLOR.

FOR MOPS, NAMELY MOPS THAT CAN BE WORN AS SLIPPERS FOR CLEANING PURPOSES (U.S. CLS. 2, 13, 23, 29, 30, 33, 40 AND 50).

FIRST USE 1-26-2007; IN COMMERCE 1-26-2007.

CLASS 21—(Continued).

3,299,934. SHU-YUN HSIA, TAOYUAN COUNTY 330, TAIWAN. SN 78-867,462. PUB. 1-16-2007, FILED 4-22-2006.

Rose & Roman

FOR TEA CUP PLATE; TRAY; FRUIT PLATE; COFFEE CUP; PLATE FOR COFFEE CUP; MEAL PLATE; RICE BOWL; SALAD BOWL; JUG; TEA POT NOT OF PRECIOUS METAL; BEVERAGeware FOR COFFEE; BEVERAGeware FOR MILK; BEVERAGeware FOR TEA; BEVERAGeware FOR LIQUOR; BEVERAGE CERAMICS WARE; SAUCER (U.S. CLS. 2, 13, 23, 29, 30, 33, 40 AND 50).

FIRST USE 1-10-2007; IN COMMERCE 6-15-2007.

3,299,972. SYLMARK HOLDINGS LIMITED, DUBLIN 2, IRELAND. SN 78-879,986. PUB. 11-21-2006, FILED 5-9-2006.

PIVOTOOL

THE MARK CONSISTS OF STANDARD CHARACTERS WITHOUT CLAIM TO ANY PARTICULAR FONT, STYLE, SIZE, OR COLOR.

FOR CLEANING MATERIALS AND INSTRUMENTS, NAMELY, SQUEEGEES, MOPS, BROOMS, SPONGES, AND DUSTING, DISH WASHING, FLOOR, POT CLEANING AND SCRUBBING BRUSHES, AND PARTS THEREOF, ALL FOR HOUSEHOLD OR COMMERCIAL USE (U.S. CLS. 2, 13, 23, 29, 30, 33, 40 AND 50).

FIRST USE 11-22-2006; IN COMMERCE 11-22-2006.

3,300,045. BUCKEYE TECHNOLOGIES INC., MEMPHIS, TN. SN 78-906,009. PUB. 1-23-2007, FILED 6-12-2006.

VERSACORE

THE MARK CONSISTS OF STANDARD CHARACTERS WITHOUT CLAIM TO ANY PARTICULAR FONT, STYLE, SIZE, OR COLOR.

FOR TOILET PAPER DISPENSER (U.S. CLS. 2, 13, 23, 29, 30, 33, 40 AND 50).

FIRST USE 7-3-2006; IN COMMERCE 7-3-2006.

CLASS 21—(Continued).

3,300,185. SUNSTAR AMERICAS, INC., CHICAGO, IL. SN 78-960,699. PUB. 1-23-2007, FILED 8-25-2006.

SUMMIT

THE MARK CONSISTS OF STANDARD CHARACTERS WITHOUT CLAIM TO ANY PARTICULAR FONT, STYLE, SIZE, OR COLOR.

FOR TOOTHBRUSHES (U.S. CLS. 2, 13, 23, 29, 30, 33, 40 AND 50).

FIRST USE 3-0-2007; IN COMMERCE 3-0-2007.

CLASS 22—CORDAGE AND FIBERS

3,298,672. AMERICHEM, INC., CUYAHOGA FALLS, OH. SN 78-242,196. PUB. 8-29-2006, FILED 4-25-2003.

FIBERTECH

FOR NATURAL PLANT FIBERS FOR USE AS A FILLER FOR PLASTIC COMPOUNDS THAT ARE USED IN THE FURTHER MANUFACTURE OF PLASTIC BUILDING MATERIALS (U.S. CLS. 1, 2, 7, 19, 22, 42 AND 50).

FIRST USE 2-14-2007; IN COMMERCE 2-14-2007.

3,299,113. RRR COMPANY (HONG KONG) LIMITED, HONG KONG, HONG KONG. SN 78-626,556. PUB. 6-20-2006, FILED 5-10-2005.

PARATOP

THE MARK CONSISTS OF STANDARD CHARACTERS WITHOUT CLAIM TO ANY PARTICULAR FONT, STYLE, SIZE, OR COLOR.

PRIORITY CLAIMED UNDER SEC. 44(D) ON ERPNTY TM OFC APPLICATION NO. 004121406, FILED 11-12-2004, REG. NO. 004121406, DATED 12-20-2005, EXPIRES 12-20-2015.

FOR TENTS, TARPAULINS, CANVAS CANOPIES AND ROPES (U.S. CLS. 1, 2, 7, 19, 22, 42 AND 50).

FIRST USE 5-9-2006; IN COMMERCE 5-9-2006.

CLASS 22—(Continued).

3,299,397. ADVANCED TECHNOLOGY MATERIALS, INC., DANBURY, CT. SN 78-730,990. PUB. 6-13-2006, FILED 10-11-2005.

NEWMIX

THE MARK CONSISTS OF STANDARD CHARACTERS WITHOUT CLAIM TO ANY PARTICULAR FONT, STYLE, SIZE, OR COLOR.

FOR PLASTIC DISPOSABLE BAGS FOR MIXING ACTIVE INGREDIENTS FOR INTERMEDIATE AND FINAL DRUG PRODUCTS (U.S. CLS. 1, 2, 7, 19, 22, 42 AND 50).

FIRST USE 12-6-2006; IN COMMERCE 12-6-2006.

3,299,453. OAKES, WILLIAM H., PORTLAND, OR. SN 78-737,985. PUB. 6-27-2006, FILED 10-21-2005.

GOYURT

THE MARK CONSISTS OF STANDARD CHARACTERS WITHOUT CLAIM TO ANY PARTICULAR FONT, STYLE, SIZE, OR COLOR.

FOR TENTS, NAMELY, MODERN YURTS (U.S. CLS. 1, 2, 7, 19, 22, 42 AND 50).

FIRST USE 12-17-2006; IN COMMERCE 12-17-2006.

3,299,512. UNIVERSAL COOPERATIVES, INC., EAGAN, MN. SN 78-747,161. PUB. 1-23-2007, FILED 11-4-2005.



FOR ROPES, CORDAGE, TWINE, BALING TWINE, RAW TEXTILE FIBERS AND STRING (U.S. CLS. 1, 2, 7, 19, 22, 42 AND 50).

FIRST USE 2-6-2006; IN COMMERCE 2-6-2006.

CLASS 22—(Continued).

3,299,818. NEMO EQUIPMENT, INC., NASHUA, NH. SN 78-823,218. PUB. 10-3-2006, FILED 2-24-2006.

AirSupported Technology

THE MARK CONSISTS OF STANDARD CHARACTERS WITHOUT CLAIM TO ANY PARTICULAR FONT, STYLE, SIZE, OR COLOR.

FOR TENTS; TENTS FOR MOUNTAINEERING OR CAMPING (U.S. CLS. 1, 2, 7, 19, 22, 42 AND 50).

FIRST USE 5-2-2005; IN COMMERCE 5-2-2005.

3,299,980. L & P PROPERTY MANAGEMENT COMPANY, SOUTH GATE, CA. SN 78-883,255. PUB. 12-26-2006, FILED 5-15-2006.

BALE GUARD

THE MARK CONSISTS OF STANDARD CHARACTERS WITHOUT CLAIM TO ANY PARTICULAR FONT, STYLE, SIZE, OR COLOR.

NO CLAIM IS MADE TO THE EXCLUSIVE RIGHT TO USE "BALE", APART FROM THE MARK AS SHOWN.

FOR PROTECTIVE BAGS CONSTRUCTED OF WOVEN POLYPROPYLENE, POLYETHYLENE FILM, BURLAP, OR WOVEN COTTON, FOR USE IN THE AGRICULTURAL FIELD FOR COVERING COTTON BALES (U.S. CLS. 1, 2, 7, 19, 22, 42 AND 50).

FIRST USE 9-1-2006; IN COMMERCE 9-1-2006.

CLASS 23—YARNS AND THREADS

3,298,967. BERROCO, INC., UXBRIDGE, MA. SN 78-575,911. PUB. 7-11-2006, FILED 2-27-2005.

FOLIAGE

THE MARK CONSISTS OF STANDARD CHARACTERS WITHOUT CLAIM TO ANY PARTICULAR FONT, STYLE, SIZE, OR COLOR.

FOR YARNS FOR HAND KNITTING (U.S. CL. 43).

FIRST USE 5-4-2005; IN COMMERCE 5-4-2005.

CLASS 24—FABRICS

CLASS 24—(Continued).

3,298,529. DAVID TEXTILES, INC., CITY OF COMMERCE, CA. SN 76-638,314. PUB. 7-18-2006, FILED 5-10-2005.

TELEGRAPH ROAD STUDIO

THE MARK CONSISTS OF STANDARD CHARACTERS WITHOUT CLAIM TO ANY PARTICULAR FONT, STYLE, SIZE, OR COLOR.

NO CLAIM IS MADE TO THE EXCLUSIVE RIGHT TO USE "STUDIO", APART FROM THE MARK AS SHOWN.

FOR TEXTILE FABRICS AND TEXTILE RELATED PRODUCTS, NAMELY THROWS, BED BLANKETS, BEDSPREADS, TABLECLOTHS, COMFORTERS, TEXTILE WALL HANGINGS, TOWELS AND PILLOW COVERS (U.S. CLS. 42 AND 50).

FIRST USE 4-30-2005; IN COMMERCE 4-30-2005.

3,298,546. RUENTEX INDUSTRIES LTD., TAIPEI, TAIWAN. SN 76-644,390. PUB. 8-8-2006, FILED 8-8-2005.

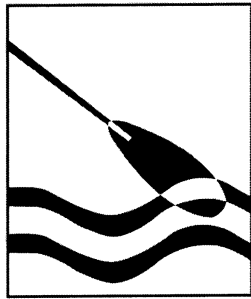

FOR CURTAIN FABRIC, COTTON QUILTS, SILK QUILTS, TOWELING QUILT, NYLON QUILT, BED SHEETS, BED COVERS, BEDSPREADS, PILLOW CASES, MOSQUITO NETS, BLANKETS, TABLECLOTHS, ARTIFICIAL SILK BLANKETS CURTAINS, DOOR CURTAINS, FABRIC CURTAINS, TOWELS, BATH TOWELS AND HANDKERCHIEFS (U.S. CLS. 42 AND 50).

FIRST USE 11-30-2004; IN COMMERCE 11-30-2004.

3,298,621. PGA TOUR, INC., PONTE VEDRA BEACH, FL. SN 77-017,400. PUB. 1-23-2007, FILED 10-10-2006.



OWNER OF U.S. REG. NOS. 1,523,862, 2,877,023, AND OTHERS.

FOR TOWELS (U.S. CLS. 42 AND 50).

FIRST USE 5-1-2007; IN COMMERCE 5-1-2007.

CLASS 24—(Continued).

3,298,895. JEREMY NOONAN, WOODINVILLE, WA. SN 78-534,449. PUB. 3-6-2007, FILED 12-17-2004.

THE BLANKET THAT GOES WITH YOU

THE MARK CONSISTS OF STANDARD CHARACTERS WITHOUT CLAIM TO ANY PARTICULAR FONT, STYLE, SIZE, OR COLOR.

NO CLAIM IS MADE TO THE EXCLUSIVE RIGHT TO USE "BLANKET", APART FROM THE MARK AS SHOWN.

FOR BLANKETS FOR OUTDOOR USE (U.S. CLS. 42 AND 50).

FIRST USE 1-25-2006; IN COMMERCE 1-26-2006.

3,298,976. DIFCO PERFORMANCE FABRICS INC., MONTREAL, QUEBEC, CANADA. SN 78-579,012. PUB. 7-18-2006, FILED 3-3-2005.

GENESIS FLEECE

THE MARK CONSISTS OF STANDARD CHARACTERS WITHOUT CLAIM TO ANY PARTICULAR FONT, STYLE, SIZE, OR COLOR.

PRIORITY CLAIMED UNDER SEC. 44(D) ON CANADA APPLICATION NO. 1249146, FILED 3-2-2005, REG. NO. TMA657518, DATED 1-27-2006, EXPIRES 1-27-2021.

OWNER OF U.S. REG. NO. 2,451,619.

NO CLAIM IS MADE TO THE EXCLUSIVE RIGHT TO USE "FLEECE", APART FROM THE MARK AS SHOWN.

FOR ARAMID AND ARAMID-BLEND FABRICS FOR USE IN THE MANUFACTURE OF CLOTHING WORN BY FIREFIGHTERS AND UTILITY, INDUSTRIAL AND CHEMICAL WORKERS (U.S. CLS. 42 AND 50).

FIRST USE 3-30-2005; IN COMMERCE 4-23-2005.

3,299,128. E2, INC., SANTA BARBARA, CA. SN 78-635,761. PUB. 7-25-2006, FILED 5-24-2005.

FELTALES

THE MARK CONSISTS OF STANDARD CHARACTERS WITHOUT CLAIM TO ANY PARTICULAR FONT, STYLE, SIZE, OR COLOR.

FOR FELT CLOTH PIECES FOR USE IN ARTS AND CRAFTS (U.S. CLS. 42 AND 50).

FIRST USE 2-10-2007; IN COMMERCE 2-10-2007.

CLASS 24—(Continued).

3,299,138. HUNTER DOUGLAS INC., UPPER SADDLE RIVER, NJ. SN 78-640,073. PUB. 6-27-2006, FILED 5-31-2005.

CASUELLE

THE MARK CONSISTS OF STANDARD CHARACTERS WITHOUT CLAIM TO ANY PARTICULAR FONT, STYLE, SIZE, OR COLOR.

FOR FABRIC FOR THE MANUFACTURE OF WINDOW COVERINGS AND WINDOW SHADINGS (U.S. CLS. 42 AND 50).

FIRST USE 8-0-2005; IN COMMERCE 8-0-2005.

3,299,319. BRAY, KRISTI L., SAN CLEMENTE, CA. AND GUTIERREZ, HEATHER R., SAN CLEMENTE, CA. SN 78-714,564. PUB. 11-28-2006, FILED 9-16-2005.

MΘMΘ

FOR NURSING BLANKETS AND BED BLANKETS (U.S. CLS. 42 AND 50).

FIRST USE 1-1-2006; IN COMMERCE 1-1-2006.

3,299,680. BLISSLIVING, INC., ROCKVILLE, MD. SN 78-782,556. PUB. 10-24-2006, FILED 12-29-2005.

BLISSLIVING

THE MARK CONSISTS OF STANDARD CHARACTERS WITHOUT CLAIM TO ANY PARTICULAR FONT, STYLE, SIZE, OR COLOR.

FOR BED LINENS, NAMELY, SHEETS, BEDCOVERS, BEDDING, PILLOWCASES, COMFORTERS, DUVETS, DUVET COVERS, THROW BLANKETS AND QUILTS (U.S. CLS. 42 AND 50).

FIRST USE 12-15-2006; IN COMMERCE 12-15-2006.

CLASS 24—(Continued).

3,299,864. TECIDOS FIAMA LTDA, SÃO PAULO, BRAZIL. SN 78-840,224. PUB. 12-19-2006, FILED 3-17-2006.



THE STIPPLING IN THE LOWER CROSSBAR IS FOR SHADING PURPOSES AND DOES NOT INDICATE COLOR.

FOR FABRICS FOR THE MANUFACTURE OF BED LINEN, NAMELY, SHEETS, PILLOW CASES, SHAMS, COVERLETS, BLANKETS AND DUVETS; FABRICS FOR THE MANUFACTURE OF DRAPERIES AND CURTAINS; UPHOLSTERY FABRICS FOR COVERING FURNITURE MADE OF ACRYLIC, COTTON, HEMP, LINEN, SYNTHETIC FIBERS, CHENILLES, TAFFETA AND BOUCLE; UPHOLSTERY FABRICS FOR COVERING FURNITURE MADE OF ACRYLIC, COTTON, HEMP, LINEN, SYNTHETIC FIBERS, CHENILLES, TAFFETA AND BOUCLE ALL COATED WITH STAIN-RESISTANT IMPERVIOUS FILMS BONDED TO THE SURFACE (U.S. CLS. 42 AND 50).

FIRST USE 0-0-1999; IN COMMERCE 10-5-2001.

3,299,986. D'AMORE, MICHELE, NEW YORK, NY. SN 78-885,347. PUB. 1-16-2007, FILED 5-17-2006.

THE NAME(S), PORTRAIT(S), AND/OR SIGNATURE(S) SHOWN IN THE MARK IDENTIFIES MICHELE D'AMORE, WHOSE CONSENT(S) TO REGISTER IS SUBMITTED.

THE MARK CONSISTS OF LETTERS IN BICKLEY SCRIPT LET WITH THE INITIAL "M" BEING AN ORIGINAL DESIGN OF A POODLE AND NOT PART OF THE FONT.

FOR PRINTED TEXTILE FABRICS OF COTTON, COTTON BLENDS, LINEN, LINEN BLENDS, SILK, SILK BLENDS, WOOL, WOOL BLENDS, HEMP, WORSTED, DAMASK, NYLON, RAYON, ACETATE, POLYESTER, SYNTHETIC FIBER FABRICS, JUTE, LUREX, MOHAIR, VELVET, SATIN, VINYL AND VINYL-COATED FABRICS AND FAKE FUR (U.S. CLS. 42 AND 50).

FIRST USE 11-30-2006; IN COMMERCE 11-30-2006.

CLASS 24—(Continued).

3,300,066. JONAS, TRINA, BURBANK, CA. SN 78-912,310.
PUB. 1-30-2007, FILED 6-20-2006.

Baby Jayne's

FOR BLANKET THROWS; BURP CLOTHS; CHILDREN'S BLANKETS; QUILTS (U.S. CLS. 42 AND 50).
FIRST USE 7-1-2006; IN COMMERCE 12-10-2006.

CLASS 25—CLOTHING

3,298,441. GOOD BUDDY, INC., LOS ANGELES, CA. SN 76-513,401. PUB. 12-16-2003, FILED 5-6-2003.

THE MOONEY SUZUKI

OWNER OF U.S. REG. NOS. 2,821,049, 2,821,050, AND 2,853,003.

FOR CLOTHING, NAMELY, T-SHIRTS (U.S. CLS. 22 AND 39).

FIRST USE 7-19-1997; IN COMMERCE 7-23-1997.

3,298,458. NISSHINBO INDUSTRIES, INC., TOKYO 103-8650, JAPAN. SN 76-576,416. PUB. 6-20-2006, FILED 2-17-2004.

EKIAN

THE MARK CONSISTS OF STANDARD CHARACTERS WITHOUT CLAIM TO ANY PARTICULAR FONT, STYLE, SIZE, OR COLOR.

OWNER OF U.S. REG. NO. 2,553,029.

FOR FABRIC USED AS AN INTEGRAL COMPONENT OF CLOTHING, NAMELY, JACKETS, PANTS, JEANS, SKIRTS, DRESS SHIRTS, CASUAL SHIRTS, BLOUSES, T-SHIRTS, POLO SHIRTS, SWEATERS, SOCKS, UNDERWEAR, AND SLEEPWEAR (U.S. CLS. 22 AND 39).

FIRST USE 3-6-2007; IN COMMERCE 3-6-2007.

3,298,475. MJA INDUSTRIES LLC, NORTH WOODMERE, NY. SN 76-606,947. PUB. 7-5-2005, FILED 8-13-2004.

ALLISON MORGAN

THE MARK CONSISTS OF STANDARD CHARACTERS WITHOUT CLAIM TO ANY PARTICULAR FONT, STYLE, SIZE, OR COLOR.

CLASS 25—(Continued).

THE NAME ALLISON MORGAN DOES NOT IDENTIFY A LIVING INDIVIDUAL.

FOR CLOTHING, NAMELY JEANS, DENIM JEANS, TROUSERS, SLACKS, ATHLETIC UNIFORMS, TOPS, JOGGING SUITS, SWEATERS (U.S. CLS. 22 AND 39).

FIRST USE 11-1-2003; IN COMMERCE 11-1-2003.

3,298,481. SAMABALY, ALY, MEDINA, OH. SN 76-613,470.
PUB. 1-17-2006, FILED 9-27-2004.

ALYMALI

THE MARK CONSISTS OF STANDARD CHARACTERS WITHOUT CLAIM TO ANY PARTICULAR FONT, STYLE, SIZE, OR COLOR.

FOR MEN'S FORMAL AND CASUAL SPORTSWEAR AND CLOTHING ACCESSORIES, NAMELY, PANTS, SHIRTS, SHORTS, T-SHIRTS, BELTS, HATS, WRIST BANDS, JACKETS; AND WOMEN'S FORMAL AND CASUAL SPORTSWEAR AND CLOTHING ACCESSORIES, NAMELY, PANTS, COATS, HATS, SHIRTS (U.S. CLS. 22 AND 39).

FIRST USE 5-11-2006; IN COMMERCE 5-11-2006.

3,298,482. BLOOM, AKIVAH, BROOKLYN, NY. AND DRA-TEL, JASON EVAN, BROOKLYN, NY. SN 76-613,768. PUB. 9-13-2005, FILED 9-28-2004.

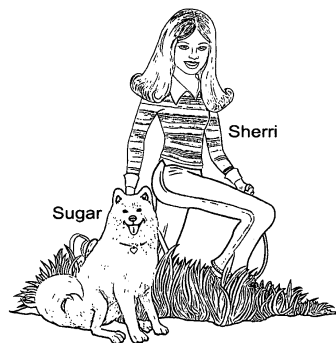

THE LINING IS A FEATURE OF THE MARK AND DOES NOT INDICATE COLOR.

THE LIKENESS (OR, "PORTRAIT") IN THE MARK DOES NOT IDENTIFY A LIVING INDIVIDUAL.

FOR BABY BIBS NOT OF PAPER, BEACHWEAR, BOTTOMS, CHILDREN'S CLOTH EATING BIBS, COVERALLS, HATS, PANTS, SHIRTS, SHORTS, SKIRTS, SWEAR PANTS, SWEAR SHIRTS, TOPS, T-SHIRTS, UNDERGARMENTS (U.S. CLS. 22 AND 39).

FIRST USE 11-17-2006; IN COMMERCE 11-17-2006.

CLASS 25—(Continued).

3,298,484. BLOOM, AKIVAH L, BROOKLYN, NY. AND DRATEL, JASON EVAN, BROOKLYN, NY. SN 76-613,815. PUB. 9-13-2005, FILED 9-27-2004.

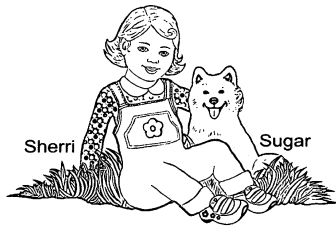

THE LIKENESS (OR, "PORTRAIT") IN THE MARK DOES NOT IDENTIFY A LIVING INDIVIDUAL.

FOR BABY BIBS NOT OF PAPER, BEACHWEAR, BOTTOMS, CHILDREN'S CLOTH EATING BIBS, COVERALLS, HATS, PANTS, SHIRTS, SHORTS, SKIRTS, SWEAR PANTS, SWEAR SHIRTS, TOPS, T-SHIRTS, UNDERGARMENTS (U.S. CLS. 22 AND 39).

FIRST USE 11-17-2006; IN COMMERCE 11-17-2006.

CLASS 25—(Continued).

NO CLAIM IS MADE TO THE EXCLUSIVE RIGHT TO USE "DENIM", APART FROM THE MARK AS SHOWN.

FOR JEANS, SHIRTS, TOPS, SHORTS, SWEATERS, JACKETS; ACTIVEWEAR, NAMELY, PANTS, JACKETS AND JOGGING SUITS; SWEAT SHIRTS, JOGGING SUITS, SCARVES, GLOVES, UNDERWEAR AND FOOTWEAR, ALL OF THE GOODS MADE IN WHOLE OR SUBSTANTIALLY IN PART OF DENIM (U.S. CLS. 22 AND 39).

FIRST USE 8-30-2005; IN COMMERCE 8-30-2005.

3,298,547. BLOOMSTON, STACY BOYD, BIRMINGHAM, AL. SN 76-645,077. PUB. 7-11-2006, FILED 8-17-2005.

SIMPLY STACY BY STACY CLAIRE BOYD

THE MARK CONSISTS OF STANDARD CHARACTERS WITHOUT CLAIM TO ANY PARTICULAR FONT, STYLE, SIZE, OR COLOR.

OWNER OF U.S. REG. NOS. 2,081,408 AND 2,899,030. "STACY CLAIRE BOYD" IDENTIFIES A LIVING INDIVIDUAL WHOSE CONSENT IS OF RECORD.

FOR CLOTHING, NAMELY BIB OVERALLS, BIB SHORTALLS, JUMPERS, DRESSES, SKIRTS, PANTS, SHORTS, SHIRTS, BLOUSES, SWEATSHIRTS, TOPS, COVERALLS, JUMPSUITS, SWEATERS, SLEEPWEAR, PAJAMAS, LAYETTES, ROMPERS, BODY SUITS; OUTERWEAR, NAMELY VESTS, SNOWSUITS, JACKETS, COATS; HEADWEAR, NAMELY HATS, CAPS, VISORS; FOOTWEAR, NAMELY SHOES, SOCKS, BOOTIES, SLIPPERS; GLOVES, MITTENS, SCARVES; HEADBANDS, CHILDREN'S CLOTH EATING BIBS (U.S. CLS. 22 AND 39).

FIRST USE 10-24-2005; IN COMMERCE 10-24-2005.

3,298,501. NEW ERA CAP COMPANY, INC., BUFFALO, NY. SN 76-628,060. PUB. 10-4-2005, FILED 1-18-2005.



OWNER OF U.S. REG. NOS. 2,014,667, 2,391,755, AND OTHERS.

FOR HEADGEAR, NAMELY HATS AND ATHLETIC CAPS (U.S. CLS. 22 AND 39).

FIRST USE 9-9-2005; IN COMMERCE 9-9-2005.

3,298,581. MYSTIQUE APPAREL GROUP INC., NEW YORK, NY. SN 76-658,020. PUB. 11-21-2006, FILED 4-7-2006.

LAST KISS

3,298,544. U.S.A. DESIGN, INC., NEW YORK, NY. SN 76-643,914. PUB. 5-2-2006, FILED 7-29-2005.

FRIED DENIM

THE MARK CONSISTS OF STANDARD CHARACTERS WITHOUT CLAIM TO ANY PARTICULAR FONT, STYLE, SIZE, OR COLOR.

FOR SPORTSWEAR, NAMELY, SPORTS COATS, SPORTS JACKETS, SPORTS JERSEYS, SPORTS OVER-UNIFORMS, SPORTS SHIRTS, AND SPORTS SHIRTS WITH SHORT SLEEVES; JACKETS, SWEATERS, AND COATS (U.S. CLS. 22 AND 39).

FIRST USE 2-0-2006; IN COMMERCE 2-0-2006.

THE MARK CONSISTS OF STANDARD CHARACTERS WITHOUT CLAIM TO ANY PARTICULAR FONT, STYLE, SIZE, OR COLOR.

CLASS 25—(Continued).

3,298,592. RON JON SURF SHOP OF FLA., INC., COCOA BEACH, FL. SN 76-659,002. PUB. 1-2-2007, FILED 4-24-2006.



OWNER OF U.S. REG. NO. 3,114,724.
FOR MEN'S, WOMEN'S AND CHILDREN'S SPORTSWEAR, NAMELY, SWEATSHIRTS, SWEAT PANTS, SWEAT SHORTS, T-SHIRTS, BATHING SUITS, BEACH COVER-UPS, CAPS, HEADBANDS, HATS, VISORS, SHOES, SOCKS, SANDALS, WET SUITS, JACKETS, PONCHOS, DRESSES, BLOUSES, SKIRTS, SHORTS AND PANTS (U.S. CLS. 22 AND 39).

FIRST USE 2-15-2007; IN COMMERCE 2-15-2007.

3,298,624. WARNACO U.S., INC., MILFORD, CT. SN 77-026,937. PUB. 2-6-2007, FILED 10-23-2006.

NO WIRES. NO WORRIES.

THE MARK CONSISTS OF STANDARD CHARACTERS WITHOUT CLAIM TO ANY PARTICULAR FONT, STYLE, SIZE, OR COLOR.

OWNER OF U.S. REG. NO. 3,136,847.
FOR INTIMATE APPAREL AND FIGURE ENHANCING GARMENTS, NAMELY, BRAS (U.S. CLS. 22 AND 39).

FIRST USE 7-31-2005; IN COMMERCE 7-31-2005.

3,298,647. NINE WEST DEVELOPMENT CORPORATION, WILMINGTON, DE. SN 78-161,451. PUB. 11-18-2003, FILED 9-6-2002.

BANDOLINOBLU

THE MARK CONSISTS OF STANDARD CHARACTERS WITHOUT CLAIM TO ANY PARTICULAR FONT, STYLE, SIZE, OR COLOR.

OWNER OF U.S. REG. NOS. 715,486, 1,391,192, AND 1,957,792.

FOR CLOTHING FOR WOMEN AND MISSES, NAMELY, SKIRTS, SLACKS, SHORTS, DRESSES, JEANS, AND JACKETS (U.S. CLS. 22 AND 39).

FIRST USE 12-31-2005; IN COMMERCE 12-31-2005.

CLASS 25—(Continued).

3,298,670. PACIFIC SUNWEAR OF CALIFORNIA, ANAHEIM, CA. SN 78-235,118. PUB. 12-2-2003, FILED 4-8-2003.



FOR MEN, WOMEN AND CHILDREN'S APPAREL, NAMELY, HATS, CAPS, VISORS, HOODS, BERETS, HEAD BANDS, SWEAT BANDS, EAR MUFFS, GLOVES, MITTENS, WRIST BANDS, SUSPENDERS, BELTS, SOCKS, STOCKINGS, PANTYHOSE, BODYSUITS, LEOTARDS, LEGGINGS, SWEAT SOCKS, THERMAL SOCKS, SANDALS, SLIPPERS, KERCHIEFS, SCARVES, MUFFLERS, BANDANNAS, NECKERCHIEFS, VESTS, PAJAMAS, ROBES, KIMONOS, CAFTANS, SMOCKS, APRONS, BOXER SHORTS, BRIEFS, UNDERPANTS, CORSETS, CORSELETS, GIRDLES, BRASSIERES, BUSTIERS, CHEMISES, TEDDIES, CAMISOLES, SLIPS, NEG-LIGEEES, PEIGNOIRS, SHIRTS, BLOUSES, KNIT TOPS, DRESSES, SKIRTS, JUMPSUITS, PANT SUITS, ROMPERS, SWIMMING TRUNKS, WET SUITS, THERMAL UNDERWEAR, UNDERSHIRTS, TUNICS, TANK TOPS, COTTON WOVEN SHIRTS, KNIT SHIRTS, POLO SHIRTS, T-SHIRTS, SWEAT SHIRTS, CREW NECK SWEATERS, V-NECK SWEATERS, TURTLENECK SWEATERS, CARDIGANS, SUITS, JOGGING SUITS, SHORTS, SWEAT SHORTS, JEANS, PANTS, SLACKS, TROUSERS, SWEAT PANTS, SKI SUITS, SKI PANTS, SKI BIBS, CAPES, SHAWLS, BLAZERS, WAISTCOATS, RAIN COATS, OVERCOATS, TOP COATS, SPORT COATS, PARKAS, BOLERO JACKETS, JACKETS, WIND RESISTANT JACKETS, OUTER JACKETS, LEATHER JACKETS, SKI JACKETS, FLANNEL JACKETS, WOOL JACKETS, POLYESTER WOVEN SHIRTS, RAYON WOVEN SHIRTS, WOOL WOVEN SHIRTS, LEATHER COATS, ELASTIC WAIST SHORTS, FIXED WAIST SHORTS, DENIM SHORTS, AND DENIM JACKETS (U.S. CLS. 22 AND 39).

FIRST USE 6-1-2004; IN COMMERCE 6-1-2004.

3,298,687. BLACKWOOD INDUSTRIES, INC., BENTONVILLE, AR. SN 78-293,421. PUB. 5-25-2004, FILED 8-28-2003.

MY SOOS

FOR CHILDREN'S SHOES (U.S. CLS. 22 AND 39).
FIRST USE 2-21-2007; IN COMMERCE 2-21-2007.

CLASS 25—(Continued).

3,298,718. VANITY FAIR, INC., WILMINGTON, DE. SN 78-351,908. PUB. 6-21-2005, FILED 1-14-2004.

BOUNCE CONTROL

THE MARK CONSISTS OF STANDARD CHARACTERS WITHOUT CLAIM TO ANY PARTICULAR FONT, STYLE, SIZE, OR COLOR.
FOR LINGERIE (U.S. CLS. 22 AND 39).
FIRST USE 6-22-2004; IN COMMERCE 6-22-2004.

3,298,750. MCCULLOUGH, ROBERT L., SANTA BARBARA, CA. AND MCCULLOUGH, SUZANNE M., SANTA BARBARA, CA. SN 78-392,425. PUB. 6-27-2006, FILED 3-29-2004.

Rincon Rats

THE MARK CONSISTS OF STANDARD CHARACTERS WITHOUT CLAIM TO ANY PARTICULAR FONT, STYLE, SIZE, OR COLOR.
THE ENGLISH TRANSLATION OF THE WORD "RINCON" IN THE MARK IS CORNER.
FOR ADULT AND CHILDREN CLOTHING, NAMELY, HATS, LONG SLEEVE AND SHORT SLEEVE T-SHIRTS, VISORS, SWEATSHIRTS, PANTS, SHORTS, JERSEYS, FOOTWEAR, AND BATHROBES (U.S. CLS. 22 AND 39).
FIRST USE 2-25-2003; IN COMMERCE 2-25-2003.

CLASS 25—(Continued).

3,298,758. JARRITOS, INC., EL PASO, TX. SN 78-411,387. PUB. 2-8-2005, FILED 4-30-2004.

BORN IN MEXICO, LOVED IN AMERICA

THE MARK CONSISTS OF STANDARD CHARACTERS WITHOUT CLAIM TO ANY PARTICULAR FONT, STYLE, SIZE, OR COLOR.
FOR CLOTHING AND SPORTS CLOTHING APPAREL AND OUTERWEAR, NAMELY T-SHIRTS, SHIRTS, SWEATSHIRTS, JACKETS, PANTS, SWEATPANTS, SHORTS, SKIRTS, SOCKS, HATS, CAPS AND NECKTIES (U.S. CLS. 22 AND 39).
FIRST USE 4-25-2006; IN COMMERCE 4-25-2006.

3,298,764. COTTON CABOODLE CO., SEATTLE, WA. SN 78-421,113. PUB. 4-5-2005, FILED 5-18-2004.

Sucre Soir

THE MARK CONSISTS OF STANDARD CHARACTERS WITHOUT CLAIM TO ANY PARTICULAR FONT, STYLE, SIZE, OR COLOR.
NO CLAIM IS MADE TO THE EXCLUSIVE RIGHT TO USE "SOIR", APART FROM THE MARK AS SHOWN.
THE ENGLISH TRANSLATION OF THE FRENCH WORDING "SUCRE SOIR" IS "SUGAR EVENING."
FOR WOMEN'S CLOTHING, NAMELY, SKIRTS, SHIRTS, PANTS, DRESSES, SHORTS, JACKETS, TANK TOPS AND SWEATSHIRTS (U.S. CLS. 22 AND 39).
FIRST USE 11-1-2001; IN COMMERCE 11-1-2001.

3,298,778. THRONEBURG, JAMES L., STATESVILLE, NC. SN 78-443,787. PUB. 7-19-2005, FILED 6-30-2004.

THORLO·THOTICS

OWNER OF U.S. REG. NOS. 1,119,696, 2,110,029, AND OTHERS.
THE MARK CONSISTS OF THE WORDS THOR LO THOTICS WITH DOTS BETWEEN THOR AND LO AND THOTICS.
FOR MEN'S, WOMEN'S AND CHILDREN'S SOCKS, SHOES, INSOLES AND FOOT BEDS FOR SHOES, AND FOOTWEAR SYSTEMS COMPRISING SOCKS AND SHOES (U.S. CLS. 22 AND 39).
FIRST USE 2-20-2007; IN COMMERCE 2-20-2007.

CLASS 25—(Continued).

3,298,779. THRONEBURG, JAMES L., STATESVILLE, NC. SN 78-443,793. PUB. 7-12-2005, FILED 6-30-2004.

CLASS 25—(Continued).

3,298,813. ROCKY BRANDS, INC., NELSONVILLE, OH. SN 78-471,685. PUB. 7-5-2005, FILED 8-23-2004.

THORLO·THOTICS

PRO-HIKER

OWNER OF U.S. REG. NOS. 1,119,696, 2,110,029, AND OTHERS.

FOR MEN'S, WOMEN'S AND CHILDREN'S SOCKS, SHOES, INSOLES AND FOOT BEDS FOR SHOES, AND FOOTWEAR SYSTEMS COMPRISING SOCKS AND SHOES (U.S. CLS. 22 AND 39).

FIRST USE 2-20-2007; IN COMMERCE 2-20-2007.

THE MARK CONSISTS OF STANDARD CHARACTERS WITHOUT CLAIM TO ANY PARTICULAR FONT, STYLE, SIZE, OR COLOR.

FOR FOOTWEAR, NAMELY, SHOES AND BOOTS (U.S. CLS. 22 AND 39).

FIRST USE 11-30-2005; IN COMMERCE 11-30-2005.

3,298,782. ROBINSON OUTDOOR PRODUCTS, LLC, CANNON FALLS, MN. SN 78-449,443. PUB. 6-21-2005, FILED 7-12-2004.

3,298,818. IRON COWGIRLS, INC., NAPERVILLE, IL. SN 78-475,766. PUB. 5-23-2006, FILED 8-30-2004.

SNO BLOCKER



THE MARK CONSISTS OF STANDARD CHARACTERS WITHOUT CLAIM TO ANY PARTICULAR FONT, STYLE, SIZE, OR COLOR.

OWNER OF U.S. REG. NOS. 2,675,234 AND 2,757,588. FOR CLOTHING, NAMELY, GLOVES (U.S. CLS. 22 AND 39).

FIRST USE 11-17-2004; IN COMMERCE 11-17-2004.

NO CLAIM IS MADE TO THE EXCLUSIVE RIGHT TO USE "AUTHENTIC", APART FROM THE MARK AS SHOWN.

FOR CLOTHING AND APPAREL, NAMELY, SHIRTS, SWEATSHIRTS, JACKETS, HEADWEAR, CAPS, HATS, AND BANDANAS (U.S. CLS. 22 AND 39).

FIRST USE 11-0-2003; IN COMMERCE 11-0-2003.

CLASS 25—(Continued).

3,298,824. SLL, INC., VERNON, CA. SN 78-478,837. PUB. 9-6-2005, FILED 9-3-2004.

TUMMY TUCK

THE MARK CONSISTS OF STANDARD CHARACTERS WITHOUT CLAIM TO ANY PARTICULAR FONT, STYLE, SIZE, OR COLOR.

FOR CLOTHING, NAMELY, BOTTOMS (U.S. CLS. 22 AND 39).

FIRST USE 12-10-2004; IN COMMERCE 12-10-2004.



3,298,863. INYOPANTZ CLOTHING COMPANY INC., BOLTON, ONTARIO, CANADA. SN 78-509,440. PUB. 12-19-2006, FILED 11-1-2004.

INYOPANTZ

THE MARK CONSISTS OF STANDARD CHARACTERS WITHOUT CLAIM TO ANY PARTICULAR FONT, STYLE, SIZE, OR COLOR.

PRIORITY CLAIMED UNDER SEC. 44(D) ON CANADA APPLICATION NO. 1230882, FILED 9-20-2004, REG. NO. TMA667573, DATED 7-13-2006, EXPIRES 7-13-2021.

FOR T-SHIRTS, HATS, PANTS (U.S. CLS. 22 AND 39).
FIRST USE 2-25-2005; IN COMMERCE 8-25-2006.



3,298,864. BLOUSEHOUSE, INC., DUXBURY, MA. SN 78-511,796. PUB. 6-27-2006, FILED 11-5-2004.

Blousehouse

THE MARK CONSISTS OF STANDARD CHARACTERS WITHOUT CLAIM TO ANY PARTICULAR FONT, STYLE, SIZE, OR COLOR.

FOR FULL-FIGURED WOMAN'S APPAREL, NAMELY BLOUSES, TUNICS, PANT SUITS AND SKIRT SETS FOR EITHER OFFICE WEAR OR LEISURE (U.S. CLS. 22 AND 39).
FIRST USE 5-1-2005; IN COMMERCE 5-1-2005.

CLASS 25—(Continued).

3,298,899. SERENITY, LOS ANGELES, CA. SN 78-538,511. PUB. 1-10-2006, FILED 12-27-2004.

serenity

THE MARK CONSISTS OF STANDARD CHARACTERS WITHOUT CLAIM TO ANY PARTICULAR FONT, STYLE, SIZE, OR COLOR.

FOR PANTS, SKIRTS, SHORTS, SKORTS, CAPRIS, JACKETS, SHIRTS, HATS, SCARVES, JUMPERS (U.S. CLS. 22 AND 39).

FIRST USE 6-0-2006; IN COMMERCE 6-0-2006.



3,298,917. AMBASSADOR PROGRAMS, INC., SPOKANE, WA. SN 78-550,399. PUB. 12-20-2005, FILED 1-19-2005.

**YOUTH FRIENDSHIP
GAMES**

THE MARK CONSISTS OF STANDARD CHARACTERS WITHOUT CLAIM TO ANY PARTICULAR FONT, STYLE, SIZE, OR COLOR.

NO CLAIM IS MADE TO THE EXCLUSIVE RIGHT TO USE "YOUTH", APART FROM THE MARK AS SHOWN.

FOR CLOTHING, NAMELY, SHIRTS (U.S. CLS. 22 AND 39).
FIRST USE 6-0-2005; IN COMMERCE 6-0-2005.

CLASS 25—(Continued).

3,298,918. WORLD TRIATHLON CORPORATION, TARPON SPRINGS, FL. SN 78-550,908. PUB. 4-4-2006, FILED 1-20-2005.

70.3

THE MARK CONSISTS OF STANDARD CHARACTERS WITHOUT CLAIM TO ANY PARTICULAR FONT, STYLE, SIZE, OR COLOR.

FOR CLOTHING FOR MEN, WOMEN AND YOUTHS, NAMELY, FLEECE SWEAT SHIRTS, SWEAT PANTS, SWEAT SHORTS AND FLEECE JACKETS; SPORT SHIRTS, SPORT SHORTS, T-SHIRTS, HATS, CAPS, SWIMWEAR, RUNNING SHORTS, PANTS AND SHIRTS, BICYCLING SHORTS, PANT, SHIRTS AND JACKETS, OUTERWEAR COATS AND JACKETS, SOCKS, GLOVES AND FOOTWEAR AND WETSUITS MARKETED IN ASSOCIATION WITH CONTESTS INVOLVING RUNNING, SWIMMING OR BIKING (U.S. CLS. 22 AND 39).
FIRST USE 11-13-2006; IN COMMERCE 11-13-2006.

CLASS 25—(Continued).

3,298,990. WALTERS, WILLIAM EDWARD, CEDAR, MI. SN 78-588,935. PUB. 7-11-2006, FILED 3-16-2005.

THE LEELANOID

THE MARK CONSISTS OF STANDARD CHARACTERS WITHOUT CLAIM TO ANY PARTICULAR FONT, STYLE, SIZE, OR COLOR.

FOR SHIRTS, PANTS, SWEATERS, FLEECE PULL-OVERS, FLEECE SHORTS, HEADGEAR, NAMELY, CAPS; OUTERWEAR, NAMELY, JACKETS, COATS, MITTENS AND GLOVES; FOOTGEAR, NAMELY, SHOES AND BOOTS (U.S. CLS. 22 AND 39).

FIRST USE 6-16-2004; IN COMMERCE 6-16-2004.

3,299,014. GLOBAL OUTDOOR PRODUCTS, SANTA PAULA, CA. SN 78-594,741. PUB. 12-13-2005, FILED 3-24-2005.

3,298,961. REOWN, TARRA WILLIAMS, WAXAHACHIE, TX. SN 78-573,174. PUB. 6-13-2006, FILED 2-23-2005.



FOR CLOTHING, NAMELY, T-SHIRTS AND HEADBANDS (U.S. CLS. 22 AND 39).
FIRST USE 3-5-2007; IN COMMERCE 3-5-2007.

Stonemaster

THE MARK CONSISTS OF STANDARD CHARACTERS WITHOUT CLAIM TO ANY PARTICULAR FONT, STYLE, SIZE, OR COLOR.

FOR MENS, WOMENS AND CHILDRENS CLOTHING—NAMELY, JACKETS, PANTS, JEANS, TIGHTS, VESTS, PULLOVERS, CARDIGANS, SOCKS, SWEATERS, UNDERWEAR, SHIRTS, SHORTS, SKIRTS, BLOUSES, DRESSES, BELTS AND TEE SHIRTS (U.S. CLS. 22 AND 39).

FIRST USE 3-5-2007; IN COMMERCE 3-5-2007.

CLASS 25—(Continued).

3,299,025. DEEGAN, BRIAN, TEMECULA, CA. SN 78-596,998.
PUB. 1-16-2007, FILED 3-29-2005.

HEVY HITTERS

THE MARK CONSISTS OF STANDARD CHARACTERS WITHOUT CLAIM TO ANY PARTICULAR FONT, STYLE, SIZE, OR COLOR.

FOR CLOTHING, NAMELY, CLOTHING FOR MOTOCROSS ENTHUSIASTS, NAMELY, HATS, SHIRTS, JACKETS, SWEATERS, BELTS, GLOVES, UNDER CLOTHING, PANTS, SHORTS, JERSEYS, SOCKS, SHOES, BOOTS, SANDALS, AND SLIPPERS (U.S. CLS. 22 AND 39).

FIRST USE 1-31-2006; IN COMMERCE 1-31-2006.

CLASS 25—(Continued).

3,299,037. TRUSTEES OF DARTMOUTH COLLEGE, HANOVER, NH. SN 78-600,315. PUB. 4-18-2006, FILED 4-1-2005.

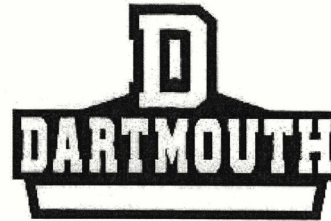

OWNER OF U.S. REG. NOS. 987,129, 2,892,273, AND OTHERS.

FOR CLOTHING, NAMELY SKI HATS, JACKETS, SWEATERS, SCARVES, CAPS, SOCKS, SWEAT SHIRTS, SWEAT PANTS, ATHLETIC JERSEYS, SHORTS, T-SHIRTS, KNIT SHIRTS, PANTS, HATS, HEADBANDS AND UNDERGARMENTS (U.S. CLS. 22 AND 39).

FIRST USE 8-1-2005; IN COMMERCE 8-1-2005.

3,299,030. VANITY FAIR, INC., WILMINGTON, DE. SN 78-598,228. PUB. 12-27-2005, FILED 3-30-2005.

EGO BOOST

THE MARK CONSISTS OF STANDARD CHARACTERS WITHOUT CLAIM TO ANY PARTICULAR FONT, STYLE, SIZE, OR COLOR.

FOR LINGERIE (U.S. CLS. 22 AND 39).

FIRST USE 1-18-2006; IN COMMERCE 1-18-2006.

3,299,047. GALLOW, HERMOINE DARLENE, STAFFORD, TX. SN 78-602,103. PUB. 1-3-2006, FILED 4-5-2005.

UNPACKINGMYSTUFF

THE MARK CONSISTS OF STANDARD CHARACTERS WITHOUT CLAIM TO ANY PARTICULAR FONT, STYLE, SIZE, OR COLOR.

FOR MEN'S, WOMEN'S AND CHILDREN'S CLOTHING, NAMELY, TANK TOPS, SHIRTS, T-SHIRTS, PANTS, SHORTS, WATER SHORTS, CROP TOPS, BRA TOPS, JACKETS, BRIEFS, HATS, CAPS, LEOTARDS, LEGGINGS, COATS, DRESSES, SKIRTS, SWEATERS, SWEATSHIRTS, SWEATPANTS, JOGGING SUITS, SWEAT SUITS, SLEEPWEAR, NIGHTGOWNS, ROBES, PAJAMAS, NIGHTSHIRTS, CASUAL FOOTWEAR, SLIPPERS, SANDALS (U.S. CLS. 22 AND 39).

FIRST USE 1-1-2007; IN COMMERCE 1-1-2007.

CLASS 25—(Continued).

3,299,051. JONES INVESTMENT CO. INC., WILMINGTON, DE. SN 78-603,853. PUB. 1-16-2007, FILED 4-7-2005.

CLASS 25—(Continued).

3,299,087. ZEPHYR ATHLETIC FOOTWEAR, INC., POTTS-TOWN, PA. SN 78-615,687. PUB. 1-17-2006, FILED 4-25-2005.

GRANE

STREAMER

THE MARK CONSISTS OF STANDARD CHARACTERS WITHOUT CLAIM TO ANY PARTICULAR FONT, STYLE, SIZE, OR COLOR.
FOR FOOTWEAR (U.S. CLS. 22 AND 39).
FIRST USE 2-1-2005; IN COMMERCE 2-1-2005.

THE MARK CONSISTS OF STANDARD CHARACTERS WITHOUT CLAIM TO ANY PARTICULAR FONT, STYLE, SIZE, OR COLOR.

FOR CLOTHING, NAMELY, PANTS, SKIRTS, AND SHIRTS (U.S. CLS. 22 AND 39).
FIRST USE 1-30-2006; IN COMMERCE 1-30-2006.

3,299,090. LOEFFLER RANDALL INC., NEW YORK, NY. SN 78-616,867. PUB. 1-17-2006, FILED 4-26-2005.

LOEFFLER RANDALL

3,299,077. MILLER INTERNATIONAL, INC., DENVER, CO. SN 78-612,482. PUB. 1-10-2006, FILED 4-20-2005.

THE MARK CONSISTS OF STANDARD CHARACTERS WITHOUT CLAIM TO ANY PARTICULAR FONT, STYLE, SIZE, OR COLOR.

FOR WOMEN'S FOOTWEAR (U.S. CLS. 22 AND 39).
FIRST USE 7-12-2005; IN COMMERCE 7-12-2005.

BODY LOVING JEANS

3,299,169. VIBRAM S.P.A., 21041 ALBIZZATE (VARESE), ITALY. SN 78-653,873. PUB. 5-9-2006, FILED 6-20-2005.

FIRE & ICE

THE MARK CONSISTS OF STANDARD CHARACTERS WITHOUT CLAIM TO ANY PARTICULAR FONT, STYLE, SIZE, OR COLOR.

NO CLAIM IS MADE TO THE EXCLUSIVE RIGHT TO USE "JEANS", APART FROM THE MARK AS SHOWN.

FOR WOMEN'S, GIRL'S AND CHILDREN'S CLOTHING, NAMELY, JEANS, TROUSERS, SHORTS, SKIRTS, SKORTS, DRESSES, VESTS, JACKETS, TOPS, SHIRTS, SWEATSHIRTS, T-SHIRTS, OVERALLS, SWEATERS, CAPS, VISORS (U.S. CLS. 22 AND 39).
FIRST USE 3-19-2007; IN COMMERCE 3-19-2007.

THE MARK CONSISTS OF STANDARD CHARACTERS WITHOUT CLAIM TO ANY PARTICULAR FONT, STYLE, SIZE, OR COLOR.

FOR SOLES FOR FOOTWEAR MADE OF A POLYMER COMPOUND (U.S. CLS. 22 AND 39).
FIRST USE 9-0-2005; IN COMMERCE 9-0-2005.

CLASS 25—(Continued).

3,299,174. WHITE HORSE APPAREL COMPANY, CENTRALIA, WA. SN 78-655,825. PUB. 10-3-2006, FILED 6-22-2005.

WHITE HORSE

THE MARK CONSISTS OF STANDARD CHARACTERS WITHOUT CLAIM TO ANY PARTICULAR FONT, STYLE, SIZE, OR COLOR.

OWNER OF U.S. REG. NO. 2,584,706.
FOR FOOTWEAR; WESTERN FOOTWEAR (U.S. CLS. 22 AND 39).
FIRST USE 11-0-2005; IN COMMERCE 11-0-2005.

3,299,184. FIGUEROA, RENZO PERCY, REDWOOD CITY, CA. SN 78-660,163. PUB. 7-4-2006, FILED 6-28-2005.

Imahog

THE MARK CONSISTS OF STANDARD CHARACTERS WITHOUT CLAIM TO ANY PARTICULAR FONT, STYLE, SIZE, OR COLOR.

FOR CLOTHING, NAMELY, SHIRTS, SWEAT SHIRTS, POLO SHIRTS, T-SHIRTS, SPORTS SHIRTS, SLEEP SHIRTS, SHORT-SLEEVED SHIRTS, SHORT-SLEEVED AND LONG SLEEVED T-SHIRTS, TANK TOPS, SWEATERS, TURTLE NECK SWEATERS, MOCK TURTLE-NECK SWEATERS, SWEAT SHIRTS, HOODED SWEAT SHIRTS, PANTS, SWEAT PANTS, SHOES, JEANS, TENNIS SHOES, ATHLETIC SHOES, BASEBALL SHOES, BOXING SHOES, FOOTBALL SHOES, BASKETBALL SHOES, HOCKEY SHOES, TRAINING SHOES, UNDER GARMENTS, SOCKS, MEN'S SOCKS, ANTI-PERSPIRANT SOCKS, BERMUDA SHORTS, BOXER SHORTS, FLEECE SHORTS, GYM SHORTS, PANTIES, BRIEFS, RUGBY SHORTS, SHORTS, SWEAT SHORTS, WALKING SHORTS, BOXER BRIEF SHORTS, UNDERWEAR THONGS, G-STRINGS, FOOTWEAR THONGS, BASEBALL CAPS, BATHING CAPS, CAP VISORS, CAPS WITH VISORS, HATS, CAPS, SWEAT BANDS, WRIST BANDS, HEAD BANDS, GLOVES, SNOWBOARD GLOVES, RIDING GLOVES, SKI GLOVES, BRAS, SPORTS BRAS, DRESSES, BLOUSES, TUBE TOPS, HALTER TOPS, BATHING SUITS, BELTS, LEATHER BELTS, JERSEYS, JACKETS, WIND RESISTANT JACKETS, RAIN COATS, COATS, PARKAS, OVERCOATS, LEATHER JACKETS, VESTS, PAJAMAS, BATH ROBES, INFANT AND TODDLER ONE PIECE CLOTHING, CLOTHING FOR WEAR IN WRESTLING GAMES, CLOTHING FOR WEAR IN JUDO PRACTICES (U.S. CLS. 22 AND 39).
FIRST USE 10-12-2005; IN COMMERCE 1-1-2006.

CLASS 25—(Continued).

3,299,213. BRIAN BONNETT, RIVERSIDE, CA. SN 78-672,102. PUB. 9-26-2006, FILED 7-18-2005.

Just Practice

THE MARK CONSISTS OF STANDARD CHARACTERS WITHOUT CLAIM TO ANY PARTICULAR FONT, STYLE, SIZE, OR COLOR.

FOR CLOTHING FOR WEAR IN JUDO PRACTICES (U.S. CLS. 22 AND 39).

FIRST USE 6-0-2005; IN COMMERCE 7-0-2005.

3,299,227. UNASU INC., BROOKLYN, NY. SN 78-677,995. PUB. 6-13-2006, FILED 7-25-2005.

WEARABLE MUSIC

THE MARK CONSISTS OF STANDARD CHARACTERS WITHOUT CLAIM TO ANY PARTICULAR FONT, STYLE, SIZE, OR COLOR.

NO CLAIM IS MADE TO THE EXCLUSIVE RIGHT TO USE "WEARABLE", APART FROM THE MARK AS SHOWN.

FOR MEN'S, WOMEN'S AND CHILDREN'S CLOTHING, NAMELY, T-SHIRTS, SHIRTS, TANK TOPS, SWEATSHIRTS, SWEATPANTS, PANTS; SHORTS, HATS, CAPS (U.S. CLS. 22 AND 39).

FIRST USE 12-1-2005; IN COMMERCE 12-1-2005.

3,299,243. HASELSON INTERNATIONAL TRADING, INC., NEW YORK, NY. SN 78-683,887. PUB. 12-19-2006, FILED 8-2-2005.

ROADBLOCK

THE MARK CONSISTS OF STANDARD CHARACTERS WITHOUT CLAIM TO ANY PARTICULAR FONT, STYLE, SIZE, OR COLOR.

FOR CLOTHING, NAMELY, MEN'S WOMEN'S CHILDREN'S AND INFANTS' SHIRTS, BLOUSES, PANTS, SHORTS, HOSIERY, JACKETS, UNDERWEAR, SWEATERS, BATHING SUITS AND SLEEPWEAR; FOOTWEAR; HATS (U.S. CLS. 22 AND 39).

FIRST USE 1-15-2006; IN COMMERCE 1-15-2006.

CLASS 25—(Continued).

3,299,257. KUHLMANN, BERNT, SANTA MONICA, CA. SN 78-691,973. PUB. 1-23-2007, FILED 8-12-2005.

XUBAZ

THE MARK CONSISTS OF STANDARD CHARACTERS WITHOUT CLAIM TO ANY PARTICULAR FONT, STYLE, SIZE, OR COLOR.

FOR CLOTHING ACCESSORIES, NAMELY FASHION SCARVES AND SHAWLS (U.S. CLS. 22 AND 39).
FIRST USE 7-31-2006; IN COMMERCE 7-31-2006.

3,299,271. LEVI STRAUSS & CO., SAN FRANCISCO, CA. SN 78-698,535. PUB. 6-20-2006, FILED 8-23-2005.

CAPITAL E

THE MARK CONSISTS OF STANDARD CHARACTERS WITHOUT CLAIM TO ANY PARTICULAR FONT, STYLE, SIZE, OR COLOR.

FOR COATS; JACKETS; JEANS; PANTS; SHIRTS; SHORTS; SKIRTS; T-SHIRTS (U.S. CLS. 22 AND 39).
FIRST USE 1-31-2006; IN COMMERCE 1-31-2006.

3,299,305. NY GEAR INC, ALBANY, NY. SN 78-710,525. PUB. 1-16-2007, FILED 9-10-2005.

HOOD RICH IT'S A LIFESTYLE

THE MARK CONSISTS OF STANDARD CHARACTERS WITHOUT CLAIM TO ANY PARTICULAR FONT, STYLE, SIZE, OR COLOR.

FOR CLOTHING, NAMELY PANTS, SHORTS, JACKETS, HATS, JERSEYS, T-SHIRTS, FOOTWEAR AND SWEATSUITS (U.S. CLS. 22 AND 39).
FIRST USE 4-12-2004; IN COMMERCE 4-12-2004.

CLASS 25—(Continued).

3,299,326. BAE, YOUNG YOUN, JUNGRANG-KU, SEOUL, REPUBLIC OF KOREA. SN 78-716,763. PUB. 11-28-2006, FILED 9-20-2005.



BRUIN

THE COLOR(S) RED IS/ARE CLAIMED AS A FEATURE OF THE MARK.

THE COLOR RED APPEARS OVER THE ENTIRE MARK, BOTH WORDS AND DESIGN.

FOR CLOTHING AND CHILDREN'S CLOTHING, NAMELY, ALOHA SHIRTS, BELTS, BLOUSES, BLUE JEANS, BRASSIERES, BUSINESS SUITS, CARDIGANS, COATS, DRESSES, DRESS SHIRTS, GLOVES, JACKETS, JUMPERS, NECKTIES, PANTS, PARKAS, POLO SHIRTS, SCARVES, SHIRTS, SKIRTS, SOCKS, STOCKINGS, SUITS, SWEATERS, TROUSERS, T-SHIRTS, UNDERPANTS, UNDERWEAR, UNIFORMS, FOOTWEAR, HATS AND VISORS (U.S. CLS. 22 AND 39).
FIRST USE 1-0-2007; IN COMMERCE 1-0-2007.

3,299,330. LV JEANS TRADING INC, JACKSON HEIGHTS, NY. SN 78-717,631. PUB. 10-24-2006, FILED 9-21-2005.

NO CLAIM IS MADE TO THE EXCLUSIVE RIGHT TO USE "JEANS" AND "USA", APART FROM THE MARK AS SHOWN.

FOR CLOTHING, NAMELY, JEANS, SUITS, TROUSERS, JACKETS, SKIRTS, KILTS, SHORTS, CARDIGANS, PYJAMAS, NIGHTWEAR, LINGERIE, VESTS, BRIEFS, UNDERWEAR, CAMISOLES, CORSETS, PETTI-COATS, GARTERS, SOCKS, TIGHTS, STOCKINGS, WAISTCOATS, COATS, TRACK SUITS, GLOVES, SCARVES, CRAVATS, CUMMERBUNDS, TIES, SHAWLS, STOLE, BOAS, VEILS, SWIMWEAR, FOOTWEAR, HEADGEAR NAMELY HATS, CAPS, SCARVES, BERETS, SHOES, BELTS FOR CLOTHING (U.S. CLS. 22 AND 39).

FIRST USE 1-1-2007; IN COMMERCE 1-1-2007.

CLASS 25—(Continued).

3,299,370. WEBSTER, FRANCES C., PALM BEACH, FL. SN 78-726,025. PUB. 2-20-2007, FILED 10-4-2005.

HEAD CASE

THE MARK CONSISTS OF STANDARD CHARACTERS WITHOUT CLAIM TO ANY PARTICULAR FONT, STYLE, SIZE, OR COLOR.

FOR SWEATSHIRTS (U.S. CLS. 22 AND 39).
FIRST USE 6-11-2007; IN COMMERCE 6-11-2007.

3,299,391. WAGNER, ROBIN K. SAN PEDRO, CA. SN 78-729,974. PUB. 8-15-2006, FILED 10-10-2005.



THE MARK CONSISTS OF STYLIZED TEXT "SUICIDE KING"; SUICIDE KING OR KING OF HEARTS IMAGE. FOR PANTS, SHIRTS, JACKETS, SUITS, SHORTS, DRESSES, BLOUSES, SKIRTS (U.S. CLS. 22 AND 39).
FIRST USE 3-5-2005; IN COMMERCE 3-5-2005.

3,299,411. LEGENDARY HOLDINGS, INC., SAN DIEGO, CA. SN 78-733,811. PUB. 2-6-2007, FILED 10-14-2005.

**ALPHAGEAR**

THE MARK CONSISTS OF THE STYLIZED "AG" OVER THE STYLIZED "ALPHAGEAR" WORD. FOR CAPS; HATS; VISORS (U.S. CLS. 22 AND 39).
FIRST USE 6-1-2005; IN COMMERCE 8-31-2005.

CLASS 25—(Continued).

3,299,449. JENDEN, NATHAN, NEW YORK, NY. SN 78-737,687. PUB. 7-4-2006, FILED 10-21-2005.

NATHAN JENDEN

THE MARK CONSISTS OF STANDARD CHARACTERS WITHOUT CLAIM TO ANY PARTICULAR FONT, STYLE, SIZE, OR COLOR.

FOR MEN'S AND WOMEN'S SPORTSWEAR, NAMELY, SHIRTS, POLOS, KNIT TOPS, VESTS, BLOUSES, T-SHIRTS, JACKETS, SWEATERS, SHORTS, SKIRTS, DRESSES, JEANS, PANTS, SUITS, OUTERWEAR IN THE NATURE OF RAIN COATS, SPORT COATS, SKI JACKETS, PARKAS, OVERCOATS, COATS, HOSIERY AND FOOTWEAR (U.S. CLS. 22 AND 39).
FIRST USE 3-25-2006; IN COMMERCE 3-25-2006.

3,299,460. PREGER & WERTENTEIL, INC., NEW YORK, NY. SN 78-738,887. PUB. 7-4-2006, FILED 10-24-2005.

EVERSTAY

THE MARK CONSISTS OF STANDARD CHARACTERS WITHOUT CLAIM TO ANY PARTICULAR FONT, STYLE, SIZE, OR COLOR.

FOR SOCKS (U.S. CLS. 22 AND 39).
FIRST USE 7-7-2006; IN COMMERCE 7-7-2006.

3,299,465. HOLT, LILY, PALM BEACH, FL. SN 78-739,492. PUB. 12-5-2006, FILED 10-24-2005.

LILY HOLT

THE MARK CONSISTS OF STANDARD CHARACTERS WITHOUT CLAIM TO ANY PARTICULAR FONT, STYLE, SIZE, OR COLOR.

THE NAME "LILY HOLT" IDENTIFIES A LIVING INDIVIDUAL WHOSE CONSENT IS OF RECORD. FOR SHOES (U.S. CLS. 22 AND 39).
FIRST USE 12-21-2001; IN COMMERCE 12-21-2001.

CLASS 25—(Continued).

3,299,473. REMELE III, LEWIS A., MINNEAPOLIS, MN. SN 78-740,552. PUB. 7-4-2006, FILED 10-26-2005.

LEWIS ALBERT

THE MARK CONSISTS OF STANDARD CHARACTERS WITHOUT CLAIM TO ANY PARTICULAR FONT, STYLE, SIZE, OR COLOR.

THE NAME(S), PORTRAIT(S), AND/OR SIGNATURE(S) SHOWN IN THE MARK IDENTIFIES LEWIS ALBERT REMELE, III, WHOSE CONSENT(S) TO REGISTER IS SUBMITTED.

FOR CLOTHING, NAMELY, DRESSES, SUITS, PANTS, JEANS, SHIRTS, TOPS, COATS, JACKETS AND BELTS (U.S. CLS. 22 AND 39).

FIRST USE 10-0-2005; IN COMMERCE 10-0-2005.

3,299,474. WARNACO U.S., INC., MILFORD, CT. SN 78-740,569. PUB. 7-4-2006, FILED 10-26-2005.

TODAY'S TAPESTRY

THE MARK CONSISTS OF STANDARD CHARACTERS WITHOUT CLAIM TO ANY PARTICULAR FONT, STYLE, SIZE, OR COLOR.

OWNER OF U.S. REG. NOS. 2,306,655, 2,423,566, AND OTHERS.

FOR INTIMATE APPAREL AND FIGURE ENHANCING GARMENTS, NAMELY, BRAS, UNDERWEAR, UNDERGARMENTS, UNDERCLOTHES, LINGERIE, FOUNDATION GARMENTS (U.S. CLS. 22 AND 39).

FIRST USE 1-1-2006; IN COMMERCE 1-1-2006.

3,299,477. DISGUISE, INC., POWAY, CA. SN 78-741,246. PUB. 6-27-2006, FILED 10-26-2005.

BECOME THE HERO

THE MARK CONSISTS OF STANDARD CHARACTERS WITHOUT CLAIM TO ANY PARTICULAR FONT, STYLE, SIZE, OR COLOR.

FOR HALLOWEEN, MASQUERADE, DRESS-UP, AND PLAY COSTUMES, AND COSTUME MASKS AND COSTUME ACCESSORIES SOLD IN CONNECTION THEREWITH NAMELY, MASKS, OVERSHOES, GLOVES, HATS, BELTS, BANDANNAS (U.S. CLS. 22 AND 39).

FIRST USE 12-8-2006; IN COMMERCE 12-8-2006.

CLASS 25—(Continued).

3,299,496. BABY ENERGY, INC, NE WYORK, NY. SN 78-744,276. PUB. 7-18-2006, FILED 11-1-2005.



NO CLAIM IS MADE TO THE EXCLUSIVE RIGHT TO USE "BABY", APART FROM THE MARK AS SHOWN.

THE COLORS BLUE, PINK AND WHITE ARE CLAIMED AS A FEATURE OF THE MARK.

THE COLOR BLUE APPEARS IN THE WORDING BABY ENERGY AND IN THE SHADING BENEATH THE BABY DESIGN. THE COLOR PINK APPEARS IN THE BABY DESIGN. THE COLOR WHITE APPEARS IN THE BABY'S CLOTHING AND IN THE BACKGROUND.

FOR INFANTWEAR AND CHILDREN'S CLOTHING, NAMELY, CLOTH AND PLASTIC BIBS, INFANT CLOTH DIAPERS, CAPS, COATS, DRESSES, FOOTWEAR, HEADWEAR, ONE PIECE GARMENT FOR INFANTS AND TODDLERS, ONE-PIECE SUITS, PLAY SUITS, PANTS, PAJAMAS, ROBES, SHIRTS, SOCKS, STOCKINGS, SWEATERS, SWEATSHIRTS, T-SHIRTS, SLEEPWEAR, AND UNDERGARMENTS (U.S. CLS. 22 AND 39).

FIRST USE 3-1-2006; IN COMMERCE 8-1-2006.

3,299,503. UNITED RETAIL INCORPORATED, ROCHELLE PARK, NJ. SN 78-745,186. PUB. 7-25-2006, FILED 11-2-2005.



OWNER OF U.S. REG. NOS. 1,678,620, 2,445,518, AND OTHERS.

NO CLAIM IS MADE TO THE EXCLUSIVE RIGHT TO USE "SOFT", APART FROM THE MARK AS SHOWN.

FOR FOOTWEAR (U.S. CLS. 22 AND 39).

FIRST USE 3-26-2007; IN COMMERCE 3-26-2007.

3,299,504. LOPEZ, LEO, MANHATTAN BEACH, CA. SN 78-745,900. PUB. 7-4-2006, FILED 11-2-2005.

SMOKE ON

CLASS 25—(Continued).

THE MARK CONSISTS OF STANDARD CHARACTERS WITHOUT CLAIM TO ANY PARTICULAR FONT, STYLE, SIZE, OR COLOR.

FOR CAPS; COATS; FOOTWEAR; HATS; JACKETS; JERSEYS; KNIT SHIRTS; PANTS; SHIRTS; SHORTS; SWEAT SHIRTS; SWEATERS; T-SHIRTS; TIES; TOPS (U.S. CLS. 22 AND 39).

FIRST USE 3-1-2007; IN COMMERCE 3-1-2007.

CLASS 25—(Continued).

3,299,548. SUN PROTECTED KIDS, LLC, STUDIO CITY, CA. SN 78-753,646. PUB. 7-18-2006, FILED 11-14-2005.

3,299,529. WOLVERINE WORLD WIDE, INC., ROCKFORD, MI. SN 78-750,379. PUB. 1-23-2007, FILED 11-9-2005.

NEW TERRAIN

THE MARK CONSISTS OF STANDARD CHARACTERS WITHOUT CLAIM TO ANY PARTICULAR FONT, STYLE, SIZE, OR COLOR.

FOR FOOTWEAR (U.S. CLS. 22 AND 39).

FIRST USE 3-31-2007; IN COMMERCE 3-31-2007.

THE MARK CONSISTS OF STANDARD CHARACTERS WITHOUT CLAIM TO ANY PARTICULAR FONT, STYLE, SIZE, OR COLOR.

NO CLAIM IS MADE TO THE EXCLUSIVE RIGHT TO USE "SUN", APART FROM THE MARK AS SHOWN.

FOR CLOTHING FOR MEN, WOMEN, AND CHILDREN, NAMELY SHIRTS, HATS, PANTS, SHORTS, T-SHIRTS, POLO SHIRTS FOR PROTECTING MEN, WOMEN, AND CHILDREN FROM SUN EXPOSURE (U.S. CLS. 22 AND 39).

FIRST USE 1-1-2006; IN COMMERCE 12-14-2006.

3,299,587. TKUU LLC, VENICE, CA. SN 78-759,994. PUB. 7-18-2006, FILED 11-23-2005.

3,299,546. TUBB, BARRY, SNYDER, TX. SN 78-753,239. PUB. 7-25-2006, FILED 11-14-2005.

CLOWN HUNT

THE MARK CONSISTS OF STANDARD CHARACTERS WITHOUT CLAIM TO ANY PARTICULAR FONT, STYLE, SIZE, OR COLOR.

FOR HEADGEAR, NAMELY, HATS AND CAPS; JACKETS; SHIRTS; T-SHIRTS (U.S. CLS. 22 AND 39).

FIRST USE 3-26-2007; IN COMMERCE 3-26-2007.

THE PROPORTION OF BLU

THE MARK CONSISTS OF STANDARD CHARACTERS WITHOUT CLAIM TO ANY PARTICULAR FONT, STYLE, SIZE, OR COLOR.

FOR COATS; DRESSES; FOOTWEAR; HEADWEAR; JACKETS; PANTS; SHORTS; SKIRTS; TOPS (U.S. CLS. 22 AND 39).

FIRST USE 2-12-2007; IN COMMERCE 2-12-2007.

CLASS 25—(Continued).

3,299,612. STOKESBARY, JEN-AI SUN, GOLDEN, CO. SN 78-766,683. PUB. 8-1-2006, FILED 12-5-2005.



THE MARK CONSISTS OF A GIRL IN A SKIRT IN THE BARREL OF A WAVE.
FOR SHOES; SKIRTS; SKIRTS AND DRESSES; SWEAT SHIRTS; SWIMSUITS; T-SHIRTS (U.S. CLS. 22 AND 39).
FIRST USE 7-13-2005; IN COMMERCE 3-15-2007.

3,299,655. KING BALLERS, INC., SACRAMENTO, CA. SN 78-774,637. PUB. 8-1-2006, FILED 12-15-2005.

KJ23

THE MARK CONSISTS OF STANDARD CHARACTERS WITHOUT CLAIM TO ANY PARTICULAR FONT, STYLE, SIZE, OR COLOR.
FOR CAPS; HATS; JOGGING SUITS; PANTS; POLO SHIRTS; SHOES; SWEAT PANTS; T-SHIRTS (U.S. CLS. 22 AND 39).
FIRST USE 3-20-2007; IN COMMERCE 3-20-2007.

3,299,671. BOB'S STORES CORP., FRAMINGHAM, MA. SN 78-779,140. PUB. 8-15-2006, FILED 12-22-2005.

ROSIE GLOW

THE MARK CONSISTS OF STANDARD CHARACTERS WITHOUT CLAIM TO ANY PARTICULAR FONT, STYLE, SIZE, OR COLOR.
FOR WOMEN'S APPAREL, NAMELY, SHIRTS, BLOUSES, SWEATERS, TOPS, PANTS, SLACKS, AND TEE SHIRTS (U.S. CLS. 22 AND 39).
FIRST USE 8-30-2006; IN COMMERCE 8-30-2006.

CLASS 25—(Continued).

3,299,715. SOLE CREATIONS INC., FLUSHING, NY. SN 78-790,939. PUB. 8-29-2006, FILED 1-13-2006.

WILD SURF

THE MARK CONSISTS OF STANDARD CHARACTERS WITHOUT CLAIM TO ANY PARTICULAR FONT, STYLE, SIZE, OR COLOR.
FOR FOOTWEAR (U.S. CLS. 22 AND 39).
FIRST USE 3-0-2006; IN COMMERCE 4-0-2006.

3,299,736. SIN, HONG LIK, VANCOUVER, BRITISH COLUMBIA, CANADA. SN 78-796,975. PUB. 10-24-2006, FILED 1-23-2006.

Truu De Nimes

THE MARK CONSISTS OF STANDARD CHARACTERS WITHOUT CLAIM TO ANY PARTICULAR FONT, STYLE, SIZE, OR COLOR.
FOR DENIM AND KNITS, NAMELY PANTS (U.S. CLS. 22 AND 39).
FIRST USE 2-1-2007; IN COMMERCE 2-1-2007.

3,299,740. DEL FORTE DENIM, BERKELEY, CA. SN 78-798,091. PUB. 3-27-2007, FILED 1-24-2006.

DEL FORTE DENIM

THE MARK CONSISTS OF STANDARD CHARACTERS WITHOUT CLAIM TO ANY PARTICULAR FONT, STYLE, SIZE, OR COLOR.
NO CLAIM IS MADE TO THE EXCLUSIVE RIGHT TO USE "DENIM", APART FROM THE MARK AS SHOWN.
FOR DENIMS, NAMELY, SKIRTS, PANTS, SHORTS AND JACKETS, ALL MADE FROM ORGANIC DENIM (U.S. CLS. 22 AND 39).
FIRST USE 5-0-2006; IN COMMERCE 5-0-2006.

CLASS 25—(Continued).

3,299,752. O'ROURKE, ASHLEY, SUN VALLEY, CA. SN 78-800,669. PUB. 9-19-2006, FILED 1-27-2006.

TOURNIQUET

THE MARK CONSISTS OF STANDARD CHARACTERS WITHOUT CLAIM TO ANY PARTICULAR FONT, STYLE, SIZE, OR COLOR.

FOR WOMEN'S CLOTHING, NAMELY, DRESSES, SHIRTS, PANTS, JEANS, JACKETS, COATS, VESTS, SWEATERS, KNIT TOPS, SKIRTS, BLOUSES, SOCKS, STOCKINGS, T-SHIRTS, SWEAT SHIRTS AND LINGERIE (U.S. CLS. 22 AND 39).

FIRST USE 9-30-2006; IN COMMERCE 9-30-2006.

3,299,780. RETAIL BRAND ALLIANCE, INC., ENFIELD, CT. SN 78-810,432. PUB. 2-27-2007, FILED 2-8-2006.

1818 REGENT

THE MARK CONSISTS OF STANDARD CHARACTERS WITHOUT CLAIM TO ANY PARTICULAR FONT, STYLE, SIZE, OR COLOR.

OWNER OF U.S. REG. NOS. 2,185,431, 3,024,278, AND OTHERS.

SEC. 2(F) AS TO "1818".

FOR JACKETS; PANTS; SUITS (U.S. CLS. 22 AND 39).

FIRST USE 8-1-2006; IN COMMERCE 8-1-2006.

3,299,781. RETAIL BRAND ALLIANCE, INC., ENFIELD, CT. SN 78-810,450. PUB. 2-27-2007, FILED 2-8-2006.

1818 FITZGERALD

THE MARK CONSISTS OF STANDARD CHARACTERS WITHOUT CLAIM TO ANY PARTICULAR FONT, STYLE, SIZE, OR COLOR.

OWNER OF U.S. REG. NOS. 2,185,431, 3,024,278, AND OTHERS.

SEC. 2(F) AS TO "1818".

FOR JACKETS; PANTS; SUITS (U.S. CLS. 22 AND 39).

FIRST USE 8-1-2006; IN COMMERCE 8-1-2006.

CLASS 25—(Continued).

3,299,789. ACI INTERNATIONAL, LOS ANGELES, CA. SN 78-814,857. PUB. 10-3-2006, FILED 2-14-2006.

WORK-EASE

THE MARK CONSISTS OF STANDARD CHARACTERS WITHOUT CLAIM TO ANY PARTICULAR FONT, STYLE, SIZE, OR COLOR.

FOR INSOLES, SOLD AS COMPONENT OF FOOTWEAR (U.S. CLS. 22 AND 39).

FIRST USE 8-0-2006; IN COMMERCE 8-0-2006.

3,299,796. YOGA WARE, INC., EL CAJON, CA. SN 78-816,384. PUB. 10-3-2006, FILED 2-16-2006.

YOGACONTIGO

THE MARK CONSISTS OF STANDARD CHARACTERS WITHOUT CLAIM TO ANY PARTICULAR FONT, STYLE, SIZE, OR COLOR.

THE ENGLISH TRANSLATION OF THE WORD "CONTIGO" IN THE MARK IS "WITH YOU".

FOR CLOTHING, NAMELY T-SHIRTS, LEGGINGS, PANTS, SWEATSHIRTS, CAPS, TANK TOPS, SHORTS (U.S. CLS. 22 AND 39).

FIRST USE 2-16-2006; IN COMMERCE 10-10-2006.

3,299,842. MAGGIE SOTTERO DESIGNS, LLC, SALT LAKE CITY, UT. SN 78-832,410. PUB. 10-17-2006, FILED 3-8-2006.

Destinations by Maggie Sottero

THE MARK CONSISTS OF STANDARD CHARACTERS WITHOUT CLAIM TO ANY PARTICULAR FONT, STYLE, SIZE, OR COLOR.

OWNER OF U.S. REG. NOS. 2,415,876, 2,935,526, AND OTHERS.

NO CLAIM IS MADE TO THE EXCLUSIVE RIGHT TO USE "DESTINATIONS", APART FROM THE MARK AS SHOWN.

THE NAME MAGGIE SOTTERO DOES NOT IDENTIFY A LIVING INDIVIDUAL.

FOR DRESSES; GOWNS; HEADWEAR; VEILS; WEDDING DRESSES; WEDDING GOWNS (U.S. CLS. 22 AND 39).

FIRST USE 8-24-2006; IN COMMERCE 12-8-2006.

CLASS 25—(Continued).

3,299,856. AMITY HOSIERY CO., INC., GARDEN CITY PARK, NY. SN 78-836,967. PUB. 12-19-2006, FILED 3-14-2006.

SPORT CIRCLE

THE MARK CONSISTS OF STANDARD CHARACTERS WITHOUT CLAIM TO ANY PARTICULAR FONT, STYLE, SIZE, OR COLOR.

NO CLAIM IS MADE TO THE EXCLUSIVE RIGHT TO USE "SPORT", APART FROM THE MARK AS SHOWN.

FOR CLOTHING, NAMELY UNDERGARMENTS, UNDERWEAR AND SOCKS; FOOTWEAR, NAMELY SLIPPERS (U.S. CLS. 22 AND 39).

FIRST USE 9-0-2006; IN COMMERCE 9-0-2006.

3,299,880. PARADIGM CONSULTING GROUP, LLC, SAN DIEGO, CA. SN 78-847,356. PUB. 10-31-2006, FILED 3-27-2006.



THE MARK CONSISTS, IN PART, OF A STICK FIGURE DESIGN OF A PERSON MADE UP OF AN OVAL WITH A BOOMERANG ON EITHER SIDE FORMING THE HEAD AND ARMS, AN OM SYMBOL FORMING THE TORSO, AND AN INFINITY SYMBOL FORMING THE LEGS.

FOR CLOTHING, NAMELY SHIRTS, TOPS, SHORT SETS, PANTS, FOOTWEAR AND CAPS (U.S. CLS. 22 AND 39).

FIRST USE 11-13-2006; IN COMMERCE 2-5-2007.

3,299,897. OISELLE RUNNING, INC., SEATTLE, WA. SN 78-856,224. PUB. 2-6-2007, FILED 4-7-2006.

OISELLE

THE MARK CONSISTS OF STANDARD CHARACTERS WITHOUT CLAIM TO ANY PARTICULAR FONT, STYLE,

CLASS 25—(Continued).

SIZE, OR COLOR.

THE FOREIGN WORDING IN THE MARK TRANSLATES INTO ENGLISH AS FEMALE BIRD.

FOR ANKLE SOCKS; GLOVES; HATS; JACKETS; JOGGING PANTS; SHIRTS; SHORT-SLEEVED OR LONG-SLEEVED T-SHIRTS; SHORTS; SPORTS JACKETS; SPORTS SHIRTS; SPORTS SHIRTS WITH SHORT SLEEVES; TRACK PANTS; WIND RESISTANT JACKETS (U.S. CLS. 22 AND 39).

FIRST USE 2-1-2006; IN COMMERCE 4-1-2006.

3,299,898. RINGLEADER CLOTHING, LLC, FALLS CHURCH, VA. SN 78-856,347. PUB. 11-21-2006, FILED 4-7-2006.

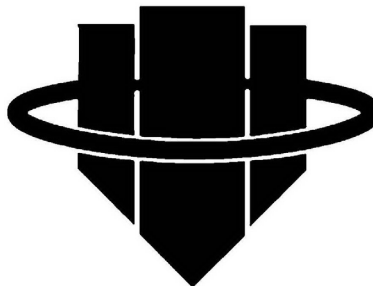

THE MARK CONSISTS OF THREE STYLIZED SHAPES CONSISTING OF RECTANGLES WITH ATTACHED TRIANGLES STANDING VERTICLE WITH TRIANGLE POINTS DOWNWARD INSIDE OF A HORIZONTALLY STRETCHED CIRCLE.

FOR ANKLE SOCKS; BOARD SHORTS; BOXER SHORTS; CAPRI PANTS; COATS FOR MEN AND WOMEN; DENIMS; FOOTWEAR, MEN'S SOCKS, SNOWBOARD PANTS, TRACK PANTS, WATERPROOF JACKETS AND PANTS; FLEECE SHORTS; GYM SHORTS; HATS; HEADWEAR; JOGGING PANTS; MEN AND WOMEN JACKETS, COATS, TROUSERS, VESTS; PANTIES, SHORTS AND BRIEFS; PANTS; SHORT-SLEEVED OR LONG-SLEEVED T-SHIRTS; SHORT-SLEEVED SHIRTS; SOCKS; SPORTS SHIRTS WITH SHORT SLEEVES; SWEAT PANTS; T-SHIRTS (U.S. CLS. 22 AND 39).

FIRST USE 2-28-2005; IN COMMERCE 5-14-2005.

CLASS 25—(Continued).

3,299,899. PENA, RENE M., LIMA, PERU. SN 78-856,759. PUB. 2-6-2007, FILED 4-7-2006.

RAFFA MOLINA

THE MARK CONSISTS OF STANDARD CHARACTERS WITHOUT CLAIM TO ANY PARTICULAR FONT, STYLE, SIZE, OR COLOR.

THE NAME RAFFA MOLINA DOES NOT IDENTIFY A LIVING INDIVIDUAL.

FOR SWEATERS, CARDIGANS, VESTS, SCARVES, GLOVES AND STOLES MADE OF ALPACA, WOOL AND MIXTURES OF ALPACA AND WOOL (U.S. CLS. 22 AND 39).

FIRST USE 7-20-2000; IN COMMERCE 2-18-2007.

3,299,942. AZZOLINI, JOSEPH, ASTORIA, NY. SN 78-869,888. PUB. 3-6-2007, FILED 4-26-2006.

Bi Latina

THE MARK CONSISTS OF STANDARD CHARACTERS WITHOUT CLAIM TO ANY PARTICULAR FONT, STYLE, SIZE, OR COLOR.

THE ENGLISH TRANSLATION OF THE FOREIGN WORD "LATINA" IN THE MARK IS "LATIN FEMALE".

FOR CLOTHING, NAMELY, HATS, SHIRTS, TOPS, PANTS, SHORTS, BOTTOMS AND JACKETS (U.S. CLS. 22 AND 39).

FIRST USE 4-26-2006; IN COMMERCE 5-31-2007.

3,299,962. KLINGLER, KATHRYN D, LOS ANGELES, CA. SN 78-877,567. PUB. 12-5-2006, FILED 5-5-2006.

Skye & Cloud

THE MARK CONSISTS OF STANDARD CHARACTERS WITHOUT CLAIM TO ANY PARTICULAR FONT, STYLE, SIZE, OR COLOR.

FOR INFANT AND TODDLER ONE PIECE CLOTHING; LOUNGEWEAR; SHIRTS; SHORT-SLEEVED OR LONG-SLEEVED T-SHIRTS; T-SHIRTS; TANK TOPS; TOPS; UNDERWEAR (U.S. CLS. 22 AND 39).

FIRST USE 11-21-2006; IN COMMERCE 11-21-2006.

CLASS 25—(Continued).

3,299,981. HARBOR FOOTWEAR GROUP LTD., PORT WASHINGTON, NY. SN 78-883,348. PUB. 12-26-2006, FILED 5-15-2006.

IMPULSE

OWNER OF U.S. REG. NO. 2,350,312.
FOR FOOTWEAR (U.S. CLS. 22 AND 39).
FIRST USE 6-0-2006; IN COMMERCE 6-0-2006.

3,299,991. AERO DESIGN AND MANUFACTURING COMPANY, INC., DULUTH, MN. SN 78-885,600. PUB. 12-19-2006, FILED 5-17-2006.

AEROSTICH TOURS

OWNER OF U.S. REG. NO. 1,873,866.

THE MARK CONSISTS OF THE WORDS "AEROSTICH TOURS" COMBINED WITH A DIAMOND SHAPE WITH CURVED ARROW INSIDE COMING OUT OF THE RIGHT SIDE.

FOR HATS, MICROFIBER SHIRTS, T-SHIRTS AND FLEECE JACKETS (U.S. CLS. 22 AND 39).

FIRST USE 8-4-2006; IN COMMERCE 8-4-2006.

3,300,029. SUE LONDON INCORPORATED, NEW YORK, NY. SN 78-901,871. PUB. 2-27-2007, FILED 6-6-2006.

Sue London

THE MARK CONSISTS OF STANDARD CHARACTERS WITHOUT CLAIM TO ANY PARTICULAR FONT, STYLE, SIZE, OR COLOR.

THE NAME SUE LONDON DOES NOT IDENTIFY A LIVING INDIVIDUAL.

FOR FOOTWEAR FOR MEN AND WOMEN (U.S. CLS. 22 AND 39).

FIRST USE 10-1-2001; IN COMMERCE 4-3-2002.

CLASS 25—(Continued).

3,300,030. POINTE NOIR PTY LTD., PYRMONT, AUSTRALIA. SN 78-902,225. PUB. 1-16-2007, FILED 6-6-2006.

TMT

THE MARK CONSISTS OF STANDARD CHARACTERS WITHOUT CLAIM TO ANY PARTICULAR FONT, STYLE, SIZE, OR COLOR.

FOR FOOTWEAR (U.S. CLS. 22 AND 39).
FIRST USE 9-30-2006; IN COMMERCE 9-30-2006.

3,300,034. M. FREDRIC & CO., AGOURA HILLS, CA. SN 78-903,137. PUB. 1-9-2007, FILED 6-7-2006.

M. FREDRIC

THE MARK CONSISTS OF STANDARD CHARACTERS WITHOUT CLAIM TO ANY PARTICULAR FONT, STYLE, SIZE, OR COLOR.

THE MARK DOES NOT IDENTIFY A LIVING INDIVIDUAL.

FOR CLOTHING, NAMELY, JEANS, TROUSERS, KHAKI PANTS, CARGO PANTS, SHORTS, DRESSES, SKIRTS, SHIRTS, T-SHIRTS, TANK TOPS, BLOUSES, SWEATERS, CARDIGANS, SWEATSHIRTS, SWEAT PANTS, SWIMWEAR, BATHING SUITS, SWIM TRUNKS, COATS, RAINWEAR, JACKETS, BLAZERS, RAINCOATS, VESTS, MITTENS, GLOVES, HEADWEAR, HATS, CAPS, VISORS, HEAD BANDS, BANDANNAS, SHOES, SANDALS, SNEAKERS, SPORTS SHOES, BOOTS, SOCKS, SLIPPERS, ROBES, BRAS, UNDERWEAR, LEGGINGS, TIGHTS, LEOTARDS, SPORTS BRAS, BRIEFS, LINGERIE, THONGS, LOUNGEWEAR, SLEEPWEAR, PAJAMAS, NIGHTGOWNS, HOSIERY, CAMISOLES, BODYSUITS, UNITARDS, APRONS, OVERALLS, JUMPSUITS, SCARVES, TIES, BELTS; INFANT WEAR; NEWBORN WEAR, NAMELY, ROMPERS, JUMPERS AND BOOTIES; INFANT DIAPER COVERS, CLOTH BIBS (U.S. CLS. 22 AND 39).
FIRST USE 12-31-1985; IN COMMERCE 12-31-1985.

CLASS 25—(Continued).

3,300,044. CODRINGTON, BYRON, FRISCO, TX. SN 78-905,522. PUB. 1-16-2007, FILED 6-11-2006.



NO CLAIM IS MADE TO THE EXCLUSIVE RIGHT TO USE "GOLF", APART FROM THE MARK AS SHOWN.

THE MARK CONSISTS OF A SHADOW FIGURE OF A MAN WITH LONG LOCKS OF HAIR, SWINGING A GOLF CLUB AT A GOLF BALL.

FOR BERMUDA SHORTS; GOLF CAPS; GOLF SHIRTS; GOLF SHOES; GOLF TROUSERS (U.S. CLS. 22 AND 39).

FIRST USE 5-1-2007; IN COMMERCE 5-1-2007.

3,300,058. SEVEN FOR ALL MANKIND, LLC, VERNON, CA. SN 78-911,082. PUB. 3-13-2007, FILED 6-19-2006.



NO CLAIM IS MADE TO THE EXCLUSIVE RIGHT TO USE "DELUXE PREMIUM DENIM", APART FROM THE MARK AS SHOWN.

FOR DENIM CLOTHING, NAMELY, JEANS, SKIRTS (U.S. CLS. 22 AND 39).

FIRST USE 2-10-2006; IN COMMERCE 2-10-2006.

CLASS 25—(Continued).

3,300,071. GRYPHON NEW YORK LLC, NEW YORK, NY. SN 78-913,497. PUB. 3-6-2007, FILED 6-21-2006.

GRYPHON NEW YORK

THE MARK CONSISTS OF STANDARD CHARACTERS WITHOUT CLAIM TO ANY PARTICULAR FONT, STYLE, SIZE, OR COLOR.

NO CLAIM IS MADE TO THE EXCLUSIVE RIGHT TO USE "NEW YORK", APART FROM THE MARK AS SHOWN. FOR CLOTHING, NAMELY, COATS, OVERCOATS, TRENCH COATS (U.S. CLS. 22 AND 39). FIRST USE 9-1-2006; IN COMMERCE 9-1-2006.



3,300,078. LAWNGRIPS, LLC, LAKE OSWEGO, OR. SN 78-916,215. PUB. 2-13-2007, FILED 6-24-2006.

Because It's Your Turf!

THE MARK CONSISTS OF STANDARD CHARACTERS WITHOUT CLAIM TO ANY PARTICULAR FONT, STYLE, SIZE, OR COLOR.

FOR SHOES (U.S. CLS. 22 AND 39). FIRST USE 6-1-2005; IN COMMERCE 9-1-2005.



3,300,140. FRESH LILY, LLC, SAN FRANCISCO, CA. SN 78-934,329. PUB. 3-6-2007, FILED 7-20-2006.

PURE STYLE

THE MARK CONSISTS OF STANDARD CHARACTERS WITHOUT CLAIM TO ANY PARTICULAR FONT, STYLE, SIZE, OR COLOR.

FOR UNDERARM PADS, STRIPS, SHIELDS, AND GUARDS THAT ADHERE TO CLOTHING (U.S. CLS. 22 AND 39). FIRST USE 7-1-2006; IN COMMERCE 9-1-2006.

CLASS 25—(Continued).

3,300,164. CALLAWAY GOLF COMPANY, CARLSBAD, CA. SN 78-947,867. PUB. 2-27-2007, FILED 8-8-2006.

Beyond the Fairway

THE MARK CONSISTS OF STANDARD CHARACTERS WITHOUT CLAIM TO ANY PARTICULAR FONT, STYLE, SIZE, OR COLOR.

FOR BELTS; BLOUSES; CAPS; DRESSES; FOOTWEAR; HATS; HOSIERY; JACKETS; SHIRTS; SHORTS; SKIRTS; SLACKS; SWEAT PANTS; SWEAT SHIRTS; SWEAT SUITS; SWEATERS; T-SHIRTS; TIES; TOPS; VESTS; VISORS (U.S. CLS. 22 AND 39). FIRST USE 10-1-2006; IN COMMERCE 10-1-2006.



3,300,174. B& Y GLOBAL SOURCING, LLC, LOS ANGELES, CA. SN 78-953,196. PUB. 3-27-2007, FILED 8-16-2006.



THE MARK CONSISTS OF A CREST CONTAINING THE WORDS PEACE OF US.

FOR APRONS; BATHING SUITS; BELTS; BLAZERS; BLOUSES; BRIEFS; COATS FOR MEN AND WOMEN; FOOTWEAR FOR MEN AND WOMEN; GLOVES; GOWNS; HEADWEAR; INFANT AND TODDLER ONE PIECE CLOTHING; INFANTS' TROUSERS; JEANS; JOGGING SUITS; KNIT SHIRTS; LINGERIE; MEN AND WOMEN JACKETS, COATS, TROUSERS, VESTS; MEN'S SUITS, WOMEN'S SUITS; NECKTIES; OVERALLS; PAJAMAS; PANTIES, SHORTS AND BRIEFS; POLO SHIRTS; ROBES; SCARVES; SHORTS; SKIRTS AND DRESSES; SOCKS AND STOCKINGS; SPORT SHIRTS; SUSPENDERS; SWEATERS; T-SHIRTS; TANK-TOPS; TROUSERS; UNDERSHIRTS; WOMEN'S UNDERWEAR (U.S. CLS. 22 AND 39). FIRST USE 2-0-2007; IN COMMERCE 2-0-2007.

CLASS 25—(Continued).

3,300,189. CALLAWAY GOLF COMPANY, CARLSBAD, CA. SN 78-968,107. PUB. 2-27-2007, FILED 9-6-2006.

WINDSPORT

THE MARK CONSISTS OF STANDARD CHARACTERS WITHOUT CLAIM TO ANY PARTICULAR FONT, STYLE, SIZE, OR COLOR.

FOR BLOUSES; CAPS; FOOTWEAR; GOLF CAPS; GOLF SHIRTS; HATS; JACKETS; PANTS; SHIRTS; SHORTS; SLACKS; SWEAT PANTS; SWEAT SHIRTS; T-SHIRTS; TANK-TOPS; VESTS; WIND SHIRTS; WIND-JACKETS; WINDSHIRTS (U.S. CLS. 22 AND 39).

FIRST USE 10-1-2006; IN COMMERCE 10-1-2006.

3,300,191. CALLAWAY GOLF COMPANY, CARLSBAD, CA. SN 78-968,459. PUB. 2-27-2007, FILED 9-6-2006.

DRYSPORT

THE MARK CONSISTS OF STANDARD CHARACTERS WITHOUT CLAIM TO ANY PARTICULAR FONT, STYLE, SIZE, OR COLOR.

FOR BLOUSES; CAPS; FOOTWEAR; GOLF CAPS; GOLF SHIRTS; HATS; JACKETS; PANTS; SHIRTS; SHORTS; SLACKS; SWEAT PANTS; SWEAT SHIRTS; T-SHIRTS; TANK TOPS; VESTS; WIND SHIRTS; WIND-JACKETS (U.S. CLS. 22 AND 39).

FIRST USE 10-1-2006; IN COMMERCE 10-1-2006.

3,300,201. CAVE SPRINGS, INC., WILMINGTON, DE. SN 78-977,965. PUB. 5-9-2006, FILED 2-18-2005.

STREETS OF L.A.

THE MARK CONSISTS OF STANDARD CHARACTERS WITHOUT CLAIM TO ANY PARTICULAR FONT, STYLE, SIZE, OR COLOR.

FOR MATERNITY CLOTHING, NAMELY, JEANS (U.S. CLS. 22 AND 39).

FIRST USE 12-20-2004; IN COMMERCE 12-20-2004.

CLASS 25—(Continued).

3,300,206. NATIONAL HOT ROD ASSOCIATION, GLEN-DORA, CA. SN 78-978,620. PUB. 2-22-2005, FILED 7-21-2004.



OWNER OF U.S. REG. NOS. 1,039,882, 1,295,041, AND 2,471,203.

THE MARK CONSISTS OF A STYLIZED REPRESENTATION OF TWO AUTOMOBILES AND THE WORDS "NATIONAL HOT ROD ASSOCIATION DEDICATED TO SAFETY".

FOR CLOTHING, NAMELY, TEE-SHIRTS (U.S. CLS. 22 AND 39).

FIRST USE 8-31-2005; IN COMMERCE 8-31-2005.

3,300,207. NATIONAL HOT ROD ASSOCIATION, GLEN-DORA, CA. SN 78-978,621. PUB. 2-22-2005, FILED 7-21-2004.



OWNER OF U.S. REG. NOS. 1,039,882, 1,295,041, AND 2,471,203.

THE MARK CONSISTS OF A STYLIZED REPRESENTATION OF TWO AUTOMOBILES AND THE WORDS "NATIONAL HOT ROD ASSOCIATION DEDICATED TO SAFETY".

FOR CLOTHING, NAMELY, TEE-SHIRTS (U.S. CLS. 22 AND 39).

FIRST USE 8-31-2005; IN COMMERCE 8-31-2005.

3,300,225. MARK EISEN, INC., NEW YORK, NY. SN 78-978,775. PUB. 7-25-2006, FILED 9-26-2005.

ME DESIGNS BY MARK EISEN

THE MARK CONSISTS OF STANDARD CHARACTERS WITHOUT CLAIM TO ANY PARTICULAR FONT, STYLE, SIZE, OR COLOR.

NO CLAIM IS MADE TO THE EXCLUSIVE RIGHT TO USE "DESIGNS", APART FROM THE MARK AS SHOWN.

FOR CLOTHING, NAMELY SHIRTS, SHORTS, PANTS, JACKETS, T-SHIRTS, SWEATSHIRTS, DRESSES, SUITS, SWEATERS, RAINWEAR, FOR MEN, WOMEN AND CHILDREN (U.S. CLS. 22 AND 39).

FIRST USE 7-29-2006; IN COMMERCE 7-29-2006.

CLASS 25—(Continued).

3,300,226. BARKER SHOES LIMITED, NORTHAMPTON, ENGLAND. SN 78-978,781. PUB. 2-20-2007, FILED 3-23-2005.



NO CLAIM IS MADE TO THE EXCLUSIVE RIGHT TO USE 1880, BLACK AND MADE IN ENGLAND, APART FROM THE MARK AS SHOWN.

THE NAME BARKER BLACK DOES NOT IDENTIFY A LIVING INDIVIDUAL.

FOR CLOTHING, NAMELY, SHOES, SANDALS, TIES, POCKET SQUARES, BELTS, AND BRACES, NAMELY, SUSPENDERS (U.S. CLS. 22 AND 39).

FIRST USE 9-1-2005; IN COMMERCE 9-1-2005.

3,300,228. LANE BRYANT PURCHASING CORP., REYNOLDSBURG, OH. SN 78-978,801. PUB. 9-12-2006, FILED 6-9-2006.

LB

THE MARK CONSISTS OF STANDARD CHARACTERS WITHOUT CLAIM TO ANY PARTICULAR FONT, STYLE, SIZE, OR COLOR.

OWNER OF U.S. REG. NOS. 1,210,665, 1,211,680, AND OTHERS.

FOR WOMEN'S WEARING APPAREL FOR PLUS-SIZES, NAMELY, TOPS, BOTTOMS AND JACKETS (U.S. CLS. 22 AND 39).

FIRST USE 5-1-2006; IN COMMERCE 5-1-2006.

3,300,231. PENDERGRASS, TORRY, WEST HOLLYWOOD, CA. SN 78-978,808. PUB. 9-26-2006, FILED 1-30-2006.

RED MONKEY

CLASS 25—(Continued).

THE MARK CONSISTS OF STANDARD CHARACTERS WITHOUT CLAIM TO ANY PARTICULAR FONT, STYLE, SIZE, OR COLOR.

OWNER OF U.S. REG. NOS. 2,634,447, 2,634,448, AND 2,648,538.

FOR CLOTHING, NAMELY HOODED SWEATSHIRTS, HATS (U.S. CLS. 22 AND 39).

FIRST USE 12-27-2001; IN COMMERCE 12-13-2003.

3,300,235. THE SHELTERED ISLANDER, LLC, HOBOKEN, NJ. SN 78-978,820. PUB. 10-24-2006, FILED 10-3-2005.



THE MARK CONSISTS OF A STYLIZED IMAGE OF AN ISLAND. THE MARK IS A STYLIZED REPRESENTATION OF SHELTER ISLAND OFF OF LONG ISLAND, NEW YORK.

FOR APPAREL, NAMELY, SHIRTS, TEE SHIRTS, POLO SHIRTS, TIES, SWEATERS, PANTS, SHORTS, SKIRTS, UNDERWEAR, BELTS, FOOTWEAR, AND JACKETS (U.S. CLS. 22 AND 39).

FIRST USE 10-0-2005; IN COMMERCE 12-0-2005.

CLASS 26—FANCY GOODS

3,298,470. YKK CORPORATION, CHIYODA-KU, TOKYO, JAPAN. SN 76-604,740. PUB. 8-30-2005, FILED 7-29-2004.

LUMINA

THE MARK CONSISTS OF STANDARD CHARACTERS WITHOUT CLAIM TO ANY PARTICULAR FONT, STYLE, SIZE, OR COLOR.

FOR SLIDE FASTENERS; HOOK AND LOOP FASTENERS; ADJUSTABLE FASTENERS; BUTTONS; SNAP BUTTONS; PRESS BUTTONS; STUD BUTTONS; HOOK AND EYES; EYELETS FOR CLOTHING; EYELETS FOR SHOES; BUCKLES; BUCKLES FOR SUSPENDERS; STRAP HOLDERS; SWIVEL HOOKS; SNAP HOOKS; CORD STOPPERS; CORD END STOPPERS; RIBBONS; ELASTIC RIBBONS; TAPES; WEBBING IN THE NATURE OF WOVEN FABRIC TAPES; PATCHES FOR DECORATION OF TEXTILE ARTICLES; BRAIDS; SEWING PINS; SEWING NEEDLES (U.S. CLS. 37, 39, 40, 42 AND 50).

FIRST USE 1-1-2005; IN COMMERCE 1-1-2005.

CLASS 26—(Continued).

3,299,100. MITCHELLACE, INC., PORTSMOUTH, OH. SN 78-622,111. PUB. 7-18-2006, FILED 5-4-2005.

RHINO TIPS

THE MARK CONSISTS OF STANDARD CHARACTERS WITHOUT CLAIM TO ANY PARTICULAR FONT, STYLE, SIZE, OR COLOR.

NO CLAIM IS MADE TO THE EXCLUSIVE RIGHT TO USE "TIPS", APART FROM THE MARK AS SHOWN, FOR SHOE LACES (U.S. CLS. 37, 39, 40, 42 AND 50). FIRST USE 4-4-2007; IN COMMERCE 4-4-2007.

CLASS 27—FLOOR COVERINGS

3,299,737. CONVERTING, INC., CLINTONVILLE, WI. SN 78-797,166. PUB. 1-23-2007, FILED 1-23-2006.

CHANGING SPACES

THE MARK CONSISTS OF STANDARD CHARACTERS WITHOUT CLAIM TO ANY PARTICULAR FONT, STYLE, SIZE, OR COLOR.

FOR NON-TEXTILE WALL HANGINGS, NAMELY, PRINTED PLASTIC WALL DECORATIONS TO COVER WALLS AND DOORS (U.S. CLS. 19, 20, 37, 42 AND 50). FIRST USE 4-1-2006; IN COMMERCE 4-1-2006.

3,299,759. E. I. DU PONT DE NEMOURS AND COMPANY, WILMINGTON, DE. SN 78-803,148. PUB. 7-18-2006, FILED 1-31-2006.

ASPIRATIONS

THE MARK CONSISTS OF STANDARD CHARACTERS WITHOUT CLAIM TO ANY PARTICULAR FONT, STYLE, SIZE, OR COLOR.

FOR RESILIENT VINYL FLOORING (U.S. CLS. 19, 20, 37, 42 AND 50). FIRST USE 4-0-2006; IN COMMERCE 4-0-2006.

CLASS 27—(Continued).

3,300,175. CCA GLOBAL PARTNERS, INC., EARTH CITY, MO. SN 78-955,179. PUB. 2-13-2007, FILED 8-18-2006.

COMFORT AIRE

THE MARK CONSISTS OF STANDARD CHARACTERS WITHOUT CLAIM TO ANY PARTICULAR FONT, STYLE, SIZE, OR COLOR.

FOR CARPET BACKING, CARPET PADDING, CARPET CUSHION, CARPET UNDERLAY AND CARPET UNDERLINING (U.S. CLS. 19, 20, 37, 42 AND 50). FIRST USE 8-30-2006; IN COMMERCE 8-30-2006.

CLASS 28—TOYS AND SPORTING GOODS

3,298,417. MEGA BRANDS INC., MONTREAL, QUEBEC. SN 76-357,115. PUB. 8-1-2006, FILED 1-10-2002.

DRAGONS

FOR CONSTRUCTION TOYS (U.S. CLS. 22, 23, 38 AND 50). FIRST USE 5-17-2005; IN COMMERCE 5-17-2005.

3,298,433. THE SAUL ZAENTZ COMPANY, DBA TOLKIEN ENTERPRISES, BERKELEY, CA. SN 76-482,243. PUB. 12-23-2003, FILED 1-14-2003.

**THE LORD OF THE RINGS
THE TWO TOWERS**

FOR BACKGAMMON SETS, EQUIPMENT PACKAGED AS A UNIT FOR PLAYING BOARD GAMES, FANTASY CHARACTER TOYS, TOY FIGURES (U.S. CLS. 22, 23, 38 AND 50).

FIRST USE 1-0-2003; IN COMMERCE 1-0-2003.

CLASS 28—(Continued).

3,298,531. HASBRO, INC., PAWTUCKET, RI. SN 76-638,787.
PUB. 9-26-2006, FILED 5-17-2005.

LET'S BE CREATIVE

THE MARK CONSISTS OF STANDARD CHARACTERS WITHOUT CLAIM TO ANY PARTICULAR FONT, STYLE, SIZE, OR COLOR.

FOR TOYS AND PLAYTHINGS; NAMELY, TOY ACTION FIGURES, TOY VEHICLES, DOLLS, DOLL CLOTHING, STUFFED TOYS, PLUSH TOYS, FOAM TOYS, CHILDREN'S MULTIPLE ACTIVITY TOYS, BATH TOYS, BATHTUB TOYS, INFLATABLE TOYS, RIDE-ON TOYS, TOY WORKBENCHES, TOY TOOLS, RATTLES, VINYL AND PLASTIC TOY ANIMALS AND CHARACTERS, TOY ROAD TRACK SETS, TRAIN SETS, FINGER PUPPETS, REMOTE CONTROL TOY VEHICLES AND CHARACTERS, TOY BAKEWARE AND COOKWARE, DOLL HOUSES, TOY CONSTRUCTION BLOCKS, SORTING, STACKING AND NESTLING TOYS, ROCKING TOYS, WIND UP TOYS, TOY WOODEN BLOCKS, AND TOY ROLLER SKATES (U.S. CLS. 22, 23, 38 AND 50).

FIRST USE 1-5-2006; IN COMMERCE 1-5-2006.

3,298,532. JOONG CHENN INDUSTRY CO., LTD., TAI-CHUNG HSIEN, TAIWAN. SN 76-638,965. PUB. 9-19-2006, FILED 5-19-2005.

FITSTAR

FOR GYMNASTIC APPARATUS, NAMELY BARBELLS, EXERCISE BENCHES, EXERCISE MACHINES, EXERCISE EQUIPMENT, NAMELY STATIONARY EXERCISE BICYCLES, STATIONARY RECUMBENT EXERCISE BICYCLES, STATIONARY UPRIGHT EXERCISE BICYCLES, MANUALLY OPERATED JOGGING MACHINES, POWERED TREADMILLS FOR RUNNING, ROWING MACHINES, WEIGHT LIFTING MACHINES, TRAMPOLINES, CHEST EXPANDERS, EXERCISE TREADMILLS, MANUALLY OPERATED AEROBIC EXERCISE EQUIPMENT AND ELLIPTICAL TRAINER MACHINES (U.S. CLS. 22, 23, 38 AND 50).

FIRST USE 2-15-2006; IN COMMERCE 2-15-2006.

3,298,550. KWIK GOAL, LTD., QUAKERTOWN, PA. SN 76-646,068. PUB. 10-24-2006, FILED 9-1-2005.

TRAINING OPPONENT MANNEQUIN**CLASS 28—(Continued).**

THE MARK CONSISTS OF STANDARD CHARACTERS WITHOUT CLAIM TO ANY PARTICULAR FONT, STYLE, SIZE, OR COLOR.

NO CLAIM IS MADE TO THE EXCLUSIVE RIGHT TO USE "TRAINING" AND "MANNEQUIN", APART FROM THE MARK AS SHOWN.

FOR HUMANOID FIGURES FOR USE IN TRAINING SOCCER KICKERS (U.S. CLS. 22, 23, 38 AND 50).

FIRST USE 1-1-2006; IN COMMERCE 1-1-2006.

3,298,558. NABAR GAMES INC., LONDON, ONTARIO. SN 76-648,354. PUB. 7-18-2006, FILED 10-12-2005.



THE COLOR(S) RED, BLUE AND WHITE IS/ARE CLAIMED AS A FEATURE OF THE MARK.

THE LARGE FOOTBALL APPEARS IN RED; THE FOOTBALL PLAYER APPEARS IN BLUE AND WHITE, CARRYING A RED AND BLUE SMALL FOOTBALL.

FOR BOARD GAMES RELATING TO FOOTBALL (U.S. CLS. 22, 23, 38 AND 50).

FIRST USE 11-16-2006; IN COMMERCE 11-21-2006.

3,298,559. NABAR GAMES INC., LONDON, ONTARIO. SN 76-648,355. PUB. 7-11-2006, FILED 10-12-2005.



NO CLAIM IS MADE TO THE EXCLUSIVE RIGHT TO USE "TOUCHDOWN FOOTBALL", APART FROM THE MARK AS SHOWN.

THE COLOR(S) RED, BLUE AND WHITE IS/ARE CLAIMED AS A FEATURE OF THE MARK.

THE SHIELD DESIGN APPEARS IN WHITE WITH BLUE AND RED OUTLINING; THE WORDING 4TH QUARTER AND FOOTBALL APPEARS IN BLUE; THE WORDING TOUCHDOWN APPEARS IN RED; THE LARGER FOOTBALL CARRIER APPEARS IN RED; THE FOOTBALL PLAYER APPEARS IN BLUE AND WHITE, CARRYING A RED AND BLUE SMALL FOOTBALL.

FOR BOARD GAMES RELATING TO FOOTBALL (U.S. CLS. 22, 23, 38 AND 50).

FIRST USE 11-16-2006; IN COMMERCE 11-21-2006.

CLASS 28—(Continued).

3,298,574. HASBRO, INC., PAWTUCKET, RI. SN 76-652,347.
PUB. 9-26-2006, FILED 12-22-2005.

IMAGINATION TAKING SHAPE

THE MARK CONSISTS OF STANDARD CHARACTERS WITHOUT CLAIM TO ANY PARTICULAR FONT, STYLE, SIZE, OR COLOR.

FOR TOYS, NAMELY TOY MODELING COMPOUNDS, TOY EXTRUDERS, TOY MOLDS AND TOY APPARATUS FOR USE IN CONNECTION WITH TOY MODELING COMPOUNDS (U.S. CLS. 22, 23, 38 AND 50).
FIRST USE 4-7-2006; IN COMMERCE 4-7-2006.

3,298,597. WIZARDS OF THE COAST, INC., PAWTUCKET, RI. SN 76-662,061. PUB. 1-16-2007, FILED 6-12-2006.

FUTURE SIGHT

THE MARK CONSISTS OF STANDARD CHARACTERS WITHOUT CLAIM TO ANY PARTICULAR FONT, STYLE, SIZE, OR COLOR.

FOR TRADING CARD GAMES (U.S. CLS. 22, 23, 38 AND 50).
FIRST USE 2-27-2007; IN COMMERCE 2-27-2007.

3,298,607. FREDRIKSON, DOUGLAS W., PHOENIX, AZ. AND VECCHIA, PAUL, PHOENIX, AZ. SN 76-978,610. PUB. 7-5-2005, FILED 12-30-2003.

TEEZ

THE MARK CONSISTS OF STANDARD CHARACTERS WITHOUT CLAIM TO ANY PARTICULAR FONT, STYLE, SIZE, OR COLOR.

FOR GAMES, NAMELY, BOARD AND PARLOR GAMES RELATING TO GOLF AND TO GOLF TRIVIA (U.S. CLS. 22, 23, 38 AND 50).
FIRST USE 2-0-2004; IN COMMERCE 2-0-2004.

CLASS 28—(Continued).

3,298,634. JAKKS PACIFIC, INC., MALIBU, CA. SN 77-039,991. PUB. 3-27-2007, FILED 11-8-2006.



OWNER OF U.S. REG. NOS. 1,105,221, 3,066,799, AND OTHERS.

THE MARK CONSISTS OF THE LETTERS XS. ON TOP OF THE LETTER S APPEAR THE WORDS ROAD CHAMPS. ON THE BOTTOM OF THE LETTERS XS APPEAR THE WORDS XTREME SPORTS. THE COLOR GRAY IS FOR SHADING PURPOSES ONLY, AND COLOR IS NOT CLAIMED AS A FEATURE OF THE MARK.

FOR TOY VEHICLES AND ACCESSORIES THEREFOR (U.S. CLS. 22, 23, 38 AND 50).
FIRST USE 11-5-2005; IN COMMERCE 11-5-2005.

3,298,678. ANDERSON, ROSE, VIENNA, VA. SN 78-256,701. PUB. 2-10-2004, FILED 6-1-2003.

GEIST

FOR BOARD GAMES; EQUIPMENT SOLD AS A UNIT FOR PLAYING A BOARD GAME (U.S. CLS. 22, 23, 38 AND 50).

FIRST USE 1-30-2004; IN COMMERCE 1-30-2004.

3,298,717. MATTEL, INC., EL SEGUNDO, CA. SN 78-351,557. PUB. 7-5-2005, FILED 1-13-2004.

STINKOR

THE MARK CONSISTS OF STANDARD CHARACTERS WITHOUT CLAIM TO ANY PARTICULAR FONT, STYLE, SIZE, OR COLOR.

FOR TOYS, GAMES AND PLAYTHINGS, NAMELY, TOY ACTION FIGURES, AND ACCESSORIES FOR ALL OF THE FOREGOING (U.S. CLS. 22, 23, 38 AND 50).
FIRST USE 9-28-2006; IN COMMERCE 9-28-2006.

CLASS 28—(Continued).

3,298,751. THE BABY EINSTEIN COMPANY, LLC, BURBANK, CA. SN 78-396,437. PUB. 12-21-2004, FILED 4-5-2004.

BABY MONET

THE MARK CONSISTS OF STANDARD CHARACTERS WITHOUT CLAIM TO ANY PARTICULAR FONT, STYLE, SIZE, OR COLOR.
FOR CRIB TOYS (U.S. CLS. 22, 23, 38 AND 50).
FIRST USE 9-0-2006; IN COMMERCE 9-0-2006.

3,298,760. MATTEL, INC., EL SEGUNDO, CA. SN 78-414,044. PUB. 10-4-2005, FILED 5-6-2004.

CHROME BURNERZ

THE MARK CONSISTS OF STANDARD CHARACTERS WITHOUT CLAIM TO ANY PARTICULAR FONT, STYLE, SIZE, OR COLOR.
FOR TOYS, GAMES AND PLAYTHINGS, NAMELY, TOY VEHICLES AND ACCESSORIES THEREFOR (U.S. CLS. 22, 23, 38 AND 50).
FIRST USE 12-31-2006; IN COMMERCE 12-31-2006.

3,298,761. MATTEL, INC., EL SEGUNDO, CA. SN 78-414,047. PUB. 10-4-2005, FILED 5-6-2004.

CHRISTMAS MORNING

THE MARK CONSISTS OF STANDARD CHARACTERS WITHOUT CLAIM TO ANY PARTICULAR FONT, STYLE, SIZE, OR COLOR.
FOR TOYS, GAMES AND PLAYTHINGS, NAMELY, DOLLS, DOLL CLOTHING AND DOLL ACCESSORIES (U.S. CLS. 22, 23, 38 AND 50).
FIRST USE 4-2-2007; IN COMMERCE 4-2-2007.

CLASS 28—(Continued).

3,298,783. DCK WALLACE, INC., RIDGEFIELD, WA. SN 78-449,504. PUB. 9-13-2005, FILED 7-12-2004.

REALITY CHECK

THE MARK CONSISTS OF STANDARD CHARACTERS WITHOUT CLAIM TO ANY PARTICULAR FONT, STYLE, SIZE, OR COLOR.
FOR BOARD GAME (U.S. CLS. 22, 23, 38 AND 50).
FIRST USE 1-1-2007; IN COMMERCE 1-1-2007.

3,298,832. DAN-DEE INTERNATIONAL, LTD., JERSEY CITY, NJ. SN 78-479,296. PUB. 7-19-2005, FILED 9-7-2004.

HUGGER

THE MARK CONSISTS OF STANDARD CHARACTERS WITHOUT CLAIM TO ANY PARTICULAR FONT, STYLE, SIZE, OR COLOR.
FOR PLUSH TOYS (U.S. CLS. 22, 23, 38 AND 50).
FIRST USE 1-12-2004; IN COMMERCE 1-12-2004.

3,298,839. RAWLINGS SPORTING GOODS COMPANY, INC., TULLAHOMA, WA. SN 78-483,561. PUB. 1-17-2006, FILED 9-14-2004.

REVOLVER

THE MARK CONSISTS OF STANDARD CHARACTERS WITHOUT CLAIM TO ANY PARTICULAR FONT, STYLE, SIZE, OR COLOR.
FOR BASEBALL BATS AND SOFTBALL BATS (U.S. CLS. 22, 23, 38 AND 50).
FIRST USE 1-0-2007; IN COMMERCE 1-0-2007.

CLASS 28—(Continued).

3,298,875. UNISEN, INC., IRVINE, CA. SN 78-521,313. PUB. 2-14-2006, FILED 11-22-2004.

CLASS 28—(Continued).

3,298,912. MATTEL, INC., EL SEGUNDO, CA. SN 78-548,982. PUB. 3-7-2006, FILED 1-18-2005.

AUTO PILOT

THE MARK CONSISTS OF STANDARD CHARACTERS WITHOUT CLAIM TO ANY PARTICULAR FONT, STYLE, SIZE, OR COLOR.

FOR COMPUTER FIRMWARE THAT ALLOWS USERS TO VARY THEIR WORKOUT AND THAT IS AN INTEGRAL PART OF EXERCISE MACHINES (U.S. CLS. 22, 23, 38 AND 50).

FIRST USE 9-0-2004; IN COMMERCE 9-0-2004.

KNIGHT STAFF

THE MARK CONSISTS OF STANDARD CHARACTERS WITHOUT CLAIM TO ANY PARTICULAR FONT, STYLE, SIZE, OR COLOR.

FOR TOYS, GAMES AND PLAYTHINGS, NAMELY, TOY ACTION FIGURES AND ACCESSORIES THEREFOR (U.S. CLS. 22, 23, 38 AND 50).

FIRST USE 3-19-2007; IN COMMERCE 3-19-2007.

3,298,897. BEAR CREEK TOYS, INC., WOODINVILLE, WA. SN 78-535,787. PUB. 9-19-2006, FILED 12-20-2004.

3,298,969. LPI, LLC, GRANGER, IN. SN 78-576,564. PUB. 7-25-2006, FILED 2-28-2005.

FUNFOBZ

THE MARK CONSISTS OF STANDARD CHARACTERS WITHOUT CLAIM TO ANY PARTICULAR FONT, STYLE, SIZE, OR COLOR.

FOR TOY AND TOY NOVELTY ITEMS, NAMELY TOY WHISTLES WITH A FLAT LENS FACE THAT OPENS TO HOLD OPTIONAL, CHANGEABLE INSERTS SUCH AS TOY TOOLS, TOY NAVIGATION AND EXPLORING DEVICES, PICTURES OF TOY CHARACTERS, AND TOY MIRRORS, FOR USE AS ATTACHMENTS OR ORNAMENTS TO ZIPPER PULLS, KEY CHAINS, "D" RINGS, BACKPACKS, AN BELT LOOPS (U.S. CLS. 22, 23, 38 AND 50).

FIRST USE 8-24-2005; IN COMMERCE 4-20-2006.



NO CLAIM IS MADE TO THE EXCLUSIVE RIGHT TO USE "GOLF", APART FROM THE MARK AS SHOWN.

FOR GOLF ACCESSORIES, NAMELY GOLF CLUBS, GOLF CLUB GRIPS, CARTRIDGE INSERTS FOR GOLF CLUBS, AND WEIGHTS FOR GOLF CLUBS (U.S. CLS. 22, 23, 38 AND 50).

FIRST USE 2-17-2005; IN COMMERCE 8-17-2006.

CLASS 28—(Continued).

3,299,000. THE MKR GROUP, INC., NEW YORK, NY. SN 78-590,663. PUB. 1-10-2006, FILED 3-18-2005.

**GEORGE A. ROMERO'S
DAWN OF THE DEAD**

THE MARK CONSISTS OF STANDARD CHARACTERS WITHOUT CLAIM TO ANY PARTICULAR FONT, STYLE, SIZE, OR COLOR.

THE NAME(S), PORTRAIT(S), AND/OR SIGNATURE(S) SHOWN IN THE MARK IDENTIFIES A PARTICULAR LIVING INDIVIDUAL, WHOSE CONSENT(S) TO REGISTER IS SUBMITTED.

FOR DOLLS; COSTUME MASKS; TOY ACTION FIGURES AND ACCESSORIES THEREFOR (U.S. CLS. 22, 23, 38 AND 50).

FIRST USE 3-31-2006; IN COMMERCE 3-31-2006.

3,299,004. RAINBOW VALLEY FIRE DEPARTMENT, L.L.C., LEAWOOD, KS. SN 78-592,487. PUB. 7-18-2006, FILED 3-22-2005.

PAM

THE MARK CONSISTS OF STANDARD CHARACTERS WITHOUT CLAIM TO ANY PARTICULAR FONT, STYLE, SIZE, OR COLOR.

FOR GAMES AND PLAYTHINGS, NAMELY, DOLLS, DOLL ACCESSORIES, PLUSH TOYS (U.S. CLS. 22, 23, 38 AND 50).

FIRST USE 10-1-2005; IN COMMERCE 10-1-2005.

CLASS 28—(Continued).

3,299,034. GRACO CHILDREN'S PRODUCTS, INC., ATLANTA, IL. SN 78-600,176. PUB. 12-27-2005, FILED 4-1-2005.

LOVIN' HUG

THE MARK CONSISTS OF STANDARD CHARACTERS WITHOUT CLAIM TO ANY PARTICULAR FONT, STYLE, SIZE, OR COLOR.

FOR INFANT SWINGS (U.S. CLS. 22, 23, 38 AND 50). FIRST USE 12-0-2005; IN COMMERCE 12-0-2005.

3,299,070. GLOBAL VR, INC., SAN JOSE, CA. SN 78-608,101. PUB. 1-10-2006, FILED 4-13-2005.

UltraPin

THE MARK CONSISTS OF STANDARD CHARACTERS WITHOUT CLAIM TO ANY PARTICULAR FONT, STYLE, SIZE, OR COLOR.

FOR COIN-OPERATED DIGITALLY EMULATED PINBALL MACHINE (U.S. CLS. 22, 23, 38 AND 50). FIRST USE 11-18-2006; IN COMMERCE 11-18-2006.

3,299,083. RUSSELL CORPORATION, ATLANTA, GA. SN 78-614,674. PUB. 7-25-2006, FILED 4-22-2005.



OWNER OF U.S. REG. NOS. 1,383,153, 1,880,728, AND OTHERS.

THE MARK CONSISTS OF A STYLIZED LETTER "S" ENCASED IN A SLANTED CIRCLE.

FOR SPORTING ARTICLES, NAMELY, BASKETBALLS, VOLLEYBALLS, SOCCER BALLS, FOOTBALLS, BASKETBALL BACKBOARDS, BASEBALLS, GOLF BALLS, GOLF CLUBS, GOLF TEES, TENNIS BALLS, TENNIS RACKETS, AND TENNIS NETS (U.S. CLS. 22, 23, 38 AND 50).

FIRST USE 4-0-2005; IN COMMERCE 8-0-2005.

CLASS 28—(Continued).

3,299,093. ASSOCIATED ELECTRICS, INC., COSTA MESA, CA. SN 78-619,347. PUB. 1-17-2006, FILED 4-28-2005.

CLASS 28—(Continued).

3,299,201. MATTEL, INC., EL SEGUNDO, CA. SN 78-665,307. PUB. 9-12-2006, FILED 7-7-2005.

RC10

THE MARK CONSISTS OF STANDARD CHARACTERS WITHOUT CLAIM TO ANY PARTICULAR FONT, STYLE, SIZE, OR COLOR.

FOR RADIO CONTROLLED TOY MODEL CARS AND RELATED ACCESSORIES, NAMELY, WHEELS AND CARRYING CASES SOLD AS A UNIT (U.S. CLS. 22, 23, 38 AND 50).

FIRST USE 12-15-1997; IN COMMERCE 12-15-1997.

TERRORDACTYL TRAP!

THE MARK CONSISTS OF STANDARD CHARACTERS WITHOUT CLAIM TO ANY PARTICULAR FONT, STYLE, SIZE, OR COLOR.

FOR TOYS, GAMES AND PLAYTHINGS, NAMELY, TOY VEHICLES AND ACCESSORIES THEREFOR (U.S. CLS. 22, 23, 38 AND 50).

FIRST USE 10-11-2006; IN COMMERCE 10-11-2006.

3,299,119. PURE FISHING, INC., SPIRIT LAKE, IA. SN 78-631,348. PUB. 7-4-2006, FILED 5-17-2005.

BAT WING FROG

THE MARK CONSISTS OF STANDARD CHARACTERS WITHOUT CLAIM TO ANY PARTICULAR FONT, STYLE, SIZE, OR COLOR.

NO CLAIM IS MADE TO THE EXCLUSIVE RIGHT TO USE "FROG", APART FROM THE MARK AS SHOWN.

FOR ARTIFICIAL FISHING BAIT (U.S. CLS. 22, 23, 38 AND 50).

FIRST USE 10-0-2004; IN COMMERCE 5-0-2005.

3,299,203. MATTEL, INC., EL SEGUNDO, CA. SN 78-665,964. PUB. 9-26-2006, FILED 7-7-2005.

3,299,191. MATTEL, INC., EL SEGUNDO, CA. SN 78-662,114. PUB. 9-5-2006, FILED 6-30-2005.

ISLAND HOPPER

NERVE HAMMER

THE MARK CONSISTS OF STANDARD CHARACTERS WITHOUT CLAIM TO ANY PARTICULAR FONT, STYLE, SIZE, OR COLOR.

FOR TOYS, GAMES AND PLAYTHINGS, NAMELY, TOY VEHICLES AND ACCESSORIES THEREFOR (U.S. CLS. 22, 23, 38 AND 50).

FIRST USE 12-31-2006; IN COMMERCE 12-31-2006.

THE MARK CONSISTS OF STANDARD CHARACTERS WITHOUT CLAIM TO ANY PARTICULAR FONT, STYLE, SIZE, OR COLOR.

FOR TOYS, GAMES AND PLAYTHINGS, NAMELY, TOY VEHICLES AND ACCESSORIES THEREFOR (U.S. CLS. 22, 23, 38 AND 50).

FIRST USE 10-11-2006; IN COMMERCE 10-11-2006.

CLASS 28—(Continued).

3,299,212. FUNIMATION PRODUCTIONS, LTD., FORT WORTH, TX. SN 78-671,486. PUB. 6-27-2006, FILED 7-15-2005.



OWNER OF U.S. REG. NO. 2,010,746.
NO CLAIM IS MADE TO THE EXCLUSIVE RIGHT TO USE "ENTERTAINMENT", APART FROM THE MARK AS SHOWN.

THE COLOR(S) RED, WHITE AND BLUE IS/ARE CLAIMED AS A FEATURE OF THE MARK.

THE MARK CONSISTS OF A LARGE BLUE QUADRILATERAL SHAPE CONTAINING A RED SUPERIMPOSED CIRCLE ON THE LEFT SIDE WITH A SMALL WHITE STAR ON THE LOWER RIGHT SIDE OF THE CIRCLE AND THE WORD FUNIMATION IN LARGE WHITE BLOCK LETTERS SUPERIMPOSED OVER THE CIRCLE AND THE QUADRILATERAL WITH THE WORD ENTERTAINMENT IN SMALLER WHITE BLOCK LETTERS SUPERIMPOSED OVER THE QUADRILATERAL UNDERNEATH THE WORD FUNIMATION.

FOR GAMES AND PLAYTHINGS NAMELY, COLLECTIBLE TOY FIGURES, ACTION FIGURES AND ACTION FIGURE ACCESSORIES, PLUSH TOYS AND TOY FIGURES (U.S. CLS. 22, 23, 38 AND 50).

FIRST USE 8-4-2005; IN COMMERCE 8-4-2005.

3,299,246. MATTEL, INC., EL SEGUNDO, CA. SN 78-685,120. PUB. 9-19-2006, FILED 8-3-2005.

2-D GIRL SHOPPING IN A 3-D WORLD

THE MARK CONSISTS OF STANDARD CHARACTERS WITHOUT CLAIM TO ANY PARTICULAR FONT, STYLE, SIZE, OR COLOR.

FOR TOYS, GAMES AND PLAYTHINGS, NAMELY, HAND HELD UNIT FOR PLAYING ELECTRONIC GAMES (U.S. CLS. 22, 23, 38 AND 50).

FIRST USE 6-12-2006; IN COMMERCE 6-12-2006.

CLASS 28—(Continued).

3,299,251. HUNTER MFG., LLP, LEXINGTON, KY. SN 78-686,751. PUB. 4-18-2006, FILED 8-5-2005.

WHERE LITTLE KIDS BECOME BIG FANS

THE MARK CONSISTS OF STANDARD CHARACTERS WITHOUT CLAIM TO ANY PARTICULAR FONT, STYLE, SIZE, OR COLOR.

FOR TOYS, NAMELY, TOY MOBILES, JIGSAW AND MANIPULATIVE PUZZLES AND BUILDING AND CONSTRUCTION BLOCKS FOR ADULTS AND CHILDREN (U.S. CLS. 22, 23, 38 AND 50).

FIRST USE 8-21-2006; IN COMMERCE 8-21-2006.

3,299,297. MATTEL, INC., EL SEGUNDO, CA. SN 78-707,945. PUB. 10-3-2006, FILED 9-7-2005.

WALL BUSTING

THE MARK CONSISTS OF STANDARD CHARACTERS WITHOUT CLAIM TO ANY PARTICULAR FONT, STYLE, SIZE, OR COLOR.

FOR TOYS, GAMES AND PLAYTHINGS, NAMELY, TOY ACTION FIGURES, TOY FIGURES AND ACCESSORIES FOR ALL OF THE FOREGOING (U.S. CLS. 22, 23, 38 AND 50).

FIRST USE 3-9-2006; IN COMMERCE 3-9-2006.

3,299,336. TWENTIETH CENTURY FOX FILM CORPORATION, LOS ANGELES, CA. SN 78-718,702. PUB. 6-13-2006, FILED 9-22-2005.

Napoleon Dynamite

THE MARK CONSISTS OF STANDARD CHARACTERS WITHOUT CLAIM TO ANY PARTICULAR FONT, STYLE, SIZE, OR COLOR.

FOR TOY ACTION FIGURES; BOARD GAMES; PLAYING CARDS; PLUSH TOYS; DOLLS; PLUSH DOLLS; TALKING DOLLS; TOY WATCHES (U.S. CLS. 22, 23, 38 AND 50).

FIRST USE 7-31-2004; IN COMMERCE 7-31-2004.

CLASS 28—(Continued).

3,299,339. FIT AND FUN, LLC, COLCHESTER, CT. SN 78-719,202. PUB. 2-20-2007, FILED 9-23-2005.

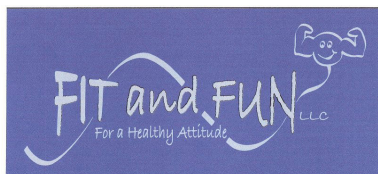

NO CLAIM IS MADE TO THE EXCLUSIVE RIGHT TO USE "LLC", APART FROM THE MARK AS SHOWN.

THE COLOR(S) BLUE AND GRAY IS/ARE CLAIMED AS A FEATURE OF THE MARK.

THE MARK CONSISTS OF GRAY LETTERING ON A BLUE BACKGROUND WITH AN UNDULATING LINE INTERSECTING THE LETTERING CONNECTING WITH A GRAY MUSCULAR HEAD AND ARMS FIGURE.

FOR MANUALLY OPERATED EXERCISE EQUIPMENT (U.S. CLS. 22, 23, 38 AND 50).

FIRST USE 5-1-2007; IN COMMERCE 5-1-2007.

3,299,412. BONANZA PRESS, INC., WOODINVILLE, WA. SN 78-733,877. PUB. 6-13-2006, FILED 10-14-2005.

TWO & OUT

THE MARK CONSISTS OF STANDARD CHARACTERS WITHOUT CLAIM TO ANY PARTICULAR FONT, STYLE, SIZE, OR COLOR.

FOR GAMING TICKETS, NAMELY, DISPOSABLE TICKET SETS FOR PLAYING GAMES OF CHANCE (U.S. CLS. 22, 23, 38 AND 50).

FIRST USE 10-4-2005; IN COMMERCE 10-4-2005.

3,299,422. MCMILLIN, AUSTIN D., TACOMA, WA. SN 78-735,385. PUB. 6-20-2006, FILED 10-18-2005.

PULSEFLEX

THE MARK CONSISTS OF STANDARD CHARACTERS WITHOUT CLAIM TO ANY PARTICULAR FONT, STYLE, SIZE, OR COLOR.

FOR EXERCISE BARS (U.S. CLS. 22, 23, 38 AND 50).

FIRST USE 2-7-2007; IN COMMERCE 2-7-2007.

CLASS 28—(Continued).

3,299,436. CABANA, ROGER, HOBE SOUND, FL. SN 78-736,377. PUB. 7-25-2006, FILED 10-19-2005.

AIM RIGHT

THE MARK CONSISTS OF STANDARD CHARACTERS WITHOUT CLAIM TO ANY PARTICULAR FONT, STYLE, SIZE, OR COLOR.

FOR GOLF BALLS (U.S. CLS. 22, 23, 38 AND 50).

FIRST USE 12-7-2006; IN COMMERCE 12-7-2006.

3,299,471. UNCLE MILTON INDUSTRIES, INC., WESTLAKE VILLAGE, CA. SN 78-740,398. PUB. 6-27-2006, FILED 10-25-2005.

DINO DIG CHALLENGE

THE MARK CONSISTS OF STANDARD CHARACTERS WITHOUT CLAIM TO ANY PARTICULAR FONT, STYLE, SIZE, OR COLOR.

FOR ELECTRONIC EDUCATIONAL GAME MACHINES FOR CHILDREN; EQUIPMENT SOLD AS A UNIT FOR PLAYING BOARD GAMES (U.S. CLS. 22, 23, 38 AND 50).

FIRST USE 9-11-2006; IN COMMERCE 10-27-2006.

3,299,494. WARRIOR LACROSSE, INC., WARREN, MI. SN 78-744,231. PUB. 7-18-2006, FILED 11-1-2005.

SUPER FLY

THE MARK CONSISTS OF STANDARD CHARACTERS WITHOUT CLAIM TO ANY PARTICULAR FONT, STYLE, SIZE, OR COLOR.

FOR PROTECTIVE SPORTS EQUIPMENT, NAMELY, GLOVES, SHOULDER PADS, AND ELBOW PADS FOR USE IN THE GAMES OF LACROSSE AND/OR HOCKEY (U.S. CLS. 22, 23, 38 AND 50).

FIRST USE 10-0-2006; IN COMMERCE 10-0-2006.

CLASS 28—(Continued).

3,299,562. INSECT LORE PRODUCTS, SHAFTER, CA. SN 78-754,671. PUB. 2-20-2007, FILED 11-15-2005.

BUTTERFLY BUNGALOW

THE MARK CONSISTS OF STANDARD CHARACTERS WITHOUT CLAIM TO ANY PARTICULAR FONT, STYLE, SIZE, OR COLOR.

NO CLAIM IS MADE TO THE EXCLUSIVE RIGHT TO USE "BUTTERFLY", APART FROM THE MARK AS SHOWN.

FOR HOBBY KITS FOR RAISING AND HATCHING BUTTERFLIES (U.S. CLS. 22, 23, 38 AND 50).
FIRST USE 3-9-2007; IN COMMERCE 3-9-2007.

3,299,646. NG ACQUISITION, LLC, MOUNT PROSPECT, IL. SN 78-772,153. PUB. 8-8-2006, FILED 12-13-2005.

THE NATURAL

THE MARK CONSISTS OF STANDARD CHARACTERS WITHOUT CLAIM TO ANY PARTICULAR FONT, STYLE, SIZE, OR COLOR.

FOR GOLF CLUB GRIPS; GOLF CLUB HEADS; GOLF CLUB SHAFTS; GOLF CLUBS (U.S. CLS. 22, 23, 38 AND 50).

FIRST USE 12-1-1996; IN COMMERCE 12-1-1996.

3,299,650. MATTEL, INC., EL SEGUNDO, CA. SN 78-773,524. PUB. 8-29-2006, FILED 12-14-2005.

LADY LUCK

THE MARK CONSISTS OF STANDARD CHARACTERS WITHOUT CLAIM TO ANY PARTICULAR FONT, STYLE, SIZE, OR COLOR.

FOR TOYS, GAMES AND PLAYTHINGS, NAMELY, DOLLS AND DOLL ACCESSORIES (U.S. CLS. 22, 23, 38 AND 50).

FIRST USE 7-17-2006; IN COMMERCE 7-17-2006.

CLASS 28—(Continued).

3,299,672. MATTEL, INC., EL SEGUNDO, CA. SN 78-779,541. PUB. 9-5-2006, FILED 12-22-2005.

ULTIMATE TERRAIN TRACTION

THE MARK CONSISTS OF STANDARD CHARACTERS WITHOUT CLAIM TO ANY PARTICULAR FONT, STYLE, SIZE, OR COLOR.

FOR TOYS, GAMES AND PLAYTHINGS, NAMELY, CHILDREN'S RIDE-ON TOYS, TOY VEHICLES AND ACCESSORIES FOR ALL OF THE FOREGOING (U.S. CLS. 22, 23, 38 AND 50).

FIRST USE 3-15-2007; IN COMMERCE 3-15-2007.

3,299,710. URETHANE SYSTEMS PLUS, INC., WAUKESHA, WI. SN 78-790,376. PUB. 9-19-2006, FILED 1-12-2006.

SOFT TOUCH

THE MARK CONSISTS OF STANDARD CHARACTERS WITHOUT CLAIM TO ANY PARTICULAR FONT, STYLE, SIZE, OR COLOR.

FOR BASEBALL AND SOFTBALL EQUIPMENT, NAMELY, SPORT FIELD BASES, PITCHER'S MOUND RUBBERS, BOUNDARY MARKERS, YARD MARKERS FOR USE BY YOUTH LEAGUE SPORTS TEAMS, MILITARY SPORTS TEAMS, SCHOOL SPORTS TEAMS, AND FEDERAL, STATE AND MUNICIPAL RECREATIONAL DEPARTMENTS (U.S. CLS. 22, 23, 38 AND 50).

FIRST USE 1-31-2006; IN COMMERCE 1-31-2006.

3,299,748. FRANKLIN SPORTS, INC., STOUGHTON, MA. SN 78-799,613. PUB. 9-26-2006, FILED 1-25-2006.



NO CLAIM IS MADE TO THE EXCLUSIVE RIGHT TO USE CONTOUR FIT SYSTEM, APART FROM THE MARK AS SHOWN.

FOR BASEBALL GLOVES (U.S. CLS. 22, 23, 38 AND 50).

FIRST USE 4-17-2006; IN COMMERCE 4-17-2006.

CLASS 28—(Continued).

3,299,775. ROCKFIT INDUSTRIES LLC, WINTER GARDEN, FL. SN 78-809,591. PUB. 4-3-2007, FILED 2-8-2006.

SWINGGYM

THE MARK CONSISTS OF STANDARD CHARACTERS WITHOUT CLAIM TO ANY PARTICULAR FONT, STYLE, SIZE, OR COLOR.

FOR EXERCISE MACHINES (U.S. CLS. 22, 23, 38 AND 50).
FIRST USE 5-3-2007; IN COMMERCE 5-3-2007.

3,299,788. NAPLES CAPITAL MANAGEMENT, LLC, NAPLES, FL. SN 78-814,533. PUB. 10-3-2006, FILED 2-14-2006.

LINXMASTER

THE MARK CONSISTS OF STANDARD CHARACTERS WITHOUT CLAIM TO ANY PARTICULAR FONT, STYLE, SIZE, OR COLOR.

FOR GOLF CLUB SWING AIDS, NAMELY PADS MADE OF COMPRESSED FOAM FOR FLEXIBILITY AND SOFT COMFORT WHICH FIT UNDER THE ARMS, SUPPORTS MADE OF ELASTIC WHICH CONNECT TO THE PADS AND GO AROUND THE BACK OF THE NECK, AND A STABILIZING GUIDE STRAP OF ELASTIC WHICH RUNS ACROSS THE CHEST AND CONNECTS THE PADS, FOR TRAINING ATHLETIC SWING, SWINGING MOTIONS FOR SPORTS, RELATED ATHLETIC MOTIONS, AND PROPER ARM PLACEMENT AND ARM RELATION TO THE BODY FOR A TRUER SWING PLANE AND MORE POWERFUL IMPACT (U.S. CLS. 22, 23, 38 AND 50).
FIRST USE 10-20-2006; IN COMMERCE 1-10-2007.

3,299,814. LEIGHT, HOWARD S., SANTA MONICA, CA. SN 78-821,136. PUB. 9-26-2006, FILED 2-22-2006.

BOOM BOARD

THE MARK CONSISTS OF STANDARD CHARACTERS WITHOUT CLAIM TO ANY PARTICULAR FONT, STYLE, SIZE, OR COLOR.

NO CLAIM IS MADE TO THE EXCLUSIVE RIGHT TO USE "BOARD", APART FROM THE MARK AS SHOWN.
FOR MANUALLY OPERATED EXERCISE MACHINE (U.S. CLS. 22, 23, 38 AND 50).
FIRST USE 12-0-2006; IN COMMERCE 12-0-2006.

CLASS 28—(Continued).

3,299,836. CYBERGUN USA, CORP, TIBURON, CA. SN 78-830,348. PUB. 10-17-2006, FILED 3-6-2006.

ULTRASONIC BBs

THE MARK CONSISTS OF STANDARD CHARACTERS WITHOUT CLAIM TO ANY PARTICULAR FONT, STYLE, SIZE, OR COLOR.

NO CLAIM IS MADE TO THE EXCLUSIVE RIGHT TO USE "BBS", APART FROM THE MARK AS SHOWN.
FOR TOY GUNS (U.S. CLS. 22, 23, 38 AND 50).
FIRST USE 3-8-2007; IN COMMERCE 3-8-2007.

3,299,848. CHAU, JIMMY, COVINA, CA. SN 78-834,937. PUB. 10-24-2006, FILED 3-11-2006.



FOR PLASTIC AND METAL TOY TRUCKS AND VEHICLES (U.S. CLS. 22, 23, 38 AND 50).
FIRST USE 5-1-2006; IN COMMERCE 9-15-2006.

3,299,890. THE HARTZ MOUNTAIN CORPORATION, SECAUCUS, NJ. SN 78-851,768. PUB. 6-20-2006, FILED 3-31-2006.

HARTZ OOGIES DOG TOY

THE MARK CONSISTS OF STANDARD CHARACTERS WITHOUT CLAIM TO ANY PARTICULAR FONT, STYLE, SIZE, OR COLOR.

NO CLAIM IS MADE TO THE EXCLUSIVE RIGHT TO USE "DOG TOY", APART FROM THE MARK AS SHOWN.
FOR PET TOYS (U.S. CLS. 22, 23, 38 AND 50).
FIRST USE 8-22-2006; IN COMMERCE 8-22-2006.

CLASS 28—(Continued).

3,299,964. SOP SERVICES, INC., LAS VEGAS, NV. SN 78-877,736. PUB. 12-12-2006, FILED 5-5-2006.

KEYSTONE

THE MARK CONSISTS OF STANDARD CHARACTERS WITHOUT CLAIM TO ANY PARTICULAR FONT, STYLE, SIZE, OR COLOR.
FOR GAME TABLES (U.S. CLS. 22, 23, 38 AND 50).
FIRST USE 9-0-2005; IN COMMERCE 9-0-2005.

3,299,985. CALLAWAY GOLF COMPANY, CARLSBAD, CA. SN 78-885,084. PUB. 1-16-2007, FILED 5-16-2006.

X-20

THE MARK CONSISTS OF STANDARD CHARACTERS WITHOUT CLAIM TO ANY PARTICULAR FONT, STYLE, SIZE, OR COLOR.
OWNER OF U.S. REG. NOS. 2,392,366, 3,099,025, AND OTHERS.
FOR GOLF CLUBS (U.S. CLS. 22, 23, 38 AND 50).
FIRST USE 8-31-2006; IN COMMERCE 8-31-2006.

3,299,993. ALEXANDER DOLL COMPANY, INC., NEW YORK, NY. SN 78-885,943. PUB. 1-2-2007, FILED 5-17-2006.

SWEET & CHIC

THE MARK CONSISTS OF STANDARD CHARACTERS WITHOUT CLAIM TO ANY PARTICULAR FONT, STYLE, SIZE, OR COLOR.
FOR DOLLS, DOLL CLOTHING AND DOLL ACCESSORIES (U.S. CLS. 22, 23, 38 AND 50).
FIRST USE 5-16-2006; IN COMMERCE 5-16-2006.

CLASS 28—(Continued).

3,300,020. JADA TOYS, INC., CITY OF INDUSTRY, CA. SN 78-898,982. PUB. 1-2-2007, FILED 6-2-2006.



THE MARK CONSISTS OF THE WORDING "FOR SALE" ABOVE A THIN RECTANGLE OVER A SHADED RECTANGULAR BACKGROUND WITH ROUNDED CORNERS ALL APPEARING WITHIN A RECTANGLE BORDER WITH STRIPS OF TAPE ON ALL FOUR CORNERS.

FOR DIECAST TOY CARS, DIECAST TOY TRUCKS, DIECAST TOY VEHICLES, AND KITS FOR MAKING SAME (U.S. CLS. 22, 23, 38 AND 50).
FIRST USE 5-30-2006; IN COMMERCE 5-30-2006.

3,300,025. ALEXANDER DOLL COMPANY, INC., NEW YORK, NY. SN 78-900,247. PUB. 1-2-2007, FILED 6-5-2006.

SWEET SARA

THE MARK CONSISTS OF STANDARD CHARACTERS WITHOUT CLAIM TO ANY PARTICULAR FONT, STYLE, SIZE, OR COLOR.
FOR DOLLS, DOLL CLOTHING AND DOLL ACCESSORIES (U.S. CLS. 22, 23, 38 AND 50).
FIRST USE 6-1-2006; IN COMMERCE 6-1-2006.

3,300,049. SANDY USA, INC., SPRINGFIELD, MO. SN 78-907,770. PUB. 2-27-2007, FILED 6-14-2006.

MY LOTERIA by Cristina Sosa Noriega

THE MARK CONSISTS OF STANDARD CHARACTERS WITHOUT CLAIM TO ANY PARTICULAR FONT, STYLE, SIZE, OR COLOR.

NO CLAIM IS MADE TO THE EXCLUSIVE RIGHT TO USE "LOTERIA", APART FROM THE MARK AS SHOWN.

"THE NAME(S), PORTRAIT(S), AND/OR SIGNATURE(S) SHOWN IN THE MARK IDENTIFIES CRISTINA SOSA NORIEGA, A LIVING INDIVIDUAL, WHOSE CONSENT(S) TO REGISTER IS SUBMITTED."

"THE FOREIGN WORDING IN THE MARK TRANSLATES INTO ENGLISH AS LOTTERY."

FOR BOARD GAME (U.S. CLS. 22, 23, 38 AND 50).
FIRST USE 5-2-2006; IN COMMERCE 1-1-2007.

CLASS 28—(Continued).

3,300,067. ALEXANDER DOLL COMPANY, INC., NEW YORK, NY. SN 78-912,385. PUB. 1-9-2007, FILED 6-20-2006.

BABY BLISS

THE MARK CONSISTS OF STANDARD CHARACTERS WITHOUT CLAIM TO ANY PARTICULAR FONT, STYLE, SIZE, OR COLOR.

FOR DOLLS, DOLL CLOTHING AND DOLL ACCESSORIES (U.S. CLS. 22, 23, 38 AND 50).
FIRST USE 6-19-2006; IN COMMERCE 6-19-2006.

CLASS 28—(Continued).

3,300,117. PURE FISHING, INC., SPIRIT LAKE, IA. SN 78-927,631. PUB. 1-9-2007, FILED 7-12-2006.

GULP! ALIVE

THE MARK CONSISTS OF STANDARD CHARACTERS WITHOUT CLAIM TO ANY PARTICULAR FONT, STYLE, SIZE, OR COLOR.

OWNER OF U.S. REG. NO. 2,902,123.
FOR ARTIFICIAL FISHING BAIT (U.S. CLS. 22, 23, 38 AND 50).
FIRST USE 6-21-2006; IN COMMERCE 6-15-2007.

3,300,073. TRANS-PACIFIC SOURCING, INC., EDINA, MN. SN 78-913,651. PUB. 4-10-2007, FILED 6-21-2006.



The logo features a stylized black waveform on the left, followed by the text "Spiral Helix Carbon Fiber" in a bold, sans-serif font.

NO CLAIM IS MADE TO THE EXCLUSIVE RIGHT TO USE "CARBON FIBER" AND "SPIRAL HELIX", APART FROM THE MARK AS SHOWN.

THE MARK CONSISTS OF A 2 DIMENSIONAL FEATURELESS REPRESENTATION OF A WAVEFORM, 1.5 TIMES THE LENGTH OF ONE COMPLETE WAVEFORM, POSITIONED DIRECTLY TO THE LEFT OF THE WORDS. THE WORDS CONSIST OF "SPIRAL HELIX CARBON FIBER", WITH THE WORDS "SPIRAL HELIX" APPEARING ABOVE THE WORDS "CARBON FIBER".

FOR FISHING RODS (U.S. CLS. 22, 23, 38 AND 50).
FIRST USE 7-11-2006; IN COMMERCE 12-10-2006.

3,300,168. BRIDGESTONE SPORTS CO., LTD., SHINAGAWA-KU, TOKYO, JAPAN. SN 78-950,015. PUB. 3-6-2007, FILED 8-11-2006.



The logo consists of the letters "GC" in a large, bold, black, sans-serif font.

FOR GOLF EQUIPMENT NAMELY GOLF CLUBS, GOLF CLUB HEADCOVERS (U.S. CLS. 22, 23, 38 AND 50).

FIRST USE 8-0-2006; IN COMMERCE 8-0-2006.

3,300,090. PT METRICS, LLC, SIMI VALLEY, CA. SN 78-918,973. PUB. 2-20-2007, FILED 6-28-2006.

PERFECT PUSHUP

THE MARK CONSISTS OF STANDARD CHARACTERS WITHOUT CLAIM TO ANY PARTICULAR FONT, STYLE, SIZE, OR COLOR.

NO CLAIM IS MADE TO THE EXCLUSIVE RIGHT TO USE "PUSHUP", APART FROM THE MARK AS SHOWN.
FOR MANUALLY-OPERATED EXERCISE EQUIPMENT (U.S. CLS. 22, 23, 38 AND 50).

FIRST USE 10-28-2006; IN COMMERCE 10-28-2006.

3,300,186. CALLAWAY GOLF COMPANY, CARLSBAD, CA. SN 78-962,613. PUB. 2-27-2007, FILED 8-29-2006.

Black Series

THE MARK CONSISTS OF STANDARD CHARACTERS WITHOUT CLAIM TO ANY PARTICULAR FONT, STYLE, SIZE, OR COLOR.

NO CLAIM IS MADE TO THE EXCLUSIVE RIGHT TO USE "SERIES", APART FROM THE MARK AS SHOWN.
FOR GOLF CLUBS (U.S. CLS. 22, 23, 38 AND 50).

FIRST USE 12-19-2006; IN COMMERCE 12-19-2006.

CLASS 28—(Continued).

3,300,192. CALLAWAY GOLF COMPANY, CARLSBAD, CA. SN 78-968,992. PUB. 2-27-2007, FILED 9-7-2006.

marXman

THE MARK CONSISTS OF STANDARD CHARACTERS WITHOUT CLAIM TO ANY PARTICULAR FONT, STYLE, SIZE, OR COLOR.

FOR GOLF CLUB COVERS; GOLF CLUBS (U.S. CLS. 22, 23, 38 AND 50).
FIRST USE 1-23-2007; IN COMMERCE 1-23-2007.

CLASS 29—MEATS AND PROCESSED FOODS

3,298,426. SIROB IMPORTS, INC., LINDENHURST, NY. SN 76-429,259. PUB. 7-6-2004, FILED 7-10-2002.

APHRODITE

FOR OLIVE OIL (U.S. CL. 46).
FIRST USE 3-28-2007; IN COMMERCE 3-28-2007.

3,298,661. NORTH DELTA SEAFOODS LTD., DELTA. BRITISH COLUMBIA, CANADA. SN 78-204,769. PUB. 2-21-2006, FILED 1-17-2003.

RAINCOAST TRADING

PRIORITY CLAIMED UNDER SEC. 44(D) ON CANADA APPLICATION NO. 1,148,095, FILED 7-25-2002, REG. NO. TMA646438, DATED 8-23-2005, EXPIRES 8-23-2020.

NO CLAIM IS MADE TO THE EXCLUSIVE RIGHT TO USE "TRADING", APART FROM THE MARK AS SHOWN.
FOR SEAFOOD PRODUCTS, NAMELY, DRIED SEAFOOD AND SMOKED SEAFOOD; FROZEN AND UNFROZEN PREPARED MEALS, ENTREES, APPETIZERS AND FROZEN AND UNFROZEN SNACKS CONSISTING PRIMARILY OF SEAFOOD; SEAFOOD, NAMELY, SOUP AND CHOWDERS (U.S. CL. 46).

FIRST USE 5-23-1997; IN COMMERCE 5-23-1997.

3,298,766. STRAUSS VEAL & LAMB INTERNATIONAL INC., HALES CORNERS, WI. SN 78-422,938. PUB. 6-21-2005, FILED 5-21-2004.

STRAUSS

THE MARK CONSISTS OF STANDARD CHARACTERS WITHOUT CLAIM TO ANY PARTICULAR FONT, STYLE,

CLASS 29—(Continued).

SIZE, OR COLOR.

OWNER OF U.S. REG. NOS. 1,017,069 AND 1,672,699.

SEC. 2(F).

FOR MEAT PRODUCTS, NAMELY RAW AND PROCESSED VEAL AND RAW AND PROCESSED LAMB (U.S. CL. 46).

FIRST USE 12-31-2006; IN COMMERCE 12-31-2006.

3,298,802. DISH D'LISH, INC., SEATTLE, WA. SN 78-460,712. PUB. 7-12-2005, FILED 8-2-2004.

PARTY IN YOUR PANTRY

THE MARK CONSISTS OF STANDARD CHARACTERS WITHOUT CLAIM TO ANY PARTICULAR FONT, STYLE, SIZE, OR COLOR.

FOR PROCESSED FOODS, NAMELY, DAIRY-BASED DIPS, DIPS EXCLUDING SALSA AND OTHER SAUCES USED AS DIPS, OR VEGETABLES; VEGETABLE-BASED, OR CHEESE SANDWICH SPREADS; PROCESSED, OLIVES, ONIONS AND PROCESSED PEPPERS (U.S. CL. 46).
FIRST USE 10-31-2002; IN COMMERCE 10-31-2002.

3,298,835. INDUSTRIAS ALIMENTICIAS ECUATORIANAS, S.A. INALESCA, GUAYAQUIL, ECUADOR. SN 78-481,286. PUB. 12-13-2005, FILED 9-9-2004.

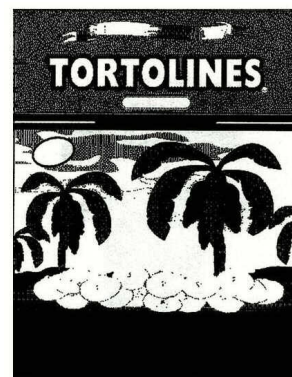

THE MARK CONSISTS OF THE WORD TORTOLINES IN STYLIZED LETTERS APPEARING IN THE UPPER PORTION OF THE LABEL DESIGN, ABOVE WHICH THERE IS A RIBBON. BELOW THE WORD TORTOLINES THERE IS A DRAWING OF A SUNSET SHOWING THE SUN IN THE BACKGROUND, THE SKY ABOVE IT AND PALM TREES IN THE MIDDLE GROUND. BELOW THE PALM TREES IN THE LOWER PORTION OF THE LABEL DESIGN THERE ARE MANY PLANTAIN CHIPS LIKE FIGURES.

FOR SALTED PLANTAIN CHIPS, SPICY PLANTAIN CHIPS, SWEET PLANTAIN CHIPS (U.S. CL. 46).
FIRST USE 9-30-1997; IN COMMERCE 9-30-2006.

CLASS 29—(Continued).

3,298,854. 812, LLC, PARK CITY, UT. SN 78-503,516. PUB. 9-27-2005, FILED 10-21-2004.

SPIRO

THE MARK CONSISTS OF STANDARD CHARACTERS WITHOUT CLAIM TO ANY PARTICULAR FONT, STYLE, SIZE, OR COLOR.

FOR PROCESSED MEAT, MEAT SNACKS, DRIED MEATS (U.S. CL. 46).

FIRST USE 6-5-2006; IN COMMERCE 6-5-2006.

CLASS 29—(Continued).

3,299,228. LUCY'S ENTERPRISES INC., CITY OF INDUSTRY, CA. SN 78-678,594. PUB. 1-16-2007, FILED 7-26-2005.



THE COLOR(S) RED, WHITE IS/ARE CLAIMED AS A FEATURE OF THE MARK.

THE WORD "YAKIN" AND THE HEART DESIGN APPEAR IN THE COLOR WHITE ON A RED OVAL BACKGROUND.

THE MARK CONSISTS OF THE WORD "YAKIN" AND THE HEART ARE IN WHITE AND THE BACKGROUND OVAL IS RED.

THE WORD "YAKIN" MEANS THE GUARD OF THE NIGHT IN JAPANESE.

FOR DAIRY-BASED BEVERAGES (U.S. CL. 46).

FIRST USE 2-23-2006; IN COMMERCE 2-23-2006.

3,299,381. ASTROCHEF, INC., LOS ANGELES, CA. SN 78-728,340. PUB. 12-19-2006, FILED 10-6-2005.

american APPETIZER

NO CLAIM IS MADE TO THE EXCLUSIVE RIGHT TO USE "APPETIZER", APART FROM THE MARK AS SHOWN.

FOR PACKAGED APPETIZERS CONSISTING PRIMARILY OF MEAT, FISH, OR POULTRY (U.S. CL. 46).

FIRST USE 11-30-2005; IN COMMERCE 11-30-2005.

3,299,013. WINOKUR, SAUNDRA, DBA SANDY OAKS OLIVE ORCHARD, ELMENDORF, TX. SN 78-594,503. PUB. 7-4-2006, FILED 3-24-2005.

SANDY OAKS ORCHARDS

THE MARK CONSISTS OF STANDARD CHARACTERS WITHOUT CLAIM TO ANY PARTICULAR FONT, STYLE, SIZE, OR COLOR.

NO CLAIM IS MADE TO THE EXCLUSIVE RIGHT TO USE "ORCHARDS", APART FROM THE MARK AS SHOWN.

FOR OLIVE LEAF JELLY, OLIVE OIL, PROCESSED OLIVES (U.S. CL. 46).

FIRST USE 1-30-2004; IN COMMERCE 1-30-2004.

3,299,571. ORO DE OLIVO USA, LLC, CORAL GABLES, FL. SN 78-755,543. PUB. 7-25-2006, FILED 11-16-2005.



CLASS 29—(Continued).

NO CLAIM IS MADE TO THE EXCLUSIVE RIGHT TO USE "OLIVO" AND THE PICTORIAL REPRESENTATION OF THE OLIVES, APART FROM THE MARK AS SHOWN.

THE ENGLISH TRANSLATION OF THE WORD ORO DE OLIVO IN THE MARK IS GOLD FROM THE OLIVE TREE. FOR OLIVE OIL (U.S. CL. 46).
FIRST USE 5-4-2006; IN COMMERCE 5-4-2006.

CLASS 29—(Continued).

3,299,658. PINE RIDGE FOODS, L.L.C., WILSON, NC. SN 78-775,128. PUB. 8-22-2006, FILED 12-16-2005.

PINE RIDGE FARMS

THE MARK CONSISTS OF STANDARD CHARACTERS WITHOUT CLAIM TO ANY PARTICULAR FONT, STYLE, SIZE, OR COLOR.

NO CLAIM IS MADE TO THE EXCLUSIVE RIGHT TO USE "FARMS", APART FROM THE MARK AS SHOWN. FOR PORK AND BEEF (U.S. CL. 46).
FIRST USE 12-15-2006; IN COMMERCE 12-15-2006.

3,299,580. NATURAL SELECTION FOODS, LLC, SAN JUAN BAUTISTA, CA. SN 78-757,070. PUB. 9-26-2006, FILED 11-18-2005.

GREEN HARVEST

THE MARK CONSISTS OF STANDARD CHARACTERS WITHOUT CLAIM TO ANY PARTICULAR FONT, STYLE, SIZE, OR COLOR.

OWNER OF U.S. REG. NO. 2,365,489.
NO CLAIM IS MADE TO THE EXCLUSIVE RIGHT TO USE "GREEN", APART FROM THE MARK AS SHOWN.

FOR CUT FRESH VEGETABLES AND SLICED FRESH VEGETABLES; SLICED FRUITS; PRE-WASHED VEGETABLE AND FRUIT SALADS; FRESH VEGETABLE SALADS, NAMELY SALADS CONSISTING OF SPECIALTY LETTUCE AND FRESH VEGETABLES; PRE-MIXED SALADS CONSISTING PRIMARILY OF CUT VEGETABLES (U.S. CL. 46).
FIRST USE 11-5-1999; IN COMMERCE 11-5-1999.

3,299,713. BREYERS YOGURT COMPANY, LLC, LONGMONT, CO. SN 78-790,656. PUB. 2-20-2007, FILED 1-12-2006.

PROBIOTIC PLUS

THE MARK CONSISTS OF STANDARD CHARACTERS WITHOUT CLAIM TO ANY PARTICULAR FONT, STYLE, SIZE, OR COLOR.

NO CLAIM IS MADE TO THE EXCLUSIVE RIGHT TO USE "PROBIOTIC", APART FROM THE MARK AS SHOWN. FOR YOGURT (U.S. CL. 46).
FIRST USE 1-31-2006; IN COMMERCE 1-31-2006.

3,299,645. GORTON'S, INC., GLOUCESTER, MA. SN 78-771,898. PUB. 3-6-2007, FILED 12-13-2005.

**TRUST THE GORTON'S
FISHERMAN**

THE MARK CONSISTS OF STANDARD CHARACTERS WITHOUT CLAIM TO ANY PARTICULAR FONT, STYLE, SIZE, OR COLOR.

OWNER OF U.S. REG. NOS. 2,608,031, 3,059,423, AND OTHERS.

FOR FRESH AND FROZEN SEAFOODS, AND PRE-PACKAGED DINNERS CONSISTING PRIMARILY OF SEAFOOD (U.S. CL. 46).
FIRST USE 6-30-2006; IN COMMERCE 6-30-2006.

3,299,776. SARA POZONSKY, KENAI, AK. SN 78-809,654. PUB. 10-10-2006, FILED 2-8-2006.

SeaBeef

THE MARK CONSISTS OF STANDARD CHARACTERS WITHOUT CLAIM TO ANY PARTICULAR FONT, STYLE, SIZE, OR COLOR.

FOR SALMON (U.S. CL. 46).
FIRST USE 1-1-2007; IN COMMERCE 3-1-2007.

CLASS 29—(Continued).

3,299,875. SOURCE OF THE NILE INC., CHICAGO, IL. SN 78-845,611. PUB. 12-19-2006, FILED 3-24-2006.

SHAHED AL SHAREK

THE MARK CONSISTS OF STANDARD CHARACTERS WITHOUT CLAIM TO ANY PARTICULAR FONT, STYLE, SIZE, OR COLOR.

"SHAHED AL SHAREK" IS A FICTITIOUS NAME WITH NO KNOWN MEANING IN A FOREIGN LANGUAGE.

FOR FROZEN MIDDLE EASTERN FRUITS AND VEGETABLES (U.S. CL. 46).

FIRST USE 6-1-2006; IN COMMERCE 6-1-2006.

3,299,910. FRESH EXPRESS INCORPORATED, SALINAS, CA. SN 78-859,413. PUB. 2-20-2007, FILED 4-11-2006.



FOR PRECUT PACKAGED FRESH VEGETABLES AND GARDEN SALADS (U.S. CL. 46).

FIRST USE 7-26-2006; IN COMMERCE 7-26-2006.

3,299,967. HP HOOD LLC, LYNNFIELD, MA. SN 78-878,535. PUB. 12-12-2006, FILED 5-8-2006.

CALORIE COUNTDOWN

THE MARK CONSISTS OF STANDARD CHARACTERS WITHOUT CLAIM TO ANY PARTICULAR FONT, STYLE, SIZE, OR COLOR.

OWNER OF U.S. REG. NOS. 917,801 AND 2,958,354. FOR FLUID MILK, NAMELY WHOLE MILK, REDUCED FAT MILK, LOW FAT MILK, SKIM MILK; FLAVORED MILK DRINKS; FLAVORED MILK-BASED DAIRY DRINKS (U.S. CL. 46).

FIRST USE 6-1-2006; IN COMMERCE 6-1-2006.

CLASS 29—(Continued).

3,300,007. HENGSHUI HONGTENG PEANUT CO., LTD., HENGSHUI, HEBEI, CHINA. SN 78-893,555. PUB. 1-16-2007, FILED 5-25-2006.

wonders

THE MARK CONSISTS OF STANDARD CHARACTERS WITHOUT CLAIM TO ANY PARTICULAR FONT, STYLE, SIZE, OR COLOR.

FOR SNACK FOODS, NAMELY, PROCESSED NUTS AND PROCESSED EDIBLE SEEDS (U.S. CL. 46).

FIRST USE 8-29-2006; IN COMMERCE 8-29-2006.

3,300,167. SYSCO CORPORATION, HOUSTON, TX. SN 78-949,326. PUB. 2-27-2007, FILED 8-10-2006.

RANCH & GRILL

THE MARK CONSISTS OF STANDARD CHARACTERS WITHOUT CLAIM TO ANY PARTICULAR FONT, STYLE, SIZE, OR COLOR.

FOR BACON; PORK (U.S. CL. 46).

FIRST USE 12-1-2006; IN COMMERCE 12-1-2006.

3,300,197. PPC MARKETING, LTD., PITTSBURGH, TX. SN 78-970,676. PUB. 3-6-2007, FILED 9-8-2006.

MERIT

THE MARK CONSISTS OF STANDARD CHARACTERS WITHOUT CLAIM TO ANY PARTICULAR FONT, STYLE, SIZE, OR COLOR.

FOR POULTRY (U.S. CL. 46).

FIRST USE 2-15-2007; IN COMMERCE 2-15-2007.

CLASS 30—STAPLE FOODS

3,298,418. MARS, INCORPORATED, MCLEAN, VA. SN 76-365,118. PUB. 10-17-2006, FILED 2-1-2002.

THE CAFE OF CHOICE

CLASS 30—(Continued).

NO CLAIM IS MADE TO THE EXCLUSIVE RIGHT TO USE "CAFE", APART FROM THE MARK AS SHOWN.
FOR COFFEE, TEA, COCOA, HOT CHOCOLATE; MIXTURES OF COFFEE, COFFEE EXTRACTS (U.S. CL. 46).
FIRST USE 1-0-2002; IN COMMERCE 1-0-2002.

CLASS 30—(Continued).

3,298,571. CHOCOLADEFABRIKEN LINDT & SPRUNGLI AG, CH-8802 KILCHBERG, SWITZERLAND. SN 76-650,745. PUB. 9-19-2006, FILED 11-22-2005.

3,298,431. ZETA ESPACIAL S.A., 08191 RUBI (BARCELONA), SPAIN. SN 76-464,478. PUB. 6-28-2005, FILED 10-28-2002.

ALLRITE

FOR CANDY (U.S. CL. 46).
FIRST USE 2-28-2003; IN COMMERCE 2-28-2003.



THE COLOR(S) GOLD, BLACK AND RED IS/ARE CLAIMED AS A FEATURE OF THE MARK.
THE REINDEER IS GOLD WITH BLACK HOOVES, A BLACK NOSE, MOUTH, EYES AND ANTLERS, AND A RED BOW.
THE MARK CONSISTS OF THE THREE-DIMENSIONAL CONFIGURATION OF A FOIL-WRAPPED, REINDEER-SHAPED CHOCOLATE. THE REINDEER IS GOLD WITH BLACK HOOVES, A BLACK NOSE, MOUTH, EYES AND ANTLERS, AND A RED BOW.
FOR CHOCOLATE (U.S. CL. 46).
FIRST USE 11-1-2004; IN COMMERCE 11-1-2004.

3,298,432. NEW CENTURY HOLDINGS, INC., EDEN PRAIRIE, MN. SN 76-465,475. PUB. 6-3-2003, FILED 11-8-2002.

COUNTRY CHOICE

OWNER OF U.S. REG. NO. 1,766,866.
FOR BREAKFAST CEREALS; CEREAL-BASED SNACK FOOD; OATMEAL; PROCESSED CEREALS; PROCESSED GRAINS; PROCESSED OATS; READY-TO-EAT CEREAL-DERIVED FOOD BARS; ROLLED OATS (U.S. CL. 46).
FIRST USE 10-24-1991; IN COMMERCE 10-24-1991.

3,298,608. CONAGRA FOODS FOOD INGREDIENTS COMPANY, INC., OMAHA, NE. SN 76-978,618. PUB. 8-29-2006, FILED 5-12-2005.

3,298,570. UNILEVER SUPPLY CHAIN, INC., CLINTON, CT. SN 76-650,076. PUB. 7-11-2006, FILED 11-9-2005.

Cyclone

OWNER OF U.S. REG. NO. 2,888,770.
FOR FROZEN CONFECTIONS (U.S. CL. 46).
FIRST USE 3-0-2006; IN COMMERCE 3-0-2006.

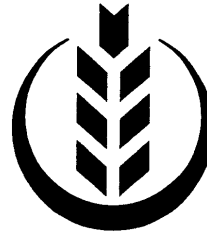

FOR FLOUR; PROCESSED WHEAT, BARLEY, CORN, RYE, SORGHUM, MILLET, OATS, CANARY SEED, RICE, JOB'S TEARS, TRITICALE, AMARANTH, QUINOA, AND TEFF (U.S. CL. 46).
FIRST USE 5-0-2006; IN COMMERCE 5-0-2006.

CLASS 30—(Continued).

3,298,610. SNAPPLE BEVERAGE CORP., RYE BROOK, NY.
SN 77-008,400. PUB. 2-6-2007, FILED 9-27-2006.

OUT OF THE BLUE-BERRY

THE MARK CONSISTS OF STANDARD CHARACTERS WITHOUT CLAIM TO ANY PARTICULAR FONT, STYLE, SIZE, OR COLOR.
FOR TEA (U.S. CL. 46).
FIRST USE 12-11-2006; IN COMMERCE 12-11-2006.

3,298,611. JELLY BELLY CANDY COMPANY, FAIRFIELD, CA. SN 77-008,564. PUB. 2-20-2007, FILED 9-27-2006.

SUMMER FRUIT STAND

THE MARK CONSISTS OF STANDARD CHARACTERS WITHOUT CLAIM TO ANY PARTICULAR FONT, STYLE, SIZE, OR COLOR.
FOR CANDY (U.S. CL. 46).
FIRST USE 4-11-2007; IN COMMERCE 4-11-2007.

3,298,618. CADBURY ADAMS USA LLC, PARSIPPANY, NJ.
SN 77-011,728. PUB. 1-16-2007, FILED 10-2-2006.

PEPPERMINT SWIRL

THE MARK CONSISTS OF STANDARD CHARACTERS WITHOUT CLAIM TO ANY PARTICULAR FONT, STYLE, SIZE, OR COLOR.
NO CLAIM IS MADE TO THE EXCLUSIVE RIGHT TO USE PEPPERMINT, APART FROM THE MARK AS SHOWN.
FOR CONFECTIONERY, NAMELY CHEWING GUM (U.S. CL. 46).
FIRST USE 5-11-2007; IN COMMERCE 5-11-2007.

CLASS 30—(Continued).

3,298,637. CADBURY ADAMS USA LLC, PARSIPPANY, NJ.
SN 77-044,681. PUB. 3-20-2007, FILED 11-15-2006.

WILD BLUEBERRY TWIST

THE MARK CONSISTS OF STANDARD CHARACTERS WITHOUT CLAIM TO ANY PARTICULAR FONT, STYLE, SIZE, OR COLOR.
NO CLAIM IS MADE TO THE EXCLUSIVE RIGHT TO USE "WILD BLUEBERRY", APART FROM THE MARK AS SHOWN.
FOR CONFECTIONERY, NAMELY CHEWING GUM (U.S. CL. 46).
FIRST USE 5-5-2007; IN COMMERCE 5-5-2007.

3,298,651. DRUMM, ROCHELLE, IRVINE, CA. SN 78-169,483.
PUB. 12-16-2003, FILED 9-30-2002.

DIAPER SNAX

NO CLAIM IS MADE TO THE EXCLUSIVE RIGHT TO USE "SNACKS", APART FROM THE MARK AS SHOWN.
FOR SNACK FOOD AND DESSERT PRODUCTS, NAMELY, PROCESSED CEREAL-DERIVED FOOD PRODUCTS FOR USE AS SNACKS, AND CHOCOLATE-COATED OR YOGURT-COATED PRETZELS (U.S. CL. 46).
FIRST USE 3-1-2007; IN COMMERCE 3-6-2007.

3,298,652. LA DONATELLA SRL, MONTEBELLUNA (TV), ITALY. SN 78-169,800. PUB. 6-27-2006, FILED 10-1-2002.



PRIORITY CLAIMED UNDER SEC. 44(D) ON ITALY APPLICATION NO. VI2002C00038, FILED 8-8-2002, REG. NO. VI2002C00038, DATED 8-8-2002, EXPIRES 8-8-2012.
FOR FRESH AND PRESERVED BAKERY PRODUCTS (U.S. CL. 46).
FIRST USE 0-0-2005; IN COMMERCE 0-0-2005.

CLASS 30—(Continued).

3,298,699. DULKRE S.A., BUENOS AIRES, ARGENTINA. SN 78-311,662. PUB. 6-20-2006, FILED 10-9-2003.

CLASS 30—(Continued).

3,298,910. NOT ONLY CHEESE INC., SARASOTA, FL. SN 78-548,337. PUB. 6-20-2006, FILED 1-15-2005.

FRUCTOFIBRA

PRIORITY CLAIMED UNDER SEC. 44(D) ON ARGENTINA APPLICATION NO. AR2429221, FILED 6-5-2003, REG. NO. 2429221, DATED 9-16-2004, EXPIRES 9-16-2014.
FOR NATURAL NON-DIETETIC SWEETENERS (U.S. CL. 46).
FIRST USE 6-14-2000; IN COMMERCE 6-14-2000.



3,298,729. COMPASS GROUP USA, INC., CHARLOTTE, NC. SN 78-370,607. PUB. 3-1-2005, FILED 2-19-2004.

LAKE STREET

THE MARK CONSISTS OF STANDARD CHARACTERS WITHOUT CLAIM TO ANY PARTICULAR FONT, STYLE, SIZE, OR COLOR.
NO CLAIM IS MADE TO THE EXCLUSIVE RIGHT TO USE "BLEND", APART FROM THE MARK AS SHOWN.
FOR COFFEE (U.S. CL. 46).
FIRST USE 3-0-2005; IN COMMERCE 3-0-2005.

NO CLAIM IS MADE TO THE EXCLUSIVE RIGHT TO USE "TIGELLA", APART FROM THE MARK AS SHOWN.
THE MARK CONSISTS IN TWO WORDS "LA TIGELLA" ON THE UPPER SIDE AND ON THE BOTTOM THE BANNER INCLUDING THE SENTENCE "THE SANDWICH IN THE STONE".
FOR SANDWICHES, FISH SANDWICHES, FRANKFURTER SANDWICHES, HAMBURGER SANDWICHES, HOT DOG SANDWICHES, BREAD, BREAD AND BUNS, BREAD CRUMB, BREAD DOUGHS, BREAD STICKS, BREAD WITH SOY BEAN, FOOD PACKAGE COMBINATIONS CONSISTING PRIMARILY OF BREAD, CRACKERS AND/OR COOKIES, PITA BREAD, ROLLS, STUFFING MIXES CONTAINING BREAD, UNLEAVENED BREAD IN THIN SHEETS, WHOLE MEAL BREAD, PASTRIES, BAGELS, EMPANADAS, CALZONES, PIZZA, FRESH PIZZA, PIZZA CRUST, PIZZA DOUGH, PREPARED PIZZAS, BARLEY FLOUR, BUCKWHEAT FLOUR, CORN FLOUR, CORN STARCH FLOUR, DRIED SUGARED CAKES OF RICE FLOUR, NAMELY, RAKUGAN, FLOUR, FLOUR FOR FOOD, FLOUR FOR MAKING DUMPLINGS OF GLUTINOUS RICE, FLOUR-BASED CHIPS, POTATO FLOUR, RICE FLOUR, RICE STARCH FLOUR, TAPIOCA FLOUR, WHEAT FLOUR, WHEAT STARCH FLOUR, CEREAL BASED SNACK FOOD, FARMNACEOUS FOOD PASTES FOR HUMAN CONSUMPTION, FOOD STARCH, READY TO EAT, CEREAL DERIVED FOOD BARS, RICE-BASED SNACK FOODS (U.S. CL. 46).
FIRST USE 3-11-2006; IN COMMERCE 3-11-2006.

CLASS 30—(Continued).

3,298,944. STARBUCKS U.S. BRANDS, LLC, MINDEN, NV.
SN 78-567,649. PUB. 1-3-2006, FILED 2-15-2005.

CLASS 30—(Continued).

3,298,945. STARBUCKS U.S. BRANDS, LLC, MINDEN, NV.
SN 78-567,713. PUB. 1-3-2006, FILED 2-15-2005.

STARBUCKS



THE MARK CONSISTS OF STANDARD CHARACTERS WITHOUT CLAIM TO ANY PARTICULAR FONT, STYLE, SIZE, OR COLOR.

OWNER OF U.S. REG. NOS. 1,452,359, 2,091,940, AND OTHERS.

FOR COFFEE; TEA; COCOA; PREPARED COFFEE AND COFFEE-BASED BEVERAGES; PREPARED ESPRESSO AND ESPRESSO-BASED BEVERAGES; BEVERAGES MADE OF TEA; POWDERED CHOCOLATE AND VANILLA; FLAVORING SYRUPS TO ADD TO BEVERAGES; BAKED GOODS, NAMELY, MUFFINS, SCONES, BISCUITS, COOKIES, PASTRIES AND BREADS; SANDWICHES; HOT AND COLD READY-TO-EAT FRUIT AND WHOLE GRAIN BASED BREAKFAST CEREAL; ICED TEA, READY-TO-DRINK TEA; CHOCOLATE FOOD BEVERAGES NOT BEING DAIRY-BASED OR VEGETABLE BASED; CHOCOLATE FOOD BEVERAGES NOT BEING DAIRY-BASED OR VEGETABLE BASED WITH COFFEE FLAVORS; COCOA PRODUCTS, NAMELY, COCOA MIXES AND COCOA POWDER; HOT CHOCOLATE; COCOA BEVERAGES WITH MILK; PREPARED COCOA AND COCOA-BASED BEVERAGES; PREPARATIONS FOR MAKING CHOCOLATE OR COCOA BASED DRINKS, NAMELY, LIQUID AND POWDERED HOT CHOCOLATE MIX AND LIQUID AND POWDERED HOT COCOA MIX; CHOCOLATE AND CANDY, NAMELY, CHOCOLATES, CHOCOLATE BARS, CHOCOLATE-COVERED COFFEE BEANS, CHOCOLATE TRUFFLES, CHOCOLATE-COVERED FRUITS, CHOCOLATE-COVERED NUTS, CHOCOLATE-COVERED DRIED FRUITS, CHOCOLATE-COVERED CRACKERS AND CHOCOLATE TOPPINGS (U.S. CL. 46).

FIRST USE 3-31-2004; IN COMMERCE 3-31-2004.

OWNER OF U.S. REG. NOS. 1,417,602, 2,091,941, AND OTHERS.

NO CLAIM IS MADE TO THE EXCLUSIVE RIGHT TO USE "COFFEE", APART FROM THE MARK AS SHOWN.

THE MARK CONSISTS OF THE WORDING "STARBUCKS COFFEE" IN A CIRCULAR SEAL WITH TWO STARS, AND DESIGN OF A SIREN (A TWO-TAILED MERMAID) WEARING A CROWN.

FOR COFFEE; TEA; COCOA; PREPARED COFFEE AND COFFEE-BASED BEVERAGES; PREPARED ESPRESSO AND ESPRESSO-BASED BEVERAGES; BEVERAGES MADE OF TEA; POWDERED CHOCOLATE AND VANILLA; FLAVORING SYRUPS TO ADD TO BEVERAGES; BAKED GOODS, NAMELY, MUFFINS, SCONES, BISCUITS, COOKIES, PASTRIES AND BREADS; SANDWICHES; HOT AND COLD READY-TO-EAT FRUIT AND WHOLE GRAIN BASED BREAKFAST CEREAL; ICED TEA, READY-TO-DRINK TEA; CHOCOLATE FOOD BEVERAGES NOT BEING DAIRY-BASED OR VEGETABLE BASED; CHOCOLATE FOOD BEVERAGES NOT BEING DAIRY-BASED OR VEGETABLE BASED WITH COFFEE FLAVORS; COCOA PRODUCTS, NAMELY, COCOA MIXES AND COCOA POWDER; HOT CHOCOLATE; COCOA BEVERAGES WITH MILK; PREPARED COCOA AND COCOA-BASED BEVERAGES; PREPARATIONS FOR MAKING CHOCOLATE OR COCOA BASED DRINKS, NAMELY, LIQUID AND POWDERED HOT CHOCOLATE MIX AND LIQUID AND POWDERED HOT COCOA MIX; CHOCOLATE AND CANDY, NAMELY, CHOCOLATES, CHOCOLATE BARS, CHOCOLATE-COVERED COFFEE BEANS, CHOCOLATE TRUFFLES, CHOCOLATE-COVERED FRUITS, CHOCOLATE-COVERED NUTS, CHOCOLATE-COVERED DRIED FRUITS, CHOCOLATE-COVERED CRACKERS AND CHOCOLATE TOPPINGS (U.S. CL. 46).

FIRST USE 3-31-2004; IN COMMERCE 3-31-2004.

CLASS 30—(Continued).

3,299,062. GUMLINK A/S, 7100 VEJLE, DENMARK. SN 78-606,442. PUB. 7-18-2006, FILED 4-11-2005.

FRESH BLAST

THE MARK CONSISTS OF STANDARD CHARACTERS WITHOUT CLAIM TO ANY PARTICULAR FONT, STYLE, SIZE, OR COLOR.

NO CLAIM IS MADE TO THE EXCLUSIVE RIGHT TO USE "FRESH", APART FROM THE MARK AS SHOWN.

FOR CONFECTIONERY, NAMELY, NON-MEDICATED CHEWING GUM (U.S. CL. 46).

FIRST USE 9-26-2006; IN COMMERCE 9-29-2006.

3,299,098. CAINS FOODS, L.P., AYER, MA. SN 78-621,068. PUB. 10-31-2006, FILED 5-2-2005.

CAROLINE'S

THE MARK CONSISTS OF STANDARD CHARACTERS WITHOUT CLAIM TO ANY PARTICULAR FONT, STYLE, SIZE, OR COLOR.

OWNER OF U.S. REG. NO. 2,973,308.

FOR BARBEQUE SAUCE; MARINADES; CONDIMENTS, NAMELY, MAYONNAISE, SAUCES, CHILI SAUCE, CHUTNEY, KETCHUP, MUSTARD AND TARTAR SAUCE; SANDWICH SPREAD, NAMELY, SPREADS COMPRISED PRIMARILY OF MAYONNAISE, MUSTARD, AND/OR OTHER SAUCES (U.S. CL. 46).

FIRST USE 2-26-2004; IN COMMERCE 2-26-2004.

3,299,133. AVALANCHE PRODUCTS, INC., ROCKLIN, CA. SN 78-638,388. PUB. 6-27-2006, FILED 5-26-2005.

AVASOFT

THE MARK CONSISTS OF STANDARD CHARACTERS WITHOUT CLAIM TO ANY PARTICULAR FONT, STYLE, SIZE, OR COLOR.

FOR FROZEN CONFECTIONS, ICE CREAM, FROZEN YOGURT (U.S. CL. 46).

FIRST USE 1-31-2006; IN COMMERCE 1-31-2006.

CLASS 30—(Continued).

3,299,146. LEWIS BROTHERS BAKERIES, INCORPORATED, DBA LEWIS BAKERIES, INC., EVANSVILLE, IN. SN 78-641,923. PUB. 2-21-2006, FILED 6-2-2005.

HIGH FIVE FOR HEALTHY KIDS

THE MARK CONSISTS OF STANDARD CHARACTERS WITHOUT CLAIM TO ANY PARTICULAR FONT, STYLE, SIZE, OR COLOR.

OWNER OF U.S. REG. NOS. 2,334,972, 2,400,072, AND 2,507,487.

FOR BAKERY GOODS (U.S. CL. 46).

FIRST USE 12-5-2006; IN COMMERCE 12-5-2006.

3,299,166. RICHARD LEBOUF ENTERTAINMENT, LLC, JENNINGS, LA. SN 78-653,436. PUB. 6-6-2006, FILED 6-17-2005.

BON TEMPS

THE MARK CONSISTS OF STANDARD CHARACTERS WITHOUT CLAIM TO ANY PARTICULAR FONT, STYLE, SIZE, OR COLOR.

THE ENGLISH TRANSLATION OF THE WORDING "BON TEMPS" IN THE MARK IS "GOOD TIME."

FOR PRODUCTS FOR FLAVORING OR SEASONING FOODSTUFF, NAMELY, MULTI-PURPOSE DRY SEASONINGS, HOT SAUCE (U.S. CL. 46).

FIRST USE 6-13-2005; IN COMMERCE 6-13-2005.

3,299,167. RICHARD LEBOUF ENTERTAINMENT, LLC, JENNINGS, LA. SN 78-653,456. PUB. 6-6-2006, FILED 6-17-2005.



NO CLAIM IS MADE TO THE EXCLUSIVE RIGHT TO USE "SEASONING", APART FROM THE MARK AS SHOWN.

THE ENGLISH TRANSLATION OF THE WORDING "BON TEMPS" IN THE MARK IS "GOOD TIME."

FOR PRODUCTS FOR FLAVORING OR SEASONING FOODSTUFF, NAMELY, MULTI-PURPOSE DRY SEASONINGS, HOT SAUCE (U.S. CL. 46).

FIRST USE 6-13-2005; IN COMMERCE 6-13-2005.

CLASS 30—(Continued).

3,299,233. HAYDELS BAKERY, JEFFERSON, LA. SN 78-680,596. PUB. 12-5-2006, FILED 7-28-2005.

CAJUNNOLI

THE MARK CONSISTS OF STANDARD CHARACTERS WITHOUT CLAIM TO ANY PARTICULAR FONT, STYLE, SIZE, OR COLOR.

OWNER OF U.S. REG. NO. 1,597,704.
FOR PASTRIES (U.S. CL. 46).
FIRST USE 11-23-2005; IN COMMERCE 12-15-2005.

3,299,234. KELLOGG NORTH AMERICA COMPANY, BATTLE CREEK, MI. SN 78-680,774. PUB. 4-18-2006, FILED 7-28-2005.



OWNER OF U.S. REG. NOS. 221,594, 844,688, AND OTHERS.

FOR COOKIES, COOKIE SANDWICHES, COOKIE BARS, CRACKERS, CRACKER SANDWICHES, PIE CRUSTS, ICE CREAM CONES (U.S. CL. 46).
FIRST USE 1-31-2005; IN COMMERCE 1-31-2005.

3,299,237. FOREVER CHEESE, ASTORIA, NY. SN 78-681,133. PUB. 9-19-2006, FILED 7-28-2005.

VALENCIANOS

THE MARK CONSISTS OF STANDARD CHARACTERS WITHOUT CLAIM TO ANY PARTICULAR FONT, STYLE, SIZE, OR COLOR.

THE ENGLISH TRANSLATION OF THE WORD VALENCIANOS IS "ONE FROM VALENCIA".
FOR CRACKERS (U.S. CL. 46).
FIRST USE 8-1-2005; IN COMMERCE 10-1-2005.

CLASS 30—(Continued).

3,299,261. COOKIE GIRL, LLC, MINDEN, NV. SN 78-694,908. PUB. 7-11-2006, FILED 8-17-2005.



NO CLAIM IS MADE TO THE EXCLUSIVE RIGHT TO USE "COOKIE", APART FROM THE MARK AS SHOWN.

THE COLOR(S) YELLOW, RED, BROWN, WHITE, BLACK AND LIGHT ORANGE IS/ARE CLAIMED AS A FEATURE OF THE MARK.

THE COLOR YELLOW APPEARS IN THE BODY SUIT, THE COLOR RED APPEARS IN THE BOOTS, CAPE, AND IN THE LETTERING "CB". THE COLOR WHITE APPEARS IN THE EYES AND TEETH OF THE COOKIE DESIGN, THE COLOR BROWN APPEARS IN THE COOKIE, THE COLOR BLACK APPEARS IN THE OUTLINE OF THE DESIGN AND LETTERING, IN THE PUPILS OF THE EYES, IN THE SHADOW UNDERNEATH THE DESIGN, AND IN THE LETTER "D". AND THE COLOR LIGHT ORANGE APPEARS IN THE WORDING "COOKIE BOY".

FOR COOKIES AND GRANOLA-BASED SNACK BARS (U.S. CL. 46).

FIRST USE 5-1-2005; IN COMMERCE 6-10-2006.

3,299,349. AGAKHANYAN, ARARAT, BURBANK, CA. SN 78-721,795. PUB. 6-6-2006, FILED 9-27-2005.

MINI PAPA

THE MARK CONSISTS OF STANDARD CHARACTERS WITHOUT CLAIM TO ANY PARTICULAR FONT, STYLE, SIZE, OR COLOR.

NO CLAIM IS MADE TO THE EXCLUSIVE RIGHT TO USE "MINI", APART FROM THE MARK AS SHOWN.

FOR PIZZA (U.S. CL. 46).
FIRST USE 2-22-2007; IN COMMERCE 2-22-2007.

CLASS 30—(Continued).

3,299,415. GRUMA CORPORATION, IRVING, TX. SN 78-734,326. PUB. 6-20-2006, FILED 10-17-2005.

NOW THERE'S AN IDEA!

THE MARK CONSISTS OF STANDARD CHARACTERS WITHOUT CLAIM TO ANY PARTICULAR FONT, STYLE, SIZE, OR COLOR.

FOR TORTILLAS, TORTILLA CHIPS (U.S. CL. 46).
FIRST USE 1-0-2007; IN COMMERCE 1-0-2007.

3,299,445. LEWIS BROTHERS BAKERIES, INCORPORATED, DBA LEWIS BAKERIES, INC., EVANSVILLE, IN. SN 78-737,349. PUB. 7-4-2006, FILED 10-20-2005.

HEALTHY LIFE IS THE WHOLE
GRAIN ANSWER!

THE MARK CONSISTS OF STANDARD CHARACTERS WITHOUT CLAIM TO ANY PARTICULAR FONT, STYLE, SIZE, OR COLOR.

OWNER OF U.S. REG. NOS. 1,815,479, 2,402,271, AND OTHERS.
FOR BREAD (U.S. CL. 46).
FIRST USE 3-1-2007; IN COMMERCE 3-1-2007.

3,299,511. KELLOGG NORTH AMERICA COMPANY, BATTLE CREEK, DE. SN 78-746,980. PUB. 4-18-2006, FILED 11-4-2005.

CRUNCHMANIA

THE MARK CONSISTS OF STANDARD CHARACTERS WITHOUT CLAIM TO ANY PARTICULAR FONT, STYLE, SIZE, OR COLOR.

FOR GRAIN-BASED SNACK FOOD (U.S. CL. 46).
FIRST USE 7-15-2006; IN COMMERCE 7-15-2006.

CLASS 30—(Continued).

3,299,617. TULSA COFFEE SERVICE INC., DBA JAVA DAVE'S EXECUTIVE COFFEE, TULSA, OK. SN 78-767,499. PUB. 9-12-2006, FILED 12-6-2005.

Bringing Coffee To Life

THE MARK CONSISTS OF STANDARD CHARACTERS WITHOUT CLAIM TO ANY PARTICULAR FONT, STYLE, SIZE, OR COLOR.

FOR COFFEE (U.S. CL. 46).
FIRST USE 10-1-2005; IN COMMERCE 10-1-2005.

3,299,663. MORRIS NATIONAL, INC., AZUSA, CA. SN 78-776,588. PUB. 8-1-2006, FILED 12-19-2005.

Lunch Time

THE MARK CONSISTS OF STANDARD CHARACTERS WITHOUT CLAIM TO ANY PARTICULAR FONT, STYLE, SIZE, OR COLOR.

FOR CANDY (U.S. CL. 46).
FIRST USE 3-6-2007; IN COMMERCE 3-6-2007.

3,299,684. CARGILL, INCORPORATED, WAYZATA, MN. SN 78-783,821. PUB. 7-11-2006, FILED 1-3-2006.

WHEATSELECT



THE MARK CONSISTS OF THE WORD WHEATSELECT AND A RECTANGLE WITH 3 STALKS OF WHEAT.

FOR FLOUR FOR FOOD (U.S. CL. 46).
FIRST USE 3-16-2006; IN COMMERCE 3-16-2006.

CLASS 30—(Continued).

3,299,728. SNACK IP HOLDINGS, INC., VANCOUVER, BC, CANADA. SN 78-795,139. PUB. 8-1-2006, FILED 1-19-2006.

RICE WORKS

THE MARK CONSISTS OF STANDARD CHARACTERS WITHOUT CLAIM TO ANY PARTICULAR FONT, STYLE, SIZE, OR COLOR.

NO CLAIM IS MADE TO THE EXCLUSIVE RIGHT TO USE "RICE", APART FROM THE MARK AS SHOWN, FOR RICE-BASED SNACK FOODS (U.S. CL. 46). FIRST USE 6-16-2006; IN COMMERCE 8-24-2006.

3,299,826. ACH FOOD COMPANIES, INC., CORDOVA, TN. SN 78-826,821. PUB. 2-13-2007, FILED 3-1-2006.

STEAK DUST

THE MARK CONSISTS OF STANDARD CHARACTERS WITHOUT CLAIM TO ANY PARTICULAR FONT, STYLE, SIZE, OR COLOR.

NO CLAIM IS MADE TO THE EXCLUSIVE RIGHT TO USE "STEAK", APART FROM THE MARK AS SHOWN, FOR MARINADES; SEASONINGS; SPICES (U.S. CL. 46). FIRST USE 12-31-2003; IN COMMERCE 12-31-2003.

3,299,938. CLARK, HARVEY P., BOYLSTON, MA. SN 78-868,988. PUB. 12-5-2006, FILED 4-25-2006.

ANGUS DRESSING

THE MARK CONSISTS OF STANDARD CHARACTERS WITHOUT CLAIM TO ANY PARTICULAR FONT, STYLE, SIZE, OR COLOR.

OWNER OF U.S. REG. NOS. 2,999,389, 3,102,434, AND 3,125,182.

NO CLAIM IS MADE TO THE EXCLUSIVE RIGHT TO USE "DRESSING", APART FROM THE MARK AS SHOWN, FOR SALAD DRESSING (U.S. CL. 46). FIRST USE 7-19-2006; IN COMMERCE 7-19-2006.

CLASS 30—(Continued).

3,299,987. GENERAL MILLS IP HOLDINGS I, LLC, MINNEAPOLIS, MN. SN 78-885,417. PUB. 10-10-2006, FILED 5-17-2006.

FRUITY CHEERIOS

THE MARK CONSISTS OF STANDARD CHARACTERS WITHOUT CLAIM TO ANY PARTICULAR FONT, STYLE, SIZE, OR COLOR.

OWNER OF U.S. REG. NOS. 414,338, 1,553,122, AND OTHERS.

NO CLAIM IS MADE TO THE EXCLUSIVE RIGHT TO USE FRUITY, APART FROM THE MARK AS SHOWN.

FOR PROCESSED CEREAL-DERIVED FOOD PRODUCT TO BE USED AS A BREAKFAST FOOD, SNACK FOOD, OR INGREDIENT FOR MAKING FOOD (U.S. CL. 46).

FIRST USE 7-25-2006; IN COMMERCE 7-25-2006.

3,300,021. QUAKER OATS COMPANY, THE, CHICAGO, IL. SN 78-899,086. PUB. 1-2-2007, FILED 6-2-2006.

CAP'N CRUNCH'S CHOCO CRUNCH

THE MARK CONSISTS OF STANDARD CHARACTERS WITHOUT CLAIM TO ANY PARTICULAR FONT, STYLE, SIZE, OR COLOR.

OWNER OF U.S. REG. NOS. 764,797, 813,548, AND OTHERS.

FOR BREAKFAST CEREAL (U.S. CL. 46).

FIRST USE 12-4-2006; IN COMMERCE 12-4-2006.

3,300,077. FREDERIC F. FOX, AUSTIN, TX. SN 78-916,178. PUB. 2-6-2007, FILED 6-24-2006.

Shaggy's

THE MARK CONSISTS OF STANDARD CHARACTERS WITHOUT CLAIM TO ANY PARTICULAR FONT, STYLE, SIZE, OR COLOR.

THE NAME SHAGGY DOES NOT IDENTIFY A LIVING INDIVIDUAL.

FOR BARBECUE SAUCE; CONDIMENT, NAMELY PEPPER SAUCE; HOT SAUCE; SAUCES; SAUCES FOR BARBECUED MEAT (U.S. CL. 46).

FIRST USE 11-15-2006; IN COMMERCE 11-15-2006.

CLASS 30—(Continued).

3,300,133. JELLY BELLY CANDY COMPANY, FAIRFIELD, CA. SN 78-932,133. PUB. 2-20-2007, FILED 7-18-2006.

CLASS 30—(Continued).

3,300,212. DR PEPPER/SEVEN UP, INC., PLANO, TX. SN 78-978,686. PUB. 7-4-2006, FILED 1-12-2006.

RECIPES FOR ROMANCE

THE MARK CONSISTS OF STANDARD CHARACTERS WITHOUT CLAIM TO ANY PARTICULAR FONT, STYLE, SIZE, OR COLOR.

FOR CANDY (U.S. CL. 46).

FIRST USE 10-27-2006; IN COMMERCE 10-27-2006.



3,300,177. ASSOCIATED SALES, INC., TUPELO, MS. SN 78-956,359. PUB. 4-10-2007, FILED 8-21-2006.

OWNER OF U.S. REG. NOS. 880,969, 1,578,002, AND OTHERS.

FOR FROZEN CONFECTIONS (U.S. CL. 46).

FIRST USE 2-28-2006; IN COMMERCE 2-28-2006.

BONE NAWN'

THE MARK CONSISTS OF STANDARD CHARACTERS WITHOUT CLAIM TO ANY PARTICULAR FONT, STYLE, SIZE, OR COLOR.

FOR BARBECUE SAUCE (U.S. CL. 46).

FIRST USE 2-1-2007; IN COMMERCE 2-1-2007.

CLASS 31—NATURAL AGRICULTURAL PRODUCTS

3,298,503. AGROMOD, S.A. DE C.V., SAN PEDRO GARZA GARCIA, NUEVO LEON, MEXICO. SN 76-629,060. PUB. 5-9-2006, FILED 1-24-2005.

3,300,193. SCHWAN'S IP, LLC, MARSHALL, MN. SN 78-969,359. PUB. 1-23-2007, FILED 9-7-2006.

SCHWAN'S MONSTER MANIA

THE MARK CONSISTS OF STANDARD CHARACTERS WITHOUT CLAIM TO ANY PARTICULAR FONT, STYLE, SIZE, OR COLOR.

OWNER OF U.S. REG. NOS. 2,243,064, 3,066,864, AND OTHERS.

FOR FROZEN COOKIE DOUGH (U.S. CL. 46).

FIRST USE 7-1-2006; IN COMMERCE 7-1-2006.

OWNER OF MEXICO REG. NO. 842772, DATED 7-19-2004, EXPIRES 5-17-2014.

FOR FRESH FRUITS (U.S. CLS. 1 AND 46).

FIRST USE 1-0-2001; IN COMMERCE 1-0-2001.

CLASS 31—(Continued).

3,298,518. WESTWAY FEED PRODUCTS, INC., TOMBALL, TX. SN 76-635,469. PUB. 7-18-2006, FILED 4-11-2005.



THE MARK CONSISTS IN PART OF A COW AT A FEED BIN.

FOR NON-MEDICATED FEED SUPPLEMENTS FOR LIVESTOCK (U.S. CLS. 1 AND 46).

FIRST USE 4-4-2007; IN COMMERCE 4-4-2007.

3,298,578. FRESH INTELLECTUAL PROPERTIES, INC., WILMINGTON, DE. SN 76-655,657. PUB. 9-26-2006, FILED 2-24-2006.

HAPPY HOUR BOUQUETS

THE MARK CONSISTS OF STANDARD CHARACTERS WITHOUT CLAIM TO ANY PARTICULAR FONT, STYLE, SIZE, OR COLOR.

NO CLAIM IS MADE TO THE EXCLUSIVE RIGHT TO USE "BOUQUETS", APART FROM THE MARK AS SHOWN. FOR LIVE FLOWER ARRANGEMENTS (U.S. CLS. 1 AND 46).

FIRST USE 10-0-2004; IN COMMERCE 10-0-2004.

3,298,583. DOSKOCIL MANUFACTURING COMPANY, INC., ARLINGTON, TX. SN 76-658,474. PUB. 2-27-2007, FILED 4-14-2006.

PETMATE BAKERY DELIGHTS

THE MARK CONSISTS OF STANDARD CHARACTERS WITHOUT CLAIM TO ANY PARTICULAR FONT, STYLE, SIZE, OR COLOR.

OWNER OF U.S. REG. NOS. 1,371,337, 2,697,708, AND OTHERS.

NO CLAIM IS MADE TO THE EXCLUSIVE RIGHT TO USE "BAKERY", APART FROM THE MARK AS SHOWN. FOR EDIBLE DOG TREATS (U.S. CLS. 1 AND 46). FIRST USE 9-30-2006; IN COMMERCE 9-30-2006.

CLASS 31—(Continued).

3,298,595. DOSKOCIL MANUFACTURING COMPANY, INC., ARLINGTON, TX. SN 76-660,647. PUB. 2-27-2007, FILED 5-25-2006.

CHEE-ZUR

THE MARK CONSISTS OF STANDARD CHARACTERS WITHOUT CLAIM TO ANY PARTICULAR FONT, STYLE, SIZE, OR COLOR.

FOR EDIBLE DOG TREATS (U.S. CLS. 1 AND 46). FIRST USE 9-30-2006; IN COMMERCE 9-30-2006.

3,298,701. WHITE, JOHN CLAYTON, RAMONA, CA. SN 78-315,779. PUB. 6-6-2006, FILED 10-20-2003.



NO CLAIM IS MADE TO THE EXCLUSIVE RIGHT TO USE AVOCADO CO. AND RAMONA, CA. APART FROM THE MARK AS SHOWN.

THE STIPPLING IS A FEATURE OF THE MARK.

FOR WOODEN AVOCADO GIFT CRATES CONSISTING PRIMARILY OF FRESH AVOCADOS, GUACAMOLE MIX, SALSA AND MIXING BOWLS, ALL SOLD AS A UNIT (U.S. CLS. 1 AND 46).

FIRST USE 7-1-2003; IN COMMERCE 11-1-2003.

3,298,747. ROYAL CANIN U.S.A., INC., ST. CHARLES, MO. SN 78-387,332. PUB. 1-24-2006, FILED 3-19-2004.

**ROYAL CANIN
VETERINARY DIET**

THE MARK CONSISTS OF STANDARD CHARACTERS WITHOUT CLAIM TO ANY PARTICULAR FONT, STYLE, SIZE, OR COLOR.

CLASS 31—(Continued).

OWNER OF U.S. REG. NOS. 1,398,736, 2,785,758, AND OTHERS.

NO CLAIM IS MADE TO THE EXCLUSIVE RIGHT TO USE VETERINARY DIET, APART FROM THE MARK AS SHOWN.

THE ENGLISH TRANSLATION OF THE FRENCH WORDING "CANIN" IS "CANINE".

SEC. 2(F) AS TO CANIN .

FOR PET FOOD (U.S. CLS. 1 AND 46).

FIRST USE 4-0-2004; IN COMMERCE 4-0-2004.

CLASS 31—(Continued).

3,299,405. WOODS & WELLS INTERNATIONAL GROUP, COVINA, CA. SN 78-732,736. PUB. 7-4-2006, FILED 10-13-2005.

W & W

3,298,995. TOPCO ASSOCIATES, LLC, SKOKIE, IL. SN 78-589,812. PUB. 12-13-2005, FILED 3-17-2005.

THE MARK CONSISTS OF STANDARD CHARACTERS WITHOUT CLAIM TO ANY PARTICULAR FONT, STYLE, SIZE, OR COLOR.

FOR PET FOOD (U.S. CLS. 1 AND 46).

FIRST USE 5-31-2006; IN COMMERCE 5-31-2006.

CLEAR VALUE

3,299,519. GULLIKSEN, GWEN, WHITTIER, CA. SN 78-748,397. PUB. 6-27-2006, FILED 11-7-2005.

ARTAINABLE

THE MARK CONSISTS OF STANDARD CHARACTERS WITHOUT CLAIM TO ANY PARTICULAR FONT, STYLE, SIZE, OR COLOR.

FOR CAT LITTER, DRY CAT FOOD, DRY DOG FOOD, DOG BISCUITS (U.S. CLS. 1 AND 46).

FIRST USE 8-1-2006; IN COMMERCE 8-1-2006.

THE MARK CONSISTS OF STANDARD CHARACTERS WITHOUT CLAIM TO ANY PARTICULAR FONT, STYLE, SIZE, OR COLOR.

FOR RAW FRUITS; RAW VEGETABLES (U.S. CLS. 1 AND 46).

FIRST USE 1-0-2006; IN COMMERCE 1-0-2006.

3,299,313. 1ST SELECT SEED, INC., NAMPA, ID. SN 78-712,534. PUB. 8-1-2006, FILED 9-14-2005.

1ST SELECT

3,299,743. SYSCO CORPORATION, HOUSTON, TX. SN 78-798,747. PUB. 10-31-2006, FILED 1-25-2006.

THE PRODUCE HUNTER

THE MARK CONSISTS OF STANDARD CHARACTERS WITHOUT CLAIM TO ANY PARTICULAR FONT, STYLE, SIZE, OR COLOR.

NO CLAIM IS MADE TO THE EXCLUSIVE RIGHT TO USE "SELECT", APART FROM THE MARK AS SHOWN.

FOR SEEDS FOR PLANTING FORAGE CROPS (U.S. CLS. 1 AND 46).

FIRST USE 8-9-2005; IN COMMERCE 8-24-2005.

THE MARK CONSISTS OF STANDARD CHARACTERS WITHOUT CLAIM TO ANY PARTICULAR FONT, STYLE, SIZE, OR COLOR.

NO CLAIM IS MADE TO THE EXCLUSIVE RIGHT TO USE "PRODUCE", APART FROM THE MARK AS SHOWN.

FOR FRESH PRODUCE, NAMELY, FRESH FRUITS AND VEGETABLES (U.S. CLS. 1 AND 46).

FIRST USE 4-1-2001; IN COMMERCE 4-1-2001.

CLASS 31—(Continued).

3,299,822. DEL MONTE CORPORATION, SAN FRANCISCO, CA. SN 78-825,222. PUB. 8-1-2006, FILED 2-28-2006.

DENTA RIFFIC

THE MARK CONSISTS OF STANDARD CHARACTERS WITHOUT CLAIM TO ANY PARTICULAR FONT, STYLE, SIZE, OR COLOR.

FOR PET FOOD AND PET SNACKS (U.S. CLS. 1 AND 46).

FIRST USE 6-21-2006; IN COMMERCE 6-21-2006.

CLASS 31—(Continued).

3,299,949. DEL MONTE CORPORATION, SAN FRANCISCO, CA. SN 78-874,050. PUB. 8-1-2006, FILED 5-2-2006.

CHEEZ PUPS

THE MARK CONSISTS OF STANDARD CHARACTERS WITHOUT CLAIM TO ANY PARTICULAR FONT, STYLE, SIZE, OR COLOR.

FOR PET FOOD (U.S. CLS. 1 AND 46).

FIRST USE 6-21-2006; IN COMMERCE 6-21-2006.

3,299,895. DLF INTERNATIONAL SEEDS, INC., HALSEY, OR. SN 78-853,943. PUB. 10-3-2006, FILED 4-4-2006.

GlucoMax

THE MARK CONSISTS OF STANDARD CHARACTERS WITHOUT CLAIM TO ANY PARTICULAR FONT, STYLE, SIZE, OR COLOR.

FOR AGRICULTURAL SEEDS, NAMELY GRASS SEED, MUSTARD SEED AND RAPESEED (U.S. CLS. 1 AND 46).

FIRST USE 2-9-2007; IN COMMERCE 2-9-2007.

3,299,982. THE HITCHIN' SPOT, LLC, LAS VEGAS, NV. SN 78-883,631. PUB. 1-16-2007, FILED 5-15-2006.

DOG-WA

THE MARK CONSISTS OF STANDARD CHARACTERS WITHOUT CLAIM TO ANY PARTICULAR FONT, STYLE, SIZE, OR COLOR.

FOR DOG FOOD (U.S. CLS. 1 AND 46).

FIRST USE 11-25-2005; IN COMMERCE 5-30-2007.

3,299,946. HIGHLINE PRODUCE LIMITED, LEAMINGTON, ONTARIO, CANADA. SN 78-873,230. PUB. 12-12-2006, FILED 5-1-2006.

Mini Bella

THE MARK CONSISTS OF STANDARD CHARACTERS WITHOUT CLAIM TO ANY PARTICULAR FONT, STYLE, SIZE, OR COLOR.

NO CLAIM IS MADE TO THE EXCLUSIVE RIGHT TO USE "MINI", APART FROM THE MARK AS SHOWN.

THE ENGLISH TRANSLATION OF THE WORD BELLA IN THE MARK IS BEAUTIFUL.

FOR FRESH MUSHROOMS (U.S. CLS. 1 AND 46).
FIRST USE 5-0-2006; IN COMMERCE 5-0-2006.

3,300,000. FRESH INTELLECTUAL PROPERTIES, INC., WILMINGTON, DE. SN 78-889,845. PUB. 11-21-2006, FILED 5-23-2006.

COSMOPOLITAN BOUQUET

THE MARK CONSISTS OF STANDARD CHARACTERS WITHOUT CLAIM TO ANY PARTICULAR FONT, STYLE, SIZE, OR COLOR.

NO CLAIM IS MADE TO THE EXCLUSIVE RIGHT TO USE "BOUQUET", APART FROM THE MARK AS SHOWN.

FOR LIVE FLOWER ARRANGEMENTS (U.S. CLS. 1 AND 46).

FIRST USE 5-26-2006; IN COMMERCE 5-26-2006.

CLASS 31—(Continued).

3,300,043. THE HITCHIN' SPOT, LLC, LAS VEGAS, NV. SN 78-905,510. PUB. 1-16-2007, FILED 6-11-2006.

CLASS 32—(Continued).

3,298,725. LAWLOR, HAROLD SEWARD, HAMPTON, VA. AND LAWLOR, REBECCA NEMIA, HAMPTON, VA. SN 78-363,811. PUB. 10-10-2006, FILED 2-6-2004.

THE LAP OF LUXURY

THE MARK CONSISTS OF STANDARD CHARACTERS WITHOUT CLAIM TO ANY PARTICULAR FONT, STYLE, SIZE, OR COLOR.
FOR DOG FOOD (U.S. CLS. 1 AND 46).
FIRST USE 11-25-2005; IN COMMERCE 5-30-2007.

ICE * WATER

3,300,054. PLAINVIEW GROWERS, INC., POMPTON PLAINS, NJ. SN 78-909,766. PUB. 2-13-2007, FILED 6-16-2006.

THE MARK CONSISTS OF STANDARD CHARACTERS WITHOUT CLAIM TO ANY PARTICULAR FONT, STYLE, SIZE, OR COLOR.
FOR BOTTLED DRINKING WATER; NON-ALCOHOLIC DRINKS, NAMELY, BOTTLED WATER, SPRING WATER, ARTESIAN WELL WATER, DRINKING WATER, MINERAL WATER, SPRING WATER, TABLE WATER, TREATED DRINKING WATER, AND FILTERED DRINKING WATER (U.S. CLS. 45, 46 AND 48).
FIRST USE 2-21-2007; IN COMMERCE 2-21-2007.

Berries & Bells

THE MARK CONSISTS OF STANDARD CHARACTERS WITHOUT CLAIM TO ANY PARTICULAR FONT, STYLE, SIZE, OR COLOR.
FOR LIVE FLOWERING PLANTS; LIVING PLANTS (U.S. CLS. 1 AND 46).
FIRST USE 9-1-2006; IN COMMERCE 11-1-2006.

3,298,746. FREELIFE INTERNATIONAL HOLDINGS, LLC, MILFORD, CT. SN 78-387,302. PUB. 1-4-2005, FILED 3-19-2004.

CLASS 32—LIGHT BEVERAGES

3,298,538. JUICEHEADS, INC., SAN BERNARDINO, CA. SN 76-642,044. PUB. 10-3-2006, FILED 6-30-2005.



NO CLAIM IS MADE TO THE EXCLUSIVE RIGHT TO USE "GOURMET JUICE", APART FROM THE MARK AS SHOWN.
FOR BEVERAGES, NAMELY FRUIT JUICES, VEGETABLE JUICES AND SMOOTHIES (U.S. CLS. 45, 46 AND 48).
FIRST USE 1-0-2006; IN COMMERCE 1-0-2006.

The Himalayan Health Secret

THE MARK CONSISTS OF STANDARD CHARACTERS WITHOUT CLAIM TO ANY PARTICULAR FONT, STYLE, SIZE, OR COLOR.
NO CLAIM IS MADE TO THE EXCLUSIVE RIGHT TO USE "HIMALAYAN", APART FROM THE MARK AS SHOWN.
FOR SPORTS DRINKS (U.S. CLS. 45, 46 AND 48).
FIRST USE 10-10-2003; IN COMMERCE 10-10-2003.

CLASS 32—(Continued).

3,298,834. BON AGROINDUSTRIAL, S.A., SANTO DOMINGO, DOMINICAN REP. SN 78-481,002. PUB. 12-20-2005, FILED 9-9-2004.

CACO E' FRUTA

THE MARK CONSISTS OF STANDARD CHARACTERS WITHOUT CLAIM TO ANY PARTICULAR FONT, STYLE, SIZE, OR COLOR.

THE FOREIGN WORDING IN THE MARK TRANSLATES INTO ENGLISH AS FRUITHEAD.

FOR BEVERAGES, NAMELY, SOFT DRINKS AND FRUIT JUICES (U.S. CLS. 45, 46 AND 48).

FIRST USE 9-29-2005; IN COMMERCE 9-29-2005.

3,299,163. PEPSICO, INC., PURCHASE, NY. SN 78-652,786. PUB. 2-28-2006, FILED 6-17-2005.

FREE RIDE

THE MARK CONSISTS OF STANDARD CHARACTERS WITHOUT CLAIM TO ANY PARTICULAR FONT, STYLE, SIZE, OR COLOR.

FOR SOFT DRINKS (U.S. CLS. 45, 46 AND 48).

FIRST USE 2-0-2007; IN COMMERCE 2-0-2007.

3,299,407. KAGOME CO., LTD., NAKA-KU NOGOYA, JAPAN. SN 78-733,350. PUB. 11-7-2006, FILED 10-14-2005.

BURGUNDY BERRY BLOSSOM

THE MARK CONSISTS OF STANDARD CHARACTERS WITHOUT CLAIM TO ANY PARTICULAR FONT, STYLE, SIZE, OR COLOR.

NO CLAIM IS MADE TO THE EXCLUSIVE RIGHT TO USE "BURGUNDY BERRY", APART FROM THE MARK AS SHOWN.

FOR BLENDED JUICES OF VEGETABLES AND FRUITS (U.S. CLS. 45, 46 AND 48).

FIRST USE 2-28-2006; IN COMMERCE 2-28-2006.

CLASS 32—(Continued).

3,299,614. DIAGEO NORTH AMERICA, INC., NORWALK, CT. SN 78-766,996. PUB. 7-18-2006, FILED 12-5-2005.

CATCH THE REAL ISLAND FLAVOR

THE MARK CONSISTS OF STANDARD CHARACTERS WITHOUT CLAIM TO ANY PARTICULAR FONT, STYLE, SIZE, OR COLOR.

FOR BREWED MALT BASED ALCOHOLIC BEVERAGES IN THE NATURE OF BEER (U.S. CLS. 45, 46 AND 48).

FIRST USE 3-13-2006; IN COMMERCE 3-13-2006.

3,299,621. DESCHUTES BREWERY, INC., BEND, OR. SN 78-768,408. PUB. 7-4-2006, FILED 12-7-2005.

INVERSION IPA

THE MARK CONSISTS OF STANDARD CHARACTERS WITHOUT CLAIM TO ANY PARTICULAR FONT, STYLE, SIZE, OR COLOR.

NO CLAIM IS MADE TO THE EXCLUSIVE RIGHT TO USE "IPA", APART FROM THE MARK AS SHOWN.

FOR ALE (U.S. CLS. 45, 46 AND 48).

FIRST USE 3-21-2006; IN COMMERCE 3-21-2006.

3,299,669. COCA-COLA COMPANY, THE, ATLANTA, GA. SN 78-778,614. PUB. 8-8-2006, FILED 12-21-2005.

FUEL TO BE FABULOUS

THE MARK CONSISTS OF STANDARD CHARACTERS WITHOUT CLAIM TO ANY PARTICULAR FONT, STYLE, SIZE, OR COLOR.

FOR NON-ALCOHOLIC BEVERAGES, NAMELY ENERGY DRINKS (U.S. CLS. 45, 46 AND 48).

FIRST USE 2-0-2006; IN COMMERCE 2-0-2006.

CLASS 32—(Continued).

3,299,742. NORTHSHORE UTILITY DISTRICT, KENMORE, WA. SN 78-798,570. PUB. 11-21-2006, FILED 1-24-2006.

EMERGENCY RAIN

THE MARK CONSISTS OF STANDARD CHARACTERS WITHOUT CLAIM TO ANY PARTICULAR FONT, STYLE, SIZE, OR COLOR.

FOR DRINKING WATER, NAMELY, POTABLE, PACKAGED WATER WITH STORAGE LIFE OF THREE TO TEN YEARS (U.S. CLS. 45, 46 AND 48).

FIRST USE 1-24-2006; IN COMMERCE 9-16-2006.

3,299,762. DESCHUTES BREWERY, INC., BEND, OR. SN 78-804,907. PUB. 7-4-2006, FILED 2-1-2006.

MIRROR MIRROR

THE MARK CONSISTS OF STANDARD CHARACTERS WITHOUT CLAIM TO ANY PARTICULAR FONT, STYLE, SIZE, OR COLOR.

OWNER OF U.S. REG. NO. 1,765,354.

FOR ALE (U.S. CLS. 45, 46 AND 48).

FIRST USE 1-18-2006; IN COMMERCE 1-18-2006.

3,299,882. PAPA'S TRANSPORT, INC., TOWNSEND, DE. SN 78-848,141. PUB. 12-5-2006, FILED 3-28-2006.

ACQUA CLEAR

THE MARK CONSISTS OF STANDARD CHARACTERS WITHOUT CLAIM TO ANY PARTICULAR FONT, STYLE, SIZE, OR COLOR.

NO CLAIM IS MADE TO THE EXCLUSIVE RIGHT TO USE "ACQUA", APART FROM THE MARK AS SHOWN.

THE FOREIGN WORDING IN THE MARK TRANSLATES INTO ENGLISH AS WATER.

FOR FLAVORED WATERS; FRUIT-FLAVORED BEVERAGES; FRUIT-FLAVORED DRINKS (U.S. CLS. 45, 46 AND 48).

FIRST USE 9-15-2006; IN COMMERCE 9-15-2006.

CLASS 32—(Continued).

3,300,065. WILD GOOSE HOLDING CO., INC., WILMINGTON, DE. SN 78-911,938. PUB. 2-13-2007, FILED 6-20-2006.

MACH W

THE MARK CONSISTS OF STANDARD CHARACTERS WITHOUT CLAIM TO ANY PARTICULAR FONT, STYLE, SIZE, OR COLOR.

FOR ENERGY DRINKS (U.S. CLS. 45, 46 AND 48).

FIRST USE 11-13-2006; IN COMMERCE 11-13-2006.

3,300,146. JACOB LEINENKUGEL BREWING CO., INC., CHIPPEWA FALLS, WI. SN 78-939,941. PUB. 2-13-2007, FILED 7-28-2006.

TAKE IN THE FLAVOR

THE MARK CONSISTS OF STANDARD CHARACTERS WITHOUT CLAIM TO ANY PARTICULAR FONT, STYLE, SIZE, OR COLOR.

FOR BEER (U.S. CLS. 45, 46 AND 48).

FIRST USE 12-15-2006; IN COMMERCE 12-15-2006.

3,300,162. PEPSICO, INC., PURCHASE, NY. SN 78-946,164. PUB. 2-6-2007, FILED 8-7-2006.

SIERRA MIST LEMON SQUEEZE

THE MARK CONSISTS OF STANDARD CHARACTERS WITHOUT CLAIM TO ANY PARTICULAR FONT, STYLE, SIZE, OR COLOR.

OWNER OF U.S. REG. NOS. 2,495,127, 2,988,284, AND OTHERS.

NO CLAIM IS MADE TO THE EXCLUSIVE RIGHT TO USE "LEMON", APART FROM THE MARK AS SHOWN.

FOR SOFT DRINKS, AND SYRUPS AND CONCENTRATES FOR MAKING THE SAME (U.S. CLS. 45, 46 AND 48).

FIRST USE 5-21-2007; IN COMMERCE 5-21-2007.

CLASS 33—WINES AND SPIRITS

CLASS 33—(Continued).

3,298,412. SAFEWAY INC., PLEASANTON, CA. SN 76-316,048. PUB. 5-21-2002, FILED 9-24-2001.

Diablo Creek Vineyards

NO CLAIM IS MADE TO THE EXCLUSIVE RIGHT TO USE "VINEYARD", APART FROM THE MARK AS SHOWN. THE ENGLISH TRANSLATION OF "DIABLO" IS DEVIL. FOR WINE (U.S. CLS. 47 AND 49).
FIRST USE 12-28-2001; IN COMMERCE 12-28-2001.

3,298,502. WESTERFIELD, DINAH BIRD, XENIA, OH. SN 76-628,405. PUB. 6-20-2006, FILED 1-20-2005.

THE THOROUGHbred OF WINES

THE MARK CONSISTS OF STANDARD CHARACTERS WITHOUT CLAIM TO ANY PARTICULAR FONT, STYLE, SIZE, OR COLOR.

NO CLAIM IS MADE TO THE EXCLUSIVE RIGHT TO USE "WINES", APART FROM THE MARK AS SHOWN. FOR WINES (U.S. CLS. 47 AND 49).
FIRST USE 10-19-2006; IN COMMERCE 10-19-2006.

3,298,620. OPERA LLC, NEW YORK, NY. SN 77-015,166. PUB. 2-20-2007, FILED 10-5-2006.

ORIEL 365

THE MARK CONSISTS OF STANDARD CHARACTERS WITHOUT CLAIM TO ANY PARTICULAR FONT, STYLE, SIZE, OR COLOR.

OWNER OF U.S. REG. NOS. 2,982,879 AND 3,050,122. FOR WINE (U.S. CLS. 47 AND 49).
FIRST USE 5-0-2007; IN COMMERCE 5-0-2007.

3,298,665. BACARDI & COMPANY LIMITED, NASSAU, NEW PROVIDENCE, BAHAMAS. SN 78-222,071. PUB. 6-22-2004, FILED 3-5-2003.

DEWAR'S SIGNATURE

OWNER OF U.S. REG. NOS. 66,490, 2,742,903, AND OTHERS. FOR SCOTCH WHISKEY (U.S. CLS. 47 AND 49).
FIRST USE 8-29-2003; IN COMMERCE 8-29-2003.

CLASS 33—(Continued).

3,298,681. MYSTIC MEADS AND MELOMELS, L.L.C., GRAND RIVER, IA. SN 78-261,077. PUB. 12-23-2003, FILED 6-11-2003.

SHADOWWALKER

FOR HANDCRAFTED MEADS AND MELOMELS (U.S. CLS. 47 AND 49).
FIRST USE 3-6-2007; IN COMMERCE 3-6-2007.

3,298,788. CELIA, VILLANUEVA, HOUSTON, TX. SN 78-453,681. PUB. 9-6-2005, FILED 7-20-2004.

Joyas de Mexico

THE MARK CONSISTS OF STANDARD CHARACTERS WITHOUT CLAIM TO ANY PARTICULAR FONT, STYLE, SIZE, OR COLOR.

NO CLAIM IS MADE TO THE EXCLUSIVE RIGHT TO USE "MEXICO", APART FROM THE MARK AS SHOWN.

THE FOREIGN WORDING IN THE MARK TRANSLATES INTO ENGLISH AS "JEWELS OF MEXICO". FOR TEQUILA PRODUCED IN THE JALISCO REGION IN MEXICO (U.S. CLS. 47 AND 49).
FIRST USE 2-10-2005; IN COMMERCE 2-10-2005.

3,298,874. ASOCIACION ARGENTINA DE ANGUS, BUENOS AIRES, ARGENTINA. SN 78-521,058. PUB. 9-5-2006, FILED 11-22-2004.

ABERDEEN ANGUS

THE MARK CONSISTS OF STANDARD CHARACTERS WITHOUT CLAIM TO ANY PARTICULAR FONT, STYLE, SIZE, OR COLOR.

OWNER OF U.S. REG. NO. 2,767,175. FOR WINES AND SPARKING WINES (U.S. CLS. 47 AND 49).
FIRST USE 11-0-1969; IN COMMERCE 3-0-2004.

CLASS 33—(Continued).

3,298,879. CRAGGY RANGE VINEYARDS LIMITED, HAVELOCK NORTH, NEW ZEALAND. SN 78-522,976. PUB. 12-20-2005, FILED 11-24-2004.

CRAGGY RANGE TE MUNA

THE MARK CONSISTS OF STANDARD CHARACTERS WITHOUT CLAIM TO ANY PARTICULAR FONT, STYLE, SIZE, OR COLOR.

NO CLAIM IS MADE TO THE EXCLUSIVE RIGHT TO USE "TE MUNA", APART FROM THE MARK AS SHOWN.

THE FOREIGN WORDING IN THE MARK TRANSLATES INTO ENGLISH AS SECRET OR SPECIAL PLACE.

FOR WINE (U.S. CLS. 47 AND 49).
FIRST USE 11-0-2002; IN COMMERCE 12-0-2002.

3,298,908. JEAN-CLAUDE BOISSET WINES, USA, INC., SAUSALITO, CA. SN 78-547,757. PUB. 5-9-2006, FILED 1-14-2005.

FRENCH RABBIT

THE MARK CONSISTS OF STANDARD CHARACTERS WITHOUT CLAIM TO ANY PARTICULAR FONT, STYLE, SIZE, OR COLOR.

NO CLAIM IS MADE TO THE EXCLUSIVE RIGHT TO USE "FRENCH", APART FROM THE MARK AS SHOWN.

FOR WINES (U.S. CLS. 47 AND 49).
FIRST USE 11-30-2005; IN COMMERCE 11-30-2005.

3,299,049. ROYAL WINE CORPORATION, BAYONNE, NJ. SN 78-603,556. PUB. 1-3-2006, FILED 4-7-2005.

GOOSE BAY

CLASS 33—(Continued).

THE MARK CONSISTS OF STANDARD CHARACTERS WITHOUT CLAIM TO ANY PARTICULAR FONT, STYLE, SIZE, OR COLOR.

FOR WINES (U.S. CLS. 47 AND 49).
FIRST USE 10-11-2005; IN COMMERCE 10-11-2005.

3,299,155. THE WINE GROUP LLC, TRACY, CA. SN 78-647,107. PUB. 9-26-2006, FILED 6-9-2005.

KILLER JUICE

THE MARK CONSISTS OF STANDARD CHARACTERS WITHOUT CLAIM TO ANY PARTICULAR FONT, STYLE, SIZE, OR COLOR.

NO CLAIM IS MADE TO THE EXCLUSIVE RIGHT TO USE "JUICE", APART FROM THE MARK AS SHOWN.

FOR WINES (U.S. CLS. 47 AND 49).
FIRST USE 6-9-2006; IN COMMERCE 6-9-2006.

3,299,288. FINE ESTATES FROM SPAIN, INC., DEDHAM, MA. SN 78-703,082. PUB. 2-6-2007, FILED 8-30-2005.

Fuego

THE MARK CONSISTS OF STANDARD CHARACTERS WITHOUT CLAIM TO ANY PARTICULAR FONT, STYLE, SIZE, OR COLOR.

THE FOREIGN WORDING IN THE MARK TRANSLATES INTO ENGLISH AS FIRE.

FOR WINES, SPARKLING WINES, AND DISTILLED SPIRITS (U.S. CLS. 47 AND 49).
FIRST USE 9-1-2006; IN COMMERCE 9-1-2006.

CLASS 33—(Continued).

3,299,289. FINE ESTATES FROM SPAIN, INC., DEDHAM, MA. SN 78-703,094. PUB. 2-6-2007, FILED 8-30-2005.

Garnacha De Fuego

THE MARK CONSISTS OF STANDARD CHARACTERS WITHOUT CLAIM TO ANY PARTICULAR FONT, STYLE, SIZE, OR COLOR.

NO CLAIM IS MADE TO THE EXCLUSIVE RIGHT TO USE "GARNACHA", APART FROM THE MARK AS SHOWN.

FOR WINES, SPARKLING WINES, AND DISTILLED SPIRITS (U.S. CLS. 47 AND 49).

FIRST USE 9-1-2006; IN COMMERCE 9-1-2006.

CLASS 33—(Continued).

3,299,424. PALI WINE COMPANY, L.P., PACIFIC PALISADES, CA. SN 78-735,762. PUB. 7-4-2006, FILED 10-18-2005.

PALI WINE COMPANY

THE MARK CONSISTS OF STANDARD CHARACTERS WITHOUT CLAIM TO ANY PARTICULAR FONT, STYLE, SIZE, OR COLOR.

NO CLAIM IS MADE TO THE EXCLUSIVE RIGHT TO USE "WINE COMPANY", APART FROM THE MARK AS SHOWN.

FOR WINE (U.S. CLS. 47 AND 49).

FIRST USE 10-2-2006; IN COMMERCE 10-2-2006.

3,299,343. DIVINE VODKA, LLC, BARODA, MI. SN 78-720,435. PUB. 9-12-2006, FILED 9-26-2005.

VODKA FROM THE VINEYARD

THE MARK CONSISTS OF STANDARD CHARACTERS WITHOUT CLAIM TO ANY PARTICULAR FONT, STYLE, SIZE, OR COLOR.

FOR VODKA (U.S. CLS. 47 AND 49).

FIRST USE 10-3-2006; IN COMMERCE 10-3-2006.

3,299,413. MARÍA Y ADELINA S.A., NEUQUÉN, ARGENTINA. SN 78-733,967. PUB. 6-27-2006, FILED 10-15-2005.

ALPATACO

THE MARK CONSISTS OF STANDARD CHARACTERS WITHOUT CLAIM TO ANY PARTICULAR FONT, STYLE, SIZE, OR COLOR.

ALPATACO IS THE NAME OF A PLANT TYPICAL OF THE PATAGONIA ZONE OF ARGENTINA. IT HAS NO TRANSLATION IN ENGLISH.

FOR APERITIFS WITH A WINE BASE; CORDIALS; DISTILLED SPIRITS; LIQUOR; WINES (U.S. CLS. 47 AND 49).

FIRST USE 8-8-2006; IN COMMERCE 8-8-2006.

3,299,552. DIAGEO NORTH AMERICA, INC., NORWALK, CT. SN 78-753,872. PUB. 7-18-2006, FILED 11-15-2005.

CATCH THE REAL ISLAND FLAVOR

THE MARK CONSISTS OF STANDARD CHARACTERS WITHOUT CLAIM TO ANY PARTICULAR FONT, STYLE, SIZE, OR COLOR.

FOR ALCOHOLIC BEVERAGES, NAMELY, DISTILLED SPIRITS (U.S. CLS. 47 AND 49).

FIRST USE 1-1-2007; IN COMMERCE 1-1-2007.

3,299,554. DIAGEO SCOTLAND LIMITED, EDINBURGH, SCOTLAND. SN 78-754,293. PUB. 7-18-2006, FILED 11-15-2005.

THE SINGLETON

THE MARK CONSISTS OF STANDARD CHARACTERS WITHOUT CLAIM TO ANY PARTICULAR FONT, STYLE, SIZE, OR COLOR.

FOR ALCOHOLIC BEVERAGES, NAMELY, WHISKY (U.S. CLS. 47 AND 49).

FIRST USE 3-30-2007; IN COMMERCE 3-30-2007.

CLASS 33—(Continued).

3,299,585. DIAGEO BRANDS B.V., AMSTERDAM, NETHERLANDS. SN 78-758,562. PUB. 9-19-2006, FILED 11-21-2005.

TANQUERAY RANGPUR

THE MARK CONSISTS OF STANDARD CHARACTERS WITHOUT CLAIM TO ANY PARTICULAR FONT, STYLE, SIZE, OR COLOR.

PRIORITY CLAIMED UNDER SEC. 44(D) ON ERPNCMNTY TM OFC APPLICATION NO. 004723821, FILED 11-4-2005.

OWNER OF U.S. REG. NOS. 120,024, 2,874,913, AND OTHERS.

NO CLAIM IS MADE TO THE EXCLUSIVE RIGHT TO USE "RANGPUR", APART FROM THE MARK AS SHOWN. FOR ALCOHOLIC BEVERAGES, NAMELY, DISTILLED SPIRITS (U.S. CLS. 47 AND 49).
FIRST USE 8-1-2006; IN COMMERCE 8-1-2006.

CLASS 33—(Continued).

3,299,769. JUICEBOX WINE COMPANY LLC, MANCHESTER, MA. SN 78-807,876. PUB. 1-30-2007, FILED 2-6-2006.

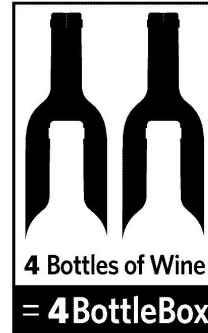

NO CLAIM IS MADE TO THE EXCLUSIVE RIGHT TO USE "4 BOTTLES OF WINE = 4 BOTTLE BOX", APART FROM THE MARK AS SHOWN.

THE MARK CONSISTS OF A REVERSE DESIGN CONSISTING OF THE IMAGE OF FOUR WINE BOTTLES AND TWO CORK PULLS.

FOR WINE (U.S. CLS. 47 AND 49).
FIRST USE 2-6-2006; IN COMMERCE 4-3-2006.

3,299,797. FQZ, LLC D/B/A SHERBROOKE CELLARS, WHITE PLAINS, NY. SN 78-816,713. PUB. 10-3-2006, FILED 2-16-2006.

FINNEGAN'S LAKE

THE MARK CONSISTS OF STANDARD CHARACTERS WITHOUT CLAIM TO ANY PARTICULAR FONT, STYLE, SIZE, OR COLOR.

FOR WINE (U.S. CLS. 47 AND 49).
FIRST USE 6-8-2006; IN COMMERCE 6-8-2006.

3,299,798. FQZ, LLC D/B/A SHERBROOKE CELLARS, WHITE PLAINS, NY. SN 78-816,715. PUB. 10-10-2006, FILED 2-16-2006.

Cocoa Hill

THE MARK CONSISTS OF STANDARD CHARACTERS WITHOUT CLAIM TO ANY PARTICULAR FONT, STYLE, SIZE, OR COLOR.

FOR ALCOHOLIC BEVERAGES, EXCLUDING BEER, NAMELY, STILL WINES, SPARKLING WINES, FORTIFIED WINES AND DISTILLED WINES (U.S. CLS. 47 AND 49).

FIRST USE 2-22-2007; IN COMMERCE 2-22-2007.

BOOKSTER

THE MARK CONSISTS OF STANDARD CHARACTERS WITHOUT CLAIM TO ANY PARTICULAR FONT, STYLE, SIZE, OR COLOR.

FOR WINE (U.S. CLS. 47 AND 49).
FIRST USE 6-7-2006; IN COMMERCE 6-7-2006.

CLASS 33—(Continued).

3,299,799. FQZ, LLC D/B/A/ SHERBROOKE CELLARS, WHITE PLAINS, NY. SN 78-816,717. PUB. 10-3-2006, FILED 2-16-2006.

LITTLE CHAZ

THE MARK CONSISTS OF STANDARD CHARACTERS WITHOUT CLAIM TO ANY PARTICULAR FONT, STYLE, SIZE, OR COLOR.
FOR WINE (U.S. CLS. 47 AND 49).
FIRST USE 5-15-2006; IN COMMERCE 5-15-2006.

3,299,806. FQZ, LLC D/B/A SHERBROOKE CELLARS, WHITE PLAINS, NY. SN 78-819,023. PUB. 10-10-2006, FILED 2-20-2006.

CHAZ POINT

THE MARK CONSISTS OF STANDARD CHARACTERS WITHOUT CLAIM TO ANY PARTICULAR FONT, STYLE, SIZE, OR COLOR.
FOR WINE (U.S. CLS. 47 AND 49).
FIRST USE 3-8-2006; IN COMMERCE 3-8-2006.

3,299,819. VINAROMA LLC, NEWARK, DE. SN 78-823,244. PUB. 1-9-2007, FILED 2-24-2006.

FRANCE SAVOUR

THE MARK CONSISTS OF STANDARD CHARACTERS WITHOUT CLAIM TO ANY PARTICULAR FONT, STYLE, SIZE, OR COLOR.
NO CLAIM IS MADE TO THE EXCLUSIVE RIGHT TO USE "FRANCE", APART FROM THE MARK AS SHOWN.
FOR WINES (U.S. CLS. 47 AND 49).
FIRST USE 11-15-2006; IN COMMERCE 11-15-2006.

CLASS 33—(Continued).

3,299,831. OSEZ VOUS? INTERNATIONAL SPIRITS LLC, WILMINGTON, DE. SN 78-828,450. PUB. 9-19-2006, FILED 3-3-2006.

ST. GERMAIN

THE MARK CONSISTS OF STANDARD CHARACTERS WITHOUT CLAIM TO ANY PARTICULAR FONT, STYLE, SIZE, OR COLOR.
FOR LIQUEURS (U.S. CLS. 47 AND 49).
FIRST USE 2-23-2007; IN COMMERCE 2-23-2007.

3,299,847. LANGETWINS WINE COMPANY, INC., ACAMPO, CA. SN 78-834,802. PUB. 10-31-2006, FILED 3-10-2006.

CIRCLE'S EDGE

THE MARK CONSISTS OF STANDARD CHARACTERS WITHOUT CLAIM TO ANY PARTICULAR FONT, STYLE, SIZE, OR COLOR.
FOR WINE (U.S. CLS. 47 AND 49).
FIRST USE 8-3-2006; IN COMMERCE 8-3-2006.

3,299,930. HEITZ WINE CELLARS, ST. HELENA, CA. SN 78-865,842. PUB. 12-5-2006, FILED 4-20-2006.



NO CLAIM IS MADE TO THE EXCLUSIVE RIGHT TO USE "NAPA VALLEY GRAPES 100%", APART FROM THE MARK AS SHOWN.
FOR WINE MADE FROM GRAPES GROWN IN THE NAPA VALLEY (U.S. CLS. 47 AND 49).
FIRST USE 9-1-2006; IN COMMERCE 9-1-2006.

CLASS 33—(Continued).

3,299,937. MIGUEL TORRES, S.A., BARCELONA, SPAIN. SN 78-868,174. PUB. 10-10-2006, FILED 4-24-2006.

MALENA

THE MARK CONSISTS OF STANDARD CHARACTERS WITHOUT CLAIM TO ANY PARTICULAR FONT, STYLE, SIZE, OR COLOR.

OWNER OF SPAIN REG. NO. 994.894, DATED 12-20-1982, EXPIRES 1-19-2012.

FOR WINES (U.S. CLS. 47 AND 49).
FIRST USE 6-24-2006; IN COMMERCE 6-24-2006.

CLASS 33—(Continued).

3,300,104. CHINA FINE WINES, LLC, SAN FRANCISCO, CA. SN 78-923,657. PUB. 2-20-2007, FILED 7-6-2006.

DRAGON'S HOLLOW

THE MARK CONSISTS OF STANDARD CHARACTERS WITHOUT CLAIM TO ANY PARTICULAR FONT, STYLE, SIZE, OR COLOR.

FOR WINE (U.S. CLS. 47 AND 49).
FIRST USE 4-23-2007; IN COMMERCE 4-23-2007.

3,299,947. SQUARE ONE ORGANIC SPIRITS, LLC, NOVATO, CA. SN 78-873,394. PUB. 12-12-2006, FILED 5-1-2006.

A SINGULAR SPIRIT

THE MARK CONSISTS OF STANDARD CHARACTERS WITHOUT CLAIM TO ANY PARTICULAR FONT, STYLE, SIZE, OR COLOR.

NO CLAIM IS MADE TO THE EXCLUSIVE RIGHT TO USE "SPIRIT", APART FROM THE MARK AS SHOWN.
FOR DISTILLED SPIRITS (U.S. CLS. 47 AND 49).
FIRST USE 4-3-2007; IN COMMERCE 4-3-2007.

3,300,165. PHILIPS, DANIEL, OXNARD, CA. SN 78-948,957. PUB. 3-13-2007, FILED 8-9-2006.

BOARDING PASS

THE MARK CONSISTS OF STANDARD CHARACTERS WITHOUT CLAIM TO ANY PARTICULAR FONT, STYLE, SIZE, OR COLOR.

FOR WINES (U.S. CLS. 47 AND 49).
FIRST USE 6-8-2007; IN COMMERCE 6-8-2007.

3,299,984. ROYAL WINE CORPORATION, BAYONNE, NJ. SN 78-884,262. PUB. 4-3-2007, FILED 5-16-2006.

CASA DA CORÇA

THE MARK CONSISTS OF STANDARD CHARACTERS WITHOUT CLAIM TO ANY PARTICULAR FONT, STYLE, SIZE, OR COLOR.

THE ENGLISH TRANSLATION OF THE FOREIGN WORDING "CASA DA CORCA" IS "HOUSE OF THE ROE DEER".

FOR WINES (U.S. CLS. 47 AND 49).
FIRST USE 1-31-2007; IN COMMERCE 1-31-2007.

3,300,166. BARONESS SMALL ESTATES, INC., DENVER, CO. SN 78-949,273. PUB. 2-20-2007, FILED 8-10-2006.

RHYME OR REASON

THE MARK CONSISTS OF STANDARD CHARACTERS WITHOUT CLAIM TO ANY PARTICULAR FONT, STYLE, SIZE, OR COLOR.

FOR RED WINE; TABLE WINES; WHITE WINE; WINE; WINES (U.S. CLS. 47 AND 49).
FIRST USE 9-13-2006; IN COMMERCE 9-13-2006.

CLASS 33—(Continued).

3,300,195. OPERA LLC, NEW YORK, NY. SN 78-970,083. PUB. 2-20-2007, FILED 9-8-2006.

ORIEL ICONIC

THE MARK CONSISTS OF STANDARD CHARACTERS WITHOUT CLAIM TO ANY PARTICULAR FONT, STYLE, SIZE, OR COLOR.

OWNER OF U.S. REG. NOS. 2,982,879 AND 3,050,122. FOR WINE (U.S. CLS. 47 AND 49). FIRST USE 12-0-2006; IN COMMERCE 12-0-2006.

3,300,218. NINER WINE ESTATES, LLC, SAN LUIS OBISPO, CA. SN 78-978,729. PUB. 11-15-2005, FILED 2-7-2005.

FOGCATCHER

THE MARK CONSISTS OF STANDARD CHARACTERS WITHOUT CLAIM TO ANY PARTICULAR FONT, STYLE, SIZE, OR COLOR.

FOR WINE (U.S. CLS. 47 AND 49). FIRST USE 3-13-2007; IN COMMERCE 3-13-2007.

CLASS 34—SMOKERS' ARTICLES

3,298,579. SINGLE STICK, INC., PHOENIX, AZ. SN 76-656,938. PUB. 10-31-2006, FILED 3-20-2006.

**PRIME TIME
HAPPY HOUR**

THE MARK CONSISTS OF STANDARD CHARACTERS WITHOUT CLAIM TO ANY PARTICULAR FONT, STYLE, SIZE, OR COLOR.

OWNER OF U.S. REG. NO. 3,023,628. FOR CIGARS (U.S. CLS. 2, 8, 9 AND 17). FIRST USE 11-8-2006; IN COMMERCE 11-8-2006.

CLASS 34—(Continued).

3,298,781. SOUTHERN COMFORT PROPERTIES, INC., SAN RAFAEL, CA. SN 78-446,391. PUB. 6-14-2005, FILED 7-6-2004.

SOUTHERN COMFORT

THE MARK CONSISTS OF STANDARD CHARACTERS WITHOUT CLAIM TO ANY PARTICULAR FONT, STYLE, SIZE, OR COLOR.

OWNER OF U.S. REG. NOS. 423,955 AND 1,522,030. FOR CIGARETTE LIGHTERS MADE OF NON-PRECIOUS METAL (U.S. CLS. 2, 8, 9 AND 17). FIRST USE 8-31-2006; IN COMMERCE 8-31-2006.

3,299,190. ZIPPMARK, INC., WILMINGTON, DE. SN 78-662,091. PUB. 3-21-2006, FILED 6-30-2005.



FOR LIGHTERS NOT OF PRECIOUS METAL (U.S. CLS. 2, 8, 9 AND 17). FIRST USE 6-30-2005; IN COMMERCE 3-16-2007.

3,299,194. SOCIETE BIC, CLICHY, FRANCE. SN 78-662,697. PUB. 9-26-2006, FILED 7-1-2005.

C2 SELECT

THE MARK CONSISTS OF STANDARD CHARACTERS WITHOUT CLAIM TO ANY PARTICULAR FONT, STYLE, SIZE, OR COLOR.

FOR CIGARETTE LIGHTERS NOT OF PRECIOUS METAL AND CASES THEREFOR (U.S. CLS. 2, 8, 9 AND 17). FIRST USE 2-17-2006; IN COMMERCE 2-17-2006.

CLASS 34—(Continued).

3,299,195. ZIPPMARK, INC., WILMINGTON, DE. SN 78-662,768. PUB. 3-21-2006, FILED 7-1-2005.

CLASS 34—(Continued).

3,299,447. ENDEMAÑO CIGARS, INC., MIAMI, FL. SN 78-737,414. PUB. 2-27-2007, FILED 10-20-2005.



zippoBLU

NO CLAIM IS MADE TO THE EXCLUSIVE RIGHT TO USE "RESERVE", APART FROM THE MARK AS SHOWN. THE NAME "ROMAY ENDEMAÑO" IDENTIFIES A LIVING INDIVIDUAL WHOSE CONSENT IS OF RECORD.

THE COLORS BROWN, LIGHT BROWN, DARK BROWN, BLACK, LIGHT YELLOW, BROWNISH PINK AND GREEN ARE CLAIMED AS A FEATURE OF THE MARK.

THE MARK CONSISTS OF THE WORDING "ROMAY ENDEMAÑO FAMILY RESERVE" IN BROWN AND A SHIELD DESIGN IN LIGHT AND DARK BROWN WITH FOUR PARTITIONS DIVIDED BY BLACK LINES. EACH PARTITION INCLUDES A DRAWING. THE FIRST PARTITION CONTAINS A STYLIZED LETTER "E" IN BLACK AGAINST A LIGHT YELLOW BACKGROUND. THE SECOND AND THIRD PARTITIONS EACH CONTAIN A SAILING VESSEL IN BLACK AGAINST A PINKISH BROWN BACKGROUND. THE FOURTH PARTITION CONTAINS THREE VERTICAL BARS; THE MIDDLE BAR IS LIGHT YELLOW AND THE BARS ON THE SIDES ARE LIGHT BROWN. IN THE CROSSING POINT OF THE PARTITIONS IS A PLAIN SHIELD IN GREEN.

FOR CIGARS; CIGARILLOS; CIGAR BANDS; CIGAR CUTTERS; CIGAR TUBES; HUMIDORS; MATCHES; MATCH BOXES NOT OF PRECIOUS METAL; MATCH HOLDERS NOT OF PRECIOUS METAL; NON-ELECTRIC CIGAR LIGHTERS NOT OF PRECIOUS METAL; SMOKING TOBACCO; SMOKING PIPES; SMOKING PIPES CLEANERS; SMOKING URNS; TOBACCO; TOBACCO POUCHES; TOBACCO SPITTOONS; SNUFF; SNUFF BOXES, NOT OF PRECIOUS METAL; SMOKELESS TOBACCO; CHEWING TOBACCO; ASHTRAYS, NOT OF PRECIOUS METAL; CIGARETTES CONTAINING TOBACCO SUBSTITUTES NOT FOR MEDICAL PURPOSES; CIGARETTES; CIGARETTES ROLLING PAPERS; CIGARETTE PAPERS; CIGARETTE LIGHTERS NOT OF PRECIOUS METAL; CIGARETTE LIGHTERS NOT FOR LAND VEHICLES; CIGARETTE HOLDERS, NOT OF PRECIOUS METAL; CIGARETTE CASES, NOT OF PRECIOUS METAL; CIGARETTE ASH RECEPTACLES; FLINTS FOR LIGHTERS; HERBS FOR SMOKING (U.S. CLS. 2, 8, 9 AND 17).

FIRST USE 2-21-2007; IN COMMERCE 2-21-2007.

OWNER OF U.S. REG. NOS. 2,001,509, 2,116,481, AND OTHERS.

FOR LIGHTERS NOT OF PRECIOUS METAL (U.S. CLS. 2, 8, 9 AND 17).

FIRST USE 7-1-2005; IN COMMERCE 3-16-2007.

CLASS 34—(Continued).

3,299,765. AREMAR IMPORT, INC., MIAMI, FL. SN 78-805,489. PUB. 10-10-2006, FILED 2-2-2006.

MARIA CHACON CIGARS

THE MARK CONSISTS OF STANDARD CHARACTERS WITHOUT CLAIM TO ANY PARTICULAR FONT, STYLE, SIZE, OR COLOR.

NO CLAIM IS MADE TO THE EXCLUSIVE RIGHT TO USE "CIGARS", APART FROM THE MARK AS SHOWN.

THE NAME MARIA CHACON IDENTIFIES A LIVING INDIVIDUAL WHOSE CONSENT IS OF RECORD.

FOR CIGAR BANDS; CIGAR BOXES NOT OF PRECIOUS METAL; CIGAR CUTTERS; CIGAR HUMIDIFIERS; CIGAR TUBES; CIGARS; NON-ELECTRIC CIGAR LIGHTERS NOT OF PRECIOUS METAL (U.S. CLS. 2, 8, 9 AND 17).

FIRST USE 5-1-2006; IN COMMERCE 5-1-2006.

3,299,766. AREMAR IMPORT, INC., MIAMI, FL. SN 78-805,578. PUB. 10-31-2006, FILED 2-2-2006.

EL ARTEMISENO

THE MARK CONSISTS OF STANDARD CHARACTERS WITHOUT CLAIM TO ANY PARTICULAR FONT, STYLE, SIZE, OR COLOR.

THE FOREIGN WORDING IN THE MARK TRANSLATES INTO ENGLISH AS THE ARTEMISENO.

FOR CIGAR BANDS; CIGAR BOXES NOT OF PRECIOUS METAL; CIGAR CUTTERS; CIGAR HUMIDIFIERS; CIGAR TUBES; CIGARS (U.S. CLS. 2, 8, 9 AND 17).

FIRST USE 5-1-2006; IN COMMERCE 5-1-2006.

3,299,793. WHAT A LIFE CO. LLC, MIDDLETOWN, CT. SN 78-816,087. PUB. 10-10-2006, FILED 2-16-2006.

CIGAR OF THE GODS

THE MARK CONSISTS OF STANDARD CHARACTERS WITHOUT CLAIM TO ANY PARTICULAR FONT, STYLE, SIZE, OR COLOR.

FOR SMOKER'S ARTICLES, NAMELY, CIGAR CASES NOT OF PRECIOUS METAL, CIGAR BOXES NOT OF PRECIOUS METAL, TOBACCO JARS NOT OF PRECIOUS METAL, CIGARS, MATCHES, CIGARETTE CASES NOT OF PRECIOUS METAL; TOBACCO (U.S. CLS. 2, 8, 9 AND 17).

FIRST USE 7-0-2004; IN COMMERCE 7-0-2004.

CLASS 34—(Continued).

3,299,832. RAMAPO TOBACCO, LLC, RALEIGH, NC. SN 78-828,601. PUB. 11-7-2006, FILED 3-3-2006.

Ramapo

THE MARK CONSISTS OF STANDARD CHARACTERS WITHOUT CLAIM TO ANY PARTICULAR FONT, STYLE, SIZE, OR COLOR.

FOR TOBACCO PRODUCTS, NAMELY, CIGARETTES, CIGARS, AND PIPE TOBACCO (U.S. CLS. 2, 8, 9 AND 17).

FIRST USE 11-15-2006; IN COMMERCE 11-15-2006.

3,299,971. RUBIN, ALAN, WESTON, FL. SN 78-879,787. PUB. 2-27-2007, FILED 5-9-2006.

ALEC BRADLEY MAXX

THE MARK CONSISTS OF STANDARD CHARACTERS WITHOUT CLAIM TO ANY PARTICULAR FONT, STYLE, SIZE, OR COLOR.

"THE NAME(S), PORTRAIT(S), AND/OR SIGNATURE(S) SHOWN IN THE MARK DOES NOT IDENTIFY A PARTICULAR LIVING INDIVIDUAL."

FOR CIGAR BANDS; CIGAR TUBES; CIGARS (U.S. CLS. 2, 8, 9 AND 17).

FIRST USE 6-15-2006; IN COMMERCE 6-15-2006.

3,300,088. THOMPSON & CO. OF TAMPA, INC., TAMPA, FL. SN 78-918,815. PUB. 2-20-2007, FILED 6-28-2006.

LEPRECHAUN

THE MARK CONSISTS OF STANDARD CHARACTERS WITHOUT CLAIM TO ANY PARTICULAR FONT, STYLE, SIZE, OR COLOR.

FOR CIGARS (U.S. CLS. 2, 8, 9 AND 17).

FIRST USE 6-4-2007; IN COMMERCE 6-4-2007.

SERVICE MARKS**CLASS 35—ADVERTISING AND BUSINESS**

CLASS 35—(Continued).

3,298,403. MACK, JAY, HENDERSON, NV. SN 75-842,953.
PUB. 12-28-2004, FILED 11-4-1999.

SMARTCLOTHES

FOR RETAIL STORES OR DISTRIBUTORSHIPS FEATURING FULLY FUNCTIONAL WEARABLE COMPUTER SYSTEMS, NAMELY, HARDWARE AND SOFTWARE, MICRO-PROCESSOR POWERED COMPUTERS FOR USE THEREWITH IN SPEECH RECOGNITION, HANDS-FREE OR KEYED DATA ENTRY, INTERNET CONNECTIVITY, DATA STORAGE, RETRIEVAL AND PROCESSING, OR COMMUNICATIONS FOR USE IN THE FIELD OF MOBILE COMPUTING (U.S. CLS. 100, 101 AND 102).

FIRST USE 2-21-2007; IN COMMERCE 2-12-0007.

3,298,424. HEKKER, LOIS M., SARASOTA, FL. SN 76-406,309.
PUB. 10-19-2004, FILED 5-13-2002.

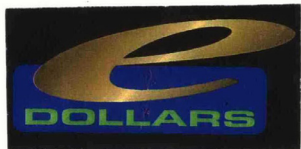

NO CLAIM IS MADE TO THE EXCLUSIVE RIGHT TO USE "E", APART FROM THE MARK AS SHOWN.

THE COLOR(S) BLACK, BLUE, GREEN AND GOLD IS/ARE CLAIMED AS A FEATURE OF THE MARK.

THE MARK CONSISTS OF A BLACK BACKGROUND, BLUE RECTANGLE WITH "DOLLARS" IN GREEN, STYLIZED "E" WITH IN GOLD.

FOR PROMOTING THE GOODS AND SERVICES OF OTHERS BY PREPARING AND PLACING ADVERTISEMENTS ON WEBSITES ACCESSED THROUGH THE INTERNET (U.S. CLS. 100, 101 AND 102).

FIRST USE 3-7-2006; IN COMMERCE 3-7-2006.

CLASS 35—(Continued).

3,298,444. LIFETIME BRANDS, INC., GARDEN CITY, NY. SN 76-523,794. PUB. 7-25-2006, FILED 6-9-2003.

KITCHEN BAZAAR

NO CLAIM IS MADE TO THE EXCLUSIVE RIGHT TO USE "KITCHEN", APART FROM THE MARK AS SHOWN.

FOR RETAIL STORES FEATURING BAKE WARE, DINNERWARES, AND FLATWARE, SERVE WARE, SMALL APPLIANCES, CUTLERY, COOKING TOOLS AND UTENSILS, BARWARE, GLASSWARE, COOKWARE, GADGETS AND HOUSE WARES; ONLINE RETAIL STORES FEATURING BAKE WARE, DINNERWARE, AND FLATWARE, SERVE WARE, SMALL APPLIANCES, CUTLERY, COOKING TOOLS AND UTENSILS, BARWARE, GLASSWARE, COOKWARE, GADGETS AND HOUSE WARES; MAIL ORDER SERVICES FEATURING BAKE WARE, DINNERWARE, FLATWARE, SERVE WARE, SMALL APPLIANCES, CUTLERY, COOKING TOOLS AND UTENSILS, BARWARE, GLASSWARE, COOKWARE, GADGETS AND HOUSE WARES; TELEPHONE ORDER-TAKING SERVICES FOR OTHERS FEATURING BAKE WARE, DINNERWARE, FLATWARE, SERVE WARE, SMALL APPLIANCES, CUTLERY, COOKING TOOLS AND UTENSILS, BARWARE, GLASSWARE, COOKWARE, GADGETS AND HOUSE WARES (U.S. CLS. 100, 101 AND 102).

FIRST USE 8-2-2003; IN COMMERCE 8-2-2003.

3,298,446. MENARD, INC., EAU CLAIRE, WI. SN 76-543,223.
PUB. 3-8-2005, FILED 9-8-2003.

OWNER OF U.S. REG. NOS. 2,078,549, 2,635,037, AND OTHERS.

SEC. 2(F).

FOR PROVIDING ON-LINE BUSINESS TO BUSINESS SERVICES, NAMELY, PROVIDING ELECTRONIC ON-LINE ORDERING SERVICES FOR THE CONVENIENCE OF VENDORS AND SUPPLIERS FEATURING HOME MAINTENANCE AND IMPROVEMENT PRODUCTS (U.S. CLS. 100, 101 AND 102).

FIRST USE 5-15-2003; IN COMMERCE 7-7-2003.

3,298,447. MENARD, INC., EAU CLAIRE, WI. SN 76-543,224.
PUB. 1-11-2005, FILED 9-8-2003.

OWNER OF U.S. REG. NOS. 2,078,549, 2,635,037, AND OTHERS.

SEC. 2(F).

FOR PROVIDING ON-LINE BUSINESS TO BUSINESS SERVICES, NAMELY, PROVIDING ELECTRONIC ON-LINE ORDERING SERVICES FOR THE CONVENIENCE OF VENDORS AND SUPPLIERS FEATURING HOME MAINTENANCE AND IMPROVEMENT PRODUCTS (U.S. CLS. 100, 101 AND 102).

FIRST USE 7-7-2003; IN COMMERCE 7-7-2003.

CLASS 35—(Continued).

3,298,523. AMERICAN SIGNATURE, INC., COLUMBUS, OH. SN 76-636,053. PUB. 1-10-2006, FILED 4-13-2005.

DISCOVER, CREATE & SAVE

THE MARK CONSISTS OF STANDARD CHARACTERS WITHOUT CLAIM TO ANY PARTICULAR FONT, STYLE, SIZE, OR COLOR.
FOR RETAIL FURNITURE STORE SERVICES (U.S. CLS. 100, 101 AND 102).
FIRST USE 10-0-2006; IN COMMERCE 10-0-2006.

3,298,543. CHAMPIONS ON THE WIND, LLC, COLOMA, MI. SN 76-643,861. PUB. 6-27-2006, FILED 7-29-2005.

CHAMPIONS ON THE WIND

THE MARK CONSISTS OF STANDARD CHARACTERS WITHOUT CLAIM TO ANY PARTICULAR FONT, STYLE, SIZE, OR COLOR.
FOR RETAIL STORE SERVICES FEATURING BIRDS AND WORKS OF ART (U.S. CLS. 100, 101 AND 102).
FIRST USE 3-1-2005; IN COMMERCE 3-1-2005.

3,298,545. I2, INC., PITTSBURGH, PA. SN 76-643,998. PUB. 8-15-2006, FILED 8-1-2005.

WISE CONTENT

THE MARK CONSISTS OF STANDARD CHARACTERS WITHOUT CLAIM TO ANY PARTICULAR FONT, STYLE, SIZE, OR COLOR.
NO CLAIM IS MADE TO THE EXCLUSIVE RIGHT TO USE "CONTENT", APART FROM THE MARK AS SHOWN.
FOR BUSINESS CONSULTING SERVICES (U.S. CLS. 100, 101 AND 102).
FIRST USE 11-30-2005; IN COMMERCE 11-30-2005.

CLASS 35—(Continued).

3,298,563. MARK AND AL, INC., GLENDORA, CA. SN 76-649,084. PUB. 10-24-2006, FILED 10-24-2005.



NO CLAIM IS MADE TO THE EXCLUSIVE RIGHT TO USE "BUYERS", "SELLERS" AND "THE FLEXIBLE LISTING PLAN", APART FROM THE MARK AS SHOWN.

THE COLOR(S) RED AND BLUE IS/ARE CLAIMED AS A FEATURE OF THE MARK.

THE MARK CONSISTS OF THE WORD "SELLERS" IN THE COLOR BLUE AT THE BOTTOM OF A CIRCLE MADE UP OF TWO RED ARROWS ON EITHER SIDE OF THE CIRCLE AND THE WORD "BUYERS" IN THE COLOR BLUE AT THE TOP OF THE CIRCLE, WITH THE WORDS "THE FLEXIBLE LISTING PLAN" WRITTEN DIRECTLY UNDERNEATH THE CIRCLE WITH THE WORDS "THE", "LISTING" AND "PLAN" IN BLUE, AND THE WORD "FLEXIBLE" IN THE COLOR RED AND IN ITALICS.

FOR REAL ESTATE SALES MANAGEMENT, NAMELY REPRESENTING BUYERS AND SELLERS IN THE AREAS OF COMMERCIAL AND RESIDENTIAL REAL ESTATE SALES (U.S. CLS. 100, 101 AND 102).
FIRST USE 1-1-2007; IN COMMERCE 1-1-2007.

3,298,569. TIGER 21, LLC, NEW YORK, NY. SN 76-649,815. PUB. 7-18-2006, FILED 11-4-2005.

Tiger 21

THE MARK CONSISTS OF STANDARD CHARACTERS WITHOUT CLAIM TO ANY PARTICULAR FONT, STYLE, SIZE, OR COLOR.

FOR BUSINESS NETWORKING OF PEER TO PEER LEARNING GROUPS OF HIGH NET WORTH INDIVIDUALS (U.S. CLS. 100, 101 AND 102).
FIRST USE 0-0-1999; IN COMMERCE 0-0-1999.

CLASS 35—(Continued).

3,298,635. EFFICIENT FRONTIERS, INC., DELAFIELD, WI. SN 77-040,544. PUB. 4-3-2007, FILED 11-9-2006.

RESERVE ANYWHERE

THE MARK CONSISTS OF STANDARD CHARACTERS WITHOUT CLAIM TO ANY PARTICULAR FONT, STYLE, SIZE, OR COLOR.

NO CLAIM IS MADE TO THE EXCLUSIVE RIGHT TO USE "RESERVE", APART FROM THE MARK AS SHOWN.

FOR MANAGEMENT AND COMPILATION OF COMPUTERIZED DATABASES (U.S. CLS. 100, 101 AND 102). FIRST USE 1-15-2007; IN COMMERCE 1-15-2007.

3,298,645. HURON LLC, SEVERN, MD. SN 78-157,463. PUB. 7-13-2004, FILED 8-23-2002.

JOY COLLECTION

NO CLAIM IS MADE TO THE EXCLUSIVE RIGHT TO USE "COLLECTION", APART FROM THE MARK AS SHOWN.

FOR RETAIL CLOTHING STORE (U.S. CLS. 100, 101 AND 102).

FIRST USE 5-29-2002; IN COMMERCE 5-29-2002.

3,298,648. PRL USA HOLDINGS, INC., WILMINGTON, DE. SN 78-166,917. PUB. 1-3-2006, FILED 9-23-2002.

BLUE LABEL

FOR RETAIL STORE SERVICES OFFERED IN FIXED LOCATIONS AND THROUGH A GLOBAL COMPUTER NETWORK FEATURING CLOTHING, FASHION ACCESSORIES, PERSONAL CARE PRODUCTS AND HOME FURNISHINGS (U.S. CLS. 100, 101 AND 102). FIRST USE 7-0-2002; IN COMMERCE 7-0-2002.

CLASS 35—(Continued).

3,298,662. NORTH DELTA SEAFOODS LTD., DELTA, BRITISH COLUMBIA. SN 78-204,778. PUB. 12-27-2005, FILED 1-17-2003.

RAINCOAST TRADING

PRIORITY CLAIMED UNDER SEC. 44(D) ON CANADA APPLICATION NO. 1,148,095, FILED 7-25-2002, REG. NO. TMA646438, DATED 8-23-2005, EXPIRES 8-23-2020.

NO CLAIM IS MADE TO THE EXCLUSIVE RIGHT TO USE TRADING, APART FROM THE MARK AS SHOWN.

FOR RETAIL OUTLET SERVICES AND WHOLESALE DISTRIBUTORSHIP SERVICES FEATURING SEAFOOD PRODUCTS, NAMELY, DRIED SEAFOOD AND SMOKED SEAFOOD, FROZEN AND UNFROZEN PREPARED MEALS, ENTREES, APPETIZERS AND FROZEN AND UNFROZEN SNACKS CONSISTING PRIMARILY OF SEAFOOD, SEAFOOD, NAMELY, SOUP AND CHOWDERS, SEAFOOD SAUCES, SEAFOOD SEASONINGS, SEAFOOD BATTERS, SEAFOOD BREADING AND SEAFOOD CHIPS, NATURAL FOOD EXTRACTS DERIVED FROM MARINE-BY-PRODUCTS AND ORGANISMS SUCH AS FISH, FISH FERTILIZER, FISH OIL, MARINE COLLAGEN, FISH PROTEIN, ALGAE, SEAWEED, FISH OR SHARK CARTILAGE AND SEA SHELLS FOR USE AS DIETARY SUPPLEMENTS, MAPLE SYRUP PRODUCTS, NAMELY, MAPLE SYRUP, MAPLE CANDIES, MAPLE CHOCOLATES, MAPLE SUGAR, MAPLE BUTTER, MAPLE TAFFY, MAPLE FUDGE AND MAPLE JELLY, AND SEAFOOD PRODUCTS, NAMELY, FRESH SEAFOOD, CANNED SEAFOOD AND FROZEN SEAFOOD (U.S. CLS. 100, 101 AND 102).

FIRST USE 5-23-1995; IN COMMERCE 5-23-1995.

3,298,686. NURSE HEALERS - PROFESSIONAL ASSOCIATES INTERNATIONAL, INC., WARNERVILLE, NY. SN 78-289,340. PUB. 7-6-2004, FILED 8-19-2003.

THERAPEUTIC TOUCH

FOR ASSOCIATION SERVICES, NAMELY, PROMOTING THE INTEREST OF NURSES AND PROMOTING PUBLIC AWARENESS OF THE NEED FOR STANDARDS AND CREDENTIALS TO PRACTICE THE ART OF ALTERNATIVE MEDICINE (U.S. CLS. 100, 101 AND 102). FIRST USE 4-0-2003; IN COMMERCE 4-0-2003.

CLASS 35—(Continued).

3,298,709. MIKE RUPERS, SAN ANSELMO, CA. SN 78-332,588. PUB. 9-7-2004, FILED 11-24-2003.

Direct Express Auto Transport

THE MARK CONSISTS OF STANDARD CHARACTERS WITHOUT CLAIM TO ANY PARTICULAR FONT, STYLE, SIZE, OR COLOR.

NO CLAIM IS MADE TO THE EXCLUSIVE RIGHT TO USE "EXPRESS AUTO TRANSPORT", APART FROM THE MARK AS SHOWN.

FOR TRANSPORTATION LOGISTICS SERVICES, NAMELY, PLANNING AND SCHEDULING SHIPMENTS FOR USERS OF TRANSPORTATION SERVICES (U.S. CLS. 100, 101 AND 102).

FIRST USE 10-21-2003; IN COMMERCE 6-28-2004.

3,298,743. LU, HUI, FLUSHING, NY. SN 78-381,490. PUB. 7-5-2005, FILED 3-10-2004.



Third Party Purchase

NO CLAIM IS MADE TO THE EXCLUSIVE RIGHT TO USE "THIRD PARTY PURCHASE", APART FROM THE MARK AS SHOWN.

FOR CONSULTING IN THE FIELD OF COMMERCIAL BUSINESS ADMINISTRATION; COST PRICE ANALYSIS; EFFICIENCY EXPERT; IMPORT AND EXPORT AGENCY; PERSONNEL ADMINISTRATION CONSULTATION; SYSTEMATIZATION OF COMPUTERS' DATABASE INFORMATION (U.S. CLS. 100, 101 AND 102).

FIRST USE 8-1-2005; IN COMMERCE 9-1-2005.

CLASS 35—(Continued).

3,298,777. HARTMAN, KALLIE, ROUND ROCK, TX. SN 78-441,243. PUB. 6-20-2006, FILED 6-25-2004.



THE COLOR(S) GREEN, BLACK, WHITE AND BLUE IS/ ARE CLAIMED AS A FEATURE OF THE MARK.

THE MARK CONSISTS OF A FIRST ROW CONSISTING OF THE TEXT "EMEDICAL IN BLUE LETTERING"; THE SECOND ROW CONSISTING OF THE TEXT "STAFFING" IN BLUE LETTERING; AND A THIRD ROW CONSISTING OF THE TEXT ".COM" IN BLUE LETTERING; WITH THE FIRST "E" (IN WHITE LETTERING) OF "EMEDICAL" EMBEDDED IN A GREEN CROSS. THE MARK ALSO CONSISTS OF A BLACK ARROW POINTING AT THE "E" IN THE CROSS.

FOR EMPLOYMENT HIRING, RECRUITING, PLACEMENT, STAFFING AND CAREER NETWORKING SERVICES, NAMELY, AN ON-LINE BIDDING SERVICE FOR MEDICAL AND DENTAL PERSONNEL WHERE HOSPITALS AND OTHER FACILITIES ARE PERMITTED TO BID ON AVAILABLE AND PREVIOUSLY CREDENTIALLED MEDICAL PERSONNEL FOR DAILY OR CONTRACT ASSIGNMENT (U.S. CLS. 100, 101 AND 102).

FIRST USE 2-1-2007; IN COMMERCE 2-1-2007.

3,298,784. MOBILE MEDIA ENTERPRISES LLC, ATLANTA, GA. SN 78-451,185. PUB. 6-27-2006, FILED 7-15-2004.

CELEBRANDO CONTIGO

THE MARK CONSISTS OF STANDARD CHARACTERS WITHOUT CLAIM TO ANY PARTICULAR FONT, STYLE, SIZE, OR COLOR.

THE MARK TRANSLATES FROM SPANISH INTO ENGLISH AS CELEBRATE WITH YOU.

FOR MARKETING, ADVERTISING AND PROMOTIONAL SERVICES, NAMELY, ORGANIZING AND ARRANGING PROMOTIONAL EVENTS, PROVIDING SAMPLE DISTRIBUTION AND OPERATING FOOD KIOSKS; ARRANGING AND CONDUCTING PROMOTIONAL TOURS FOR THE PURPOSES OF ADVERTISING, MARKETING AND PROMOTING THE GOODS AND SERVICES OF OTHERS; ARRANGING AND CONDUCTING MOBILE EXHIBITIONS AND MOBILE DISPLAYS FOR BUSINESS AND ADVERTISING PURPOSES; PLANNING AND CONDUCTING MOBILE EXHIBITIONS AND PRESENTATIONS FOR ADVERTISING PURPOSES; ORGANIZING AND ARRANGING MOBILE EXHIBITIONS AND MOBILE DISPLAYS FEATURING THE GOODS AND SERVICES OF OTHERS FOR PROMOTIONAL PURPOSES, NAMELY, DISTRIBUTING PRODUCT AND SERVICE LITERATURE, PRODUCT AND SERVICE INFORMATION, PROVIDING PRODUCT DEMONSTRATIONS, PROVIDING PRESENTATIONS ABOUT THE PRODUCTS AND SERVICES OF OTHERS AND PROVIDING FREE PRODUCT SAMPLES; DISSEMINATION OF ADVERTISING MATTER; ORGANIZING EXHIBITIONS FOR THE PURPOSES OF ADVERTISING, PROMOTING AND MARKETING THE GOODS AND SERVICES OF OTHERS BY DISTRIBUTING PRODUCT

CLASS 35—(Continued).

AND SERVICE LITERATURE, PRODUCT AND SERVICE INFORMATION, PROVIDING PRODUCT DEMONSTRATIONS, PROVIDING PRESENTATIONS ABOUT THE PRODUCTS AND SERVICES OF OTHERS AND PROVIDING FREE PRODUCT SAMPLES; ARRANGING AND CONDUCTING EXHIBITIONS FOR BUSINESS AND ADVERTISING PURPOSES; PLANNING AND CONDUCTING EXHIBITIONS AND PRESENTATIONS FOR ADVERTISING PURPOSES; BUSINESS MARKETING CONSULTING SERVICES; DIRECT MARKETING ADVERTISING FOR OTHERS; DEVELOPING PROMOTIONAL CAMPAIGNS FOR BUSINESS; PREPARATION OF CUSTOM ADVERTISEMENTS AND CUSTOM PROMOTIONAL PRODUCTS FOR OTHERS; PREPARING PROMOTIONAL AND MERCHANDISING MATERIAL FOR OTHERS; PROMOTING THE SALE OF GOODS AND SERVICES OF OTHERS THROUGH THE DISTRIBUTION OF PRINTED MATERIAL; PREPARING AND DISPLAYING ADVERTISEMENTS FOR OTHERS; PREPARING AND PLACING OUTDOOR ADVERTISEMENTS FOR OTHERS; PROMOTING EVENTS OF OTHERS; TEMPORARY RETAIL STORES SET UP ON-SITE AT VARIOUS PUBLIC VENUES, NAMELY AT PROMOTIONAL EVENTS AND EXHIBITIONS, BUT NOT ON SCHOOL PROPERTY NOR TO PROVIDE SHOPPING FACILITIES FOR STUDENTS; TEMPORARY, MOBILE RETAIL STORES SET UP ON-SITE AT VARIOUS PUBLIC VENUES, NAMELY AT PROMOTIONAL EVENTS AND EXHIBITIONS, BUT NOT ON SCHOOL PROPERTY NOR TO PROVIDE SHOPPING FACILITIES FOR STUDENTS; PROMOTING THE GOODS AND SERVICES OF OTHERS BY ARRANGING FOR SPONSORS TO AFFILIATE THEIR GOODS AND SERVICES WITH A PUBLIC EVENT, EXHIBITION, TOUR OR DISPLAY; EMPLOYMENT HIRING, RECRUITING, PLACEMENT AND STAFFING SERVICES FOR EVENTS, EXHIBITIONS AND TOURS; DIRECT MAIL ADVERTISING; DISSEMINATION OF ADVERTISING FOR OTHERS VIA THE INTERNET AND ELECTRONIC MAIL; ELECTRONIC BILLBOARD ADVERTISING; PROVIDING TELEVISION AND RADIO ADVERTISING FOR OTHERS; PRODUCTION AND DISTRIBUTION OF RADIO AND TELEVISION COMMERCIALS; BUSINESS MARKETING AND DIRECT MAIL CONSULTING SERVICES; PROVIDING WEB SITES WHICH FEATURE ADVERTISEMENTS FOR THE GOODS AND SERVICES OF OTHERS ON A GLOBAL COMPUTER NETWORK; PROVIDING INFORMATION ABOUT THE GOODS AND SERVICES OF OTHERS VIA THE GLOBAL COMPUTER NETWORK; PROVIDING SPACE AT WEB SITES FOR THE ADVERTISEMENT OF THE GOODS AND SERVICES OF OTHERS (U.S. CLS. 100, 101 AND 102).

FIRST USE 1-1-2007; IN COMMERCE 1-1-2007.

3,298,801. FLORIDA, RICHARD, WASHINGTON, DC. SN 78-460,535. PUB. 1-3-2006, FILED 8-2-2004.

CREATIVE CLASS

THE MARK CONSISTS OF STANDARD CHARACTERS WITHOUT CLAIM TO ANY PARTICULAR FONT, STYLE, SIZE, OR COLOR.

NO CLAIM IS MADE TO THE EXCLUSIVE RIGHT TO USE "CREATIVE", APART FROM THE MARK AS SHOWN.

FOR BRAND DEVELOPMENT FOR GROUP OF INDIVIDUALS IN CREATIVE FIELDS OF EMPLOYMENT, WHERE THE INDIVIDUAL'S PRIMARY EMPLOYMENT DUTIES REQUIRE HIM OR HER TO INNOVATE, CREATE, OR HIGH-LEVEL PROBLEM-SOLVE, NAMELY— THE ARTS, MUSIC, SCIENCE AND ENGINEERING, DESIGN, ENTREPRENEURSHIP, EDUCATION, AND THE KNOWLEDGE-BASED PROFESSIONS OF BUSINESS, FINANCE, LAW, AND HEALTH CARE (U.S. CLS. 100, 101 AND 102).

FIRST USE 3-13-2007; IN COMMERCE 3-13-2007.

CLASS 35—(Continued).

3,298,841. RESOURCES CONNECTION INC., COSTA MESA, CA. SN 78-485,709. PUB. 9-27-2005, FILED 9-17-2004.

RESOURCES GLOBAL PROFESSIONALS

THE MARK CONSISTS OF STANDARD CHARACTERS WITHOUT CLAIM TO ANY PARTICULAR FONT, STYLE, SIZE, OR COLOR.

NO CLAIM IS MADE TO THE EXCLUSIVE RIGHT TO USE "PROFESSIONALS", APART FROM THE MARK AS SHOWN.

FOR TEMPORARY EMPLOYMENT AGENCIES, NAMELY, PROVIDING EXPERIENCED PROFESSIONALS TO CLIENTS FOR DISCRETE PERIODS IN THE FIELD OF MANAGEMENT CONSULTING, ACCOUNTING AND FINANCE, RISK MANAGEMENT AND INTERNAL AUDIT, INFORMATION TECHNOLOGY, HUMAN RESOURCES, LEGAL SERVICES AND SUPPLY CHAIN MANAGEMENT (U.S. CLS. 100, 101 AND 102).

FIRST USE 2-0-2007; IN COMMERCE 2-0-2007.

3,298,850. MARKETING RESEARCH SERVICES INC., CINCINNATI, OH. SN 78-497,855. PUB. 11-21-2006, FILED 10-11-2004.



THE COLOR(S) ORANGE, GREEN, AND PURPLE IS/ARE CLAIMED AS A FEATURE OF THE MARK.

THE COLOR ORANGE APPEARS ALONG THE TOP OF THE LOGO BEHIND THE WORD 'ENFOQUE,' THE COLOR GREEN APPEARS THROUGH THE MIDDLE OF THE LOGO BEHIND THE WORD 'ENFOQUE,' THE COLOR PURPLE APPEARS ALONG THE BOTTOM OF THE LOGO BEHIND THE WORD 'ENFOQUE.'

THE FOREIGN WORDING IN THE MARK TRANSLATES INTO ENGLISH AS FOCUS.

FOR MARKETING RESEARCH SERVICES, NAMELY, A COLLECTION OF QUANTITATIVE AND QUALITATIVE RESEARCH ORGANIZED IN A THREE STEP FRAMEWORK AND USED SPECIFICALLY FOR BUSINESSES TO CONDUCT MARKETING RESEARCH AMONG HISPANIC CONSUMERS (U.S. CLS. 100, 101 AND 102).

FIRST USE 1-1-2005; IN COMMERCE 1-1-2005.

CLASS 35—(Continued).

3,298,920. PROGRAM PLANNING PROFESSIONALS, INC., ANN ARBOR, MI. SN 78-552,516. PUB. 5-9-2006, FILED 1-24-2005.

MPA

THE MARK CONSISTS OF STANDARD CHARACTERS WITHOUT CLAIM TO ANY PARTICULAR FONT, STYLE, SIZE, OR COLOR.

FOR ASSOCIATION SERVICES, NAMELY PROMOTING THE INTERESTS OF COMPUTER SOFTWARE PROJECT MANAGEMENT PROFESSIONALS (U.S. CLS. 100, 101 AND 102).

FIRST USE 4-1-2005; IN COMMERCE 4-1-2005.

3,298,929. PERPETUAL LICENSING LLC, NEW YORK, NY. SN 78-559,009. PUB. 5-30-2006, FILED 2-2-2005.

Extending
Desirable Brands

THE MARK CONSISTS OF STANDARD CHARACTERS WITHOUT CLAIM TO ANY PARTICULAR FONT, STYLE, SIZE, OR COLOR.

NO CLAIM IS MADE TO THE EXCLUSIVE RIGHT TO USE BRANDS, APART FROM THE MARK AS SHOWN.

FOR BUSINESS CONSULTING AND MANAGEMENT SERVICES, NAMELY, CONSULTANCY SERVICES IN THE FIELD OF MANAGING INTELLECTUAL PROPERTIES (U.S. CLS. 100, 101 AND 102).

FIRST USE 4-4-2005; IN COMMERCE 4-4-2005.

CLASS 35—(Continued).

3,298,956. PROGRAM PLANNING PROFESSIONALS, INC., ANN ARBOR, MI. SN 78-571,990. PUB. 5-9-2006, FILED 2-22-2005.



THE COLOR(S) BLUE AND YELLOW IS/ARE CLAIMED AS A FEATURE OF THE MARK.

THE COLOR(S) YELLOW APPEARS IN THE OUTER CIRCLE AND DIAMOND DESIGNS. THE COLOR BLUE APPEARS IN THE INNER CIRCLE DESIGN.

FOR ASSOCIATION SERVICES, NAMELY PROMOTING THE INTERESTS OF COMPUTER SOFTWARE PROJECT MANAGEMENT PROFESSIONALS (U.S. CLS. 100, 101 AND 102).

FIRST USE 4-1-2005; IN COMMERCE 4-1-2005.

3,298,958. DELAWARE NORTH COMPANIES TRAVEL HOSPITALITY SERVICES, INC., BUFFALO, NY. SN 78-572,166. PUB. 9-26-2006, FILED 2-22-2005.



THE MARK CONSISTS OF THE WORDS EVERYTHING ASAP IN STYLIZED FORM WITH AN AIRPLANE POSITIONED SUCH THAT ITS TAIL LEADS INTO THE LETTER "A" IN ASAP.

FOR RETAIL STORE SERVICES FEATURING HEALTH AND BEAUTY PRODUCTS AND CONVENIENCE STORE ITEMS (U.S. CLS. 100, 101 AND 102).

FIRST USE 11-6-2005; IN COMMERCE 11-6-2005.

CLASS 35—(Continued).

3,299,015. FRAUDHALT LTD, DUBLIN 3, IRELAND. SN 78-594,970. PUB. 6-27-2006, FILED 3-25-2005.

CLASS 35—(Continued).

3,299,052. PULSE 360, INC., GETZVILLE, NY. SN 78-603,944. PUB. 1-3-2006, FILED 4-7-2005.

FRAUDHALT

DEMOTARGET

THE MARK CONSISTS OF STANDARD CHARACTERS WITHOUT CLAIM TO ANY PARTICULAR FONT, STYLE, SIZE, OR COLOR.

FOR DISSEMINATION OF ADVERTISING FOR OTHERS VIA THE INTERNET (U.S. CLS. 100, 101 AND 102).

FIRST USE 11-6-2006; IN COMMERCE 11-6-2006.

THE MARK CONSISTS OF STANDARD CHARACTERS WITHOUT CLAIM TO ANY PARTICULAR FONT, STYLE, SIZE, OR COLOR.

FOR BUSINESS INVESTIGATION SERVICES IN THE FIELD OF IDENTIFICATION OF COUNTERFEIT PRODUCTS (U.S. CLS. 100, 101 AND 102).

FIRST USE 2-2-2005; IN COMMERCE 2-2-2005.

3,299,103. MARFRED INDUSTRIES, SUN VALLEY, CA. SN 78-623,717. PUB. 10-3-2006, FILED 5-5-2005.

VYANT

3,299,039. CUNNINGHAM LINDSEY U.S., INC., SCHAUMBURG, IL. SN 78-600,341. PUB. 12-27-2005, FILED 4-1-2005.

THE MARK CONSISTS OF STANDARD CHARACTERS WITHOUT CLAIM TO ANY PARTICULAR FONT, STYLE, SIZE, OR COLOR.

FOR MARKETING SERVICES, NAMELY, CREATING CORPORATE AND BRAND IDENTITY FOR OTHERS; CONCEPT AND BRAND DEVELOPMENT IN THE CONSUMER PRODUCTS FIELD; DISTRIBUTION AND DISSEMINATION OF ADVERTISING FOR OTHERS; DEVELOPMENT OF MARKETING STRATEGIES AND CONCEPTS FOR OTHERS (U.S. CLS. 100, 101 AND 102).

FIRST USE 10-1-2005; IN COMMERCE 10-1-2005.

CUNNINGHAM LINDSEY ENVIRONMENTAL SOLUTIONS

3,299,104. MINDWAVE RESEARCH, INC., AUSTIN, TX. SN 78-624,156. PUB. 7-25-2006, FILED 5-5-2005.

RQM

THE MARK CONSISTS OF STANDARD CHARACTERS WITHOUT CLAIM TO ANY PARTICULAR FONT, STYLE, SIZE, OR COLOR.

NO CLAIM IS MADE TO THE EXCLUSIVE RIGHT TO USE "ENVIRONMENTAL SOLUTIONS", APART FROM THE MARK AS SHOWN.

FOR FISHERIES MANAGEMENT (U.S. CLS. 100, 101 AND 102).

FIRST USE 1-1-2002; IN COMMERCE 1-1-2002.

THE MARK CONSISTS OF STANDARD CHARACTERS WITHOUT CLAIM TO ANY PARTICULAR FONT, STYLE, SIZE, OR COLOR.

FOR CONDUCTING CUSTOMIZED CONSUMER SATISFACTION RESEARCH SURVEYS FOR BUSINESS CUSTOMERS IN THE INFORMATION TECHNOLOGY MARKET (U.S. CLS. 100, 101 AND 102).

FIRST USE 8-1-2005; IN COMMERCE 2-1-2006.

CLASS 35—(Continued).

3,299,107. AMERICAN ASSOCIATION OF SENIOR PERSONS, INC., BOCA RATON, FL. SN 78-625,467. PUB. 1-24-2006, FILED 5-9-2005.

SPEAKING UP FOR AMERICA'S
NEW MAJORITY

THE MARK CONSISTS OF STANDARD CHARACTERS WITHOUT CLAIM TO ANY PARTICULAR FONT, STYLE, SIZE, OR COLOR.

FOR ADMINISTRATION OF A DISCOUNT PROGRAM FOR ENABLING PARTICIPANTS TO OBTAIN DISCOUNTS ON GOODS AND SERVICES THROUGH USE OF A DISCOUNT MEMBERSHIP CARD (U.S. CLS. 100, 101 AND 102).

FIRST USE 3-29-2007; IN COMMERCE 3-29-2007.

3,299,122. SOPHIE ROSE, LLC, WILLIAMSBURG, VA. SN 78-632,798. PUB. 7-25-2006, FILED 5-18-2005.

Bark Vineyards

THE MARK CONSISTS OF STANDARD CHARACTERS WITHOUT CLAIM TO ANY PARTICULAR FONT, STYLE, SIZE, OR COLOR.

FOR ON-LINE RETAIL STORE SERVICES AND RETAIL STORE SERVICES FEATURING ANIMAL NOVELTIES, NAMELY, GRAVY FOR USE WITH PET FOOD, PET TREATS, AND PET-THEMED ITEMS FOR PEOPLE, NAMELY, HANDBAGS AND WINE BAGS (U.S. CLS. 100, 101 AND 102).

FIRST USE 9-1-2005; IN COMMERCE 2-10-2005.

3,299,124. WTC-TRADE MART, L.P., DALLAS, TX. SN 78-634,362. PUB. 7-18-2006, FILED 5-20-2005.

F!NDS

THE MARK CONSISTS OF STANDARD CHARACTERS WITHOUT CLAIM TO ANY PARTICULAR FONT, STYLE, SIZE, OR COLOR.

FOR ARRANGING, CONDUCTING AND PROMOTING GIFT AND HOME TEMPORARY TRADE SHOWS HELD MULTIPLE TIMES EACH YEAR IN DALLAS FOR WHOLESALE BUYERS (U.S. CLS. 100, 101 AND 102).

FIRST USE 10-0-2005; IN COMMERCE 10-0-2005.

CLASS 35—(Continued).

3,299,125. RAZLETOVSKY, ALEX, MISSION VIEJO, CA. SN 78-634,428. PUB. 6-20-2006, FILED 5-22-2005.

WOWQUOTE

THE MARK CONSISTS OF STANDARD CHARACTERS WITHOUT CLAIM TO ANY PARTICULAR FONT, STYLE, SIZE, OR COLOR.

FOR BUSINESS LEADS COLLECTION AND MATCHING SERVICES, MAINLY, COLLECTING CONSUMER REQUEST FOR SERVICES AND MATCHING THOSE CONSUMER REQUESTS TO BUSINESSES INTERESTED IN THOSE REQUESTS (U.S. CLS. 100, 101 AND 102).

FIRST USE 2-28-2007; IN COMMERCE 2-28-2007.

3,299,143. WELLBEING GROUP, INC., CORAL GABLES, FL. SN 78-641,075. PUB. 9-26-2006, FILED 6-1-2005.



NO CLAIM IS MADE TO THE EXCLUSIVE RIGHT TO USE "WELLBEING GROUP", APART FROM THE MARK AS SHOWN.

THE COLOR(S) BLUE AND PURPLE IS/ARE CLAIMED AS A FEATURE OF THE MARK.

THE MARK CONSISTS OF A HUMAN DESIGN WITH LEGS OVER A BALL AS PUNCTUATION OVER THE LETTER "I". THE WORD GROUP UNDER THE LETTERS (EING) OF THE WORD WELLBEING. THE COLOR BLUE APPEARS IN THE TERM "WELLBEING", EXCEPT FOR THE "I" AND IN THE HUMAN FIGURE, EXCEPT FOR THE HEAD, AND THE COLOR PURPLE APPEARS IN THE SHADED CIRCLE, THE HUMAN FIGURE'S HEAD, THE TERM "GROUP" AND THE "I" OF "WELLBEING".

FOR RETAIL STORE SERVICES FEATURING AROMATHERAPY PRODUCTS, YOGA AND TAICHI ACCESSORIES AND VIDEOS (U.S. CLS. 100, 101 AND 102).

FIRST USE 12-0-2004; IN COMMERCE 12-0-2004.

CLASS 35—(Continued).

3,299,177. PILI CARRERA, S.A., 36417 MOS (PONTEVEDRA), SPAIN. SN 78-657,713. PUB. 3-14-2006, FILED 6-24-2005.

PILI CARRERA

THE MARK CONSISTS OF STANDARD CHARACTERS WITHOUT CLAIM TO ANY PARTICULAR FONT, STYLE, SIZE, OR COLOR.

THE NAME "PILI CARRERA" DOES NOT IDENTIFY A LIVING INDIVIDUAL.

THE ENGLISH TRANSLATION OF THE SPANISH WORDING "CARRERA" IS "RACE".

FOR RETAIL CLOTHING STORES, RETAIL CLOTHING BOUTIQUES (U.S. CLS. 100, 101 AND 102).

FIRST USE 10-0-1994; IN COMMERCE 10-0-1994.

CLASS 35—(Continued).

3,299,188. LIPSON ASSOCIATES, INC., DBA LIPSON-ALPORT-GLASS & ASSOCIATES, NORTHBROOK, IL. SN 78-661,762. PUB. 9-12-2006, FILED 6-30-2005.

NEURODESIGN

THE MARK CONSISTS OF STANDARD CHARACTERS WITHOUT CLAIM TO ANY PARTICULAR FONT, STYLE, SIZE, OR COLOR.

FOR ADVERTISING AND MARKETING SERVICES, NAMELY, BRAND BUILDING AND BRAND CONCEPT EVALUATION AND STUDIES, AND PROVIDING SPECIFIC CRITERIA FOR PRODUCT, PACKAGING, LABEL, STRUCTURE AND BRAND DESIGN BASED ON THE DISCIPLINES OF NEURO MARKETING AND NEURO SCIENCE (U.S. CLS. 100, 101 AND 102).

FIRST USE 1-17-2006; IN COMMERCE 1-17-2006.

3,299,178. SPELL, JAMES G., EAGLE, CO. SN 78-657,938. PUB. 10-24-2006, FILED 6-24-2005.

TELED

THE MARK CONSISTS OF STANDARD CHARACTERS WITHOUT CLAIM TO ANY PARTICULAR FONT, STYLE, SIZE, OR COLOR.

FOR BUSINESS CONSULTATION AND INFORMATION SERVICES IN THE AREA OF COMMUNICATING OVER THE INTERNET, USING DIGITAL MEDIA TOOLS, FORMULATING ADVERTISING CAMPAIGN, CREATING AND GIVING PRESENTATIONS, CREATING AND CONDUCTING SURVEYS, AND DEVELOPING INDIVIDUAL MANAGEMENT SKILLS (U.S. CLS. 100, 101 AND 102).

FIRST USE 1-23-2007; IN COMMERCE 1-23-2007.

3,299,206. THE SOUTHERN SPORTSMAN, INC., INMAN, SC. SN 78-667,334. PUB. 8-8-2006, FILED 7-11-2005.

THE SOUTHERN SPORTSMAN

NO CLAIM IS MADE TO THE EXCLUSIVE RIGHT TO USE "SPORTSMAN", APART FROM THE MARK AS SHOWN.

FOR RETAIL SPORTING GOODS STORE SERVICES AND ONLINE RETAIL STORE SERVICES FEATURING HUNTER'S CLOTHING, GEAR AND EQUIPMENT, INCLUDING RIFLES AND AMMUNITION THEREFOR, PREPACKAGED FISHING TRIPS, NAMELY, GUIDED AND UNGUIDED PREPACKAGED FISHING TRIPS, FISHERMAN'S CLOTHING, GEAR AND EQUIPMENT, INCLUDING BOATING EQUIPMENT (U.S. CLS. 100, 101 AND 102).

FIRST USE 9-0-2005; IN COMMERCE 3-0-2006.

CLASS 35—(Continued).

3,299,207. THE SOUTHERN SPORTSMAN, INC., INMAN, SC.
SN 78-667,344. PUB. 9-12-2006, FILED 7-11-2005.



NO CLAIM IS MADE TO THE EXCLUSIVE RIGHT TO USE "SPORTSMAN", APART FROM THE MARK AS SHOWN.

THE MARK CONSISTS OF THE STYLIZED WORD THE OVER THE STYLIZED WORDS SOUTHERN SPORTSMAN OVER A BOW OVER THE WORDING WHERE ADVENTURES BEGIN RESTING ON AN ARROW.

FOR RETAIL SPORTING GOODS STORE SERVICES AND ONLINE RETAIL STORE SERVICES FEATURING HUNTER'S CLOTHING, GEAR AND EQUIPMENT, INCLUDING RIFLES AND AMMUNITION THEREFOR, PREPACKAGED FISHING TRIPS, NAMELY, GUIDED AND UNGUIDED PREPACKAGED FISHING TRIPS, FISHERMAN'S CLOTHING, GEAR AND EQUIPMENT, INCLUDING BOATING EQUIPMENT (U.S. CLS. 100, 101 AND 102).

FIRST USE 9-0-2005; IN COMMERCE 3-0-2006.

3,299,208. HAVEN NETWORKS, INC., PARKSVILLE, BRITISH COLUMBIA, CANADA. SN 78-667,794. PUB. 8-15-2006, FILED 7-11-2005.

CLOGGER

THE MARK CONSISTS OF STANDARD CHARACTERS WITHOUT CLAIM TO ANY PARTICULAR FONT, STYLE, SIZE, OR COLOR.

FOR PROMOTING THE GOODS AND SERVICES OF OTHERS THROUGH ONLINE CATALOGING OF THOSE GOODS AND SERVICES (U.S. CLS. 100, 101 AND 102).

FIRST USE 12-12-2006; IN COMMERCE 12-12-2006.

CLASS 35—(Continued).

3,299,216. UNITARIAN UNIVERSALIST ASSOCIATION, BOSTON, MA. SN 78-672,939. PUB. 7-4-2006, FILED 7-18-2005.



THE MARK CONSISTS OF A CHALICE DESIGN, FOR ASSOCIATION SERVICES, NAMELY, PROMOTING THE INTERESTS OF MEMBERS OF THE UNITARIAN UNIVERSALIST FAITH (U.S. CLS. 100, 101 AND 102).

FIRST USE 6-1-2005; IN COMMERCE 9-1-2005.

3,299,220. KERI THOMAS COMMUNICATIONS, LLC, AUSTIN, TX. SN 78-675,015. PUB. 3-28-2006, FILED 7-21-2005.

FUTURESCRIPT

THE MARK CONSISTS OF STANDARD CHARACTERS WITHOUT CLAIM TO ANY PARTICULAR FONT, STYLE, SIZE, OR COLOR.

FOR BUSINESS CONSULTING SERVICES (U.S. CLS. 100, 101 AND 102).

FIRST USE 2-26-2007; IN COMMERCE 2-26-2007.

3,299,226. CHEW ON THIS DOG BAKERY, INC., FRANKFORT, IL. SN 78-677,810. PUB. 10-31-2006, FILED 7-25-2005.

CHEW ON THIS

THE MARK CONSISTS OF STANDARD CHARACTERS WITHOUT CLAIM TO ANY PARTICULAR FONT, STYLE, SIZE, OR COLOR.

FOR ON-LINE AND RETAIL STORE SERVICES FEATURING PET PRODUCTS AND SUPPLIES, NAMELY, COLLARS AND LEASHES, PET JEWELRY, PET TOYS, PET TREATS, PET APPAREL, ID TAGS, PET BEDDING, FEEDING DISHES, PET GROOMING SUPPLIES, CAGES, AND OTHER PET-RELATED ACCESSORIES (U.S. CLS. 100, 101 AND 102).

FIRST USE 8-6-2004; IN COMMERCE 8-6-2004.

CLASS 35—(Continued).

3,299,235. LITE-PREP SURFACE PREPARATION EQUIPMENT, LLC, TALLMADGE, OH. SN 78-680,865. PUB. 5-9-2006, FILED 7-28-2005.

CLASS 35—(Continued).

3,299,253. EPIPELINE, INC., HERNDON, VA. SN 78-690,343. PUB. 6-13-2006, FILED 8-11-2005.



MEET AT THE OPPORTUNITY

OWNER OF U.S. REG. NO. 2,882,633.
NO CLAIM IS MADE TO THE EXCLUSIVE RIGHT TO USE "GROUP OF COMPANIES", APART FROM THE MARK AS SHOWN.

THE MARK CONSISTS OF STYLIZED WORDS CENTERED BETWEEN TWO SETS OF SLANTED VERTICAL BARS.

FOR ON-LINE RETAIL AND WHOLESALE STORE SERVICES FEATURING SURFACE PREPARATION EQUIPMENT, NAMELY, SHOT BLASTING EQUIPMENT, SCARIFIERS, GRINDERS, FLOOR TAG SYSTEMS, MIXING EQUIPMENT, PNEUMATIC TOOLS, VACUUM SYSTEMS, STRIPPING MACHINES, FLOOR GRINDERS, AND GRINDING WHEELS, SCARIFIERS, BLADES AND CUTTING TEETH; RETAIL AND WHOLESALE STORE SERVICES FEATURING SURFACE PREPARATION EQUIPMENT, NAMELY, SHOT BLASTING EQUIPMENT, SCARIFIERS, GRINDERS, FLOOR TAG SYSTEMS, MIXING EQUIPMENT, PNEUMATIC TOOLS, VACUUM SYSTEMS, STRIPPING MACHINES, FLOOR GRINDERS, AND GRINDING WHEELS, SCARIFIERS, BLADES AND CUTTING TEETH (U.S. CLS. 100, 101 AND 102).

FIRST USE 1-15-2005; IN COMMERCE 1-15-2005.

THE MARK CONSISTS OF STANDARD CHARACTERS WITHOUT CLAIM TO ANY PARTICULAR FONT, STYLE, SIZE, OR COLOR.

FOR SUBSCRIPTIONS TO ON-LINE DATABASES FEATURING GOVERNMENTAL BUSINESS OPPORTUNITIES (U.S. CLS. 100, 101 AND 102).

FIRST USE 8-12-2005; IN COMMERCE 9-22-2006.

3,299,260. MASHAT, EYAD ABDULLAH, MAKKAH, SAUDI ARABIA. SN 78-693,388. PUB. 4-25-2006, FILED 8-16-2005.

3,299,239. RENMEN LIMITED, PORTLAND, OR. SN 78-682,021. PUB. 6-27-2006, FILED 7-29-2005.

DO IT WITH PASSION



THE MARK CONSISTS OF STANDARD CHARACTERS WITHOUT CLAIM TO ANY PARTICULAR FONT, STYLE, SIZE, OR COLOR.

FOR PROMOTING THE GOODS AND SERVICES OF OTHERS BY MEANS OF OPERATING AN ON-LINE SHOPPING MALL WITH LINKS TO THE RETAIL WEB SITES OF OTHERS; INFOMEDIARY SERVICES, NAMELY FACILITATING TRANSACTIONS BETWEEN BUYERS AND SELLERS THROUGH PROVIDING BUYERS WITH INFORMATION ABOUT SELLERS, GOODS, AND/OR SERVICES; PROMOTING THE GOODS AND SERVICES OF OTHERS; PROVIDING ON-LINE DIRECTORY INFORMATION SERVICES FEATURING HYPERLINKS TO OTHER WEBSITES (U.S. CLS. 100, 101 AND 102).

FIRST USE 6-2-2005; IN COMMERCE 6-2-2005.

THE COLOR(S) ORANGE, WHITE, AND RED IS/ARE CLAIMED AS A FEATURE OF THE MARK.

THE COLOR ORANGE APPEARS IN THE BACKGROUND OF THE MARK. THE COLOR WHITE APPEARS IN THE WORD "FEMI" IN THE MARK. THE COLOR RED APPEARS IN THE NUMBER "9" IN THE MARK.

FOR RETAIL CLOTHING STORES (U.S. CLS. 100, 101 AND 102).

FIRST USE 1-29-2007; IN COMMERCE 1-29-2007.

CLASS 35—(Continued).

3,299,268. ULTIMATE ACQUISITION PARTNERS, L.P., THORNTON, CO. SN 78-697,584. PUB. 5-23-2006, FILED 8-22-2005.

INTECHXICATION

THE MARK CONSISTS OF STANDARD CHARACTERS WITHOUT CLAIM TO ANY PARTICULAR FONT, STYLE, SIZE, OR COLOR.

FOR RETAIL STORE SERVICES FOR CONSUMER PRODUCTS IN THE FIELD OF ELECTRONICS FEATURING A WIDE VARIETY OF CONSUMER ELECTRONICS FOR THE HOME, CAR AND PERSON (U.S. CLS. 100, 101 AND 102).

FIRST USE 8-22-2005; IN COMMERCE 9-11-2005.

3,299,280. TOP HAT, INC., SHAKOPEE, MN. SN 78-701,759. PUB. 5-23-2006, FILED 8-26-2005.

BE ICED

THE MARK CONSISTS OF STANDARD CHARACTERS WITHOUT CLAIM TO ANY PARTICULAR FONT, STYLE, SIZE, OR COLOR.

FOR RETAIL JEWELRY STORE SERVICES (U.S. CLS. 100, 101 AND 102).

FIRST USE 10-27-2005; IN COMMERCE 10-27-2005.

3,299,295. HUMAN CAPITAL SOLUTIONS, LLC, WESTCHESTER, PA. SN 78-706,097. PUB. 10-31-2006, FILED 9-2-2005.

CELEBRATE TECHNOLOGY

THE MARK CONSISTS OF STANDARD CHARACTERS WITHOUT CLAIM TO ANY PARTICULAR FONT, STYLE, SIZE, OR COLOR.

NO CLAIM IS MADE TO THE EXCLUSIVE RIGHT TO USE "TECHNOLOGY", APART FROM THE MARK AS SHOWN.

FOR ORGANIZING AND CONDUCTING JOB FAIRS; JOB FAIR SPONSORING, NAMELY, PROMOTING THE GOODS AND SERVICES OF OTHERS BY ARRANGING FOR SPONSORS TO AFFILIATE THEIR GOODS AND SERVICES WITH JOB FAIRS (U.S. CLS. 100, 101 AND 102).

FIRST USE 12-22-2004; IN COMMERCE 2-1-2005.

CLASS 35—(Continued).

3,299,311. MOSZKITO, INC., SCOTTSDALE, AZ. SN 78-711,579. PUB. 2-6-2007, FILED 9-13-2005.

MOSZKITO

THE MARK CONSISTS OF STANDARD CHARACTERS WITHOUT CLAIM TO ANY PARTICULAR FONT, STYLE, SIZE, OR COLOR.

OWNER OF U.S. REG. NO. 2,633,255.

FOR RETAIL STORE SERVICES, NAMELY, RETAIL AND ON-LINE STORES FEATURING SANDALS AND ORTHOTICS (U.S. CLS. 100, 101 AND 102).

FIRST USE 5-0-2006; IN COMMERCE 5-0-2006.

3,299,327. WYLIE, MICHAEL DILLON, CALABASAS, CA. SN 78-716,764. PUB. 6-13-2006, FILED 9-20-2005.

ABWAY TECHNOLOGY

THE MARK CONSISTS OF STANDARD CHARACTERS WITHOUT CLAIM TO ANY PARTICULAR FONT, STYLE, SIZE, OR COLOR.

NO CLAIM IS MADE TO THE EXCLUSIVE RIGHT TO USE "TECHNOLOGY", APART FROM THE MARK AS SHOWN.

FOR ON-LINE RETAIL STORE SERVICES FEATURING COMPUTER HARDWARE, SOFTWARE, AND DOWNLOADABLE PROGRAMS (U.S. CLS. 100, 101 AND 102).

FIRST USE 10-0-2005; IN COMMERCE 10-0-2005.

3,299,358. TEPPER, SPENCER, FOX POINT, WI. SN 78-723,425. PUB. 9-5-2006, FILED 9-29-2005.

COMPIRION

THE MARK CONSISTS OF STANDARD CHARACTERS WITHOUT CLAIM TO ANY PARTICULAR FONT, STYLE, SIZE, OR COLOR.

FOR BUSINESS MANAGEMENT CONSULTATION IN THE FIELD OF HEALTH CARE (U.S. CLS. 100, 101 AND 102).

FIRST USE 11-3-2005; IN COMMERCE 11-3-2005.

CLASS 35—(Continued).

3,299,377. WISCONSIN STATE TELECOMMUNICATIONS ASSOCIATION, INC., MADISON, WI. SN 78-727,780. PUB. 1-16-2007, FILED 10-6-2005.



OWNER OF U.S. REG. NOS. 2,278,884, 2,290,876, AND 2,298,818.

NO CLAIM IS MADE TO THE EXCLUSIVE RIGHT TO USE THE OUTLINE OF THE STATE OF WISCONSIN, APART FROM THE MARK AS SHOWN.

THE COLOR(S) LIGHT BLUE AND DARK BLUE IS/ARE CLAIMED AS A FEATURE OF THE MARK.

THE MARK CONSISTS OF THE OUTLINE OF THE STATE OF WISCONSIN WITHIN A LIGHT BLUE CIRCLE, AND THE LETTERS "WSTA" IN DARK BLUE WITH THE "W" AND PART OF THE "S" SUPERIMPOSED OVER THE WISCONSIN DESIGN.

FOR ASSOCIATION SERVICES, NAMELY, PROMOTING THE INTERESTS OF INDIVIDUALS AND ASSOCIATIONS ASSOCIATED WITH THE TELECOMMUNICATIONS INDUSTRY (U.S. CLS. 100, 101 AND 102).

FIRST USE 9-30-2005; IN COMMERCE 10-10-2005.

3,299,388. CAPITAL TECHSEARCH, INC., RICHMOND, VA. SN 78-729,627. PUB. 10-31-2006, FILED 10-10-2005.



*A Higher Standard for
IT Staffing & Executive Search*

NO CLAIM IS MADE TO THE EXCLUSIVE RIGHT TO USE "TECHSEARCH, INC., IT, STAFFING AND EXECUTIVE SEARCH", APART FROM THE MARK AS SHOWN.

THE GRAY TONES IN THE DRAWING ARE USED FOR SHADING PURPOSES ONLY.

FOR EXECUTIVE RECRUITING AND PLACEMENT SERVICES (U.S. CLS. 100, 101 AND 102).

FIRST USE 10-0-2006; IN COMMERCE 10-0-2006.

CLASS 35—(Continued).

3,299,396. GENERAL MILLS, INC., MINNEAPOLIS, MN. SN 78-730,820. PUB. 6-20-2006, FILED 10-11-2005.

POWER CAT

THE MARK CONSISTS OF STANDARD CHARACTERS WITHOUT CLAIM TO ANY PARTICULAR FONT, STYLE, SIZE, OR COLOR.

OWNER OF U.S. REG. NO. 2,748,625.

FOR PROVIDING CUSTOM ANALYSIS OF RETAIL SALES TO FOOD RETAILERS TO AID THEM IN MANAGING THEIR RETAILING STRATEGIES (U.S. CLS. 100, 101 AND 102).

FIRST USE 1-3-2006; IN COMMERCE 1-3-2006.

3,299,401. DIRECTNET, LLC, WOODBRIDGE, CT. SN 78-731,751. PUB. 9-12-2006, FILED 10-12-2005.

ESTREETLOANS

THE MARK CONSISTS OF STANDARD CHARACTERS WITHOUT CLAIM TO ANY PARTICULAR FONT, STYLE, SIZE, OR COLOR.

FOR ONLINE DIRECT MARKETING SERVICES FOR LENDERS (U.S. CLS. 100, 101 AND 102).

FIRST USE 3-5-2007; IN COMMERCE 3-5-2007.

3,299,406. ARTHA IMPORTS CORPORATION, RICHMOND, VA. SN 78-733,307. PUB. 6-20-2006, FILED 10-14-2005.



NO CLAIM IS MADE TO THE EXCLUSIVE RIGHT TO USE "GLOBAL HOME FURNISHINGS", APART FROM THE MARK AS SHOWN.

THE MARK CONSISTS OF A STYLIZED DRAGONFLY WITHIN A SQUARE.

FOR RETAIL HOME AND GARDEN FURNISHINGS STORES (U.S. CLS. 100, 101 AND 102).

FIRST USE 10-1-2005; IN COMMERCE 5-1-2006.

CLASS 35—(Continued).

3,299,409. EBAY INC., SAN JOSE, CA. SN 78-733,648. PUB. 6-27-2006, FILED 10-14-2005.

YOU CAN GET IT ON EBAY

THE MARK CONSISTS OF STANDARD CHARACTERS WITHOUT CLAIM TO ANY PARTICULAR FONT, STYLE, SIZE, OR COLOR.

FOR ON-LINE TRADING SERVICES TO FACILITATE THE SALE OF GOODS AND SERVICES BY OTHERS VIA A COMPUTER NETWORK AND PROVIDING EVALUATIVE FEEDBACK AND RATINGS OF SELLERS' GOODS AND SERVICES, THE VALUE AND PRICES OF SELLERS' GOODS AND SERVICES, BUYERS' AND SELLERS' PERFORMANCE, DELIVERY, AND OVERALL TRADING EXPERIENCE IN CONNECTION THEREWITH; ADVERTISING AND ADVERTISEMENT SERVICES (U.S. CLS. 100, 101 AND 102).

FIRST USE 10-17-2005; IN COMMERCE 10-17-2005.

CLASS 35—(Continued).

3,299,433. INDOBUDI, LLC, EMERYVILLE, CA. SN 78-736,313. PUB. 7-4-2006, FILED 10-19-2005.

BALI KINGDOM

THE MARK CONSISTS OF STANDARD CHARACTERS WITHOUT CLAIM TO ANY PARTICULAR FONT, STYLE, SIZE, OR COLOR.

NO CLAIM IS MADE TO THE EXCLUSIVE RIGHT TO USE "BALI", APART FROM THE MARK AS SHOWN.

FOR ON-LINE RETAIL STORE SERVICES FEATURING JEWELRY (U.S. CLS. 100, 101 AND 102).

FIRST USE 2-22-2007; IN COMMERCE 2-22-2007.

3,299,441. FIRST AMERICAN REAL ESTATE SOLUTIONS LLC, WESTLAKE, TX. SN 78-736,834. PUB. 7-11-2006, FILED 10-20-2005.

TAXWATCH

THE MARK CONSISTS OF STANDARD CHARACTERS WITHOUT CLAIM TO ANY PARTICULAR FONT, STYLE, SIZE, OR COLOR.

FOR REAL ESTATE TAX REPORTING SERVICES (U.S. CLS. 100, 101 AND 102).

FIRST USE 3-31-2005; IN COMMERCE 3-31-2005.

3,299,419. COLUMBIA FOREST PRODUCTS, INC., PORTLAND, OR. SN 78-734,849. PUB. 7-18-2006, FILED 10-17-2005.

COLUMBIA REWARDS

THE MARK CONSISTS OF STANDARD CHARACTERS WITHOUT CLAIM TO ANY PARTICULAR FONT, STYLE, SIZE, OR COLOR.

OWNER OF U.S. REG. NOS. 2,331,608, 2,765,002, AND OTHERS.

NO CLAIM IS MADE TO THE EXCLUSIVE RIGHT TO USE "REWARDS", APART FROM THE MARK AS SHOWN.

FOR AWARD PROGRAM, NAMELY, PROMOTING THE SALE OF PRODUCTS BY OTHERS THROUGH THE ADMINISTRATION OF AN INCENTIVE PROGRAM (U.S. CLS. 100, 101 AND 102).

FIRST USE 1-2-2006; IN COMMERCE 1-2-2006.

3,299,454. BRITISH VIRGIN ISLANDS TOURIST BOARD, TORTOLA, BR. VIRGIN ISLANDS. SN 78-738,028. PUB. 6-27-2006, FILED 10-21-2005.

NATURE'S LITTLE SECRETS

THE MARK CONSISTS OF STANDARD CHARACTERS WITHOUT CLAIM TO ANY PARTICULAR FONT, STYLE, SIZE, OR COLOR.

FOR PROMOTING TOURISM IN THE BRITISH VIRGIN ISLANDS (U.S. CLS. 100, 101 AND 102).

FIRST USE 11-0-1990; IN COMMERCE 11-0-1990.

CLASS 35—(Continued).

3,299,458. JIM MORAN & ASSOCIATES, INC., DEERFIELD BEACH, FL. SN 78-738,433. PUB. 7-4-2006, FILED 10-21-2005.



FOR AUTOMOBILE DEALERSHIPS (U.S. CLS. 100, 101 AND 102).
FIRST USE 8-0-2006; IN COMMERCE 8-0-2006.

Marketing Dashboard

THE MARK CONSISTS OF STANDARD CHARACTERS WITHOUT CLAIM TO ANY PARTICULAR FONT, STYLE, SIZE, OR COLOR.

NO CLAIM IS MADE TO THE EXCLUSIVE RIGHT TO USE "MARKETING", APART FROM THE MARK AS SHOWN.

FOR BUSINESS MARKETING SERVICES AND PROVIDING BUSINESS MARKETING INFORMATION, NAMELY, PROVIDING CLIENT MARKETING DATA FOR PURPOSES OF ANALYSIS, REPORTING, AND DECISION SUPPORT (U.S. CLS. 100, 101 AND 102).
FIRST USE 3-1-2003; IN COMMERCE 3-1-2003.

CLASS 35—(Continued).

3,299,472. SOFTWARE MANAGEMENT CONSULTANTS, INC., GLENDALE, CA. SN 78-740,465. PUB. 7-18-2006, FILED 10-26-2005.

**PROFESSIONAL PEOPLE.
EXCEPTIONAL RESULTS.**

THE MARK CONSISTS OF STANDARD CHARACTERS WITHOUT CLAIM TO ANY PARTICULAR FONT, STYLE, SIZE, OR COLOR.

FOR TEMPORARY AND PERMANENT EMPLOYMENT CONSULTING, PLACEMENT AND RECRUITING SERVICES FOR INFORMATION TECHNOLOGY PROFESSIONALS (U.S. CLS. 100, 101 AND 102).

FIRST USE 1-0-2006; IN COMMERCE 1-0-2006.

3,299,479. COMP.NATION COMPUTER SUPPLY, LLC, BRENTWOOD, TN. SN 78-741,634. PUB. 2-13-2007, FILED 10-27-2005.

Comp.Nation
Bringing I.T. all together

FOR RETAIL AND ON-LINE RETAIL STORE SERVICES FEATURING OFFICE SUPPLIES AND OFFICE MACHINES (U.S. CLS. 100, 101 AND 102).

FIRST USE 4-17-2000; IN COMMERCE 4-17-2000.

3,299,480. VISIBILITY RESOURCE GROUP, INC., EAGLE, ID. SN 78-741,653. PUB. 7-4-2006, FILED 10-27-2005.

VISIBILITY

THE MARK CONSISTS OF STANDARD CHARACTERS WITHOUT CLAIM TO ANY PARTICULAR FONT, STYLE, SIZE, OR COLOR.

FOR PERSONNEL PLACEMENT AND RECRUITMENT SERVICES (U.S. CLS. 100, 101 AND 102).
FIRST USE 12-7-2005; IN COMMERCE 3-3-2006.

CLASS 35—(Continued).

3,299,513. HOLISTIC TECHNOLOGIES ENTERPRISE, INC., CENTENNIAL, CO. SN 78-747,261. PUB. 7-18-2006, FILED 11-4-2005.

DIVINE PHYSICS

THE MARK CONSISTS OF STANDARD CHARACTERS WITHOUT CLAIM TO ANY PARTICULAR FONT, STYLE, SIZE, OR COLOR.

FOR RETAIL STORES FEATURING HEALTH, NUTRITION, WELLNESS AND COSMETIC PREPARATIONS AND PRODUCTS AND PRINTED LITERATURE MATERIALS ON SUCH SUBJECTS. AVAILABLE BOTH ON LINE AND AT THE STORE LOCATION (U.S. CLS. 100, 101 AND 102).

FIRST USE 12-0-2005; IN COMMERCE 12-0-2005.

3,299,520. SALES GEN CORP, BEVERLY HILLS, CA. SN 78-748,552. PUB. 7-11-2006, FILED 11-7-2005.

SalesGen

THE MARK CONSISTS OF STANDARD CHARACTERS WITHOUT CLAIM TO ANY PARTICULAR FONT, STYLE, SIZE, OR COLOR.

FOR ADVERTISING AND COMMERCIAL INFORMATION SERVICES, VIA THE INTERNET (U.S. CLS. 100, 101 AND 102).

FIRST USE 5-23-2006; IN COMMERCE 6-15-2006.

3,299,523. SIX CONTINENTS HOTELS, INC., ATLANTA, GA. SN 78-749,081. PUB. 1-16-2007, FILED 11-8-2005.

HOTELOGIC

THE MARK CONSISTS OF STANDARD CHARACTERS WITHOUT CLAIM TO ANY PARTICULAR FONT, STYLE, SIZE, OR COLOR.

FOR PROVIDING E-COMMERCE SERVICES TO HOTELS, NAMELY, DEVELOPING MARKETING PROGRAMS FOR HOTELS TO INCREASE INTERNET REVENUES (U.S. CLS. 100, 101 AND 102).

FIRST USE 10-20-2006; IN COMMERCE 10-20-2006.

CLASS 35—(Continued).

3,299,534. CHOWDHURY, SUBIR, BLOOMFIELD HILLS, MI. SN 78-751,077. PUB. 8-1-2006, FILED 11-10-2005.

LEO

THE MARK CONSISTS OF STANDARD CHARACTERS WITHOUT CLAIM TO ANY PARTICULAR FONT, STYLE, SIZE, OR COLOR.

FOR BUSINESS CONSULTING RELATING TO IMPROVING BUSINESS PERFORMANCE (U.S. CLS. 100, 101 AND 102).

FIRST USE 11-1-2005; IN COMMERCE 11-1-2005.

3,299,549. TAIL WIND TECHNOLOGIES CORPORATION, MINNETONKA, MN. SN 78-753,681. PUB. 10-17-2006, FILED 11-14-2005.



NO CLAIM IS MADE TO THE EXCLUSIVE RIGHT TO USE "TECHNOLOGIES", APART FROM THE MARK AS SHOWN.

FOR EMPLOYMENT PLACEMENT AND STAFFING SERVICES NAMELY, OFFERING APPLICATION DEVELOPMENT STAFF, NAMELY PROJECT MANAGERS, APPLICATION DEVELOPERS, QUALITY ASSURANCE ANALYSTS AND SYSTEM ARCHITECTS FOR COMPUTER CONSULTING, DESIGNING, DEVELOPING, TESTING AND PROJECT MANAGEMENT FOR MEDIUM AND LARGE COMPANIES TO ASSIST IN ALL PHASES OF SOFTWARE DEVELOPMENT (U.S. CLS. 100, 101 AND 102).

FIRST USE 11-4-2005; IN COMMERCE 11-4-2005.

CLASS 35—(Continued).

3,299,606. TARGA RESOURCES, INC., HOUSTON, TX. SN 78-765,090. PUB. 2-6-2007, FILED 12-1-2005.



"THE FOREIGN WORDING IN THE MARK TRANSLATES INTO ENGLISH AS SHIELD OR A COMMEMORATIVE INSCRIBED TABLET AFFIXED TO OR SET INTO A WALL."

FOR ARRANGING FOR THE TRANSMISSION AND DISTRIBUTION OF NATURAL GAS AND NATURAL GAS LIQUIDS FOR OTHERS; ADVERTISING AND MARKETING SERVICES, DEVELOPMENT OF MARKETING STRATEGIES AND CONCEPTS AND LOGISTIC MANAGEMENT SERVICES FOR OTHERS, ALL IN THE FIELD OF NATURAL GAS AND NATURAL GAS LIQUIDS; OPERATION OF NATURAL GAS PROCESSING PLANTS FOR OTHERS (U.S. CLS. 100, 101 AND 102).

FIRST USE 12-1-2005; IN COMMERCE 12-1-2005.

3,299,674. TECHNOLOGY PARADISE CORPORATION, SEMINOLE, FL. SN 78-780,316. PUB. 8-22-2006, FILED 12-23-2005.

**YOUR DESTINATION FOR
TECHNOLOGY**

THE MARK CONSISTS OF STANDARD CHARACTERS WITHOUT CLAIM TO ANY PARTICULAR FONT, STYLE, SIZE, OR COLOR.

FOR ON-LINE RETAIL STORE SERVICES FEATURING COMPUTER SOFTWARE AND HARDWARE, NAMELY, MONITORS, PRINTERS, FLAT SCREENS, PERIPHERALS, CABLES, CONNECTORS, TONER CARTRIDGES, PRINTER RIBBON, PROJECTERS, SERVERS, SCANNERS, CAMERAS, HEADSETS, KEYBOARDS, ROUTERS, MODEMS, LAPTOPS, MICE, COPIERS, CAMCORDERS, BATTERIES, INVERTERS, LINE CONDITIONERS, POWER STRIPS AND ADAPTERS (U.S. CLS. 100, 101 AND 102).

FIRST USE 7-31-2006; IN COMMERCE 7-31-2006.

CLASS 35—(Continued).

3,299,694. SYMETRA LIFE INSURANCE COMPANY, BELLEVUE, WA. SN 78-786,788. PUB. 2-27-2007, FILED 1-6-2006.

PROFITBUILDER

THE MARK CONSISTS OF STANDARD CHARACTERS WITHOUT CLAIM TO ANY PARTICULAR FONT, STYLE, SIZE, OR COLOR.

FOR CREATION OF MARKETING TOOLS DESIGNED TO PROVIDE TARGETED BUSINESS SOLUTIONS AND INCREASE A CLIENT COMPANY'S KNOWLEDGE OF CUSTOMER NEEDS AND PROVIDE THE STRATEGIES TO HELP MEET THEM (U.S. CLS. 100, 101 AND 102).

FIRST USE 2-24-2006; IN COMMERCE 6-18-2006.

3,299,719. BLACK PEARL TECHNOLOGIES, LLC, SALT LAKE CITY, UT. SN 78-792,479. PUB. 9-5-2006, FILED 1-16-2006.

WARMTRAX

THE MARK CONSISTS OF STANDARD CHARACTERS WITHOUT CLAIM TO ANY PARTICULAR FONT, STYLE, SIZE, OR COLOR.

FOR ONLINE RETAILING SERVICES FEATURING ELECTRICAL HEATING SYSTEMS, NAMELY UNDER-FLOOR HEATING SYSTEMS, IMBEDDED HEATING SYSTEMS AND SNOW AND ICE MELTING SYSTEMS (U.S. CLS. 100, 101 AND 102).

FIRST USE 6-27-2006; IN COMMERCE 6-27-2006.

3,299,732. EMANATE LLC, NEW YORK, NY. SN 78-795,521. PUB. 10-3-2006, FILED 1-20-2006.

EMANATE

THE MARK CONSISTS OF STANDARD CHARACTERS WITHOUT CLAIM TO ANY PARTICULAR FONT, STYLE, SIZE, OR COLOR.

FOR PUBLIC RELATIONS SERVICES; DIRECT MARKETING ADVERTISING; INTERACTIVE ADVERTISING AND MARKETING FOR OTHERS; BUSINESS MARKETING CONSULTING IN THE FIELD OF BUZZ MARKETING AND SOCIAL NETWORKING; ADVERTISING AND MARKETING, NAMELY, VIRAL MARKETING (U.S. CLS. 100, 101 AND 102).

FIRST USE 3-1-2006; IN COMMERCE 3-1-2006.

CLASS 35—(Continued).

3,299,750. PLANET BEACH BRANDS, LLC, NEW ORLEANS, LA. SN 78-800,194. PUB. 11-21-2006, FILED 1-26-2006.

CLASS 35—(Continued).

3,299,768. CRAWFORD COUNTY CONVENTION & VISITORS BUREAU, PITTSBURG, KS. SN 78-806,763. PUB. 9-26-2006, FILED 2-3-2006.

Contempo Spa

CRAWFORD COUNTY, KANSAS
THE FOOTBALL CAPITAL OF
KANSAS

THE MARK CONSISTS OF STANDARD CHARACTERS WITHOUT CLAIM TO ANY PARTICULAR FONT, STYLE, SIZE, OR COLOR.

NO CLAIM IS MADE TO THE EXCLUSIVE RIGHT TO USE "SPA", APART FROM THE MARK AS SHOWN.

FOR FRANCHISING, NAMELY OFFERING TECHNICAL ASSISTANCE IN THE ESTABLISHMENT AND/OR OPERATION OF TANNING SALONS AND SPAS (U.S. CLS. 100, 101 AND 102).

FIRST USE 8-15-2005; IN COMMERCE 8-15-2005.

THE MARK CONSISTS OF STANDARD CHARACTERS WITHOUT CLAIM TO ANY PARTICULAR FONT, STYLE, SIZE, OR COLOR.

NO CLAIM IS MADE TO THE EXCLUSIVE RIGHT TO USE "CRAWFORD COUNTY, KANSAS", APART FROM THE MARK AS SHOWN.

FOR CHAMBER OF COMMERCE SERVICES, NAMELY, PROMOTING BUSINESS AND TOURISM IN THE CRAWFORD COUNTY, KANSAS AREA (U.S. CLS. 100, 101 AND 102).

FIRST USE 5-0-2006; IN COMMERCE 5-0-2006.

3,299,763. WACHOVIA CORPORATION, CHARLOTTE, NC. SN 78-805,139. PUB. 2-6-2007, FILED 2-2-2006.

3,299,784. AEROTEK, INC., HANOVER, MD. SN 78-811,133. PUB. 12-26-2006, FILED 2-9-2006.



OWNER OF U.S. REG. NO. 2,742,925.
NO CLAIM IS MADE TO THE EXCLUSIVE RIGHT TO USE REGIONAL FOUNDATION, APART FROM THE MARK AS SHOWN.

FOR CHARITABLE SERVICES, NAMELY, ORGANIZING AND CONDUCTING COMMUNITY SERVICE PROJECTS (U.S. CLS. 100, 101 AND 102).

FIRST USE 4-30-2003; IN COMMERCE 7-1-2003.

AEROTEK PROFESSIONAL SERVICES

THE MARK CONSISTS OF STANDARD CHARACTERS WITHOUT CLAIM TO ANY PARTICULAR FONT, STYLE, SIZE, OR COLOR.

NO CLAIM IS MADE TO THE EXCLUSIVE RIGHT TO USE "PROFESSIONAL SERVICES", APART FROM THE MARK AS SHOWN.

FOR EMPLOYMENT AGENCIES; EMPLOYMENT COUNSELING AND RECRUITING; EMPLOYMENT HIRING, RECRUITING, PLACEMENT, STAFFING AND CAREER NETWORKING SERVICES; PERSONNEL PLACEMENT AND RECRUITMENT; TEMPORARY EMPLOYMENT AGENCIES (U.S. CLS. 100, 101 AND 102).

FIRST USE 4-1-2006; IN COMMERCE 4-1-2006.

CLASS 35—(Continued).

3,299,808. KUZMA, ROBERT, WILMINGTON, NC. SN 78-819,555. PUB. 11-28-2006, FILED 2-21-2006.



NO CLAIM IS MADE TO THE EXCLUSIVE RIGHT TO USE "HEALTH SHOPPE", APART FROM THE MARK AS SHOWN.

FOR RETAIL STORES FEATURING VITAMINS, DIETARY SUPPLEMENTS, HEALTH FOODS, FITNESS PRODUCTS, COSMETICS AND BODY CARE PRODUCTS (U.S. CLS. 100, 101 AND 102).

FIRST USE 8-13-2006; IN COMMERCE 8-13-2006.

3,299,815. CLUB STAFFING, INC., BOCA RATON, FL. SN 78-822,237. PUB. 10-24-2006, FILED 2-23-2006.

EXCEPTIONAL HEALTHCARE.
DELIVERED.

THE MARK CONSISTS OF STANDARD CHARACTERS WITHOUT CLAIM TO ANY PARTICULAR FONT, STYLE, SIZE, OR COLOR.

FOR EMPLOYMENT HIRING, RECRUITING, PLACEMENT, STAFFING AND CAREER NETWORKING SERVICES IN THE HEALTHCARE FIELD (U.S. CLS. 100, 101 AND 102).

FIRST USE 11-9-2006; IN COMMERCE 11-9-2006.

3,299,820. PAIVA, INC., INDIANAPOLIS, IN. SN 78-824,174. PUB. 8-1-2006, FILED 2-27-2006.

ENERGY FROM WITHIN

THE MARK CONSISTS OF STANDARD CHARACTERS WITHOUT CLAIM TO ANY PARTICULAR FONT, STYLE, SIZE, OR COLOR.

FOR MAIL ORDER SERVICES, CATALOGUE SERVICES, RETAIL STORES AND ON-LINE RETAIL STORES FEATURING WOMEN'S CLOTHING, FOOTWEAR, HEAD WEAR, WATCHES, SUNGLASSES, BAGS, SHOE CARE PRODUCTS, PERSONAL CARE ITEMS, AND ACCESSORIES (U.S. CLS. 100, 101 AND 102).

FIRST USE 4-0-2006; IN COMMERCE 4-0-2006.

CLASS 35—(Continued).

3,299,824. NEWLEVEL GROUP, LLC, NAPA, CA. SN 78-826,484. PUB. 11-28-2006, FILED 3-1-2006.

HIGH SATISFACTION DAY

THE MARK CONSISTS OF STANDARD CHARACTERS WITHOUT CLAIM TO ANY PARTICULAR FONT, STYLE, SIZE, OR COLOR.

FOR BUSINESS CONSULTATION SERVICES; MANAGEMENT AND BUSINESS CONSULTING SERVICES IN THE FIELD OF ORGANIZATIONAL AND WORK PROCESS CHANGE, DESIGN AND DEVELOPMENT, AS WELL AS LEADERSHIP AND MANAGEMENT (U.S. CLS. 100, 101 AND 102).

FIRST USE 12-0-2006; IN COMMERCE 12-0-2006.

3,299,841. WRIGHT CONSULTING GROUP LLC, DBA HEALTHY HOME SAVINGS PROGRAM AND HEALTHY HOME ADVERTISING GROUP AND HEALTHY HOME MARKETING GROUP, BREA, CA. SN 78-832,048. PUB. 12-12-2006, FILED 3-8-2006.



NO CLAIM IS MADE TO THE EXCLUSIVE RIGHT TO USE "HEALTH CARE SAVINGS", APART FROM THE MARK AS SHOWN.

FOR PROMOTIONAL ADVERTISING SERVICES, NAMELY, PROMOTING THE HOME CARE MEDICAL PRODUCTS OF OTHERS VIA PRINT AND ELECTRONIC MEDIA (U.S. CLS. 100, 101 AND 102).

FIRST USE 9-1-2006; IN COMMERCE 9-1-2006.

3,299,870. IP FILEPOINT, LLC, SAN DIEGO, CA. SN 78-842,338. PUB. 2-13-2007, FILED 3-21-2006.

IP Filepoint

THE MARK CONSISTS OF STANDARD CHARACTERS WITHOUT CLAIM TO ANY PARTICULAR FONT, STYLE, SIZE, OR COLOR.

NO CLAIM IS MADE TO THE EXCLUSIVE RIGHT TO USE "IP", APART FROM THE MARK AS SHOWN.

FOR CONSULTING SERVICES IN THE FIELD OF MANAGING INTELLECTUAL PROPERTIES (U.S. CLS. 100, 101 AND 102).

FIRST USE 3-9-2007; IN COMMERCE 3-9-2007.

CLASS 35—(Continued).

3,299,876. MASON COMPANIES INC., CHIPPEWA FALLS, WI. SN 78-845,714. PUB. 11-28-2006, FILED 3-24-2006.



OWNER OF U.S. REG. NOS. 2,605,442, 2,992,709, AND OTHERS.

FOR COMPUTERIZED ONLINE RETAIL STORE SERVICES IN THE FIELD OF FOOTWEAR, CLOTHING AND ACCESSORIES; MAIL ORDER CATALOG SERVICES FEATURING FOOTWEAR, CLOTHING AND ACCESSORIES (U.S. CLS. 100, 101 AND 102).

FIRST USE 9-14-2006; IN COMMERCE 9-14-2006.

3,299,900. TRUVEON CORPORATION, DURHAM, NC. SN 78-856,818. PUB. 11-28-2006, FILED 4-7-2006.

TruMetrics

THE MARK CONSISTS OF STANDARD CHARACTERS WITHOUT CLAIM TO ANY PARTICULAR FONT, STYLE, SIZE, OR COLOR.

FOR COLLECTION, PREPARATION, COMPOSITION, STORAGE, PROCESSING, ACQUISITION AND PROVISION OF BUSINESS INFORMATION, DATA, STATISTICS AND INDICES IN THE CLIMATE CONTROL SYSTEM AND BUILDING AUTOMATION INDUSTRY; PROVIDING STATISTICAL INFORMATION IN THE CLIMATE CONTROL SYSTEM AND BUILDING AUTOMATION INDUSTRY (U.S. CLS. 100, 101 AND 102).

FIRST USE 5-21-2006; IN COMMERCE 5-21-2006.

3,299,903. PRICELESS RENT-A-CAR LLC, LAUREL, MD. SN 78-857,489. PUB. 2-13-2007, FILED 4-10-2006.

PRICELESS

THE MARK CONSISTS OF STANDARD CHARACTERS WITHOUT CLAIM TO ANY PARTICULAR FONT, STYLE, SIZE, OR COLOR.

OWNER OF U.S. REG. NOS. 1,545,692 AND 2,023,484.

FOR RETAIL DEALERSHIPS IN THE FIELD OF USED CARS (U.S. CLS. 100, 101 AND 102).

FIRST USE 9-30-1999; IN COMMERCE 9-30-1999.

CLASS 35—(Continued).

3,299,922. WINESTYLES, INC., MARGATE, FL. SN 78-864,171. PUB. 11-28-2006, FILED 4-18-2006.

BECAUSE EVERY DAY IS AN
OCCASION

THE MARK CONSISTS OF STANDARD CHARACTERS WITHOUT CLAIM TO ANY PARTICULAR FONT, STYLE, SIZE, OR COLOR.

FOR RETAIL STORE SERVICES FEATURING WINE, WINE ACCESSORIES AND GIFT ITEMS (U.S. CLS. 100, 101 AND 102).

FIRST USE 5-1-2006; IN COMMERCE 5-1-2006.

3,299,933. COOL SCHOOL INCENTIVES, INC., BECKER, MN. SN 78-867,176. PUB. 11-28-2006, FILED 4-21-2006.

Be Your Own Cool

THE MARK CONSISTS OF STANDARD CHARACTERS WITHOUT CLAIM TO ANY PARTICULAR FONT, STYLE, SIZE, OR COLOR.

FOR ADVERTISING, MARKETING AND PROMOTION SERVICES (U.S. CLS. 100, 101 AND 102).

FIRST USE 10-10-2006; IN COMMERCE 10-10-2006.

3,299,963. THE SPA EXCHANGE, LLC, MINNETONKA, MN. SN 78-877,582. PUB. 12-12-2006, FILED 5-5-2006.

THE SPA EXCHANGE THE
SOURCE FOR HEALTH THROUGH
WATER

THE MARK CONSISTS OF STANDARD CHARACTERS WITHOUT CLAIM TO ANY PARTICULAR FONT, STYLE, SIZE, OR COLOR.

NO CLAIM IS MADE TO THE EXCLUSIVE RIGHT TO USE "SPA", APART FROM THE MARK AS SHOWN.

FOR DISTRIBUTORSHIP SERVICES FEATURING PRODUCTS USED BY SPAS (U.S. CLS. 100, 101 AND 102).

FIRST USE 3-0-2006; IN COMMERCE 3-0-2006.

CLASS 35—(Continued).

3,299,970. CLEAR CHANNEL BROADCASTING, INC., SAN ANTONIO, TX. SN 78-879,143. PUB. 12-5-2006, FILED 5-8-2006.

SEEK IT LOCAL

THE MARK CONSISTS OF STANDARD CHARACTERS WITHOUT CLAIM TO ANY PARTICULAR FONT, STYLE, SIZE, OR COLOR.

FOR ADVERTISING SERVICES, NAMELY, PROMOTING THE GOODS AND SERVICES OF OTHERS VIA PLACEMENT OF ADVERTISEMENTS IN NON-INTERACTIVE AND INTERACTIVE MEDIA PROGRAMS AND PUBLICATIONS ACCESSED THROUGH A GLOBAL COMPUTER NETWORK; MARKET RESEARCH AND ANALYSIS; PROVIDING A WEBSITE OFFERING INFORMATION ON LOCAL BUSINESSES AND EVENTS (U.S. CLS. 100, 101 AND 102).

FIRST USE 8-10-2006; IN COMMERCE 8-10-2006.

CLASS 35—(Continued).

3,299,979. PERFORMANCE EXHAUST PLUS, ST. CHARLES, MO. SN 78-882,953. PUB. 1-9-2007, FILED 5-12-2006.



NO CLAIM IS MADE TO THE EXCLUSIVE RIGHT TO USE "PERFORMANCE EXHAUST", APART FROM THE MARK AS SHOWN.

THE MARK CONSISTS OF STYLIZED WORDS, "PERFORMANCE EXHAUST PLUS" WITHIN AN IMAGE OF AN EXHAUST.

SEC. 2(F).

FOR ON-LINE RETAIL STORE SERVICES FEATURING AUTOMOTIVE AND TRUCK EXHAUST EQUIPMENT (U.S. CLS. 100, 101 AND 102).

FIRST USE 4-26-2006; IN COMMERCE 4-6-2007.

3,299,978. DAIL'S INC., PORTSMOUTH, VA. SN 78-882,237. PUB. 12-5-2006, FILED 5-12-2006.

bloomin' dail's

THE MARK CONSISTS OF STANDARD CHARACTERS WITHOUT CLAIM TO ANY PARTICULAR FONT, STYLE, SIZE, OR COLOR.

FOR RETAIL STORE SERVICES, NAMELY, A SECTION WITHIN A RETAIL ESTABLISHMENT THAT FEATURES PLANTS (U.S. CLS. 100, 101 AND 102).

FIRST USE 4-1-2005; IN COMMERCE 4-1-2005.

3,300,006. GLOBAL PHARMACEUTICAL SERVICES, SHREWSBURY, NJ. SN 78-893,501. PUB. 1-2-2007, FILED 5-25-2006.

H.O.M.E. - HOSPITAL TO
OUTPATIENT MADE EASY

THE MARK CONSISTS OF STANDARD CHARACTERS WITHOUT CLAIM TO ANY PARTICULAR FONT, STYLE, SIZE, OR COLOR.

FOR RETAIL PHARMACY SERVICES (U.S. CLS. 100, 101 AND 102).

FIRST USE 1-1-2005; IN COMMERCE 4-1-2005.

CLASS 35—(Continued).

3,300,009. ACCURACAST LIMITED, LONDON, UNITED KINGDOM. SN 78-893,931. PUB. 1-2-2007, FILED 5-26-2006.

100% Ethical SEO

THE MARK CONSISTS OF STANDARD CHARACTERS WITHOUT CLAIM TO ANY PARTICULAR FONT, STYLE, SIZE, OR COLOR.

FOR ADVERTISING, MARKETING AND PROMOTION SERVICES; PROMOTING THE GOODS AND SERVICES OF OTHERS THROUGH SEARCH ENGINE REFERRAL TRAFFIC ANALYSIS AND REPORTING; PROMOTING, ADVERTISING AND MARKETING OF THE ON-LINE WEBSITES OF OTHERS (U.S. CLS. 100, 101 AND 102).

FIRST USE 7-1-2004; IN COMMERCE 6-24-2005.

3,300,028. DRINX FINE WINE AND SPIRITS, LLC, D'IBERVILLE, MS. SN 78-901,423. PUB. 2-6-2007, FILED 6-6-2006.



NO CLAIM IS MADE TO THE EXCLUSIVE RIGHT TO USE "DRINKS", "FINE WINE", "SPIRITS" OR "LLC", APART FROM THE MARK AS SHOWN.

THE MARK CONSISTS OF THE WORDS DRINX FINE WINE SPIRITS LLC WITH A STYLIZED I IN THE WORD DRINX THAT IS ALSO INTENDED TO FORM THE STEM OF A WINE GLASS.

FOR RETAIL STORES FEATURING WINE, SPIRITS AND BAR SUPPLIES (U.S. CLS. 100, 101 AND 102).

FIRST USE 10-18-2006; IN COMMERCE 10-18-2006.

CLASS 35—(Continued).

3,300,031. SCOOP MANAGEMENT LLC, NEW YORK, NY. SN 78-902,836. PUB. 1-16-2007, FILED 6-7-2006.

S. C. P.

FOR RETAIL STORE SERVICES FEATURING CLOTHING, FOOTWEAR, JEWELRY, WATCHES, BAGS, EYEWEAR AND PERFUMES (U.S. CLS. 100, 101 AND 102).
FIRST USE 2-15-2007; IN COMMERCE 2-15-2007.

3,300,047. MYREEL.COM, LLC, LOS ANGELES, CA. SN 78-906,171. PUB. 1-16-2007, FILED 6-12-2006.

MYREEL

THE MARK CONSISTS OF STANDARD CHARACTERS WITHOUT CLAIM TO ANY PARTICULAR FONT, STYLE, SIZE, OR COLOR.

FOR PROVIDING A WEBSITE WHICH FEATURES DEMO REELS OF TALENT FOR DISSEMINATION TO OTHER ENTERTAINMENT ENTITIES (U.S. CLS. 100, 101 AND 102).

FIRST USE 1-1-2006; IN COMMERCE 10-1-2006.

3,300,057. SAUNDERS, ENRICO, LEAMINGTON SPA, UNITED KINGDOM. SN 78-910,854. PUB. 2-13-2007, FILED 6-19-2006.

LINKRANK

THE MARK CONSISTS OF STANDARD CHARACTERS WITHOUT CLAIM TO ANY PARTICULAR FONT, STYLE, SIZE, OR COLOR.

FOR COMMERCIAL AND BUSINESS INFORMATION MANAGEMENT SERVICES, NAMELY, MEASURING THE VALUE OF LINKS AND ADVERTISEMENTS ON WEBSITES BASED ON SPECIFIED CRITERIA (U.S. CLS. 100, 101 AND 102).

FIRST USE 5-14-2007; IN COMMERCE 5-14-2007.

CLASS 35—(Continued).

3,300,069. EXPONENTIAL INTERACTIVE, INC., EMERYVILLE, CA. SN 78-912,621. PUB. 4-3-2007, FILED 6-20-2006.

MetroTip

THE MARK CONSISTS OF STANDARD CHARACTERS WITHOUT CLAIM TO ANY PARTICULAR FONT, STYLE, SIZE, OR COLOR.

FOR ADVERTISING AGENCY SERVICES; BUSINESS MARKETING SERVICES; CREATIVE DESIGN SERVICES, NAMELY CREATING CORPORATE AND BRAND IDENTITY FOR OTHERS IN THE FIELD OF ADVERTISING, AND CREATING AND UPDATING OF ADVERTISING MATERIAL; DISSEMINATION OF ADVERTISING FOR OTHERS VIA THE INTERNET AND OTHER MEANS OF COMMUNICATION (U.S. CLS. 100, 101 AND 102).

FIRST USE 3-5-2007; IN COMMERCE 3-5-2007.

3,300,075. HANNAFORD LICENSING CORP., SCARBOROUGH, ME. SN 78-915,635. PUB. 12-19-2006, FILED 6-23-2006.

Guiding Stars

THE MARK CONSISTS OF STANDARD CHARACTERS WITHOUT CLAIM TO ANY PARTICULAR FONT, STYLE, SIZE, OR COLOR.

FOR RETAIL SUPERMARKET SERVICE, NAMELY A FOOD NUTRITIONAL VALUE NAVIGATION SYSTEM THAT MAKES IT EASY FOR CUSTOMERS TO FIND AND BUY PRODUCTS HAVING NUTRITIONAL CHARACTERISTICS OF INTEREST TO THEM (U.S. CLS. 100, 101 AND 102).

FIRST USE 8-12-2006; IN COMMERCE 8-12-2006.

3,300,099. ADAMSHAND INC, WESTBOROUGH, MA. SN 78-920,924. PUB. 2-13-2007, FILED 6-30-2006.

HIREZON

THE MARK CONSISTS OF STANDARD CHARACTERS WITHOUT CLAIM TO ANY PARTICULAR FONT, STYLE, SIZE, OR COLOR.

FOR EMPLOYMENT HIRING, RECRUITING, PLACEMENT, STAFFING AND CAREER NETWORKING SERVICES (U.S. CLS. 100, 101 AND 102).

FIRST USE 6-29-2006; IN COMMERCE 8-4-2006.

CLASS 35—(Continued).

3,300,105. CFOED, L.L.C, DBA SMART SAMANTHA, ALPHARETTA, GA. SN 78-923,661. PUB. 12-26-2006, FILED 7-6-2006.

BIZDOMS

THE MARK CONSISTS OF STANDARD CHARACTERS WITHOUT CLAIM TO ANY PARTICULAR FONT, STYLE, SIZE, OR COLOR.

FOR BUSINESS ADVICE AND INFORMATION (U.S. CLS. 100, 101 AND 102).

FIRST USE 2-1-2007; IN COMMERCE 2-1-2007.

3,300,107. PAPERLY, LLC, CHICAGO, IL. SN 78-923,955. PUB. 2-20-2007, FILED 7-6-2006.

Paperly

THE MARK CONSISTS OF STANDARD CHARACTERS WITHOUT CLAIM TO ANY PARTICULAR FONT, STYLE, SIZE, OR COLOR.

FOR RETAIL STORE SERVICES FEATURING STATIONERY, PRINTED INVITATIONS, AND ANNOUNCEMENT CARDS (U.S. CLS. 100, 101 AND 102).

FIRST USE 5-1-2007; IN COMMERCE 5-1-2007.

3,300,111. COUNCIL FOR AFFORDABLE QUALITY HEALTHCARE, WASHINGTON, DC. SN 78-926,476. PUB. 3-6-2007, FILED 7-11-2006.

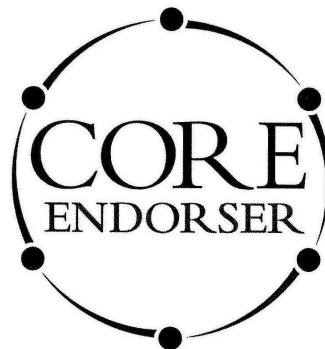

NO CLAIM IS MADE TO THE EXCLUSIVE RIGHT TO USE "ENDORSER", APART FROM THE MARK AS SHOWN. FOR ASSOCIATION SERVICES, NAMELY, PROMOTING THE SIMPLIFYING OF HEALTHCARE ADMINISTRATION (U.S. CLS. 100, 101 AND 102).

FIRST USE 10-19-2006; IN COMMERCE 10-19-2006.

CLASS 35—(Continued).

3,300,126. HARMONY PHARMACY & HEALTH CENTER, INC., PURCHASE, NY. SN 78-930,846. PUB. 3-6-2007, FILED 7-17-2006.

HARMONY PHARMACY

THE MARK CONSISTS OF STANDARD CHARACTERS WITHOUT CLAIM TO ANY PARTICULAR FONT, STYLE, SIZE, OR COLOR.

NO CLAIM IS MADE TO THE EXCLUSIVE RIGHT TO USE "PHARMACY", APART FROM THE MARK AS SHOWN.

FOR RETAIL PHARMACY SERVICES (U.S. CLS. 100, 101 AND 102).

FIRST USE 3-22-2007; IN COMMERCE 3-22-2007.

3,300,178. W3I HOLDINGS, LLC, SARTELL, MN. SN 78-956,762. PUB. 1-30-2007, FILED 8-21-2006.

W3I

THE MARK CONSISTS OF STANDARD CHARACTERS WITHOUT CLAIM TO ANY PARTICULAR FONT, STYLE, SIZE, OR COLOR.

FOR ADVERTISING AGENCIES; ADVERTISING AGENCIES, NAMELY, PROMOTING THE GOODS AND SERVICES OF OTHERS; ADVERTISING AND ADVERTISEMENT SERVICES; ADVERTISING AND COMMERCIAL INFORMATION SERVICES, VIA THE INTERNET; ADVERTISING AND MARKETING; ADVERTISING AND PROMOTION SERVICES AND RELATED CONSULTING; ADVERTISING BY TRANSMISSION OF ONLINE PUBLICITY FOR THIRD PARTIES THROUGH ELECTRONIC COMMUNICATIONS NETWORKS; ADVERTISING CONSULTATION; ADVERTISING SERVICES; ADVERTISING VIA ELECTRONIC MEDIA AND SPECIFICALLY THE INTERNET; DISSEMINATION OF ADVERTISING FOR OTHERS VIA AN ONLINE COMMUNICATIONS NETWORK ON THE INTERNET; DISSEMINATION OF ADVERTISING FOR OTHERS VIA THE INTERNET; DISSEMINATION OF ADVERTISING MATTER; ELECTRONIC BILLBOARD ADVERTISING; ELECTRONIC COMMERCE SERVICES, NAMELY PROVIDING INFORMATION PRODUCTS VIA TELECOMMUNICATION NETWORKS FOR ADVERTISING AND SALES PURPOSES; ON-LINE ADVERTISING ON COMPUTER COMMUNICATION NETWORKS; ONLINE ADVERTISING AND MARKETING SERVICES; PREPARATION OF CUSTOM ADVERTISEMENTS FOR OTHERS; PREPARATION OF CUSTOM OR NON-CUSTOM ADVERTISING FOR BUSINESSES FOR DISSEMINATION VIA THE WEB, CD OR DVD FOR OPTIONAL UPLOAD OR DOWNLOAD TO A COMPUTER; PREPARING ADVERTISEMENTS FOR OTHERS (U.S. CLS. 100, 101 AND 102).

FIRST USE 12-29-2006; IN COMMERCE 12-29-2006.

CLASS 36—INSURANCE AND FINANCIAL**CLASS 36—(Continued).**

3,298,401. 21TH CENTURY INSURANCE GROUP, WOODLAND HILLS, CA. SN 75-721,881. PUB. 1-11-2000, FILED 6-4-1999.

**21st Century Insurance**

NO CLAIM IS MADE TO THE EXCLUSIVE RIGHT TO USE "INSURANCE", APART FROM THE MARK AS SHOWN.

THE MARK CONSISTS OF A ROMAN COLUMN WITH THE WORDING "21ST CENTURY INSURANCE".

FOR INSURANCE UNDERWRITING SERVICES IN THE FIELDS OF PERSONAL AUTOMOBILE INSURANCE, HOMEOWNER'S INSURANCE, AND PERSONAL UMBRELLA INSURANCE POLICIES (U.S. CLS. 100, 101 AND 102).

FIRST USE 0-0-2004; IN COMMERCE 0-0-2004.

3,298,440. STONE EAGLE DEVELOPMENT, LLC, LOS ANGELES, CA. SN 76-500,833. PUB. 1-6-2004, FILED 3-5-2003.

STONE EAGLE

FOR REAL ESTATE MANAGEMENT SERVICES, NAMELY, MANAGEMENT AND OPERATION OF RESIDENTIAL COMMUNITIES (U.S. CLS. 100, 101 AND 102).

FIRST USE 11-10-2006; IN COMMERCE 11-10-2006.

3,298,456. MIDLAND STATES BANCORP, INC., EFFINGHAM, IL. SN 76-575,318. PUB. 12-12-2006, FILED 2-12-2004.

MIDLAND STATES BANK

THE MARK CONSISTS OF STANDARD CHARACTERS WITHOUT CLAIM TO ANY PARTICULAR FONT, STYLE, SIZE, OR COLOR.

NO CLAIM IS MADE TO THE EXCLUSIVE RIGHT TO USE "BANK", APART FROM THE MARK AS SHOWN.

FOR BANKING SERVICES, NAMELY, SAVINGS ACCOUNT SERVICES, CHECKING ACCOUNT SERVICES, TRUST ACCOUNT SERVICES, ATM SERVICES AND DEBIT CARD SERVICES (U.S. CLS. 100, 101 AND 102).

FIRST USE 6-0-2005; IN COMMERCE 6-0-2005.

CLASS 36—(Continued).

3,298,506. THE PRINCETON CORPORATION, KENTLAND, IN. SN 76-631,159. PUB. 6-13-2006, FILED 2-11-2005.

MORE

THE MARK CONSISTS OF STANDARD CHARACTERS WITHOUT CLAIM TO ANY PARTICULAR FONT, STYLE, SIZE, OR COLOR.

FOR ADMINISTERING LIFE INSURANCE PROGRAMS FOR OTHERS (U.S. CLS. 100, 101 AND 102).
FIRST USE 12-16-2005; IN COMMERCE 12-16-2005.

3,298,535. MERRILL LYNCH & CO., INC., NEW YORK, NY. SN 76-640,975. PUB. 10-31-2006, FILED 6-16-2005.

MERRILL LYNCH INSTITUTIONAL CONSULTING GROUP

THE MARK CONSISTS OF STANDARD CHARACTERS WITHOUT CLAIM TO ANY PARTICULAR FONT, STYLE, SIZE, OR COLOR.

OWNER OF U.S. REG. NOS. 2,465,877 AND 2,727,413.
NO CLAIM IS MADE TO THE EXCLUSIVE RIGHT TO USE "INSTITUTIONAL CONSULTING GROUP", APART FROM THE MARK AS SHOWN.

FOR FINANCIAL SERVICES, NAMELY, FINANCIAL ADVISORY, FINANCIAL INVESTMENT AND FINANCIAL REPORTING SERVICES (U.S. CLS. 100, 101 AND 102).

FIRST USE 11-1-2005; IN COMMERCE 11-1-2005.

3,298,573. FIRST NLC FINANCIAL SERVICES, LLC, DEERFIELD BEACH, FL. SN 76-651,431. PUB. 7-25-2006, FILED 11-25-2005.

FIRSTLOOK

THE MARK CONSISTS OF STANDARD CHARACTERS WITHOUT CLAIM TO ANY PARTICULAR FONT, STYLE, SIZE, OR COLOR.

FOR RETAIL AND WHOLESALE LENDING SERVICES (U.S. CLS. 100, 101 AND 102).
FIRST USE 8-1-2005; IN COMMERCE 8-1-2005.

CLASS 36—(Continued).

3,298,588. HMS NATIONAL, INC., FT. LAUDERDALE, FL. SN 76-658,798. PUB. 1-30-2007, FILED 4-21-2006.

PROTECT YOUR EVERY MOVE

THE MARK CONSISTS OF STANDARD CHARACTERS WITHOUT CLAIM TO ANY PARTICULAR FONT, STYLE, SIZE, OR COLOR.

FOR PROVIDING EXTENDED WARRANTY CONTRACTS AND SERVICE CONTRACTS ON HOMES, AND PROVIDING ERRORS AND OMISSIONS INSURANCE IN THE FIELD OF REAL ESTATE (U.S. CLS. 100, 101 AND 102).

FIRST USE 6-15-2006; IN COMMERCE 6-15-2006.

3,298,615. AMERICAN INTERNATIONAL GROUP, INC., NEW YORK, NY. SN 77-010,752. PUB. 1-16-2007, FILED 9-29-2006.

AIG RESIDENTIAL RECONSTRUCTION INDEX

THE MARK CONSISTS OF STANDARD CHARACTERS WITHOUT CLAIM TO ANY PARTICULAR FONT, STYLE, SIZE, OR COLOR.

OWNER OF U.S. REG. NOS. 1,151,229, 1,273,845, AND OTHERS.

NO CLAIM IS MADE TO THE EXCLUSIVE RIGHT TO USE "RESIDENTIAL RECONSTRUCTION", APART FROM THE MARK AS SHOWN.

FOR INSURANCE UNDERWRITING IN THE FIELD OF PROPERTY AND CASUALTY (U.S. CLS. 100, 101 AND 102).

FIRST USE 4-6-2007; IN COMMERCE 4-6-2007.

3,298,616. AMERICAN INTERNATIONAL GROUP, INC., NEW YORK, NY. SN 77-010,807. PUB. 1-16-2007, FILED 9-29-2006.

AIG RRI

THE MARK CONSISTS OF STANDARD CHARACTERS WITHOUT CLAIM TO ANY PARTICULAR FONT, STYLE, SIZE, OR COLOR.

OWNER OF U.S. REG. NOS. 1,151,229, 1,273,845, AND OTHERS.

FOR INSURANCE UNDERWRITING IN THE FIELD OF PROPERTY AND CASUALTY (U.S. CLS. 100, 101 AND 102).

FIRST USE 4-6-2007; IN COMMERCE 4-6-2007.

CLASS 36—(Continued).

3,298,644. WACHOVIA CORPORATION, CHARLOTTE, NC. SN 78-156,399. PUB. 11-21-2006, FILED 8-21-2002.

ENVISION

OWNER OF U.S. REG. NOS. 1,616,062 AND 2,411,631. FOR INVESTMENT AND INSURANCE PLANNING AND CONSULTATION SERVICES (U.S. CLS. 100, 101 AND 102).

FIRST USE 8-26-2002; IN COMMERCE 3-0-2003.

3,298,707. EQUITY ANALYTICS, LLC, ATLANTA, GA. SN 78-322,116. PUB. 3-22-2005, FILED 11-3-2003.

Option Navigator

THE MARK CONSISTS OF STANDARD CHARACTERS WITHOUT CLAIM TO ANY PARTICULAR FONT, STYLE, SIZE, OR COLOR.

NO CLAIM IS MADE TO THE EXCLUSIVE RIGHT TO USE OPTION, APART FROM THE MARK AS SHOWN.

FOR FINANCIAL VALUATION OF EMPLOYEE STOCK OPTIONS FOR COMPANIES THAT ISSUE EQUITY COMPENSATION TO THEIR OWN EMPLOYEES AND EXECUTIVES AND RELATED PARTIES, AND WHO NEED TO COMPLY WITH FEDERAL REGULATIONS, BUT NOT INCLUDING ANY INVESTMENT ADVISORY SERVICES, WEALTH MANAGEMENT, OR ASSET ALLOCATION SERVICES, AND NOT INVOLVING ANY VALUATION OF PUBLICLY-TRADED SECURITY OPTIONS ISSUED BY THIRD PARTIES (U.S. CLS. 100, 101 AND 102).

FIRST USE 6-14-2004; IN COMMERCE 6-14-2004.

3,298,710. CHAKRAVORTY, SUDEEP GOPAL, WEXFORD, PA. SN 78-333,962. PUB. 1-17-2006, FILED 11-27-2003.

The IND-US Valley Civilization

THE MARK CONSISTS OF STANDARD CHARACTERS WITHOUT CLAIM TO ANY PARTICULAR FONT, STYLE, SIZE, OR COLOR.

FOR REAL ESTATE MANAGEMENT, NAMELY, ADMINISTRATION OF CULTURE-BASED RESIDENTIAL COMMUNITIES FOR ASIAN INDIAN AMERICANS (U.S. CLS. 100, 101 AND 102).

FIRST USE 4-5-2007; IN COMMERCE 4-5-2007.

CLASS 36—(Continued).

3,298,713. WALLOS, ROBERT, KATONAH, NY. SN 78-337,069. PUB. 1-18-2005, FILED 12-5-2003.

MOB INDEX

THE MARK CONSISTS OF STANDARD CHARACTERS WITHOUT CLAIM TO ANY PARTICULAR FONT, STYLE, SIZE, OR COLOR.

NO CLAIM IS MADE TO THE EXCLUSIVE RIGHT TO USE INDEX, APART FROM THE MARK AS SHOWN.

FOR FINANCIAL INFORMATION SERVICES, NAMELY TRACKING EQUITY TRADING ACTIVITY EXCLUDING MUNICIPAL BONDS (U.S. CLS. 100, 101 AND 102).

FIRST USE 5-26-2006; IN COMMERCE 5-26-2006.

3,298,755. MATTEL, INC., EL SEGUNDO, CA. SN 78-404,591. PUB. 6-20-2006, FILED 4-20-2004.

MATTEL

THE MARK CONSISTS OF STANDARD CHARACTERS WITHOUT CLAIM TO ANY PARTICULAR FONT, STYLE, SIZE, OR COLOR.

FOR BANKING AND FINANCIAL-RELATED SERVICES, NAMELY, DEBIT CARD AND CREDIT CARD SERVICES (U.S. CLS. 100, 101 AND 102).

FIRST USE 2-23-2007; IN COMMERCE 2-23-2007.

CLASS 36—(Continued).

3,298,815. FEDERAL NATIONAL MORTGAGE ASSOCIATION, DBA FANNIE MAE, WASHINGTON, DC. SN 78-472,888. PUB. 7-5-2005, FILED 8-24-2004.

EXPRESSPATH

THE MARK CONSISTS OF STANDARD CHARACTERS WITHOUT CLAIM TO ANY PARTICULAR FONT, STYLE, SIZE, OR COLOR.
FOR MORTGAGE LOAN SERVICES (U.S. CLS. 100, 101 AND 102).
FIRST USE 9-0-2004; IN COMMERCE 9-0-2004.

3,298,837. CHECKFREE SERVICES, INC., NORCROSS, GA. SN 78-482,415. PUB. 12-27-2005, FILED 9-13-2004.

CHECKFREE EPL

THE MARK CONSISTS OF STANDARD CHARACTERS WITHOUT CLAIM TO ANY PARTICULAR FONT, STYLE, SIZE, OR COLOR.
OWNER OF U.S. REG. NO. 2,695,972.
FOR INVESTMENT PORTFOLIO MANAGEMENT SERVICES (U.S. CLS. 100, 101 AND 102).
FIRST USE 1-4-2004; IN COMMERCE 1-4-2004.

3,298,848. ASSURANT, INC., NEW YORK, NY. SN 78-492,494. PUB. 11-14-2006, FILED 9-30-2004.

RENTERSECURITY.COM

THE MARK CONSISTS OF STANDARD CHARACTERS WITHOUT CLAIM TO ANY PARTICULAR FONT, STYLE, SIZE, OR COLOR.
FOR INSURANCE SERVICES, NAMELY, UNDERWRITING INSURANCE FOR PERSONAL PROPERTY AND LIABILITY OF RESIDENTIAL TENANTS (U.S. CLS. 100, 101 AND 102).
FIRST USE 9-0-2006; IN COMMERCE 9-0-2006.

CLASS 36—(Continued).

3,298,927. BAY AREA LAW ENFORCEMENT ASSISTANCE FUND, SAN FRANCISCO, CA. SN 78-556,938. PUB. 5-16-2006, FILED 1-31-2005.



NO CLAIM IS MADE TO THE EXCLUSIVE RIGHT TO USE BAY AREA LAW ENFORCEMENT ASSISTANCE FUND, APART FROM THE MARK AS SHOWN.

THE COLORS RED, WHITE AND BLUE ARE CLAIMED AS A FEATURE OF THE MARK.

THE MARK CONSISTS OF SHIELD-SHAPED LOGO DIVIDED HORIZONTALLY WITH "BAY AREA LAW ENFORCEMENT ASSISTANCE FUND" IN WHITE LETTERS IN THE UPPER FIELD AGAINST A BLUE BACKGROUND AND A FLAG-DRAPED COFFIN WITH RED ROSE IN THE LOWER FIELD WITH RED AND WHITE DIAGONAL STRIPES TO THE UPPER LEFT OF THE LOWER FIELD.

FOR CHARITABLE ASSISTANCE FOR LAW ENFORCEMENT PERSONNEL, THEIR FAMILIES AND THOSE WHO ASSIST THEM, NAMELY, PROVIDING EDUCATIONAL SCHOLARSHIPS (U.S. CLS. 100, 101 AND 102).
FIRST USE 10-3-2003; IN COMMERCE 11-30-2003.

3,298,930. GMAC MORTGAGE LLC, WILMINGTON, DE. SN 78-559,960. PUB. 5-9-2006, FILED 2-3-2005.

105 SELECT

THE MARK CONSISTS OF STANDARD CHARACTERS WITHOUT CLAIM TO ANY PARTICULAR FONT, STYLE, SIZE, OR COLOR.

FOR REAL ESTATE MORTGAGE BANKING AND LENDING SERVICES; LOAN ORIGINATION AND FINANCING VIA A GLOBAL COMMUNICATIONS NETWORK (U.S. CLS. 100, 101 AND 102).
FIRST USE 4-18-2005; IN COMMERCE 4-18-2005.

CLASS 36—(Continued).

3,298,935. INA CORPORATION, PHILADELPHIA, PA. SN 78-563,125. PUB. 7-18-2006, FILED 2-8-2005.

CLASS 36—(Continued).

3,298,991. GROWTH ORGANIZATION OF TOPEKA/SHAWNEE COUNTY, INC., TOPEKA, KS. SN 78-589,416. PUB. 12-13-2005, FILED 3-17-2005.

INTERNATIONAL ADVANTAGE EXPRESS

THE MARK CONSISTS OF STANDARD CHARACTERS WITHOUT CLAIM TO ANY PARTICULAR FONT, STYLE, SIZE, OR COLOR.

OWNER OF U.S. REG. NO. 1.658.511.

NO CLAIM IS MADE TO THE EXCLUSIVE RIGHT TO USE "INTERNATIONAL" OR "EXPRESS", APART FROM THE MARK AS SHOWN.

FOR INSURANCE UNDERWRITING SERVICES IN THE FIELDS OF TRAVEL INSURANCE, GENERAL COMMERCIAL PROPERTY, CASUALTY AND LIABILITY INSURANCE, COMMERCIAL AUTOMOBILE COVERAGE, VOLUNTARY WORKERS' COMPENSATION FOR EMPLOYEES TRAVELING AND/OR ASSIGNED OVERSEAS, TRAVEL ACCIDENT AND SICKNESS COVERAGE, KIDNAP, RANSOM AND EXTORTION, PROPERTY INSURANCE, CRIME COVERAGE, POLITICAL RISK COVERAGE, AND MARINE CARGO INSURANCE (U.S. CLS. 100, 101 AND 102).

FIRST USE 9-0-2005; IN COMMERCE 9-0-2005.

CENTRAL CROSSING

THE MARK CONSISTS OF STANDARD CHARACTERS WITHOUT CLAIM TO ANY PARTICULAR FONT, STYLE, SIZE, OR COLOR.

FOR RENTAL OF OFFICE SPACE; RENTAL OF BUILDINGS IN THE NATURE OF INDUSTRIAL AND COMMERCIAL FACILITIES; BUILDING AND REAL ESTATE MANAGEMENT SERVICES (U.S. CLS. 100, 101 AND 102).

FIRST USE 4-1-2005; IN COMMERCE 4-1-2005.

3,299,002. MCEAGLE DEVELOPMENT, L.C., O'FALLON, MO. SN 78-591,652. PUB. 7-25-2006, FILED 3-21-2005.

3,298,953. FIRST CITIZENS BANK, ELIZABETHTOWN, KY. SN 78-570,268. PUB. 6-20-2006, FILED 2-18-2005.

BARATHAVEN



THE MARK CONSISTS OF STANDARD CHARACTERS WITHOUT CLAIM TO ANY PARTICULAR FONT, STYLE, SIZE, OR COLOR.

FOR REAL ESTATE MANAGEMENT SERVICES, NAMELY, MANAGING COMMERCIAL, RECREATIONAL AND RESIDENTIAL COMMUNITIES (U.S. CLS. 100, 101 AND 102).

FIRST USE 7-0-2005; IN COMMERCE 7-0-2005.

FOR ELECTRONIC PAYMENT, NAMELY, ELECTRONIC PROCESSING AND TRANSMISSION OF BILL PAYMENT DATA (U.S. CLS. 100, 101 AND 102).

FIRST USE 10-15-2004; IN COMMERCE 10-15-2004.

CLASS 36—(Continued).

3,299,021. ONSET MANAGEMENT COMPANY, ANN ARBOR, MI. SN 78-595,941. PUB. 12-27-2005, FILED 3-28-2005.



NO CLAIM IS MADE TO THE EXCLUSIVE RIGHT TO USE "MI", "CD", "MICHIGAN", AND "CERTIFICATE OF DEPOSIT", APART FROM THE MARK AS SHOWN.

THE MARK CONSISTS OF ACRONYMS AND WORDS, NAMELY, MI MICHIGAN INNOVATION CD CERTIFICATE OF DEPOSIT, GRAPHICALLY ARRANGED AND DIVIDED BY TAPERED LINES.

FOR FINANCIAL SERVICES, NAMELY, ISSUING CERTIFICATES OF DEPOSIT (U.S. CLS. 100, 101 AND 102).

FIRST USE 4-30-2005; IN COMMERCE 4-30-2005.

3,299,022. LASALLE BANK CORPORATION, CHICAGO, IL. SN 78-596,242. PUB. 7-11-2006, FILED 3-28-2005.

**LASALLE BANK
MIDWEST N.A.**

THE MARK CONSISTS OF STANDARD CHARACTERS WITHOUT CLAIM TO ANY PARTICULAR FONT, STYLE, SIZE, OR COLOR.

OWNER OF U.S. REG. NOS. 1,898,288 AND 2,317,980.

NO CLAIM IS MADE TO THE EXCLUSIVE RIGHT TO USE "BANK MIDWEST N.A.", APART FROM THE MARK AS SHOWN.

FOR BANKING SERVICES (U.S. CLS. 100, 101 AND 102).

FIRST USE 9-12-2005; IN COMMERCE 9-12-2005.

CLASS 36—(Continued).

3,299,024. AMERICAN FAMILY LIFE ASSURANCE COMPANY OF COLUMBUS, COLUMBUS, GA. SN 78-596,803. PUB. 6-27-2006, FILED 3-29-2005.

VISION NOW

THE MARK CONSISTS OF STANDARD CHARACTERS WITHOUT CLAIM TO ANY PARTICULAR FONT, STYLE, SIZE, OR COLOR.

NO CLAIM IS MADE TO THE EXCLUSIVE RIGHT TO USE "VISION", APART FROM THE MARK AS SHOWN.

FOR INSURANCE SERVICES, NAMELY, THE UNDERWRITING, ISSUING AND ADMINISTRATION OF VISION INSURANCE BENEFITS, INCLUDING PROCESSING INSURANCE CLAIMS AND BENEFITS (U.S. CLS. 100, 101 AND 102).

FIRST USE 7-0-2005; IN COMMERCE 7-0-2005.

3,299,092. PAN PACIFIC BANK, FREMONT, CA. SN 78-618,998. PUB. 7-4-2006, FILED 4-28-2005.



THE COLORS GREEN AND GOLD ARE CLAIMED AS FEATURES OF THE MARK.

THE MARK CONSISTS OF A GREEN CIRCLE WITH GOLD WAVES.

FOR BANKING SERVICES (U.S. CLS. 100, 101 AND 102).

FIRST USE 7-18-2005; IN COMMERCE 7-18-2005.

CLASS 36—(Continued).

3,299,094. MERCANTILE BANK CORPORATION, WYOMING, MI. SN 78-620,647. PUB. 12-19-2006, FILED 5-2-2005.



OWNER OF U.S. REG. NOS. 2,301,537 AND 2,927,999.
 NO CLAIM IS MADE TO THE EXCLUSIVE RIGHT TO USE "BANK OF MICHIGAN", APART FROM THE MARK AS SHOWN.
 THE MARK CONSISTS OF THE TRADEMARK MERCANTILE BANK OF MICHIGAN AND A PYRAMID OR TRIANGLE DESIGN.
 SEC. 2(F) AS TO "MERCANTILE".
 FOR BANKING SERVICES (U.S. CLS. 100, 101 AND 102).
 FIRST USE 8-1-2005; IN COMMERCE 8-1-2005.

3,299,126. LIFE SETTLEMENT PROVIDERS, LLC, BALTIMORE, MD. SN 78-635,129. PUB. 2-21-2006, FILED 5-23-2005.

GLSB

THE MARK CONSISTS OF STANDARD CHARACTERS WITHOUT CLAIM TO ANY PARTICULAR FONT, STYLE, SIZE, OR COLOR.
 FOR VIATICAL SETTLEMENT SERVICES (U.S. CLS. 100, 101 AND 102).
 FIRST USE 8-15-2005; IN COMMERCE 8-15-2005.

CLASS 36—(Continued).

3,299,158. KWSL, LLC, CINCINNATI, OH. SN 78-648,300. PUB. 7-18-2006, FILED 6-10-2005.



NO CLAIM IS MADE TO THE EXCLUSIVE RIGHT TO USE "OHIO LENDING", APART FROM THE MARK AS SHOWN.
 FOR STUDENT LOAN SERVICES IN THE NATURE OF STUDENT LOAN HOLDING AND PURCHASING (U.S. CLS. 100, 101 AND 102).
 FIRST USE 9-30-2005; IN COMMERCE 9-30-2005.

3,299,197. CESSNA AIRCRAFT COMPANY, WICHITA, KS. SN 78-663,846. PUB. 10-10-2006, FILED 7-5-2005.



FOR EXTENDED WARRANTIES ON AIRCRAFT ENGINES (U.S. CLS. 100, 101 AND 102).
 FIRST USE 12-1-2005; IN COMMERCE 12-1-2005.

3,299,248. PENNSYLVANIA STATE EMPLOYEES CREDIT UNION, HARRISBURG, PA. SN 78-685,582. PUB. 4-25-2006, FILED 8-4-2005.

UPOST

THE MARK CONSISTS OF STANDARD CHARACTERS WITHOUT CLAIM TO ANY PARTICULAR FONT, STYLE, SIZE, OR COLOR.
 OWNER OF U.S. REG. NO. 2,703,124.
 FOR BANKING SERVICES CONDUCTED VIA COMPUTER, NAMELY DEPOSITS (U.S. CLS. 100, 101 AND 102).
 FIRST USE 3-0-2003; IN COMMERCE 3-0-2003.

CLASS 36—(Continued).

3,299,274. ARAPAHO POINT PARTNERS, LLC, MANHATTAN BEACH, CA. SN 78-699,263. PUB. 12-5-2006, FILED 8-24-2005.

CLASS 36—(Continued).

3,299,285. STERLING STAMOS CAPITAL MANAGEMENT, L.P., NEW YORK, NY. SN 78-702,258. PUB. 7-4-2006, FILED 8-29-2005.

THE PELOTON

THE MARK CONSISTS OF STANDARD CHARACTERS WITHOUT CLAIM TO ANY PARTICULAR FONT, STYLE, SIZE, OR COLOR.

FOR LEASING OF REAL ESTATE; OPERATING MARKETPLACES FOR SELLERS OF GOODS AND/OR SERVICES; PROVIDING INFORMATION IN THE FIELD OF REAL ESTATE BY MEANS OF LINKING THE WEB SITE TO OTHER WEB SITES FEATURING REAL ESTATE INFORMATION; REAL ESTATE INVESTMENT; REAL ESTATE SYNDICATION (U.S. CLS. 100, 101 AND 102).

FIRST USE 8-1-2005; IN COMMERCE 8-1-2005.

Doing Well By Doing Good

THE MARK CONSISTS OF STANDARD CHARACTERS WITHOUT CLAIM TO ANY PARTICULAR FONT, STYLE, SIZE, OR COLOR.

FOR ADVICE RELATING TO INVESTMENTS; EQUITY CAPITAL INVESTMENT; FUND INVESTMENT CONSULTATION; FUNDS INVESTMENT; INVESTMENT ADVICE; INVESTMENT BROKERAGE; INVESTMENT CONSULTATION; INVESTMENT MANAGEMENT (U.S. CLS. 100, 101 AND 102).

FIRST USE 2-28-2005; IN COMMERCE 2-28-2005.

3,299,279. FISH FINANCIAL, LLC, MARTINSBURG, WV. SN 78-701,548. PUB. 5-23-2006, FILED 8-26-2005.

3,299,294. PROSTIC, MERRY, MISSION HILLS, KS. SN 78-705,547. PUB. 7-18-2006, FILED 9-1-2005.

28 DAYS TO FINANCIAL HEALTH

THE MARK CONSISTS OF STANDARD CHARACTERS WITHOUT CLAIM TO ANY PARTICULAR FONT, STYLE, SIZE, OR COLOR.

FOR FINANCIAL PLANNING CONSULTATION (U.S. CLS. 100, 101 AND 102).

FIRST USE 5-1-2006; IN COMMERCE 5-1-2006.

RED SHOE SOCIETY

3,299,281. FIRST AMERICAN CORELOGIC, INC., SACRAMENTO, CA. SN 78-701,849. PUB. 7-4-2006, FILED 8-26-2005.

THE MARK CONSISTS OF STANDARD CHARACTERS WITHOUT CLAIM TO ANY PARTICULAR FONT, STYLE, SIZE, OR COLOR.

NO CLAIM IS MADE TO THE EXCLUSIVE RIGHT TO USE "SOCIETY", APART FROM THE MARK AS SHOWN.

FOR CHARITABLE FUNDRAISING SERVICES, NAMELY FUNDRAISING FOR THE FUNDING OF RESEARCH RELATED TO THE TREATMENT OF AND PSYCHOSOCIAL ISSUES RELATED TO METASTATIC CANCERS; FUNDRAISING FOR COMMUNITY AWARENESS PROGRAMS ABOUT METASTATIC CANCERS; FUNDRAISING FOR COMMUNITY SUPPORT GROUPS AND INDIVIDUAL SUPPORT SERVICES FOR PATIENTS WITH METASTATIC CANCER AND THEIR CAREGIVERS; FUNDRAISING TO SUPPORT COMMUNITY AWARENESS AND SUPPORT PROGRAMS OFFERED BY THE METACANCER FOUNDATION (U.S. CLS. 100, 101 AND 102).

FIRST USE 10-19-2006; IN COMMERCE 10-19-2006.

CORELOGIC

THE MARK CONSISTS OF STANDARD CHARACTERS WITHOUT CLAIM TO ANY PARTICULAR FONT, STYLE, SIZE, OR COLOR.

FOR FINANCIAL SERVICES, NAMELY ASSESSMENT AND MANAGEMENT OF LOAN RISK AND FRAUD IN THE FIELDS OF MORTGAGE LENDING AND INVESTING (U.S. CLS. 100, 101 AND 102).

FIRST USE 2-15-2006; IN COMMERCE 2-15-2006.

CLASS 36—(Continued).

3,299,302. ACROSS AMERICA REAL ESTATE, DENVER, CO. SN 78-709,213. PUB. 2-6-2007, FILED 9-8-2005.



NO CLAIM IS MADE TO THE EXCLUSIVE RIGHT TO USE "AMERICA" AND "REAL ESTATE", APART FROM THE MARK AS SHOWN.

THE COLORS RED AND DARK BLUE ARE CLAIMED AS A FEATURE OF THE MARK.

THE MARK CONSISTS OF A RED STAR BETWEEN THE DARK BLUE WORDS "ACROSS" AND "AMERICA", THREE RED CURVED STRIPES SHOWN ABOVE THE DARK BLUE WORD "ACROSS", ALL OF WHICH IS SHOWN ABOVE THE DARK BLUE WORDS "REAL ESTATE".

FOR REAL ESTATE INVESTMENT (U.S. CLS. 100, 101 AND 102).

FIRST USE 10-6-2005; IN COMMERCE 10-6-2005.

3,299,309. CAMBRIAN CAPITAL LIMITED PARTNERSHIP, MANCHESTER, MA. SN 78-711,245. PUB. 5-30-2006, FILED 9-12-2005.

CAMBRIAN CAPITAL

THE MARK CONSISTS OF STANDARD CHARACTERS WITHOUT CLAIM TO ANY PARTICULAR FONT, STYLE, SIZE, OR COLOR.

NO CLAIM IS MADE TO THE EXCLUSIVE RIGHT TO USE "CAPITAL", APART FROM THE MARK AS SHOWN.

FOR FINANCIAL SERVICES, NAMELY, MANAGEMENT OF AND INVESTMENT IN HEDGE FUNDS (U.S. CLS. 100, 101 AND 102).

FIRST USE 2-0-2006; IN COMMERCE 2-0-2006.

3,299,314. FIRST AMERICAN REAL ESTATE SOLUTIONS LLC, WESTLAKE, TX. SN 78-712,744. PUB. 7-4-2006, FILED 9-14-2005.

FAPAY

THE MARK CONSISTS OF STANDARD CHARACTERS WITHOUT CLAIM TO ANY PARTICULAR FONT, STYLE, SIZE, OR COLOR.

FOR ELECTRONIC PAYMENT, NAMELY, PROCESSING MORTGAGE PAYMENT DATA IN ORDER TO CAPTURE DEFAULT PAYMENT OF BORROWERS (U.S. CLS. 100, 101 AND 102).

FIRST USE 2-13-2006; IN COMMERCE 2-13-2006.

CLASS 36—(Continued).

3,299,350. ANDY MAY GROUP, LLC, RALEIGH, NC. SN 78-722,233. PUB. 6-13-2006, FILED 9-28-2005.

**THE GOLD STANDARD IN TRUTH
IN LENDING**

THE MARK CONSISTS OF STANDARD CHARACTERS WITHOUT CLAIM TO ANY PARTICULAR FONT, STYLE, SIZE, OR COLOR.

FOR HOME MORTGAGE LENDING AND HOME EQUITY LOANS (U.S. CLS. 100, 101 AND 102).

FIRST USE 1-1-2005; IN COMMERCE 1-1-2005.

3,299,364. WACHOVIA CORPORATION, CHARLOTTE, NC. SN 78-725,413. PUB. 6-27-2006, FILED 10-3-2005.

**WACHOVIA GLOBAL ASSET
MANAGEMENT**

THE MARK CONSISTS OF STANDARD CHARACTERS WITHOUT CLAIM TO ANY PARTICULAR FONT, STYLE, SIZE, OR COLOR.

OWNER OF U.S. REG. NOS. 2,611,937, 2,791,817, AND OTHERS.

NO CLAIM IS MADE TO THE EXCLUSIVE RIGHT TO USE "GLOBAL ASSET MANAGEMENT", APART FROM THE MARK AS SHOWN.

FOR INVESTMENT ADVISORY SERVICES (U.S. CLS. 100, 101 AND 102).

FIRST USE 9-30-2005; IN COMMERCE 5-0-2006.

3,299,376. CAMBRIAN CAPITAL LIMITED PARTNERSHIP, MANCHESTER, MA. SN 78-726,974. PUB. 5-23-2006, FILED 10-5-2005.

CAMCAP

THE MARK CONSISTS OF STANDARD CHARACTERS WITHOUT CLAIM TO ANY PARTICULAR FONT, STYLE, SIZE, OR COLOR.

FOR FINANCIAL SERVICES, NAMELY, MANAGEMENT OF AND INVESTMENT IN HEDGE FUNDS (U.S. CLS. 100, 101 AND 102).

FIRST USE 2-0-2006; IN COMMERCE 2-0-2006.

CLASS 36—(Continued).

3,299,440. PRIDGEN, DURWARD B., HILTON HEAD ISLAND, SC. SN 78-736,833. PUB. 7-4-2006, FILED 10-20-2005.

OLD COOT CONSULTATIONS

THE MARK CONSISTS OF STANDARD CHARACTERS WITHOUT CLAIM TO ANY PARTICULAR FONT, STYLE, SIZE, OR COLOR.

NO CLAIM IS MADE TO THE EXCLUSIVE RIGHT TO USE "CONSULTATIONS", APART FROM THE MARK AS SHOWN.

FOR REAL ESTATE CONSULTANCY (U.S. CLS. 100, 101 AND 102).

FIRST USE 1-0-2007; IN COMMERCE 1-0-2007.

3,299,455. INTERACTIVE BROKERS LLC, GREENWICH, CT. SN 78-738,093. PUB. 7-11-2006, FILED 10-21-2005.

**INTELLIGENT DESIGN THAT
EVEN DARWIN COULD
APPRECIATE**

THE MARK CONSISTS OF STANDARD CHARACTERS WITHOUT CLAIM TO ANY PARTICULAR FONT, STYLE, SIZE, OR COLOR.

FOR FINANCIAL SERVICES, NAMELY, ASSISTING OTHERS WITH THE COMPLETION OF FINANCIAL TRANSACTIONS FOR STOCKS, BONDS, SECURITIES, FUTURES AND EQUITIES (U.S. CLS. 100, 101 AND 102).

FIRST USE 1-9-2006; IN COMMERCE 1-9-2006.

3,299,459. SAGEVIEW CAPITAL L.L.C., GREENWICH, CT. SN 78-738,880. PUB. 7-4-2006, FILED 10-24-2005.

SAGEVIEW CAPITAL

THE MARK CONSISTS OF STANDARD CHARACTERS WITHOUT CLAIM TO ANY PARTICULAR FONT, STYLE, SIZE, OR COLOR.

NO CLAIM IS MADE TO THE EXCLUSIVE RIGHT TO USE "CAPITAL", APART FROM THE MARK AS SHOWN.

FOR FINANCIAL SERVICES, NAMELY, MANAGEMENT OF A CAPITAL INVESTMENT FUND, AND INVESTMENT ADVISORY SERVICES (U.S. CLS. 100, 101 AND 102).

FIRST USE 5-11-2006; IN COMMERCE 5-11-2006.

CLASS 36—(Continued).

3,299,498. OLD LINE BANK, BOWIE, MD. SN 78-744,483. PUB. 7-25-2006, FILED 11-1-2005.

OLD LINE MARINE

THE MARK CONSISTS OF STANDARD CHARACTERS WITHOUT CLAIM TO ANY PARTICULAR FONT, STYLE, SIZE, OR COLOR.

NO CLAIM IS MADE TO THE EXCLUSIVE RIGHT TO USE "MARINE", APART FROM THE MARK AS SHOWN.

FOR BANKING SERVICES (U.S. CLS. 100, 101 AND 102).

FIRST USE 9-30-2005; IN COMMERCE 9-30-2005.

3,299,508. TWIN FINANCIAL, INC., KANSAS CITY, MO. SN 78-746,427. PUB. 7-11-2006, FILED 11-3-2005.

expertise²

THE MARK CONSISTS OF THE TERM EXPERTISE IN STYLIZED LETTERING WITH THE NUMBER 2 AT THE END OF THE LETTERING IN EXPONENTIAL POSITION REPRESENTED IN SUPERSCRIPIT PLACEMENT.

FOR FINANCIAL PLANNING; FINANCIAL EVALUATION FOR INSURANCE PURPOSES; INSURANCE CONSULTATION; CONSULTATION AND ADMINISTRATION OF EXECUTIVE AND EMPLOYEE BENEFIT PROGRAMS; AND INVESTMENT SERVICES, NAMELY, ASSET ACCUMULATION, CONSULTATION, DEVELOPMENT, AND MANAGEMENT SERVICES (U.S. CLS. 100, 101 AND 102).

FIRST USE 3-1-2006; IN COMMERCE 3-1-2006.

CLASS 36—(Continued).

3,299,545. CARLSON, SCOTT A., NORTH RICHLAND HILLS, TX. SN 78-753,131. PUB. 7-18-2006, FILED 11-14-2005.

CLASS 36—(Continued).

3,299,622. SPRINGBOK SERVICES, INC., ENGLEWOOD, CO. SN 78-768,437. PUB. 8-22-2006, FILED 12-7-2005.

UnderScore

SPRINGBOK

FOR AUTOMOBILE FINANCING (U.S. CLS. 100, 101 AND 102).
FIRST USE 3-15-2007; IN COMMERCE 3-15-2007.

THE MARK CONSISTS OF STANDARD CHARACTERS WITHOUT CLAIM TO ANY PARTICULAR FONT, STYLE, SIZE, OR COLOR.

FOR CLIENT SERVICE AND CARDHOLDER SERVICES, NAMELY STORED VALUE DEBIT CARD ISSUANCE, DEBIT CARD TRANSACTION PROCESSING SERVICES AND RISK MANAGEMENT; PROFESSIONAL CONSULTING SERVICES IN THE FIELD OF STORED VALUE DEBIT CARD ISSUANCE, RISK MANAGEMENT, CREDIT CARDS AND CREDIT (U.S. CLS. 100, 101 AND 102).

FIRST USE 10-19-2005; IN COMMERCE 2-2-2006.

3,299,566. SBLI USA MUTUAL LIFE INSURANCE COMPANY, INC., NEW YORK, NY. SN 78-754,806. PUB. 7-25-2006, FILED 11-16-2005.

EASY 1-2-3

3,299,624. SPRINGBOK SERVICES, INC., ENGLEWOOD, CO. SN 78-768,441. PUB. 8-22-2006, FILED 12-7-2005.

THE MARK CONSISTS OF STANDARD CHARACTERS WITHOUT CLAIM TO ANY PARTICULAR FONT, STYLE, SIZE, OR COLOR.

FOR INSURANCE AND FINANCIAL SERVICES, NAMELY, UNDERWRITING OF ANNUITIES, LIFE INSURANCE AND ACCIDENT AND HEALTH INSURANCE (U.S. CLS. 100, 101 AND 102).

FIRST USE 12-2-2005; IN COMMERCE 12-2-2005.

POWERING PREPAID

3,299,572. SUNTRUST BANKS, INC., ORLANDO, FL. SN 78-755,766. PUB. 8-29-2006, FILED 11-17-2005.

THE MARK CONSISTS OF STANDARD CHARACTERS WITHOUT CLAIM TO ANY PARTICULAR FONT, STYLE, SIZE, OR COLOR.

NO CLAIM IS MADE TO THE EXCLUSIVE RIGHT TO USE PREPAID, APART FROM THE MARK AS SHOWN.

FOR CLIENT SERVICE AND CARDHOLDER SERVICES, NAMELY STORED VALUE DEBIT CARD ISSUANCE, DEBIT CARD TRANSACTION PROCESSING SERVICES AND RISK MANAGEMENT; PROFESSIONAL CONSULTING SERVICES IN THE FIELD OF STORED VALUE DEBIT CARD ISSUANCE, RISK MANAGEMENT, CREDIT CARDS AND CREDIT (U.S. CLS. 100, 101 AND 102).

FIRST USE 11-2-2005; IN COMMERCE 2-2-2006.

ROAD WARRIOR

THE MARK CONSISTS OF STANDARD CHARACTERS WITHOUT CLAIM TO ANY PARTICULAR FONT, STYLE, SIZE, OR COLOR.

FOR BANKING AND CREDIT CARD SERVICES (U.S. CLS. 100, 101 AND 102).

FIRST USE 4-0-2005; IN COMMERCE 4-0-2005.

CLASS 36—(Continued).

3,299,714. SPRINGBOK SERVICES, INC., ENGLEWOOD, CO. SN 78-790,738. PUB. 8-29-2006, FILED 1-12-2006.

**AGILE, SECURE & POWERFUL
PREPAID SOLUTIONS**

THE MARK CONSISTS OF STANDARD CHARACTERS WITHOUT CLAIM TO ANY PARTICULAR FONT, STYLE, SIZE, OR COLOR.

NO CLAIM IS MADE TO THE EXCLUSIVE RIGHT TO USE "PREPAID SOLUTIONS", APART FROM THE MARK AS SHOWN.

FOR CLIENT SERVICE AND CARDHOLDER SERVICES, NAMELY STORED VALUE DEBIT CARD ISSUANCE, DEBIT CARD TRANSACTION PROCESSING SERVICES AND RISK MANAGEMENT; PROFESSIONAL CONSULTING SERVICES IN THE FIELD OF STORED VALUE DEBIT CARD ISSUANCE, RISK MANAGEMENT, CREDIT CARDS AND CREDIT (U.S. CLS. 100, 101 AND 102).

FIRST USE 11-2-2005; IN COMMERCE 2-1-2006.

3,299,727. AMERICAN INTERNATIONAL GROUP, INC., NEW YORK, NY. SN 78-794,879. PUB. 9-12-2006, FILED 1-19-2006.

EMERGING EDGE

THE MARK CONSISTS OF STANDARD CHARACTERS WITHOUT CLAIM TO ANY PARTICULAR FONT, STYLE, SIZE, OR COLOR.

FOR ANNUITY UNDERWRITING; INVESTMENT MANAGEMENT OF AND DISTRIBUTION OF VARIABLE ANNUITIES (U.S. CLS. 100, 101 AND 102).

FIRST USE 6-1-2006; IN COMMERCE 6-1-2006.

3,299,730. PREMIER TEN THIRTY ONE CAPITAL CORP., SANTA MONICA, CA. SN 78-795,303. PUB. 5-1-2007, FILED 1-19-2006.

PROPOINT

THE MARK CONSISTS OF STANDARD CHARACTERS WITHOUT CLAIM TO ANY PARTICULAR FONT, STYLE, SIZE, OR COLOR.

FOR FINANCIAL EXCHANGE SERVICES; FINANCIAL CONSULTATION SERVICES; FINANCIAL SERVICES, NAMELY, ASSISTING OTHERS WITH THE COMPLETION OF FINANCIAL TRANSACTIONS FOR SECURITIES (U.S. CLS. 100, 101 AND 102).

FIRST USE 4-0-2006; IN COMMERCE 4-0-2006.

CLASS 36—(Continued).

3,299,731. PREMIER TEN THIRTY ONE CAPITAL CORP., SANTA MONICA, CA. SN 78-795,314. PUB. 5-1-2007, FILED 1-19-2006.



PropPoint

THE COLOR(S) BLUE, GREEN AND WHITE IS/ARE CLAIMED AS A FEATURE OF THE MARK.

THE MARK CONSISTS OF A WHITE EIGHT POINTED STAR SURROUNDED BY A MISCELLANEOUS GREEN SHAPE WITH THE WORD PROPOINT WRITTEN BELOW IT IN BLUE LETTERS.

FOR FINANCIAL EXCHANGE SERVICES; FINANCIAL CONSULTATION SERVICES; FINANCIAL SERVICES, NAMELY, ASSISTING OTHERS WITH THE COMPLETION OF FINANCIAL TRANSACTIONS FOR SECURITIES (U.S. CLS. 100, 101 AND 102).

FIRST USE 4-0-2006; IN COMMERCE 4-0-2006.

3,299,733. AMERICAN INTERNATIONAL GROUP, INC., NEW YORK, NY. SN 78-795,579. PUB. 9-12-2006, FILED 1-20-2006.

GOT PROTECTION

THE MARK CONSISTS OF STANDARD CHARACTERS WITHOUT CLAIM TO ANY PARTICULAR FONT, STYLE, SIZE, OR COLOR.

FOR INSURANCE UNDERWRITING IN THE FIELD OF MOTORCYCLE INSURANCE (U.S. CLS. 100, 101 AND 102).

FIRST USE 12-1-2005; IN COMMERCE 12-1-2005.

3,299,734. DELTA DENTAL PLAN OF WISCONSIN, INC., STEVENS POINT, WI. SN 78-795,708. PUB. 9-19-2006, FILED 1-20-2006.

Wyssta

THE MARK CONSISTS OF STANDARD CHARACTERS WITHOUT CLAIM TO ANY PARTICULAR FONT, STYLE, SIZE, OR COLOR.

FOR INSURANCE UNDERWRITING SERVICES (U.S. CLS. 100, 101 AND 102).

FIRST USE 4-1-2006; IN COMMERCE 4-1-2006.

CLASS 36—(Continued).

3,299,738. GE MONEY BANK, SALT LAKE CITY, UT. SN 78-797,409. PUB. 10-17-2006, FILED 1-23-2006.

GET CASH ON THE DASH

THE MARK CONSISTS OF STANDARD CHARACTERS WITHOUT CLAIM TO ANY PARTICULAR FONT, STYLE, SIZE, OR COLOR.
FOR CREDIT AND CASH CARD SERVICES (U.S. CLS. 100, 101 AND 102).
FIRST USE 7-31-2005; IN COMMERCE 7-31-2005.

3,299,757. DAVID J. BOCZAR, LLC, EASTON, CT. SN 78-802,764. PUB. 11-28-2006, FILED 1-30-2006.



NO CLAIM IS MADE TO THE EXCLUSIVE RIGHT TO USE "WEALTH ADVISORS", APART FROM THE MARK AS SHOWN.
FOR PRIVATE WEALTH MANAGEMENT AND FINANCIAL PLANNING SERVICES (U.S. CLS. 100, 101 AND 102).
FIRST USE 1-27-2006; IN COMMERCE 1-27-2006.

3,299,785. INCHARGE INSTITUTE OF AMERICA, INC., ORLANDO, FL. SN 78-811,347. PUB. 9-26-2006, FILED 2-9-2006.

BRIGHTSCORE

THE MARK CONSISTS OF STANDARD CHARACTERS WITHOUT CLAIM TO ANY PARTICULAR FONT, STYLE, SIZE, OR COLOR.
FOR CREDIT REPORT ANALYSIS AND COUNSELING SERVICES FOR INDIVIDUAL CONSUMERS (U.S. CLS. 100, 101 AND 102).
FIRST USE 2-27-2006; IN COMMERCE 2-27-2006.

CLASS 36—(Continued).

3,299,813. AMERICAN INTERNATIONAL GROUP, INC., NEW YORK, NY. SN 78-820,928. PUB. 9-26-2006, FILED 2-22-2006.

AIG VALIC POWER INDEX ANNUITY

THE MARK CONSISTS OF STANDARD CHARACTERS WITHOUT CLAIM TO ANY PARTICULAR FONT, STYLE, SIZE, OR COLOR.
OWNER OF U.S. REG. NOS. 1,172,557, 3,114,373, AND OTHERS.
NO CLAIM IS MADE TO THE EXCLUSIVE RIGHT TO USE "INDEX ANNUITY", APART FROM THE MARK AS SHOWN.
FOR ANNUITY UNDERWRITING; INVESTMENT MANAGEMENT OF AND DISTRIBUTION OF VARIABLE ANNUITIES (U.S. CLS. 100, 101 AND 102).
FIRST USE 3-26-2006; IN COMMERCE 3-26-2006.

3,299,843. AMERICAN REO CORP, BULVERDE, TX. SN 78-832,869. PUB. 2-20-2007, FILED 3-8-2006.



NO CLAIM IS MADE TO THE EXCLUSIVE RIGHT TO USE "AMERICAN REO", APART FROM THE MARK AS SHOWN.
THE COLOR(S) RED, WHITE AND BLUE IS/ARE CLAIMED AS A FEATURE OF THE MARK.
THE MARK CONSISTS OF STATUE OF LIBERTY IN BLUE ENCIRCLED IN RED WITH RIBBON ACROSS BREAST WITH WORDS "FIRST IN SERVICE" IN BLUE. WORDS AMERICAN REO IN BLUE ENCOMPASS THE TOP PORTION & ARE CIRCLED BY RED.
FOR REAL ESTATE AGENCIES (U.S. CLS. 100, 101 AND 102).
FIRST USE 1-1-2006; IN COMMERCE 1-1-2006.

CLASS 36—(Continued).

3,299,851. PREMIERETRADE FINANCIAL, INC., ALTA-MONTE SPRINGS, FL. SN 78-836,602. PUB. 11-7-2006, FILED 3-14-2006.

LONDON MARK

THE MARK CONSISTS OF STANDARD CHARACTERS WITHOUT CLAIM TO ANY PARTICULAR FONT, STYLE, SIZE, OR COLOR.

THE MARK LONDON MARK REFERS TO A LIVING INDIVIDUAL WHOSE CONSENT IS OF RECORD.

FOR FINANCIAL SERVICES, NAMELY, BROKERAGE SERVICES RELATING TO SECURITIES, STOCKS, BONDS, OPTIONS, MUTUAL FUNDS AND FOREIGN CURRENCY; FINANCIAL ANALYSIS RELATING TO THE PURCHASING AND TRADING OF SECURITIES, STOCKS, BONDS, OPTIONS, MUTUAL FUNDS AND FOREIGN CURRENCY; AND COMPUTER SERVICES, NAMELY, PROVIDING INFORMATION VIA AN INTERNET WEB SITE IN THE AREA OF INVESTMENT ANALYSIS AND THE PURCHASE OR TRADING OF SECURITIES, STOCKS, BONDS, OPTIONS, MUTUAL FUNDS, FUTURES, COMMODITIES AND FOREIGN CURRENCY (U.S. CLS. 100, 101 AND 102).
FIRST USE 1-1-2006; IN COMMERCE 9-1-2006.

3,299,852. IPM CORP. OF BREVARD, INC., ARDEN, NC. SN 78-836,606. PUB. 10-24-2006, FILED 3-14-2006.

TONSOFRENTALS.COM

THE MARK CONSISTS OF STANDARD CHARACTERS WITHOUT CLAIM TO ANY PARTICULAR FONT, STYLE, SIZE, OR COLOR.

FOR MANAGEMENT OF RENTAL PROPERTIES OWNED BY OTHERS (U.S. CLS. 100, 101 AND 102).
FIRST USE 4-15-2006; IN COMMERCE 4-15-2006.

CLASS 36—(Continued).

3,299,853. IPM CORP. OF BREVARD, INC., ARDEN, NC. SN 78-836,614. PUB. 10-24-2006, FILED 3-14-2006.



THE COLOR(S) RED, BLUE AND BLACK IS/ARE CLAIMED AS A FEATURE OF THE MARK.

THE MARK CONSISTS OF THE ROOF, WINDOW AND CHIMNEY ARE OUTLINED IN BLACK, SMOKE FROM THE CHIMNEY IS BLACK, FIVE BRICKS IN CHIMNEY ARE RED, "TONS" IS IN RED, "OF" IS IN BLUE, "RENTALS.COM" IS IN RED.

FOR MANAGEMENT OF RENTAL PROPERTIES OWNED BY OTHERS (U.S. CLS. 100, 101 AND 102).
FIRST USE 4-15-2006; IN COMMERCE 4-15-2006.

3,299,912. COMPUCREDIT INTELLECTUAL PROPERTY HOLDINGS CORP. II, LAS VEGAS, NV. SN 78-861,110. PUB. 10-31-2006, FILED 4-13-2006.

SALUTE

THE MARK CONSISTS OF STANDARD CHARACTERS WITHOUT CLAIM TO ANY PARTICULAR FONT, STYLE, SIZE, OR COLOR.

FOR CREDIT CARD SERVICES (U.S. CLS. 100, 101 AND 102).
FIRST USE 12-6-2006; IN COMMERCE 12-6-2006.

3,299,941. AMERIPRISE FINANCIAL, INC., MINNEAPOLIS, MN. SN 78-869,862. PUB. 1-23-2007, FILED 4-26-2006.

**PROTECT IT. LOCK IT.
TAKE IT.**

THE MARK CONSISTS OF STANDARD CHARACTERS WITHOUT CLAIM TO ANY PARTICULAR FONT, STYLE, SIZE, OR COLOR.

FOR FINANCIAL SERVICES, NAMELY, RETIREMENT PLANNING SERVICES; FINANCIAL PLANNING SERVICES IN THE FIELD OF DEFINED BENEFIT SERVICES, DEFINED CONTRIBUTION SERVICES, RETIREMENT SERVICES AND RETIREMENT PLANNING SERVICES (U.S. CLS. 100, 101 AND 102).
FIRST USE 6-0-2006; IN COMMERCE 6-0-2006.

CLASS 36—(Continued).

3,299,959. AMERICAN INTERNATIONAL GROUP, INC., NEW YORK, NY. SN 78-876,704. PUB. 3-13-2007, FILED 5-4-2006.

POLARIS PREFERRED SOLUTION

THE MARK CONSISTS OF STANDARD CHARACTERS WITHOUT CLAIM TO ANY PARTICULAR FONT, STYLE, SIZE, OR COLOR.

OWNER OF U.S. REG. NO. 1,806,410.

NO CLAIM IS MADE TO THE EXCLUSIVE RIGHT TO USE "PREFERRED SOLUTION", APART FROM THE MARK AS SHOWN.

FOR ANNUITY UNDERWRITING; INVESTMENT MANAGEMENT OF AND DISTRIBUTION OF VARIABLE ANNUITIES (U.S. CLS. 100, 101 AND 102).

FIRST USE 9-5-2006; IN COMMERCE 9-5-2006.

3,299,960. AMERICAN INTERNATIONAL GROUP, INC., NEW YORK, NY. SN 78-876,711. PUB. 3-13-2007, FILED 5-4-2006.

SEASONS PREFERRED SOLUTION

THE MARK CONSISTS OF STANDARD CHARACTERS WITHOUT CLAIM TO ANY PARTICULAR FONT, STYLE, SIZE, OR COLOR.

OWNER OF U.S. REG. NO. 2,139,404.

NO CLAIM IS MADE TO THE EXCLUSIVE RIGHT TO USE "PREFERRED SOLUTION", APART FROM THE MARK AS SHOWN.

FOR ANNUITY UNDERWRITING; INVESTMENT MANAGEMENT OF AND DISTRIBUTION OF VARIABLE ANNUITIES (U.S. CLS. 100, 101 AND 102).

FIRST USE 9-5-2006; IN COMMERCE 9-5-2006.

3,299,966. GREYCROFT LLC, NEW YORK, NY. SN 78-878,474. PUB. 12-12-2006, FILED 5-8-2006.

GREYCROFT

THE MARK CONSISTS OF STANDARD CHARACTERS WITHOUT CLAIM TO ANY PARTICULAR FONT, STYLE, SIZE, OR COLOR.

FOR FINANCIAL SERVICES, NAMELY PROVIDING INVESTMENT ADVISORY SERVICES, AND FINANCIAL AND VENTURE CAPITAL CONSULTATION SERVICES (U.S. CLS. 100, 101 AND 102).

FIRST USE 6-0-2006; IN COMMERCE 6-0-2006.

CLASS 36—(Continued).

3,299,992. NSCB, LLC, SPARTANBURG, SC. SN 78-885,765. PUB. 2-6-2007, FILED 5-17-2006.

CAROLINA ALLIANCE BANK

THE MARK CONSISTS OF STANDARD CHARACTERS WITHOUT CLAIM TO ANY PARTICULAR FONT, STYLE, SIZE, OR COLOR.

NO CLAIM IS MADE TO THE EXCLUSIVE RIGHT TO USE "CAROLINA" OR "BANK", APART FROM THE MARK AS SHOWN.

FOR BANKING SERVICES (U.S. CLS. 100, 101 AND 102).

FIRST USE 1-8-2007; IN COMMERCE 1-8-2007.

3,300,001. PLAZA BANK, IRVINE, CA. SN 78-890,001. PUB. 1-16-2007, FILED 5-23-2006.



NO CLAIM IS MADE TO THE EXCLUSIVE RIGHT TO USE "BANK", APART FROM THE MARK AS SHOWN.

FOR BANKING SERVICES (U.S. CLS. 100, 101 AND 102).

FIRST USE 12-30-2005; IN COMMERCE 12-30-2005.

CLASS 36—(Continued).

3,300,035. OGDENBANCSHARES, INC., AMES, IA. SN 78-903,529. PUB. 1-9-2007, FILED 6-8-2006.

FOCUSED ON YOU

THE MARK CONSISTS OF STANDARD CHARACTERS WITHOUT CLAIM TO ANY PARTICULAR FONT, STYLE, SIZE, OR COLOR.

FOR BANKING; BANKING CONSULTATION; FINANCIAL ANALYSIS AND CONSULTATION; FINANCIAL MANAGEMENT; FINANCIAL PLANNING; FINANCIAL PLANNING CONSULTATION; FINANCIAL PORTFOLIO MANAGEMENT; FINANCIAL SERVICES IN THE FIELD OF MONEY LENDING; INVESTMENT BANKING SERVICES; MORTGAGE BANKING; MORTGAGE BANKING SERVICES, NAMELY, ORIGINATION, ACQUISITION, SERVICING, SECURITIZATION AND BROKERAGE OF MORTGAGE LOANS; ON-LINE BANKING SERVICES; SAVINGS BANK SERVICES (U.S. CLS. 100, 101 AND 102).

FIRST USE 10-16-2006; IN COMMERCE 10-16-2006.

3,300,037. AMERICAN INTERNATIONAL GROUP, INC., NEW YORK, NY. SN 78-904,167. PUB. 1-23-2007, FILED 6-8-2006.

ECONNECTIONS

THE MARK CONSISTS OF STANDARD CHARACTERS WITHOUT CLAIM TO ANY PARTICULAR FONT, STYLE, SIZE, OR COLOR.

FOR INSURANCE UNDERWRITING IN THE FIELD OF LIFE INSURANCE AND ANNUITIES (U.S. CLS. 100, 101 AND 102).

FIRST USE 8-10-2006; IN COMMERCE 8-10-2006.

3,300,038. AMERICAN INTERNATIONAL GROUP, INC., NEW YORK, NY. SN 78-904,186. PUB. 1-23-2007, FILED 6-8-2006.

**PROTECTION, PREDICTABILITY
AND PARTICIPATION**

THE MARK CONSISTS OF STANDARD CHARACTERS WITHOUT CLAIM TO ANY PARTICULAR FONT, STYLE, SIZE, OR COLOR.

FOR FINANCIAL SERVICES IN THE FIELD OF VARIABLE ANNUITIES (U.S. CLS. 100, 101 AND 102).

FIRST USE 5-1-2006; IN COMMERCE 5-1-2006.

CLASS 36—(Continued).

3,300,048. KEYS FEDERAL CREDIT UNION, KEY WEST, FL. SN 78-906,630. PUB. 1-30-2007, FILED 6-13-2006.

**THE PERFECT LOAN FOR THE
PERFECT HOME**

THE MARK CONSISTS OF STANDARD CHARACTERS WITHOUT CLAIM TO ANY PARTICULAR FONT, STYLE, SIZE, OR COLOR.

FOR MORTGAGE BANKING SERVICES, NAMELY, ORIGINATION, ACQUISITION, SERVICING, SECURITIZATION AND BROKERAGE OF MORTGAGE LOANS (U.S. CLS. 100, 101 AND 102).

FIRST USE 8-27-2006; IN COMMERCE 8-27-2006.

3,300,072. HERITAGE UNION SERVICES, LLC, RICHMOND, VA. SN 78-913,579. PUB. 2-13-2007, FILED 6-21-2006.

SALARYSHIELD

THE MARK CONSISTS OF STANDARD CHARACTERS WITHOUT CLAIM TO ANY PARTICULAR FONT, STYLE, SIZE, OR COLOR.

FOR LIFE INSURANCE AGENCY AND BROKERAGE; LIFE INSURANCE CLAIMS PROCESSING, UNDERWRITING, ISSUING, PREMIUM RATES COMPUTING AND ADMINISTRATION (U.S. CLS. 100, 101 AND 102).

FIRST USE 9-30-2006; IN COMMERCE 9-30-2006.

3,300,085. NORTHERN MASSACHUSETTS TELEPHONE WORKERS CREDIT UNION, LOWELL, MA. SN 78-918,427. PUB. 1-23-2007, FILED 6-28-2006.



NO CLAIM IS MADE TO THE EXCLUSIVE RIGHT TO USE "COMMUNITY CREDIT UNION", APART FROM THE MARK AS SHOWN.

THE MARK CONSISTS OF THE LETTERS NMTW IN A RECTANGLE AND THE WORDS COMMUNITY CREDIT UNION BELOW THE RECTANGLE.

FOR CREDIT UNIONS (U.S. CLS. 100, 101 AND 102).

FIRST USE 4-25-2007; IN COMMERCE 4-25-2007.

CLASS 36—(Continued).

3,300,087. CITIZENS TRUST MORTGAGE CORPORATION, MAITLAND, FL. SN 78-918,474. PUB. 2-13-2007, FILED 6-28-2006.

ADVANCED ADVISOR ALLIANCE

THE MARK CONSISTS OF STANDARD CHARACTERS WITHOUT CLAIM TO ANY PARTICULAR FONT, STYLE, SIZE, OR COLOR.

NO CLAIM IS MADE TO THE EXCLUSIVE RIGHT TO USE "ADVISOR ALLIANCE", APART FROM THE MARK AS SHOWN.

FOR CONSULTING SERVICES RELATING TO MORTGAGE BANKING; MORTGAGE BANKING SERVICES; LOAN FINANCING SERVICES; OPERATING MARKETPLACES FOR REAL ESTATE TRANSACTIONS (U.S. CLS. 100, 101 AND 102).

FIRST USE 9-0-2006; IN COMMERCE 9-0-2006.

3,300,094. ALLIANZ LIFE INSURANCE COMPANY OF NORTH AMERICA, MINNEAPOLIS, MN. SN 78-920,287. PUB. 2-20-2007, FILED 6-29-2006.

BONUS MASTERDEX

THE MARK CONSISTS OF STANDARD CHARACTERS WITHOUT CLAIM TO ANY PARTICULAR FONT, STYLE, SIZE, OR COLOR.

OWNER OF U.S. REG. NOS. 2,992,565, 2,995,183, AND 2,995,184.

FOR ANNUITY UNDERWRITING; INVESTMENT MANAGEMENT OF AND DISTRIBUTION OF VARIABLE ANNUITIES (U.S. CLS. 100, 101 AND 102).

FIRST USE 11-30-2006; IN COMMERCE 11-30-2006.

3,300,096. FOOTBALL NORTHWEST LLC, KIRKLAND, WA. SN 78-920,486. PUB. 2-6-2007, FILED 6-30-2006.

**CLASS 36—(Continued).**

THE MARK CONSISTS OF THE IMAGE OF THE FAN DISPLAYING THE #1 HAND SIGN IN THE CENTER OF THE NUMBER 12.

FOR ACCEPTING AND ADMINISTERING MONETARY CHARITABLE CONTRIBUTIONS; CHARITABLE FUND RAISING; PHILANTHROPIC SERVICES CONCERNING MONETARY DONATIONS; POLITICAL FUND-RAISING SERVICES; PROVIDING COLLEGE SCHOLARSHIPS; PROVIDING EDUCATIONAL SCHOLARSHIPS; PROVIDING GRANTS TO CHARITABLE ORGANIZATIONS (U.S. CLS. 100, 101 AND 102).

FIRST USE 6-30-2006; IN COMMERCE 8-12-2006.

3,300,103. LIU, RALPH Y., NORCO, CA. SN 78-923,068. PUB. 3-6-2007, FILED 7-5-2006.

SwapRent

THE MARK CONSISTS OF STANDARD CHARACTERS WITHOUT CLAIM TO ANY PARTICULAR FONT, STYLE, SIZE, OR COLOR.

FOR BANKING SERVICES; REAL ESTATE BROKERAGE; AND LEASING OF REAL ESTATE (U.S. CLS. 100, 101 AND 102).

FIRST USE 5-19-2006; IN COMMERCE 5-19-2006.

3,300,122. BALTIMORE LIFE INSURANCE COMPANY, THE, BALTIMORE, MD. SN 78-928,852. PUB. 3-27-2007, FILED 7-13-2006.

BALTIMORE LIFE ADVANTAGE
ACCOUNT

THE MARK CONSISTS OF STANDARD CHARACTERS WITHOUT CLAIM TO ANY PARTICULAR FONT, STYLE, SIZE, OR COLOR.

OWNER OF U.S. REG. NOS. 2,697,540 AND 2,951,029. NO CLAIM IS MADE TO THE EXCLUSIVE RIGHT TO USE "ACCOUNT", APART FROM THE MARK AS SHOWN. SEC. 2(F) AS TO BALTIMORE LIFE.

FOR INSURANCE ADMINISTRATION IN THE FIELD OF LIFE INSURANCE THROUGH A RETAINED ASSET ACCOUNT (U.S. CLS. 100, 101 AND 102).

FIRST USE 10-9-2006; IN COMMERCE 10-9-2006.

CLASS 36—(Continued).

3,300,136. LYNNGVAR FINANCIAL, INC, ROCKLIN, CA. SN 78-932,833. PUB. 3-6-2007, FILED 7-19-2006.

THE HOME LOAN COACH

THE MARK CONSISTS OF STANDARD CHARACTERS WITHOUT CLAIM TO ANY PARTICULAR FONT, STYLE, SIZE, OR COLOR.

NO CLAIM IS MADE TO THE EXCLUSIVE RIGHT TO USE "HOME LOAN", APART FROM THE MARK AS SHOWN.

FOR RESIDENTIAL MORTGAGE FINANCING (U.S. CLS. 100, 101 AND 102).
FIRST USE 11-20-2006; IN COMMERCE 11-20-2006.

3,300,150. DIVINS INVESTMENTS LLC, JACKSON, MI. SN 78-942,211. PUB. 3-6-2007, FILED 8-1-2006.



NO CLAIM IS MADE TO THE EXCLUSIVE RIGHT TO USE VALLARTA AND LUXURY VACATION RENTALS, APART FROM THE MARK AS SHOWN.

THE MARK CONSISTS OF A PALM TREE SEPARATING THE WORDS VALLARTA AND JOY WITH THE WORDS LUXURY VACATION RENTALS APPEARING BELOW ON A SHADED RECTANGULAR BACKGROUND.

FOR REAL ESTATE LISTING; REAL ESTATE SERVICES, NAMELY, RENTAL OF VACATION HOMES, CONDOMINIUMS, CABINS, AND VILLAS USING PAY PER CLICK ADVERTISING ON A GLOBAL COMPUTER NETWORK; RENTAL OF CABINS (U.S. CLS. 100, 101 AND 102).

FIRST USE 8-1-2006; IN COMMERCE 8-1-2006.

3,300,190. UNIVERSITY OF IOWA COMMUNITY CREDIT UNION, IOWA CITY, IA. SN 78-968,449. PUB. 2-20-2007, FILED 9-6-2006.

LIFE WITHOUT LIMITS

THE MARK CONSISTS OF STANDARD CHARACTERS WITHOUT CLAIM TO ANY PARTICULAR FONT, STYLE, SIZE, OR COLOR.

FOR CREDIT UNION SERVICES (U.S. CLS. 100, 101 AND 102).

FIRST USE 4-23-2007; IN COMMERCE 4-23-2007.

CLASS 37—CONSTRUCTION AND REPAIR

3,298,692. ROELAND ENTERPRISES, ROCKAWAY, NJ. SN 78-301,676. PUB. 9-13-2005, FILED 9-17-2003.



NO CLAIM IS MADE TO THE EXCLUSIVE RIGHT TO USE "HOME IMPROVERS", APART FROM THE MARK AS SHOWN.

FOR HOME IMPROVEMENTS, NAMELY, THE REPAIR AND REPLACEMENT OF SIDING, ROOFING, DOORS, DECKS, WINDOWS AND ROOM ADDITIONS (U.S. CLS. 100, 103 AND 106).

FIRST USE 1-1-1997; IN COMMERCE 1-1-1997.

3,298,772. FLOOD 911, INC., PLACENTIA, CA. SN 78-432,645. PUB. 6-27-2006, FILED 6-9-2004.

Flood 911

THE MARK CONSISTS OF STANDARD CHARACTERS WITHOUT CLAIM TO ANY PARTICULAR FONT, STYLE, SIZE, OR COLOR.

NO CLAIM IS MADE TO THE EXCLUSIVE RIGHT TO USE "FLOOD", APART FROM THE MARK AS SHOWN.

FOR RESIDENTIAL AND COMMERCIAL CONSTRUCTION, REPAIR AND RESTORATION OF BUILDINGS (U.S. CLS. 100, 103 AND 106).

FIRST USE 12-11-2001; IN COMMERCE 12-11-2001.

CLASS 37—(Continued).

3,298,924. CERTIFIED EROSION CONTROL, LLC, GRAF-TON, OH. SN 78-556,222. PUB. 9-19-2006, FILED 1-28-2005.



NO CLAIM IS MADE TO THE EXCLUSIVE RIGHT TO USE "CERTIFIED EROSION CONTROL", APART FROM THE MARK AS SHOWN.

FOR SOIL EROSION CONTROL SERVICES (U.S. CLS. 100, 103 AND 106).

FIRST USE 3-25-2007; IN COMMERCE 3-25-2007.

CLASS 37—(Continued).

3,298,943. KEMPSHIRE ENTERPRISES, LLC, DBA/FREEDOM WASH, VIRGINIA BEACH, VA. SN 78-567,036. PUB. 1-23-2007, FILED 2-14-2005.

FREEDOM WASH

THE MARK CONSISTS OF STANDARD CHARACTERS WITHOUT CLAIM TO ANY PARTICULAR FONT, STYLE, SIZE, OR COLOR.

NO CLAIM IS MADE TO THE EXCLUSIVE RIGHT TO USE "WASH", APART FROM THE MARK AS SHOWN.

FOR CAR WASH SERVICES FOR MOTOR VEHICLES (U.S. CLS. 100, 103 AND 106).

FIRST USE 7-0-2004; IN COMMERCE 12-28-2004.

3,299,171. ALASKA STRUCTURES, INC., ANCHORAGE, AK. SN 78-654,963. PUB. 5-23-2006, FILED 6-21-2005.

BLU-MED ONCALL

THE MARK CONSISTS OF STANDARD CHARACTERS WITHOUT CLAIM TO ANY PARTICULAR FONT, STYLE, SIZE, OR COLOR.

NO CLAIM IS MADE TO THE EXCLUSIVE RIGHT TO USE "ON CALL", APART FROM THE MARK AS SHOWN.

FOR SUPPLY AND ERECTION OF MOBILE MEDICAL, HOSPITAL AND SURGICAL TREATMENT FACILITIES ON AN ON-DEMAND BASIS BY SUBSCRIPTION (U.S. CLS. 100, 103 AND 106).

FIRST USE 4-30-2005; IN COMMERCE 4-30-2005.

3,298,931. AMERICAN MAGLINE GROUP, LOS ANGELES, CA. SN 78-560,359. PUB. 3-21-2006, FILED 2-3-2005.

THE FIRST FORTY MILES

THE MARK CONSISTS OF STANDARD CHARACTERS WITHOUT CLAIM TO ANY PARTICULAR FONT, STYLE, SIZE, OR COLOR.

FOR CONSTRUCTION PLANNING FOR A HIGH SPEED RAIL LINE FOR THE TRANSPORTATION OF PASSENGERS AND GOODS (U.S. CLS. 100, 103 AND 106).

FIRST USE 6-21-2000; IN COMMERCE 6-1-2002.

3,299,282. MILES CARS, LLC, FRANKLIN, TN. SN 78-701,909. PUB. 5-9-2006, FILED 8-27-2005.



THE MARK CONSISTS OF THE STYLIZED WORD MILES IN AN OVAL DESIGN.

FOR AUTOMOBILE CLEANING AND CAR WASHING (U.S. CLS. 100, 103 AND 106).

FIRST USE 2-23-2007; IN COMMERCE 2-23-2007.

CLASS 37—(Continued).

3,299,283. MILES CARS, LLC, FRANKLIN, TN. SN 78-701,910.
PUB. 5-9-2006, FILED 8-27-2005.

MILES

THE MARK CONSISTS OF STANDARD CHARACTERS WITHOUT CLAIM TO ANY PARTICULAR FONT, STYLE, SIZE, OR COLOR.

FOR AUTOMOBILE CLEANING AND CAR WASHING (U.S. CLS. 100, 103 AND 106).

FIRST USE 2-23-2007; IN COMMERCE 2-23-2007.

3,299,335. UNIVERSITY OF SOUTH CAROLINA, COLUMBIA, SC. SN 78-718,355. PUB. 6-13-2006, FILED 9-22-2005.

INNOVISTA

THE MARK CONSISTS OF STANDARD CHARACTERS WITHOUT CLAIM TO ANY PARTICULAR FONT, STYLE, SIZE, OR COLOR.

FOR REAL ESTATE DEVELOPMENT OF A RESEARCH AND TECHNOLOGY PARK, CONDOMINIUMS, RESIDENTIAL HOUSING, AND COMMERCIAL, RETAIL, EDUCATIONAL AND OFFICE PROPERTIES (U.S. CLS. 100, 103 AND 106).

FIRST USE 10-6-2005; IN COMMERCE 10-6-2005.

3,299,426. WL HOMES LLC, NEWPORT BEACH, CA. SN 78-735,785. PUB. 6-13-2006, FILED 10-18-2005.

LAINGURBAN

THE MARK CONSISTS OF STANDARD CHARACTERS WITHOUT CLAIM TO ANY PARTICULAR FONT, STYLE, SIZE, OR COLOR.

FOR RESIDENTIAL REAL ESTATE DEVELOPMENT SERVICES (U.S. CLS. 100, 103 AND 106).

FIRST USE 3-28-2006; IN COMMERCE 3-28-2006.

CLASS 37—(Continued).

3,299,439. FARLOW, JEFFREY C., GREENSBORO, NC. SN 78-736,801. PUB. 8-8-2006, FILED 10-20-2005.

MECHANICAL ASSETS

THE MARK CONSISTS OF STANDARD CHARACTERS WITHOUT CLAIM TO ANY PARTICULAR FONT, STYLE, SIZE, OR COLOR.

FOR ONLINE INFORMATION SERVICES, NAMELY, PROVIDING MAINTENANCE INFORMATION AND DATA FOR HVAC EQUIPMENT OF SERVICE SUBSCRIBERS (U.S. CLS. 100, 103 AND 106).

FIRST USE 11-15-2006; IN COMMERCE 11-15-2006.

3,299,673. HEAVENLY TOUCH FRANCHISING CORP., AKRON, OH. SN 78-780,018. PUB. 9-12-2006, FILED 12-23-2005.



NO CLAIM IS MADE TO THE EXCLUSIVE RIGHT TO USE "MAIDS", APART FROM THE MARK AS SHOWN.

FOR CLEANING OF RESIDENTIAL HOUSES AND COMMERCIAL BUILDINGS (U.S. CLS. 100, 103 AND 106).

FIRST USE 3-16-2007; IN COMMERCE 3-16-2007.

3,299,695. GEEK TEKS, INC., JOLIET, IL. SN 78-787,251. PUB. 3-6-2007, FILED 1-9-2006.



NO CLAIM IS MADE TO THE EXCLUSIVE RIGHT TO USE "SOLUTIONS FOR TECHNOLOGY PROBLEMS", APART FROM THE MARK AS SHOWN.

THE COLOR(S) RED, BLACK AND DARK GRAY IS/ARE CLAIMED AS A FEATURE OF THE MARK.

THE GEEK PORTION OF "GEEKTEKS" IS RED WHILE THE TEKS PORTION IS DARK GRAY. THE WORDING GEEK SOLUTIONS FOR TECHNICAL PROBLEMS IS DARK GRAY. THE SEVEN LARGE SPHERES ARE RED. THE THREE SMALL SPHERES ARE BLACK.

FOR COMPUTER INSTALLATION AND REPAIR (U.S. CLS. 100, 103 AND 106).

FIRST USE 10-1-2004; IN COMMERCE 2-5-2005.

CLASS 37—(Continued).

3,299,932. SAVION COMPANIES, LLC, DELRAY BEACH, FL. SN 78-866,575. PUB. 11-14-2006, FILED 4-21-2006.

SAVION

THE MARK CONSISTS OF STANDARD CHARACTERS WITHOUT CLAIM TO ANY PARTICULAR FONT, STYLE, SIZE, OR COLOR.

FOR CONSTRUCTION SERVICES, NAMELY, PLANNING, LAYING OUT, AND CUSTOM CONSTRUCTION OF RESIDENTIAL COMMUNITIES, RECREATIONAL FACILITIES, SOCIAL, AND COMMUNITY FACILITIES; REAL ESTATE DEVELOPMENT (U.S. CLS. 100, 103 AND 106).

FIRST USE 6-18-1997; IN COMMERCE 6-18-1997.

3,300,017. EXTERMINATORS, INC., KENMORE, WA. SN 78-897,341. PUB. 1-2-2007, FILED 5-31-2006.

GOT RATS?

THE MARK CONSISTS OF STANDARD CHARACTERS WITHOUT CLAIM TO ANY PARTICULAR FONT, STYLE, SIZE, OR COLOR.

NO CLAIM IS MADE TO THE EXCLUSIVE RIGHT TO USE "RATS", APART FROM THE MARK AS SHOWN.

FOR PEST CONTROL (U.S. CLS. 100, 103 AND 106).

FIRST USE 6-1-2006; IN COMMERCE 6-1-2006.

3,300,132. SMITH & NEPHEW, INC., MEMPHIS, TN. SN 78-931,860. PUB. 12-19-2006, FILED 7-18-2006.

AGILE-CARE

THE MARK CONSISTS OF STANDARD CHARACTERS WITHOUT CLAIM TO ANY PARTICULAR FONT, STYLE, SIZE, OR COLOR.

FOR REPAIR SERVICES FOR MEDICAL APPARATUS AND INSTRUMENTS (U.S. CLS. 100, 103 AND 106).

FIRST USE 9-22-2006; IN COMMERCE 9-22-2006.

CLASS 37—(Continued).

3,300,145. GRAYCO RESTORATION LLC, MISSION, KS. SN 78-939,120. PUB. 3-20-2007, FILED 7-27-2006.

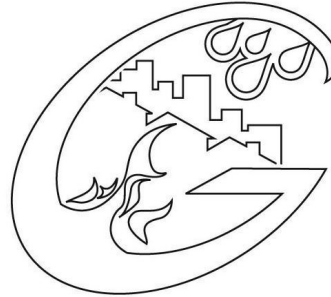

THE MARK CONSISTS OF A STYLIZED G WITH RAIN, FIRE AND ROOF TOPS.

FOR BUILDING CONSTRUCTION AND REPAIR (U.S. CLS. 100, 103 AND 106).

FIRST USE 1-31-2006; IN COMMERCE 1-31-2006.

CLASS 38—COMMUNICATION

3,298,422. WEIRD TV, TARZANA, CA. SN 76-397,351. PUB. 1-13-2004, FILED 4-15-2002.

WEIRD TV

NO CLAIM IS MADE TO THE EXCLUSIVE RIGHT TO USE "TV", APART FROM THE MARK AS SHOWN.

FOR BROADCASTING SERVICES, NAMELY, DIGITAL AUDIO AND VIDEO BROADCASTING, AND BROADCASTING PROGRAMS VIA THE INTERNET (U.S. CLS. 100, 101 AND 104).

FIRST USE 0-0-1994; IN COMMERCE 0-0-1997.

3,298,479. CANDERRIX INTERNET, LLC, WESTFIELD, MA. SN 76-612,734. PUB. 10-11-2005, FILED 9-24-2004.

CANDERRIX INTERNET

THE MARK CONSISTS OF STANDARD CHARACTERS WITHOUT CLAIM TO ANY PARTICULAR FONT, STYLE, SIZE, OR COLOR.

NO CLAIM IS MADE TO THE EXCLUSIVE RIGHT TO USE "INTERNET", APART FROM THE MARK AS SHOWN.

FOR TELECOMMUNICATIONS SERVICES, NAMELY, ELECTRONIC TRANSMISSION OF DATA, IMAGES, DOCUMENTS, AND SOUND VIA COMPUTER NETWORKS; PROVIDING ONLINE ELECTRONIC BULLETIN BOARDS FOR TRANSMISSION OF MESSAGES, PHOTOS, AND NOTES AMONG A GROUP OF COMPUTER USERS CONCERNING USER-DEFINED TOPICS; PROVIDING REAL-TIME COMMUNICATION SERVICES VIA COMPUTER NETWORKS, NAMELY, ELECTRONIC MAIL SERVICES (U.S. CLS. 100, 101 AND 104).

FIRST USE 12-0-2006; IN COMMERCE 12-0-2006.

CLASS 38—(Continued).

3,298,575. MUSHYGUSHY.COM, LLC, LIVINGSTON, NJ. SN 76-653,808. PUB. 8-29-2006, FILED 1-23-2006.

CLASS 38—(Continued).

3,298,947. CH2M HILL, INC., ENGLEWOOD, CO. SN 78-568,064. PUB. 7-11-2006, FILED 2-15-2005.

GUSHYGRAM

ICIT

THE MARK CONSISTS OF STANDARD CHARACTERS WITHOUT CLAIM TO ANY PARTICULAR FONT, STYLE, SIZE, OR COLOR.
FOR ELECTRONIC MAIL MESSAGING SERVICE (U.S. CLS. 100, 101 AND 104).
FIRST USE 2-1-2007; IN COMMERCE 2-1-2007.

THE MARK CONSISTS OF STANDARD CHARACTERS WITHOUT CLAIM TO ANY PARTICULAR FONT, STYLE, SIZE, OR COLOR.
FOR SECURE SATELLITE COMMUNICATION SERVICES AND WIRELESS BROADBAND COMMUNICATIONS SERVICES PROVIDED IN CONNECTION WITH HOMELAND SECURITY, PUBLIC AND PRIVATE SECURITY AND EMERGENCY INCIDENT MANAGEMENT AND RESPONSE; TRANSMISSION OF INFORMATION BY DATA COMMUNICATIONS FOR ASSISTING DECISION MAKING IN EMERGENCY SITUATIONS (U.S. CLS. 100, 101 AND 104).
FIRST USE 5-17-2006; IN COMMERCE 5-17-2006.

3,298,933. BLUE FROG MOBILE, INC., SEATTLE, WA. SN 78-562,706. PUB. 6-13-2006, FILED 2-8-2005.

3,298,988. KROEGER MEDIA INC., LA SALLE, MANITOBA, CANADA. SN 78-588,272. PUB. 11-29-2005, FILED 3-16-2005.

LEMON KISS

HANK FM

THE MARK CONSISTS OF STANDARD CHARACTERS WITHOUT CLAIM TO ANY PARTICULAR FONT, STYLE, SIZE, OR COLOR.
FOR TELECOMMUNICATION SERVICES, NAMELY, WIRELESS TRANSMISSION, UPLOADING AND DOWNLOADING OF CUSTOMIZED AND FEATURED RING TONES TO WIRELESS MOBILE COMMUNICATION DEVICES; TRANSMISSION OF NEWS AND INFORMATION VIA WIRELESS MOBILE COMMUNICATION DEVICES (U.S. CLS. 100, 101 AND 104).
FIRST USE 2-4-2005; IN COMMERCE 2-4-2005.

THE MARK CONSISTS OF STANDARD CHARACTERS WITHOUT CLAIM TO ANY PARTICULAR FONT, STYLE, SIZE, OR COLOR.
NO CLAIM IS MADE TO THE EXCLUSIVE RIGHT TO USE "FM", APART FROM THE MARK AS SHOWN.
FOR RADIO BROADCASTING SERVICE (U.S. CLS. 100, 101 AND 104).
FIRST USE 3-25-2005; IN COMMERCE 2-25-2005.

CLASS 38—(Continued).

3,299,055. SAVVY MISS, LLC, LOS ANGELES, CA. SN 78-604,759. PUB. 12-27-2005, FILED 4-8-2005.

SAVVY MISS

THE MARK CONSISTS OF STANDARD CHARACTERS WITHOUT CLAIM TO ANY PARTICULAR FONT, STYLE, SIZE, OR COLOR.

FOR ELECTRONIC TRANSMISSION OF DATA AND DOCUMENTS VIA COMPUTER TERMINALS ON A GLOBAL COMPUTER NETWORK; ELECTRONIC MAIL SERVICES; DELIVERY OF MESSAGES BY ELECTRONIC TRANSMISSION; PROVIDING ON-LINE CHAT ROOMS, ELECTRONIC MESSAGE BOARDS, DELIVERY OF MESSAGES BY ELECTRONIC TRANSMISSION, AND ELECTRONIC MAIL SERVICES FOR THE PURPOSE OF ENABLING THE DEVELOPMENT OF INTERPERSONAL SOCIAL NETWORKS AND FRIENDSHIPS AMONG COMPUTER USERS; AND, PROVIDING ON-LINE CHAT ROOMS AND ELECTRONIC BULLETIN BOARDS FOR THE TRANSMISSION OF MESSAGES AMONG COMPUTER USERS CONCERNING SOCIAL RELATIONSHIPS, CAREERS, HEALTH, EDUCATION, VOLUNTEER ORGANIZATIONS, INTERNATIONAL LIFESTYLES, NEWS AND CURRENT EVENTS (U.S. CLS. 100, 101 AND 104).
FIRST USE 5-9-2006; IN COMMERCE 5-9-2006.

3,299,165. MBLOX INCORPORATED, SUNNYVALE, CA. SN 78-653,378. PUB. 3-14-2006, FILED 6-17-2005.

MBLOX

THE MARK CONSISTS OF STANDARD CHARACTERS WITHOUT CLAIM TO ANY PARTICULAR FONT, STYLE, SIZE, OR COLOR.

FOR ELECTRONIC TRANSMISSION OF COMMUNICATIONS, DATA, IMAGES, TEXT AND AUDIO CONTENT (U.S. CLS. 100, 101 AND 104).
FIRST USE 6-1-2003; IN COMMERCE 6-1-2003.

3,299,225. MAXX WIRELESS, INC., SAN FRANCISCO, CA. SN 78-676,645. PUB. 6-13-2006, FILED 7-22-2005.



NO CLAIM IS MADE TO THE EXCLUSIVE RIGHT TO USE "SPORTS", APART FROM THE MARK AS SHOWN.
THE COLOR(S) RED, BLACK AND WHITE IS/ARE CLAIMED AS A FEATURE OF THE MARK.

CLASS 38—(Continued).

THE MARK CONSISTS OF A RED LETTER "M" WITH THE WORD "MAXX" WRITTEN ACROSS IN STYLIZED LETTERS THAT ARE WHITE IN COLOR. THE WORD "SPORTS" IS IN BLACK AND RUNS UNDER THE ENTIRE LENGTH OF THE "M".

FOR WIRELESS ELECTRONIC TRANSMISSION OF VOICE SIGNALS, DATA, FACSIMILES, IMAGES, VIDEO AND INFORMATION; WIRELESS COMMUNICATIONS SERVICES, NAMELY, TRANSMISSION OF AUDIO, VIDEO AND GRAPHICS TO MOBILE DEVICES; WIRELESS STREAMING OF AUDIO AND VIDEO MATERIAL TO MOBILE DEVICES (U.S. CLS. 100, 101 AND 104).
FIRST USE 9-1-2006; IN COMMERCE 9-1-2006.

3,299,323. DERMATEC INTERNATIONAL, HELOTES, TX. SN 78-716,077. PUB. 9-5-2006, FILED 9-19-2005.

Dermatec International

THE MARK CONSISTS OF STANDARD CHARACTERS WITHOUT CLAIM TO ANY PARTICULAR FONT, STYLE, SIZE, OR COLOR.

NO CLAIM IS MADE TO THE EXCLUSIVE RIGHT TO USE INTERNATIONAL, APART FROM THE MARK AS SHOWN.

FOR TRANSMISSION OF INFORMATION VIA NATIONAL AND INTERNATIONAL NETWORKS (U.S. CLS. 100, 101 AND 104).
FIRST USE 10-10-2005; IN COMMERCE 10-10-2005.

3,299,333. PACE ANALYTICAL SERVICES, INC., MINNEAPOLIS, MN. SN 78-718,208. PUB. 2-13-2007, FILED 9-22-2005.

PACEPORT

THE MARK CONSISTS OF STANDARD CHARACTERS WITHOUT CLAIM TO ANY PARTICULAR FONT, STYLE, SIZE, OR COLOR.

OWNER OF U.S. REG. NOS. 1,517,650, 1,519,396, AND 2,370,194.

FOR PROVIDING CLIENT ACCESS TO LAB ANALYSIS VIA THE INTERNET (U.S. CLS. 100, 101 AND 104).
FIRST USE 6-0-2006; IN COMMERCE 6-0-2006.

CLASS 38—(Continued).

3,299,355. THAYER, DONALD O., ELMONT, NY. SN 78-723,017. PUB. 9-19-2006, FILED 9-29-2005.

EPIXEL

THE MARK CONSISTS OF STANDARD CHARACTERS WITHOUT CLAIM TO ANY PARTICULAR FONT, STYLE, SIZE, OR COLOR.

OWNER OF U.S. REG. NO. 2,365,849.
FOR PROVIDING E-MAIL SERVICES (U.S. CLS. 100, 101 AND 104).
FIRST USE 0-0-2001; IN COMMERCE 0-0-2001.

3,299,359. MAXX WIRELESS, INC., SAN FRANCISCO, CA. SN 78-724,047. PUB. 7-11-2006, FILED 9-30-2005.



NO CLAIM IS MADE TO THE EXCLUSIVE RIGHT TO USE MOBILE, APART FROM THE MARK AS SHOWN.

THE COLOR(S) RED, BLACK AND WHITE ARE CLAIMED AS A FEATURE OF THE MARK.

THE MARK CONSISTS OF A RED LETTER "M" WITH THE WORD "MAXX" WRITTEN ACROSS IN STYLIZED LETTERS THAT ARE WHITE IN COLOR. THE WORD "SPORTS" IS IN BLACK RUNS UNDER THE ENTIRE LENGTH OF THE "M".

FOR WIRELESS ELECTRONIC TRANSMISSION OF VOICE SIGNALS, DATA, FACSIMILES, IMAGES, VIDEO AND INFORMATION; WIRELESS COMMUNICATIONS SERVICES, NAMELY, TRANSMISSION OF AUDIO, VIDEO AND GRAPHICS TO MOBILE DEVICES; WIRELESS STREAMING OF AUDIO AND VIDEO MATERIAL TO MOBILE DEVICES (U.S. CLS. 100, 101 AND 104).
FIRST USE 9-1-2006; IN COMMERCE 9-1-2006.

CLASS 38—(Continued).

3,299,362. NETFLIX, INC., LOS GATOS, CA. SN 78-725,329. PUB. 1-16-2007, FILED 10-3-2005.

NETFLIX

THE MARK CONSISTS OF STANDARD CHARACTERS WITHOUT CLAIM TO ANY PARTICULAR FONT, STYLE, SIZE, OR COLOR.

OWNER OF U.S. REG. NO. 2,552,950.
SEC. 2(F).
FOR VIDEO-ON-DEMAND TRANSMISSION SERVICES; VIDEO BROADCASTING; TRANSMISSION OF VOICE, DATA, IMAGES, SIGNALS, MESSAGES AND INFORMATION (U.S. CLS. 100, 101 AND 104).
FIRST USE 1-16-2007; IN COMMERCE 1-16-2007.

3,299,522. SANSAY, INC., SAN DIEGO, CA. SN 78-748,848. PUB. 7-11-2006, FILED 11-7-2005.

SANSAY

THE MARK CONSISTS OF STANDARD CHARACTERS WITHOUT CLAIM TO ANY PARTICULAR FONT, STYLE, SIZE, OR COLOR.

FOR VOICE OVER INTERNET PROTOCOL (VOIP) SERVICES (U.S. CLS. 100, 101 AND 104).
FIRST USE 12-31-2003; IN COMMERCE 12-31-2003.

CLASS 38—(Continued).

3,299,615. SIA BOUNS, RIGA, LATVIA. SN 78-767,180. PUB. 7-18-2006, FILED 12-6-2005.

shop A

THE MARK CONSISTS OF STANDARD CHARACTERS WITHOUT CLAIM TO ANY PARTICULAR FONT, STYLE, SIZE, OR COLOR.

NO CLAIM IS MADE TO THE EXCLUSIVE RIGHT TO USE "SHOP", APART FROM THE MARK AS SHOWN.

FOR AUDIO BROADCASTING; AUDIO TELECONFERENCING; BROADCASTING PROGRAMS VIA A GLOBAL COMPUTER NETWORK; CELLULAR TELEPHONE COMMUNICATION; COMMUNICATION BY ELECTRONIC COMPUTER TERMINALS; COMMUNICATION BY MOBILE TELEPHONE; COMMUNICATION SERVICES, NAMELY, ELECTRONIC TRANSMISSION OF DATA AND DOCUMENTS AMONG USERS OF COMPUTERS; COMMUNICATION VIA COMPUTER TERMINALS, BY DIGITAL TRANSMISSION OR BY SATELLITE; COMMUNICATIONS BY COMPUTER TERMINALS; COMMUNICATIONS SERVICES, NAMELY, TRANSMITTING STREAMED SOUND AND AUDIO-VISUAL RECORDINGS VIA THE INTERNET; COMPUTER AIDED TRANSMISSION OF INFORMATION AND IMAGES; DELIVERY OF MESSAGES BY ELECTRONIC TRANSMISSION; DELIVERY OF PERSONALIZED GREETING CARDS TO OTHERS VIA ELECTRONIC MAIL; ELECTRONIC DATA TRANSMISSION; ELECTRONIC DELIVERY OF IMAGES AND PHOTOGRAPHS VIA A GLOBAL COMPUTER NETWORK; ELECTRONIC MAIL SERVICES; ELECTRONIC MESSAGE TRANSMISSION; ELECTRONIC TRANSMISSION OF DATA AND DOCUMENTS VIA COMPUTER TERMINALS; INFORMATION TRANSMISSION SERVICES VIA DIGITAL NETWORKS; INTERNET TELEPHONY SERVICES; INTERSTATE TELEPHONE SERVICES; MOBILE TELEPHONE COMMUNICATION; MOBILE TELEPHONY; NEWS AGENCIES, NAMELY, THE TRANSMISSION OF NEWS ITEMS TO NEWS REPORTING ORGANIZATIONS; ON-LINE DOCUMENT DELIVERY VIA A GLOBAL COMPUTER NETWORK; PROVIDING TELECOMMUNICATIONS CONNECTIONS TO A GLOBAL COMPUTER NETWORK; PROVIDING TELEPHONE CONFERENCING SERVICES; SATELLITE COMMUNICATION SERVICES; TELECOMMUNICATION ACCESS SERVICES; TELECOMMUNICATION SERVICES IN THE FIELD OF PROVIDING LONG DISTANCE SERVICE WITH AUDIO ADVERTISING FOR OTHERS AS A COMPONENT OF THE LONG DISTANCE SERVICE; TELECOMMUNICATION SERVICES, NAMELY, LOCAL AND LONG DISTANCE TRANSMISSION OF VOICE, DATA, GRAPHICS BY MEANS OF TELEPHONE, TELEGRAPHIC, CABLE, AND SATELLITE TRANSMISSIONS; TELECOMMUNICATIONS BY E-MAIL; TELECOMMUNICATIONS CONSULTATION; TELECOMMUNICATIONS SERVICES, NAMELY, PERSONAL COMMUNICATION SERVICES; TELEPHONE COMMUNICATION SERVICES; TELEVISION TRANSMISSION SERVICES; TRANSFER OF DATA BY TELECOMMUNICATIONS; TRANSMISSION OF DATABASE INFORMATION VIA TELECOMMUNICATIONS NETWORKS; TRANSMISSION OF INFORMATION BY ELECTRONIC COMMUNICATIONS NETWORKS; VIDEO TELECONFERENCING; WEB MESSAGING; WIRELESS DIGITAL MESSAGING SERVICES; WIRELESS VOICE MAIL SERVICES (U.S. CLS. 100, 101 AND 104).

FIRST USE 3-10-2007; IN COMMERCE 3-10-2007.

CLASS 38—(Continued).

3,299,681. HIGHROAD SOLUTION, L.L.C., ASHBURN, VA. SN 78-783,161. PUB. 3-27-2007, FILED 12-30-2005.



NO CLAIM IS MADE TO THE EXCLUSIVE RIGHT TO USE "SOLUTION", APART FROM THE MARK AS SHOWN. FOR ELECTRONIC DOCUMENT DELIVERY CONSULTATION SERVICE, NAMELY, ELECTRONIC MESSAGE TRANSMISSION (U.S. CLS. 100, 101 AND 104). FIRST USE 12-21-2005; IN COMMERCE 1-2-2006.

3,299,883. MARSALKA, JOSEPH P., COLUMBUS, OH. SN 78-848,282. PUB. 10-31-2006, FILED 3-28-2006.

TWINKLE STAR

THE MARK CONSISTS OF STANDARD CHARACTERS WITHOUT CLAIM TO ANY PARTICULAR FONT, STYLE, SIZE, OR COLOR.

FOR ELECTRONIC, ELECTRIC, AND DIGITAL TRANSMISSION OF VOICE, DATA, IMAGES, SIGNALS, AND MESSAGES (U.S. CLS. 100, 101 AND 104).

FIRST USE 2-15-2006; IN COMMERCE 9-20-2006.

3,299,931. JOIPHONE, LLC, DELRAY BEACH, FL. SN 78-866,223. PUB. 12-5-2006, FILED 4-20-2006.

WE BRING JOY TO YOUR LIFE!

THE MARK CONSISTS OF STANDARD CHARACTERS WITHOUT CLAIM TO ANY PARTICULAR FONT, STYLE, SIZE, OR COLOR.

FOR PROVIDING VOICE COMMUNICATION SERVICES VIA THE INTERNET (U.S. CLS. 100, 101 AND 104).

FIRST USE 11-15-2006; IN COMMERCE 11-15-2006.

CLASS 38—(Continued).

3,300,042. INTELSAT, LTD., PEMBROKE, BERMUDA. SN 78-905,123. PUB. 2-13-2007, FILED 6-9-2006.

CLOSER, BY FAR

THE MARK CONSISTS OF STANDARD CHARACTERS WITHOUT CLAIM TO ANY PARTICULAR FONT, STYLE, SIZE, OR COLOR.

FOR COMMUNICATIONS SERVICES, NAMELY, TRANSMISSION OF AUDIO, VIDEO, VOICE, IMAGES, AND DATA, VIA SATELLITE (U.S. CLS. 100, 101 AND 104).

FIRST USE 7-3-2006; IN COMMERCE 7-3-2006.

3,300,102. MAINSTREAM HOLDINGS, LLC, WEST PALM BEACH, FL. SN 78-922,998. PUB. 2-20-2007, FILED 7-5-2006.



THE MARK CONSISTS OF THE WORD MOLI.

FOR PROVIDING E-MAIL SERVICES; PROVIDING ON-LINE CHAT ROOMS AND ELECTRONIC BULLETIN BOARDS FOR TRANSMISSION OF MESSAGES AND PHOTOS AMONG USERS IN THE FIELD OF GENERAL INTEREST; PROVIDING ON-LINE CHAT ROOMS FOR TRANSMISSION OF MESSAGES AND PHOTOS AMONG COMPUTER USERS CONCERNING TOPICS OF GENERAL INTEREST (U.S. CLS. 100, 101 AND 104).

FIRST USE 7-1-2006; IN COMMERCE 5-1-2007.

CLASS 39—TRANSPORTATION AND STORAGE

3,298,460. LIFE STORAGE CENTERS, LLC, ELGIN, IL. SN 76-585,047. PUB. 1-11-2005, FILED 4-5-2004.

LIFE'S FULL OF STUFF...STORE IT

FOR STORAGE OF HOUSEHOLD, BUSINESS, RECREATIONAL AND PERSONAL GOODS, ONLY AT OFF-SITE FACILITIES AND UNDER CLIMATE CONTROLLED AND AMBIENT CONDITIONS, AND EXPRESSLY EXCLUDING INSTALLATION OF CLOSETS AND STORAGE SPACE FACILITIES AND DESIGN SERVICES IN THE FIELD OF CUSTOMIZED CLOSETS AND STORAGE SPACE (U.S. CLS. 100 AND 105).

FIRST USE 1-31-2004; IN COMMERCE 1-31-2004.

CLASS 39—(Continued).

3,298,900. HENDERSON, WAYNE C., DOYLESTOWN, PA. SN 78-539,936. PUB. 10-25-2005, FILED 12-30-2004.



THE COLOR(S) MAROON, GOLDEN YELLOW AND COOL GREY IS/ARE CLAIMED AS A FEATURE OF THE MARK.

THE COLORS IN THE OVAL APPEAR IN MAROON, BLENDING FROM LEFT TO RIGHT INTO GOLDEN YELLOW. THE WORD JETHERE APPEARS WITH THE WORD "JET" IN MAROON AND THE WORD "THERE" IN COOL GRAY. THE JETHERE LOGO IS PRINTED WITH THE FONTS TIMES BOLD FOR "JET" AND TIMES FOR "THERE".

THE MARK CONSISTS OF A MODIFIED OVAL SHAPE WITH THE WORD JETHERE APPEARING BENEATH THE ELLIPTICAL FORM.

FOR PRIVATE JET TRANSPORT (U.S. CLS. 100 AND 105).

FIRST USE 3-10-2006; IN COMMERCE 3-10-2006.

3,299,108. CHRISTENSON TRANSPORTATION, STRAFORD, MO. SN 78-625,741. PUB. 2-14-2006, FILED 5-9-2005.

"Where the Truckers Truck"

THE MARK CONSISTS OF STANDARD CHARACTERS WITHOUT CLAIM TO ANY PARTICULAR FONT, STYLE, SIZE, OR COLOR.

FOR TRANSPORTATION OF GOODS BY TRUCK (U.S. CLS. 100 AND 105).

FIRST USE 7-10-2005; IN COMMERCE 7-25-2005.

CLASS 39—(Continued).

3,299,117. MOLINA-LOPEZ, GEORGINA, CHICAGO, IL. SN 78-627,431. PUB. 6-27-2006, FILED 5-11-2005.



NO CLAIM IS MADE TO THE EXCLUSIVE RIGHT TO USE "SERVICIOS LATINOS", APART FROM THE MARK AS SHOWN.

THE ENGLISH TRANSLATION OF SERVICIOS LATINOS IS LATIN SERVICES.

FOR PACKAGE DELIVERY SERVICES (U.S. CLS. 100 AND 105).

FIRST USE 5-9-2006; IN COMMERCE 5-9-2006.

3,299,360. LIFESTEM, INC., IRVINE, CA. SN 78-724,216. PUB. 8-29-2006, FILED 9-30-2005.

Stem Cell Microbank

THE MARK CONSISTS OF STANDARD CHARACTERS WITHOUT CLAIM TO ANY PARTICULAR FONT, STYLE, SIZE, OR COLOR.

NO CLAIM IS MADE TO THE EXCLUSIVE RIGHT TO USE "STEM CELL", APART FROM THE MARK AS SHOWN. FOR STORAGE OF BIOLOGICAL TISSUE, NAMELY, HUMAN STEM CELLS FROM VARIOUS TISSUE SOURCES (U.S. CLS. 100 AND 105).

FIRST USE 7-28-2006; IN COMMERCE 7-28-2006.

3,299,639. PRIVATUS, LTD., CHARLOTTE, NC. SN 78-771,093. PUB. 11-14-2006, FILED 12-12-2005.

PRIVATUS

THE MARK CONSISTS OF STANDARD CHARACTERS WITHOUT CLAIM TO ANY PARTICULAR FONT, STYLE, SIZE, OR COLOR.

FOR AUTOMOBILE CLUB SERVICES, NAMELY PROVIDING THE USE OF LUXURY AND HIGH PERFORMANCE AUTOMOBILES TO AUTOMOBILE ENTHUSIASTS WHO ARE CLUB MEMBERS (U.S. CLS. 100 AND 105).

FIRST USE 5-19-2006; IN COMMERCE 5-19-2006.

CLASS 39—(Continued).

3,299,830. FERRELLGAS PARTNERS, L.P., OVERKLAND, KS. SN 78-827,703. PUB. 10-17-2006, FILED 3-2-2006.

FERRELLGAS YOUR PROPANE
CONNECTION

THE MARK CONSISTS OF STANDARD CHARACTERS WITHOUT CLAIM TO ANY PARTICULAR FONT, STYLE, SIZE, OR COLOR.

OWNER OF U.S. REG. NOS. 1,852,964, 2,054,208, AND OTHERS.

FOR SUPPLYING PROPANE GAS FUEL TO OTHERS (U.S. CLS. 100 AND 105).

FIRST USE 3-0-2006; IN COMMERCE 3-0-2006.

3,299,954. DOORMAN ONLINE LLC, STATEN ISLAND, NY. SN 78-875,238. PUB. 2-13-2007, FILED 5-3-2006.



NO CLAIM IS MADE TO THE EXCLUSIVE RIGHT TO USE "ONLINE", APART FROM THE MARK AS SHOWN.

THE STIPPLING IS FOR SHADING PURPOSES ONLY.

THE MARK CONSISTS OF A COMPUTER WITH A MAN COMING OUT OF THE SCREEN HOLDING A GIFT BOX AND THE STYLIZED TEXT DOORMAN ONLINE SOMEONE YOU CAN TRUST. AROUND THAT IN A CIRCLE.

FOR COURIER SERVICES (U.S. CLS. 100 AND 105).

FIRST USE 6-5-2006; IN COMMERCE 6-5-2006.

CLASS 39—(Continued).

3,299,974. MOBLEY, MICHAEL D., CLERMONT, FL. SN 78-880,747. PUB. 12-5-2006, FILED 5-10-2006.



NO CLAIM IS MADE TO THE EXCLUSIVE RIGHT TO USE "COURIER SERVICES, INC.", APART FROM THE MARK AS SHOWN.

THE COLOR(S) MAROON, WHITE, BLACK AND BROWN IS/ARE CLAIMED AS A FEATURE OF THE MARK

THE MARK CONSISTS OF STYLIZED LETTERS M, D AND M CONFIGURED IN THE FOREGOING ORDER FURTHER CONFIGURED DIAGONALLY; DESCENDING FROM LEFT TO RIGHT; EACH LETTER M, D AND M CONFIGURED WITH FONT COMPRISING ROUNDED CURVES AND FLAT EDGES; EACH LETTER M, D AND M CONFIGURED HAVING A MAROON COLORED BODY WITH A WHITE BOUNDARY; EACH LETTER M, D AND M CONFIGURED DESCENDING TOWARDS BUT SLIGHTLY HIDING A JUXTAPOSITIONED VAN WITH A WHITE COLOR WITH THE DETAILS OF THE VAN IN BLACK AND WORDS "COURIER SERVICES, INC." CONFIGURED JUST OVER SAID VAN IN MAROON; SAID LETTERS M, D AND M, SAID VAN, AND SAID WORDS "COURIER SERVICES, INC." ALL SUPERIMPOSED OVER A BROWN COLORED PACKAGE WRAPPED WITH A WHITE COLORED STRING, TIED INTO A BOW.

FOR COURIER SERVICES (U.S. CLS. 100 AND 105).
FIRST USE 5-12-2006; IN COMMERCE 5-12-2006.

CLASS 40—(Continued).

3,298,868. BENNETT, JASON A, YUCAIPA, CA. AND BENNETT, TWILA C, YUCAIPA, CA. SN 78-515,154. PUB. 7-25-2006, FILED 11-11-2004.



NO CLAIM IS MADE TO THE EXCLUSIVE RIGHT TO USE "CHOPPERS", APART FROM THE MARK AS SHOWN.

FOR BUILDING CUSTOM MOTORCYCLES FOR STREET USE, AND CUSTOM AUTOMOBILES (U.S. CLS. 100, 103 AND 106).

FIRST USE 5-29-2004; IN COMMERCE 5-29-2004.

3,299,990. AERO DESIGN AND MANUFACTURING COMPANY, INC., DULUTH, MN. SN 78-885,596. PUB. 12-19-2006, FILED 5-17-2006.



OWNER OF U.S. REG. NO. 1,873,866.
NO CLAIM IS MADE TO THE EXCLUSIVE RIGHT TO USE "TOURS", APART FROM THE MARK AS SHOWN.

THE MARK CONSISTS OF THE WORDS "AEROSTICH TOURS" COMBINED WITH A DIAMOND SHAPE WITH CURVED ARROW INSIDE COMING OUT OF THE RIGHT SIDE.

FOR ARRANGING AND CONDUCTING MOTORCYCLE TOURS FOR OTHERS (U.S. CLS. 100 AND 105).
FIRST USE 8-4-2006; IN COMMERCE 8-4-2006.

3,299,038. CUNNINGHAM LINDSEY U.S., INC., SCHAUMBURG, IL. SN 78-600,334. PUB. 12-27-2005, FILED 4-1-2005.

CUNNINGHAM LINDSEY
ENVIRONMENTAL
SOLUTIONS

THE MARK CONSISTS OF STANDARD CHARACTERS WITHOUT CLAIM TO ANY PARTICULAR FONT, STYLE, SIZE, OR COLOR.

NO CLAIM IS MADE TO THE EXCLUSIVE RIGHT TO USE "ENVIRONMENTAL SOLUTIONS", APART FROM THE MARK AS SHOWN.

FOR MOLD REMEDIATION, PETROLEUM SPILL REMEDIATION, CHEMICAL REMEDIATION, AND ENVIRONMENTAL RESTORATION SERVICES, NAMELY HABITAT RESTORATION VIA SOIL, WASTE, AND WATER TREATMENT (U.S. CLS. 100, 103 AND 106).
FIRST USE 1-1-2002; IN COMMERCE 1-1-2002.

CLASS 40—MATERIAL TREATMENT

CLASS 40—(Continued).

3,299,101. HALLIBURTON ENERGY SERVICES, INC., CARROLLTON, TX. SN 78-622,182. PUB. 1-24-2006, FILED 5-4-2005.

PROPSTOP

THE MARK CONSISTS OF STANDARD CHARACTERS WITHOUT CLAIM TO ANY PARTICULAR FONT, STYLE, SIZE, OR COLOR.

FOR POST-FRACTURE REMEDIAL SERVICE USED TO REVERSE PRODUCTION DECLINES IN OIL AND GAS WELLS (U.S. CLS. 100, 103 AND 106).

FIRST USE 5-1-2006; IN COMMERCE 5-1-2006.

3,299,296. GRAYHILL, INC., LAGRANGE, IL. SN 78-706,168. PUB. 7-18-2006, FILED 9-2-2005.



OWNER OF U.S. REG. NOS. 731,443, 2,600,313, AND OTHERS.

NO CLAIM IS MADE TO THE EXCLUSIVE RIGHT TO USE "EMBEDDED CUSTOM MOBILE SOLUTIONS", APART FROM THE MARK AS SHOWN.

FOR CUSTOM MANUFACTURE OF MOBILE ELECTRONIC DEVICES (U.S. CLS. 100, 103 AND 106).

FIRST USE 11-1-2005; IN COMMERCE 11-1-2005.

3,299,374. G CORP. USA, DELRAY BEACH, FL. SN 78-726,686. PUB. 6-27-2006, FILED 10-5-2005.



THE COLORS RED AND BLUE ARE CLAIMED AS A FEATURE OF THE MARK.

THE COLOR RED APPEARS IN THE FLAMES AND HALF MOON. THE COLOR BLUE APPEARS IN THE LETTER G.

THE MARK CONSISTS OF THE LETTER G AND C SUPERIMPOSED NEXT TO A HALF-MOON WITH FLAMES EMANATING FROM THE LEFT OF THE G AND C.

FOR CUSTOM MANUFACTURE OF CHIMINEAS, CANDLES AND CANDLE HOLDERS (U.S. CLS. 100, 103 AND 106).

FIRST USE 1-25-2006; IN COMMERCE 1-25-2006.

CLASS 40—(Continued).

3,299,516. INGEAR CORPORATION, BUFFALO GROVE, IL. SN 78-747,430. PUB. 7-4-2006, FILED 11-4-2005.

RESISTALON

THE MARK CONSISTS OF STANDARD CHARACTERS WITHOUT CLAIM TO ANY PARTICULAR FONT, STYLE, SIZE, OR COLOR.

FOR TREATMENT OF MATERIALS NAMELY PROVIDING STAIN AND WATER REPELLENCY TREATMENTS TO FABRICS (U.S. CLS. 100, 103 AND 106).

FIRST USE 3-31-2006; IN COMMERCE 3-31-2006.

3,299,607. TARGA RESOURCES, INC., HOUSTON, TX. SN 78-765,093. PUB. 2-6-2007, FILED 12-1-2005.



"THE FOREIGN WORDING IN THE MARK TRANSLATES INTO ENGLISH AS SHIELD OR A COMMERATIVE INSCRIBED TABLET AFFIXED TO OR SET INTO A WALL."

FOR PROCESSING OF NATURAL GAS FOR OTHERS, NAMELY, NATURAL GAS PRODUCTION SERVICES, REFINING OF NATURAL GAS, TREATMENT OF NATURAL GAS (U.S. CLS. 100, 103 AND 106).

FIRST USE 12-1-2005; IN COMMERCE 12-1-2005.

3,300,139. CNC PRO LLC, CARROLLTON, TX. SN 78-934,061. PUB. 3-6-2007, FILED 7-20-2006.

CNC PRO

THE MARK CONSISTS OF STANDARD CHARACTERS WITHOUT CLAIM TO ANY PARTICULAR FONT, STYLE, SIZE, OR COLOR.

NO CLAIM IS MADE TO THE EXCLUSIVE RIGHT TO USE "CNC", APART FROM THE MARK AS SHOWN.

FOR CONTRACT MANUFACTURING IN THE FIELD OF MACHINE PARTS (U.S. CLS. 100, 103 AND 106).

FIRST USE 11-15-2006; IN COMMERCE 11-15-2006.

CLASS 40—(Continued).

3,300,141. MHB ENTERPRISES, SAINT CHARLES, MO. SN 78-936,556. PUB. 2-13-2007, FILED 7-24-2006.

CLASS 41—(Continued).

3,298,524. DARE MIGHTY THINGS, INC., PORTSMOUTH, NH. SN 76-636,055. PUB. 8-15-2006, FILED 4-13-2005.

Merwin, Hulbert & Co.

NATIONAL CHALLENGE INSTITUTE

THE MARK CONSISTS OF STANDARD CHARACTERS WITHOUT CLAIM TO ANY PARTICULAR FONT, STYLE, SIZE, OR COLOR.

NO CLAIM IS MADE TO THE EXCLUSIVE RIGHT TO USE "CO.", APART FROM THE MARK AS SHOWN.

FOR CUSTOM MANUFACTURE FIREARMS, SPECIFICALLY, REVOLVERS, PISTOLS, RIFLES AND SHOT-GUNS (U.S. CLS. 100, 103 AND 106).

FIRST USE 6-1-2007; IN COMMERCE 6-1-2007.

THE MARK CONSISTS OF STANDARD CHARACTERS WITHOUT CLAIM TO ANY PARTICULAR FONT, STYLE, SIZE, OR COLOR.

NO CLAIM IS MADE TO THE EXCLUSIVE RIGHT TO USE "NATIONAL" AND "INSTITUTE", APART FROM THE MARK AS SHOWN.

FOR EDUCATIONAL SERVICES, NAMELY, PROVIDING PROGRAMS TO ASSIST PEOPLE IN DEALING WITH CONFLICT AND MANAGING STRESS AND ANGER, AND PROGRAMS FOR AT-RISK YOUTH; PROVIDING WORKSHOPS THAT TEACH PARTICIPANTS HOW TO CREATE CURRICULUM, TOOLS AND STRATEGIES FOR EFFECTIVE LESSON PLANS DEALING WITH CONFLICT AND MANAGING STRESS AND ANGER AND PROGRAMS FOR AT-RISK YOUTH (U.S. CLS. 100, 101 AND 107).

FIRST USE 7-0-2005; IN COMMERCE 10-3-2005.

CLASS 41—EDUCATION AND ENTERTAINMENT

3,298,516. METCALF, MARK D., FOREST GROVE, OR. SN 76-635,084. PUB. 1-3-2006, FILED 3-31-2005.

3,298,530. XCELERATE FITNESS, REEDLEY, CA. SN 76-638,765. PUB. 2-28-2006, FILED 5-17-2005.

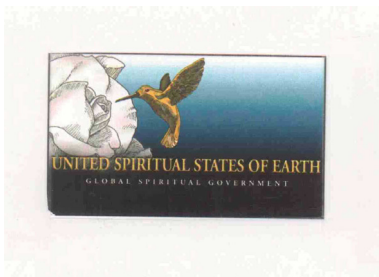

THE COLOR(S) GOLD, WHITE, BLUE GRAY AND BLACK IS/ARE CLAIMED AS A FEATURE OF THE MARK.

THE COLOR GOLD APPEARS IN A HUMMING BIRD BESIDE A WHITE ROSE WITH GRAY SHADING ABOVE WORDING IN TWO LINES IN THE COLOR GOLD ON A GENERALLY BLUE BACKGROUND THAT FADES TO BLACK AT THE BOTTOM AND WHITE AT THE TOP OF A BLACK RECTANGLE THAT BORDERS THE MARK.

FOR PROVIDING TRAINING IN THE FIELDS OF CONSTRUCTION OF HOUSING AND SHELTER, CREATION OF MEDICINES, NAMELY PREVENTATIVE MEDICINES, NUTRITION, AND INTERPERSONAL RELATIONSHIPS (U.S. CLS. 100, 101 AND 107).

FIRST USE 2-4-2007; IN COMMERCE 2-4-2007.



NO CLAIM IS MADE TO THE EXCLUSIVE RIGHT TO USE "FITNESS", APART FROM THE MARK AS SHOWN.

FOR HEALTH CLUB SERVICES, NAMELY, PROVIDING INSTRUCTION AND EQUIPMENT IN THE FIELD OF PHYSICAL EXERCISE (U.S. CLS. 100, 101 AND 107).

FIRST USE 6-1-2005; IN COMMERCE 6-1-2005.

CLASS 41—(Continued).

3,298,537. DARE MIGHTY THINGS, INC., PORTSMOUTH, NH. SN 76-642,027. PUB. 8-8-2006, FILED 6-30-2005.



FOR EDUCATIONAL SERVICES, NAMELY PROVIDING PROGRAMS TO ASSIST PEOPLE IN DEALING WITH CONFLICT AND MANAGING STRESS AND ANGER, AND PROGRAMS FOR AT-RISK YOUTH; PROVIDING WORKSHOPS THAT TEACH PARTICIPANTS HOW TO CREATE CURRICULUM, TOOLS AND STRATEGIES FOR EFFECTIVE LESSON PLANS DEALING WITH CONFLICT AND MANAGING STRESS AND ANGER AND PROGRAMS FOR AT-RISK YOUTH (U.S. CLS. 100, 101 AND 107).

FIRST USE 7-0-2005; IN COMMERCE 10-3-2005.

CLASS 41—(Continued).

3,298,542. ADVANCE MAGAZINE PUBLISHERS INC., NEW YORK, NY. SN 76-643,520. PUB. 10-24-2006, FILED 7-25-2005.

ALLURE BACKSTAGE

THE MARK CONSISTS OF STANDARD CHARACTERS WITHOUT CLAIM TO ANY PARTICULAR FONT, STYLE, SIZE, OR COLOR.

OWNER OF U.S. REG. NOS. 1,378,072, 2,802,011, AND OTHERS.

NO CLAIM IS MADE TO THE EXCLUSIVE RIGHT TO USE "BACKSTAGE", APART FROM THE MARK AS SHOWN.

FOR ENTERTAINMENT SERVICES, NAMELY, A TELEVISION SERIES AND PERIODICALLY PRODUCED TELEVISION SPECIALS ABOUT BEING BACKSTAGE AT FASHION SHOWS AND FEATURING INFORMATION AND ADVICE ABOUT STYLE AND BEAUTY (U.S. CLS. 100, 101 AND 107).

FIRST USE 10-21-2001; IN COMMERCE 10-21-2001.

3,298,540. HOUGHTON MIFFLIN COMPANY, BOSTON, MA. SN 76-642,906. PUB. 6-20-2006, FILED 7-15-2005.



OWNER OF U.S. REG. NO. 2,617,098.
FOR EDUCATIONAL SERVICES, NAMELY ON-LINE TESTING AND TRAINING IN THE FIELDS OF READING, LANGUAGE ARTS, ENGLISH, MATHEMATICS, SCIENCE, SOCIAL STUDIES AND STANDARD COMPUTER PROGRAMS AND APPLICATIONS VIA A GLOBAL COMPUTER NETWORK (U.S. CLS. 100, 101 AND 107).

FIRST USE 1-0-2004; IN COMMERCE 1-0-2004.

3,298,551. OCEAN RIDGE PLANTATION GOLF, INC., OCEAN ISLE BEACH, NC. SN 76-646,110. PUB. 9-19-2006, FILED 9-2-2005.

LEOPARD'S CHASE

THE MARK CONSISTS OF STANDARD CHARACTERS WITHOUT CLAIM TO ANY PARTICULAR FONT, STYLE, SIZE, OR COLOR.

FOR GOLF COURSE SERVICES (U.S. CLS. 100, 101 AND 107).

FIRST USE 3-20-2007; IN COMMERCE 3-20-2007.

CLASS 41—(Continued).

3,298,566. BNP MEDIA II, LLC, TROY, MI. SN 76-649,358. PUB. 11-21-2006, FILED 10-28-2005.



The logo for Sustainable Packaging Forum features the words "SUSTAINABLE" and "PACKAGING" stacked vertically on the left, and "FORUM" on the right. A diagonal line runs from the top right of "SUSTAINABLE" to the bottom left of "FORUM", intersecting "PACKAGING".

NO CLAIM IS MADE TO THE EXCLUSIVE RIGHT TO USE "SUSTAINABLE PACKAGING FORUM", APART FROM THE MARK AS SHOWN.

FOR EDUCATIONAL SERVICES, NAMELY PROVIDING BUSINESS CONFERENCES IN THE FIELD OF SUSTAINABLE PACKAGING, FOCUSING ON COMPREHENSIVE ANALYSIS OF THE THREE TENETS OF SUSTAINABILITY NAMELY, ECONOMIC, SOCIAL AND THE ENVIRONMENT, AND THEIR IMPACT ON SUSTAINABLE OPERATIONS AMONG CONSUMER GOODS PRODUCERS AND THEIR BOTTOM-LINE IMPACT ON SUSTAINABLE PACKAGE PRODUCTION THROUGH THE USE OF LIVE PRESENTATIONS AND PANELS TARGETING THEORETICAL, PRACTICAL, TECHNICAL TOOLS AND PROCESSES THAT CONSUMER PACKAGE GOODS, PACKAGING SUPPLIERS, DESIGNERS, AND CONVERTERS MUST EMBRACE AND EMPLOY TO CREATE AND MAINTAIN ECONOMICALLY PROFITABLE, ECOLOGICALLY REGENERATIVE, AND SOCIALLY EMPOWERING ACTIVITIES THROUGH INTELLIGENT DESIGN AND OPERATIONS (U.S. CLS. 100, 101 AND 107).

FIRST USE 2-15-2005; IN COMMERCE 2-15-2005.

3,298,568. POPKIN, JEFF, NEEDHAM, MA. SN 76-649,709. PUB. 7-4-2006, FILED 11-3-2005.

THE RESOLUTION BALL

THE MARK CONSISTS OF STANDARD CHARACTERS WITHOUT CLAIM TO ANY PARTICULAR FONT, STYLE, SIZE, OR COLOR.

NO CLAIM IS MADE TO THE EXCLUSIVE RIGHT TO USE "BALL", APART FROM THE MARK AS SHOWN.

FOR ENTERTAINMENT SERVICES, NAMELY ORGANIZING AND CONDUCTING SOCIAL DANCES AND PARTIES FOR OTHERS (U.S. CLS. 100, 101 AND 107).

FIRST USE 11-15-1995; IN COMMERCE 11-15-1995.

CLASS 41—(Continued).

3,298,594. SPANISH BROADCASTING SYSTEM, INC., CONUT GROVE, FL. SN 76-660,598. PUB. 2-20-2007, FILED 5-25-2006.

EL CIRCULO

THE MARK CONSISTS OF STANDARD CHARACTERS WITHOUT CLAIM TO ANY PARTICULAR FONT, STYLE, SIZE, OR COLOR.

THE SPANISH WORDS IN THE MARK MEAN "THE CIRCLE."

FOR ENTERTAINMENT IN THE NATURE OF AN ONGOING SPANISH LANGUAGE TELEVISION PROGRAM FEATURING A CONTINUING MAGAZINE STYLE SHOW EXAMINING THE LIFESTYLES OF THE ELITE AND WEALTHY (U.S. CLS. 100, 101 AND 107).

FIRST USE 3-1-2006; IN COMMERCE 3-1-2006.

3,298,603. BIOWARE CORP., EDMONTON, ALBERTA T6H 5R7, CANADA. SN 76-978,558. PUB. 7-26-2005, FILED 5-7-2004.

DRAGON AGE

THE MARK CONSISTS OF STANDARD CHARACTERS WITHOUT CLAIM TO ANY PARTICULAR FONT, STYLE, SIZE, OR COLOR.

NO CLAIM IS MADE TO THE EXCLUSIVE RIGHT TO USE "DRAGON", APART FROM THE MARK AS SHOWN.

FOR ENTERTAINMENT SERVICES, NAMELY, ONLINE INTERACTIVE COMPUTER GAME PROVIDED BY MEANS OF A GLOBAL COMPUTER NETWORK (U.S. CLS. 100, 101 AND 107).

FIRST USE 6-0-2004; IN COMMERCE 6-0-2004.

3,298,641. CAMPANALI, WILLIAM J, TOWACO, NJ. SN 78-136,419. PUB. 1-13-2004, FILED 6-17-2002.

VIDOLO

FOR CARTOON STRIP SYNDICATION SERVICES VIA A GLOBAL COMPUTER NETWORK (U.S. CLS. 100, 101 AND 107).

FIRST USE 3-31-2007; IN COMMERCE 4-2-2007.

CLASS 41—(Continued).

3,298,659. PERFECT 10, INC., BEVERLY HILLS, CA. SN 78-195,885. PUB. 2-24-2004, FILED 12-18-2002.

NATURAL 10

FOR ENTERTAINMENT SERVICES NAMELY, PROVIDING ON-LINE ADULT ENTERTAINMENT, BEAUTY CONTESTS, PICTURES OF FEMALE MODELS, INTERVIEWS, FICTIONAL STORIES, AND ARTICLES ON HUMAN RELATIONS, SPORTS, ENTERTAINMENT, LIFESTYLES, AND FITNESS (U.S. CLS. 100, 101 AND 107).

FIRST USE 3-31-2003; IN COMMERCE 3-31-2003.

3,298,677. BEECHAM JAIK, GRACE, MALIBU, CA. SN 78-252,751. PUB. 6-20-2006, FILED 5-21-2003.

**JAKE GRACE FREESTYLE
YOGA**

NO CLAIM IS MADE TO THE EXCLUSIVE RIGHT TO USE "FREESTYLE YOGA", APART FROM THE MARK AS SHOWN.

SEC. 2(F).

FOR EDUCATION, NAMELY, PROVIDING HEALTH, FITNESS, AND YOGA INSTRUCTION AND TRAINING (U.S. CLS. 100, 101 AND 107).

FIRST USE 6-1-2001; IN COMMERCE 9-1-2001.

3,298,684. QUIKSILVER, INC., HUNTINGTON BEACH, CA. SN 78-272,367. PUB. 12-20-2005, FILED 7-9-2003.

ROXY

FOR ENTERTAINMENT SERVICES, NAMELY PROVIDING MUSIC RECORDING STUDIOS; PROVIDING INFORMATION IN THE FIELD OF MUSIC, INFORMATION IN THE FIELD OF MUSIC AND COMMENTARY AND ARTICLES ABOUT MUSIC VIA A GLOBAL COMPUTER NETWORK (U.S. CLS. 100, 101 AND 107).

FIRST USE 8-1-2006; IN COMMERCE 8-1-2006.

3,298,703. APOLLO GROUP, INC., PHOENIX, AZ. SN 78-316,534. PUB. 1-4-2005, FILED 10-21-2003.

WRITEPOINT

FOR EDUCATION SERVICES, NAMELY, ASSESSING WRITING SKILLS FOR OTHERS AND PROVIDING FEEDBACK VIA THE INTERNET (U.S. CLS. 100, 101 AND 107).

FIRST USE 7-0-2004; IN COMMERCE 7-0-2004.

CLASS 41—(Continued).

3,298,704. APOLLO GROUP, INC., PHOENIX, AZ. SN 78-316,559. PUB. 1-11-2005, FILED 10-21-2003.



FOR EDUCATION SERVICES, NAMELY, ASSESSING WRITING SKILLS FOR OTHERS AND PROVIDING FEEDBACK VIA THE INTERNET (U.S. CLS. 100, 101 AND 107).

FIRST USE 1-1-2007; IN COMMERCE 1-1-2007.

3,298,731. GAMELOGIC INC., WALTHAM, MA. SN 78-371,518. PUB. 7-5-2005, FILED 2-20-2004.



OWNER OF U.S. REG. NOS. 2,865,746 AND 2,865,747. FOR ENTERTAINMENT SERVICES, NAMELY, CONDUCTING INTERACTIVE GAMES VIA SATELLITE, CABLE TELEVISION, TELEPHONE AND THE INTERNET (U.S. CLS. 100, 101 AND 107).

FIRST USE 12-10-2003; IN COMMERCE 12-10-2003.

3,298,734. JIM MCLEAN ENTERPRISES, INC., MIAMI, FL. SN 78-375,460. PUB. 7-18-2006, FILED 2-27-2004.

X-FACTOR

THE MARK CONSISTS OF STANDARD CHARACTERS WITHOUT CLAIM TO ANY PARTICULAR FONT, STYLE, SIZE, OR COLOR.

FOR EDUCATIONAL SERVICES, NAMELY, PROVIDING INSTRUCTION, TRAINING AND COURSES IN THE FIELD OF GOLF (U.S. CLS. 100, 101 AND 107).

FIRST USE 0-0-1992; IN COMMERCE 0-0-1994.

CLASS 41—(Continued).

3,298,807. GREENGRASS PRODUCTIONS, INC., BURBANK, CA. SN 78-465,314. PUB. 6-27-2006, FILED 8-10-2004.

BRAT CAMP

THE MARK CONSISTS OF STANDARD CHARACTERS WITHOUT CLAIM TO ANY PARTICULAR FONT, STYLE, SIZE, OR COLOR.

NO CLAIM IS MADE TO THE EXCLUSIVE RIGHT TO USE "CAMP", APART FROM THE MARK AS SHOWN.

FOR ENTERTAINMENT IN THE NATURE OF A REALITY TELEVISION SERIES (U.S. CLS. 100, 101 AND 107).

FIRST USE 7-13-2005; IN COMMERCE 7-13-2005.

3,298,836. WORLD WRESTLING ENTERTAINMENT, INC., STAMFORD, CT. SN 78-481,858. PUB. 7-5-2005, FILED 9-10-2004.

NEW YEAR'S REVOLUTION

THE MARK CONSISTS OF STANDARD CHARACTERS WITHOUT CLAIM TO ANY PARTICULAR FONT, STYLE, SIZE, OR COLOR.

FOR ENTERTAINMENT SERVICES, NAMELY, THE PRODUCTION AND EXHIBITION OF PROFESSIONAL WRESTLING EVENTS RENDERED LIVE AND THROUGH THE MEDIA OF TELEVISION; PROVIDING WRESTLING NEWS AND INFORMATION VIA A GLOBAL COMPUTER NETWORK (U.S. CLS. 100, 101 AND 107).

FIRST USE 1-9-2005; IN COMMERCE 1-9-2005.

CLASS 41—(Continued).

3,298,845. MONSTER CABLE PRODUCTS, INC., BRISBANE, CA. SN 78-491,081. PUB. 1-10-2006, FILED 9-28-2004.

MONSTERPARK.COM

THE MARK CONSISTS OF STANDARD CHARACTERS WITHOUT CLAIM TO ANY PARTICULAR FONT, STYLE, SIZE, OR COLOR.

FOR SERVICES IN CONNECTION WITH ENTERTAINMENT, SPORTING, AND CULTURAL ACTIVITIES NAMELY PROFESSIONAL FOOTBALL GAMES, MUSICAL CONCERTS, HOLIDAY FESTIVALS, EASTER EGG HUNTS AND AUTOMOBILE SHOWS (U.S. CLS. 100, 101 AND 107).

FIRST USE 3-7-2007; IN COMMERCE 3-7-2007.

3,298,887. GANNAWAY, RICHARD LAYTON, SAFETY HARBOR, FL. SN 78-527,486. PUB. 1-10-2006, FILED 12-6-2004.

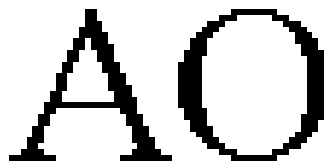

THE MARK CONSISTS OF STANDARD CHARACTERS WITHOUT CLAIM TO ANY PARTICULAR FONT, STYLE, SIZE, OR COLOR.

FOR MULTIMEDIA ENTERTAINMENT SERVICES, NAMELY MUSIC COMPOSITION FOR OTHERS, PRESENTATION OF LIVE MUSIC PERFORMANCES, AND MOTION PICTURE FILM PRODUCTION (U.S. CLS. 100, 101 AND 107).

FIRST USE 4-1-2007; IN COMMERCE 5-11-2007.

3,298,926. HUMANA INC., LOUISVILLE, KY. SN 78-556,642. PUB. 11-8-2005, FILED 1-31-2005.

MYREALITY CHECK

THE MARK CONSISTS OF STANDARD CHARACTERS WITHOUT CLAIM TO ANY PARTICULAR FONT, STYLE, SIZE, OR COLOR.

FOR PROVIDING INFORMATION ONLINE IN THE FIELD OF INDIVIDUAL HEALTH AND FITNESS ASSESSMENT AND EVALUATION, AND IMPROVING HEALTH AND FITNESS (U.S. CLS. 100, 101 AND 107).

FIRST USE 3-31-2005; IN COMMERCE 3-31-2005.

CLASS 41—(Continued).

3,298,934. BLUE FROG MOBILE, INC., SEATTLE, WA. SN 78-562,713. PUB. 6-13-2006, FILED 2-8-2005.

CLASS 41—(Continued).

3,298,939. MAZER, LARRY, VORHEES, NJ. AND BORROR, TIM, VORHEES, NJ. AND CONROY, PAUL, VORHEES, NJ. SN 78-565,773. PUB. 4-25-2006, FILED 2-11-2005.

LEMON KISS

THE MARK CONSISTS OF STANDARD CHARACTERS WITHOUT CLAIM TO ANY PARTICULAR FONT, STYLE, SIZE, OR COLOR.

FOR ENTERTAINMENT SERVICES IN THE NATURE OF PROVIDING AUDIO VISUAL CONTENT IN THE NATURE OF NEWS, ENTERTAINMENT, AND CULTURE VIA A GLOBAL COMMUNICATIONS NETWORK (U.S. CLS. 100, 101 AND 107).

FIRST USE 2-4-2005; IN COMMERCE 2-4-2005.

Sounds of the Underground

THE MARK CONSISTS OF STANDARD CHARACTERS WITHOUT CLAIM TO ANY PARTICULAR FONT, STYLE, SIZE, OR COLOR.

FOR ENTERTAINMENT SERVICES IN THE NATURE OF A LIVE MUSICAL FESTIVAL (U.S. CLS. 100, 101 AND 107).

FIRST USE 6-25-2005; IN COMMERCE 6-25-2005.

3,298,938. NATIONAL ACADEMY OF RECORDING ARTS & SCIENCES, INC., THE, SANTA MONICA, CA. SN 78-565,165. PUB. 8-15-2006, FILED 2-10-2005.

3,298,942. PSYCHOLOGICAL ASSOCIATES, INC., ST. LOUIS, MO. SN 78-566,885. PUB. 11-8-2005, FILED 2-14-2005.

**SELLING TO THE POWER OF Q4**

OWNER OF U.S. REG. NOS. 887,642, 1,865,177, AND 2,332,258.

NO CLAIM IS MADE TO THE EXCLUSIVE RIGHT TO USE "JAZZ", APART FROM THE MARK AS SHOWN.

FOR EDUCATIONAL SERVICES, NAMELY, CONDUCTING CONCERTS, WORKSHOPS AND SEMINARS TO PROMOTE ARTISTIC PROGRESS AND ACHIEVEMENT IN THE FIELD OF RECORDING ARTS AND SCIENCES; AND ENTERTAINMENT SERVICES IN THE NATURE OF A TELEVISION PROGRAM FEATURING MUSIC (U.S. CLS. 100, 101 AND 107).

FIRST USE 2-13-2005; IN COMMERCE 2-13-2005.

THE MARK CONSISTS OF STANDARD CHARACTERS WITHOUT CLAIM TO ANY PARTICULAR FONT, STYLE, SIZE, OR COLOR.

FOR EDUCATIONAL SERVICES, NAMELY, CONDUCTING SEMINARS IN SALES, MANAGEMENT, LEADERSHIP AND HUMAN RELATIONS (U.S. CLS. 100, 101 AND 107).

FIRST USE 11-0-2006; IN COMMERCE 11-0-2006.

CLASS 41—(Continued).

3,298,965. AMERICAN MULTI-CINEMA, INC., KANSAS CITY, MO. SN 78-574,475. PUB. 12-27-2005, FILED 2-24-2005.

YOU'RE THE STAR

THE MARK CONSISTS OF STANDARD CHARACTERS WITHOUT CLAIM TO ANY PARTICULAR FONT, STYLE, SIZE, OR COLOR.

FOR MOVIE THEATERS (U.S. CLS. 100, 101 AND 107).
FIRST USE 4-28-2006; IN COMMERCE 4-28-2006.

3,298,996. LEE, JAE SIK, SEOUL, REPUBLIC OF KOREA. SN 78-590,100. PUB. 7-18-2006, FILED 3-18-2005.



THE UPPER PART OF THE NON-LATIN CHARACTERS IN THE MARK TRANSLITERATE TO "BONKUKKUMUN," AND THE LOWER PART OF THE NON-LATIN CHARACTERS IN THE MARK TRANSLITERATE TO "BONKUKKUM"; THESE TWO CHARACTERS PROVIDE A FANCIFUL MARK. THEREFORE, THERE IS NO ENGLISH TRANSLATION OF THE "BONKUKKUMUN" AND "BONKUKKUM" RESPECTIVELY IN THE MARK.

FOR KENDO INSTRUCTION; TEACHING IN THE FIELD OF KENDO INSTRUCTION; PROVIDING FACILITIES FOR KENDO TOURNAMENT; OFFICIATING AT KENDO SPORTS CONTESTS; OPERATION OF SPORTS CAMP FOR KENDO; RENTALS OF EQUIPMENT FOR KENDO (U.S. CLS. 100, 101 AND 107).
FIRST USE 5-27-2006; IN COMMERCE 5-27-2006.

CLASS 41—(Continued).

3,298,999. THE MKR GROUP, INC., NEW YORK, NY. SN 78-590,579. PUB. 1-10-2006, FILED 3-18-2005.

**GEORGE A. ROMERO'S
DAWN OF THE DEAD**

THE MARK CONSISTS OF STANDARD CHARACTERS WITHOUT CLAIM TO ANY PARTICULAR FONT, STYLE, SIZE, OR COLOR.

THE NAME(S), PORTRAIT(S), AND/OR SIGNATURE(S) SHOWN IN THE MARK IDENTIFIES A PARTICULAR LIVING INDIVIDUAL, WHOSE CONSENT(S) TO REGISTER IS SUBMITTED.

FOR INTERNET SERVICES PROVIDING INFORMATION VIA AN ELECTRONIC GLOBAL COMPUTER NETWORK IN THE FIELD OF ENTERTAINMENT RELATING SPECIFICALLY TO MUSIC, MOVIES, AND TELEVISION; PROVIDING GENERAL INTEREST NEWS, ENTERTAINMENT, AND EDUCATIONAL INFORMATION VIA A GLOBAL COMPUTER NETWORK (U.S. CLS. 100, 101 AND 107).
FIRST USE 4-4-2007; IN COMMERCE 4-4-2007.

3,299,041. SEVEN HILLS HOLDING COMPANY, LLC, EAST ALTON, IL. SN 78-600,536. PUB. 1-3-2006, FILED 4-1-2005.

CIRCLE C STABLES

THE MARK CONSISTS OF STANDARD CHARACTERS WITHOUT CLAIM TO ANY PARTICULAR FONT, STYLE, SIZE, OR COLOR.

NO CLAIM IS MADE TO THE EXCLUSIVE RIGHT TO USE "STABLES", APART FROM THE MARK AS SHOWN.

FOR ENTERTAINMENT SERVICES IN THE NATURE OF HORSE RACING EVENTS (U.S. CLS. 100, 101 AND 107).
FIRST USE 10-15-2006; IN COMMERCE 10-15-2006.

3,299,045. SCHIFF, RAE, EVANSTON, IL. SN 78-601,606. PUB. 7-11-2006, FILED 4-4-2005.



NO CLAIM IS MADE TO THE EXCLUSIVE RIGHT TO USE AWARDS, APART FROM THE MARK AS SHOWN.

CLASS 41—(Continued).

THE COLORS BLUE AND GREEN ARE CLAIMED AS A FEATURE OF THE MARK.

THE COLORS BLUE AND GREEN APPEAR IN ALL LETTERS OF THE CLUBBIE AWARDS TRADEMARK.

FOR ENTERTAINMENT SERVICES, NAMELY, CONDUCTING AWARDS PROGRAMS TO RECOGNIZE ACHIEVEMENT IN THE NATIONAL MULTIMEDIA NIGHTLIFE INDUSTRY (U.S. CLS. 100, 101 AND 107).

FIRST USE 1-1-1991; IN COMMERCE 11-0-1992.

3,299,063. ATTLEBORO MUSEUM, INC., ATTLEBORO, MA. SN 78-606,638. PUB. 7-11-2006, FILED 4-12-2005.



THE MARK CONSISTS OF THE STYLIZED LETTERS A, A, AND M.

FOR OPERATION OF AN ART MUSEUM; ART EXHIBITIONS; MUSEUM SERVICES; PROVIDING GUIDED MUSEUM TOURS; CONDUCTING ENTERTAINMENT EXHIBITIONS IN THE FIELD OF THE VISUAL AND PERFORMING ARTS; ENTERTAINMENT EXHIBITION IN THE NATURE OF ART FESTIVALS; EDUCATIONAL AND ENTERTAINMENT SERVICES, NAMELY, PROVIDING COURSES OF INSTRUCTION, CLASSES, SEMINARS AND LECTURES IN THE FIELD OF ART, AND PROVIDING LIVE DANCE, MUSICAL, AND DRAMATIC PERFORMANCES IN THE FIELD OF THE VISUAL AND PERFORMING ARTS (U.S. CLS. 100, 101 AND 107).

FIRST USE 5-10-2005; IN COMMERCE 5-10-2005.

3,299,064. RED RIBBON MEMORIES LLC, RACINE, WI. SN 78-607,081. PUB. 1-10-2006, FILED 4-12-2005.

RED RIBBON MEMORIES

THE MARK CONSISTS OF STANDARD CHARACTERS WITHOUT CLAIM TO ANY PARTICULAR FONT, STYLE, SIZE, OR COLOR.

FOR DIGITAL PRODUCTION SERVICES, NAMELY, PRODUCING PERSONALIZED DIGITAL PRESENTATIONS FOR OTHERS BY USING PHOTOGRAPHS, AUDIO CLIPS AND VIDEO EXCERPTS OF PERSONS, PLACES AND THINGS, INCLUDING CORPORATE EVENTS AND PERSONAL EVENTS SUCH AS BIRTHDAYS, GRADUATIONS, WEDDINGS, ANNIVERSARIES, REUNIONS, FUNERALS AND THE LIKE, TO CREATE A DIGITAL SCRAPBOOK (U.S. CLS. 100, 101 AND 107).

FIRST USE 9-28-2006; IN COMMERCE 9-28-2006.

CLASS 41—(Continued).

3,299,078. HOLYFIELD, LOUISE, DALLAS, TX. SN 78-612,773. PUB. 1-24-2006, FILED 4-20-2005.

IS YOUR SKIN BEING SPOON FED?

THE MARK CONSISTS OF STANDARD CHARACTERS WITHOUT CLAIM TO ANY PARTICULAR FONT, STYLE, SIZE, OR COLOR.

FOR EDUCATIONAL SERVICES, NAMELY, PROVIDING TEACHING AND TRAINING SEMINARS AND WORKSHOPS IN THE FIELD OF PROPER SKIN-CARE AND MAKE-UP APPLICATION (U.S. CLS. 100, 101 AND 107).

FIRST USE 3-1-2007; IN COMMERCE 3-1-2007.

3,299,089. INTERBOTS INITIATIVE LLC, PITTSBURGH, PA. SN 78-616,576. PUB. 11-14-2006, FILED 4-25-2005.

Quasi

THE MARK CONSISTS OF STANDARD CHARACTERS WITHOUT CLAIM TO ANY PARTICULAR FONT, STYLE, SIZE, OR COLOR.

FOR ENTERTAINMENT IN THE NATURE OF LIVE AND VIDEO PERFORMANCES AT CONVENTIONS, CORPORATE EVENTS, SEMINARS, TRADESHOWS, AND CHILDREN'S EVENTS, BY FICTIONAL, INTERACTIVE, ANIMATRONIC AND VIRTUAL CHARACTERS; ENTERTAINMENT SERVICES IN THE NATURE OF PERFORMANCES FOR THEMED ENTERTAINMENT VENUES, PARKS AND MUSEUMS BY FICTIONAL, INTERACTIVE, ANIMATRONIC AND VIRTUAL CHARACTERS; RADIO ENTERTAINMENT SERVICES, NAMELY RADIO PROGRAMS FEATURING PERFORMANCES BY FICTIONAL, INTERACTIVE, ANIMATRONIC AND VIRTUAL CHARACTERS; TELEVISION ENTERTAINMENT SERVICES, NAMELY TELEVISION PROGRAMS FEATURING PERFORMANCES BY FICTIONAL, INTERACTIVE, ANIMATRONIC AND VIRTUAL CHARACTERS (U.S. CLS. 100, 101 AND 107).

FIRST USE 5-31-2005; IN COMMERCE 5-31-2005.

CLASS 41—(Continued).

3,299,115. TOBIN, STACEY C., CHICAGO, IL. SN 78-627,237.
PUB. 10-3-2006, FILED 5-10-2005.

The Tobin Touch

THE MARK CONSISTS OF STANDARD CHARACTERS WITHOUT CLAIM TO ANY PARTICULAR FONT, STYLE, SIZE, OR COLOR.

FOR EDITING OF WRITTEN SCIENTIFIC AND MEDICAL TEXT AND CONSULTING SERVICES RELATED THERETO (U.S. CLS. 100, 101 AND 107).

FIRST USE 3-15-2007; IN COMMERCE 3-15-2007.

3,299,121. BOARDROOM INC., STAMFORD, CT. SN 78-632,539. PUB. 6-6-2006, FILED 5-18-2005.

BOTTOM LINE EXPERTS

THE MARK CONSISTS OF STANDARD CHARACTERS WITHOUT CLAIM TO ANY PARTICULAR FONT, STYLE, SIZE, OR COLOR.

OWNER OF U.S. REG. NOS. 2,142,989, 2,368,185, AND OTHERS.

NO CLAIM IS MADE TO THE EXCLUSIVE RIGHT TO USE "EXPERTS", APART FROM THE MARK AS SHOWN.

FOR PROVIDING ONLINE NEWSLETTERS AND INSTRUCTIONAL PUBLICATIONS COVERING A WIDE RANGE OF ISSUES AND TOPICS IN THE FIELDS OF BUSINESS, FINANCE, HEALTH, NUTRITION, PERSONAL, LIFESTYLE AND SELF-IMPROVEMENT, ACCESSIBLE VIA A GLOBAL COMPUTER NETWORK (U.S. CLS. 100, 101 AND 107).

FIRST USE 3-21-2007; IN COMMERCE 3-21-2007.

3,299,127. LT MEDIA GROUP LLC, LEANDER, TX. SN 78-635,758. PUB. 2-21-2006, FILED 5-24-2005.

Lovetripper

THE MARK CONSISTS OF STANDARD CHARACTERS WITHOUT CLAIM TO ANY PARTICULAR FONT, STYLE, SIZE, OR COLOR.

FOR PUBLISHING OF WEB MAGAZINES (U.S. CLS. 100, 101 AND 107).

FIRST USE 2-14-2000; IN COMMERCE 2-14-2000.

CLASS 41—(Continued).

3,299,144. MASSEY, JAYME A, ROSEVILLE, CA. SN 78-641,409. PUB. 2-28-2006, FILED 6-1-2005.

TODDLEARN

THE MARK CONSISTS OF STANDARD CHARACTERS WITHOUT CLAIM TO ANY PARTICULAR FONT, STYLE, SIZE, OR COLOR.

FOR EDUCATIONAL SERVICES, NAMELY, CONDUCTING PARENT AND CHILD EDUCATIONALLY BASED PLAY CLASSES IN THE FIELD OF EARLY CHILDHOOD EDUCATION FEATURING ARTS AND CRAFTS, MAKE BELIEVE, SINGING, AND GYM ACTIVITIES (U.S. CLS. 100, 101 AND 107).

FIRST USE 6-1-2004; IN COMMERCE 6-2-2005.

3,299,193. VIACOM INTERNATIONAL INC., NEW YORK, NY. SN 78-662,428. PUB. 3-14-2006, FILED 7-1-2005.

WISECRACK

THE MARK CONSISTS OF STANDARD CHARACTERS WITHOUT CLAIM TO ANY PARTICULAR FONT, STYLE, SIZE, OR COLOR.

FOR ENTERTAINMENT SERVICES IN THE NATURE OF AN ON-GOING TELEVISION SERIES, FEATURING LIVE ACTION, COMEDY AND DRAMA; PROVIDING ONLINE INFORMATION IN THE FIELD OF ENTERTAINMENT CONCERNING TELEVISION PROGRAMS (U.S. CLS. 100, 101 AND 107).

FIRST USE 11-20-2006; IN COMMERCE 11-20-2006.

3,299,205. MVP SPORTSPLEX LLC, GRAND RAPIDS, MI. SN 78-667,328. PUB. 10-10-2006, FILED 7-11-2005.

MVP ATHLETIC CLUB

THE MARK CONSISTS OF STANDARD CHARACTERS WITHOUT CLAIM TO ANY PARTICULAR FONT, STYLE, SIZE, OR COLOR.

OWNER OF U.S. REG. NO. 2,972,551.

NO CLAIM IS MADE TO THE EXCLUSIVE RIGHT TO USE "ATHLETIC CLUB", APART FROM THE MARK AS SHOWN.

FOR ATHLETIC CLUB SERVICES, NAMELY PROVIDING FITNESS, SPORTS AND EXERCISE FACILITIES AND INSTRUCTION (U.S. CLS. 100, 101 AND 107).

FIRST USE 3-5-2007; IN COMMERCE 3-5-2007.

CLASS 41—(Continued).

3,299,209. BACHAND, GREGORY N., WALLINGFORD, CT. SN 78-668,493. PUB. 4-25-2006, FILED 7-12-2005.



THE COLOR(S) BLACK, WHITE AND GOLD IS/ARE CLAIMED AS A FEATURE OF THE MARK.

THE TERM MONEY AND THE NEARER SQUARE ARE SHOWN IN GOLD WHILE THE WORDS THE GRADUATE SCHOOL OF AND THE FARTHER SQUARE ARE BLACK, ALL ON A WHITE BACKGROUND.

THE MARK CONSISTS OF THE WORDS THE GRADUATE SCHOOL OF MONEY AND A PAIR OF LIKE-SIZED OVERLAPPING AND OFFSET SQUARES, THE NEARER OF WHICH IS DIAGONALLY SLOTTED.

FOR EDUCATIONAL SERVICES, NAMELY LECTURE PRESENTATIONS TO FINANCIAL MANAGEMENT PROFESSIONALS (U.S. CLS. 100, 101 AND 107).

FIRST USE 5-18-2005; IN COMMERCE 5-18-2005.

3,299,232. SUNNY LEISURE, INC., PORT OF SPAIN, TRINIDAD/TOBAGO. SN 78-680,568. PUB. 4-25-2006, FILED 7-28-2005.



THE COLOR(S) GOLD IS/ARE CLAIMED AS A FEATURE OF THE MARK.

THE MARK CONSISTS OF A REVERSE DOLLAR SIGN IN GOLD.

FOR PROVIDING INTERNET ONLINE CASINO GAMBLING AND GAMING SERVICES (U.S. CLS. 100, 101 AND 107).

FIRST USE 2-1-2005; IN COMMERCE 2-1-2005.

CLASS 41—(Continued).

3,299,278. SPIDELL PUBLISHING INC., ANAHEIM, CA. SN 78-701,379. PUB. 5-16-2006, FILED 8-26-2005.

SPIDELL TAX SEMINARS

THE MARK CONSISTS OF STANDARD CHARACTERS WITHOUT CLAIM TO ANY PARTICULAR FONT, STYLE, SIZE, OR COLOR.

OWNER OF U.S. REG. NOS. 2,994,628 AND 3,062,222.

NO CLAIM IS MADE TO THE EXCLUSIVE RIGHT TO USE "TAX SEMINARS", APART FROM THE MARK AS SHOWN.

FOR PROVIDING SEMINARS IN THE FIELDS OF TAXES AND FINANCIAL MATTERS (U.S. CLS. 100, 101 AND 107).

FIRST USE 12-1-2006; IN COMMERCE 1-31-2007.

3,299,287. SESAME WORKSHOP, NEW YORK, NY. SN 78-702,389. PUB. 6-20-2006, FILED 8-29-2005.

THE UPSIDE DOWN SHOW

THE MARK CONSISTS OF STANDARD CHARACTERS WITHOUT CLAIM TO ANY PARTICULAR FONT, STYLE, SIZE, OR COLOR.

NO CLAIM IS MADE TO THE EXCLUSIVE RIGHT TO USE "SHOW", APART FROM THE MARK AS SHOWN.

FOR ONGOING TELEVISION SERIES FEATURING ANIMATION AND LIVE ACTION DIRECTED TO CHILDREN (U.S. CLS. 100, 101 AND 107).

FIRST USE 10-13-2006; IN COMMERCE 10-13-2006.

3,299,303. PATHBUILDERS, INC., ATLANTA, GA. SN 78-709,815. PUB. 6-13-2006, FILED 9-9-2005.

Achieva

THE MARK CONSISTS OF STANDARD CHARACTERS WITHOUT CLAIM TO ANY PARTICULAR FONT, STYLE, SIZE, OR COLOR.

FOR CONDUCTING CLASSES, SEMINARS, CONFERENCES, RESEARCH GROUPS, WORKING GROUPS, AND PROGRAMS IN THE FIELDS OF PERSONAL AND PROFESSIONAL SKILLS, CAREER DEVELOPMENT, AND HUMAN CAPITAL MANAGEMENT, AND PUBLISHING PRINTED MATERIALS AND ONLINE INFORMATION IN CONNECTION THEREWITH (U.S. CLS. 100, 101 AND 107).

FIRST USE 12-9-2005; IN COMMERCE 12-9-2005.

CLASS 41—(Continued).

3,299,310. BLACK ENTERTAINMENT TELEVISION LLC, WASHINGTON, DC. SN 78-711,520. PUB. 7-25-2006, FILED 9-13-2005.



OWNER OF U.S. REG. NO. 2,690,656.
NO CLAIM IS MADE TO THE EXCLUSIVE RIGHT TO USE "GOSPEL", APART FROM THE MARK AS SHOWN. THE NAME "BOBBY JONES" IDENTIFIES A LIVING INDIVIDUAL WHOSE CONSENT IS OF RECORD.
FOR ENTERTAINMENT SERVICES IN THE NATURE OF AN ON-GOING MUSICAL AND VARIETY TELEVISION PROGRAM (U.S. CLS. 100, 101 AND 107).
FIRST USE 10-9-2005; IN COMMERCE 10-9-2005.

CLASS 41—(Continued).

3,299,341. SPIRAL CONNECTION, INC., WINSTON-SALEM, NC. SN 78-720,224. PUB. 5-23-2006, FILED 9-26-2005.

SPIRAL CONNECTION

THE MARK CONSISTS OF STANDARD CHARACTERS WITHOUT CLAIM TO ANY PARTICULAR FONT, STYLE, SIZE, OR COLOR.

FOR EDUCATION SERVICES, NAMELY, PROVIDING SEMINARS, CONFERENCES, WORKSHOPS AND CLASSES IN THE FIELD OF ORGANIZATIONAL STRATEGY, HUMAN CAPITAL MANAGEMENT AND MEASUREMENT, JOB ANALYSIS, PROFESSIONAL DEVELOPMENT, EVALUATING AND DEVELOPING LEADERSHIP SKILLS, MEASURING AND IMPROVING EMPLOYEE PRODUCTIVITY, IMPROVING COMMUNICATION SKILLS, MEETING FACILITATION, AND COURSE MATERIALS DISTRIBUTED IN CONNECTION THEREWITH; PERSONAL COACHING SERVICES IN THE FIELD OF EXECUTIVE COACHING SERVICES; PROVIDING NEWSLETTERS IN THE FIELD OF HUMAN RESOURCE AND PERSONNEL MANAGEMENT, ASSESSMENT AND STRATEGY, PROFESSIONAL DEVELOPMENT, EMPLOYEE MEASUREMENT AND RELATIONSHIP MANAGEMENT VIA E-MAIL (U.S. CLS. 100, 101 AND 107).

FIRST USE 4-30-2006; IN COMMERCE 4-30-2006.

3,299,345. MAJOR LEAGUE LACROSSE LLC, BRIGHTON, MA. SN 78-720,613. PUB. 7-4-2006, FILED 9-26-2005.

DENVER OUTLAWS

THE MARK CONSISTS OF STANDARD CHARACTERS WITHOUT CLAIM TO ANY PARTICULAR FONT, STYLE, SIZE, OR COLOR.

NO CLAIM IS MADE TO THE EXCLUSIVE RIGHT TO USE "DENVER", APART FROM THE MARK AS SHOWN.

FOR ENTERTAINMENT IN THE NATURE OF LACROSSE GAMES, COMPETITIONS AND TOURNAMENTS; ENTERTAINMENT, NAMELY, PARTICIPATION IN LACROSSE GAMES AND COMPETITIONS; CONDUCTING ENTERTAINMENT EXHIBITIONS IN THE NATURE OF LACROSSE GAMES AND COMPETITIONS; ORGANIZING EXHIBITIONS FOR THE SPORT OF LACROSSE; PROVIDING FACILITIES FOR LACROSSE TOURNAMENTS; ARRANGING AND CONDUCTING ATHLETIC COMPETITIONS; ENTERTAINMENT IN THE NATURE OF ON-GOING TELEVISION PROGRAMS IN THE FIELD OF SPORTING EVENTS; ENTERTAINMENT, NAMELY, A CONTINUING SPORTS EVENT SHOW BROADCAST OVER TELEVISION, SATELLITE, AUDIO AND VIDEO MEDIA; ENTERTAINMENT SERVICES, NAMELY, PROVIDING A TELEVISION PROGRAM FEATURING SPORTING EVENTS VIA A GLOBAL COMPUTER NETWORK; PROVIDING AN ON-LINE COMPUTER DATABASE IN THE FIELD OF LACROSSE; ENTERTAINMENT SERVICES, NAMELY, PROVIDING A WEB SITE FEATURING INFORMATION PERTAINING TO LACROSSE GOODS AND SERVICES (U.S. CLS. 100, 101 AND 107).

FIRST USE 10-31-2005; IN COMMERCE 10-31-2005.

3,299,337. UNIVERSAL CITY STUDIOS LLLP, UNIVERSAL CITY, CA. SN 78-718,735. PUB. 7-11-2006, FILED 9-22-2005.

UNIVERSAL ANIMATION STUDIOS

THE MARK CONSISTS OF STANDARD CHARACTERS WITHOUT CLAIM TO ANY PARTICULAR FONT, STYLE, SIZE, OR COLOR.

OWNER OF U.S. REG. NOS. 2,438,538, 2,758,255, AND OTHERS.

NO CLAIM IS MADE TO THE EXCLUSIVE RIGHT TO USE "ANIMATION STUDIOS", APART FROM THE MARK AS SHOWN.

FOR ENTERTAINMENT SERVICES IN THE NATURE OF PRODUCTION OF ANIMATED AND LIVE-ACTION MOTION PICTURE FILMS AND TELEVISION PROGRAMS; PRODUCTION OF PRE-RECORDED VIDEO TAPES, VIDEO CASSETTES AND DVDS ALL FEATURING ANIMATED AND LIVE-ACTION MOTION PICTURE FILMS AND TELEVISION PROGRAMS; PRODUCTION AND DISTRIBUTION OF ANIMATED AND LIVE-ACTION MOTION PICTURE FILMS AND TELEVISION PROGRAMS FOR OTHERS (U.S. CLS. 100, 101 AND 107).

FIRST USE 3-21-2006; IN COMMERCE 3-21-2006.

CLASS 41—(Continued).

3,299,353. STEPHEN J. PISHNERY, AKA MURDER BY MIDNIGHT, NORTH OLMSTED, OH. SN 78-722,807. PUB. 8-1-2006, FILED 9-28-2005.

CLASS 41—(Continued).

3,299,375. URBAN ADVENTURES COMPANIES, INC, WASHINGTON, DC. SN 78-726,909. PUB. 12-26-2006, FILED 10-5-2005.

Vida Fitness

MURDER BY MIDNIGHT

THE MARK CONSISTS OF STANDARD CHARACTERS WITHOUT CLAIM TO ANY PARTICULAR FONT, STYLE, SIZE, OR COLOR.

FOR COMPOSITION OF MUSIC FOR OTHERS; ENTERTAINMENT IN THE NATURE OF VISUAL AND AUDIO PERFORMANCES, AND MUSICAL, VARIETY, NEWS AND COMEDY SHOWS; ENTERTAINMENT IN THE NATURE OF VISUAL AND AUDIO PERFORMANCES, NAMELY, MUSICAL BAND, ROCK GROUP, GYMNASIAC, DANCE, AND BALLET PERFORMANCES; ENTERTAINMENT NAMELY, LIVE PERFORMANCES BY A MUSICAL BAND; ENTERTAINMENT SERVICES, NAMELY, AN ONLINE ACTIVITY WHERE YOU CREATE YOUR OWN MUSIC VIDEOS; ENTERTAINMENT SERVICES, NAMELY, PROVIDING A WEB SITE FEATURING MUSICAL PERFORMANCES, MUSICAL VIDEOS, RELATED FILM CLIPS, PHOTOGRAPHS, AND OTHER MULTIMEDIA MATERIALS; ENTERTAINMENT SERVICES, NAMELY, PROVIDING PRERECORDED MUSIC, INFORMATION IN THE FIELD OF MUSIC, AND COMMENTARY AND ARTICLES ABOUT MUSIC, ALL ON-LINE VIA A GLOBAL COMPUTER NETWORK; ENTERTAINMENT, NAMELY LIVE MUSIC CONCERTS; ENTERTAINMENT, NAMELY LIVE PERFORMANCES BY MUSICAL BANDS; MUSIC COMPOSITION AND TRANSCRIPTION FOR OTHERS; MUSIC COMPOSITION FOR OTHERS; MUSIC PRODUCTION SERVICES; MUSIC PUBLISHING SERVICES; MUSIC TRANSCRIPTION FOR OTHERS; PLANNING ARRANGEMENT OF SHOWING MOVIES, SHOWS, PLAYS OR MUSICAL PERFORMANCES; PRESENTATION OF MUSICAL PERFORMANCE; PROVIDING FACILITIES FOR MOVIES, SHOWS, PLAYS, MUSIC OR EDUCATIONAL TRAINING; PROVIDING RATINGS FOR TELEVISION, MOVIE, MUSIC, VIDEO AND VIDEO GAME CONTENT; PUBLICATION OF MUSICAL TEXTS; RENTAL OF MUSICAL INSTRUMENTS; RENTAL OF PHONOGRAPHIC AND MUSIC RECORDINGS; THEATRICAL AND MUSICAL FLOOR SHOWS PROVIDED AT DISCOTEQUES AND NIGHTCLUBS (U.S. CLS. 100, 101 AND 107).

FIRST USE 4-5-2005; IN COMMERCE 6-4-2005.

THE MARK CONSISTS OF STANDARD CHARACTERS WITHOUT CLAIM TO ANY PARTICULAR FONT, STYLE, SIZE, OR COLOR.

NO CLAIM IS MADE TO THE EXCLUSIVE RIGHT TO USE "FITNESS", APART FROM THE MARK AS SHOWN.

THE ENGLISH TRANSLATION OF THE WORD VIDA IN THE MARK IS LIFE.

FOR PHYSICAL FITNESS INSTRUCTION; PROVIDING FITNESS AND EXERCISE FACILITIES (U.S. CLS. 100, 101 AND 107).

FIRST USE 12-15-2006; IN COMMERCE 12-15-2006.

3,299,382. TASWERKS LLC, BERKELEY, CA. SN 78-728,385. PUB. 6-20-2006, FILED 10-6-2005.

THE HEALING HEARTH

THE MARK CONSISTS OF STANDARD CHARACTERS WITHOUT CLAIM TO ANY PARTICULAR FONT, STYLE, SIZE, OR COLOR.

FOR EDUCATIONAL SERVICES, NAMELY, CONDUCTING CLASSES IN THE FIELD OF COOKING (U.S. CLS. 100, 101 AND 107).

FIRST USE 12-0-2005; IN COMMERCE 12-0-2005.

CLASS 41—(Continued).

3,299,392. BASIC TRAUMA LIFE SUPPORT INTERNATIONAL, INC., OAKBROOK TERRACE, IL. SN 78-730,177. PUB. 6-13-2006, FILED 10-10-2005.



OWNER OF U.S. REG. NO. 1,928,942.

NO CLAIM IS MADE TO THE EXCLUSIVE RIGHT TO USE "INTERNATIONAL TRAUMA LIFE SUPPORT", APART FROM THE MARK AS SHOWN.

THE LINING IS A FEATURE OF THE MARK AND DOES NOT INDICATE COLOR.

FOR EDUCATIONAL SERVICES, NAMELY CONDUCTING WORKSHOPS, COURSES, AND CONFERENCES IN THE FIELD OF EMERGENCY MEDICAL CARE AND LIFE SUPPORT, AND DISTRIBUTION OF BOOKS AND COURSE MATERIALS THEREWITH (U.S. CLS. 100, 101 AND 107).

FIRST USE 10-0-2005; IN COMMERCE 10-0-2005.

CLASS 41—(Continued).

3,299,450. THE PROGRAMMING GROUP LTD., NEW YORK, NY. SN 78-737,846. PUB. 7-4-2006, FILED 10-21-2005.

MEDIAPLACE

THE MARK CONSISTS OF STANDARD CHARACTERS WITHOUT CLAIM TO ANY PARTICULAR FONT, STYLE, SIZE, OR COLOR.

FOR PROGRAMMING SERVICES, NAMELY, PROVIDING AUDIO AND VISUAL PROGRAMMING TO CAPTIVE AUDIENCES IN THE HOSPITALITY INDUSTRY, HEALTH CARE INDUSTRY, SPORTS ARENAS, EDUCATIONAL FACILITIES, ARMED FORCES BASES, STORES AND INSTITUTIONS BY WAY OF TELEVISION, RADIO, GLOBAL WIDE AREA NETWORKS, LOCAL NETWORKS, AND SATELLITE AND CELLULAR NETWORKS (U.S. CLS. 100, 101 AND 107).

FIRST USE 9-0-2005; IN COMMERCE 9-0-2005.

3,299,452. SOMMERS, SUSAN, NEW YORK, NY. SN 78-737,951. PUB. 7-18-2006, FILED 10-21-2005.

STYLE POWER

THE MARK CONSISTS OF STANDARD CHARACTERS WITHOUT CLAIM TO ANY PARTICULAR FONT, STYLE, SIZE, OR COLOR.

NO CLAIM IS MADE TO THE EXCLUSIVE RIGHT TO USE "STYLE", APART FROM THE MARK AS SHOWN.

FOR EDUCATIONAL SERVICES, NAMELY PROVIDING SEMINARS IN THE FIELD OF PERSONAL PRESENCE, PERSONAL STYLE, FASHION, ETIQUETTE AND PERSONAL DEMEANOR FOR CORPORATIONS, GROUPS AND INDIVIDUALS (U.S. CLS. 100, 101 AND 107).

FIRST USE 2-27-2007; IN COMMERCE 3-27-2007.

3,299,408. KEITH I BARKSDALE, SAN DIEGO, CA. SN 78-733,384. PUB. 8-1-2006, FILED 10-14-2005.

40LoveFitness

THE MARK CONSISTS OF BENT BARBELL WITH WEIGHTS ATTACHED AT BOTH ENDS AND TWO TENNIS RACQUETS CROSSED WITH THE NUMBER 40 AND THE LETTERS LOVEFITNESS.

FOR TENNIS INSTRUCTION (U.S. CLS. 100, 101 AND 107).

FIRST USE 1-3-2007; IN COMMERCE 1-3-2007.

3,299,487. TRIFECTA ENTERTAINMENT, LLC, ENCINO, CA. SN 78-742,929. PUB. 7-11-2006, FILED 10-28-2005.

TRIFECTA

THE MARK CONSISTS OF STANDARD CHARACTERS WITHOUT CLAIM TO ANY PARTICULAR FONT, STYLE, SIZE, OR COLOR.

FOR TELEVISION AND FILM PRODUCTION SERVICES (U.S. CLS. 100, 101 AND 107).

FIRST USE 7-1-2005; IN COMMERCE 7-1-2005.

CLASS 41—(Continued).

3,299,491. 2218 WESTERN LLC, SEATTLE, WA. SN 78-743,891.
PUB. 7-4-2006, FILED 10-31-2005.

VENOM

THE MARK CONSISTS OF STANDARD CHARACTERS WITHOUT CLAIM TO ANY PARTICULAR FONT, STYLE, SIZE, OR COLOR.

FOR DISCOTHEQUES; OPERATING OF A DISCOTHEQUE (U.S. CLS. 100, 101 AND 107).

FIRST USE 12-31-2005; IN COMMERCE 12-31-2005.

3,299,492. CONOVER, DONALD L., ANNAPOLIS, MD. SN 78-744,148. PUB. 7-11-2006, FILED 11-1-2005.

WORDS MATTER

THE MARK CONSISTS OF STANDARD CHARACTERS WITHOUT CLAIM TO ANY PARTICULAR FONT, STYLE, SIZE, OR COLOR.

FOR ENTERTAINMENT SERVICES, NAMELY, PROVIDING A TELEVISION PROGRAM IN THE FIELD OF NEWS, CURRENT AFFAIRS, COMMENTARY AND INTERVIEWS VIA A GLOBAL COMPUTER NETWORK; ENTERTAINMENT, NAMELY A CONTINUING NEWS, CURRENT AFFAIRS, COMMENTARY AND INTERVIEW SHOW BROADCAST OVER TELEVISION, SATELLITE, AUDIO, AND VIDEO MEDIA; ONLINE JOURNALS, NAMELY, BLOGS FEATURING NEWS, CURRENT AFFAIRS, COMMENTARY AND INTERVIEWS (U.S. CLS. 100, 101 AND 107).

FIRST USE 10-8-2005; IN COMMERCE 10-8-2005.

3,299,526. THOENE, THOMAS LUKE, LOS OSOS, CA. SN 78-749,724. PUB. 8-1-2006, FILED 11-8-2005.

AURI

THE MARK CONSISTS OF STANDARD CHARACTERS WITHOUT CLAIM TO ANY PARTICULAR FONT, STYLE, SIZE, OR COLOR.

OWNER OF U.S. REG. NO. 2,978,944.

FOR AUDIO RECORDING AND PRODUCTION (U.S. CLS. 100, 101 AND 107).

FIRST USE 11-1-2005; IN COMMERCE 2-28-2007.

CLASS 41—(Continued).

3,299,532. MAJOR LEAGUE BASEBALL PROPERTIES, INC., NEW YORK, NY. SN 78-750,693. PUB. 7-4-2006, FILED 11-9-2005.

MLB.COM

THE MARK CONSISTS OF STANDARD CHARACTERS WITHOUT CLAIM TO ANY PARTICULAR FONT, STYLE, SIZE, OR COLOR.

OWNER OF U.S. REG. NOS. 2,800,750, 2,800,752, AND OTHERS.

FOR ENTERTAINMENT SERVICES, NAMELY, BASEBALL GAMES, COMPETITIONS AND EXHIBITIONS RENDERED AND THROUGH BROADCAST MEDIA INCLUDING TELEVISION AND RADIO, AND VIA A GLOBAL COMPUTER NETWORK OR A COMMERCIAL ON-LINE SERVICE; INFORMATION SERVICES, NAMELY, PROVIDING INFORMATION IN THE FIELD OF SPORTS, ENTERTAINMENT AND RELATED TOPICS, AND PROVIDING FOR INFORMATIONAL MESSAGES RELATING THERETO; ENTERTAINMENT SERVICES, NAMELY, PROVIDING MULTI-USER INTERACTIVE COMPUTER GAMES ALL VIA A GLOBAL COMPUTER NETWORK OR A COMMERCIAL ON-LINE SERVICE; EDUCATIONAL SERVICES IN THE NATURE OF BASEBALL SKILLS PROGRAMS, BASEBALL CAMPS, SEMINARS AND CLINICS OFFERED AND THROUGH ON-LINE INSTRUCTION; ENTERTAINMENT SERVICES, NAMELY, PRODUCTION OF PROGRAMMING BROADCAST VIA TELEVISION, RADIO AND A GLOBAL COMPUTER NETWORK OR A COMMERCIAL ON-LINE SERVICE; ORGANIZING COMMUNITY SPORTING EVENTS; ORGANIZING AND CONDUCTING FANTASY SPORTS, SPORTS CONTESTS AND SWEEPSTAKES; FAN CLUBS; PROVIDING ON-LINE NEWSLETTERS IN THE FIELD OF BASEBALL (U.S. CLS. 100, 101 AND 107).

FIRST USE 1-1-2001; IN COMMERCE 1-1-2001.

3,299,541. VIACOM INTERNATIONAL INC., NEW YORK, NY. SN 78-752,235. PUB. 6-27-2006, FILED 11-11-2005.

THE DRUG YEARS

THE MARK CONSISTS OF STANDARD CHARACTERS WITHOUT CLAIM TO ANY PARTICULAR FONT, STYLE, SIZE, OR COLOR.

FOR ENTERTAINMENT SERVICES IN THE NATURE OF TELEVISION SERIES, FEATURING LIVE ACTION, COMEDY AND DRAMA; PROVIDING ONLINE INFORMATION IN THE FIELD OF ENTERTAINMENT CONCERNING TELEVISION PROGRAMS (U.S. CLS. 100, 101 AND 107).

FIRST USE 11-16-2006; IN COMMERCE 11-16-2006.

CLASS 41—(Continued).

3,299,553. WE: WOMEN'S ENTERTAINMENT LLC, JERICHO, NY. SN 78-754,112. PUB. 1-9-2007, FILED 11-15-2005.

HOLIDAY HOME INVASION

THE MARK CONSISTS OF STANDARD CHARACTERS WITHOUT CLAIM TO ANY PARTICULAR FONT, STYLE, SIZE, OR COLOR.

FOR ENTERTAINMENT SERVICES, NAMELY, AN ON-GOING REALITY-BASED TELEVISION PROGRAM IN THE NATURE OF HOME MAKEOVERS (U.S. CLS. 100, 101 AND 107).

FIRST USE 12-31-2005; IN COMMERCE 12-31-2005.

3,299,616. EF CULTURAL TOURS SARL (ZUG BRANCH), ZUG, SWITZERLAND. SN 78-767,309. PUB. 8-8-2006, FILED 12-6-2005.

iStory

THE MARK CONSISTS OF STANDARD CHARACTERS WITHOUT CLAIM TO ANY PARTICULAR FONT, STYLE, SIZE, OR COLOR.

FOR EDUCATIONAL SERVICES, NAMELY, PROVIDING COURSES OF INSTRUCTION IN THE USE OF VIDEO AND AUDIO RECORDING EQUIPMENT AND COMPUTERS TO TOURISTS ON TRAVEL TOURS; ENTERTAINMENT SERVICES, NAMELY, ORGANIZING SEMINARS AND MEETINGS FEATURING FILMS OR OTHER MULTIMEDIA PROJECTS, INCLUDING TRAVEL DOCUMENTARIES (U.S. CLS. 100, 101 AND 107).

FIRST USE 1-0-2006; IN COMMERCE 1-0-2006.

3,299,635. BOARD OF REGENTS OF THE UNIVERSITY SYSTEM OF GEORGIA, ATLANTA, GA. SN 78-770,320. PUB. 7-11-2006, FILED 12-9-2005.

EAGLE INFORMATICS

THE MARK CONSISTS OF STANDARD CHARACTERS WITHOUT CLAIM TO ANY PARTICULAR FONT, STYLE, SIZE, OR COLOR.

OWNER OF U.S. REG. NO. 1,697,700.

NO CLAIM IS MADE TO THE EXCLUSIVE RIGHT TO USE "INFORMATICS", APART FROM THE MARK AS SHOWN.

FOR EDUCATIONAL SERVICES, NAMELY CONDUCTING COURSES OF STUDY AT THE UNIVERSITY LEVEL (U.S. CLS. 100, 101 AND 107).

FIRST USE 2-23-2005; IN COMMERCE 2-23-2005.

CLASS 41—(Continued).

3,299,647. LEADING EDGE MARKETING, INC., NASSAU, NEW PROVIDENCE, BAHAMAS. SN 78-772,770. PUB. 7-4-2006, FILED 12-14-2005.

**Some guys "get it" ...some
guys don't**

THE MARK CONSISTS OF STANDARD CHARACTERS WITHOUT CLAIM TO ANY PARTICULAR FONT, STYLE, SIZE, OR COLOR.

FOR PROVIDING NEWSLETTERS IN THE FIELD OF SEXUAL ACTIVITIES, SEXUAL HEALTH, AND RELATED PRODUCTS INFORMATION VIA E-MAIL (U.S. CLS. 100, 101 AND 107).

FIRST USE 12-1-2005; IN COMMERCE 12-1-2005.

3,299,651. COURTROOM TELEVISION NETWORK LLC, NEW YORK, NY. SN 78-774,357. PUB. 7-18-2006, FILED 12-15-2005.

HOT PURSUIT

THE MARK CONSISTS OF STANDARD CHARACTERS WITHOUT CLAIM TO ANY PARTICULAR FONT, STYLE, SIZE, OR COLOR.

FOR ENTERTAINMENT SERVICES, NAMELY ON-GOING CABLE TELEVISION PROGRAMS ON THE SUBJECTS OF CRIME, CRIMINAL JUSTICE, LAW ENFORCEMENT AND CRIMINAL INVESTIGATIONS; PROVIDING INFORMATION AND ENTERTAINMENT OVER THE INTERNET ABOUT TELEVISION PROGRAMS ON THE SUBJECTS OF CRIME, CRIMINAL JUSTICE, LAW ENFORCEMENT AND CRIMINAL INVESTIGATIONS (U.S. CLS. 100, 101 AND 107).

FIRST USE 1-12-2006; IN COMMERCE 1-12-2006.

3,299,654. MIRAGE RESORTS, INCORPORATED, LAS VEGAS, NV. SN 78-774,466. PUB. 9-26-2006, FILED 12-15-2005.

JET MIRAGE NIGHTCLUB

THE MARK CONSISTS OF STANDARD CHARACTERS WITHOUT CLAIM TO ANY PARTICULAR FONT, STYLE, SIZE, OR COLOR.

OWNER OF U.S. REG. NOS. 1,948,786, 2,951,094, AND OTHERS.

NO CLAIM IS MADE TO THE EXCLUSIVE RIGHT TO USE "NIGHTCLUB", APART FROM THE MARK AS SHOWN.

FOR NIGHT CLUBS (U.S. CLS. 100, 101 AND 107).

FIRST USE 12-30-2005; IN COMMERCE 12-30-2005.

CLASS 41—(Continued).

3,299,662. EDITORIAL PROJECTS IN EDUCATION, INC., BETHESDA, MD. SN 78-776,581. PUB. 2-27-2007, FILED 12-19-2005.

NCLB ALERT

THE MARK CONSISTS OF STANDARD CHARACTERS WITHOUT CLAIM TO ANY PARTICULAR FONT, STYLE, SIZE, OR COLOR.

NO CLAIM IS MADE TO THE EXCLUSIVE RIGHT TO USE "NCLB", APART FROM THE MARK AS SHOWN.

FOR PROVIDING ONLINE NEWSLETTERS IN THE FIELD OF EDUCATION, SPECIFICALLY, IN AREAS RELATING TO LEGISLATION FOR IMPROVING EDUCATION (U.S. CLS. 100, 101 AND 107).

FIRST USE 3-1-2007; IN COMMERCE 6-27-2007.

3,299,664. BEAULIEU GROUP, LLC, DALTON, GA. SN 78-776,885. PUB. 7-4-2006, FILED 12-20-2005.

BEAU-TECH

THE MARK CONSISTS OF STANDARD CHARACTERS WITHOUT CLAIM TO ANY PARTICULAR FONT, STYLE, SIZE, OR COLOR.

FOR TRAINING SERVICES IN THE FIELD OF THE INSTALLATION OF RESIDENTIAL AND COMMERCIAL CARPET (U.S. CLS. 100, 101 AND 107).

FIRST USE 12-31-2005; IN COMMERCE 12-31-2005.

3,299,667. EDITORIAL PROJECTS IN EDUCATION, INC., BETHESDA, MD. SN 78-777,549. PUB. 3-13-2007, FILED 12-20-2005.

CURRICULUM MATTERS

THE MARK CONSISTS OF STANDARD CHARACTERS WITHOUT CLAIM TO ANY PARTICULAR FONT, STYLE, SIZE, OR COLOR.

NO CLAIM IS MADE TO THE EXCLUSIVE RIGHT TO USE "CURRICULUM", APART FROM THE MARK AS SHOWN.

FOR PROVIDING ONLINE NEWSLETTERS IN THE FIELD OF EDUCATION (U.S. CLS. 100, 101 AND 107).

FIRST USE 4-1-2006; IN COMMERCE 6-25-2007.

CLASS 41—(Continued).

3,299,696. WE: WOMEN'S ENTERTAINMENT LLC, JERICHO, NY. SN 78-787,336. PUB. 1-9-2007, FILED 1-9-2006.



THE COLOR(S) BLUE AND BEIGE IS/ARE CLAIMED AS A FEATURE OF THE MARK.

THE MARK CONSISTS OF THE WORDS "SKATING'S NEXT STAR" APPEARS IN BLUE, AND THE LAST "A" IS ACTUALLY A BEIGE STAR.

FOR ENTERTAINMENT SERVICES, NAMELY, AN ON-GOING REALITY-BASED TELEVISION PROGRAM IN THE FIELD OF FIGURE SKATING (U.S. CLS. 100, 101 AND 107).

FIRST USE 1-3-2006; IN COMMERCE 1-3-2006.

3,299,702. BLACK BELT KARATE STUDIO INC., RACINE, WI. SN 78-788,254. PUB. 9-5-2006, FILED 1-10-2006.



NO CLAIM IS MADE TO THE EXCLUSIVE RIGHT TO USE THE NON-LATIN CHARACTERS THAT MEAN "KARATE", APART FROM THE MARK AS SHOWN.

THE MARK CONSISTS IN PART OF THE PROFILE OF A BLACK WAR HORSE ASSOCIATED WITH KARATE.

THE NON-LATIN CHARACTERS IN THE MARK TRANSLITERATE TO "KARA" AND "TE", AND THIS MEANS "EMPTY HAND" IN ENGLISH AND IS UNDERSTOOD AS THE WORD "KARATE".

FOR MARTIAL ARTS INSTRUCTION (U.S. CLS. 100, 101 AND 107).

FIRST USE 11-1-2005; IN COMMERCE 11-1-2005.

CLASS 41—(Continued).

3,299,739. THE CARTOON NETWORK, INC., ATLANTA, GA. SN 78-797,922. PUB. 9-12-2006, FILED 1-24-2006.

PLATFORM INTERNATIONAL
ANIMATION FESTIVAL

THE MARK CONSISTS OF STANDARD CHARACTERS WITHOUT CLAIM TO ANY PARTICULAR FONT, STYLE, SIZE, OR COLOR.

NO CLAIM IS MADE TO THE EXCLUSIVE RIGHT TO USE "INTERNATIONAL ANIMATION FESTIVAL", APART FROM THE MARK AS SHOWN.

FOR ENTERTAINMENT SERVICES, NAMELY, PLANNING, ORGANIZING AND CONDUCTING FILM FESTIVALS (U.S. CLS. 100, 101 AND 107).

FIRST USE 6-5-2006; IN COMMERCE 6-5-2006.

3,299,772. SEARCH BY HEADLINES.COM, RENO, NV. SN 78-809,155. PUB. 11-14-2006, FILED 2-7-2006.



NO CLAIM IS MADE TO THE EXCLUSIVE RIGHT TO USE "SEARCH BY HEADLINES", APART FROM THE MARK AS SHOWN.

FOR PROVIDING ON-LINE REFERENCE INFORMATION AND NEWS IN THE FIELD OF CURRENT EVENTS REPORTING; PROVIDING A WEBSITE ALLOWING OTHERS TO POST NEWS WITH MULTIPLE ROTATING HEADLINES AND SEARCH NEWS RELATED ITEMS BY HEADLINE AND KEYWORDS (U.S. CLS. 100, 101 AND 107).

FIRST USE 1-6-2006; IN COMMERCE 3-12-2006.

3,299,790. RAYNALDO, GARZA, MONARCH BEACH, CA. SN 78-814,954. PUB. 10-3-2006, FILED 2-15-2006.

OLEWOOD

THE MARK CONSISTS OF STANDARD CHARACTERS WITHOUT CLAIM TO ANY PARTICULAR FONT, STYLE, SIZE, OR COLOR.

FOR ENTERTAINMENT SERVICES, NAMELY IN THE NATURE OF ONGOING TELEVISION, RADIO AND INTERNET PROGRAMS IN THE FIELDS OF MUSIC, SPORTS, TELEVISION, MOTION PICTURES, POLITICS, EDUCATION, NEWS AND AWARDS; PRODUCTION OF TELEVISION, RADIO AND INTERNET PROGRAMS; AND DISTRIBUTION OF FOR OTHERS (U.S. CLS. 100, 101 AND 107).

FIRST USE 4-10-2002; IN COMMERCE 1-15-2007.

CLASS 41—(Continued).

3,299,802. CHICAGO SUN-TIMES LLC, CHICAGO, IL. SN 78-817,623. PUB. 10-10-2006, FILED 2-17-2006.

STNG WIRE

THE MARK CONSISTS OF STANDARD CHARACTERS WITHOUT CLAIM TO ANY PARTICULAR FONT, STYLE, SIZE, OR COLOR.

NO CLAIM IS MADE TO THE EXCLUSIVE RIGHT TO USE "WIRE", APART FROM THE MARK AS SHOWN.

FOR PROVIDING NEWS REPORTING SERVICES (U.S. CLS. 100, 101 AND 107).

FIRST USE 2-13-2006; IN COMMERCE 2-13-2006.

3,299,803. IBARRA BRITO GROUP, INC., SALT LAKE CITY, UT. SN 78-818,076. PUB. 10-3-2006, FILED 2-17-2006.

EXPRESSCOACH

THE MARK CONSISTS OF STANDARD CHARACTERS WITHOUT CLAIM TO ANY PARTICULAR FONT, STYLE, SIZE, OR COLOR.

FOR EDUCATIONAL SERVICES, NAMELY, CONDUCTING ON-LINE TEACHING AND COACHING TO TRAIN PERSONNEL IN THE AUTOMOTIVE SALES AND SERVICE INDUSTRY (U.S. CLS. 100, 101 AND 107).

FIRST USE 11-30-2004; IN COMMERCE 10-11-2006.

3,299,821. LOOMIS, ROBERT VERNE, ST. CHARLES, IL. SN 78-824,528. PUB. 10-17-2006, FILED 2-27-2006.

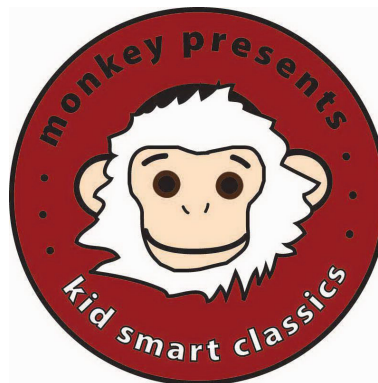

NO CLAIM IS MADE TO THE EXCLUSIVE RIGHT TO USE "CLASSICS", APART FROM THE MARK AS SHOWN.

THE COLOR(S) RED, WHITE, BLACK, BEIGE, BROWN IS/ARE CLAIMED AS A FEATURE OF THE MARK.

CLASS 41—(Continued).

THE MARK CONSISTS OF A SMILING MONKEY FACE INSIDE A RED CIRCLE WITH THE TEXT "MONKEY PRESENTS..." CURVING IN AN ARC ABOVE THE MONKEY'S FACE AND "KID SMART CLASSICS" BELOW. A DEEP RED IS USED FOR THE BACKGROUND, WHITE FOR THE MONKEY'S BEARD-LIKE FACIAL HAIR AND TEXT, BLACK FOR TEXT AND THE MONKEY'S OUTLINE AND HEAD, AND BEIGE AND BROWN FOR THE MONKEY'S FACE AND EYES RESPECTIVELY.

FOR ENTERTAINMENT SERVICES IN THE NATURE OF ON-GOING TELEVISION PROGRAMS IN THE FIELD OF CHILDREN'S ENTERTAINMENT (U.S. CLS. 100, 101 AND 107).

FIRST USE 9-16-2005; IN COMMERCE 2-28-2007.

CLASS 41—(Continued).

3,299,879. CHANG, STEVE P, DBA TEEBOX MARKETING SOLUTIONS, LA JOLLA, CA. SN 78-847,293. PUB. 11-14-2006, FILED 3-27-2006.



3,299,838. INSPIRVISION LLC, MOUNTAIN VIEW, CA. SN 78-830,643. PUB. 10-24-2006, FILED 3-7-2006.



THE MARK CONSISTS OF THE WORD "TEEBOX" IN A MODIFIED "EXCELERATE" FONT AT TWICE THE NORMAL HEIGHT FOLLOWED BY ".COM".

FOR PROVIDING A WEBSITE THROUGH WHICH GOLFERS RESERVE TEE TIMES AT GOLF COURSES (U.S. CLS. 100, 101 AND 107).

FIRST USE 12-30-2006; IN COMMERCE 12-31-2006.

THE MARK CONSISTS OF THE CAPITAL LETTER "I" FOLLOWED BY LOWER CASE "NSPIRVISION" STYLIZED AND COMBINED INTO A WORD.

FOR ON-LINE PUBLICATION OF PHOTOGRAPHS AND VIDEOS; PUBLISHING OF WEB MAGAZINES; ENTERTAINMENT SERVICES, NAMELY, PROVIDING ON-LINE REVIEWS OF PHOTOGRAPHS, MOVIES, VIDEOS, BOOKS; MOTION PICTURE FILM PRODUCTION (U.S. CLS. 100, 101 AND 107).

FIRST USE 1-1-2006; IN COMMERCE 2-10-2006.

3,299,888. GROUP FITNESS USA, LLC, GAITHERSBURG, MD. SN 78-850,878. PUB. 11-21-2006, FILED 3-31-2006.

3,299,862. BAKER, DOUGLAS DANE, KNOXVILLE, TN. SN 78-838,155. PUB. 11-21-2006, FILED 3-15-2006.



NO CLAIM IS MADE TO THE EXCLUSIVE RIGHT TO USE "KNOXVILLE", APART FROM THE MARK AS SHOWN.

FOR NEWSPAPER PUBLICATION (U.S. CLS. 100, 101 AND 107).

FIRST USE 4-20-2006; IN COMMERCE 4-20-2006.



THE MARK CONSISTS OF STANDARD CHARACTERS WITHOUT CLAIM TO ANY PARTICULAR FONT, STYLE, SIZE, OR COLOR.

NO CLAIM IS MADE TO THE EXCLUSIVE RIGHT TO USE BODY, APART FROM THE MARK AS SHOWN.

FOR PHYSICAL HEALTH AND FITNESS INSTRUCTION; PHYSICAL FITNESS AND WELLNESS CONSULTATION; PHYSICAL FITNESS INSTRUCTION SERVICES FOR THE PURPOSE OF PERSONAL MOTIVATION (U.S. CLS. 100, 101 AND 107).

FIRST USE 3-18-2006; IN COMMERCE 3-18-2006.

CLASS 41—(Continued).

3,299,907. THE WIGGLES PTY LIMITED, NEW SOUTH WALES, AUSTRALIA. SN 78-858,555. PUB. 2-27-2007, FILED 4-11-2006.



OWNER OF U.S. REG. NOS. 2,207,356, 3,139,404, AND OTHERS.

FOR LIVE PERFORMANCES FEATURING COSTUMED CHARACTERS; LIVE PERFORMANCES FEATURING MUSIC, SONGS AND DIALOGUE; PROVIDING RECREATIONAL AND EDUCATIONAL FACILITIES, NAMELY, THEATRES, PLAYGROUNDS, PLAYING AREAS AND PLAY FACILITIES FOR CHILDREN AND ACCOMPANYING ADULTS (U.S. CLS. 100, 101 AND 107).

FIRST USE 9-25-2006; IN COMMERCE 9-25-2006.

3,299,911. KIEHFUSS, MOLLIE, GREENBRAE, CA. SN 78-860,891. PUB. 12-5-2006, FILED 4-13-2006.

From The Hip

THE MARK CONSISTS OF STANDARD CHARACTERS WITHOUT CLAIM TO ANY PARTICULAR FONT, STYLE, SIZE, OR COLOR.

FOR ENTERTAINMENT SERVICES, NAMELY, PRODUCTION OF VIDEO FOR OTHERS FOR USE IN DVD'S, TELEVISION PROGRAMS AND ON WEB SITES FEATURING PARENTING INFORMATION AND ADVICE (U.S. CLS. 100, 101 AND 107).

FIRST USE 8-1-2006; IN COMMERCE 8-1-2006.

CLASS 41—(Continued).

3,299,918. KUYPER COLLEGE, GRAND RAPIDS, MI. SN 78-863,653. PUB. 7-18-2006, FILED 4-18-2006.

KUYPER  COLLEGE

NO CLAIM IS MADE TO THE EXCLUSIVE RIGHT TO USE "COLLEGE", APART FROM THE MARK AS SHOWN. THE MARK CONSISTS OF A LAMP INSIDE AN OVAL IN BETWEEN THE WORDS KUYPER AND COLLEGE.

FOR EDUCATIONAL SERVICES NAMELY PROVIDING COURSES OF INSTRUCTION AT THE COLLEGE LEVEL (U.S. CLS. 100, 101 AND 107).

FIRST USE 4-20-2006; IN COMMERCE 4-20-2006.

3,299,926. UNIVERSAL CITY STUDIOS LLLP, UNIVERSAL CITY, CA. SN 78-865,035. PUB. 11-28-2006, FILED 4-19-2006.

THE FAST AND THE FURIOUS: EXTREME CLOSE-UP

THE MARK CONSISTS OF STANDARD CHARACTERS WITHOUT CLAIM TO ANY PARTICULAR FONT, STYLE, SIZE, OR COLOR.

FOR ENTERTAINMENT SERVICES IN THE NATURE OF AN AMUSEMENT PARK ATTRACTION (U.S. CLS. 100, 101 AND 107).

FIRST USE 6-10-2006; IN COMMERCE 6-10-2006.

3,299,952. HERSHEY CHOCOLATE & CONFECTIONERY CORPORATION, WHEAT RIDGE, CO. SN 78-874,993. PUB. 10-10-2006, FILED 5-3-2006.

REESE'S XTREME CUP CHALLENGE

THE MARK CONSISTS OF STANDARD CHARACTERS WITHOUT CLAIM TO ANY PARTICULAR FONT, STYLE, SIZE, OR COLOR.

OWNER OF U.S. REG. NOS. 1,074,163, 1,834,806, AND OTHERS.

FOR ENTERTAINMENT IN THE NATURE OF AN AMUSEMENT PARK RIDE (U.S. CLS. 100, 101 AND 107).

FIRST USE 5-5-2006; IN COMMERCE 5-5-2006.

CLASS 41—(Continued).

3,299,957. WARNER BROS. ENTERTAINMENT INC., BURBANK, CA. SN 78-875,530. PUB. 11-21-2006, FILED 5-3-2006.

THE CLASS

THE MARK CONSISTS OF STANDARD CHARACTERS WITHOUT CLAIM TO ANY PARTICULAR FONT, STYLE, SIZE, OR COLOR.

FOR ENTERTAINMENT SERVICES IN THE NATURE OF LIVE-ACTION, COMEDY, DRAMA AND ANIMATED TELEVISION SERIES; PRODUCTION OF LIVE-ACTION, COMEDY, DRAMA AND ANIMATED TELEVISION SERIES; INTERNET SERVICES PROVIDING INFORMATION VIA AN ELECTRONIC GLOBAL COMPUTER NETWORK IN THE FIELD OF ENTERTAINMENT RELATING SPECIFICALLY TO TELEVISION (U.S. CLS. 100, 101 AND 107).

FIRST USE 9-18-2006; IN COMMERCE 9-18-2006.

3,299,973. CRATERIAN PERFORMANCES COMPANY, MEDFORD, OR. SN 78-880,450. PUB. 1-2-2007, FILED 5-10-2006.

It's more than
entertainment. It's
life. Don't miss it.

THE MARK CONSISTS OF STANDARD CHARACTERS WITHOUT CLAIM TO ANY PARTICULAR FONT, STYLE, SIZE, OR COLOR.

FOR PERFORMING ART SERVICES, NAMELY, THEATER PRODUCTIONS (U.S. CLS. 100, 101 AND 107).
FIRST USE 12-3-2006; IN COMMERCE 12-3-2006.

CLASS 41—(Continued).

3,299,976. ANTI-STEROID PROGRAM, LLC, KEY LARGO, FL. SN 78-882,079. PUB. 12-12-2006, FILED 5-12-2006.



FOR EDUCATIONAL AND SPORTS TRAINING SERVICES, NAMELY, EDUCATING ATHLETES THROUGH LECTURES, WORKSHOPS, TRAINING SESSIONS, AND CAMP PROGRAMS ABOUT THE IMPORTANCE OF STAYING OFF STEROIDS AND OTHER HARMFUL ILLEGAL PERFORMANCE ENHANCERS AND ABOUT HEALTHY ALTERNATIVE SOLUTIONS FOR ENHANCING SPORTS PERFORMANCE; PROVIDING ON-LINE INFORMATION ABOUT THE IMPORTANCE OF STAYING OFF STEROIDS AND OTHER HARMFUL ILLEGAL PERFORMANCE ENHANCERS AND ABOUT HEALTHY ALTERNATIVE SOLUTIONS FOR ENHANCING SPORTS PERFORMANCE (U.S. CLS. 100, 101 AND 107).

FIRST USE 6-0-2006; IN COMMERCE 6-0-2006.

3,299,994. CFOED, L.L.C., DBA SMART SAMANTHA, ALPHARETTA, GA. SN 78-886,872. PUB. 12-12-2006, FILED 5-18-2006.

SMART SAMANTHA

THE MARK CONSISTS OF STANDARD CHARACTERS WITHOUT CLAIM TO ANY PARTICULAR FONT, STYLE, SIZE, OR COLOR.

FOR EDUCATION SERVICES, NAMELY, PROVIDING ON-LINE TRAINING AND TUTORING IN THE FORM OF SEMINARS, CONFERENCES, WORKSHOPS, AND INTERACTIVE WEBSITES IN THE FIELD(S) OF BUSINESS AND ENTREPRENEURISM (U.S. CLS. 100, 101 AND 107).
FIRST USE 1-21-2007; IN COMMERCE 1-21-2007.

CLASS 41—(Continued).

3,299,996. NEXT STEP PUBLISHING, INC., VICTOR, NY. SN 78-887,239. PUB. 12-12-2006, FILED 5-18-2006.



OWNER OF U.S. REG. NOS. 2,222,157, 3,067,634, AND OTHERS.

THE MARK CONSISTS OF THE WORDING "NEXTSTEP YOUR LIFE, AFTER HIGH SCHOOL" TOGETHER WITH A STYLIZED FOOT DESIGN.

FOR PUBLICATION OF BOOKS, MAGAZINES, ELECTRONIC PUBLICATIONS, CDS AND THE TEXT AND GRAPHIC WORKS OF OTHERS ON THE TOPICS OF COLLEGE PLANNING, CAREER PLANNING, LIFE SKILLS, BRANDING, MARKETING AND ADVERTISING CONTENT (U.S. CLS. 100, 101 AND 107).
FIRST USE 9-0-2005; IN COMMERCE 9-0-2005.

CLASS 41—(Continued).

3,300,036. PGA TOUR, INC., PONTE VEDRA BEACH, FL. SN 78-903,630. PUB. 1-9-2007, FILED 6-8-2006.

COME TO PLAY

THE MARK CONSISTS OF STANDARD CHARACTERS WITHOUT CLAIM TO ANY PARTICULAR FONT, STYLE, SIZE, OR COLOR.

FOR CONDUCTING A SERIES OF PROFESSIONAL GOLF TOURNAMENTS (U.S. CLS. 100, 101 AND 107).
FIRST USE 6-1-2007; IN COMMERCE 6-1-2007.

3,300,059. DOLAN PRODUCTIONS, LLC, BROOKFIELD, WI. SN 78-911,307. PUB. 1-30-2007, FILED 6-19-2006.

**A HUSBAND & WIFE VACATION:
FOR BETTER, FOR WORSE!**

3,300,012. KENTUCKY COMMUNITY AND TECHNICAL COLLEGE SYSTEM, VERSAILLES, KY. SN 78-895,673. PUB. 1-9-2007, FILED 5-30-2006.



THE MARK CONSISTS OF STANDARD CHARACTERS WITHOUT CLAIM TO ANY PARTICULAR FONT, STYLE, SIZE, OR COLOR.

FOR ENTERTAINMENT IN THE NATURE OF ONGOING TELEVISION PROGRAMS IN THE FIELD OF TRAVEL (U.S. CLS. 100, 101 AND 107).
FIRST USE 8-5-2006; IN COMMERCE 8-5-2006.

3,300,084. SKADDEN, ARPS, SLATE, MEAGHER & FLOM LLP, NEW YORK, NY. SN 78-918,310. PUB. 2-13-2007, FILED 6-27-2006.

LA25

NO CLAIM IS MADE TO THE EXCLUSIVE RIGHT TO USE "NORTH AMERICAN RACING ACADEMY", APART FROM THE MARK AS SHOWN.

THE COLORS BLUE, GOLD, WHITE, YELLOW, AND GRAY ARE CLAIMED AS A FEATURE OF THE MARK.

THE COLOR BLUE APPEARS ON THE JOCKEY SILKS, SADDLECLOTH AND THE OUTLINE OF THE HORSE AND ON THE OUTLINE OF A DIAMOND, A LINE EXTENDING ON EITHER SIDE FROM THE DIAMOND AND IN THE LETTERS AND WORD NARA AND NORTH AMERICAN RACING ACADEMY. THE COLOR GOLD APPEARS ON THE JOCKEY'S CAP AND SILKS, A SADDLECLOTH AND IN THE CENTER OF THE DIAMOND BEHIND THE LETTERS NARA; THE COLORS GRAY, YELLOW, AND WHITE APPEAR IN THE SHADED IMPRESSIONS OF THE JOCKEY AND HORSE POSITIONED IN THE BACKGROUND, WITH THE COLOR WHITE DISPLAYED AS THE BODY COLOR OF THE HORSE.

FOR PROVIDING COURSES OF INSTRUCTION FOR PARTICIPANTS IN THE HORSE RACING INDUSTRY (U.S. CLS. 100, 101 AND 107).
FIRST USE 9-11-2006; IN COMMERCE 9-11-2006.

THE MARK CONSISTS OF STANDARD CHARACTERS WITHOUT CLAIM TO ANY PARTICULAR FONT, STYLE, SIZE, OR COLOR.

FOR ART EXHIBITIONS; ENTERTAINMENT IN THE NATURE OF COMPETITIONS IN THE FIELD OF ART (U.S. CLS. 100, 101 AND 107).
FIRST USE 7-7-2006; IN COMMERCE 7-7-2006.

CLASS 41—(Continued).

3,300,119. MICHAELS, STELLA, DBA KICKIN' THE BOTTLE MUSIC, NEW YORK, NY. SN 78-928,139. PUB. 3-13-2007, FILED 7-12-2006.

Stella's Attic

THE MARK CONSISTS OF STANDARD CHARACTERS WITHOUT CLAIM TO ANY PARTICULAR FONT, STYLE, SIZE, OR COLOR.

FOR PRESENTATION OF MUSICAL PERFORMANCE (U.S. CLS. 100, 101 AND 107).

FIRST USE 11-27-1999; IN COMMERCE 1-7-2001.

3,300,142. STEVEN E. STRATMAN, MINNEAPOLIS, MN. SN 78-936,557. PUB. 2-27-2007, FILED 7-24-2006.



NO CLAIM IS MADE TO THE EXCLUSIVE RIGHT TO USE "COMPANY", APART FROM THE MARK AS SHOWN. THE MARK CONSISTS OF A GLOBE INSIDE A COMPASS.

FOR PUBLICATION OF TRAVEL GUIDES (U.S. CLS. 100, 101 AND 107).

FIRST USE 4-1-2006; IN COMMERCE 8-25-2006.

3,300,151. BENJAMIN B. HANSEN, LOS ANGELES, CA. SN 78-942,562. PUB. 2-27-2007, FILED 8-1-2006.

STREET BEAT

THE COLOR(S) RED, WHITE AND BLACK IS/ARE CLAIMED AS A FEATURE OF THE MARK.

THE MARK CONSISTS OF THE WORDS STREET BEAT IN RED WITH WHITE CRACKS AND OUTLINED IN BLACK.

FOR ENTERTAINMENT IN THE NATURE OF LIVE PERFORMANCES BY A MUSICAL BAND (U.S. CLS. 100, 101 AND 107).

FIRST USE 10-13-2004; IN COMMERCE 5-20-2007.

CLASS 41—(Continued).

3,300,219. MICROSOFT CORPORATION, REDMOND, WA. SN 78-978,730. PUB. 9-12-2006, FILED 2-3-2006.

NINETY-NINE NIGHTS

THE MARK CONSISTS OF STANDARD CHARACTERS WITHOUT CLAIM TO ANY PARTICULAR FONT, STYLE, SIZE, OR COLOR.

FOR PROVIDING A WEB SITE FEATURING INFORMATION IN THE FIELD OF COMPUTER GAMES, SCIENCE FICTION, GAMES AND ENTERTAINMENT; PROVIDING INFORMATION ON-LINE RELATING TO COMPUTER GAMES AND COMPUTER ENHANCEMENTS FOR GAMES (U.S. CLS. 100, 101 AND 107).

FIRST USE 8-15-2006; IN COMMERCE 8-15-2006.

3,300,230. BRICK, SHARON M., NEW YORK, NY. AND FULLERTON, DONNA M., NEW YORK, NY. SN 78-978,805. PUB. 9-12-2006, FILED 12-28-2005.



FOR SEMINARS IN THE FIELD OF LEADERSHIP, PERSONAL DEVELOPMENT, MOTIVATION AND CONSULTATION THEREOF IN PERSON AND VIA GLOBAL COMPUTER NETWORK (U.S. CLS. 100, 101 AND 107).

FIRST USE 4-15-2005; IN COMMERCE 4-15-2005.

CLASS 41—(Continued).

3,300,232. TAKE THAT PRODUCTIONS, INC, DBA HIP HOP HARRY PRODUCTIONS, BEVERLY HILLS, CA. SN 78-978,809. PUB. 9-12-2006, FILED 5-12-2005.

HIP HOP HARRY

THE MARK CONSISTS OF STANDARD CHARACTERS WITHOUT CLAIM TO ANY PARTICULAR FONT, STYLE, SIZE, OR COLOR.

NO CLAIM IS MADE TO THE EXCLUSIVE RIGHT TO USE "HIP HOP", APART FROM THE MARK AS SHOWN.

FOR ENTERTAINMENT SERVICES IN THE NATURE OF ON-GOING TELEVISION PROGRAMS AND LIVE VARIETY PERFORMANCES BY COSTUMED AND NON-COSTUMED PERFORMERS IN THE FIELD OF CHILDREN'S ENTERTAINMENT (U.S. CLS. 100, 101 AND 107).

FIRST USE 8-24-2006; IN COMMERCE 8-24-2006.

CLASS 42—(Continued).

3,298,486. LANTEIGNE, MARK, AUSTIN, TX. SN 76-614,886. PUB. 7-18-2006, FILED 10-2-2004.

THIRD I/O

THE MARK CONSISTS OF STANDARD CHARACTERS WITHOUT CLAIM TO ANY PARTICULAR FONT, STYLE, SIZE, OR COLOR.

NO CLAIM IS MADE TO THE EXCLUSIVE RIGHT TO USE "I/O", APART FROM THE MARK AS SHOWN.

FOR COMPUTER SERVICES NAMELY, DESIGNING OF DATA STORAGE SYSTEMS AND INFRASTRUCTURES FOR OTHERS; SOFTWARE DESIGN, DEVELOPMENT AND IMPLEMENTATION; COMPUTER TESTING SERVICES; TECHNICAL SUPPORT SERVICES NAMELY, TROUBLESHOOTING OF COMPUTER HARDWARE AND SOFTWARE PROBLEMS; AND COMPUTER CONSULTING (U.S. CLS. 100 AND 101).

FIRST USE 10-12-2004; IN COMMERCE 10-12-2004.

3,298,520. HEALTH DIALOG SERVICES CORPORATION, BOSTON, MA. SN 76-635,507. PUB. 1-10-2006, FILED 4-7-2005.

UNWARRANTED VARIATION

THE MARK CONSISTS OF STANDARD CHARACTERS WITHOUT CLAIM TO ANY PARTICULAR FONT, STYLE, SIZE, OR COLOR.

FOR MEDICAL DATA ANALYSIS AND RESEARCH SERVICES (U.S. CLS. 100 AND 101).

FIRST USE 12-31-1999; IN COMMERCE 12-31-1999.

CLASS 42—SCIENTIFIC, COMPUTER AND LEGAL SERVICES

3,298,478. UCN, INC., BLUFFDALE, UT. SN 76-610,965. PUB. 7-4-2006, FILED 9-8-2004.

INTOUCH

THE MARK CONSISTS OF STANDARD CHARACTERS WITHOUT CLAIM TO ANY PARTICULAR FONT, STYLE, SIZE, OR COLOR.

FOR APPLICATION SERVICE PROVIDER (ASP) FEATURING SOFTWARE FOR LOGGING, RECORDING, MONITORING, TRACKING, REPORTING AND DISPOSITIONING OF TELEPHONE CALLS, FACSIMILE TRANSMISSIONS, E-MAILS, AND WEB BASED MESSAGES TO IN-OFFICE OR AT-HOME WORKERS, PARTIES, CALLERS OR CUSTOMERS FOR USE IN THE FIELDS OF CUSTOMER SERVICE, CUSTOMER SUPPORT, INSIDE SALES, COLLECTIONS OR DIRECT RESPONSE MARKETING (U.S. CLS. 100 AND 101).

FIRST USE 3-31-2004; IN COMMERCE 3-31-2004.

3,298,548. AG BELL ACADEMY FOR LISTENING AND SPOKEN LANGUAGE, WASHINGTON, DC. SN 76-645,476. PUB. 6-27-2006, FILED 8-22-2005.

AG BELL ACADEMY FOR LISTENING AND SPOKEN LANGUAGE

THE MARK CONSISTS OF STANDARD CHARACTERS WITHOUT CLAIM TO ANY PARTICULAR FONT, STYLE, SIZE, OR COLOR.

NO CLAIM IS MADE TO THE EXCLUSIVE RIGHT TO USE "ACADEMY FOR LISTENING AND SPOKEN LANGUAGE", APART FROM THE MARK AS SHOWN.

FOR TESTING, ANALYSIS, AND EVALUATION OF HOW OTHERS ASSIST INDIVIDUALS WHO ARE DEAF OR HARD OF HEARING TO LISTEN AND SPEAK, FOR THE PURPOSE OF CERTIFICATION (U.S. CLS. 100 AND 101).

FIRST USE 12-0-2005; IN COMMERCE 12-0-2005.

CLASS 42—(Continued).

3,298,560. URAC, WASHINGTON, DC. SN 76-648,753. PUB. 6-20-2006, FILED 10-13-2005.

ACCREDITNET

THE MARK CONSISTS OF STANDARD CHARACTERS WITHOUT CLAIM TO ANY PARTICULAR FONT, STYLE, SIZE, OR COLOR.

FOR PROVIDING ONLINE NON-DOWNLOADABLE SOFTWARE FOR MANAGING THE PROCESS OF HEALTH CARE MANAGEMENT ACCREDITATION AND CERTIFICATION; AND ACCREDITATION AND CERTIFICATION SERVICES, NAMELY, ANALYSIS AND EVALUATION OF THE QUALITY AND EFFICIENCY OF HEALTH CARE SERVICES FOR THE PURPOSE OF ACCREDITATION AND CERTIFICATION (U.S. CLS. 100 AND 101).

FIRST USE 10-30-2005; IN COMMERCE 1-1-2006.

3,298,565. IDEAS WELL DONE, LLC, WINOOSKI, VT. SN 76-649,244. PUB. 7-18-2006, FILED 10-27-2005.

IDEAS WELL DONE

THE MARK CONSISTS OF STANDARD CHARACTERS WITHOUT CLAIM TO ANY PARTICULAR FONT, STYLE, SIZE, OR COLOR.

FOR PRODUCT DEVELOPMENT, NAMELY DEVELOPMENT OF FOOD SERVICE EQUIPMENT (U.S. CLS. 100 AND 101).

FIRST USE 2-22-2007; IN COMMERCE 2-22-2007.

3,298,671. INNOVAPORT LLC, WHITEFISH BAY, WI. SN 78-240,854. PUB. 1-13-2004, FILED 4-22-2003.

INNOVAPORT

FOR LICENSING AND TRANSFER OF INTELLECTUAL PROPERTY (U.S. CLS. 100 AND 101).

FIRST USE 3-12-2007; IN COMMERCE 3-12-2007.

3,298,737. FLORIDA HOSPITAL COLLEGE OF HEALTH SCIENCE, ORLANDO, FL. SN 78-378,931. PUB. 12-13-2005, FILED 3-4-2004.

OSWORX**CLASS 42—(Continued).**

THE MARK CONSISTS OF STANDARD CHARACTERS WITHOUT CLAIM TO ANY PARTICULAR FONT, STYLE, SIZE, OR COLOR.

FOR PROVIDING ONLINE NON-DOWNLOADABLE SOFTWARE FOR USE IN DEVELOPING EDUCATIONAL AND TRAINING PROGRAMS FOR USE IN DISTANCE LEARNING (U.S. CLS. 100 AND 101).

FIRST USE 2-22-2007; IN COMMERCE 2-22-2007.

3,298,925. DISPLAY-BOX LLC, BAY HEAD, NJ. SN 78-556,516. PUB. 6-13-2006, FILED 1-30-2005.

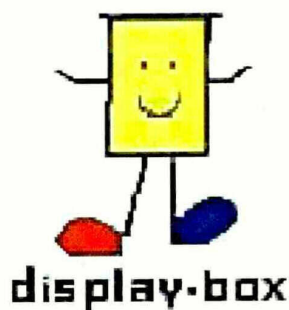

THE COLOR(S) YELLOW, RED AND BLUE IS/ARE CLAIMED AS A FEATURE OF THE MARK.

THE COLOR YELLOW APPEARS INSIDE THE STYLIZED PACKAGE, THE COLOR RED APPEARS IN THE RIGHT FOOT AND THE COLOR BLUE APPEARS IN THE LEFT FOOT OF THE STYLIZED PACKAGE.

FOR DESIGN AND DEVELOPMENT SERVICES FOR OTHERS IN CONNECTION WITH MODULAR AND PORTABLE SUPPORTS, SHELVES, COUNTERS, GRAPHICS AND DISPLAYS FOR TRADE SHOW AND POINT OF SALE DISPLAYS, EXHIBITS AND BOOTHS (U.S. CLS. 100 AND 101).

FIRST USE 11-1-2001; IN COMMERCE 11-21-2001.

3,298,975. CITY OF GAINESVILLE, FLORIDA, DBA GAINESVILLE REGIONAL UTILITIES, GAINESVILLE, FL. SN 78-578,489. PUB. 6-6-2006, FILED 3-2-2005.



OWNER OF U.S. REG. NO. 2,508,279.

THE COLOR(S) GREEN, BLUE, AND ORANGE IS/ARE CLAIMED AS A FEATURE OF THE MARK.

THE COLORS GREEN AND BLUE APPEAR ON THE ALLIGATOR AND THE COLOR ORANGE APPEARS IN THE WORD GATOR.NET, ON THE FOOTBALL AND IN THE BACKGROUND, AND ALL THREE COLORS ARE

CLASS 42—(Continued).

CLAIMED AS A FEATURE OF THE MARK.
 THE MARK CONSISTS OF THE STYLIZED WORD MARK GATOR.NET WHERE THE GATORS GROWL ONLINE JUXTAPOSED IN FRONT OF AN ARTISTIC RENDITION OF AN ALLIGATOR CARRYING A FOOTBALL.
 FOR PROVIDING MULTIPLE-USE ACCESS TO A GLOBAL COMPUTER INFORMATION NETWORK FOR THE TRANSFER AND DISSEMINATION OF A WIDE RANGE OF INFORMATION (U.S. CLS. 100 AND 101).
 FIRST USE 8-1-2005; IN COMMERCE 8-1-2005.

CLASS 42—(Continued).

3,299,149. TAN, YEW GEE CHRISTOPHER, SHATIN, NEW TERRITORIES, HONG KONG. SN 78-644,840. PUB. 11-7-2006, FILED 6-6-2005.

3,299,007. PC LAN TECHS, INC., WEST PALM BEACH, FL. SN 78-593,007. PUB. 5-30-2006, FILED 3-23-2005.



NO CLAIM IS MADE TO THE EXCLUSIVE RIGHT TO USE "PC LAN TECHS COMPUTER AND NETWORKING SOLUTIONS", APART FROM THE MARK AS SHOWN.
 THE COLORS BLUE, LIGHT BLUE, AND PURPLE ARE CLAIMED AS A FEATURE OF THE MARK.
 THE COLORS BLUE, LIGHT BLUE AND PURPLE APPEAR ON THE MAP OF FLORIDA AND GLOBE AND LETTERING.
 THE MARK CONSISTS OF PC LAN TECHS COMPUTER AND NETWORKING SOLUTIONS AND MAP OF FLORIDA.
 FOR TECHNICAL SUPPORT SERVICES, NAMELY, TROUBLESHOOTING OF COMPUTER HARDWARE, NETWORKS AND SOFTWARE PROBLEMS (U.S. CLS. 100 AND 101).
 FIRST USE 1-1-2001; IN COMMERCE 1-1-2001.

THE MARK CONSISTS OF THE WORDS KNOWLEDGE COMMUNITY, FIVE CHINESE CHARACTERS AND A DEVICE.
 THE NON-LATIN CHARACTER(S) IN THE MARK TRANSLITERATES INTO ZHI; SHI; YAN; XI; QUN, AND THIS MEANS PERCEIVE; RECOGNIZE; RESEARCH; PRACTICE; MULTITUDE IN ENGLISH.
 FOR COMPUTER SERVICE, NAMELY, PROVIDING A COMPUTER-SUPPORTED COLLABORATION INTERACTIVE ONLINE COMPUTER PLATFORM IN THE FIELD OF EDUCATION WHICH FACILITATES STUDENTS' LEARNING; COMPUTER SERVICE, NAMELY, ACTING AS AN APPLICATION SERVICE PROVIDER IN THE FIELD OF KNOWLEDGE MANAGEMENT TO HOST COMPUTER APPLICATION SOFTWARE FOR THE COLLECTION, EDITING, ORGANIZING, MODIFYING, BOOK MARKING, TRANSMISSION, STORAGE AND SHARING OF DATA AND INFORMATION; COMPUTER SERVICE, NAMELY, ACTING AS AN APPLICATION SERVICE PROVIDER IN THE FIELD OF KNOWLEDGE MANAGEMENT TO HOST COMPUTER APPLICATION SOFTWARE FOR SEARCHING AND RETRIEVING INFORMATION FROM DATABASES AND COMPUTER NETWORKS; COMPUTER SERVICE, NAMELY, ACTING AS AN APPLICATION SERVICE PROVIDER IN THE FIELD OF KNOWLEDGE MANAGEMENT TO HOST COMPUTER APPLICATION SOFTWARE FOR CREATING SEARCHABLE DATABASES OF INFORMATION AND DATA; COMPUTER SERVICES, NAMELY CREATING INDEXES OF INFORMATION, SITES AND OTHER RESOURCES AVAILABLE ON COMPUTER NETWORKS; COMPUTER SERVICES, NAMELY, MANAGING WEB SITES FOR OTHERS; COMPUTER SOFTWARE CONSULTATION, DEVELOPMENT, DESIGN AND MAINTENANCE; DESIGN OF HOME PAGES, COMPUTER SOFTWARE AND WEB SITES; HOSTING THE WEB SITES OF OTHERS ON A COMPUTER SERVER FOR A GLOBAL COMPUTER NETWORK (U.S. CLS. 100 AND 101).
 FIRST USE 7-1-2004; IN COMMERCE 7-1-2005.

CLASS 42—(Continued).

3,299,222. TRIAD HOSPITALS, INC., PLANO, TX. SN 78-675,592. PUB. 12-12-2006, FILED 7-21-2005.

LABCARE PLUS

THE MARK CONSISTS OF STANDARD CHARACTERS WITHOUT CLAIM TO ANY PARTICULAR FONT, STYLE, SIZE, OR COLOR.

FOR MEDICAL LABORATORY SERVICES, NAMELY, LABORATORY TESTING, EVALUATION, AND RESEARCH SERVICES; MEDICAL LABORATORY SERVICES, NAMELY, DISEASE MANAGEMENT AND PATHOLOGY SERVICES; AND MEDICAL LABORATORY SERVICES, NAMELY, PROVIDING MEDICAL LABORATORY INFORMATION TO HEALTH CARE PROVIDERS, MANAGED CARE PROVIDERS AND PATIENTS VIA GLOBAL COMPUTER NETWORKS, FACSIMILE, AND SIMILAR MEANS (U.S. CLS. 100 AND 101). FIRST USE 12-31-2005; IN COMMERCE 12-31-2005.

3,299,223. TRIAD HOSPITALS, INC., PLANO, TX. SN 78-675,717. PUB. 1-2-2007, FILED 7-21-2005.



FOR MEDICAL LABORATORY SERVICES, NAMELY, LABORATORY TESTING, EVALUATION, AND RESEARCH SERVICES; MEDICAL LABORATORY SERVICES, NAMELY, DISEASE MANAGEMENT AND PATHOLOGY SERVICES; AND MEDICAL LABORATORY SERVICES, NAMELY, PROVIDING MEDICAL LABORATORY INFORMATION TO HEALTH CARE PROVIDERS, MANAGED CARE PROVIDERS AND PATIENTS VIA GLOBAL COMPUTER NETWORKS, FACSIMILE, AND SIMILAR MEANS (U.S. CLS. 100 AND 101). FIRST USE 12-31-2005; IN COMMERCE 12-31-2005.

CLASS 42—(Continued).

3,299,242. STAYSTAFFED TECHNOLOGIES, LLC, BOCA RATON, FL. SN 78-683,390. PUB. 11-14-2006, FILED 8-2-2005.

**STAY STAFFED CANDIDATE
DIRECT**

THE MARK CONSISTS OF STANDARD CHARACTERS WITHOUT CLAIM TO ANY PARTICULAR FONT, STYLE, SIZE, OR COLOR.

FOR APPLICATION SERVICE PROVIDER FEATURING SOFTWARE FOR PERSONNEL STAFFING, SCHEDULING AND TIME CONTROL MANAGEMENT, INCLUDING REPORTING AND TRACKING FEATURES IN THE FIELD OF HEALTHCARE STAFFING MANAGEMENT (U.S. CLS. 100 AND 101).

FIRST USE 3-22-2007; IN COMMERCE 3-22-2007.

3,299,272. HANSEN TECHNOLOGIES CORP., BURR RIDGE, IL. SN 78-698,565. PUB. 10-3-2006, FILED 8-23-2005.



THE NAME "HANSEN" IN THE MARK DOES NOT IDENTIFY A LIVING INDIVIDUAL.

FOR DESIGN OF LARGE INDUSTRIAL AND COMMERCIAL REFRIGERATION SYSTEMS FOR OTHERS (U.S. CLS. 100 AND 101).

FIRST USE 5-1-1996; IN COMMERCE 5-1-1996.

3,299,322. COMPLUS DATA INNOVATIONS, INC., TARRYTOWN, NY. SN 78-715,378. PUB. 12-26-2006, FILED 9-19-2005.

FASTTRACK

THE MARK CONSISTS OF STANDARD CHARACTERS WITHOUT CLAIM TO ANY PARTICULAR FONT, STYLE, SIZE, OR COLOR.

FOR PARKING TICKET MANAGEMENT SERVICES IN THE NATURE OF PROVIDING ON-LINE NON-DOWNLOADABLE SOFTWARE FOR MUNICIPALITIES AND UNIVERSITIES THAT TRACKS ISSUED PARKING VIOLATIONS WITHIN THEIR JURISDICTIONS AND PERMITS AUTHORIZED PERSONS TO ENTER TICKETS ISSUED FOR VIOLATIONS, RESEARCH TICKET HISTORY, PROCESS FINE PAYMENTS, AND ISSUE REPORTS RELATED THERETO (U.S. CLS. 100 AND 101).

FIRST USE 10-1-2005; IN COMMERCE 10-1-2005.

CLASS 42—(Continued).

3,299,331. THE CARPET AND RUG INSTITUTE, DALTON, GA. SN 78-717,757. PUB. 6-27-2006, FILED 9-21-2005.

CARPET CLEANING IS NOW
ROCKET SCIENCE

THE MARK CONSISTS OF STANDARD CHARACTERS WITHOUT CLAIM TO ANY PARTICULAR FONT, STYLE, SIZE, OR COLOR.

FOR EVALUATION AND TESTING OF CLEANING EXTRACTORS AND DEVICES FOR OTHERS (U.S. CLS. 100 AND 101).

FIRST USE 4-1-2006; IN COMMERCE 4-1-2006.

3,299,380. EARTHLINK, INC., ATLANTA, GA. SN 78-727,951. PUB. 6-13-2006, FILED 10-6-2005.

EARTHLINK CYBER CHECK

THE MARK CONSISTS OF STANDARD CHARACTERS WITHOUT CLAIM TO ANY PARTICULAR FONT, STYLE, SIZE, OR COLOR.

OWNER OF U.S. REG. NOS. 1,950,376, 2,556,818, AND OTHERS.

NO CLAIM IS MADE TO THE EXCLUSIVE RIGHT TO USE "CYBER CHECK", APART FROM THE MARK AS SHOWN.

FOR MAINTENANCE OF COMPUTER SOFTWARE, NAMELY, REMOVAL OF SPYWARE, COMPUTER VIRUSES AND OTHER SOFTWARE PROBLEMS THROUGH USE OF A REMOTE DESKTOP SHARING TOOL, ENABLING SERVICE TECHNICIANS TO VIEW, CONTROL AND CLEAN COMPUTERS REMOTELY (U.S. CLS. 100 AND 101).

FIRST USE 3-1-2006; IN COMMERCE 3-1-2006.

3,299,467. DATADEFENSE, LLC, MADISON, WI. SN 78-739,662. PUB. 7-4-2006, FILED 10-25-2005.

dataDEFENSE

THE MARK CONSISTS OF STANDARD CHARACTERS WITHOUT CLAIM TO ANY PARTICULAR FONT, STYLE, SIZE, OR COLOR.

FOR COMPUTER SECURITY SERVICE, NAMELY, RESTRICTING ACCESS TO AND BY COMPUTER NETWORKS TO AND OF UNDESIRE WEB SITES, MEDIA AND INDIVIDUALS AND FACILITIES (U.S. CLS. 100 AND 101).

FIRST USE 1-1-2006; IN COMMERCE 1-1-2006.

CLASS 42—(Continued).

3,299,486. JS PRODUCTS, INC., LAS VEGAS, NV. SN 78-742,797. PUB. 9-26-2006, FILED 10-28-2005.



NO CLAIM IS MADE TO THE EXCLUSIVE RIGHT TO USE "PROGRAM", APART FROM THE MARK AS SHOWN. THE MARK CONSISTS OF THE WORDS PARTNER SUPPORT PROGRAM WITH A SUN AND TWO SHAKING HANDS.

FOR RESEARCH AND DEVELOPMENT FOR NEW PRODUCTS FOR OTHERS (U.S. CLS. 100 AND 101).

FIRST USE 11-3-2005; IN COMMERCE 11-3-2005.

3,299,551. HAWKES, KENNETH GALE, MIAMI, FL. SN 78-753,840. PUB. 11-21-2006, FILED 11-15-2005.



NO CLAIM IS MADE TO THE EXCLUSIVE RIGHT TO USE "MARITIME MEDIATION, INC. SPECIALIZING IN ADMIRALTY, MARITIME, AND TRANSPORTATION DISPUTE RESOLUTION MMI", APART FROM THE MARK AS SHOWN.

THE MARK CONSISTS OF A CREST HAVING A BOAT, TRUCK, AIRPLANE AND SHIP PICTURED THEREON, THE CREST BEING LOCATED IN FRONT OF AN ANCHOR HAVING ROPE AND TWO SWORDS WHICH CROSS ONE ANOTHER. THE WORDS MARITIME MEDIATION, INC SPECIALIZING IN ADMIRALTY, MARITIME, AND TRANSPORTATION DISPUTE RESOLUTION ENIRCLE THE CREST.

THE ENGLISH TRANSLATION OF "EST MODUS IN REBUS" IS "THERE IS A MIDDLE COURSE IN ALL THINGS".

FOR ALTERNATIVE DISPUTE RESOLUTION (U.S. CLS. 100 AND 101).

FIRST USE 12-7-2005; IN COMMERCE 11-3-2006.

CLASS 42—(Continued).

3,299,581. RIGHT MEDIA INC., NEW YORK, NY. SN 78-757,206. PUB. 10-24-2006, FILED 11-18-2005.

Media Guard

THE MARK CONSISTS OF STANDARD CHARACTERS WITHOUT CLAIM TO ANY PARTICULAR FONT, STYLE, SIZE, OR COLOR.

OWNER OF U.S. REG. NO. 2,983,347.

NO CLAIM IS MADE TO THE EXCLUSIVE RIGHT TO USE "MEDIA", APART FROM THE MARK AS SHOWN.

FOR MONITORING SERVICES FOR OTHERS, NAMELY, MONITORING WEBSITES AND ADVERTISEMENTS FOR THE QUALITY OF THEIR CONTENT, NAMELY, COMPUTER SERVICES TO MONITOR AND SCREEN WEBSITES AND ONLINE ADVERTISEMENTS TO FILTER BY CLASSIFYING AND TAGGING WEBSITES AND ONLINE ADVERTISEMENTS REGARDING QUALITATIVE ATTRIBUTES, QUANTITATIVE ATTRIBUTES, AND TECHNICAL DESCRIPTIONS (U.S. CLS. 100 AND 101).

FIRST USE 2-6-2006; IN COMMERCE 2-6-2006.

CLASS 42—(Continued).

3,299,618. DWELLNET TECHNOLOGIES, BELLEVUE, WA. SN 78-767,951. PUB. 8-22-2006, FILED 12-6-2005.

DWELL.NET

THE MARK CONSISTS OF STANDARD CHARACTERS WITHOUT CLAIM TO ANY PARTICULAR FONT, STYLE, SIZE, OR COLOR.

OWNER OF U.S. REG. NO. 2,540,903.

FOR PROVIDING TECHNICAL INFORMATION IN THE FIELD OF HOME CONTROL AND AUTOMATION (U.S. CLS. 100 AND 101).

FIRST USE 7-23-2006; IN COMMERCE 7-23-2006.

3,299,623. SPRINGBOK SERVICES, INC., ENGLEWOOD, CO. SN 78-768,438. PUB. 8-22-2006, FILED 12-7-2005.

SPRINGBOK

NATIONAL NOTARY

3,299,588. NATIONAL NOTARY ASSOCIATION, CHATSWORTH, CA. SN 78-760,647. PUB. 7-11-2006, FILED 11-23-2005.

THE MARK CONSISTS OF STANDARD CHARACTERS WITHOUT CLAIM TO ANY PARTICULAR FONT, STYLE, SIZE, OR COLOR.

OWNER OF U.S. REG. NOS. 1,632,322, 1,634,447, AND OTHERS.

SEC. 2(F).

FOR PROVIDING AN ON-LINE DATABASE FEATURING INFORMATION ABOUT NOTARY PUBLICS (U.S. CLS. 100 AND 101).

FIRST USE 2-12-2007; IN COMMERCE 2-12-2007.

THE MARK CONSISTS OF STANDARD CHARACTERS WITHOUT CLAIM TO ANY PARTICULAR FONT, STYLE, SIZE, OR COLOR.

FOR PROVIDING ONLINE NON-DOWNLOADABLE SOFTWARE FOR USE IN STORED VALUE DEBIT CARD ISSUANCE, PROCESSING, FULFILLMENT, RISK MANAGEMENT, CLIENT SERVICES AND CARDHOLDER SERVICES; TECHNICAL CONSULTATION IN THE FIELD OF ONLINE NON-DOWNLOADABLE SOFTWARE FOR USE IN STORED VALUE DEBIT CARD ISSUANCE, PROCESSING, FULFILLMENT, RISK MANAGEMENT, CLIENT SERVICES AND CARDHOLDER SERVICES (U.S. CLS. 100 AND 101).

FIRST USE 10-19-2005; IN COMMERCE 2-2-2006.

CLASS 42—(Continued).

3,299,656. RGLOBE, SAN FRANCISCO, CA. SN 78-774,679.
PUB. 8-8-2006, FILED 12-15-2005.

Partner. On Demand.

THE MARK CONSISTS OF STANDARD CHARACTERS WITHOUT CLAIM TO ANY PARTICULAR FONT, STYLE, SIZE, OR COLOR.

FOR PROVIDING TEMPORARY USE OF ON-LINE NON-DOWNLOADABLE SOFTWARE FOR USE TO STORE, MANAGE, TRACK, ANALYZE AND REPORT DATA IN THE FIELDS OF SALES, PARTNERSHIPS, ALLIANCES, JOINT-VENTURES, PROMOTION, CUSTOMER INFORMATION, PARTNER RELATIONSHIP DEVELOPMENT, PARTNER RELATIONSHIP MANAGEMENT; PROVIDING TEMPORARY USE OF ON-LINE NON-DOWNLOADABLE SOFTWARE TO FACILITATE COMMUNICATION, COLLABORATION, AND NETWORKING AMONG BUSINESS PROFESSIONALS (U.S. CLS. 100 AND 101).
FIRST USE 3-1-2006; IN COMMERCE 3-1-2006.

CLASS 42—(Continued).

3,299,866. KATLIN SMITH COMMUNICATIONS LLC, VANCOUVER, WA. SN 78-841,092. PUB. 10-24-2006, FILED 3-20-2006.

Urban Words

THE MARK CONSISTS OF STANDARD CHARACTERS WITHOUT CLAIM TO ANY PARTICULAR FONT, STYLE, SIZE, OR COLOR.

FOR TECHNICAL WRITING FOR OTHERS AND GRAPHIC DESIGN SERVICES (U.S. CLS. 100 AND 101).
FIRST USE 1-22-2007; IN COMMERCE 1-22-2007.

3,299,893. I-DECIDE, INC., LEONIA, NJ. SN 78-853,208. PUB. 11-21-2006, FILED 4-4-2006.

Content my way

3,299,686. ADVANCEDMD SOFTWARE, INC., DRAPER, UT. SN 78-784,646. PUB. 9-5-2006, FILED 1-4-2006.

ADVANCEDEMR

THE MARK CONSISTS OF STANDARD CHARACTERS WITHOUT CLAIM TO ANY PARTICULAR FONT, STYLE, SIZE, OR COLOR.

OWNER OF U.S. REG. NO. 3,039,850.
FOR PROVIDING TEMPORARY USE OF ONLINE NONDOWNLOADABLE SOFTWARE FOR USE IN DATABASE MANAGEMENT FOR HEALTHCARE PRACTICES IN THE AREAS OF PATIENT BILLING, INSURANCE BILLING, ELECTRONIC CLAIMS PROCESSING, ACCOUNTS RECEIVABLE TRAILING, PATIENT SCHEDULING, CREATING AND MAINTAINING PATIENT DEMOGRAPHICS AND MEDICAL HISTORY RECORDS, CREATING AND MAINTAINING PATIENT INSURANCE RECORDS; AND PROVIDING USE OF ONLINE NONDOWNLOADABLE SOFTWARE FOR USE IN ONLINE DATABASE MANAGEMENT OF HEALTHCARE PRACTICES FOR USE IN PRESCRIPTION WRITING AND MANAGEMENT, TRANSCRIPTION MANAGEMENT, DICTATION MANAGEMENT, CREATION AND MAINTENANCE OF LABORATORY TEST RESULTS, AND MANAGEMENT OF PATIENT FILES AND CHARTS (U.S. CLS. 100 AND 101).
FIRST USE 11-19-2005; IN COMMERCE 11-19-2005.

THE MARK CONSISTS OF STANDARD CHARACTERS WITHOUT CLAIM TO ANY PARTICULAR FONT, STYLE, SIZE, OR COLOR.

NO CLAIM IS MADE TO THE EXCLUSIVE RIGHT TO USE CONTENT, APART FROM THE MARK AS SHOWN.

FOR COMPUTER SERVICES, NAMELY, CREATING AND MONITORING USER-CUSTOMIZABLE DIGITAL CONTENT VIA AN INFORMATION NETWORK (U.S. CLS. 100 AND 101).

FIRST USE 6-4-2006; IN COMMERCE 6-26-2006.

3,300,046. AEGERION PHARMACEUTICALS, INC., BRIDGEWATER, NJ. SN 78-906,083. PUB. 1-23-2007, FILED 6-12-2006.

AEGERION

THE MARK CONSISTS OF STANDARD CHARACTERS WITHOUT CLAIM TO ANY PARTICULAR FONT, STYLE, SIZE, OR COLOR.

FOR PHARMACEUTICAL RESEARCH AND DEVELOPMENT (U.S. CLS. 100 AND 101).

FIRST USE 6-0-2006; IN COMMERCE 6-0-2006.

CLASS 42—(Continued).

3,300,081. RIGHTANSWERS, LLC, CLARK, NJ. SN 78-917,084. PUB. 2-13-2007, FILED 6-26-2006.

CLASS 42—(Continued).

3,300,208. XENOBIOTIC DETECTION SYSTEMS, INC., DURHAM, NC. SN 78-978,622. PUB. 8-2-2005, FILED 2-20-2004.

HELPIINFO

THE MARK CONSISTS OF STANDARD CHARACTERS WITHOUT CLAIM TO ANY PARTICULAR FONT, STYLE, SIZE, OR COLOR.

FOR PROVIDING COMPUTER TECHNOLOGY INFORMATION VIA A GLOBAL COMPUTER NETWORK; TECHNICAL SUPPORT SERVICES, NAMELY, TROUBLESHOOTING OF COMPUTER HARDWARE AND SOFTWARE PROBLEMS; DEVELOPMENT OF COMPUTER PROGRAMS FOR KNOWLEDGE-BASED COMPUTER SYSTEMS; COMPUTER CONSULTATION SERVICES IN THE FIELD OF TROUBLESHOOTING COMPUTER HARDWARE AND SOFTWARE; PROVIDING ONLINE TECHNICAL SUPPORT AND KNOWLEDGE BASE SERVICES IN THE FIELD OF HOME AND MOBILE COMPUTING, APPLICATION SOFTWARE, OPERATING SYSTEMS, COMPUTER DEVICE CONFIGURATION, SOFTWARE GAMES AND OTHER TECHNOLOGY BASED PRODUCTS USED IN THE HOME (U.S. CLS. 100 AND 101).

FIRST USE 7-31-2006; IN COMMERCE 7-31-2006.

3,300,115. INTERNATIONAL WEB PROPERTIES, LLC, INDIANAPOLIS, IN. SN 78-927,071. PUB. 3-13-2007, FILED 7-11-2006.



FOR COMPUTER SERVICES, NAMELY, HOSTING ON-LINE WEB FACILITIES FOR ORGANIZING AND CONDUCTING ON-LINE GATHERINGS AND INTERACTIVE DISCUSSIONS; PROVIDING CUSTOMIZED WEB PAGES FEATURING USER-DEFINED INFORMATION, FAMILY HISTORIES, SHARED CALENDARS AND PHOTOGRAPHS (U.S. CLS. 100 AND 101).

FIRST USE 3-20-2006; IN COMMERCE 3-30-2006.

3,300,170. TEVORA BUSINESS SOLUTIONS, INC., IRVINE, CA. SN 78-950,875. PUB. 4-3-2007, FILED 8-12-2006.

TEVORA

THE MARK CONSISTS OF STANDARD CHARACTERS WITHOUT CLAIM TO ANY PARTICULAR FONT, STYLE, SIZE, OR COLOR.

FOR COMPUTER CONSULTATION IN THE FIELD OF COMPUTER SECURITY AND SYSTEMS INTEGRATION (U.S. CLS. 100 AND 101).

FIRST USE 2-0-2003; IN COMMERCE 2-0-2003.

LUMI-CELL

THE MARK CONSISTS OF STANDARD CHARACTERS WITHOUT CLAIM TO ANY PARTICULAR FONT, STYLE, SIZE, OR COLOR.

FOR SCIENTIFIC AND MEDICAL RESEARCH, NAMELY, BIOASSAY SERVICES, NAMELY, DETECTING THE PRESENCE OF TOXINS IN SOLID, LIQUID AND/OR GASEOUS MATERIALS; CONDUCTING BIOCHEMICAL, BIOLOGICAL, AND CHEMICAL ANALYSIS; PREPARING MEDIA FOR USE IN BIOCHEMICAL, BIOLOGICAL AND CHEMICAL ANALYSIS AND IN TISSUE CULTURE; AND PROVIDING INSTRUMENTAL MATERIALS IN CONJUNCTION THEREWITH (U.S. CLS. 100 AND 101).

FIRST USE 8-21-2005; IN COMMERCE 8-21-2005.

3,300,209. BETH ISRAEL DEACONESS MEDICAL CENTER, INC., BOSTON, MA. SN 78-978,629. PUB. 7-25-2006, FILED 11-9-2005.

SEEING IS CURING

THE MARK CONSISTS OF STANDARD CHARACTERS WITHOUT CLAIM TO ANY PARTICULAR FONT, STYLE, SIZE, OR COLOR.

FOR MEDICAL AND SCIENTIFIC RESEARCH SERVICES IN THE FIELD OF CANCER TREATMENT AND DIAGNOSIS (U.S. CLS. 100 AND 101).

FIRST USE 1-12-2006; IN COMMERCE 1-12-2006.

CLASS 42—(Continued).

3,300,222. BOEHRINGER INGELHEIM INTERNATIONAL GMBH, INGELHEIM AM RHEIN, FED REP GERMANY. SN 78-978,754. PUB. 10-4-2005, FILED 7-29-2004.

RE-SOLVE

THE MARK CONSISTS OF STANDARD CHARACTERS WITHOUT CLAIM TO ANY PARTICULAR FONT, STYLE, SIZE, OR COLOR.

FOR CONDUCTING CLINICAL TRIALS OF PHARMACEUTICAL PRODUCTS DIRECTED TO THE TREATMENT AND PREVENTION OF THROMBOSIS (U.S. CLS. 100 AND 101).

FIRST USE 1-18-2006; IN COMMERCE 1-18-2006.

CLASS 43—HOTEL AND RESTAURANT SERVICES

3,298,450. PERAZA-HERNANDEZ, SILAS, EL SALVADOR, CENTRAL AMERICA, EL SALVADOR. SN 76-548,656. PUB. 7-12-2005, FILED 9-16-2003.

POLLO MASTER

NO CLAIM IS MADE TO THE EXCLUSIVE RIGHT TO USE "POLLO", APART FROM THE MARK AS SHOWN.

THE FOREIGN WORDING IN THE MARK TRANSLATES INTO ENGLISH AS "CHICKEN MASTER".

FOR RESTAURANT SERVICES (U.S. CLS. 100 AND 101).

FIRST USE 11-22-2006; IN COMMERCE 11-22-2006.

3,298,656. CATALINA RESTAURANT GROUP, CARSBAD, CA. SN 78-185,709. PUB. 2-1-2005, FILED 11-15-2002.

CATALINA RESTAURANT GROUP

NO CLAIM IS MADE TO THE EXCLUSIVE RIGHT TO USE RESTAURANT GROUP, APART FROM THE MARK AS SHOWN.

FOR RESTAURANT SERVICES (U.S. CLS. 100 AND 101).

FIRST USE 1-13-2003; IN COMMERCE 1-31-2003.

3,298,658. TAMARACK RESORT LLC, BOISE, ID. SN 78-195,800. PUB. 9-27-2005, FILED 12-18-2002.

TAMARACK

THE MARK CONSISTS OF THE WORD TAMARACK WRITTEN IN BLOCK CAPITAL LETTERS. THE "T" AT THE

CLASS 43—(Continued).

BEGINNING OF THE WORD AND THE "K" AT THE END OF THE WORD EXTEND BELOW THE REMAINING LETTERS IN THE MIDDLE. THE CROSS THROUGH THE MIDDLE OF THE FIRST "A" EXTENDS TO THE LEFT, BEHIND THE "T" IN AN ARC AROUND TO THE BOTTOM OF THE "T". THE RIGHT BOTTOM LEG OF THE "R" SWEEPS DOWNWARD AND TO THE RIGHT BELOW THE "A" IMMEDIATELY TO THE RIGHT AND ARCS UPWARD TOWARD THE BOTTOM OF THE "C". THE TOP RIGHT ARM OF THE "K" EXTENDS UPWARD IN AN ARC WHICH ENDS POINTING DOWNWARD AT THE END OF THE WORD.

FOR PROVIDING HOTELS AND LODGES; AND PROVIDING CONVENTION CENTER SERVICES (U.S. CLS. 100 AND 101).

FIRST USE 10-0-2004; IN COMMERCE 12-31-2004.

3,298,682. BELLAGIO, LLC, LAS VEGAS, NV. SN 78-267,083. PUB. 2-24-2004, FILED 6-25-2003.

SENSI

THE ENGLISH TRANSLATION OF THE ITALIAN WORD "SENSI" IN THE MARK IS "SENSE OR CONSCIOUSNESS".

FOR RESTAURANT, BAR AND LOUNGE SERVICES (U.S. CLS. 100 AND 101).

FIRST USE 12-23-2004; IN COMMERCE 12-23-2004.

3,298,744. VICINO, ROBERT K., DEL MAR, CA. SN 78-382,325. PUB. 1-4-2005, FILED 3-11-2004.

LEGACY CLUB

THE MARK CONSISTS OF STANDARD CHARACTERS WITHOUT CLAIM TO ANY PARTICULAR FONT, STYLE, SIZE, OR COLOR.

FOR ADULT DAY CARE (U.S. CLS. 100 AND 101).

FIRST USE 3-25-2007; IN COMMERCE 3-25-2007.

CLASS 43—(Continued).

3,298,768. CELEBRATIONS MANAGEMENT, INC., HIGHLAND VILLAGE, TX. SN 78-427,881. PUB. 7-12-2005, FILED 6-1-2004.

CLASS 43—(Continued).

3,298,873. NGUYEN, DIEP, SILVER SPRING, MD. SN 78-519,991. PUB. 10-11-2005, FILED 11-19-2004.

LIFE'S A BEACH

THE MARK CONSISTS OF STANDARD CHARACTERS WITHOUT CLAIM TO ANY PARTICULAR FONT, STYLE, SIZE, OR COLOR.

FOR RESTAURANT SERVICES (U.S. CLS. 100 AND 101).

FIRST USE 3-19-2007; IN COMMERCE 3-19-2007.

PHO REAL

THE MARK CONSISTS OF STANDARD CHARACTERS WITHOUT CLAIM TO ANY PARTICULAR FONT, STYLE, SIZE, OR COLOR.

FOR RESTAURANT THAT SERVES VIETNAMESE FOOD (U.S. CLS. 100 AND 101).

FIRST USE 4-15-2005; IN COMMERCE 4-15-2005.

3,298,810. FENG MING CORP., HOUSTON, TX. SN 78-467,132. PUB. 8-9-2005, FILED 8-13-2004.

3,298,885. BURWOOD ENTERPRISES, LLC, CHICAGO, IL. SN 78-525,619. PUB. 9-6-2005, FILED 12-2-2004.



NO CLAIM IS MADE TO THE EXCLUSIVE RIGHT TO USE "RESTAURANT & BAR", APART FROM THE MARK AS SHOWN.

THE MARK CONSISTS OF THE WORDS "YAO RESTAURANT AND BAR" ALONG WITH A DESIGN ELEMENT CONTAINING ANCIENT CHINESE TEXT WHICH TRANSLATES INTO THE SURNAME "YAO".

FOR RESTAURANT AND BAR SERVICES (U.S. CLS. 100 AND 101).

FIRST USE 2-21-2005; IN COMMERCE 2-21-2005.

F212°

THE MARK CONSISTS OF STANDARD CHARACTERS WITHOUT CLAIM TO ANY PARTICULAR FONT, STYLE, SIZE, OR COLOR.

FOR CAFE, COFFEE SHOP AND COFFEE HOUSE SERVICES (U.S. CLS. 100 AND 101).

FIRST USE 4-30-2005; IN COMMERCE 4-30-2005.

CLASS 43—(Continued).

3,298,919. P. Q. LICENSING, S.A., 11 AT B-1000 BRUSSELS, BELGIUM. SN 78-552,437. PUB. 5-9-2006, FILED 1-24-2005.

LE PAIN QUOTIDIEN

THE MARK CONSISTS OF STANDARD CHARACTERS WITHOUT CLAIM TO ANY PARTICULAR FONT, STYLE, SIZE, OR COLOR.

OWNER OF U.S. REG. NO. 2,211,381.
THE ENGLISH TRANSLATION OF THE FRENCH WORD "LE PAIN QUOTIDIEN" IN THE MARK IS DAILY BREAD. FOR RESTAURANT SERVICES (U.S. CLS. 100 AND 101).
FIRST USE 1-0-1997; IN COMMERCE 1-0-1997.

3,299,011. AEGIS SENIOR COMMUNITIES, LLC, REDMOND, WA. SN 78-593,617. PUB. 6-27-2006, FILED 3-23-2005.

AEGISLIVING

THE MARK CONSISTS OF STANDARD CHARACTERS WITHOUT CLAIM TO ANY PARTICULAR FONT, STYLE, SIZE, OR COLOR.

FOR PROVIDING ASSISTED LIVING FACILITIES FOR THE ELDERLY IN THE NATURE OF INDEPENDENT HOUSES AND LONG-TERM CARE FACILITIES (U.S. CLS. 100 AND 101).
FIRST USE 8-1-2004; IN COMMERCE 8-1-2004.

3,299,032. CSH-INGRE LLC, MISSISSAUGA, CANADA. SN 78-599,572. PUB. 12-27-2005, FILED 3-31-2005.

INDEPENDENCE THAT MATTERS

THE MARK CONSISTS OF STANDARD CHARACTERS WITHOUT CLAIM TO ANY PARTICULAR FONT, STYLE, SIZE, OR COLOR.

FOR RETIREMENT HOMES PROVIDING RETIREMENT HOME SERVICES (U.S. CLS. 100 AND 101).
FIRST USE 9-17-2006; IN COMMERCE 9-17-2006.

CLASS 43—(Continued).

3,299,086. FORZA, ASHEVILLE, NC. SN 78-614,836. PUB. 9-26-2006, FILED 4-22-2005.

TUPELO HONEY CAFE

THE MARK CONSISTS OF STANDARD CHARACTERS WITHOUT CLAIM TO ANY PARTICULAR FONT, STYLE, SIZE, OR COLOR.

NO CLAIM IS MADE TO THE EXCLUSIVE RIGHT TO USE "CAFE", APART FROM THE MARK AS SHOWN. FOR CAFES; RESTAURANTS; CATERING (U.S. CLS. 100 AND 101).
FIRST USE 7-27-2000; IN COMMERCE 7-27-2000.

3,299,097. DIGEROLAMO, CHARLES, KERNERSVILLE, NC. SN 78-621,026. PUB. 1-24-2006, FILED 5-2-2005.

WANNA WRAP

THE MARK CONSISTS OF STANDARD CHARACTERS WITHOUT CLAIM TO ANY PARTICULAR FONT, STYLE, SIZE, OR COLOR.

NO CLAIM IS MADE TO THE EXCLUSIVE RIGHT TO USE "WRAP", APART FROM THE MARK AS SHOWN. FOR RESTAURANT SERVICES, FEATURING TORTILLA WRAPS CONSISTING OF ITALIAN, SOUTH OF THE BORDER, ASIAN, AND AMERICAN RECIPES (U.S. CLS. 100 AND 101).
FIRST USE 11-24-2006; IN COMMERCE 11-24-2006.

3,299,198. METROFRESH, INC., ATLANTA, GA. SN 78-664,384. PUB. 4-11-2006, FILED 7-6-2005.



MetroFresh
FRESH FOOD FAST

NO CLAIM IS MADE TO THE EXCLUSIVE RIGHT TO USE "FRESH FOOD FAST", APART FROM THE MARK AS SHOWN.

THE COLORS GRAY, GREEN AND WHITE ARE

CLASS 43—(Continued).

CLAIMED AS A FEATURE OF THE MARK.

THE COLOR GREEN APPEARS IN THE OVAL ABOVE THE BOWL DESIGN AND IN THE TERM FRESH. THE COLOR WHITE APPEARS IN THE LETTER M AND IN A PORTION OF THE BOWL. THE COLOR GRAY APPEARS IN THE REMAINDER OF THE BOWL AND IN THE WORDING METRO AND FRESH FOOD FAST.

FOR RESTAURANT SERVICES (U.S. CLS. 100 AND 101).

FIRST USE 10-10-2005; IN COMMERCE 10-10-2005.

3,299,221. SODEXHO OPERATIONS, LLC, GAITHERSBURG, MD. SN 78-675,224. PUB. 4-4-2006, FILED 7-21-2005.

CHIVES AMERICAN GRILL

THE MARK CONSISTS OF STANDARD CHARACTERS WITHOUT CLAIM TO ANY PARTICULAR FONT, STYLE, SIZE, OR COLOR.

NO CLAIM IS MADE TO THE EXCLUSIVE RIGHT TO USE "AMERICAN GRILL", APART FROM THE MARK AS SHOWN.

FOR RESTAURANT SERVICES RENDERED PRIMARILY IN HEALTH CARE AND ASSISTED LIVING FACILITIES (U.S. CLS. 100 AND 101).

FIRST USE 2-0-2006; IN COMMERCE 2-0-2006.

3,299,264. ALLRECIPES.COM, INC., SEATTLE, WA. SN 78-696,496. PUB. 7-11-2006, FILED 8-19-2005.

COOKNIK

THE MARK CONSISTS OF STANDARD CHARACTERS WITHOUT CLAIM TO ANY PARTICULAR FONT, STYLE, SIZE, OR COLOR.

FOR PROVIDING DATABASES IN THE FIELD OF FOOD, COOKING, RECIPES, MENUS, COOKING TIPS, COOKING INFORMATION, REVIEWS, GROCERY SHOPPING LISTS, WINE, BEVERAGES, NUTRITION, ENTERTAINING, NAMELY, DINING AND FOOD-RELATED SPECIAL EVENT PLANNING, KITCHENWARE, COOKING EQUIPMENT AND ACCESSORIES (U.S. CLS. 100 AND 101).

FIRST USE 9-30-2005; IN COMMERCE 9-30-2005.

CLASS 43—(Continued).

3,299,275. GASTRO PUBS, LTD., FORT WORTH, TX. SN 78-699,815. PUB. 6-13-2006, FILED 8-24-2005.

DUCE

THE MARK CONSISTS OF STANDARD CHARACTERS WITHOUT CLAIM TO ANY PARTICULAR FONT, STYLE, SIZE, OR COLOR.

THE FOREIGN WORDING IN THE MARK TRANSLATES INTO ENGLISH AS COMMANDER.

FOR RESTAURANT SERVICES (U.S. CLS. 100 AND 101).

FIRST USE 5-14-2006; IN COMMERCE 5-14-2006.

3,299,308. KAFE KALIK USA, LLC, WINDERMERE, FL. SN 78-710,969. PUB. 7-4-2006, FILED 9-12-2005.

KAFE KALIK

THE MARK CONSISTS OF STANDARD CHARACTERS WITHOUT CLAIM TO ANY PARTICULAR FONT, STYLE, SIZE, OR COLOR.

NO CLAIM IS MADE TO THE EXCLUSIVE RIGHT TO USE "CAFE", APART FROM THE MARK AS SHOWN.

FOR RESTAURANTS, BAR SERVICES, CATERING (U.S. CLS. 100 AND 101).

FIRST USE 2-15-2005; IN COMMERCE 2-16-2007.

3,299,373. WYNN RESORTS HOLDINGS, LLC, LAS VEGAS, NV. SN 78-726,382. PUB. 6-6-2006, FILED 10-4-2005.

AN AFFAIR TO REMEMBER

THE MARK CONSISTS OF STANDARD CHARACTERS WITHOUT CLAIM TO ANY PARTICULAR FONT, STYLE, SIZE, OR COLOR.

FOR RESTAURANT, BAR AND COCKTAIL LOUNGE SERVICES (U.S. CLS. 100 AND 101).

FIRST USE 12-28-2005; IN COMMERCE 12-28-2005.

CLASS 43—(Continued).

3,299,457. LORETTO ASSOCIATES LLC, SANTA FE, NM. SN 78-738,384. PUB. 11-21-2006, FILED 10-21-2005.

ART AND SOUL OF SANTA FE

THE MARK CONSISTS OF STANDARD CHARACTERS WITHOUT CLAIM TO ANY PARTICULAR FONT, STYLE, SIZE, OR COLOR.

NO CLAIM IS MADE TO THE EXCLUSIVE RIGHT TO USE "SANTA FE", APART FROM THE MARK AS SHOWN. FOR HOTEL SERVICES FOR PREFERRED CUSTOMERS; HOTELS; RESORT HOTELS; RESORT LODGING SERVICES (U.S. CLS. 100 AND 101).

FIRST USE 2-1-2006; IN COMMERCE 2-1-2006.

3,299,567. EASTERN MOTOR INNS, INC., ROANOKE, VA. SN 78-755,165. PUB. 7-18-2006, FILED 11-16-2005.

INN DEMAND

THE MARK CONSISTS OF STANDARD CHARACTERS WITHOUT CLAIM TO ANY PARTICULAR FONT, STYLE, SIZE, OR COLOR.

FOR MOTEL SERVICES (U.S. CLS. 100 AND 101). FIRST USE 10-0-2006; IN COMMERCE 1-0-2007.

3,299,605. BISHOP'S LODGE - VEF II OPERATOR, INC., SANTA FE, NM. SN 78-765,034. PUB. 11-14-2006, FILED 12-1-2005.



NO CLAIM IS MADE TO THE EXCLUSIVE RIGHT TO USE "LODGE RANCH RESORT & SPA", APART FROM THE MARK AS SHOWN.

THE MARK CONSISTS OF FOUR MEN RIDING HORSES. FOR RESORT HOTELS AND RESORT LODGING SERVICES (U.S. CLS. 100 AND 101).

FIRST USE 10-0-2005, 07/25/1961.; IN COMMERCE 10-0-2005, 07/25/1961..

CLASS 43—(Continued).

3,299,638. GULF COAST VENTURES LLC, STUDIO CITY, CA. SN 78-770,889. PUB. 8-22-2006, FILED 12-11-2005.

Harry Kane's Island Grill
& Rum Bar

THE MARK CONSISTS OF STANDARD CHARACTERS WITHOUT CLAIM TO ANY PARTICULAR FONT, STYLE, SIZE, OR COLOR.

NO CLAIM IS MADE TO THE EXCLUSIVE RIGHT TO USE "ISLAND GRILL & RUM BAR", APART FROM THE MARK AS SHOWN.

THE NAME(S), PORTRAIT(S), AND/OR SIGNATURE(S) SHOWN IN THE MARK DOES NOT IDENTIFY A PARTICULAR LIVING INDIVIDUAL.

FOR RESTAURANT AND BAR SERVICES (U.S. CLS. 100 AND 101).

FIRST USE 12-1-2006; IN COMMERCE 12-1-2006.

3,299,653. MIRAGE RESORTS, INCORPORATED, LAS VEGAS, NV. SN 78-774,459. PUB. 9-26-2006, FILED 12-15-2005.

JET MIRAGE NIGHTCLUB

THE MARK CONSISTS OF STANDARD CHARACTERS WITHOUT CLAIM TO ANY PARTICULAR FONT, STYLE, SIZE, OR COLOR.

OWNER OF U.S. REG. NOS. 1,948,786, 2,951,094, AND OTHERS.

NO CLAIM IS MADE TO THE EXCLUSIVE RIGHT TO USE "NIGHTCLUB", APART FROM THE MARK AS SHOWN.

FOR COCKTAIL LOUNGES; RESTAURANT AND BAR SERVICES (U.S. CLS. 100 AND 101).

FIRST USE 12-30-2005; IN COMMERCE 12-30-2005.

3,299,689. BONDI LIFESAVER HOLDINGS PTY LTD, CLAREMONT, AUSTRALIA. SN 78-785,977. PUB. 8-29-2006, FILED 1-5-2006.

BONDI

THE MARK CONSISTS OF STANDARD CHARACTERS WITHOUT CLAIM TO ANY PARTICULAR FONT, STYLE, SIZE, OR COLOR.

FOR RESTAURANT SERVICES, BAR SERVICES, AND CAFE SERVICES (U.S. CLS. 100 AND 101).

FIRST USE 1-10-2007; IN COMMERCE 1-10-2007.

CLASS 43—(Continued).

3,299,786. HEARST HOLDINGS, INC., NEW YORK, NY. AND FLEISCHER STUDIOS, INC., BEVERLY HILLS, CA. SN 78-813,055. PUB. 9-26-2006, FILED 2-13-2006.



OWNER OF U.S. REG. NOS. 2,349,360, 2,378,474, AND OTHERS.

NO CLAIM IS MADE TO THE EXCLUSIVE RIGHT TO USE "DINER", APART FROM THE MARK AS SHOWN. FOR RESTAURANTS (U.S. CLS. 100 AND 101). FIRST USE 4-1-2007; IN COMMERCE 4-1-2007.

3,299,791. AWESOME ICE, INC., EAST PETERSBURG, PA. SN 78-814,971. PUB. 11-14-2006, FILED 2-15-2006.

FOUNTAIN OF FRUIT

THE MARK CONSISTS OF STANDARD CHARACTERS WITHOUT CLAIM TO ANY PARTICULAR FONT, STYLE, SIZE, OR COLOR.

FOR RESTAURANT SERVICES, FEATURING A CHOCOLATE FOUNTAIN, FRUIT, PRETZELS, MARSHMALLOW, CHOCOLATE AND OTHER SNACK FOOD ITEMS, CHOCOLATE-DIPPED FOOD ITEMS, FRUIT SMOOTHIES AND OTHER BLENDED BEVERAGES, SOFT DRINKS, ICE CREAM, AND WATER ICE (U.S. CLS. 100 AND 101).

FIRST USE 4-15-2006; IN COMMERCE 4-29-2006.

CLASS 43—(Continued).

3,299,859. LADNER, HEATHER E., KERRVILLE, TX. SN 78-837,590. PUB. 10-31-2006, FILED 3-15-2006.

FAT ARMADILLO'S

THE MARK CONSISTS OF STANDARD CHARACTERS WITHOUT CLAIM TO ANY PARTICULAR FONT, STYLE, SIZE, OR COLOR.

FOR RESTAURANT SERVICES (U.S. CLS. 100 AND 101).

FIRST USE 11-14-2006; IN COMMERCE 11-14-2006.

3,299,881. AWESOME ICE, INC., EAST PETERSBURG, PA. SN 78-848,065. PUB. 9-26-2006, FILED 3-28-2006.



THE MARK CONSISTS OF THE WORDS "FOUNTAIN OF FRUIT" IN STYLIZED FORM AND WITH DEPICTIONS OF FRUIT IN PLACE OF CERTAIN LETTERS OR PARTS OF LETTERS.

FOR RESTAURANT SERVICES, FEATURING A CHOCOLATE FOUNTAIN, FRUIT, PRETZELS, MARSHMALLOW, CHOCOLATE AND OTHER SNACK FOOD ITEMS, CHOCOLATE-DIPPED FOOD ITEMS, FRUIT SMOOTHIES AND OTHER BLENDED BEVERAGES, SOFT DRINKS, ICE CREAM, AND WATER ICE (U.S. CLS. 100 AND 101).

FIRST USE 4-15-2006; IN COMMERCE 4-29-2006.

3,299,924. ELEPHANT STEPS, LLC, NEW CANAAN, CT. SN 78-864,544. PUB. 12-5-2006, FILED 4-19-2006.

ELEPHANT STEPS

THE MARK CONSISTS OF STANDARD CHARACTERS WITHOUT CLAIM TO ANY PARTICULAR FONT, STYLE, SIZE, OR COLOR.

FOR COFFEE HOUSE, CANTEEN AND SNACK BAR SERVICES (U.S. CLS. 100 AND 101).

FIRST USE 4-10-2006; IN COMMERCE 11-6-2006.

CLASS 43—(Continued).

3,299,943. KEVIN L KIRBY INC., CHARLOTTESVILLE, VA.
SN 78-870,206. PUB. 11-28-2006, FILED 4-26-2006.

LAZY PARROT

THE MARK CONSISTS OF STANDARD CHARACTERS
WITHOUT CLAIM TO ANY PARTICULAR FONT, STYLE,
SIZE, OR COLOR.

FOR RESTAURANT AND BAR SERVICES (U.S. CLS.
100 AND 101).
FIRST USE 3-25-2007; IN COMMERCE 3-25-2007.

3,300,091. MOORE, LONNIE, HOLLYWOOD, CA. SN 78-
919,461. PUB. 2-13-2007, FILED 6-28-2006.

KETCHUP

THE MARK CONSISTS OF STANDARD CHARACTERS
WITHOUT CLAIM TO ANY PARTICULAR FONT, STYLE,
SIZE, OR COLOR.

FOR RESTAURANTS (U.S. CLS. 100 AND 101).
FIRST USE 3-19-2007; IN COMMERCE 3-19-2007.

3,300,092. MOORE, LONNIE, HOLLYWOOD, CA. SN 78-
919,462. PUB. 2-13-2007, FILED 6-28-2006.

TEN PIN ALLEY

THE MARK CONSISTS OF STANDARD CHARACTERS
WITHOUT CLAIM TO ANY PARTICULAR FONT, STYLE,
SIZE, OR COLOR.

FOR RESTAURANTS (U.S. CLS. 100 AND 101).
FIRST USE 2-6-2007; IN COMMERCE 2-6-2007.

CLASS 43—(Continued).

3,300,123. BETTER EATING CONCEPTS, LLC, LOS AN-
GELES, CA. SN 78-930,204. PUB. 2-27-2007, FILED 7-14-
2006.



NO CLAIM IS MADE TO THE EXCLUSIVE RIGHT TO
USE "VEGGIE GRILL", APART FROM THE MARK AS
SHOWN.

THE MARK CONSISTS OF A STYLIZED LEAF ON THE
LEFT SIDE OF AND EXTENDING ABOVE THE WORDS
"THE VEGGIE GRILL".

FOR RESTAURANT SERVICES; RESTAURANTS (U.S.
CLS. 100 AND 101).
FIRST USE 10-1-2006; IN COMMERCE 10-1-2006.

3,300,233. RENAISSANCE HOTEL HOLDINGS, INC.,
BETHESDA, MD. SN 78-978,811. PUB. 10-11-2005, FILED
5-17-2004.

EAT.DRINK.BALANCE.

THE MARK CONSISTS OF STANDARD CHARACTERS
WITHOUT CLAIM TO ANY PARTICULAR FONT, STYLE,
SIZE, OR COLOR.

NO CLAIM IS MADE TO THE EXCLUSIVE RIGHT TO
USE "EAT DRINK", APART FROM THE MARK AS SHOWN.

FOR RESTAURANT AND CATERING SERVICES (U.S.
CLS. 100 AND 101).
FIRST USE 9-1-2005; IN COMMERCE 9-1-2005.

**CLASS 44—MEDICAL, BEAUTY AND AGRI-
CULTURAL SERVICES**

3,298,556. CREATIVE HAIRDRESSERS, INC., VIENNA, VA.
SN 76-646,937. PUB. 12-12-2006, FILED 9-16-2005.

WE WOULDN'T GIVE A HAIRCUT ANY OTHER WAY

THE MARK CONSISTS OF STANDARD CHARACTERS
WITHOUT CLAIM TO ANY PARTICULAR FONT, STYLE,
SIZE, OR COLOR.

FOR HAIR SALON SERVICES (U.S. CLS. 100 AND 101).
FIRST USE 11-14-2005; IN COMMERCE 11-14-2005.

CLASS 44—(Continued).

3,298,599. PRIZM ASSOCIATES, INC., GREAT NECK, NY.
SN 76-663,294. PUB. 4-3-2007, FILED 7-18-2006.

ALL ACCESS DENTAL

THE MARK CONSISTS OF STANDARD CHARACTERS WITHOUT CLAIM TO ANY PARTICULAR FONT, STYLE, SIZE, OR COLOR.

NO CLAIM IS MADE TO THE EXCLUSIVE RIGHT TO USE "DENTAL", APART FROM THE MARK AS SHOWN. FOR DENTAL SERVICES (U.S. CLS. 100 AND 101). FIRST USE 9-1-2006; IN COMMERCE 9-1-2006.

3,298,626. SANDOW, ADAM I., BOCA RATON, FL. SN 77-029,707. PUB. 3-20-2007, FILED 10-26-2006.

DAILYBEAUTY

THE MARK CONSISTS OF STANDARD CHARACTERS WITHOUT CLAIM TO ANY PARTICULAR FONT, STYLE, SIZE, OR COLOR.

FOR PROVIDING INFORMATION ABOUT BEAUTY AND COSMETIC ENHANCEMENT BY MEANS OF A WEB SITE (U.S. CLS. 100 AND 101). FIRST USE 12-20-2006; IN COMMERCE 12-20-2006.

3,298,666. E.R. SQUIBB & SONS, L.L.C., PRINCETON, NJ. SN 78-222,992. PUB. 10-21-2003, FILED 3-7-2003.

MAKING A DIFFERENCE IN PEOPLE'S LIVES

THE MARK CONSISTS OF STANDARD CHARACTERS WITHOUT CLAIM TO ANY PARTICULAR FONT, STYLE, SIZE, OR COLOR.

FOR PROVIDING INFORMATION TO PHYSICIANS, HEALTH CARE PROFESSIONALS AND PATIENTS ON THE TOPIC OF HEALTH ISSUES AND HEALTH AWARENESS (U.S. CLS. 100 AND 101). FIRST USE 4-21-2005; IN COMMERCE 4-21-2005.

CLASS 44—(Continued).

3,298,825. ELIZABETH F. CALLAHAN, M.D., LLC, BRADENTON, FL. SN 78-479,132. PUB. 2-6-2007, FILED 9-6-2004.

SKIN SMART DERMATOLOGY

THE MARK CONSISTS OF STANDARD CHARACTERS WITHOUT CLAIM TO ANY PARTICULAR FONT, STYLE, SIZE, OR COLOR.

NO CLAIM IS MADE TO THE EXCLUSIVE RIGHT TO USE "SKIN" AND "DERMATOLOGY", APART FROM THE MARK AS SHOWN.

FOR DERMATOLOGY SKIN CARE SERVICES (U.S. CLS. 100 AND 101). FIRST USE 11-30-2004; IN COMMERCE 11-30-2004.

3,298,840. STATION CASINOS, INC., LAS VEGAS, NV. SN 78-485,110. PUB. 12-13-2005, FILED 9-16-2004.

RED ROCK SPA

THE MARK CONSISTS OF STANDARD CHARACTERS WITHOUT CLAIM TO ANY PARTICULAR FONT, STYLE, SIZE, OR COLOR.

OWNER OF U.S. REG. NOS. 2,845,193 AND 2,931,043. NO CLAIM IS MADE TO THE EXCLUSIVE RIGHT TO USE "SPA", APART FROM THE MARK AS SHOWN.

FOR BEAUTY SALON AND HEALTH SPA SERVICES, NAMELY: COSMETIC BODY CARE SERVICES; COSMETICIAN SERVICES; HAIRDRESSING SALONS; HAIR CUTTING; HAIR STYLING; HAIRDRESSING SERVICES; MANICURING; MASSAGE; SKIN CARE SALONS (U.S. CLS. 100 AND 101).

FIRST USE 4-1-2006; IN COMMERCE 4-1-2006.

CLASS 44—(Continued).

3,298,921. LEHIGH VALLEY PHYSICIAN HOSPITAL ORGANIZATION, INC., ALLENTOWN, PA. SN 78-552,680. PUB. 8-1-2006, FILED 1-24-2005.



NO CLAIM IS MADE TO THE EXCLUSIVE RIGHT TO USE "PREFERRED HEALTH MANAGEMENT", APART FROM THE MARK AS SHOWN.

FOR MANAGED HEALTH CARE SERVICES; CASE MANAGEMENT, NAMELY MAINTAINING FILES AND RECORDS CONCERNING THE MEDICAL CONDITION OF INDIVIDUALS; DISEASE MANAGEMENT, NAMELY PHYSICIAN SERVICES (U.S. CLS. 100 AND 101).
FIRST USE 4-0-2005; IN COMMERCE 4-0-2005.

3,299,036. CUNNINGHAM LINDSEY U.S., INC., SCHAMBURG, IL. SN 78-600,310. PUB. 8-8-2006, FILED 4-1-2005.

THE MARK CONSISTS OF STANDARD CHARACTERS WITHOUT CLAIM TO ANY PARTICULAR FONT, STYLE, SIZE, OR COLOR.

FOR AQUATIC AND WILDLIFE HABITAT RESTORATION SERVICES (U.S. CLS. 100 AND 101).
FIRST USE 1-1-2002; IN COMMERCE 1-1-2002.

3,299,048. MEDEM, INC., SAN FRANCISCO, CA. SN 78-602,506. PUB. 7-11-2006, FILED 4-5-2005.



NO CLAIM IS MADE TO THE EXCLUSIVE RIGHT TO USE "INTERACTIVE HEALTH RECORD", APART FROM

CLASS 44—(Continued).

THE MARK AS SHOWN.

THE PORTION OF THE MARK COMPRISED OF A CROSS DESIGN IS NOT DISPLAYED IN THE COLOR RED. APPLICANT DOES NOT AND WILL NOT USE THE CROSS DESIGN THAT APPEARS IN ITS MARK IN THE COLOR RED.

FOR PROVIDING AN ONLINE MEDICAL HEALTH RECORDS DATABASE, VIA A SECURED NETWORK, UNDER THE PRIMARY CONTROL OF THE PATIENT THAT IS LINKED TO THE PATIENT'S PHYSICIAN WITH ACCESS BY OTHER CLINICIANS BASED UPON PATIENT APPROVAL; AUTOMATED MEDICAL INFORMATION REMINDERS THAT ARE SPECIFIC TO THE PATIENT'S MEDICATIONS OR MEDICAL CONDITIONS; MEDICAL SERVICES, NAMELY, PROVIDING ONLINE MEDICAL CONSULTATIONS, PROVIDING PRESCRIPTIONS AND PRESCRIPTION RENEWALS VIA A GLOBAL COMPUTER NETWORK (U.S. CLS. 100 AND 101).

FIRST USE 4-1-2007; IN COMMERCE 4-1-2007.

3,299,175. CHARLES H. SIMPSON III, D.D.S. P.A., APEX, NC. SN 78-656,590. PUB. 8-15-2006, FILED 6-23-2005.

Renaissance Dentistry

THE MARK CONSISTS OF STANDARD CHARACTERS WITHOUT CLAIM TO ANY PARTICULAR FONT, STYLE, SIZE, OR COLOR.

NO CLAIM IS MADE TO THE EXCLUSIVE RIGHT TO USE "DENTISTRY", APART FROM THE MARK AS SHOWN.

FOR FAMILY AND COSMETIC DENTAL SERVICES (U.S. CLS. 100 AND 101).

FIRST USE 9-20-2004; IN COMMERCE 9-20-2004.

3,299,315. HEALTH CARE AND RETIREMENT CORPORATION OF AMERICA, TOLEDO, OH. SN 78-713,615. PUB. 12-5-2006, FILED 9-15-2005.

HEARTLAND HOSPICE HOUSE

THE MARK CONSISTS OF STANDARD CHARACTERS WITHOUT CLAIM TO ANY PARTICULAR FONT, STYLE, SIZE, OR COLOR.

OWNER OF U.S. REG. NOS. 1,300,002 AND 3,026,062.

NO CLAIM IS MADE TO THE EXCLUSIVE RIGHT TO USE "HOSPICE HOUSE", APART FROM THE MARK AS SHOWN.

FOR PROVIDING HEALTH CARE AND RETIREMENT FACILITY SERVICES, NAMELY, HEALTH CARE, PHYSICAL AND OCCUPATIONAL REHABILITATION, TRANSITIONAL HEALTH CARE, NURSING HOME CARE, HOME HEALTH AND HOSPICE CARE (U.S. CLS. 100 AND 101).

FIRST USE 3-0-2006; IN COMMERCE 3-0-2006.

CLASS 44—(Continued).

3,299,329. PERFORMANCE PEDIATRICS, LLC, PLYMOUTH, MA. SN 78-716,897. PUB. 12-12-2006, FILED 9-20-2005.

PERFORMANCE PEDIATRICS

THE MARK CONSISTS OF STANDARD CHARACTERS WITHOUT CLAIM TO ANY PARTICULAR FONT, STYLE, SIZE, OR COLOR.

NO CLAIM IS MADE TO THE EXCLUSIVE RIGHT TO USE "PEDIATRICS", APART FROM THE MARK AS SHOWN.

FOR PEDIATRIC MEDICAL AND MENTAL HEALTH SERVICES (U.S. CLS. 100 AND 101).

FIRST USE 12-1-2006; IN COMMERCE 12-1-2006.

3,299,481. SIMON, ARTHUR J., ATLANTA, GA. SN 78-741,696. PUB. 7-4-2006, FILED 10-27-2005.

yourLIFT
Limited Incision Facial
Tightening

THE MARK CONSISTS OF STANDARD CHARACTERS WITHOUT CLAIM TO ANY PARTICULAR FONT, STYLE, SIZE, OR COLOR.

NO CLAIM IS MADE TO THE EXCLUSIVE RIGHT TO USE "LIMITED INCISION FACIAL TIGHTENING", APART FROM THE MARK AS SHOWN.

FOR MEDICAL SERVICES (U.S. CLS. 100 AND 101).

FIRST USE 11-28-2005; IN COMMERCE 11-28-2005.

3,299,490. BOWTIE, INC., IRVINE, CA. SN 78-743,874. PUB. 1-16-2007, FILED 10-31-2005.

KOI CHANNEL

THE MARK CONSISTS OF STANDARD CHARACTERS WITHOUT CLAIM TO ANY PARTICULAR FONT, STYLE, SIZE, OR COLOR.

OWNER OF U.S. REG. NO. 2,273,140.

NO CLAIM IS MADE TO THE EXCLUSIVE RIGHT TO USE "KOI", APART FROM THE MARK AS SHOWN.

FOR COMPUTER SERVICES, NAMELY, PROVIDING ONLINE INFORMATION IN THE FIELD OF ANIMALS AND PETS RELATING TO BREEDING, SELECTION, CARE, HEALTH AND NUTRITION (U.S. CLS. 100 AND 101).

FIRST USE 1-0-2007; IN COMMERCE 1-0-2007.

CLASS 44—(Continued).

3,299,591. WILLIAMS, RICHARD B., BILLINGS, MT. SN 78-761,755. PUB. 7-25-2006, FILED 11-28-2005.

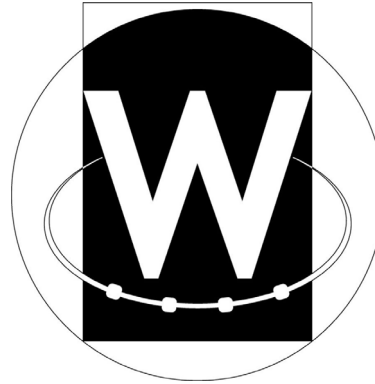

FOR DENTIST AND ORTHODONTIC SERVICES (U.S. CLS. 100 AND 101).

FIRST USE 4-1-2006; IN COMMERCE 4-1-2006.

3,299,675. CHOPRA ENTERPRISES, LLC, CARLSBAD, CA. SN 78-780,397. PUB. 9-19-2006, FILED 12-23-2005.

LILA HASTA

THE MARK CONSISTS OF STANDARD CHARACTERS WITHOUT CLAIM TO ANY PARTICULAR FONT, STYLE, SIZE, OR COLOR.

NO CLAIM IS MADE TO THE EXCLUSIVE RIGHT TO USE "HASTA", APART FROM THE MARK AS SHOWN.

THE FOREIGN WORDING IN THE MARK TRANSLATES INTO ENGLISH AS "PLAYFUL OR PLAY" FOR LILA AND "HAND" FOR HASTA.

FOR HEALTH SPA SERVICES FOR HEALTH AND WELLNESS OF THE BODY AND SPIRIT OFFERED AT A HEALTH RESORT; HEALTH SPA SERVICES, NAMELY, COSMETIC BODY CARE SERVICES; MASSAGE; SKIN CARE SALONS (U.S. CLS. 100 AND 101).

FIRST USE 11-30-2005; IN COMMERCE 11-30-2005.

3,299,676. CHOPRA ENTERPRISES, LLC, CARLSBAD, CA. SN 78-780,408. PUB. 9-19-2006, FILED 12-23-2005.

LILA PADA

THE MARK CONSISTS OF STANDARD CHARACTERS WITHOUT CLAIM TO ANY PARTICULAR FONT, STYLE, SIZE, OR COLOR.

CLASS 44—(Continued).

NO CLAIM IS MADE TO THE EXCLUSIVE RIGHT TO USE "PADA", APART FROM THE MARK AS SHOWN.

THE FOREIGN WORDING IN THE MARK TRANSLATES INTO ENGLISH AS "PLAYFUL OR PLAY" FOR LILA AND "FOOT" FOR PADA.

FOR HEALTH SPA SERVICES FOR HEALTH AND WELLNESS OF THE BODY AND SPIRIT OFFERED AT A HEALTH RESORT; HEALTH SPA SERVICES, NAMELY, COSMETIC BODY CARE SERVICES; MASSAGE; SKIN CARE SALONS (U.S. CLS. 100 AND 101).

FIRST USE 11-30-2005; IN COMMERCE 11-30-2005.

3,299,682. RAYMAC ASSOCIATES INC, LAS VEGAS, NV. SN 78-783,337. PUB. 9-5-2006, FILED 12-30-2005.

DIETBYDNA

THE MARK CONSISTS OF STANDARD CHARACTERS WITHOUT CLAIM TO ANY PARTICULAR FONT, STYLE, SIZE, OR COLOR.

FOR WEIGHT REDUCTION DIET PLANNING AND SUPERVISION (U.S. CLS. 100 AND 101).

FIRST USE 12-29-2005; IN COMMERCE 7-5-2006.

3,299,940. DIETERS EDGE LLC, WOODBURY, CT. SN 78-869,487. PUB. 11-28-2006, FILED 4-25-2006.



NO CLAIM IS MADE TO THE EXCLUSIVE RIGHT TO USE "DIETERS"; "PERMANENT WEIGHT MANAGEMENT", APART FROM THE MARK AS SHOWN.

THE MARK CONSISTS OF THE LOGO HAS A FIGURE WITH ARMS RAISED WITH A SUN BURST BEHIND THE FIGURE AND A BANNER WITH LETTERING DIETERS EDGE CURVING ACROSS THE FIGURE. THE WORDS PERMANENT WEIGHT MANAGEMENT FORM A CIRCULAR PATTERN AROUND THE FIGURE.

FOR WEIGHT REDUCTION DIET PLANNING AND SUPERVISION (U.S. CLS. 100 AND 101).

FIRST USE 4-27-2006; IN COMMERCE 6-15-2006.

CLASS 44—(Continued).

3,300,055. MPD MEDICAL ASSOCIATES (MA), P.C., LEXINGTON, MA. SN 78-910,033. PUB. 1-23-2007, FILED 6-16-2006.

HELPING PEOPLE BECOME PARENTS

THE MARK CONSISTS OF STANDARD CHARACTERS WITHOUT CLAIM TO ANY PARTICULAR FONT, STYLE, SIZE, OR COLOR.

FOR MEDICAL SERVICES IN THE FIELD OF FERTILITY (U.S. CLS. 100 AND 101).

FIRST USE 7-1-2006; IN COMMERCE 7-1-2006.

3,300,203. CR SPA, LLC, TUCSON, AZ. SN 78-978,589. PUB. 7-5-2005, FILED 2-17-2004.

LIFE ENHANCEMENT RESORT

THE MARK CONSISTS OF STANDARD CHARACTERS WITHOUT CLAIM TO ANY PARTICULAR FONT, STYLE, SIZE, OR COLOR.

NO CLAIM IS MADE TO THE EXCLUSIVE RIGHT TO USE "RESORT", APART FROM THE MARK AS SHOWN.

SEC. 2(F) AS TO "LIFE ENHANCEMENT".

FOR PROVIDING COUNSELING SERVICES TO BUSINESSES AND ORGANIZATIONS WISHING TO ESTABLISH AND TO OPERATE A COMPREHENSIVE WELLNESS PROGRAM FOR EMPLOYEES AND THEIR FAMILIES THAT TEACHES AND ENCOURAGES SUPPORTIVE AND POSITIVE HEALTH PRACTICES THROUGH FITNESS, NUTRITION, STRESS MANAGEMENT AND SAFETY CONSCIOUSNESS (U.S. CLS. 100 AND 101).

FIRST USE 9-30-2004; IN COMMERCE 9-30-2004.

CLASS 45—PERSONAL SERVICES

CLASS 45—(Continued).

3,298,638. INTEGRAL INSTITUTE, INC., BOULDER, CO. SN 77-050,235. PUB. 2-20-2007, FILED 11-22-2006.

INTEGRAL NAKED

THE MARK CONSISTS OF STANDARD CHARACTERS WITHOUT CLAIM TO ANY PARTICULAR FONT, STYLE, SIZE, OR COLOR.

OWNER OF U.S. REG. NO. 2,740,694.
FOR PROVIDING ON-LINE INFORMATION IN THE FIELD OF SPIRITUALITY, SELF-HELP, AND PERSONAL EMPOWERMENT SUBJECT MATTERS (U.S. CLS. 100 AND 101).

FIRST USE 5-1-2003; IN COMMERCE 5-1-2003.

CLASS 45—(Continued).

3,299,073. PAWS, WHISKERS & WAGS, LLC, ATLANTA, GA. SN 78-610,741. PUB. 9-26-2006, FILED 4-18-2005.

Pet Tracker 360

THE MARK CONSISTS OF STANDARD CHARACTERS WITHOUT CLAIM TO ANY PARTICULAR FONT, STYLE, SIZE, OR COLOR.

NO CLAIM IS MADE TO THE EXCLUSIVE RIGHT TO USE "PET TRACKER", APART FROM THE MARK AS SHOWN.

FOR TRACKING SERVICE FOR HOUSEHOLD PETS AND DOMESTIC ANIMALS BY MEANS OF PROVIDING PET IDENTIFICATION TAGS FOR THE PET OR ANIMAL TO WEAR ALLOWING THEM TO BE IDENTIFIED AFTER DEATH OR CREMATION OF THE ANIMAL (U.S. CLS. 100 AND 101).

FIRST USE 6-0-2005; IN COMMERCE 6-0-2005.

3,299,072. PAWS, WHISKERS & WAGS, LLC, ATLANTA, GA. SN 78-610,719. PUB. 9-26-2006, FILED 4-18-2005.



NO CLAIM IS MADE TO THE EXCLUSIVE RIGHT TO USE "PET TRACKER", APART FROM THE MARK AS SHOWN.

FOR TRACKING SERVICE FOR HOUSEHOLD PETS AND DOMESTIC ANIMALS BY MEANS OF PROVIDING PET IDENTIFICATION TAGS FOR THE PET OR ANIMAL TO WEAR ALLOWING THEM TO BE IDENTIFIED AFTER DEATH OR CREMATION OF THE ANIMAL (U.S. CLS. 100 AND 101).

FIRST USE 6-0-2005; IN COMMERCE 6-0-2005.

3,299,091. LIEBOV, OFIR, FREEHOLD, NJ. SN 78-617,266. PUB. 6-20-2006, FILED 4-26-2005.



NO CLAIM IS MADE TO THE EXCLUSIVE RIGHT TO USE "CHILDCAM LIVE INTERNET VIDEO SERVICES", APART FROM THE MARK AS SHOWN.

THE COLOR(S) PURPLE, WHITE, GRAY, BLUE, YELLOW IS/ARE CLAIMED AS A FEATURE OF THE MARK.

THE MARK CONSISTS OF PURPLE COMPUTER SCREEN WITH WHITE EYE IN THE MIDDLE. BLUE COMPUTER KEYBOARD WITH GRAY CABLE CONNECTING IT TO SCREEN. WORD CHILD IS IN YELLOW AND WORD CAM IS IN BLUE.

FOR ON-LINE MONITORING, NAMELY, VIDEO MONITORING OF FACILITIES, VIEWABLE THROUGH THE INTERNET FOR MONITORING PURPOSES IN THE FIELD OF CHILD CARE, NAMELY, INTERNET BASED VIDEO-MONITORING OF CHILD CARE CENTERS, SCHOOLS, AND REMOTE LOCATIONS WHERE PARENTS AND AUTHORIZED USERS ARE ABLE VIEW LIVE VIDEO, OVER THE INTERNET, FROM CAMERAS LOCATED IN THE DAYCARE CENTERS, SCHOOLS AND REMOTE LOCATIONS (U.S. CLS. 100 AND 101).

FIRST USE 12-1-2005; IN COMMERCE 12-1-2005.

CLASS 45—(Continued).

3,299,340. HAWKINS, DAVID R., PEMBROKE PINES, FL. SN 78-720,084. PUB. 9-5-2006, FILED 9-25-2005.

CLASS 45—(Continued).

3,299,626. ADEMOLA, ADE, BROOKLYN, NY. SN 78-768,982. PUB. 8-1-2006, FILED 12-8-2005.

Green Shirt Society

SPIRITUAL LIVING IN ACTION

THE MARK CONSISTS OF STANDARD CHARACTERS WITHOUT CLAIM TO ANY PARTICULAR FONT, STYLE, SIZE, OR COLOR.

NO CLAIM IS MADE TO THE EXCLUSIVE RIGHT TO USE "SOCIETY", APART FROM THE MARK AS SHOWN.

FOR SOCIAL CLUB FOR MEN 55 YEARS OF AGE OR OLDER FOR THE PURPOSE OF FRIENDSHIP AND SOCIALLY ACCEPTABLE, LEGAL ACTIVITIES (U.S. CLS. 100 AND 101).

FIRST USE 4-9-2007; IN COMMERCE 4-9-2007.

THE MARK CONSISTS OF STANDARD CHARACTERS WITHOUT CLAIM TO ANY PARTICULAR FONT, STYLE, SIZE, OR COLOR.

FOR PROVIDING INFORMATION IN THE FIELD OF SELF-IMPROVEMENT (U.S. CLS. 100 AND 101).

FIRST USE 1-1-2006; IN COMMERCE 1-6-2006.

3,299,484. MATCH.COM, L.P., DALLAS, TX. SN 78-742,647. PUB. 7-4-2006, FILED 10-28-2005.

3,300,129. SARRECCHIA, ROBERTO, ROMA, ITALY. SN 78-931,482. PUB. 3-13-2007, FILED 7-18-2006.

MATCHWORDS

qmpeople

THE MARK CONSISTS OF STANDARD CHARACTERS WITHOUT CLAIM TO ANY PARTICULAR FONT, STYLE, SIZE, OR COLOR.

FOR COMPUTER SERVICES, NAMELY, PROVIDING INFORMATION REGARDING, AND IN THE NATURE OF, ON-LINE DATING, SEARCH AND INTRODUCTION SERVICES (U.S. CLS. 100 AND 101).

FIRST USE 11-17-2005; IN COMMERCE 11-17-2005.

THE MARK CONSISTS OF STANDARD CHARACTERS WITHOUT CLAIM TO ANY PARTICULAR FONT, STYLE, SIZE, OR COLOR.

FOR WEB SITE SERVICES FEATURING ON-LINE DATING CLUB (U.S. CLS. 100 AND 101).

FIRST USE 6-20-2007; IN COMMERCE 6-20-2007.

* * * * *

PRIOR UNITED STATES CLASSIFICATION

APPLICATION IN ONE CLASS

COLLECTIVE MEMBERSHIP MARKS

CLASS 200—COLLECTIVE MEMBERSHIP

3,298,987. MORRIS & DICKSON CO., LTD., SHREVEPORT, LA. SN 78-587,906. PUB. 8-1-2006, FILED 3-15-2005.

3,299,704. NATIONAL BOARD OF SURGICAL TECHNOLOGY AND SURGICAL ASSISTING, LITTLETON, CO. SN 78-788,288. PUB. 3-6-2007, FILED 1-10-2006.

WE CARE PHARMACY

THE MARK CONSISTS OF STANDARD CHARACTERS WITHOUT CLAIM TO ANY PARTICULAR FONT, STYLE, SIZE, OR COLOR.

NO CLAIM IS MADE TO THE EXCLUSIVE RIGHT TO USE "PHARMACY", APART FROM THE MARK AS SHOWN.

FOR INDICATING MEMBERSHIP IN A(N) ASSOCIATION OF INDEPENDENT PHARMACIES (U.S. CL. 200). FIRST USE 8-1-2004; IN COMMERCE 8-20-2005.

CST-CVS

THE MARK CONSISTS OF STANDARD CHARACTERS WITHOUT CLAIM TO ANY PARTICULAR FONT, STYLE, SIZE, OR COLOR.

OWNER OF U.S. REG. NO. 1,825,663.

THE CERTIFICATION MARK, AS INTENDED TO BE USED BY AUTHORIZED PERSONS, IS INTENDED TO CERTIFY A SPECIFIC LEVEL OF TRAINING, EDUCATION AND EXPERIENCE IN SURGICAL TECHNOLOGY.

FOR MEDICAL SERVICES IN THE FIELD OF SURGICAL TECHNOLOGY (U.S. CL. B). FIRST USE 9-23-2006; IN COMMERCE 9-23-2006.

CERTIFICATION MARKS

CLASS B—SERVICES

3,299,703. NATIONAL BOARD OF SURGICAL TECHNOLOGY AND SURGICAL ASSISTING, LITTLETON, CO. SN 78-788,262. PUB. 3-6-2007, FILED 1-10-2006.

3,299,800. NATIONAL BOARD OF SURGICAL TECHNOLOGY & SURGICAL ASSISTING, LITTLETON, CO. SN 78-817,113. PUB. 3-6-2007, FILED 2-16-2006.

CST-OS

THE MARK CONSISTS OF STANDARD CHARACTERS WITHOUT CLAIM TO ANY PARTICULAR FONT, STYLE, SIZE, OR COLOR.

OWNER OF U.S. REG. NO. 1,825,663.

THE CERTIFICATION MARK, AS INTENDED TO BE USED BY AUTHORIZED PERSONS, IS INTENDED TO CERTIFY A SPECIFIC LEVEL OF TRAINING, EDUCATION AND EXPERIENCE IN SURGICAL TECHNOLOGY.

FOR MEDICAL SERVICES IN THE FIELD OF SURGICAL TECHNOLOGY (U.S. CL. B). FIRST USE 9-23-2006; IN COMMERCE 9-23-2006.

CFA-OS

THE MARK CONSISTS OF STANDARD CHARACTERS WITHOUT CLAIM TO ANY PARTICULAR FONT, STYLE, SIZE, OR COLOR.

OWNER OF U.S. REG. NO. 1,860,579.

THE CERTIFICATION MARK, AS INTENDED TO BE USED BY AUTHORIZED PERSONS, IS INTENDED TO CERTIFY A SPECIFIC LEVEL OF TRAINING, EDUCATION AND EXPERIENCE IN SURGICAL ASSISTING.

FOR MEDICAL SERVICES IN THE FIELD OF SURGICAL ASSISTING (U.S. CL. B). FIRST USE 9-23-2006; IN COMMERCE 9-23-2006.

* * * * *

SUPPLEMENTAL REGISTER

These registrations are not subject to opposition.

SECTION 1.— INTERNATIONAL CLASSIFICATION

The short titles associated below with the international class numbers are terms designed merely for quick identification and are not an official part of the international classification. The full names of international classes are given in section 6.1 of the trademark rules of practice.

The designation "U.S. Cl." appearing in this section refers to the U.S. class in effect prior to Sep. 1, 1973 rather than the international class which applies to applications filed on or after that date. For adoption of international classification see notice in the OFFICIAL GAZETTE of Jun. 26, 1973 (911 O.G. TM 210).

Application in more than one class

3,300,238. WINDOW-FIX, INC., BROOKLYN, NY. SN 76-652,481. FILED P.R. 12-15-2005; AM. S.R. 12-18-2006.

WINDOW-FIX

THE MARK CONSISTS OF STANDARD CHARACTERS WITHOUT CLAIM TO ANY PARTICULAR FONT, STYLE, SIZE, OR COLOR.

CLASS 6—METAL GOODS

FOR BUILDING WINDOW PARTS MADE ENTIRELY OR PRIMARILY OF METAL, NAMELY, WINDOW BALANCES, SHOES, TILT LOCKS, WINDOW LOCKS, TILT PINS, WINDOW OPERATION CRANKS, ALL DISTRIBUTED TO THE RETAIL TRADE; BUILDING WINDOW PARTS MADE ENTIRELY OR PRIMARILY OF METAL, NAMELY, WINDOW BALANCES DISTRIBUTED TO THE WHOLESALE TRADE (U.S. CLS. 2, 12, 13, 14, 23, 25 AND 50).

FIRST USE 8-0-2004; IN COMMERCE 8-0-2004.

CLASS 19—NON-METALLIC BUILDING MATERIALS

FOR INSULATED AND NON-INSULATED BUILDING WINDOW GLASS REPLACEMENTS, ALL DISTRIBUTED TO THE RETAIL TRADE, AND INSULATED GLASS DISTRIBUTED TO THE WHOLESALE TRADE (U.S. CLS. 1, 12, 33 AND 50).

FIRST USE 8-0-2004; IN COMMERCE 8-0-2004.

3,300,249. INSTALLS INC, LLC, BUFFALO, NY. SN 77-008,885. FILED P.R. 9-27-2006; AM. S.R. 8-7-2007.

NEAT CLOSETS

THE MARK CONSISTS OF STANDARD CHARACTERS WITHOUT CLAIM TO ANY PARTICULAR FONT, STYLE, SIZE, OR COLOR.

NO CLAIM IS MADE TO THE EXCLUSIVE RIGHT TO USE "CLOSETS", APART FROM THE MARK AS SHOWN.

CLASS 37—CONSTRUCTION AND REPAIR

FOR CUSTOM CONSTRUCTION AND INSTALLATION OF CLOSET SYSTEMS, STORAGE SPACE SYSTEMS AND HOME OFFICE SYSTEMS (U.S. CLS. 100, 103 AND 106).

FIRST USE 2-19-2007; IN COMMERCE 6-15-2007.

CLASS 42—SCIENTIFIC, COMPUTER AND LEGAL SERVICES

FOR DESIGN SERVICES IN THE FIELD OF CUSTOMIZED CLOSETS, STORAGE SYSTEMS AND HOME OFFICES (U.S. CLS. 100 AND 101).

FIRST USE 2-19-2007; IN COMMERCE 6-15-2007.

3,300,308. CANONIC CORP, SAN DIEGO, CA. SN 77-162,343. FILED P.R. 4-20-2007; AM. S.R. 8-22-2007.

MODEL DRIVEN BUSINESS

THE MARK CONSISTS OF STANDARD CHARACTERS WITHOUT CLAIM TO ANY PARTICULAR FONT, STYLE, SIZE, OR COLOR.

NO CLAIM IS MADE TO THE EXCLUSIVE RIGHT TO USE "BUSINESS", APART FROM THE MARK AS SHOWN.

CLASS 35—ADVERTISING AND BUSINESS

FOR BUSINESS CONSULTING AND INFORMATION SERVICES (U.S. CLS. 100, 101 AND 102).

FIRST USE 3-15-2007; IN COMMERCE 3-15-2007.

CLASS 42—SCIENTIFIC, COMPUTER AND LEGAL SERVICES

FOR CONSULTING SERVICES IN THE FIELD OF DESIGN, SELECTION, IMPLEMENTATION AND USE OF COMPUTER HARDWARE AND SOFTWARE SYSTEMS FOR OTHERS (U.S. CLS. 100 AND 101).

FIRST USE 3-15-2007; IN COMMERCE 3-15-2007.

3,300,315. MTD PRODUCTS INC, VALLEY CITY, OH. SN 78-528,182. FILED P.R. 12-7-2004; AM. S.R. 8-13-2007.

3,300,321. SIERRA PROPERTIES I, LLC, TAMPA, FL. SN 78-612,161. FILED P.R. 4-19-2005; AM. S.R. 7-26-2007.

OPERATOR CONTROLLED REVERSE

THE MARK CONSISTS OF STANDARD CHARACTERS WITHOUT CLAIM TO ANY PARTICULAR FONT, STYLE, SIZE, OR COLOR.

CLASS 7—MACHINERY

FOR RIDING LAWN MOWERS FEATURING REVERSE GEAR MOWING (U.S. CLS. 13, 19, 21, 23, 31, 34 AND 35).
FIRST USE 3-31-1995; IN COMMERCE 3-31-1995.

CLASS 12—VEHICLES

FOR LAWN TRACTORS AND GARDEN TRACTORS FEATURING REVERSE GEAR MOWING (U.S. CLS. 19, 21, 23, 31, 35 AND 44).
FIRST USE 3-31-1995; IN COMMERCE 3-31-1995.

3,300,318. KUSHKA COSMETICS LLC, LANSING, KS. SN 78-553,231. FILED P.R. 1-25-2005; AM. S.R. 2-27-2006.

MICRONIZED INTACT COLLAGEN

THE MARK CONSISTS OF STANDARD CHARACTERS WITHOUT CLAIM TO ANY PARTICULAR FONT, STYLE, SIZE, OR COLOR.

NO CLAIM IS MADE TO THE EXCLUSIVE RIGHT TO USE COLLAGEN, APART FROM THE MARK AS SHOWN.

CLASS 3—COSMETICS AND CLEANING PREPARATIONS

FOR CHEMICAL INGREDIENT COMPLEX SOLD AS AN INTEGRAL COMPONENT OF ITS NON-MEDICATED SKIN CARE PREPARATIONS, COSMETICS, AND HAIR CARE PREPARATIONS (U.S. CLS. 1, 4, 6, 50, 51 AND 52).
FIRST USE 9-0-2005; IN COMMERCE 9-0-2005.

CLASS 5—PHARMACEUTICALS

FOR CHEMICAL INGREDIENT COMPLEX SOLD AS AN INTEGRAL COMPONENT OF PHARMACEUTICAL PRODUCTS AND PREPARATIONS FOR USE IN DERMATOLOGY (U.S. CLS. 6, 18, 44, 46, 51 AND 52).
FIRST USE 9-0-2005; IN COMMERCE 9-0-2005.

FLORIDA NATIONAL GOLF CLUB

THE MARK CONSISTS OF STANDARD CHARACTERS WITHOUT CLAIM TO ANY PARTICULAR FONT, STYLE, SIZE, OR COLOR.

CLASS 25—CLOTHING

FOR GOLF APPAREL, NAMELY, GOLF CAPS, SHIRTS, HATS, CAPS, GOLF SHIRTS (U.S. CLS. 22 AND 39).
FIRST USE 7-19-2007; IN COMMERCE 7-23-2007.

CLASS 28—TOYS AND SPORTING GOODS

FOR GOLF BALLS AND GOLF TOWELS (U.S. CLS. 22, 23, 38 AND 50).
FIRST USE 7-19-2007; IN COMMERCE 7-23-2007.

3,300,326. CAREER EDUCATION CORPORATION, HOFFMAN ESTATES, IL. SN 78-725,227. FILED P.R. 10-3-2005; AM. S.R. 6-5-2007.

CHEFS.COM

THE MARK CONSISTS OF STANDARD CHARACTERS WITHOUT CLAIM TO ANY PARTICULAR FONT, STYLE, SIZE, OR COLOR.

CLASS 38—COMMUNICATION

FOR PROVIDING ON-LINE CHAT ROOMS, ELECTRONIC BULLETIN BOARDS, AND OTHER ONLINE ELECTRONIC FACILITIES, NAMELY, ON-LINE JOURNALS IN THE FORM OF BLOGS, AND STREAMING OF AUDIO RECORDINGS FOR THE TRANSMISSION OF MESSAGES AND INFORMATION AMONG USERS IN THE FIELD OF FOOD, RESTAURANTS, RECIPES, COOKING, AND ENTERTAINING (U.S. CLS. 100, 101 AND 104).
FIRST USE 10-0-2005; IN COMMERCE 10-0-2005.

CLASS 43—HOTEL AND RESTAURANT SERVICES

FOR PROVIDING INFORMATION IN THE FIELDS OF FOOD, RESTAURANTS, RECIPES, COOKING AND ENTERTAINING BY MEANS OF A GLOBAL COMPUTER NETWORK (U.S. CLS. 100 AND 101).
FIRST USE 10-0-2005; IN COMMERCE 10-0-2005.

3,300,328. ROANE, KIT R, BROOKLYN, TX. AND ROANE, SAMUEL L. R., BROOKLYN, NY. SN 78-737,921. FILED P.R. 10-21-2005; AM. S.R. 6-4-2007.

WarShooter

THE MARK CONSISTS OF STANDARD CHARACTERS WITHOUT CLAIM TO ANY PARTICULAR FONT, STYLE, SIZE, OR COLOR.

CLASS 35—ADVERTISING AND BUSINESS

FOR ADVERTISING AND PUBLICITY SERVICES, NAMELY, PROMOTING THE GOODS, SERVICES, BRAND IDENTITY AND COMMERCIAL INFORMATION AND NEWS OF THIRD PARTIES THROUGH ON-LINE MEDIUM; MARKETING SERVICES, NAMELY, PROVIDING INFORMATIONAL WEB PAGES DESIGNED TO GENERATE SALES TRAFFIC VIA HYPERLINKS TO OTHER WEB SITES; PROMOTING THE GOODS AND SERVICES OF OTHERS BY MEANS OF OPERATING AN ON-LINE SHOPPING MALL WITH LINKS TO THE RETAIL WEB SITES OF OTHERS; PROMOTING THE GOODS AND SERVICES OF OTHERS BY PROVIDING A WEB SITE AT WHICH USERS CAN LINK TO THESE GOODS AND SERVICES; PROMOTING THE GOODS AND SERVICES OF OTHERS BY PROVIDING HYPERTEXT LINKS TO THE WEB SITES OF OTHERS; PROVIDING A WEB SITE AT WHICH USERS CAN OFFER GOODS FOR SALE AND BUY GOODS OFFERED BY OTHERS; PROVIDING ON-LINE DIRECTORY INFORMATION SERVICES ALSO FEATURING HYPERLINKS TO OTHER WEB SITES; PROVIDING SPACE AT A WEB SITE FOR THE ADVERTISEMENT OF THE GOODS AND SERVICES OF OTHERS (U.S. CLS. 100, 101 AND 102).

FIRST USE 10-8-2005; IN COMMERCE 10-10-2005.

CLASS 41—EDUCATION AND ENTERTAINMENT

FOR ENTERTAINMENT SERVICES, NAMELY, PROVIDING A WEB SITE FEATURING FILM CLIPS, PHOTOGRAPHS, AND OTHER MULTIMEDIA MATERIALS; NEWS AGENCIES, NAMELY, GATHERING AND DISSEMINATION OF NEWS; NEWS ANALYSIS AND FEATURES DISTRIBUTION; PROVIDING NEWS IN THE NATURE OF CURRENT EVENT REPORTING (U.S. CLS. 100, 101 AND 107).

FIRST USE 10-8-2005; IN COMMERCE 10-10-2005.
3,300,335. APR ACQUISITION, INC., HOUSTON, TX. SN 78-771,482. FILED P.R. 12-12-2005; AM. S.R. 8-16-2007.

THE EVENT RENTAL SPECIALISTS

THE MARK CONSISTS OF STANDARD CHARACTERS WITHOUT CLAIM TO ANY PARTICULAR FONT, STYLE, SIZE, OR COLOR.

CLASS 35—ADVERTISING AND BUSINESS

FOR RETAIL AND WHOLESALE OUTLET SERVICES IN THE FIELD OF PARTY SUPPLIES (U.S. CLS. 100, 101 AND 102).

FIRST USE 6-0-2006; IN COMMERCE 6-0-2006.

CLASS 37—CONSTRUCTION AND REPAIR

FOR RENTAL OF PARTY AND EVENT EQUIPMENT AND FURNITURE, NAMELY, RENTAL OF TEMPORARY LIGHTING (U.S. CLS. 100, 103 AND 106).

FIRST USE 6-0-2006; IN COMMERCE 6-0-2006.

CLASS 41—EDUCATION AND ENTERTAINMENT

FOR RENTAL OF PARTY AND EVENT EQUIPMENT AND FURNITURE, NAMELY, RENTAL OF DANCE FLOORS AND TEMPORARY SOUND EQUIPMENT; PARTY AND SPECIAL EVENT PLANNING AND SPECIAL EVENT PLANNING CONSULTATION SERVICES (U.S. CLS. 100, 101 AND 107).

FIRST USE 6-0-2006; IN COMMERCE 6-0-2006.

CLASS 43—HOTEL AND RESTAURANT SERVICES

FOR RENTAL OF PARTY AND EVENT EQUIPMENT AND FURNITURE, NAMELY, RENTAL OF FURNITURE IN THE NATURE OF TABLES AND CHAIRS, PORTABLE STAGES, SILVERWARE, CHINA, TABLEWARE, GLASSWARE, LINENS, CATERING EQUIPMENT, TENTS, AND CANOPIES (U.S. CLS. 100 AND 101).

FIRST USE 6-0-2006; IN COMMERCE 6-0-2006.

3,300,341. RNB ENTERTAINMENT GROUP, INC., SAN FRANCISCO, CA. SN 78-826,556. FILED P.R. 3-1-2006; AM. S.R. 1-22-2007.



OWNER OF U.S. REG. NO. 3,197,728.
NO CLAIM IS MADE TO THE EXCLUSIVE RIGHT TO USE "ENTERTAINMENT GROUP", APART FROM THE MARK AS SHOWN.

THE COLOR(S) BLUE AND BLACK IS/ARE CLAIMED AS A FEATURE OF THE MARK.

THE COLOR BLUE IS LOCATED IN THE TERM RNB. THE REMAINING WORDING IS IN BLACK.

CLASS 9—ELECTRICAL AND SCIENTIFIC APPARATUS

FOR CDS AND DVDS FEATURING MUSICAL PERFORMANCES (U.S. CLS. 21, 23, 26, 36 AND 38).

FIRST USE 1-13-2006; IN COMMERCE 1-13-2006.

CLASS 41—EDUCATION AND ENTERTAINMENT

FOR MUSIC PRODUCTION SERVICES (U.S. CLS. 100, 101 AND 107).

FIRST USE 1-13-2006; IN COMMERCE 1-13-2006.

3,300,343. MARX, DONALD L., ARLINGTON, VA. SN 78-841,109. FILED P.R. 3-20-2006; AM. S.R. 8-12-2007.

3,300,374. AMERICAN SYSTEMS CORPORATION, CHANTILLY, VA. SN 78-952,214. FILED P.R. 8-15-2006; AM. S.R. 8-20-2007.

Kids Reading to Kids

THE MARK CONSISTS OF STANDARD CHARACTERS WITHOUT CLAIM TO ANY PARTICULAR FONT, STYLE, SIZE, OR COLOR.

CLASS 16—PAPER GOODS AND PRINTED MATTER

FOR SERIES OF BOOKS FEATURING CHILDREN'S READING IMPROVEMENT AND CHARACTER DEVELOPMENT (U.S. CLS. 2, 5, 22, 23, 29, 37, 38 AND 50).
FIRST USE 3-20-2005; IN COMMERCE 10-11-2005.

CLASS 41—EDUCATION AND ENTERTAINMENT

FOR EDUCATIONAL SERVICES NAMELY CONDUCTING PROGRAMS IN THE FIELD OF CHILDREN'S READING IMPROVEMENT AND CHARACTER DEVELOPMENT (U.S. CLS. 100, 101 AND 107).
FIRST USE 3-20-2005; IN COMMERCE 10-11-2005.

3,300,367. CUSTOMIZED PHARMACEUTICAL LEARNING SYSTEMS, INC., ADDISON, TX. SN 78-940,365. FILED P.R. 7-28-2006; AM. S.R. 6-25-2007.

CANCER COMM

THE MARK CONSISTS OF STANDARD CHARACTERS WITHOUT CLAIM TO ANY PARTICULAR FONT, STYLE, SIZE, OR COLOR.

CLASS 35—ADVERTISING AND BUSINESS

FOR BUSINESS MARKETING CONSULTING SERVICES (U.S. CLS. 100, 101 AND 102).
FIRST USE 1-1-2007; IN COMMERCE 1-1-2007.

CLASS 41—EDUCATION AND ENTERTAINMENT

FOR EDUCATIONAL SERVICES, NAMELY, CONDUCTING SEMINARS, CONFERENCES, SYMPOSIA, WORKSHOPS, AND SPEAKER TRAINING IN THE FIELDS OF ONCOLOGY, PHARMACEUTICALS AND EXECUTIVE DEVELOPMENT, AND THE DISTRIBUTION OF COURSE MATERIALS IN CONNECTION THEREWITH (U.S. CLS. 100, 101 AND 107).
FIRST USE 1-1-2007; IN COMMERCE 1-1-2007.

AMERICAN SYSTEMS

THE MARK CONSISTS OF STANDARD CHARACTERS WITHOUT CLAIM TO ANY PARTICULAR FONT, STYLE, SIZE, OR COLOR.

NO CLAIM IS MADE TO THE EXCLUSIVE RIGHT TO USE "SYSTEMS", APART FROM THE MARK AS SHOWN.

CLASS 35—ADVERTISING AND BUSINESS

FOR GLOBAL BUSINESS MANAGEMENT SERVICES; GLOBAL OUTSOURCING SERVICES; GLOBAL CUSTOMER ON-SITE PERSONNEL SOURCING, INCLUDING PROGRAM MANAGEMENT, FUNCTIONAL MANAGEMENT, AND RELATED SPECIALIZED CONSULTING SERVICES (U.S. CLS. 100, 101 AND 102).
FIRST USE 3-0-2006; IN COMMERCE 3-0-2006.

CLASS 36—INSURANCE AND FINANCIAL

FOR SPECIALIZED FINANCIAL CONSULTING SERVICES (U.S. CLS. 100, 101 AND 102).
FIRST USE 3-0-2006; IN COMMERCE 3-0-2006.

CLASS 37—CONSTRUCTION AND REPAIR

FOR GLOBAL INSTALLATION AND MAINTENANCE OF VOICE, DATA, VIDEO, AND SECURITY NETWORKS (U.S. CLS. 100, 103 AND 106).
FIRST USE 3-0-2006; IN COMMERCE 3-0-2006.

CLASS 41—EDUCATION AND ENTERTAINMENT

FOR GLOBAL TRAINING SERVICES IN THE FIELDS OF CURRICULUM DEVELOPMENT, OF BUSINESS-NEEDS ANALYSIS, OF BUSINESS-REQUIREMENTS DEFINITION, OF INSTRUCTIONAL SERVICES, AND OF COMPUTER BASED TRAINING SYSTEMS (U.S. CLS. 100, 101 AND 107).
FIRST USE 3-0-2006; IN COMMERCE 3-0-2006.

CLASS 42—SCIENTIFIC, COMPUTER AND LEGAL SERVICES

FOR GLOBAL ENGINEERING SERVICES; GLOBAL SOFTWARE DEVELOPMENT SERVICES FOR OTHERS, NAMELY, FULL LIFE CYCLE SOFTWARE DEVELOPMENT AND SOFTWARE INTEGRATION-CONSULTING SERVICES; GLOBAL INSTALLATION OF COMPUTER SOFTWARE; GLOBAL DESIGN OF BROADBAND, BASEBAND, AND FIBRE OPTIC CABLE SYSTEMS; ENGINEERING SERVICES TO ASSESS VOICE, DATA, AND VIDEO CABLING REQUIREMENTS (U.S. CLS. 100 AND 101).
FIRST USE 3-0-2006; IN COMMERCE 3-0-2006.

3,300,375. AMERICAN SYSTEMS CORPORATION, CHANTILLY, VA. SN 78-952,217. FILED P.R. 8-15-2006; AM. S.R. 8-20-2007.

CLASS 42—SCIENTIFIC, COMPUTER AND LEGAL SERVICES

FOR GLOBAL ENGINEERING SERVICES; GLOBAL SOFTWARE DEVELOPMENT SERVICES FOR OTHERS, NAMELY, FULL LIFE CYCLE SOFTWARE DEVELOPMENT AND SOFTWARE INTEGRATION-CONSULTING SERVICES; GLOBAL INSTALLATION OF COMPUTER SOFTWARE; GLOBAL DESIGN OF BROADBAND, BASEBAND, AND FIBRE OPTIC CABLE SYSTEMS; ENGINEERING SERVICES TO ASSESS VOICE, DATA, AND VIDEO CABLING REQUIREMENTS (U.S. CLS. 100 AND 101).

FIRST USE 3-0-2006; IN COMMERCE 3-0-2006.

AMERICAN SYSTEMS CORPORATION

3,300,383. GENERATE, INC., MAYNARD, MA. SN 78-962,597. FILED P.R. 8-29-2006; AM. S.R. 6-25-2007.

THE MARK CONSISTS OF STANDARD CHARACTERS WITHOUT CLAIM TO ANY PARTICULAR FONT, STYLE, SIZE, OR COLOR.

NO CLAIM IS MADE TO THE EXCLUSIVE RIGHT TO USE "SYSTEMS CORPORATION", APART FROM THE MARK AS SHOWN.

NETWORKED INTELLIGENCE

CLASS 35—ADVERTISING AND BUSINESS

FOR GLOBAL BUSINESS MANAGEMENT SERVICES; GLOBAL OUTSOURCING SERVICES; GLOBAL CUSTOMER ON-SITE PERSONNEL SOURCING, INCLUDING PROGRAM MANAGEMENT, FUNCTIONAL MANAGEMENT, AND RELATED SPECIALIZED CONSULTING SERVICES (U.S. CLS. 100, 101 AND 102).

FIRST USE 3-0-2006; IN COMMERCE 3-0-2006.

THE MARK CONSISTS OF STANDARD CHARACTERS WITHOUT CLAIM TO ANY PARTICULAR FONT, STYLE, SIZE, OR COLOR.

NO CLAIM IS MADE TO THE EXCLUSIVE RIGHT TO USE "INTELLIGENCE", APART FROM THE MARK AS SHOWN.

CLASS 35—ADVERTISING AND BUSINESS

CLASS 36—INSURANCE AND FINANCIAL

FOR SPECIALIZED FINANCIAL CONSULTING SERVICES (U.S. CLS. 100, 101 AND 102).

FIRST USE 3-0-2006; IN COMMERCE 3-0-2006.

FOR ONLINE BUSINESS RELATIONSHIP MANAGEMENT SERVICES, NAMELY, PROVIDING BUSINESS AND CAREER NETWORKING SERVICES; PROVIDING ON-LINE COMPUTER DATABASES IN THE FIELDS OF BUSINESS AND COMPANY INFORMATION AND NEWS, EXECUTIVE PROFILES AND INFORMATION FEATURING BUSINESS RELATIONSHIP PATHS (U.S. CLS. 100, 101 AND 102).

FIRST USE 6-0-2004; IN COMMERCE 2-0-2005.

CLASS 37—CONSTRUCTION AND REPAIR

FOR GLOBAL INSTALLATION AND MAINTENANCE OF VOICE, DATA, VIDEO, AND SECURITY NETWORKS (U.S. CLS. 100, 103 AND 106).

FIRST USE 3-0-2006; IN COMMERCE 3-0-2006.

CLASS 42—SCIENTIFIC, COMPUTER AND LEGAL SERVICES

CLASS 41—EDUCATION AND ENTERTAINMENT

FOR GLOBAL TRAINING SERVICES IN THE FIELDS OF CURRICULUM DEVELOPMENT, OF BUSINESS-NEEDS ANALYSIS, OF BUSINESS-REQUIREMENTS DEFINITION, OF INSTRUCTIONAL SERVICES, AND OF COMPUTER BASED TRAINING SYSTEMS (U.S. CLS. 100, 101 AND 107).

FIRST USE 3-0-2006; IN COMMERCE 3-0-2006.

FOR APPLICATION SERVICE PROVIDER (ASP) FEATURING SOFTWARE IN THE FIELD OF BUSINESS AND COMPANY NEWS AND EXECUTIVES' PROFILES AND DATABASE SERVICES, NAMELY, ACTING AS AN APPLICATION SERVICE PROVIDER IN THE FIELD OF BUSINESS NETWORKING TO HOST COMPUTER APPLICATION SOFTWARE FOR SEARCHING AND RETRIEVING INFORMATION FROM DATABASES AND COMPUTER NETWORKS (U.S. CLS. 100 AND 101).

FIRST USE 6-0-2004; IN COMMERCE 2-0-2005.

* * * * *

SECTION 2.— INTERNATIONAL CLASSIFICATION

The short titles associated below with the international class numbers are terms designed merely for quick identification and are not an official part of the international classification. The full names of international classes are given in section 6.1 of the trademark rules of practice.

The designation "U.S. Cl." appearing in this section refers to the U.S. class in effect prior to Sep. 1, 1973 rather than the international class which applies to applications filed on or after that date. For adoption of international classification see notice in the OFFICIAL GAZETTE of Jun. 26, 1973 (911 O.G. TM 210).

Application in one class

CLASS 3—COSMETICS AND CLEANING PREPARATIONS

3,300,313. BATH & BODY WORKS BRAND MANAGEMENT, INC., REYNOLDSBURG, OH. SN 78-455,066. FILED P.R. 7-22-2004; AM. S.R. 7-12-2007.

THE TAHITIAN VANILLA CANDLE CO.

THE MARK CONSISTS OF STANDARD CHARACTERS WITHOUT CLAIM TO ANY PARTICULAR FONT, STYLE, SIZE, OR COLOR.

NO CLAIM IS MADE TO THE EXCLUSIVE RIGHT TO USE "CANDLE CO.", APART FROM THE MARK AS SHOWN.

FOR FRAGRANT ROOM SPRAYS, POTPOURRI, REFILLS FOR ELECTRIC FRAGRANCE DISPENSERS, AND PERSONAL CARE PRODUCTS, NAMELY, BODY CREAM, BODY LOTION, BODY SCRUB, BODY WASH, BUBBLE BATH, ESSENTIAL OILS, SHOWER GELS AND SOAPS (U.S. CLS. 1, 4, 6, 50, 51 AND 52).

FIRST USE 9-25-2006; IN COMMERCE 9-25-2006.

CLASS 5—PHARMACEUTICALS

3,300,371. MELROCK, LTD., SARANAC, MI. SN 78-951,299. FILED P.R. 8-14-2006; AM. S.R. 7-9-2007.

CONCEPTION CAP

THE MARK CONSISTS OF STANDARD CHARACTERS WITHOUT CLAIM TO ANY PARTICULAR FONT, STYLE, SIZE, OR COLOR.

NO CLAIM IS MADE TO THE EXCLUSIVE RIGHT TO USE "CAP", APART FROM THE MARK AS SHOWN.

FOR FERTILITY ENHANCEMENT PREPARATION, NAMELY CERVICAL CAPS (U.S. CLS. 6, 18, 44, 46, 51 AND 52).

FIRST USE 4-26-2006; IN COMMERCE 4-26-2006.

CLASS 6—METAL GOODS

TM 1622

CLASS 6—(Continued).

3,300,245. LEADING EDGE DISTRIBUTION LTD., WALTON HILLS, OH. SN 76-674,106. FILED P.R. 3-15-2007; AM. S.R. 7-5-2007.

TIN PLATE LITE

THE MARK CONSISTS OF STANDARD CHARACTERS WITHOUT CLAIM TO ANY PARTICULAR FONT, STYLE, SIZE, OR COLOR.

NO CLAIM IS MADE TO THE EXCLUSIVE RIGHT TO USE "TIN PLATE", APART FROM THE MARK AS SHOWN. FOR TIN PLATED STEEL COILS FOR USE IN THE WINDOW INDUSTRY (U.S. CLS. 2, 12, 13, 14, 23, 25 AND 50).

FIRST USE 9-1-2006; IN COMMERCE 9-1-2006.

3,300,266. HUDSON LOCK, LLC, HUDSON, MA. SN 77-057,065. FILED P.R. 12-5-2006; AM. S.R. 7-11-2007.

HIDE-A-KEY

THE MARK CONSISTS OF STANDARD CHARACTERS WITHOUT CLAIM TO ANY PARTICULAR FONT, STYLE, SIZE, OR COLOR.

FOR MAGNETIZED METAL BOXES WITH A SLIDING LID FOR HOLDING KEYS, COINS AND THE LIKE (U.S. CLS. 2, 12, 13, 14, 23, 25 AND 50).

FIRST USE 11-4-1949; IN COMMERCE 11-10-1949.

CLASS 6—(Continued).

3,300,282. QUALITY FENCE BUILDERS, INC., AUBURN, WA. SN 77-081,170. FILED P.R. 1-11-2007; AM. S.R. 7-3-2007.

**TWIN-TRAC CANTILEVERED
SLIDING GATE**

THE MARK CONSISTS OF STANDARD CHARACTERS WITHOUT CLAIM TO ANY PARTICULAR FONT, STYLE, SIZE, OR COLOR.

NO CLAIM IS MADE TO THE EXCLUSIVE RIGHT TO USE "CANTILEVERED SLIDING GATE", APART FROM THE MARK AS SHOWN.

FOR METAL GATES AND FENCING (U.S. CLS. 2, 12, 13, 14, 23, 25 AND 50).

FIRST USE 8-1-2005; IN COMMERCE 8-1-2005.

CLASS 7—MACHINERY

3,300,279. SMART MOTION ROBOTICS, INC., GILBERTS, IL. SN 77-073,671. FILED P.R. 12-29-2006; AM. S.R. 6-15-2007.

SMARTPACKER

THE MARK CONSISTS OF STANDARD CHARACTERS WITHOUT CLAIM TO ANY PARTICULAR FONT, STYLE, SIZE, OR COLOR.

FOR PACKING MACHINES (U.S. CLS. 13, 19, 21, 23, 31, 34 AND 35).

FIRST USE 6-21-2006; IN COMMERCE 6-21-2006.

CLASS 9—ELECTRICAL AND SCIENTIFIC APPARATUS

3,300,237. CLARITI EYEWEAR, INC., SANTA FE SPRINGS, CA. SN 76-611,040. FILED P.R. 9-13-2004; AM. S.R. 1-11-2007.

FLEXTITANIUM

THE MARK CONSISTS OF STANDARD CHARACTERS WITHOUT CLAIM TO ANY PARTICULAR FONT, STYLE, SIZE, OR COLOR.

FOR EYEWEAR, NAMELY, EYEGLASSES, SUNGLASSES AND FRAMES AND REPLACEMENT PARTS THEREFOR; EYEWEAR ACCESSORIES, NAMELY, EYEGLASS HOLDERS, CASES AND POUCHES (U.S. CLS. 21, 23, 26, 36 AND 38).

FIRST USE 7-5-2001; IN COMMERCE 7-8-2001.

CLASS 9—(Continued).

3,300,239. HIE ELECTRONICS, INC., MCKINNEY, TX. SN 76-654,383. FILED P.R. 2-1-2006; AM. S.R. 5-23-2007.

TBYTE

THE MARK CONSISTS OF STANDARD CHARACTERS WITHOUT CLAIM TO ANY PARTICULAR FONT, STYLE, SIZE, OR COLOR.

FOR OPTICAL STORAGE SOLUTIONS, NAMELY, DIGITAL DATA STORAGE AND RETRIEVAL SYSTEMS CONSISTING OF DIGITAL DATA RECORDING DEVICES, NAMELY, OPTICAL DISC DRIVES, BLANK RECORDABLE AND REWRITABLE OPTICAL AND MAGNETO-OPTICAL DISCS, NAMELY, COMPACT DISC, DVD DISCS, MECHANICAL ROBOT DEVICES, DISK MEDIA MAGAZINES AND SOFTWARE USED FOR RECORDING, STORING, CATALOGING, RETRIEVING AND PLAYBACK OF OPTICAL DATA (U.S. CLS. 21, 23, 26, 36 AND 38).

FIRST USE 3-17-2005; IN COMMERCE 5-5-2005.

3,300,251. ABB SCHWEIZ AG, BADEN, SWITZERLAND. SN 77-015,519. FILED P.R. 10-6-2006; AM. S.R. 7-24-2007.

FOCS

THE MARK CONSISTS OF STANDARD CHARACTERS WITHOUT CLAIM TO ANY PARTICULAR FONT, STYLE, SIZE, OR COLOR.

OWNER OF SWITZERLAND REG. NO. 526545, DATED 8-18-2004, EXPIRES 8-18-2014.

FOR MEASURING INSTRUMENTS IN THE NATURE OF FEELERS, NAMELY, SENSORS FOR MEASURING ELECTRICAL CURRENT (U.S. CLS. 21, 23, 26, 36 AND 38).

FIRST USE 2-22-2005; IN COMMERCE 12-21-2005.

3,300,291. LOVEJOY, CHARLEE R., CASTLE ROCK, CO. SN 77-118,761. FILED 2-28-2007.

MouseBoard

THE MARK CONSISTS OF STANDARD CHARACTERS WITHOUT CLAIM TO ANY PARTICULAR FONT, STYLE, SIZE, OR COLOR.

FOR COMPUTER MOUSE ACCESSORY, NAMELY, A RIGID COMPUTER MOUSE PAD ADAPTED FOR PLACEMENT ON THE LEG OR LAP OF A USER (U.S. CLS. 21, 23, 26, 36 AND 38).

FIRST USE 1-0-1997; IN COMMERCE 1-0-1997.

CLASS 9—(Continued).

3,300,340. VOXWARE, INC., LAWRENCEVILLE, NJ. SN 78-801,187. FILED P.R. 1-27-2006; AM. S.R. 8-7-2007.

VOXMANAGER

THE MARK CONSISTS OF STANDARD CHARACTERS WITHOUT CLAIM TO ANY PARTICULAR FONT, STYLE, SIZE, OR COLOR.

FOR COMPUTER SOFTWARE FOR MANAGING VOICE-ENABLED WIRELESS HANDHELD DEVICES VIA THE INTERNET (U.S. CLS. 21, 23, 26, 36 AND 38).

FIRST USE 9-26-2005; IN COMMERCE 9-26-2005.

3,300,344. FEDERAL SIGNAL CORPORATION, OAK BROOK, IL. SN 78-847,672. FILED P.R. 3-28-2006; AM. S.R. 8-17-2007.

RUMBLER

THE MARK CONSISTS OF STANDARD CHARACTERS WITHOUT CLAIM TO ANY PARTICULAR FONT, STYLE, SIZE, OR COLOR.

FOR LOW FREQUENCY AMPLIFIER AND SPEAKER FOR USE WITH SIRENS FOR EMERGENCY VEHICLES (U.S. CLS. 21, 23, 26, 36 AND 38).

FIRST USE 1-0-2006; IN COMMERCE 1-17-2006.

3,300,350. ELECA INTERNATIONAL, INC., WALNUT, CA. SN 78-904,734. FILED P.R. 6-9-2006; AM. S.R. 6-20-2007.

eMIXER

FOR SOUND MIXERS (U.S. CLS. 21, 23, 26, 36 AND 38). FIRST USE 6-1-2007; IN COMMERCE 6-1-2007.

CLASS 9—(Continued).

3,300,353. L-1 IDENTITY SOLUTIONS, INC., STAMFORD, CT. SN 78-921,491. FILED P.R. 6-30-2006; AM. S.R. 6-11-2007.

OFFENDER-ID

THE MARK CONSISTS OF STANDARD CHARACTERS WITHOUT CLAIM TO ANY PARTICULAR FONT, STYLE, SIZE, OR COLOR.

FOR COMPUTER HARDWARE DEVICE COMPRISING OF AN IRIS SCANNER, A COMPUTER PROCESSOR AND COMPUTER SOFTWARE FOR USE IN IDENTIFICATION OF USERS BY THE USER'S BIOMETRIC INFORMATION (U.S. CLS. 21, 23, 26, 36 AND 38).

FIRST USE 5-1-2005; IN COMMERCE 5-1-2005.

3,300,364. GOTTROX LLC, CHICAGO, IL. SN 78-939,637. FILED P.R. 7-28-2006; AM. S.R. 6-25-2007.

ROTATOR

THE MARK CONSISTS OF STANDARD CHARACTERS WITHOUT CLAIM TO ANY PARTICULAR FONT, STYLE, SIZE, OR COLOR.

FOR REORIENTABLE ELECTRICAL POWER DISTRIBUTION UNITS (U.S. CLS. 21, 23, 26, 36 AND 38).

FIRST USE 6-15-2007; IN COMMERCE 6-15-2007.

3,300,387. THOMSON HEALTHCARE INC., MONTVALE, NJ. SN 78-972,554. FILED P.R. 9-12-2006; AM. S.R. 6-15-2007.

1ST MEDICAL RESPONSE

THE MARK CONSISTS OF STANDARD CHARACTERS WITHOUT CLAIM TO ANY PARTICULAR FONT, STYLE, SIZE, OR COLOR.

FOR DOWNLOADABLE DATABASE THAT CONTAINS INFORMATION FOR DEVELOPING TRAINING PROGRAMS FOR FIRST AID OR INITIAL RESPONSE TO ACCIDENTS OR ILLNESSES OCCURRING IN THE WORKPLACE (U.S. CLS. 21, 23, 26, 36 AND 38).

FIRST USE 4-1-1989; IN COMMERCE 4-1-1989.

CLASS 10—MEDICAL APPARATUS

CLASS 10—(Continued).

3,300,275. BAMBURGH MARRSH, LLC, VANCOUVER, WA.
SN 77-062,880. FILED P.R. 12-12-2006; AM. S.R. 7-10-2007.

4SALIVA

THE MARK CONSISTS OF STANDARD CHARACTERS WITHOUT CLAIM TO ANY PARTICULAR FONT, STYLE, SIZE, OR COLOR.

FOR ORAL FLUID DIAGNOSTIC DEVICES FOR DETECTING INFECTIOUS DISEASES, ONCOLOGY MARKERS, DRUGS OF ABUSE AND AGENTS OF BIOTERROR (U.S. CLS. 26, 39 AND 44).
FIRST USE 10-1-2003; IN COMMERCE 10-1-2003.

CLASS 12—VEHICLES

3,300,243. FENTON, RONALD L., MT. PROSPECT, IL. SN 76-667,913. FILED P.R. 10-23-2006; AM. S.R. 7-13-2007.

SAFETYWRAPPER

THE MARK CONSISTS OF STANDARD CHARACTERS WITHOUT CLAIM TO ANY PARTICULAR FONT, STYLE, SIZE, OR COLOR.

FOR EXTERNAL FITTED COVERINGS FOR A FUEL TANK FOR LAND VEHICLES (U.S. CLS. 19, 21, 23, 31, 35 AND 44).
FIRST USE 7-5-2007; IN COMMERCE 7-5-2007.

3,300,257. MARATHON INDUSTRIES, INC., KENT, WA. SN 77-038,322. FILED P.R. 11-7-2006; AM. S.R. 3-22-2007.

UNIVERSAL FIT AIR FILLED WHEELBARROW TIRE

THE MARK CONSISTS OF STANDARD CHARACTERS WITHOUT CLAIM TO ANY PARTICULAR FONT, STYLE, SIZE, OR COLOR.

NO CLAIM IS MADE TO THE EXCLUSIVE RIGHT TO USE "WHEELBARROW TIRE", APART FROM THE MARK AS SHOWN.

FOR TIRES FOR LAND VEHICLES (U.S. CLS. 19, 21, 23, 31, 35 AND 44).
FIRST USE 9-1-2005; IN COMMERCE 4-11-2006.

CLASS 12—(Continued).

3,300,352. RING & PINION SERVICE, INC., EVERETT, WA.
SN 78-914,855. FILED P.R. 6-22-2006; AM. S.R. 6-1-2007.

USA STANDARD GEAR

THE MARK CONSISTS OF STANDARD CHARACTERS WITHOUT CLAIM TO ANY PARTICULAR FONT, STYLE, SIZE, OR COLOR.

FOR LAND VEHICLE PARTS, NAMELY, AXLES, DIFFERENTIALS AND COMPONENTS THEREFORE, NAMELY, RING AND PINIONS (U.S. CLS. 19, 21, 23, 31, 35 AND 44).

FIRST USE 5-31-2007; IN COMMERCE 5-31-2007.

CLASS 15—MUSICAL INSTRUMENTS

3,300,355. SHS INTERNATIONAL, INC., INDIANAPOLIS, IN.
SN 78-923,580. FILED P.R. 7-6-2006; AM. S.R. 8-7-2007.

DEVLIN

THE MARK CONSISTS OF STANDARD CHARACTERS WITHOUT CLAIM TO ANY PARTICULAR FONT, STYLE, SIZE, OR COLOR.

FOR GUITARS (U.S. CLS. 2, 21 AND 36).
FIRST USE 6-0-2006; IN COMMERCE 6-0-2006.

CLASS 16—PAPER GOODS AND PRINTED MATTER

3,300,244. ADVANCE MAGAZINE PUBLISHERS INC., NEW YORK, NY. SN 76-672,628. FILED P.R. 2-13-2007; AM. S.R. 7-8-2007.

BEAUTY

FOR MAGAZINE COLUMN, SECTION AND FEATURE COVERING TOPICS OF INTEREST ABOUT BEAUTY FOR WOMEN (U.S. CLS. 2, 5, 22, 23, 29, 37, 38 AND 50).

FIRST USE 8-0-2005; IN COMMERCE 8-0-2005.

CLASS 16—(Continued).

3,300,271. WILLIAM O. CLEVERLEY, LTD., DBA CLEVERLEY & ASSOCIATES, WORTHINGTON, OH. SN 77-057,905. FILED P.R. 12-6-2006; AM. S.R. 8-22-2007.

COMMUNITY VALUE INDEX

THE MARK CONSISTS OF STANDARD CHARACTERS WITHOUT CLAIM TO ANY PARTICULAR FONT, STYLE, SIZE, OR COLOR.

NO CLAIM IS MADE TO THE EXCLUSIVE RIGHT TO USE INDEX, APART FROM THE MARK AS SHOWN.

FOR PRINTED REPORTS FEATURING ANALYSIS OF HOSPITAL FINANCIAL INFORMATION (U.S. CLS. 2, 5, 22, 23, 29, 37, 38 AND 50).

FIRST USE 3-1-2003; IN COMMERCE 3-1-2003.

3,300,284. HEALTHCARE STRATEGY GROUP, LLC, LOUISVILLE, KY. SN 77-094,611. FILED P.R. 1-30-2007; AM. S.R. 7-12-2007.

PHYSICIAN STRATEGY NEWS

THE MARK CONSISTS OF STANDARD CHARACTERS WITHOUT CLAIM TO ANY PARTICULAR FONT, STYLE, SIZE, OR COLOR.

NO CLAIM IS MADE TO THE EXCLUSIVE RIGHT TO USE "NEWS", APART FROM THE MARK AS SHOWN.

FOR NEWSLETTERS IN THE FIELD OF HEALTHCARE PROVIDERS AND PHYSICIAN RELATIONSHIPS (U.S. CLS. 2, 5, 22, 23, 29, 37, 38 AND 50).

FIRST USE 9-7-2006; IN COMMERCE 9-7-2006.

3,300,294. NATIONAL INK, LLC, SANTEE, CA. SN 77-127,202. FILED P.R. 3-9-2007; AM. S.R. 7-3-2007.



FOR WRITING INKS; INKS FOR MARKERS (U.S. CLS. 2, 5, 22, 23, 29, 37, 38 AND 50).
FIRST USE 11-1-2003; IN COMMERCE 11-1-2003.

CLASS 16—(Continued).

3,300,295. NATIONAL INK, LLC, SANTEE, CA. SN 77-127,266. FILED P.R. 3-9-2007; AM. S.R. 7-3-2007.



FOR WRITING INKS; INKS FOR MARKERS (U.S. CLS. 2, 5, 22, 23, 29, 37, 38 AND 50).
FIRST USE 11-1-2003; IN COMMERCE 11-1-2003.

3,300,296. NATIONAL INK, LLC, SANTEE, CA. SN 77-127,278. FILED P.R. 3-9-2007; AM. S.R. 7-3-2007.



FOR WRITING INKS; INKS FOR MARKERS (U.S. CLS. 2, 5, 22, 23, 29, 37, 38 AND 50).
FIRST USE 11-1-2003; IN COMMERCE 11-1-2003.

3,300,330. COVENANT REVIEW, LLC, NEW YORK, NY. SN 78-740,503. FILED P.R. 10-26-2005; AM. S.R. 7-24-2007.

Covenant Review

THE MARK CONSISTS OF STANDARD CHARACTERS WITHOUT CLAIM TO ANY PARTICULAR FONT, STYLE, SIZE, OR COLOR.

NO CLAIM IS MADE TO THE EXCLUSIVE RIGHT TO USE "REVIEW", APART FROM THE MARK AS SHOWN.

FOR PRINTED PUBLICATIONS, NAMELY, WRITTEN COMMENTARY, REPORTS, AND NEWSLETTERS COMMENTING ON BONDS, LOANS, AND OTHER DOCUMENTS USED IN CONNECTION WITH FINANCING ACTIVITIES (U.S. CLS. 2, 5, 22, 23, 29, 37, 38 AND 50).

FIRST USE 2-9-2006; IN COMMERCE 2-9-2006.

CLASS 16—(Continued).

3,300,345. ZELCO INDUSTRIES, INC., MOUNT VERNON, NY. SN 78-848,193. FILED P.R. 3-28-2006; AM. S.R. 8-7-2007.

BOOK TAGS

THE MARK CONSISTS OF STANDARD CHARACTERS WITHOUT CLAIM TO ANY PARTICULAR FONT, STYLE, SIZE, OR COLOR.

FOR PLASTIC PAPER CLIPS WITH STICKERS THAT ARE USED WITH BOOKS (U.S. CLS. 2, 5, 22, 23, 29, 37, 38 AND 50).

FIRST USE 8-31-2006; IN COMMERCE 8-31-2006.

CLASS 18—LEATHER GOODS

3,300,299. WRAP'N WEAR LLC, CLINTON, UT. SN 77-136,414. FILED P.R. 3-21-2007; AM. S.R. 7-2-2007.

Wrap 'n Wear

THE MARK CONSISTS OF STANDARD CHARACTERS WITHOUT CLAIM TO ANY PARTICULAR FONT, STYLE, SIZE, OR COLOR.

FOR BABY CARRIERS WORN ON THE BODY (U.S. CLS. 1, 2, 3, 22 AND 41).

FIRST USE 8-1-2006; IN COMMERCE 8-1-2006.

3,300,323. SALSA SEVEN INC., THE, GREAT NECK, NY. SN 78-680,086. FILED P.R. 7-27-2005; AM. S.R. 8-15-2007.



FOR WALLETS; LEATHER BAGS; ALL PURPOSE SPORT BAGS; SHOE BAGS FOR TRAVEL (U.S. CLS. 1, 2, 3, 22 AND 41).

FIRST USE 8-15-2006; IN COMMERCE 8-15-2006.

CLASS 20—FURNITURE AND ARTICLES NOT OTHERWISE CLASSIFIED**CLASS 20—(Continued).**

3,300,327. SEGIS, SPA, POGGIBONSI (SI), ITALY. SN 78-726,359. FILED P.R. 10-4-2005; AM. S.R. 9-12-2006.



THE LINING IS A FEATURE OF THE MARK AND DOES NOT INDICATE COLOR.

THE MARK CONSISTS OF THE DESIGN OF A CHAIR, FOR FURNITURE, NAMELY, CHAIRS. (U.S. CLS. 2, 13, 22, 25, 32 AND 50).

FIRST USE 5-5-2005; IN COMMERCE 5-5-2005.

CLASS 21—HOUSEWARES AND GLASS

3,300,286. BRADSHAW INTERNATIONAL, INC., RANCHO CUCAMONGA, CA. SN 77-099,410. FILED P.R. 2-5-2007; AM. S.R. 7-30-2007.



FOR WATERPROOF CARDBOARD ITEMS THAT FOLD TO CREATE SERVINGWARE, NAMELY CARDBOARD NAPKIN AND UTENSIL HOLDERS, SERVING BOWLS, SNACK BOWLS AND PARTY BOWLS, AND CAKE AND CUPCAKE STANDS (U.S. CLS. 2, 13, 23, 29, 30, 33, 40 AND 50).

FIRST USE 10-0-2006; IN COMMERCE 2-0-2007.

CLASS 21—(Continued).

3,300,287. BRADSHAW INTERNATIONAL, INC., RANCHO CUCAMONGA, CA. SN 77-099,415. FILED P.R. 2-5-2007; AM. S.R. 7-30-2007.

Party Pop-Ups

THE MARK CONSISTS OF STANDARD CHARACTERS WITHOUT CLAIM TO ANY PARTICULAR FONT, STYLE, SIZE, OR COLOR.

FOR WATERPROOF CARDBOARD ITEMS THAT FOLD TO CREATE SERVINGWARE, NAMELY CARDBOARD NAPKIN AND UTENSIL HOLDERS, SERVING BOWLS, SNACK BOWLS AND PARTY BOWLS, AND CAKE AND CUPCAKE STANDS (U.S. CLS. 2, 13, 23, 29, 30, 33, 40 AND 50).

FIRST USE 10-0-2006; IN COMMERCE 2-0-2007.

3,300,290. MEDTECH PRODUCTS INC., IRVINGTON, NY. SN 77-113,533. FILED P.R. 2-22-2007; AM. S.R. 7-5-2007.

THE WORLD'S BEST TOOTHPICK

THE MARK CONSISTS OF STANDARD CHARACTERS WITHOUT CLAIM TO ANY PARTICULAR FONT, STYLE, SIZE, OR COLOR.

NO CLAIM IS MADE TO THE EXCLUSIVE RIGHT TO USE "TOOTHPICK", APART FROM THE MARK AS SHOWN.

FOR TOOTHPICKS (U.S. CLS. 2, 13, 23, 29, 30, 33, 40 AND 50).

FIRST USE 12-31-2002; IN COMMERCE 12-31-2002.

3,300,360. BEACHTECH CORPORATION, HONOLULU, HI. SN 78-934,883. FILED P.R. 7-21-2006; AM. S.R. 2-12-2007.

Hawaiian Cooler

THE MARK CONSISTS OF STANDARD CHARACTERS WITHOUT CLAIM TO ANY PARTICULAR FONT, STYLE, SIZE, OR COLOR.

NO CLAIM IS MADE TO THE EXCLUSIVE RIGHT TO USE "COOLER", APART FROM THE MARK AS SHOWN.

FOR SOFT SIDED AND HARD-SIDED INSULATED PORTABLE COOLERS ALL IN THE FORMS OF BACKPACKS, CAN-WRAPPS, LUNCH BAGS, BOTTLE SACKS COLLAPSIBLE COOLERS AND ICE PACKS TO KEEP FOOD AND DRINK COLD (U.S. CLS. 2, 13, 23, 29, 30, 33, 40 AND 50).

FIRST USE 7-15-1989; IN COMMERCE 7-15-1989.

CLASS 21—(Continued).

3,300,363. CHANNEL DISTRIBUTION, LAKE FOREST, CA. SN 78-937,964. FILED P.R. 7-26-2006; AM. S.R. 5-18-2007.

Dental Work

THE MARK CONSISTS OF STANDARD CHARACTERS WITHOUT CLAIM TO ANY PARTICULAR FONT, STYLE, SIZE, OR COLOR.

NO CLAIM IS MADE TO THE EXCLUSIVE RIGHT TO USE "DENTAL", APART FROM THE MARK AS SHOWN.

FOR ELECTRIC TOOTHBRUSHES; MANUAL TOOTHBRUSHES; ORAL HYGIENE DEVICES, NAMELY, INTERDENTAL CLEANERS; SYNTHETIC FIBERS FOR THE MANUFACTURE OF BRUSHES, NAMELY, TOOTHBRUSHES, HAIR BRUSHES AND CLEANING BRUSHES; TOOTHBRUSH CASES; TOOTHBRUSH HOLDERS (U.S. CLS. 2, 13, 23, 29, 30, 33, 40 AND 50).

FIRST USE 7-1-2006; IN COMMERCE 7-1-2006.

3,300,384. PHAN, KIEU THI-BICH, AUSTIN, TX. SN 78-964,355. FILED P.R. 8-30-2006; AM. S.R. 8-2-2007.



THE COLOR(S) BLUE IS/ARE CLAIMED AS A FEATURE OF THE MARK.

THE MARK CONSISTS OF THE COLOR BLUE APPLIED TO THE ENTIRE SURFACE OF A PLASTIC CONTAINER FOR WASHING BRASSIERES, BIKINI TOPS AND PANTIES. THE DOTTED OUTLINE OF THE GOODS IS INTENDED TO SHOW THE POSITION OF THE MARK ON THE GOODS AND IS NOT PART OF THE MARK.

FOR PORTABLE PLASTIC CONTAINER SOLD EMPTY USED TO STORE BRASSIERES, BIKINI TOPS AND PANTIES AND USED TO HOLD THE FOREGOING ITEMS IN THE WASHER AND DRYER TO PREVENT DAMAGE TO THE ITEMS WHILE BEING WASHED AND DRIED (U.S. CLS. 2, 13, 23, 29, 30, 33, 40 AND 50).

FIRST USE 4-1-2005; IN COMMERCE 10-24-2005.

CLASS 25—CLOTHING

CLASS 25—(Continued).

3,300,263. RANDAZZO, DOTTIE, WOODLAND HILLS, CA.
SN 77-052,474. FILED P.R. 11-28-2006; AM. S.R. 5-17-2007.

LIFE IS SHORT WEAR YOUR
JEWELRY

THE MARK CONSISTS OF STANDARD CHARACTERS
WITHOUT CLAIM TO ANY PARTICULAR FONT, STYLE,
SIZE, OR COLOR.

FOR APRONS; HEADGEAR, NAMELY, HATS; JACK-
ETS; SHORT-SLEEVED OR LONG-SLEEVED T-SHIRTS;
T-SHIRTS (U.S. CLS. 22 AND 39).
FIRST USE 5-9-2006; IN COMMERCE 5-9-2006.

CLASS 25—(Continued).

3,300,346. BROOKLYN WINE COMPANY INC., BROOKLYN,
NY. SN 78-849,263. FILED P.R. 3-29-2006; AM. S.R. 7-20-
2007.

BROOKLYN WINE CO.

THE MARK CONSISTS OF STANDARD CHARACTERS
WITHOUT CLAIM TO ANY PARTICULAR FONT, STYLE,
SIZE, OR COLOR.

NO CLAIM IS MADE TO THE EXCLUSIVE RIGHT TO
USE "CO.", APART FROM THE MARK AS SHOWN.
FOR CLOTHING NAMELY, SHORT-SLEEVED OR
LONG-SLEEVED T-SHIRTS, APRONS, SMOCKS, POLO
SHIRTS, SWEATSHIRTS, SHIRTS, SWEATERS, JACK-
ETS, PULLOVERS (U.S. CLS. 22 AND 39).
FIRST USE 2-1-2007; IN COMMERCE 2-1-2007.

3,300,298. O'DONNELL, EILEEN M, NORRIDGE, IL. SN 77-
135,891. FILED P.R. 3-20-2007; AM. S.R. 7-9-2007.

guaranteed for life

THE MARK CONSISTS OF STANDARD CHARACTERS
WITHOUT CLAIM TO ANY PARTICULAR FONT, STYLE,
SIZE, OR COLOR.

FOR MEN'S AND WOMEN'S CLOTHING NAMELY,
SWEATSHIRTS, T-SHIRTS, SHORTS, PANTS, SWEAT-
PANTS, SKI JACKETS, BATHING SUITS, BATHING
TRUNKS, TANK TOPS, KNIT SHIRTS, RAINCOATS,
RAINWEAR, BASEBALL HATS, SOCKS, UNDERWEAR
(U.S. CLS. 22 AND 39).
FIRST USE 7-1-2006; IN COMMERCE 7-1-2006.

3,300,312. FAUTSCH, WILLIAM C., PHOENIX, AZ. SN 78-
309,839. FILED 10-6-2003.

WAIT TIL THIS YEAR

FOR CLOTHING, NAMELY, T-SHIRTS, JERSEYS,
HATS, CAPS, SHIRTS, SWEATSHIRTS (U.S. CLS. 22
AND 39).
FIRST USE 2-0-2004; IN COMMERCE 2-0-2004.

3,300,361. RULE 66, LLC, ESCONDIDO, CA. SN 78-935,943.
FILED P.R. 7-24-2006; AM. S.R. 8-9-2007.

GOETZ

THE MARK CONSISTS OF STANDARD CHARACTERS
WITHOUT CLAIM TO ANY PARTICULAR FONT, STYLE,
SIZE, OR COLOR.

FOR WEARING APPAREL NAMELY SHIRTS,
SHORTS, PANTS AND CAPS (U.S. CLS. 22 AND 39).
FIRST USE 1-1-2007; IN COMMERCE 1-1-2007.

CLASS 28—TOYS AND SPORTING GOODS

3,300,248. C1 DESIGN GROUP LTD, KETCHUM, ID. SN 77-
002,225. FILED P.R. 9-19-2006; AM. S.R. 8-15-2007.

HARD ALOX

THE MARK CONSISTS OF STANDARD CHARACTERS
WITHOUT CLAIM TO ANY PARTICULAR FONT, STYLE,
SIZE, OR COLOR.

FOR FISHING REELS (U.S. CLS. 22, 23, 38 AND 50).
FIRST USE 9-1-2006; IN COMMERCE 9-1-2006.

CLASS 28—(Continued).

3,300,274. ADVANCED BUSINESS PARTNERS I, LLC, VANCOUVER, WA. SN 77-061,699. FILED P.R. 12-11-2006; AM. S.R. 7-31-2007.

BALL TECHNOLOGIES

THE MARK CONSISTS OF STANDARD CHARACTERS WITHOUT CLAIM TO ANY PARTICULAR FONT, STYLE, SIZE, OR COLOR.

NO CLAIM IS MADE TO THE EXCLUSIVE RIGHT TO USE "BALL", APART FROM THE MARK AS SHOWN.

FOR SPORTING GOODS, NAMELY, GOLF BALL TESTER, NAMELY, A DEVICE THAT TESTS THE ROUNDNESS OF GOLF BALLS (U.S. CLS. 22, 23, 38 AND 50).

FIRST USE 6-12-2007; IN COMMERCE 6-12-2007.

3,300,354. TITLE BOXING, LLC, LENEXA, KS. SN 78-921,922. FILED P.R. 7-3-2006; AM. S.R. 8-6-2007.



NO CLAIM IS MADE TO THE EXCLUSIVE RIGHT TO USE GEL ENFORCED LINING, APART FROM THE MARK AS SHOWN.

FOR BOXING AND MARTIAL ARTS EQUIPMENT, NAMELY, BOXING GLOVES, GRAPPLING GLOVES, MIXED MARTIAL ARTS GLOVES, PUNCHING BAGS, BODY PROTECTORS, PUNCH MITTS, PUNCH SHIELDS (U.S. CLS. 22, 23, 38 AND 50).

FIRST USE 9-30-2006; IN COMMERCE 9-30-2006.

CLASS 29—MEATS AND PROCESSED FOODS

3,300,358. DRAGON HERBS, SANTA MONICA, CA. SN 78-932,412. FILED P.R. 7-18-2006; AM. S.R. 6-20-2007.

HEAVEN MOUNTAIN

THE MARK CONSISTS OF STANDARD CHARACTERS WITHOUT CLAIM TO ANY PARTICULAR FONT, STYLE, SIZE, OR COLOR.

FOR DRIED FRUITS; FRUITS, NAMELY DRIED WOLFBERRIES AND GOJI BERRIES (U.S. CL. 46).

FIRST USE 11-30-1996; IN COMMERCE 11-30-1996.

CLASS 30—STAPLE FOODS

3,300,253. FLANNERY, MICHAEL, BIRDSBORO, PA. SN 77-022,923. FILED P.R. 10-17-2006; AM. S.R. 7-30-2007.

Philly's Finest Soft Pretzels

NO CLAIM IS MADE TO THE EXCLUSIVE RIGHT TO USE "SOFT PRETZELS", APART FROM THE MARK AS SHOWN.

THE MARK CONSISTS OF STYLIZED LETTERING. FOR PRETZELS, TWISTS MADE FROM DOUGH, AND PASTRIES (U.S. CL. 46).

FIRST USE 9-1-2006; IN COMMERCE 9-1-2006.

3,300,333. MCCAIN FOODS USA, INC., LISLE, IL. SN 78-757,899. FILED P.R. 11-21-2005; AM. S.R. 11-29-2006.

DESSERT MINIS

THE MARK CONSISTS OF STANDARD CHARACTERS WITHOUT CLAIM TO ANY PARTICULAR FONT, STYLE, SIZE, OR COLOR.

NO CLAIM IS MADE TO THE EXCLUSIVE RIGHT TO USE "DESSERT", APART FROM THE MARK AS SHOWN.

FOR PREPARED DESSERTS, NAMELY, BREADED AND BATTERED BAKERY DESSERTS (U.S. CL. 46).

FIRST USE 12-12-2005; IN COMMERCE 12-12-2005.

3,300,380. R & A PREMIUM FOODS LLC, CARNATION, WA. SN 78-954,771. FILED P.R. 8-17-2006; AM. S.R. 7-3-2007.

FARMERS MARKET FRENCH ROAST

THE MARK CONSISTS OF STANDARD CHARACTERS WITHOUT CLAIM TO ANY PARTICULAR FONT, STYLE, SIZE, OR COLOR.

NO CLAIM IS MADE TO THE EXCLUSIVE RIGHT TO USE "FRENCH ROAST", APART FROM THE MARK AS SHOWN.

FOR COFFEE (U.S. CL. 46).

FIRST USE 6-9-2006; IN COMMERCE 6-9-2006.

CLASS 31—NATURAL AGRICULTURAL PRODUCTS

CLASS 31—(Continued).

3,300,342. BRUSH, JOANNE WALKER, GENESEO, IL. AND BRUSH, GEORGE HENRY JR, GENESEO, IL. SN 78-840,567. FILED 3-18-2006.

AmericasPremier

THE MARK CONSISTS OF STANDARD CHARACTERS WITHOUT CLAIM TO ANY PARTICULAR FONT, STYLE, SIZE, OR COLOR.

FOR LIVE ANIMALS, NAMELY, ALPACAS (U.S. CLS. 1 AND 46).

FIRST USE 11-1-2005; IN COMMERCE 11-1-2005.

3,300,351. SANBON, INC., EL CENTRO, CA. SN 78-908,390. FILED P.R. 6-14-2006; AM. S.R. 8-17-2007.

FULL OF FLAVOR

THE MARK CONSISTS OF STANDARD CHARACTERS WITHOUT CLAIM TO ANY PARTICULAR FONT, STYLE, SIZE, OR COLOR.

FOR FRESH FRUITS; FRESH VEGETABLES (U.S. CLS. 1 AND 46).

FIRST USE 6-30-2007; IN COMMERCE 6-30-2007.

3,300,377. MAR-GEN SALES CO., INC., NOGALES, AZ. SN 78-953,818. FILED P.R. 8-16-2006; AM. S.R. 7-17-2007.

BAJA PREMIUM

THE MARK CONSISTS OF STANDARD CHARACTERS WITHOUT CLAIM TO ANY PARTICULAR FONT, STYLE, SIZE, OR COLOR.

FOR FRESH FRUITS AND VEGETABLES (U.S. CLS. 1 AND 46).

FIRST USE 1-15-2004; IN COMMERCE 1-15-2004.

CLASS 32—LIGHT BEVERAGES**CLASS 32—(Continued).**

3,300,236. THE JUICE COMPANY (EUROPE) LIMITED, LONDON N1 0QH, ENGLAND. SN 76-287,744. FILED P.R. 7-19-2001; AM. S.R. 2-26-2003.

SMOOTHIEPACK

PRIORITY CLAIMED UNDER SEC. 44(D) ON UNITED KINGDOM APPLICATION NO. 2258524, FILED 1-20-2001, REG. NO. 2339498, DATED 8-1-2003, EXPIRES 8-1-2013.

FOR BLENDED PURE FRUIT BEVERAGES (U.S. CLS. 45, 46 AND 48).

CLASS 33—WINES AND SPIRITS

3,300,258. CARMEN E. BAZZINI, BAYVILLE, NY. SN 77-040,278. FILED P.R. 11-9-2006; AM. S.R. 6-29-2007.

BAZZINI

THE MARK CONSISTS OF STANDARD CHARACTERS WITHOUT CLAIM TO ANY PARTICULAR FONT, STYLE, SIZE, OR COLOR.

FOR APERITIF WINES; APERITIFS WITH A WINE BASE; COOKING WINE; FRUIT WINE; GRAPE WINE; KITS FOR MAKING WINE; NATURAL SPARKLING WINES; PORT WINES; PREPARED WINE COCKTAILS; RED WINE; SPARKLING FRUIT WINE; SPARKLING GRAPE WINE; SPARKLING WINE; STRAWBERRY WINE; SWEET WINES; TABLE WINES; TONIC SWEET GRAPE WINE CONTAINING EXTRACTS FROM GINSENG AND CONCHONA BARK (NINJIN-KINATETSU WINE); WHITE WINE; WINE; WINE COOLERS; WINE PUNCH; WINE PUNCHES; WINES (U.S. CLS. 47 AND 49).

FIRST USE 9-2-2006; IN COMMERCE 11-9-2006.

3,300,268. BRESSLER VINEYARDS, LLC, ST. HELENA, CA. SN 77-057,372. FILED P.R. 12-5-2006; AM. S.R. 6-29-2007.

BRESSLER

THE MARK CONSISTS OF STANDARD CHARACTERS WITHOUT CLAIM TO ANY PARTICULAR FONT, STYLE, SIZE, OR COLOR.

FOR WINE (U.S. CLS. 47 AND 49).

FIRST USE 1-26-2004; IN COMMERCE 1-26-2004.

CLASS 33—(Continued).

3,300,347. BROOKLYN WINE COMPANY INC., BROOKLYN, NY. SN 78-849,290. FILED P.R. 3-29-2006; AM. S.R. 7-20-2007.

BROOKLYN WINE CO.

THE MARK CONSISTS OF STANDARD CHARACTERS WITHOUT CLAIM TO ANY PARTICULAR FONT, STYLE, SIZE, OR COLOR.

NO CLAIM IS MADE TO THE EXCLUSIVE RIGHT TO USE "WINE CO.", APART FROM THE MARK AS SHOWN. FOR RED WINE, WHITE WINE, CHAMPAGNE (U.S. CLS. 47 AND 49).

FIRST USE 2-1-2007; IN COMMERCE 2-1-2007.

3,300,373. SELENE WINES, INC., NAPA, CA. SN 78-952,173. FILED P.R. 8-15-2006; AM. S.R. 7-5-2007.

CHESLER

THE MARK CONSISTS OF STANDARD CHARACTERS WITHOUT CLAIM TO ANY PARTICULAR FONT, STYLE, SIZE, OR COLOR.

FOR WINE (U.S. CLS. 47 AND 49).
FIRST USE 6-15-2005; IN COMMERCE 6-15-2005.

CLASS 34—SMOKERS' ARTICLES

3,300,362. NATIONAL TOBACCO COMPANY, L.P., LOUISVILLE, KY. SN 78-937,835. FILED P.R. 7-26-2006; AM. S.R. 7-17-2007.

SWEET 'N SMOKEY

THE MARK CONSISTS OF STANDARD CHARACTERS WITHOUT CLAIM TO ANY PARTICULAR FONT, STYLE, SIZE, OR COLOR.

FOR TOBACCO, NAMELY, SMOKELESS TOBACCO (U.S. CLS. 2, 8, 9 AND 17).
FIRST USE 10-18-2006; IN COMMERCE 10-18-2006.

SERVICE MARKS**CLASS 35—ADVERTISING AND BUSINESS****CLASS 35—(Continued).**

3,300,242. AMINI INNOVATION CORPORATION, SANTA FE SPRINGS, CA. SN 76-658,246. FILED P.R. 4-11-2006; AM. S.R. 5-4-2007.

ORIGINAL HOME DESIGNS FROM THE MICHAEL AMINI SIGNATURE SERIES

THE MARK CONSISTS OF STANDARD CHARACTERS WITHOUT CLAIM TO ANY PARTICULAR FONT, STYLE, SIZE, OR COLOR.

OWNER OF U.S. REG. NOS. 2,853,087 AND 2,922,067.

NO CLAIM IS MADE TO THE EXCLUSIVE RIGHT TO USE "ORIGINAL HOME DESIGNS" OR "SIGNATURE SERIES", APART FROM THE MARK AS SHOWN.

THE NAME MICHAEL AMINI IDENTIFIES A LIVING INDIVIDUAL WHOSE CONSENT IS OF RECORD.

FOR FURNITURE (U.S. CLS. 100, 101 AND 102).
FIRST USE 4-1-2004; IN COMMERCE 4-1-2004.

3,300,246. GEORGE LITTLE MANAGEMENT, LLC, WHITE PLAINS, NY. SN 76-674,873. FILED P.R. 3-30-2007; AM. S.R. 7-21-2007.

CADEAUX

THE MARK CONSISTS OF STANDARD CHARACTERS WITHOUT CLAIM TO ANY PARTICULAR FONT, STYLE, SIZE, OR COLOR.

"CADEAUX" IS A FRENCH WORD MEANING "GIFTS". FOR ORGANIZING AND CONDUCTING TRADE SHOWS IN THE FIELD OF LUXURY GIFT PRODUCTS (U.S. CLS. 100, 101 AND 102).

FIRST USE 11-28-2006; IN COMMERCE 11-28-2006.

3,300,247. GEORGE LITTLE MANAGEMENT, LLC, WHITE PLAINS, NY. SN 76-675,496. FILED P.R. 4-13-2007; AM. S.R. 6-15-2007.

GLOBAL HOME DECOR

THE MARK CONSISTS OF STANDARD CHARACTERS WITHOUT CLAIM TO ANY PARTICULAR FONT, STYLE, SIZE, OR COLOR.

OWNER OF U.S. REG. NO. 3,034,059.

FOR CONDUCTING AND PROMOTING TRADE SHOWS IN THE FIELD OF HOUSE FURNISHINGS (U.S. CLS. 100, 101 AND 102).

FIRST USE 5-8-2007; IN COMMERCE 5-8-2007.

CLASS 35—(Continued).

3,300,260. KEENE PROMOTIONS, INC., AUBURNDALE, MA. SN 77-047,025. FILED P.R. 11-17-2006; AM. S.R. 7-6-2007.

KEENE PROMOTIONS, INC.

THE MARK CONSISTS OF STANDARD CHARACTERS WITHOUT CLAIM TO ANY PARTICULAR FONT, STYLE, SIZE, OR COLOR.

NO CLAIM IS MADE TO THE EXCLUSIVE RIGHT TO USE "PROMOTIONS, INC.", APART FROM THE MARK AS SHOWN.

FOR WHOLESALE DISTRIBUTORSHIP IN THE FIELD OF PROMOTIONAL PRODUCTS (U.S. CLS. 100, 101 AND 102).

FIRST USE 3-0-2006; IN COMMERCE 3-0-2006.

CLASS 35—(Continued).

3,300,265. EDCARE MANAGEMENT, INC., FORT LAUDERDALE, FL. SN 77-057,052. FILED P.R. 12-5-2006; AM. S.R. 7-26-2007.

EXCELLENCE IN MEDICAL MANAGEMENT

THE MARK CONSISTS OF STANDARD CHARACTERS WITHOUT CLAIM TO ANY PARTICULAR FONT, STYLE, SIZE, OR COLOR.

NO CLAIM IS MADE TO THE EXCLUSIVE RIGHT TO USE "MEDICAL MANAGEMENT", APART FROM THE MARK AS SHOWN.

FOR EMPLOYMENT STAFFING FOR MEDICAL OFFICES; MEDICAL OFFICE MANAGEMENT SERVICES, NAMELY, MANAGEMENT OF MEDICAL OFFICE BUSINESS AFFAIRS, EMPLOYEE ATTENDANCE, DUTY ASSIGNMENTS, PAYROLL, JOB COSTING, OFFICE ADMINISTRATION, PATIENT SCHEDULING, AND BILLINGS (U.S. CLS. 100, 101 AND 102).

FIRST USE 12-19-2006; IN COMMERCE 12-19-2006.

3,300,262. HENRY, MAXIME, ROMANS, FRANCE. SN 77-050,732. FILED P.R. 11-26-2006; AM. S.R. 7-5-2007.

Global Supply Chain Council

THE MARK CONSISTS OF STANDARD CHARACTERS WITHOUT CLAIM TO ANY PARTICULAR FONT, STYLE, SIZE, OR COLOR.

NO CLAIM IS MADE TO THE EXCLUSIVE RIGHT TO USE "COUNCIL", APART FROM THE MARK AS SHOWN.

FOR ASSOCIATION SERVICES, NAMELY, PROMOTING THE INTERESTS OF SUPPLY CHAIN, PROCUREMENT AND LOGISTICS PROFESSIONALS WORLDWIDE (U.S. CLS. 100, 101 AND 102).

FIRST USE 7-1-2006; IN COMMERCE 7-1-2006.

3,300,276. LSN, INC., ATLANTA, GA. SN 77-066,058. FILED P.R. 12-18-2006; AM. S.R. 8-14-2007.

TXT2VOTE

THE MARK CONSISTS OF STANDARD CHARACTERS WITHOUT CLAIM TO ANY PARTICULAR FONT, STYLE, SIZE, OR COLOR.

FOR DESIGNING AND CREATING PROMOTIONAL CAMPAIGNS FOR ADVERTISERS TO MEASURE CONSUMER RESPONSES BY VOTING THROUGH THE USE OF WIRELESS TEXT MESSAGING SERVICES (U.S. CLS. 100, 101 AND 102).

FIRST USE 12-20-2005; IN COMMERCE 12-20-2005.

CLASS 35—(Continued).

3,300,305. SMALL BUSINESS FINANCIAL MANAGEMENT GROUP, INC., ROWLETT, TX. SN 77-149,775. FILED P.R. 4-5-2007; AM. S.R. 7-25-2007.

CLASS 35—(Continued).

3,300,309. COLTENBACK, JEFFREY H., BLOOMFEILD, NJ. SN 77-169,580. FILED P.R. 5-1-2007; AM. S.R. 8-15-2007.

America's Best Accountants

THE MARK CONSISTS OF STANDARD CHARACTERS WITHOUT CLAIM TO ANY PARTICULAR FONT, STYLE, SIZE, OR COLOR.

NO CLAIM IS MADE TO THE EXCLUSIVE RIGHT TO USE "ACCOUNTANTS", APART FROM THE MARK AS SHOWN.

FOR ACCOUNTANCY SERVICES (U.S. CLS. 100, 101 AND 102).

FIRST USE 10-1-2006; IN COMMERCE 10-1-2006.

3,300,306. CALYX & COROLLA, INC., DBA CALYX FLOWERS, SHELBURNE, VT. SN 77-156,009. FILED P.R. 4-13-2007; AM. S.R. 8-15-2007.

Holistic Pet Care

THE MARK CONSISTS OF STANDARD CHARACTERS WITHOUT CLAIM TO ANY PARTICULAR FONT, STYLE, SIZE, OR COLOR.

NO CLAIM IS MADE TO THE EXCLUSIVE RIGHT TO USE "PET", APART FROM THE MARK AS SHOWN.

FOR RETAIL PET STORES (U.S. CLS. 100, 101 AND 102).

FIRST USE 9-1-2003; IN COMMERCE 9-1-2006.

FLOWERS IN A HATBOX

THE MARK CONSISTS OF STANDARD CHARACTERS WITHOUT CLAIM TO ANY PARTICULAR FONT, STYLE, SIZE, OR COLOR.

FOR ONLINE, CATALOG AND TELEPHONE ORDERING SERVICES FEATURING FLOWERS AND GIFTS ARRANGED FOR DELIVERY IN DECORATIVE HATBOXES (U.S. CLS. 100, 101 AND 102).

FIRST USE 10-1-2006; IN COMMERCE 10-1-2006.

3,300,310. CALYX & COROLLA, INC., DBA CALYX FLOWERS.COM, SHELBURNE, VT. SN 77-169,625. FILED P.R. 5-1-2007; AM. S.R. 8-15-2007.

3,300,307. CALYX & COROLLA, INC., DBA CALYX FLOWERS, SHELBURNE, VT. SN 77-156,047. FILED P.R. 4-13-2007; AM. S.R. 8-15-2007.

GIFTS IN A HATBOX

PLANTS IN A HATBOX

THE MARK CONSISTS OF STANDARD CHARACTERS WITHOUT CLAIM TO ANY PARTICULAR FONT, STYLE, SIZE, OR COLOR.

FOR ONLINE, CATALOG AND TELEPHONE ORDERING SERVICES FEATURING FLOWERS AND GIFTS ARRANGED FOR DELIVERY IN DECORATIVE HATBOXES (U.S. CLS. 100, 101 AND 102).

FIRST USE 10-1-2006; IN COMMERCE 10-1-2006.

THE MARK CONSISTS OF STANDARD CHARACTERS WITHOUT CLAIM TO ANY PARTICULAR FONT, STYLE, SIZE, OR COLOR.

FOR ONLINE, CATALOG AND TELEPHONE ORDERING SERVICES FEATURING GIFTS ARRANGED FOR DELIVERY IN DECORATIVE HATBOXES (U.S. CLS. 100, 101 AND 102).

FIRST USE 11-6-2006; IN COMMERCE 11-6-2006.

CLASS 35—(Continued).

3,300,316. OMIDYAR NETWORK LLC, REDWOOD CITY, CA. SN 78-548,174. FILED P.R. 1-14-2005; AM. S.R. 9-14-2006.

CLASS 35—(Continued).

3,300,320. THE CORPORATE EXECUTIVE BOARD COMPANY, WASHINGTON, DC. SN 78-605,185. FILED P.R. 4-8-2005; AM. S.R. 11-2-2006.

OMIDYAR

ADR

THE MARK CONSISTS OF STANDARD CHARACTERS WITHOUT CLAIM TO ANY PARTICULAR FONT, STYLE, SIZE, OR COLOR.

FOR PROVIDING RESEARCH SERVICES RELATING TO BEST PRACTICES OF INTERNAL CORPORATE AUDITORS. (U.S. CLS. 100, 101 AND 102).

FIRST USE 12-0-2004; IN COMMERCE 12-0-2004.

THE MARK CONSISTS OF STANDARD CHARACTERS WITHOUT CLAIM TO ANY PARTICULAR FONT, STYLE, SIZE, OR COLOR.

FOR ADVICE AND CONSULTANCY RELATING TO THE ORGANIZATION AND MANAGEMENT OF BUSINESSES AND NON-PROFIT ORGANIZATIONS; ANALYSES AND APPRAISALS OF ENTERPRISES AND NON-PROFIT ORGANIZATIONS; BUSINESS AND NON-PROFIT ORGANIZATION DEVELOPMENT SERVICES, NAMELY, PROVIDING START-UP SUPPORT FOR THE ORGANIZATIONS OF OTHERS; BUSINESS AND NON-PROFIT ORGANIZATIONAL LEADERSHIP DEVELOPMENT; BUSINESS AND NON-PROFIT ORGANIZATIONAL NETWORKING SERVICES; BUSINESS SERVICES, NAMELY, MATCHING POTENTIAL INVESTORS WITH ENTREPRENEURS NEEDING FUNDING; DEVELOPING AND COORDINATING VOLUNTEER PROJECTS WITH AND FOR CHARITABLE ORGANIZATIONS; PROMOTING ECONOMIC AND CIVIC DEVELOPMENT WORLDWIDE; PROMOTING THE GOODS AND SERVICES OF OTHERS BY PROVIDING LINKS TO THE WEB SITES OF OTHERS; INFORMATION AND DATA COMPILING AND ANALYZING RELATING TO NON-PROFIT ORGANIZATION AND ENTERPRISE MANAGEMENT; CONDUCTING ONLINE SURVEYS AND RANKINGS OF WEBSITES AND PROGRAMS RELATED TO ENVIRONMENTAL, CIVIC, EDUCATIONAL, SOCIAL WELFARE, AND CHARITABLE PROGRAMS DEVELOPED AND/OR RUN BY THIRD PARTIES; PROVIDING INFORMATION IN THE FIELD OF COMMUNITY DEVELOPMENT VIA THE INTERNET (U.S. CLS. 100, 101 AND 102).

FIRST USE 6-0-2004; IN COMMERCE 6-0-2004.

3,300,331. ALIAKSANDR, DALHITSKI, NORTHGLENN, CO. SN 78-747,698. FILED P.R. 11-4-2005; AM. S.R. 6-4-2007.

DomesticSale

THE MARK CONSISTS OF STANDARD CHARACTERS WITHOUT CLAIM TO ANY PARTICULAR FONT, STYLE, SIZE, OR COLOR.

FOR ONLINE CLASSIFIED ADVERTISING SERVICES (U.S. CLS. 100, 101 AND 102).

FIRST USE 11-5-2003; IN COMMERCE 11-5-2003.

CLASS 35—(Continued).

3,300,336. KOCH, KENNETH B., NASHVILLE, TN. SN 78-779,637. FILED P.R. 12-22-2005; AM. S.R. 7-11-2007.

GiveAGift

THE MARK CONSISTS OF STANDARD CHARACTERS WITHOUT CLAIM TO ANY PARTICULAR FONT, STYLE, SIZE, OR COLOR.

FOR MARKETING SERVICES, NAMELY, PROMOTING THE GOODS AND SERVICES OF OTHERS BY PROVIDING A COMPUTER LINK TO WEBSITES THROUGH WHICH THE GOODS AND SERVICES OF OTHERS MAY BE REDEEMED AS A RESULT OF THE DISTRIBUTION OF GIFT TOKENS (U.S. CLS. 100, 101 AND 102).

FIRST USE 11-28-2002; IN COMMERCE 11-28-2002.

CLASS 35—(Continued).

3,300,381. R. S. MEANS COMPANY, INC., NEWTON, MA. SN 78-960,265. FILED P.R. 8-25-2006; AM. S.R. 8-23-2007.

BUILDQUOTE

THE MARK CONSISTS OF STANDARD CHARACTERS WITHOUT CLAIM TO ANY PARTICULAR FONT, STYLE, SIZE, OR COLOR.

FOR PROVIDING INFORMATION ONLINE REGARDING COST ESTIMATES FOR CONTRACTING WORK TO CONSTRUCT PERSONAL RESIDENCES BASED ON STOCK PLANS; PROVIDING COST ANALYSIS AND ASSESSMENT INFORMATION ONLINE REGARDING ESTIMATES FOR CONSTRUCTING PERSONAL RESIDENCES BASED ON STOCK PLANS (U.S. CLS. 100, 101 AND 102).

FIRST USE 12-0-2006; IN COMMERCE 12-0-2006.

CLASS 36—INSURANCE AND FINANCIAL

3,300,250. GROUP BENEFITS, LTD., URBANDALE, IA. SN 77-010,571. FILED P.R. 9-29-2006; AM. S.R. 6-12-2007.

America's Healthplan Consultants

THE MARK CONSISTS OF STANDARD CHARACTERS WITHOUT CLAIM TO ANY PARTICULAR FONT, STYLE, SIZE, OR COLOR.

NO CLAIM IS MADE TO THE EXCLUSIVE RIGHT TO USE "CONSULTANTS", APART FROM THE MARK AS SHOWN.

FOR INSURANCE CONSULTATION AND PROVIDING INSURANCE INFORMATION IN THE FIELDS OF HEALTH INSURANCE, PRESCRIPTION DRUGS INSURANCE, DENTAL INSURANCE, VISION INSURANCE, LIFE INSURANCE, ANNUITY INSURANCE, DISABILITY INCOME INSURANCE, LONG TERM CARE INSURANCE, TRAVEL INSURANCE, SPECIALTY DISEASE INSURANCE, IDENTITY THEFT INSURANCE, AND PRE-PAID LEGAL INSURANCE; INSURANCE ENROLLMENT, NAMELY MEDICAL INSURANCE UNDERWRITING IN THE FIELDS OF HEALTH INSURANCE, PRESCRIPTION DRUGS INSURANCE, DENTAL INSURANCE, VISION INSURANCE, LIFE INSURANCE, ANNUITY INSURANCE, DISABILITY INCOME INSURANCE, LONG TERM CARE INSURANCE, TRAVEL INSURANCE, SPECIALTY DISEASE INSURANCE, IDENTITY THEFT INSURANCE, AND PRE-PAID LEGAL INSURANCE (U.S. CLS. 100, 101 AND 102).

FIRST USE 12-29-2006; IN COMMERCE 12-29-2006.

3,300,376. KNOWLEDGESTORM, INC., ALPHARETTA, GA. SN 78-952,224. FILED P.R. 8-15-2006; AM. S.R. 6-14-2007.

FINDTECH

THE MARK CONSISTS OF STANDARD CHARACTERS WITHOUT CLAIM TO ANY PARTICULAR FONT, STYLE, SIZE, OR COLOR.

FOR PROVIDING INFORMATION ABOUT IT PRODUCTS AND SERVICES FROM SEARCHABLE INDEXES AND DATABASES TO FACILITATE COMPARISON SHOPPING, IN THE FORM OF TEXT, ELECTRONIC DOCUMENTS, DATABASES, GRAPHICS AND AUDIO VISUAL INFORMATION, BY MEANS OF GLOBAL COMPUTER INFORMATION NETWORKS (U.S. CLS. 100, 101 AND 102).

FIRST USE 10-0-2005; IN COMMERCE 10-0-2005.

CLASS 36—(Continued).

3,300,252. COMMUNITY BANK OF THE BAY, OAKLAND, CA. SN 77-017,705. FILED P.R. 10-10-2006; AM. S.R. 7-2-2007.



NO CLAIM IS MADE TO THE EXCLUSIVE RIGHT TO USE "FUND", APART FROM THE MARK AS SHOWN.

THE MARK CONSISTS OF OAKLAND, THE BACKGROUND WORD IN BLACK, BEARS A LARGE O. "1ST" APPEARS IN WHITE OVER THE LARGE O. FUND IN BLACK APPEARS BELOW THE LEFT SIDE OF OAKLAND.

FOR BANKING; BANKING CONSULTATION; INVESTMENT BANKING SERVICES; ISSUANCE OF BANK CHECKS; ISSUING OF BANK CHEQUES; MORTGAGE BANKING; MORTGAGE BANKING SERVICES, NAMELY, ORIGINATION, ACQUISITION, SERVICING, SECURITIZATION AND BROKERAGE OF MORTGAGE LOANS; MORTGAGE SERVICES, NAMELY, BUYER PRE-QUALIFICATION OF MORTGAGES FOR MORTGAGE BROKERS AND BANKS; ON-LINE BANKING SERVICES; PROVIDING BANK ACCOUNT INFORMATION BY TELEPHONE; SAVINGS BANK SERVICES (U.S. CLS. 100, 101 AND 102).

FIRST USE 3-31-2004; IN COMMERCE 3-31-2004.

3,300,256. GUNTER, JUTIKI T., OAKLAND, CA. SN 77-037,460. FILED P.R. 11-6-2006; AM. S.R. 7-12-2007.

YOUNG MONEY MANAGER

THE MARK CONSISTS OF STANDARD CHARACTERS WITHOUT CLAIM TO ANY PARTICULAR FONT, STYLE, SIZE, OR COLOR.

FOR PROVIDING A WEBSITE FEATURING INFORMATION IN THE FIELD OF MONEY MANAGEMENT AND PERSONAL FINANCE FOR USE BY INDIVIDUALS, CHILDREN AND FAMILIES (U.S. CLS. 100, 101 AND 102).

FIRST USE 5-14-2005; IN COMMERCE 8-10-2006.

CLASS 36—(Continued).

3,300,259. COMMUNITY BANK OF THE BAY, OAKLAND, CA. SN 77-041,969. FILED P.R. 11-11-2006; AM. S.R. 7-2-2007.

BAY AREA GREEN FUND

THE MARK CONSISTS OF STANDARD CHARACTERS WITHOUT CLAIM TO ANY PARTICULAR FONT, STYLE, SIZE, OR COLOR.

NO CLAIM IS MADE TO THE EXCLUSIVE RIGHT TO USE "GREEN FUND", APART FROM THE MARK AS SHOWN.

FOR FINANCIAL SERVICES, NAMELY, INVESTMENT SERVICES IN THE FIELD OF SECURITIES, MUTUAL FUNDS AND MONEY MARKET FUNDS (U.S. CLS. 100, 101 AND 102).

FIRST USE 7-1-2007; IN COMMERCE 7-1-2007.

3,300,281. INTELLIVUE NM LLC, AUSTIN, TX. SN 77-078,220. FILED P.R. 1-8-2007; AM. S.R. 7-23-2007.



NO CLAIM IS MADE TO THE EXCLUSIVE RIGHT TO USE "BUSINESS BROKER", APART FROM THE MARK AS SHOWN.

"THE COLOR(S) BLUE, GRAY AND BLACK IS/ARE CLAIMED AS A FEATURE OF THE MARK."

"THE MARK CONSISTS OF THE NUMERAL "1" AND A SQUARE FEATURED IN THE COLOR BLUE, A PERCENTAGE SYMBOL FEATURED IN THE COLOR GRAY, AND THE WORDING "BUSINESS BROKER" FEATURED IN THE COLOR BLACK."

FOR BUSINESS BROKERAGE (U.S. CLS. 100, 101 AND 102).

FIRST USE 12-12-2006; IN COMMERCE 12-12-2006.

CLASS 36—(Continued).

3,300,285. SALLIE MAE, INC., RESTON, VA. SN 77-097,554. FILED P.R. 2-2-2007; AM. S.R. 6-18-2007.

Private Consolidation Loan

THE MARK CONSISTS OF STANDARD CHARACTERS WITHOUT CLAIM TO ANY PARTICULAR FONT, STYLE, SIZE, OR COLOR.

NO CLAIM IS MADE TO THE EXCLUSIVE RIGHT TO USE "CONSOLIDATION LOAN", APART FROM THE MARK AS SHOWN.

FOR PROVIDING STUDENT LOAN INFORMATION; STUDENT LOAN SERVICES (U.S. CLS. 100, 101 AND 102).

FIRST USE 5-12-2006; IN COMMERCE 5-12-2006.

3,300,292. SOMMERS, JONATHAN, ATLANTA, GA. SN 77-126,433. FILED P.R. 3-9-2007; AM. S.R. 6-28-2007.

DIAMOND GRADERS OF AMERICA

THE MARK CONSISTS OF STANDARD CHARACTERS WITHOUT CLAIM TO ANY PARTICULAR FONT, STYLE, SIZE, OR COLOR.

FOR DIAMOND APPRAISALS; AND PREPARING REPORTS ON DIAMOND APPRAISALS FOR OTHERS (U.S. CLS. 100, 101 AND 102).

FIRST USE 8-10-2006; IN COMMERCE 10-1-2006.

CLASS 36—(Continued).

3,300,311. WILLOW FINANCIAL BANCORP, INC., WAYNE, PA. SN 77-170,730. FILED P.R. 5-2-2007; AM. S.R. 7-12-2007.

THE MARK CONSISTS OF TWO REGIONS EACH HAVING A PERIMETER COMPOSED OF LINEAR AND CURVED SEGMENTS.

FOR BANKING SERVICES; FINANCIAL SERVICES, NAMELY, PROVIDING ESCROW ACCOUNTS, ESTATE ACCOUNTS, TRUST MANAGEMENT ACCOUNTS, EDUCATIONAL SAVINGS ACCOUNTS, RETIREMENT SAVINGS ACCOUNTS, AND MONEY LENDING; INVESTMENT SERVICES, NAMELY, INVESTMENT MANAGEMENT AND CONSULTATION IN THE FIELDS OF TRUST MANAGEMENT, RETIREMENT PLANNING, ESTATE PLANNING, LIFE INSURANCE, AND COLLEGE FUNDING; BROKERAGE SERVICES IN THE FIELD OF ANNUITIES, MUTUAL FUNDS, STOCKS, BONDS, AND INSURANCE (U.S. CLS. 100, 101 AND 102).

FIRST USE 9-21-2006; IN COMMERCE 9-21-2006.

3,300,329. KEMPER DEVELOPMENT COMPANY, BELLEVUE, WA. SN 78-739,403. FILED P.R. 10-24-2005; AM. S.R. 6-6-2007.

THE BELLEVUE COLLECTION

THE MARK CONSISTS OF STANDARD CHARACTERS WITHOUT CLAIM TO ANY PARTICULAR FONT, STYLE, SIZE, OR COLOR.

FOR REAL ESTATE LEASING AND PROPERTY MANAGEMENT SERVICES, NAMELY SHOPPING CENTER LEASING AND MANAGEMENT SERVICES; LEASING AND MANAGEMENT OF MIXED-USE REAL ESTATE COMPLEXES CONTAINING VARIOUS COMBINATIONS OF RETAIL, OFFICE, HOTEL, ENTERTAINMENT, FOOD AND RESIDENTIAL FACILITIES; SHOPPING CENTER SERVICES, NAMELY RENTAL OF SHOPPING CENTER SPACE (U.S. CLS. 100, 101 AND 102).

FIRST USE 8-5-2005; IN COMMERCE 8-5-2005.

3,300,348. AFFINITY DIRECT, LLC, ENGLEWOOD CLIFFS, NJ. SN 78-857,695. FILED P.R. 4-10-2006; AM. S.R. 8-20-2007.

COLLEGE GRAD AUTO LOAN

CLASS 36—(Continued).

THE MARK CONSISTS OF STANDARD CHARACTERS WITHOUT CLAIM TO ANY PARTICULAR FONT, STYLE, SIZE, OR COLOR.

NO CLAIM IS MADE TO THE EXCLUSIVE RIGHT TO USE "LOAN", APART FROM THE MARK AS SHOWN.
FOR FINANCIAL LOAN CONSULTATION (U.S. CLS. 100, 101 AND 102).
FIRST USE 3-21-2006; IN COMMERCE 3-21-2006.

3,300,359. WE BUY UNWANTED HOUSES, LLC, PHOENIX, AZ. SN 78-934,362. FILED P.R. 7-20-2006; AM. S.R. 7-2-2007.

We Buy Unwanted Houses.com

THE MARK CONSISTS OF STANDARD CHARACTERS WITHOUT CLAIM TO ANY PARTICULAR FONT, STYLE, SIZE, OR COLOR.

FOR REAL ESTATE BROKERAGE AND INVESTMENT SERVICES (U.S. CLS. 100, 101 AND 102).
FIRST USE 5-1-2006; IN COMMERCE 5-1-2006.

3,300,370. LLS NORTH AMERICA, LLC, SPOKANE, WA. SN 78-947,679. FILED P.R. 8-8-2006; AM. S.R. 6-27-2007.

LITTLE LOAN SHOP

THE MARK CONSISTS OF STANDARD CHARACTERS WITHOUT CLAIM TO ANY PARTICULAR FONT, STYLE, SIZE, OR COLOR.

OWNER OF U.S. REG. NO. 3,272,333.
FOR FINANCIAL SERVICES, NAMELY, MONEY LENDING (U.S. CLS. 100, 101 AND 102).
FIRST USE 5-1-2007; IN COMMERCE 5-1-2007.

CLASS 37—CONSTRUCTION AND REPAIR

3,300,241. REMOTEVIDEO, LLC, OLATHE, KS. SN 76-657,252. FILED P.R. 3-24-2006; AM. S.R. 3-7-2007.

REMOTEVIDEO

THE MARK CONSISTS OF STANDARD CHARACTERS WITHOUT CLAIM TO ANY PARTICULAR FONT, STYLE, SIZE, OR COLOR.

FOR INSTALLATION AND MAINTENANCE OF VIDEO SURVEILLANCE EQUIPMENT (U.S. CLS. 100, 103 AND 106).
FIRST USE 2-0-1998; IN COMMERCE 2-0-1998.

CLASS 37—(Continued).

3,300,302. POWER ROOTER INC., LONGMONT, CO. SN 77-140,869. FILED 3-26-2007.

POWER ROOTER

THE MARK CONSISTS OF STANDARD CHARACTERS WITHOUT CLAIM TO ANY PARTICULAR FONT, STYLE, SIZE, OR COLOR.

FOR DRAIN CLEANING AND PLUMBING REPAIR (U.S. CLS. 100, 103 AND 106).
FIRST USE 8-25-2005; IN COMMERCE 2-15-2006.

CLASS 38—COMMUNICATION

3,300,288. ARNOLD, DANNY H, COPPELL, TX. SN 77-105,769. FILED P.R. 2-13-2007; AM. S.R. 6-19-2007.

The Texas BBQ Forum

THE MARK CONSISTS OF STANDARD CHARACTERS WITHOUT CLAIM TO ANY PARTICULAR FONT, STYLE, SIZE, OR COLOR.

NO CLAIM IS MADE TO THE EXCLUSIVE RIGHT TO USE "BBQ FORUM", APART FROM THE MARK AS SHOWN.

FOR PROVIDING ON-LINE FORUMS FOR TRANSMISSION OF MESSAGES AMONG COMPUTER USERS CONCERNING BBQ AND COOKING (U.S. CLS. 100, 101 AND 104).
FIRST USE 12-1-2006; IN COMMERCE 12-1-2006.

3,300,314. COURTROOM TELEVISION NETWORK LLC, NEW YORK, NY. SN 78-525,073. FILED P.R. 12-1-2004; AM. S.R. 12-16-2005.

THE INVESTIGATION
CHANNEL

THE MARK CONSISTS OF STANDARD CHARACTERS WITHOUT CLAIM TO ANY PARTICULAR FONT, STYLE, SIZE, OR COLOR.

FOR TELEVISION BROADCASTING SERVICES; AND THE ELECTRONIC TRANSMISSION OF TEXT, DATA, AUDIO AND VIDEO VIA CABLE, WIRELESS COMMUNICATIONS NETWORK AND THE INTERNET (U.S. CLS. 100, 101 AND 104).

FIRST USE 8-29-2003; IN COMMERCE 8-29-2003.

CLASS 38—(Continued).

3,300,385. ASSOCIATION FOR FINANCIAL PROFESSIONALS, INC., BETHESDA, MD. SN 78-965,774. FILED P.R. 9-1-2006; AM. S.R. 6-25-2007.

CLASS 39—(Continued).

3,300,357. MIDWEST ETHANOL TRANSPORT, LLC, GRANITE FALLS, MN. SN 78-931,614. FILED P.R. 7-18-2006; AM. S.R. 6-26-2007.

THE TREASURERS NETWORK

THE MARK CONSISTS OF STANDARD CHARACTERS WITHOUT CLAIM TO ANY PARTICULAR FONT, STYLE, SIZE, OR COLOR.

FOR PROVIDING ON-LINE LISTSERVICES FOR THE TRANSMISSION OF MESSAGES AMONG COMPUTER USERS CONCERNING TOPICS RELATED TO CORPORATE TREASURY AND FINANCIAL ISSUES (U.S. CLS. 100, 101 AND 104).

FIRST USE 8-1-2006; IN COMMERCE 8-1-2006.

MIDWEST ETHANOL TRANSPORT

THE MARK CONSISTS OF STANDARD CHARACTERS WITHOUT CLAIM TO ANY PARTICULAR FONT, STYLE, SIZE, OR COLOR.

NO CLAIM IS MADE TO THE EXCLUSIVE RIGHT TO USE ETHANOL TRANSPORT, APART FROM THE MARK AS SHOWN.

FOR TRANSPORTATION AND STORAGE OF FUELS (U.S. CLS. 100 AND 105).

FIRST USE 5-6-2007; IN COMMERCE 5-6-2007.

CLASS 39—TRANSPORTATION AND STORAGE

3,300,317. OMIDYAR NETWORK LLC, REDWOOD CITY, CA. SN 78-548,195. FILED P.R. 1-14-2005; AM. S.R. 9-11-2006.

CLASS 40—MATERIAL TREATMENT

3,300,337. ALL AMERICAN PUBLISHING, BOISE, ID. SN 78-780,137. FILED P.R. 12-23-2005; AM. S.R. 12-19-2006.

OMIDYAR

YOUR OFFICIAL GEAR

THE MARK CONSISTS OF STANDARD CHARACTERS WITHOUT CLAIM TO ANY PARTICULAR FONT, STYLE, SIZE, OR COLOR.

FOR ELECTRONIC STORAGE OF MESSAGES AND DATA (U.S. CLS. 100 AND 105).

FIRST USE 6-0-2004; IN COMMERCE 6-0-2004.

THE MARK CONSISTS OF STANDARD CHARACTERS WITHOUT CLAIM TO ANY PARTICULAR FONT, STYLE, SIZE, OR COLOR.

NO CLAIM IS MADE TO THE EXCLUSIVE RIGHT TO USE "GEAR", APART FROM THE MARK AS SHOWN.

FOR CUSTOMIZED PRINTING OF COMPANY, SCHOOL, TEAM AND OTHER ORGANIZATIONS' NAMES AND LOGOS FOR PROMOTIONAL AND ADVERTISING PURPOSES ON THE CLOTHING OF OTHERS (U.S. CLS. 100, 103 AND 106).

FIRST USE 12-1-2005; IN COMMERCE 12-1-2005.

CLASS 40—(Continued).

3,300,366. COGSDILL TOOL PRODUCTS, INC., LUGOFF, SC. SN 78-940,265. FILED P.R. 7-28-2006; AM. S.R. 7-6-2007.

LIGHT ACTIVATED ADHESIVE GRIPPING

THE MARK CONSISTS OF STANDARD CHARACTERS WITHOUT CLAIM TO ANY PARTICULAR FONT, STYLE, SIZE, OR COLOR.

NO CLAIM IS MADE TO THE EXCLUSIVE RIGHT TO USE LIGHT ACTIVATED ADHESIVE, APART FROM THE MARK AS SHOWN.

FOR MANUFACTURE OF WORK HOLDING FOR THE PRODUCTION MACHINING INDUSTRY TO THE ORDER AND SPECIFICATION OF OTHERS; MANUFACTURE OF WORK HOLDING SYSTEMS TO THE ORDER AND SPECIFICATION OF OTHERS (U.S. CLS. 100, 103 AND 106).

FIRST USE 5-1-2006; IN COMMERCE 5-1-2006.

CLASS 41—(Continued).

3,300,254. UNITED SAFETY COUNCIL, INC., ORLANDO, FL. SN 77-026,732. FILED P.R. 10-23-2006; AM. S.R. 7-3-2007.

Central Florida Safety Council

THE MARK CONSISTS OF STANDARD CHARACTERS WITHOUT CLAIM TO ANY PARTICULAR FONT, STYLE, SIZE, OR COLOR.

OWNER OF U.S. REG. NOS. 2,963,211 AND 3,215,447. NO CLAIM IS MADE TO THE EXCLUSIVE RIGHT TO USE "COUNCIL", APART FROM THE MARK AS SHOWN.

FOR EDUCATIONAL SERVICES, NAMELY, CONDUCTING CLASSES, SEMINARS, AND WORKSHOPS IN THE FIELD OF OCCUPATIONAL SAFETY, MOTOR VEHICLE SAFETY, AND HEALTHCARE SAFETY, TOGETHER WITH THE DISTRIBUTION OF COURSE MATERIALS IN CONNECTION THEREWITH; VEHICLE DRIVING INSTRUCTION, NAMELY, DRIVING INSTRUCTION FOR AUTOMOBILES (U.S. CLS. 100, 101 AND 107).

FIRST USE 1-1-2000; IN COMMERCE 1-1-2000.

3,300,378. PROPETRO SERVICES, INCORPORATED, MIDLAND, TX. SN 78-954,248. FILED P.R. 8-17-2006; AM. S.R. 7-16-2007.

PRO PETRO

THE MARK CONSISTS OF STANDARD CHARACTERS WITHOUT CLAIM TO ANY PARTICULAR FONT, STYLE, SIZE, OR COLOR.

NO CLAIM IS MADE TO THE EXCLUSIVE RIGHT TO USE "PETRO", APART FROM THE MARK AS SHOWN.

FOR OIL AND GAS WELL TREATMENT (U.S. CLS. 100, 103 AND 106).

FIRST USE 9-9-2005; IN COMMERCE 9-9-2005.

3,300,269. PERAZA, WILLIAM, JR, DBA CORPORATE POKER TOUR, MIAMI, FL. SN 77-057,689. FILED P.R. 12-5-2006; AM. S.R. 6-17-2007.

Corporate Poker Tour

THE MARK CONSISTS OF STANDARD CHARACTERS WITHOUT CLAIM TO ANY PARTICULAR FONT, STYLE, SIZE, OR COLOR.

NO CLAIM IS MADE TO THE EXCLUSIVE RIGHT TO USE POKER, APART FROM THE MARK AS SHOWN.

FOR ENTERTAINMENT IN THE NATURE OF ONGOING TELEVISION PROGRAMS IN THE FIELD OF POKER EXHIBITIONS; ENTERTAINMENT IN THE NATURE OF LIVE POKER TOURNAMENTS; ENTERTAINMENT SERVICES, NAMELY, ARRANGING AND CONDUCTING OF COMPETITIONS FOR POKER; ENTERTAINMENT, NAMELY A CONTINUING POKER SHOW BROADCAST OVER TELEVISION, SATELLITE, AUDIO, AND VIDEO MEDIA; ORGANIZING EXHIBITIONS FOR POKER TOURNAMENTS (U.S. CLS. 100, 101 AND 107).

FIRST USE 10-1-2005; IN COMMERCE 10-1-2006.

CLASS 41—EDUCATION AND ENTERTAINMENT

CLASS 41—(Continued).

3,300,270. PERAZA, WILLIAM, JR, MIAMI, FL. SN 77-057,723. FILED P.R. 12-5-2006; AM. S.R. 6-23-2007.

Corporate Poker

THE MARK CONSISTS OF STANDARD CHARACTERS WITHOUT CLAIM TO ANY PARTICULAR FONT, STYLE, SIZE, OR COLOR.

NO CLAIM IS MADE TO THE EXCLUSIVE RIGHT TO USE "POKER", APART FROM THE MARK AS SHOWN.

FOR ENTERTAINMENT IN THE NATURE OF ONGOING TELEVISION PROGRAMS IN THE FIELD OF POKER; ENTERTAINMENT IN THE NATURE OF POKER GAMES; ENTERTAINMENT NAMELY, PRODUCTION OF POKER EXHIBITIONS; ENTERTAINMENT SERVICES, NAMELY, PARTICIPATION IN POKER TOURNAMENTS; ENTERTAINMENT SERVICES, NAMELY, PROVIDING A TELEVISION PROGRAM IN THE FIELD OF POKER VIA A GLOBAL COMPUTER NETWORK; ENTERTAINMENT, NAMELY A CONTINUING POKER SHOW BROADCAST OVER TELEVISION, SATELLITE, AUDIO, AND VIDEO MEDIA (U.S. CLS. 100, 101 AND 107).

FIRST USE 1-6-2004; IN COMMERCE 1-6-2005.

CLASS 41—(Continued).

3,300,273. PERAZA, WILLIAM, JR, MIAMI, FL. SN 77-059,607. FILED P.R. 12-7-2006; AM. S.R. 6-22-2007.

Corporate Poker Games

THE MARK CONSISTS OF STANDARD CHARACTERS WITHOUT CLAIM TO ANY PARTICULAR FONT, STYLE, SIZE, OR COLOR.

NO CLAIM IS MADE TO THE EXCLUSIVE RIGHT TO USE "POKER GAMES", APART FROM THE MARK AS SHOWN.

FOR ENTERTAINMENT IN THE NATURE OF COMPETITIONS IN THE FIELD OF POKER; ENTERTAINMENT IN THE NATURE OF POKER GAMES; ENTERTAINMENT IN THE NATURE OF POKER TOURNAMENTS; ENTERTAINMENT NAMELY, PRODUCTION OF POKER TOURNAMENTS; ENTERTAINMENT SERVICES, NAMELY, ARRANGING AND CONDUCTING OF COMPETITIONS FOR POKER; ENTERTAINMENT SERVICES, NAMELY, PROVIDING A TELEVISION PROGRAM IN THE FIELD OF POKER VIA A GLOBAL COMPUTER NETWORK; ENTERTAINMENT, NAMELY A CONTINUING POKER SHOW BROADCAST OVER TELEVISION, SATELLITE, AUDIO, AND VIDEO MEDIA (U.S. CLS. 100, 101 AND 107).

FIRST USE 1-1-2006; IN COMMERCE 1-1-2006.

3,300,272. TRUE AZIMUTH, LLC, FAIRLEE, VT. SN 77-058,605. FILED P.R. 12-6-2006; AM. S.R. 6-20-2007.

Reality Coach

THE MARK CONSISTS OF STANDARD CHARACTERS WITHOUT CLAIM TO ANY PARTICULAR FONT, STYLE, SIZE, OR COLOR.

FOR PERSONAL COACHING SERVICES IN THE FIELD OF LIFE, CAREER, BUSINESS OR RELATIONSHIPS (U.S. CLS. 100, 101 AND 107).

FIRST USE 11-2-2006; IN COMMERCE 11-2-2006.

3,300,278. J. WALTER THOMPSON U.S.A., INC., NEW YORK, NY. SN 77-070,634. FILED P.R. 12-22-2006; AM. S.R. 7-9-2007.

BarRants

THE MARK CONSISTS OF STANDARD CHARACTERS WITHOUT CLAIM TO ANY PARTICULAR FONT, STYLE, SIZE, OR COLOR.

FOR ENTERTAINMENT SERVICES IN THE NATURE OF AN INTERACTIVE INTERNET WEBSITE FEATURING AUDIO READINGS OF DISCUSSIONS IN BARS (U.S. CLS. 100, 101 AND 107).

FIRST USE 8-22-2006; IN COMMERCE 8-22-2006.

CLASS 41—(Continued).

3,300,280. MEDELIA COMMUNICATIONS, LLC, HOLLYWOOD, FL. SN 77-075,748. FILED P.R. 1-4-2007; AM. S.R. 7-23-2007.

Women Certified

THE MARK CONSISTS OF STANDARD CHARACTERS WITHOUT CLAIM TO ANY PARTICULAR FONT, STYLE, SIZE, OR COLOR.

FOR WORKSHOPS AND SEMINARS IN THE FIELD OF SALES TRAINING (U.S. CLS. 100, 101 AND 107).
FIRST USE 5-14-2007; IN COMMERCE 5-14-2007.

3,300,293. TRUSTEES OF THE COLLEGE OF THE HOLY CROSS, WORCESTER, MA. SN 77-127,100. FILED P.R. 3-9-2007; AM. S.R. 8-13-2007.

WORCESTER SUMMER SHAKESPEARE FESTIVAL

THE MARK CONSISTS OF STANDARD CHARACTERS WITHOUT CLAIM TO ANY PARTICULAR FONT, STYLE, SIZE, OR COLOR.

NO CLAIM IS MADE TO THE EXCLUSIVE RIGHT TO USE "SUMMER SHAKESPEARE FESTIVAL", APART FROM THE MARK AS SHOWN.

FOR ENTERTAINMENT SERVICES IN THE NATURE OF THEATRE PRODUCTIONS (U.S. CLS. 100, 101 AND 107).
FIRST USE 8-1-2007; IN COMMERCE 8-1-2007.

CLASS 41—(Continued).

3,300,300. MARSHALL-ATTLE, FELICIA, LINDENWOLD, NJ. SN 77-139,707. FILED P.R. 3-25-2007; AM. S.R. 7-11-2007.

Business Television Network

THE MARK CONSISTS OF STANDARD CHARACTERS WITHOUT CLAIM TO ANY PARTICULAR FONT, STYLE, SIZE, OR COLOR.

NO CLAIM IS MADE TO THE EXCLUSIVE RIGHT TO USE "TELEVISION NETWORK", APART FROM THE MARK AS SHOWN.

FOR DIRECTION OF MAKING RADIO OR TELEVISION PROGRAMS; DISTRIBUTION OF TELEVISION PROGRAMMING TO CABLE TELEVISION SYSTEMS; DISTRIBUTION OF TELEVISION PROGRAMS FOR OTHERS; ENTERTAINMENT IN THE NATURE OF ONGOING TELEVISION PROGRAMS IN THE FIELD OF BUSINESS; ENTERTAINMENT IN THE NATURE OF TELEVISION NEWS SHOWS; ENTERTAINMENT SERVICES, NAMELY, PROVIDING A TELEVISION PROGRAM IN THE FIELD OF BUSINESS VIA A GLOBAL COMPUTER NETWORK; ENTERTAINMENT, NAMELY A CONTINUING BUSINESS INFORMATION SHOW BROADCAST OVER TELEVISION, SATELLITE, AUDIO, AND VIDEO MEDIA; PRODUCTION AND DISTRIBUTION OF TELEVISION SHOWS AND MOVIES; PRODUCTION OF CABLE TELEVISION PROGRAMS; PRODUCTION OF CLOSED CAPTION TELEVISION PROGRAMS; PRODUCTION OF RADIO AND TELEVISION PROGRAMS; PRODUCTION OF VIDEO AND CREATION OF VISUAL EFFECTS FOR OTHERS FOR USE IN DVDS, TELEVISION PROGRAMS AND ON WEBSITES; PRODUCTION OF VISUAL EFFECTS FOR VIDEOS, DVDS, TELEVISION AND FOR INTERNET WEBSITES; TELEVISION PRODUCTION (U.S. CLS. 100, 101 AND 107).

FIRST USE 2-20-2007; IN COMMERCE 2-22-2007.

3,300,301. MARYLAND PUBLIC BROADCASTING COMMISSION, OWINGS MILLS, MD. SN 77-140,586. FILED 3-26-2007.

CHESAPEAKE BAY WEEK

THE MARK CONSISTS OF STANDARD CHARACTERS WITHOUT CLAIM TO ANY PARTICULAR FONT, STYLE, SIZE, OR COLOR.

NO CLAIM IS MADE TO THE EXCLUSIVE RIGHT TO USE "CHESAPEAKE BAY", APART FROM THE MARK AS SHOWN.

FOR ENTERTAINMENT, NAMELY TELEVISION PROGRAMMING FEATURING THE CHESAPEAKE BAY (U.S. CLS. 100, 101 AND 107).
FIRST USE 5-22-2005; IN COMMERCE 5-22-2005.

CLASS 41—(Continued).

3,300,304. VOD ADVERTISING SERVICES, AVV, ORANJESTAD, ARUBA. SN 77-144,803. FILED P.R. 3-30-2007; AM. S.R. 7-26-2007.

SEX MOVIES ON POD

THE MARK CONSISTS OF STANDARD CHARACTERS WITHOUT CLAIM TO ANY PARTICULAR FONT, STYLE, SIZE, OR COLOR.

NO CLAIM IS MADE TO THE EXCLUSIVE RIGHT TO USE "POD", APART FROM THE MARK AS SHOWN.

FOR ENTERTAINMENT SERVICES, NAMELY A WEBSITE FEATURING VIDEOS, IMAGES AND MOVIE CLIPS IN THE FIELD OF ADULT CONTENT AND SUBJECTS (U.S. CLS. 100, 101 AND 107).

FIRST USE 11-29-2005; IN COMMERCE 11-29-2005.

3,300,325. MULTICAST MEDIA TECHNOLOGIES, INC., ATLANTA, GA. SN 78-724,879. FILED P.R. 10-3-2005; AM. S.R. 10-3-2005.

QUILTERS NEWS NETWORK

THE MARK CONSISTS OF STANDARD CHARACTERS WITHOUT CLAIM TO ANY PARTICULAR FONT, STYLE, SIZE, OR COLOR.

NO CLAIM IS MADE TO THE EXCLUSIVE RIGHT TO USE "NEWS NETWORK", APART FROM THE MARK AS SHOWN.

FOR PROVIDING ENTERTAINMENT INFORMATION ON QUILTING, KNITTING AND CRAFTS VIA WEBSITES ON THE INTERNET; ENTERTAINMENT, NAMELY, CONTINUING SHOWS IN THE FIELDS OF QUILTING AND KNITTING BROADCAST OVER TELEVISION AND SATELLITE VIDEO MEDIA (U.S. CLS. 100, 101 AND 107).

FIRST USE 4-29-2005; IN COMMERCE 4-29-2005.

CLASS 41—(Continued).

3,300,349. REDBOX AUTOMATED RETAIL, LLC, OAKBROOK TERRACE, IL. SN 78-865,999. FILED P.R. 4-20-2006; AM. S.R. 6-27-2007.



THE MARK CONSISTS OF A 3-DIMENSIONAL CUBE WITH ROUNDED EDGES.

FOR RENTAL OF DVDS FEATURING ENTERTAINMENT CONTENT THROUGH AUTOMATED VENDING MACHINES (U.S. CLS. 100, 101 AND 107).

FIRST USE 6-0-2005; IN COMMERCE 6-0-2005.

3,300,356. CALIFORNIA EMERGENCY PHYSICIANS MEDICAL GROUP, EMERYVILLE, CA. SN 78-931,168. FILED P.R. 7-17-2006; AM. S.R. 6-11-2007.

RAPID MEDICAL EVALUATION

THE MARK CONSISTS OF STANDARD CHARACTERS WITHOUT CLAIM TO ANY PARTICULAR FONT, STYLE, SIZE, OR COLOR.

FOR EDUCATIONAL SERVICES, NAMELY PROVIDING CLASSES, SEMINARS, CONFERENCES, WORKSHOPS AND INSTRUCTION IN THE MEDICAL FIELD PERTAINING TO ACCELERATING THE PROCESS OF PATIENT TREATMENT IN HOSPITAL EMERGENCY DEPARTMENTS (U.S. CLS. 100, 101 AND 107).

FIRST USE 9-1-2003; IN COMMERCE 9-1-2003.

CLASS 41—(Continued).

3,300,372. DAWN M. D'AMICO, BRISTOL, PA. SN 78-951,670. FILED P.R. 8-14-2006; AM. S.R. 6-19-2007.

CLASS 42—(Continued).

3,300,283. LUMBER LIQUIDATORS, INC., TOANO, VA. SN 77-090,408. FILED P.R. 1-24-2007; AM. S.R. 7-11-2007.

Kinky Quizzo

FLOOR FINDER

THE MARK CONSISTS OF STANDARD CHARACTERS WITHOUT CLAIM TO ANY PARTICULAR FONT, STYLE, SIZE, OR COLOR.

NO CLAIM IS MADE TO THE EXCLUSIVE RIGHT TO USE "QUIZZO", APART FROM THE MARK AS SHOWN.

FOR ENTERTAINMENT SERVICES IN THE FORM OF AN ADULT TRIVIA GAME USED AS ENTERTAINMENT IN VARIOUS NIGHTSPOTS SUCH AS BARS AND ALSO PRIVATE PARTIES (U.S. CLS. 100, 101 AND 107).
FIRST USE 8-0-2004; IN COMMERCE 10-0-2004.

THE MARK CONSISTS OF STANDARD CHARACTERS WITHOUT CLAIM TO ANY PARTICULAR FONT, STYLE, SIZE, OR COLOR.

FOR PROVIDING INFORMATION IN THE FIELD OF FLOOR COVERINGS BY MEANS OF A GLOBAL COMPUTER NETWORK (U.S. CLS. 100 AND 101).
FIRST USE 5-9-2006; IN COMMERCE 5-9-2006.

3,300,382. SOCIETY FOR COLLEGE AND UNIVERSITY PLANNING, ANN ARBOR, MI. SN 78-962,108. FILED P.R. 8-28-2006; AM. S.R. 7-20-2007.

3,300,289. S & P TECHNOLOGIES, INC., MANLIUS, NY. SN 77-110,363. FILED P.R. 2-18-2007; AM. S.R. 6-6-2007.

CAMPUS SUSTAINABILITY DAY

The Emergency Responder Reply System

THE MARK CONSISTS OF STANDARD CHARACTERS WITHOUT CLAIM TO ANY PARTICULAR FONT, STYLE, SIZE, OR COLOR.

FOR ORGANIZING AND CONDUCTING SEMINARS AND PANEL DISCUSSIONS VIA ONLINE WEBCASTS AND ORGANIZING LIVE SEMINARS AND WORKSHOPS IN COLLABORATION WITH COLLEGES AND UNIVERSITIES ACROSS THE NATION TO BE CONDUCTED ON A DESIGNATED DAY, ALL ON THE SUBJECT OF PROMOTING SOCIALLY AND ENVIRONMENTALLY RESPONSIBLE DECISIONS IN ORDER TO CREATE A HEALTHY, JUST AND SUSTAINABLE SOCIETY (U.S. CLS. 100, 101 AND 107).
FIRST USE 4-15-2003; IN COMMERCE 4-15-2003.

THE MARK CONSISTS OF STANDARD CHARACTERS WITHOUT CLAIM TO ANY PARTICULAR FONT, STYLE, SIZE, OR COLOR.

FOR PROVIDING AN INTERNET WEB SITE FOR EMERGENCY RESPONDERS TO NOTIFY PERSONS VIEWING WEB SITE THAT THEY ARE RESPONDING TO AN EMERGENCY BY DIALING PHONE NUMBER THAT POSTS THEIR INFORMATION ON THAT WEB SITE (U.S. CLS. 100 AND 101).
FIRST USE 10-2-2006; IN COMMERCE 2-10-2007.

CLASS 42—SCIENTIFIC, COMPUTER AND LEGAL SERVICES

CLASS 42—(Continued).

3,300,319. BUSINESS LAW VENTURES, P.C., ROSEVILLE, CA. SN 78-592,755. FILED P.R. 3-22-2005; AM. S.R. 5-16-2007.

**Business Law
Ventures**

THE MARK CONSISTS OF STANDARD CHARACTERS WITHOUT CLAIM TO ANY PARTICULAR FONT, STYLE, SIZE, OR COLOR.

NO CLAIM IS MADE TO THE EXCLUSIVE RIGHT TO USE "BUSINESS LAW", APART FROM THE MARK AS SHOWN.

FOR LEGAL SERVICES (U.S. CLS. 100 AND 101).
FIRST USE 3-29-2001; IN COMMERCE 3-29-2001.

3,300,332. THOMSON LEARNING INC., STAMFORD, CT. SN 78-756,095. FILED P.R. 11-17-2005; AM. S.R. 11-29-2006.

NetManager

THE MARK CONSISTS OF STANDARD CHARACTERS WITHOUT CLAIM TO ANY PARTICULAR FONT, STYLE, SIZE, OR COLOR.

FOR PROVIDING A WEB-ENABLED LEARNING MANAGEMENT SYSTEM COMPRISED OF ONLINE NON-DOWNLOADABLE COMPUTER SOFTWARE ALLOWS SUPERVISORS, MANAGERS AND VALIDATORS TO MONITOR THEIR STAFF'S PARTICIPATION IN INSTRUCTOR-LED CLASSES OR COMPUTER-BASED LEARNING COURSES, REVIEW STAFF'S TRANSCRIPTS, VIEW CLASS CALENDAR OF INSTRUCTOR-LED CLASSES (U.S. CLS. 100 AND 101).

FIRST USE 8-1-2002; IN COMMERCE 8-1-2002.

CLASS 42—(Continued).

3,300,334. BUSINESS & LEGAL REPORTS, INC., OLD SAYBROOK, CT. SN 78-764,341. FILED P.R. 12-1-2005; AM. S.R. 7-19-2007.

MY SAFETY MANAGER

THE MARK CONSISTS OF STANDARD CHARACTERS WITHOUT CLAIM TO ANY PARTICULAR FONT, STYLE, SIZE, OR COLOR.

FOR PROVIDING ONLINE NON-DOWNLOADABLE COMPUTER SOFTWARE FOR ADMINISTERING ORGANIZATIONAL COMPLIANCE WITH GOVERNMENTAL REGULATIONS, NAMELY, ADMINISTERING ORGANIZATIONAL EMPLOYEE TRAINING RECORDS, ADMINISTERING ORGANIZATIONAL EMPLOYEE INJURY AND ILLNESS RECORDS, AND ADMINISTERING ORGANIZATIONAL EMPLOYEE LICENSE RECORDS AND REQUIREMENTS (U.S. CLS. 100 AND 101).

FIRST USE 10-31-2005; IN COMMERCE 10-31-2005.

3,300,369. DAILYTECH, LLC, RALEIGH, NC. SN 78-944,597. FILED P.R. 8-3-2006; AM. S.R. 7-6-2007.

DAILYTECH

THE MARK CONSISTS OF STANDARD CHARACTERS WITHOUT CLAIM TO ANY PARTICULAR FONT, STYLE, SIZE, OR COLOR.

FOR PROVIDING A WEB SITE THAT FEATURES INFORMATION ON COMPUTER TECHNOLOGY AND PROGRAMMING, NAMELY, ELECTRONIC PRODUCT TECHNOLOGY NEWS, REVIEWS OF ARTICLES AND INFORMATIONAL MATERIALS CONCERNING ELECTRONIC PRODUCTS, NAMELY, COMPUTERS, COMPUTER SOFTWARE, COMPUTER HARDWARE, COMPUTER PERIPHERALS, COMPUTER ACCESSORIES, ELECTRONIC GAME SYSTEMS HARDWARE, SOFTWARE, AND PERIPHERALS, GPS TECHNOLOGY, WIRELESS PHONES AND DIGITAL TECHNOLOGY (U.S. CLS. 100 AND 101).

FIRST USE 9-15-2005; IN COMMERCE 1-1-2006.

CLASS 43—HOTEL AND RESTAURANT SERVICES

CLASS 43—(Continued).

3,300,267. BEST WESTERN INTERNATIONAL, INC., PHOENIX, AZ. SN 77-057,167. FILED P.R. 12-5-2006; AM. S.R. 7-3-2007.

BEST OF THE BEST

THE MARK CONSISTS OF STANDARD CHARACTERS WITHOUT CLAIM TO ANY PARTICULAR FONT, STYLE, SIZE, OR COLOR.
FOR HOTEL SERVICES (U.S. CLS. 100 AND 101).
FIRST USE 1-1-2005; IN COMMERCE 1-1-2005.

3,300,324. COPELAND, AL C., METAIRIE, LA. SN 78-701,082. FILED P.R. 8-26-2005; AM. S.R. 9-21-2006.

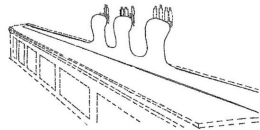

THE MARK CONSISTS OF THE DESIGN OF THE APPLICANT'S BAR TOP WITH ICE TOWERS, USED FOR DISPENSING BEER AND OTHER BEVERAGES. THE DOTTED LINES ARE INTENDED TO SHOW THE POSITIONING OF THE MARK, AND ARE NOT A PART OF THE MARK.
FOR RESTAURANT AND LOUNGE SERVICES (U.S. CLS. 100 AND 101).
FIRST USE 5-31-2005; IN COMMERCE 5-31-2005.

CLASS 43—(Continued).

3,300,339. AIZHI, INC., OCEANSIDE, CA. SN 78-792,208. FILED P.R. 1-16-2006; AM. S.R. 8-9-2007.

LOS TACOS

THE MARK CONSISTS OF STANDARD CHARACTERS WITHOUT CLAIM TO ANY PARTICULAR FONT, STYLE, SIZE, OR COLOR.
THE ENGLISH TRANSLATION OF LOS TACOS, IS THE TACOS.
FOR RESTAURANT SERVICES (U.S. CLS. 100 AND 101).
FIRST USE 7-31-2005; IN COMMERCE 7-31-2005.

3,300,365. PICCADILLY RESTAURANTS, LLC, BATON ROUGE, LA. SN 78-939,987. FILED P.R. 7-28-2006; AM. S.R. 7-4-2007.

CAVALLO'S

THE MARK CONSISTS OF STANDARD CHARACTERS WITHOUT CLAIM TO ANY PARTICULAR FONT, STYLE, SIZE, OR COLOR.
FOR RESTAURANT SERVICES (U.S. CLS. 100 AND 101).
FIRST USE 2-28-2005; IN COMMERCE 2-28-2005.

CLASS 44—MEDICAL, BEAUTY AND AGRICULTURAL SERVICES

3,300,255. BAYLOR UNIVERSITY, WACO, TX. SN 77-031,440. FILED P.R. 10-27-2006; AM. S.R. 7-4-2007.

THE HEART HOSPITAL BAYLOR PLANO

THE MARK CONSISTS OF STANDARD CHARACTERS WITHOUT CLAIM TO ANY PARTICULAR FONT, STYLE, SIZE, OR COLOR.
FOR MEDICAL SERVICES (U.S. CLS. 100 AND 101).
FIRST USE 1-17-2007; IN COMMERCE 1-17-2007.

CLASS 44—(Continued).

3,300,264. REPRODUCTIVE MEDICINE AND SURGERY CENTER OF VIRGINIA, PLC, CHARLOTTESVILLE, VA. SN 77-056,379. FILED 12-4-2006.

Reproductive Medicine and Surgery Center of Virginia

THE MARK CONSISTS OF STANDARD CHARACTERS WITHOUT CLAIM TO ANY PARTICULAR FONT, STYLE, SIZE, OR COLOR.

NO CLAIM IS MADE TO THE EXCLUSIVE RIGHT TO USE "REPRODUCTIVE MEDICINE AND SURGERY CENTER", APART FROM THE MARK AS SHOWN.

FOR GENETIC TESTING FOR MEDICAL PURPOSES; MAINTAINING FILES AND RECORDS CONCERNING THE MEDICAL CONDITION OF INDIVIDUALS; MAINTAINING PERSONAL MEDICAL HISTORY RECORDS AND FILES; MEDICAL AND PHARMACEUTICAL CONSULTATION; MEDICAL CLINICS; MEDICAL CONSULTATIONS; MEDICAL COUNSELING; MEDICAL IMAGING SERVICES; MEDICAL IMAGING SERVICES NAMELY CONSULTING SERVICES IN THE FIELD OF USING AND OPERATING MEDICAL IMAGING APPARATUS INCLUDING X-RAY, COMPUTED TOMOGRAPHY, MAGNETIC RESONANCE IMAGING, ULTRASOUND, AND POSITRON EMISSION TOMOGRAPHY APPARATUS; MEDICAL INFORMATION; MEDICAL RADIOLOGY SERVICES; MEDICAL SERVICES; MEDICAL SERVICES, NAMELY, IN VITRO FERTILIZATION; MEDICAL SERVICES, NAMELY, SERVICES IN CONNECTION WITH HUMAN REPRODUCTION; MEDICAL TESTING; PREPARATION AND DISPENSING OF MEDICATIONS; PROVIDING MEDICAL INFORMATION; PROVIDING MEDICAL INFORMATION, CONSULTANCY AND ADVISORY SERVICES (U.S. CLS. 100 AND 101).

FIRST USE 6-16-2006; IN COMMERCE 10-1-2006.

3,300,277. RETINA ASSOCIATES, P.S.C., DBA THE EYE CARE INSTITUTE, LOUISVILLE, KY. SN 77-067,103. FILED P.R. 12-19-2006; AM. S.R. 6-11-2007.

Leaders in LASIK

THE MARK CONSISTS OF STANDARD CHARACTERS WITHOUT CLAIM TO ANY PARTICULAR FONT, STYLE, SIZE, OR COLOR.

NO CLAIM IS MADE TO THE EXCLUSIVE RIGHT TO USE "LASIK", APART FROM THE MARK AS SHOWN.

FOR TREATMENT OF EYE DISEASES AND CONDITIONS (U.S. CLS. 100 AND 101).

FIRST USE 9-1-2006; IN COMMERCE 9-1-2006.

CLASS 44—(Continued).

3,300,297. AURORA DENVER CARDIOLOGY ASSOCIATES, P.C., DENVER, CO. SN 77-131,239. FILED P.R. 3-14-2007; AM. S.R. 6-29-2007.

THE HEART SPECIALISTS OF COLORADO

THE MARK CONSISTS OF STANDARD CHARACTERS WITHOUT CLAIM TO ANY PARTICULAR FONT, STYLE, SIZE, OR COLOR.

NO CLAIM IS MADE TO THE EXCLUSIVE RIGHT TO USE "HEART SPECIALISTS", APART FROM THE MARK AS SHOWN.

FOR MEDICAL SERVICES; MEDICAL SERVICES, NAMELY, IN THE FIELD OF CARDIOLOGY (U.S. CLS. 100 AND 101).

FIRST USE 3-5-2007; IN COMMERCE 3-5-2007.

3,300,322. DIMARIA, ROSE, EAST HAMPSTEAD, NH. SN 78-612,948. FILED P.R. 4-20-2005; AM. S.R. 5-31-2007.

Doctor Dental MD

THE MARK CONSISTS OF STANDARD CHARACTERS WITHOUT CLAIM TO ANY PARTICULAR FONT, STYLE, SIZE, OR COLOR.

FOR PROVIDING INFORMATION ABOUT DENTISTRY, DENTAL HEALTH, ORAL HYGIENE, ORAL DISEASE, DENTAL CURES, DENTAL MEDICINE, DENTAL DIAGNOSIS, DENTAL TREATMENT, DENTAL COUNSELING, DENTAL ADVICE AND VENDORS, AND PATIENTS VIA THE INTERNET (U.S. CLS. 100 AND 101).

FIRST USE 2-27-2007; IN COMMERCE 2-27-2007.

3,300,338. LADEWIG, MICHELLE, DALLAS, TX. SN 78-784,909. FILED P.R. 1-4-2006; AM. S.R. 8-13-2007.

BODY MELT

THE MARK CONSISTS OF STANDARD CHARACTERS WITHOUT CLAIM TO ANY PARTICULAR FONT, STYLE, SIZE, OR COLOR.

FOR SALON SERVICES, NAMELY, BODY WRAP TREATMENTS (U.S. CLS. 100 AND 101).

FIRST USE 10-1-2005; IN COMMERCE 10-1-2005.

CLASS 45—(Continued).

3,300,368. CIGNA INTELLECTUAL PROPERTY, INC., CLAYMONT, DE. SN 78-941,156. FILED P.R. 7-31-2006; AM. S.R. 6-7-2007.

CARE ADVOCACY MANAGEMENT SYSTEM

THE MARK CONSISTS OF STANDARD CHARACTERS WITHOUT CLAIM TO ANY PARTICULAR FONT, STYLE, SIZE, OR COLOR.

NO CLAIM IS MADE TO THE EXCLUSIVE RIGHT TO USE "MANAGEMENT SYSTEM", APART FROM THE MARK AS SHOWN.

FOR PROVIDING BEHAVIORAL HEALTH INFORMATION; AND MANAGED HEALTH CARE SERVICES (U.S. CLS. 100 AND 101).

FIRST USE 7-15-2006; IN COMMERCE 7-15-2006.

3,300,379. CLEAN AIR LAWN CARE, INC., FORT COLLINS, CO. SN 78-954,261. FILED P.R. 8-17-2006; AM. S.R. 8-2-2007.

CLEAN AIR

THE MARK CONSISTS OF STANDARD CHARACTERS WITHOUT CLAIM TO ANY PARTICULAR FONT, STYLE, SIZE, OR COLOR.

FOR LAWN CARE; LAWN MOWING SERVICES; AND LANDSCAPING GARDENING SERVICES (U.S. CLS. 100 AND 101).

FIRST USE 5-0-2006; IN COMMERCE 5-0-2006.

3,300,386. AUGUSTA BACK PROPERTIES LLC, AUGUSTA, GA. SN 78-971,596. FILED P.R. 9-11-2006; AM. S.R. 6-13-2007.

Augusta Back

CLASS 45—(Continued).

THE MARK CONSISTS OF STANDARD CHARACTERS WITHOUT CLAIM TO ANY PARTICULAR FONT, STYLE, SIZE, OR COLOR.

NO CLAIM IS MADE TO THE EXCLUSIVE RIGHT TO USE "BACK", APART FROM THE MARK AS SHOWN.

FOR MEDICAL SERVICES RELATED TO BACK AND NECK CARE, NAMELY, SPINE SURGERY AND SPINE PHYSICAL THERAPY (U.S. CLS. 100 AND 101).

FIRST USE 6-28-2006; IN COMMERCE 6-28-2006.

CLASS 45—PERSONAL SERVICES

3,300,261. ORPHAN OUTREACH, DALLAS, TX. SN 77-049,602. FILED P.R. 11-22-2006; AM. S.R. 5-29-2007.

ORPHAN OUTREACH

THE MARK CONSISTS OF STANDARD CHARACTERS WITHOUT CLAIM TO ANY PARTICULAR FONT, STYLE, SIZE, OR COLOR.

FOR RELIGIOUS AND CHARITABLE SERVICES, NAMELY MINISTERING TO ORPHANS AROUND THE WORLD, PARTICULARLY CHILDREN AFFECTED BY THE AIDS CRISIS BY MEETING SPIRITUAL, PHYSICAL, EMOTIONAL AND EDUCATIONAL NEEDS (U.S. CLS. 100 AND 101).

FIRST USE 11-20-2006; IN COMMERCE 11-20-2006.

3,300,303. STIBERMAN, MARISA G., BAY HARBOR ISLANDS, FL. SN 77-143,238. FILED P.R. 3-28-2007; AM. S.R. 7-10-2007.

Immigration P.A.

THE MARK CONSISTS OF STANDARD CHARACTERS WITHOUT CLAIM TO ANY PARTICULAR FONT, STYLE, SIZE, OR COLOR.

NO CLAIM IS MADE TO THE EXCLUSIVE RIGHT TO USE "P.A.", APART FROM THE MARK AS SHOWN.

FOR LEGAL SERVICES (U.S. CLS. 100 AND 101).

FIRST USE 10-28-2004; IN COMMERCE 10-28-2004.

PRIOR UNITED STATES CLASSIFICATION

APPLICATION IN ONE CLASS

CERTIFICATION MARKS

CLASS B—SERVICES

3,300,240. MICHAEL STEIN AND JOYCE KEYSER, DEER-FIELD BEACH, FL. SN 76-654,529. FILED P.R. 2-3-2006; AM. S.R. 7-26-2007.

THE CERTIFICATION MARK, AS USED BY PERSONS AUTHORIZED BY THE CERTIFIER, CERTIFIES THAT THE RESTAURANTS, INSTITUTIONS AND FOOD SERVICE OUTLETS ARE NOT SERVING BEEF, PORK, POULTRY, MILK, CHEESE OR EGGS THAT ARE DERIVED FROM CLONED ANIMAL OR THEIR OFFSPRING.

FOR RESTAURANTS, INSTITUTIONS AND FOOD SERVICES OUTLETS THAT SERVE BEEF, PORK, POULTRY, MILK, CHEESE, OR EGGS (U.S. CL. B).
FIRST USE 6-22-2007; IN COMMERCE 6-22-2007.

GUARANTEED CLONE FREE

THE MARK CONSISTS OF STANDARD CHARACTERS WITHOUT CLAIM TO ANY PARTICULAR FONT, STYLE, SIZE, OR COLOR.

* * * * *

TRADEMARK REGISTRATIONS RENEWED

The designation "U.S. Cl." appearing in this section refers to the U.S. class in effect prior to Sep. 1, 1973 rather than the international class which applies to applications filed on or after that date. For adoption of international classification see notice in the OFFICIAL GAZETTE of Jun. 26, 1973 (911 O.G. TM 210).

117,704.	CRISCO (STYLIZED). U.S. CL. 46. (INT. CL. 29). REG. 7-24-1917.	823,707.	JUICE BOWL. U.S. CL. 46. (INT. CL. 31). REG. 2-7-1967.
215,445.	WILLIAMS (STYLIZED). U.S. CL. 4. (INT. CL. 3). REG. 7-20-1926.	828,204.	SELLSTROM. U.S. CL. 26 ONLY. (INT. CLS. 1, 9 AND 10). REG. 5-2-1967.
227,991.	LIGHTNIN (STYLIZED). U.S. CL. 21. (INT. CL. 9). REG. 5-17-1927.	830,117.	RED JACKET. U.S. CL. 21. (INT. CL. 9). REG. 6-13-1967.
230,899.	KRASDALE. U.S. CL. 46. (INT. CLS. 1, 5, 29, 30, 31 AND 32). REG. 8-9-1927.	830,482.	FLUORO GLIDE (STYLIZED). U.S. CL. 15. (INT. CL. 4). REG. 6-20-1967.
231,203.	METRO GOLDWYN MAYER ARS GRATIA ARTIS AND DESIGN. U.S. CL. 26. (INT. CL. 9). REG. 8-16-1927.	830,507.	GTC. U.S. CL. 21. (INT. CL. 9). REG. 6-20-1967.
243,192.	BOSISTO'S EUCALYPTUS OIL. U.S. CL. 6. (INT. CL. 3). REG. 6-12-1928.	831,353.	SPRAY MIST. U.S. CL. 21. (INT. CL. 9). REG. 7-4-1967.
344,590.	SHOCKING. U.S. CL. 51. (INT. CLS. 3 AND 5). REG. 3-30-1937.	831,392.	SUNDYNE. U.S. CL. 23. (INT. CL. 7). REG. 7-4-1967.
347,926.	DURA HOOKS. U.S. CL. 23. (INT. CL. 8). REG. 7-13-1937.	831,825.	S AND DESIGN. U.S. CL. 36. (INT. CL. 15). REG. 7-11-1967.
352,721.	SEA-BOUND. U.S. CL. 46. (INT. CL. 31). REG. 12-7-1937.	832,210.	CAMEL AND DESIGN. U.S. CL. 35. (INT. CL. 12). REG. 7-18-1967.
352,925.	SEA-CURED. U.S. CL. 46. (INT. CL. 31). REG. 12-14-1937.	832,338.	CUBITAINER AND DESIGN. U.S. CL. 2. (INT. CLS. 16 AND 20). REG. 7-25-1967.
353,990.	MISCELLANEOUS DESIGN. U.S. CL. 38. (INT. CL. 16). REG. 1-25-1938.	832,339.	HEDLINER AND DESIGN. U.S. CL. 2. (INT. CL. 20). REG. 7-25-1967.
355,843.	THERMOTABS. U.S. CL. 6. (INT. CL. 5). REG. 4-5-1938.	832,356.	CHEMFOS. U.S. CL. 6. (INT. CL. 1). REG. 7-25-1967.
426,658.	BANTAM (STYLIZED). U.S. CL. 31. (INT. CL. 11). REG. 1-7-1947.	832,523.	PORTA-PLANT. U.S. CL. 32. (INT. CL. 20). REG. 7-25-1967.
426,781.	AEROJET. U.S. CL. 23. (INT. CL. 7). REG. 1-14-1947.	832,526.	ENVIRAMEDIC. U.S. CL. 34. (INT. CL. 11). REG. 7-25-1967.
426,990.	ARALEN. U.S. CL. 18. (INT. CL. 5). REG. 1-21-1947.	832,704.	HESS AND DESIGN. U.S. CL. 103. (INT. CLS. 37 AND 40). REG. 7-25-1967.
431,884.	TUINAL. U.S. CL. 18. (INT. CL. 5). REG. 8-12-1947.	832,705.	HESS AND DESIGN. U.S. CL. 103. (INT. CLS. 37 AND 40). REG. 7-25-1967.
433,594.	CLAIROXIDE. U.S. CL. 6. (INT. CL. 5). REG. 10-21-1947.	832,921.	TREND. U.S. CL. 36. (INT. CL. 9). REG. 8-1-1967.
438,846.	CHALLENGE AND DESIGN. U.S. CL. 23. (INT. CLS. 6, 7, 8, 9, 11, 12, 16, 21 AND 28). REG. 5-11-1948.	832,981.	LANVIN. U.S. CL. 39. (INT. CL. 25). REG. 8-1-1967.
639,242.	MARTIN SENOUR PAINTS AND DESIGN. U.S. CL. 16. (INT. CL. 2). REG. 1-1-1957.	833,021.	MASECA AND DESIGN. U.S. CL. 46. (INT. CL. 30). REG. 8-1-1967.
642,366.	SURF RIDER. U.S. CL. 39. (INT. CL. 25). REG. 3-5-1957.	833,431.	CAL-MARK. U.S. CL. 44. (INT. CL. 10). REG. 8-8-1967.
645,009.	WORCESTER (STYLIZED). U.S. CL. 13. (INT. CL. 6). REG. 5-7-1957.	833,650.	EBEL AND DESIGN. U.S. CL. 27. (INT. CL. 14). REG. 8-15-1967.
648,383.	ZIPS (STYLIZED). U.S. CL. 46. (INT. CL. 30). REG. 7-9-1957.	833,766.	MOL-MIX. U.S. CL. 46. (INT. CL. 31). REG. 8-15-1967.
648,536.	NESACAINE (STYLIZED). U.S. CL. 18. (INT. CL. 5). REG. 7-16-1957.	833,824.	BARNABY BEAR. U.S. CL. 107. (INT. CL. 41). REG. 8-15-1967.
648,585.	TOWMOTOR (STYLIZED). U.S. CL. 23. (INT. CL. 12). REG. 7-16-1957.	833,855.	GRILAMID. INT. CL. 1. (U.S. CL. 1). REG. 8-22-1967.
648,588.	SURFACE. U.S. CL. 26. (INT. CL. 9). REG. 7-16-1957.	834,728.	LIBBEY. U.S. CL. 33. (INT. CL. 21). REG. 9-5-1967.
649,459.	MISCELLANEOUS DESIGN. U.S. CL. 200. REG. 7-30-1957.	836,017.	FRIGITRONICS. U.S. CL. 44. (INT. CL. 10). REG. 9-26-1967.
649,561.	RUSTSOLVO (STYLIZED). U.S. CL. 15. (INT. CL. 4). REG. 8-6-1957.	839,490.	HOBIE AND DESIGN. U.S. CL. 22. (INT. CL. 28). REG. 11-28-1967.
650,065.	PSYCHRON (STYLIZED). U.S. CL. 26. (INT. CL. 9). REG. 8-13-1957.	839,847.	W WEST-O-MATIC AND DESIGN. U.S. CL. 12. (INT. CL. 19). REG. 12-5-1967.
650,224.	MISCELLANEOUS DESIGN. U.S. CL. 46. (INT. CL. 30). REG. 8-13-1957.	843,134.	H AND DESIGN. U.S. CL. 19. (INT. CL. 12). REG. 1-30-1968.
650,225.	KIKKOMAN. U.S. CL. 46. (INT. CL. 30). REG. 8-13-1957.	1,045,158.	AFS. U.S. CLS. 200, 102, 105 AND 107 ONLY. (INT. CLS. 36, 39 AND 41). REG. 7-27-1976.
650,651.	KIKKO MAN (STYLIZED). U.S. CL. 46. (INT. CL. 30). REG. 8-20-1957.	1,055,842.	TERRA. INT. CL. 1. (U.S. CL. 10). REG. 1-11-1977.
650,734.	CHLOROWAX 50. U.S. CL. 6. (INT. CL. 4). REG. 8-27-1957.	1,056,866.	LAWRENCE. INT. CL. 6. (U.S. CLS. 2, 12, 13, 14, 23, 25 AND 50). REG. 1-25-1977.
656,534.	REALIME. U.S. CL. 46. (INT. CLS. 29 AND 32). REG. 12-31-1957.	1,058,103.	LYMPHOPREP. INT. CL. 1. (U.S. CL. 6). REG. 2-8-1977.
656,553.	ENRICO'S. U.S. CL. 46. (INT. CLS. 29 AND 30). REG. 12-31-1957.	1,058,752.	EXEL INN (STYLIZED). INT. CL. 42. (U.S. CL. 100). REG. 2-8-1977.
		1,059,007.	DURAVANE. INT. CL. 7. (U.S. CL. 23). REG. 2-15-1977.
		1,062,017.	CLAIROL PROFESSIONAL. INT. CL. 3. (U.S. CL. 51). REG. 3-29-1977.
		1,064,193.	VULKALENT. INT. CL. 1. (U.S. CL. 6). REG. 4-26-1977.

- 1,066,884. BAKE WELL. INT. CL. 31. (U.S. CL. 46). REG. 5-31-1977.
- 1,067,263. BEKA. INT. CL. 26. (U.S. CLS. 37, 39, 40, 42 AND 50). REG. 6-7-1977.
- 1,067,512. KELCOLOID O. INT. CL. 1. (U.S. CL. 48). REG. 6-14-1977.
- 1,068,197. WORLD TEAM. INT. CL. 28. (U.S. CL. 22). REG. 6-21-1977.
- 1,068,731. STUDEBAKER DRIVERS CLUB. INT. CL. 42. (U.S. CL. 100). REG. 6-28-1977.
- 1,068,849. KEEPSAKE. INT. CL. 4. (U.S. CL. 15). REG. 7-5-1977.
- 1,068,879. STA-LOK. INT. CL. 6. (U.S. CLS. 2, 12, 13, 14, 23, 25 AND 50). REG. 7-5-1977.
- 1,069,460. SHIRAKIKU AND DESIGN. INT. CLS. 29 AND 30. (U.S. CL. 46). REG. 7-12-1977.
- 1,069,486. KENTUCKY DALE. INT. CL. 33. (U.S. CL. 49). REG. 7-12-1977.
- 1,069,523. BELTWAY. INT. CL. 39. (U.S. CL. 105). REG. 7-12-1977.
- 1,069,524. BELTWAY MOVERS BMA AND DESIGN. INT. CL. 39. (U.S. CL. 105). REG. 7-12-1977.
- 1,069,642. STARCH STAB (STYLIZED). INT. CL. 1. (U.S. CL. 6). REG. 7-19-1977.
- 1,069,802. HOBIE. INT. CL. 12. (U.S. CL. 19). REG. 7-19-1977.
- 1,069,977. SMITH & WESSON. INT. CL. 41. (U.S. CL. 107). REG. 7-19-1977.
- 1,070,049. PARALAC. INT. CL. 1. (U.S. CL. 5). REG. 7-26-1977.
- 1,070,250. PILLOW KINGDOM. INT. CLS. 20 AND 42 ONLY. (U.S. CLS. 2, 13, 22, 25, 32, 50 AND 101). REG. 7-26-1977.
- 1,070,467. BRADY. INT. CLS. 1, 6, 7, 8, 9, 16 AND 17. (U.S. CLS. 5, 6, 21, 23, 26, 34, 37, 38, 40 AND 50). REG. 8-2-1977.
- 1,070,498. BICKMORE. INT. CL. 5. (U.S. CL. 18). REG. 8-2-1977.
- 1,070,742. LAMBERTI. INT. CL. 33. (U.S. CL. 47). REG. 8-2-1977.
- 1,070,841. MARY KAY. INT. CL. 3. (U.S. CLS. 1, 4, 6, 50, 51 AND 52). REG. 8-9-1977.
- 1,071,078. STOCK-LIX. INT. CL. 31. (U.S. CL. 46). REG. 8-9-1977.
- 1,071,114. VISA. INT. CL. 36. (U.S. CL. 102). REG. 8-9-1977.
- 1,071,131. AVIS. INT. CL. 39. (U.S. CL. 105). REG. 8-9-1977.
- 1,071,246. PADLOCK. INT. CL. 3. (U.S. CL. 4). REG. 8-16-1977.
- 1,071,373. H (STYLIZED). INT. CLS. 12 AND 22. (U.S. CL. 19). REG. 8-16-1977.
- 1,071,396. JOSE RAMIREZ (STYLIZED). INT. CL. 15. (U.S. CL. 36). REG. 8-16-1977.
- 1,071,427. THE COLLEGE BOARD REVIEW. (STYLIZED). INT. CL. 16. (U.S. CL. 38). REG. 8-16-1977.
- 1,071,619. Q102. INT. CL. 38. (U.S. CL. 104). REG. 8-16-1977.
- 1,071,921. MISCELLANEOUS DESIGN. INT. CL. 33. (U.S. CL. 49). REG. 8-23-1977.
- 1,071,925. ROYAL CORREGIDOR. INT. CL. 33. (U.S. CL. 47). REG. 8-23-1977.
- 1,071,926. ROYAL AMBROSANTE. INT. CL. 33. (U.S. CL. 47). REG. 8-23-1977.
- 1,071,979. CINCINNATI BENGALS. INT. CL. 41. (U.S. CL. 107). REG. 8-23-1977.
- 1,072,112. ATRITA. INT. CL. 7. (U.S. CL. 23). REG. 8-30-1977.
- 1,073,147. DURA-PRO. INT. CLS. 17 AND 24. (U.S. CLS. 1 AND 2). REG. 9-13-1977.
- 1,073,472. FILTER FLO. INT. CL. 7. (U.S. CL. 23). REG. 9-20-1977.
- 1,073,794. SW AND DESIGN. INT. CL. 41. (U.S. CL. 107). REG. 9-20-1977.
- 1,073,913. PELICAN. INT. CL. 6. (U.S. CLS. 2, 12, 13, 14, 23, 25 AND 50). REG. 9-27-1977.
- 1,074,489. CONSERVA. INT. CL. 11. (U.S. CLS. 13, 21, 23, 31 AND 34). REG. 10-4-1977.
- 1,075,020. A + B (STYLIZED). INT. CL. 19. (U.S. CL. 12). REG. 10-11-1977.
- 1,075,094. WRANGLER (STYLIZED). INT. CL. 25. (U.S. CL. 39). REG. 10-11-1977.
- 1,076,540. MISCELLANEOUS DESIGN. INT. CL. 29. (U.S. CL. 46). REG. 11-1-1977.
- 1,076,583. CHEF'S BLEND. INT. CL. 31. (U.S. CL. 46). REG. 11-1-1977.
- 1,076,821. GAR-FIL. INT. CL. 7. (U.S. CL. 23). REG. 11-8-1977.
- 1,079,249. NO-NIK. INT. CL. 8. (U.S. CL. 23). REG. 12-13-1977.
- 1,080,168. FIORICET. INT. CL. 5. (U.S. CL. 18). REG. 12-27-1977.
- 1,080,646. RICO'S. INT. CL. 42. (U.S. CL. 100). REG. 12-27-1977.
- 1,082,012. CAT TECH. INT. CL. 37. (U.S. CL. 103). REG. 1-10-1978.
- 1,088,151. SOLAROLL AND DESIGN. INT. CL. 19. (U.S. CL. 12). REG. 3-28-1978.
- 1,092,487. S AND DESIGN. INT. CL. 36. (U.S. CL. 102). REG. 5-30-1978.
- 1,092,901. LOCATELLI. INT. CL. 29. (U.S. CL. 46). REG. 6-6-1978.
- 1,097,038. THE GAP AND DESIGN. INT. CL. 42. (U.S. CL. 101). REG. 7-18-1978.
- 1,286,155. HONG MEI AND DESIGN. INT. CLS. 29, 30, 32 AND 33. (U.S. CLS. 46, 47, 48 AND 49). REG. 7-17-1984.
- 1,327,677. BELL AND DESIGN. INT. CL. 38. (U.S. CLS. 100, 101 AND 104). REG. 7-30-1957.
- 1,335,485. MISCELLANEOUS DESIGN. INT. CL. 35 ONLY. (U.S. CLS. 100, 101 AND 102). REG. 5-14-1985.
- 1,368,479. VHT AND DESIGN. INT. CLS. 1, 2, 3, 4 AND 17. (U.S. CLS. 4, 5, 6, 15, 16 AND 52). REG. 11-5-1985.
- 1,375,506. RASTER. INT. CL. 7. (U.S. CL. 23). REG. 12-17-1985.
- 1,382,427. ACCESSORY STREET (STYLIZED). INT. CL. 25. (U.S. CL. 39). REG. 2-11-1986.
- 1,393,007. SOUNDFIELD. INT. CL. 9. (U.S. CL. 21). REG. 5-13-1986.
- 1,404,795. PACIFIC. INT. CL. 11. (U.S. CLS. 13, 31 AND 34). REG. 8-12-1986.
- 1,409,254. DELTANET. INT. CL. 9. (U.S. CL. 26). REG. 9-16-1986.
- 1,419,801. THX. INT. CLS. 9 AND 41. (U.S. CLS. 21, 100 AND 107). REG. 12-9-1986.
- 1,421,293. DI NOLA. INT. CL. 29. (U.S. CL. 46). REG. 12-16-1986.
- 1,421,775. MASTERPIECE. INT. CL. 9. (U.S. CL. 38). REG. 12-23-1986.
- 1,422,742. MIGHTY FLOW!. INT. CL. 12. (U.S. CLS. 19 AND 35). REG. 12-30-1986.
- 1,423,012. LEKI. INT. CL. 28. (U.S. CL. 22). REG. 12-30-1986.
- 1,423,670. INTRAGROUND. INT. CL. 9. (U.S. CL. 21). REG. 1-6-1987.
- 1,425,259. THE RED SNAPPER DURANGO, COLORADO AND DESIGN. INT. CL. 42. (U.S. CL. 100). REG. 1-13-1987.
- 1,425,441. BERGEMANN AND DESIGN. INT. CLS. 7 AND 9 ONLY. (U.S. CLS. 23 AND 26). REG. 1-20-1987.
- 1,426,047. ICOS. INT. CL. 42. (U.S. CLS. 100 AND 103). REG. 1-20-1987.
- 1,426,147. WINDSHIELD MAGIC. INT. CL. 1. (U.S. CL. 1). REG. 1-27-1987.
- 1,426,162. HIGH FASHION. INT. CL. 2. (U.S. CL. 11). REG. 1-27-1987.
- 1,426,460. LUMBOTRAIN. INT. CL. 10. (U.S. CL. 44). REG. 1-27-1987.
- 1,426,493. F AND DESIGN. INT. CL. 12. (U.S. CL. 19). REG. 1-27-1987.
- 1,426,953. ICOS AND DESIGN. INT. CL. 42. (U.S. CLS. 100 AND 103). REG. 1-27-1987.
- 1,427,417. SEE THE SOUNDS. INT. CL. 16. (U.S. CL. 38). REG. 2-3-1987.
- 1,427,633. RENT MOTHER NATURE. INT. CLS. 29, 30 AND 42. (U.S. CLS. 46, 100 AND 101). REG. 2-3-1987.
- 1,428,039. DIANIX. INT. CL. 2. (U.S. CL. 6). REG. 2-10-1987.
- 1,428,146. DYNACO. INT. CL. 9. (U.S. CL. 21). REG. 2-10-1987.
- 1,428,294. SUNCREST. INT. CL. 12. (U.S. CLS. 19 AND 35). REG. 2-10-1987.
- 1,428,526. ONE STEP UP. INT. CL. 25. (U.S. CL. 39). REG. 2-10-1987.
- 1,431,488. INVESTMENT HORIZONS. INT. CL. 36. (U.S. CL. 102). REG. 3-3-1987.
- 1,431,541. FORMULA SAE. INT. CL. 41. (U.S. CL. 107). REG. 3-3-1987.
- 1,431,684. FERRING. INT. CLS. 5 AND 10. (U.S. CLS. 18 AND 44). REG. 3-10-1987.
- 1,432,609. PENNSYLVANIA COOLER AND DESIGN. INT. CL. 1. (U.S. CL. 6). REG. 3-17-1987.
- 1,435,158. AUDIO EDITIONS. INT. CL. 42. (U.S. CL. 101). REG. 3-31-1987.

- 1,436,270. MISCELLANEOUS DESIGN. INT. CL. 9. (U.S. CLS. 21 AND 23). REG. 4-14-1987.
- 1,440,148. SNARE. INT. CL. 35. (U.S. CL. 101). REG. 5-19-1987.
- 1,441,199. EPHA. INT. CL. 17. (U.S. CL. 1). REG. 6-2-1987.
- 1,441,389. MUSTANG. INT. CL. 32. (U.S. CL. 48). REG. 6-2-1987.
- 1,442,825. LIZ CLAIBORNE. INT. CLS. 9, 18 AND 25 ONLY. (U.S. CLS. 1, 2, 3, 22, 26, 39 AND 41). REG. 6-16-1987.
- 1,442,940. CNS. INT. CL. 9. (U.S. CL. 21). REG. 6-16-1987.
- 1,443,517. S & H GREEN STAMPS SPERRY AND HUTCHINSON DISCOUNT FOR CASH VALUE 10 MILLS AND DESIGN. INT. CL. 35. (U.S. CL. 101). REG. 6-16-1987.
- 1,443,905. ENDOVISION. INT. CLS. 9 AND 10. (U.S. CLS. 26 AND 44). REG. 6-23-1987.
- 1,444,688. EN/ACT. INT. CL. 1. (U.S. CL. 6). REG. 6-30-1987.
- 1,444,840. FAVOR (STYLIZED). INT. CL. 5. (U.S. CL. 18). REG. 6-30-1987.
- 1,444,857. SUPER-X. INT. CL. 6. (U.S. CLS. 2, 12, 13, 14, 23, 25 AND 50). REG. 6-30-1987.
- 1,445,037. GA 3000. INT. CL. 11. (U.S. CL. 31). REG. 6-30-1987.
- 1,445,146. TENSAR AND DESIGN. INT. CLS. 17 AND 19. (U.S. CLS. 1, 12 AND 14). REG. 6-30-1987.
- 1,445,233. MOON TIDE. INT. CL. 25. (U.S. CLS. 22 AND 39). REG. 6-30-1987.
- 1,445,649. IMAGINEASIA. INT. CL. 41. (U.S. CL. 107). REG. 6-30-1987.
- 1,445,734. ABSORB-A-SPILL. INT. CL. 3. (U.S. CL. 52). REG. 6-30-1987.
- 1,445,762. DON. INT. CLS. 3, 4, 5, 7, 8, 9, 16, 20, 21, 22, 29, 32 AND 42 ONLY. (U.S. CLS. 1, 2, 4, 5, 6, 7, 13, 15, 18, 19, 21, 22, 23, 25, 26, 29, 30, 31, 32, 33, 34, 35, 37, 38, 40, 42, 44, 45, 46, 48, 50, 51, 52, 100 AND 101 ONLY). REG. 7-7-1987.
- 1,445,796. MACROLITE. INT. CL. 1. (U.S. CLS. 1 AND 6). REG. 7-7-1987.
- 1,445,800. SUPERCERA. INT. CL. 1. (U.S. CL. 6). REG. 7-7-1987.
- 1,445,858. VAN CLEEF & ARPELS. INT. CL. 3. (U.S. CLS. 1, 4, 6, 50, 51 AND 52). REG. 7-7-1987.
- 1,445,896. CAMOUFLAGE/COVER SPOT AND DESIGN. INT. CL. 5. (U.S. CLS. 18 AND 44). REG. 7-7-1987.
- 1,446,086. FIZZ. INT. CLS. 9 AND 11. (U.S. CLS. 21 AND 26). REG. 7-7-1987.
- 1,446,116. STEADYBAG. INT. CL. 9. (U.S. CL. 26). REG. 7-7-1987.
- 1,446,173. POLO. INT. CL. 9. (U.S. CL. 26). REG. 7-7-1987.
- 1,446,210. AUTOCYCLE. INT. CL. 10. (U.S. CL. 44). REG. 7-7-1987.
- 1,446,217. ENDORAY. INT. CL. 10. (U.S. CLS. 2 AND 44). REG. 7-7-1987.
- 1,446,237. BOEING. INT. CL. 11. (U.S. CL. 21). REG. 7-7-1987.
- 1,446,279. BEECHJET. INT. CL. 12. (U.S. CL. 19). REG. 7-7-1987.
- 1,446,281. STAR WIRE. INT. CL. 12. (U.S. CL. 19). REG. 7-7-1987.
- 1,446,336. MICROREF AND DESIGN. INT. CL. 16. (U.S. CL. 38). REG. 7-7-1987.
- 1,446,454. SCOOTER. INT. CL. 20. (U.S. CL. 32). REG. 7-7-1987.
- 1,446,455. BOEING. INT. CL. 20. (U.S. CLS. 2, 13, 22, 25, 32 AND 50). REG. 7-7-1987.
- 1,446,608. SHAMPOO CHEZ AND DESIGN. INT. CL. 42 ONLY. (U.S. CL. 100). REG. 7-7-1987.
- 1,447,073. 7-60. INT. CL. 5. (U.S. CLS. 18 AND 46). REG. 7-14-1987.
- 1,447,074. 4-80. INT. CL. 5. (U.S. CL. 46). REG. 7-14-1987.
- 1,447,113. CFAC. INT. CL. 6. (U.S. CL. 14). REG. 7-14-1987.
- 1,447,232. THRASHER. INT. CLS. 16 AND 25 ONLY. (U.S. CLS. 38, 39 AND 50). REG. 7-14-1987.
- 1,447,343. ESTILUZ AND DESIGN. INT. CL. 11. (U.S. CL. 21). REG. 7-14-1987.
- 1,447,730. FAR GREAT AND DESIGN. INT. CL. 28. (U.S. CL. 22). REG. 7-14-1987.
- 1,447,815. DAY 14. INT. CL. 31. (U.S. CL. 46). REG. 7-14-1987.
- 1,447,826. DOBLE URUGUAYA AND DESIGN. INT. CL. 32. (U.S. CL. 48). REG. 7-14-1987.
- 1,447,885. WORLD VISION. INT. CL. 36. (U.S. CLS. 100, 101 AND 102). REG. 7-14-1987.
- 1,447,899. APM AND DESIGN. INT. CL. 37. (U.S. CL. 103). REG. 7-14-1987.
- 1,447,938. MISCELLANEOUS DESIGN. INT. CL. 41. (U.S. CL. 107). REG. 7-14-1987.
- 1,447,957. EYE CARE FOR YOU!. INT. CL. 42. (U.S. CL. 100). REG. 7-14-1987.
- 1,448,028. VISCOMATIC. INT. CLS. 1, 7 AND 12. (U.S. CLS. 6, 19, 23 AND 35). REG. 7-21-1987.
- 1,448,044. VESTAMELT. INT. CL. 1. (U.S. CL. 5). REG. 7-21-1987.
- 1,448,128. VELCON. INT. CLS. 6, 7, 9, 17 AND 42. (U.S. CLS. 13, 23, 26, 31, 35, 100 AND 103). REG. 7-21-1987.
- 1,448,140. MECHLOK. INT. CL. 6. (U.S. CL. 25). REG. 7-21-1987.
- 1,448,165. CASCADE SYSTEM. INT. CL. 7. (U.S. CL. 23). REG. 7-21-1987.
- 1,448,317. GSDL. INT. CL. 9. (U.S. CL. 38). REG. 7-21-1987.
- 1,448,335. SCAVENGER. INT. CL. 11. (U.S. CLS. 23 AND 31). REG. 7-21-1987.
- 1,448,338. NICOTRA. INT. CL. 11. (U.S. CL. 34). REG. 7-21-1987.
- 1,448,350. GENERAL ELECTRIC. INT. CL. 11. (U.S. CLS. 21, 31 AND 34). REG. 7-21-1987.
- 1,448,405. BILLY BOB'S TEXAS AND DESIGN. INT. CLS. 16, 21 AND 25. (U.S. CLS. 2, 5, 22, 23, 29, 30, 33, 37, 38, 39 AND 50). REG. 7-21-1987.
- 1,448,523. FLEXCRETE. INT. CL. 19. (U.S. CL. 12). REG. 7-21-1987.
- 1,448,542. RISE AND SHINE. INT. CL. 20. (U.S. CL. 32). REG. 7-21-1987.
- 1,448,761. PRIME REEF. INT. CL. 31. (U.S. CLS. 1 AND 46). REG. 7-21-1987.
- 1,448,787. DEPLINK. INT. CL. 35. (U.S. CL. 101). REG. 7-21-1987.
- 1,448,791. ORGANIZATIONS UNLIMITED. INT. CL. 35. (U.S. CL. 101). REG. 7-21-1987.
- 1,448,979. YMCA OF THE USA. INT. CL. 42. (U.S. CL. 107). REG. 7-21-1987.
- 1,449,032. MISCELLANEOUS DESIGN. INT. CL. 42. (U.S. CL. 101). REG. 7-21-1987.
- 1,449,075. YMCA OF THE USA. U.S. CL. 200. REG. 7-21-1987.
- 1,449,095. POPS (STYLIZED). INT. CL. 30. (U.S. CL. 46). REG. 7-21-1987.
- 1,449,099. THE PROTECTOR AND DESIGN. INT. CLS. 1, 2 AND 3. (U.S. CL. 6). REG. 7-28-1987.
- 1,449,113. ARBORCHEM. INT. CLS. 1 AND 8. (U.S. CLS. 6 AND 23). REG. 7-28-1987.
- 1,449,137. COPPER-BOND (STYLIZED). INT. CL. 1. (U.S. CL. 5). REG. 7-28-1987.
- 1,449,146. PITT-FLEX. INT. CL. 2. (U.S. CL. 16). REG. 7-28-1987.
- 1,449,160. EVENTONE. INT. CL. 3. (U.S. CL. 51). REG. 7-28-1987.
- 1,449,167. LAVILIN. INT. CL. 3. (U.S. CL. 51). REG. 7-28-1987.
- 1,449,246. SIDERCA. INT. CL. 6. (U.S. CL. 13). REG. 7-28-1987.
- 1,449,355. HOTSET (STYLIZED). INT. CLS. 9 AND 11. (U.S. CLS. 26 AND 34). REG. 7-28-1987.
- 1,449,397. FLYTECH AND DESIGN. INT. CL. 9. (U.S. CLS. 21 AND 26). REG. 7-28-1987.
- 1,449,497. PIPELLE (STYLIZED). INT. CL. 10. (U.S. CL. 44). REG. 7-28-1987.
- 1,449,579. MISCELLANEOUS DESIGN. INT. CL. 14. (U.S. CLS. 27 AND 28). REG. 7-28-1987.
- 1,449,722. BLOCKHOUSE. INT. CL. 20. (U.S. CL. 32). REG. 7-28-1987.
- 1,449,862. ROLLERCOASTER. INT. CL. 28. (U.S. CL. 22). REG. 7-28-1987.
- 1,449,909. MISCELLANEOUS DESIGN. INT. CL. 29. (U.S. CL. 46). REG. 7-28-1987.
- 1,449,922. MARTA. INT. CL. 29. (U.S. CL. 46). REG. 7-28-1987.
- 1,449,945. PUNTINI. INT. CL. 30. (U.S. CL. 46). REG. 7-28-1987.
- 1,450,139. APPLEWOODS. INT. CL. 42. (U.S. CL. 100). REG. 7-28-1987.
- 1,450,161. THE CRANIAL ACADEMY. U.S. CL. 200. REG. 7-28-1987.
- 1,450,218. MAGMA FIBER. INT. CL. 1. (U.S. CL. 6). REG. 8-4-1987.
- 1,450,231. ULTRA BRAND. INT. CL. 1. (U.S. CL. 6). REG. 8-4-1987.
- 1,450,298. NATURE-GLO. INT. CL. 4. (U.S. CLS. 1 AND 15). REG. 8-4-1987.
- 1,450,333. COOPER AND DESIGN. INT. CL. 6. (U.S. CL. 13). REG. 8-4-1987.

- 1,450,349. NITANIUM. INT. CLS. 6 AND 10. (U.S. CLS. 14 AND 44). REG. 8-4-1987.
- 1,450,434. EXL. INT. CLS. 9 AND 11. (U.S. CLS. 13 AND 21). REG. 8-4-1987.
- 1,450,467. TESTOTERM. INT. CL. 9. (U.S. CL. 26). REG. 8-4-1987.
- 1,450,484. CLARITY. INT. CL. 9. (U.S. CL. 21). REG. 8-4-1987.
- 1,450,618. FLUSHMATE. INT. CL. 11. (U.S. CL. 13). REG. 8-4-1987.
- 1,450,625. NSA (STYLIZED). INT. CL. 11. (U.S. CL. 31). REG. 8-4-1987.
- 1,450,681. NA AND DESIGN. INT. CLS. 16, 20, 25 AND 42. (U.S. CLS. 13, 38, 39 AND 100). REG. 8-4-1987.
- 1,450,698. MAGNUM. INT. CL. 16. (U.S. CLS. 23, 31 AND 50). REG. 8-4-1987.
- 1,450,719. THE LIFE BUILDER. INT. CL. 16. (U.S. CLS. 36 AND 38). REG. 8-4-1987.
- 1,450,823. SECUR-HASP II. INT. CL. 20. (U.S. CL. 50). REG. 8-4-1987.
- 1,450,940. MISCELLANEOUS DESIGN. INT. CL. 25. (U.S. CL. 39). REG. 8-4-1987.
- 1,451,064. SINATRA'S TOP OF THE LINE AND DESIGN. INT. CL. 29. (U.S. CL. 46). REG. 8-4-1987.
- 1,451,110. DOLE AND DESIGN. INT. CL. 30. (U.S. CL. 46). REG. 8-4-1987.
- 1,451,140. MISCELLANEOUS DESIGN. INT. CL. 30. (U.S. CL. 46). REG. 8-4-1987.
- 1,451,333. NOBODY COVERS YOU BETTER. INT. CL. 37. (U.S. CL. 103). REG. 8-4-1987.
- 1,451,337. F E. INT. CL. 37. (U.S. CL. 103). REG. 8-4-1987.
- 1,451,369. PEIRONE. INT. CL. 39. (U.S. CL. 105). REG. 8-4-1987.
- 1,451,409. FMA. INT. CL. 41. (U.S. CL. 107). REG. 8-4-1987.
- 1,451,415. IDEA. INT. CL. 41. (U.S. CLS. 100 AND 107). REG. 8-4-1987.
- 1,451,516. 2ND AVE DELI. INT. CL. 42. (U.S. CL. 100). REG. 8-4-1987.
- 1,451,517. 2ND AVE DELI (STYLIZED). INT. CL. 42. (U.S. CL. 100). REG. 8-4-1987.
- 1,451,650. HYDRO-CLIMAT ORLANE. INT. CL. 3. (U.S. CLS. 1, 4, 6, 50, 51 AND 52). REG. 8-11-1987.
- 1,451,827. TECHCRAFT. INT. CL. 9. (U.S. CLS. 21, 23, 26, 36 AND 38). REG. 8-11-1987.
- 1,451,914. BUFFALO. INT. CL. 9. (U.S. CLS. 26 AND 38). REG. 8-11-1987.
- 1,451,930. GLORY. INT. CL. 9. (U.S. CL. 26). REG. 8-11-1987.
- 1,451,959. SCHAU INS LAND. INT. CL. 9. (U.S. CLS. 36 AND 38). REG. 8-11-1987.
- 1,451,996. TORQ-FLEX. INT. CL. 10. (U.S. CL. 44). REG. 8-11-1987.
- 1,452,144. NOMASTYL. INT. CL. 19. (U.S. CL. 12). REG. 8-11-1987.
- 1,452,187. ACADEMY. INT. CL. 20. (U.S. CL. 32). REG. 8-11-1987.
- 1,452,309. HAWG BOSS. INT. CL. 28. (U.S. CL. 22). REG. 8-11-1987.
- 1,452,395. KIKKOMAN. INT. CL. 30. (U.S. CL. 46). REG. 8-11-1987.
- 1,452,407. CHEW-ETS. INT. CL. 30. (U.S. CL. 46). REG. 8-11-1987.
- 1,452,431. ROPITEAU. INT. CL. 33. (U.S. CLS. 47 AND 49). REG. 8-11-1987.
- 1,452,434. LEON PALAIS (STYLIZED). INT. CL. 33. (U.S. CLS. 47 AND 49). REG. 8-11-1987.
- 1,452,719. FLAME GARD. INT. CL. 1. (U.S. CL. 6). REG. 8-18-1987.
- 1,452,772. EFFAX (STYLIZED). INT. CL. 3. (U.S. CLS. 4, 6 AND 52). REG. 8-18-1987.
- 1,452,779. BELAMI (STYLIZED). INT. CL. 3. (U.S. CLS. 1, 4, 6, 50, 51 AND 52). REG. 8-18-1987.
- 1,452,852. ROSS. INT. CLS. 5 AND 10. (U.S. CLS. 18 AND 44). REG. 8-18-1987.
- 1,453,391. PENNYSTICKS (STYLIZED). INT. CL. 30. (U.S. CL. 46). REG. 8-18-1987.
- 1,453,462. THE JURAN TRILOGY. INT. CL. 35. (U.S. CL. 101). REG. 8-18-1987.
- 1,453,538. FE AND DESIGN. INT. CL. 37. (U.S. CL. 103). REG. 8-18-1987.
- 1,453,574. DIAMONTOLOGY. INT. CL. 41. (U.S. CL. 107). REG. 8-18-1987.
- 1,453,591. THE COMPLETE NEGOTIATOR. INT. CL. 41. (U.S. CL. 107). REG. 8-18-1987.
- 1,453,752. PROTEx. INT. CL. 1. (U.S. CLS. 6 AND 15). REG. 8-25-1987.
- 1,453,964. ULTRATAGGER. INT. CL. 8. (U.S. CL. 23). REG. 8-25-1987.
- 1,454,052. ACCEPTOR. INT. CL. 9. (U.S. CL. 21). REG. 8-25-1987.
- 1,454,651. TURN YOUR HEART TOWARD HOME. INT. CLS. 41 AND 42. (U.S. CLS. 100, 101 AND 107). REG. 8-25-1987.
- 1,454,709. ORIGINAL CRISPY PIZZA CRUST CO. OF BOSTON, INC.. INT. CL. 42. (U.S. CL. 101). REG. 8-25-1987.
- 1,454,736. ACQUASUS. INT. CL. 42. (U.S. CL. 100). REG. 8-25-1987.
- 1,454,791. PEANUT MAKER. INT. CL. 1. (U.S. CL. 10). REG. 9-1-1987.
- 1,454,827. ALBERTO. INT. CL. 3. (U.S. CL. 51). REG. 9-1-1987.
- 1,455,030. MISCELLANEOUS DESIGN. INT. CL. 9. (U.S. CL. 26). REG. 9-1-1987.
- 1,455,173. GENMAR. INT. CL. 12. (U.S. CL. 19). REG. 9-1-1987.
- 1,455,422. CHINA CLUB. INT. CL. 25. (U.S. CL. 39). REG. 9-1-1987.
- 1,455,741. BABY SAFE AND DESIGN. INT. CL. 37. (U.S. CL. 103). REG. 9-1-1987.
- 1,455,887. DANSERGIA. INT. CL. 42. (U.S. CL. 100). REG. 9-1-1987.
- 1,456,091. FRIALEN. INT. CLS. 9 AND 17 ONLY. (U.S. CLS. 12 AND 26). REG. 9-8-1987.
- 1,456,111. P. L. PORTER CO.. INT. CL. 6. (U.S. CL. 25). REG. 9-8-1987.
- 1,456,113. PLP AND DESIGN. INT. CL. 6. (U.S. CL. 25). REG. 9-8-1987.
- 1,456,171. TECHNIVORM. INT. CL. 7. (U.S. CL. 23). REG. 9-8-1987.
- 1,456,496. ODYSSEY. INT. CL. 16. (U.S. CL. 38). REG. 9-8-1987.
- 1,456,590. CERVELLE. INT. CL. 25. (U.S. CL. 39). REG. 9-8-1987.
- 1,456,816. SCU (STYLIZED). INT. CL. 36. (U.S. CL. 102). REG. 9-8-1987.
- 1,456,909. ORGANETICS. INT. CL. 41. (U.S. CLS. 100 AND 107). REG. 9-8-1987.
- 1,456,988. IL TEATRO ENERGETICO. INT. CL. 42. (U.S. CL. 100). REG. 9-8-1987.
- 1,457,239. TOXI-RACK. INT. CL. 9. (U.S. CL. 26). REG. 9-15-1987.
- 1,457,891. WEGMANS (STYLIZED). INT. CLS. 3, 5, 29, 30, 31 AND 32 ONLY. (U.S. CLS. 1, 29, 44, 45, 46 AND 52). REG. 9-22-1987.
- 1,457,990. TOKIN. INT. CLS. 6 AND 9 ONLY. (U.S. CLS. 13, 21 AND 26). REG. 9-22-1987.
- 1,458,037. TITRALAB. INT. CL. 9. (U.S. CL. 26). REG. 9-22-1987.
- 1,458,103. HUBBELL JUNIORS. INT. CL. 9. (U.S. CL. 21). REG. 9-22-1987.
- 1,458,213. MISCELLANEOUS DESIGN. INT. CL. 11. (U.S. CL. 34). REG. 9-22-1987.
- 1,458,228. PROGRESS AND DESIGN. INT. CL. 11. (U.S. CLS. 21 AND 34). REG. 9-22-1987.
- 1,458,983. ELUMATEC AND DESIGN. INT. CL. 7. (U.S. CL. 23). REG. 9-29-1987.
- 1,459,247. NECK MATE. INT. CL. 20. (U.S. CL. 32). REG. 9-29-1987.
- 1,460,324. GREGORY "THE SERVICE THAT CARES" AND DESIGN. INT. CL. 37. (U.S. CL. 103). REG. 10-6-1987.
- 1,460,946. ERIE AND DESIGN. INT. CL. 21. (U.S. CL. 29). REG. 10-13-1987.
- 1,461,406. MOOSEWOOD RESTAURANT. INT. CL. 42. (U.S. CL. 100). REG. 10-13-1987.
- 1,461,536. DRANO. INT. CL. 1. (U.S. CL. 6). REG. 10-20-1987.
- 1,461,671. ESCO AND DESIGN. INT. CL. 7. (U.S. CL. 23). REG. 10-20-1987.
- 1,461,848. OPTIMOUNT. INT. CL. 16. (U.S. CL. 37). REG. 10-20-1987.
- 1,461,996. EBELLE (STYLIZED). INT. CL. 25. (U.S. CL. 39). REG. 10-20-1987.
- 1,462,221. INSOUTH (STYLIZED). INT. CL. 36. (U.S. CL. 102). REG. 10-20-1987.
- 1,465,180. CONTINENTAL. INT. CLS. 8, 12, 20 AND 21. (U.S. CLS. 2, 13, 19, 23, 29 AND 32). REG. 11-17-1987.
- 1,466,330. JAYCEES MAGAZINE. INT. CL. 16. (U.S. CL. 38). REG. 11-24-1987.
- 1,466,396. HONEY GRIP. INT. CL. 25. (U.S. CL. 39). REG. 11-24-1987.

- 1,466,404. OCCHIVERDI (STYLIZED). INT. CL. 25. (U.S. CL. 39). REG. 11-24-1987.
- 1,466,651. GUS MACKER. INT. CL. 41. (U.S. CL. 107). REG. 11-24-1987.
- 1,466,791. INFECTION CONTROL REPORT. INT. CL. 16. (U.S. CL. 38). REG. 11-24-1987.
- 1,467,128. * MEG AND DESIGN. INT. CL. 9. (U.S. CL. 26). REG. 12-1-1987.
- 1,467,394. AQUANET (STYLIZED). INT. CL. 22. (U.S. CL. 7). REG. 12-1-1987.
- 1,467,439. BARRY BRICKEN. INT. CL. 25. (U.S. CL. 39). REG. 12-1-1987.
- 1,467,470. PRIORITY MALE. INT. CL. 25. (U.S. CL. 39). REG. 12-1-1987.
- 1,467,924. SUVAXYN. INT. CL. 5. (U.S. CL. 18). REG. 12-8-1987.
- 1,468,012. ODAWARA. INT. CL. 7. (U.S. CL. 23). REG. 12-8-1987.
- 1,468,578. DESERT BRAVE. INT. CL. 31. (U.S. CL. 46). REG. 12-8-1987.
- 1,468,814. STREAMLINE. INT. CL. 7. (U.S. CL. 23). REG. 12-15-1987.
- 1,468,878. VAN DIJCK. INT. CL. 9. (U.S. CLS. 21 AND 26). REG. 12-15-1987.
- 1,469,514. CRATE&BARREL (STYLIZED). INT. CL. 42. (U.S. CL. 101). REG. 12-15-1987.
- 1,469,515. CRATE AND BARREL. INT. CL. 42. (U.S. CL. 101). REG. 12-15-1987.
- 1,469,557. MISCELLANEOUS DESIGN. INT. CL. 9. (U.S. CL. 23). REG. 12-15-1987.
- 1,470,004. CAPITAL ADVANTAGE. INT. CL. 36. (U.S. CL. 102). REG. 12-22-1987.
- 1,470,222. WORLD CLASS CHILI. INT. CL. 42. (U.S. CL. 100). REG. 12-22-1987.
- 1,470,429. FLO-PACKER (STYLIZED). INT. CL. 7. (U.S. CL. 23). REG. 12-29-1987.
- 1,470,447. OLSON. INT. CLS. 7 AND 8. (U.S. CL. 23). REG. 12-29-1987.
- 1,470,715. ECU. INT. CLS. 25 AND 41. (U.S. CLS. 39 AND 107). REG. 12-29-1987.
- 1,470,919. CAR GUARD AND DESIGN. INT. CL. 36. (U.S. CL. 102). REG. 12-29-1987.
- 1,471,161. PROTECTION PLUS. INT. CL. 5. (U.S. CL. 44). REG. 1-5-1988.
- 1,471,482. YAZOO. INT. CL. 25. (U.S. CL. 39). REG. 1-5-1988.
- 1,471,690. TRAILER TRANSIT INC. A SPECIALIZED CARRIER AND DESIGN. INT. CL. 39. (U.S. CL. 105). REG. 1-5-1988.
- 1,471,791. MONITOR/IMPACT. INT. CL. 9. (U.S. CL. 26). REG. 1-5-1988.
- 1,471,925. SNOWDEN-PENCER (STYLIZED). INT. CL. 10 ONLY. (U.S. CL. 44). REG. 1-12-1988.
- 1,473,140. TMEH (STYLIZED). INT. CL. 16. (U.S. CL. 38). REG. 1-19-1988.
- 1,473,855. BOSISTO'S PARROT BRAND AND DESIGN. INT. CL. 5. (U.S. CL. 18). REG. 1-26-1988.
- 1,474,356. ROGELIO BUENO (STYLIZED). INT. CL. 30. (U.S. CL. 46). REG. 1-26-1988.
- 1,474,602. TRAVELODGE. INT. CL. 42. (U.S. CL. 100). REG. 1-26-1988.
- 1,475,433. THE LIGHTFOOT PLANNING GROUP AND DESIGN. INT. CL. 42. (U.S. CLS. 100, 102 AND 103). REG. 2-2-1988.
- 1,475,666. FEREX. INT. CL. 9. (U.S. CL. 26). REG. 2-9-1988.
- 1,475,883. AMERICAN ASSOCIATION OF INDIVIDUAL INVESTORS. INT. CL. 16. (U.S. CL. 38). REG. 2-9-1988.
- 1,475,976. PINKY. INT. CL. 25. (U.S. CL. 39). REG. 2-9-1988.
- 1,476,692. MISCELLANEOUS DESIGN. INT. CL. 9. (U.S. CL. 21). REG. 2-16-1988.
- 1,477,761. ALAN LEBOW. INT. CL. 25. (U.S. CL. 39). REG. 2-23-1988.
- 1,478,275. MICROTUFF. INT. CL. 6. (U.S. CL. 14). REG. 3-1-1988.
- 1,481,897. PRU-MATIC. INT. CL. 36. (U.S. CLS. 100, 101 AND 102). REG. 3-22-1988.
- 1,483,038. TESTANDRAIN. INT. CL. 6. (U.S. CL. 13). REG. 4-5-1988.
- 1,483,498. STACK-ALL. INT. CL. 21. (U.S. CLS. 2 AND 13). REG. 4-5-1988.
- 1,483,571. SWEET POTATOES. INT. CL. 25. (U.S. CL. 39). REG. 4-5-1988.
- 1,484,218. CHARVEL BY JACKSON/CHARVEL AND DESIGN. INT. CL. 15. (U.S. CL. 36). REG. 4-12-1988.
- 1,484,314. HI-LO. INT. CL. 21. (U.S. CL. 29). REG. 4-12-1988.
- 1,485,282. FIVE STAR STRUCTURAL CONCRETE. INT. CL. 19. (U.S. CL. 12). REG. 4-19-1988.
- 1,487,908. EVA OF NEW YORK (STYLIZED). INT. CL. 42. (U.S. CL. 100). REG. 5-10-1988.
- 1,489,209. MINI-GAS. INT. CL. 11. (U.S. CL. 34). REG. 5-24-1988.
- 1,489,883. MISCELLANEOUS DESIGN. INT. CL. 7. (U.S. CL. 23). REG. 5-31-1988.
- 1,492,446. SUPERIOR FARMS AND DESIGN. INT. CL. 29. (U.S. CL. 46). REG. 6-14-1988.
- 1,493,377. KRACKEL AND DESIGN. INT. CL. 30. (U.S. CL. 46). REG. 6-21-1988.
- 1,493,378. MR. GOODBAR AND DESIGN. INT. CL. 30. (U.S. CL. 46). REG. 6-21-1988.
- 1,493,855. INSUL-VAPOR. INT. CL. 6. (U.S. CL. 12). REG. 6-28-1988.
- 1,494,082. ACCUMIX R. INT. CL. 9. (U.S. CL. 26). REG. 6-28-1988.
- 1,494,446. BOSTON. INT. CL. 33. (U.S. CL. 49). REG. 6-28-1988.
- 1,495,603. PHOS-LO. INT. CL. 5. (U.S. CL. 18). REG. 7-12-1988.
- 1,496,525. LIPOTRIAD. INT. CL. 5. (U.S. CL. 18). REG. 7-19-1988.
- 1,497,765. SAV-A-FLOOR. INT. CL. 20. (U.S. CL. 32). REG. 7-26-1988.
- 1,599,448. E-A-R TONE. INT. CL. 10. (U.S. CLS. 26, 39 AND 44). REG. 6-5-1990.
- 1,933,337. REGENERON. INT. CL. 5. (U.S. CLS. 6, 18, 44, 46, 51 AND 52). REG. 11-7-1995.
- 1,941,410. MAINTAINIT. INT. CL. 9. (U.S. CLS. 21, 23, 26, 36 AND 38). REG. 12-12-1995.
- 1,971,168. EMACK & BOLIO'S ICE CREAM AND YOGURT FOR THE CONNOISSEUR. INT. CL. 30. (U.S. CL. 46). REG. 4-30-1996.
- 1,983,200. EURO RSCG. INT. CLS. 35, 38 AND 41 ONLY. (U.S. CLS. 100, 101, 104 AND 107). REG. 7-2-1996.
- 1,993,507. BIG BOB'S NEW & USED CARPET AND DESIGN. INT. CLS. 35 AND 42. (U.S. CLS. 100, 101 AND 102). REG. 8-13-1996.
- 1,997,527. PROTECHTOR. INT. CL. 9. (U.S. CLS. 21, 23, 26, 36 AND 38). REG. 8-27-1996.
- 2,003,569. HYDRA-RAM UNLTD. INT. CL. 8. (U.S. CLS. 23, 28 AND 44). REG. 9-24-1996.
- 2,003,838. ALTERA. INT. CL. 17. (U.S. CLS. 1 AND 12). REG. 10-1-1996.
- 2,007,214. READYCHEK. INT. CL. 36. (U.S. CLS. 100, 101 AND 102). REG. 10-8-1996.
- 2,007,882. CAREERSITE. INT. CL. 35. (U.S. CLS. 100, 101 AND 102). REG. 10-15-1996.
- 2,011,750. BIG BOB'S CARPET CLEANING COMPANY AND DESIGN. INT. CL. 37. (U.S. CLS. 100, 103 AND 106). REG. 10-29-1996.
- 2,016,615. EAGLE HARDWARE & GARDEN AND DESIGN. INT. CL. 42. (U.S. CL. 101). REG. 11-19-1996.
- 2,021,546. HURRICLON. INT. CL. 7 ONLY. (U.S. CL. 23). REG. 12-10-1996.
- 2,025,005. IT WORKS. INT. CL. 35. (U.S. CLS. 100, 101 AND 102). REG. 12-24-1996.
- 2,026,574. SRAD. INT. CL. 12. (U.S. CLS. 19, 21, 23, 31, 35 AND 44). REG. 12-31-1996.
- 2,026,850. DIRECTED PERCEPTION AND DESIGN. INT. CL. 9. (U.S. CLS. 21, 23, 26, 36 AND 38). REG. 12-31-1996.
- 2,027,460. UNIVAULT AND DESIGN. INT. CL. 22. (U.S. CLS. 1, 2, 7, 19, 22, 42 AND 50). REG. 12-31-1996.
- 2,027,976. THE FEMALE CONTRACEPTIVE YOU CAN'T FEEL!. INT. CL. 5. (U.S. CLS. 6, 18, 44, 46, 51 AND 52). REG. 12-31-1996.
- 2,028,607. MISCELLANEOUS DESIGN. INT. CL. 30. (U.S. CL. 46). REG. 1-7-1997.
- 2,029,413. HAKIM. INT. CL. 10. (U.S. CLS. 26, 39 AND 44). REG. 1-14-1997.
- 2,029,629. HR CERTIFICATION INSTITUTE SOCIETY FOR HUMAN RESOURCE MANAGEMENT AND DESIGN. INT. CL. 16. (U.S. CLS. 2, 5, 22, 23, 29, 37, 38 AND 50). REG. 1-14-1997.
- 2,030,097. IVL. INT. CLS. 9 AND 15. (U.S. CLS. 2, 21, 23, 26, 36 AND 38). REG. 1-14-1997.
- 2,030,107. HEALTHMAPS. INT. CLS. 9 AND 16. (U.S. CLS. 2, 5, 21, 22, 23, 26, 29, 36, 37, 38 AND 50). REG. 1-14-1997.
- 2,030,122. NATURE'S BEST. INT. CL. 16. (U.S. CLS. 2, 5, 22, 23, 29, 37, 38 AND 50). REG. 1-14-1997.

- 2,030,964. SKIN TIGHT. INT. CL. 3. (U.S. CLS. 1, 4, 6, 50, 51 AND 52). REG. 1-14-1997.
- 2,031,691. ECA. INT. CL. 16. (U.S. CLS. 2, 5, 22, 23, 29, 37, 38 AND 50). REG. 1-21-1997.
- 2,032,346. MAN HOOD. INT. CL. 10. (U.S. CLS. 26, 39 AND 44). REG. 1-21-1997.
- 2,032,630. VMC. INT. CL. 25. (U.S. CLS. 22 AND 39). REG. 1-21-1997.
- 2,032,974. NY APPEAL. INT. CL. 25. (U.S. CLS. 22 AND 39). REG. 1-21-1997.
- 2,033,552. MAIL-A-MEADOW. INT. CL. 16. (U.S. CLS. 2, 5, 22, 23, 29, 37, 38 AND 50). REG. 1-28-1997.
- 2,033,593. STOCK (STYLIZED). INT. CL. 7. (U.S. CLS. 13, 19, 21, 23, 31, 34 AND 35). REG. 1-28-1997.
- 2,033,670. OUTDOOR ADVENTURES AND DESIGN. INT. CL. 18. (U.S. CLS. 1, 2, 3, 22 AND 41). REG. 1-28-1997.
- 2,033,818. YOUNG AT HEART WHERE LIFE BEGINS AT 60 AND DESIGN. INT. CL. 42. (U.S. CLS. 100 AND 101). REG. 1-28-1997.
- 2,034,090. AIRONET. INT. CL. 9. (U.S. CLS. 21, 23, 26, 36 AND 38). REG. 1-28-1997.
- 2,034,113. TOPIX. INT. CLS. 3 AND 5. (U.S. CLS. 1, 4, 6, 18, 44, 46, 50, 51 AND 52). REG. 1-28-1997.
- 2,034,507. NUQUEST. INT. CL. 9. (U.S. CLS. 21, 23, 26, 36 AND 38). REG. 1-28-1997.
- 2,034,742. MCM AND DESIGN. INT. CL. 9. (U.S. CLS. 21, 23, 26, 36 AND 38). REG. 2-4-1997.
- 2,034,743. MCM AND DESIGN. INT. CL. 18. (U.S. CLS. 1, 2, 3, 22 AND 41). REG. 2-4-1997.
- 2,034,744. MCM AND DESIGN. INT. CL. 25. (U.S. CLS. 22 AND 39). REG. 2-4-1997.
- 2,034,916. POWER METAL. INT. CL. 14. (U.S. CLS. 2, 27, 28 AND 50). REG. 2-4-1997.
- 2,034,980. ZUKO (STYLIZED). INT. CL. 32. (U.S. CLS. 45, 46 AND 48). REG. 2-4-1997.
- 2,035,257. MAN TALK. INT. CL. 41. (U.S. CLS. 100, 101 AND 107). REG. 2-4-1997.
- 2,035,273. NEW YORK SUPER FUDGE CHUNK. INT. CL. 30. (U.S. CL. 46). REG. 2-4-1997.
- 2,035,461. ACUPRESS. INT. CL. 5. (U.S. CLS. 6, 18, 44, 46, 51 AND 52). REG. 2-4-1997.
- 2,035,998. TTS. INT. CLS. 9 AND 16. (U.S. CLS. 2, 5, 21, 22, 23, 26, 29, 36, 37, 38 AND 50). REG. 2-4-1997.
- 2,036,090. MEDALIST. INT. CL. 20. (U.S. CLS. 2, 13, 22, 25, 32 AND 50). REG. 2-4-1997.
- 2,036,091. CONTESTANT. INT. CL. 20. (U.S. CLS. 2, 13, 22, 25, 32 AND 50). REG. 2-4-1997.
- 2,036,166. KSA COLLECTIBLES AND DESIGN. INT. CL. 28. (U.S. CLS. 22, 23, 38 AND 50). REG. 2-4-1997.
- 2,037,888. DATATIPS. INT. CL. 9. (U.S. CLS. 21, 23, 26, 36 AND 38). REG. 2-11-1997.
- 2,038,268. READYPRICE. INT. CL. 9. (U.S. CLS. 21, 23, 26, 36 AND 38). REG. 2-18-1997.
- 2,038,273. BUNGIE. INT. CLS. 9 AND 28. (U.S. CLS. 21, 22, 23, 26, 36, 38 AND 50). REG. 2-18-1997.
- 2,040,002. NORTHERN MICHIGAN UNIVERSITY. INT. CLS. 16, 25 AND 41. (U.S. CLS. 2, 5, 22, 23, 29, 37, 38, 39, 50, 100, 101 AND 107). REG. 2-25-1997.
- 2,041,765. CLEVER CATCH. INT. CLS. 16 AND 28. (U.S. CLS. 2, 5, 22, 23, 29, 37, 38 AND 50). REG. 3-4-1997.
- 2,042,819. R. C. GORMAN. INT. CL. 16. (U.S. CLS. 2, 5, 22, 23, 29, 37, 38 AND 50). REG. 3-11-1997.
- 2,044,117. DICKIE SPIELZEUG AND DESIGN. INT. CL. 28. (U.S. CLS. 22, 23, 38 AND 50). REG. 3-11-1997.
- 2,045,130. BLACK HOLE. INT. CL. 28. (U.S. CLS. 22, 23, 38 AND 50). REG. 3-11-1997.
- 2,047,049. ACTIVE. INT. CLS. 1 AND 5. (U.S. CLS. 1, 5, 6, 10, 18, 26, 44, 46, 51 AND 52). REG. 3-25-1997.
- 2,048,202. ZEPHYR. INT. CL. 35. (U.S. CLS. 100, 101 AND 102). REG. 3-25-1997.
- 2,049,734. ANCHOR BAY ENTERTAINMENT AND DESIGN. INT. CL. 42. (U.S. CLS. 100 AND 101). REG. 4-1-1997.
- 2,049,752. ACADEME TODAY. INT. CLS. 41 AND 42. (U.S. CLS. 100, 101 AND 107). REG. 4-1-1997.
- 2,053,242. COLDFIRE. INT. CL. 9. (U.S. CLS. 21, 23, 26, 36 AND 38). REG. 4-15-1997.
- 2,053,905. ESCO AND DESIGN. INT. CLS. 1 AND 3. (U.S. CLS. 1, 4, 5, 6, 10, 26, 46, 50, 51 AND 52). REG. 4-22-1997.
- 2,054,843. PLANET. INT. CL. 35. (U.S. CLS. 100, 101 AND 102). REG. 4-22-1997.
- 2,054,940. 2 BE (STYLIZED). INT. CL. 3. (U.S. CLS. 1, 4, 6, 50, 51 AND 52). REG. 4-22-1997.
- 2,056,347. NO-SNOW. INT. CL. 18. (U.S. CLS. 1, 2, 3, 22 AND 41). REG. 4-22-1997.
- 2,057,891. DIA-CLUST. INT. CL. 40. (U.S. CLS. 100, 103 AND 106). REG. 4-29-1997.
- 2,059,524. MUSTANG. INT. CL. 28. (U.S. CLS. 22, 23, 38 AND 50). REG. 5-6-1997.
- 2,059,525. FORD. INT. CL. 28. (U.S. CLS. 22, 23, 38 AND 50). REG. 5-6-1997.
- 2,060,456. PETROLEUM & RESOURCES CORPORATION. INT. CL. 36. (U.S. CLS. 100, 101 AND 102). REG. 5-13-1997.
- 2,061,961. DURASHIELD. INT. CL. 17. (U.S. CLS. 1, 5, 12, 13, 35 AND 50). REG. 5-13-1997.
- 2,062,781. CDI. INT. CL. 35. (U.S. CLS. 100, 101 AND 102). REG. 5-20-1997.
- 2,064,150. ELANPLUS. INT. CL. 9. (U.S. CLS. 21, 23, 26, 36 AND 38). REG. 5-20-1997.
- 2,064,803. MISCELLANEOUS DESIGN. INT. CL. 33. (U.S. CLS. 47 AND 49). REG. 5-27-1997.
- 2,066,336. DOCUCOPY. INT. CL. 16. (U.S. CLS. 2, 5, 22, 23, 29, 37, 38 AND 50). REG. 6-3-1997.
- 2,067,751. WINUPS. INT. CL. 9. (U.S. CLS. 21, 23, 26, 36 AND 38). REG. 6-3-1997.
- 2,067,811. MONSTER BALLS. INT. CL. 13. (U.S. CLS. 2 AND 9). REG. 6-3-1997.
- 2,067,829. BIO-FOAM. INT. CL. 16. (U.S. CLS. 2, 5, 22, 23, 29, 37, 38 AND 50). REG. 6-3-1997.
- 2,067,833. SKY PARADE. INT. CL. 13. (U.S. CLS. 2 AND 9). REG. 6-3-1997.
- 2,070,247. COLOR SIETE. INT. CL. 25. (U.S. CLS. 22 AND 39). REG. 6-10-1997.
- 2,071,136. H&S HEINEMAN&STERN AND DESIGN. INT. CL. 29. (U.S. CL. 46). REG. 6-17-1997.
- 2,071,846. BUCKHORN MUSEUMS. INT. CL. 41. (U.S. CLS. 100, 101 AND 107). REG. 6-17-1997.
- 2,072,603. TANSIL. INT. CL. 9. (U.S. CLS. 21, 23, 26, 36 AND 38). REG. 6-17-1997.
- 2,072,613. CONVERT-A-FOOT. INT. CL. 25. (U.S. CLS. 22 AND 39). REG. 6-17-1997.
- 2,072,717. CRAZY GROUND HOG. INT. CL. 13. (U.S. CLS. 2 AND 9). REG. 6-17-1997.
- 2,072,728. WELLSKETCH (STYLIZED). INT. CL. 9. (U.S. CLS. 21, 23, 26, 36 AND 38). REG. 6-17-1997.
- 2,072,826. HOW ARTISTS SEE. INT. CL. 16. (U.S. CLS. 2, 5, 22, 23, 29, 37, 38 AND 50). REG. 6-17-1997.
- 2,072,853. MENTALSPICE. INT. CL. 9. (U.S. CLS. 21, 23, 26, 36 AND 38). REG. 6-17-1997.
- 2,072,910. CONLUX AND DESIGN. INT. CL. 9. (U.S. CLS. 21, 23, 26, 36 AND 38). REG. 6-24-1997.
- 2,072,989. EURO KERA. INT. CLS. 11, 19 AND 21. (U.S. CLS. 1, 2, 12, 13, 21, 23, 29, 30, 31, 33, 34, 40 AND 50). REG. 6-24-1997.
- 2,073,181. RESPECTFUL PARENTING. INT. CL. 42. (U.S. CLS. 100 AND 101). REG. 6-24-1997.
- 2,073,280. IRI INDUSTRIAL RISK INSURERS AND DESIGN. INT. CL. 36. (U.S. CLS. 100, 101 AND 102). REG. 6-24-1997.
- 2,073,462. TALKAMERICA. INT. CL. 38 ONLY. (U.S. CLS. 100, 101 AND 104). REG. 6-24-1997.
- 2,073,470. GATEWAY.COM. INT. CL. 35. (U.S. CLS. 100, 101 AND 102). REG. 6-24-1997.
- 2,073,530. BUCOL. INT. CL. 24. (U.S. CLS. 42 AND 50). REG. 6-24-1997.
- 2,073,651. NISSAN AND DESIGN. INT. CLS. 12 AND 18. (U.S. CLS. 1, 2, 3, 19, 21, 22, 23, 31, 35, 41 AND 44). REG. 6-24-1997.
- 2,073,684. COCOPLANTERS. INT. CL. 21. (U.S. CLS. 2, 13, 23, 29, 30, 33, 40 AND 50). REG. 6-24-1997.
- 2,073,762. AWARENESS IS POWER. INT. CL. 41. (U.S. CLS. 100, 101 AND 107). REG. 6-24-1997.
- 2,074,227. FUNCASTLE PUBLICATIONS AND DESIGN. INT. CL. 16. (U.S. CLS. 2, 5, 22, 23, 29, 37, 38 AND 50). REG. 6-24-1997.
- 2,074,262. BLUE MOON. INT. CL. 9. (U.S. CLS. 21, 23, 26, 36 AND 38). REG. 6-24-1997.
- 2,074,523. EY/PASSPORT. INT. CL. 9. (U.S. CLS. 21, 23, 26, 36 AND 38). REG. 6-24-1997.
- 2,074,689. ITERATIONS. INT. CL. 9. (U.S. CLS. 21, 23, 26, 36 AND 38). REG. 6-24-1997.
- 2,074,747. WIRING HARNESS NEWS. INT. CL. 16. (U.S. CLS. 2, 5, 22, 23, 29, 37, 38 AND 50). REG. 6-24-1997.
- 2,074,916. BESTCHOICE AND DESIGN. INT. CL. 36. (U.S. CLS. 100, 101 AND 102). REG. 7-1-1997.

- 2,074,921. UNGUATOR. INT. CLS. 7 AND 20. (U.S. CLS. 2, 13, 19, 21, 22, 23, 25, 31, 32, 34, 35 AND 50). REG. 7-1-1997.
- 2,074,964. MUDSLIDE. INT. CL. 15. (U.S. CLS. 2, 21 AND 36). REG. 7-1-1997.
- 2,075,062. LABOR SYSTEMS JOB CENTER AND DESIGN. INT. CL. 35. (U.S. CLS. 100, 101 AND 102). REG. 7-1-1997.
- 2,075,112. SYSMELEC AND DESIGN. INT. CL. 7. (U.S. CLS. 13, 19, 21, 23, 31, 34 AND 35). REG. 7-1-1997.
- 2,075,192. SEAL-SPOUT. INT. CL. 7. (U.S. CLS. 13, 19, 21, 23, 31, 34 AND 35). REG. 7-1-1997.
- 2,075,565. DISH AND DESIGN. INT. CLS. 37 AND 38. (U.S. CLS. 100, 101, 103, 104 AND 106). REG. 7-1-1997.
- 2,075,591. VIRTUAL COMMISSARY. INT. CL. 35. (U.S. CLS. 100, 101 AND 102). REG. 7-1-1997.
- 2,075,631. MICRO-DIP. INT. CL. 9. (U.S. CLS. 21, 23, 26, 36 AND 38). REG. 7-1-1997.
- 2,075,688. THE AIM GROUP AND DESIGN. INT. CL. 35. (U.S. CLS. 100, 101 AND 102). REG. 7-1-1997.
- 2,075,718. PEARL DROPS. INT. CL. 3. (U.S. CLS. 1, 4, 6, 50, 51 AND 52). REG. 7-1-1997.
- 2,075,838. INVESTING IN RESOURCES FOR THE FUTURE. INT. CL. 36. (U.S. CLS. 100, 101 AND 102). REG. 7-1-1997.
- 2,076,036. MISCELLANEOUS DESIGN. INT. CL. 25. (U.S. CLS. 22 AND 39). REG. 7-1-1997.
- 2,076,166. CAPTURA. INT. CL. 10. (U.S. CLS. 26, 39 AND 44). REG. 7-1-1997.
- 2,076,206. ESPA. INT. CL. 11. (U.S. CLS. 13, 21, 23, 31 AND 34). REG. 7-1-1997.
- 2,076,225. ROYAL VINTER. INT. CL. 30. (U.S. CL. 46). REG. 7-1-1997.
- 2,076,267. GASTIPS. INT. CL. 42. (U.S. CLS. 100 AND 101). REG. 7-1-1997.
- 2,076,452. USF AND DESIGN. INT. CL. 39. (U.S. CLS. 100 AND 105). REG. 7-1-1997.
- 2,076,562. CROCKER. INT. CL. 25. (U.S. CLS. 22 AND 39). REG. 7-1-1997.
- 2,076,674. RESEAL. INT. CLS. 6 AND 17. (U.S. CLS. 1, 2, 5, 12, 13, 14, 23, 25, 35 AND 50). REG. 7-8-1997.
- 2,076,882. AMPHITOL. INT. CL. 1. (U.S. CLS. 1, 5, 6, 10, 26 AND 46). REG. 7-8-1997.
- 2,076,896. MANAGING MICROBES AND DESIGN. INT. CL. 41. (U.S. CLS. 100, 101 AND 107). REG. 7-8-1997.
- 2,076,901. MISCELLANEOUS DESIGN. INT. CL. 3. (U.S. CLS. 1, 4, 6, 50, 51 AND 52). REG. 7-8-1997.
- 2,077,033. NATIONWIDE NOW. INT. CL. 38. (U.S. CLS. 100, 101 AND 104). REG. 7-8-1997.
- 2,077,090. RALPH LAUREN. INT. CL. 42. (U.S. CLS. 100 AND 101). REG. 7-8-1997.
- 2,077,259. JUNGLE JIM'S. INT. CL. 7. (U.S. CLS. 13, 19, 21, 23, 31, 34 AND 35). REG. 7-8-1997.
- 2,077,320. MISCELLANEOUS DESIGN. INT. CL. 36. (U.S. CLS. 100, 101 AND 102). REG. 7-8-1997.
- 2,077,325. OKELL'S FIREPLACE. INT. CL. 42. (U.S. CLS. 100 AND 101). REG. 7-8-1997.
- 2,077,429. MISCELLANEOUS DESIGN. INT. CL. 29. (U.S. CL. 46). REG. 7-8-1997.
- 2,077,496. AVAILZ. INT. CL. 9. (U.S. CLS. 21, 23, 26, 36 AND 38). REG. 7-8-1997.
- 2,077,642. CORONER AND DESIGN. INT. CL. 25. (U.S. CLS. 22 AND 39). REG. 7-8-1997.
- 2,077,656. WEEKLY READER BIG ISSUE!. INT. CL. 16. (U.S. CLS. 2, 5, 22, 23, 29, 37, 38 AND 50). REG. 7-8-1997.
- 2,077,681. L.A. COUNTY CORONER AND DESIGN. INT. CL. 25. (U.S. CLS. 22 AND 39). REG. 7-8-1997.
- 2,077,755. AGFA AND DESIGN. INT. CLS. 1, 2, 7, 9, 10, 16, 37 AND 41. (U.S. CLS. 1, 2, 5, 6, 10, 11, 13, 16, 19, 21, 22, 23, 26, 29, 31, 34, 35, 36, 37, 38, 39, 44, 46, 50, 100, 101, 103, 106 AND 107). REG. 7-8-1997.
- 2,077,813. MASTIP. INT. CL. 7. (U.S. CLS. 13, 19, 21, 23, 31, 34 AND 35). REG. 7-8-1997.
- 2,077,872. TWINSCAN. INT. CL. 9. (U.S. CLS. 21, 23, 26, 36 AND 38). REG. 7-8-1997.
- 2,077,909. INTELLITRONICS. INT. CL. 9. (U.S. CLS. 21, 23, 26, 36 AND 38). REG. 7-8-1997.
- 2,078,265. ACOUSTIBOND. INT. CL. 19. (U.S. CLS. 1, 12, 33 AND 50). REG. 7-15-1997.
- 2,078,347. DASAPRAKASH. INT. CL. 42. (U.S. CLS. 100 AND 101). REG. 7-15-1997.
- 2,078,350. DECISIONBASE. INT. CLS. 9, 16 AND 42. (U.S. CLS. 2, 5, 21, 22, 23, 26, 29, 36, 37, 38, 50, 100 AND 101). REG. 7-15-1997.
- 2,078,361. GLOBAL BEST PRACTICES. INT. CL. 35. (U.S. CLS. 100, 101 AND 102). REG. 7-15-1997.
- 2,078,380. BUTLER INTERNATIONAL, INC.. INT. CLS. 35, 40 AND 42. (U.S. CLS. 100, 101, 102, 103 AND 106). REG. 7-15-1997.
- 2,078,381. MINDPOWER FOR A CHANGING WORLD. INT. CLS. 35, 40 AND 42. (U.S. CLS. 100, 101, 102, 103 AND 106). REG. 7-15-1997.
- 2,078,535. MAX'S DINER. INT. CL. 42. (U.S. CLS. 100 AND 101). REG. 7-15-1997.
- 2,078,692. SC AND DESIGN. U.S. CL. B. REG. 7-15-1997.
- 2,078,782. SAFIZYM. INT. CL. 1. (U.S. CLS. 1, 5, 6, 10, 26 AND 46). REG. 7-15-1997.
- 2,078,825. IEG AND DESIGN. INT. CL. 16. (U.S. CLS. 2, 5, 22, 23, 29, 37, 38 AND 50). REG. 7-15-1997.
- 2,078,866. UNITHERM. INT. CL. 17. (U.S. CLS. 1, 5, 12, 13, 35 AND 50). REG. 7-15-1997.
- 2,078,976. MISCELLANEOUS DESIGN. INT. CLS. 41 AND 42. (U.S. CLS. 100, 101 AND 107). REG. 7-15-1997.
- 2,079,169. NEVR-DULL THE ORIGINAL MAGIC WADDING POLISH AUTOMOTIVE TRIM SILVERWARE COOKWARE AND DESIGN. INT. CL. 3. (U.S. CLS. 1, 4, 6, 50, 51 AND 52). REG. 7-15-1997.
- 2,079,228. FLUFTEX. INT. CL. 5. (U.S. CLS. 6, 18, 44, 46, 51 AND 52). REG. 7-15-1997.
- 2,079,253. EQUATION OF SLEEP. INT. CL. 20. (U.S. CLS. 2, 13, 22, 25, 32 AND 50). REG. 7-15-1997.
- 2,079,269. DINING IN. INT. CL. 42. (U.S. CLS. 100 AND 101). REG. 7-15-1997.
- 2,079,278. ROTI PAN. INT. CL. 21. (U.S. CLS. 2, 13, 23, 29, 30, 33, 40 AND 50). REG. 7-15-1997.
- 2,079,327. ROAD TO THE WHITE HOUSE. INT. CL. 41. (U.S. CLS. 100, 101 AND 107). REG. 7-15-1997.
- 2,079,388. MADE FOR PRAISE. INT. CL. 16. (U.S. CLS. 2, 5, 22, 23, 29, 37, 38 AND 50). REG. 7-15-1997.
- 2,079,571. AMERICAN ALTERNATIVE INSURANCE CORPORATION. INT. CL. 36. (U.S. CLS. 100, 101 AND 102). REG. 7-15-1997.
- 2,079,664. RIVER HORSE. INT. CLS. 25 AND 32. (U.S. CLS. 22, 39, 45, 46 AND 48). REG. 7-15-1997.
- 2,079,666. ACQUA DI PARMA COLONIA PARMA (ITALY) AND DESIGN. INT. CL. 3. (U.S. CLS. 1, 4, 6, 50, 51 AND 52). REG. 7-15-1997.
- 2,079,684. MISCELLANEOUS DESIGN. U.S. CL. A. REG. 7-15-1997.
- 2,079,713. MAXXON. INT. CL. 19. (U.S. CLS. 1, 12, 33 AND 50). REG. 7-15-1997.
- 2,079,739. GORE-TEX. INT. CL. 24. (U.S. CLS. 42 AND 50). REG. 7-15-1997.
- 2,079,771. CAPITAL GARMENT CO. USA, INC.. INT. CL. 35. (U.S. CLS. 100, 101 AND 102). REG. 7-15-1997.
- 2,079,773. CONFRUITY CRISP. INT. CL. 30. (U.S. CL. 46). REG. 7-15-1997.
- 2,079,777. TASKFORCE. INT. CLS. 24 AND 27. (U.S. CLS. 19, 20, 37, 42 AND 50). REG. 7-15-1997.
- 2,079,909. SPECIAL EDUCATION TODAY. INT. CL. 16. (U.S. CLS. 2, 5, 22, 23, 29, 37, 38 AND 50). REG. 7-15-1997.
- 2,079,936. IMC. INT. CL. 16. (U.S. CLS. 2, 5, 22, 23, 29, 37, 38 AND 50). REG. 7-15-1997.
- 2,080,126. PROWALL. INT. CL. 19. (U.S. CLS. 1, 12, 33 AND 50). REG. 7-15-1997.
- 2,080,177. PRIVATE HARVEST. INT. CLS. 29 AND 30. (U.S. CL. 46). REG. 7-15-1997.
- 2,080,191. FORD AND DESIGN. INT. CL. 28. (U.S. CLS. 22, 23, 38 AND 50). REG. 7-15-1997.
- 2,080,292. THE ART OF HARMONY: AN ART COMPETITION. INT. CLS. 16 AND 41. (U.S. CLS. 2, 5, 22, 23, 29, 37, 38, 50, 100, 101 AND 107). REG. 7-15-1997.
- 2,080,581. MISCELLANEOUS DESIGN. INT. CLS. 1, 3 AND 7. (U.S. CLS. 1, 4, 5, 6, 10, 13, 19, 21, 23, 26, 31, 34, 35, 46, 50, 51 AND 52). REG. 7-22-1997.
- 2,080,606. SHELTER SUPPLY AND DESIGN. INT. CL. 42. (U.S. CLS. 100 AND 101). REG. 7-22-1997.
- 2,080,628. COLLABORATIVE, COOPERATIVE, COMPETITIVE AND DESIGN. INT. CL. 41. (U.S. CLS. 100, 101 AND 107). REG. 7-22-1997.
- 2,080,671. A1. INT. CLS. 7, 9 AND 12. (U.S. CLS. 13, 19, 21, 23, 26, 31, 34, 35, 36, 38 AND 44). REG. 7-22-1997.
- 2,080,679. YDRIVE. INT. CL. 41. (U.S. CLS. 100, 101 AND 107). REG. 7-22-1997.
- 2,080,690. AQUACENTER. INT. CLS. 1 AND 42. (U.S. CLS. 1, 5, 6, 10, 26, 46, 100 AND 101). REG. 7-22-1997.

- 2,080,726. BEMCO CHAMPION. INT. CL. 20. (U.S. CLS. 2, 13, 22, 25, 32 AND 50). REG. 7-22-1997.
- 2,080,819. PRESERVED TREESCAPES INTERNATIONAL AND DESIGN. INT. CLS. 37 AND 40. (U.S. CLS. 100, 103 AND 106). REG. 7-22-1997.
- 2,080,830. MEDTRIALS INCORPORATED AND DESIGN. INT. CLS. 35 AND 42. (U.S. CLS. 100, 101 AND 102). REG. 7-22-1997.
- 2,080,868. STORAGEONE. INT. CL. 39. (U.S. CLS. 100 AND 105). REG. 7-22-1997.
- 2,080,890. THE LPD VIDEO JOURNAL OF EDUCATION. INT. CL. 9. (U.S. CLS. 21, 23, 26, 36 AND 38). REG. 7-22-1997.
- 2,080,933. BOXWARE. INT. CL. 20. (U.S. CLS. 2, 13, 22, 25, 32 AND 50). REG. 7-22-1997.
- 2,080,943. CHAMPION HEALTH. INT. CL. 42. (U.S. CLS. 100 AND 101). REG. 7-22-1997.
- 2,080,971. NEXT TO NATURE. INT. CL. 5. (U.S. CLS. 6, 18, 44, 46, 51 AND 52). REG. 7-22-1997.
- 2,081,025. MISCELLANEOUS DESIGN. INT. CL. 36. (U.S. CLS. 100, 101 AND 102). REG. 7-22-1997.
- 2,081,038. CITIZEN SCHOOLS. INT. CL. 41. (U.S. CLS. 100, 101 AND 107). REG. 7-22-1997.
- 2,081,055. AMTECH. INT. CLS. 9 AND 37. (U.S. CLS. 21, 23, 26, 36, 38, 100, 103 AND 106). REG. 7-22-1997.
- 2,081,073. ASI AND DESIGN. INT. CL. 7. (U.S. CLS. 13, 19, 21, 23, 31, 34 AND 35). REG. 7-22-1997.
- 2,081,119. WINAVL (STYLIZED). INT. CL. 9. (U.S. CLS. 21, 23, 26, 36 AND 38). REG. 7-22-1997.
- 2,081,129. ON THE WATER. INT. CL. 16. (U.S. CLS. 2, 5, 22, 23, 29, 37, 38 AND 50). REG. 7-22-1997.
- 2,081,149. BONNIE J. INT. CL. 14. (U.S. CLS. 2, 27, 28 AND 50). REG. 7-22-1997.
- 2,081,207. GRAND CARAVAN. INT. CL. 12. (U.S. CLS. 19, 21, 23, 31, 35 AND 44). REG. 7-22-1997.
- 2,081,250. ABSTINENCE THE SAFEST SEX OF ALL. INT. CL. 42. (U.S. CLS. 100 AND 101). REG. 7-22-1997.
- 2,081,323. THE WRITE STUFF. INT. CLS. 35 AND 42. (U.S. CLS. 100, 101 AND 102). REG. 7-22-1997.
- 2,081,486. ANARK. INT. CL. 9. (U.S. CLS. 21, 23, 26, 36 AND 38). REG. 7-22-1997.
- 2,081,487. AIGA. INT. CL. 42. (U.S. CLS. 100 AND 101). REG. 7-22-1997.
- 2,081,523. HOB KNOBS AND DESIGN. INT. CLS. 20 AND 21. (U.S. CLS. 2, 13, 22, 23, 25, 29, 30, 32, 33, 40 AND 50). REG. 7-22-1997.
- 2,081,527. LIFTEM. INT. CL. 10. (U.S. CLS. 26, 39 AND 44). REG. 7-22-1997.
- 2,081,588. TOP CARE. INT. CL. 5. (U.S. CLS. 6, 18, 44, 46, 51 AND 52). REG. 7-22-1997.
- 2,081,641. MANAGING YOUR DIABETES. INT. CL. 42. (U.S. CLS. 100 AND 101). REG. 7-22-1997.
- 2,081,645. MISCELLANEOUS DESIGN. INT. CL. 42. (U.S. CLS. 100 AND 101). REG. 7-22-1997.
- 2,081,705. NEXTEK. INT. CL. 42. (U.S. CLS. 100 AND 101). REG. 7-22-1997.
- 2,081,706. TOMORROW'S TECHNOLOGY FOR TODAY'S PRODUCTS. INT. CL. 42. (U.S. CLS. 100 AND 101). REG. 7-22-1997.
- 2,081,722. N HUSKERS AND DESIGN. INT. CL. 25 ONLY. (U.S. CLS. 22 AND 39). REG. 7-22-1997.
- 2,081,809. WINDOWS ACADEMY. INT. CL. 9. (U.S. CLS. 21, 23, 26, 36 AND 38). REG. 7-22-1997.
- 2,081,826. DINO-BUDDIES. INT. CL. 14. (U.S. CLS. 2, 27, 28 AND 50). REG. 7-22-1997.
- 2,081,827. DINO-BUDDIES. INT. CL. 21. (U.S. CLS. 2, 13, 23, 29, 30, 33, 40 AND 50). REG. 7-22-1997.
- 2,081,855. NITREK. INT. CL. 5. (U.S. CLS. 6, 18, 44, 46, 51 AND 52). REG. 7-22-1997.
- 2,081,875. MICROSOFT EXCHANGE SERVER. INT. CL. 16. (U.S. CLS. 2, 5, 22, 23, 29, 37, 38 AND 50). REG. 7-22-1997.
- 2,081,909. SMARTCELLS. INT. CL. 27. (U.S. CLS. 19, 20, 37, 42 AND 50). REG. 7-22-1997.
- 2,081,938. LUMIFORM. INT. CL. 11. (U.S. CLS. 13, 21, 23, 31 AND 34). REG. 7-22-1997.
- 2,081,942. KIDS AT HOPE. INT. CL. 41. (U.S. CLS. 100, 101 AND 107). REG. 7-22-1997.
- 2,081,978. TEACHER TALK. INT. CLS. 9 AND 16. (U.S. CLS. 2, 5, 21, 22, 23, 26, 29, 36, 37, 38 AND 50). REG. 7-22-1997.
- 2,081,999. INFORM LITE ALERT. INT. CL. 9. (U.S. CLS. 21, 23, 26, 36 AND 38). REG. 7-22-1997.
- 2,082,043. A KINDER SUN. INT. CL. 3. (U.S. CLS. 1, 4, 6, 50, 51 AND 52). REG. 7-22-1997.
- 2,082,068. LAUNCH PUBLIC RELATIONS. INT. CL. 35. (U.S. CLS. 100, 101 AND 102). REG. 7-22-1997.
- 2,082,080. SHAPESHEET. INT. CL. 9. (U.S. CLS. 21, 23, 26, 36 AND 38). REG. 7-22-1997.
- 2,082,162. CUSTODYSTATION. INT. CL. 9. (U.S. CLS. 21, 23, 26, 36 AND 38). REG. 7-22-1997.
- 2,082,205. TESTEXPRESS. INT. CL. 9. (U.S. CLS. 21, 23, 26, 36 AND 38). REG. 7-22-1997.
- 2,082,233. DURALOC. INT. CL. 17. (U.S. CLS. 1, 5, 12, 13, 35 AND 50). REG. 7-22-1997.
- 2,082,380. YUM YUM MIX. INT. CL. 1. (U.S. CLS. 1, 5, 6, 10, 26 AND 46). REG. 7-22-1997.
- 2,082,469. HOW TO LISTEN. INT. CL. 41. (U.S. CLS. 100, 101 AND 107). REG. 7-22-1997.
- 2,082,550. PE (STYLIZED). INT. CL. 9. (U.S. CLS. 21, 23, 26, 36 AND 38). REG. 7-22-1997.
- 2,082,591. ENTITY. INT. CL. 9. (U.S. CLS. 21, 23, 26, 36 AND 38). REG. 7-22-1997.
- 2,082,595. MISCELLANEOUS DESIGN. INT. CL. 9. (U.S. CLS. 21, 23, 26, 36 AND 38). REG. 7-22-1997.
- 2,082,612. "THE ORIGINAL BANANA SHOOTER". INT. CL. 33. (U.S. CLS. 47 AND 49). REG. 7-22-1997.
- 2,082,626. HEALTH CARE ADVISORY BOARD. INT. CL. 42. (U.S. CLS. 100 AND 101). REG. 7-22-1997.
- 2,082,642. CLAYS FOR KIDS. INT. CL. 41 ONLY. (U.S. CLS. 100, 101 AND 107). REG. 7-22-1997.
- 2,082,681. UNITED AMERICAN HEALTH CARE CORPORATION. INT. CLS. 35 AND 36. (U.S. CLS. 100, 101 AND 102). REG. 7-29-1997.
- 2,082,703. MISCELLANEOUS DESIGN. INT. CL. 17. (U.S. CL. 13). REG. 7-29-1997.
- 2,082,708. COUGAR. INT. CL. 28. (U.S. CL. 22). REG. 7-29-1997.
- 2,082,732. MISCELLANEOUS DESIGN. INT. CL. 25. (U.S. CLS. 22 AND 39). REG. 7-29-1997.
- 2,082,785. SPOT IMAGE AND DESIGN. INT. CLS. 9, 38 AND 42 ONLY. (U.S. CLS. 21, 23, 26, 36, 38, 100, 101 AND 104). REG. 7-29-1997.
- 2,082,812. KIDDER. INT. CL. 28. (U.S. CLS. 22, 23, 38 AND 50). REG. 7-29-1997.
- 2,082,865. NONNA ITALIA AND DESIGN. INT. CL. 30 ONLY. (U.S. CL. 46). REG. 7-29-1997.
- 2,082,964. GERSON. INT. CL. 21. (U.S. CLS. 2, 13, 23, 29, 30, 33, 40 AND 50). REG. 7-29-1997.
- 2,082,983. LANDSBERG QUALITY INSTITUTE AND DESIGN. INT. CL. 41. (U.S. CLS. 100, 101 AND 107). REG. 7-29-1997.
- 2,082,989. ALLOSOURCE. INT. CL. 5. (U.S. CLS. 6, 18, 44, 46, 51 AND 52). REG. 7-29-1997.
- 2,083,054. MAX'S EATZ. INT. CL. 42. (U.S. CLS. 100 AND 101). REG. 7-29-1997.
- 2,083,067. BOXLIGHT. INT. CL. 9. (U.S. CLS. 21, 23, 26, 36 AND 38). REG. 7-29-1997.
- 2,083,076. INTERIM OCCUPATIONAL HEALTH. INT. CLS. 35, 41 AND 42. (U.S. CLS. 100, 101, 102 AND 107). REG. 7-29-1997.
- 2,083,147. INTERSCHUTZ. INT. CLS. 16, 35 AND 41. (U.S. CLS. 2, 5, 22, 23, 29, 37, 38, 50, 100, 101, 102 AND 107). REG. 7-29-1997.
- 2,083,152. SPANK SPORT. INT. CL. 25. (U.S. CLS. 22 AND 39). REG. 7-29-1997.
- 2,083,241. WHERE FRIENDS TELL FRIENDS TO BUY. INT. CL. 42. (U.S. CLS. 100 AND 101). REG. 7-29-1997.
- 2,083,256. P.A.W.S (STYLIZED). INT. CL. 28. (U.S. CLS. 22, 23, 38 AND 50). REG. 7-29-1997.
- 2,083,261. GEOTEX. INT. CL. 19. (U.S. CLS. 1, 12, 33 AND 50). REG. 7-29-1997.
- 2,083,286. LAMPLIGHT. INT. CLS. 4 AND 11 ONLY. (U.S. CLS. 1, 6, 13, 15, 21, 23, 31 AND 34). REG. 7-29-1997.
- 2,083,303. SAF-ISIS. INT. CLS. 1 AND 30. (U.S. CLS. 1, 5, 6, 10, 26 AND 46). REG. 7-29-1997.
- 2,083,350. MRS. UNITED STATES (STYLIZED). INT. CL. 41. (U.S. CLS. 100, 101 AND 107). REG. 7-29-1997.
- 2,083,466. NATURE-BRIGHT. INT. CL. 3. (U.S. CLS. 1, 4, 6, 50, 51 AND 52). REG. 7-29-1997.
- 2,083,475. OCTFCU PARTNERS IN EDUCATION SINCE 1934 ORANGE COUNTY TEACHERS FEDERAL CREDIT UNION AND DESIGN. INT. CL. 36. (U.S. CLS. 100, 101 AND 102). REG. 7-29-1997.
- 2,083,498. CARAS. INT. CL. 9. (U.S. CLS. 21, 23, 26, 36 AND 38). REG. 7-29-1997.
- 2,083,507. LI AND DESIGN. INT. CLS. 35 AND 41. (U.S. CLS. 100, 101, 102 AND 107). REG. 7-29-1997.

- 2,083,516. BILGE SENTRY ELECTRONIC AND DESIGN. INT. CL. 9. (U.S. CLS. 21, 23, 26, 36 AND 38). REG. 7-29-1997.
- 2,083,557. MISHIMA AND DESIGN. INT. CL. 42. (U.S. CLS. 100 AND 101). REG. 7-29-1997.
- 2,083,602. NATHAN ASSOCIATES INC.. INT. CLS. 35 AND 36. (U.S. CLS. 100, 101 AND 102). REG. 7-29-1997.
- 2,083,680. TEACHER CREATED MATERIALS. INT. CL. 16. (U.S. CLS. 2, 5, 22, 23, 29, 37, 38 AND 50). REG. 7-29-1997.
- 2,083,688. MISCELLANEOUS DESIGN. INT. CL. 29. (U.S. CL. 46). REG. 7-29-1997.
- 2,083,703. ELECTROTORQUE PLUS. INT. CL. 9. (U.S. CLS. 21, 23, 26, 36 AND 38). REG. 7-29-1997.
- 2,083,718. FLAMINGO. INT. CL. 29. (U.S. CL. 46). REG. 7-29-1997.
- 2,083,736. BLUE WING. INT. CLS. 36 AND 42. (U.S. CLS. 100, 101 AND 102). REG. 7-29-1997.
- 2,083,737. MISCELLANEOUS DESIGN. INT. CLS. 36 AND 42. (U.S. CLS. 100, 101 AND 102). REG. 7-29-1997.
- 2,083,740. MEDALLA ULTRA LIGHT (STYLIZED). INT. CL. 32. (U.S. CLS. 45, 46 AND 48). REG. 7-29-1997.
- 2,083,752. TOFFEE PISTACHIO DELIGHTS. INT. CL. 30. (U.S. CL. 46). REG. 7-29-1997.
- 2,083,777. ISBA AND DESIGN. INT. CL. 42. (U.S. CLS. 100 AND 101). REG. 7-29-1997.
- 2,083,778. ISBA AND DESIGN. INT. CL. 41. (U.S. CLS. 100, 101 AND 107). REG. 7-29-1997.
- 2,083,787. LAW ED SERIES AND DESIGN. INT. CL. 41. (U.S. CLS. 100, 101 AND 107). REG. 7-29-1997.
- 2,083,794. V AND DESIGN. INT. CL. 25. (U.S. CLS. 22 AND 39). REG. 7-29-1997.
- 2,083,802. CELLFOOD. INT. CL. 5. (U.S. CLS. 6, 18, 44, 46, 51 AND 52). REG. 7-29-1997.
- 2,083,884. SHARK CHAIN. INT. CL. 7. (U.S. CLS. 13, 19, 21, 23, 31, 34 AND 35). REG. 7-29-1997.
- 2,083,901. LEE MYLES. INT. CL. 37. (U.S. CLS. 100, 103 AND 106). REG. 7-29-1997.
- 2,083,926. POST-POSITIVE. INT. CL. 42. (U.S. CLS. 100 AND 101). REG. 7-29-1997.
- 2,083,943. ST. THOMAS. INT. CL. 20. (U.S. CLS. 2, 13, 22, 25, 32 AND 50). REG. 7-29-1997.
- 2,083,945. ST. CAROLINE. INT. CL. 20. (U.S. CLS. 2, 13, 22, 25, 32 AND 50). REG. 7-29-1997.
- 2,084,008. SLICK-PAK. INT. CL. 1. (U.S. CLS. 1, 5, 6, 10, 26 AND 46). REG. 7-29-1997.
- 2,084,019. L0430. INT. CL. 10. (U.S. CLS. 26, 39 AND 44). REG. 7-29-1997.
- 2,084,028. CAPTAIN CARROT. INT. CL. 5. (U.S. CLS. 6, 18, 44, 46, 51 AND 52). REG. 7-29-1997.
- 2,084,037. HGX-3. INT. CL. 1. (U.S. CLS. 1, 5, 6, 10, 26 AND 46). REG. 7-29-1997.
- 2,084,062. HAYES THE LOCAL HANDPIECE REPAIR CENTER AND DESIGN. INT. CL. 37. (U.S. CLS. 100, 103 AND 106). REG. 7-29-1997.
- 2,084,093. NEXTEK AND DESIGN. INT. CL. 42. (U.S. CLS. 100 AND 101). REG. 7-29-1997.
- 2,084,098. JAMAC AND DESIGN. INT. CL. 35. (U.S. CLS. 100, 101 AND 102). REG. 7-29-1997.
- 2,084,119. HABIB AMERICAN BANK. INT. CL. 36. (U.S. CLS. 100, 101 AND 102). REG. 7-29-1997.
- 2,084,165. SIDEWINDER. INT. CL. 6. (U.S. CLS. 2, 12, 13, 14, 23, 25 AND 50). REG. 7-29-1997.
- 2,084,201. CENTRAL POINT FOR MEMORIES. INT. CL. 39. (U.S. CLS. 100 AND 105). REG. 7-29-1997.
- 2,084,215. OASIS ONE ACTION STENT INTRODUCTION SYSTEM AND DESIGN. INT. CL. 10. (U.S. CLS. 26, 39 AND 44). REG. 7-29-1997.
- 2,084,232. MISCELLANEOUS DESIGN. INT. CLS. 1, 17, 19, 20, 22, 24 AND 27 ONLY. (U.S. CLS. 1, 2, 5, 6, 7, 10, 12, 13, 19, 20, 22, 25, 26, 32, 33, 35, 37, 42, 46 AND 50). REG. 7-29-1997.
- 2,084,233. CONTAINS SOYOIL AND DESIGN. U.S. CL. A. REG. 7-29-1997.
- 2,084,260. CRYSTALWEAR. INT. CL. 14. (U.S. CLS. 2, 27, 28 AND 50). REG. 7-29-1997.
- 2,084,266. INVENTOR'S WORLD. INT. CL. 16. (U.S. CLS. 2, 5, 22, 23, 29, 37, 38 AND 50). REG. 7-29-1997.
- 2,084,310. LUXURA. INT. CL. 11. (U.S. CLS. 13, 21, 23, 31 AND 34). REG. 7-29-1997.
- 2,084,342. ENVIRO-LOC. INT. CL. 17. (U.S. CLS. 1, 5, 12, 13, 35 AND 50). REG. 7-29-1997.
- 2,084,375. GO BANANAS. INT. CL. 29. (U.S. CL. 46). REG. 7-29-1997.
- 2,084,391. NETT. INT. CL. 7. (U.S. CLS. 13, 19, 21, 23, 31, 34 AND 35). REG. 7-29-1997.
- 2,084,443. NEW LINEAGE NORITAKE N AND DESIGN. INT. CL. 21. (U.S. CLS. 2, 13, 23, 29, 30, 33, 40 AND 50). REG. 7-29-1997.
- 2,084,468. ACCLAIM ADMINISTRATORS (STYLIZED). INT. CL. 36. (U.S. CLS. 100, 101 AND 102). REG. 7-29-1997.
- 2,084,485. SPACE ALIENS. INT. CL. 42. (U.S. CLS. 100 AND 101). REG. 7-29-1997.
- 2,084,587. MAKIN' IT EASY. INT. CL. 29 ONLY. (U.S. CL. 46). REG. 7-29-1997.
- 2,084,597. SUZY ON-CUE. INT. CL. 41. (U.S. CLS. 100, 101 AND 107). REG. 7-29-1997.
- 2,084,620. NET.COLLECT. INT. CL. 9. (U.S. CLS. 21, 23, 26, 36 AND 38). REG. 7-29-1997.
- 2,084,648. CAT-TRENDS. INT. CL. 9. (U.S. CLS. 21, 23, 26, 36 AND 38). REG. 7-29-1997.
- 2,084,697. THE BLUE MOOSE AND DESIGN. INT. CLS. 25 AND 42. (U.S. CLS. 22, 39, 100 AND 101). REG. 7-29-1997.
- 2,084,731. NO-CO. INT. CL. 7. (U.S. CLS. 13, 19, 21, 23, 31, 34 AND 35). REG. 7-29-1997.
- 2,084,732. NO-NOX AND DESIGN. INT. CL. 11. (U.S. CLS. 13, 21, 23, 31 AND 34). REG. 7-29-1997.
- 2,084,867. COMFORT CRAFTED. INT. CL. 37. (U.S. CLS. 100, 103 AND 106). REG. 7-29-1997.
- 2,084,882. BRECKENRIDGE. INT. CL. 20. (U.S. CLS. 2, 13, 22, 25, 32 AND 50). REG. 7-29-1997.
- 2,084,910. FINAL DOOM. INT. CL. 28. (U.S. CLS. 22, 23, 38 AND 50). REG. 7-29-1997.
- 2,084,995. FUNDCENTER. INT. CL. 36. (U.S. CLS. 100, 101 AND 102). REG. 7-29-1997.
- 2,085,031. SPACE CAMP. INT. CLS. 18, 21 AND 25. (U.S. CLS. 1, 2, 3, 13, 22, 23, 29, 30, 33, 39, 40, 41 AND 50). REG. 7-29-1997.
- 2,085,054. MISCELLANEOUS DESIGN. INT. CL. 9. (U.S. CLS. 21, 23, 26, 36 AND 38). REG. 7-29-1997.
- 2,085,102. MISCELLANEOUS DESIGN. INT. CL. 22. (U.S. CLS. 1, 2, 7, 19, 22, 42 AND 50). REG. 7-29-1997.
- 2,085,138. CLASSIC NORTHWEST ALES. INT. CL. 32. (U.S. CL. 46). REG. 8-5-1997.
- 2,085,198. HYDAK. INT. CL. 1. (U.S. CLS. 1, 5, 6, 10, 26 AND 46). REG. 8-5-1997.
- 2,085,265. OLIGOLD. INT. CL. 1. (U.S. CLS. 1, 5, 6, 10, 26 AND 46). REG. 8-5-1997.
- 2,085,272. B-93.7. INT. CL. 38. (U.S. CLS. 100, 101 AND 104). REG. 8-5-1997.
- 2,085,281. VET SOLUTIONS AND DESIGN. INT. CL. 5. (U.S. CLS. 6, 18, 44, 46, 51 AND 52). REG. 8-5-1997.
- 2,085,291. THE OUTER LIMITS (STYLIZED). INT. CL. 41. (U.S. CLS. 100, 101 AND 107). REG. 8-5-1997.
- 2,085,396. FX RACK. INT. CL. 15. (U.S. CLS. 2, 21 AND 36). REG. 8-5-1997.
- 2,085,421. NETWORK APPLIANCE AND DESIGN. INT. CL. 9. (U.S. CLS. 21, 23, 26, 36 AND 38). REG. 8-5-1997.
- 2,085,440. ALLERGY CONTROL. INT. CL. 24 ONLY. (U.S. CLS. 42 AND 50). REG. 8-5-1997.
- 2,085,446. HUDSON VALLEY RENEGADES. INT. CL. 41. (U.S. CLS. 100, 101 AND 107). REG. 8-5-1997.
- 2,085,489. SEA SHEPHERD. INT. CL. 42. (U.S. CLS. 100 AND 101). REG. 8-5-1997.
- 2,085,552. FRIGOTAINER AND DESIGN. INT. CL. 21. (U.S. CLS. 2, 13, 23, 29, 30, 33, 40 AND 50). REG. 8-5-1997.
- 2,085,581. CARITEN. INT. CLS. 36 AND 42. (U.S. CLS. 100, 101 AND 102). REG. 8-5-1997.
- 2,085,582. 3 POMMES AND DESIGN. INT. CL. 25. (U.S. CLS. 22 AND 39). REG. 8-5-1997.
- 2,085,585. RPMS RESOURCE TO PROFESSIONALS & MANAGERS AND DESIGN. INT. CLS. 35 AND 42. (U.S. CLS. 100, 101 AND 102). REG. 8-5-1997.
- 2,085,591. ALCOWEB. INT. CLS. 38 AND 42 ONLY. (U.S. CLS. 100, 101 AND 104). REG. 8-5-1997.
- 2,085,614. ENGLANDER FITNESS. INT. CL. 20. (U.S. CLS. 2, 13, 22, 25, 32 AND 50). REG. 8-5-1997.
- 2,085,665. CARITEN AND DESIGN. INT. CLS. 36 AND 42. (U.S. CLS. 100, 101 AND 102). REG. 8-5-1997.
- 2,085,674. APEC. INT. CLS. 16 AND 42. (U.S. CLS. 2, 5, 22, 23, 29, 37, 38, 50, 100 AND 101). REG. 8-5-1997.
- 2,085,675. AMERICAN PRINTING AND ENVELOPE COMPANY. INT. CLS. 16 AND 42. (U.S. CLS. 2, 5, 22, 23, 29, 37, 38, 50, 100 AND 101). REG. 8-5-1997.

- 2,085,692. D AND DESIGN. INT. CL. 25. (U.S. CLS. 22 AND 39). REG. 8-5-1997.
- 2,085,708. LACE SILHOUETTES LINGERIE AND DESIGN. INT. CL. 35. (U.S. CLS. 100, 101 AND 102). REG. 8-5-1997.
- 2,085,845. RED V. INT. CL. 29. (U.S. CL. 46). REG. 8-5-1997.
- 2,085,850. TIME LIFE KIDS AND DESIGN. INT. CL. 9 ONLY. (U.S. CLS. 21, 23, 26, 36 AND 38). REG. 8-5-1997.
- 2,085,877. NATIONAL FINALS RODEO. INT. CL. 26. (U.S. CLS. 37, 39, 40, 42 AND 50). REG. 8-5-1997.
- 2,085,885. SPEAKEASY. INT. CL. 28. (U.S. CLS. 22, 23, 38 AND 50). REG. 8-5-1997.
- 2,085,920. UNDERGROUND INTELLIGENCE. INT. CL. 16. (U.S. CLS. 2, 5, 22, 23, 29, 37, 38 AND 50). REG. 8-5-1997.
- 2,085,938. MIDLIFE FOR WOMEN II. INT. CL. 5. (U.S. CLS. 6, 18, 44, 46, 51 AND 52). REG. 8-5-1997.
- 2,085,940. BLISSFUL SLEEP. INT. CL. 5. (U.S. CLS. 6, 18, 44, 46, 51 AND 52). REG. 8-5-1997.
- 2,085,979. NAPLEX. INT. CL. 16. (U.S. CLS. 2, 5, 22, 23, 29, 37, 38 AND 50). REG. 8-5-1997.
- 2,085,996. VALU TIME. INT. CL. 3. (U.S. CLS. 1, 4, 6, 50, 51 AND 52). REG. 8-5-1997.
- 2,085,998. VALU TIME. INT. CL. 16. (U.S. CLS. 2, 5, 22, 23, 29, 37, 38 AND 50). REG. 8-5-1997.
- 2,086,072. SILVERSNEAKERS. INT. CL. 41. (U.S. CLS. 100, 101 AND 107). REG. 8-5-1997.
- 2,086,116. IT'S LONELY AT THE TOP. INT. CL. 25. (U.S. CLS. 22 AND 39). REG. 8-5-1997.
- 2,086,133. 21 CHOICES FROZEN YOGURT AND DESIGN. INT. CL. 29. (U.S. CL. 46). REG. 8-5-1997.
- 2,086,171. ILVA AND DESIGN. INT. CLS. 2 AND 17. (U.S. CLS. 1, 5, 6, 11, 12, 13, 16, 35 AND 50). REG. 8-5-1997.
- 2,086,254. 1-800 GIVE LIFE. INT. CL. 16. (U.S. CLS. 2, 5, 22, 23, 29, 37, 38 AND 50). REG. 8-5-1997.
- 2,086,306. THE PAPER SHACK & PARTY STORE. INT. CL. 42. (U.S. CLS. 100 AND 101). REG. 8-5-1997.
- 2,086,322. PUMA. INT. CL. 5. (U.S. CLS. 6, 18, 44, 46, 51 AND 52). REG. 8-5-1997.
- 2,086,348. AT&T WORLDNET. INT. CLS. 38 AND 42. (U.S. CLS. 100, 101 AND 104). REG. 8-5-1997.
- 2,086,544. GRAFFITI HURTS AND DESIGN. INT. CL. 42. (U.S. CLS. 100 AND 101). REG. 8-5-1997.
- 2,086,550. COMMUNICLAMP. INT. CL. 6. (U.S. CLS. 2, 12, 13, 14, 23, 25 AND 50). REG. 8-5-1997.
- 2,086,552. SAHARA MAT. INT. CL. 27. (U.S. CLS. 19, 20, 37, 42 AND 50). REG. 8-5-1997.
- 2,086,638. ANIMAL SHELTERING. INT. CL. 16. (U.S. CLS. 2, 5, 22, 23, 29, 37, 38 AND 50). REG. 8-5-1997.
- 2,086,643. VIPOND. INT. CLS. 37 AND 42. (U.S. CLS. 100, 101, 103 AND 106). REG. 8-5-1997.
- 2,086,735. FERAG (STYLIZED). INT. CLS. 6, 12, 16 AND 20. (U.S. CLS. 2, 5, 12, 13, 14, 19, 21, 22, 23, 25, 29, 31, 32, 35, 37, 38, 44 AND 50). REG. 8-12-1997.
- 2,086,747. PLATER'S CHOICE. INT. CL. 6. (U.S. CLS. 2, 12, 13, 14, 23, 25 AND 50). REG. 8-12-1997.
- 2,086,867. TRAVEL SMART. INT. CL. 9. (U.S. CLS. 21, 23, 26, 36 AND 38). REG. 8-12-1997.
- 2,086,984. STANDING IN THE WORD. INT. CL. 41. (U.S. CLS. 100, 101 AND 107). REG. 8-12-1997.
- 2,086,989. CIF. INT. CL. 41. (U.S. CLS. 100, 101 AND 107). REG. 8-12-1997.
- 2,087,043. MEMORY MAKERS. INT. CL. 16. (U.S. CLS. 2, 5, 22, 23, 29, 37, 38 AND 50). REG. 8-12-1997.
- 2,087,079. E-Z. INT. CL. 16. (U.S. CLS. 2, 5, 22, 23, 29, 37, 38 AND 50). REG. 8-12-1997.
- 2,087,120. VOCAL EYES MUSIC AND DESIGN. INT. CL. 9. (U.S. CLS. 21, 23, 26, 36 AND 38). REG. 8-12-1997.
- 2,087,130. TRAFAG. INT. CL. 9. (U.S. CLS. 21, 23, 26, 36 AND 38). REG. 8-12-1997.
- 2,087,192. AKBAR. INT. CL. 19. (U.S. CLS. 1, 12, 33 AND 50). REG. 8-12-1997.
- 2,087,314. DIAMOND. INT. CL. 28. (U.S. CLS. 22, 23, 38 AND 50). REG. 8-12-1997.
- 2,087,480. VISALIA OAKS. INT. CL. 41. (U.S. CLS. 100, 101 AND 107). REG. 8-12-1997.
- 2,087,595. SLINGSHOT. INT. CL. 35. (U.S. CLS. 100, 101 AND 102). REG. 8-12-1997.
- 2,087,626. KZG. INT. CL. 28. (U.S. CLS. 22, 23, 38 AND 50). REG. 8-12-1997.
- 2,087,721. TEXAFIL. INT. CL. 4. (U.S. CLS. 1, 6 AND 15). REG. 8-12-1997.
- 2,087,733. STERLING. INT. CL. 10. (U.S. CLS. 26, 39 AND 44). REG. 8-12-1997.
- 2,087,736. HYPLUS. INT. CL. 2. (U.S. CLS. 6, 11 AND 16). REG. 8-12-1997.
- 2,087,842. BARBIE (STYLIZED). INT. CL. 28. (U.S. CLS. 22, 23, 38 AND 50). REG. 8-12-1997.
- 2,087,962. R REGENCY (STYLIZED). INT. CL. 41. (U.S. CLS. 100, 101 AND 107). REG. 8-12-1997.
- 2,088,126. SURE-BOND. INT. CL. 3. (U.S. CLS. 1, 4, 6, 50, 51 AND 52). REG. 8-12-1997.
- 2,088,198. VALKYRIE. INT. CL. 12. (U.S. CLS. 19, 21, 23, 31, 35 AND 44). REG. 8-12-1997.
- 2,088,269. ALWAYS ANOTHER NEAT IDEA. INT. CL. 21. (U.S. CLS. 2, 13, 23, 29, 30, 33, 40 AND 50). REG. 8-12-1997.
- 2,088,320. ECLIPSE. INT. CL. 16. (U.S. CLS. 2, 5, 22, 23, 29, 37, 38 AND 50). REG. 8-12-1997.
- 2,088,423. BOUQUET MATES. INT. CL. 21. (U.S. CLS. 2, 13, 23, 29, 30, 33, 40 AND 50). REG. 8-12-1997.
- 2,088,491. TRANSPORTAINMENT. INT. CL. 39. (U.S. CLS. 100 AND 105). REG. 8-19-1997.
- 2,088,534. SCHWINGS. INT. CL. 30. (U.S. CL. 46). REG. 8-19-1997.
- 2,088,576. PRISCILLA OF BOSTON. INT. CL. 42. (U.S. CLS. 100 AND 101). REG. 8-19-1997.
- 2,088,731. NETAPP. INT. CL. 9. (U.S. CLS. 21, 23, 26, 36 AND 38). REG. 8-19-1997.
- 2,088,758. BLUEGREEN. INT. CLS. 36 AND 37. (U.S. CLS. 100, 101, 102, 103 AND 106). REG. 8-19-1997.
- 2,088,761. D SH NETWORK AND DESIGN. INT. CLS. 37 AND 38. (U.S. CLS. 100, 101, 103, 104 AND 106). REG. 8-19-1997.
- 2,088,805. ETEC ENVIRONMENTAL TECHNICAL SALES, INC. AND DESIGN. INT. CL. 35. (U.S. CLS. 100, 101 AND 102). REG. 8-19-1997.
- 2,088,839. DENTDEMON PAINTLESS DENT REMOVAL SPECIALISTS DD AND DESIGN. INT. CL. 37. (U.S. CLS. 100, 103 AND 106). REG. 8-19-1997.
- 2,088,940. DOCUCENTRIC. INT. CL. 9. (U.S. CLS. 21, 23, 26, 36 AND 38). REG. 8-19-1997.
- 2,088,956. MENARDS AND DESIGN. INT. CL. 42. (U.S. CLS. 100 AND 101). REG. 8-19-1997.
- 2,088,977. PRXN AND DESIGN. INT. CL. 35. (U.S. CLS. 100, 101 AND 102). REG. 8-19-1997.
- 2,088,978. PRXN AND DESIGN. INT. CL. 36. (U.S. CLS. 100, 101 AND 102). REG. 8-19-1997.
- 2,088,998. GUESTWARE. INT. CL. 9. (U.S. CLS. 21, 23, 26, 36 AND 38). REG. 8-19-1997.
- 2,089,133. LITTLE MOUTH BURGER. INT. CL. 30. (U.S. CL. 46). REG. 8-19-1997.
- 2,089,158. LC-DCP. INT. CL. 10. (U.S. CLS. 26, 39 AND 44). REG. 8-19-1997.
- 2,089,170. EDMC. INT. CL. 36. (U.S. CLS. 100, 101 AND 102). REG. 8-19-1997.
- 2,089,232. CHAMBOURG. INT. CL. 20. (U.S. CLS. 2, 13, 22, 25, 32 AND 50). REG. 8-19-1997.
- 2,089,344. MISCELLANEOUS DESIGN. INT. CL. 14. (U.S. CLS. 2, 27, 28 AND 50). REG. 8-19-1997.
- 2,089,348. DISTRIBUTECH '96 (STYLIZED). INT. CL. 35. (U.S. CLS. 100, 101 AND 102). REG. 8-19-1997.
- 2,089,353. HIRECOUNSEL. INT. CL. 35. (U.S. CLS. 100, 101 AND 102). REG. 8-19-1997.
- 2,089,377. RUSTIC TOUCH. INT. CL. 3. (U.S. CLS. 1, 4, 6, 50, 51 AND 52). REG. 8-19-1997.
- 2,089,447. CINNAMON STREET. INT. CL. 42. (U.S. CLS. 100 AND 101). REG. 8-19-1997.
- 2,089,507. BBA. INT. CL. 36. (U.S. CLS. 100, 101 AND 102). REG. 8-19-1997.
- 2,089,562. FLUMPA. INT. CL. 16. (U.S. CLS. 2, 5, 22, 23, 29, 37, 38 AND 50). REG. 8-19-1997.
- 2,089,650. MYRTHA POOLS AND DESIGN. INT. CL. 6. (U.S. CLS. 2, 12, 13, 14, 23, 25 AND 50). REG. 8-19-1997.
- 2,089,735. FINGER BANGLES. INT. CL. 14. (U.S. CLS. 2, 27, 28 AND 50). REG. 8-19-1997.
- 2,089,846. MISCELLANEOUS DESIGN. INT. CLS. 35 AND 41. (U.S. CLS. 100, 101, 102 AND 107). REG. 8-19-1997.
- 2,090,023. HOLIDAY TOWN. INT. CL. 36. (U.S. CLS. 100, 101 AND 102). REG. 8-19-1997.
- 2,090,078. MACSCREEN. INT. CL. 17. (U.S. CLS. 1, 5, 12, 13, 35 AND 50). REG. 8-19-1997.
- 2,090,287. TENDERBITE. INT. CL. 30. (U.S. CL. 46). REG. 8-26-1997.
- 2,090,588. MISCELLANEOUS DESIGN. INT. CL. 17. (U.S. CLS. 1, 5, 12, 13, 35 AND 50). REG. 8-26-1997.

- 2,090,596. BLUEGREEN AND DESIGN. INT. CLS. 36 AND 37. (U.S. CLS. 100, 101, 102, 103 AND 106). REG. 8-26-1997.
- 2,090,609. PLOT EXPRESS. INT. CL. 9. (U.S. CLS. 21, 23, 26, 36 AND 38). REG. 8-26-1997.
- 2,090,641. ICHAT. INT. CLS. 9 AND 42. (U.S. CLS. 21, 23, 26, 36, 38, 100 AND 101). REG. 8-26-1997.
- 2,090,927. QUALTECH. INT. CLS. 9 AND 20. (U.S. CLS. 2, 13, 21, 22, 23, 25, 26, 32, 36, 38 AND 50). REG. 8-26-1997.
- 2,091,123. FIVE CROWNS. INT. CL. 28. (U.S. CLS. 22, 23, 38 AND 50). REG. 8-26-1997.
- 2,091,137. MEDALIST. INT. CL. 9. (U.S. CLS. 21, 23, 26, 36 AND 38). REG. 8-26-1997.
- 2,091,139. ST. MARTIN. INT. CL. 20. (U.S. CLS. 2, 13, 22, 25, 32 AND 50). REG. 8-26-1997.
- 2,091,233. NUTRIVENE-D. INT. CL. 5. (U.S. CLS. 6, 18, 44, 46, 51 AND 52). REG. 8-26-1997.
- 2,091,281. VITA-DREAMS. INT. CL. 5. (U.S. CLS. 6, 18, 44, 46, 51 AND 52). REG. 8-26-1997.
- 2,091,293. COUNTRY VILLAGE. INT. CL. 41. (U.S. CLS. 100, 101 AND 107). REG. 8-26-1997.
- 2,091,340. CONDO LIFESTYLES. INT. CL. 16. (U.S. CLS. 2, 5, 22, 23, 29, 37, 38 AND 50). REG. 8-26-1997.
- 2,091,360. SHAPING THINGS TO COME. INT. CL. 42. (U.S. CLS. 100 AND 101). REG. 8-26-1997.
- 2,091,413. MISCELLANEOUS DESIGN. INT. CL. 3. (U.S. CLS. 1, 4, 6, 50, 51 AND 52). REG. 8-26-1997.
- 2,091,462. NASE AND DESIGN. INT. CL. 25. (U.S. CLS. 22 AND 39). REG. 8-26-1997.
- 2,091,537. SAN FRANCISCO WARRIORS AND DESIGN. INT. CL. 25. (U.S. CLS. 22 AND 39). REG. 8-26-1997.
- 2,091,641. UNITED ARTISTS AND DESIGN. INT. CLS. 9, 16 AND 41. (U.S. CLS. 2, 5, 21, 22, 23, 26, 29, 36, 37, 38, 50, 100, 101 AND 107). REG. 8-26-1997.
- 2,091,832. JUILLIARD. INT. CL. 9. (U.S. CLS. 21, 23, 26, 36 AND 38). REG. 8-26-1997.
- 2,091,886. AUTO CLEAN. INT. CL. 9. (U.S. CLS. 21, 23, 26, 36 AND 38). REG. 8-26-1997.
- 2,091,948. K.C.S.. INT. CL. 9. (U.S. CLS. 21, 23, 26, 36 AND 38). REG. 8-26-1997.
- 2,091,981. FIRST RESURRECTION CHURCHES OF CHRIST HOUSEHOLDS OF FAITH. INT. CL. 16. (U.S. CLS. 2, 5, 22, 23, 29, 37, 38 AND 50). REG. 8-26-1997.
- 2,092,214. TARANTULA. INT. CL. 33. (U.S. CLS. 47 AND 49). REG. 8-26-1997.
- 2,092,227. SOUNDPOINT. INT. CL. 9. (U.S. CLS. 21, 23, 26, 36 AND 38). REG. 8-26-1997.
- 2,092,247. ULTRA MELT. INT. CL. 1. (U.S. CLS. 1, 5, 6, 10, 26 AND 46). REG. 8-26-1997.
- 2,092,273. NUTRITIONAL INSIGHTS. INT. CL. 16. (U.S. CLS. 2, 5, 22, 23, 29, 37, 38 AND 50). REG. 8-26-1997.
- 2,092,613. SAATITECH AND DESIGN. INT. CLS. 1 AND 24. (U.S. CLS. 1, 5, 6, 10, 26, 42, 46 AND 50). REG. 9-2-1997.
- 2,092,780. ADI-WEAR (STYLIZED). INT. CL. 25. (U.S. CLS. 22 AND 39). REG. 9-2-1997.
- 2,092,956. UNIVERSAL FOOTCARE PRODUCTS. INT. CL. 42. (U.S. CLS. 100 AND 101). REG. 9-2-1997.
- 2,093,151. BOULEVARD. INT. CL. 9. (U.S. CLS. 21, 23, 26, 36 AND 38). REG. 9-2-1997.
- 2,093,190. OCLASSEN. INT. CL. 5. (U.S. CLS. 6, 18, 44, 46, 51 AND 52). REG. 9-2-1997.
- 2,093,381. LEE KUM KEE HONG KONG AND DESIGN. INT. CL. 30. (U.S. CL. 46). REG. 9-2-1997.
- 2,093,445. WORDNET. INT. CL. 9. (U.S. CLS. 21, 23, 26, 36 AND 38). REG. 9-2-1997.
- 2,093,656. ENVIROGUARD. INT. CL. 11. (U.S. CLS. 13, 21, 23, 31 AND 34). REG. 9-2-1997.
- 2,093,691. REDI-LOC. INT. CL. 9. (U.S. CLS. 21, 23, 26, 36 AND 38). REG. 9-2-1997.
- 2,093,741. ANIMAL PLANET. INT. CLS. 38 AND 41. (U.S. CLS. 100, 101, 104 AND 107). REG. 9-2-1997.
- 2,093,801. SAFETY-SHROUD. INT. CL. 9. (U.S. CLS. 21, 23, 26, 36 AND 38). REG. 9-2-1997.
- 2,093,907. TOBACCO ASIA. INT. CL. 16. (U.S. CLS. 2, 5, 22, 23, 29, 37, 38 AND 50). REG. 9-2-1997.
- 2,094,456. CRYSTAL GROOMING ACHIEVEMENT AWARDS. INT. CL. 41. (U.S. CLS. 100, 101 AND 107). REG. 9-9-1997.
- 2,094,474. LABGAS SYSTEMS. INT. CL. 9. (U.S. CLS. 21, 23, 26, 36 AND 38). REG. 9-9-1997.
- 2,094,563. UMKC. INT. CL. 28. (U.S. CLS. 22, 23, 38 AND 50). REG. 9-9-1997.
- 2,094,565. COACO. INT. CL. 25. (U.S. CLS. 22 AND 39). REG. 9-9-1997.
- 2,094,788. SAMMY SUPER SCREW AND DESIGN. INT. CL. 6. (U.S. CLS. 2, 12, 13, 14, 23, 25 AND 50). REG. 9-9-1997.
- 2,094,850. QWIK PM. INT. CLS. 1 AND 9. (U.S. CLS. 1, 5, 6, 10, 21, 23, 26, 36, 38 AND 46). REG. 9-9-1997.
- 2,094,954. THE RIGHT PIE. INT. CL. 30. (U.S. CL. 46). REG. 9-9-1997.
- 2,095,100. AT THE BUZZER. INT. CL. 16. (U.S. CLS. 2, 5, 22, 23, 29, 37, 38 AND 50). REG. 9-9-1997.
- 2,095,323. SPIRAFLEX. INT. CL. 16. (U.S. CLS. 2, 5, 22, 23, 29, 37, 38 AND 50). REG. 9-9-1997.
- 2,095,448. NEUTRA AIR. INT. CL. 5. (U.S. CLS. 6, 18, 44, 46, 51 AND 52). REG. 9-9-1997.
- 2,095,450. UNIZYME. INT. CL. 5. (U.S. CLS. 6, 18, 44, 46, 51 AND 52). REG. 9-9-1997.
- 2,095,496. LEE KUM KEE AND DESIGN. INT. CL. 30. (U.S. CL. 46). REG. 9-9-1997.
- 2,096,718. AUTOCIRC. INT. CL. 7. (U.S. CLS. 13, 19, 21, 23, 31, 34 AND 35). REG. 9-16-1997.
- 2,096,932. EVS. INT. CL. 28. (U.S. CLS. 22, 23, 38 AND 50). REG. 9-16-1997.
- 2,097,106. PONTIS. INT. CL. 9. (U.S. CLS. 21, 23, 26, 36 AND 38). REG. 9-16-1997.
- 2,097,497. NSTEP. INT. CL. 42. (U.S. CLS. 100 AND 101). REG. 9-16-1997.
- 2,097,525. ARCATALERT. INT. CL. 16. (U.S. CLS. 2, 5, 22, 23, 29, 37, 38 AND 50). REG. 9-16-1997.
- 2,097,560. THE BOSS WITH THE HOT SAUCE. INT. CL. 41. (U.S. CLS. 100, 101 AND 107). REG. 9-16-1997.
- 2,097,952. HONGDOU AND DESIGN. INT. CL. 25. (U.S. CLS. 22 AND 39). REG. 9-16-1997.
- 2,098,369. VALLEY LANE. INT. CL. 25. (U.S. CLS. 22 AND 39). REG. 9-16-1997.
- 2,098,432. MISCELLANEOUS DESIGN. INT. CL. 30. (U.S. CL. 46). REG. 9-16-1997.
- 2,098,531. REGGIO CHILDREN AND DESIGN. INT. CLS. 9, 16, 41 AND 42. (U.S. CLS. 2, 5, 21, 22, 23, 26, 29, 36, 37, 38, 50, 100, 101 AND 107). REG. 9-23-1997.
- 2,098,597. MISCELLANEOUS DESIGN. INT. CL. 8. (U.S. CLS. 23, 28 AND 44). REG. 9-23-1997.
- 2,098,625. AGR AND DESIGN. INT. CLS. 7 AND 9. (U.S. CLS. 13, 19, 21, 23, 26, 31, 34, 35, 36 AND 38). REG. 9-23-1997.
- 2,098,747. SWITCHOUT. INT. CL. 9. (U.S. CLS. 21, 23, 26, 36 AND 38). REG. 9-23-1997.
- 2,098,962. N AND DESIGN. INT. CL. 5. (U.S. CLS. 6, 18, 44, 46, 51 AND 52). REG. 9-23-1997.
- 2,099,108. OFFICEFINDER. INT. CL. 42. (U.S. CLS. 100 AND 101). REG. 9-23-1997.
- 2,099,172. TREDTRAK. INT. CL. 9. (U.S. CLS. 21, 23, 26, 36 AND 38). REG. 9-23-1997.
- 2,099,274. THE GEATOR WITH THE HEATER. INT. CL. 41. (U.S. CLS. 100, 101 AND 107). REG. 9-23-1997.
- 2,099,577. BIKER TRASH. INT. CL. 25. (U.S. CLS. 22 AND 39). REG. 9-23-1997.
- 2,100,052. PERFORMANCE V. INT. CL. 7. (U.S. CLS. 13, 19, 21, 23, 31, 34 AND 35). REG. 9-23-1997.
- 2,100,271. BIOVERSE. INT. CL. 1. (U.S. CLS. 1, 5, 6, 10, 26 AND 46). REG. 9-23-1997.
- 2,100,397. ARTIC JACK AND DESIGN. INT. CL. 25. (U.S. CLS. 22 AND 39). REG. 9-23-1997.
- 2,100,796. TREESCAPES. INT. CL. 26. (U.S. CLS. 37, 39, 40, 42 AND 50). REG. 9-30-1997.
- 2,100,803. VERSALT. INT. CL. 1. (U.S. CLS. 1, 5, 6, 10, 26 AND 46). REG. 9-30-1997.
- 2,100,902. FLORIDELLA. INT. CL. 32. (U.S. CLS. 45, 46 AND 48). REG. 9-30-1997.
- 2,100,934. MISCELLANEOUS DESIGN. INT. CL. 39. (U.S. CLS. 100 AND 105). REG. 9-30-1997.
- 2,100,960. SPARTAN RX AND DESIGN. INT. CL. 42. (U.S. CLS. 100 AND 101). REG. 9-30-1997.
- 2,101,111. ERICKSON BEAMON. INT. CL. 18. (U.S. CLS. 1, 2, 3, 22 AND 41). REG. 9-30-1997.
- 2,101,112. ERICKSON BEAMON. INT. CL. 25. (U.S. CLS. 22 AND 39). REG. 9-30-1997.
- 2,101,113. ERICKSON BEAMON. INT. CL. 14. (U.S. CLS. 2, 27, 28 AND 50). REG. 9-30-1997.
- 2,101,134. MISCELLANEOUS DESIGN. INT. CLS. 36 AND 42. (U.S. CLS. 100, 101 AND 102). REG. 9-30-1997.
- 2,101,365. DERMA DREAM. INT. CL. 5. (U.S. CLS. 6, 18, 44, 46, 51 AND 52). REG. 9-30-1997.

- 2,101,422. FL MP AND DESIGN. INT. CL. 42. (U.S. CLS. 100 AND 101). REG. 9-30-1997.
- 2,101,432. HALLELUJAH ACRES. INT. CL. 35. (U.S. CLS. 100, 101 AND 102). REG. 9-30-1997.
- 2,101,450. BIG AL'S. INT. CL. 37. (U.S. CLS. 100, 103 AND 106). REG. 9-30-1997.
- 2,101,670. SKIRT. INT. CL. 16. (U.S. CLS. 2, 5, 22, 23, 29, 37, 38 AND 50). REG. 9-30-1997.
- 2,102,317. TENNESSEE CONNECTIONS. INT. CL. 16. (U.S. CLS. 2, 5, 22, 23, 29, 37, 38 AND 50). REG. 9-30-1997.
- 2,102,326. PERCEPTIONS... AND REALITIES. INT. CLS. 35 AND 42. (U.S. CLS. 100, 101 AND 102). REG. 9-30-1997.
- 2,102,343. WILDFIRE (STYLIZED). INT. CL. 41. (U.S. CLS. 100, 101 AND 107). REG. 9-30-1997.
- 2,102,437. EL POLLO SUPREMO. INT. CL. 42. (U.S. CLS. 100 AND 101). REG. 10-7-1997.
- 2,102,553. ANYTHING THAT TEARS. INT. CL. 40. (U.S. CLS. 100, 103 AND 106). REG. 10-7-1997.
- 2,103,059. AMERICA'S SUMMER PLACE. INT. CL. 42. (U.S. CLS. 100 AND 101). REG. 10-7-1997.
- 2,103,060. WORLD'S LARGEST SUMMER HOTEL. INT. CL. 42. (U.S. CLS. 100 AND 101). REG. 10-7-1997.
- 2,103,077. SPECIAL DARK. INT. CL. 30. (U.S. CL. 46). REG. 10-7-1997.
- 2,103,279. MISCELLANEOUS DESIGN. INT. CL. 37. (U.S. CLS. 100, 103 AND 106). REG. 10-7-1997.
- 2,103,280. ALWAYS A DEAL YOU CAN TRUST. INT. CL. 37. (U.S. CLS. 100, 103 AND 106). REG. 10-7-1997.
- 2,103,292. KERRYBITS. INT. CL. 30. (U.S. CL. 46). REG. 10-7-1997.
- 2,103,462. 3M. INT. CL. 3. (U.S. CLS. 1, 4, 6, 50, 51 AND 52). REG. 10-7-1997.
- 2,103,624. RB AND DESIGN. INT. CL. 14. (U.S. CLS. 2, 27, 28 AND 50). REG. 10-7-1997.
- 2,103,885. FRENCH CAFE. INT. CL. 21. (U.S. CLS. 2, 13, 23, 29, 30, 33, 40 AND 50). REG. 10-7-1997.
- 2,104,130. CLAMATO PICANTE. INT. CL. 32. (U.S. CLS. 45, 46 AND 48). REG. 10-7-1997.
- 2,104,460. PREFERRED SUEDE. INT. CL. 24. (U.S. CLS. 42 AND 50). REG. 10-7-1997.
- 2,105,265. ALC (STYLIZED). INT. CL. 7. (U.S. CLS. 13, 19, 21, 23, 31, 34 AND 35). REG. 10-14-1997.
- 2,105,869. HOME TECH. INT. CL. 9. (U.S. CLS. 21, 23, 26, 36 AND 38). REG. 10-14-1997.
- 2,106,517. ROCKINGHAM GROUP (STYLIZED). INT. CL. 36. (U.S. CLS. 100, 101 AND 102). REG. 10-21-1997.
- 2,106,797. TOYO. INT. CL. 15. (U.S. CLS. 2, 21 AND 36). REG. 10-21-1997.
- 2,106,939. CLOUD-NINE HERBAL DIP. INT. CL. 5. (U.S. CLS. 6, 18, 44, 46, 51 AND 52). REG. 10-21-1997.
- 2,106,985. MISCELLANEOUS DESIGN. INT. CLS. 35 AND 37. (U.S. CLS. 100, 101, 102, 103 AND 106). REG. 10-21-1997.
- 2,107,014. MALLARD SYSTEMS. INT. CL. 37. (U.S. CLS. 100, 103 AND 106). REG. 10-21-1997.
- 2,107,618. NEXTEC. INT. CL. 40. (U.S. CLS. 100, 103 AND 106). REG. 10-21-1997.
- 2,107,733. VERDICT. INT. CL. 28. (U.S. CLS. 22, 23, 38 AND 50). REG. 10-21-1997.
- 2,107,917. FLAT FOOT AND DESIGN. INT. CL. 10. (U.S. CLS. 26, 39 AND 44). REG. 10-21-1997.
- 2,108,285. HERDON (STYLIZED). INT. CL. 7. (U.S. CLS. 13, 19, 21, 23, 31, 34 AND 35). REG. 10-28-1997.
- 2,108,425. DUNBAR ARMORED. INT. CL. 39. (U.S. CLS. 100 AND 105). REG. 10-28-1997.
- 2,108,437. ENERGY CLUB. INT. CLS. 29, 30 AND 31. (U.S. CLS. 1 AND 46). REG. 10-28-1997.
- 2,108,700. TEKSOL. INT. CL. 3. (U.S. CLS. 1, 4, 6, 50, 51 AND 52). REG. 10-28-1997.
- 2,108,754. E EMERSON HORN EDITIONS AND DESIGN. INT. CL. 16. (U.S. CLS. 2, 5, 22, 23, 29, 37, 38 AND 50). REG. 10-28-1997.
- 2,109,112. VALTAP. INT. CL. 4. (U.S. CLS. 1, 6 AND 15). REG. 10-28-1997.
- 2,109,601. BINAURA. INT. CL. 9. (U.S. CLS. 21, 23, 26, 36 AND 38). REG. 10-28-1997.
- 2,109,624. P PING PONG AND DESIGN. INT. CL. 31. (U.S. CLS. 1 AND 46). REG. 10-28-1997.
- 2,109,843. EXPRESSIONS FROM HALLMARK AND DESIGN. INT. CL. 16. (U.S. CLS. 2, 5, 22, 23, 29, 37, 38 AND 50). REG. 10-28-1997.
- 2,110,760. ASIAMART. INT. CL. 35. (U.S. CLS. 100, 101 AND 102). REG. 11-4-1997.
- 2,111,069. H (STYLIZED). INT. CL. 9. (U.S. CLS. 21, 23, 26, 36 AND 38). REG. 11-4-1997.
- 2,111,070. DIRECT GENERAL FINANCIAL SERVICES. INT. CL. 36. (U.S. CLS. 100, 101 AND 102). REG. 11-4-1997.
- 2,111,190. BENESSERE. INT. CL. 33. (U.S. CLS. 47 AND 49). REG. 11-4-1997.
- 2,111,450. SWEET ESCAPES. INT. CL. 30. (U.S. CL. 46). REG. 11-4-1997.
- 2,111,604. NORTH SAILS. INT. CLS. 18, 22, 24, 25, 28 AND 40. (U.S. CLS. 1, 2, 3, 7, 19, 22, 23, 38, 39, 41, 42, 50, 100, 103 AND 106). REG. 11-11-1997.
- 2,111,746. GRANDVIEW. INT. CL. 20. (U.S. CLS. 2, 13, 22, 25, 32 AND 50). REG. 11-11-1997.
- 2,112,045. COOL POOL. INT. CL. 28. (U.S. CLS. 22, 23, 38 AND 50). REG. 11-11-1997.
- 2,112,553. SPACE CAMP. INT. CL. 16. (U.S. CLS. 2, 5, 22, 23, 29, 37, 38 AND 50). REG. 11-11-1997.
- 2,112,683. H (STYLIZED). INT. CL. 22. (U.S. CLS. 1, 2, 7, 19, 22, 42 AND 50). REG. 11-11-1997.
- 2,112,719. UDDERLY SMOOTH AND DESIGN. INT. CL. 5. (U.S. CLS. 6, 18, 44, 46, 51 AND 52). REG. 11-11-1997.
- 2,112,867. TOTAL PLASTICS, INC.. INT. CL. 42. (U.S. CLS. 100 AND 101). REG. 11-11-1997.
- 2,112,881. NOW. INT. CL. 9. (U.S. CLS. 21, 23, 26, 36 AND 38). REG. 11-11-1997.
- 2,113,275. KITCHENART. INT. CL. 21. (U.S. CLS. 2, 13, 23, 29, 30, 33, 40 AND 50). REG. 11-18-1997.
- 2,113,459. SKYWARD AND DESIGN. INT. CLS. 9, 41 AND 42. (U.S. CLS. 21, 23, 26, 36, 38, 100, 101 AND 107). REG. 11-18-1997.
- 2,113,661. MICROIDS. INT. CL. 28. (U.S. CLS. 22, 23, 38 AND 50). REG. 11-18-1997.
- 2,113,811. SPIRA/FLO (STYLIZED). INT. CL. 6. (U.S. CLS. 2, 12, 13, 14, 23, 25 AND 50). REG. 11-18-1997.
- 2,114,548. COLOR THRU. INT. CL. 19. (U.S. CLS. 1, 12, 33 AND 50). REG. 11-18-1997.
- 2,114,842. XPS. INT. CL. 10. (U.S. CLS. 26, 39 AND 44). REG. 11-18-1997.
- 2,114,854. H HUNKERS AND DESIGN. INT. CL. 25. (U.S. CLS. 22 AND 39). REG. 11-18-1997.
- 2,114,883. FIND YOUR STRENGTH. INT. CL. 25. (U.S. CLS. 22 AND 39). REG. 11-18-1997.
- 2,114,914. DENSEVEYOR. INT. CL. 7. (U.S. CLS. 13, 19, 21, 23, 31, 34 AND 35). REG. 11-25-1997.
- 2,115,577. CDF FIREFIGHTERS AND DESIGN. INT. CL. 25. (U.S. CLS. 22 AND 39). REG. 11-25-1997.
- 2,115,980. FX-2 AND DESIGN. INT. CL. 9. (U.S. CLS. 21, 23, 26, 36 AND 38). REG. 11-25-1997.
- 2,116,051. ARCTIC SPURS. INT. CL. 28. (U.S. CLS. 22, 23, 38 AND 50). REG. 11-25-1997.
- 2,116,161. SPECIAL LIX. INT. CL. 31. (U.S. CLS. 1 AND 46). REG. 11-25-1997.
- 2,116,444. SHOUT. INT. CL. 3. (U.S. CLS. 1, 4, 6, 50, 51 AND 52). REG. 11-25-1997.
- 2,116,469. SKIMMITS. INT. CL. 21. (U.S. CLS. 2, 13, 23, 29, 30, 33, 40 AND 50). REG. 11-25-1997.
- 2,116,777. INNUWINDOW. INT. CL. 35. (U.S. CLS. 100, 101 AND 102). REG. 11-25-1997.
- 2,116,892. BLISS. INT. CL. 42. (U.S. CLS. 100 AND 101). REG. 11-25-1997.
- 2,117,068. PRISM. INT. CL. 19. (U.S. CLS. 1, 12, 33 AND 50). REG. 11-25-1997.
- 2,118,091. IF YOU WANT A PIECE OF THE ACTION...YOU'VE GOT TO GET A PRESS PASS. INT. CL. 16. (U.S. CLS. 2, 5, 22, 23, 29, 37, 38 AND 50). REG. 12-2-1997.
- 2,118,679. GRAMERCY. INT. CL. 16. (U.S. CLS. 2, 5, 22, 23, 29, 37, 38 AND 50). REG. 12-9-1997.
- 2,119,161. IMPULSE. INT. CL. 10. (U.S. CLS. 26, 39 AND 44). REG. 12-9-1997.
- 2,119,530. FORST AND DESIGN. INT. CL. 7. (U.S. CLS. 13, 19, 21, 23, 31, 34 AND 35). REG. 12-9-1997.
- 2,119,752. TOUCH-KNIFE. INT. CL. 8. (U.S. CLS. 23, 28 AND 44). REG. 12-9-1997.
- 2,119,851. ISOBAR. INT. CL. 1. (U.S. CLS. 1, 5, 6, 10, 26 AND 46). REG. 12-9-1997.
- 2,119,902. VIEW-LERS. INT. CL. 16. (U.S. CLS. 2, 5, 22, 23, 29, 37, 38 AND 50). REG. 12-9-1997.
- 2,119,907. 7 SHORES. INT. CL. 29. (U.S. CL. 46). REG. 12-9-1997.

- 2,120,181. NITROSTEEL. INT. CLS. 6 AND 40. (U.S. CLS. 2, 12, 13, 14, 23, 25, 50, 100, 103 AND 106). REG. 12-9-1997.
- 2,120,240. EASY 1. INT. CL. 36. (U.S. CLS. 100, 101 AND 102). REG. 12-9-1997.
- 2,120,267. PSYCSEARCH (STYLIZED). INT. CL. 42. (U.S. CLS. 100 AND 101). REG. 12-9-1997.
- 2,120,339. DALMATIAN PRESS. INT. CLS. 16 AND 41. (U.S. CLS. 2, 5, 22, 23, 29, 37, 38, 50, 100, 101 AND 107). REG. 12-9-1997.
- 2,120,410. TPI. INT. CL. 42. (U.S. CLS. 100 AND 101). REG. 12-9-1997.
- 2,120,453. HIT HARD (STYLIZED). INT. CL. 25. (U.S. CLS. 22 AND 39). REG. 12-9-1997.
- 2,120,837. SIHI DRY (STYLIZED). INT. CL. 7. (U.S. CLS. 13, 19, 21, 23, 31, 34 AND 35). REG. 12-16-1997.
- 2,120,879. SOLITAIRE MANIA. INT. CL. 28. (U.S. CLS. 22, 23, 38 AND 50). REG. 12-16-1997.
- 2,120,900. ANACAPA AND DESIGN. INT. CL. 31. (U.S. CLS. 1 AND 46). REG. 12-16-1997.
- 2,120,990. CONDUX. INT. CLS. 7 AND 9. (U.S. CLS. 13, 19, 21, 23, 26, 31, 34, 35, 36 AND 38). REG. 12-16-1997.
- 2,121,244. PRIORITY SYSTEMS. INT. CL. 35. (U.S. CLS. 100, 101 AND 102). REG. 12-16-1997.
- 2,121,310. CROCAS PBT. INT. CL. 9. (U.S. CLS. 21, 23, 26, 36 AND 38). REG. 12-16-1997.
- 2,121,618. SYON. INT. CL. 1. (U.S. CLS. 1, 5, 6, 10, 26 AND 46). REG. 12-16-1997.
- 2,121,672. TENDER SECRETS AND DESIGN. INT. CL. 25. (U.S. CLS. 22 AND 39). REG. 12-16-1997.
- 2,121,683. BLACK SHADOW AND DESIGN. INT. CL. 25. (U.S. CLS. 22 AND 39). REG. 12-16-1997.
- 2,121,686. WIN STUFF. INT. CL. 41. (U.S. CLS. 100, 101 AND 107). REG. 12-16-1997.
- 2,122,284. DAIHOS FIRST CHOICE. INT. CL. 30. (U.S. CL. 46). REG. 12-16-1997.
- 2,122,386. GRILL HAPPY. INT. CL. 30. (U.S. CL. 46). REG. 12-16-1997.
- 2,122,605. STONE CREEK. INT. CL. 30. (U.S. CL. 46). REG. 12-23-1997.
- 2,123,032. MISCELLANEOUS DESIGN. INT. CL. 42. (U.S. CLS. 100 AND 101). REG. 12-23-1997.
- 2,123,612. HANDY ART AND DESIGN. INT. CL. 2. (U.S. CLS. 6, 11 AND 16). REG. 12-23-1997.
- 2,123,637. HANDY ART (STYLIZED). INT. CL. 2. (U.S. CLS. 6, 11 AND 16). REG. 12-23-1997.
- 2,123,869. GLEAMING SKIN. INT. CL. 3. (U.S. CLS. 1, 4, 6, 50, 51 AND 52). REG. 12-23-1997.
- 2,123,906. ACME. INT. CL. 31. (U.S. CLS. 1 AND 46). REG. 12-23-1997.
- 2,124,045. DUCK POND CELLARS. INT. CL. 33. (U.S. CLS. 47 AND 49). REG. 12-23-1997.
- 2,124,144. MICROZIDE. INT. CL. 5. (U.S. CLS. 6, 18, 44, 46, 51 AND 52). REG. 12-23-1997.
- 2,124,206. PETROVIEW PLUS. INT. CL. 9. (U.S. CLS. 21, 23, 26, 36 AND 38). REG. 12-23-1997.
- 2,124,601. NAUTICUS. INT. CL. 25. (U.S. CLS. 22 AND 39). REG. 12-30-1997.
- 2,125,047. AUTO CONNECTION A PROGRAM OF CFCU FINANCIAL SERVICES, INC. AND DESIGN. INT. CLS. 36 AND 39. (U.S. CLS. 100, 101, 102 AND 105). REG. 12-30-1997.
- 2,125,399. MULTI-WRAP. INT. CL. 16. (U.S. CLS. 2, 5, 22, 23, 29, 37, 38 AND 50). REG. 12-30-1997.
- 2,125,448. LEADERSHIP/IMPACT. INT. CLS. 16 AND 41. (U.S. CLS. 2, 5, 22, 23, 29, 37, 38, 50, 100, 101 AND 107). REG. 12-30-1997.
- 2,125,673. FORUM ONE. INT. CL. 42. (U.S. CLS. 100 AND 101). REG. 12-30-1997.
- 2,125,784. INNEREAM TRENCHLESS PIPE REPLACEMENT SYSTEM AND DESIGN. INT. CL. 37. (U.S. CLS. 100, 103 AND 106). REG. 12-30-1997.
- 2,125,790. POWERPLY. INT. CL. 28. (U.S. CLS. 22, 23, 38 AND 50). REG. 12-30-1997.
- 2,125,860. RHEEM - RUUD UNIVERSAL AND DESIGN. INT. CL. 11. (U.S. CLS. 13, 21, 23, 31 AND 34). REG. 12-30-1997.
- 2,126,950. MARBLE/MARBLE (STYLIZED). INT. CL. 41. (U.S. CLS. 100, 101 AND 107). REG. 1-6-1998.
- 2,127,275. CRUISE MASTERS. INT. CL. 39. (U.S. CLS. 100 AND 105). REG. 1-6-1998.
- 2,127,638. TAX PRO. INT. CL. 9. (U.S. CLS. 21, 23, 26, 36 AND 38). REG. 1-6-1998.
- 2,127,739. NUTRALICIOUS. INT. CL. 5. (U.S. CLS. 6, 18, 44, 46, 51 AND 52). REG. 1-6-1998.
- 2,127,981. A ACTIVE ANKLE AND DESIGN. INT. CLS. 10 AND 28. (U.S. CLS. 22, 23, 26, 38, 39, 44 AND 50). REG. 1-13-1998.
- 2,128,606. STEELSEAL. INT. CL. 1. (U.S. CLS. 1, 5, 6, 10, 26 AND 46). REG. 1-13-1998.
- 2,128,736. SAHARA. INT. CL. 10. (U.S. CLS. 26, 39 AND 44). REG. 1-13-1998.
- 2,129,488. ALCOQUEST. INT. CL. 1. (U.S. CLS. 1, 5, 6, 10, 26 AND 46). REG. 1-13-1998.
- 2,130,224. REI AND DESIGN. INT. CL. 35. (U.S. CLS. 100, 101 AND 102). REG. 1-20-1998.
- 2,130,337. JUNK YARD DOG. INT. CL. 9. (U.S. CLS. 21, 23, 26, 36 AND 38). REG. 1-20-1998.
- 2,130,475. HILTON. INT. CL. 11. (U.S. CLS. 13, 21, 23, 31 AND 34). REG. 1-20-1998.
- 2,130,566. PEPE LOPEZ. INT. CL. 33. (U.S. CLS. 47 AND 49). REG. 1-20-1998.
- 2,130,580. THE EGG & I AND DESIGN. INT. CL. 42. (U.S. CLS. 100 AND 101). REG. 1-20-1998.
- 2,130,959. NATULOVE. INT. CL. 21 ONLY. (U.S. CLS. 2, 13, 23, 29, 30, 33, 40 AND 50). REG. 1-20-1998.
- 2,131,088. STANDARD TEXTILE AND DESIGN. INT. CLS. 35 AND 42. (U.S. CLS. 100, 101 AND 102). REG. 1-20-1998.
- 2,131,330. OVATION. INT. CL. 10. (U.S. CLS. 26, 39 AND 44). REG. 1-20-1998.
- 2,131,589. GRIFFON CORPORATION AND DESIGN. INT. CL. 35. (U.S. CLS. 100, 101 AND 102). REG. 1-27-1998.
- 2,131,788. HOG. INT. CL. 9. (U.S. CLS. 21, 23, 26, 36 AND 38). REG. 1-27-1998.
- 2,131,819. MICRO PRECISION. INT. CL. 7. (U.S. CLS. 13, 19, 21, 23, 31, 34 AND 35). REG. 1-27-1998.
- 2,132,494. KERGUN. INT. CL. 19. (U.S. CLS. 1, 12, 33 AND 50). REG. 1-27-1998.
- 2,132,495. KERPLAST. INT. CL. 19. (U.S. CLS. 1, 12, 33 AND 50). REG. 1-27-1998.
- 2,132,759. MRS. GROSSMAN'S. INT. CL. 16. (U.S. CLS. 2, 5, 22, 23, 29, 37, 38 AND 50). REG. 1-27-1998.
- 2,132,854. PAR-A-DICE. INT. CL. 41. (U.S. CLS. 100, 101 AND 107). REG. 1-27-1998.
- 2,133,198. STARK SISTERS GRANOLA (STYLIZED). INT. CL. 30. (U.S. CL. 46). REG. 1-27-1998.
- 2,133,292. COLONIAL CONNECTION. INT. CL. 36. (U.S. CLS. 100, 101 AND 102). REG. 1-27-1998.
- 2,133,593. K B. INT. CL. 29. (U.S. CL. 46). REG. 2-3-1998.
- 2,133,763. PURESYN INC.. INT. CL. 5. (U.S. CLS. 6, 18, 44, 46, 51 AND 52). REG. 2-3-1998.
- 2,134,039. U.P.T., INC. INSPECTION & RESTORATION SERVICES AND DESIGN. INT. CL. 37. (U.S. CLS. 100, 103 AND 106). REG. 2-3-1998.
- 2,137,001. S AND DESIGN. INT. CL. 1. (U.S. CLS. 1, 5, 6, 10, 26 AND 46). REG. 2-17-1998.
- 2,137,212. RUNABOUT. INT. CL. 12. (U.S. CLS. 19, 21, 23, 31, 35 AND 44). REG. 2-17-1998.
- 2,137,838. SAMPLETS. INT. CL. 30. (U.S. CL. 46). REG. 2-17-1998.
- 2,138,342. CARLO PAZOLINI AND DESIGN. INT. CLS. 18 AND 25. (U.S. CLS. 1, 2, 3, 22, 39 AND 41). REG. 2-24-1998.
- 2,138,421. TANVIR. INT. CL. 25. (U.S. CLS. 22 AND 39). REG. 2-24-1998.
- 2,138,573. ACE. INT. CL. 12. (U.S. CLS. 19, 21, 23, 31, 35 AND 44). REG. 2-24-1998.
- 2,139,179. NAWLA TRADERS MARKET. INT. CL. 35. (U.S. CLS. 100, 101 AND 102). REG. 2-24-1998.
- 2,139,964. SURF RIDE. INT. CLS. 25 AND 28. (U.S. CLS. 22, 23, 38, 39 AND 50). REG. 3-3-1998.
- 2,140,170. AEROTRON. INT. CL. 11. (U.S. CLS. 13, 21, 23, 31 AND 34). REG. 3-3-1998.
- 2,141,632. GENERATION ACTS. INT. CL. 41. (U.S. CLS. 100, 101 AND 107). REG. 3-3-1998.
- 2,142,581. BG. INT. CL. 31. (U.S. CLS. 1 AND 46). REG. 3-10-1998.
- 2,142,586. TASSAJARA. INT. CL. 12. (U.S. CLS. 19, 21, 23, 31, 35 AND 44). REG. 3-10-1998.
- 2,142,596. CD-RAMA. INT. CL. 9. (U.S. CLS. 21, 23, 26, 36 AND 38). REG. 3-10-1998.
- 2,145,308. BLITZ. INT. CL. 7. (U.S. CLS. 13, 19, 21, 23, 31, 34 AND 35). REG. 3-17-1998.
- 2,145,891. FPIC AND DESIGN. INT. CL. 36. (U.S. CLS. 100, 101 AND 102). REG. 3-24-1998.
- 2,146,279. BIG MAX. INT. CL. 12. (U.S. CLS. 19, 21, 23, 31, 35 AND 44). REG. 3-24-1998.

- 2,147,394. TECHNI EDGE. INT. CL. 8. (U.S. CLS. 23, 28 AND 44). REG. 3-31-1998.
- 2,147,395. SEATFINDER. INT. CL. 39. (U.S. CLS. 100 AND 105). REG. 3-31-1998.
- 2,148,365. CHALLENGER. INT. CL. 11. (U.S. CLS. 13, 21, 23, 31 AND 34). REG. 3-31-1998.
- 2,148,437. DENTAL INDEMNITY USA. INT. CL. 36. (U.S. CLS. 100, 101 AND 102). REG. 3-31-1998.
- 2,148,485. TITAN SPEED ENGINEERING AND DESIGN. INT. CL. 7. (U.S. CLS. 13, 19, 21, 23, 31, 34 AND 35). REG. 4-7-1998.
- 2,149,643. POLY PELLET. INT. CL. 21. (U.S. CLS. 2, 13, 23, 29, 30, 33, 40 AND 50). REG. 4-7-1998.
- 2,150,451. PERE ALESSANDRO. INT. CL. 33. (U.S. CLS. 47 AND 49). REG. 4-14-1998.
- 2,150,603. MEDIMETRIX. INT. CL. 35. (U.S. CLS. 100, 101 AND 102). REG. 4-14-1998.
- 2,150,641. T & C SURF. INT. CL. 35. (U.S. CLS. 100, 101 AND 102). REG. 4-14-1998.
- 2,150,928. AFFINITY. INT. CL. 33. (U.S. CLS. 47 AND 49). REG. 4-14-1998.
- 2,151,576. ARROW RACING AND DESIGN. INT. CL. 12. (U.S. CLS. 19, 21, 23, 31, 35 AND 44). REG. 4-21-1998.
- 2,152,147. MEDIMETRIX AND DESIGN. INT. CL. 35. (U.S. CLS. 100, 101 AND 102). REG. 4-21-1998.
- 2,152,166. WHAT'S HAPPENING (STYLIZED). INT. CL. 16. (U.S. CLS. 2, 5, 22, 23, 29, 37, 38 AND 50). REG. 4-21-1998.
- 2,152,167. FIESTA (STYLIZED). INT. CL. 16. (U.S. CLS. 2, 5, 22, 23, 29, 37, 38 AND 50). REG. 4-21-1998.
- 2,152,980. GRAND DADDY. INT. CL. 31. (U.S. CLS. 1 AND 46). REG. 4-21-1998.
- 2,153,734. FAITH IN ACTION. INT. CL. 36. (U.S. CLS. 100, 101 AND 102). REG. 4-28-1998.
- 2,154,300. UNLYTIC. INT. CL. 9. (U.S. CLS. 21, 23, 26, 36 AND 38). REG. 4-28-1998.
- 2,154,331. TORCUP (STYLIZED). INT. CL. 7. (U.S. CLS. 13, 19, 21, 23, 31, 34 AND 35). REG. 4-28-1998.
- 2,154,858. BUDOSHIN JU-JITSU YUDANSHAKAI AND DESIGN. INT. CL. 41. (U.S. CLS. 100, 101 AND 107). REG. 5-5-1998.
- 2,155,329. TOPCATS. INT. CL. 41. (U.S. CLS. 100, 101 AND 107). REG. 5-5-1998.
- 2,155,368. SUNPATCH. INT. CL. 1. (U.S. CLS. 1, 5, 6, 10, 26 AND 46). REG. 5-5-1998.
- 2,155,439. BULLET POINTS. INT. CL. 36. (U.S. CLS. 100, 101 AND 102). REG. 5-5-1998.
- 2,156,060. CDF FIREFIGHTERS. INT. CLS. 16 AND 42. (U.S. CLS. 2, 5, 22, 23, 29, 37, 38, 50, 100 AND 101). REG. 5-12-1998.
- 2,156,356. IST AND DESIGN. INT. CL. 36. (U.S. CLS. 100, 101 AND 102). REG. 5-12-1998.
- 2,156,772. CHAPERON. INT. CL. 16 ONLY. (U.S. CLS. 2, 5, 22, 23, 29, 37, 38 AND 50). REG. 5-12-1998.
- 2,157,903. FRUIT CHOCOLATES. INT. CL. 30. (U.S. CL. 46). REG. 5-12-1998.
- 2,158,382. JOIN-UP. INT. CL. 41. (U.S. CLS. 100, 101 AND 107). REG. 5-19-1998.
- 2,158,510. EXPECTMORE. INT. CL. 42. (U.S. CLS. 100 AND 101). REG. 5-19-1998.
- 2,158,638. TRIPS FOR KIDS. INT. CL. 41. (U.S. CLS. 100, 101 AND 107). REG. 5-19-1998.
- 2,158,649. ZEBBRANO. INT. CL. 12. (U.S. CLS. 19, 21, 23, 31, 35 AND 44). REG. 5-19-1998.
- 2,158,867. MISCELLANEOUS DESIGN. INT. CL. 5. (U.S. CLS. 6, 18, 44, 46, 51 AND 52). REG. 5-19-1998.
- 2,159,030. IT STICK. INT. CL. 3. (U.S. CLS. 1, 4, 6, 50, 51 AND 52). REG. 5-19-1998.
- 2,159,633. WEBLOGIC. INT. CL. 9. (U.S. CLS. 21, 23, 26, 36 AND 38). REG. 5-19-1998.
- 2,160,094. THE HEALTHY SUPERMARKET. INT. CLS. 35 AND 42. (U.S. CLS. 100, 101 AND 102). REG. 5-26-1998.
- 2,160,095. EARTH FARE. INT. CLS. 35 AND 42. (U.S. CLS. 100, 101 AND 102). REG. 5-26-1998.
- 2,160,564. PET-CAL. INT. CL. 5. (U.S. CLS. 6, 18, 44, 46, 51 AND 52). REG. 5-26-1998.
- 2,160,704. MARACOM. INT. CL. 16. (U.S. CLS. 2, 5, 22, 23, 29, 37, 38 AND 50). REG. 5-26-1998.
- 2,161,298. LINKWAY. INT. CL. 9. (U.S. CLS. 21, 23, 26, 36 AND 38). REG. 6-2-1998.
- 2,161,548. APRENDA. INT. CL. 16. (U.S. CLS. 2, 5, 22, 23, 29, 37, 38 AND 50). REG. 6-2-1998.
- 2,162,134. CHESTER EARTH ANT. INT. CL. 16. (U.S. CLS. 2, 5, 22, 23, 29, 37, 38 AND 50). REG. 6-2-1998.
- 2,162,470. AGGRESSIVE EYEWEAR. INT. CL. 9. (U.S. CLS. 21, 23, 26, 36 AND 38). REG. 6-2-1998.
- 2,162,720. THE SLOMIN'S SHIELD HOME SECURITY SYSTEM 1 800 ALARM ME AND DESIGN. INT. CL. 37. (U.S. CLS. 100, 103 AND 106). REG. 6-2-1998.
- 2,163,782. BA BLUE ANGEL PLUS (STYLIZED). INT. CL. 11. (U.S. CLS. 13, 21, 23, 31 AND 34). REG. 6-9-1998.
- 2,163,978. THE COSTCO CONNECTION. INT. CL. 16. (U.S. CLS. 2, 5, 22, 23, 29, 37, 38 AND 50). REG. 6-9-1998.
- 2,164,079. MISCELLANEOUS DESIGN. INT. CL. 31. (U.S. CLS. 1 AND 46). REG. 6-9-1998.
- 2,164,506. LUXURELLE. INT. CLS. 20 AND 24. (U.S. CLS. 2, 13, 22, 25, 32, 42 AND 50). REG. 6-9-1998.
- 2,164,531. KEY WEST AIRE AND DESIGN. INT. CL. 11. (U.S. CLS. 13, 21, 23, 31 AND 34). REG. 6-9-1998.
- 2,164,537. EDGECOAT AND DESIGN. INT. CL. 6. (U.S. CLS. 2, 12, 13, 14, 23, 25 AND 50). REG. 6-9-1998.
- 2,164,596. THE SLOMIN'S SHIELD HOME SECURITY SYSTEM 1 800 ALARM ME AND DESIGN. INT. CL. 42. (U.S. CLS. 100 AND 101). REG. 6-9-1998.
- 2,164,724. STAMPEDE. INT. CL. 22. (U.S. CLS. 1, 2, 7, 19, 22, 42 AND 50). REG. 6-9-1998.
- 2,165,157. BUSINESS PLAN PRO. INT. CL. 9. (U.S. CLS. 21, 23, 26, 36 AND 38). REG. 6-16-1998.
- 2,165,713. DESIGNED BY CHEFS FOR CHEFS. INT. CL. 25. (U.S. CLS. 22 AND 39). REG. 6-16-1998.
- 2,165,847. THERMA-WAVE. INT. CL. 9. (U.S. CLS. 21, 23, 26, 36 AND 38). REG. 6-16-1998.
- 2,166,489. ACID PLUS. INT. CL. 3. (U.S. CLS. 1, 4, 6, 50, 51 AND 52). REG. 6-16-1998.
- 2,166,780. WATCH THAT CHILD!. INT. CL. 42. (U.S. CLS. 100 AND 101). REG. 6-23-1998.
- 2,167,139. SERVCO. INT. CL. 35. (U.S. CLS. 100, 101 AND 102). REG. 6-23-1998.
- 2,167,363. SUPERCOOL. INT. CL. 1. (U.S. CLS. 1, 5, 6, 10, 26 AND 46). REG. 6-23-1998.
- 2,168,337. SPIRITSMITH. INT. CL. 42. (U.S. CLS. 100 AND 101). REG. 6-23-1998.
- 2,168,659. CLEARLY THE VERIBEST TASTE AND DESIGN. INT. CL. 30. (U.S. CL. 46). REG. 6-23-1998.
- 2,169,144. ADVOSERV. INT. CLS. 41 AND 42. (U.S. CLS. 100, 101 AND 107). REG. 6-30-1998.
- 2,169,170. SOUNDTRACKER. INT. CL. 9. (U.S. CLS. 21, 23, 26, 36 AND 38). REG. 6-30-1998.
- 2,169,486. AUGUSTA. INT. CL. 11. (U.S. CLS. 13, 21, 23, 31 AND 34). REG. 6-30-1998.
- 2,169,624. CLR AND DESIGN. INT. CL. 3. (U.S. CLS. 1, 4, 6, 50, 51 AND 52). REG. 6-30-1998.
- 2,170,356. PARROT. INT. CL. 30. (U.S. CL. 46). REG. 6-30-1998.
- 2,171,081. BST AND DESIGN. INT. CLS. 41 AND 42. (U.S. CLS. 100, 101 AND 107). REG. 7-7-1998.
- 2,171,163. ASSOCIATED PARTSTOCK AND DESIGN. INT. CL. 39. (U.S. CLS. 100 AND 105). REG. 7-7-1998.
- 2,171,653. ULTRASEEK. INT. CLS. 9 AND 42. (U.S. CLS. 21, 23, 26, 36, 38, 100 AND 101). REG. 7-7-1998.
- 2,171,881. GREAT GRIP. INT. CL. 8. (U.S. CLS. 23, 28 AND 44). REG. 7-7-1998.
- 2,171,926. STAMPEDE AND DESIGN. INT. CL. 22. (U.S. CLS. 1, 2, 7, 19, 22, 42 AND 50). REG. 7-7-1998.
- 2,172,615. LONGABERGER. INT. CLS. 20 AND 21. (U.S. CLS. 2, 13, 22, 23, 25, 29, 30, 32, 33, 40 AND 50). REG. 7-14-1998.
- 2,172,683. ASSOCIATED INTERNATIONAL AND DESIGN. INT. CL. 39. (U.S. CLS. 100 AND 105). REG. 7-14-1998.
- 2,173,074. THE OFFICE PROFESSIONAL. INT. CL. 16. (U.S. CLS. 2, 5, 22, 23, 29, 37, 38 AND 50). REG. 7-14-1998.
- 2,174,225. ELLISON (STYLIZED). INT. CL. 16. (U.S. CLS. 2, 5, 22, 23, 29, 37, 38 AND 50). REG. 7-21-1998.
- 2,174,310. LEAFLET MISSAL. INT. CL. 16. (U.S. CLS. 2, 5, 22, 23, 29, 37, 38 AND 50). REG. 7-21-1998.
- 2,174,788. WINPROXY. INT. CL. 9. (U.S. CLS. 21, 23, 26, 36 AND 38). REG. 7-21-1998.
- 2,175,003. THE RELATIONSHIP EXPERTS. INT. CL. 42. (U.S. CLS. 100 AND 101). REG. 7-21-1998.
- 2,175,678. VISUALCN. INT. CL. 9. (U.S. CLS. 21, 23, 26, 36 AND 38). REG. 7-21-1998.
- 2,176,034. MISCELLANEOUS DESIGN. INT. CL. 41. (U.S. CLS. 100, 101 AND 107). REG. 7-28-1998.

SEPT. 25, 2007

U.S. PATENT AND TRADEMARK OFFICE

TM 1665

2,176,419. GIANT TIGER. INT. CL. 35. (U.S. CLS. 100, 101 AND 102). REG. 7-28-1998. 2,176,706. HSC. INT. CL. 42. (U.S. CLS. 100 AND 101). REG. 7-28-1998.

* * * * *

TRADEMARK REGISTRATIONS CANCELED

The designation "U.S. Cl." appearing in this section refers to the U.S. class in effect prior to Sep. 1, 1973 rather than the international class which applies to applications filed on or after that date. For adoption of international classification see notice in the OFFICIAL GAZETTE of Jun. 26, 1973 (911 O.G. TM 210).

SECTION 7(D)

- 1,465,509. SAVANT. INT. CL. 20. REG. 11-17-1987.
2,072,096. THE ALWAYS FITTING BRA. INT. CL. 25. REG. 6-17-1997.
2,355,395. VIVAYOU AND DESIGN. INT. CL. 25. REG. 6-6-2000.
2,444,059. AG-TUFF. INT. CL. 19. REG. 4-17-2001.
2,489,899. J E E V E S AND DESIGN. INT. CL. 11. REG. 9-18-2001.
2,511,836. LI & FUNG AND DESIGN. INT. CL. 25. REG. 11-27-2001.
2,641,327. LIVEADVICE. INT. CL. 35. REG. 10-22-2002.
2,648,423. FINESSA (STYLIZED). INT. CLS. 29 AND 32. REG. 11-12-2002.
2,903,198. BONNE BOUCHÉE (STYLIZED). INT. CL. 30. REG. 11-16-2004.
2,971,097. BAD BOY. INT. CL. 5. REG. 7-19-2005.
3,175,040. PEOPLE. PROCESS. PERFORMANCE. STANDARD CHARACTER MARK INT. CLS. 16, 35 AND 41. REG. 11-21-2006.
- 1,416,378. MISCELLANEOUS DESIGN. INT. CL. 5. REG. 11-11-1986.
1,416,381. 3M (STYLIZED). INT. CL. 5. REG. 11-11-1986.
1,416,383. BLAZER AND DESIGN. INT. CLS. 6 AND 28. REG. 11-11-1986.
1,416,385. SNAP-UP. INT. CL. 6. REG. 11-11-1986.
1,416,386. P-H-I-L-A-D-E-L-P-H-I-A GET TO KNOW US! AND DESIGN. INT. CLS. 6, 12, 14, 16, 18, 20, 21, 24, 25, 26 AND 35. REG. 11-11-1986.
1,416,393. BRSP. INT. CL. 6. REG. 11-11-1986.
1,416,396. CRAFTSMAN. INT. CL. 6. REG. 11-11-1986.
1,416,397. QUARTER-MILER AND DESIGN. INT. CL. 6. REG. 11-11-1986.
1,416,398. EASY CLAMP. INT. CL. 6. REG. 11-11-1986.
1,416,400. MISCELLANEOUS DESIGN. INT. CL. 6. REG. 11-11-1986.
1,416,403. THE WINDOW OF A LIFETIME. INT. CL. 6. REG. 11-11-1986.
1,416,404. HANDY ANDY. INT. CL. 6. REG. 11-11-1986.
1,416,405. SPARKLE. INT. CL. 7. REG. 11-11-1986.
1,416,410. SUNDS DEFIBRATOR AND DESIGN. INT. CLS. 7, 9 AND 11. REG. 11-11-1986.
1,416,411. WALE. INT. CL. 7. REG. 11-11-1986.
1,416,422. TD. INT. CL. 7. REG. 11-11-1986.
1,416,429. VP SYSTEM (STYLIZED). INT. CL. 7. REG. 11-11-1986.
1,416,433. MEDALIST. INT. CL. 8. REG. 11-11-1986.
1,416,435. GRT. INT. CL. 8. REG. 11-11-1986.
1,416,446. TREVITEST. INT. CL. 9. REG. 11-11-1986.
1,416,448. PLAYHOUSE VIDEO. INT. CL. 9. REG. 11-11-1986.
1,416,451. EASYCOM AND DESIGN. INT. CL. 9. REG. 11-11-1986.
1,416,452. DIPLOMAT. INT. CL. 9. REG. 11-11-1986.
1,416,460. SURGIWARE. INT. CL. 9. REG. 11-11-1986.
1,416,461. SOLARI UDINE. INT. CL. 9. REG. 11-11-1986.
1,416,462. EXCALIBUR (STYLIZED). INT. CL. 9. REG. 11-11-1986.
1,416,464. MSP. INT. CL. 9. REG. 11-11-1986.
1,416,467. TEMPLATES OF DOOM (STYLIZED). INT. CL. 9. REG. 11-11-1986.
1,416,471. FOLLOW ME. INT. CLS. 9 AND 16. REG. 11-11-1986.
1,416,472. TYM/COMM. INT. CL. 9. REG. 11-11-1986.
1,416,477. ULTRASTEP. INT. CL. 9. REG. 11-11-1986.
1,416,482. SCHOLAR CHIPS SOFTWARE, INC.. INT. CL. 9. REG. 11-11-1986.
1,416,483. MICRODOT. INT. CL. 9. REG. 11-11-1986.
1,416,484. DIGITAL DINING. INT. CL. 9. REG. 11-11-1986.
1,416,487. THE BLUE JEANS MILLIONAIRE. INT. CL. 9. REG. 11-11-1986.
1,416,488. SUPER DUPER. INT. CL. 9. REG. 11-11-1986.
1,416,489. TIME. INT. CL. 9. REG. 11-11-1986.
1,416,493. 5000. INT. CL. 9. REG. 11-11-1986.
1,416,501. BICOR. INT. CL. 10. REG. 11-11-1986.
1,416,502. TACH-E-Z MICRO COIL (STYLIZED). INT. CL. 10. REG. 11-11-1986.
1,416,503. BODY GLOVE (STYLIZED). INT. CLS. 10, 14, 18, 25 AND 28. REG. 11-11-1986.
1,416,509. SAN-SPLINT (STYLIZED). INT. CL. 10. REG. 11-11-1986.
1,416,512. SECOR. INT. CL. 10. REG. 11-11-1986.
1,416,519. ROTO-LOUVER. INT. CL. 11. REG. 11-11-1986.
1,416,524. INERTRON. INT. CL. 11. REG. 11-11-1986.

SECTION 8

- 220,199. H. U.S. CL. 13. REG. 11-2-1926.
220,901. BUSCH PALE DRY GINGER ALE AND DESIGN. U.S. CL. 45. REG. 11-16-1926.
1,045,158. AFS. U.S. CLS. 3, 28, 37, 38 AND 39, ONLY. REG. 7-27-1976.
1,067,042. SPRINGFIELD. INT. CL. 5 ONLY. REG. 6-7-1977.
1,070,250. PILLOW KINGDOM. INT. CL. 37 ONLY. REG. 7-26-1977.
1,335,485. MISCELLANEOUS DESIGN. INT. CL. 16 ONLY. REG. 5-14-1985.
1,409,462. SCROLLWARE. INT. CL. 21. REG. 9-16-1986.
1,416,308. POWER X AND DESIGN. INT. CL. 1. REG. 11-11-1986.
1,416,320. BARNYARD AID. INT. CL. 1. REG. 11-11-1986.
1,416,322. RELEAD. INT. CL. 1. REG. 11-11-1986.
1,416,327. RESOLV. INT. CL. 2. REG. 11-11-1986.
1,416,331. CLEANER'S CHOICE. INT. CL. 3. REG. 11-11-1986.
1,416,332. TP ONE THOUSAND (STYLIZED). INT. CL. 3. REG. 11-11-1986.
1,416,336. KONA KLEEN. INT. CL. 3. REG. 11-11-1986.
1,416,337. CHAMELEON. INT. CL. 3. REG. 11-11-1986.
1,416,340. GINNIE JOHANSEN. INT. CL. 3. REG. 11-11-1986.
1,416,343. ELECTRODERMA BASIC. INT. CL. 3. REG. 11-11-1986.
1,416,353. GIBRALTAR. INT. CL. 3. REG. 11-11-1986.
1,416,360. EZY WRAP. INT. CLS. 5 AND 10. REG. 11-11-1986.
1,416,367. MISCELLANEOUS DESIGN. INT. CL. 5. REG. 11-11-1986.
1,416,374. LENS FRESH. INT. CL. 5. REG. 11-11-1986.
1,416,375. DEN-10 (STYLIZED). INT. CL. 5. REG. 11-11-1986.
1,416,376. PLAGATOX. INT. CL. 5. REG. 11-11-1986.
1,416,377. SPARTRIX. INT. CL. 5. REG. 11-11-1986.

- 1,416,526. CITATION COMFORT (STYLIZED). INT. CL. 11. REG. 11-11-1986.
- 1,416,527. SOFT WAREWASHING. INT. CL. 11. REG. 11-11-1986.
- 1,416,528. ELEGANTE. INT. CL. 11. REG. 11-11-1986.
- 1,416,532. BLACK MAX. INT. CL. 12. REG. 11-11-1986.
- 1,416,540. USA PRODUCTS AND DESIGN. INT. CLS. 12 AND 22. REG. 11-11-1986.
- 1,416,542. ULTRAVAR. INT. CL. 12. REG. 11-11-1986.
- 1,416,551. DIAMOND COMMANDER. INT. CL. 12. REG. 11-11-1986.
- 1,416,555. CONSTITUTION. INT. CL. 12. REG. 11-11-1986.
- 1,416,564. S.A.L.. INT. CL. 14. REG. 11-11-1986.
- 1,416,568. PHOTO BUYS. INT. CL. 16. REG. 11-11-1986.
- 1,416,578. PHYSICIANS' DESK REFERENCE FOR NON-PRESCRIPTION DRUGS. INT. CL. 16. REG. 11-11-1986.
- 1,416,579. PHYSICIANS' DESK REFERENCE FOR OPHTHALMOLOGY. INT. CL. 16. REG. 11-11-1986.
- 1,416,580. DENTAL HEALTH ADVISER. INT. CL. 16. REG. 11-11-1986.
- 1,416,589. REDLAW REDBOOK. INT. CL. 16. REG. 11-11-1986.
- 1,416,591. CLOSER THAN YOU THINK. INT. CL. 16. REG. 11-11-1986.
- 1,416,595. THE HUNTING & FISHING LIBRARY AND DESIGN. INT. CL. 16. REG. 11-11-1986.
- 1,416,600. MISCELLANEOUS DESIGN. INT. CL. 16. REG. 11-11-1986.
- 1,416,611. PATHFINDER. INT. CL. 16. REG. 11-11-1986.
- 1,416,623. GARLAND. INT. CL. 16. REG. 11-11-1986.
- 1,416,624. LIMUSA. INT. CL. 16. REG. 11-11-1986.
- 1,416,631. COMPUSLETTE. INT. CL. 16. REG. 11-11-1986.
- 1,416,655. SAFETY-SHIELD. INT. CL. 20. REG. 11-11-1986.
- 1,416,659. HOMECRAFT. INT. CL. 20. REG. 11-11-1986.
- 1,416,664. SEALY THE SLEEP EXPERTS. INT. CL. 20. REG. 11-11-1986.
- 1,416,669. KANGA-ROCKA-ROO (STYLIZED). INT. CL. 20. REG. 11-11-1986.
- 1,416,673. PM (STYLIZED). INT. CL. 20. REG. 11-11-1986.
- 1,416,678. PILLOWTONIC. INT. CL. 20. REG. 11-11-1986.
- 1,416,682. TAMPER-FRESH. INT. CL. 20. REG. 11-11-1986.
- 1,416,687. BOW AND DESIGN. INT. CL. 21. REG. 11-11-1986.
- 1,416,690. SCOOPER BOWL. INT. CL. 21. REG. 11-11-1986.
- 1,416,691. SPARTAN. INT. CL. 21. REG. 11-11-1986.
- 1,416,699. RAINSHOWER. INT. CL. 21. REG. 11-11-1986.
- 1,416,701. PROMISE. INT. CL. 23. REG. 11-11-1986.
- 1,416,710. ADJUSTAJEAN. INT. CL. 25. REG. 11-11-1986.
- 1,416,719. MISCELLANEOUS DESIGN. INT. CL. 25. REG. 11-11-1986.
- 1,416,727. X-STATICS AND DESIGN. INT. CL. 25. REG. 11-11-1986.
- 1,416,736. HARBOR ONE (STYLIZED). INT. CL. 25. REG. 11-11-1986.
- 1,416,737. HARBOR ONE AND DESIGN. INT. CL. 25. REG. 11-11-1986.
- 1,416,739. ACTIVITIES. INT. CL. 25. REG. 11-11-1986.
- 1,416,741. LITTLE RUFF. INT. CL. 25. REG. 11-11-1986.
- 1,416,742. "SATINMAID" (STYLIZED). INT. CL. 25. REG. 11-11-1986.
- 1,416,746. ULTRA PRO. INT. CL. 25. REG. 11-11-1986.
- 1,416,747. DIANA HARTMAN AND DESIGN. INT. CL. 25. REG. 11-11-1986.
- 1,416,763. LIBERTY. INT. CL. 28. REG. 11-11-1986.
- 1,416,793. BAT MITZBEAR. INT. CL. 28. REG. 11-11-1986.
- 1,416,795. BABYTIME. INT. CL. 28. REG. 11-11-1986.
- 1,416,796. STUFFS. INT. CL. 28. REG. 11-11-1986.
- 1,416,797. MISCELLANEOUS DESIGN. INT. CL. 28. REG. 11-11-1986.
- 1,416,803. CARD-B-LOON. INT. CL. 28. REG. 11-11-1986.
- 1,416,808. HOT SHOOTER. INT. CL. 28. REG. 11-11-1986.
- 1,416,811. BABY DON'T CRY. INT. CL. 28. REG. 11-11-1986.
- 1,416,813. WHERE IN THE WORLD ARE YOU?. INT. CL. 28. REG. 11-11-1986.
- 1,416,819. MISCELLANEOUS DESIGN. INT. CL. 29. REG. 11-11-1986.
- 1,416,822. OLD TIME. INT. CLS. 29, 30 AND 32. REG. 11-11-1986.
- 1,416,832. ENGLISH FARMSHIRE. INT. CL. 29. REG. 11-11-1986.
- 1,416,833. ROYAL COPENHAGEN. INT. CL. 29. REG. 11-11-1986.
- 1,416,838. TOFULITE. INT. CL. 30. REG. 11-11-1986.
- 1,416,842. ORIGINAL AMS-BREZEL AUS HEIDELBERG AND DESIGN. INT. CL. 30. REG. 11-11-1986.
- 1,416,843. STORCK AND DESIGN. INT. CL. 30. REG. 11-11-1986.
- 1,416,845. NEEDLERS. INT. CL. 30. REG. 11-11-1986.
- 1,416,848. AMERICAN HOST. INT. CL. 30. REG. 11-11-1986.
- 1,416,852. GLISTER. INT. CL. 30. REG. 11-11-1986.
- 1,416,856. DINNER BELL. INT. CL. 31. REG. 11-11-1986.
- 1,416,858. EMERALD ACRES, INC. AND DESIGN. INT. CL. 31. REG. 11-11-1986.
- 1,416,862. SOKOTA. INT. CL. 31. REG. 11-11-1986.
- 1,416,864. DIXIE PRIDE. INT. CL. 31. REG. 11-11-1986.
- 1,416,866. SPECIAL X. INT. CL. 31. REG. 11-11-1986.
- 1,416,879. JOSEF FRIEDERICH WEINBAU-WEINKELLER-EIEN-ZELL A.D. MOSEL AND DESIGN. INT. CL. 33. REG. 11-11-1986.
- 1,416,881. BARON DE LA LIGNE. INT. CL. 33. REG. 11-11-1986.
- 1,416,882. LA GRATITUDE. INT. CL. 33. REG. 11-11-1986.
- 1,416,886. CHESTNUT HILL. INT. CL. 33. REG. 11-11-1986.
- 1,416,889. TROPIK SUN FRUIT & NUT AND DESIGN. INT. CLS. 35 AND 42. REG. 11-11-1986.
- 1,416,890. P.K.G.'S (STYLIZED). INT. CLS. 35 AND 39. REG. 11-11-1986.
- 1,416,891. P.K.G.'S PACKAGING AND SENDING PROS AND DESIGN. INT. CLS. 35 AND 39. REG. 11-11-1986.
- 1,416,892. YOUR PARTNERS IN PRODUCTIVITY. INT. CLS. 35 AND 42. REG. 11-11-1986.
- 1,416,893. INTERNATIONAL PARTNERSHIP AND DESIGN. INT. CLS. 35 AND 42. REG. 11-11-1986.
- 1,416,899. MISCELLANEOUS DESIGN. INT. CL. 35. REG. 11-11-1986.
- 1,416,906. LOUISIANA WE'RE REALLY COOKIN'! AND DESIGN. INT. CL. 35. REG. 11-11-1986.
- 1,416,909. DOLPHIN AND DESIGN. INT. CL. 35. REG. 11-11-1986.
- 1,416,912. COMMON SENSE. INT. CL. 36. REG. 11-11-1986.
- 1,416,914. VMS REALTY, INC.. INT. CLS. 36 AND 37. REG. 11-11-1986.
- 1,416,916. CAL FED. INT. CL. 36. REG. 11-11-1986.
- 1,416,920. ASSURANCE PLUS A MANAGED APPROACH TO COST EFFECTIVE UTILIZATION (STYLIZED). INT. CL. 36. REG. 11-11-1986.
- 1,416,923. PROTECTING YOUR WAY OF LIFE THROUGHOUT THE WORLD. INT. CL. 36. REG. 11-11-1986.
- 1,416,924. LEISURE PARK. INT. CLS. 36, 41 AND 42. REG. 11-11-1986.
- 1,416,931. WEATHERPROOF BECAUSE THE SKY'S YOUR LIMIT... AND DESIGN. INT. CL. 36. REG. 11-11-1986.
- 1,416,937. M (STYLIZED). INT. CL. 36. REG. 11-11-1986.
- 1,416,945. TANDEM. INT. CL. 37. REG. 11-11-1986.
- 1,416,946. AFFORDABLE LUXURY HOMES AND DESIGN. INT. CLS. 37 AND 42. REG. 11-11-1986.
- 1,416,951. CARMEL MOUNTAIN RANCH (STYLIZED). INT. CL. 37. REG. 11-11-1986.
- 1,416,952. MISCELLANEOUS DESIGN. INT. CL. 37. REG. 11-11-1986.
- 1,416,953. NO FAULT TENNIS COURTS AND DESIGN. INT. CL. 37. REG. 11-11-1986.
- 1,416,954. THE COMPUTERIZED COBBLER. INT. CL. 37. REG. 11-11-1986.
- 1,416,956. MISCELLANEOUS DESIGN. INT. CL. 37. REG. 11-11-1986.
- 1,416,958. MISCELLANEOUS DESIGN. INT. CL. 37. REG. 11-11-1986.
- 1,416,959. LASERNET. INT. CL. 38. REG. 11-11-1986.
- 1,416,963. THE B. INT. CL. 39. REG. 11-11-1986.

- 1,416,965. AGENCY RENT-A-CAR A AND DESIGN. INT. CL. 39. REG. 11-11-1986.
- 1,416,967. COLUMBUS LINE. INT. CL. 39. REG. 11-11-1986.
- 1,416,968. SKY (STYLIZED). INT. CL. 39. REG. 11-11-1986.
- 1,416,969. ACTION EXPRESS. INT. CL. 39. REG. 11-11-1986.
- 1,416,980. TREVIAN. INT. CL. 41. REG. 11-11-1986.
- 1,416,981. NATIONAL GEOGRAPHIC EXPLORER. INT. CL. 41. REG. 11-11-1986.
- 1,416,985. CAREER ACCESS AND DESIGN. INT. CL. 41. REG. 11-11-1986.
- 1,416,986. VICTORY VIDEO. INT. CLS. 41 AND 42. REG. 11-11-1986.
- 1,416,989. DEVRY WE'RE SERIOUS ABOUT SUCCESS. INT. CL. 41. REG. 11-11-1986.
- 1,416,990. ADVENTURE CLUB AND DESIGN. INT. CL. 41. REG. 11-11-1986.
- 1,417,001. NATIONAL ASSOCIATION FOR AMBULATORY CARE AND DESIGN. INT. CL. 42. REG. 11-11-1986.
- 1,417,002. THE ELEPHANT BAR & RESTAURANT. INT. CL. 42. REG. 11-11-1986.
- 1,417,009. MURDER INK AND DESIGN. INT. CL. 42. REG. 11-11-1986.
- 1,417,015. MISCELLANEOUS DESIGN. INT. CL. 42. REG. 11-11-1986.
- 1,417,018. MISCELLANEOUS DESIGN. INT. CL. 42. REG. 11-11-1986.
- 1,417,021. WINDSOR COURT HOTEL AND DESIGN. INT. CL. 42. REG. 11-11-1986.
- 1,417,022. MISCELLANEOUS DESIGN. INT. CL. 42. REG. 11-11-1986.
- 1,417,027. THE ANSEL ADAMS GALLERY. INT. CL. 42. REG. 11-11-1986.
- 1,417,033. THOMPSON FOOD BASKET. INT. CL. 42. REG. 11-11-1986.
- 1,417,035. INNER CIRCLE. INT. CL. 42. REG. 11-11-1986.
- 1,417,037. SBI (STYLIZED). INT. CL. 42. REG. 11-11-1986.
- 1,417,038. QUADGRAPHICS QG AND DESIGN. INT. CL. 42. REG. 11-11-1986.
- 1,417,040. NATURAL CATARACT SURGERY. INT. CL. 42. REG. 11-11-1986.
- 1,417,042. THE DISC-CONNECTION AND DESIGN. INT. CL. 42. REG. 11-11-1986.
- 1,417,043. NORTHWEST WEB. INT. CL. 42. REG. 11-11-1986.
- 1,417,045. TASTE THE REAL DIFFERENCE. INT. CL. 42. REG. 11-11-1986.
- 1,417,046. WALLY WOOFER. INT. CL. 42. REG. 11-11-1986.
- 1,417,054. RED RUBBER. INT. CL. 7. REG. 11-11-1986.
- 1,417,055. RAZOR-PHREE. INT. CL. 8. REG. 11-11-1986.
- 1,417,062. MONTHLY PRESCRIBING REFERENCE AND DESIGN. INT. CL. 16. REG. 11-11-1986.
- 1,417,063. THE BETTER PHONE BOOK. INT. CL. 16. REG. 11-11-1986.
- 1,417,071. EXAMINATIONS ON DEMAND. INT. CL. 42. REG. 11-11-1986.
- 1,425,441. BERGEMANN AND DESIGN. INT. CL. 6 ONLY. REG. 1-20-1987.
- 1,442,825. LIZ CLAIBORNE. INT. CLS. 16, 24 AND 34 ONLY. REG. 6-16-1987.
- 1,445,762. DON. INT. CLS. 1, 12, 24, 27, 30 AND 34 ONLY. REG. 7-7-1987.
- 1,446,608. SHAMPOO CHEZ AND DESIGN. INT. CL. 28 ONLY. REG. 7-7-1987.
- 1,457,891. WEGMANS (STYLIZED). INT. CL. 21 ONLY. REG. 9-22-1987.
- 1,471,925. SNOWDEN-PENCER (STYLIZED). INT. CL. 5 ONLY. REG. 1-12-1988.
- 1,952,014. CAFE EROTICA. INT. CL. 42. REG. 1-23-1996.
- 1,983,200. EURO RSCG. INT. CL. 16 ONLY. REG. 7-2-1996.
- 2,014,637. SD SOUND DYNAMICS AND DESIGN. INT. CL. 9. REG. 11-12-1996.
- 2,014,641. LYNX GLOBAL TELECOM DATABASE. INT. CL. 42. REG. 11-12-1996.
- 2,014,643. THE COLLECTOR. INT. CL. 16. REG. 11-12-1996.
- 2,014,657. AUDIENCE. INT. CL. 9. REG. 11-12-1996.
- 2,014,661. TPSYS (STYLIZED). INT. CLS. 7 AND 9. REG. 11-12-1996.
- 2,014,666. MISCELLANEOUS DESIGN. INT. CL. 30. REG. 11-12-1996.
- 2,014,667. NEW ERA AND DESIGN. INT. CL. 25. REG. 11-12-1996.
- 2,014,672. BLOCKBUSTER VIDEO AND DESIGN. INT. CLS. 9 AND 28. REG. 11-12-1996.
- 2,014,676. E-Z FLOW. INT. CL. 21. REG. 11-12-1996.
- 2,014,677. UNIVERSAL AND DESIGN. INT. CL. 35. REG. 11-12-1996.
- 2,014,681. JPI (STYLIZED). INT. CLS. 9 AND 28. REG. 11-12-1996.
- 2,014,691. ANGELIKA FILMS AND DESIGN. INT. CLS. 9 AND 41. REG. 11-12-1996.
- 2,014,695. STRIKE ZONE AND DESIGN. INT. CL. 28. REG. 11-12-1996.
- 2,014,701. ACQUA LIMONE AND DESIGN. INT. CL. 25. REG. 11-12-1996.
- 2,014,715. PREVIEW COLLECTION. INT. CL. 25. REG. 11-12-1996.
- 2,014,720. ENGLISH GARDEN. INT. CLS. 20 AND 21. REG. 11-12-1996.
- 2,014,727. DISLOC. INT. CL. 11. REG. 11-12-1996.
- 2,014,732. THE BEST BATTERY. INT. CL. 9. REG. 11-12-1996.
- 2,014,733. OLFA AND DESIGN. INT. CLS. 20 AND 21. REG. 11-12-1996.
- 2,014,736. PREFERRED WORKCARE. INT. CL. 36. REG. 11-12-1996.
- 2,014,746. JAKE & CO.. INT. CL. 25. REG. 11-12-1996.
- 2,014,753. GPS. INT. CL. 9. REG. 11-12-1996.
- 2,014,760. MERCY SHIPS. INT. CLS. 41 AND 42. REG. 11-12-1996.
- 2,014,767. THOUGHT BALLOON. INT. CL. 25. REG. 11-12-1996.
- 2,014,774. 128XP/10. INT. CL. 10. REG. 11-12-1996.
- 2,014,777. RAZO (STYLIZED). INT. CL. 12. REG. 11-12-1996.
- 2,014,786. CADET RACE TRAILERS. INT. CL. 12. REG. 11-12-1996.
- 2,014,788. K4. INT. CL. 28. REG. 11-12-1996.
- 2,014,799. AUTOTRACER. INT. CLS. 16 AND 36. REG. 11-12-1996.
- 2,014,804. BENE-FIT. INT. CL. 1. REG. 11-12-1996.
- 2,014,805. ST. MAARTEN (STYLIZED). INT. CLS. 18 AND 25. REG. 11-12-1996.
- 2,014,811. MISCELLANEOUS DESIGN. INT. CL. 7. REG. 11-12-1996.
- 2,014,814. 3000. INT. CL. 9. REG. 11-12-1996.
- 2,014,816. Z16 PLUS (STYLIZED). INT. CL. 4. REG. 11-12-1996.
- 2,014,820. JTRACS. INT. CL. 9. REG. 11-12-1996.
- 2,014,824. ROYAL LIMITED. INT. CLS. 8, 14 AND 21. REG. 11-12-1996.
- 2,014,844. ORI. INT. CL. 42. REG. 11-12-1996.
- 2,014,851. FLEXIS. INT. CL. 10. REG. 11-12-1996.
- 2,014,853. SMARTPARTNERS. INT. CL. 36. REG. 11-12-1996.
- 2,014,856. COMPUTER PERFORMANCE. INT. CLS. 9, 37 AND 42. REG. 11-12-1996.
- 2,014,857. KID'SCRAFT. INT. CL. 16. REG. 11-12-1996.
- 2,014,868. PIXPAK AND DESIGN. INT. CL. 9. REG. 11-12-1996.
- 2,014,869. PORTLAND BREWING 1339 OREGON HONEY BEERBREWED WITH REAL HONEY BLONDISH GOLD AND AND DESIGN. INT. CL. 32. REG. 11-12-1996.
- 2,014,871. MPSI'S CAPS. INT. CL. 9. REG. 11-12-1996.
- 2,014,879. CHESAPEAKE BOAT SHOW. INT. CL. 35. REG. 11-12-1996.
- 2,014,884. CAKE DELIGHTS. INT. CL. 30. REG. 11-12-1996.
- 2,014,887. RHYMEWIZARD. INT. CL. 9. REG. 11-12-1996.
- 2,014,889. AUDIO D. INT. CL. 10. REG. 11-12-1996.
- 2,014,898. CHESAPEAKE BAY BOAT SHOW. INT. CL. 35. REG. 11-12-1996.
- 2,014,904. DIMON AND DESIGN. INT. CL. 42. REG. 11-12-1996.
- 2,014,919. INDULGENCE WITH CONSCIENCE. INT. CL. 5. REG. 11-12-1996.
- 2,014,924. Z BRAKE. INT. CL. 7. REG. 11-12-1996.

- 2,014,925. PIZZA PUB RESTAURANT AND DESIGN. INT. CL. 42. REG. 11-12-1996.
- 2,014,932. PERFORMANCE (STYLIZED). INT. CLS. 9 AND 35. REG. 11-12-1996.
- 2,014,938. QUICKALIGN BRAKES & SUSPENSION AND DESIGN. INT. CL. 37. REG. 11-12-1996.
- 2,014,944. LYNN UNIVERSITY. INT. CL. 41. REG. 11-12-1996.
- 2,014,960. MISCELLANEOUS DESIGN. INT. CL. 41. REG. 11-12-1996.
- 2,014,989. COMPUWAVE. INT. CL. 37. REG. 11-12-1996.
- 2,014,991. V-LITE AND DESIGN. INT. CL. 9. REG. 11-12-1996.
- 2,014,994. GALILEO TECHNOLOGY. INT. CLS. 40 AND 42. REG. 11-12-1996.
- 2,014,995. GALILEO. INT. CL. 9. REG. 11-12-1996.
- 2,015,016. BUTTERFLY TV CREATIONS. INT. CL. 35. REG. 11-12-1996.
- 2,015,020. PETER RABBIT VILLAGE. INT. CL. 41. REG. 11-12-1996.
- 2,015,024. READY TO BLEND AND DESIGN. INT. CL. 32. REG. 11-12-1996.
- 2,015,034. FILING CABINET. INT. CL. 38. REG. 11-12-1996.
- 2,015,039. TREVLA. INT. CL. 9. REG. 11-12-1996.
- 2,015,040. SPEEDLUBE AND DESIGN. INT. CL. 37. REG. 11-12-1996.
- 2,015,042. P PHILADELPHIA INTERNATIONAL AIRPORT AND DESIGN. INT. CL. 39. REG. 11-12-1996.
- 2,015,043. SCANTASTIC (STYLIZED). INT. CL. 9. REG. 11-12-1996.
- 2,015,047. HARMONY. INT. CL. 16. REG. 11-12-1996.
- 2,015,048. NATIONAL LEGAL BUREAU AND DESIGN. INT. CL. 42. REG. 11-12-1996.
- 2,015,055. LAKE COUNTY CHAMBER OF COMMERCE CONTINUOUS SERVICE SINCE 1915 STRENGTH THROUGH DIVERSITY AND DESIGN. INT. CL. 35. REG. 11-12-1996.
- 2,015,058. VINCAM. INT. CLS. 35 AND 36. REG. 11-12-1996.
- 2,015,061. HUBBELL QUALITY AND DESIGN. INT. CL. 29. REG. 11-12-1996.
- 2,015,070. TEAM LABS AND DESIGN. INT. CL. 16. REG. 11-12-1996.
- 2,015,071. TEAM LABS AND DESIGN. INT. CL. 9. REG. 11-12-1996.
- 2,015,085. TRUE VALUE. INT. CL. 9. REG. 11-12-1996.
- 2,015,098. FIBER-LITE. INT. CL. 13. REG. 11-12-1996.
- 2,015,109. CHIEF AUTOMOTIVE SYSTEMS. INT. CLS. 7 AND 9. REG. 11-12-1996.
- 2,015,122. VSM. INT. CL. 35. REG. 11-12-1996.
- 2,015,124. TONTI PROPERTIES. INT. CL. 36. REG. 11-12-1996.
- 2,015,128. UNIVERSAL SWING DANCE AND DESIGN. INT. CL. 41. REG. 11-12-1996.
- 2,015,131. EPILOR. INT. CL. 10. REG. 11-12-1996.
- 2,015,133. ENVIRONMENTAL ROUTENET. INT. CL. 42. REG. 11-12-1996.
- 2,015,138. VANELLI'S PM AND DESIGN. INT. CL. 42. REG. 11-12-1996.
- 2,015,154. INDIGO (STYLIZED). INT. CLS. 1, 2, 3, 7, 9, 16, 24 AND 42. REG. 11-12-1996.
- 2,015,164. C CEDARS BANK (STYLIZED). INT. CL. 36. REG. 11-12-1996.
- 2,015,176. FLAMINGO PLAYERS CLUB. INT. CLS. 41 AND 42. REG. 11-12-1996.
- 2,015,189. ELLEN LANGE. INT. CL. 3. REG. 11-12-1996.
- 2,015,190. YAO! YOUNG AMERICA OUTDOORS AND DESIGN. INT. CLS. 25 AND 41. REG. 11-12-1996.
- 2,015,214. KAISI AND DESIGN. INT. CL. 30. REG. 11-12-1996.
- 2,015,233. PYRO-GUARD. INT. CL. 17. REG. 11-12-1996.
- 2,015,237. MISCELLANEOUS DESIGN. INT. CL. 31. REG. 11-12-1996.
- 2,015,243. PRSM. INT. CL. 42. REG. 11-12-1996.
- 2,015,248. PEERLESS ELECTRIC. INT. CLS. 7 AND 11. REG. 11-12-1996.
- 2,015,259. EAGLE VALLEY. INT. CL. 29. REG. 11-12-1996.
- 2,015,278. MISCELLANEOUS DESIGN. INT. CL. 37. REG. 11-12-1996.
- 2,015,289. MOORE GROUP AND DESIGN. INT. CL. 36. REG. 11-12-1996.
- 2,015,316. POTION AND DESIGN. INT. CL. 3. REG. 11-12-1996.
- 2,015,321. LASH GROUP. INT. CL. 35. REG. 11-12-1996.
- 2,015,338. WEBPLAN. INT. CL. 9. REG. 11-12-1996.
- 2,015,341. VIBRA. INT. CL. 9. REG. 11-12-1996.
- 2,015,342. ARCTIC THAW. INT. CL. 11. REG. 11-12-1996.
- 2,015,348. INFODOG AND DESIGN. INT. CL. 42. REG. 11-12-1996.
- 2,015,361. SAFETSPIN AND DESIGN. INT. CL. 9. REG. 11-12-1996.
- 2,015,366. TEXTURES. INT. CL. 9. REG. 11-12-1996.
- 2,015,370. GRAMS (STYLIZED). INT. CL. 9. REG. 11-12-1996.
- 2,015,382. LEVOLOR EXPRESS AND DESIGN. INT. CL. 20. REG. 11-12-1996.
- 2,015,386. DOME-INATOR. INT. CL. 22. REG. 11-12-1996.
- 2,015,390. UNION BANKING ACCESS. INT. CL. 36. REG. 11-12-1996.
- 2,015,392. LUCA + MARCO. INT. CL. 25. REG. 11-12-1996.
- 2,015,406. MICHAEL MARKOWITZ + ASSOCIATES. INT. CL. 35. REG. 11-12-1996.
- 2,015,407. MICHAEL MARKOWITZ + ASSOCIATES. INT. CL. 42. REG. 11-12-1996.
- 2,015,413. TREASURY DIRECT AND DESIGN. INT. CLS. 16 AND 36. REG. 11-12-1996.
- 2,015,425. SPACEWISE. INT. CL. 20. REG. 11-12-1996.
- 2,015,433. BOB'S PRINTING, INC.. INT. CL. 16. REG. 11-12-1996.
- 2,015,454. TROPHY. INT. CL. 37. REG. 11-12-1996.
- 2,015,480. FROST WATCH. INT. CL. 9. REG. 11-12-1996.
- 2,015,491. PHOTOLAM. INT. CL. 17. REG. 11-12-1996.
- 2,015,493. THINK MEMORY. THINK KINGSTON.. INT. CL. 9. REG. 11-12-1996.
- 2,015,496. THE PROVEN DEFENSE. INT. CL. 5. REG. 11-12-1996.
- 2,015,498. GLOBAL VISION AND DESIGN. INT. CL. 9. REG. 11-12-1996.
- 2,015,499. LASERTRAC AND DESIGN. INT. CL. 9. REG. 11-12-1996.
- 2,015,500. THE EASY WEIGH. INT. CL. 42. REG. 11-12-1996.
- 2,015,524. SLR729LC. INT. CL. 6. REG. 11-12-1996.
- 2,015,526. SL730C. INT. CL. 6. REG. 11-12-1996.
- 2,015,534. P728C. INT. CL. 6. REG. 11-12-1996.
- 2,015,536. THREE MEN AND A TENOR AND DESIGN. INT. CL. 41. REG. 11-12-1996.
- 2,015,549. HEATWAVE. INT. CL. 11. REG. 11-12-1996.
- 2,015,571. LEARNING EXPRESS AND DESIGN. INT. CL. 42. REG. 11-12-1996.
- 2,015,599. SAFE-GARD. INT. CL. 10. REG. 11-12-1996.
- 2,015,600. MISCELLANEOUS DESIGN. INT. CL. 16. REG. 11-12-1996.
- 2,015,601. AGA JOHN. INT. CL. 27. REG. 11-12-1996.
- 2,015,603. THE DICKENS CAROLERS. INT. CL. 41. REG. 11-12-1996.
- 2,015,608. THE WORLD'S COOLEST SPORTS STORE. INT. CL. 42. REG. 11-12-1996.
- 2,015,619. BASEMENT CLEAR. INT. CL. 1. REG. 11-12-1996.
- 2,015,639. NAFSA NATIONAL ASSOCIATION OF FINANCIAL SERVICES AUDITORS AND DESIGN. INT. CL. 42. REG. 11-12-1996.
- 2,015,647. LAKES REGION FACTORY STORES AND DESIGN. INT. CL. 36. REG. 11-12-1996.
- 2,015,648. SANIBEL FACTORY STORES AND DESIGN. INT. CL. 36. REG. 11-12-1996.
- 2,015,653. MOTHER'S CHOICE. INT. CL. 25. REG. 11-12-1996.
- 2,015,669. CPMI. INT. CL. 37. REG. 11-12-1996.
- 2,015,671. VIRTUAL REALITY TO REALITY. INT. CL. 41. REG. 11-12-1996.
- 2,015,678. OTIX. INT. CL. 5. REG. 11-12-1996.
- 2,015,687. CROWN POINT GRAPHICS. INT. CL. 16. REG. 11-12-1996.
- 2,015,690. DONLAR AND DESIGN. INT. CL. 1. REG. 11-12-1996.
- 2,015,696. RFP SOLUTIONS (STYLIZED). INT. CL. 35. REG. 11-12-1996.

- 2,015,703. VIDEO MARKETPLACE. INT. CL. 42. REG. 11-12-1996.
- 2,015,718. 96° (STYLIZED). INT. CL. 25. REG. 11-12-1996.
- 2,015,720. TEC/GLO. INT. CL. 2. REG. 11-12-1996.
- 2,015,724. MSE. INT. CL. 2. REG. 11-12-1996.
- 2,015,734. WCFC. INT. CL. 38. REG. 11-12-1996.
- 2,015,742. CLARK'S REGISTER. INT. CL. 42. REG. 11-12-1996.
- 2,015,743. HUL-IT AND DESIGN. INT. CL. 7. REG. 11-12-1996.
- 2,015,745. SHERPA (STYLIZED). INT. CL. 12. REG. 11-12-1996.
- 2,015,755. GRAVE MATTERS. INT. CL. 42. REG. 11-12-1996.
- 2,015,758. KIDS ZONE PAINT. INT. CL. 2. REG. 11-12-1996.
- 2,015,770. SUPRA COOLANT. INT. CL. 1. REG. 11-12-1996.
- 2,015,772. MEXICO WATCH AND DESIGN. INT. CL. 16. REG. 11-12-1996.
- 2,015,803. MULTI-GINSENG. INT. CL. 5. REG. 11-12-1996.
- 2,015,812. CHEAPER THAN DIRT. INT. CL. 42. REG. 11-12-1996.
- 2,015,824. PRIMROSE SCHOOLS HELPING HANDS AND DESIGN. INT. CLS. 41 AND 42. REG. 11-12-1996.
- 2,015,825. PRIMROSE SCHOOLS I'VE GOT PRIDE! AND DESIGN. INT. CLS. 41 AND 42. REG. 11-12-1996.
- 2,015,826. PRIMROSE SCHOOLS MR. CAN DO AND DESIGN. INT. CLS. 41 AND 42. REG. 11-12-1996.
- 2,015,828. STOMAX. INT. CL. 5. REG. 11-12-1996.
- 2,015,831. BECAUSE YOU CAN'T PATENT A FRAGRANCE. INT. CL. 3. REG. 11-12-1996.
- 2,015,838. ON COURSE ADVISORY. INT. CL. 16. REG. 11-12-1996.
- 2,015,840. RPI ROYAL PRODUCTS INC. INT. CL. 5. REG. 11-12-1996.
- 2,015,843. SHUTTLE U-4. INT. CL. 28. REG. 11-12-1996.
- 2,015,856. BOGGY BOTTOM BAYOU. INT. CL. 28. REG. 11-12-1996.
- 2,015,857. GET OUT WHILE YOU CAN. INT. CLS. 18 AND 25. REG. 11-12-1996.
- 2,015,858. PRIMROSE SCHOOLS NOGGIN' JOGGIN' AND DESIGN. INT. CLS. 41 AND 42. REG. 11-12-1996.
- 2,015,869. IT'S ALL ABOUT THE KIDS. INT. CL. 25. REG. 11-12-1996.
- 2,015,878. THIN-TEX. INT. CL. 1. REG. 11-12-1996.
- 2,015,883. COLOR-ACT. INT. CL. 1. REG. 11-12-1996.
- 2,015,885. MONUMENTS OF THE WORLD. INT. CL. 14. REG. 11-12-1996.
- 2,015,891. MATCH-LINK. INT. CLS. 38 AND 42. REG. 11-12-1996.
- 2,015,906. EXCELTAG. INT. CL. 16. REG. 11-12-1996.
- 2,015,918. RUBENSTEIN BROS. ALL AMERICAN SPORTSMAN SHOP AND DESIGN. INT. CL. 25. REG. 11-12-1996.
- 2,015,919. ENERGY FIT. INT. CL. 25. REG. 11-12-1996.
- 2,015,923. THERA PATCH. INT. CL. 5. REG. 11-12-1996.
- 2,015,935. TURBOSUN. INT. CL. 11. REG. 11-12-1996.
- 2,015,936. NATURE'S BASE AND DESIGN. INT. CL. 5. REG. 11-12-1996.
- 2,015,958. THE TOTAL QUALITY DISTRIBUTOR. INT. CL. 42. REG. 11-12-1996.
- 2,015,959. TOTAL QUALITY DISTRIBUTION. INT. CL. 42. REG. 11-12-1996.
- 2,015,960. TOTAL QUALITY DISTRIBUTOR. INT. CL. 42. REG. 11-12-1996.
- 2,015,973. WORLD T.E.A.M.. INT. CLS. 25 AND 41. REG. 11-12-1996.
- 2,015,974. SALZGITTER-HYDRAULIKSTEMPEL GMBH AND DESIGN. INT. CL. 7. REG. 11-12-1996.
- 2,015,985. GOLDILUX. INT. CL. 9. REG. 11-12-1996.
- 2,015,996. COMSORT. INT. CLS. 41 AND 42. REG. 11-12-1996.
- 2,016,000. CLASSIQUES ENTIER. INT. CL. 18. REG. 11-12-1996.
- 2,016,001. GIBSON-HOMANS PRO'S CHOICE. INT. CL. 19. REG. 11-12-1996.
- 2,016,011. ARACHNOROD. INT. CL. 28. REG. 11-12-1996.
- 2,016,017. TROPICAL SPORTSWEAR INTERNATIONAL. INT. CL. 25. REG. 11-12-1996.
- 2,016,021. MISCELLANEOUS DESIGN. INT. CL. 9. REG. 11-12-1996.
- 2,016,024. REXALL MANAGED CARE. INT. CL. 5. REG. 11-12-1996.
- 2,016,033. BOSTON CR TEST TOOL. INT. CL. 10. REG. 11-12-1996.
- 2,016,039. MEDQUERY. INT. CL. 9. REG. 11-12-1996.
- 2,016,064. POLAR 10. INT. CL. 25. REG. 11-12-1996.
- 2,016,082. CIBAFIX. INT. CL. 1. REG. 11-12-1996.
- 2,016,084. SCENT STONE. INT. CL. 21. REG. 11-12-1996.
- 2,016,093. TV 2000. INT. CLS. 38 AND 41. REG. 11-12-1996.
- 2,016,095. CSEP. INT. CL. 9. REG. 11-12-1996.
- 2,016,102. AMTRIX. INT. CL. 9. REG. 11-12-1996.
- 2,016,109. VIACOM CONSUMER PRODUCTS. INT. CL. 42. REG. 11-12-1996.
- 2,016,118. TERMINATOR SYSTEM. INT. CL. 11. REG. 11-12-1996.
- 2,016,119. TERMINATOR U (STYLIZED). INT. CL. 11. REG. 11-12-1996.
- 2,016,123. BIG HEADS. INT. CL. 20. REG. 11-12-1996.
- 2,016,137. CONFETTI AND DESIGN. INT. CL. 28. REG. 11-12-1996.
- 2,016,141. SILENT TREATMENT. INT. CL. 3. REG. 11-12-1996.
- 2,016,143. DOCTOR'S PLUS+. INT. CL. 5. REG. 11-12-1996.
- 2,016,150. MONOLITH NETCORP. INT. CL. 35. REG. 11-12-1996.
- 2,016,156. LIQUAMIX. INT. CL. 5. REG. 11-12-1996.
- 2,016,163. MISCELLANEOUS DESIGN. INT. CL. 9. REG. 11-12-1996.
- 2,016,169. NEEDLEXPRESS. INT. CLS. 26 AND 42. REG. 11-12-1996.
- 2,016,177. MISCELLANEOUS DESIGN. INT. CLS. 7, 9 AND 11. REG. 11-12-1996.
- 2,016,203. AERO COSMETICS. INT. CL. 3. REG. 11-12-1996.
- 2,016,211. DOWN TO EARTH PRODUCTIONS. INT. CL. 41. REG. 11-12-1996.
- 2,016,212. WONDER WAND (STYLIZED). INT. CL. 9. REG. 11-12-1996.
- 2,016,220. CONDONE AND DESIGN. INT. CL. 16. REG. 11-12-1996.
- 2,016,221. SAINT THOMAS HEALTHCENTER. INT. CL. 42. REG. 11-12-1996.
- 2,016,224. IMPAK. INT. CLS. 9 AND 16. REG. 11-12-1996.
- 2,016,228. REBIS. INT. CL. 9. REG. 11-12-1996.
- 2,016,232. PINWOOD SPRINGS. INT. CL. 32. REG. 11-12-1996.
- 2,016,236. THE WORLD'S FAVORITE CLUB. INT. CL. 33. REG. 11-12-1996.
- 2,016,240. WATER PRO. INT. CLS. 17 AND 21. REG. 11-12-1996.
- 2,016,242. BLAST KAST. INT. CL. 37. REG. 11-12-1996.
- 2,016,249. PSORI CLEAR. INT. CL. 5. REG. 11-12-1996.
- 2,016,265. CYCLE. INT. CL. 31. REG. 11-12-1996.
- 2,016,286. VANGUARD AND DESIGN. INT. CL. 8. REG. 11-12-1996.
- 2,016,296. ALPHA. INT. CL. 30. REG. 11-12-1996.
- 2,016,301. HOME AT LAST! AND DESIGN. INT. CL. 35. REG. 11-12-1996.
- 2,016,305. SECRET OF EVERMORE. INT. CL. 28. REG. 11-12-1996.
- 2,016,338. RONIN WARRIORS. INT. CL. 28. REG. 11-12-1996.
- 2,016,354. MISCELLANEOUS DESIGN. INT. CL. 42. REG. 11-12-1996.
- 2,016,365. CAMERA CONFIGURATOR. INT. CL. 9. REG. 11-12-1996.
- 2,016,368. ANTBOXX AND DESIGN. INT. CL. 7. REG. 11-12-1996.
- 2,016,369. HAZSTAR. INT. CL. 35. REG. 11-12-1996.
- 2,016,373. JUPITER. INT. CL. 16. REG. 11-12-1996.
- 2,016,377. PIVOT AND DESIGN. INT. CL. 10. REG. 11-12-1996.
- 2,016,382. CORY EVERSON'S. INT. CL. 25. REG. 11-12-1996.
- 2,016,385. WEAR & SHARE. INT. CL. 28. REG. 11-12-1996.
- 2,016,398. BODYCENTERED. INT. CLS. 5 AND 42. REG. 11-12-1996.
- 2,016,404. TURBO SHOT. INT. CL. 3. REG. 11-12-1996.

- 2,016,436. GOLF REPUBLIC. INT. CL. 25. REG. 11-12-1996.
 2,016,438. BESTWAY. INT. CL. 29. REG. 11-12-1996.
 2,016,441. MAKE A FAST FRIEND HUG A GREYHOUND NATIONAL SIGHTHOUND RESCUE & ADOPTION, INC. AND DESIGN. INT. CL. 42. REG. 11-12-1996.
 2,016,442. PAYMENT ADVANTAGE. INT. CL. 36. REG. 11-12-1996.
 2,016,450. SOFT COMFORT. INT. CL. 5. REG. 11-12-1996.
 2,016,452. MEDUCATOR. INT. CL. 9. REG. 11-12-1996.
 2,016,453. CCI. INT. CL. 14. REG. 11-12-1996.
 2,016,458. THE FUME-GATOR AND DESIGN. INT. CL. 11. REG. 11-12-1996.
 2,016,496. ESSENTIAL. INT. CL. 11. REG. 11-12-1996.
 2,016,509. A NATION CONNECTED. INT. CL. 42. REG. 11-12-1996.
 2,016,510. I'M THE MAN. INT. CL. 25. REG. 11-12-1996.
 2,016,517. NATURAL BEAUTY. INT. CL. 25. REG. 11-12-1996.
 2,016,525. OPB AND DESIGN. INT. CL. 7. REG. 11-12-1996.
 2,016,528. CLEAR COURT. INT. CL. 28. REG. 11-12-1996.
 2,016,530. TEAMTEST. INT. CL. 42. REG. 11-12-1996.
 2,016,538. EXPOWEB. INT. CL. 42. REG. 11-12-1996.
 2,016,539. BRAIDINI. INT. CL. 26. REG. 11-12-1996.
 2,016,547. BLACKRIDGE MOUNTAIN. INT. CL. 25. REG. 11-12-1996.
 2,016,560. LESLIE FAY. INT. CL. 25. REG. 11-12-1996.
 2,016,571. BEER MASTER'S TASTING SOCIETY. INT. CLS. 16, 21, 25 AND 42. REG. 11-12-1996.
 2,016,583. NETPRO. INT. CL. 16. REG. 11-12-1996.
 2,016,587. SMARTSENSOR. INT. CL. 11. REG. 11-12-1996.
 2,016,588. SMARTFLOOD. INT. CL. 11. REG. 11-12-1996.
 2,016,594. VISUALIZER. INT. CL. 9. REG. 11-12-1996.
 2,016,596. TENDER ROAST. INT. CL. 42. REG. 11-12-1996.
 2,029,632. KARMANN AND DESIGN. INT. CLS. 37, 40 AND 42 ONLY. REG. 1-14-1997.
 2,056,728. AIRWAVES AND DESIGN. INT. CL. 42 ONLY. REG. 4-29-1997.
 2,073,462. TALKAMERICA. INT. CL. 9 ONLY. REG. 6-24-1997.
 2,081,722. N HUSKERS AND DESIGN. INT. CL. 41 ONLY. REG. 7-22-1997.
 2,083,286. LAMPLIGHT. INT. CL. 5 ONLY. REG. 7-29-1997.
 2,084,587. MAKIN' IT EASY. INT. CL. 30 ONLY. REG. 7-29-1997.
 2,312,212. FIRETAK AND DESIGN. INT. CL. 9. REG. 1-25-2000.
 2,347,661. TYDEN BRAMMALL AND DESIGN. INT. CLS. 6 AND 20. REG. 5-2-2000.
 2,403,038. FORD RANGER. INT. CL. 25. REG. 11-14-2000.
 2,403,040. STONE RIDGE BY ALDO AND DESIGN. INT. CLS. 18 AND 25. REG. 11-14-2000.
 2,403,041. STONE RIDGE BY ALDO AND DESIGN. INT. CLS. 18 AND 25. REG. 11-14-2000.
 2,403,046. OUTBACK NATURAL'S. INT. CL. 3. REG. 11-14-2000.
 2,403,047. G GRIP SHIFT AND DESIGN. INT. CLS. 12 AND 25. REG. 11-14-2000.
 2,403,048. HANSA AND DESIGN. INT. CLS. 1, 9 AND 11. REG. 11-14-2000.
 2,403,049. CHA ONLINE. INT. CL. 42. REG. 11-14-2000.
 2,403,051. ME TV AND DESIGN. INT. CL. 41. REG. 11-14-2000.
 2,403,054. GOLFMASTERS.COM. INT. CL. 41. REG. 11-14-2000.
 2,403,055. AVS (STYLIZED). INT. CL. 42. REG. 11-14-2000.
 2,403,060. BRUNSWICK. INT. CL. 36. REG. 11-14-2000.
 2,403,061. KC DIRECT (STYLIZED). INT. CL. 25. REG. 11-14-2000.
 2,403,066. CLINFAX (STYLIZED). INT. CLS. 9, 16 AND 42. REG. 11-14-2000.
 2,403,068. PASTAWORKS AND DESIGN. INT. CL. 35. REG. 11-14-2000.
 2,403,071. QANTAS FLYING TOWARDS 2000. INT. CL. 16. REG. 11-14-2000.
 2,403,072. QANTAS FLYING TOWARDS 2000. INT. CL. 42. REG. 11-14-2000.
 2,403,073. CRAZY BONES AND DESIGN. INT. CL. 28. REG. 11-14-2000.
 2,403,074. THE FABFOUR SUPERSTORE. INT. CL. 35. REG. 11-14-2000.
 2,403,076. CHATEAU AMARETTO HANDMADE DOMINICAN REPUBLIC AND DESIGN. INT. CL. 34. REG. 11-14-2000.
 2,403,077. MARKETTOUCH. INT. CLS. 35 AND 42. REG. 11-14-2000.
 2,403,080. SAMARITAN CARE HOSPICE OF PENNSYLVANIA. INT. CL. 42. REG. 11-14-2000.
 2,403,081. SUPER CROSS. INT. CL. 28. REG. 11-14-2000.
 2,403,083. F FINISHER AND DESIGN. INT. CL. 25. REG. 11-14-2000.
 2,403,084. ELASTYL. INT. CLS. 1 AND 3. REG. 11-14-2000.
 2,403,085. MISCELLANEOUS DESIGN. INT. CL. 37. REG. 11-14-2000.
 2,403,091. ROSEVILLE TELEPHONE FOUNDATION AND DESIGN. INT. CL. 36. REG. 11-14-2000.
 2,403,092. LIBERTY INTERNATIONAL ENTERTAINMENT INC.. INT. CL. 41. REG. 11-14-2000.
 2,403,093. IF AND DESIGN. INT. CLS. 35, 41 AND 42. REG. 11-14-2000.
 2,403,094. LIBERTY INTERNATIONAL ENTERTAINMENT INC. AND DESIGN. INT. CL. 41. REG. 11-14-2000.
 2,403,096. HELTON AND DESIGN. INT. CL. 12. REG. 11-14-2000.
 2,403,102. FISCH VORTEX - D. INT. CL. 8. REG. 11-14-2000.
 2,403,104. THE CHRISTIAN ECLECTIC READERS AND STUDY GUIDE. INT. CL. 16. REG. 11-14-2000.
 2,403,106. INTRALOAN (STYLIZED). INT. CL. 42. REG. 11-14-2000.
 2,403,111. FLYZ BOXERS AND DESIGN. INT. CL. 25. REG. 11-14-2000.
 2,403,114. PASTOR'S PRAYER PARTNERS AND DESIGN. INT. CL. 42. REG. 11-14-2000.
 2,403,119. PMCC MORTGAGE CORP.. INT. CL. 36. REG. 11-14-2000.
 2,403,121. SIM TRAVELSOME. INT. CL. 10. REG. 11-14-2000.
 2,403,122. IBOOKMARKS. INT. CL. 42. REG. 11-14-2000.
 2,403,123. ALAN MARCUS & CO. INT. CL. 35. REG. 11-14-2000.
 2,403,127. ABI THE ALIEN. INT. CL. 41. REG. 11-14-2000.
 2,403,128. BACI DESIGNS AND DESIGN. INT. CLS. 20 AND 42. REG. 11-14-2000.
 2,403,132. HOME RUN BABY (STYLIZED). INT. CL. 28. REG. 11-14-2000.
 2,403,133. DECIM. INT. CLS. 5, 40 AND 42. REG. 11-14-2000.
 2,403,134. HES. INT. CL. 42. REG. 11-14-2000.
 2,403,136. GLYCOSOLE. INT. CL. 5. REG. 11-14-2000.
 2,403,137. ODYSSEY V-MAIL. INT. CL. 9. REG. 11-14-2000.
 2,403,140. FAST EDDIE'S BILLIARDS & NEIGHBORHOOD SALOON. INT. CLS. 41 AND 42. REG. 11-14-2000.
 2,403,142. LIVING YOGA AND DESIGN. INT. CL. 25. REG. 11-14-2000.
 2,403,143. AUTOMOTIVE WORLD. INT. CLS. 9, 16, 35, 41 AND 42. REG. 11-14-2000.
 2,403,144. AMERICAN SYSTEMS REGISTRAR ASR AND DESIGN. INT. CL. 42. REG. 11-14-2000.
 2,403,145. YOURSCHOOLSHOP.COM. INT. CL. 35. REG. 11-14-2000.
 2,403,146. MISCELLANEOUS DESIGN. INT. CL. 35. REG. 11-14-2000.
 2,403,149. CATPROG. INT. CLS. 9, 35 AND 42. REG. 11-14-2000.
 2,403,150. CHICAGO FREEZE. INT. CLS. 20, 21, 24, 25 AND 28. REG. 11-14-2000.
 2,403,151. AMICA FOUNDATION AND DESIGN. INT. CL. 36. REG. 11-14-2000.
 2,403,152. QUEST CONSULTANTS INC. AND DESIGN. INT. CLS. 9 AND 42. REG. 11-14-2000.
 2,403,156. FRACTURE. INT. CLS. 9 AND 41. REG. 11-14-2000.
 2,403,157. LAGRANGE. INT. CL. 9. REG. 11-14-2000.
 2,403,158. ODYSSEY MULTIMEDIA GALLERY. INT. CL. 9. REG. 11-14-2000.

- 2,403,160. MISCELLANEOUS DESIGN. INT. CLS. 9, 16, 35, 36 AND 38. REG. 11-14-2000.
- 2,403,161. CUSHIONFLEX. INT. CLS. 1 AND 17. REG. 11-14-2000.
- 2,403,164. COMMOUSE. INT. CL. 9. REG. 11-14-2000.
- 2,403,165. KID'S CLUB AND DESIGN. INT. CL. 35. REG. 11-14-2000.
- 2,403,171. YA YOUTHLINE AMERICA AND DESIGN. INT. CL. 42. REG. 11-14-2000.
- 2,403,173. QUICKSILVER. INT. CL. 9. REG. 11-14-2000.
- 2,403,174. JCENTRAL. INT. CL. 42. REG. 11-14-2000.
- 2,403,175. ITACA (STYLIZED). INT. CLS. 9, 16 AND 42. REG. 11-14-2000.
- 2,403,176. LAKELAND HEALTH SERVICES. INT. CLS. 36, 41 AND 42. REG. 11-14-2000.
- 2,403,181. PEOPLEPOST. INT. CLS. 38 AND 42. REG. 11-14-2000.
- 2,403,183. V.T.I. PEARLS. INT. CL. 1. REG. 11-14-2000.
- 2,403,184. REASOL. INT. CLS. 7 AND 11. REG. 11-14-2000.
- 2,403,185. COPOS. INT. CL. 11. REG. 11-14-2000.
- 2,403,186. TIREX. INT. CL. 11. REG. 11-14-2000.
- 2,403,187. PERMASEAL WATERPROOFING SYSTEM AND DESIGN. INT. CL. 1. REG. 11-14-2000.
- 2,403,189. AOL REWARDS. INT. CL. 35. REG. 11-14-2000.
- 2,403,190. CHILD NET MEDICAL ASSOCIATES AND DESIGN. INT. CL. 42. REG. 11-14-2000.
- 2,403,194. MISCELLANEOUS DESIGN. INT. CLS. 35 AND 37. REG. 11-14-2000.
- 2,403,198. INTRO. INT. CL. 35. REG. 11-14-2000.
- 2,403,201. D D DARSEE AND DAVID'S AND DESIGN. INT. CLS. 3 AND 5. REG. 11-14-2000.
- 2,403,204. GEFFEN CANCER CENTER AND RESEARCH INSTITUTE. INT. CL. 42. REG. 11-14-2000.
- 2,403,207. NORTH AMERICAN ONEDISC. INT. CL. 9. REG. 11-14-2000.
- 2,403,208. IAAF GOLDEN LEAGUE. INT. CLS. 9, 14, 25, 32, 38, 41 AND 42. REG. 11-14-2000.
- 2,403,211. IMS RACING AND DESIGN. INT. CL. 25. REG. 11-14-2000.
- 2,403,212. LAZ E SUZ AND DESIGN. INT. CL. 21. REG. 11-14-2000.
- 2,403,214. SITE DRIVER AND DESIGN. INT. CL. 9. REG. 11-14-2000.
- 2,403,215. COUNTDOWN ON BEALE. INT. CL. 41. REG. 11-14-2000.
- 2,403,217. SECONDMARKET. INT. CL. 42. REG. 11-14-2000.
- 2,403,218. MISCELLANEOUS DESIGN. INT. CL. 10. REG. 11-14-2000.
- 2,403,219. THEWHIZ.COM. INT. CL. 42. REG. 11-14-2000.
- 2,403,221. TRANS MINERAL USA AND DESIGN. INT. CL. 19. REG. 11-14-2000.
- 2,403,222. CATS AND DESIGN. INT. CL. 9. REG. 11-14-2000.
- 2,403,223. EXTENT RBS. INT. CL. 9. REG. 11-14-2000.
- 2,403,226. GOOD NEWS. INT. CL. 1. REG. 11-14-2000.
- 2,403,229. SLIP PROTECTION COATING AND DESIGN. INT. CL. 2. REG. 11-14-2000.
- 2,403,231. M F S HERITAGE PLANNING AND DESIGN. INT. CL. 36. REG. 11-14-2000.
- 2,403,232. INTEGRA. INT. CL. 7. REG. 11-14-2000.
- 2,403,235. FANTASY CAFE. INT. CLS. 35 AND 42. REG. 11-14-2000.
- 2,403,237. ONE WORLD-ONE LANGUAGE LANGUAGE-FORCE AND DESIGN. INT. CL. 9. REG. 11-14-2000.
- 2,403,240. AUTOMOTIVE TECHNICAL RESOURCES. INT. CL. 41. REG. 11-14-2000.
- 2,403,241. OP POWERTOOLS. INT. CL. 9. REG. 11-14-2000.
- 2,403,242. DYNAMIC MUTUAL FUNDS AND DESIGN. INT. CL. 36. REG. 11-14-2000.
- 2,403,245. ETHAN ALLEN AMERICAN ARTISAN AND DESIGN. INT. CL. 20. REG. 11-14-2000.
- 2,403,246. TRIAD TECHNOLOGY GROUP AND DESIGN. INT. CL. 35. REG. 11-14-2000.
- 2,403,248. TARGETRAK 1 (STYLIZED). INT. CL. 9. REG. 11-14-2000.
- 2,403,252. GLOBALVUE. INT. CL. 35. REG. 11-14-2000.
- 2,403,253. FIRSTPLUS RACING #13 AND DESIGN. INT. CL. 20. REG. 11-14-2000.
- 2,403,254. MILLENNIUM COLLECTION. INT. CLS. 6, 20 AND 21. REG. 11-14-2000.
- 2,403,255. REPLACE. INT. CL. 6. REG. 11-14-2000.
- 2,403,256. SILK BLOSSOM. INT. CL. 25. REG. 11-14-2000.
- 2,403,258. THE DRS SYSTEM. INT. CL. 10. REG. 11-14-2000.
- 2,403,261. REEMTSMA QUALITATSAUSLESE ERNTE 23 AND DESIGN. INT. CL. 34. REG. 11-14-2000.
- 2,403,262. KALAMAZOO GRILL. INT. CL. 11. REG. 11-14-2000.
- 2,403,268. VACUFLEX. INT. CL. 10. REG. 11-14-2000.
- 2,403,270. RAPIDPLUS. INT. CL. 42. REG. 11-14-2000.
- 2,403,271. REWARD. INT. CL. 36. REG. 11-14-2000.
- 2,403,275. BRAIN SHAKER XTREME. INT. CL. 9. REG. 11-14-2000.
- 2,403,279. INCERAL. INT. CL. 10. REG. 11-14-2000.
- 2,403,280. YAR AND DESIGN. INT. CL. 42. REG. 11-14-2000.
- 2,403,281. XAARDIGITAL. INT. CLS. 2, 7, 9, 16 AND 17. REG. 11-14-2000.
- 2,403,284. CONFETTI. INT. CL. 42. REG. 11-14-2000.
- 2,403,285. BIOGRAPHY. INT. CL. 16. REG. 11-14-2000.
- 2,403,292. ULTRASCREEEN. INT. CL. 41. REG. 11-14-2000.
- 2,403,295. TREASURES OF THE HEART. INT. CL. 16. REG. 11-14-2000.
- 2,403,296. SEPTTEST. INT. CL. 5. REG. 11-14-2000.
- 2,403,297. TRAVIS BOATING CENTER AND DESIGN. INT. CL. 12. REG. 11-14-2000.
- 2,403,298. TRAVIS BOATING CENTER AND DESIGN. INT. CL. 7. REG. 11-14-2000.
- 2,403,300. MISCELLANEOUS DESIGN. INT. CLS. 3, 9, 14, 18, 25, 28 AND 32. REG. 11-14-2000.
- 2,403,301. DB (STYLIZED). INT. CLS. 35, 37 AND 41. REG. 11-14-2000.
- 2,403,304. TELECALM (STYLIZED). INT. CL. 42. REG. 11-14-2000.
- 2,403,306. SORTMASTER. INT. CL. 9. REG. 11-14-2000.
- 2,403,307. CORE. INT. CL. 42. REG. 11-14-2000.
- 2,403,309. VALORCARE. INT. CL. 37. REG. 11-14-2000.
- 2,403,310. GET SMART.GET NEXTEL.. INT. CL. 38. REG. 11-14-2000.
- 2,403,315. XS AND DESIGN. INT. CL. 20. REG. 11-14-2000.
- 2,403,318. EARMAX. INT. CL. 10. REG. 11-14-2000.
- 2,403,323. PROSTAR. INT. CL. 1. REG. 11-14-2000.
- 2,403,325. DUSTY DOG RECORDS. INT. CL. 9. REG. 11-14-2000.
- 2,403,327. NORTHERN APPAREL. INT. CL. 25. REG. 11-14-2000.
- 2,403,328. STAY FRESHER. INT. CL. 11. REG. 11-14-2000.
- 2,403,329. GSTA. INT. CL. 42. REG. 11-14-2000.
- 2,403,332. M MALAKAN DIAMOND CO. AND DESIGN. INT. CL. 14. REG. 11-14-2000.
- 2,403,333. CRITTER DETECTIVES AND DESIGN. INT. CL. 37. REG. 11-14-2000.
- 2,403,335. COACH NEW YORK. INT. CL. 25. REG. 11-14-2000.
- 2,403,338. MISCELLANEOUS DESIGN. INT. CLS. 3, 6, 8, 11, 20 AND 21. REG. 11-14-2000.
- 2,403,339. 84+. INT. CL. 35. REG. 11-14-2000.
- 2,403,340. MISCELLANEOUS DESIGN. INT. CL. 9. REG. 11-14-2000.
- 2,403,341. TELEGENISYS. INT. CL. 9. REG. 11-14-2000.
- 2,403,342. THE SANDCASTLES PROGRAM. INT. CLS. 16 AND 41. REG. 11-14-2000.
- 2,403,344. SMART SYNTHETICS MAINTENANCE AND REPAIRTECHNOLOGY. INT. CLS. 1 AND 2. REG. 11-14-2000.
- 2,403,351. COSTCO ONLINE AND DESIGN. INT. CL. 35. REG. 11-14-2000.
- 2,403,352. SON AMAR AND DESIGN. INT. CLS. 41 AND 42. REG. 11-14-2000.
- 2,403,355. MEANPALS. INT. CL. 9. REG. 11-14-2000.
- 2,403,359. LIGHTPHASE (STYLIZED). INT. CLS. 9, 37 AND 41. REG. 11-14-2000.
- 2,403,362. CASTROL CONSUMER VISIONS PARTNERS IN PERFORMANCE AND DESIGN. INT. CL. 35. REG. 11-14-2000.
- 2,403,365. GLO POWER. INT. CL. 3. REG. 11-14-2000.
- 2,403,366. D V I DIVERSIFIED VENTURES, INC. AND DESIGN. INT. CLS. 35 AND 38. REG. 11-14-2000.

- 2,403,367. ECO PAPER TREE FREE CIGARETTE PAPER AND DESIGN. INT. CL. 34. REG. 11-14-2000.
- 2,403,371. THE ESSENTIALS WEB SITE PACKAGE. INT. CL. 42. REG. 11-14-2000.
- 2,403,373. PREFERRED WIRELESS AND DESIGN. INT. CLS. 35 AND 36. REG. 11-14-2000.
- 2,403,374. OLDE VILLAGE CANDLE COMPANY AND DESIGN. INT. CL. 4. REG. 11-14-2000.
- 2,403,376. MISCELLANEOUS DESIGN. INT. CLS. 9, 41 AND 42. REG. 11-14-2000.
- 2,403,377. ATAMA. INT. CLS. 35 AND 36. REG. 11-14-2000.
- 2,403,379. LVRS. INT. CLS. 39 AND 42. REG. 11-14-2000.
- 2,403,385. LIFTKING 55 AND DESIGN. INT. CL. 12. REG. 11-14-2000.
- 2,403,387. CLASSIC EAGLE. INT. CL. 35. REG. 11-14-2000.
- 2,403,388. TOP COAT. INT. CL. 1. REG. 11-14-2000.
- 2,403,392. LITERARY CLASSICS AND DESIGN. INT. CLS. 16 AND 21. REG. 11-14-2000.
- 2,403,394. BUILDING ASSURANCE. INT. CL. 36. REG. 11-14-2000.
- 2,403,400. ENDOBON. INT. CLS. 5 AND 10. REG. 11-14-2000.
- 2,403,401. ULTRATEC. INT. CL. 9. REG. 11-14-2000.
- 2,403,402. MAXI-MIND. INT. CL. 5. REG. 11-14-2000.
- 2,403,405. EFFIX. INT. CLS. 9 AND 42. REG. 11-14-2000.
- 2,403,406. TIGA. INT. CLS. 22, 25 AND 28. REG. 11-14-2000.
- 2,403,407. BUY SELL TRADE WWW.GRETNABIKES.COM LEADERS IN PRE-OWNED BICYCLE LISTING SERVICES AND DESIGN. INT. CL. 35. REG. 11-14-2000.
- 2,403,409. JANTZEN AND DESIGN. INT. CLS. 9, 25 AND 28. REG. 11-14-2000.
- 2,403,415. FANTASIE OF ENGLAND. INT. CL. 25. REG. 11-14-2000.
- 2,403,416. SYNCROFLOW. INT. CL. 11. REG. 11-14-2000.
- 2,403,419. MISCELLANEOUS DESIGN. INT. CL. 20. REG. 11-14-2000.
- 2,403,421. MYCO FACTORS. INT. CL. 5. REG. 11-14-2000.
- 2,403,422. "NATURALLY SAFE" AND DESIGN. INT. CL. 5. REG. 11-14-2000.
- 2,403,425. AMERICAN MOTORCYCLE HARDWARE MADE IN THE U.S.A. AND DESIGN. INT. CLS. 6, 8, 9, 12, 17 AND 20. REG. 11-14-2000.
- 2,403,428. JUBICOAT. INT. CL. 2. REG. 11-14-2000.
- 2,403,429. MISCELLANEOUS DESIGN. INT. CL. 9. REG. 11-14-2000.
- 2,403,431. IN HAND MUSEUM. INT. CL. 20. REG. 11-14-2000.
- 2,403,432. AMNIOFLATOR. INT. CL. 10. REG. 11-14-2000.
- 2,403,433. LOVE THAT MUD. INT. CL. 35. REG. 11-14-2000.
- 2,403,434. SUPERIOR PRODUCTS FROM SUPERIOR MINES. INT. CL. 35. REG. 11-14-2000.
- 2,403,435. WHERE TOYS BECOME FINE ART. INT. CL. 16. REG. 11-14-2000.
- 2,403,438. FPE. INT. CL. 9. REG. 11-14-2000.
- 2,403,440. RCN THE LIVE WIRE OF COMMUNICATIONS. INT. CL. 38. REG. 11-14-2000.
- 2,403,441. ESP HEADLINERS. INT. CLS. 35 AND 42. REG. 11-14-2000.
- 2,403,442. ERGO NEST. INT. CL. 10. REG. 11-14-2000.
- 2,403,447. PRIME NEST. INT. CL. 10. REG. 11-14-2000.
- 2,403,449. CUSTOMCORE RFB. INT. CL. 5. REG. 11-14-2000.
- 2,403,450. E THE NATIONAL COUNCIL FOR ETHICAL DISCERNMENT AND DESIGN. INT. CL. 41. REG. 11-14-2000.
- 2,403,455. PRODUCT ISLAND. INT. CL. 27. REG. 11-14-2000.
- 2,403,458. STUVEX AND DESIGN. INT. CLS. 9 AND 42. REG. 11-14-2000.
- 2,403,459. SUNKIST PREMIUM FLOWERS AND DESIGN. INT. CL. 31. REG. 11-14-2000.
- 2,403,461. HI-VAL AND DESIGN. INT. CL. 34. REG. 11-14-2000.
- 2,403,462. BRAND-WISE. INT. CL. 42. REG. 11-14-2000.
- 2,403,464. CHINA BRITE. INT. CL. 19. REG. 11-14-2000.
- 2,403,465. TPMATCH. INT. CL. 9. REG. 11-14-2000.
- 2,403,467. ALLEGHENY WOODLANDS RESEARCH GROUP, INC.. INT. CL. 35. REG. 11-14-2000.
- 2,403,468. TPGEN. INT. CL. 9. REG. 11-14-2000.
- 2,403,469. INSURQUOTE. INT. CLS. 9 AND 36. REG. 11-14-2000.
- 2,403,474. QVL. INT. CL. 19. REG. 11-14-2000.
- 2,403,476. SU LIN. INT. CLS. 20 AND 24. REG. 11-14-2000.
- 2,403,484. PASTUREPHLEX AND DESIGN. INT. CL. 21. REG. 11-14-2000.
- 2,403,487. TELE BUSINESS USA IN TOUCH WITH AMERICA AND DESIGN. INT. CL. 35. REG. 11-14-2000.
- 2,403,490. RENEGADE. INT. CL. 9. REG. 11-14-2000.
- 2,403,491. PLANET POWERSPORTS. INT. CL. 35. REG. 11-14-2000.
- 2,403,493. M/D MEDICAL DEVICE AXIS 99 AND DESIGN. INT. CL. 41. REG. 11-14-2000.
- 2,403,497. PCROOMLINK AND DESIGN. INT. CL. 38. REG. 11-14-2000.
- 2,403,499. COUNTERPOINT SOFTWARE. INT. CL. 9. REG. 11-14-2000.
- 2,403,500. NEW ZEALAND MERINO AND DESIGN. INT. CL. 24. REG. 11-14-2000.
- 2,403,505. PERFORMANCE PLUS. INT. CL. 35. REG. 11-14-2000.
- 2,403,506. MIRACID PROFESSIONAL. INT. CL. 1. REG. 11-14-2000.
- 2,403,507. COLORADO COUNTRY. INT. CL. 41. REG. 11-14-2000.
- 2,403,508. THE SMARTEST MOVE YOU'LL EVER MAKE. INT. CL. 39. REG. 11-14-2000.
- 2,403,514. FUTURES PLUS AND DESIGN. INT. CL. 36. REG. 11-14-2000.
- 2,403,518. BANTAM. INT. CL. 34. REG. 11-14-2000.
- 2,403,520. AF ACCU FIND INTERNET SERVICES AND DESIGN. INT. CL. 42. REG. 11-14-2000.
- 2,403,521. POINT. INT. CL. 35. REG. 11-14-2000.
- 2,403,523. SAIR AND DESIGN. INT. CL. 35. REG. 11-14-2000.
- 2,403,524. CPT AND DESIGN. INT. CL. 41. REG. 11-14-2000.
- 2,403,526. WESTBANK ANGLERS. INT. CLS. 35 AND 39. REG. 11-14-2000.
- 2,403,527. ACCURSHEAR. INT. CL. 7. REG. 11-14-2000.
- 2,403,530. DENOvonet. INT. CL. 36. REG. 11-14-2000.
- 2,403,532. VACUUM MAGIC. INT. CL. 5. REG. 11-14-2000.
- 2,403,539. ASIAN CHERRY. INT. CL. 41. REG. 11-14-2000.
- 2,403,540. CENTURA PRO. INT. CL. 21. REG. 11-14-2000.
- 2,403,541. YANKEE BANK NOTES. INT. CLS. 16 AND 42. REG. 11-14-2000.
- 2,403,544. FAT CAT 2000. INT. CL. 37. REG. 11-14-2000.
- 2,403,545. CP COMPONENT PRO (STYLIZED). INT. CL. 35. REG. 11-14-2000.
- 2,403,546. RIVER, LAKES, BAYS 'N BAYOUS TRASH BASH AND DESIGN. INT. CL. 41. REG. 11-14-2000.
- 2,403,555. YCHECK. INT. CLS. 5 AND 42. REG. 11-14-2000.
- 2,403,556. ICYSPICY. INT. CL. 42. REG. 11-14-2000.
- 2,403,557. ELECTROSTORE. INT. CL. 35. REG. 11-14-2000.
- 2,403,558. YEAST CHECK. INT. CLS. 5 AND 42. REG. 11-14-2000.
- 2,403,560. MISCELLANEOUS DESIGN. INT. CL. 42. REG. 11-14-2000.
- 2,403,563. GENZYME OPCAB. INT. CL. 10. REG. 11-14-2000.
- 2,403,564. NEOGEO POCKET AND DESIGN. INT. CLS. 9 AND 28. REG. 11-14-2000.
- 2,403,565. PHARM FRESH AND DESIGN. INT. CL. 29. REG. 11-14-2000.
- 2,403,571. LOW-ESLAP. INT. CL. 9. REG. 11-14-2000.
- 2,403,576. BIKINIGRAM. INT. CL. 42. REG. 11-14-2000.
- 2,403,577. B AND DESIGN. INT. CL. 25. REG. 11-14-2000.
- 2,403,579. TERESALOUISE (STYLIZED). INT. CL. 41. REG. 11-14-2000.
- 2,403,583. YOUR OFFICE IS OUR BUSINESS. INT. CL. 36. REG. 11-14-2000.
- 2,403,585. FUTURESCOPE. INT. CL. 36. REG. 11-14-2000.
- 2,403,587. CTS PRODUCTIONS. INT. CL. 41. REG. 11-14-2000.
- 2,403,588. RIS LOGIC2000. INT. CL. 9. REG. 11-14-2000.
- 2,403,589. FUNDS-IN. INT. CL. 36. REG. 11-14-2000.
- 2,403,590. THE BRAKE. INT. CL. 21. REG. 11-14-2000.
- 2,403,591. METABOSPRAY. INT. CL. 5. REG. 11-14-2000.
- 2,403,593. NO LOOT RECORDS. INT. CL. 25. REG. 11-14-2000.

- 2,403,594. BENCHMARKER. INT. CL. 7. REG. 11-14-2000.
 2,403,595. PUSHMASTER. INT. CL. 8. REG. 11-14-2000.
 2,403,598. CLT. INT. CL. 9. REG. 11-14-2000.
 2,403,599. MISCELLANEOUS DESIGN. INT. CL. 42. REG. 11-14-2000.
 2,403,603. COMEDY CARAVAN. INT. CL. 41. REG. 11-14-2000.
 2,403,604. TRIAD. INT. CL. 16. REG. 11-14-2000.
 2,403,605. CUMMINGS & LOCKWOOD'S E-INFO (STYLIZED). INT. CL. 16. REG. 11-14-2000.
 2,403,606. BRANDMANIA.COM AND DESIGN. INT. CL. 35. REG. 11-14-2000.
 2,403,608. MISCELLANEOUS DESIGN. INT. CL. 41. REG. 11-14-2000.
 2,403,611. IMAGIO. INT. CL. 19. REG. 11-14-2000.
 2,403,612. MONTANA A BETTER BRAND OF LOCATIONS AND DESIGN. INT. CL. 35. REG. 11-14-2000.
 2,403,613. PERSPECTIVE AND DESIGN. INT. CL. 16. REG. 11-14-2000.
 2,403,615. TECHNOST. INT. CL. 38. REG. 11-14-2000.
 2,403,617. FUN FONTS. INT. CL. 9. REG. 11-14-2000.
 2,403,618. DOLIVAXIL. INT. CL. 5. REG. 11-14-2000.
 2,403,619. HIRESYSTEMS AND DESIGN. INT. CL. 35. REG. 11-14-2000.
 2,403,620. AQUABLOC. INT. CL. 1. REG. 11-14-2000.
 2,403,621. GEOCOSMETIQUE. INT. CL. 3. REG. 11-14-2000.
 2,403,623. SUZUMO. INT. CL. 7. REG. 11-14-2000.
 2,403,624. SENSORS EXPRESS AND DESIGN. INT. CL. 42. REG. 11-14-2000.
 2,403,625. NEO TAC. INT. CL. 1. REG. 11-14-2000.
 2,403,628. ONEBOX. INT. CL. 9. REG. 11-14-2000.
 2,403,629. STR AND DESIGN. INT. CL. 16. REG. 11-14-2000.
 2,403,631. MISCELLANEOUS DESIGN. INT. CL. 11. REG. 11-14-2000.
 2,403,632. AGCO. INT. CL. 24. REG. 11-14-2000.
 2,403,633. IMAGE CARE. INT. CLS. 35 AND 42. REG. 11-14-2000.
 2,403,634. OGARIN. INT. CL. 5. REG. 11-14-2000.
 2,403,635. TODAY/TOMORROW BLUEPRINTS. INT. CL. 35. REG. 11-14-2000.
 2,403,638. THE LINKSHARE NETWORK. INT. CL. 35. REG. 11-14-2000.
 2,403,640. TESTED TOUGH TO PERFORM IN ALL WEATHER. INT. CL. 2. REG. 11-14-2000.
 2,403,642. STICKER MAGIC. INT. CL. 16. REG. 11-14-2000.
 2,403,643. WAFFLECHEF. INT. CLS. 11 AND 21. REG. 11-14-2000.
 2,403,644. E-TO-E. INT. CL. 35. REG. 11-14-2000.
 2,403,645. GET YOUR SHARE. INT. CL. 35. REG. 11-14-2000.
 2,403,647. EQUITYALERT.COM. INT. CL. 36. REG. 11-14-2000.
 2,403,648. DAYS OF A SPORTSMAN. INT. CL. 41. REG. 11-14-2000.
 2,403,651. CONTENT AND DESIGN. INT. CL. 16. REG. 11-14-2000.
 2,403,654. IF THIS HOUSE COULD TALK. INT. CL. 9. REG. 11-14-2000.
 2,403,657. 911 CANCER. INT. CL. 42. REG. 11-14-2000.
 2,403,658. BR BANGRECORDS AND DESIGN. INT. CL. 35. REG. 11-14-2000.
 2,403,661. MEMCO. INT. CL. 16. REG. 11-14-2000.
 2,403,662. STAY-PUT. INT. CL. 6. REG. 11-14-2000.
 2,403,663. MUSICIANS EXCHANGE. INT. CL. 35. REG. 11-14-2000.
 2,403,664. MYCME.COM. INT. CL. 41. REG. 11-14-2000.
 2,403,665. H.E.L.P. (HOMETOWN EMERGENCY LOANER PHONES). INT. CL. 42. REG. 11-14-2000.
 2,403,668. ENS. INT. CL. 42. REG. 11-14-2000.
 2,403,671. ECONO PRO. INT. CL. 27. REG. 11-14-2000.
 2,403,672. BUILDING VISIONS AND DESIGN. INT. CL. 35. REG. 11-14-2000.
 2,403,673. TAG AND DESIGN. INT. CL. 42. REG. 11-14-2000.
 2,403,675. OPEN SOCIETY INSTITUTE AND DESIGN. INT. CLS. 16, 36 AND 41. REG. 11-14-2000.
 2,403,676. QBUILDER. INT. CL. 9. REG. 11-14-2000.
 2,403,677. LIVE TONIGHT. INT. CLS. 16 AND 41. REG. 11-14-2000.
 2,403,678. TRIAD AND DESIGN. INT. CLS. 9 AND 16. REG. 11-14-2000.
 2,403,679. PULP. INT. CLS. 9 AND 41. REG. 11-14-2000.
 2,403,680. BANKING ON MAIN STREET. INT. CLS. 35, 41 AND 42. REG. 11-14-2000.
 2,403,681. TRAC. INT. CL. 36. REG. 11-14-2000.
 2,403,682. CHANGING THE WAY EMPLOYEES VIEW THEIR BENEFITS. INT. CLS. 35 AND 36. REG. 11-14-2000.
 2,403,685. DP-INTERACTIVE. INT. CL. 42. REG. 11-14-2000.
 2,403,686. GR8VALUE (STYLIZED). INT. CL. 1. REG. 11-14-2000.
 2,403,689. THE BREASTFEEDING CENTER NOURISHING THE FUTURE (STYLIZED). INT. CLS. 41 AND 42. REG. 11-14-2000.
 2,403,692. SCHINDLER 550. INT. CLS. 7 AND 37. REG. 11-14-2000.
 2,403,696. EDGEXPERIENCE. INT. CL. 41. REG. 11-14-2000.
 2,403,697. THE FOAM PUMP AND DESIGN. INT. CL. 21. REG. 11-14-2000.
 2,403,699. YOUR SOURCE FOR WORKSTYLE AND LIFESTYLE TECHNOLOGY. INT. CL. 35. REG. 11-14-2000.
 2,403,704. WORLD GOURMET CUISINE AND DESIGN. INT. CL. 42. REG. 11-14-2000.
 2,403,705. GFI AND DESIGN. INT. CL. 29. REG. 11-14-2000.
 2,403,706. MISCELLANEOUS DESIGN. INT. CL. 36. REG. 11-14-2000.
 2,403,709. MTOOL AND DESIGN. INT. CL. 35. REG. 11-14-2000.
 2,403,711. WCQ. INT. CLS. 7 AND 40. REG. 11-14-2000.
 2,403,712. WEST COAST QUARTZ. INT. CLS. 7 AND 40. REG. 11-14-2000.
 2,403,714. READY SEAL. INT. CL. 2. REG. 11-14-2000.
 2,403,715. BUZZ'N'SPOON. INT. CL. 28. REG. 11-14-2000.
 2,403,716. MISCELLANEOUS DESIGN. INT. CL. 35. REG. 11-14-2000.
 2,403,718. UPDATEWATCH. INT. CL. 42. REG. 11-14-2000.
 2,403,719. E COM MALLS AND DESIGN. INT. CL. 35. REG. 11-14-2000.
 2,403,720. CHILD PLAY CENTER AND DESIGN. INT. CL. 42. REG. 11-14-2000.
 2,403,722. IM IMHOTECH AND DESIGN. INT. CL. 35. REG. 11-14-2000.
 2,403,724. WLEC AND DESIGN. INT. CLS. 35, 36 AND 42. REG. 11-14-2000.
 2,403,725. NUUDLES. INT. CLS. 20 AND 28. REG. 11-14-2000.
 2,403,727. AUTOMOTIVE.COM AND DESIGN. INT. CL. 35. REG. 11-14-2000.
 2,403,728. MISCELLANEOUS DESIGN. INT. CL. 9. REG. 11-14-2000.
 2,403,730. LOCK BUTLER (STYLIZED). INT. CL. 9. REG. 11-14-2000.
 2,403,731. IFN. INT. CL. 36. REG. 11-14-2000.
 2,403,736. WE'LL SAVE YOU A SEAT. INT. CL. 41. REG. 11-14-2000.
 2,403,737. MERCHANTWORKS. INT. CL. 9. REG. 11-14-2000.
 2,403,738. SCHAFFNER AND DESIGN. INT. CLS. 7 AND 9. REG. 11-14-2000.
 2,403,741. BIG SAVER FOODS. INT. CL. 35. REG. 11-14-2000.
 2,403,742. AMERICAN HOTEL & MOTEL ASSOCIATION EDUCATIONAL INSTITUTE AND DESIGN. INT. CL. 41. REG. 11-14-2000.
 2,403,743. C AND DESIGN. INT. CLS. 5, 9 AND 10. REG. 11-14-2000.
 2,403,744. MISCELLANEOUS DESIGN. INT. CLS. 35, 36 AND 37. REG. 11-14-2000.
 2,403,745. JEFFREY ROBERT AND DESIGN. INT. CL. 14. REG. 11-14-2000.
 2,403,746. SOMETIMES IT'S BEST TO ORDER IN. INT. CL. 35. REG. 11-14-2000.
 2,403,750. FLEXSOURCE. INT. CL. 35. REG. 11-14-2000.
 2,403,752. AVENUE HOME. INT. CLS. 3 AND 4. REG. 11-14-2000.
 2,403,753. HOMECHOICE RENTALS. INT. CLS. 41 AND 42. REG. 11-14-2000.

- 2,403,755. AD RIDES. INT. CL. 35. REG. 11-14-2000.
2,403,756. GREAT PEOPLE MAKE GOOD THINGS HAPPEN. INT. CLS. 35, 36 AND 37. REG. 11-14-2000.
2,403,759. STILLSITE. INT. CL. 10. REG. 11-14-2000.
2,403,761. VENEZIA JEANS CLOTHING CO. VJ AND DESIGN. INT. CLS. 18 AND 35. REG. 11-14-2000.
2,403,766. WOMEN WORKING, 2000 AND BEYOND. INT. CL. 41. REG. 11-14-2000.
2,403,767. CLEVELAND TODAY AND DESIGN. INT. CL. 35. REG. 11-14-2000.
2,403,768. HOT CROSS AND DESIGN. INT. CL. 16. REG. 11-14-2000.
2,403,769. BANZAI. INT. CL. 25. REG. 11-14-2000.
2,403,776. WINDOWMAX BLINDS AND DESIGN. INT. CL. 35. REG. 11-14-2000.
2,403,777. GRANDE SENSATIONS. INT. CL. 33. REG. 11-14-2000.
2,403,779. COULEUR GLACEE. INT. CL. 3. REG. 11-14-2000.
2,403,781. KSL AND DESIGN. INT. CL. 11. REG. 11-14-2000.
2,403,782. MISCELLANEOUS DESIGN. INT. CL. 5. REG. 11-14-2000.
2,403,783. SHOPA SCHOOL & HOME OFFICE PRODUCTS ASSOCIATION AND DESIGN. INT. CL. 16. REG. 11-14-2000.
2,403,784. MORGAN MORGAN DE TOI AND DESIGN. INT. CL. 35. REG. 11-14-2000.
2,403,786. THE NEW POWER OF ONE. INT. CL. 35. REG. 11-14-2000.
2,403,788. MISCELLANEOUS DESIGN. INT. CL. 32. REG. 11-14-2000.
2,403,794. NWB CASUALS. INT. CL. 18. REG. 11-14-2000.
2,403,795. SUN DESIRE. INT. CL. 3. REG. 11-14-2000.
2,403,796. HUPAPURE. INT. CL. 5. REG. 11-14-2000.
2,403,797. PRINCEGRIP. INT. CL. 3. REG. 11-14-2000.
2,403,798. CAREER 2.0. INT. CL. 42. REG. 11-14-2000.
2,403,799. JORGINA AND DESIGN. INT. CL. 3. REG. 11-14-2000.
2,403,802. MISCELLANEOUS DESIGN. INT. CL. 37. REG. 11-14-2000.
2,403,803. CRUCIBLE ARTISTS AND DESIGN. INT. CL. 9. REG. 11-14-2000.
2,403,806. CLINI-CALL. INT. CLS. 35 AND 38. REG. 11-14-2000.
2,403,807. PROEL AND DESIGN. INT. CLS. 9 AND 15. REG. 11-14-2000.
2,403,811. MAKING GOOD FOOD BETTER. INT. CL. 16. REG. 11-14-2000.
2,403,812. MISCELLANEOUS DESIGN. INT. CLS. 41 AND 42. REG. 11-14-2000.
2,403,813. SMILE CARE. INT. CL. 10. REG. 11-14-2000.
2,403,815. RHYTHMS OF THE AMERICAS. INT. CL. 41. REG. 11-14-2000.
2,403,816. U.S.S. FMW TRADEWINDS AND DESIGN. INT. CL. 24. REG. 11-14-2000.
2,403,818. DON'T USE A COOLER WITHOUT IT. INT. CL. 11. REG. 11-14-2000.
2,403,820. ANTAGONIST.COM. INT. CL. 41. REG. 11-14-2000.
2,403,821. PRD-66. INT. CL. 1. REG. 11-14-2000.
2,403,826. BARPOINT.COM AND DESIGN. INT. CLS. 35 AND 42. REG. 11-14-2000.
2,403,828. CHINA ENTERTAINMENT NETWORK. INT. CL. 16. REG. 11-14-2000.
2,403,829. CUTTHEPRICE.COM AND DESIGN. INT. CL. 35. REG. 11-14-2000.
2,403,830. ZIGZAG. INT. CL. 20. REG. 11-14-2000.
2,403,832. QUICKSILVER AND DESIGN. INT. CL. 42. REG. 11-14-2000.
2,403,833. PHTLS. INT. CL. 41. REG. 11-14-2000.
2,403,834. A AMIRI AND DESIGN. INT. CL. 25. REG. 11-14-2000.
2,403,835. IONBUILDER (STYLIZED). INT. CL. 9. REG. 11-14-2000.
2,403,836. KULCHA THREDZ. INT. CL. 25. REG. 11-14-2000.
2,403,837. MAINTRAX (STYLIZED). INT. CL. 35. REG. 11-14-2000.
2,403,838. STAGE COACH SAUCES BAR G RANCH AND DESIGN. INT. CL. 30. REG. 11-14-2000.
2,403,842. RISTORANTE LA TORRETTA PIZZERIA AND DESIGN. INT. CL. 42. REG. 11-14-2000.
2,403,843. DJ CRAZE. INT. CL. 41. REG. 11-14-2000.
2,403,844. MISCELLANEOUS DESIGN. INT. CL. 38. REG. 11-14-2000.
2,403,845. ASHI AMERICAN SOCIETY OF HOME INSPECTORS AND DESIGN. INT. CL. 42. REG. 11-14-2000.
2,403,846. BLENDING EXPERIENCE AND INTEGRITY FOR QUALITY PRODUCTS. INT. CL. 35. REG. 11-14-2000.
2,403,848. TEXATRONICS. INT. CL. 40. REG. 11-14-2000.
2,403,849. 1 BRAND AND DESIGN. INT. CL. 1. REG. 11-14-2000.
2,403,851. UNITED IDEAS. INT. CLS. 25, 35 AND 42. REG. 11-14-2000.
2,403,853. MISCELLANEOUS DESIGN. INT. CLS. 9 AND 42. REG. 11-14-2000.
2,403,854. WILLCO. INT. CL. 41. REG. 11-14-2000.
2,403,855. EA SPORTS NET. INT. CL. 9. REG. 11-14-2000.
2,403,856. URBAN FOX. INT. CL. 9. REG. 11-14-2000.
2,403,859. ABG BILL-ME. INT. CLS. 35 AND 42. REG. 11-14-2000.
2,403,861. A MEAL IN A CAKE. INT. CL. 30. REG. 11-14-2000.
2,403,863. MARTIAL ARTS WORLD AND DESIGN. INT. CL. 41. REG. 11-14-2000.
2,403,866. NUSOURCE (STYLIZED). INT. CL. 42. REG. 11-14-2000.
2,403,867. DEVINCI BONDED PORCELAIN. INT. CL. 15. REG. 11-14-2000.
2,403,869. CABLES & CHIPS. INT. CLS. 35 AND 37. REG. 11-14-2000.
2,403,870. BLUE TOOLS. INT. CL. 36. REG. 11-14-2000.
2,403,874. SLAB. INT. CL. 9. REG. 11-14-2000.
2,403,875. SLAB AND DESIGN. INT. CL. 9. REG. 11-14-2000.
2,403,877. CAMPECHE DELUXE SHRIMP (STYLIZED). INT. CL. 29. REG. 11-14-2000.
2,403,879. EUNIVERSE. INT. CLS. 35, 38, 41 AND 42. REG. 11-14-2000.
2,403,882. GRAND ALUMINA. INT. CL. 12. REG. 11-14-2000.
2,403,883. PVS. INT. CL. 9. REG. 11-14-2000.
2,403,884. WEATHERMATE. INT. CLS. 1 AND 3. REG. 11-14-2000.
2,403,886. DANIMALS DANNON FOREST PACK 3 CHERRY 3 STRAWBERRY AND DESIGN. INT. CL. 29. REG. 11-14-2000.
2,403,888. GFIVE. INT. CL. 28. REG. 11-14-2000.
2,403,889. MATTHEW ERICKSON JEWELERS. INT. CLS. 35, 36 AND 37. REG. 11-14-2000.
2,403,890. THE GODDESS CLUB. INT. CL. 41. REG. 11-14-2000.
2,403,893. PRISMARTE. INT. CLS. 11 AND 16. REG. 11-14-2000.
2,403,894. SOULED OUT. INT. CL. 41. REG. 11-14-2000.
2,403,896. GROMMETTE AND DESIGN. INT. CL. 25. REG. 11-14-2000.
2,403,898. PRODUCERS GUILD OF AMERICA, INC.. INT. CL. 41. REG. 11-14-2000.
2,403,899. GOLDEN LAUREL AWARDS. INT. CL. 41. REG. 11-14-2000.
2,403,900. PRODUCERS GUILD OF AMERICA AND DESIGN. INT. CL. 41. REG. 11-14-2000.
2,403,902. CLUB AMIGOS SOL MELIA AND DESIGN. INT. CLS. 35, 36, 39 AND 42. REG. 11-14-2000.
2,403,905. FIRST CLASS AUTO CUSTOM AND DESIGN. INT. CLS. 35 AND 37. REG. 11-14-2000.
2,403,907. MISCELLANEOUS DESIGN. INT. CL. 9. REG. 11-14-2000.
2,403,908. UNIVERSITYSUITE. INT. CL. 9. REG. 11-14-2000.
2,403,912. DOCUMORPH. INT. CL. 9. REG. 11-14-2000.
2,403,913. PIC AND DESIGN. INT. CL. 9. REG. 11-14-2000.
2,403,914. FILMS 4 AUCTION AND DESIGN. INT. CL. 35. REG. 11-14-2000.
2,403,915. PHONECARD BY COMMUNICATIONS DESIGN GROUP, INC. AND DESIGN. INT. CL. 16. REG. 11-14-2000.

- 2,403,919. SNAKE OIL STIR FRY. INT. CL. 30. REG. 11-14-2000.
- 2,403,920. OTHERWORLD WOK SAUCE. INT. CL. 30. REG. 11-14-2000.
- 2,403,925. PRO EZ. INT. CL. 10. REG. 11-14-2000.
- 2,403,926. UPTIME ONE AND DESIGN. INT. CL. 9. REG. 11-14-2000.
- 2,403,930. MC INTELIGUIDE. INT. CLS. 9 AND 42. REG. 11-14-2000.
- 2,403,932. LOSE THE AUTO BODY BLUES. INT. CL. 37. REG. 11-14-2000.
- 2,403,933. PERFECT COLOR. INT. CL. 16. REG. 11-14-2000.
- 2,403,934. ORIENTXPRESS. INT. CL. 9. REG. 11-14-2000.
- 2,403,936. MISCELLANEOUS DESIGN. INT. CL. 42. REG. 11-14-2000.
- 2,403,937. KITTY PALS. INT. CL. 28. REG. 11-14-2000.
- 2,403,938. KEY WELDER CORP. AND DESIGN. INT. CL. 42. REG. 11-14-2000.
- 2,403,939. JCM ENGINEERING AND DESIGN. INT. CL. 40. REG. 11-14-2000.
- 2,403,943. COMMUNITY PLANNER PRO. INT. CL. 9. REG. 11-14-2000.
- 2,403,949. SITEWIRE GOLF AND DESIGN. INT. CLS. 35 AND 42. REG. 11-14-2000.
- 2,403,951. POWER RANKINGS. INT. CL. 36. REG. 11-14-2000.
- 2,403,952. ESPN NOW. INT. CLS. 38 AND 41. REG. 11-14-2000.
- 2,403,955. ZINGIFORCE. INT. CL. 5. REG. 11-14-2000.
- 2,403,961. GEOTOUCH. INT. CL. 42. REG. 11-14-2000.
- 2,403,962. CLEARPOINT CLEANING & RECYCLING. INT. CL. 37. REG. 11-14-2000.
- 2,403,963. YSSERANE. INT. CLS. 3 AND 5. REG. 11-14-2000.
- 2,403,966. WAMPUMWARE. INT. CL. 9. REG. 11-14-2000.
- 2,403,970. ATTENTION. INT. CLS. 35 AND 36. REG. 11-14-2000.
- 2,403,972. ARKANSAS TECH UNIVERSITY. INT. CL. 41. REG. 11-14-2000.
- 2,403,975. PUT US TO THE TEST. INT. CL. 42. REG. 11-14-2000.
- 2,403,977. YES WARE AND DESIGN. INT. CL. 9. REG. 11-14-2000.
- 2,403,978. WATCHFIRE E-QUALITY SUITE. INT. CL. 9. REG. 11-14-2000.
- 2,403,980. TABWARE. INT. CL. 9. REG. 11-14-2000.
- 2,403,985. HEADBOARD AND DESIGN. INT. CL. 20. REG. 11-14-2000.
- 2,403,987. 4SS (STYLIZED). INT. CLS. 25 AND 28. REG. 11-14-2000.
- 2,403,989. STRIP'N AID AND DESIGN. INT. CL. 28. REG. 11-14-2000.
- 2,403,991. OPTIM. INT. CL. 9. REG. 11-14-2000.
- 2,403,993. THE SOURCE. INT. CL. 16. REG. 11-14-2000.
- 2,403,995. TEXOLUTIONS. INT. CL. 42. REG. 11-14-2000.
- 2,403,996. POCKET FLUENCY SYSTEM. INT. CL. 10. REG. 11-14-2000.
- 2,403,997. LVA. INT. CL. 36. REG. 11-14-2000.
- 2,403,998. OUT FOR FUN. INT. CL. 41. REG. 11-14-2000.
- 2,404,001. LIFEWRTING. INT. CL. 41. REG. 11-14-2000.
- 2,404,002. SPRINGTIME IN THE PARK. INT. CL. 35. REG. 11-14-2000.
- 2,404,003. HOUSE OF LADDERS, INC. AND DESIGN. INT. CLS. 6 AND 20. REG. 11-14-2000.
- 2,404,005. MISCELLANEOUS DESIGN. INT. CL. 38. REG. 11-14-2000.
- 2,404,006. BRAZIL DIRECT. INT. CL. 39. REG. 11-14-2000.
- 2,404,007. PRIMAGEN. INT. CL. 5. REG. 11-14-2000.
- 2,404,010. FOAMSEAL. INT. CL. 2. REG. 11-14-2000.
- 2,404,011. PNLABS. INT. CL. 35. REG. 11-14-2000.
- 2,404,014. BRAZELTON FOUNDATION. INT. CL. 36. REG. 11-14-2000.
- 2,404,015. GINGEREASE. INT. CL. 30. REG. 11-14-2000.
- 2,404,016. MOORE. INT. CL. 39. REG. 11-14-2000.
- 2,404,020. CROSTOWN TENNIS. INT. CL. 41. REG. 11-14-2000.
- 2,404,025. HEWLETT PACKARD. INT. CL. 9. REG. 11-14-2000.
- 2,404,027. FREIGHTPRO.COM AND DESIGN. INT. CL. 39. REG. 11-14-2000.
- 2,404,037. BOXY BUT GOOD. INT. CL. 9. REG. 11-14-2000.
- 2,404,039. MISCELLANEOUS DESIGN. INT. CL. 5. REG. 11-14-2000.
- 2,404,040. INTERNATIONAL TASTE OF TENNIS. INT. CL. 41. REG. 11-14-2000.
- 2,404,046. UVC ULTIMATE VITAMIN COMPLEX AND DESIGN. INT. CL. 5. REG. 11-14-2000.
- 2,404,047. REPRINT MINT. INT. CLS. 16 AND 40. REG. 11-14-2000.
- 2,404,048. SOB SAME OLE BAND. INT. CL. 41. REG. 11-14-2000.
- 2,404,051. WALMAC INTL AND DESIGN. INT. CLS. 41 AND 42. REG. 11-14-2000.
- 2,404,052. OPTICS ONE. INT. CL. 10. REG. 11-14-2000.
- 2,404,053. ASK THE HANDYMAN. INT. CL. 41. REG. 11-14-2000.
- 2,404,059. D AND DESIGN. INT. CL. 35. REG. 11-14-2000.
- 2,404,060. ONLINE INFORMATION AND DESIGN. INT. CL. 42. REG. 11-14-2000.
- 2,404,061. FITWEST. INT. CL. 35. REG. 11-14-2000.
- 2,404,062. BISTATE.COM. INT. CL. 42. REG. 11-14-2000.
- 2,404,064. NATIONAL ASSOCIATION OF CHILD ADVOCATES AND DESIGN. INT. CL. 42. REG. 11-14-2000.
- 2,404,067. GET THE LOYAL TREATMENT.. INT. CL. 42. REG. 11-14-2000.
- 2,404,071. VEGA SYSTEM. INT. CL. 10. REG. 11-14-2000.
- 2,404,073. PROFICY FOR MANUFACTURING. INT. CL. 9. REG. 11-14-2000.
- 2,404,075. THERE ARE NO MAGIC BALLS, ONLY MAGIC BOWLERS! AND DESIGN. INT. CL. 35. REG. 11-14-2000.
- 2,404,076. EASY STREET GOURMET. INT. CL. 29. REG. 11-14-2000.
- 2,404,077. PAGOO. INT. CL. 38. REG. 11-14-2000.
- 2,404,080. COLORBOND. INT. CL. 9. REG. 11-14-2000.
- 2,404,081. BCIFUTURES.COM. INT. CL. 36. REG. 11-14-2000.
- 2,404,082. TERALIGHT. INT. CL. 9. REG. 11-14-2000.
- 2,404,083. KC DIAZ MEXICAN GRILL. INT. CL. 42. REG. 11-14-2000.
- 2,404,084. ANGELA MIA PASTA BAR. INT. CL. 42. REG. 11-14-2000.
- 2,404,085. IDEC. INT. CL. 9. REG. 11-14-2000.
- 2,404,086. KIMBERLY C. COLLECTION. INT. CL. 14. REG. 11-14-2000.
- 2,404,088. PARAKEY. INT. CL. 9. REG. 11-14-2000.
- 2,404,089. WATUSI WATUSI WATER WEAR "W" WATUSI WATER WEAR (STYLIZED). INT. CL. 25. REG. 11-14-2000.
- 2,404,093. DARK AGES COMPUTING. INT. CL. 41. REG. 11-14-2000.
- 2,404,095. BETTER BRANDS. INT. CL. 35. REG. 11-14-2000.
- 2,404,102. BARTERPRO. INT. CL. 9. REG. 11-14-2000.
- 2,404,105. REMEMBER WHEN. INT. CLS. 16 AND 35. REG. 11-14-2000.
- 2,404,107. PASSION & PRINCIPLES. INT. CL. 41. REG. 11-14-2000.
- 2,404,108. KORANITE. INT. CL. 20. REG. 11-14-2000.
- 2,404,109. BOBBY CHAN. INT. CL. 25. REG. 11-14-2000.
- 2,404,110. LENDERS BANK LEADING THE WAY AND DESIGN. INT. CL. 36. REG. 11-14-2000.
- 2,404,111. THE CAKE DOCTOR. INT. CL. 1. REG. 11-14-2000.
- 2,404,114. BLAZING PIANOS AND DESIGN. INT. CL. 41. REG. 11-14-2000.
- 2,404,115. MOODFOOD RECORDS. INT. CL. 9. REG. 11-14-2000.
- 2,404,118. PEPPER DELIGHTS. INT. CL. 29. REG. 11-14-2000.
- 2,404,120. SOCCER AGE. INT. CLS. 35, 41 AND 42. REG. 11-14-2000.
- 2,404,122. IPC PLASTICS. INT. CL. 40. REG. 11-14-2000.
- 2,404,123. CHONDRO-TEN. INT. CL. 5. REG. 11-14-2000.
- 2,404,126. SM-SCENARIO. INT. CL. 42. REG. 11-14-2000.
- 2,404,127. CHILDREN'S MUSEUM OF RICHMOND SEE MORE DO MORE BE MORE AND DESIGN. INT. CL. 41. REG. 11-14-2000.

- 2,404,132. MY PEAPOD. INT. CL. 35. REG. 11-14-2000.
 2,404,134. V-LOCK. INT. CL. 6. REG. 11-14-2000.
 2,404,135. TERRASPA. INT. CL. 3. REG. 11-14-2000.
 2,404,136. WE CAN HELP. INT. CL. 35. REG. 11-14-2000.
 2,404,137. MID WEST MAFIA. INT. CL. 41. REG. 11-14-2000.
 2,404,138. ANIMAL CONNECTION. INT. CL. 42. REG. 11-14-2000.
 2,404,139. GLOWING ART. INT. CL. 4. REG. 11-14-2000.
 2,404,140. 5 PALMS MARKETING, INC.. INT. CL. 35. REG. 11-14-2000.
 2,404,141. CPA AND DESIGN. INT. CL. 41. REG. 11-14-2000.
 2,404,142. SUCCESSFUL CPA INSTITUTE. INT. CL. 41. REG. 11-14-2000.
 2,404,143. PROVIDING THE POWER TO GROW. INT. CL. 36. REG. 11-14-2000.
 2,404,145. CLIENT COMMUNICATOR. INT. CL. 42. REG. 11-14-2000.
 2,404,147. FTI FINANCIAL TECHNOLOGIES AND DESIGN. INT. CL. 35. REG. 11-14-2000.
 2,404,150. THE INTERNATIONAL HORSE RACE. INT. CL. 28. REG. 11-14-2000.
 2,404,151. IDENT-A-FILE. INT. CL. 16. REG. 11-14-2000.
 2,404,154. I INSIGNIA AND DESIGN. INT. CL. 36. REG. 11-14-2000.
 2,404,155. EDUPASS. INT. CL. 41. REG. 11-14-2000.
 2,404,156. DSM. INT. CL. 35. REG. 11-14-2000.
 2,404,157. PARADISE. INT. CL. 30. REG. 11-14-2000.
 2,404,158. CHICKTIONARY. INT. CL. 41. REG. 11-14-2000.
 2,404,159. PASTA MAGIC. INT. CL. 30. REG. 11-14-2000.
 2,404,160. POP A TOP COOLERS. INT. CL. 21. REG. 11-14-2000.
 2,404,161. NATURE'S PARADISE. INT. CL. 30. REG. 11-14-2000.
 2,404,168. PROPERTYMOVER.COM. INT. CL. 36. REG. 11-14-2000.
 2,404,169. WAVIX. INT. CL. 42. REG. 11-14-2000.
 2,404,171. PERFORMANCELINE.COM. INT. CL. 35. REG. 11-14-2000.
 2,404,172. RANGE MASTER. INT. CL. 30. REG. 11-14-2000.
 2,404,176. LIVING TAROT. INT. CL. 41. REG. 11-14-2000.
 2,404,178. SPEEDYE. INT. CL. 2. REG. 11-14-2000.
 2,404,179. MASADA MINERAL HERB SPA. INT. CL. 3. REG. 11-14-2000.
 2,404,180. THE ADDRESS BOOK OF THE FUTURE. INT. CL. 35. REG. 11-14-2000.
 2,404,183. BUDGET MART. INT. CL. 35. REG. 11-14-2000.
 2,404,184. MEATJACK. INT. CL. 41. REG. 11-14-2000.
 2,404,187. OMNIWOMAN. INT. CL. 5. REG. 11-14-2000.
 2,404,188. FAITH AND REASON AND DESIGN. INT. CL. 41. REG. 11-14-2000.
 2,404,189. NIVOX. INT. CL. 40. REG. 11-14-2000.
 2,404,193. VALDA. INT. CL. 5. REG. 11-14-2000.
 2,404,194. WE WORK IN GENES (STYLIZED). INT. CL. 1. REG. 11-14-2000.
 2,404,195. STORMCAST. INT. CL. 42. REG. 11-14-2000.
 2,404,196. SAILCAST. INT. CL. 42. REG. 11-14-2000.
 2,404,197. PRECISIONCAST. INT. CL. 42. REG. 11-14-2000.
 2,404,198. GOLFCAST. INT. CL. 42. REG. 11-14-2000.
 2,404,199. ENERGYCAST. INT. CL. 42. REG. 11-14-2000.
 2,404,200. PILOTBRIEF VECTOR. INT. CLS. 9 AND 42. REG. 11-14-2000.
 2,404,201. THE NO NONSENSE SUPPLEMENTS. INT. CL. 5. REG. 11-14-2000.
 2,404,202. SKICAST. INT. CL. 42. REG. 11-14-2000.
 2,404,203. WEATHERPRODUCER. INT. CL. 9. REG. 11-14-2000.
 2,404,207. MOONLIGHT. INT. CL. 21. REG. 11-14-2000.
 2,404,208. CYCLONERAID. INT. CL. 9. REG. 11-14-2000.
 2,404,210. BIG RIG RECORDS. INT. CL. 9. REG. 11-14-2000.
 2,404,211. SEAFRY AND DESIGN. INT. CL. 29. REG. 11-14-2000.
 2,404,214. ANCHOR GAMING. INT. CL. 35. REG. 11-14-2000.
 2,404,215. KITECAST. INT. CL. 42. REG. 11-14-2000.
 2,404,218. AWLSTAR. INT. CL. 2. REG. 11-14-2000.
 2,404,219. EDVENTIONS. INT. CL. 42. REG. 11-14-2000.
 2,404,222. MISCELLANEOUS DESIGN. INT. CL. 35. REG. 11-14-2000.
 2,404,223. VINITY WINE COMPANY. INT. CL. 35. REG. 11-14-2000.
 2,404,225. NEWCON AND DESIGN. INT. CL. 28. REG. 11-14-2000.
 2,404,228. HELPING KIDS LOVE READING...ONE LETTER AT A TIME. INT. CL. 41. REG. 11-14-2000.
 2,404,229. THE NEW CHOICE IN THE WEST.. INT. CL. 39. REG. 11-14-2000.
 2,404,230. MISCELLANEOUS DESIGN. INT. CL. 42. REG. 11-14-2000.
 2,404,231. PETROPAC AND DESIGN. INT. CLS. 35 AND 37. REG. 11-14-2000.
 2,404,234. GAMES. AND DESIGN. INT. CL. 9. REG. 11-14-2000.
 2,404,235. AGE AWARE. INT. CL. 41. REG. 11-14-2000.
 2,404,236. MASTER CABBIE TAXI ACADEMY. INT. CL. 41. REG. 11-14-2000.
 2,404,238. R-A AND DESIGN. INT. CL. 3. REG. 11-14-2000.
 2,404,239. COLGATE TARTAR CONTROL MINT PASTE AND DESIGN. INT. CL. 3. REG. 11-14-2000.
 2,404,240. COLOGATE BAKING SODA & PEROXIDE AND DESIGN. INT. CL. 3. REG. 11-14-2000.
 2,404,241. COLGATE BAKING SODA & PEROXIDE WHITENING AND DESIGN. INT. CL. 3. REG. 11-14-2000.
 2,404,244. FRATELLI LOLLINO. INT. CLS. 30 AND 42. REG. 11-14-2000.
 2,404,247. ZOOLOOSE. INT. CL. 20. REG. 11-14-2000.
 2,404,251. FROM GRANDMA'S HEART. INT. CL. 28. REG. 11-14-2000.
 2,404,254. WIPM. INT. CLS. 9 AND 42. REG. 11-14-2000.
 2,404,256. ASK ENGINEERING AND DESIGN. INT. CL. 42. REG. 11-14-2000.
 2,404,257. POSITION IS EVERYTHING. INT. CL. 18. REG. 11-14-2000.
 2,404,259. MAXI-IRON. INT. CL. 1. REG. 11-14-2000.
 2,404,260. WORDNOW. INT. CLS. 9 AND 42. REG. 11-14-2000.
 2,404,261. CHING CHING CHA. INT. CL. 42. REG. 11-14-2000.
 2,404,263. RIGHT CHOICE FOR CME AND DESIGN. INT. CL. 41. REG. 11-14-2000.
 2,404,264. ADVANCED AND DESIGN. INT. CL. 35. REG. 11-14-2000.
 2,404,266. BUSTIYOS. INT. CL. 3. REG. 11-14-2000.
 2,404,267. RIQUELME. INT. CL. 3. REG. 11-14-2000.
 2,404,268. BUSTIYOS. INT. CL. 5. REG. 11-14-2000.
 2,404,269. RAIL-GUARD. INT. CL. 12. REG. 11-14-2000.
 2,404,272. SOMETHING SPECIAL INCENTIVE. INT. CL. 35. REG. 11-14-2000.
 2,404,274. MISCELLANEOUS DESIGN. INT. CL. 9. REG. 11-14-2000.
 2,404,277. DUPHARJECT. INT. CL. 10. REG. 11-14-2000.
 2,404,280. TOTALSURVIVAL.COM. INT. CL. 35. REG. 11-14-2000.
 2,404,281. POLKA DOC IT. INT. CL. 16. REG. 11-14-2000.
 2,404,285. THE FIESTA PAGES. INT. CL. 16. REG. 11-14-2000.
 2,404,286. ERELAY (STYLIZED). INT. CL. 35. REG. 11-14-2000.
 2,404,297. FASTSETTLE. INT. CL. 42. REG. 11-14-2000.
 2,404,298. COUGAR VIDEO EDITION. INT. CL. 9. REG. 11-14-2000.
 2,404,299. PARA-ENGINEERING. INT. CL. 42. REG. 11-14-2000.
 2,404,301. IMMUNOPRO. INT. CL. 5. REG. 11-14-2000.
 2,404,302. JACK. INT. CL. 8. REG. 11-14-2000.
 2,404,305. ALPHACRAZE.COM. INT. CL. 35. REG. 11-14-2000.
 2,404,306. AMPCO EXPRESS AIRPORT PARKING AND DESIGN. INT. CL. 39. REG. 11-14-2000.
 2,404,307. DR. K. INT. CL. 10. REG. 11-14-2000.
 2,404,308. DR. K. INT. CL. 5. REG. 11-14-2000.
 2,404,311. MAXI-BRAIN. INT. CL. 5. REG. 11-14-2000.
 2,404,312. DUOCRETE-FORTE. INT. CL. 5. REG. 11-14-2000.
 2,404,313. XYNOLEN. INT. CL. 5. REG. 11-14-2000.
 2,404,319. IMA VEIN. INT. CL. 10. REG. 11-14-2000.
 2,404,320. IVY ARM. INT. CL. 10. REG. 11-14-2000.

- 2,404,321. ESCROWBOARD.COM. INT. CL. 35. REG. 11-14-2000.
- 2,404,322. ALL WOUND UP AND DESIGN. INT. CL. 28. REG. 11-14-2000.
- 2,404,323. ALL WOUND UP. INT. CL. 28. REG. 11-14-2000.
- 2,404,324. PETHUNTERS. INT. CL. 42. REG. 11-14-2000.
- 2,404,326. IUCN RED LIST OF THREATENED PLANTS. INT. CL. 16. REG. 11-14-2000.
- 2,404,327. IUCN RED LIST OF THREATENED ANIMALS. INT. CL. 16. REG. 11-14-2000.
- 2,404,328. GHIRARDELLI. INT. CL. 16. REG. 11-14-2000.
- 2,404,330. AGENDA SOUTH FLORIDA. INT. CL. 16. REG. 11-14-2000.
- 2,404,331. DURGA HERBALIX. INT. CL. 3. REG. 11-14-2000.
- 2,404,332. DURGA MATES. INT. CL. 3. REG. 11-14-2000.
- 2,404,338. MISCELLANEOUS DESIGN. INT. CL. 25. REG. 11-14-2000.
- 2,404,342. MAZARIN. INT. CL. 3. REG. 11-14-2000.
- 2,404,343. HWANHEE. INT. CL. 3. REG. 11-14-2000.
- 2,404,344. WILD JUNIPER FRIDAY AND DESIGN. INT. CL. 3. REG. 11-14-2000.
- 2,404,345. CACTUS SATURDAY AND DESIGN. INT. CL. 3. REG. 11-14-2000.
- 2,404,347. APPLE SUNDAY AND DESIGN. INT. CL. 3. REG. 11-14-2000.
- 2,404,348. NATURAL TUESDAY AND DESIGN. INT. CL. 3. REG. 11-14-2000.
- 2,404,349. GREEN TEA MONDAY AND DESIGN. INT. CL. 3. REG. 11-14-2000.
- 2,404,350. RAIN WEDNESDAY AND DESIGN. INT. CL. 3. REG. 11-14-2000.
- 2,404,351. LAVENDER THURSDAY AND DESIGN. INT. CL. 3. REG. 11-14-2000.
- 2,404,352. WAKMAIL. INT. CL. 41. REG. 11-14-2000.
- 2,404,353. HBUSINESS. INT. CL. 36. REG. 11-14-2000.
- 2,404,355. SUIT YOUR STYLE. INT. CL. 25. REG. 11-14-2000.
- 2,404,356. HHOME. INT. CL. 36. REG. 11-14-2000.
- 2,404,357. COMMERCIAL PROPERTIES ONLINE AND DESIGN. INT. CL. 36. REG. 11-14-2000.
- 2,404,363. TRACKD. INT. CL. 9. REG. 11-14-2000.
- 2,404,364. RETIREVIEW. INT. CL. 36. REG. 11-14-2000.
- 2,404,365. SMOOTH MOVES. INT. CL. 9. REG. 11-14-2000.
- 2,404,366. LTS. INT. CL. 12. REG. 11-14-2000.
- 2,404,370. E AND DESIGN. INT. CL. 9. REG. 11-14-2000.
- 2,404,371. SEAHORSE. INT. CL. 12. REG. 11-14-2000.
- 2,404,374. AUDIOLINK. INT. CL. 9. REG. 11-14-2000.
- 2,404,375. GRAFUSION. INT. CL. 42. REG. 11-14-2000.
- 2,404,377. ALTAVISTA FREE ACCESS. INT. CL. 38. REG. 11-14-2000.
- 2,404,378. STANDMASTER. INT. CL. 28. REG. 11-14-2000.
- 2,404,380. B94. INT. CL. 38. REG. 11-14-2000.
- 2,404,381. ABC PAC AND DESIGN. INT. CL. 42. REG. 11-14-2000.
- 2,404,382. ABC TODAY. INT. CLS. 16 AND 42. REG. 11-14-2000.
- 2,404,383. TIPSS. INT. CL. 6. REG. 11-14-2000.
- 2,404,385. START RIGHT!. INT. CL. 42. REG. 11-14-2000.
- 2,404,386. DESIGN RIGHT!. INT. CL. 42. REG. 11-14-2000.
- 2,404,387. END RIGHT!. INT. CL. 42. REG. 11-14-2000.
- 2,404,388. TRAIN RIGHT!. INT. CL. 42. REG. 11-14-2000.
- 2,404,389. DEVELOP RIGHT!. INT. CL. 42. REG. 11-14-2000.
- 2,404,390. MOUNTAIN KIDS KIT AND DESIGN. INT. CL. 9. REG. 11-14-2000.
- 2,404,392. A WATER SYSTEM YOU CAN CALL YOUR OWN. INT. CL. 11. REG. 11-14-2000.
- 2,404,393. AUSTIN SOFTWARE COUNCIL AND DESIGN. INT. CL. 42. REG. 11-14-2000.
- 2,404,394. AUSTIN SOFTWARE COUNCIL. INT. CL. 42. REG. 11-14-2000.
- 2,404,396. COVENANT CARDS. INT. CL. 16. REG. 11-14-2000.
- 2,404,397. REMORA. INT. CL. 28. REG. 11-14-2000.
- 2,404,400. SMARTLIVING. INT. CL. 16. REG. 11-14-2000.
- 2,404,401. PLANET 56. INT. CL. 16. REG. 11-14-2000.
- 2,404,402. ZAKIR HUSSAIN. INT. CL. 41. REG. 11-14-2000.
- 2,404,404. MISCELLANEOUS DESIGN. INT. CLS. 3 AND 5. REG. 11-14-2000.
- 2,404,405. TALENT2000. INT. CL. 16. REG. 11-14-2000.
- 2,404,410. MISCELLANEOUS DESIGN. INT. CL. 16. REG. 11-14-2000.
- 2,404,412. ANTIQUE GARDEN. INT. CL. 3. REG. 11-14-2000.
- 2,404,415. SLUTMAGNET. INT. CLS. 25 AND 41. REG. 11-14-2000.
- 2,404,416. BRIDESHEAD. INT. CL. 42. REG. 11-14-2000.
- 2,404,417. MISCELLANEOUS DESIGN. INT. CL. 14. REG. 11-14-2000.
- 2,404,418. MISCELLANEOUS DESIGN. INT. CL. 14. REG. 11-14-2000.
- 2,404,419. OCX. INT. CL. 9. REG. 11-14-2000.
- 2,404,420. TRANSART. INT. CL. 16. REG. 11-14-2000.
- 2,404,422. MISCELLANEOUS DESIGN. INT. CL. 7. REG. 11-14-2000.
- 2,404,424. UMANO AND DESIGN. INT. CL. 9. REG. 11-14-2000.
- 2,404,425. CROSS-CLIP. INT. CL. 18. REG. 11-14-2000.
- 2,404,428. MISCELLANEOUS DESIGN. INT. CL. 35. REG. 11-14-2000.
- 2,404,429. WHIFFS. INT. CL. 9. REG. 11-14-2000.
- 2,404,430. RESUMETRAK. INT. CL. 35. REG. 11-14-2000.
- 2,404,431. PARAPILLOW. INT. CL. 24. REG. 11-14-2000.
- 2,404,432. MISCELLANEOUS DESIGN. INT. CL. 36. REG. 11-14-2000.
- 2,404,433. HARRY DICKSON. INT. CL. 25. REG. 11-14-2000.
- 2,404,434. MT:2. INT. CL. 25. REG. 11-14-2000.
- 2,404,435. FLXKID.00. INT. CL. 25. REG. 11-14-2000.
- 2,404,436. KIDFLX.00. INT. CL. 25. REG. 11-14-2000.
- 2,404,438. ENERGY SAVING EPSON AND DESIGN. INT. CLS. 7, 9, 14 AND 16. REG. 11-14-2000.
- 2,404,439. MALHAS. INT. CLS. 3, 14 AND 18. REG. 11-14-2000.
- 2,404,440. INSIDE ART. INT. CLS. 20 AND 28. REG. 11-14-2000.
- 2,404,441. CHILDREN'S TIME MACHINE. INT. CLS. 35 AND 41. REG. 11-14-2000.
- 2,404,444. MILLENNIUM. INT. CL. 41. REG. 11-14-2000.
- 2,404,445. PEEK A BOO BOO. INT. CL. 5. REG. 11-14-2000.
- 2,404,446. VIRTUAL FIELDTRIP. INT. CL. 9. REG. 11-14-2000.
- 2,404,449. FAKK2. INT. CL. 25. REG. 11-14-2000.
- 2,404,450. CLARK EXPRESS. INT. CL. 42. REG. 11-14-2000.
- 2,404,451. KING OF THE HILL. INT. CL. 41. REG. 11-14-2000.
- 2,404,452. ADBC. INT. CL. 9. REG. 11-14-2000.
- 2,404,453. TURN TO A NAME YOU CAN TRUST, TURN TO MONTEFIORE. INT. CL. 42. REG. 11-14-2000.
- 2,404,454. ISCP AND DESIGN. INT. CL. 9. REG. 11-14-2000.
- 2,404,455. QUICK OMELETS. INT. CL. 29. REG. 11-14-2000.
- 2,404,460. CATALINA GOLF. INT. CL. 25. REG. 11-14-2000.
- 2,404,462. ACM AND DESIGN. INT. CL. 36. REG. 11-14-2000.
- 2,404,463. VEDANTA. INT. CL. 3. REG. 11-14-2000.
- 2,404,464. QUIK-4. INT. CL. 35. REG. 11-14-2000.
- 2,404,467. PERSONAL LOCATOR AND DESIGN. INT. CL. 38. REG. 11-14-2000.
- 2,404,469. DISK TRACY. INT. CL. 9. REG. 11-14-2000.
- 2,404,472. WALL BUBBLE GUM. INT. CL. 30. REG. 11-14-2000.
- 2,404,474. MISCELLANEOUS DESIGN. INT. CL. 5. REG. 11-14-2000.
- 2,404,475. SUNSET BAY. INT. CL. 42. REG. 11-14-2000.
- 2,404,476. WORLD AMERICAN PARTS. INT. CL. 12. REG. 11-14-2000.
- 2,404,479. ISIS. INT. CL. 9. REG. 11-14-2000.
- 2,404,482. FP EXPRESS. INT. CL. 18. REG. 11-14-2000.
- 2,404,484. TURBO CREDIT. INT. CL. 36. REG. 11-14-2000.
- 2,404,486. PERFORMANCE MARKETING. INT. CL. 36. REG. 11-14-2000.
- 2,404,487. HPM UNIVERSAL. INT. CL. 7. REG. 11-14-2000.
- 2,404,488. DET KJOBENHAVNSKE REASSURANCE-COMPAGNI A/S AND DESIGN. INT. CL. 36. REG. 11-14-2000.
- 2,404,489. NIOBRUSH. INT. CL. 21. REG. 11-14-2000.
- 2,404,490. LAP WIZARD. INT. CL. 20. REG. 11-14-2000.
- 2,404,491. KNUCKLEHEADS. INT. CL. 30. REG. 11-14-2000.
- 2,404,492. TECHNOLOGY ATTITUDE COMFORT (STYLIZED). INT. CL. 25. REG. 11-14-2000.
- 2,404,498. HORIZON V. INT. CL. 12. REG. 11-14-2000.

- 2,404,499. THE NATURAL WAY TO PROTECT YOUR HEALTH. INT. CL. 5. REG. 11-14-2000.
- 2,404,500. WORKSITE IMPACT. INT. CLS. 9 AND 42. REG. 11-14-2000.
- 2,404,501. AMERICAN GOLF PLAYERS ASSOCIATION. INT. CL. 42. REG. 11-14-2000.
- 2,404,502. AROMA BASICS. INT. CL. 3. REG. 11-14-2000.
- 2,404,503. LE BARNES. INT. CL. 25. REG. 11-14-2000.
- 2,404,504. GETTING AHEAD MEANS EDUCATION. INT. CL. 42. REG. 11-14-2000.
- 2,404,505. TOP GUN. INT. CLS. 41 AND 42. REG. 11-14-2000.
- 2,404,506. AMS. INT. CL. 10. REG. 11-14-2000.
- 2,404,508. PROXIMA THERAPEUTICS. INT. CL. 10. REG. 11-14-2000.
- 2,404,511. COLDYICIN. INT. CL. 5. REG. 11-14-2000.
- 2,404,512. NO EMPTY CHAIRS. INT. CL. 41. REG. 11-14-2000.
- 2,404,513. STARES. INT. CL. 35. REG. 11-14-2000.
- 2,404,515. MAGNUM. INT. CL. 7. REG. 11-14-2000.
- 2,404,517. SLAMFIST. INT. CL. 28. REG. 11-14-2000.
- 2,404,520. I'VE GOT HEART. INT. CL. 42. REG. 11-14-2000.
- 2,404,521. TREASURES OF THE WORLD. INT. CL. 9. REG. 11-14-2000.
- 2,404,522. ALLER-PURE. INT. CL. 11. REG. 11-14-2000.
- 2,404,523. ETM TICKET MACHINE AND DESIGN. INT. CLS. 39 AND 42. REG. 11-14-2000.
- 2,404,524. DSIC DIGITAL SYSTEMS INTERNATIONAL CORPORATION AND DESIGN. INT. CLS. 35, 37 AND 42. REG. 11-14-2000.
- 2,404,526. MYSTIC KNIGHTS OF TIR NA NOG. INT. CL. 25. REG. 11-14-2000.
- 2,404,527. CENTELLIS. INT. CL. 9. REG. 11-14-2000.
- 2,404,529. DURAFIN SFP (STYLIZED). INT. CL. 40. REG. 11-14-2000.
- 2,404,530. SUMMERTIME CHAMPIONS. INT. CLS. 41 AND 42. REG. 11-14-2000.
- 2,404,531. AUTO MAG. INT. CL. 7. REG. 11-14-2000.
- 2,404,534. AUTO STOP AND DESIGN. INT. CL. 21. REG. 11-14-2000.
- 2,404,535. BUFFET BUDDY. INT. CL. 21. REG. 11-14-2000.
- 2,404,539. MAGNA PHARMACEUTICALS. INT. CL. 35. REG. 11-14-2000.
- 2,404,541. POLYPRESS. INT. CL. 1. REG. 11-14-2000.
- 2,404,548. SPRAY FOR LIFE (STYLIZED). INT. CL. 5. REG. 11-14-2000.
- 2,404,549. PENDLETON SINCE 1863 AND DESIGN. INT. CL. 25. REG. 11-14-2000.
- 2,404,551. O JUST AND DESIGN. INT. CL. 5. REG. 11-14-2000.
- 2,404,554. OFFICECOM. INT. CL. 9. REG. 11-14-2000.
- 2,404,555. FIELDERS CHOICE AND DESIGN. INT. CL. 31. REG. 11-14-2000.
- 2,404,556. METAPHORIA. INT. CL. 9. REG. 11-14-2000.
- 2,404,557. MORE CONNECTED. INT. CL. 9. REG. 11-14-2000.
- 2,404,558. CION. INT. CL. 9. REG. 11-14-2000.
- 2,404,560. WRITERS' CHAMP. INT. CLS. 41 AND 42. REG. 11-14-2000.
- 2,404,564. ARDENTE ESPRESSIONE. INT. CL. 33. REG. 11-14-2000.
- 2,404,565. LITTER FLUSH AND DESIGN. INT. CL. 21. REG. 11-14-2000.
- 2,404,572. VIRTOOLS. INT. CL. 9. REG. 11-14-2000.
- 2,404,573. ANTHONY BRADEN. INT. CL. 3. REG. 11-14-2000.
- 2,404,575. TROUBLELIGHT AND DESIGN. INT. CL. 9. REG. 11-14-2000.
- 2,404,576. PHARAOH'S TRILOGY. INT. CL. 41. REG. 11-14-2000.
- 2,404,577. GSN. INT. CL. 9. REG. 11-14-2000.
- 2,404,579. EXPLORE YOUR WORLD. INT. CL. 28. REG. 11-14-2000.
- 2,404,581. DXT. INT. CL. 5. REG. 11-14-2000.
- 2,404,582. OUTDOORS ILLUSTRATED. INT. CL. 16. REG. 11-14-2000.
- 2,404,584. VISION EASY STEP. INT. CL. 9. REG. 11-14-2000.
- 2,404,585. WORK FORCE. INT. CL. 27. REG. 11-14-2000.
- 2,404,586. CRAZY PROGRESSIVES. INT. CL. 41. REG. 11-14-2000.
- 2,404,587. PC INDESK NEW GENERATION AND DESIGN. INT. CL. 20. REG. 11-14-2000.
- 2,404,588. UNLOCK THE VALUE. INT. CL. 36. REG. 11-14-2000.
- 2,404,589. SANDART. INT. CL. 30. REG. 11-14-2000.
- 2,404,591. FATAL RELATIONS. INT. CL. 9. REG. 11-14-2000.
- 2,404,592. A LIFETIME OF MUSIC FOR THE 21ST CENTURY. INT. CL. 9. REG. 11-14-2000.
- 2,404,593. 3F FORM FIT FUNCTION CARBON BRUSHES AND DESIGN. INT. CL. 7. REG. 11-14-2000.
- 2,404,595. SLIDER. INT. CL. 9. REG. 11-14-2000.
- 2,404,598. COMPETELINK. INT. CL. 35. REG. 11-14-2000.
- 2,404,599. C&L AND DESIGN. INT. CL. 35. REG. 11-14-2000.
- 2,404,600. MISCELLANEOUS DESIGN. INT. CL. 25. REG. 11-14-2000.
- 2,404,602. AMARILLO AND DESIGN. INT. CL. 36. REG. 11-14-2000.
- 2,404,603. MINIMUMM'S. INT. CL. 24. REG. 11-14-2000.
- 2,404,604. XTENDER. INT. CL. 9. REG. 11-14-2000.
- 2,404,605. QUIET HANDS. INT. CL. 28. REG. 11-14-2000.
- 2,404,606. SEASONE MAPPER. INT. CL. 9. REG. 11-14-2000.
- 2,404,608. VETERINARY ORAL HEALTH COUNCIL VOHC ACCEPTED HELPS CONTROL TARTAR HELPS CONTROL AND DESIGN. U.S. CL. A. REG. 11-14-2000.
- 2,404,609. MISCELLANEOUS DESIGN. INT. CL. 41. REG. 11-14-2000.
- 2,404,611. VPSM. INT. CL. 9. REG. 11-14-2000.
- 2,404,612. BIOFORM. INT. CL. 5. REG. 11-14-2000.
- 2,404,613. SENIOR ZONE. INT. CLS. 35 AND 38. REG. 11-14-2000.
- 2,404,614. OPTIMIZE. INT. CL. 42. REG. 11-14-2000.
- 2,404,616. ROTORLUB. INT. CL. 4. REG. 11-14-2000.
- 2,404,617. WINNING SHOTS. INT. CL. 28. REG. 11-14-2000.
- 2,404,619. SPA HOSIERY COLLECTION. INT. CL. 10. REG. 11-14-2000.
- 2,404,621. MODUFLEX. INT. CL. 7. REG. 11-14-2000.
- 2,404,622. WALLOPS!. INT. CL. 30. REG. 11-14-2000.
- 2,404,623. THE DENTURE THAT FITS YOUR LIFESTYLE. INT. CL. 40. REG. 11-14-2000.
- 2,404,624. IP ADDRESSWORKS. INT. CL. 9. REG. 11-14-2000.
- 2,404,625. OPTIDOS. INT. CL. 10. REG. 11-14-2000.
- 2,404,628. CHART START. INT. CL. 16. REG. 11-14-2000.
- 2,404,630. FARMERS BASKET. INT. CLS. 29 AND 30. REG. 11-14-2000.
- 2,404,635. MONY THE MONY GROUP AND DESIGN. INT. CL. 36. REG. 11-14-2000.
- 2,404,637. BAKEMAN'S AND DESIGN. INT. CL. 30. REG. 11-14-2000.
- 2,404,638. GUERRILLA COM. INT. CL. 9. REG. 11-14-2000.
- 2,404,639. GUERRILLA VB. INT. CL. 9. REG. 11-14-2000.
- 2,404,640. FRESH CATCH. INT. CL. 42. REG. 11-14-2000.
- 2,404,645. NIRVANA (STYLIZED). INT. CL. 4. REG. 11-14-2000.
- 2,404,646. PRO-GRADE. INT. CL. 7. REG. 11-14-2000.
- 2,404,647. GOODTIMES PAGING. INT. CL. 9. REG. 11-14-2000.
- 2,404,648. MISCELLANEOUS DESIGN. INT. CL. 41. REG. 11-14-2000.
- 2,404,650. EARTHWAVE. INT. CL. 9. REG. 11-14-2000.
- 2,404,655. CHILDRENS MADE HORSES. INT. CL. 41. REG. 11-14-2000.
- 2,404,657. NBA STORE AND DESIGN. INT. CL. 32. REG. 11-14-2000.
- 2,404,661. IT'S WHAT'S INSIDE. INT. CL. 32. REG. 11-14-2000.
- 2,404,662. BOONEEZ. INT. CL. 28. REG. 11-14-2000.
- 2,404,663. BOLEO AND DESIGN. INT. CL. 30. REG. 11-14-2000.
- 2,404,664. VIXCON. INT. CL. 38. REG. 11-14-2000.
- 2,404,665. ZZZZIP!! HEAR IT CLOSE!. INT. CL. 16. REG. 11-14-2000.
- 2,404,666. ENDURON. INT. CL. 26. REG. 11-14-2000.
- 2,404,667. 24 SWAT SEVERE WEATHER ALERT TEAM AND DESIGN. INT. CL. 42. REG. 11-14-2000.

- 2,404,669. INSTITUTIONAL SELECT. INT. CL. 36. REG. 11-14-2000.
- 2,404,670. INFINITY NOW. INT. CL. 39. REG. 11-14-2000.
- 2,404,671. OPTICAST. INT. CLS. 1 AND 7. REG. 11-14-2000.
- 2,404,672. NURIT PC TERMINAL. INT. CL. 9. REG. 11-14-2000.
- 2,404,675. TEKCAM. INT. CL. 9. REG. 11-14-2000.
- 2,404,676. GATEWAY AUTHORIZED RESELLER AND DESIGN. INT. CLS. 9 AND 42. REG. 11-14-2000.
- 2,404,680. SOUTHERN CALIFORNIA LIVING. INT. CL. 16. REG. 11-14-2000.
- 2,404,683. EUROTRASH. INT. CL. 9. REG. 11-14-2000.
- 2,404,686. APOLLO. INT. CL. 9. REG. 11-14-2000.
- 2,404,689. MISCELLANEOUS DESIGN. INT. CL. 25. REG. 11-14-2000.
- 2,404,690. READIROLL. INT. CL. 21. REG. 11-14-2000.
- 2,404,691. DATA DEFENDER. INT. CL. 9. REG. 11-14-2000.
- 2,404,693. ORBITAL SOFTWARE. INT. CL. 9. REG. 11-14-2000.
- 2,404,694. THE STERLING CONNECTION. INT. CL. 14. REG. 11-14-2000.
- 2,404,695. 21ST CENTURY KIDS AND DESIGN. INT. CL. 41. REG. 11-14-2000.
- 2,404,697. JACK POTS. INT. CL. 41. REG. 11-14-2000.
- 2,404,698. SN AND DESIGN. INT. CL. 25. REG. 11-14-2000.
- 2,404,700. VIGILANCE. INT. CL. 42. REG. 11-14-2000.
- 2,404,704. ALLOTTA KONE. INT. CL. 30. REG. 11-14-2000.
- 2,404,708. ALL VOLUNTEER YACHT CLUB. INT. CL. 25. REG. 11-14-2000.
- 2,404,709. THE MATERNITY CLOSET. INT. CL. 35. REG. 11-14-2000.
- 2,404,713. MDWEB.COMPENDIUM. INT. CL. 16. REG. 11-14-2000.
- 2,404,715. WEBSCOPE. INT. CL. 9. REG. 11-14-2000.
- 2,404,717. P PRECISA THE IT SPECIALIST (STYLIZED). INT. CL. 9. REG. 11-14-2000.
- 2,404,718. HOME INTERIORS & GIFTS. INT. CLS. 3 AND 4. REG. 11-14-2000.
- 2,404,719. BATTLE BORN CIGAR CO. AND DESIGN. INT. CL. 35. REG. 11-14-2000.
- 2,404,720. DENWEST (STYLIZED). INT. CLS. 16, 20 AND 25. REG. 11-14-2000.
- 2,404,721. HANG-OUT. INT. CL. 20. REG. 11-14-2000.
- 2,404,723. FLUORCHEM AND DESIGN. INT. CL. 9. REG. 11-14-2000.
- 2,404,724. SMAC. INT. CLS. 35 AND 42. REG. 11-14-2000.
- 2,404,725. TOP CAT. INT. CL. 9. REG. 11-14-2000.
- 2,404,726. ASHWOOD LANE'S KAOS KINGDOM. INT. CLS. 20, 25 AND 27. REG. 11-14-2000.
- 2,404,727. JONES-GMO AND DESIGN. INT. CL. 37. REG. 11-14-2000.
- 2,404,728. J.A. JONES OF THE CAROLINAS AND DESIGN. INT. CL. 37. REG. 11-14-2000.
- 2,404,729. J.A. JONES-GMO. INT. CL. 37. REG. 11-14-2000.
- 2,404,730. J.A. JONES-GMO, LLC. INT. CL. 37. REG. 11-14-2000.
- 2,404,733. I AM GROWING. INT. CL. 16. REG. 11-14-2000.
- 2,404,736. PCM. INT. CL. 42. REG. 11-14-2000.
- 2,404,740. KIT (STYLIZED). INT. CL. 25. REG. 11-14-2000.
- 2,404,743. DREAM TRAVELER. INT. CL. 19. REG. 11-14-2000.
- 2,404,744. MARTEST 21. INT. CL. 20. REG. 11-14-2000.
- 2,404,745. SOYBURG,USA. INT. CL. 29. REG. 11-14-2000.
- 2,404,746. KOOL STUF. INT. CL. 30. REG. 11-14-2000.
- 2,404,747. LOGOAMERICA. INT. CL. 35. REG. 11-14-2000.
- 2,404,748. PROVEN RETURN ON INTEGRATION. INT. CL. 9. REG. 11-14-2000.
- 2,404,749. SPOOKYTIME. INT. CLS. 20 AND 28. REG. 11-14-2000.
- 2,404,750. CYBERDOCS ROUTING. INT. CL. 9. REG. 11-14-2000.
- 2,404,751. GROUND COVER. INT. CL. 27. REG. 11-14-2000.
- 2,404,755. RUBICON. INT. CL. 9. REG. 11-14-2000.
- 2,404,756. NATIONAL PLANNING CORPORATION AND DESIGN. INT. CL. 36. REG. 11-14-2000.
- 2,404,759. SANCHEZ/NITZBERG. INT. CL. 40. REG. 11-14-2000.
- 2,404,760. DILBERT GUMMY-BERTS. INT. CL. 30. REG. 11-14-2000.
- 2,404,761. BEDROOM EYES. INT. CL. 35. REG. 11-14-2000.
- 2,404,762. I M HERE. INT. CL. 38. REG. 11-14-2000.
- 2,404,764. LIPSERVICE. INT. CL. 9. REG. 11-14-2000.
- 2,404,766. TANISHA. INT. CL. 28. REG. 11-14-2000.
- 2,404,767. MAYA. INT. CL. 28. REG. 11-14-2000.
- 2,404,770. LINESCOUT. INT. CL. 9. REG. 11-14-2000.
- 2,404,771. COPPERGAIN. INT. CL. 9. REG. 11-14-2000.
- 2,404,772. SILVER LABEL TEA. INT. CL. 30. REG. 11-14-2000.
- 2,404,775. FREQUENT FLYER PLUS. INT. CL. 35. REG. 11-14-2000.
- 2,404,778. UCAN. INT. CL. 20. REG. 11-14-2000.
- 2,404,779. CLIFTON BAY. INT. CL. 33. REG. 11-14-2000.
- 2,404,781. CAPS-LOCK. INT. CL. 10. REG. 11-14-2000.
- 2,404,782. SILENT STUDIO. INT. CL. 9. REG. 11-14-2000.
- 2,404,783. HEALTHY HOLD. INT. CL. 3. REG. 11-14-2000.
- 2,404,786. SEMI-FAST. INT. CL. 28. REG. 11-14-2000.
- 2,404,787. MISCELLANEOUS DESIGN. INT. CL. 31. REG. 11-14-2000.
- 2,404,788. NATURE'S A.C. BLAST. INT. CL. 32. REG. 11-14-2000.
- 2,404,790. BABYBAC AND DESIGN. INT. CL. 18. REG. 11-14-2000.
- 2,404,791. PLAY BY THE RULES. INT. CL. 42. REG. 11-14-2000.
- 2,404,792. AVIGEN. INT. CL. 5. REG. 11-14-2000.
- 2,404,793. STRETCH APPEAL. INT. CL. 9. REG. 11-14-2000.
- 2,404,794. NUTRITONIX. INT. CL. 9. REG. 11-14-2000.
- 2,404,795. MALE DEFENSE. INT. CL. 5. REG. 11-14-2000.
- 2,404,798. NSC NCR SALES CENTER AND DESIGN. INT. CL. 35. REG. 11-14-2000.
- 2,404,803. MOTODRILL. INT. CL. 28. REG. 11-14-2000.
- 2,404,804. NITE OWL. INT. CL. 9. REG. 11-14-2000.
- 2,404,805. SERENETTE. INT. CL. 24. REG. 11-14-2000.
- 2,404,817. THERMATOL. INT. CL. 5. REG. 11-14-2000.
- 2,404,818. OPTISHADES. INT. CL. 1. REG. 11-14-2000.
- 2,404,820. E SPACE. INT. CLS. 36, 37 AND 39. REG. 11-14-2000.
- 2,404,821. PUMPING GAS. INT. CL. 41. REG. 11-14-2000.
- 2,404,822. PREMIUM GAS. INT. CL. 41. REG. 11-14-2000.
- 2,404,823. EXTREME GAS. INT. CL. 41. REG. 11-14-2000.
- 2,404,825. MILLENNIUM. INT. CL. 7. REG. 11-14-2000.
- 2,404,829. CEDAR HOLLOW. INT. CL. 21. REG. 11-14-2000.
- 2,404,831. SNAPSHOT. INT. CL. 30. REG. 11-14-2000.
- 2,404,832. AROMA. INT. CL. 9. REG. 11-14-2000.
- 2,404,833. MOUNTAIN ATTACK. INT. CL. 28. REG. 11-14-2000.
- 2,404,834. MICROFERRET. INT. CL. 10. REG. 11-14-2000.
- 2,404,837. FABU-LAS. INT. CL. 1. REG. 11-14-2000.
- 2,404,838. @TIME AND DESIGN. INT. CL. 9. REG. 11-14-2000.
- 2,404,840. SNAG. INT. CL. 25. REG. 11-14-2000.
- 2,404,841. DOUBLE FEATURE. INT. CL. 3. REG. 11-14-2000.
- 2,404,842. PURITONE. INT. CL. 5. REG. 11-14-2000.
- 2,404,843. SPORTSMAP BY THE LAWRENCE GROUP AND DESIGN. INT. CL. 16. REG. 11-14-2000.
- 2,404,846. MISCELLANEOUS DESIGN. INT. CL. 16. REG. 11-14-2000.
- 2,404,850. MISCELLANEOUS DESIGN. INT. CL. 30. REG. 11-14-2000.
- 2,404,851. ICED GUSHER. INT. CL. 32. REG. 11-14-2000.
- 2,404,853. STORKY ON A STICK. INT. CL. 16. REG. 11-14-2000.
- 2,404,856. TREE WIZ. INT. CL. 11. REG. 11-14-2000.
- 2,404,859. NEWSONPAPER.COM. INT. CL. 42. REG. 11-14-2000.
- 2,404,860. WE ALL MAKE A DIFFERENCE. INT. CL. 42. REG. 11-14-2000.
- 2,404,861. VITAMIN LAB. INT. CL. 5. REG. 11-14-2000.
- 2,404,864. MISCELLANEOUS DESIGN. INT. CL. 28. REG. 11-14-2000.
- 2,404,865. LAW THREADS AND DESIGN. INT. CL. 42. REG. 11-14-2000.
- 2,404,867. DESTINATION STARDOM. INT. CL. 41. REG. 11-14-2000.

- 2,404,869. SITS LIKE A SOFA AND SLEEPS LIKE A BED. INT. CL. 20. REG. 11-14-2000.
- 2,404,870. INFLEX. INT. CL. 20. REG. 11-14-2000.
- 2,404,872. FEAT-IN-CLAY. INT. CL. 20. REG. 11-14-2000.
- 2,404,874. CELLSURE. INT. CL. 5. REG. 11-14-2000.
- 2,404,876. BEE FRESH AND DESIGN. INT. CL. 25. REG. 11-14-2000.
- 2,404,877. TOUCON MON. INT. CL. 42. REG. 11-14-2000.
- 2,404,879. THERMOSYN. INT. CL. 5. REG. 11-14-2000.
- 2,404,881. STEELHEAD. INT. CL. 28. REG. 11-14-2000.
- 2,404,883. GREAT TASTE ENDURES. INT. CL. 42. REG. 11-14-2000.
- 2,404,884. FRONT ROW. INT. CL. 3. REG. 11-14-2000.
- 2,404,895. PARENTS WHO CARE. INT. CLS. 9 AND 16. REG. 11-14-2000.
- 2,404,898. HTTP://WWW.SU.EDU (STYLIZED). INT. CL. 36. REG. 11-14-2000.
- 2,404,900. HYPERBOWL. INT. CLS. 28 AND 41. REG. 11-14-2000.
- 2,404,901. NATURE'S BASIC THE COOPERATIVE CHOICE AND DESIGN. INT. CLS. 5, 29 AND 31. REG. 11-14-2000.
- 2,404,902. REPLAY RECORDS. INT. CL. 9. REG. 11-14-2000.
- 2,404,903. SLANT A WHOLE NEW ANGLE. INT. CL. 25. REG. 11-14-2000.
- 2,404,906. IN THE ROUGH. INT. CL. 25. REG. 11-14-2000.
- 2,404,909. EASY TRIM. INT. CL. 7. REG. 11-14-2000.
- 2,404,911. GLOBAL SUPPLY CHAIN. INT. CL. 16. REG. 11-14-2000.
- 2,404,914. THE PACKAGING INDUSTRY'S ONLY SUPER DISTRIBUTOR. INT. CL. 35. REG. 11-14-2000.
- 2,404,917. BUSINESSWOMEN'S RESEARCH INSTITUTE. INT. CL. 35. REG. 11-14-2000.
- 2,404,918. TOP DRAWER MEDICAL ART. INT. CL. 42. REG. 11-14-2000.
- 2,404,920. NETDOCUMENTS. INT. CLS. 9 AND 42. REG. 11-14-2000.
- 2,404,921. SURGICAL EXPRESS. INT. CL. 39. REG. 11-14-2000.
- 2,404,922. NO BUST BLACKJACK. INT. CL. 28. REG. 11-14-2000.
- 2,404,923. GREAT GIFTS IN UNDER 30 MINUTES. INT. CL. 16. REG. 11-14-2000.
- 2,404,926. STOCKMONITOR.COM. INT. CL. 36. REG. 11-14-2000.
- 2,404,927. CORRECTIVE FITNESS SYSTEM. INT. CL. 28. REG. 11-14-2000.
- 2,404,928. EXACTNESS IN FINANCIAL PLANNING. INT. CL. 9. REG. 11-14-2000.
- 2,404,932. KANSAS CITY VACATION & TRAVEL EXPO. INT. CL. 39. REG. 11-14-2000.
- 2,404,933. MISCELLANEOUS DESIGN. INT. CL. 3. REG. 11-14-2000.
- 2,404,934. U.S. ARCHITECTURE. INT. CL. 16. REG. 11-14-2000.
- 2,404,935. COSMETICSURGERY.COM. INT. CL. 42. REG. 11-14-2000.
- 2,404,939. KELLEY SCHOOL OF BUSINESS. INT. CL. 41. REG. 11-14-2000.
- 2,404,942. MOVING EXPRESS. INT. CL. 39. REG. 11-14-2000.
- 2,404,944. TIBETMED (STYLIZED). INT. CL. 42. REG. 11-14-2000.
- 2,404,945. EXPENSENET. INT. CL. 9. REG. 11-14-2000.
- 2,404,946. RECOMPOSER. INT. CL. 9. REG. 11-14-2000.
- 2,404,947. ADHD.COM. INT. CL. 41. REG. 11-14-2000.
- 2,452,203. TROLL AND DESIGN. INT. CLS. 25, 35 AND 42 ONLY. REG. 5-15-2001.
- 2,466,950. SUPERDOGS INTERNATIONALE AND DESIGN. INT. CLS. 9 AND 25 ONLY. REG. 7-10-2001.
- 2,472,640. PERSONS. INT. CL. 28 ONLY. REG. 7-31-2001.
- 2,473,149. MPJE. INT. CL. 9 ONLY. REG. 7-31-2001.
- 2,473,978. COMET. INT. CL. 9 ONLY. REG. 7-31-2001.
- 2,475,013. GDFOK AND DESIGN. INT. CLS. 31 AND 32 ONLY. REG. 8-7-2001.
- 2,476,523. GRUGA. INT. CL. 11 ONLY. REG. 8-7-2001.
- 2,477,239. WEEKENDER. INT. CL. 12 ONLY. REG. 8-14-2001.
- 2,511,327. PEAPOD AND DESIGN. INT. CL. 16 ONLY. REG. 11-27-2001.
- 2,523,854. AU PAIN DORE. INT. CL. 42 ONLY. REG. 1-1-2002.

SECTION 18

- 1,080,510. KAHALA. INT. CL. 28. REG. 12-27-1977.
- 1,650,821. ALCHEMY BY JOO MEE. INT. CL. 25. REG. 7-16-1991.
- 2,091,683. RACING GREEN. INT. CLS. 18 AND 25. REG. 8-26-1997.
- 2,493,641. NAMES NET. INT. CLS. 38 AND 42. REG. 9-25-2001.
- 2,495,958. W WELTMEISTER AND DESIGN. INT. CL. 15. REG. 10-9-2001.
- 2,577,204. ANCHOR USA (STYLIZED). INT. CLS. 6, 18 AND 22. REG. 6-11-2002.
- 2,581,046. MASSAGEFINDER. INT. CL. 35. REG. 6-18-2002.
- 2,617,039. AUCTION BROADCASTER AND DESIGN. INT. CL. 9. REG. 9-10-2002.
- 2,711,445. EMILY'S TOYS. INT. CL. 35. REG. 4-29-2003.
- 2,804,007. ETERNA AND DESIGN. INT. CL. 31. REG. 1-13-2004.
- 2,918,485. PARTNERS IN PRACTICE. INT. CL. 35. REG. 1-18-2005.
- 2,964,983. CRAWDADDY. INT. CL. 25. REG. 7-5-2005.
- 3,050,854. SPIRIT OF COMMUNICATION AND DESIGN. INT. CL. 9. REG. 1-24-2006.
- 3,066,475. GOLF WARRIOR. INT. CL. 28. REG. 3-7-2006.
- 3,150,253. FLORIDA DOCTORS INSURANCE COMPANYS-TANDARD CHARACTER MARK INT. CL. 36. REG. 9-26-2006.
- 3,166,662. UNREELSTANDARD CHARACTER MARK INT. CL. 25. REG. 10-31-2006.

SECTION 37

- 2,466,435. LIBRARY STUDIO. INT. CL. 9. REG. 7-3-2001.

INADVERTENTLY ISSUED REGISTRATION NUMBERS

- 3,207,173. MAYAN LABORATORIES LLC STANDARD CHARACTER MARK INT. CL. 10. REG. 2-13-2007. RESTORED TO SN 76-648,039.
- 3,223,569. A-1 U STORE IT. INT. CL. 39. REG. 4-3-2007. RESTORED TO SN 75-332,567.
- 3,259,747. STREET BOSS (STYLIZED). INT. CL. 25. REG. 7-10-2007. RESTORED TO SN 76-641,454.
- 3,260,037. AQUA VIDASTANDARD CHARACTER MARK INT. CL. 32. REG. 7-10-2007. RESTORED TO SN 78-600,455.
- 3,260,232. PSSSTANDARD CHARACTER MARK INT. CL. 35. REG. 7-10-2007. RESTORED TO SN 78-762,175.
- 3,264,036. MISCELLANEOUS DESIGN. INT. CL. 8. REG. 7-17-2007. RESTORED TO SN 77-001,664.
- 3,267,502. INSECT-O-MATIC STANDARD CHARACTER MARK INT. CLS. 9 AND 11. REG. 7-24-2007. RESTORED TO SN 77-009,230.

TM 1682

OFFICIAL GAZETTE

SEPT. 25, 2007

3,274,959. PAYPOLLSTANDARD CHARACTER MARK
INT. CL. 36. REG. 8-7-2007. RESTORED TO SN
78-905,653.

* * * * *

TRADEMARK REGISTRATIONS AMENDED, CORRECTED, ETC.

The designation "U.S. Cl." appearing in this section refers to the U.S. class in effect prior to Sep. 1, 1973 rather than the international class which applies to applications filed on or after that date. For adoption of international classification see notice in the OFFICIAL GAZETTE of Jun. 26, 1973 (911 O.G. TM 210).

Any change to the registration will be indicated at the bottom of each entry under ELEMENTS AMENDED, CORRECTED OR RESTRICTED. With the exception of changes to the goods and services, additions to the registration will appear in asterisks and deletions of the registration will appear in brackets. Elements which are only changed will be listed with no punctuation. As to the goods/services statement, amendments to the goods/services will appear in asterisks and deletions will appear in brackets. In addition if any change to the goods/services occurs, the element "Goods/Services" will be listed under ELEMENTS AMENDED, CORRECTED OR RESTRICTED.

352,087. REG. 11-16-1937. SUNKIST GROWERS, INC. (CALIFORNIA CORPORATION) 14130 RIVERSIDE DR., SHERMAN OAKS, CA, 91423, SN 71-395,217. FILED 7-15-1937. PRINCIPAL REGISTER.

1,276,048. REG. 5-1-1984. ROLF INSTITUTE OF STRUCTURAL INTEGRATION (CALIFORNIA NON-PROFIT CORPORATION) 5055 CHAPARRAL CT, SUITE 103, BOULDER, CO, 80301, SN 73-269,343. FILED 7-7-1980. PRINCIPAL REGISTER.

SUNKIST

INT. CL. 8/U.S. CL. 23

FOR KNIVES.

FIRST USE 11-16-1921; IN COMMERCE 11-16-1921.

ELEMENTS AMENDED
ASSIGNMENT/NAME CHANGE
MARK

426,532. REG. 12-31-1946. SYROCO, INC. (DELAWARE CORPORATION) 7528 STATE FAIR BOULEVARD, BALDWINVILLE, NY, 13027, SN 71-487,292. FILED 8-18-1945. PRINCIPAL REGISTER.

SYROCO

THE MARK CONSISTS OF STANDARD CHARACTERS WITHOUT CLAIM TO ANY PARTICULAR FONT, STYLE, SIZE, OR COLOR.

NO CLAIM IS MADE TO ANY PARTICULAR FONT STYLE, SIZE, OR COLOR.

INT. CL. 20/U.S. CL. 50

FOR [RELIGIOUS AND] GIFT STATUES, STATUETTES, [ARTIFICIAL FLOWERS,] WALL PLAQUES, FIGURINES FOR [CHURCH AND] HOME DECORATION, ALL MADE OF PLASTIC MATERIAL [; SMALL PLASTIC ALTARS, SMALL PLASTIC SHRINES FOR ORNAMENTAL PURPOSES AND COMBINATION DOG SETS CONSISTING OF DOG BRUSH, LEASH AND HOLDER].

FIRST USE 5-1-1911; IN COMMERCE 5-1-1911.

ELEMENTS AMENDED
ASSIGNMENT/NAME CHANGE
DISCLAIMER
MARK

ROLFING

OWNER OF U.S. REG. NO. 1,118,481.

INT. CL. 16/U.S. CL. 38

FOR ARTICLES, PAMPHLETS, BROCHURES REGARDING THE STRUCTURAL ALIGNMENT OF THE BODY.

FIRST USE 0-0-1971; IN COMMERCE 0-0-1971.

ELEMENTS CORRECTED

OWNER NAME

OWNER ADDRESS

1,383,598. REG. 2-18-1986. MERRICK'S, INC. (WISCONSIN CORPORATION) 2415 PARVIEW ROAD, MIDDLETON, WI, 53562, SN 73-543,298. FILED 6-17-1985. PRINCIPAL REGISTER.

SUPER LAMB

NO CLAIM IS MADE TO THE EXCLUSIVE RIGHT TO USE "LAMB", APART FROM THE MARK AS SHOWN.

INT. CL. 31/U.S. CL. 46

FOR MILK REPLACER FOR BABY LAMBS.

FIRST USE 12-16-1982; IN COMMERCE 12-16-1982.

ELEMENTS AMENDED
OWNER ADDRESS
ASSIGNMENT/NAME CHANGE
MARK

1,820,251. REG. 2-8-1994. BAB, INC. (DELAWARE CORPORATION) 8501 WEST HIGGINS ROAD, SUITE 320, CHICAGO, IL, 60601, SN 74-357,736. FILED 2-5-1993. PRINCIPAL REGISTER.



NO CLAIM IS MADE TO THE EXCLUSIVE RIGHT TO USE "BAGELS", APART FROM THE MARK AS SHOWN. AS TO "BIG APPLE BAGELS".
 INT. CL. 42/U.S. CLS. 100 AND 101
 FOR RESTAURANTS AND RETAIL SHOPS FEATURING FRESHLY-BAKED BAGELS.
 FIRST USE 10-18-1986; IN COMMERCE 10-18-1986.

ELEMENTS AMENDED
 MARK

1,921,794. REG. 9-26-1995. INTERLINK ELECTRONICS, INC. (CALIFORNIA CORPORATION) 546 FLYNN ROAD, CAMARILLO, CA, 93012, SN 74-585,923. FILED 10-14-1994. PRINCIPAL REGISTER.

REMOTEPOINT

INT. CL. 9/U.S. CLS. 21, 23, 26, 36 AND 38
 FOR COMPUTER CURSOR CONTROL DEVICES.
 FIRST USE 10-13-1994; IN COMMERCE 10-13-1994.

ELEMENTS AMENDED
 DATE OF FIRST USE
 DATE OF FIRST USE IN COMMERCE

2,009,452. REG. 10-22-1996. BANCO DE LA REPUBLICA ORIENTAL DEL URUGUAY (URUGUAY CORPORATION) CERRITO 351- MONTEVIDEO, URUGUAY., SN 74-619,808. FILED 1-5-1995. PRINCIPAL REGISTER.

BROU

INT. CL. 36/U.S. CLS. 100, 101 AND 102
 FOR BANKING SERVICES AND FINANCIAL SERVICES, NAMELY, FINANCIAL ANALYSIS AND CONSULTATION, FINANCIAL CLEARING HOUSES, FINANCIAL EXCHANGE, FINANCIAL FORECASTING, FINANCIAL GUARANTEE AND SURETY, FINANCIAL INVESTMENT IN THE FIELD OF REAL ESTATE AND SECURITIES, FINANCIAL MANAGEMENT, FINANCIAL PLANNING; TRAVELER'S CHECK ISSUANCE; CREDIT CARD SERVICES.
 FIRST USE 10-0-1981; IN COMMERCE 10-0-1981.

ELEMENTS AMENDED
 MARK

2,046,736. REG. 3-18-1997. RANGEFINDER PUBLISHING CO., INC. (CALIFORNIA CORPORATION) 1312 LINCOLN BOULEVARD, SANTA MONICA, CA, 90406, SN 74-672,091. FILED P.R. 5-10-1995; AM. S.R. 4-16-1996. SUPPLEMENTAL REGISTER.

WEDDING & PORTRAIT PHOTOGRAPHERS INTERNATIONAL

NO CLAIM IS MADE TO THE EXCLUSIVE RIGHT TO USE "WEDDING AND PORTRAIT PHOTOGRAPHERS", APART FROM THE MARK AS SHOWN.
 INT. CL. 42/U.S. CLS. 100 AND 101
 FOR ASSOCIATION SERVICES, NAMELY, PROMOTING THE INTERESTS OF PERSONS INVOLVED WITH PROFESSIONALLY PHOTOGRAPHING WEDDINGS AND PORTRAITS.
 FIRST USE 5-0-1995; IN COMMERCE 5-0-1995.

ELEMENTS AMENDED
 MARK

2,064,703. REG. 5-27-1997. HONGOS DE MEXICO, S.A. DE C.V. (MEXICO CORPORATION) J. M. CASTORENA NO. 74, 05000 MEXICO, D.F., MEXICO., SN 75-045,808. FILED 1-19-1996. PRINCIPAL REGISTER.



OWNER OF MEXICO REG. NO. 444718, DATED 3-11-1992. THE ENGLISH TRANSLATION OF THE MARK IS "WHITE MOUNTAIN".
 INT. CL. 29/U.S. CL. 46
 FOR PROCESSED MUSHROOMS.

ELEMENTS AMENDED
 MARK

2,067,352. REG. 6-3-1997. POINT B SOLUTIONS GROUP LLP (WASHINGTON LIMITED LIABILITY PARTNERSHIP) 1420 FIFTH AVENUE, SUITE 2200, SEATTLE, WA, 98101, SN 75-168,533. FILED 9-19-1996. PRINCIPAL REGISTER.



INT. CL. 35/U.S. CLS. 100, 101 AND 102

FOR BUSINESS CONSULTATION SERVICES.
FIRST USE 9-1-1996; IN COMMERCE 9-18-1996.

ELEMENTS AMENDED
MARK

2,092,780. REG. 9-2-1997. ADIDAS AG (FED REP GERMANY JOINT STOCK COMPANY) ADI-DASSLER-STRASSE 1, HERZOGENAURACH, FED REP GERMANY, 91074, SN 75-090,893. FILED 4-8-1996. PRINCIPAL REGISTER.

ADIWEAR

OWNER OF U.S. REG. NOS. 641,906, 1,940,156 AND OTHERS.

INT. CL. 25/U.S. CLS. 22 AND 39

FOR [BOOTS, SLIPPERS, SANDALS,] SPECIFIC PURPOSE ATHLETIC SHOES, AND GENERAL PURPOSE SPORT SHOES.

FIRST USE 1-0-1996; IN COMMERCE 1-0-1996.

ELEMENTS AMENDED
MARK

2,110,533. REG. 11-4-1997. INTERCAPITAL PARTNERS, LLC (ILLINOIS LTD LIAB CO) 414 NORTH ORLEANS, SUITE 304, CHICAGO, IL, 60610, SN 75-133,333. FILED 7-12-1996. PRINCIPAL REGISTER.

INTERCAPITAL PARTNERS, LLC

NO CLAIM IS MADE TO THE EXCLUSIVE RIGHT TO USE "PARTNERS, LTD.", APART FROM THE MARK AS SHOWN.

INT. CL. 36/U.S. CLS. 100, 101 AND 102

FOR REAL ESTATE FINANCING SERVICES.

FIRST USE 6-0-1992; IN COMMERCE 6-0-1992.

INT. CL. 37/U.S. CLS. 100, 103 AND 106

FOR REAL ESTATE DEVELOPMENT SERVICES.

FIRST USE 6-0-1992; IN COMMERCE 6-0-1992.

ELEMENTS AMENDED
MARK

2,394,539. REG. 10-17-2000. EXECUTIVE CONVERSATION, INC. (WASHINGTON CORPORATION) 1421 34TH AVENUE, SUITE 300, SEATTLE, WA, 98122, SN 75-328,192. FILED 7-21-1997. PRINCIPAL REGISTER.

EXECUTIVE CONVERSATION

NO CLAIM IS MADE TO THE EXCLUSIVE RIGHT TO USE "EXECUTIVE", APART FROM THE MARK AS SHOWN.

INT. CL. 9/U.S. CLS. 21, 23, 26, 36 AND 38

FOR COMPUTER PROGRAMS IN THE FIELD OF BUSINESS MANAGEMENT, SALES AND MARKETING, ADMINISTRATION AND EDUCATION, NAMELY, COMPUTER PROGRAMS [TO PROVIDE SPREAD-SHEET, WORD PROCESSING, PERSONAL ORGANIZER AND CONTACT FUNCTIONS, CALENDAR FUNCTIONS AND] FOR USE IN CONJUNCTION WITH CLASSROOM INSTRUCTION AND TRAINING IN BUSINESS MANAGEMENT, SALES AND MARKETING, ADMINISTRATION, EDUCATION, PERSONNEL AND INTERPERSONAL SKILLS, AND BOOKS AND MANUALS DISTRIBUTED THEREWITH.

FIRST USE 0-0-1994; IN COMMERCE 0-0-1994.

INT. CL. 16/U.S. CLS. 2, 5, 22, 23, 29, 37, 38 AND 50

FOR CALENDARS, NOTEPADS; BOOKS, MANUALS, PUBLICATIONS, NAMELY TEXT BOOKS, NEWSLETTERS, WORKBOOKS AND PRINTED INSTRUCTIONAL, EDUCATIONAL AND TEACHING MATERIALS, ALL FOR USE IN THE FIELD OF BUSINESS MANAGEMENT, SALES AND MARKETING, ADMINISTRATION, EDUCATION, PERSONNEL AND INTERPERSONAL SKILLS.

FIRST USE 0-0-1994; IN COMMERCE 0-0-1994.

INT. CL. 41/U.S. CLS. 100, 101 AND 107

FOR EDUCATIONAL SERVICES, NAMELY, CONDUCTING CLASSES AND SEMINARS FEATURING BUSINESS MANAGEMENT, SALES AND MARKETING, ADMINISTRATION, EDUCATION, PERSONAL AND INTERPERSONAL SKILLS, AND CONSULTATION RENDERED IN CONNECTION THEREWITH AND BOOKS AND MANUALS DISTRIBUTED THEREWITH.

FIRST USE 0-0-1994; IN COMMERCE 0-0-1994.

ELEMENTS AMENDED
MARK

2,403,334. REG. 11-14-2000. M. K. PRODUCTS, INC. (CALIFORNIA CORPORATION) 16882 ARMSTRONG AVE., IRVINE, CA, 92606, SN 75-605,039. FILED 12-14-1998. PRINCIPAL REGISTER.

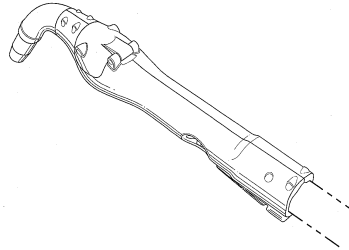

THE MARK CONSISTS OF AN OVERALL CONFIGURATION AND IMAGE OF AN ARC WELDING TORCH.

INT. CL. 9/U.S. CLS. 21, 23, 26, 36 AND 38

FOR ELECTRIC ARC WELDING TORCHES.

FIRST USE 6-0-1967; IN COMMERCE 6-0-1967.

ELEMENTS AMENDED
MARK

2,446,933. REG. 4-24-2001. STREAMLIGHT, INC. (DELAWARE CORPORATION) 1030 W. GERMANTOWN PIKE, NORRISTOWN, PA, 19403, SN 75-668,642. FILED 3-25-1999. PRINCIPAL REGISTER.

PROPOLYMER

INT. CL. 11/U.S. CLS. 13, 21, 23, 31 AND 34

FOR FLASHLIGHTS.
FIRST USE 7-15-1999; IN COMMERCE 7-15-1999.

ELEMENTS AMENDED
MARK

2,469,517. REG. 7-17-2001. G. LOOMIS, INC. (WASHINGTON CORPORATION) 1359 DOWN RIVER DRIVE, WOODLANE, WA, 98674, SN 76-048,755. FILED 5-15-2000. PRINCIPAL REGISTER.

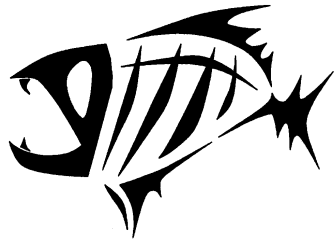

INT. CL. 25/U.S. CLS. 22 AND 39
FOR CAPS, HATS, JACKETS, PULL-OVERS, SHIRTS, SWEAT SHIRTS, T-SHIRTS, TOPS, TURTLE NECK SHIRTS, VESTS AND WIND RESISTANT JACKETS.
FIRST USE 8-0-1997; IN COMMERCE 8-0-1997.

ELEMENTS AMENDED
DATE OF FIRST USE
DATE OF FIRST USE IN COMMERCE

2,490,595. REG. 9-18-2001. DRIVER'S WAY, INC. (ALABAMA CORPORATION), DBA DRIVER'S WAY OF BIRMINGHAM, INC., 100 DRIVER'S WAY, PELHAM, AL, 35124, SN 76-121,688. FILED 8-31-2000. PRINCIPAL REGISTER.

DRIVER'S WAY

INT. CL. 35/U.S. CLS. 100, 101 AND 102
FOR AUTOMOBILE DEALERSHIPS.
FIRST USE 1-0-1999; IN COMMERCE 1-0-1999.

ELEMENTS CORRECTED
DBA/AKA
OWNER NAME

2,516,975. REG. 12-11-2001. STORIS, INC. (NEW JERSEY CORPORATION) SUITE 302, 400 VALLEY ROAD, MT. ARLINGTON, NJ, 07856, SN 76-136,839. FILED 9-27-2000. PRINCIPAL REGISTER.

STORIS

INT. CL. 9/U.S. CLS. 21, 23, 26, 36 AND 38

FOR COMPUTER SOFTWARE FOR USE BY RETAILERS TO TRACK INVENTORY, PURCHASING, SALES, ACCOUNTS RECEIVABLE AND ACCOUNTS PAYABLE.
FIRST USE 0-0-1987; IN COMMERCE 0-0-1987.

ELEMENTS CORRECTED
OWNER NAME

2,574,188. REG. 5-28-2002. ECOUNT, INC. (DELAWARE CORPORATION) 555 NORTH LANE, SUITE 5040, CONSHOHOCKEN, PA, 19428, SN 75-745,299. FILED 8-2-1999. PRINCIPAL REGISTER.

ECOUNT

INT. CL. 36/U.S. CLS. 100, 101 AND 102
FOR FINANCIAL SERVICES, NAMELY, PREPAID ELECTRONIC DEBIT ACCOUNT SERVICES PROVIDED VIA A GLOBAL COMPUTER NETWORK.
FIRST USE 10-0-1999; IN COMMERCE 10-0-1999.

ELEMENTS CORRECTED
GOODS/SERVICES

2,643,146. REG. 10-29-2002. GRUPO, ANDREA S.A. DE C.V. (MEXICO CORPORATION) J.A. DE TORRES NO. 106, FRACC. SAN JERONIMO C.P. 37148, LEON, GUANAJUANTO, MEXICO., SN 75-458,550. FILED 3-27-1998. PRINCIPAL REGISTER.



INT. CL. 18/U.S. CLS. 1, 2, 3, 22 AND 41
FOR HANDBAGS, SHOULDER BAGS, TOTE BAGS, WALLETS, PURSES, AND BOOK BAGS.
FIRST USE 1-20-2001; IN COMMERCE 1-20-2001.

INT. CL. 25/U.S. CLS. 22 AND 39
FOR SHOES, NAMELY, BOOTS, SANDALS, AND SNEAKERS, BELTS AND HOSIERY.
FIRST USE 1-20-2001; IN COMMERCE 1-20-2001.

INT. CL. 35/U.S. CLS. 100, 101 AND 102
FOR RETAIL SHOE STORE SERVICES.
FIRST USE 1-20-2001; IN COMMERCE 1-20-2001.

ELEMENTS AMENDED
MARK

2,651,090. REG. 11-19-2002. THE MORROW INSTITUTE MEDICAL GROUP, INC. (CALIFORNIA CORPORATION) 69780 STELLAR DRIVE, RANCHO MIRAGE, CA, 92270, SN 76-051,836. FILED 5-17-2000. PRINCIPAL REGISTER.

2,781,021. REG. 11-11-2003. SYNEX CORPORATION (DELAWARE CORPORATION) 44201 NOBEL DRIVE, FREMONT, CA, 94538, SN 76-007,320. FILED 3-20-2000. PRINCIPAL REGISTER.

SPECIALTY PLASTIC SURGERY

NO CLAIM IS MADE TO THE EXCLUSIVE RIGHT TO USE "PLASTIC SURGERY", APART FROM THE MARK AS SHOWN.

SEC. 2(F).
INT. CL. 42/U.S. CLS. 100 AND 101
FOR MEDICAL SERVICES.
FIRST USE 3-1-1997; IN COMMERCE 3-1-1997.

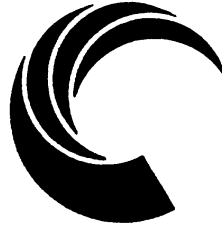

ELEMENTS CORRECTED
OWNER NAME

2,664,144. REG. 12-17-2002. STORIS, INC. (NEW JERSEY CORPORATION) 300 LITTLETON ROAD, PARSIPPANY, NJ, 07054, SN 76-144,339. FILED 10-11-2000. PRINCIPAL REGISTER.

ESTORIS

INT. CL. 9/U.S. CLS. 21, 23, 26, 36 AND 38
FOR COMPUTER SOFTWARE FOR USE BY RETAILERS TO TRACK INVENTORY, PURCHASING, SALES, ACCOUNTS RECEIVABLE AND ACCOUNTS PAYABLE.
FIRST USE 4-0-1999; IN COMMERCE 4-0-1999.

INT. CL. 35/U.S. CLS. 100, 101 AND 102
FOR DISTRIBUTORSHIP SERVICES FEATURING COMPUTERS, COMPUTER HARDWARE, COMPUTER AND NETWORK SOFTWARE, COMPUTER AND NETWORK COMPONENTS, AND COMPUTER AND NETWORK PERIPHERALS; VALUE-ADDED RESELLER DISTRIBUTORSHIP SERVICES IN THE FIELDS OF COMPUTERS, COMPUTER HARDWARE, COMPUTER AND NETWORK SOFTWARE, COMPUTER AND NETWORK COMPONENTS, AND COMPUTER AND NETWORK PERIPHERALS; DISTRIBUTORSHIPS IN THE FIELDS OF COMPUTERS, COMPUTER HARDWARE, COMPUTER AND NETWORK SOFTWARE, COMPUTER AND NETWORK COMPONENTS, AND COMPUTER AND NETWORK PERIPHERALS.

ELEMENTS CORRECTED
OWNER NAME

FIRST USE 1-4-1994; IN COMMERCE 1-4-1994.
INT. CL. 40/U.S. CLS. 100, 103 AND 106
FOR CONTRACT ASSEMBLY AND MANUFACTURING OF COMPUTERS, COMPUTER HARDWARE, SERVERS, CACHE SERVERS, NETWORK ATTACHED STORAGE SERVERS, STORAGE AREA NETWORK SERVERS, INTERNET APPLIANCES, TELECOMMUNICATIONS EQUIPMENT, NOTEBOOK COMPUTERS, LAPTOP COMPUTERS, PORTABLE COMPUTERS, AND WORKSTATIONS.

2,746,486. REG. 8-5-2003. DEMOCRATA CALCADOS E ARTIFATOS DE COURO LTDA. (BRAZIL LTD LIAB CO) RUA CORONEL TAMARINDO, 2435, VILA NICACIO, FRANCA, SAO PAULO CEP 14405- 140, BRAZIL., SN 76-401,493. FILED 4-29-2002. PRINCIPAL REGISTER.

FIRST USE 1-4-1994; IN COMMERCE 1-4-1994.
INT. CL. 42/U.S. CLS. 100 AND 101
FOR COMPUTER SYSTEM INTEGRATION; TECHNICAL CONSULTATION IN THE FIELDS OF COMPUTERS, COMPUTER HARDWARE, COMPUTER SOFTWARE, COMPUTER NETWORKS, COMPUTER TELEPHONY, COMPUTER-RELATED SERVICES, DESIGN, ENGINEERING, AND MANUFACTURING OF PRINTED CIRCUIT BOARDS, CHASSIS AND POWER SUPPLIES, MATERIALS MANAGEMENT, PRODUCT ASSEMBLY, COMPONENT SOURING AND PROCUREMENT, BUILD-TO-ORDER SERVICES, CONFIGURE-TO-ORDER SERVICES, LOGISTICS, CUSTOMER TECHNICAL SUPPORT, ORDER PROCESSING AND TRACKING, DISTRIBUTION TO OTHERS, INFORMATION TECHNOLOGY SERVICES, ONLINE PRODUCT AND SYSTEM CONFIGURATION, ONLINE ORDERING, ONLINE SHIPMENT TRACKING AND BILLING, AND INTERNET-BASED SERVICES.



OWNER OF BRAZIL REG. NO. 817970908, DATED 10-1-1996, EXPIRES 10-1-2006.

THE ENGLISH TRANSLATION OF THE WORD "DEMOCRATA" IN THE MARK IS "DEMOCRAT".

INT. CL. 25/U.S. CLS. 22 AND 39
FOR FOOTWEAR.

FIRST USE 1-4-1994; IN COMMERCE 1-0-1994.

ELEMENTS CORRECTED
OWNER NAME

ELEMENTS CORRECTED
DATE OF FIRST USE
DATE OF FIRST USE IN COMMERCE
[GOODS/SERVICES]
[INTERNATIONAL CLASS(ES)]

2,872,629. REG. 8-10-2004. XORAN TECHNOLOGIES, LLC (MICHIGAN LTD LIAB CO) 309 N. FIRST STREET, ANN ARBOR, MI, 48103, SN 78-159,080. FILED 8-29-2002. PRINCIPAL REGISTER.

XORAN TECHNOLOGIES

NO CLAIM IS MADE TO THE EXCLUSIVE RIGHT TO USE "TECHNOLOGIES", APART FROM THE MARK AS SHOWN.

INT. CL. 10/U.S. CLS. 26, 39 AND 44

FOR MEDICAL IMAGING DEVICES, NAMELY, COMPUTED TOMOGRAPHY (CT) DEVICES FOR USE IN THE MEDICAL AND DENTAL FIELDS.

FIRST USE 2-5-2004; IN COMMERCE 3-9-2004.

ELEMENTS CORRECTED
OWNER NAME

2,903,869. REG. 11-16-2004. AELUROS, INC. (DELAWARE CORPORATION) 201 SAN ANTONIO CIRCLE, SUITE 172, MOUNTAIN VIEW, CA, 94040, SN 78-185,712. FILED 11-15-2002. PRINCIPAL REGISTER.

AELUROS

THE ENGLISH TRANSLATION OF THE WORD "AELUROS" IN THE MARK IS "FELINE".

INT. CL. 9/U.S. CLS. 21, 23, 26, 36 AND 38

FOR COMPUTER SOFTWARE AND FIRMWARE FOR COMMUNICATION OF DATA; COMPUTER HARDWARE; SEMICONDUCTORS; SEMICONDUCTOR DEVICES; SEMICONDUCTOR CHIPS; INTEGRATED CIRCUITS; SEMICONDUCTORS FOR USE IN NETWORKING DEVICES; SEMICONDUCTORS FOR USE IN CONNECTION WITH HIGH SPEED COMMUNICATION SYSTEMS AND SERVICES.

FIRST USE 6-26-2003; IN COMMERCE 6-26-2003.

INT. CL. 42/U.S. CLS. 100 AND 101

FOR SEMICONDUCTOR DESIGN SERVICES; TECHNICAL CONSULTATION IN THE FIELD OF SEMICONDUCTORS AND NETWORK DEVICES.

FIRST USE 1-30-2003; IN COMMERCE 1-30-2003.

ELEMENTS CORRECTED
GOODS/SERVICES

3,003,668. REG. 10-4-2005. MRS. CLARK'S FOODS, L.C. (IOWA LTD LIAB CO) 740 S.E. DALBY DRIVE, ANKENY, IA, 50021, SN 78-338,415. FILED 12-9-2003. PRINCIPAL REGISTER.

SEÑORA CLARK'S

THE MARK CONSISTS OF STANDARD CHARACTERS WITHOUT CLAIM TO ANY PARTICULAR FONT, STYLE, SIZE, OR COLOR.

OWNER OF U.S. REG. NOS. 1,770,243 AND 2,278,686.

THE FOREIGN WORDING IN THE MARK TRANSLATES INTO ENGLISH AS MRS. CLARK'S.

SEC. 2(F).

INT. CL. 30/U.S. CL. 46

FOR MAYONNAISE AND SALAD DRESSINGS .
FIRST USE 8-1-2002; IN COMMERCE 8-1-2002.

ELEMENTS CORRECTED
OWNER NAME

3,025,160. REG. 12-13-2005. CHEMISCHE FABRIK BUDENHEIM KG (FED REP GERMANY LIMITED PARTNERSHIP) RHEINSTRASSE 27, D-55257 BUDENHEIM, FED REP GERMANY., SN 76-559,489. FILED 11-12-2003. PRINCIPAL REGISTER.

BUDAL

THE MARK CONSISTS OF STANDARD CHARACTERS WITHOUT CLAIM TO ANY PARTICULAR FONT, STYLE, SIZE, OR COLOR.

OWNER OF FED REP GERMANY REG. NO. 30252144, DATED 10-7-2003, EXPIRES 10-7-2013.

INT. CL. 1/U.S. CLS. 1

FOR CHEMICAL SUBSTANCES FOR PRESERVING FOODSTUFFS; CHEMICAL COMPOSITIONS FOR USE IN THE PRODUCTION OF FOOD PRODUCTS, NAMELY, FOR PREVENTING BLOOD COAGULATION AND FOR SOFTENING MEAT FIBRES; CHEMICALS USED IN PHOTOGRAPHY; WATER SOFTENING CHEMICAL PREPARATION; CHEMICALS, NAMELY WATER SOFTENING AGENTS AND ANTI-INCRUSTANTS; CHEMICALS, NAMELY ION EXCHANGERS; CHEMICALS FOR USE IN THE MANUFACTURE OF FOOD, COSMETIC, TOILETRIES AND PERSONAL CARE PRODUCTS, NAMELY, EMULSIFYING AGENTS; FIRE EXTINGUISHING COMPOSITIONS; TEXTILE IMPREGNATING CHEMICALS, PAPER IMPREGNATING CHEMICALS; CHEMICAL FLAME PROTECTION SUBSTANCES; CHEMICALS FOR INDUSTRIAL USE, NAMELY AUXILIARY AGENTS FOR ELECTROPLATING, FOR THE CERAMICS AND GLASS INDUSTRY, AND FOR THE SURFACE TREATMENT OF METALS; CHEMICAL PRODUCTS FOR THE MANUFACTURE OF METAL JOINTS BY SOLDERING AND WELDING, NAMELY WELDING FLUXES AND FLUXING AGENTS; PHOSPHORIC SALTS; FERTILIZERS FOR AGRICULTURAL USE; FERTILIZERS FOR DOMESTIC USE; PLANT NUTRIENT SALTS; CHEMICALS FOR USE IN THE FINISHING AND TANNING OF LEATHER; MELTING SALTS FOR CHEESE; CHEMICAL ADDITIVES FOR USE IN THE MANUFACTURE OF CONDENSED MILK; EMULSIFYING AGENTS FOR EDIBLE FATS AND OILS; CHEMICAL ADDITIVES FOR DIETETIC FOODSTUFFS AND FOR FOODSTUFFS FOR ANIMALS; * LEAVENING AGENTS OF A CHEMICAL NATURE FOR USE IN THE MANUFACTURE OF FOOD PRODUCTS; * [LEAVENING AGENTS INCLUDING BAKING POWDER; BAKING AGENTS;] CHEMICAL PRODUCTS FOR MINERAL ENRICHMENT, AS ANTI-CAKING AGENTS, FOR TREATMENT OF POTATOES AND VEGETABLES AS WELL AS FOR TREATMENT OF EGGS; CHEMICAL ADDITIVES FOR THE PREPARATION OF DAIRY PRODUCTS, DESSERTS AND DRINKS, FOR NOODLES AND OTHER DOUGH PRODUCTS.

FIRST USE ; IN COMMERCE .

INT. CL. 5/U.S. CLS. 6, 18, 44, 46, 51 AND 52

FOR MEDICATED SPA BATH SALTS AND MEDICATED BATH SALTS.

FIRST USE ; IN COMMERCE .

INT. CL. 30/U.S. CL. 46

FOR FOOD LEAVENING AGENTS, INCLUDING BAKING POWDER; BAKING AGENTS, NAMELY BAKERY MIXES.

FIRST USE ; IN COMMERCE .

INT. CL. 31/U.S. CLS. 1 AND 46

FOR FOODSTUFFS FOR ANIMALS.
FIRST USE ; IN COMMERCE .

3,028,301. REG. 12-13-2005. ARTHUR DOGSWELL, L.L.C.
(CALIFORNIA LIMITED LIABILITY CORPORATION)
#456, 2443 FILLMORE STREET, SAN FRANCISCO, CA,
94115, SN 78-499,852. FILED 10-14-2004. PRINCIPAL REG-
ISTER.

ELEMENTS CORRECTED
GOODS/SERVICES

3,028,291. REG. 12-13-2005. ARTHUR DOGSWELL, L.L.C.
(CALIFORNIA LTD LIAB CO) #456, 2443 FILLMORE
STREET, SAN FRANCISCO, CA, 94115, SN 78-499,825.
FILED 10-14-2004. PRINCIPAL REGISTER.

HAPPY HIPS

MELLOW MUT

THE MARK CONSISTS OF STANDARD CHARACTERS
WITHOUT CLAIM TO ANY PARTICULAR FONT, STYLE,
SIZE, OR COLOR.

NO CLAIM IS MADE TO THE EXCLUSIVE RIGHT TO
USE "HIPS", APART FROM THE MARK AS SHOWN.

INT. CL. 31/U.S. CLS. 1 AND 46

FOR EDIBLE DOG TREATS TO HELP MAINTAIN
HEALTHY JOINTS.

FIRST USE 3-11-2004; IN COMMERCE 3-11-2004.

THE MARK CONSISTS OF STANDARD CHARACTERS
WITHOUT CLAIM TO ANY PARTICULAR FONT, STYLE,
SIZE, OR COLOR.

INT. CL. 31/U.S. CLS. 1 AND 46

FOR EDIBLE DOG TREATS FOR A HEALTHY
LIFESTYLE.

FIRST USE 3-11-2004; IN COMMERCE 3-11-2004.

ELEMENTS CORRECTED
OWNER NAME
MARK

ELEMENTS CORRECTED
OWNER NAME

3,030,306. REG. 12-13-2005. TOKIDOKI, LLC (CALIFORNIA
LTD LIAB CO) #207, 127 E. 9TH STREET, LOS ANGELES,
CA, 90015, SN 78-350,903. FILED 1-12-2004. PRINCIPAL
REGISTER.

3,028,299. REG. 12-13-2005. ARTHUR DOGSWELL, L.L.C.
(CALIFORNIA LIMITED LIABILITY CORPORATION)
#456, 2443 FILLMORE STREET, SAN FRANCISCO, CA,
94115, SN 78-499,841. FILED 10-14-2004. PRINCIPAL REG-
ISTER.



HAPPY HEART

THE MARK CONSISTS OF STANDARD CHARACTERS
WITHOUT CLAIM TO ANY PARTICULAR FONT, STYLE,
SIZE, OR COLOR.

NO CLAIM IS MADE TO THE EXCLUSIVE RIGHT TO
USE "HEART", APART FROM THE MARK AS SHOWN.

INT. CL. 31/U.S. CLS. 1 AND 46

FOR EDIBLE DOG TREATS TO HELP MAINTAIN A
HEALTHY HEART.

FIRST USE 3-11-2004; IN COMMERCE 3-11-2004.

THE MARK CONSISTS OF AN IMAGE OF A HEART AND
CROSS BONES.

INT. CL. 18/U.S. CLS. 1, 2, 3, 22 AND 41

FOR WALLETS.

FIRST USE 4-0-2003; IN COMMERCE 7-0-2005.

INT. CL. 25/U.S. CLS. 22 AND 39

FOR MEN'S, WOMEN'S AND CHILDREN'S CLOTH-
ING; NAMELY, SHIRTS, T-SHIRTS, [SWEATSHIRTS,
TANK TOP, VESTS, DICKIES, BLOUSES, COATS, JACK-
ETS, SWEATERS, SWEATSHIRTS, PULLOVERS, SKIRTS,
DRESSES, PANTS, SWEAT PANTS, SHORTS, BEACH
WEAR, SWIMWEAR,] *AND* BELTS [, HATS, CAPS,
VISORS AND FOOTWEAR].

FIRST USE 5-1-2002; IN COMMERCE 5-1-2002.

INT. CL. 26/U.S. CLS. 37, 39, 40, 42 AND 50

ELEMENTS CORRECTED
OWNER NAME

FOR HAIR CLIPS.
FIRST USE 10-30-2004; IN COMMERCE 10-30-2004.

ELEMENTS CORRECTED
GOODS/SERVICES
DATE OF FIRST USE
DATE OF FIRST USE IN COMMERCE

3,038,651. REG. 1-10-2006. KABUSHIKI KAISHA SONY COMPUTER ENTERTAINMENT (JAPAN CORPORATION), TA SONY COMPUTER ENTERTAINMENT INC., 1-1, AKASAKA 7-CHOME, MINATO-KU, TOKYO 107-0052, JAPAN., SN 75-938,272. FILED 3-8-2000. PRINCIPAL REGISTER.



OWNER OF JAPAN REG. NO. 4599973, DATED 8-30-2002, EXPIRES 8-30-2012.

OWNER OF U.S. REG. NOS. 1,903,261, 2,343,853 AND OTHERS.

NO CLAIM IS MADE TO THE EXCLUSIVE RIGHT TO USE "COM", APART FROM THE MARK AS SHOWN.

INT. CL. 9/U.S. CLS. 21, 23, 26, 36 AND 38

FOR AIR TANKS FOR USE IN SCUBA DIVING; BULLET-PROOF VESTS AND CLOTHING; COMPUTER GAME CARTRIDGES; COMPUTER GAME CASSETTES; COMPUTER GAME DISCS; COMPUTER GAME EQUIPMENT CONTAINING MEMORY DEVICES, NAMELY, DISCS; COMPUTER GAME JOYSTICKS; COMPUTER GAME PROGRAMS; COMPUTER GAME SOFTWARE; COMPUTER GAME TAPES; GLASS TUBES FOR SCIENTIFIC PURPOSES; GRADUATED GLASSWARE; LABORATORY GLASSWARE; HIGHWAY SAFETY CONES; LIFE BELTS; LIFE JACKETS; LIFE NETS; LIFE PRESERVERS; LIFE-BUOYS; LIFE-SAVING RAFTS; MACHINES FOR PLAYING GAMES OF CHANCE; INTERACTIVE MULTIMEDIA COMPUTER GAME PROGRAM; INTERACTIVE VIDEO GAME PROGRAMS; INTERACTIVE VIDEO GAMES OF VIRTUAL REALITY COMPRISED OF COMPUTER HARDWARE AND SOFTWARE; JOYSTICKS FOR VIDEO GAMES; PROTECTIVE CLOTHING; PROTECTIVE GLOVES FOR INDUSTRIAL USE; PROTECTIVE OR SAFETY HELMETS; RADON DETECTORS; REGULATORS FOR USE IN SCUBA DIVING; RESPIRATORS OTHER THAN FOR ARTIFICIAL RESPIRATION; RESPIRATORY MASK FILTERS; RHEOSTATS; RING BUOYS FOR USE IN WATER RESCUE; SAFETY GOGGLES; SAFETY HARNESSES OTHER THAN FOR VEHICLES OR SPORTS PURPOSES; SAFETY MARKERS; SAFETY OR PROTECTIVE HELMETS; SAFETY PRODUCTS, NAMELY, REFLECTIVE HELMET SKIRTS; SAFETY PRODUCTS, NAMELY, REFLECTIVE SAFETY BANDS TO BE WORN ON THE BODY; SMOKE DETECTORS; SUPPORT BELTS FOR WORKERS; VENDING MACHINES; VIDEO GAME CARTRIDGES; VIDEO GAME DISCS; VIDEO GAME INTERACTIVE CONTROL FLOOR PADS OR MATS; VIDEO GAME INTERACTIVE REMOTE CONTROL UNITS; VIDEO GAME JOYSTICKS; VIDEO GAME MACHINES FOR USE WITH TELEVISIONS; VIDEO GAME SOFTWARE; VIDEO GAME TAPE CASSETTES; VIRTUAL REALITY GAME SOFTWARE; WARNING TRIANGLES TO INDICATE VEHICLE BREAKDOWNS; WATER SKI SAFETY VESTS.

FIRST USE ; IN COMMERCE .

INT. CL. 14/U.S. CLS. 2, 27, 28 AND 50

FOR ALARM CLOCKS; ANKLE BRACELETS; ASH-TRAYS OF PRECIOUS METAL; BADGES OF PRECIOUS METAL; BRACELETS OF PRECIOUS METAL; BROOCHES; BUSTS OF PRECIOUS METAL; CANDLE HOLDERS OF PRECIOUS METAL; CANDLE RINGS OF PRECIOUS METAL; CANDLE SNUFFERS OF PRECIOUS METAL; CANDLESTICKS OF PRECIOUS METAL; CHARMS; CHRONOGRAPHS FOR USE AS WATCHES; CHRONOMETERS; CIGARETTE CASES MADE OF PRECIOUS METAL; CIGARETTE HOLDERS OF PRECIOUS METAL; CIGARETTE LIGHTERS OF PRECIOUS METAL; CLOCKS INCORPORATING RADIOS; CLOCKS; COFFEE POTS OF PRECIOUS METAL; COFFEE SERVICES OF PRECIOUS METAL; COSTUME JEWELRY; CRUET STANDS FOR OIL OR VINEGAR OF PRECIOUS METAL; CRUETS OF PRECIOUS METAL; CUFF-LINKS; DECORATIVE BOXES MADE OF PRECIOUS METAL; DIAMONDS; EAR CLIPS; EARRINGS; EMERALDS; FIGURES OF PRECIOUS METAL; FIGURINES OF PRECIOUS METAL; GRAVE MARKERS OF PRECIOUS METAL; HAT ORNAMENTS OF PRECIOUS METAL; HAT PINS OF PRECIOUS METAL; INGOTS OF PRECIOUS METAL; JEWELRY BOXES OF PRECIOUS METAL; JEWELRY CASES OF PRECIOUS METAL; JEWELRY FINDINGS; JEWELRY PINS FOR USE ON HATS; JEWELRY; MATCH BOXES OF PRECIOUS METAL; MATCH HOLDERS OF PRECIOUS METAL; MEDALLIONS; NAPKIN RINGS OF PRECIOUS METAL; NECKLACES; NECKTIE FASTENERS; NUT CRACKERS OF PRECIOUS METAL; ORNAMENTAL LAPEL PINS; ORNAMENTAL PINS; PEARLS; PENDANTS; PIGGY BANKS MADE OF PRECIOUS METAL; PINS BEING JEWELRY; POCKET WATCHES; PRECIOUS GEMSTONES; PRECIOUS METALS AND THEIR ALLOYS SOLD IN BULK; RINGS BEING JEWELRY; SCULPTURES MADE OF PRECIOUS METAL; SEMI-PRECIOUS GEMSTONES; SERVIETTE RINGS OF PRECIOUS METAL; SERVING PLATTERS OF PRECIOUS METAL; SHOE ORNAMENTS OF PRECIOUS METAL; SNUFF BOXES OF PRECIOUS METAL; STATUES OF PRECIOUS METAL; STATUETTES OF PRECIOUS METAL; STOP WATCHES; SUN DIALS; TANKARDS OF PRECIOUS METAL; TEA BALLS OF PRECIOUS METAL; TEA INFUSERS OF PRECIOUS METAL; TEA POTS OF PRECIOUS METAL; TEA SERVICES OF PRECIOUS METAL; TIE CLIPS; TIE FASTENERS; TIE PINS; TIE TACKS; TOMBSTONES OF PRECIOUS METAL; WALL CLOCKS; WATCH BANDS; WATCH CASES; WATCH CHAINS; WATCH FOBS; WATCH MOVEMENTS; WATCH STRAPS; WATCHES CONTAINING A GAME FUNCTION; WATCHES; WEDDING BANDS; WRISTWATCHES.

FIRST USE ; IN COMMERCE .

INT. CL. 16/U.S. CLS. 2, 5, 22, 23, 29, 37, 38 AND 50

FOR GARBAGE BAGS OF PLASTIC FOR HOUSEHOLD USE; PAPER BANNERS; PAPER GARBAGE BAGS FOR HOUSEHOLD USE; PAPER BLINDS; PAPER FLAGS; PAPER AND [KERCHIEFS] * HANDKERCHIEFS * ; PLAYING CARDS; TABLE CLOTHS OF PAPER; TABLE NAPKINS OF PAPER.

FIRST USE ; IN COMMERCE .

INT. CL. 18/U.S. CLS. 1, 2, 3, 22 AND 41

FOR ANIMAL GAME BAGS; ATHLETIC BAGS; BARREL BAGS; BEACH BAGS; BEACH UMBRELLAS; BOOK BAGS; BOSTON BAGS; BRIEFBAGS; CANE HANDLES; CANES; CARRY-ON BAGS; CLUTCH BAGS; DIAPER BAGS; DOG CLOTHING; DOG COLLARS; DRAW-STRING POUCHES; DUFFEL BAGS; FEEDBAGS FOR ANIMALS; FELT POUCHES; GARMENT BAGS FOR TRAVEL; GOLF UMBRELLAS; GYM BAGS; HANDBAGS; HUNTERS' GAME BAGS; KNAPSACKS; OVERNIGHT BAGS; PARASOLS; PATIO UMBRELLAS; ROLL BAGS; SCHOOL BAGS; SCHOOL BOOK BAGS; SHAVING BAGS SOLD EMPTY; SHOE BAGS FOR TRAVEL; SHOPPING BAGS WITH WHEELS ATTACHED; SHOULDER BAGS; SPORTSMAN'S HUNTING BAGS; SUIT BAGS; TOOL BAGS SOLD EMPTY; TOTE BAGS; TRAVEL BAGS; TRAVELING BAGS; UMBRELLAS; VANITY CASES SOLD EMPTY; WALKING STICKS; WRIST MOUNTED CARRYALL BAGS; WRIST MOUNTED PURSES.

FIRST USE ; IN COMMERCE .

INT. CL. 21/U.S. CLS. 2, 13, 23, 29, 30, 33, 40 AND 50

FOR BOOT JACKS; BOTTLE OPENERS; CANDLE STICKS NOT OF PRECIOUS METAL; CHAMBER POTS; CINDER SIFTERS, FOR HOUSEHOLD USE; CLOTHES BRUSHES; COAL SCUTTLES; COCKTAIL SHAKERS; DENTAL FLOSS; DRINKING FLASKS; DUSTING GLOVES; EGG CUPS; FLOWER POTS; FLY SWATTERS; ICE PAILS; LEMON SQUEEZERS; MOUSE TRAPS; NAPKIN HOLDERS NOT OF PRECIOUS METAL; PEPPER MILLS; ROLLING PINS; SALT SHAKERS; SHOE BRUSHES; SHOE HORNS; SHOE TREES; SOAP DISPENSERS; TOILET TISSUE HOLDERS; TOOTHPICK HOLDERS; TOOTHPICKS; TRAYS FOR USE IN FINGER NAIL POLISHING; TRIVETS; VACUUM BOTTLES; WATERING CANS; WHISKS; WIND CHIMES.
FIRST USE ; IN COMMERCE .

INT. CL. 24/U.S. CLS. 42 AND 50

FOR BED SHEETS; CURTAINS; DISH CLOTHS; DRAPERIES; MOSQUITO NETS; PILLOW CASES; TABLE CLOTHS NOT OF PAPER; WINDOW CURTAINS.
FIRST USE ; IN COMMERCE .

INT. CL. 25/U.S. CLS. 22 AND 39

FOR AFTER SKI BOOTS; ALBS; APRONS; ASCOTS; ATHLETIC FOOTWEAR, ATHLETIC SHOES; ATHLETIC UNIFORMS; BABUSHKAS; BABY BUNTING; BALLOON PANTS; BANDANAS; BANDEAUX; BASEBALL CAPS; BATHING CAPS; BATHING SUITS; BATHING TRUNKS; BATHROBES; BEACH COVERUPS; BEACHWEAR; BED JACKETS; BERETS; BERMUDA SHORTS; BIKINIS; BLAZERS; BLOOMERS; BLOUSES; BLOUSONS; BOAS; BODY SHAPERS; BODY SUITS; BOLEROS; BONNETS; BOOTIES; BOOTS; BOTTOMS; BOW TIES; BOXER SHORTS; BRAS; BRASSIERES; BREECHES; BUSTIERS; CAFTANS; CAMISOLES; CAPES; CARDIGANS; CASOCKS; CHAPS; CHASUBLES; CHEMISES; CHEMISSETTES; CLOGS; CLOTH BIBS; CLOTH DIAPERS; COATS; COLLARS; COMBINATIONS; COMPETITORS' NUMBERS OF TEXTILE; CORSELETS; COVERALLS; COVERUPS; CRAVATS; CREEPERS; CUFFS; CULOTTES; CUMMERBUNDS; DICKIES; DRESS SHIELDS; DRESSES; DRESSING GOWNS; DRY SUITS; DUNGAREES; EAR MUFFS; ESPADRILLES; EVENING GOWNS; FISHING VESTS; FISHING WADERS; FLIGHT SUITS; FOOTWEAR; FOUL WEATHER GEAR; FOUNDATION GARMENTS; FROCKS; FUR CLOAKS; FUR COATS; FUR JACKETS; FUR STOLE; GABERDINES; GAITERS; GALOSHES; GARTER BELTS; GAUCHOS; GLOVES; GOLF SHIRTS; GOLF SHOES; GOWNS; GREATCOATS; GYM SHORTS; GYM SUITS; HALLOWEEN COSTUMES; HALTER TOPS; HATS; HEAD BANDS; HEAD WEAR; HEEL INSERTS; HEELS; HOSIERY; HOUSECOATS; INFANTWEAR; INNER SOLES; INSOLES; JACKETS; JEANS; JERKINS; JODHPURS; JOGGING SUITS; JUMPERS; JUMPSUITS; KERCHIEFS; KILTS; KIMONOS; KNEE HIGHS; KNICKERS; KNIT SHIRTS; LAB COATS; LAYETTES; LEATHER COATS; LEATHER JACKETS; LEG WARMERS; LEGGINGS; LEOTARDS; LIGHT-REFLECTING COATS; LIGHT-REFLECTING JACKETS; LINGERIE; LOUNGEWEAR; MAILLOTS; MANTILLAS; MASQUERADE COSTUMES AND MASKS SOLD IN CONNECTION THEREWITH; MASQUERADE COSTUMES; MINISKIRTS; MITTENS; MOCCASINS; MONEY BELTS; MUFFS; MUKLUKS; MUU MUUS; NECK BANDS; NECKERCHIEFS; NECKTIES; NECKWEAR; NEGLIGEES; NIGHT GOWNS; NIGHT SHIRTS; OVERALLS; OVERCOATS; OVERSHOES; PAJAMAS; PANTALOONS; PANTIES; PANTS; PANTSUITS; PANTYHOSE; PARASOLS; PAREU; PARKAS; PEDAL PUSHERS; PEIGNOIRS; PELERINES; PELISSES; PETTICOATS; PINAFORES; PLAY SUITS; PLUS FOURS; POCKET SQUARES; POLO SHIRTS; PONCHOS; PULLOVERS; QUILTED VESTS; RAIN COATS; RAIN SUITS; RAINWEAR ROBES; ROMPERS; RUBBERS; SANDALS; SARIS; SARONGS; SASHES; SCARVES; SHAWLS; SHIRTS; SHOES; SHORTALLS; SHORTS; SHOULDER PADS FOR CLOTHING; SHOWER CAPS; SINGLET; SKI BIBS; SKI BOOT BAGS; SKI BOOTS; SKI GLOVES; SKI MASKS; SKI PANTS; SKI SUITS; SKI WEAR; SKIRTS; SKORTS; SLACKS; SLEEP MASKS; SLEEPWEAR; SLIPPERS; SLIPS; SMOCKS; SNEAKERS; SNOW PANTS; SNOW SUITS; SNOWBOARD BOOTS; SNOWBOARD GLOVES; SOCKS; SPORT COATS; SPORT SHIRTS; STOCKINGS; STOLE; SUIT COATS; SUITS; SUN VISORS; SUNSUITS; SUSPENDERS; SWADDLING CLOTHES; SWEAT BANDS; SWEAT PANTS; SWEAT SHIRTS; SWEAT SHORTS; SWEAT SUITS; SWEATERS; SWEATSOCKS; SWIM TRUNKS; SWIM WEAR; SWIMSUITS; T-SHIRTS;

TAILLEURS; TANGAS; TANK TOPS; TAP PANTS; TEDDIES; TENNIS WEAR; THERMAL SOCKS; THERMAL UNDERWEAR; TIGHTS; TOE BOXES; TOGAS; TOPCOATS; TOQUES; TRACKSUITS; TROUSERS; TUNICS; TURBANS; TURTLENECK [SWEATERS] * SWEATERS * ; TURTLENECKS; TUXEDOS; UNDERCLOTHES; UNDERGARMENTS; UNDERPANTS; UNDERSHIRTS; UNDERWEAR; UNIFORMS; UNITARDS; V-NECK SWEATERS; VEILS; VESTED SUITS; VESTS; VISORS; WAISTCOATS; WARM UP SUITS; WEDDING GOWNS; WET SUITS; WIND RESISTANT JACKETS; WINDSHIRTS; WRIST BANDS; ZOOT SUITS; ZORI.
FIRST USE ; IN COMMERCE .

INT. CL. 26/U.S. CLS. 37, 39, 40, 42 AND 50

FOR BUTTONS FOR CLOTHING; CAMPAIGN BUTTONS; CLOTHING BUCKLES; ELASTIC RIBBONS; ELASTIC TAPE; EMBROIDERED EMBLEMS; HAIR ORNAMENTS; HAIR ORNAMENTS IN THE NATURE OF HAIR WRAPS; HAIR RIBBONS; HOOK AND LOOP FASTENING TAPE; HOOK AND PILE FASTENING TAPES; ORNAMENTAL NOVELTY BUTTONS; ORNAMENTAL RIBBONS MADE OF TEXTILES; PRESS BUTTONS; PRIZE RIBBONS; RIBBONS FOR GIFT WRAPPING; RIBBONS; RIVET BUTTONS; SHIRT BUTTONS; SHOE LACES; SHOE ORNAMENTS NOT OF PRECIOUS METAL; SLIDE FASTENERS; SNAP FASTENERS; TAPE FOR FIXING WIGS.
FIRST USE ; IN COMMERCE .

INT. CL. 28/U.S. CLS. 22, 23, 38 AND 50

FOR ACTION FIGURES AND ACCESSORIES THEREFOR; ACTION FIGURES; ACTION SKILL GAMES; ACTION-TYPE TARGET GAMES; ADULTS' AND CHILDREN'S PARTY GAMES; AERO-DYNAMIC DISK FOR USE IN PLAYING CATCHING GAMES; AIR MATTRESSES FOR RECREATIONAL USE; AMUSEMENT PARK RIDES; ANIMAL ATTRACTANT SCENTS; ANKLE AND WRIST WEIGHTS FOR EXERCISE; ARCADE GAMES; ARM GUARDS FOR ATHLETIC USE; ATHLETIC SPORTING GOODS, NAMELY, ATHLETIC WRIST AND JOINT SUPPORTS; ATHLETIC SUPPORTERS; ATHLETIC TAPE; BABY MULTIPLE ACTIVITY TOYS; BABY RATTLES; BACKBOARDS FOR BASKETBALL; BACKGAMMON GAME SETS; BADMINTON FLOOR PLATES; BADMINTON GAME PLAYING EQUIPMENT; BADMINTON RACKET STRINGS; BADMINTON RACKETS; BADMINTON SETS; BADMINTON SHUTTLECOCKS; BADMINTON UPRIGHTS; BALL BEARINGS FOR IN-LINE SKATES; BALL BEARINGS FOR ROLLER SKATES; BALL CAGES; BALL PITCHING MACHINES; BALLOONS; BARBELLS; BASEBALL BASES; BASEBALL BATS; BASEBALL BATTING GLOVES; BASEBALL BATTING TEES; BASEBALL GLOVES; BASEBALL MITTS; BASEBALLS; BASKETBALL GOAL SETS; BASKETBALL GOALS; BASKETBALL NETS; BASKETBALLS; BATH TOYS; BATHTUB TOYS; BATTING GLOVES; BEACH BALLS; BEAN BAGS; BENDABLE TOYS; BICYCLING GLOVES; BILLIARD BALLS; BILLIARD BRIDGES; BILLIARD BUMPERS; BILLIARD CHALK; BILLIARD CUE RACKS; BILLIARD CUES; BILLIARD CUSHIONS; BILLIARD GAME PLAYING EQUIPMENT; BILLIARD NETS; BILLIARD TABLES; BILLIARD TALLY BALLS; BILLIARD TIPS; BILLIARD TRIANGLES; BINGO CARDS; BINGO GAME PLAYING EQUIPMENT; BIRD CALLS; BLOCKING DUMMIES; BOARD GAMES; BOBSLEDS; BOCCI BALLS; BODY BOARDS; BOOMERANGS; BOWLING BAGS; BOWLING BALL COVERS; BOWLING BALL RETURNS; BOWLING BALLS; BOWLING DEFLECTORS; BOWLING PINS; BOWLING PINSETTERS AND PARTS THEREFOR; BOWLING PIT MATS; BOXING BAG SWIVEL MECHANISMS; BOXING BAGS; BOXING GLOVES; BUBBLE MAKING WAND AND SOLUTION SETS; CAPS FOR TOY PISTOLS; CARD GAMES; CASES FOR ACTION FIGURES; CASES FOR PLAY ACCESSORIES; CASES FOR TOY STRUCTURES; CASES FOR TOY VEHICLES; CAT TOYS; CATCHERS' MASKS; CHECKER SETS; CHEERLEADING POM-POMS; CHESS SETS; CHEST PROTECTORS FOR SPORTS; CHILDREN'S ACTIVITY TABLES CONTAINING MANIPULATIVE TOYS WHICH CONVERT TO EASELS; CHRISTMAS GARLANDS; CHRISTMAS STOCKINGS; CHRISTMAS TREE SKIRTS; CHRISTMAS TREE STAND COVERS; CHRISTMAS TREE STANDS; CLIMBERS' HARNESSSES; COIN-OPERATED VIDEO GAMES; COLLECTABLE TOY FIGURES; CONSTRUCTION TOYS; COSTUME MASKS; CRAFT SETS FOR DECORATING BALLOONS; CRIB MOBILES; CRIB TOYS; CRICKET BALLS; CRICKET BATS; CROSSBOWS; CURLING STONES; DART BOARD CASES; DART BOARDS; DART CARRYING CASES; DART FLIGHTS;

DART POINT SHARPENERS; DART POINTS; DART SHAFTS; DART STEMS; DARTS; DICE; DISC TOSS TOYS; DISCUS; DIVOT REPAIR TOOL FOR GOLFERS; DOG TOYS; DOLL ACCESSORIES; DOLL CASES; DOLL CLOTHING; DOLL COSTUMES; DOLL FURNITURE; DOLL HOUSE FURNISHINGS; DOLL HOUSES; DOLLS AND ACCESSORIES THEREFOR; DOLLS AND PLAYSETS THEREFOR; DOLLS; DOMINOES; DRAWING TOYS; DUCK BLINDS; DUMBBELL SETS; DUMBBELLS; EASTER EGG COLORING KITS; EGG DECORATING KITS; ELBOW GUARDS FOR ATHLETIC USE; ELBOW [PADT] * PADS * FOR ATHLETIC USE; ELECTRIC ACTION TOYS; ELECTRIC TOY TRAIN TRANSFORMERS; ELECTRONIC DART GAMES; ELECTRONIC EDUCATIONAL GAME MACHINES FOR CHILDREN; ELECTRONIC GAME EQUIPMENT WITH A WATCH FUNCTION; EQUIPMENT SOLD AS A UNIT FOR PLAYING A MEMORY GAME; EXERCISE BARS; EXERCISE BENCHES; EXERCISE DOORWAY GYM BARS; EXERCISE EQUIPMENT FOR LATERAL MOVEMENT IN A SKATING MOTION; EXERCISE EQUIPMENT, NAMELY, STAIR-STEPPING MACHINES; EXERCISE MACHINES; EXERCISE PLATFORMS; EXERCISE TABLES; EXERCISE TRAMPOLINES; EXERCISE TREADMILLS; EXERCISE WEIGHT CUFFS; EXERCISE WEIGHTS; EXERCISING EQUIPMENT, NAMELY MANUALLY OPERATED JOGGING MACHINES; EXERCISING EQUIPMENT, NAMELY POWERED TREADMILLS FOR RUNNING; EXERCISING EQUIPMENT, NAMELY PULLEYS; EXERCISING EQUIPMENT, NAMELY ROWING MACHINES; EXERCISING EQUIPMENT, NAMELY WEIGHT LIFTING MACHINES; EXERCISING PULLEYS; FANTASY CHARACTER TOYS; FIELD HOCKEY BALLS; FIELD HOCKEY GOALIE PADS; FIELD HOCKEY STICKS; FINS FOR BODY BOARDS; FIREARM TARGETS; FIRST BASEMAN'S MITTS; FISH ATTRACTANTS; FISHING BUOYS; FISHING CREELS; FISHING EQUIPMENT, NAMELY WINGING MATERIAL FOR FISHING JIGS AND STREAMERS; FISHING FLIES; FISHING FLOATS; FISHING FLY BOXES; FISHING HOOKS; FISHING LEADERS; FISHING LINES; FISHING LURE BOXES; FISHING LURE PARTS; FISHING LURES; FISHING PLUGS; FISHING POLE HOLDERS WORN ON THE BODY; FISHING REELS; FISHING ROD BLANKS; FISHING ROD HANDLES; FISHING ROD HOLDERS; FISHING RODS; FISHING SAFETY HARNESS; FISHING SPINNERS; FISHING TACKLE BOXES; FISHING TACKLE CONTAINERS; FISHING TACKLE; FLIES FOR USE IN FISHING; FLIPPERS FOR USE IN SCUBA DIVING; FLOATING RECREATIONAL LOUNGE CHAIRS; FLYING DISCS; FOOTBALL BODY PROTECTORS; FOOTBALL GIRDLES; FOOTBALL SHOULDER PADS; FOOTBALLS; GAME EQUIPMENT NAMELY, CHIPS; GAME TABLES; GAMING TABLES; GOALKEEPERS' GLOVES; GOLF ACCESSORY POUCHES; GOLF BAG COVERS; GOLF BAG TAGS; GOLF BAGS; GOLF BALL MARKERS; GOLF BALL RETRIEVERS; GOLF BALLS; GOLF CLUB HEADS; GOLF CLUB INSERTS; GOLF CLUB SHAFTS; GOLF CLUBS; GOLF FLAGS; GOLF GLOVES; GOLF IRONS; GOLF PUTTER COVERS; GOLF PUTTERS; GOLF TEE MARKERS; GOLF TEES; GRIP TAPES FOR BASEBALL BATS; GRIP TAPES FOR GOLF CLUBS; GRIP TAPES FOR RACKETS; GYMNASTIC APPARATUS; GYMNASTIC HORIZONTAL BARS; GYMNASTIC PARALLEL BARS; GYMNASTIC TRAINING STOOLS; GYMNASTIC VAULTING HORSES; HAND PADS FOR ATHLETIC USE; HANDBALL GLOVES; HANDBALLS; HAND HELD UNIT FOR PLAYING ELECTRONIC GAME; HANDLE GRIPS FOR SPORTING EQUIPMENT; HANG GLIDERS; HEAD COVERS FOR GOLF CLUBS; HOCKEY GLOVES; HOCKEY PUCKS; HOCKEY STICKS; HOME PLATES; HORSESHOES FOR RECREATIONAL PURPOSES; HUNTERS' SCENT CAMOUFLAGE; HUNTERS' SCENT LURE; HUNTING ARROW POINTS; HUNTING BLINDS; HUNTING BOWS; HUNTING CAMOUFLAGE USED AS HUNTING BLINDS; HUNTING GAME CALLS; HUNTING STANDS; ICE FISHING STRIKE INDICATOR; ICE HOCKEY GOALIE PADS; ICE HOCKEY STICKS; ICE SKATES; IN-LINE SKATES; INFANT ACTION CRIB TOYS; INFANT TOYS; INFLATABLE BOP BAGS; INFLATABLE INNER TUBES FOR AQUATIC RECREATIONAL USE; INFLATABLE TOYS SHOWING DECORATIVE PICTURES; INFLATABLE TOYS; JIGSAW PUZZLES; JUMP ROPES; KARATE GLOVES; KARATE HEAD GUARDS; KARATE KICK PADS; KARATE SHIN PADS; [KTRATE] * KARATE * TARGET PADS; KENO CARDS; KICK BOARD FLOTATION DEVICES FOR RECREATIONAL USE;

KICKING TEES; KITE HANDLES; KITE LINES; KITE PARTS; KITE REELS; KITE STRING; KITE TAILS; KITES; KITS FOR BUILDING OUTDOOR PLAY EQUIPMENT; KNEE GUARDS FOR ATHLETIC USE; KNEE PADS FOR ATHLETIC USE; LCD GAME MACHINES; LACROSSE BALL BAGS; LACROSSE BALLS; LACROSSE STICKS; LEASHES USED IN CONJUNCTION WITH SURFING; LEG GUARDS FOR ATHLETIC USE; LEG WEIGHTS FOR ATHLETIC USE; LEG WEIGHTS FOR EXERCISING; LOTTERY CARDS; LOTTERY TICKETS; LURES FOR HUNTING; MAGIC TRICKS; MAH JONG GAMES; MANIPULATIVE GAMES; MANIPULATIVE PUZZLES; MARBLES; MARIONETTE PUPPETS; MECHANICAL ACTION TOYS; MECHANICAL TOYS; MOBILES FOR CHILDREN; MOUNTAINEERING EQUIPMENT, NAMELY, BINDING STRAPS; MOUNTAINEERING EQUIPMENT, NAMELY, CARABINERS; MOUNTAINEERING EQUIPMENT NAMELY, HOOK AND RING COMBINATIONS; MOUNTAINEERING EQUIPMENT, NAMELY, HOOKS; MOUTH GUARDS FOR ATHLETIC USE; MUSIC BOX TOYS; MUSICAL TOYS; NEEDLES FOR PUMPS FOR INFLATING SPORTS EQUIPMENT; NETBALLS; PADDLE BALL GAMES; PADDLE BALLS; PADDLES FOR USE IN PADDLE BALL GAMES; PAPER AIRPLANES; PAPER DOLLS; PAPER FACE MASKS; PARAGLIDERS; PARLOR GAMES; PARTY FAVORS IN THE NATURE OF SMALL TOYS; PET TOYS; PINBALL-TYPE GAMES; [PINTAS] * PINATAS*; PITCHERS' PLATES; PLATFORM TENNIS BALLS; PLATFORM TENNIS NETS; PLATFORM TENNIS PADDLES; PLAY HOUSES; PLAY MATS CONTAINING INFANT TOYS; PLAY MATS FOR USE WITH TOY VEHICLES; PLAY TENTS; PLAYGROUND BALLS; PLAY SET BUILDINGS; PLAYSETS FOR DOLLS; PLUSH TOYS; POOL BRIDGES; POOL BUMPERS; POOL CHALK HOLDERS; POOL CUE CASES; POOL CUE CEMENT; POOL CUE CHALK; POOL CUE CLAMPS; POOL CUE RACKS; POOL CUE REPAIR KITS; POOL CUE TIPS; POOL CUES; POOL CUSHIONS; POOL TALLY BALLS; POP UP TOYS; PORCELAIN DOLLS; PORTABLE SUPPORT STRUCTURES FOR DANCE AND OTHER EXERCISES; POSITIONABLE TOY FIGURES; PRINTING TOYS; PROMOTIONAL GAME CARDS; PROMOTIONAL GAME MATERIALS; PULL TOYS; PUMPS FOR INFLATING SPORTS EQUIPMENT, SUCH AS BASKETBALLS, FOOTBALLS; PUNCHING BAGS; PUNCHING TOYS; PUPPETS; PUSH TOYS; RACKET GRIP TAPE; RACQUET BALL GLOVES; RACQUET BALL NETS; RACQUET BALL RACKET COVERS; RACQUET BALL RACKET STRINGS; RACQUET BALL RACKETS; RACQUET BALLS; RADIO CONTROLLED MODEL VEHICLES; RADIO CONTROLLED TOY VEHICLES; RAG DOLLS; RIDE-ON TOYS; RING BUOYS FOR RECREATIONAL USE; ROCKING HORSES; ROLE PLAYING GAME EQUIPMENT IN THE NATURE OF GAME BOOK MANUALS; ROLE PLAYING GAMES; ROLLER SKATES; RUBBER ACTION BALLS; RUGBY BALLS; SAFETY PADDING FOR VOLLEYBALL AND TENNIS UP-RIGHTS; SAIL BOARD FOOT RESTRAINTS; SAIL BOARD FOOT STRAPS; SAIL BOARD LEASHES; SAIL BOARD MASTS; SAIL BOARDS; SAND TOYS; SANDBOX TOYS; SCUBA DIVING MASKS; SCUBA EQUIPMENT, NAMELY SPRING ACTIVATED SPEARGUNS; SCUBA FINS; SCUBA FLIPPERS; SCUBA GOGGLES; SCUBA MASKS; SCUBA SNORKELS; SHIN GUARDS FOR ATHLETIC USE; SHIN PADS FOR ATHLETIC USE; SHOULDER PAD ELASTIC FOR ATHLETIC USE; SHOULDER PAD LACELOCKS FOR ATHLETIC USE; SHOULDER PAD LACES FOR ATHLETIC USE; SKATEBOARDS; SKETCHING TOYS; SKI BINDINGS AND PARTS THEREFOR; SKI BRAKES; SKI EDGES; SKI POLES; SKI ROPES; SKI SCRAPPERS; SKI WAX; SKIM BOARDS; SKIN DIVING MASKS; SKIPPING ROPE; SKIS; [TTITTLES] * SKITTLES * ; SLEDGES FOR USE IN DOWNHILL AMUSEMENT RIDES; SLING SHOTS; SNORKELS; SNOW BOARDS; SNOW SAUCERS; SNOW SHOES; SNOW SKIS; SNOW SLEDGES FOR RECREATIONAL USE; SOCCER BALLS; SOFT SCULPTURE DOLLS; SOFT SCULPTURE PLUSH TOYS; SOFTBALL BATS; SOFTBALL GLOVES; SOFTBALL MITTS; SPINNING; SPORT BALLS; SPORTSMAN'S FISHING BAGS; SPRING BAR TENSION SETS FOR USE IN EXERCISING; SPRING BARS FOR EXERCISING; SQUASH BALLS; SQUASH RACKET COVERS; SQUASH RACKET STRINGS; SQUASH RACKETS; SQUEEZE TOYS; STAND ALONE VIDEO GAME MACHINES; STATIONARY EXERCISE BICYCLES; STUFFED TOY ANIMALS; STUFFED TOYS; SURF FINS; SURFBOARD FINS; SURFBOARD LEASHES; SURFBOARD WAX; SURF-

BOARDS; SWIM BOARDS FOR RECREATIONAL USE; SWIM FINS; SWIM FLOATS FOR RECREATIONAL USE; SWIM GOGGLES; SWIM MASKS; [SE] SWIMMING EQUIPMENT, NAMELY, RACING LANES; SWIMMING EQUIPMENT, NAMELY, STARTING BLOCKS; SWIMMING GLOVES; SWING SETS; TABLE TENNIS BALLS; TABLE TENNIS NETS; TABLE TENNIS PADDLES; TABLE TENNIS POST SETS; TABLE TENNIS RACKETS; TABLE TENNIS TABLES; TALKING TOYS; TARGET GAMES; TARGETS; TEACHING MATERIALS IN THE FORM OF CARD GAMES; TEDDY BEARS; TENNIS BALL RETRIEVERS; TENNIS BALLS; TENNIS NETS; TENNIS RACKET COVERS; TENNIS RACKET PRESSES; TENNIS RACKET STRINGS; TENNIS RACKETS; TENNIS UPRIGHTS; TETHER BALLS; THROAT PROTECTORS FOR ATHLETIC USE; TOSSING DISC TOYS; TOY ACTION FIGURES AND ACCESSORIES THEREFOR; TOY ACTION FIGURES; TOY ARMOR; TOY ARTIFICIAL FINGERNAILS; TOY BOWS AND ARROWS; TOY BOXES; TOY FIGURES; TOY GLIDERS; TOY GUNS; TOY HOLSTERS; TOY HOOP SETS; TOY MOBILES; TOY MODEL HOBBY CRAFT KITS; TOY MODELING DOUGH; TOY PISTOLS; TOY PUTTY; TOY ROCKETS; TOY SNOW GLOBES; TOY STAMPS; TOY SWORDS; TOY VEHICLES; TOY VEHICLES WITH TRANSFORMING PARTS; TOY WATCHES; TOY WEAPONS; TOYS, NAMELY, A DISK TO TOSS IN PLAYING A GAME WHEREIN OTHER DISKS ARE FLIPPED AND COLLECTED; TRACTORS AND SLEDS FOR USE IN DOWNHILL AMUSEMENT RIDES; TRAIN SET ACCESSORIES, NAMELY, ARTIFICIAL TREES, TURF, FOLIAGE, BAL- LAST, LICHEN AND GRASS; TRANSFORMING RO- BOTIC TOY VEHICLES; TRANSFORMING ROBOTIC TOYS; UMPIRE PROTECTION EQUIPMENT; VEN- TRILQUIST'S DUMMIES; VIDEO OUTPUT GAMES; VOLLEYBALL FLOOR PLATES; VOLLEYBALL GAME PLAYING EQUIPMENT; VOLLEYBALL NET ANTEN- NAS; VOLLEYBALL NETS; VOLLEYBALL UPRIGHTS; VOLLEYBALLS; WAKE BOARDS; WATER PISTOLS; WATER SKI ROPE BRIDGES; WATER SQUIRTING TOYS; WATER WING SWIM AIDS FOR RECREA- TIONAL USE; WATER SKI BINDINGS; WATERSKI BRIDLES; WATER SKI CARRYING CASES; WATERSKI GLOVES; WATERSKI HANDLES; WATERSKI ROPE BRIDLES; WATERSKI ROPE HANDLES; WATERSKI ROPES; WATERSKI TOW HARNESSERS; WATERSKI TOW ROPES; WATERSKIS; WEIGHT LIFTING BELTS; WEIGHT LIFTING BENCHES AND BENCH ACCES- SORIES; WEIGHT LIFTING GLOVES; WIND-UP TOYS; WIND-UP WALKING TOYS; WRIST AND ANKLE WEIGHTS FOR EXERCISE; YO-YOS.
FIRST USE ; IN COMMERCE .

ELEMENTS CORRECTED
OWNER ADDRESS

3,075,995. REG. 4-4-2006. ARTHUR DOGSWELL, L.L.C. (CALIFORNIA LTD LIAB CO) #456, 2443 FILLMORE STREET, SAN FRANCISCO, CA, 94115, SN 78-499.685. FILED 10-14-2004. PRINCIPAL REGISTER.

BREATHIES

THE MARK CONSISTS OF STANDARD CHARACTERS WITHOUT CLAIM TO ANY PARTICULAR FONT, STYLE, SIZE, OR COLOR.
INT. CL. 31/U.S. CLS. 1 AND 46

FOR EDIBLE DOG TREATS TO HELP MAINTAIN FRESH BREATH AND HEALTHY TEETH.
FIRST USE 3-11-2004; IN COMMERCE 3-11-2004.

ELEMENTS CORRECTED
OWNER NAME
MARK

3,128,639. REG. 8-15-2006. IAC SEARCH & MEDIA, INC. (DELAWARE CORPORATION) 555 12TH STREET, SUITE 500, OAKLAND, CA, 94607, SN 78-306,655. FILED 9-29-2003. PRINCIPAL REGISTER.

POPSWATTER

THE MARK CONSISTS OF STANDARD CHARACTERS WITHOUT CLAIM TO ANY PARTICULAR FONT, STYLE, SIZE, OR COLOR.
INT. CL. 9/U.S. CLS. 21, 23, 26, 36 AND 38
FOR DOWNLOADABLE COMPUTER SOFTWARE FOR USE BY OTHERS IN BLOCKING UNSOLICITED POP-UP ADVERTISEMENTS AND POP-UP WEB LINKS TO WEB SITES OTHER THAN THAT CURRENTLY BEING VIEWED BY USER.
FIRST USE 8-13-2003; IN COMMERCE 8-13-2003.

ELEMENTS CORRECTED
ASSIGNMENT/NAME CHANGE

3,143,825. REG. 9-19-2006. DIEFFENBACHER GMBH + CO. KG (FED REP GERMANY CORPORATION) HEILBRONNER STRASSE, EPPINGEN, FED REP GERMANY, D-75031, SN 76-268,303. FILED 6-6-2001. PRINCIPAL REGISTER.

CONTI PANEL SYSTEM

OWNER OF ERPN CMNTY TM OFC REG. NO. 002246676, DATED 11-8-2002.

NO CLAIM IS MADE TO THE EXCLUSIVE RIGHT TO USE "PANEL SYSTEM", APART FROM THE MARK AS SHOWN.

INT. CL. 7/U.S. CLS. 13, 19, 21, 23, 31, 34 AND 35
FOR MACHINES FOR PROCESSING OF METAL, SYNTHETIC MATERIALS AND WOOD, FOR MANU- FACTURING AND PROCESSING OF PLASTER PLATES, AND FOR HYDRAULIC PRESSES FOR PROCESSING METAL SYNTHETIC MATERIALS, WOOD AND PLAS- TER PLATES; HYDRAULIC ACTUATION UNITS OF FUNCTIONAL UNITS AND CYLINDERS FOR MOVING AND LIFTING STACKS OF PARTICLE BOARDS.
FIRST USE ; IN COMMERCE .

INT. CL. 9/U.S. CLS. 21, 23, 26, 36 AND 38
FOR COMPUTER SOFTWARE FOR CONTROL OF MACHINES FOR PROCESSING OF METAL, SYN- THETIC MATERIALS AND WOOD, FOR MANUFAC- TURING AND PROCESSING OF PLASTER PLATES AS WELL AS FOR DRAINAGE OF FOSSILIAN FUELS, IN PARTICULAR HYDRAULIC PRESSES; MONITORING DEVICES FOR METAL, SYNTHETIC MATERIALS AND WOOD PROCESSING MACHINES, FOR MANUFAC- TURING AND PROCESSING OF PLASTER PLATES HY- DRAULIC PRESSES AS WELL AS FOR DRAINAGE OF FOSSILIAN FUELS.
FIRST USE ; IN COMMERCE .

INT. CL. 35/U.S. CLS. 100, 101 AND 102
FOR BUSINESS PLANNING.
FIRST USE ; IN COMMERCE .
INT. CL. 37/U.S. CLS. 100, 103 AND 106

FOR CONSTRUCTION PLANNING * FOR * HYDRAULIC PRESSES AND WOOD PROCESSING MACHINES FOR THE MANUFACTURE AND PROCESSING OF PLASTER PLATES, AND FOR THE DRAINAGE OF FOSSILIAN FUELS; * MAINTENANCE OF HYDRAULIC PRESSES AND WOOD PROCESSING MACHINES FOR THE MANUFACTURE AND PROCESSING OF PLASTER PLATES, AND FOR THE DRAINAGE OF FOSSILIAN FUELS *.

FIRST USE ; IN COMMERCE .

ELEMENTS AMENDED
GOODS/SERVICES

3,156,989. REG. 10-17-2006. TIME UNWIND INCORPORATED (CALIFORNIA CORPORATION) P.O. BOX 54003, IRVINE, CA, 92619, SN 78-638,063. FILED 5-26-2005. PRINCIPAL REGISTER.



VEIN CONTROL

NO CLAIM IS MADE TO THE EXCLUSIVE RIGHT TO USE "VEIN", APART FROM THE MARK AS SHOWN.

THE MARK CONSISTS OF AN ICON COMPOSED OF A CIRCLE THAT CONTAINS THE LETTER "V" BEHIND A HORIZONTALLY ORIENTED WHITE RECTANGLE AND THE STYLIZED WORDS "VEIN CONTROL" PLACED UNDERNEATH THE ICON.

INT. CL. 44/U.S. CLS. 100 AND 101

FOR MEDICAL AND BEAUTY SERVICES, NAMELY DIAGNOSIS, EVALUATION AND TREATMENT OF VEIN DISEASES AND OTHER BLOOD VESSEL RELATED DISORDERS.

FIRST USE 10-4-2004; IN COMMERCE 5-5-2005.

ELEMENTS CORRECTED
OWNER NAME

3,159,314. REG. 10-17-2006. DISNEY ENTERPRISES, INC. (DELAWARE CORPORATION) 500 S. BUENA VISTA STREET, BURBANK, CA, 915210001, SN 76-456,544. FILED 10-3-2002. PRINCIPAL REGISTER.

ALIAS

INT. CL. 9/U.S. CLS. 21, 23, 26, 36 AND 38

FOR INTERACTIVE VIDEO GAME PROGRAMS FEATURING CHARACTERS AND THEMES FROM THE TELEVISION SERIES "ALIAS"; VIDEO GAME SOFTWARE FEATURING CHARACTERS AND THEMES FROM THE TELEVISION SERIES "ALIAS"; INTERACTIVE MULTIMEDIA COMPUTER GAME PROGRAMS FEATURING CHARACTERS AND THEMES FROM THE TELEVISION SERIES "ALIAS"; COMPUTER GAME SOFTWARE FEATURING CHARACTERS AND THEMES FROM THE TELEVISION SERIES "ALIAS", AND PRE-RECORDED VIDEO DISCS FEATURING ACTION ESPIONAGE STORIES.

FIRST USE 5-0-2004; IN COMMERCE 5-0-2004.

INT. CL. 21/U.S. CLS. 2, 13, 23, 29, 30, 33, 40 AND 50
FOR MUGS.

FIRST USE 1-0-2005; IN COMMERCE 1-0-2005.

ELEMENTS CORRECTED
GOODS/SERVICES

3,184,016. REG. 12-12-2006. ADAPTIVE AUDIO LIMITED (UNITED KINGDOM LIMITED COMPANY) 3 MONTFORT HEIGHTS, HALTERWORTH LANE, ROMSEY SO51 9LP, UNITED KINGDOM., SN 79-014,470. FILED 3-15-2005. PRINCIPAL REGISTER.

OPSODIS

THE MARK CONSISTS OF STANDARD CHARACTERS WITHOUT CLAIM TO ANY PARTICULAR FONT, STYLE, SIZE, OR COLOR.

PRIORITY DATE OF 9-15-2004 IS CLAIMED.

OWNER OF INTERNATIONAL REGISTRATION 0860361 DATED 3-15-2005, EXPIRES 3-15-2015.

OWNER OF U.S. REG. NO. 2,735,732.

INT. CL. 9/U.S. CLS. 21, 23, 26, 36 AND 38

FOR APPARATUS FOR RECORDING, TRANSMISSION OR REPRODUCTION OF SOUND, IMAGES OR ACOUSTIC DATA; SOUND [AMPLIFIERS] *AMPLIFIERS*, SUB-WOOFERS, AND SPEAKERS; HIGH FIDELITY AUDIO APPARATUS AND INSTRUMENTS NAMELY, CD'S, DVD'S, COMPUTER MEMORY HARDWARE, MEMORY CARDS; LOUD SPEAKERS; RECORDS, TAPES, DISCS, CARDS AND WIRES ALL FOR THE RECORDAL, TRANSMISSION OR REPRODUCTION OF AUDIO, VISUAL AND AUDIO-VISUAL DATA; CD'S, DVD'S, COMPUTER MEMORY CARDS AND WIRES ALL FOR CONTAINING PRE-RECORDED AUDIO, VISUAL AND AUDIO-VISUAL DATA; PARTS AND FITTINGS FOR THE AFORESAID GOODS.

FIRST USE ; IN COMMERCE .

ELEMENTS CORRECTED
GOODS/SERVICES

3,191,090. REG. 1-2-2007. GLAXO GROUP LIMITED (UNITED KINGDOM CORPORATION) GLAXO WELLCOME HOUSE, BERKELEY AVENUE, GREENFORD, UNITED KINGDOM, UB6 0NN, SN 78-526,072. FILED 12-2-2004. PRINCIPAL REGISTER.

PREZYRA

THE MARK CONSISTS OF STANDARD CHARACTERS WITHOUT CLAIM TO ANY PARTICULAR FONT, STYLE, SIZE, OR COLOR.

PRIORITY CLAIMED UNDER SEC. 44(D) ON UNITED KINGDOM APPLICATION NO. 2378052, FILED 11-15-2004, REG. NO. 2378052, DATED 11-15-2004, EXPIRES 11-15-2014.

INT. CL. 5/U.S. CLS. 6, 18, 44, 46, 51 AND 52

FOR PHARMACEUTICAL PREPARATIONS AND SUBSTANCES FOR THE TREATMENT OF INFECTIOUS DISEASES, PAIN, INFLAMMATION, SEPSIS, ALOPECIA AND OBESITY, AND FOR THE TREATMENT OF VIRAL, METABOLIC, MUSCULOSKELETAL, CARDIO-PULMONARY, GENITOURINARY, ONCOLOGICAL, RESPIRATORY, [NEUROLOGICAL,]GASTROINTESTINAL, HORMONAL, DERMATOLOGICAL AND PSYCHIATRIC RELATED DISEASES AND DISORDERS AND SKIN AND TISSUE REPAIR PREPARATIONS.
FIRST USE ; IN COMMERCE .

ELEMENTS CORRECTED
GOODS/SERVICES

3,197,014. REG. 1-9-2007. SISER S.R.L. (ITALY LTD LIAB CO) VIALE DELLA TECNICA, 18, I-36100 VICENZA, ITALY., SN 79-021,316. FILED 7-22-2005. PRINCIPAL REGISTER.

ELASTICUT

THE MARK CONSISTS OF STANDARD CHARACTERS WITHOUT CLAIM TO ANY PARTICULAR FONT, STYLE, SIZE, OR COLOR.

PRIORITY DATE OF 5-20-2005 IS CLAIMED.

OWNER OF INTERNATIONAL REGISTRATION 0878027 DATED 7-22-2005, EXPIRES 7-22-2015.

INT. CL. 16/U.S. CLS. 2, 5, 22, 23, 29, 37, 38 AND 50

FOR HEAT ADHESIVE TRANSFER MATERIALS THAT MAY BE TRANSFERRED ONTO TEXTILES, NAMELY, IRON-ON TRANSFERS SIMILAR TO DECALS THAT TRANSFER ONTO TEXTILES WHEN HEATED, PLASTIC TRANSFERS SIMILAR TO DECALS THAT TRANSFER ONTO TEXTILES WHEN HEATED, HEAT TRANSFER PAPER.

FIRST USE ; IN COMMERCE .

ELEMENTS CORRECTED
[GOODS/SERVICES]
[INTERNATIONAL CLASS(ES)]

3,199,032. REG. 1-16-2007. RAMBACH ALAIN (FRANCE INDIVIDUAL) 73, BOULEVARD MONTPARNASSE, F-75006 PARIS, FRANCE., SN 79-014,464. FILED 7-29-2005. PRINCIPAL REGISTER.

AQUACHROM

PRIORITY DATE OF 2-24-2005 IS CLAIMED.
OWNER OF INTERNATIONAL REGISTRATION 0859513 DATED 7-29-2005, EXPIRES 7-29-2015.

INT. CL. 1/U.S. CLS. 1

FOR LIQUID CULTURE MEDIUM FOR DETECTING MICROBIAL CONTAMINATION OF WATER.

FIRST USE ; IN COMMERCE .

ELEMENTS CORRECTED
GOODS/SERVICES

3,224,488. REG. 4-3-2007. SUPERVALU INC. (DELAWARE CORPORATION) 11840 VALLEY VIEW ROAD, EDEN PRAIRIE, MN, 553443691, SN 78-773,448. FILED 12-14-2005. PRINCIPAL REGISTER.



OWNER OF U.S. REG. NOS. 1,204,794, 1,274,441 AND OTHERS.

NO CLAIM IS MADE TO THE EXCLUSIVE RIGHT TO USE WE VALUE YOU, APART FROM THE MARK AS SHOWN.

INT. CL. 35/U.S. CLS. 100, 101 AND 102

FOR RETAIL GROCERY STORE SERVICES.

FIRST USE 12-11-2005; IN COMMERCE 12-11-2005.

ELEMENTS AMENDED
DISCLAIMER

3,225,862. REG. 4-3-2007. CASIO KEISANKI KABUSHIKI KAISHA (JAPAN CORPORATION), DBA CASIO COMPUTER CO., LTD., 6-2, HON-MACHI 1-CHOME, SHIBUYA-KU, TOKYO, JAPAN., SN 78-646,982. FILED 6-9-2005. PRINCIPAL REGISTER.

DIRECT MOVIE

THE MARK CONSISTS OF STANDARD CHARACTERS WITHOUT CLAIM TO ANY PARTICULAR FONT, STYLE, SIZE, OR COLOR.

NO CLAIM IS MADE TO THE EXCLUSIVE RIGHT TO USE "MOVIE", APART FROM THE MARK AS SHOWN.

INT. CL. 9/U.S. CLS. 21, 23, 26, 36 AND 38

FOR [HANDHELD PERSONAL COMPUTERS; PERSONAL DIGITAL ASSISTANTS; PERSONAL COMPUTERS; COMPUTER PERIPHERALS; PRINTERS FOR COMPUTERS; COMPUTER SOFTWARE FOR USE IN DATABASE MANAGEMENT, FOR WORD PROCESSING, COMPUTER AIDED DESIGN (CAD), RETRIEVAL, GAMES AND UTILITIES, FOR USE AS A SPREADSHEET; COMPUTER SOFTWARE FOR A PERSONAL COMPUTER FOR USE IN ACHIEVING DATA EXCHANGE BETWEEN A PERSONAL COMPUTER AND A WRIST WATCH OR A DIGITAL CAMERA; ELECTRONIC CALCULATORS; ELECTRONIC PERSONAL ORGANIZERS;] DIGITAL CAMERAS; [PRINTERS FOR DIGITAL CAMERAS; LCD TELEVISION SETS; VEHICLE NAVIGATION SYSTEM CONSISTING OF COMPUTER SOFTWARE FEATURING A DATABASE OF MAP COORDINATES AND LOCATIONS, A GLOBAL POSITIONING SATELLITE RECEIVER, ELECTRICAL CABLE AND DOCUMENTATION ALL SOLD AS A UNIT; CELLULAR TELEPHONES; ELECTRONIC LABEL PRINTERS; RADIO PAGERS; RADIOS; COMPACT DISK PLAYERS; APPARATUS FOR RECORDING, TRANSMISSION OR REPRODUCTION OF SOUND OR IMAGES; AUDIO AND VIDEO TAPE RECORDERS; PRE-RECORDED AUDIO CASSETTES AND VIDEOTAPES FEATURING MUSIC, MOVIES, VIDEO GAMES; MOTION PICTURE FILMS FEATURING ENTERTAINMENT AND GENERAL INFORMATION, NAMELY, MUSIC, VAUDEVILLES, PLAYS, COMIC CHATS, SPEECHES AND LECTURES; DISC TITLE PRINTERS; MULTIMEDIA VIDEO PROJECTORS FOR TRANSMISSION OR REPRODUCTION OF IMAGES, SOUND AND DATA; VISUAL PRESENTERS, NAMELY, APPARATUS FOR TRANSMISSION OR REPRODUCTION OF IMAGES AND SOUND; SEMI-CONDUCTOR MEMORY UNITS; COMPUTER SOFTWARE FOR TRANSMITTING DIGITAL IMAGES TAKEN BY DIGITAL CAMERAS; IMAGE SCANNERS; BATTERIES].
FIRST USE 6-0-2005; IN COMMERCE 6-0-2005.

ELEMENTS CORRECTED
GOODS/SERVICES

3,233,843. REG. 4-24-2007. MATSUSHITA ELECTRIC INDUSTRIAL CO., LTD. (JAPAN CORPORATION) 1006, OAZA KADOMA, KADOMA-SHI, OSAKA-FU, JAPAN., SN 76-502,203. FILED 3-24-2003. PRINCIPAL REGISTER.

Panasonic ideas for life

OWNER OF U.S. REG. NOS. 640,961, 2,451,162 AND OTHERS.

INT. CL. 7/U.S. CLS. 13, 19, 21, 23, 31, 34 AND 35
FOR ELECTRIC SCREW DRIVERS; ELECTRIC HAND DRILLS; COMPRESSORS, NAMELY AIR COMPRESSORS, ELECTRIC MEAT GRINDERS; ELECTRIC VACUUM CLEANERS.

FIRST USE 5-31-2003; IN COMMERCE 5-31-2003.
INT. CL. 8/U.S. CLS. 23, 28 AND 44

FOR ELECTRIC SHAVERS; BLADES FOR ELECTRIC SHAVERS; ELECTRIC HAIR CLIPPERS; ELECTRIC DEPILETORS; ELECTRIC BEARD TRIMMERS; ELECTRIC HAIR TRIMMERS; ELECTRIC NOSE TRIMMERS; ELECTRIC RAZORS.

FIRST USE 5-31-2003; IN COMMERCE 5-31-2003.
INT. CL. 9/U.S. CLS. 21, 23, 26, 36 AND 38

FOR PLAIN PAPER COPIERS; BATTERIES; DRY CELLS; RECHARGEABLE BATTERIES; BATTERY CHARGERS; SOLAR CELLS; FUEL CELLS; NICKEL CADMIUM BATTERIES; NICKEL HYDROGEN BATTERIES; LITHIUM BATTERIES LITHIUM ION BATTERIES; PUSH SWITCHES; SLIDE SWITCHES; TOUCH SWITCHES; DETECTOR SWITCHES; ACOUSTIC MACHINES AND APPARATUS, NAMELY RADIOS, CASSETTE TAPE PLAYERS AND/OR RECORDERS, RADIO CASSETTE RECORDERS, DAT RECORDERS, PORTABLE CASSETTE TAPE PLAYERS, CASES FOR CASSETTE TAPE PLAYERS, PORTABLE CASSETTE PLAYERS WITH RADIOS, COMPACT DISC PLAYERS AND/OR RECORDERS, DVD AUDIO PLAYERS AND/OR RECORDERS, SECURE DIGITAL AUDIO PLAYERS AND/OR RECORDERS, MP3 (MPEG-1 AUDIO LAYER-3) PLAYERS, SPEAKERS, TUNERS, STEREO COMPONENT SYSTEM, RADIOS INCORPORATING CLOCKS, IC CHIP RECORDERS, HEADPHONES, CORDLESS HEADPHONES, EARPHONES, EARPHONES WITH MICROPHONES, CAR AUDIO SYSTEMS, MAGNETIC TAPE CLEANERS, AUDIO-VISUAL MACHINES AND APPARATUS NAMELY TELEVISION RECEIVERS, PLASMA TELEVISION RECEIVERS; PARTS AND ACCESSORIES FOR PLASMA DISPLAY NAMELY STANDS, PARTS AND ACCESSORIES FOR PLASMA DISPLAY NAMELY WALL HANGING FITTINGS, LCD TELEVISION RECEIVERS, COMBINED TELEVISION RECEIVERS WITH VIDEO TAPE RECORDERS, COMBINED TELEVISION RECEIVER WITH DISK PLAYERS, TUNERS FOR CABLE BROADCASTING, TERRESTRIAL TUNERS, TUNERS FOR TELEVISION, TUNERS FOR AUDIO BROADCASTING, INTERNET RECEIVERS, VIDEO CASSETTE RECORDERS, CAMCORDERS, CABLES FOR CAMCORDERS, CASES FOR CAMCORDERS, AC (ALTERNATING CURRENT) ADAPTERS FOR CAMCORDERS, BATTERIES FOR CAMCORDERS, TRIPODS FOR CAMERAS, DIGITAL STILL CAMERAS, BATTERIES FOR DIGITAL CAMERAS, AC (ALTERNATING CURRENT) ADAPTERS FOR DIGITAL CAMERAS, DVD VIDEO PLAYERS AND/OR RECORDERS, DIGITAL HD (HIGH DEFINITION) VIDEO CASSETTE TAPE RECORDERS, BLANK OPTICAL DISC CARTRIDGES; COMMUNICATION MACHINES AND APPARATUS, NAMELY, FACSIMILE TRANSCIEVERS, TELEPHONES, CELLULAR MOBILE TELEPHONES, TELEPHONE ANSWERING MACHINES; RADIOS FOR VEHICLES, PERSONAL HANDY-PHONES; SUPERVISION APPARATUS AND INSTRUMENTS, NAMELY, COMMUNICATION AND MONITORING SYSTEM FOR APARTMENT BUILDINGS; COMMUNICATION AND MONITORING APPARATUS FOR BUILDINGS; TRANSFORMERS; POWER CAPACITORS; COMPUTERS AND COMPUTER PERIPHERAL EQUIPMENT, NAMELY, GATEWAY APPARATUS FOR COMPUTER NETWORK, PC CARD ADAPTER FOR MEMORY CARDS, CD-ROM DRIVES, CARD READERS, CARD READER AND/OR WRITERS, BAR CODE READERS, DVD-RAM AND/OR ROM DRIVES; BLANK EXTERNAL STORAGE MEDIA, NAMELY BLANK VIDEO CASSETTE TAPES, BLANK CLEANING TAPES FOR TAPE DRIVES, BLANK DIGITAL VIDEO CASSETTE TAPES, BLANK AUDIO CASSETTE TAPES, BLANK FLOPPY DISCS, BLANK OPTICAL DISCS, BLANK MINI-DISCS, BLANK DVDS, BLANK SD (SECURE DIGITAL) MEMORY CARDS; SENSORS NAMELY MR (MAGNETIC RESISTANT) SENSORS, PHOTO SENSORS, POSITION SENSORS, ANGULAR RATE SENSORS, MAGNETIC SENSORS; ELECTRONIC COMPONENTS, NAMELY LIGHT EMITTING DIODES, DIODES, TRANSISTORS, IC (INTEGRATED CIRCUIT) MEMORY CARDS, LSI, ONE CHIP MICROCOMPUTERS, CCD IMAGE SENSORS, COIN VALIDATING UNITS, COIN SELECTOR UNITS, BILL VALIDATING UNITS, BILL SELECTOR UNITS, PRINTED WIRING BOARDS, SINGLE-SIDED PRINTED WIRING BOARDS, DOUBLE SIDED PRINTED WIRING BOARDS, MULTILAYER PRINTED WIRING BOARDS, PRINTED CIRCUIT SUBSTRATES, PARTS OF COPYING MACHINES AND FACSIMILE MACHINES, NAMELY MAGNET ROLLS FOR DEVELOPING AND CLEANING DEVICES, DC/DC CONVERTERS, INDUCTORS AND COILS, FIXED INDUCTORS, VARIABLE INDUCTORS, FILTERS OF ELECTRIC SIGNALS, EMI (ELECTROMAGNETIC INTERFERENCE) FILTERS, NOISE FILTERS USED TO PREVENT EXTERNAL NOISE COMING FROM THE POWER LINE OR TO REDUCE NOISE GENERATED BY THE SERVO MOTOR, SAW (SURFACE ACOUSTIC WAVE) FILTERS, CERAMIC FILTERS, LINE FILTERS, LASER DIODE MODULES, PHOTO DIODE

MODULES, OPTICAL CONNECTORS, ASPHERICAL LENSES, INPUT AND OUTPUT TRANSFORMERS, PIEZOELECTRIC TRANSFORMERS, THERMISTORS, VARIATORS AND SURGE ABSORBERS, CERAMIC RESONATORS, SAW (SURFACE ACOUSTIC WAVE) RESONATORS, RESISTORS, POTENTIOMETERS, TRIMMER POTENTIOMETERS, R NETWORKS CONSISTING OF REGISTER ARRAY FOR INTERFACE CIRCUIT, ENCODERS, COILS, CHOKE COILS, PANEL SWITCHES, TOUCH PANELS, REMOTE CONTROLS FOR RADIOS, TELEVISIONS, STEREOS, ANALOG TUNERS, DIGITAL TUNERS, ELECTRONIC TUNERS, DUPLEXERS, WIRELESS COMMUNICATION MODULES/UNITS; ELECTRIC UTENSILS FOR THE HOUSEHOLD, NAMELY ELECTRIC FLAT IRONS, ELECTRIC CURLERS FOR EYELASHES.

FIRST USE 5-31-2003; IN COMMERCE 5-31-2003.

INT. CL. 10/U.S. CLS. 26, 39 AND 44

FOR SURGICAL, MEDICAL, DENTAL AND VETERINARY APPARATUS AND INSTRUMENTS, NAMELY ELECTRONIC BLOOD PRESSURE METERS, ELECTRIC HANDY MASSAGERS, ELECTRIC MASSAGE CHAIRS, ELECTRIC MASSAGERS.

FIRST USE 5-31-2003; IN COMMERCE 5-31-2003.

INT. CL. 11/U.S. CLS. 13, 21, 23, 31 AND 34

FOR INSTALLATIONS FOR LIGHTING, NAMELY MINIATURE BULBS, SCREW-IN FLUORESCENT LAMPS, FLUORESCENT LAMPS, FLASH LIGHTS, HEAD LAMPS; AUTOMATIC BREAD MAKERS FOR HOME USE; ELECTRIC PRESSURE COOKERS; ELECTRIC RICE COOKERS; ELECTRIC ROASTERS; OVENS FOR COOKING; TOASTERS; MICROWAVE OVENS; ELECTRIC FREEZING SHOW CASES; VENTILATING APPARATUS AND INSTRUMENTS, NAMELY ELECTRIC FANS, VENTILATING FANS, CEILING FANS, VENTILATION FANS, ELECTRIC PORE CLEANERS FOR DOMESTIC USE.

FIRST USE 5-31-2003; IN COMMERCE 5-31-2003.

INT. CL. 16/U.S. CLS. 2, 5, 22, 23, 29, 37, 38 AND 50

FOR OFFICE REQUISITES, NAMELY ELECTRIC STAPLERS, BATTERY-OPERATED LETTER OPENERS, ELECTRIC PENCIL SHARPENERS, ELECTRIC HOLE PUNCHES.

FIRST USE 5-31-2003; IN COMMERCE 5-31-2003.

INT. CL. 21/U.S. CLS. 2, 13, 23, 29, 30, 33, 40 AND 50

FOR HOUSEHOLD UTENSILS, NAMELY WATER APPARATUS FOR CLEANING TEETH AND GUMS, ELECTRIC MOUTH WASHING AND RINSING DEVICES.

FIRST USE 5-31-2003; IN COMMERCE 5-31-2003.

INT. CL. 37/U.S. CLS. 100, 103 AND 106

FOR CONSTRUCTION, REPAIR, MAINTENANCE, FITTING AND INSTALLATION OF ELECTRIC AND ELECTRONIC APPARATUS AND INSTRUMENTS, NAMELY INSTALLATION OF ELECTRIC APPLIANCE, REPAIR OF RADIO RECEIVERS AND TELEVISION RECEIVERS, REPAIR AND MAINTENANCE OF ELECTRICAL COMMUNICATION APPARATUS AND INSTRUMENTS, REPAIR AND MAINTENANCE OF HOUSEHOLD ELECTRIC APPLIANCE, REPAIR AND MAINTENANCE OF ELECTRIC LIGHTING APPARATUS, REPAIR AND MAINTENANCE OF MEDICAL APPARATUS AND INSTRUMENTS, REPAIR AND MAINTENANCE OF COOKING APPARATUS FOR INDUSTRIAL PURPOSES, REPAIR AND MAINTENANCE OF MUSICAL INSTRUMENTS, REPAIR OF TOILET STOOL UNITS WITH WASHING WATER SQUIRTS; INSTALLATION, MAINTENANCE AND REPAIR OF COMPUTER HARDWARE; REPAIR AND MAINTENANCE OF AIR-CONDITIONING APPARATUS; OFFICE MACHINES AND EQUIPMENT INSTALLATION, MAINTENANCE AND REPAIR; BICYCLE REPAIR; REPAIR AND MAINTENANCE OF COMPUTERS; REPAIR AND MAINTENANCE OF ELECTRONIC PRINTERS; TELEPHONE REPAIR; TELECOMMUNICATION EQUIPMENT INSTALLATION AND REPAIR.

FIRST USE 5-31-2003; IN COMMERCE 5-31-2003.

ELEMENTS CORRECTED
GOODS/SERVICES

3,242,283. REG. 5-15-2007. WORLD SHOE ASSOCIATION, INC. (CALIFORNIA CORPORATION) 15821 VENTURA BOULEVARD, SUITE 415, ENCINO, CA, 91436, SN 78-932,146. FILED 7-18-2006. PRINCIPAL REGISTER.

THE COLLECTIONS AT WSA

THE MARK CONSISTS OF STANDARD CHARACTERS WITHOUT CLAIM TO ANY PARTICULAR FONT, STYLE, SIZE, OR COLOR.

OWNER OF U.S. REG. NO. 2,569,367.

NO CLAIM IS MADE TO THE EXCLUSIVE RIGHT TO USE "COLLECTIONS", APART FROM THE MARK AS SHOWN.

INT. CL. 35/U.S. CLS. 100, 101 AND 102

FOR ARRANGING AND CONDUCTING BUSINESS CONFERENCES; ARRANGING AND CONDUCTING OF FAIRS AND EXHIBITIONS FOR BUSINESS AND ADVERTISING PURPOSES; ARRANGING AND CONDUCTING TRADE SHOW EXHIBITIONS IN THE FIELD OF FOOTWEAR AND RELATED ACCESSORIES, NAMELY HANDBAGS; ARRANGING AND CONDUCTING TRADE SHOWS IN THE FIELD OF FOOTWEAR AND RELATED ACCESSORIES, NAMELY HANDBAGS.

FIRST USE 3-30-2000; IN COMMERCE 3-30-2000.

ELEMENTS CORRECTED

OWNER NAME

OWNER ADDRESS

MARK TYPE

DATE OF FIRST USE

DATE OF FIRST USE IN COMMERCE

[GOODS/SERVICES]

[INTERNATIONAL CLASS(ES)]

3,242,888. REG. 5-15-2007. LEE, AMY (UNITED STATES INDIVIDUAL) 2049 CENTURY PARK EAST, SUITE 4250, C/O 110 MANAGEMENT, INC., LOS ANGELES, CA, 90067, SN 78-479,794. FILED 9-7-2004. PRINCIPAL REGISTER.

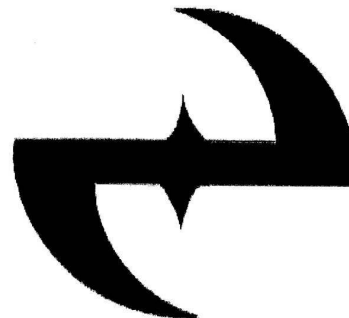

INT. CL. 41/U.S. CLS. 100, 101 AND 107

FOR RECORD PRODUCTION; MUSIC PRODUCTION; AUDIO RECORDING AND PRODUCTION; VIDEOTAPE PRODUCTION; MOTION PICTURE SONG PRODUCTION; ENTERTAINMENT SERVICES, NAMELY, PRODUCTION OF MUSICAL AUDIO PROGRAMS ON AUDIO AND VIDEO TAPES; MUSIC COMPOSITION AND TRANSCRIPTION FOR OTHERS; SONG WRITING SERVICES; ENTERTAINMENT IN THE NATURE OF A LIVE MUSICAL PERFORMER, MUSICAL BAND OR MUSICAL GROUP; ENTERTAINMENT IN THE NATURE OF LIVE PERFORMANCES BY A MUSICAL ARTIST, MUSICAL GROUP OR MUSICAL BAND; ENTERTAINMENT IN THE NATURE OF VISUAL AND AUDIO PERFORMANCES BY A MUSICAL ARTIST, MUSICAL GROUP AND MUSICAL BAND; ENTERTAINMENT, NAMELY, LIVE MUSIC CONCERTS; LIVE PERFORMANCES FEATURING PRERECORDED VOCAL AND INSTRUMENTAL PERFORMANCES VIEWED ON A BIG SCREEN; PLANNING ARRANGEMENT OF SHOWING MOVIES, SHOWS, PLAYS OR MUSICAL PERFORMANCES; ENTERTAINMENT, NAMELY, PERSONAL APPEARANCES BY A MUSICIAN, MUSICAL GROUP OR MUSICAL BAND; ENTERTAINMENT SERVICES NAMELY LIVE, TELEVISED AND MOVIE APPEARANCES BY A PROFESSIONAL ENTERTAINER; ENTERTAINMENT SERVICES, NAMELY, PROVIDING A WEB SITE FEATURING MUSICAL PERFORMANCES, MUSICAL VIDEOS, RELATED FILM CLIPS, PHOTOGRAPHS, AND OTHER MULTIMEDIA MATERIALS; ENTERTAINMENT SERVICES, NAMELY, PROVIDING PRERECORDED MUSIC, INFORMATION IN THE FIELD OF MUSIC, COMMENTARY AND ARTICLES ABOUT MUSIC, ALL ONLINE VIA A GLOBAL COMPUTER NETWORK; ENTERTAINMENT IN THE NATURE OF LIVE TRAVELING TOURS BY A PROFESSIONAL ENTERTAINER FEATURING MUSIC; ENTERTAINMENT IN THE NATURE OF LIVE TRAVELING TOURS BY A BAND FEATURING MUSICAL PERFORMANCES.
FIRST USE 1-24-2002; IN COMMERCE 1-24-2002.

ELEMENTS CORRECTED
GOODS/SERVICES

3,248,106. REG. 5-29-2007. MICROVENTION, INC. (DELAWARE CORPORATION) 75 COLUMBIA, SUITE A, ALISO VIEJO, CA, 92656, SN 78-401,561. FILED 4-14-2004. PRINCIPAL REGISTER.

OPTIFLEX

THE MARK CONSISTS OF STANDARD CHARACTERS WITHOUT CLAIM TO ANY PARTICULAR FONT, STYLE, SIZE, OR COLOR.
INT. CL. 10/U.S. CLS. 26, 39 AND 44
FOR DETACHABLE CONNECTORS FOR ATTACHING CATHETERS TO IMPLANTS FOR USE IN VASCULAR EMBOLIZATION.
FIRST USE 5-31-2004; IN COMMERCE 5-31-2004.

ELEMENTS CORRECTED
DATE OF FIRST USE
DATE OF FIRST USE IN COMMERCE

3,257,465. REG. 7-3-2007. INTERNATIONAL CODE COUNCIL, INC. (CALIFORNIA CORPORATION) 5203 LEESBURG PIKE, SUITE 600, FALLS CHURCH, VA, 220413405, SN 76-658,733. FILED 4-19-2006. PRINCIPAL REGISTER.

TOGETHER – BUILDING A SAFER WORLD

THE MARK CONSISTS OF STANDARD CHARACTERS WITHOUT CLAIM TO ANY PARTICULAR FONT, STYLE, SIZE, OR COLOR.
OWNER OF U.S. REG. NO. 2,675,390.
INT. CL. 35/U.S. CLS. 100, 101 AND 102
FOR ASSOCIATION SERVICES, NAMELY PROMOTING THE INTERESTS OF BUILDING, CONSTRUCTION, AND SAFETY CODE DEVELOPERS, ENFORCERS, AND USERS.
FIRST USE 3-0-2003; IN COMMERCE 6-0-2003.
INT. CL. 36/U.S. CLS. 100, 101 AND 102
FOR CHARITABLE FUNDRAISING.
FIRST USE 3-0-2003; IN COMMERCE 6-0-2003.

ELEMENTS CORRECTED
GOODS/SERVICES

3,263,646. REG. 7-10-2007. MTI INSTRUMENTS, INC. (NEW YORK CORPORATION) 325 WASHINGTON AVENUE EXTENSION, ALBANY, NY, 12205, SN 78-826,587. FILED P.R. 3-1-2006; AM. S.R. 4-27-2007. SUPPLEMENTAL REGISTER.

FOTONIC SENSOR

THE MARK CONSISTS OF STANDARD CHARACTERS WITHOUT CLAIM TO ANY PARTICULAR FONT, STYLE, SIZE, OR COLOR.
NO CLAIM IS MADE TO THE EXCLUSIVE RIGHT TO USE "SENSOR", APART FROM THE MARK AS SHOWN.
INT. CL. 9/U.S. CLS. 21, 23, 26, 36 AND 38
FOR ELECTRONIC INSTRUMENTS, NAMELY, SENSORS FOR MEASURING DISPLACEMENT, POSITION, AND VIBRATION.
FIRST USE 2-28-1981; IN COMMERCE 2-28-1981.

ELEMENTS CORRECTED
OWNER NAME

3,276,346. REG. 8-7-2007. HAEMONETICS CORPORATION (MASSACHUSETTS CORPORATION) 400 WOOD ROAD, BRAINTREE, MA, 02184, SN 78-486,338. FILED 9-20-2004. PRINCIPAL REGISTER.

CYMBAL

THE MARK CONSISTS OF STANDARD CHARACTERS WITHOUT CLAIM TO ANY PARTICULAR FONT, STYLE, SIZE, OR COLOR.
INT. CL. 10/U.S. CLS. 26, 39 AND 44

SEPT. 25, 2007

U.S. PATENT AND TRADEMARK OFFICE

TM 1699

FOR BLOOD PROCESSING EQUIPMENT FOR MEDICAL USE.
FIRST USE 3-22-2005; IN COMMERCE 3-22-2005.

3,280,649. REG. 8-14-2007. OCEANIC INTERNATIONAL, LLC (DELAWARE LTD LIAB CO) 808 MEYER BLVD., KANSAS CITY, MO, 64113, SN 78-675,476. FILED 7-21-2005. PRINCIPAL REGISTER.

ELEMENTS CORRECTED
MARK



NO CLAIM IS MADE TO THE EXCLUSIVE RIGHT TO USE "INTERNATIONAL", APART FROM THE MARK AS SHOWN.

THE COLOR(S) BLUE AND GREY IS/ARE CLAIMED AS A FEATURE OF THE MARK.

THE MARK CONSISTS OF THE WORD "OCEANIC" IN BLUE AND GREY LETTERING, THE LETTER "I" IN BLUE AND GREY AND THE REMAINDER OF THE WORD "INTERNATIONAL" IN GREY. THE LETTERS "O" AND "I" IN THE MARK ARE INTERLOCKING.

INT. CL. 36/U.S. CLS. 100, 101 AND 102

FOR CONSULTING SERVICES IN THE FIELD OF INSURANCE AND REINSURANCE.

FIRST USE 7-15-2006; IN COMMERCE 7-15-2006.

ELEMENTS CORRECTED
DESCRIPTION OF MARK

* * * * *

TRADEMARK REGISTRATIONS—NEW CERTIFICATES

New Certificates issued under section 7(d) of the Trademark Act of 1946 for the unexpired term of the original registrations.

2,950,735. E-CAPITAL. INT. CL. 36. E-CAPITAL, INC., SANTA CLARA, CA. REG. 5-17-2005. NEW CERT. SEC. 7(D) TO REGISTRANT.

3,046,737. MISS ATTITUDE. INT. CL. 3. MCRAE, BIRMINGHAM, AL. REG. 1-17-2006. NEW CERT. SEC. 7(D) TO REGISTRANT.

* * * * *

INDEX OF REGISTRANTS

SEPT. 25, 2007

(Registered; Renewed; Canceled; Amended, Corrected, etc.; New Certificates; 12c Publications.)

The designation "U.S. Cl." appearing in this section refers to the U.S. class in effect prior to Sep. 1, 1973 rather than the international class which applies to applications filed on or after that date. For adoption of international classification see notice in the OFFICIAL GAZETTE of Jun. 26, 1973 (911 O.G. TM 210).

(FIRM AS)/; FUTURE INFORMATION RESEARCH MANAGEMENT AS, N-0377 OSLO, NORWAY:
3,298,240, PUB. 7-10-2007. MULTIPLE CLASS, INT. CLS. 9, 35 AND 42.

A & B INGREDIENTS, INC., FAIRFIELD, NJ:
3,298,589, INT. CL. 5.

A & D FIRENZE, INC. D/B/A, VIVOLI CAFÉ & TRATTORIA, WEST HOLLYWOOD, CA:
3,297,698, PUB. 7-10-2007. INT. CL. 43.

A & T EUROPE S.P.A., MANTOVA, ITALY:
2,089,650, REN. 8-23-07. INT. CL. 6.

A B C AUTO ALARMS, INC., ELK GROVE VILLAGE, IL:
1,416,532, CANC. INT. CL. 12.

A CANDLE IN THE WINDOW, INC., NEW YORK, NY:
3,297,360, PUB. 7-10-2007. INT. CL. 4.

A FIRST-CLASS MOVE LLC, FALLS CHURCH, VA:
3,296,188, PUB. 7-10-2007. MULTIPLE CLASS, INT. CLS. 39 AND 45.

A TEC HOLDING GMBH, EBERSTEIN, AUSTRIA, ZYK-LONTECHNIK GMBH, A-3500 KREMS/DONAU (NIEDERÖSTERREICH), AUSTRIA:
2,021,546, REN. 8-20-07. INT. CL. 7.

A. RAYMOND & CIE, FRANCE:
3,298,395, PUB. 7-10-2007. MULTIPLE CLASS, INT. CLS. 9, 16 AND 35.

A.I.M. GROUP, INC., THE, BRENTWOOD, TN:
2,075,688, REN. 8-23-07. INT. CL. 35.

A.L. VERNA COMPANY, INC., VINELAND, NJ:
3,297,942, PUB. 7-10-2007. INT. CL. 29.

A.L.S. INDUSTRIES, INC., TORRANCE, CA:
2,404,595, CANC. INT. CL. 9.

A.M. CASTLE & CO., FRANKLIN PARK, IL:
3,297,988, PUB. 7-10-2007. INT. CL. 6.

A.S.X. 99, INC., MANHATTAN BEACH, CA:
2,404,435, CANC. INT. CL. 25.
2,404,436, CANC. INT. CL. 25.

A.W. CHESTERTON CO., WOBURN, MA:
649,561, REN. 8-18-07. U.S. CL. 15 (INT. CL. 4).

A&D ENGINEERING, INC., MILPITAS, CA:
3,298,005, PUB. 7-10-2007. INT. CL. 10.

A&E TELEVISION NETWORKS, NEW YORK, NY:
2,403,285, CANC. INT. CL. 16.

A-SPIRE FINANCIAL CORPORATION, PORTLAND, OR:
3,296,232, PUB. 4-3-2007. INT. CL. 41.
3,296,246, PUB. 4-3-2007. INT. CL. 41.

AAA FAIR CREDIT FOUNDATION, SALT LAKE CITY, UT:
3,297,863, PUB. 7-10-2007. MULTIPLE CLASS, INT. CLS. 36 AND 41.
3,297,864, PUB. 7-10-2007. MULTIPLE CLASS, INT. CLS. 36 AND 41.
3,297,866, PUB. 7-10-2007. INT. CL. 36.

AACME TECHNOLOGIES, INC., SIOUX CITY, IA:
2,403,719, CANC. INT. CL. 35.

AAF - MCQUAY INC, UNITED STATES:
3,298,243, PUB. 7-10-2007. MULTIPLE CLASS, INT. CLS. 6, 7, 9 AND 11.

AAMP OF FLORIDA, INC., CLEARWATER, FL:
3,299,493, INT. CL. 9.

AARON INVESTMENT COMPANY, GREENVILLE, DE:
3,296,204, PUB. 7-10-2007. MULTIPLE CLASS, INT. CLS. 35, 36, 37, 39, 41, 42, 43 AND 45.

AARON YUK TONG CHEUNG, SHATIN, HONG KONG:
2,080,679, REN. 8-17-07. INT. CL. 41.

AAT COMMUNICATIONS CORP., BOCA RATON, FL:
3,297,910, PUB. 7-10-2007. MULTIPLE CLASS, INT. CLS. 35, 37 AND 38.

AB ORWAK, SAVSJO, SWEDEN:
3,298,831, INT. CL. 7.

ABALINE PAPER PRODUCTS, INC., PORT READING, NJ:
3,297,372, PUB. 7-10-2007. MULTIPLE CLASS, INT. CLS. 5 AND 21.

ABB SCHWEIZ AG, BADEN, SWITZERLAND:
3,300,251, INT. CL. 9.

ABBEVILLE PRESS, INC., NEW YORK, NY:
2,072,826, REN. 8-23-07. INT. CL. 16.

ABBOTT LABORATORIES, NORTH CHICAGO, IL, TA ROSS LABORATORIES:
1,452,852, REN. 8-17-07. MULTIPLE CLASS, INT. CLS. 5 AND 10.

ABBOTT LABORATORIES, ABBOTT PARK, IL:
3,299,595, INT. CL. 10.

ABBY Z, INC., NEW YORK, NY:
2,404,903, CANC. INT. CL. 25.

ABERCROMBIE & FITCH TRADING CO., NEW ALBANY, OH:
3,296,572, PUB. 7-10-2007. INT. CL. 25.

ABF FREIGHT SYSTEM, INC., FORT SMITH, AR:
3,298,100, PUB. 7-10-2007. INT. CL. 39.
3,298,101, PUB. 7-10-2007. INT. CL. 39.

ABG ACQUISITION CORPORATION, MIRA LOME, CA:
2,403,859, CANC. MULTIPLE CLASS, INT. CLS. 35 AND 42.

ABLE PLANET, INCORPORATED, WHEAT RIDGE, CO:
3,298,898, MULTIPLE CLASS, INT. CLS. 9 AND 10.

ABOVE AND BEYOND INTERNATIONAL LLC, LAKEVILLE, CT:
2,404,576, CANC. INT. CL. 41.

ABRA AUTOMOTIVE SYSTEMS, INC., BROOKLYN CENTER, MN:
2,403,932, CANC. INT. CL. 37.

ABRAXIS BIOSCIENCES, INC., LOS ANGELES, CA, WALLACE & TIERNAN INCORPORATED, BELLEVILLE, NJ:
648,536, REN. 8-23-07. U.S. CL. 18 (INT. CL. 5).

ABSOLUTE MOLE CONTROL, LLC, TACOMA, WA:
3,296,900, PUB. 7-10-2007. INT. CL. 37.
3,296,901, PUB. 7-10-2007. INT. CL. 9.

ABSOLUTELYNEW, SAN FRANCISCO, CA:
3,296,632, PUB. 7-10-2007. INT. CL. 21.

ACCIN CORPORATION, CLIFTON, NJ:
3,296,724, PUB. 7-10-2007. INT. CL. 10.

ACCLAIM LIGHTING LLC, LOS ANGELES, CA:
3,296,006, PUB. 7-10-2007. INT. CL. 11.

ACCLIVUS CORPORATION, DALLAS, TX:
2,080,628, REN. 8-17-07. INT. CL. 41.

ACCO BRANDS CORPORATION, LINCOLNSHIRE, IL:
3,299,535, INT. CL. 16.

ACCREDITED GEM CONSULTANTS INC., GENEVA, IL:
2,403,889, CANC. MULTIPLE CLASS, INT. CLS. 35, 36 AND 37.

ACCREDITED HOME LENDERS, INC., SAN DIEGO, CA:
3,296,226, PUB. 4-3-2007. INT. CL. 35.

- ACCRETION PHARMACEUTICALS PTE LTD, #02-00 H-H INDUSTRIAL BUILDING, SINGAPORE:
2,015,936, CANC. INT. CL. 5.
- ACCU-SORT SYSTEMS, INC., TELFORD, PA:
3,297,248, PUB. 7-10-2007. INT. CL. 9.
- ACCUBALANCE CORPORATION, ST. HELENA, CA:
3,298,443, INT. CL. 9.
- ACCUFIND INTERNET SERVICES, NAZARETH, PA:
2,403,520, CANC. INT. CL. 42.
- ACCURACAST LIMITED, LONDON, UNITED KINGDOM:
3,300,009, INT. CL. 35.
- ACCURATE HOME IMPROVEMENT, INC., TITUSVILLE, FL:
2,107,014, REN. 8-17-07. INT. CL. 37.
- ACCURAY INCORPORATED, SUNNYVALE, CA:
3,298,517, INT. CL. 10.
- ACE LIMITED, HAMILTON, BERMUDA:
3,297,045, PUB. 7-10-2007. INT. CL. 36.
- ACH FOOD COMPANIES, INC., CORDOVA, TN:
3,299,826, INT. CL. 30.
- ACI INTERNATIONAL, LOS ANGELES, CA:
3,299,789, INT. CL. 25.
- ACQUA DI PARMA S.R.L., MILAN, ITALY, ACQUA DI PARMA S.N.C., 40100 BOLOGNA, ITALY:
2,079,666, REN. 8-20-07. INT. CL. 3.
- ACQUA LIMONE TRADING AB, S-412 51 GOTEBORG, SWEDEN:
2,014,701, CANC. INT. CL. 25.
- ACROSS AMERICA REAL ESTATE, DENVER, CO:
3,299,302, INT. CL. 36.
- ACTION EXPRESS, INC., BOISE, ID:
1,416,969, CANC. INT. CL. 39.
- ACTION GAMING, INC., LAS VEGAS, NV:
3,299,120, INT. CL. 9.
- ACTIONPRO MEDIA PRODUCTIONS CORPORATION, BENTONVILLE, AR:
3,299,809, INT. CL. 16.
- ACTIVE ANKLE SYSTEMS, INC., JEFFERSONVILLE, IN:
2,127,981, REN. 8-17-07. MULTIPLE CLASS, INT. CLS. 10 AND 28.
- ACTIVE 20-30 USA & CANADA, SACRAMENTO, CA:
3,297,597, PUB. 7-10-2007. MULTIPLE CLASS, INT. CLS. 35, 36 AND 41.
3,297,598, PUB. 7-10-2007. MULTIPLE CLASS, INT. CLS. 35, 36 AND 41.
- ACTIVISION PUBLISHING, INC., SANTA MONICA, CA:
3,299,080, INT. CL. 9.
- ACTORIS SOFTWARE, INCORPORATED, ESCONDIDO, CA:
3,299,112, INT. CL. 9.
- ACUITY BRANDS, INC., ATLANTA, GA:
3,298,415, MULTIPLE CLASS, INT. CLS. 1, 2, 3, 4, 5, 7, 9, 11, 17 AND 21.
- ACUMEN MEDICAL, INC., SUNNYVALE, CA:
3,297,738, PUB. 7-10-2007. INT. CL. 10.
- ACUO TECHNOLOGIES, LLC, OAKDALE, MN:
3,297,851, PUB. 7-10-2007. MULTIPLE CLASS, INT. CLS. 9 AND 39.
- ACUSHNET COMPANY, FAIR HAVEN, MA:
1,416,797, CANC. INT. CL. 28.
- ACUSON CORPORATION, MOUNTAIN VIEW, CA:
2,014,774, CANC. INT. CL. 10.
- AD RIDES, INC., COSTA MESA, CA:
2,403,755, CANC. INT. CL. 35.
- ADAGER CORPORATION, THE, SUN VALLEY, ID:
2,404,452, CANC. INT. CL. 9.
- ADAMENCE INTERNATIONAL LIMITED (SOCIÉTÉ DE DROIT IRLANDAIS IMMATRICULÉE SOUS LE NUMÉRO 400262), RANELAGH, DUBLIN 6, IRELAND:
3,298,192, PUB. 7-10-2007. INT. CL. 14.
- ADAMSHAND INC, WESTBOROUGH, MA:
3,300,099, INT. CL. 35.
- ADAPTIVE AUDIO LIMITED, ROMSEY SO51 9LP, UNITED KINGDOM:
3,184,016, COR. INT. CL. 9.
- ADDICT LTD., SOUTHAMPTON, UNITED KINGDOM:
3,299,961, INT. CL. 9.
- ADDITECH, INC., HOUSTON, TX:
3,297,574, PUB. 7-10-2007. INT. CL. 9.
- ADEMOLA, ADE, BROOKLYN, NY:
3,299,626, INT. CL. 45.
- ADHD.COM LLC, CINCINNATI, OH:
2,404,947, CANC. INT. CL. 41.
- ADIDAS AG, HERZOGENAURACH, FED REP GERMANY, ADIDAS AG, HERZOGENAURACH D-91072, FED REP GERMANY:
2,092,780, REN. 8-20-07. INT. CL. 25.
ADIDAS AG, HERZOGENAURACH D-91072, FED REP GERMANY TO ADIDAS AG, HERZOGENAURACH, FED REP GERMANY:
2,092,780, AM. INT. CL. 25.
- ADINA DESIGN, INC., VAN NUYS, CA:
3,299,365, INT. CL. 14.
- ADJUSTABLE FIXTURE CO., MILWAUKEE, WI:
2,403,631, CANC. INT. CL. 11.
- ADM CORPORATION, MILLSTONE, NJ:
2,125,399, REN. 8-21-07. INT. CL. 16.
- ADMAREX, INC.:
1,416,591, CANC. INT. CL. 16.
- ADMINISTRADORA DE MARCAS RD, S. DE R.L. DE C.V., CH-6301 ZUG, SWITZERLAND:
3,297,707, PUB. 7-10-2007. MULTIPLE CLASS, INT. CLS. 9 AND 38.
3,297,772, PUB. 7-10-2007. MULTIPLE CLASS, INT. CLS. 9 AND 38.
- ADMISSION CORPORATION, SAN RAMON, CA:
3,297,316, PUB. 7-10-2007. INT. CL. 35.
- ADORAMA, INC., NEW YORK, NY:
3,296,024, PUB. 7-10-2007. MULTIPLE CLASS, INT. CLS. 35 AND 40.
- ADRIAN SAND & STONE, INC., SYLVANIA, OH:
2,403,434, CANC. INT. CL. 35.
- ADS, LLC, HUNTSVILLE, AL:
2,085,920, REN. 8-20-07. INT. CL. 16.
- ADVANCE MAGAZINE PUBLISHERS INC., NEW YORK, NY:
3,296,118, PUB. 7-10-2007. INT. CL. 24.
3,298,542, INT. CL. 41.
3,300,244, INT. CL. 16.
- ADVANCE MERCHANDISING COMPANY, INC., ROANOKE, VA:
3,300,050, INT. CL. 3.
- ADVANCED BUSINESS PARTNERS I, LLC, VANCOUVER, WA:
3,300,274, INT. CL. 28.
- ADVANCED CHIP ENGINEERING TECHNOLOGY INC., HSINCHU HSIEN, TAIWAN:
3,298,823, INT. CL. 9.
3,298,826, INT. CL. 9.
3,298,827, INT. CL. 9.
3,298,828, INT. CL. 9.
3,298,829, INT. CL. 9.
3,298,830, INT. CL. 9.
3,298,833, INT. CL. 9.
- ADVANCED COMPUTER COMMUNICATIONS, SANTA BARBARA, CA:
2,404,611, CANC. INT. CL. 9.
- ADVANCED ENERGY PRODUCTS CORP., DAVIS, CA:
3,297,999, PUB. 7-10-2007. INT. CL. 11.
- ADVANCED FOODS NUTRITION BROKER LLC, RAHWAY, NJ:
3,297,858, PUB. 7-10-2007. MULTIPLE CLASS, INT. CLS. 29, 30 AND 32.
- ADVANCED FUNCTIONS TECHNOLOGY OF FLORIDA, INC., CLEARWATER, FL:
3,297,134, PUB. 7-10-2007. INT. CL. 9.
- ADVANCED HAIR STUDIO (EUROPE) LTD, DUBLIN 2, IRELAND:
3,298,740, MULTIPLE CLASS, INT. CLS. 16 AND 26.
- ADVANCED RESEARCH AND TECHNOLOGY INSTITUTE, INC., BLOOMINGTON, IN:
2,404,939, CANC. INT. CL. 41.
- ADVANCED SEPARATION TECHNOLOGIES INCORPORATED, PITTSBURGH, PA:
2,016,095, CANC. INT. CL. 9.

- ADVANCED SPORTS, INC., PHILADELPHIA, PA:
1,428,294. REN. 8-22-07. INT. CL. 12.
- ADVANCED TECHNOLOGY MATERIALS, INC., DAN-
BURY, CT:
3,299,397, INT. CL. 22.
- ADVANCED-HR, INC., SARATOGA, CA:
2,403,685. CANC. INT. CL. 42.
- ADVANCEDMD SOFTWARE, INC., DRAPER, UT:
3,299,686, INT. CL. 42.
- ADVANSTAR COMMUNICATIONS INC., DULUTH, MN:
2,403,624. CANC. INT. CL. 42.
- ADVANSTAR COMMUNICATIONS, INC., DULUTH, MN,
IRVING-CLUOD PUBLISHING COMPANY, THE, CHICA-
GO, IL:
1,466,791. REN. 8-22-07. INT. CL. 16.
- ADVANTIS HOSPITALITY ALLIANCE L.L.C., MURFREES-
BORO, TN:
3,296,712, PUB. 7-10-2007. INT. CL. 35.
- ADVISORY BOARD COMPANY, THE, WASHINGTON, DC:
2,082,626. REN. 8-18-07. INT. CL. 42.
- ADVISORY COMMUNICATIONS SYSTEMS, INC., LAN-
HAM, MD:
2,015,048, CANC. INT. CL. 42.
- ADVOSERV PROGRAMS, INC., BEAR, DE:
2,169,144. REN. 8-23-07. MULTIPLE CLASS, INT. CLS. 41
AND 42.
- AEGERION PHARMACEUTICALS, INC., BRIDGEWATER,
NJ:
3,300,046, INT. CL. 42.
- AEGIS SENIOR COMMUNITIES, LLC, REDMOND, WA:
3,299,011, INT. CL. 43.
- AELUROS, INC., MOUNTAIN VIEW, CA:
2,903,869, COR. MULTIPLE CLASS, INT. CLS. 9 AND 42.
- AERO DESIGN AND MANUFACTURING COMPANY, INC.,
DULUTH, MN:
3,299,988, INT. CL. 16.
3,299,989, MULTIPLE CLASS, INT. CLS. 16, 25 AND 39.
3,299,990, INT. CL. 39.
3,299,991, INT. CL. 25.
- AEROJET-GENERAL CORPORATION, SACRAMENTO, CA,
AEROJET ENGINEERING CORPORATION, AZUSA, CA:
426,781. REN. 8-23-07. U.S. CL. 23 (INT. CL. 7).
- AEROPOSTALE WEST, INC., WAYNE, NJ:
3,299,252, INT. CL. 9.
- AEROSPHERE, INC., ALAMO, CA:
3,297,747, PUB. 7-10-2007. INT. CL. 28.
- AEROTEK, INC., HANOVER, MD:
3,299,784, INT. CL. 35.
- AESCHLEMAN FUR CO., INC., ROANOKE, IL:
2,404,662, CANC. INT. CL. 28.
- AESCULAP AG & CO. KG, D-78532 TUTTLINGEN, FED REP
GERMANY:
2,404,071, CANC. INT. CL. 10.
- AETNA INC., BLUE BELL, PA:
2,016,039, CANC. INT. CL. 9.
- AFFILIATED INDEPENDENT DISTRIBUTORS, INC., KING
OF PRUSSIA, PA:
3,297,215, PUB. 7-10-2007. INT. CL. 35.
- AFFINIA GROUP, INC., ANN ARBOR, MI:
3,299,936, INT. CL. 12.
- AFFINITY DIRECT, LLC, ENGLEWOOD CLIFFS, NJ:
3,300,348, INT. CL. 36.
- AFFINITY INTERNET, INC., FORT LAUDERDALE, FL:
3,297,501, PUB. 7-10-2007. INT. CL. 42.
- AFFORDABLE LUXURY HOMES, INC., MARKLE, IN:
1,416,946, CANC. MULTIPLE CLASS, INT. CLS. 37 AND
42.
- AFFORDABLE TICKET SERVICE, INC., INDIANAPOLIS,
IN:
3,296,664, PUB. 7-10-2007. INT. CL. 41.
- AFS FOUNDATION, ZURICH, SWITZERLAND, AMERI-
CAN FIELD SERVICE, INC., NEW YORK, NY:
1,045,158. REN. 8-20-07. MULTIPLE CLASS, U.S. CLS. 102
(INT. CL. 36), 105 (INT. CL. 39), 107 (INT. CL. 41)
AND 200.
- AG BELL ACADEMY FOR LISTENING AND SPOKEN
LANGUAGE, WASHINGTON, DC:
3,298,548, INT. CL. 42.
- AG PARTNERS COOP, GOODHUE, MN:
3,296,343, PUB. 7-10-2007. INT. CL. 31.
- AGA JOHN ORIENTAL RUGS, LOS ANGELES, CA:
2,015,601, CANC. INT. CL. 27.
- AGAKHANYAN, ARARAT, BURBANK, CA:
3,299,349, INT. CL. 30.
- AGCO CORPORATION, DULUTH, GA:
2,403,632, CANC. INT. CL. 24.
- AGENCY RENT-A-CAR, INC., SOLON, OH:
1,416,965, CANC. INT. CL. 39.
- AGENDA U.S.A., INC., NEW YORK, NY:
2,404,330, CANC. INT. CL. 16.
- AGF MANUFACTURING, INC., MALVERN, PA:
1,483,038. REN. 8-22-07. INT. CL. 6.
- AGFA-GEVAERT N.V. & CO. KG, D-51373 LEVERKUSEN,
FED REP GERMANY:
2,077,755. REN. 8-17-07. MULTIPLE CLASS, INT. CLS. 1,
2, 7, 9, 10, 16, 37 AND 41.
- AGP-L.P.:
1,416,866, CANC. INT. CL. 31.
- AGR INTERNATIONAL, INC., BUTLER, PA:
2,098,625. REN. 8-23-07. MULTIPLE CLASS, INT. CLS. 7
AND 9.
- AGRIBIOTECH, INC., HENDERSON, NV:
2,404,787, CANC. INT. CL. 31.
- AGRILIANCE LLC., ST. PAUL, MN:
3,296,607, PUB. 7-10-2007. MULTIPLE CLASS, INT. CLS.
35 AND 42.
- AGRIZAP, INC., VENTURA, CA:
3,299,718, INT. CL. 9.
- AGROMOD, S.A. DE C.V., SAN PEDRO GARZA GARCIA,
NUEVO LEON, MEXICO:
3,298,503, INT. CL. 31.
- AGUGIARO & FIGNA MOLINI S.P.A., ITALY:
3,298,274, PUB. 7-10-2007. INT. CL. 30.
- AGUILAR, QUETZALCOATL, CARLSBAD, CA:
2,404,415, CANC. MULTIPLE CLASS, INT. CLS. 25 AND
41.
- AHD INTERNATIONAL, LLC, ATLANTA, GA:
3,298,735, INT. CL. 5.
- AHOLD LICENSING SA, GENEVA, SWITZERLAND:
3,297,769, PUB. 7-10-2007. INT. CL. 35.
- AIM TECHNOLOGIES, INC., CAPE CORAL, FL:
2,083,516. REN. 8-22-07. INT. CL. 9.
- AIRWAVES, INC., SHERMAN OAKS, CA:
2,056,728, CANC. INT. CL. 42.
- AISIN SEIKI KABUSHIKI KAISHA, JAPAN:
3,298,358, PUB. 7-10-2007. MULTIPLE CLASS, INT. CLS. 7
AND 12.
- AIZHI, INC., OCEANSIDE, CA:
3,300,339, INT. CL. 43.
- AJ TRUCCO, INC., BRONX, NY:
3,297,803, PUB. 7-10-2007. INT. CL. 31.
- AKTIEBOLAGET SKF, 415 50 GOTEBOURG, SWEDEN TO
FLEXLINK SYSTEMS AB, GOTEBOURG, SWEDEN:
2,014,811, CANC. INT. CL. 7.
- AKTSIONERNO DROUJESTVO; "HUVEPHARMA", BUL-
GARIA:
3,298,323, PUB. 7-10-2007. MULTIPLE CLASS, INT. CLS. 5
AND 31.
3,298,337, PUB. 7-10-2007. INT. CL. 5.
- AL COLLINS GRAPHIC DESIGN SCHOOL, LTD., HOFF-
MAN ESTATES, IL:
3,297,855, PUB. 7-10-2007. INT. CL. 41.
- AL'S CABINETS, INC., BURNSVILLE, MN:
3,296,717, PUB. 7-10-2007. INT. CL. 40.
- ALABAMA LAUNCHPAD, BIRMINGHAM, AL:
3,297,050, PUB. 7-10-2007. INT. CL. 35.
- ALABAMA SPACE SCIENCE EXHIBIT COMMISSION,
HUNTSVILLE, AL, DBA UNITED STATES SPACE AND
ROCKET CENTER:
2,085,031. REN. 8-20-07. MULTIPLE CLASS, INT. CLS. 18,
21 AND 25.
2,112,553. REN. 8-23-07. INT. CL. 16.
- ALAMO CROCKETT PALACE, LTD., SAN ANTONIO, TX:
2,404,505, CANC. MULTIPLE CLASS, INT. CLS. 41 AND
42.

- ALAN LEBOW, INC., OCEAN RIDGE, FL:
1,477,761. REN. 8-22-07. INT. CL. 25.
- ALAN LEE DISTRIBUTORS, TEMECULA, CA:
3,296,382. PUB. 7-10-2007. INT. CL. 31.
- ALAN LEE DISTRIBUTORS, INC., TEMECULA, CA:
3,296,383. PUB. 7-10-2007. INT. CL. 31.
- ALAN MARCUS & CO., LLC, WASHINGTON, DC:
2,403,123. CANC. INT. CL. 35.
- ALASKA STRUCTURES, INC., ANCHORAGE, AK:
3,298,989. MULTIPLE CLASS, INT. CLS. 35 AND 42.
3,299,171. INT. CL. 37.
- ALBERTO-CULVER INTERNATIONAL, INC., MELROSE PARK, IL:
1,454,827. REN. 8-23-07. INT. CL. 3.
- ALBRECHT, KATHY ELLEN, SCOTTS VALLEY, CA:
2,404,324. CANC. INT. CL. 42.
- ALCAN ALUMINUM CORPORATION, CLEVELAND, OH:
1,416,397. CANC. INT. CL. 6.
- ALCAS CORPORATION, OLEAN, NY:
3,299,369. INT. CL. 8.
- ALCATEL, 75008 PARIS, FRANCE:
2,404,080. CANC. INT. CL. 9.
2,404,082. CANC. INT. CL. 9.
- ALCATEL LUCENT, FRANCE:
3,298,275. PUB. 7-10-2007. INT. CL. 9.
- ALCOA INC., PITTSBURGH, PA:
2,403,811. CANC. INT. CL. 16.
- ALDI INC., BATAVIA, IL:
2,404,172. CANC. INT. CL. 30.
- ALDO SHOES INC., VILLE ST-LAURENT, QUEBEC, CANADA:
2,403,040. CANC. MULTIPLE CLASS, INT. CLS. 18 AND 25.
2,403,041. CANC. MULTIPLE CLASS, INT. CLS. 18 AND 25.
- ALERT-ALL CORP., NEW HOLLAND, PA:
3,298,878. INT. CL. 16.
- ALESYS, INC., ALACHUA, FL:
2,089,846. REN. 8-17-07. MULTIPLE CLASS, INT. CLS. 35 AND 41.
- ALEXANDER DOLL COMPANY, INC., NEW YORK, NY:
3,299,993. INT. CL. 28.
3,300,025. INT. CL. 28.
3,300,067. INT. CL. 28.
- ALEXANDERS, DAVID, KARLSRUHE, BADEN-WURTEMBERG, FED REP GERMANY:
3,297,378. PUB. 7-10-2007. INT. CL. 35.
- ALEXION PHARMACEUTICALS, INC., CHESHIRE, CT:
3,300,217. INT. CL. 5.
- ALFA LAVAL NAKSKOV A/S, DENMARK:
3,298,231. PUB. 7-10-2007. INT. CL. 9.
- ALIAKSANDR, DALHITSKI, NORTHGLEN, CO:
3,300,331. INT. CL. 35.
- ALICE J. BERLOW, D/B/A THE ISLAND GROWN INITIATIVE, BOSTON, MA:
3,297,692. PUB. 7-10-2007. INT. CL. 35.
- ALIGNMED, INC., SANTA ANA, CA:
3,297,503. PUB. 7-10-2007. INT. CL. 10.
- ALIGNMENT CONCEPTS, INC., NEW BRAUNFELS, TX:
2,014,938. CANC. INT. CL. 37.
- ALJO QUALITY WINDOWS, INC., TIGARD, OR:
1,416,403. CANC. INT. CL. 6.
- ALK-ABELLO A/S, DENMARK:
3,298,359. PUB. 7-10-2007. MULTIPLE CLASS, INT. CLS. 5, 42 AND 44.
- ALL ACCESS APPAREL, INC., MONTEBELLO, CA:
3,298,416. MULTIPLE CLASS, INT. CLS. 9 AND 18.
- ALL AMERICAN FOODS INC., MANKATO, MN:
2,403,846. CANC. INT. CL. 35.
- ALL AMERICAN PUBLISHING, BOISE, ID:
3,300,337. INT. CL. 40.
- ALL EASTERN IOWA GUTTER, INC., CEDAR RAPIDS, IA:
3,296,424. PUB. 7-10-2007. MULTIPLE CLASS, INT. CLS. 37 AND 40.
- ALL IN A ROW, LLC, DALLAS, TX:
3,298,133. PUB. 7-10-2007. INT. CL. 45.
- ALL WRITE PUBLISHING, LLC, HUDSON, OH, DBA ALL-WRITE INK:
3,298,047. PUB. 7-10-2007. INT. CL. 35.
- ALLEGIANCE CORPORATION, MCGAW PARK, IL:
1,471,925. REN. 8-20-07. INT. CL. 10.
1,471,925. CANC. INT. CL. 5.
- ALLEGIANCE HILLVIEW, LP, DALLAS, TX:
3,298,052. PUB. 7-10-2007. MULTIPLE CLASS, INT. CLS. 36 AND 37.
3,298,053. PUB. 7-10-2007. MULTIPLE CLASS, INT. CLS. 36 AND 37.
- ALLEN BROTHERS, INC., CHICAGO, IL:
3,297,650. PUB. 7-10-2007. MULTIPLE CLASS, INT. CLS. 29 AND 30.
- ALLEN, LINDA, SALEM, OR:
3,296,548. PUB. 7-10-2007. INT. CL. 41.
- ALLERGAN, INC., IRVINE, CA:
1,416,374. CANC. INT. CL. 5.
- ALLERGY CONTROL PRODUCTS, INC., RIDGEFIELD, CT, ALLERGY CONTROL PRODUCTS, INC., RIDGEFIELD, CT:
2,085,440. REN. 8-20-07. INT. CL. 24.
- ALLERGY CONTROL PRODUCTS, INC., RIDGEFIELD, CT:
2,404,522. CANC. INT. CL. 11.
- ALLIANCE TRADING, INC., COVINGTON, LA:
3,297,366. PUB. 7-10-2007. INT. CL. 35.
- ALLIANCEBERNSTEIN L.P., NEW YORK, NY:
2,404,462. CANC. INT. CL. 36.
- ALLIANZ LIFE INSURANCE COMPANY OF NORTH AMERICA, MINNEAPOLIS, MN:
3,300,094. INT. CL. 36.
- ALLIED DOMECQ & WINE USA, INC., BINGHAM FARMS, MI:
2,016,236. CANC. INT. CL. 33.
- ALLIED MINERAL PRODUCTS, INC., COLUMBUS, OH:
3,296,798. PUB. 7-10-2007. INT. CL. 19.
3,296,799. PUB. 7-10-2007. INT. CL. 19.
- ALLIED-SIGNAL INC.:
1,416,542. CANC. INT. CL. 12.
- ALLODIUM INVESTMENT CONSULTANTS, LLC, MINNEAPOLIS, MN:
3,296,842. PUB. 7-10-2007. INT. CL. 36.
- ALLOSOURCE, CENTENNIAL, CO:
2,082,989. REN. 8-18-07. INT. CL. 5.
- ALLRECIPES.COM, INC., SEATTLE, WA:
3,299,264. INT. CL. 43.
- ALLURENT, INC., CAMBRIDGE, MA:
3,299,273. MULTIPLE CLASS, INT. CLS. 41 AND 42.
- ALLWAY TOOLS, INC., BRONX, NY:
3,297,018. PUB. 7-10-2007. INT. CL. 8.
- ALLYLESS, INC., LAS VEGAS, NV:
3,296,469. PUB. 7-10-2007. INT. CL. 16.
- ALM. BRAND AF 1792 G/S, DK-2800 LYNGBY, DENMARK:
2,404,488. CANC. INT. CL. 36.
- ALMATIS, INC., LEETSDALE, PA:
1,452,719. REN. 8-23-07. INT. CL. 1.
- ALMQUIST MANUFACTURING LTD., MILFORD, PA:
1,416,308. CANC. INT. CL. 1.
- ALPHA INNOTECH CORP, SAN LEANDRO, CA:
2,404,723. CANC. INT. CL. 9.
- ALPHA KAPPA ALPHA SORORITY, INC., CHICAGO, IL:
3,298,147. PUB. 7-10-2007. MULTIPLE CLASS, INT. CLS. 14, 16 AND 35.
- ALPHA PEST CONTROL INCORPORATED, VANCOUVER, WA:
3,297,829. PUB. 7-10-2007. INT. CL. 37.
- ALPHACRAZE.COM CORP., PORT CHESTER, NY:
2,404,305. CANC. INT. CL. 35.
- ALPHAGARY CORPORATION, LEOMINSTER, MA:
2,403,161. CANC. MULTIPLE CLASS, INT. CLS. 1 AND 17.
- ALPINE LINK CORPORATION, SAINT JO, TX:
3,296,838. PUB. 7-10-2007. MULTIPLE CLASS, INT. CLS. 35 AND 41.
- ALPINE OVERHEAD DOORS, INC., EAST SETAUKET, NY:
1,493,855. REN. 8-20-07. INT. CL. 6.
- ALSTOM POWER INC., WINDSOR, CT:
3,297,048. PUB. 7-10-2007. INT. CL. 9.

ALTANA, INC., MELVILLE, NY:
3,298,767, INT. CL. 5.

ALTAVISTA COMPANY, PALO ALTO, CA:
2,404,377, CANC. INT. CL. 38.

ALTER, JOSEPH S., HOLLYWOOD, CA:
2,404,764, CANC. INT. CL. 9.

ALTERNATIVE INVESTMENT RESEARCH AND TECHNOLOGIES LLC, NEW YORK, NY:
3,297,816, PUB. 7-10-2007. INT. CL. 36.

ALTERNATIVE MEDICINE FOUNDATION, INC., BETHESDA, MD:
2,404,944, CANC. INT. CL. 42.

ALTICOR INC., ADA, MI, AMWAY CORPORATION, ADA, MI:
2,098,962. REN. 8-18-07. INT. CL. 5.

ALUM-A-POLE CORPORATION, SCRANTON, PA:
3,296,677, PUB. 7-10-2007. INT. CL. 8.

ALUMAX INC., NORCROSS, GA:
1,416,385, CANC. INT. CL. 6.

ALYSSA YACHT CHARTER & BROKER AG, SWITZERLAND:
3,298,235, PUB. 7-10-2007. MULTIPLE CLASS, INT. CLS. 35, 36 AND 39.

AMARILLO COMMUNITY FEDERAL CREDIT UNION, AMARILLO, TX:
2,404,602, CANC. INT. CL. 36.

AMARILLO HARDWARE COMPANY, AMARILLO, TX:
3,299,385, INT. CL. 8.

AMARU ENTERTAINMENT, INC., WEST HOLLYWOOD, CA:
3,298,442, INT. CL. 14.

AMATEUR POKER LEAGUE, INC., WICHITA, KS:
3,298,050, PUB. 7-10-2007. MULTIPLE CLASS, INT. CLS. 35 AND 41.

AMB PROPERTY CORPORATION, SAN FRANCISCO, CA:
2,404,820, CANC. MULTIPLE CLASS, INT. CLS. 36, 37 AND 39.

AMBASSADOR PROGRAMS, INC., SPOKANE, WA:
3,298,917, INT. CL. 25.

AMBASSADORS FOR CHILDREN, INDIANAPOLIS, IN:
3,297,884, PUB. 7-10-2007. INT. CL. 35.
3,297,885, PUB. 7-10-2007. INT. CL. 35.

AMBATI, BALAMURALI, AUGUSTA, GA AND AMBATI, JAYAKRISHNA, AUGUSTA, GA:
3,299,515, INT. CL. 5.

AMBER BLANCO, SAN GABRIEL, CA:
3,296,340, PUB. 7-10-2007. INT. CL. 24.
3,296,341, PUB. 7-10-2007. INT. CL. 24.

AMBICO, INC., NORWOOD, NJ:
1,416,488, CANC. INT. CL. 9.

AMBISEA TECHNOLOGY CORP., LTD, HONG KONG, HONG KONG:
3,299,361, INT. CL. 10.

AMCOR LIMITED, BUENA PARK, CA:
3,296,911, PUB. 7-10-2007. INT. CL. 35.

AMCOR SUNCLIPSE NORTH AMERICA, BUENA PARK, CA, SUNCLIPSE, INC., MONTEBELLO, CA, DBA LANDSBERG QUALITY INSTITUTE:
2,082,983. REN. 8-17-07. INT. CL. 41.

AMERELLA OF CANADA LTD., VILLE ST LAURENT, QUEBEC, CANADA:
2,403,327, CANC. INT. CL. 25.

AMERICA'S COMMUNITY BANKERS, WASHINGTON, DC:
3,298,472, MULTIPLE CLASS, INT. CLS. 16, 35, 36 AND 41.

AMERICAN AIRLINES, INC., DFW AIRPORT, TX:
2,404,229, CANC. INT. CL. 39.
2,404,272, CANC. INT. CL. 35.

AMERICAN ANTHROPOLOGICAL ASSOCIATION, ARLINGTON, VA:
3,296,516, PUB. 7-10-2007. INT. CL. 42.

AMERICAN ASSOCIATION FOR CLINICAL CHEMISTRY, INC., WASHINGTON, DC:
3,298,112, PUB. 7-10-2007. INT. CL. 42.

AMERICAN ASSOCIATION OF INDIVIDUAL INVESTORS, INC., CHICAGO, IL:
1,475,883. REN. 8-20-07. INT. CL. 16.

AMERICAN ASSOCIATION OF SENIOR PERSONS, INC., BOCA RATON, FL:
3,299,107, INT. CL. 35.

AMERICAN ASSOCIATION OF STATE HIGHWAY AND TRANSPORTATION OFFICIALS (AASHTO), WASHINGTON, DC:
2,097,106. REN. 8-23-07. INT. CL. 9.

AMERICAN BANKERS INSURANCE GROUP, INC., MIAMI, FL:
2,403,127, CANC. INT. CL. 41.

AMERICAN BILTRITE INC., WELLESLEY HILLS, MA:
2,061,961. REN. 8-17-07. INT. CL. 17.
2,114,548. REN. 8-17-07. INT. CL. 19.

AMERICAN BLIND AND WALLPAPER FACTORY, INC., PLYMOUTH, MI:
3,296,707, PUB. 7-10-2007. INT. CL. 35.

AMERICAN BUILDING SUPPLY, INC., SACRAMENTO, CA:
3,295,988, PUB. 7-10-2007. INT. CL. 19.

AMERICAN CATHOLIC PRESS, SOUTH HOLLAND, IL:
2,174,310. REN. 8-22-07. INT. CL. 16.

AMERICAN COLLEGE OF RHEUMATOLOGY, ATLANTA, GA:
2,404,263, CANC. INT. CL. 41.

AMERICAN COLLEGE, THE, BRYN MAWR, PA:
1,417,071, CANC. INT. CL. 42.

AMERICAN CONSULTING COMPANY, HARPER WOODS, MI:
2,918,485, CANC. INT. CL. 35.

AMERICAN CYCLE SYSTEMS INC., BALDWIN PARK, CA:
3,298,455, INT. CL. 12.

AMERICAN DAIRY QUEEN CORPORATION, EDINA, MN:
2,404,831, CANC. INT. CL. 30.

AMERICAN EXPRESS COMPANY, NEW YORK, NY:
2,403,870, CANC. INT. CL. 36.

AMERICAN EXPRESS MARKETING & DEVELOPMENT CORP., NEW YORK, NY:
3,296,520, PUB. 7-10-2007. INT. CL. 36.
3,299,953, INT. CL. 16.

AMERICAN FAMILY LIFE ASSURANCE COMPANY OF COLUMBUS, COLUMBUS, GA:
3,299,024, INT. CL. 36.

AMERICAN FIELD SERVICE, INC., NEW YORK, NY TO AFS FOUNDATION, ZURICH, SWITZERLAND:
1,045,158, CANC. MULTIPLE CLASS, U.S. CLS. 3, 28, 37, 38 AND 39.

AMERICAN FLATBREAD HOLDING COMPANY, WAITSFIELD, VT:
3,298,048, PUB. 7-10-2007. INT. CL. 30.

AMERICAN GOLF CORPORATION, SANTA MONICA, CA:
2,404,501, CANC. INT. CL. 42.

AMERICAN HEALTH NETWORK, INC., INDIANAPOLIS, IN:
3,298,084, PUB. 7-10-2007. MULTIPLE CLASS, INT. CLS. 35 AND 44.

AMERICAN HOMESTAR CORPORATION, LEAGUE CITY, TX:
3,298,407, MULTIPLE CLASS, INT. CLS. 35 AND 40.

AMERICAN HUNTER, INC., TALLAHASSEE, FL:
3,297,622, PUB. 7-10-2007. INT. CL. 7.

AMERICAN INK JET CORPORATION, BILLERICA, MA:
2,015,600, CANC. INT. CL. 16.

AMERICAN INSTITUTE OF GRAPHIC ARTS, NEW YORK, NY:
2,081,487. REN. 8-23-07. INT. CL. 42.

AMERICAN INSTITUTE OF HEALTHCARE, INC., SPOKANE, WA:
2,403,422, CANC. INT. CL. 5.

- AMERICAN INTERNATIONAL GROUP, INC., NEW YORK, NY:
 1,416,931, CANC. INT. CL. 36.
 3,298,615, INT. CL. 36.
 3,298,616, INT. CL. 36.
 3,299,727, INT. CL. 36.
 3,299,733, INT. CL. 36.
 3,299,813, INT. CL. 36.
 3,299,959, INT. CL. 36.
 3,299,960, INT. CL. 36.
 3,300,037, INT. CL. 36.
 3,300,038, INT. CL. 36.
- AMERICAN LABORATORIES, INC., OMAHA, NE:
 3,299,761, INT. CL. 5.
- AMERICAN MAGLINE GROUP, LOS ANGELES, CA:
 3,298,931, INT. CL. 37.
- AMERICAN MULTI-CINEMA, INC., KANSAS CITY, MO:
 3,298,965, INT. CL. 41.
- AMERICAN NATIONAL RED CROSS, WASHINGTON, DC,
 AKA AMERICAN RED CROSS:
 2,086,254, REN. 8-17-07. INT. CL. 16.
- AMERICAN ORTHODONTICS CORPORATION, SHEBOYGAN, WI:
 3,299,904, INT. CL. 10.
- AMERICAN PRINTING AND ENVELOPE COMPANY, NEW YORK, NY:
 2,085,674, REN. 8-21-07. MULTIPLE CLASS, INT. CLS. 16 AND 42.
 2,085,675, REN. 8-21-07. MULTIPLE CLASS, INT. CLS. 16 AND 42.
- AMERICAN PROMOTIONAL EVENTS, INC., FLORENCE, AL:
 2,067,811, REN. 8-22-07. INT. CL. 13.
- AMERICAN PROMOTIONAL EVENTS, INC., FLORENCE, AL, AMERICAN PROMOTIONAL EVENTS, INC., FLORENCE, AL:
 2,067,833, REN. 8-22-07. INT. CL. 13.
 2,072,717, REN. 8-22-07. INT. CL. 13.
- AMERICAN PSYCHOLOGICAL ASSOCIATION, WASHINGTON, DC:
 2,120,267, REN. 8-23-07. INT. CL. 42.
- AMERICAN REO CORP, BULVERDE, TX:
 3,299,843, INT. CL. 36.
- AMERICAN RESCUE DOG ASSOCIATION, INC., BRISTOW, VA:
 3,298,023, PUB. 7-10-2007. INT. CL. 39.
 3,298,024, PUB. 7-10-2007. INT. CL. 39.
- AMERICAN SAFETY RAZOR COMPANY, CEDAR KNOLLS, NJ:
 3,300,188, INT. CL. 8.
- AMERICAN SAILING ASSOCIATION, LOS ANGELES, CA:
 3,299,573, INT. CL. 16.
- AMERICAN SEATING COMPANY, GRAND RAPIDS, MI:
 3,299,599, INT. CL. 20.
- AMERICAN SIGNATURE, INC., COLUMBUS, OH:
 3,298,523, INT. CL. 35.
- AMERICAN SOCIETY FOR LASER MEDICINE AND SURGERY, INC., WAUSAU, WI:
 3,296,701, PUB. 7-10-2007. MULTIPLE CLASS, INT. CLS. 9, 16, 35, 38 AND 41.
- AMERICAN SOCIETY OF HOME INSPECTORS, INC, DES PLAINES, IL:
 2,403,845, CANC. INT. CL. 42.
- AMERICAN SOCIOLOGICAL ASSOCIATION, WASHINGTON, DC:
 3,296,788, PUB. 7-10-2007. INT. CL. 16.
 3,297,148, PUB. 7-10-2007. INT. CL. 16.
- AMERICAN SOYBEAN ASSOCIATION, ST. LOUIS, MO:
 2,084,233, REN. 8-23-07. U.S. CL. A.
- AMERICAN SPORTS LICENSING, INC., WILMINGTON, DE:
 3,298,690, INT. CL. 12.
 3,298,691, INT. CL. 12.
- AMERICAN STORES COMPANY, LLC, BOISE, ID:
 2,123,906, REN. 8-20-07. INT. CL. 31.
- AMERICAN SUPERCONDUCTOR CORPORATION, WESTBOROUGH, MA:
 3,300,214, INT. CL. 9.
- AMERICAN SYSTEMS CORPORATION, CHANTILLY, VA:
 3,300,374, MULTIPLE CLASS, INT. CLS. 35, 36, 37, 41 AND 42.
 3,300,375, MULTIPLE CLASS, INT. CLS. 35, 36, 37, 41 AND 42.
- AMERICAN SYSTEMS REGISTRAR, L.L.C., GRAND RAPIDS, MI:
 2,403,144, CANC. INT. CL. 42.
- AMERICAN TACK & HARDWARE CO., INC., SADDLE RIVER, NJ:
 2,073,684, REN. 8-23-07. INT. CL. 21.
- AMERICAN TECHNOLOGY CORPORATION, SAN DIEGO, CA:
 3,297,262, PUB. 7-10-2007. INT. CL. 9.
- AMERICAN TOOL COMPANIES, INC., HOFFMAN ESTATES, IL:
 2,404,302, CANC. INT. CL. 8.
- AMERICAN VALVE, INC., GREENSBORO, NC:
 3,300,215, INT. CL. 11.
 3,300,216, INT. CL. 11.
- AMERICAN WEST MARKETING, INC., BOZEMAN, MT:
 3,297,536, PUB. 4-17-2007. INT. CL. 11.
- AMERICAN WOODMARK CORPORATION, WINCHESTER, VA:
 2,084,882, REN. 8-18-07. INT. CL. 20.
 3,298,493, INT. CL. 20.
- AMERICHEM, INC., CUYAHOGA FALLS, OH:
 3,298,672, INT. CL. 22.
- AMERIFIT NUTRITION, INC., BLOOMFIELD, CT:
 3,299,189, INT. CL. 5.
- AMERIPRISE FINANCIAL, INC., MINNEAPOLIS, MN:
 2,014,853, CANC. INT. CL. 36.
 3,299,941, INT. CL. 36.
- AMES TRUE TEMPER PROPERTIES, INC., WILMINGTON, DE:
 3,299,834, INT. CL. 8.
- AMICA MUTUAL INSURANCE COMPANY, LINCOLN, RI:
 2,403,151, CANC. INT. CL. 36.
- AMINI INNOVATION CORPORATION, SANTA FE SPRINGS, CA:
 3,300,242, INT. CL. 35.
- AMIRI, INC., DECATUR, GA:
 2,403,834, CANC. INT. CL. 25.
- AMITY HOSIERY CO., INC., GARDEN CITY PARK, NY:
 3,299,856, INT. CL. 25.
- AMONES, TROY, ARCATA, CA:
 3,299,891, INT. CL. 16.
- AMPAD CORPORATION, HOLYOKE, MA:
 1,416,631, CANC. INT. CL. 16.
- AMPCO SYSTEM PARKING, INC., LOS ANGELES, CA:
 2,404,306, CANC. INT. CL. 39.
- AMS DIVERSIFIED SERVICES, LTD., LAS VEGAS, NV:
 2,404,110, CANC. INT. CL. 36.
- AMSDEN, MATTHEW, SANTA MONICA, CA:
 3,296,227, PUB. 7-10-2007. MULTIPLE CLASS, INT. CLS. 35 AND 39.
- AMVIC INC., TORONTO, CANADA:
 3,297,434, PUB. 7-10-2007. INT. CL. 19.
- AMWAY CORPORATION, ADA, MI:
 1,416,852, CANC. INT. CL. 30.
- ANARK CORPORATION, BOULDER, CO:
 2,081,486, REN. 8-22-07. INT. CL. 9.
- ANATEX ENTERPRISES, INC., VAN NUYS, CA:
 1,449,862, REN. 8-23-07. INT. CL. 28.
- ANCHOR FABRICATION PARTNERSHIP, LTD., FORT WORTH, TX:
 3,297,232, PUB. 7-10-2007. MULTIPLE CLASS, INT. CLS. 40 AND 42.
 3,297,234, PUB. 7-10-2007. MULTIPLE CLASS, INT. CLS. 40 AND 42.
- ANCHOR HOCKING CORPORATION, LANCASTER, OH:
 1,409,462, CANC. INT. CL. 21.
- ANCHOR USA, SAN DIEGO, CA:
 2,577,204, CANC. MULTIPLE CLASS, INT. CLS. 6, 18 AND 22.
- ANCILLARY CARE MANAGEMENT, INC., EDEN PRAIRIE, MN:
 3,297,129, PUB. 7-10-2007. MULTIPLE CLASS, INT. CLS.

41 AND 44.
ANDERSEN BROTHERS HOLDING COMPANY, INC., THE,
DALTON, GA:
2,404,585, CANC. INT. CL. 27.
ANDERSON & BOUTWELL, ATTYS AT LAW, HAMMOND,
LA:
3,298,097, PUB. 7-10-2007. INT. CL. 42.
ANDERSON BROTHERS ARTISTIC IRON, INC., CORONA,
CA:
3,297,623, PUB. 7-10-2007. INT. CL. 19.
ANDERSON PERFORMANCE IMPROVEMENT COMPANY,
LTD., HASTINGS, MN:
3,297,890, PUB. 7-10-2007. INT. CL. 35.
ANDERSON PRESS INCORPORATED, FLORENCE, AL:
2,120,339, REN. 8-23-07. MULTIPLE CLASS, INT. CLS. 16
AND 41.
ANDERSON, CATHERINE, KOCHAN, GERMANTOWN,
MD:
3,298,679, INT. CL. 16.
ANDERSON, ROSE, VIENNA, VA:
3,298,678, INT. CL. 28.
ANDIS COMPANY, STURTEVANT, WI:
3,297,163, PUB. 7-10-2007. MULTIPLE CLASS, INT. CLS.
8, 9 AND 11.
ANDORRA CREDIT REPAIR, CORP., SCOTTSDALE, AZ:
3,296,136, PUB. 7-10-2007. INT. CL. 36.
ANDREW L WHEELER, CAPITOLA, CA:
3,296,887, PUB. 7-10-2007. INT. CL. 41.
ANDREWS INTERNATIONAL, INC., BRONX, NY:
3,298,140, PUB. 7-10-2007. INT. CL. 45.
ANDREWS, JAMES, S., BURNSVILLE, MN:
3,296,687, PUB. 7-10-2007. INT. CL. 9.
ANDROS, CHRIS, CLEARWATER, FL:
2,404,383, CANC. INT. CL. 6.
ANDY MAY GROUP, LLC, RALEIGH, NC:
3,299,350, INT. CL. 36.
ANEW TECHNOLOGY CORPORATION, BURLINGTON,
MA:
2,110,760, REN. 8-20-07. INT. CL. 35.
ANGEL FARMS MINISTRIES, A CORPORATION SOLE,
KEAAU, HI:
3,297,860, PUB. 7-10-2007. INT. CL. 44.
ANGELA WRIGHT COLLECTION, INC., JERSEY CITY, NJ:
3,296,729, PUB. 7-10-2007. INT. CL. 25.
3,296,731, PUB. 7-10-2007. INT. CL. 25.
ANGELHEALTHCARE INVESTORS, LLC, NEWTON, MA:
3,296,451, PUB. 7-10-2007. INT. CL. 36.
ANGELIKA FILM CENTERS, INC., NEW YORK, NY TO
READING INVESTMENT COMPANY, INC., WILMING-
TON, DE:
2,014,691, CANC. MULTIPLE CLASS, INT. CLS. 9 AND
41.
ANGELS AMONG US, INC., ELKHORN, NE:
3,296,759, PUB. 7-10-2007. INT. CL. 36.
ANHEUSER-BUSCH, INCORPORATED, ST. LOUIS, MO:
220,901, CANC. U.S. CL. 45.
2,404,791, CANC. INT. CL. 42.
2,404,860, CANC. INT. CL. 42.
ANHUI ANLI ARTIFICIAL LEATHER CO., LTD, HEFEI,
ANHUI 230011, CHINA:
3,298,397, PUB. 7-10-2007. INT. CL. 18.
ANIMALS MATTER, INC., TORRANCE, CA:
3,299,683, INT. CL. 20.
ANNALEE MOBILITEE DOLLS, INC., MEREDITH, NH:
2,014,643, CANC. INT. CL. 16.
ANNIE'S ENTERPRISES, NORTH CALAIS, VT:
2,404,159, CANC. INT. CL. 30.
ANSCHUTZ 12K COMPANY, LOS ANGELES, CA:
3,296,801, PUB. 7-10-2007. INT. CL. 41.
ANSCOTT CHEMICAL INDUSTRIES, INC., WAYNE, NJ,
DBA CALED SIGNAL CHEMICAL:
1,416,331, CANC. INT. CL. 3.
ANSON IMPORTS, LTD. CO., SUNNY ISLES, FL:
3,297,033, PUB. 7-10-2007. INT. CL. 33.
ANTENNA THEATRE, INC., SAUSALITO, CA:
3,299,420, INT. CL. 20.
ANTI-STERIOD PROGRAM, LLC, KEY LARGO, FL:
3,299,976, INT. CL. 41.
ANTONIAK, PETER RICHARD, SAN BRUNO, CA, DBA
SOLAR SYSTEMS SOFTWARE:
1,416,467, CANC. INT. CL. 9.
ANTS, INCORPORATED, ALBUQUERQUE, NM:
2,403,431, CANC. INT. CL. 20.
ANZELL AUTOMOTIVE, INC., NORFOLK, VA:
2,101,450, REN. 8-20-07. INT. CL. 37.
2,103,279, REN. 8-17-07. INT. CL. 37.
2,103,280, REN. 8-20-07. INT. CL. 37.
AOC, LLC, COLLIERVILLE, TN:
2,404,541, CANC. INT. CL. 1.
AOL LLC, DULLES, VA:
2,403,189, CANC. INT. CL. 35.
2,403,731, CANC. INT. CL. 36.
AOPEN AMERICA INCORPORATED, SAN JOSE, CA:
2,403,545, CANC. INT. CL. 35.
AP ED VENTURES, LLC, FISHER ISLAND, FL:
3,299,896, MULTIPLE CLASS, INT. CLS. 38 AND 41.
APARTMENT REALTY ADVISORS, INC., ATLANTA, GA:
3,296,752, PUB. 7-10-2007. INT. CL. 36.
APARTMENT SOLUTIONS, INC., NAPERVILLE, IL:
3,297,257, PUB. 7-10-2007. INT. CL. 36.
APEX MEDIA SALES, INC., SCOTTSDALE, AZ:
2,077,496, REN. 8-17-07. INT. CL. 9.
APIAN SOFTWARE, SEATTLE, WA:
2,084,620, REN. 8-23-07. INT. CL. 9.
APIO, INC., GUADALUPE, CA:
3,297,565, PUB. 7-10-2007. INT. CL. 29.
APM, INC., ELKTON, MD:
1,447,899, REN. 8-17-07. INT. CL. 37.
APOLLO GROUP, INC., PHOENIX, AZ:
2,403,736, CANC. INT. CL. 41.
3,298,703, INT. CL. 41.
3,298,704, INT. CL. 41.
APOTHECUS PHARMACEUTICAL CORP., OYSTER BAY,
NY, APOTHECUS, INC., OYSTER BAY, NY:
2,027,976, REN. 8-17-07. INT. CL. 5.
APPA, ALEXANDRIA, VA:
3,296,773, PUB. 7-10-2007. INT. CL. 41.
3,296,775, PUB. 7-10-2007. INT. CL. 41.
APPLE INC., CUPERTINO, CA:
2,090,641, REN. 8-22-07. MULTIPLE CLASS, INT. CLS. 9
AND 42.
3,297,109, PUB. 7-10-2007. INT. CL. 9.
3,298,028, PUB. 7-10-2007. MULTIPLE CLASS, INT. CLS.
35 AND 41.
3,298,654, MULTIPLE CLASS, INT. CLS. 9, 38, 39, 41 AND
42.
3,299,823, INT. CL. 9.
APPLETON ELECTRIC LLC, ROSEMONT, IL:
1,423,670, REN. 8-17-07. INT. CL. 9.
APPLICA CONSUMER PRODUCTS, INC., MIRAMAR, FL,
BLACK & DECKER CORPORATION, THE, TOWSON,
MD:
2,091,886, REN. 8-17-07. INT. CL. 9.
APPLIED MATERIALS GMBH & CO. KG, FED REP
GERMANY:
3,298,183, PUB. 7-10-2007. INT. CL. 7.
APPMAIL LLC, SAN MATEO, CA:
3,296,693, PUB. 7-10-2007. INT. CL. 38.
APR ACQUISITION, INC., HOUSTON, TX:
3,300,335, MULTIPLE CLASS, INT. CLS. 35, 37, 41 AND
43.
AQUA GENERAL, INC., HOUSTON, TX:
3,299,839, INT. CL. 11.
AQUACENTER, INC., LELAND, MS:
2,080,690, REN. 8-17-07. MULTIPLE CLASS, INT. CLS. 1
AND 42.
AQUARIA, INC., SIMI VALLEY, CA:
1,450,698, REN. 8-18-07. INT. CL. 16.
AQUARIA, INC., MOORPARK, CA:
2,088,320, REN. 8-22-07. INT. CL. 16.
AQUASOL CORPORATION, PINEVILLE, NC:
2,403,620, CANC. INT. CL. 1.
AQUATHIN CORP., POMPANO BEACH, FL:
3,298,590, INT. CL. 1.
AQUATIC CENTER INC., MCHENRY, MD:
3,297,384, PUB. 7-10-2007. MULTIPLE CLASS, INT. CLS.

- 35 AND 39.
 AQUABANC, LLC, BUFFALO GROVE, IL:
 3,296,449, PUB. 7-10-2007. INT. CL. 9.
 ARAMARK EDUCATIONAL RESOURCES, INC., GOLDEN,
 CO:
 2,404,530, CANC. MULTIPLE CLASS, INT. CLS. 41 AND
 42.
 ARAMIS INC., NEW YORK, NY:
 2,404,841, CANC. INT. CL. 3.
 2,404,884, CANC. INT. CL. 3.
 3,299,506, INT. CL. 3.
 ARAPAHO POINT PARTNERS, LLC, MANHATTAN
 BEACH, CA:
 3,299,274, INT. CL. 36.
 ARBINET-THEXCHANGE, INC., NEW BRUNSWICK, NJ:
 3,297,169, PUB. 7-10-2007. INT. CL. 35.
 ARBINGER COMPANY, INC., THE, SALT LAKE CITY, UT:
 2,404,512, CANC. INT. CL. 41.
 ARBO, INC., LAFAYETTE, CA:
 2,403,861, CANC. INT. CL. 30.
 ARBY'S, INC., FT. LAUDERDALE, FL:
 2,404,883, CANC. INT. CL. 42.
 ARC-COM FABRICS, INC., ORANGEBURG, NY:
 2,079,777, REN. 8-17-07. MULTIPLE CLASS, INT. CLS. 24
 AND 27.
 ARCADIA GROUP BRANDS LIMITED, LONDON, UNITED
 KINGDOM:
 3,298,013, PUB. 7-10-2007. INT. CL. 25.
 ARCADIS CORPORATE SERVICES, INC., HIGHLANDS
 RANCH, CO:
 3,298,785, MULTIPLE CLASS, INT. CLS. 37 AND 42.
 ARCAL GOLF INC., LEHI, UT:
 2,014,788, CANC. INT. CL. 28.
 ARCAT, INC., SHELTON, CT, ARCHITECT'S CATALOG,
 THE, FAIRFIELD, CT:
 2,097,525, REN. 8-22-07. INT. CL. 16.
 ARCHITEL HOLDINGS LLC, DALLAS, TX:
 3,296,527, PUB. 7-10-2007. INT. CL. 38.
 ARDENTE ESPRESSIONE, INC., NAPA, CA:
 2,404,564, CANC. INT. CL. 33.
 AREMAR IMPORT, INC., MIAMI, FL:
 3,299,765, INT. CL. 34.
 3,299,766, INT. CL. 34.
 AREXIS AB, SE-413 46 GÖTEBORG, SWEDEN:
 3,298,163, PUB. 7-10-2007. INT. CL. 5.
 3,298,164, PUB. 7-10-2007. INT. CL. 5.
 ARGILLON GMBH, 96257 REDWITZ, FED REP GERMANY:
 3,298,205, PUB. 7-10-2007. MULTIPLE CLASS, INT. CLS.
 1, 7, 9 AND 17.
 ARICH INC., NEW YORK, NY:
 2,404,531, CANC. INT. CL. 7.
 ARIMA CAPITAL, LLC, WASHINGTON, DC:
 3,297,695, PUB. 7-10-2007. INT. CL. 36.
 3,297,696, PUB. 7-10-2007. INT. CL. 36.
 ARISTA NUTRACEUTICALS, INC., FALLON, NV:
 3,300,144, INT. CL. 5.
 ARISTOCRAT TECHNOLOGIES AUSTRALIA PTY LTD.,
 LANE COVE, 2066, NSW, AUSTRALIA:
 3,295,995, PUB. 7-10-2007. INT. CL. 9.
 ARKANSAS TECH UNIVERSITY, RUSSELLVILLE, AR:
 2,403,972, CANC. INT. CL. 41.
 ARKEMA INC., PHILADELPHIA, PA:
 3,297,823, PUB. 7-10-2007. MULTIPLE CLASS, INT. CLS. 6
 AND 17.
 ARLUY, S.L., 26006 LOGRONO (LA RIOJA), SPAIN:
 2,404,663, CANC. INT. CL. 30.
 ARM LIMITED, CAMBRIDGE, ENGLAND:
 3,297,226, PUB. 7-10-2007. MULTIPLE CLASS, INT. CLS.
 9, 16 AND 42.
 ARMITE LABORATORIES, COSTA MESA, CA:
 3,296,193, PUB. 7-10-2007. INT. CL. 4.
 ARMSTRONG, BRUCE R., AKRON, OH, DBA SEE THE
 SOUNDS PUBLISHING COMPANY AND ARMSTRONG,
 VICKI J., AKRON, OH, DBA SEE THE SOUNDS PUBLISH-
 ING COMPANY:
 1,427,417, REN. 8-23-07. INT. CL. 16.
 ARNOLD, DANNY H., COPPELL, TX:
 3,300,288, INT. CL. 38.
 ARNOLD, DANNY H., COPPELL, TX:
 3,296,885, PUB. 7-10-2007. INT. CL. 30.
 AROMA COMPUTER INC., DIAMOND BAR, CA:
 2,404,832, CANC. INT. CL. 9.
 AROMATICA, INC., SAN MARCOS, CA:
 3,297,380, PUB. 7-10-2007. INT. CL. 30.
 ART & SOUL, LLC, SEDONA, AZ:
 2,404,743, CANC. INT. CL. 19.
 ART IN MOTION, LLC, CHICAGO, IL:
 2,403,914, CANC. INT. CL. 35.
 ARTHA IMPORTS CORPORATION, RICHMOND, VA:
 3,299,406, INT. CL. 35.
 ARTHROCARE CORPORATION, SUNNYVALE, CA:
 2,404,781, CANC. INT. CL. 10.
 3,298,719, INT. CL. 10.
 ARTHUR DOGSWELL, L.L.C., SAN FRANCISCO, CA:
 3,028,291, COR. INT. CL. 31.
 3,028,301, COR. INT. CL. 31.
 3,075,995, COR. INT. CL. 31.
 ARTHUR S. DEMOSS FOUNDATION, ST. DAVIDS, PA:
 2,081,250, REN. 8-17-07. INT. CL. 42.
 ARTISENT, INC., BOSTON, MA:
 3,298,822, INT. CL. 9.
 ARTIZAN INTERNET SERVICES, LLC, WINDSOR, CT:
 3,297,594, PUB. 7-10-2007. MULTIPLE CLASS, INT. CLS.
 35 AND 42.
 3,297,596, PUB. 7-10-2007. MULTIPLE CLASS, INT. CLS.
 35 AND 42.
 ARTNEWS, LLC, NEW YORK, NY:
 3,297,014, PUB. 7-10-2007. INT. CL. 41.
 ARTWORK SYSTEMS GROUP NV, B-9000 GENT, BEL-
 GIUM:
 3,297,428, PUB. 7-10-2007. MULTIPLE CLASS, INT. CLS.
 9, 35 AND 42.
 3,297,429, PUB. 7-10-2007. MULTIPLE CLASS, INT. CLS.
 9, 35 AND 42.
 3,297,430, PUB. 7-10-2007. MULTIPLE CLASS, INT. CLS.
 9, 35 AND 42.
 ARYSTA LIFESCIENCE NORTH AMERICA CORPORA-
 TION, CARY, NC:
 3,299,145, INT. CL. 5.
 3,299,276, INT. CL. 5.
 AS GOOD AS MOTHER'S INC., FOREST PARK, IL:
 3,296,266, PUB. 7-10-2007. INT. CL. 30.
 ASC INCORPORATED, SOUTHGATE, MI:
 3,298,716, INT. CL. 12.
 ASCEND MEDIA PROFESSIONAL SERVICES, LLC, OVER-
 LAND PARK, KS:
 3,297,724, PUB. 7-10-2007. INT. CL. 41.
 ASCENDES CORPORATION, ROSWELL, GA:
 2,403,077, CANC. MULTIPLE CLASS, INT. CLS. 35 AND
 42.
 ASCENTIAL SOFTWARE CORPORATION, WESTBORO,
 MA, PRISM SOLUTIONS, INC., SUNNYVALE, CA:
 2,074,689, REN. 8-22-07. INT. CL. 9.
 ASIA FOODS INTERNATIONAL, LLC, DAYTON, NJ:
 3,297,497, PUB. 7-10-2007. MULTIPLE CLASS, INT. CLS.
 24, 29 AND 30.
 ASIA OIL SEALS CO., LTD., FUH HSING HSIANG, TAI-
 WAN:
 3,299,202, MULTIPLE CLASS, INT. CLS. 7 AND 17.
 ASM; AUTOMATION SENSORIK MESSTECHNIK GMBH,
 FED REP GERMANY:
 3,298,269, PUB. 7-10-2007. INT. CL. 9.
 ASOCIACION ARGENTINA DE ANGUS, BUENOS AIRES,
 ARGENTINA:
 3,298,874, INT. CL. 33.
 ASPEN BENEFITS GROUP, L.L.C., LAS VEGAS, NV:
 3,299,517, INT. CL. 3.
 3,299,518, INT. CL. 5.
 ASPEN DESIGNS, INC., NEW YORK, NY:
 3,298,485, INT. CL. 14.
 ASPEN PET PRODUCTS, INC., DENVER, CO:
 3,300,076, INT. CL. 6.
 3,300,163, INT. CL. 18.
 ASPIRATION MEDICAL TECHNOLOGY, LLC., DAVIE, FL:
 3,299,690, INT. CL. 10.

ASPLUNDH INVESTMENTS, INC., WILMINGTON, DE,
ASPLUNDH TREE EXPERT CO., WILLOW GROVE, PA,
DBA ARBORCHEM PRODUCTS CO.:
1,449,113. REN. 8-17-07. MULTIPLE CLASS, INT. CLS. 1
AND 8.

ASPLUNDH INVESTMENTS, INC., WILLOW GROVE, PA:
2,134,039. REN. 8-17-07. INT. CL. 37.

ASSAD, BECKER Q., FOUNTAIN VALLEY, CA:
3,297,329. PUB. 7-10-2007. MULTIPLE CLASS, INT. CLS.
35 AND 37.

ASSET MANAGEMENT GROUP, L.L.C., NORMAN, OK:
3,296,362. PUB. 7-10-2007. INT. CL. 43.

ASSISTEX, INC., SAN ANTONIO, TX:
3,296,013. PUB. 7-10-2007. U.S. CL. B.

ASSOCIATED BANC-CORP, GREEN BAY, WI:
3,297,190. PUB. 7-10-2007. INT. CL. 36.

ASSOCIATED BODYWORK & MASSAGE PROFESSIONALS,
INC., EVERGREEN, CO:
2,158,510. REN. 8-17-07. INT. CL. 42.

ASSOCIATED BODYWORK & MASSAGE PROFESSIONALS,
EVERGREEN, CO:
2,581,046. CANC. INT. CL. 35.

ASSOCIATED BUILDERS AND CONTRACTORS, INC.,
ROSSLYN, VA:
2,404,381. CANC. INT. CL. 42.
2,404,382. CANC. MULTIPLE CLASS, INT. CLS. 16 AND
42.

ASSOCIATED COURIERS, INC., MARYLAND HEIGHTS,
MO:
3,297,223. PUB. 7-10-2007. INT. CL. 39.

ASSOCIATED ELECTRICS, INC., COSTA MESA, CA:
3,299,093. INT. CL. 28.

ASSOCIATED GLOBAL SYSTEMS, INC., NEW HYDE
PARK, NY:
2,171,163. REN. 8-21-07. INT. CL. 39.
2,172,683. REN. 8-21-07. INT. CL. 39.

ASSOCIATED PRODUCT TECHNOLOGIES, INC., KENIL-
WORTH, NJ:
3,299,096. MULTIPLE CLASS, INT. CLS. 3 AND 5.

ASSOCIATED SALES, INC., TUPELO, MS:
3,300,177. INT. CL. 30.

ASSOCIATION FOR FINANCIAL PROFESSIONALS, INC.,
BETHESDA, MD:
3,300,385. INT. CL. 38.

ASSOCIATION FOR UNMANNED VEHICLE SYSTEMS
INTERNATIONAL, ARLINGTON, VA:
3,297,352. PUB. 7-10-2007. INT. CL. 16.

ASSOCIATION OF AMERICAN MEDICAL COLLEGES,
WASHINGTON, DC:
3,298,821. MULTIPLE CLASS, INT. CLS. 16, 35, 36, 41
AND 42.

ASSOCIATION OF UNIVERSITY RESEARCH PARKS, RE-
STON, VA:
3,296,205. PUB. 7-10-2007. INT. CL. 35.
3,296,206. PUB. 7-10-2007. INT. CL. 35.
3,296,207. PUB. 7-10-2007. INT. CL. 35.

ASSOCIAZIONE "LE VIGNE DEL LAZIO", ITALY:
3,298,374. PUB. 7-10-2007. INT. CL. 35.

ASSURANT, INC., NEW YORK, NY:
3,298,848. INT. CL. 36.

AST SERVICES, LLC, DANBURY, CT:
1,448,335. REN. 8-17-07. INT. CL. 11.

ASTRAEA, LLC, LIVINGSTON, NJ:
3,297,838. PUB. 7-10-2007. INT. CL. 4.

ASTROCHEF, INC., LOS ANGELES, CA:
3,299,381. INT. CL. 29.

AT LEAST, S.A., SPAIN:
3,298,391. PUB. 7-10-2007. MULTIPLE CLASS, INT. CLS.
3, 18 AND 25.

AT&T CORP., NEW YORK, NY:
2,404,762. CANC. INT. CL. 38.
3,050,854. CANC. INT. CL. 9.

AT&T KNOWLEDGE VENTURES II, L.P., RENO, NV:
2,086,348. REN. 8-22-07. MULTIPLE CLASS, INT. CLS. 38
AND 42.

ATAMA AG, 81675 MUGHEN/MUNICH, FED REP GER-
MANY:
2,403,377. CANC. MULTIPLE CLASS, INT. CLS. 35 AND
36.

ATEN INTERNATIONAL CO., LTD., TAIPEI, TAIWAN:
3,299,217. INT. CL. 9.

ATHLON SPORTS COMMUNICATIONS, INC., NASHVILLE,
TN:
2,095,100. REN. 8-18-07. INT. CL. 16.

ATKINS & ASSOCIATES, INC., SAN ANTONIO, TX:
2,404,428. CANC. INT. CL. 35.

ATLAS COPCO TOOLS AB, STOCKHOLM, SWEDEN:
3,298,739. INT. CL. 7.

ATLAS INVESTMENT COMPANY, INC., BLOOMINGTON,
DE:
3,296,330. PUB. 7-10-2007. INT. CL. 39.

ATLAS ISLAND MEDIA, INC., SAN FRANCISCO, CA:
3,296,512. PUB. 7-10-2007. INT. CL. 35.

ATLUS U.S.A., INC., IRVINE, CA:
3,300,019. INT. CL. 9.
3,300,138. INT. CL. 9.

ATRICURE INC., WEST CHESTER, OH:
3,299,501. INT. CL. 10.
3,299,502. INT. CL. 10.

ATS SYSTEMS OREGON INC., CORVALLIS, OR:
2,403,173. CANC. INT. CL. 9.

ATTENTUS MEDICAL SALES, INC., HUMBLE, TX:
3,296,114. PUB. 7-10-2007. INT. CL. 35.

ATTLEBORO MUSEUM, INC., ATTLEBORO, MA:
3,299,063. INT. CL. 41.

ATWELL, ROBERT P., SAN MARCOS, CA:
3,297,216. PUB. 7-10-2007. INT. CL. 41.

ATWOOD MOBILE PRODUCTS, INC., ELKHART, IN:
1,997,527. REN. 8-21-07. INT. CL. 9.

AUBURN CONSOLIDATED INDUSTRIES, INC., AUBURN,
NE:
3,298,623. INT. CL. 7.

AUDIO AND VIDEO LABS, INC., PENNSAUKEN, NJ:
3,300,134. MULTIPLE CLASS, INT. CLS. 35, 40 AND 42.

AUDIO PARTNERS, INC., THE, AUBURN, CA:
1,435,158. REN. 8-17-07. INT. CL. 42.

AUDIO PRODUCTS INTERNATIONAL CORP., SCARBOR-
OUGH, ONTARIO, CANADA:
2,014,637. CANC. INT. CL. 9.

AUGUST STORCK KG, HALLE (WESTF.), FED REP GER-
MANY:
1,416,843. CANC. INT. CL. 30.

AUGUST STORCK KG, BERLIN, FED REP GERMANY:
3,297,292. PUB. 7-10-2007. INT. CL. 30.

AUGUSTA BACK PROPERTIES LLC, AUGUSTA, GA:
3,300,386. INT. CL. 44.

AUGUSTA PROFESSIONAL BASEBALL LLC, BALTIMORE,
MD:
3,299,576. MULTIPLE CLASS, INT. CLS. 16, 25, 28 AND
41.

AURA LAMP & LIGHTING, INC., CHICAGO, IL:
2,404,804. CANC. INT. CL. 9.

AURORA DENVER CARDIOLOGY ASSOCIATES, P.C.,
DENVER, CO:
3,300,297. INT. CL. 44.

AUSTIN SOFTWARE COUNCIL, AUSTIN, TX:
2,404,393. CANC. INT. CL. 42.
2,404,394. CANC. INT. CL. 42.

AUSTRALIAN GOLD, INC., INDIANAPOLIS, IN:
2,015,935. CANC. INT. CL. 11.
3,298,423. INT. CL. 3.
3,299,255. INT. CL. 3.
3,300,083. INT. CL. 3.

AUTEC POWER SYSTEMS, INC., SIMI VALLEY, CA:
3,296,977. PUB. 7-10-2007. INT. CL. 9.

AUTHENTIC MODELS, INC., EUGENE, OR:
3,296,025. PUB. 7-10-2007. MULTIPLE CLASS, INT. CLS.
11, 16, 20, 21 AND 28.

AUTHENTIC MODELS, U.S.A., INC., EUGENE, OR:
3,296,026. PUB. 7-10-2007. MULTIPLE CLASS, INT. CLS.
11, 16, 20, 21 AND 28.

AUTO REJUVENATOR, INC., IRVINE, CA:
3,297,545. PUB. 7-10-2007. INT. CL. 37.

AUTOMATE TECHNOLOGIES LLC, RIVERHEAD, NY:
3,298,467. INT. CL. 7.

- AUTOMATED COLLECTION CONTROL, INC., MONTVILLE, NJ:
3,297,032, PUB. 7-10-2007. INT. CL. 35.
- AUTOMATED LEGAL SYSTEMS, INC., UNIVERSAL CITY, TX:
3,297,496, PUB. 7-10-2007. INT. CL. 38.
- AUTOMATED SYSTEM DESIGN, INC., ROSWELL, GA:
2,403,544, CANC. INT. CL. 37.
- AUTOMATIC SYSTEMS, INC., KANSAS CITY, MO, AUTOMATIC SYSTEMS, INC., KANSAS CITY, MO:
2,081,073. REN. 8-23-07. INT. CL. 7.
- AUTOMATION GROUP, INC., THE, HOUSTON, TX:
2,403,673, CANC. INT. CL. 42.
- AUTOMOTIVE ENGINEERING MANAGEMENT SERVICES, INC., BRIGHTON, MI:
2,016,530, CANC. INT. CL. 42.
- AUTOMOTIVE TECHNICAL RESOURCES, INC., STERLING HEIGHTS, MI:
2,403,240, CANC. INT. CL. 41.
- AUTOMOTIVE.COM, INC., SANTA ANA, CA:
2,403,727, CANC. INT. CL. 35.
- AUTONATION INCORPORATED, FORT LAUDERDALE, FL:
2,403,720, CANC. INT. CL. 42.
- AUTONOMY CORPORATION PLC, CAMBRIDGE, UNITED KINGDOM:
3,297,205, PUB. 7-10-2007. MULTIPLE CLASS, INT. CLS. 9, 35, 38 AND 42.
- AVALANCHE PRODUCTS, INC., ROCKLIN, CA:
3,299,133, INT. CL. 30.
- AVANQUEST PUBLISHING USA, INC., PLEASANTON, CA:
3,297,208, PUB. 7-10-2007. INT. CL. 9.
- AVANTI PETROLEUM INC., DENVER, CO:
2,404,183, CANC. INT. CL. 35.
- AVEDA CORPORATION, MINNEAPOLIS, MN:
3,296,315, PUB. 7-10-2007. INT. CL. 41.
- AVELAR, SAUL Y, LAS VEGAS, NV:
2,120,453. REN. 8-18-07. INT. CL. 25.
- AVIGEN, INC., ALAMEDA, CA:
2,404,792, CANC. INT. CL. 5.
- AVNET, INC., PHOENIX, AZ:
2,404,911, CANC. INT. CL. 16.
- AVODAH PUBLISHING, INC., KALISPELL, MT:
3,299,075, INT. CL. 16.
- AVS TECHNOLOGIES LIMITED PARTNERSHIP, TORONTO, ONTARIO, CANADA:
2,403,055, CANC. INT. CL. 42.
- AWESOME ICE, INC., EAST PETERSBURG, PA:
3,299,791, INT. CL. 43.
3,299,881, INT. CL. 43.
- AXIOM SOLUTIONS, INC., BARRINGTON, IL:
2,403,633, CANC. MULTIPLE CLASS, INT. CLS. 35 AND 42.
- AXIS-SHIELD POC AS, OSLO, NORWAY:
1,058,103. REN. 8-23-07. INT. CL. 1.
- AXS CAPITAL LTD., 8002 ZURICH, SWITZERLAND:
3,299,755, INT. CL. 33.
- AYS SPORTS MARKETING, INC., PHILADELPHIA, PA:
2,404,040, CANC. INT. CL. 41.
- AYTON, ANTHONY, KNOXVILLE, TN:
3,297,749, PUB. 7-10-2007. INT. CL. 37.
- AZURO, INC., SANTA CLARA, CA:
3,296,980, PUB. 7-10-2007. INT. CL. 9.
3,296,981, PUB. 7-10-2007. INT. CL. 9.
- AZZOLINI, JOSEPH, ASTORIA, NY:
3,299,942, INT. CL. 25.
- B & A PRODUCTIONS LLC, HONOLULU, HI:
2,404,867, CANC. INT. CL. 41.
- B.J. ALAN COMPANY, YOUNGSTOWN, OH:
3,298,614, INT. CL. 13.
- B & Y GLOBAL SOURCING, LLC, LOS ANGELES, CA:
3,300,174, INT. CL. 25.
- BAB, INC., CHICAGO, IL:
1,820,251, AM. INT. CL. 42.
- BABSON CAPITAL MANAGEMENT LLC, BOSTON, MA:
3,296,072, PUB. 7-10-2007. INT. CL. 36.
- BABY DELIGHT, INC., WOODBRIDGE, CA:
3,299,402, INT. CL. 20.
- BABY ENERGY, INC. NE WYORK, NY:
3,299,496, INT. CL. 25.
- BACARDI & COMPANY LIMITED, NASSAU, NEW PROVIDENCE, BAHAMAS:
3,298,665, INT. CL. 33.
- BACCHUS GROUP PRODUCTIONS LTD., CHICAGO, IL:
2,403,815, CANC. INT. CL. 41.
- BACHAND, GREGORY N., WALLINGFORD, CT:
3,299,209, INT. CL. 41.
- BACKCHANNELMEDIA, INC., BOSTON, MA:
3,297,907, PUB. 7-10-2007. INT. CL. 35.
3,297,912, PUB. 7-10-2007. INT. CL. 35.
- BACOU-DALLOZ EYE & FACE PROTECTION, INC., SMITHFIELD, RI:
3,299,543, INT. CL. 9.
- BADERET U.S.A., INC., ST. PAUL, MN:
2,403,229, CANC. INT. CL. 2.
- BAE, YOUNG YOUN, JUNGRANG-KU, SEOUL, REPUBLIC OF KOREA:
3,299,326, INT. CL. 25.
- BAHIR, TAL, PALMDALE, CA:
3,296,485, PUB. 7-10-2007. INT. CL. 19.
- BAKEMANS INDUSTRIES LIMITED, BADARPUR, NEW DELHI - 110044, INDIA:
2,404,637, CANC. INT. CL. 30.
- BAKER HUGHES INCORPORATED, HOUSTON, TX:
2,403,934, CANC. INT. CL. 9.
- BAKER, DOUGLAS DANE, KNOXVILLE, TN:
3,299,862, INT. CL. 41.
- BAKKA CORP., EL PASO, TX:
3,296,149, PUB. 7-10-2007. INT. CL. 25.
- BALCONES RECYCLING, INC., AUSTIN, TX:
2,102,553. REN. 8-23-07. INT. CL. 40.
- BALDOCK, EDWARD, CRONULLA, AUSTRALIA AND BALDOCK, LINDA, CRONULLA, AUSTRALIA, SPANK TRADING PTY LTD., BEACONSFIELD 2014, AUSTRALIA, DBA SPANK SPORTSWEAR:
2,083,152. REN. 8-20-07. INT. CL. 25.
- BALLANTINE PRODUCE CO., INC., SANGER, CA:
3,296,732, PUB. 7-10-2007. INT. CL. 31.
- BALLY GAMING INTERNATIONAL, INC., LAS VEGAS, NV:
3,299,783, INT. CL. 9.
3,299,810, INT. CL. 9.
- BALMAIN S.A., PARIS, FRANCE:
3,298,904, INT. CL. 3.
- BALTHASAR, CHRISTOPHER, SANTA CRUZ, CA:
2,404,645, CANC. INT. CL. 4.
- BALTIMORE CHILDREN'S MUSEUM, INC., THE, BALTIMORE, MD:
2,404,609, CANC. INT. CL. 41.
2,404,648, CANC. INT. CL. 41.
- BALTIMORE LIFE INSURANCE COMPANY, THE, BALTIMORE, MD:
3,300,122, INT. CL. 36.
- BAMBURGH MARRSH, LLC, VANCOUVER, WA:
3,300,275, INT. CL. 10.
- BANCO DE LA REPUBLICA ORIENTAL DEL URUGUAY, CERRITO 351- MONTEVIDEO, URUGUAY:
2,009,452, AM. INT. CL. 36.
- BANCO ITAU BBA S.A., SAO PAULO, BRAZIL:
2,089,507. REN. 8-20-07. INT. CL. 36.
- BANG RECORDS INCORPORATED, DARIEN, CT:
2,403,658, CANC. INT. CL. 35.
- BANGKIT U.S.A., INC., VERNON, CA:
3,296,544, PUB. 7-10-2007. INT. CL. 22.
- BANGLADESH ASSOCIATION OF AMERICA, INC., SPRINGFIELD, VA:
3,297,811, PUB. 4-3-2007. INT. CL. 36.
- BANGOR SAVINGS BANK, BANGOR, ME:
3,297,040, PUB. 7-10-2007. INT. CL. 36.
- BANKS, KHALISHA T., NEW YORK, NY:
3,297,600, PUB. 4-17-2007. INT. CL. 35.
- BANZAI CREATIONS INC., COATESVILLE, PA:
2,403,769, CANC. INT. CL. 25.
- BANZAI CREATIONS, INC., COATESVILLE, PA:
2,403,577, CANC. INT. CL. 25.

BARBERAN, S.A., C/ GALILEO 3-9, SPAIN:
3,299,594, INT. CL. 11.

BARCLAY ENTERPRISES, INC., COLTON, CA:
3,296,917, PUB. 7-10-2007. INT. CL. 9.
3,296,935, PUB. 7-10-2007. INT. CL. 9.

BARCLAYS GLOBAL INVESTORS, N.A., SAN FRANCISCO, CA:
3,297,960, PUB. 7-10-2007. MULTIPLE CLASS, INT. CLS. 36 AND 41.

BARDAHL MANUFACTURING CORPORATION, SEATTLE, WA:
1,453,752. REN. 8-20-07. INT. CL. 1.

BARENBRUG USA, INC., TANGENT, OR, NORMARC, INC., TANGENT, OR, DBA BARENBRUG USA:
2,142,581. REN. 8-17-07. INT. CL. 31.

BARIATRIX NUTRITION INC., LACHINE, QUEBEC, CANADA:
3,296,240, PUB. 7-10-2007. INT. CL. 30.

BARK 'N BUBBLES DOG WASH, LLC, ASHBURN, VA:
3,296,389, PUB. 7-10-2007. INT. CL. 44.

BARKER SHOES LIMITED, NORTHAMPTON, ENGLAND:
3,300,226, INT. CL. 25.

BARLEAN'S ORGANIC OILS, FERNDALE, WA:
2,403,565, CANC. INT. CL. 29.

BARNABAS MINISTRIES, INC., HOPKINTON, MA:
3,296,031, PUB. 7-10-2007. INT. CL. 35.

BARNES, STEVEN, LONGVIEW, WA:
2,404,001, CANC. INT. CL. 41.

BARNSTEAD COMPANY, NEWTON, MA:
426,658. REN. 8-17-07. U.S. CL. 31 (INT. CL. 11).

BARONESS SMALL ESTATES, INC., DENVER, CO:
3,300,166, INT. CL. 33.

BARPOINT.COM, INC., MIAMI, FL:
2,403,826, CANC. MULTIPLE CLASS, INT. CLS. 35 AND 42.

BARRICINI FOODS INC.:
1,416,838, CANC. INT. CL. 30.

BARRY JOEL KAPLAN, INC., SAN DIEGO, CA:
3,298,753, INT. CL. 10.

BARTIMAEUS GROUP, MCLEAN, VA:
2,403,376, CANC. MULTIPLE CLASS, INT. CLS. 9, 41 AND 42.

BARTON BRANDS, LTD., CHICAGO, IL:
2,064,803. REN. 8-23-07. INT. CL. 33.
2,082,612. REN. 8-23-07. INT. CL. 33.

BARTON INCORPORATED, CHICAGO, IL:
1,494,446. REN. 8-17-07. INT. CL. 33.

BASEMENT MANAGER, LLC, NEW YORK, NY:
3,296,271, PUB. 7-10-2007. MULTIPLE CLASS, INT. CLS. 41 AND 43.

BASF AKTIENGESELLSCHAFT, FED REP GERMANY:
3,298,187, PUB. 7-10-2007. INT. CL. 1.
3,298,319, PUB. 7-10-2007. INT. CL. 5.

BASIC TRAUMA LIFE SUPPORT INTERNATIONAL, INC., OAKBROOK TERRACE, IL:
3,299,392, INT. CL. 41.

BASS PRO TRADEMARKS, L.L.C., SPRINGFIELD, MO:
3,296,836, PUB. 7-10-2007. INT. CL. 9.
3,297,143, PUB. 7-10-2007. INT. CL. 9.

BATA BRANDS S.A R.L., LUXEMBOURG, SUCCURSALE DE LAUSANNE, SWITZERLAND:
3,298,207, PUB. 7-10-2007. INT. CL. 25.

BATES COMMUNICATIONS, INC., WELLESLEY, MA:
3,298,855, MULTIPLE CLASS, INT. CLS. 16 AND 35.

BATH & BODY WORKS BRAND MANAGEMENT, INC., REYNOLDSBURG, OH:
3,300,313, INT. CL. 3.

BATTERIES PLUS, LLC, HARTLAND, WI:
3,299,649, INT. CL. 9.

BATTERY-BIZ, INC., NEWBURY PARK, CA:
3,296,008, PUB. 7-10-2007. INT. CL. 9.

BAUERFEIND ORTHOPADIE GMBH & CO. KG, D-4152 KEMPEN 1, FED REP GERMANY, BAUERFEIND GMBH, KEMPEN, FED REP GERMANY:
1,426,460. REN. 8-22-07. INT. CL. 10.

BAUERFEIND ORTHOPADIE GMBH & CO. KG, D-47906 KEMPEN, FED REP GERMANY:
2,404,619, CANC. INT. CL. 10.

BAUM, JOANNE, GOLDEN, CO:
2,073,181. REN. 8-17-07. INT. CL. 42.

BAY AREA LAW ENFORCEMENT ASSISTANCE FUND, SAN FRANCISCO, CA:
3,298,927, INT. CL. 36.

BAYER CORPORATION, ELKHART, IN:
2,404,612, CANC. INT. CL. 5.

BAYER CROPSCIENCE AG, MONHEIM, FED REP GERMANY:
2,086,322. REN. 8-18-07. INT. CL. 5.

BAYER HEALTHCARE LLC, PITTSBURGH, PA:
3,299,670, INT. CL. 5.

BAYLEY & BENDER, SILVER SPRING, MD:
2,073,762. REN. 8-22-07. INT. CL. 41.

BAYLISS, DONNA M., BIGGS, CA:
3,298,936, INT. CL. 3.

BAYLOR UNIVERSITY, WACO, TX:
3,300,255, INT. CL. 44.

BAZAARVOICE, INC., AUSTIN, TX:
3,296,895, PUB. 7-10-2007. INT. CL. 42.

BBC BRANDS, LLC, BOSTON, MA:
2,404,661, CANC. INT. CL. 32.

BC INTERNATIONAL COSMETIC & IMAGE SERVICES, INC., WILMINGTON, DE:
2,404,795, CANC. INT. CL. 5.

BDA HOLDINGS, LLC, PHOENIX, AZ:
3,300,131, INT. CL. 16.

BE-OUR-GUEST NETWORK, INC., SARASOTA, FL:
3,296,963, PUB. 7-10-2007. INT. CL. 35.

BEA SYSTEMS, INC., SAN JOSE, CA:
2,159,633. REN. 8-17-07. INT. CL. 9.

BEACH, SHANNON, NORTH HOLLYWOOD, CA:
3,300,033, INT. CL. 18.

BEACHTECH CORPORATION, HONOLULU, HI:
3,300,360, INT. CL. 21.

BEACON ROOFING SUPPLY, INC., PEABODY, MA:
3,296,353, PUB. 7-10-2007. INT. CL. 35.
3,296,354, PUB. 7-10-2007. INT. CL. 35.
3,296,355, PUB. 7-10-2007. INT. CL. 35.
3,296,356, PUB. 7-10-2007. INT. CL. 35.
3,296,357, PUB. 7-10-2007. INT. CL. 35.
3,296,358, PUB. 7-10-2007. INT. CL. 35.
3,296,385, PUB. 7-10-2007. INT. CL. 35.
3,296,421, PUB. 7-10-2007. INT. CL. 6.

BEAR CREEK TOYS, INC., WOODINVILLE, WA:
3,298,897, INT. CL. 28.

BEAULIEU GROUP, LLC, DALTON, GA:
3,298,093, PUB. 7-10-2007. INT. CL. 3.
3,299,664, INT. CL. 41.

BEAUTY HOLDING LLC, DENTON, TX:
2,088,126. REN. 8-20-07. INT. CL. 3.

BEAUTYBANK INC., NEW YORK, NY:
3,300,181, INT. CL. 3.

BEAVER MACHINE CORPORATION, NEWMARKER, ONTARIO, CANADA, MACHINE-O-MATIC LIMITED, NEWMARKET, ONTARIO, CANADA:
2,082,595. REN. 8-23-07. INT. CL. 9.

BEBE STUDIO, INC., LOS ANGELES, CA:
2,054,940. REN. 8-20-07. INT. CL. 3.

BECK AG, INC., SACRAMENTO, CA:
3,298,103, PUB. 6-5-2007. INT. CL. 35.

BECKER, PAUL F., STUART, FL:
3,299,678, INT. CL. 10.

BECTON DICKINSON AND COMPANY, FRANKLIN LAKES, NJ:
2,015,131, CANC. INT. CL. 10.

BEDDOWS COMMODITIES, INC., JUPITER, FL:
2,404,081, CANC. INT. CL. 36.

BEDROOM EYES, LLC, CHANDLER, AZ:
2,404,761, CANC. INT. CL. 35.

BEECHAM JAIK, GRACE, MALIBU, CA:
3,298,677, INT. CL. 41.

BEEKLEY CORPORATION, BRISTOL, CT:
2,015,906, CANC. INT. CL. 16.

BEHAVIORAL SCIENCE TECHNOLOGY, INC., OJAI, CA:
2,171,081. REN. 8-20-07. MULTIPLE CLASS, INT. CLS. 41 AND 42.

- BEHRINGER HARVARD LAKEWAY, L.P., AUSTIN, TX:
3,296,059, PUB. 7-10-2007. INT. CL. 43.
- BEIJING BEIXIONG TEC. & IND. CO., LTD., CHINA:
3,298,327, PUB. 7-10-2007. INT. CL. 21.
- BEL HOLDINGS, LLC, SMYRNA, GA:
3,297,846, PUB. 7-10-2007. MULTIPLE CLASS, INT. CLS. 9
AND 41.
- BEL-ORO INTERNATIONAL, INC., NEW YORK, NY:
3,300,068, INT. CL. 14.
3,300,095, INT. CL. 14.
- BELAE BRANDS, INC., SCOTTSDALE, AZ:
2,404,404, CANC. MULTIPLE CLASS, INT. CLS. 3 AND 5.
- BELANGER, INC., NORTHVILLE, MI:
3,296,391, PUB. 7-10-2007. INT. CL. 7.
- BELDEN TECHNOLOGIES, INC., ST. LOUIS, MO:
2,404,725, CANC. INT. CL. 9.
- BELFORT INSTRUMENT COMPANY, BALTIMORE, MD,
BENDIX AVIATION CORPORATION, DETROIT, MI:
650,065, REN. 8-23-07. U.S. CL. 26 (INT. CL. 9).
- BELL, CAROLYN JILL, LEAWOOD, KS:
3,296,540, PUB. 7-10-2007. INT. CL. 42.
- BELLAGIO, LLC, LAS VEGAS, NV:
3,298,682, INT. CL. 43.
- BELLETHIERE, GENE, MACUNGIE, PA:
3,296,143, PUB. 7-10-2007. INT. CL. 41.
- BELLSOUTH INTELLECTUAL PROPERTY CORPORA-
TION, WILMINGTON, DE:
1,327,677, REN. 8-17-07. INT. CL. 38.
3,297,608, PUB. 7-10-2007. MULTIPLE CLASS, INT. CLS.
38 AND 45.
- BELSHAW BROS., INC, SEATTLE, WA:
1,073,472, REN. 8-18-07. INT. CL. 7.
- BELTWAY MOVERS ASSOCIATES, INC., FORESTVILLE,
MD:
1,069,523, REN. 8-17-07. INT. CL. 39.
1,069,524, REN. 8-17-07. INT. CL. 39.
- BELVEDERE FINANCIAL SYSTEMS, INC., BOSTON, MA
TO DST INTERNATIONAL NORTH AMERICA, LTD,
BOSTON, MA:
2,014,753, CANC. INT. CL. 9.
- BELVEDERE INTERNATIONAL INC., MISSISSAUGA, ON-
TARIO L5R 3G3, CANADA:
2,403,046, CANC. INT. CL. 3.
- BEMCO ASSOCIATES, INC., DES PLAINES, IL:
2,080,726, REN. 8-22-07. INT. CL. 20.
- BEN & JERRY'S HOMEMADE, INC., BURLINGTON, VT:
2,035,273, REN. 8-20-07. INT. CL. 30.
- BENCHMARK MEDICAL, INC., MALVERN, PA:
3,295,974, PUB. 10-21-2003. MULTIPLE CLASS, INT. CLS.
35 AND 44.
- BENCOM LLC, CORDOVA, TN:
3,297,034, PUB. 7-10-2007. INT. CL. 36.
3,297,167, PUB. 7-10-2007. INT. CL. 36.
- BENEFIT COSMETICS, LLC, SAN FRANCISCO, CA, BENE-
FIT COSMETICS, INC., SAN FRANCISCO, CA:
2,159,030, REN. 8-17-07. INT. CL. 3.
- BENESSERE VINEYARDS, LTD., ST. HELENA, CA:
2,111,190, REN. 8-22-07. INT. CL. 33.
- BENJAMIN B. HANSEN, LOS ANGELES, CA:
3,300,151, INT. CL. 41.
- BENNETT, JASON A, YUCAIPA, CA AND BENNETT,
TWILA C, YUCAIPA, CA:
3,298,868, INT. CL. 40.
- BENNETT, LEEKAY, DELAWARE, OH:
3,299,118, INT. CL. 16.
- BENNOTI INC., NEW YORK, NY:
3,297,065, PUB. 7-10-2007. MULTIPLE CLASS, INT. CLS.
11 AND 30.
- BENTLEY LINGERIE, INC., JERSEY CITY, NJ:
2,016,517, CANC. INT. CL. 25.
- BENZEL'S BRETZEL BAKERY, INC., ALTOONA, PA:
1,453,391, REN. 8-22-07. INT. CL. 30.
- BEPE ENTERPRISES, LLC, DANA POINT, CA:
3,297,491, PUB. 7-10-2007. INT. CL. 43.
- BERCOM INTERNATIONAL, LLC, CHANHASSEN, MN:
3,297,569, PUB. 7-10-2007. INT. CL. 21.
- BERGE, RICK, FARIBAULT, MN AND BERGE, LESLIE,
FARIBAULT, MN:
3,299,636, INT. CL. 20.
- BERGEMANN GMBH, WESEL, FED REP GERMANY:
1,425,441, REN. 8-17-07. MULTIPLE CLASS, INT. CLS. 7
AND 9.
1,425,441, CANC. INT. CL. 6.
- BERGEN BRUNSWIG CORPORATION, ORANGE, CA:
1,416,892, CANC. MULTIPLE CLASS, INT. CLS. 35 AND
42.
- BERINGER, ALESSA, KELSO, WA:
3,295,985, PUB. 7-10-2007. MULTIPLE CLASS, INT. CLS. 3
AND 5.
- BERLE ENTERPRISES, INC., CHARLESTON, SC:
1,467,439, REN. 8-23-07. INT. CL. 25.
- BERROCO, INC., UXBRIDGE, MA:
3,298,967, INT. CL. 23.
- BERTELLI VALENTE, SHERMAN OAKS, CA:
3,296,409, PUB. 7-10-2007. INT. CL. 41.
- BEST BATTERY CO., INC., THE, BALTIMORE, MD:
2,014,732, CANC. INT. CL. 9.
- BEST DOCTORS, INC., BOSTON, MA:
3,297,547, PUB. 7-10-2007. INT. CL. 35.
- BEST WESTERN INTERNATIONAL, INC., PHOENIX, AZ:
3,300,267, INT. CL. 43.
- BEST'S STUDIO, INC., YOSEMITE NATIONAL PARK, CA,
DBA THE ANSEL ADAMS GALLERY:
1,417,027, CANC. INT. CL. 42.
- BESTECH, A DIVISION OF BOUDREAU-ESPLEY-PITRE
CORPORATION, SUDBURY, CANADA:
3,296,530, PUB. 7-10-2007. INT. CL. 42.
- BESTOLIFE CORPORATION, DALLAS, TX:
3,298,122, PUB. 7-10-2007. INT. CL. 17.
- BETA BRANDS LIMITED, LONDON, ONTARIO, CANADA
TO BETA BRANDS LIMITED, LONDON, ONTARIO,
CANADA:
2,016,296, CANC. INT. CL. 30.
- BETE FOG NOZZLE, INC., GREENFIELD, MA:
3,297,090, PUB. 7-10-2007. INT. CL. 7.
- BETH ISRAEL DEACONESS MEDICAL CENTER, INC.,
BOSTON, MA:
3,300,209, INT. CL. 42.
- BETTER BASKETBALL, INC., ATLANTA, GA:
3,297,552, PUB. 7-10-2007. INT. CL. 9.
3,297,553, PUB. 7-10-2007. INT. CL. 41.
- BETTER BRANDS, INC., WINDSOR, CT:
2,404,095, CANC. INT. CL. 35.
- BETTER BUSINESS CORPORATION PLUMBING, WAL-
NUT, CA:
1,416,958, CANC. INT. CL. 37.
- BETTER EATING CONCEPTS, LLC, LOS ANGELES, CA:
3,300,123, INT. CL. 43.
- BEVERLY HILLS PET HOTELS, INC., CLEVELAND, OH:
3,298,720, MULTIPLE CLASS, INT. CLS. 43 AND 44.
- BEVERLY INTERNATIONAL NUTRITION, LLC, COLD
SPRING, KY:
2,404,201, CANC. INT. CL. 5.
- BEYOND SOLUTIONS, INC., BUENA PARK, CA:
2,617,039, CANC. INT. CL. 9.
- BFC ACQUISITION CORPORATION, SYLACAUGA, AL:
2,404,259, CANC. INT. CL. 1.
- BFS BRANDS, LLC, NASHVILLE, TN:
3,299,860, MULTIPLE CLASS, INT. CLS. 35 AND 37.
3,299,861, MULTIPLE CLASS, INT. CLS. 35 AND 37.
- BFS DIVERSIFIED PRODUCTS, LLC, INDIANAPOLIS, IN,
FIRESTONE TIRE & RUBBER COMPANY, THE, AKRON,
OH:
1,451,333, REN. 8-22-07. INT. CL. 37.
- BFSM, L.L.C., DALLAS, TX:
3,296,195, PUB. 7-10-2007. INT. CL. 18.
- BHL S.A., LUXEMBOURG:
3,298,232, PUB. 7-10-2007. INT. CL. 3.
- BI-STATE CONSULTING, CHESTERFIELD, MO:
2,404,062, CANC. INT. CL. 42.
- BIC SPORT S.A., 56006 VANNES CEDEX, FRANCE:
2,403,406, CANC. MULTIPLE CLASS, INT. CLS. 22, 25
AND 28.

BICYCLE TOOLS, INC., ST. PAUL, MN, DBA PARK TOOL CO.:
3,296,636, PUB. 7-10-2007. INT. CL. 21.

BIEN-AIR HOLDING SA, SWITZERLAND:
3,298,159, PUB. 7-10-2007. INT. CL. 10.

BIG BOB'S NEW & USED CARPET OF AMERICA, INC., SHAWNEE MISSION, KS:
1,993,507. REN. 8-23-07. MULTIPLE CLASS, INT. CLS. 35 AND 42.
2,011,750. REN. 8-23-07. INT. CL. 37.

BIG GAME FLORIDA, L.L.C., DAYTONA BEACH, FL:
2,085,692. REN. 8-18-07. INT. CL. 25.

BIG M, INC., TOTOWA, NJ:
2,121,672. REN. 8-22-07. INT. CL. 25.

BIGELOW MERCHANDISING, LLC, COLUMBUS, OH:
3,298,903, INT. CL. 3.

BIKER TRASH INC., DENVER, CO:
2,099,577. REN. 8-23-07. INT. CL. 25.

BIKERS AGAINST CHILD ABUSE, PROVO, UT:
3,296,235, PUB. 7-10-2007. INT. CL. 35.

BILL'S GHOST & SPIRITS LLC, GUADALUPE, AZ:
3,296,380, PUB. 7-10-2007. INT. CL. 35.

BILLIARD EXCHANGE, INC., LAFAYETTE, CO, DBA POOLDAWG:
3,296,689, PUB. 7-10-2007. INT. CL. 35.

BINARY ENGINEERING SOFTWARE, INC, BELMONT, MA:
3,296,968, PUB. 7-10-2007. INT. CL. 35.

BINARYLABS, INC., SAN DIEGO, CA:
2,403,181, CANC. MULTIPLE CLASS, INT. CLS. 38 AND 42.

BINAURA CORPORATION, SANTA CRUZ, CA, BINAURA CORPORATION, SANTA CRUZ, CA:
2,109,601. REN. 8-20-07. INT. CL. 9.

BINDAN CORPORATION, OAK BROOK, IL:
3,297,725, PUB. 7-10-2007. INT. CL. 9.

BINNACLE LLC, CHAGRIN FALLS, OH:
2,403,588, CANC. INT. CL. 9.

BIO-LAB, INC., LAWRENCEVILLE, GA:
3,299,354, INT. CL. 5.

BIO-LOGIC, FRANCE:
3,298,347, PUB. 7-10-2007. MULTIPLE CLASS, INT. CLS. 9 AND 42.

BIOCLIMATIC AIR SYSTEMS, LLC, DELRAN, NJ:
2,140,170. REN. 8-23-07. INT. CL. 11.

BIOCOAT, INCORPORATED, HORSHAM, PA:
2,085,198. REN. 8-18-07. INT. CL. 1.

BIOKEMIKAL S.A. DE C.V., SANTO TOMÁS, SAN SALVADOR, EL SALVADOR:
3,298,457, INT. CL. 5.

BIOLA UNIVERSITY, INC., LA MIRADA, CA:
3,297,778, PUB. 7-10-2007. INT. CL. 41.

BIOMET DEUTSCHLAND GMBH, 14167 BERLIN, FED REP GERMANY:
2,403,400, CANC. MULTIPLE CLASS, INT. CLS. 5 AND 10.

BIONDI, AMY, WEYMOUTH, MA:
3,297,539, PUB. 7-10-2007. INT. CL. 16.

BIOSPHERE MEDICAL, INC., ROCKLAND, MA:
3,296,507, PUB. 7-10-2007. INT. CL. 10.
3,296,508, PUB. 7-10-2007. INT. CL. 10.

BIOTECHNI, FRANCE:
3,298,341, PUB. 7-10-2007. INT. CL. 10.

BIOVERSE, INC., PIPESTONE, MN:
2,100,271. REN. 8-17-07. INT. CL. 1.

BIOVET JSC, PESHTERA, BULGARIA:
3,298,307, PUB. 7-10-2007. MULTIPLE CLASS, INT. CLS. 5 AND 31.

BIOWARE CORP., EDMONTON, ALBERTA T6H 5R7, CANADA:
3,298,603, INT. CL. 41.

BISHOP-WISECARVER CORPORATION, PITTSBURG, CA:
3,297,946, PUB. 7-10-2007. INT. CL. 7.

BISHOP'S LODGE - VEF II OPERATOR, INC., SANTA FE, NM:
3,299,605, INT. CL. 43.

BITRODE CORPORATION, FENTON, MO:
2,175,678. REN. 8-23-07. INT. CL. 9.

BIZET HUMAN ASSET MANAGEMENT, INC., PITTSBURGH, PA:
3,175,040, CANC. MULTIPLE CLASS, INT. CLS. 16, 35 AND 41.

BÉHAR, YVES, SAN FRANCISCO, CA:
3,297,713, PUB. 7-10-2007. MULTIPLE CLASS, INT. CLS. 35 AND 42.

BKBG ENTERPRISES, INC., ELK GROVE VILLAGE, IL, DBA DEVANCO FOODS:
3,297,579, PUB. 7-10-2007. INT. CL. 29.

BLACK BELT KARATE STUDIO INC., RACINE, WI:
3,299,702, INT. CL. 41.

BLACK ENTERTAINMENT TELEVISION LLC, WASHINGTON, DC:
3,299,310, INT. CL. 41.

BLACK JESUS LLC, VENICE, CA:
3,296,262, PUB. 7-10-2007. INT. CL. 25.

BLACK MOUNTAIN ROYALTY LP, DALLAS, TX:
3,298,083, PUB. 7-10-2007. INT. CL. 42.

BLACK PEARL TECHNOLOGIES, LLC, SALT LAKE CITY, UT:
3,299,719, INT. CL. 35.

BLACK PHALANX, INC., NEW ORLEANS, LA:
2,404,048, CANC. INT. CL. 41.

BLACK RAG CLOTHING, SEATTLE, WA:
3,296,244, PUB. 7-10-2007. INT. CL. 25.

BLACK, MARIAN T., BOULDER CITY, NV:
3,296,946, PUB. 7-10-2007. INT. CL. 16.

BLACK, SENGERS & ASSOCIATES, MASSANUTTEN, VA:
3,296,913, PUB. 7-10-2007. INT. CL. 41.

BLACKSTONE CALLING CARD, INC., MIAMI, FL:
2,404,410, CANC. INT. CL. 16.

BLACKSTONE INDUSTRIES, INC., BETHEL, CT, DBA THE OLSON SAW COMPANY:
1,470,447. REN. 8-18-07. MULTIPLE CLASS, INT. CLS. 7 AND 8.

BLACKWELL PUBLISHING INC., MALDEN, MA:
3,297,568, PUB. 7-10-2007. MULTIPLE CLASS, INT. CLS. 9, 16 AND 41.

BLACKWOOD INDUSTRIES, INC., BENTONVILLE, AR:
3,298,687, INT. CL. 25.

BLADE NETWORK TECHNOLOGIES, INC., SANTA CLARA, CA:
3,299,630, INT. CL. 9.

BLAIR CORPORATION, WARREN, PA:
2,403,467, CANC. INT. CL. 35.

BLASER & WOLTERS SPECIALTY COFFEE TRADING CO., PLANTATION, FL:
3,298,057, PUB. 7-10-2007. INT. CL. 30.

BLAVAT, JERRY, PHILADELPHIA, PA:
2,097,560. REN. 8-22-07. INT. CL. 41.
2,099,274. REN. 8-20-07. INT. CL. 41.

BLAZER MANUFACTURING CO., INC., COLUMBUS, NE:
1,416,383, CANC. MULTIPLE CLASS, INT. CLS. 6 AND 28.

BLISS WORLD LLC, NEW YORK, NY:
2,116,892. REN. 8-18-07. INT. CL. 42.

BLISSLIVING, INC., ROCKVILLE, MD:
3,299,680, INT. CL. 24.

BLOCK DRUG COMPANY, INC., WEST TRENTON, NJ:
3,298,636, INT. CL. 5.
3,299,950, INT. CL. 5.

BLOCKBUSTER INC., DALLAS, TX TO BLOCKBUSTER INC., DALLAS, TX:
2,014,672, CANC. MULTIPLE CLASS, INT. CLS. 9 AND 28.

BLOCKHOUSE COMPANY, INC., YORK, PA:
1,449,722. REN. 8-23-07. INT. CL. 20.

BLOOM, AKIVAH, BROOKLYN, NY AND DRATEL, JASON EVAN, BROOKLYN, NY:
3,298,482, INT. CL. 25.

BLOOM, AKIVAH L., BROOKLYN, NY AND DRATEL, JASON EVAN, BROOKLYN, NY:
3,298,484, INT. CL. 25.

BLOOMSTON, STACY BOYD, BIRMINGHAM, AL:
3,298,547, INT. CL. 25.

BLOUSEHOUSE, INC., DUXBURY, MA:
3,298,864, INT. CL. 25.

- BLT MANAGEMENT LLC, NEW YORK, NY:
3,297,602, PUB. 7-10-2007. MULTIPLE CLASS, INT. CLS. 29, 30 AND 43.
- BLUE AUDIO INC., SEATTLE, WA:
2,035,257. REN. 8-20-07. INT. CL. 41.
- BLUE COAT SYSTEMS, INC., SUNNYVALE, CA, OSITIS, VILIS, CASTRO VALLEY, CA:
2,174,788. REN. 8-20-07. INT. CL. 9.
- BLUE CROSS AND BLUE SHIELD ASSOCIATION, CHICAGO, IL:
3,296,318, PUB. 7-10-2007. INT. CL. 36.
- BLUE DIAMOND GROWERS, SACRAMENTO, CA:
3,296,875, PUB. 7-10-2007. INT. CL. 41.
- BLUE FOX NEDGRAPHICS, INC., NEW YORK, NY:
2,404,584, CANC. INT. CL. 9.
- BLUE FROG MOBILE, INC., SEATTLE, WA:
3,298,933, INT. CL. 38.
3,298,934, INT. CL. 41.
- BLUE GRASS PROVISIONS COMPANY INCORPORATED, CRESCENT SPRINGS, KY:
2,133,593. REN. 8-22-07. INT. CL. 29.
- BLUE J INTERNATIONAL INC., S. EL MONTE, CA:
3,299,909, MULTIPLE CLASS, INT. CLS. 13 AND 28.
- BLUE SKY RESEARCH, INC., PORTLAND, OR:
2,015,366, CANC. INT. CL. 9.
- BLUE STEEL STUDIO, LLC, SANTA FE, NM:
3,296,955, PUB. 7-10-2007. INT. CL. 35.
- BLUE VENTURE SOLUTIONS, INC., FAIRPORT, NY:
3,297,245, PUB. 7-10-2007. INT. CL. 12.
- BLUE WING, INC., ST. PAUL, MN, HOPPE, MARK A., ST. PAUL, MN:
2,083,736. REN. 8-22-07. MULTIPLE CLASS, INT. CLS. 36 AND 42.
- BLUECROSS BLUESHIELD OF TENNESSEE, INC., CHATTANOOGA, TN:
3,297,872, PUB. 7-10-2007. INT. CL. 42.
3,297,931, PUB. 7-10-2007. INT. CL. 42.
- BLUEGREEN CORPORATION, BOCA RATON, FL, BLUEGREEN CORPORATION, BOCA RATON, FL:
2,088,758. REN. 8-17-07. MULTIPLE CLASS, INT. CLS. 36 AND 37.
2,090,596. REN. 8-23-07. MULTIPLE CLASS, INT. CLS. 36 AND 37.
- BLUEMARK, LLC, NEW PALTZ, NY:
3,297,954, PUB. 7-10-2007. MULTIPLE CLASS, INT. CLS. 36 AND 42.
- BLUMENTHAL LANSING COMPANY, CARLSTADT, NJ:
3,296,242, PUB. 7-10-2007. MULTIPLE CLASS, INT. CLS. 8 AND 26.
- BLUMENTHAL/LANSING COMPANY, LLC, CARLSTADT, NJ:
2,404,251, CANC. INT. CL. 28.
- BMRB LTD., LONDON, ENGLAND:
3,297,398, PUB. 7-10-2007. MULTIPLE CLASS, INT. CLS. 9, 35 AND 42.
- BNP MEDIA II, LLC, TROY, MI:
3,298,566, INT. CL. 41.
- BO CAI ENTERPRISE CO., LTD., YONGKANG CITY, TAINAN COUNTY, TAIWAN:
3,297,488, PUB. 7-10-2007. INT. CL. 9.
- BOARD OF DIRECTORS, GREATER KELLY DEVELOPMENT AUTHORITY, SAN ANTONIO, TX:
3,300,198, MULTIPLE CLASS, INT. CLS. 35 AND 39.
- BOARD OF REGENTS OF THE UNIVERSITY OF NEBRASKA, LINCOLN, NE:
2,081,722. REN. 8-20-07. INT. CL. 25.
2,081,722, CANC. INT. CL. 41.
- BOARD OF REGENTS OF THE UNIVERSITY SYSTEM OF GEORGIA, ATLANTA, GA:
3,297,154, PUB. 7-10-2007. MULTIPLE CLASS, INT. CLS. 25 AND 41.
3,299,635, INT. CL. 41.
- BOARDMAN MOLDED PRODUCTS, INC., YOUNGSTOWN, OH:
2,403,671, CANC. INT. CL. 27.
- BOARDMAN, TERESA L., MOUNTAIN VIEW, CA:
2,403,579, CANC. INT. CL. 41.
- BOARDROOM INC., STAMFORD, CT:
3,299,121, INT. CL. 41.
- BOATMAN'S COFFEE, INC., MT. VERNON, WA:
2,403,560, CANC. INT. CL. 42.
- BOB DEMATTEIS CO., GRASS VALLEY, CA:
3,299,328, INT. CL. 16.
- BOB SWANSON GIVE A LIFE FOUNDATION, INC., PALM BEACH GARDENS, FL:
3,298,090, PUB. 7-10-2007. INT. CL. 35.
- BOB'S PRINTING, INC., SAN DIEGO, CA:
2,015,433, CANC. INT. CL. 16.
- BOB'S REEDVILLE PLUMBING, LLC, HILLSBORO, OR:
3,296,535, PUB. 7-10-2007. INT. CL. 37.
- BOB'S STORES CORP., FRAMINGHAM, MA:
3,299,671, INT. CL. 25.
- BODET & HORST GMBH & CO. KG, 09481 ELTERLEIN, FED REP GERMANY:
3,297,922, PUB. 7-10-2007. MULTIPLE CLASS, INT. CLS. 10, 20 AND 24.
- BODY WISE INTERNATIONAL, LLC, TUSTIN, CA:
3,298,959, INT. CL. 5.
- BOEHME FILATEX, INC., REIDSVILLE, NC:
2,087,721. REN. 8-17-07. INT. CL. 4.
- BOEHRINGER INGELHEIM INTERNATIONAL GMBH, INGELHEIM AM RHEIN, FED REP GERMANY:
3,300,222, INT. CL. 42.
- BOEING MANAGEMENT COMAPANY, SEAL BEACH, CA:
1,446,455. REN. 8-17-07. INT. CL. 20.
- BOEING MANAGEMENT COMPANY, SEAL BEACH, CA:
1,446,237. REN. 8-17-07. INT. CL. 11.
- BOIS B.S.L. ÉNERGIE INC., MONT-JOLI, CANADA:
3,299,746, INT. CL. 4.
- BOLTUN CORPORATION, TAINAN HSIEN, TAIWAN:
3,298,886, MULTIPLE CLASS, INT. CLS. 7 AND 12.
- BOMBARDIER RECREATIONAL PRODUCTS INC., VALCOURT, QUEBEC, CANADA:
1,494,082. REN. 8-17-07. INT. CL. 9.
- BON AGROINDUSTRIAL, S.A., SANTO DOMINGO, DOMINICAN REP:
3,298,834, INT. CL. 32.
- BONANZA PRESS, INC., WOODINVILLE, WA:
3,299,412, INT. CL. 28.
- BONDI LIFESAVER HOLDINGS PTY LTD, CLAREMONT, AUSTRALIA:
3,299,689, INT. CL. 43.
- BONE SUPPORT AB, SWEDEN:
3,298,199, PUB. 7-10-2007. MULTIPLE CLASS, INT. CLS. 5 AND 41.
- BOOKSTORE MANAGER, INC., ABILENE, TX:
3,297,489, PUB. 7-10-2007. INT. CL. 42.
- BOONE AND CROCKETT CLUB, MISSOULA, MT:
3,297,008, PUB. 7-10-2007. INT. CL. 13.
- BOSTICK, CHARLES ROBERT II, GARDENA, CA:
3,298,714, INT. CL. 21.
- BOSTON MEDICAL CENTER, BOSTON, MA:
2,403,689, CANC. MULTIPLE CLASS, INT. CLS. 41 AND 42.
- BOSTON TEST TOOL COMPANY, WINSTON-SALEM, NC:
2,016,033, CANC. INT. CL. 10.
- BOTTO GIUSEPPE & FIGLI S.P.A., ITALY:
3,298,182, PUB. 7-10-2007. MULTIPLE CLASS, INT. CLS. 24 AND 25.
- BOULANGERIE AU PAIN DORE LTEE, MONTREAL, QUEBEC H3W 1Z2, CANADA:
2,523,854, CANC. INT. CL. 42.
- BOUMA, SARIAN S., ANNAPOLIS, MD:
3,299,259, MULTIPLE CLASS, INT. CLS. 3 AND 25.
- BOURN & KOCH, INC., ROCKFORD, IL:
3,297,628, PUB. 7-10-2007. INT. CL. 7.
- BOWERS, DANA N., CHICAGO, IL:
3,299,965, INT. CL. 16.
- BOWKER, MARC, LIMA, OH:
3,296,258, PUB. 7-10-2007. INT. CL. 35.
- BOWRON, BRIAN K., TEMPERANCE, MI:
2,404,565, CANC. INT. CL. 21.
- BOWTIE, INC., IRVINE, CA:
3,299,490, INT. CL. 44.

- BOXED BOOKS, INC., LAWRENCEVILLE, NJ:
3,299,568, INT. CL. 16.
3,299,569, INT. CL. 16.
- BOXLIGHT CORPORATION, POULSBO, WA:
2,083,067, REN. 8-20-07, INT. CL. 9.
- BOXY BUT GOOD, INC., AUSTIN, TX:
2,404,037, CANC. INT. CL. 9.
- BOYD GAMING CORPORATION, LAS VEGAS, NV:
2,132,854, REN. 8-17-07, INT. CL. 41.
- BOYS SPEAK OUT, INC., ATLANTA, GA:
3,296,940, PUB. 7-10-2007, INT. CL. 41.
- BOYT BRANDS, INC., IOWA FALLS, IA:
3,300,173, INT. CL. 18.
- BRADLEES STORES, INC., BRAintree, MA TO GERBER CHILDRENWEAR, INC., GREENVILLE, SC:
2,015,653, CANC. INT. CL. 25.
- BRADSHAW INTERNATIONAL, INC., RANCHO CUCA-MONGA, CA:
3,300,286, INT. CL. 21.
3,300,287, INT. CL. 21.
- BRADY CORPORATION, MILWAUKEE, WI:
1,070,467, REN. 8-20-07, MULTIPLE CLASS, INT. CLS. 1, 6, 7, 8, 9, 16 AND 17.
- BRAIN INJURY ASSOCIATION OF AMERICA, MCLEAN, VA:
3,296,547, PUB. 6-26-2007, MULTIPLE CLASS, INT. CLS. 35 AND 41.
- BRAINSTORM CORPORATION, TEMPLE CITY, CA:
3,296,843, PUB. 7-10-2007, INT. CL. 9.
- BRAMBLES INDUSTRIES LIMITED, SYDNEY NSW 2000, AUSTRALIA:
3,298,160, PUB. 7-10-2007, MULTIPLE CLASS, INT. CLS. 20, 35, 37, 38, 39, 40 AND 42.
- BRAMMALL, INC., ANGOLA, IN:
2,347,661, CANC. MULTIPLE CLASS, INT. CLS. 6 AND 20.
- BRANDIMATION INC., MORRISVILLE, PA:
3,297,883, PUB. 7-10-2007, INT. CL. 42.
- BRANDIMATION, INC., MORRISVILLE, PA:
3,297,881, PUB. 7-10-2007, INT. CL. 42.
3,297,882, PUB. 7-10-2007, INT. CL. 42.
- BRANDINO BRANDOLINI D'ADDA, VENEZIA, ITALY:
3,297,840, PUB. 7-10-2007, INT. CL. 33.
- BRANDWISE, LLC, NEW YORK, NY:
2,403,462, CANC. INT. CL. 42.
- BRASSTECH, INC., SANTA ANA, CA:
3,297,753, PUB. 7-10-2007, MULTIPLE CLASS, INT. CLS. 6, 11, 20 AND 21.
- BRAUN, HANS J., NEPHI, UT:
2,495,958, CANC. INT. CL. 15.
- BRAVO SPORTS, CYPRESS, CA:
3,298,664, MULTIPLE CLASS, INT. CLS. 18, 25 AND 28.
- BRAVOSOLUTION S.P.A., BERGAMO, ITALY:
3,298,085, PUB. 7-10-2007, INT. CL. 35.
- BRAY, KRISTI L., SAN CLEMENTE, CA AND GUTIERREZ, HEATHER R., SAN CLEMENTE, CA:
3,299,319, INT. CL. 24.
- BRAZELTON TOUCHPOINTS PROJECT, INC., BOSTON, MA:
2,404,014, CANC. INT. CL. 36.
- BRAZOS ELECTRIC POWER COOPERATIVE, INC., WACO, TX:
3,298,022, PUB. 7-10-2007, MULTIPLE CLASS, INT. CLS. 35, 39 AND 40.
- BREESE, CHRISTINE, C., ARCATA, CA:
3,297,631, PUB. 7-10-2007, INT. CL. 9.
- BRENCO SURFACE ENGINEERING PTY LTD, VICTORIA 3020, AUSTRALIA:
3,297,337, PUB. 7-10-2007, MULTIPLE CLASS, INT. CLS. 1 AND 2.
- BRENT, WILLIAM A., WASHINGTON, DC:
2,403,828, CANC. INT. CL. 16.
- BRESSLER VINEYARDS, LLC, ST. HELENA, CA:
3,300,268, INT. CL. 33.
- BREWER, FARON C., SPANISH FORT, AL:
3,298,008, PUB. 7-10-2007, INT. CL. 41.
- BREYERS YOGURT COMPANY, LLC, LONGMONT, CO:
3,299,713, INT. CL. 29.
- BRI ROOFING & SHEET METAL, INC., HASLET, TX:
3,298,071, PUB. 7-10-2007, INT. CL. 37.
- BRIAN BONNETT, RIVERSIDE, CA:
3,299,213, INT. CL. 25.
- BRIAN LEHMAN, BERNE, IN:
3,298,058, PUB. 7-10-2007, INT. CL. 30.
- BRIAN QUAGLIA, PROVIDENCE, RI:
3,296,163, PUB. 7-10-2007, INT. CL. 28.
- BRICK, SHARON M., NEW YORK, NY AND FULLERTON, DONNA M., NEW YORK, NY:
3,300,230, INT. CL. 41.
- BRIDGE BANK, N.A., SANTA CLARA, CA:
2,403,711, CANC. MULTIPLE CLASS, INT. CLS. 7 AND 40.
2,403,712, CANC. MULTIPLE CLASS, INT. CLS. 7 AND 40.
- BRIDGESTONE SPORTS CO., LTD., SHINAGAWA-KU, TOKYO, JAPAN:
3,300,168, INT. CL. 28.
- BRIGHTDOOR SYSTEMS, INC., CARY, NC:
3,296,755, PUB. 7-10-2007, INT. CL. 42.
- BRIGITTE ELEONORE LHENRY, FRANCE:
3,298,253, PUB. 7-10-2007, INT. CL. 1.
- BRINKER INTERNATIONAL HOLDINGS, LP, DALLAS, TX:
2,089,133, REN. 8-18-07, INT. CL. 30.
- BRINTON, DAVID, NORTH HOLLYWOOD, CA:
3,299,210, MULTIPLE CLASS, INT. CLS. 9, 16 AND 41.
- BRITE WAY PRODUCTS COMPANY, NEW YORK, NY:
1,416,405, CANC. INT. CL. 7.
- BRITEAGE CORPORATION, LAGUNA HILLS, CA:
3,300,194, INT. CL. 5.
3,300,196, INT. CL. 5.
- BRITISH TELECOMMUNICATIONS PLC, LONDON EC1A 6B2, ENGLAND:
1,416,472, CANC. INT. CL. 9.
- BRITISH VIRGIN ISLANDS TOURIST BOARD, TORTOLA, BR. VIRGIN ISLANDS:
3,299,454, INT. CL. 35.
- BROADCAST ELECTRONICS, INC., QUINCY, IL:
3,297,847, PUB. 7-10-2007, MULTIPLE CLASS, INT. CLS. 9 AND 38.
- BROKER EXCHANGE NETWORK, LLC, ROCHESTER, MN:
3,296,055, PUB. 7-10-2007, INT. CL. 35.
- BROOKLYN HEIGHTS MONTESSORI SCHOOL, BROOKLYN, NY:
3,297,343, PUB. 7-10-2007, INT. CL. 41.
- BROOKLYN WINE COMPANY INC., BROOKLYN, NY:
3,300,346, INT. CL. 25.
3,300,347, INT. CL. 33.
- BROOKS, MICHAEL A., IRVINE, CA:
3,296,982, PUB. 7-10-2007, INT. CL. 36.
- BROTHERS, LONNY, CARDIFF BY THE SEA, CA AND BROTHERS, ROBIN, CARDIFF BY THE SEA, CA:
3,296,150, PUB. 6-26-2007, INT. CL. 25.
- BROWN-FORMAN CORPORATION, LOUISVILLE, KY:
2,130,566, REN. 8-23-07, INT. CL. 33.
- BROWN-MILANS, CYNTHIA, ARLINGTON, VA, TA C. MILANS:
2,404,417, CANC. INT. CL. 14.
- BROWN, BRUCE A., GAVIOTO, CA:
3,298,604, MULTIPLE CLASS, INT. CLS. 6, 9, 11, 14, 16, 18, 21, 24, 25, 28 AND 32.
3,298,605, MULTIPLE CLASS, INT. CLS. 6, 9, 11, 14, 16, 18, 21, 24, 25, 28 AND 32.
- BROWN, ERIC, CEDARHURST, NY:
3,298,507, MULTIPLE CLASS, INT. CLS. 16 AND 41.
- BROWN, OWEN J. JR., PITTSFIELD, IL:
3,296,447, PUB. 7-10-2007, INT. CL. 7.
- BROWNE & CO. LTD., MARKHAM, ONTARIO, CANADA:
2,403,697, CANC. INT. CL. 21.
- BRUEGGER'S ENTERPRISES, INC., BURLINGTON, VT:
2,123,032, REN. 8-23-07, INT. CL. 42.
- BRUKER BIOSPIN MRI GMBH, D-76275 ETTLINGEN, FED REP GERMANY:
3,296,064, PUB. 7-10-2007, MULTIPLE CLASS, INT. CLS. 9 AND 10.

- BRUNI GLASS PACKAGING, INC., POMPANO BEACH, FL:
3,297,253, PUB. 7-10-2007. MULTIPLE CLASS, INT. CLS.
35 AND 40.
- BRUNO INDEPENDENT LIVING AIDS, INC., OCONOMO-
WOC, WI:
3,297,211, PUB. 7-10-2007. INT. CL. 12.
- BRUNSWICK LEASING LIMITED, HAMILTON HM11,
BERMUDA:
2,403,060, CANC. INT. CL. 36.
- BRUSH, JOANNE WALKER, GENESEO, IL AND BRUSH,
GEORGE HENRY JR, GENESEO, IL:
3,300,342, INT. CL. 31.
- BSH HOME APPLIANCES CORPORATION, HUNTINGTON
BEACH, CA:
3,299,485, MULTIPLE CLASS, INT. CLS. 7 AND 11.
- BUCCELLATI HOLDING AMERICA, INC., NEW YORK,
NY:
3,264,036, CANC. IIRN. RESTORED TO S.N. 77-001,664.
- BUCHANAN, JAMES W., CLEVELAND, OH:
2,404,137, CANC. INT. CL. 41.
- BUCKEYE TECHNOLOGIES INC., MEMPHIS, TN:
3,300,045, INT. CL. 21.
- BUENO ALIMENTOS, S.A., KM 3.5, STA. CATARINA N.,
MEXICO:
1,474,356, REN. 8-23-07. INT. CL. 30.
- BUILDING OWNERS AND MANAGERS INSTITUTE IN-
TERNATIONAL, INC., ARNOLD, MD. BUILDING OWN-
ERS AND MANAGERS INSTITUTE INTERNATIONAL,
ARNOLD, MD:
1,451,409, REN. 8-17-07. INT. CL. 41.
- BUILDING SYSTEMS DESIGN, ATLANTA, GA:
2,403,613, CANC. INT. CL. 16.
- BUILDING VISIONS, INC., SAN FRANCISCO, CA:
2,403,672, CANC. INT. CL. 35.
- BULAVIN, DMITRY, SAMARA, RUSSIAN FED.:
3,296,674, PUB. 7-10-2007. MULTIPLE CLASS, INT. CLS.
9, 35 AND 41.
- BULGARI S.P.A., ITALY:
3,298,342, PUB. 7-10-2007. INT. CL. 16.
- BULLDOG BAG LTD., RICHMOND, B.C., CANADA:
3,297,354, PUB. 7-10-2007. MULTIPLE CLASS, INT. CLS.
16 AND 17.
- BULLOCK, KATHERINE, W, COLUMBIA, SC:
3,296,251, PUB. 7-10-2007. INT. CL. 36.
- BUMGARNER, F. KEITH, BUFORD, GA:
3,299,137, INT. CL. 16.
- BUMPERDOC, INC., SAN DIEGO, CA:
3,296,364, PUB. 7-10-2007. INT. CL. 37.
- BUNHEADS, INC., SARATOGA SPRINGS, NY:
2,158,867, REN. 8-17-07. INT. CL. 5.
- BUREAU OF THE PUBLIC DEBT, PARKERSBURG, WV:
2,015,413, CANC. MULTIPLE CLASS, INT. CLS. 16 AND
36.
- BURLINGTON NETWORKS INC., IRVINE, CA:
2,404,006, CANC. INT. CL. 39.
- BURSAW, MICHAEL, CARMEL, IN:
2,015,687, CANC. INT. CL. 16.
- BURWEN, PETER, ANTRIM, NH:
3,296,989, PUB. 7-10-2007. INT. CL. 41.
- BURWOOD ENTERPRISES, LLC, CHICAGO, IL:
3,298,885, INT. CL. 43.
- BUSHTRACKS AFRICAN EXPEDITIONS, INC., HEALDS-
BURG, CA:
3,296,646, PUB. 7-10-2007. INT. CL. 39.
- BUSINESS & LEGAL REPORTS, INC., OLD SAYBROOK, CT:
3,300,334, INT. CL. 42.
- BUSINESS LAW VENTURES, P.C., ROSEVILLE, CA:
3,300,319, INT. CL. 42.
- BUSS-SMS GMBH VERFAHRENSTECHNIK, BUTZBACH,
ZWEIGNIEDERLASSUNG PRATTELN, 4133 PRATTELN,
SWITZERLAND:
2,403,184, CANC. MULTIPLE CLASS, INT. CLS. 7 AND
11.
2,403,185, CANC. INT. CL. 11.
2,403,186, CANC. INT. CL. 11.
- BUTLER ANIMAL HEALTH SUPPLY, LLC, DUBLIN, OH:
3,296,484, PUB. 7-10-2007. INT. CL. 5.
- BUTLER HOME PRODUCTS, LLC, HOLLISTON, MA, EASY
DAY MANUFACTURING COMPANY, HOLLISTON, MA:
2,088,269, REN. 8-23-07. INT. CL. 21.
- BUTLER INTERNATIONAL, INC., MONTVALE, NJ:
2,078,380, REN. 8-18-07. MULTIPLE CLASS, INT. CLS. 35,
40 AND 42.
2,078,381, REN. 8-18-07. MULTIPLE CLASS, INT. CLS. 35,
40 AND 42.
- BUTTERFLY TV CREATIONS CO., FORT LAUDERDALE,
FL:
2,015,016, CANC. INT. CL. 35.
- BVG RESORT HOMES, INC., TAMPA, FL:
3,298,993, MULTIPLE CLASS, INT. CLS. 36, 43 AND 45.
- BYK-CHEMIE GMBH, WESEL, FED REP GERMANY:
3,297,206, PUB. 7-10-2007. MULTIPLE CLASS, INT. CLS.
1, 40, 41 AND 42.
- BYRNE, EILEEN, CARDIFF, CA TO LUNADA BAY COR-
PORATION, ANAHEIM, CA:
2,015,718, CANC. INT. CL. 25.
- BYUN, DONGHWAN, REPUBLIC OF KOREA:
3,298,262, PUB. 7-10-2007. MULTIPLE CLASS, INT. CLS. 7
AND 12.
- C J SPITONY'S INC., NEW BALTIMORE, VA:
3,296,845, PUB. 7-10-2007. INT. CL. 43.
- C. L. SWANSON CORPORATION, MADISON, WI:
3,298,986, MULTIPLE CLASS, INT. CLS. 35 AND 43.
- C.A.P. MARKETING CONSULTANTS INC., WINTER PARK,
FL:
2,014,925, CANC. INT. CL. 42.
- C.I. COLOR SIETE S.A., CALDAS, COLOMBIA, M&R
COMPANIA LTDA., MANIZALES, COLOMBIA:
2,070,247, REN. 8-23-07. INT. CL. 25.
- C.I.T. S.P.A. CONFEZIONI ITALIANE TESSILI COMMER-
CIO INDUSTRIA TESSUTI, I-20121 MILANO, ITALY:
3,298,179, PUB. 7-10-2007. MULTIPLE CLASS, INT. CLS.
3, 18 AND 25.
3,298,180, PUB. 7-10-2007. MULTIPLE CLASS, INT. CLS.
3, 18 AND 25.
- C.O.D CREATIONS OF DENIM PTY LTD, AUSTRALIA:
3,298,389, PUB. 7-10-2007. INT. CL. 25.
- C.P. MORGAN COMMUNITIES, L.P., INDIANAPOLIS, IN:
3,296,545, PUB. 7-10-2007. INT. CL. 37.
- C.U.U.L., INC., BEVERLY HILLS, CA:
3,297,755, PUB. 7-10-2007. INT. CL. 42.
- C&W DESIGN, LLC, PITTSBURGH, PA:
3,299,404, INT. CL. 6.
- C-THRU RULER COMPANY, THE, BLOOMFIELD, CT:
2,119,902, REN. 8-18-07. INT. CL. 16.
- C/BASE, INC., CONSHOHOCKEN, PA:
2,574,188, COR. INT. CL. 36.
- C/HCA, INC., BRENTWOOD, TN:
3,296,103, PUB. 7-10-2007. MULTIPLE CLASS, INT. CLS.
35, 36 AND 41.
3,296,104, PUB. 7-10-2007. MULTIPLE CLASS, INT. CLS.
35, 36 AND 41.
- C'WATRE, ASHBURN, VA:
3,297,363, PUB. 7-10-2007. INT. CL. 3.
3,297,364, PUB. 7-10-2007. INT. CL. 3.
3,297,369, PUB. 7-10-2007. INT. CL. 3.
- CAB FOOTWEAR, LP, EL PASO, TX:
3,297,715, PUB. 7-10-2007. INT. CL. 25.
- CABADOS, RICHARD, CARLSBAD, CA:
3,296,234, PUB. 6-5-2007. INT. CL. 11.
- CABANA, ROGER, HOBE SOUND, FL:
3,299,436, INT. CL. 28.
- CABICO, ROBERT LUIS, CHULA VISTA, CA:
2,016,510, CANC. INT. CL. 25.
- CABLES AND CHIPS, INC., NEW YORK, NY:
2,403,869, CANC. MULTIPLE CLASS, INT. CLS. 35 AND
37.
- CABOT HOSIERY MILLS, INC., NORTHFIELD, VT:
3,297,254, PUB. 7-10-2007. INT. CL. 25.
- CABOT SAFETY INTERMEDIATE CORPORATION, NEW-
ARK, DE, CABOT CORPORATION, WALTHAM, MA:
1,599,448, REN. 8-21-07. INT. CL. 10.
- CABOT SAFETY INTERMEDIATE CORPORATION, NEW-
ARK, DE:
3,298,808, INT. CL. 9.

- CADBURY ADAMS USA LLC, PARSIPPANY, NJ:
3,298,618, INT. CL. 30.
3,298,637, INT. CL. 30.
- CADBURY BEVERAGES DELAWARE, INC., WILMINGTON, DE, REALEMON-PURITAN CO., CHICAGO, IL:
656,534, REN. 8-17-07. U.S. CL. 46 (INT. CLS. 29 AND 32).
- CADDIE MASTER ENTERPRISES, INC., PINEHURST, NC:
3,298,011, PUB. 7-10-2007. MULTIPLE CLASS, INT. CLS. 41 AND 45.
- CAE INC., SAINT-LAURENT, QUEBEC, CANADA:
3,297,691, PUB. 7-10-2007. INT. CL. 9.
- CAFEPRESS.COM, INC., FOSTER CITY, CA:
3,297,969, PUB. 7-10-2007. INT. CL. 41.
- CAINS FOODS, L.P., AYER, MA:
3,299,098, INT. CL. 30.
- CAKE, LLC, SANTA MONICA, CA:
3,296,410, PUB. 7-10-2007. MULTIPLE CLASS, INT. CLS. 35 AND 41.
- CALEFFI S.P.A., ITALY:
3,298,354, PUB. 7-10-2007. INT. CL. 25.
- CALIFORNIA COSTUME COLLECTIONS, INC., LOS ANGELES, CA:
3,297,482, PUB. 7-10-2007. INT. CL. 25.
- CALIFORNIA EMERGENCY PHYSICIANS MEDICAL GROUP, EMERYVILLE, CA:
3,300,356, INT. CL. 41.
- CALIFORNIA EXOTIC NOVELTIES LLC, CHINO, CA:
3,296,870, PUB. 7-10-2007. INT. CL. 10.
3,297,170, PUB. 7-10-2007. INT. CL. 10.
- CALIFORNIA EXPANDED METAL PRODUCTS COMPANY, CITY OF INDUSTRY, CA, DBA CEMCO CORPORATION:
3,299,395, INT. CL. 6.
3,299,398, INT. CL. 6.
- CALIFORNIA FEDERAL SAVINGS AND LOAN ASSOCIATION, LOS ANGELES, CA:
1,416,916, CANC. INT. CL. 36.
- CALIFORNIA FLEURISH, INC., EL CAJON, CA:
2,404,412, CANC. INT. CL. 3.
- CALIFORNIA FRUIT GROWERS EXCHANGE, LOS ANGELES, CA TO SUNKIST GROWERS, INC., SHERMAN OAKS, CA:
352,087, AM. U.S. CL. 23.
- CALLAWAY GOLF COMPANY, CARLSBAD, CA:
2,404,881, CANC. INT. CL. 28.
3,299,985, INT. CL. 28.
3,300,164, INT. CL. 25.
3,300,186, INT. CL. 28.
3,300,189, INT. CL. 25.
3,300,191, INT. CL. 25.
3,300,192, INT. CL. 28.
- CALVARY CHAPEL CHURCH, INC., FT. LAUDERDALE, FL:
3,296,321, PUB. 7-10-2007. MULTIPLE CLASS, INT. CLS. 9, 38, 41 AND 45.
- CALYX & COROLLA, INC., SHELBURNE, VT, DBA CALYX FLOWERS:
3,300,306, INT. CL. 35.
3,300,307, INT. CL. 35.
- CALYX & COROLLA, INC., SHELBURNE, VT, DBA CALYX FLOWERS.COM:
3,300,310, INT. CL. 35.
- CAMARDA FINANCIAL ADVISORS, INC., ORANGE PARK, FL:
3,297,836, PUB. 7-10-2007. INT. CL. 36.
- CAMBRIAN CAPITAL LIMITED PARTNERSHIP, MANCHESTER, MA:
3,299,309, INT. CL. 36.
3,299,376, INT. CL. 36.
- CAMBRIDGE RESEARCH & INSTRUMENTATION, INC., WOBURN, MA:
3,298,491, INT. CL. 9.
- CAMBRIDGE SCIENTIFIC ABSTRACTS, LIMITED PARTNERSHIP, BETHESDA, MD:
2,015,133, CANC. INT. CL. 42.
- CAMP BOW WOW DISTRIBUTION LLC, BOULDER, CO:
3,297,609, PUB. 7-10-2007. INT. CL. 43.
3,297,610, PUB. 7-10-2007. INT. CL. 44.
- CAMP SUNSHINE AT SEBAGO LAKE, INC., CASCO, ME:
3,296,303, PUB. 7-10-2007. INT. CL. 36.
- CAMPALUMNI.COM LLC, NEW YORK, NY:
3,296,165, PUB. 7-10-2007. INT. CL. 38.
- CAMPANALI, WILLIAM J, TOWACO, NJ:
3,298,641, INT. CL. 41.
- CAMPER, S.L., SPAIN:
3,298,245, PUB. 7-10-2007. INT. CL. 25.
- CAMPUS CRUSADE FOR CHRIST, INC., ORLANDO, FL:
3,296,228, PUB. 7-10-2007. INT. CL. 9.
- CAMPUS CURRENT, INC., ROCHESTER, NY:
3,297,038, PUB. 7-10-2007. MULTIPLE CLASS, INT. CLS. 41 AND 45.
- CAMS MEDICAL INSTRUMENTS, INC., ORLANDO, FL:
3,296,871, PUB. 7-10-2007. INT. CL. 10.
- CAN 56, INC., EDEN PRAIRIE, MN:
2,403,392, CANC. MULTIPLE CLASS, INT. CLS. 16 AND 21.
- CANCER TREATMENT CONSULTANTS, LLC, MEMPHIS, TN:
2,403,657, CANC. INT. CL. 42.
- CANDERRIX INTERNET, LLC, WESTFIELD, MA:
3,298,479, INT. CL. 38.
- CANDLE CORPORATION OF AMERICA, DES PLAINES, IL:
3,297,853, PUB. 7-10-2007. INT. CL. 4.
- CANDY TOWN USA, INC., BILLINGS, MT:
3,296,880, PUB. 7-10-2007. MULTIPLE CLASS, INT. CLS. 30 AND 35.
3,296,881, PUB. 7-10-2007. MULTIPLE CLASS, INT. CLS. 30 AND 35.
- CANICA DESIGN INC., ALMONTE, ONTARIO, CANADA:
3,299,574, INT. CL. 5.
- CANNON SAFE, INC., SAN BERNARDINO, CA:
3,297,985, PUB. 7-10-2007. INT. CL. 6.
- CANNON, JUSTIN RUSSELL, BERKELEY, CA:
3,296,699, PUB. 7-10-2007. INT. CL. 45.
- CANON COMMUNICATIONS LLC, LOS ANGELES, CA:
3,297,276, PUB. 7-10-2007. INT. CL. 35.
- CANON KABUSHIKI KAISHA, TOKYO, JAPAN:
1,416,623, CANC. INT. CL. 16.
- CANONIC CORP. SAN DIEGO, CA:
3,300,308, MULTIPLE CLASS, INT. CLS. 35 AND 42.
- CANSEL SURVEY EQUIPMENT INC., BURNABY, BRITISH COLUMBIA, CANADA:
3,300,120, INT. CL. 9.
- CANTER, CYNTHIA K., MISSION VIEJO, CA:
3,296,543, PUB. 7-10-2007. INT. CL. 25.
- CAPEWELL COMPONENTS COMPANY, LLC, CROMWELL, CT, ALCO STANDARD CORPORATION, FREMONT, OH:
1,079,249, REN. 8-18-07. INT. CL. 8.
- CAPEWELL HORSENAIIS, INC., BLOOMFIELD, CT:
1,450,333, REN. 8-20-07. INT. CL. 6.
- CAPITAL BLUE CROSS, HARRISBURG, PA:
1,470,004, REN. 8-23-07. INT. CL. 36.
- CAPITAL E (BERMUDA) LTD., HAMILTON, BERMUDA:
3,297,194, PUB. 7-5-2005. INT. CL. 36.
- CAPITAL GARMENT CO. USA, INC., NEWTON CENTRE, MA:
2,079,771, REN. 8-18-07. INT. CL. 35.
- CAPITAL MORTGAGE SERVICES, INC., ALPHARETTA, GA:
3,297,467, PUB. 7-10-2007. INT. CL. 36.
- CAPITAL TECHSEARCH, INC., RICHMOND, VA:
3,299,388, INT. CL. 35.
- CAPITOL WHOLESALE MEATS, INC., CHICAGO, IL:
3,296,202, PUB. 7-10-2007. INT. CL. 29.
- CAPP ENTERPRISES, INC., NEW YORK, NY, UNITED FEATURE SYNDICATE, INC., NEW YORK, NY:
353,990, REN. 8-23-07. U.S. CL. 38 (INT. CL. 16).
- CAPPELLEN & ASSOCIATES, HOUSTON, TX:
3,296,711, PUB. 7-10-2007. INT. CL. 35.
- CAPRARELLI, LYNN, SANTA CLARITA, CA:
2,403,802, CANC. INT. CL. 37.
- CAPTARA CORPORATION, SAN FRANCISCO, CA:
3,298,793, MULTIPLE CLASS, INT. CLS. 35 AND 36.
- CAPTIVIEW, INC., HOUSTON, TX:
3,297,094, PUB. 7-10-2007. INT. CL. 38.

- CARAPELLI FIRENZE S.P.A., TAVARNELLE VAL DI PESA, ITALY:
3,298,016, PUB. 7-10-2007. INT. CL. 29.
- CARAT CREATION INC., EAST BRUNSWICK, NJ:
2,016,453, CANC. INT. CL. 14.
- CARDIAC PATHWAYS CORPORATION, SUNNYVALE, CA:
2,404,506, CANC. INT. CL. 10.
- CARDINAL BRANDS, INC., LAWRENCE, KS:
3,297,365, PUB. 7-10-2007. INT. CL. 16.
3,299,176, INT. CL. 16.
- CARDINAL LABORATORIES, INC., AZUSA, CA:
2,094,456, REN. 8-17-07. INT. CL. 41.
- CARDINAL LABORATORIES, INC., BALDWIN PARK, CA:
3,296,147, PUB. 7-10-2007. INT. CL. 31.
- CARDONE INDUSTRIES, INC., PHILADELPHIA, PA:
2,080,671, REN. 8-17-07. MULTIPLE CLASS, INT. CLS. 7, 9 AND 12.
- CARDS 4 TWINS, FERNANDINA BEACH, FL:
3,296,218, PUB. 7-10-2007. INT. CL. 16.
- CAREER EDUCATION CORPORATION, HOFFMAN ESTATES, IL:
3,300,326, MULTIPLE CLASS, INT. CLS. 38 AND 43.
- CAREER VENTURES, LLC, DENVER, CO:
2,007,882, REN. 8-22-07. INT. CL. 35.
- CAREFLITE, GRAND PRAIRIE, TX:
3,297,812, PUB. 4-3-2007. INT. CL. 39.
- CAREPAK SOLUTIONS, INC., JACKSONVILLE, FL:
3,298,026, PUB. 7-10-2007. INT. CL. 16.
- CARGAS SYSTEMS, INC., LANCASTER, PA:
3,297,590, PUB. 7-10-2007. MULTIPLE CLASS, INT. CLS. 35 AND 42.
- CARGILL CONSULTING GROUP, INC., LOS ANGELES, CA:
3,296,967, PUB. 7-10-2007. INT. CL. 35.
- CARGILL, INCORPORATED, WAYZATA, MN:
2,016,156, CANC. INT. CL. 5.
2,404,486, CANC. INT. CL. 36.
3,297,119, PUB. 7-10-2007. INT. CL. 5.
3,299,466, INT. CL. 1.
3,299,684, INT. CL. 30.
- CARIB SEA, INC., FT. PIERCE, FL:
3,297,499, PUB. 7-10-2007. INT. CL. 19.
- CARIBBEAN WEDDINGS, INC., FORT LAUDERDALE, FL:
3,296,976, PUB. 7-10-2007. INT. CL. 39.
- CARIBE FOODS, INC., BRONX, NY:
3,297,321, PUB. 7-10-2007. INT. CL. 29.
- CARLISLE FOODSERVICE PRODUCTS, INCORPORATED, OKLAHOMA CITY, OK:
1,483,498, REN. 8-22-07. INT. CL. 21.
1,484,314, REN. 8-23-07. INT. CL. 21.
- CARLISLE FOODSERVICE PRODUCTS, INCORPORATED, OKLAHOMA CITY, OK, CARLISLE FOODSERVICE PRODUCTS, INCORPORATED, OKLAHOMA CITY, OK:
2,149,643, REN. 8-22-07. INT. CL. 21.
- CARLISLE PLASTICS, INC., MINNEAPOLIS, MN TO COVALENCE SPECIALTY MATERIALS CORP., MINNEAPOLIS, MN:
2,015,491, CANC. INT. CL. 17.
- CARLO PAZOLINI ITALIA S.R.L., CIVITANOVA MARCHE (MC), ITALY:
2,138,342, REN. 8-23-07. MULTIPLE CLASS, INT. CLS. 18 AND 25.
- CARLSON, OAKLEY, SEATTLE, WA AND REED, BRENDA, SEATTLE, WA:
3,300,172, INT. CL. 18.
- CARLSON, SCOTT A., NORTH RICHLAND HILLS, TX:
3,299,545, INT. CL. 36.
- CARLUCCI, DANIEL VICTOR, ROLLING HILLS ESTATES, CA:
2,016,150, CANC. INT. CL. 35.
- CARMEL MOUNTAIN RANCH, SAN DIEGO, CA:
1,416,951, CANC. INT. CL. 37.
1,416,952, CANC. INT. CL. 37.
- CARMEN E. BAZZINI, BAYVILLE, NY:
3,300,258, INT. CL. 33.
- CARNAVALI, ROBERT J., CONCORD, CA, DBA AL E. PRODUCTIONS:
2,015,869, CANC. INT. CL. 25.
- CARNIVAL CORPORATION, MIAMI, FL:
3,298,856, MULTIPLE CLASS, INT. CLS. 39 AND 43.
- CAROLINA EAR RESEARCH INSTITUTE, THE, RALEIGH, NC:
3,296,539, PUB. 7-10-2007. INT. CL. 41.
- CAROLINA VOYAGE, LLC, HOLLYWOOD, FL:
2,127,275, REN. 8-20-07. INT. CL. 39.
- CAROLINAS FURNITURE MARKET, INC., CHARLOTTE, NC, DBA INTRO:
2,403,198, CANC. INT. CL. 35.
- CARPENTER CO., RICHMOND, VA:
1,448,542, REN. 8-22-07. INT. CL. 20.
1,459,247, REN. 8-23-07. INT. CL. 20.
2,084,232, REN. 8-23-07. MULTIPLE CLASS, INT. CLS. 1, 17, 19, 20, 22, 24 AND 27.
- CARPENTER, ALICE ANN, CINCINNATI, OH:
2,015,755, CANC. INT. CL. 42.
- CARPLEX, CARMEL, IN:
3,296,313, PUB. 7-10-2007. MULTIPLE CLASS, INT. CLS. 35 AND 36.
- CARR SPECIALTY BAITS, INC., ST. AUGUSTINE, FL:
3,297,521, PUB. 7-10-2007. INT. CL. 35.
- CARRAWAY, DWAYNE, EAST ST. LOUIS, IL:
2,403,593, CANC. INT. CL. 25.
- CARROLL COMPANY, GARLAND, TX:
2,166,489, REN. 8-20-07. INT. CL. 3.
- CARSON PIRIE SCOTT II, INC., MILWAUKEE, WI:
3,046,737 NEW CERT. 9-25-2007. INT. CL. 3.
- CARTER LAW FIRM, P.S., BELLEVUE, WA:
3,296,181, PUB. 7-10-2007. INT. CL. 45.
- CARTER, KIRSTEN, ELGIN, TX:
2,404,176, CANC. INT. CL. 41.
- CARTER, T., HARRISBURG, PA, DBA HONOR WEAR:
3,297,697, PUB. 7-10-2007. INT. CL. 25.
- CARUS PUBLISHING COMPANY, PERU, IL, KALMBACH PUBLISHING CO., MILWAUKEE, WI:
1,456,496, REN. 8-17-07. INT. CL. 16.
- CARUSO, GEORGIA, SAINT AUGUSTINE, FL:
3,296,486, PUB. 7-10-2007. INT. CL. 18.
- CASCADE MEDICAL ENTERPRISES, LLC, WAYNE, NJ:
3,297,566, PUB. 7-10-2007. INT. CL. 10.
- CASCADES CUT STONE COMPANY, FINDLAY, OH:
3,296,509, PUB. 7-10-2007. INT. CL. 19.
- CASCADES FINE PAPERS GROUP INC./CASCADES GROUPE PAPIERS FINS INC., MONTREAL, QUEBEC, CANADA:
3,296,084, PUB. 7-10-2007. INT. CL. 16.
- CASEY FAMILY PROGRAMS, SEATTLE, WA:
3,297,779, PUB. 7-10-2007. MULTIPLE CLASS, INT. CLS. 41 AND 45.
- CASHEL, JIM, SONOMA, CA:
2,125,673, REN. 8-23-07. INT. CL. 42.
- CASIO KEISANKI KABUSHIKI KAISHA, TOKYO, JAPAN, DBA CASIO COMPUTER CO., LTD.:
3,225,862, COR. INT. CL. 9.
- CASTELLA IMPORTS, INC., HAUPPAUGE, NY:
3,299,539, MULTIPLE CLASS, INT. CLS. 2 AND 30.
- CASTELLARNAU REBULL, TIRS, SPAIN:
3,298,303, PUB. 7-10-2007. INT. CL. 36.
- CASTELLBLANCH, S.A., SPAIN:
3,298,301, PUB. 7-10-2007. INT. CL. 33.
- CASTER, FRANCE:
3,298,299, PUB. 7-10-2007. INT. CL. 3.
- CASTROL LIMITED, SWINDON, WILTSHIRE SN3 1RE, ENGLAND:
2,403,362, CANC. INT. CL. 35.
- CAT TECH LLC, PASADENA, TX:
1,082,012, REN. 8-20-07. INT. CL. 37.
- CATALINA RESTAURANT GROUP, CARSBAD, CA:
3,298,656, INT. CL. 43.
- CATHOLIC HEALTH ASSOCIATION OF THE UNITED STATES, ST. LOUIS, MO:
2,403,049, CANC. INT. CL. 42.
- CATWALK TELEVISION NETWORK, ONTARIO, CA:
3,297,604, PUB. 7-10-2007. INT. CL. 41.
- CAVE SPRINGS, INC., WILMINGTON, DE:
3,300,201, INT. CL. 25.

CAVORT INTERNATIONAL, INC., VERNON, CA:
3,297,795, PUB. 7-10-2007. INT. CL. 25.

CBG BIOTECH, LTD. CO., NAPLES, FL:
3,299,147, INT. CL. 11.

CBG, INC., LAS VEGAS, NV:
2,133,292, REN. 8-23-07. INT. CL. 36.

CBS RADIO HOLDINGS, INC., NEW YORK, NY:
2,404,380, CANC. INT. CL. 38.

CBS RADIO INC., NEW YORK, NY:
2,404,053, CANC. INT. CL. 41.

CBS RADIO STATIONS INC., NEW YORK, NY, TAFT
BROADCASTING COMPANY, CINCINNATI, OH:
1,071,619, REN. 8-20-07. INT. CL. 38.

CCA GLOBAL PARTNERS, INC., EARTH CITY, MO:
3,300,175, INT. CL. 27.

CCA INDUSTRIES, INC., EAST RUTHERFORD, NJ:
3,297,859, PUB. 7-10-2007. INT. CL. 5.

CCC ACQUISITION CORPORATION, NEW YORK, NY:
2,404,460, CANC. INT. CL. 25.

CDF FIREFIGHTERS, SACRAMENTO, CA:
2,115,577, REN. 8-21-07. INT. CL. 25.
2,156,060, REN. 8-22-07. MULTIPLE CLASS, INT. CLS. 16
AND 42.

CDMDATA, INC., SCOTTSDALE, AZ:
3,299,939, INT. CL. 9.

CEDARS BANK, LOS ANGELES, CA:
2,015,164, CANC. INT. CL. 36.

CEES AKKERMANS, NETHERLANDS:
3,298,258, PUB. 7-10-2007. INT. CL. 25.

CELEBRATIONS MANAGEMENT, INC., HIGHLAND VIL-
LAGE, TX:
3,298,768, INT. CL. 43.

CELEBRITY PLAYERS TOUR, RALEIGH, NC:
2,403,524, CANC. INT. CL. 41.

CELESTIAL SEASONINGS, INC., BOULDER, CO:
2,404,015, CANC. INT. CL. 30.

CELGENE CORPORATION, SUMMIT, NJ:
3,260,232, CANC. IIRN. RESTORED TO S.N. 78-762,175.
3,298,069, PUB. 7-10-2007. MULTIPLE CLASS, INT. CLS.
39 AND 44.

CELIA, VILLANUEVA, HOUSTON, TX:
3,298,788, INT. CL. 33.

CELL DESIGN LLC, SMYRNA, GA:
3,296,908, PUB. 7-10-2007. MULTIPLE CLASS, INT. CLS.
42 AND 44.

CELL TECH INTERNATIONAL INC., KLAMATH FALLS,
OR:
3,296,035, PUB. 7-10-2007. INT. CL. 5.

CELL US TRADEMARK LTD., MISSISSAUGA, ONTARIO,
CANADA:
3,298,894, INT. CL. 5.

CELLCO PARTNERSHIP, BASKING RIDGE, NJ, DBA
VERIZON WIRELESS:
3,299,829, MULTIPLE CLASS, INT. CLS. 38 AND 41.

CEMAPHORE SYSTEMS, INC., SAN MATEO, CA:
3,299,560, INT. CL. 9.
3,299,561, INT. CL. 9.

CENEGRA HEALTH SYSTEM, MCHENRY, IL:
2,016,354, CANC. INT. CL. 42.

CENTER FOR APPLIED RESEARCH, INC., ARLINGTON
HEIGHTS, IL:
2,125,448, REN. 8-23-07. MULTIPLE CLASS, INT. CLS. 16
AND 41.

CENTER FOR ASSOCIATION LEADERSHIP, THE, WA-
SHINGTON, DC:
2,404,002, CANC. INT. CL. 35.

CENTER FOR PUBLIC SAFETY EXCELLENCE, INC.,
CHANTILLY, VA:
3,297,382, PUB. 7-10-2007. INT. CL. 42.

CENTER FOR YOUTH AS RESOURCES, WASHINGTON,
DC:
2,403,280, CANC. INT. CL. 42.

CENTER OF THE WORLD, INC., FELICITY, CA:
2,084,201, REN. 8-23-07. INT. CL. 39.

CENTRADE INC., TORONTO, ONTARIO, CANADA:
3,296,685, PUB. 7-10-2007. INT. CL. 21.

CENTRAL FLORIDA INVESTMENTS, INC., ORLANDO, FL:
3,298,561, INT. CL. 16.

CENTURIA CORPORATION, STERLING, VA:
3,296,219, PUB. 7-10-2007. INT. CL. 9.

CENTURY PRODUCTS COMPANY, MACEDONIA, OH:
1,416,669, CANC. INT. CL. 20.

CEREXAGRI, PLAISIR, FRANCE:
3,297,304, PUB. 7-10-2007. MULTIPLE CLASS, INT. CLS. 1
AND 5.

CERTAINTED CORPORATION, VALLEY FORGE, PA:
3,297,151, PUB. 7-10-2007. INT. CL. 19.

CERTES FINANCIAL PROS, ST. LOUIS PARK, MN:
3,296,695, PUB. 7-10-2007. INT. CL. 35.

CERTIFIED EROSION CONTROL, LLC, GRAFTON, OH:
3,298,924, INT. CL. 37.

CERTIFIED GROCERS OF CALIFORNIA, LTD., LOS AN-
GELES, CA:
1,067,042, CANC. INT. CL. 5.

CERTIPAY AMERICA, LLC, AUBURNDALE, FL:
3,297,392, PUB. 7-10-2007. MULTIPLE CLASS, INT. CLS. 9
AND 35.

CERVECERIA INDIA, INC., MAYAGUEZ, PUERTO RICO:
2,083,740, REN. 8-20-07. INT. CL. 32.

CERYX INC., TORONTO, ONTARIO, CANADA:
3,297,212, PUB. 7-10-2007. MULTIPLE CLASS, INT. CLS.
39 AND 42.

CESSNA AIRCRAFT COMPANY, WICHITA, KS:
3,299,197, INT. CL. 36.

CETALUS LLC, BURLINGTON, MA:
3,296,642, PUB. 7-10-2007. MULTIPLE CLASS, INT. CLS.
35 AND 45.

CFCU FINANCIAL SERVICES, INC., ITHACA, NY:
2,125,047, REN. 8-21-07. MULTIPLE CLASS, INT. CLS. 36
AND 39.

CFOED, L.L.C., ALPHARETTA, GA, DBA SMART SA-
MANTHA:
3,300,105, INT. CL. 35.

CFOED, L.L.C., ALPHARETTA, GA, DBA SMART SA-
MANTHA:
3,299,994, INT. CL. 41.

CGC INC., TORONTO, ONTARIO, CANADA:
2,078,265, REN. 8-17-07. INT. CL. 19.

CGI TECHNOLOGIES AND SOLUTIONS INC., FAIRFAX,
VA:
2,404,370, CANC. INT. CL. 9.

CHÂTEAU DE COGNAC S.A., SOCIÉTÉ ANONYME,
FRANCE:
3,298,328, PUB. 7-10-2007. INT. CL. 33.

CHACONIE, OOHLALA, N. HOLLYWOOD, CA:
3,296,183, PUB. 7-10-2007. MULTIPLE CLASS, INT. CLS. 9
AND 41.

CHAIM LOWENSTEIN, JACKSONVILLE, FL:
3,296,429, PUB. 7-10-2007. INT. CL. 9.

CHAKRAVORTY, SUDEEP GOPAL, WEXFORD, PA:
3,298,710, INT. CL. 36.

CHALLENGE MACHINERY COMPANY, THE, NORTON
SHORES, MI:
438,846, REN. 8-20-07. U.S. CL. 23 (INT. CLS. 6, 7, 8, 9, 11,
12, 16, 21 AND 28).

CHALLENGER PARTNERS, LTD., MENTOR, OH:
3,297,231, PUB. 7-10-2007. INT. CL. 12.

CHAMMAH, EZRA, NEW YORK, NY:
2,404,120, CANC. MULTIPLE CLASS, INT. CLS. 35, 41
AND 42.

CHAMPION HEALTH ASSOCIATES, LLC, COLORADO
SPRINGS, CO:
2,080,943, REN. 8-17-07. INT. CL. 42.

CHAMPION INTERNATIONAL CORPORATION, STAM-
FORD, CT:
2,404,504, CANC. INT. CL. 42.

CHAMPION SOLUTIONS GROUP, INC., BOCA RATON, FL:
3,296,250, PUB. 7-10-2007. INT. CL. 42.

CHAMPIONS ON THE WIND, LLC, COLOMA, MI:
3,298,543, INT. CL. 35.

CHAMPS ELYSEES, INC., NASHVILLE, TN:
1,451,959, REN. 8-23-07. INT. CL. 9.

CHANCE ENTERPRISES, L.L.C., HOLDEN, UT:
3,297,970, PUB. 7-10-2007. MULTIPLE CLASS, INT. CLS.
8, 20 AND 21.

- CHANG, STEVE P. LA JOLLA, CA, DBA TEEBOX MARKET-
ING SOLUTIONS:
3,299,879, INT. CL. 41.
- CHANNEL DISTRIBUTION, LAKE FOREST, CA:
3,300,363, INT. CL. 21.
- CHAPARRAL STEEL INVESTMENTS, INC., MIDLOTHIAN,
TX:
1,478,275, REN. 8-23-07, INT. CL. 6.
- CHARCOAL MASTER INTERNATIONAL INC., CITY OF
INDUSTRY, CA:
2,403,818, CANC. INT. CL. 11.
- CHARLES H. SIMPSON III, D.D.S, P.A., APEX, NC:
3,299,175, INT. CL. 44.
- CHARLES HORN, WEATHERFORD, TX:
3,296,537, PUB. 6-26-2007, INT. CL. 36.
- CHARLES SCHWAB & CO., INC., SAN FRANCISCO, CA:
2,404,669, CANC. INT. CL. 36.
- CHARLES, STANLEY W., BALTIMORE, MD:
3,299,059, INT. CL. 16.
- CHARTER OAK GROUP, LTD., VIENNA, VA:
2,015,647, CANC. INT. CL. 36.
- CHARTER OAK GROUP, LTD., VIENNA, VA TO TANGER
PROPERTIES LIMITED PARTNERSHIP, GREENSBORO,
NC:
2,015,648, CANC. INT. CL. 36.
- CHASE INTERNATIONAL, SONOMA, CA:
2,404,440, CANC. MULTIPLE CLASS, INT. CLS. 20 AND
28.
- CHATAM INTERNATIONAL INCORPORATED, WILMING-
TON, DE, CHARLES JACQUIN ET CIE., INC., PHILA-
DELPHIA, PA:
1,071,921, REN. 8-20-07, INT. CL. 33.
- CHATT, HOWARD, N LAS VEGAS, NV, DBA PIGNOSE
INDUSTRIES:
2,131,788, REN. 8-17-07, INT. CL. 9.
- CHAU, JIMMY, COVINA, CA:
3,299,848, INT. CL. 28.
- CHAUDHURI, RATAN K., LINCOLN PARK, NJ:
3,296,256, PUB. 7-10-2007, INT. CL. 1.
- CHECK PAYMENT SYSTEMS ASSOCIATION, INC., WA-
SHINGTON, DC:
2,079,684, REN. 8-22-07, U.S. CL. A.
- CHECKFREE SERVICES, INC., NORCROSS, GA:
3,298,837, INT. CL. 36.
- CHECKPOINT SYSTEMS, INC., THOROFARE, NJ:
3,298,469, INT. CL. 9.
- CHECKSON DIE CASTING & PRODUCT FACTORY LTD.,
SHATIN, HONG KONG:
3,299,892, INT. CL. 11.
- CHEEBURGER CHEEBURGER RESTAURANTS, INC.,
FORT MYERS, FL:
3,297,807, PUB. 7-10-2007, INT. CL. 32.
- CHEF REVIVAL U.S.A., INC., LODI, NJ:
2,165,713, REN. 8-20-07, INT. CL. 25.
- CHEMICAL SPECIALTIES MANUFACTURING CORPORA-
TION, BALTIMORE, MD:
1,445,734, REN. 8-18-07, INT. CL. 3.
- CHEMISCHE FABRIK BUDENHEIM KG, D-55257 BUDEN-
HEIM, FED REP GERMANY:
3,025,160, COR. MULTIPLE CLASS, INT. CLS. 1, 5, 30
AND 31.
- CHERRY POCKET FISH CAMP, LAKE WALES, FL:
3,296,954, PUB. 7-10-2007, INT. CL. 36.
- CHERRY, JENNIFER J., SAINT LOUIS, MO:
3,299,497, INT. CL. 5.
- CHESAPEAKE LOGISTICS LLC, ARNOLD, MD:
2,403,997, CANC. INT. CL. 36.
- CHEVRON INTELLECTUAL PROPERTY LLC, SAN RA-
MON, CA:
3,296,829, PUB. 7-10-2007, INT. CL. 1.
- CHEVRON PHILLIPS CHEMICAL COMPANY LP, THE
WOODLANDS, TX:
2,082,703, REN. 8-17-07, INT. CL. 17.
- CHEVRON U.S.A. INC., SAN RAMON, CA:
3,299,575, INT. CL. 4.
- CHEW ON THIS DOG BARKERY, INC., FRANKFORT, IL:
3,299,226, INT. CL. 35.
- CHI'S ENTERPRISE, INC., ANAHEIM, CA:
3,296,214, PUB. 7-10-2007, INT. CL. 5.
3,296,215, PUB. 7-10-2007, INT. CL. 5.
- CHICAGO SUN-TIMES LLC, CHICAGO, IL:
3,299,802, INT. CL. 41.
- CHIEF AUTOMOTIVE SYSTEMS, INC., GRAND ISLAND,
NE:
2,015,109, CANC. MULTIPLE CLASS, INT. CLS. 7 AND 9.
- CHILD PROTECTION EDUCATION OF AMERICA, INC.,
TAMPA, FL:
3,296,467, PUB. 7-10-2007, INT. CL. 36.
- CHILDNET MEDICAL ASSOCIATES, INC., FRESNO, CA:
2,403,190, CANC. INT. CL. 42.
- CHILDREN'S MUSEUM OF RICHMOND, RICHMOND, VA:
2,404,127, CANC. INT. CL. 41.
- CHILDREN'S MADE HORSES, INC., SAN ANTONIO, TX:
2,404,655, CANC. INT. CL. 41.
- CHILDRESS VINEYARDS, LLC, WELCOME, NC:
3,298,749, INT. CL. 14.
- CHINA FINE WINES, LLC, SAN FRANCISCO, CA:
3,300,104, INT. CL. 33.
- CHINA MINSHENG BANKING CORP., LTD., BEIJING, P.R.,
CHINA:
3,298,017, PUB. 7-10-2007, INT. CL. 36.
- CHINA NATIONAL CEREALS, OILS & FOODSTUFFS IM-
PORT & EXPORT CORPORATION, BEIJING 100005,
CHINA:
3,298,158, PUB. 7-10-2007, MULTIPLE CLASS, INT. CLS.
29, 30, 31, 32, 33 AND 36.
- CHINA NATIONAL CEREALS, OILS AND FOODSTUFFS
IMPORT AND EXPORT CORPORATION, BEIJING 100005,
CHINA:
1,286,155, REN. 8-21-07, MULTIPLE CLASS, INT. CLS. 29,
30, 32 AND 33.
- CHINA NATIONAL LIGHT INDUSTRIAL PRODUCTS IM-
PORT & EXPORT CORP., HEILONGJIANG BRANCH,
HARBIN, CHINA:
1,416,687, CANC. INT. CL. 21.
- CHINA WIDE GROUP HOLDINGS LIMITED, TSIMSHAT-
SUI, HONG KONG:
3,298,136, PUB. 7-10-2007, INT. CL. 9.
- CHING CHING CHA L.L.C, WASHINGTON, DC:
2,404,261, CANC. INT. CL. 42.
- CHIPKIN, LAWRENCE I, PATTERSON, NY:
3,296,588, PUB. 7-10-2007, INT. CL. 31.
- CHIPMAN UNION, INC., NEW YORK, NY:
1,416,746, CANC. INT. CL. 25.
- CHIPURNOI INCORPORATED, SHARON, CT:
1,449,945, REN. 8-17-07, INT. CL. 30.
- CHITTENDEN TRUST COMPANY, BURLINGTON, VT:
3,297,358, PUB. 7-10-2007, INT. CL. 36.
- CHO, SU B., LA HABRA, CA:
3,296,032, PUB. 7-10-2007, INT. CL. 25.
- CHOCOLADEFABRIKEN LINDT & SPRUNGLI AG, KILCH-
BERG, SWITZERLAND:
2,404,328, CANC. INT. CL. 16.
- CHOCOLADEFABRIKEN LINDT & SPRUNGLI AG, CH-
8802 KILCHBERG, SWITZERLAND:
3,298,571, INT. CL. 30.
- CHOCOLATERIE STAM USA, INC., DES MOINES, IA:
3,296,748, PUB. 7-10-2007, INT. CL. 30.
- CHOO CHOO IMPORTS, LLC, PORTLAND, OR:
3,296,106, PUB. 7-10-2007, INT. CL. 31.
- CHOPRA ENTERPRISES, LLC, CARLSBAD, CA:
3,299,675, INT. CL. 44.
3,299,676, INT. CL. 44.
- CHOPRA, RAJ K., WESTBURY, NY:
3,300,053, INT. CL. 5.
- CHOU, POHSIU, ANAHEIM HILLS, CA:
3,296,556, PUB. 7-10-2007, INT. CL. 9.
- CHOWDHURY, SUBIR, BLOOMFIELD HILLS, MI:
3,299,534, INT. CL. 35.
- CHRISSEY'S SWEET TREATS CO., DELRAY BEACH, FL:
3,297,892, PUB. 7-10-2007, INT. CL. 30.
- CHRISTENSON TRANSPORTATION, STRAFFORD, MO:
3,299,108, INT. CL. 39.

- CHRISTIAN RELIEF SERVICES CHARITIES, INC., ALEXANDRIA, VA, RUNNING STRONG FOR AMERICAN INDIAN YOUTH, INC., LORTON, VA:
2,101,134. REN. 8-20-07. MULTIPLE CLASS, INT. CLS. 36 AND 42.
- CHRISTIE MANSON & WOODS LTD., LONDON, UNITED KINGDOM:
3,298,107, PUB. 7-10-2007. INT. CL. 16.
- CHRISTOPHER LUKE RIZIK, NORTHVILLE, MI:
3,296,727, PUB. 7-10-2007. INT. CL. 41.
- CHRISTOPHER V. PERRY FAMILY LIMITED PARTNERSHIP, HOUSTON, TX:
3,297,274, PUB. 7-10-2007. INT. CL. 43.
- CHUAH, KHAI GAN, AUSTIN, TX:
3,296,818, PUB. 7-10-2007. INT. CL. 12.
- CHUMBLEY, JAMES F., SEATTLE, WA:
3,297,418, PUB. 7-10-2007. INT. CL. 22.
- CHUMBLEY, JAMES F., EDMONDS, WA:
3,297,419, PUB. 7-10-2007. INT. CL. 22.
- CHUNGBUKSOJU CO., LTD., CHUNGHEONGBUK-DO, REPUBLIC OF KOREA:
3,298,109, PUB. 7-10-2007. INT. CL. 33.
- CHURCH & DWIGHT CO., INC., PRINCETON, NJ, CARTER-WALLACE, INC., NEW YORK, NY:
2,075,718. REN. 8-18-07. INT. CL. 3.
- CHURCH & DWIGHT COMPANY, GREEN RIVER, WY:
3,298,606, INT. CL. 7.
3,300,205, INT. CL. 7.
- CHURCH OF ACTS, INC., INDIANAPOLIS, IN:
2,141,632. REN. 8-23-07. INT. CL. 41.
- CHURCH OF GOD, CLEVELAND, TN:
2,403,114, CANC. INT. CL. 42.
- CH2M HILL, INC., ENGLEWOOD, CO:
3,298,947, INT. CL. 38.
- CIBA VISION CORPORATION, DULUTH, GA, CIBA-GEIGY CORPORATION, ARDSLEY, NY, DBA CIBA VISION CORPORATION:
2,095,450. REN. 8-20-07. INT. CL. 5.
- CIBA-GEIGY CORPORATION, ARDSLEY, NY TO CIBA SPECIALITY CHEMICALS CORPORATION, TARRY-TOWN, NY:
2,016,082, CANC. INT. CL. 1.
- CIGNA INTELLECTUAL PROPERTY, INC., CLAYMONT, DE:
3,300,368, INT. CL. 44.
- CILANTRO TRADING INTERNATIONAL, LTD., KETTERING, OH:
3,296,555, PUB. 7-10-2007. INT. CL. 30.
- CIMEX MEDICAL INNOVATIONS, L.C., COVINGTON, LA:
3,299,168, INT. CL. 10.
- CIMOROSE, RONALD S., ELKTON, MD:
3,259,747, CANC. IIRN. RESTORED TO S.N. 76-641,454.
- CINCINNATI BENGALS, INC., CINCINNATI, OH:
1,071,979. REN. 8-17-07. INT. CL. 41.
- CINCINNATI SUB-ZERO PRODUCTS, INC., CINCINNATI, OH:
3,298,521, INT. CL. 10.
- CINEMASTAR LUXURY THEATERS, INC., OCEANSIDE, CA:
3,297,563, PUB. 7-10-2007. INT. CL. 41.
- CINNABON, INC., ATLANTA, GA:
2,098,432. REN. 8-23-07. INT. CL. 30.
- CINNAMON MCCANN, WASHINGTON, DC:
3,297,057, PUB. 7-10-2007. INT. CL. 36.
- CINTEK SYSTEM, INC., GARDENA, CA:
3,296,081, PUB. 7-10-2007. INT. CL. 19.
- CIRCLE GROUP INTERNET INC, MUNDELEIN, IL:
2,403,589, CANC. INT. CL. 36.
- CISCO TECHNOLOGY, INC., SAN JOSE, CA, AIRONET WIRELESS COMMUNICATIONS, INC., AKRON, OH:
2,034,090. REN. 8-22-07. INT. CL. 9.
- CITIZEN SCHOOLS, INC., BOSTON, MA:
2,081,038. REN. 8-17-07. INT. CL. 41.
- CITIZENS FINANCIAL GROUP, INC., PROVIDENCE, RI:
3,296,957, PUB. 7-10-2007. INT. CL. 36.
- CITIZENS TRUST MORTGAGE CORPORATION, MAITLAND, FL:
3,300,087, INT. CL. 36.
- CITY DIRECTORY, INC., BELMONT, IA:
2,062,781. REN. 8-23-07. INT. CL. 35.
- CITY OF GAINESVILLE, FLORIDA, GAINESVILLE, FL, DBA GAINESVILLE REGIONAL UTILITIES:
3,298,975, INT. CL. 42.
- CITY OF LOS ANGELES, LOS ANGELES, CA:
3,298,866, MULTIPLE CLASS, INT. CLS. 25 AND 41.
- CITY OF NORFOLK, VIRGINIA, NORFOLK, VA, NATIONAL MARITIME CENTER, THE, NORFOLK, VA:
2,124,601. REN. 8-17-07. INT. CL. 25.
- CITY OF PHILADELPHIA, DIVISION OF AVIATION, PHILADELPHIA, PA:
2,015,042, CANC. INT. CL. 39.
- CLAD HOLDINGS CORP., CORAOPOLIS, PA, ALL-CLAD METALCRAFTERS INC., CANONSBURG, PA:
2,079,278. REN. 8-17-07. INT. CL. 21.
- CLAIMS RESOURCE MANAGEMENT, INC., ACTON, CA:
2,084,468. REN. 8-17-07. INT. CL. 36.
- CLARIANT AG, SWITZERLAND:
3,298,161, PUB. 7-10-2007. MULTIPLE CLASS, INT. CLS. 35 AND 38.
3,298,249, PUB. 7-10-2007. MULTIPLE CLASS, INT. CLS. 1 AND 3.
3,298,288, PUB. 7-10-2007. INT. CL. 1.
- CLARIFI, INC., YONKERS, NY:
3,297,265, PUB. 7-10-2007. MULTIPLE CLASS, INT. CLS. 9 AND 41.
- CLARITI EYEWEAR, INC., SANTA FE SPRINGS, CA:
3,300,237, INT. CL. 9.
- CLARK & ASSOCIATES, INC., SANTA FE SPRINGS, CA:
3,299,583, INT. CL. 8.
- CLARK BRANDS LLC, HIGHLAND PARK, IL:
2,404,450, CANC. INT. CL. 42.
- CLARK, CHARLES K., HARLINGEN, TX:
3,297,915, PUB. 7-10-2007. INT. CL. 41.
- CLARK, HARVEY P., BOYLSTON, MA:
3,299,938, INT. CL. 30.
- CLARK, JAMES, CEDAR LAKE, IN:
3,297,269, PUB. 7-10-2007. INT. CL. 9.
- CLARK, JOHN G., PROVIDENCE, RI, DBA CLARK'S REGISTER:
2,015,742, CANC. INT. CL. 42.
- CLASS ACT CREDIT UNION, LOUISVILLE, KY:
3,298,105, PUB. 7-10-2007. INT. CL. 36.
- CLASS ACT FEDERAL CREDIT UNION, LOUISVILLE, KY:
3,298,099, PUB. 7-10-2007. INT. CL. 36.
- CLASSIC EAGLE DISTRIBUTING, LLC, LAWRENCE, KS:
2,403,387, CANC. INT. CL. 35.
- CLAYS FOR KIDS FOUNDATION, LOVELAND, CO:
2,082,642. REN. 8-17-07. INT. CL. 41.
- CLEAN AIR LAWN CARE, INC., FORT COLLINS, CO:
3,300,379, INT. CL. 44.
- CLEAN PLATE CLUB, LLC, EVANSTON, IL:
3,296,719, PUB. 7-10-2007. INT. CL. 43.
- CLEANERS.TV, INC., TOMS RIVER, NJ:
3,298,582, INT. CL. 21.
- CLEAR CHANNEL BROADCASTING, INC., SAN ANTONIO, TX, CLEAR CHANNEL RADIO, INC., SAN ANTONIO, TX:
2,085,272. REN. 8-20-07. INT. CL. 38.
- CLEAR CHANNEL BROADCASTING, INC., SAN ANTONIO, TX:
3,299,970, INT. CL. 35.
- CLEAR!BLUE HOLDINGS, LLC, BIRMINGHAM, MI:
3,297,926, PUB. 7-10-2007. INT. CL. 35.
- CLEARCALM INC., CALGARY, ALBERTA, CANADA:
3,297,225, PUB. 7-10-2007. INT. CL. 9.
- CLEARWAY MINNESOTA, MINNEAPOLIS, MN:
3,296,850, PUB. 7-10-2007. INT. CL. 35.
- CLEVELAND TODAY, CLEVELAND, OH:
2,403,767, CANC. INT. CL. 35.
- CLIFF'S FIRE EXTINGUISHER CO., INC., WOODSTOCK, GA:
2,106,985. REN. 8-20-07. MULTIPLE CLASS, INT. CLS. 35 AND 37.
- CLIFFORD J. RUDDLE, D.D.S., A.P.C., SANTA BARBARA, CA:
3,299,231, INT. CL. 10.

- CLIFFTON D. MAY, BEAVER DAM, WI:
3,296,263, PUB. 7-10-2007. INT. CL. 44.
- CLOCKWORK HOME SERVICES, INC., SARASOTA, FL:
3,296,307, PUB. 7-10-2007. INT. CL. 37.
- CLOONAN PETER J, MONONA, WI, DBA COMPUTER REPAIR PROS:
3,296,861, PUB. 7-10-2007. INT. CL. 9.
- CLOPAY BUILDING PRODUCTS R&D COMPANY, INC., MASON, OH, DBA CLOPAY BUILDING PRODUCTS COMPANY, INC.:
3,297,470, PUB. 7-10-2007. MULTIPLE CLASS, INT. CLS. 17 AND 19.
- CLORE AUTOMOTIVE LLC, LEXENA, KS:
3,298,646, INT. CL. 9.
- CLUB STAFFING, INC., BOCA RATON, FL:
3,299,815, INT. CL. 35.
- CLYDE BERGEMANN DELTA DUCON, INC., MALVERN, PA:
2,113,811. REN. 8-23-07. INT. CL. 6.
- CNA FINANCIAL CORPORATION, CHICAGO, IL:
2,403,394, CANC. INT. CL. 36.
- CNA NATIONAL WARRANTY CORPORATION, SCOTTS-DALE, AZ:
3,297,953, PUB. 7-10-2007. INT. CL. 36.
- CNC PRO LLC, CARROLLTON, TX:
3,300,139, INT. CL. 40.
- CO-ENZYME TECHNOLOGY LIMITED, SAN DIEGO, CA:
2,403,136, CANC. INT. CL. 5.
- COACH'S EDGE, INC., THE, LAWRENCE, KS:
2,403,696, CANC. INT. CL. 41.
- COAST NOVELTY MANUFACTURING CO., VENICE, CA:
2,404,111, CANC. INT. CL. 1.
- COASTAL CORPORATION, THE, HOUSTON, TX:
2,404,851, CANC. INT. CL. 32.
- COASTAL PET PRODUCTS, INC., ALLIANCE, OH:
3,300,098, INT. CL. 18.
- COATS CANADA INC., TORONTO, CANADA:
1,416,701, CANC. INT. CL. 23.
- COBALT GROUP, INC., THE, SEATTLE, WA:
2,403,371, CANC. INT. CL. 42.
- COBBLESTONE CONSULTING, INC., ATLANTA, GA:
3,296,546, PUB. 7-10-2007. INT. CL. 35.
- COBRA ELECTRONICS CORPORATION, CHICAGO, IL:
2,169,170. REN. 8-17-07. INT. CL. 9.
- COCA-COLA COMPANY, THE, ATLANTA, GA:
2,080,292. REN. 8-18-07. MULTIPLE CLASS, INT. CLS. 16 AND 41.
3,299,669, INT. CL. 32.
- COCO-COLA COMPANY, THE, ATLANTA, GA:
1,445,037. REN. 8-18-07. INT. CL. 11.
- CODA COFFEE COMPANY, DENVER, CO:
3,296,492, PUB. 7-10-2007. INT. CL. 30.
- CODRINGTON, BYRON, FRISCO, TX:
3,300,044, INT. CL. 25.
- COFFMAN, SUE, DALLAS, TX, DBA WORDS WORTH, LTD.:
2,404,560, CANC. MULTIPLE CLASS, INT. CLS. 41 AND 42.
- COGSDILL TOOL PRODUCTS, INC., LUGOFF, SC:
3,300,366, INT. CL. 40.
- COLART INTERNATIONAL, 72000 LE MANS, FRANCE:
3,297,219, PUB. 7-10-2007. INT. CL. 2.
- COLEMAN FAMILY PROPERTIES, NEW ORLEANS, LA:
1,417,021, CANC. INT. CL. 42.
1,417,022, CANC. INT. CL. 42.
- COLEMAN, CHRISSENA A., HACKENSACK, NJ:
3,297,188, PUB. 4-11-2006. INT. CL. 35.
- COLGATE-PALMOLIVE COMPANY, NEW YORK, NY:
2,404,239, CANC. INT. CL. 3.
2,404,240, CANC. INT. CL. 3.
2,404,241, CANC. INT. CL. 3.
3,298,763, INT. CL. 3.
3,298,816, INT. CL. 3.
3,299,857, INT. CL. 3.
3,299,858, INT. CL. 3.
- COLLECTIVE LICENSING INTERNATIONAL, LLC, ENGLEWOOD, CO:
1,450,940. REN. 8-18-07. INT. CL. 25.
- COLLEGE ENTRANCE EXAMINATION BOARD, NEW YORK, NY:
1,071,427. REN. 8-20-07. INT. CL. 16.
- COLOM, DAMIAN SEGUI, 07193 PALMA DE MALLORCA (BALEARES), SPAIN:
2,403,352, CANC. MULTIPLE CLASS, INT. CLS. 41 AND 42.
- COLONIAL MIRROR & GLASS CORPORATION, BROOKLYN, NY:
3,297,825, PUB. 7-10-2007. INT. CL. 19.
3,297,827, PUB. 7-10-2007. INT. CL. 11.
3,297,828, PUB. 7-10-2007. INT. CL. 19.
3,297,831, PUB. 7-10-2007. INT. CL. 21.
- COLOSSUS MEDIA CORPORATION, BRIDGETOWN, BARBADOS:
3,296,654, PUB. 7-10-2007. INT. CL. 41.
- COLTENBACK, JEFFREY H., BLOOMFELD, NJ:
3,300,309, INT. CL. 35.
- COLTEX B.V., NETHERLANDS:
3,298,302, PUB. 7-10-2007. MULTIPLE CLASS, INT. CLS. 18, 25 AND 35.
- COLUMBIA COLLEGE, COLUMBIA, MO:
3,296,538, PUB. 7-10-2007. INT. CL. 41.
- COLUMBIA FALLS ALUMINUM COMPANY, COLUMBIA FALLS, MT:
1,447,113. REN. 8-20-07. INT. CL. 6.
- COLUMBIA FOREST PRODUCTS, INC., PORTLAND, OR:
3,299,419, INT. CL. 35.
- COLUMBIA NEUROSURGICAL ASSOCIATES, L.L.C., PORTLAND, OR:
3,297,616, PUB. 7-10-2007. INT. CL. 44.
- COMAU SPA, I-10095 GRUGLIASCO, TORINO, ITALY:
3,298,277, PUB. 7-10-2007. MULTIPLE CLASS, INT. CLS. 7 AND 9.
- COMCAST SPORTSNET PHILADELPHIA, L.P., PHILADELPHIA, PA:
3,297,672, PUB. 7-10-2007. INT. CL. 41.
- COME ON MUSIC CORP., OSAKA, 532, JAPAN:
2,404,946, CANC. INT. CL. 9.
- COMEBACK BREWING, INC., SAN ANTONIO, TX, BRIDGEPORT BREWING COMPANY, BEAVERTON, OR:
2,085,138. REN. 8-22-07. INT. CL. 32.
- COMEDY CARAVAN, GLADWYNE, PA:
2,403,603, CANC. INT. CL. 41.
- COMET GMBH PYROTECHNIK - APPARATEBAU, 27574 BREMERHAVEN, FED REP GERMANY:
2,473,978, CANC. INT. CL. 9.
- COMMAND TOOLING SYSTEMS, LLC, RAMSEY, MN:
2,131,819. REN. 8-17-07. INT. CL. 7.
- COMMERCIAL NOMINEES PTY LIMITED, MELBOURNE VICTORIA 3000, AUSTRALIA:
2,403,160, CANC. MULTIPLE CLASS, INT. CLS. 9, 16, 35, 36 AND 38.
- COMMONWEALTH PLYWOOD, LTD., ST. THERESE QUEBEC, CANADA:
3,296,334, PUB. 7-10-2007. INT. CL. 19.
- COMMSCOPE, INC. OF NORTH CAROLINA, HICKORY, NC:
3,299,977, INT. CL. 9.
- COMMUNICATIONS DESIGN GROUP, INC., STAMFORD, CT:
2,403,915, CANC. INT. CL. 16.
- COMMUNITY BANK OF THE BAY, OAKLAND, CA:
3,300,252, INT. CL. 36.
3,300,259, INT. CL. 36.
- COMMUNITY CONNECT INC., NEW YORK, NY:
3,297,125, PUB. 7-10-2007. INT. CL. 45.
3,297,126, PUB. 7-10-2007. INT. CL. 45.
3,297,127, PUB. 7-10-2007. INT. CL. 45.
- COMMUNITY VOICE MAIL NATIONAL OFFICE, SEATTLE, WA:
3,297,296, PUB. 7-10-2007. INT. CL. 38.
3,297,300, PUB. 7-10-2007. INT. CL. 38.
- COMP.NATION COMPUTER SUPPLY, LLC, BRENTWOOD, TN:
3,299,479, INT. CL. 35.

- COMPAGNIA ITALIANA DELLA FRUTTA S.P.A., 48020 RAVENNA, ITALY:
3,297,877, PUB. 7-10-2007. INT. CL. 31.
- COMPAGNIE DES GRANDS VINS DU JURA (SARL), LONS LE SAUNIER, FRANCE:
1,452,434, REN. 8-20-07. INT. CL. 33.
- COMPANIA DE PRODUCTOS, ALIMENTOS Y SERVICIOS CORPORA S.A., SANTIAGO, CHILE:
2,034,980, REN. 8-20-07. INT. CL. 32.
- COMPASS BANCSHARES, INC., BIRMINGHAM, AL:
3,298,974, MULTIPLE CLASS, INT. CLS. 36 AND 45.
- COMPASS GROUP USA, INC., CHARLOTTE, NC:
3,298,729, INT. CL. 30.
- COMPETELINK, INC., FAIRFAX, VA:
2,404,598, CANC. INT. CL. 35.
2,404,599, CANC. INT. CL. 35.
- COMPETITIVE ADVANTAGE, INC., EDDYSTONE, PA:
2,404,228, CANC. INT. CL. 41.
- COMPLUS DATA INNOVATIONS, INC., TARRYTOWN, NY:
3,299,322, INT. CL. 42.
- COMPONENT EQUIPMENT CO., INC., CAMARILLO, CA, DBA CECO:
2,115,980, REN. 8-23-07. INT. CL. 9.
- COMPONENTS PLUS, LLC, HARTLAND, WI:
3,299,306, INT. CL. 7.
- COMPOSED LIFE SERVICES, PLLC, DURHAM, NC:
3,296,513, PUB. 7-10-2007. INT. CL. 41.
- COMPTEL, WASHINGTON, DC:
3,297,674, PUB. 7-10-2007. INT. CL. 35.
- COMPTOIR NOUVEAU DE LA PARFUMERIE, PARIS, FRANCE:
1,452,779, REN. 8-18-07. INT. CL. 3.
- COMPUCREDIT INTELLECTUAL PROPERTY HOLDINGS CORP. II, LAS VEGAS, NV:
3,299,912, INT. CL. 36.
- COMPUPAY, INC., MIRAMAR, FL:
3,299,265, MULTIPLE CLASS, INT. CLS. 35 AND 36.
- COMPUSERVE INCORPORATED, COLUMBUS, OH TO AOL LLC, DULLES, VA:
2,015,034, CANC. INT. CL. 38.
- COMPUTER PERFORMANCE INC., SANTA CLARA, CA:
2,014,856, CANC. MULTIPLE CLASS, INT. CLS. 9, 37 AND 42.
- COMPUTER PLUG INC., NORTH YORK, ONTARIO, CANADA:
1,451,827, REN. 8-17-07. INT. CL. 9.
- COMPUTING SOLUTIONS LTD, DROITWICH WORCS WR9 8DN, ENGLAND:
2,161,298, REN. 8-20-07. INT. CL. 9.
- COMPUWAVE INC, GOLETA, CA:
2,014,989, CANC. INT. CL. 37.
- CONAGRA FOODS FOOD INGREDIENTS COMPANY, INC., OMAHA, NE:
3,298,608, INT. CL. 30.
- CONAGRA FOODS PACKAGED FOODS COMPANY, INC., OMAHA, NE:
2,404,083, CANC. INT. CL. 42.
2,404,084, CANC. INT. CL. 42.
- CONAIR CORPORATION, EDISON, NJ:
1,416,528, CANC. INT. CL. 11.
- CONAIR CORPORATION, STAMFORD, CT, FRANZUS COMPANY INC., BEACON FALLS, CT:
2,086,867, REN. 8-22-07. INT. CL. 9.
- CONAIR CORPORATION, STAMFORD, CT:
3,299,123, MULTIPLE CLASS, INT. CLS. 9 AND 11.
3,299,603, MULTIPLE CLASS, INT. CLS. 7 AND 11.
- CONCEPT INTERACTIVE INC., CAMBRIDGE, CANADA:
3,297,512, PUB. 7-10-2007. MULTIPLE CLASS, INT. CLS. 9 AND 42.
- CONCORDIA MANUFACTURING, LLC, COVENTRY, RI:
3,299,029, INT. CL. 10.
- CONDUX INTERNATIONAL, INC., MANKATO, MN:
2,120,990, REN. 8-22-07. MULTIPLE CLASS, INT. CLS. 7 AND 9.
- CONFRÉRIE DE LA CHAÎNE DES RÔTISSEURS, FRANCE:
3,298,236, PUB. 4-3-2007. MULTIPLE CLASS, INT. CLS. 16, 41 AND 43.
- CONNECT COMMUNICATIONS CORPORATION, LITTLE ROCK, AR:
2,403,844, CANC. INT. CL. 38.
- CONNECTICUT CENTER FOR ADVANCED TECHNOLOGY, INC., EAST HARTFORD, CT, CT:
3,296,384, PUB. 7-10-2007. MULTIPLE CLASS, INT. CLS. 35, 41 AND 42.
- CONOVER, DONALD L., ANNAPOLIS, MD:
3,299,492, INT. CL. 41.
- CONSERVATION SERVICES GROUP, INC., WESTBOROUGH, MA:
2,084,867, REN. 8-20-07. INT. CL. 37.
2,083,884, REN. 8-23-07. INT. CL. 7.
- CONSOLIDATED CARBIDE, LAKE HAVASU, AZ:
2,083,884, REN. 8-23-07. INT. CL. 7.
- CONSOLIDATED STORES CORPORATION, COLUMBUS, OH TO CONSOLIDATED PROPERTY HOLDINGS, INC., LAS VEGAS, NV:
2,016,240, CANC. MULTIPLE CLASS, INT. CLS. 17 AND 21.
- CONSORCIO DEL JAMÓN SERRANO ESPAÑOL, SPAIN:
3,298,201, PUB. 7-10-2007. MULTIPLE CLASS, INT. CLS. 29 AND 35.
- CONTEC, INC., SPARTANBURG, SC:
3,298,480, INT. CL. 16.
- CONTINENTAL COMMERCIAL PRODUCTS, LLC, BRIDGETON, MO:
1,465,180, REN. 8-22-07. MULTIPLE CLASS, INT. CLS. 8, 12, 20 AND 21.
- CONTINENTAL HEALTH PROMOTION, INC., RICHMOND, VA:
3,297,106, PUB. 7-10-2007. MULTIPLE CLASS, INT. CLS. 41 AND 44.
- CONTINENTAL PROMOTION GROUP, INC., TAMPA, FL:
3,296,053, PUB. 7-10-2007. INT. CL. 35.
- CONTOURE INT, INC., SARASOTA, FL:
3,299,414, INT. CL. 11.
- CONTRACT FREIGHTERS, INC., JOPLIN, MO:
3,298,706, MULTIPLE CLASS, INT. CLS. 35 AND 39.
- CONVERGYS INFORMATION MANAGEMENT GROUP INC., CINCINNATI, OH:
2,403,054, CANC. INT. CL. 41.
- CONVERSATION PIECES, INC., BALA CYNWYD, PA:
2,403,132, CANC. INT. CL. 28.
- CONVERTING, INC., CLINTONVILLE, WI:
3,299,737, INT. CL. 27.
- COOK INCORPORATED, BLOOMINGTON, IN:
1,451,996, REN. 8-17-07. INT. CL. 10.
2,404,834, CANC. INT. CL. 10.
- COOK, CAROLINE J, WILLIAMSPORT, OH AND COOK, DOUGLAS, WILLIAMSPORT, OH:
3,296,342, PUB. 7-10-2007. INT. CL. 36.
- COOKIE GIRL, LLC, MINDEN, NV:
3,299,261, INT. CL. 30.
- COOL GEEKS, INC., WESTPORT, MA:
3,296,853, PUB. 7-10-2007. INT. CL. 37.
- COOL SCHOOL INCENTIVES, INC., BECKER, MN:
3,299,933, INT. CL. 35.
- COOLEY GODWARD KRONISH LLP, PALO ALTO, CA:
2,403,493, CANC. INT. CL. 41.
- COOPER, AARON A., SAN MARCOS, TX:
3,296,477, PUB. 7-10-2007. INT. CL. 9.
- COOPERSURGICAL, INC., TRUMBULL, CT, FRIGITRONICS, INC., BRIDGEPORT, CT:
836,017, REN. 8-22-07. U.S. CL. 44 (INT. CL. 10).
- COORS GLOBAL PROPERTIES, INC., GOLDEN, CO:
3,297,189, PUB. 7-10-2007. INT. CL. 32.
- COPELAND, AL C., METAIRIE, LA:
3,300,324, INT. CL. 43.
- COPERION WAESCHLE GMBH & CO. KG, FED REP GERMANY:
3,298,170, PUB. 7-10-2007. INT. CL. 7.
- CORBITT CYPRESS SALES, INC., JASPER, FL:
1,416,864, CANC. INT. CL. 31.
- CORDER, BEVERLY, VAN NUYS, CA:
3,297,869, PUB. 7-10-2007. INT. CL. 25.
- CORDES, AMANDA M, LAS VEGAS, NV:
3,298,044, PUB. 7-10-2007. INT. CL. 28.

- CORDIS EUROPA N.V., RODEN, NETHERLANDS:
1,416,512, CANC. INT. CL. 10.
- CORE COMMUNITIES, LLC, PORT ST. LUCIE, FL:
3,297,178, PUB. 3-23-2004. MULTIPLE CLASS, INT. CLS.
36 AND 37.
- CORECOMM LIMITED, NEW YORK, NY:
2,404,005, CANC. INT. CL. 38.
- CORN PRODUCTS INTERNATIONAL, INC., WESTCHESTER, IL:
3,299,291, INT. CL. 1.
- CORNERSTONE ACQUISITION & MANAGEMENT COMPANY LLC, GREENWICH, CT:
3,296,499, PUB. 7-10-2007. INT. CL. 41.
- CORPORATE AND TRANSPORTATION SECURITY SOLUTIONS LLC, WESTPORT, CT:
3,297,944, PUB. 7-10-2007. MULTIPLE CLASS, INT. CLS.
42 AND 45.
- 3,297,945, PUB. 7-10-2007. MULTIPLE CLASS, INT. CLS.
42 AND 45.
- CORPORATE CONSULTING SOLUTIONS, INC., SARATOGA, CA:
2,403,217, CANC. INT. CL. 42.
- CORPORATE DINING, INC., CHAGRIN FALLS, OH:
3,296,675, PUB. 7-10-2007. INT. CL. 35.
- CORPORATE SCREENING SERVICES, INC., CLEVELAND, OH:
3,300,155, MULTIPLE CLASS, INT. CLS. 35 AND 45.
- CORPORATE SPORT, INC., FAIRFAX, VA:
3,296,681, PUB. 7-10-2007. INT. CL. 35.
- CORPORATION EPIDERMA INC., QUEBEC (QUEBEC), CANADA:
3,296,002, PUB. 7-10-2007. MULTIPLE CLASS, INT. CLS. 3
AND 44.
- CORPUS CHRISTI REGIONAL TRANSIT AUTHORITY, CORPUS CHRISTI, TX:
1,416,963, CANC. INT. CL. 39.
- CORSI, CONNIE, BROOKLYN, NY, DBA DI NOLA FOODS COMPANY:
1,421,293, REN. 8-17-07. INT. CL. 29.
- CORTEC CORPORATION, ST. PAUL, MN:
3,296,873, PUB. 7-10-2007. INT. CL. 17.
- CORY EVERSON FITNESS, INC., COLUMBUS, OH TO EVERSON, CORY L., ENCINO, CA:
2,016,382, CANC. INT. CL. 25.
- COSENTINO SIGNATURE WINERIES, YOUNTVILLE, CA:
3,297,322, PUB. 7-10-2007. INT. CL. 33.
- COSMA S.P.A., I-31045 MOTTA DI LIVENZA (TREVISO), ITALY:
3,298,248, PUB. 7-10-2007. MULTIPLE CLASS, INT. CLS. 3
AND 25.
- COSMETIC DERMATOLOGY, INC., MIAMI, FL:
3,299,544, INT. CL. 3.
- COSMETIC GROUP USA, INC., SUN VALLEY, CA:
1,416,337, CANC. INT. CL. 3.
- COSMETICA LABORATORIES INC., SCARBOROUGH, ONTARIO, CANADA:
2,404,573, CANC. INT. CL. 3.
- COSMOS CORPORATION, WENTZVILLE, MO:
3,297,654, PUB. 7-10-2007. INT. CL. 3.
3,297,655, PUB. 7-10-2007. INT. CL. 3.
- COST, PLANNING AND MANAGEMENT INTERNATIONAL, INC., DES MOINES, IA:
2,015,669, CANC. INT. CL. 37.
- COSTCO WHOLESALE CORPORATION, ISSAQUAH, WA:
2,403,351, CANC. INT. CL. 35.
- COSTCO WHOLESALE MEMBERSHIP, INC., ISSAQUAH, WA, COSTCO WHOLESALE CORPORATION, ISSAQUAH, WA:
2,163,978, REN. 8-18-07. INT. CL. 16.
- COSTELLO, SHELAGH, SWAMPSCOTT, MA:
3,297,006, PUB. 7-10-2007. INT. CL. 25.
- COTENE/WHALEDENT, INC.:
1,416,502, CANC. INT. CL. 10.
- COTTER & COMPANY, CHICAGO, IL TO TRUE VALUE COMPANY, CHICAGO, IL:
2,015,085, CANC. INT. CL. 9.
- COTTON CABOODLE CO., SEATTLE, WA:
3,298,764, INT. CL. 25.
- COTY US LLC, NEW YORK, NY:
3,298,842, INT. CL. 3.
- COULTER, KEVIN, NEW LENOX, IL:
3,296,782, PUB. 7-10-2007. INT. CL. 35.
- COULTER, WILLIAM WICKERT, TAKOMA PARK, MD:
3,299,085, INT. CL. 9.
- COUNCIL FOR AFFORDABLE QUALITY HEALTHCARE, WASHINGTON, DC:
3,300,111, INT. CL. 35.
- COUNCIL OF REGISTRARS (CORE) ASSOCIATION, 1215 GENEVA, SWITZERLAND:
2,403,307, CANC. INT. CL. 42.
- COUNCIL ON UNDERGRADUATE RESEARCH, WASHINGTON, DC:
3,296,112, PUB. 7-10-2007. MULTIPLE CLASS, INT. CLS.
16, 35 AND 41.
- COUNTERPOINT SOFTWARE, INC., ANCHORAGE, AK:
2,403,499, CANC. INT. CL. 9.
- COUNTY OF KAUAI, LIHUE, HI:
3,296,902, PUB. 7-10-2007. MULTIPLE CLASS, U.S. CLS. A
AND B.
- COUNTY OF SAN BERNARDINO, THE, SAN BERNARDINO, CA:
2,403,292, CANC. INT. CL. 41.
- COURTESY TRAVEL, INC., ELKINS PARK, PA:
3,298,029, PUB. 7-10-2007. INT. CL. 39.
- COURTROOM TELEVISION NETWORK LLC, NEW YORK, NY:
3,299,651, INT. CL. 41.
3,300,314, INT. CL. 38.
- COVENANT REVIEW, LLC, NEW YORK, NY:
3,300,330, INT. CL. 16.
- COVIL, INC., FOOTHILL RANCH, CA:
2,091,293, REN. 8-17-07. INT. CL. 41.
- COWAN, JULIE R., EVANSTON, IL:
3,296,827, PUB. 7-10-2007. INT. CL. 41.
- CPFILMS INC., FIELDALE, VA:
3,299,196, INT. CL. 17.
- CPTMED, INC., NORCROSS, GA:
3,297,930, PUB. 7-10-2007. INT. CL. 10.
- CR SPA, LLC, TUCSON, AZ:
3,300,203, INT. CL. 44.
- CRAFTSMAN COTTAGES, INC., DECATUR, GA:
3,297,495, PUB. 7-10-2007. INT. CL. 37.
- Craggy Range Vineyards Limited, Havelock North, New Zealand:
3,298,879, INT. CL. 33.
- CRANE CO., STAMFORD, CT:
1,448,140, REN. 8-21-07. INT. CL. 6.
1,456,111, REN. 8-22-07. INT. CL. 6.
1,456,113, REN. 8-22-07. INT. CL. 6.
- CRANE COMPOSITES, INC., JOLIET, IL:
2,155,368, REN. 8-18-07. INT. CL. 1.
- CRANIAL ACADEMY, INC., THE, INDIANAPOLIS, IN, CRANIAL ACADEMY, THE, MERIDIAN, ID:
1,450,161, REN. 8-17-07. U.S. CL. 200.
- CRATERIAN PERFORMANCES COMPANY, MEDFORD, OR:
3,299,973, INT. CL. 41.
- CRAWFORD COUNTY CONVENTION & VISITORS BUREAU, PITTSBURG, KS:
3,299,768, INT. CL. 35.
- CRAWFORD, CHARLES GARVIN, COUNTY DOWN BT23 5QL, UNITED KINGDOM:
3,297,425, PUB. 7-10-2007. MULTIPLE CLASS, INT. CLS.
1, 9, 16, 35 AND 38.
- CRAWFORD, KATHERINE, PHILADELPHIA, PA:
2,403,890, CANC. INT. CL. 41.
- CRAWLEY, MICHAEL F., MARYVILLE, TN:
2,114,914, REN. 8-18-07. INT. CL. 7.
- CREATION'S GARDEN NATURAL PRODUCTS, INC., VALENCIA, CA:
3,299,756, INT. CL. 5.
- CREATIVE CHARACTER LICENSING, PEBBLE BEACH, CA:
2,084,597, REN. 8-18-07. INT. CL. 41.
- CREATIVE ENERGIES INC, OCALA, FL:
2,015,386, CANC. INT. CL. 22.

- CREATIVE EXPANSIONS, INC., NEW YORK, NY:
2,403,766, CANC. INT. CL. 41.
- CREATIVE HAIRDRESSERS, INC., VIENNA, VA:
3,298,556, INT. CL. 44.
- CREATIVWORKS, L.L.C., SAINT LOUIS, MO:
2,075,591. REN. 8-23-07. INT. CL. 35.
- CREDIT UNION ASSOCIATION OF COLORADO, ARVADA,
CO:
3,296,521, PUB. 6-26-2007. INT. CL. 35.
- CREEKWOOD PROPERTY CORPORATION, DALLAS, TX,
DBA TONTI PROPERTIES:
2,015,124, CANC. INT. CL. 36.
- CREST FINANCIAL STRATEGIES LTD., CHICAGO, IL:
3,297,983, PUB. 7-10-2007. INT. CL. 36.
- CRILLY, JAMES P, COSTA MESA, CA:
3,296,768, PUB. 7-10-2007. MULTIPLE CLASS, INT. CLS. 9
AND 41.
- CRIMSON TRACE CORPORATION, BEAVERTON, OR:
3,296,133, PUB. 7-10-2007. INT. CL. 13.
- CRITTER DETECTIVES, INCORPORATED, LOMBARD, IL:
2,403,333, CANC. INT. CL. 37.
- CROSSLAND ASSOCIATE, INC., NEW YORK, NY:
2,032,974. REN. 8-17-07. INT. CL. 25.
- CROSSWIND PROJECT MANAGEMENT INC., CARROLL-
TON, TX:
3,296,363, PUB. 7-10-2007. INT. CL. 41.
- CROUCH MARTIN D., PORTLAND, OR:
3,297,977, PUB. 7-10-2007. INT. CL. 42.
- CRUCIBLE MATERIALS CORPORATION, SOLVAY, NY:
1,444,857. REN. 8-18-07. INT. CL. 6.
- CRYSTAL COMPASS CONSULTING, LLC, MILPITAS, CA:
3,297,810, PUB. 7-10-2007. MULTIPLE CLASS, INT. CLS.
35 AND 36.
- CRYSTAL SPRINGS, LAS VEGAS, NV:
2,127,739. REN. 8-23-07. INT. CL. 5.
- CS L.L.C., LITTLETON, CO:
3,296,860, PUB. 7-10-2007. INT. CL. 35.
- CSH-INGRE LLC, MISSISSAUGA, CANADA:
3,299,032, INT. CL. 43.
- CSIR, PRETORIA, SOUTH AFRICA:
2,015,985, CANC. INT. CL. 9.
- CSORBA, JOHN, NORFOLK, VA:
3,298,499, INT. CL. 16.
- CSPE, LLC, BENSLEM, PA:
3,297,911, PUB. 7-10-2007. INT. CL. 35.
- CST INDUSTRIES, INC., KANSAS CITY, DE:
2,164,537. REN. 8-18-07. INT. CL. 6.
- CTA, INC., FENTON, MO:
3,297,929, PUB. 7-10-2007. MULTIPLE CLASS, INT. CLS.
14 AND 16.
- CTB IP, INC., WILMINGTON, DE:
3,298,913, INT. CL. 6.
- CTD, INC., FORT WORTH, TX:
2,015,812, CANC. INT. CL. 42.
- CTG ATHLETICS LLC, BRONX, NY:
3,300,213, MULTIPLE CLASS, INT. CLS. 25 AND 28.
- CTI INDUSTRIES CORP., BARRINGTON, IL:
1,416,803, CANC. INT. CL. 28.
- CTVGLOBEMEDIA PUBLISHING INC./PUBLICATIONS
CTVGLOBEMEDIA INC., TORONTO, ONTARIO, CANA-
DA:
3,297,474, PUB. 7-10-2007. MULTIPLE CLASS, INT. CLS.
35 AND 41.
- CUBEWARE GMBH, ROSENHEIM, FED REP GERMANY:
3,299,423, MULTIPLE CLASS, INT. CLS. 41 AND 42.
- CUEROFLEX S.A., PROVINCIA DE BUENOS AIRES, AR-
GENTINA:
3,295,967, PUB. 6-26-2007. INT. CL. 18.
- CULLIMORE AND RING TECHNOLOGIES, INC., LITTLE-
TON, CO:
3,297,043, PUB. 7-10-2007. INT. CL. 9.
- CUMMINGS & LOCKWOOD, STAMFORD, CT:
2,403,605, CANC. INT. CL. 16.
- CUNNINGHAM LINDSEY U.S., INC., SCHAUMBURG, IL:
3,299,035, MULTIPLE CLASS, INT. CLS. 35 AND 40.
3,299,036, INT. CL. 44.
3,299,038, INT. CL. 40.
3,299,039, INT. CL. 35.
- CURATORS OF THE UNIVERSITY OF MISSOURI, THE,
COLUMBIA, MO:
2,094,563. REN. 8-22-07. INT. CL. 28.
- CURTICE-BURNS FOODS, INC., ROCHESTER, NY TO
LINDEN OAKS CORPORATION, WILMINGTON, DE:
2,084,587, CANC. INT. CL. 30.
- CURTIS, TIM, LOMITA, CA:
3,297,664, PUB. 7-10-2007. INT. CL. 9.
- CUSHION CONNECTION, INC., HOLLYWOOD, FL:
3,296,448, PUB. 7-10-2007. INT. CL. 35.
- CUSTOM CARBON COMPOSITE CREATIONS, INC., OAK-
DALE, CA:
3,296,478, PUB. 7-10-2007. INT. CL. 10.
- CUSTOM MANUFACTURING & ENGINEERING, INC., ST.
PETERSBURG, FL:
3,295,980, PUB. 7-10-2007. INT. CL. 9.
- CUSTOMER OPERATIONS PERFORMANCE CENTER INC.,
AMHERST, NY:
3,297,774, PUB. 7-10-2007. U.S. CL. B.
- CUSTOMIZED PHARMACEUTICAL LEARNING SYSTEMS,
INC., ADDISON, TX:
3,300,367, MULTIPLE CLASS, INT. CLS. 35 AND 41.
- CUTTHEPRICE.COM, INC., KNOXVILLE, TN:
2,403,829, CANC. INT. CL. 35.
- CWW-USA, LLC, MIAMI, FL:
3,299,031, INT. CL. 9.
- CY DECOSSE INCORPORATED, MINNETONKA, MN:
1,416,595, CANC. INT. CL. 16.
- CYBERGUN USA, CORP, TIBURON, CA:
3,299,836, INT. CL. 28.
- CYCLACEL LIMITED, DUNDEE, UNITED KINGDOM:
3,297,209, PUB. 7-10-2007. MULTIPLE CLASS, INT. CLS. 1
AND 5.
3,297,210, PUB. 7-10-2007. MULTIPLE CLASS, INT. CLS. 1
AND 5.
- CYCLE EXPRESS, INC., POWAY, CA:
2,403,491, CANC. INT. CL. 35.
- CYCLO INDUSTRIES, L.L.C., PALM BEACH GARDENS, FL:
2,403,849, CANC. INT. CL. 1.
- CYGNET FINANCIAL CORPORATION, PHOENIX, AZ:
2,403,706, CANC. INT. CL. 36.
- CYKL TECHNOLOGY INC., MELBOURNE, FL:
1,416,524, CANC. INT. CL. 11.
- CYTYC CORPORATION, MARLBOROUGH, MA:
2,404,508, CANC. INT. CL. 10.
- C1 DESIGN GROUP LTD, KETCHUM, ID:
3,300,248, INT. CL. 28.
- D & D GROUP PTY LTD, BROOKVALE, 2100, NSW,
AUSTRALIA:
3,297,271, PUB. 7-10-2007. INT. CL. 6.
3,297,272, PUB. 7-10-2007. INT. CL. 20.
- D. & J.F. CELLARS, INC., DUNDEE, OR:
2,124,045. REN. 8-23-07. INT. CL. 33.
- D. L. DYKES, JR. FOUNDATION, THE, SHREVEPORT, LA:
2,404,188, CANC. INT. CL. 41.
- D.D.G., NAAMLOZE VENNOOTSCHAP, BELGIUM:
3,298,264, PUB. 7-10-2007. INT. CL. 11.
- D'AMORE, MICHELE, NEW YORK, NY:
3,299,986, INT. CL. 24.
- D'ANGELO, KRISTEN M., TRABUCO CANYON, CA AND
COLE, VICKIE A., ORANGE, CA:
3,300,108, INT. CL. 14.
- D'FIRO DESIGN INC., LAFAYETTE, CA:
3,298,978, MULTIPLE CLASS, INT. CLS. 18 AND 20.
- D'FIRO DESIGN, INC., LAFAYETTE, CA:
3,298,979, INT. CL. 18.
3,298,980, MULTIPLE CLASS, INT. CLS. 18 AND 20.
- DADCO, INC., PLYMOUTH, MI:
3,298,733, INT. CL. 7.
- DAIL'S INC., PORTSMOUTH, VA:
3,299,978, INT. CL. 35.
- DAILYTECH, LLC, RALEIGH, NC:
3,300,369, INT. CL. 42.
- DAIMLERCHRYSLER COMPANY LLC, AUBURN HILLS,
MI:
3,298,789, INT. CL. 12.
- DAIOHS FIRST CHOICE SERVICES, DOWNEY, CA:
2,122,284. REN. 8-23-07. INT. CL. 30.

- DAITO WOOLEN SPINNING & WEAVING; CO., LTD, JAPAN:
3,298,394, PUB. 7-10-2007. MULTIPLE CLASS, INT. CLS. 22 AND 23.
- DAKOCYTOMATION DENMARK A/S, DENMARK:
3,298,154, PUB. 3-6-2007. MULTIPLE CLASS, INT. CLS. 1 AND 5.
- DALE MEDICAL PRODUCTS, INC., PLAINVILLE, MA:
3,297,476, PUB. 7-10-2007. INT. CL. 10.
- DALK ENTERPRISES, INC., NEW YORK, NY:
2,403,256, CANC. INT. CL. 25.
- DAN-DEE INTERNATIONAL, LTD., JERSEY CITY, NJ:
3,298,832, INT. CL. 28.
- DANA INNOVATIONS, SAN CLEMENTE, CA:
2,105,869, REN. 8-23-07. INT. CL. 9.
- DANIEL J. PRINZING, ENCINITAS, CA:
3,296,746, PUB. 7-10-2007. INT. CL. 42.
- DANIEL, JERRY, SAN JUAN CAPISTRANO, CA:
3,296,255, PUB. 7-10-2007. INT. CL. 39.
- DANIELI & C. OFFICINE MECCANICHE SPA, ITALY:
3,298,202, PUB. 7-10-2007. MULTIPLE CLASS, INT. CLS. 9 AND 11.
- DANIELS, DANIEL KENT, ELLOREE, SC:
2,016,232, CANC. INT. CL. 32.
- DANILOSKI, BRIAN MATTHEW, SYKESVILLE, MD:
2,404,184, CANC. INT. CL. 41.
- DANLY IEM LLC, BOSTON, MA:
1,489,883, REN. 8-17-07. INT. CL. 7.
- DANNON COMPANY, INC., THE, TARRYTOWN, NY:
2,403,886, CANC. INT. CL. 29.
- DANNY CASH UNLIMITED, LLC, ENGLEWOOD, CO:
3,296,658, PUB. 7-10-2007. INT. CL. 30.
- DANSTAR FERMENT AG, ZUG, SWITZERLAND:
3,297,338, PUB. 7-10-2007. INT. CL. 30.
- DARE MIGHTY THINGS, INC., PORTSMOUTH, NH:
3,298,524, INT. CL. 41.
3,298,537, INT. CL. 41.
- DARKE COUNTY HORSESHOE CLUB, INC., GREENVILLE, OH:
3,298,143, PUB. 7-10-2007. INT. CL. 41.
- DART INDUSTRIES INC., ORLANDO, FL:
3,297,763, PUB. 7-10-2007. INT. CL. 21.
3,297,771, PUB. 7-10-2007. INT. CL. 21.
- DARYL FLOOD WAREHOUSE & MOVERS, INC., CARROLLTON, TX:
2,403,508, CANC. INT. CL. 39.
- DASAPRAKASH PRIVATE LIMITED, MADRAS, INDIA:
2,078,347, REN. 8-23-07. INT. CL. 42.
- DASH.COM, NEW YORK, NY:
2,404,059, CANC. INT. CL. 35.
- DATA TRACK, LLC, NORTHPORT, NY:
2,403,521, CANC. INT. CL. 35.
- DATADANCER MEDICAL SYSTEMS, CHICO, CA:
3,296,488, PUB. 7-10-2007. INT. CL. 9.
3,296,489, PUB. 7-10-2007. INT. CL. 9.
- DATADDEFENSE, LLC, MADISON, WI:
3,299,467, INT. CL. 42.
- DAVESFAVS.COM, INC., TORRANCE, CA:
3,296,496, PUB. 7-10-2007. INT. CL. 36.
- DAVID ALLEN & CO., OJAI, CA:
3,297,371, PUB. 7-10-2007. MULTIPLE CLASS, INT. CLS. 9 AND 16.
- DAVID J. BOCZAR, LLC, EASTON, CT:
3,299,757, INT. CL. 36.
- DAVID SALES, INC., ANAHEIM, CA:
3,296,041, PUB. 7-10-2007. INT. CL. 35.
- DAVID TEXTILES, INC., CITY OF COMMERCE, CA:
3,298,529, INT. CL. 24.
- DAVIDSON ASSOCIATES, INC., NORCROSS, GA:
2,403,583, CANC. INT. CL. 36.
- DAVIS COMPANIES, INC, SHAWNEE, KS:
2,404,932, CANC. INT. CL. 39.
- DAVIS, DANIEL E., HARLINGEN, TX:
3,296,663, PUB. 7-10-2007. INT. CL. 7.
- DAVIS, KERI, SAN DIEGO, CA:
3,297,465, PUB. 7-10-2007. INT. CL. 44.
- DAWN FOODS, INC., JACKSON, MI:
3,296,124, PUB. 7-10-2007. INT. CL. 30.
3,296,126, PUB. 7-10-2007. INT. CL. 30.
- DAWN M. D'AMICO, BRISTOL, PA:
3,300,372, INT. CL. 41.
- DAYSTAR TECHNOLOGIES, INC., HALFMOON, NY:
3,298,705, INT. CL. 9.
- DB SOUND L.P., DES PLAINES, IL:
2,403,301, CANC. MULTIPLE CLASS, INT. CLS. 35, 37 AND 41.
- DBD, INC., CONSHONOCKEN, PA, PRISCILLA OF BOSTON, INC., CHARLESTOWN, MA:
2,088,576, REN. 8-23-07. INT. CL. 42.
- DC COMICS, NEW YORK, NY:
3,299,017, INT. CL. 9.
- DCE APRILIS, INC., MIDLAND, MI:
3,298,439, INT. CL. 9.
- DCK WALLACE, INC., RIDGEFIELD, WA:
3,298,783, INT. CL. 28.
- DDC, INCORPORATED, LEAWOOD, KS:
3,299,531, INT. CL. 20.
- DEBOER, INC., ENGLEWOOD, CO TO RFP SOLUTIONS, LTD., DENVER, CO:
2,015,696, CANC. INT. CL. 35.
- DEBRA'S NATURAL GOURMET, INC., CONCORD, MA:
2,133,198, REN. 8-17-07. INT. CL. 30.
- DECATHLON, VILLENEUVE D'ASCQ, FRANCE:
3,297,405, PUB. 7-10-2007. MULTIPLE CLASS, INT. CLS. 3, 4, 5, 6, 8, 9, 11, 12, 16, 18, 20, 21, 25, 28, 31, 39, 41, 43 AND 44.
- DECISION RESOURCES, INC., WALTHAM, MA:
2,078,350, REN. 8-18-07. MULTIPLE CLASS, INT. CLS. 9, 16 AND 42.
- DECOR GRATES INCORPORATED, TORONTO, CANADA:
3,296,948, PUB. 7-10-2007. MULTIPLE CLASS, INT. CLS. 6 AND 20.
- DEEGAN, BRIAN, TEMECULA, CA:
3,299,025, INT. CL. 25.
- DEERE & COMPANY, MOLINE, IL:
2,081,025, REN. 8-20-07. INT. CL. 36.
- DEFINITIVE DETAILING, LLC, RUMSON, NJ:
3,297,001, PUB. 7-10-2007. INT. CL. 37.
- DEFOORE, WILLIAM GRAY, AUBREY, TX AND DEFOORE, CINDY P., AUBREY, TX:
3,297,839, PUB. 7-10-2007. MULTIPLE CLASS, INT. CLS. 9 AND 41.
- DEGUDENT GMBH, HANAU-WOLFGANG, FED REP GERMANY:
2,403,743, CANC. MULTIPLE CLASS, INT. CLS. 5, 9 AND 10.
- DEGUSSA AG, DUSSELDORF, FED REP GERMANY:
1,448,044, REN. 8-23-07. INT. CL. 1.
- DEKORON UNITHERM, INC., CAPE CORAL, FL, FURON COMPANY, CAPE CORAL, FL:
2,078,866, REN. 8-17-07. INT. CL. 17.
- DEL FORTE DENIM, BERKELEY, CA:
3,299,740, INT. CL. 25.
- DEL MONTE CORPORATION, SAN FRANCISCO, CA:
3,299,822, INT. CL. 31.
3,299,949, INT. CL. 31.
- DELAWARE CAPITAL FORMATION, INC., WILMINGTON, DE, DOVER CORPORATION, GRAND RAPIDS, MI:
1,059,007, REN. 8-17-07. INT. CL. 7.
- DELAWARE NORTH COMPANIES TRAVEL HOSPITALITY SERVICES, INC., BUFFALO, NY:
3,298,958, INT. CL. 35.
- DELGADO, ARIST, MIAMI, FL:
2,403,843, CANC. INT. CL. 41.
- DELTA DENTAL PLAN OF WISCONSIN, INC., STEVENS POINT, WI:
3,299,734, INT. CL. 36.
- DELTA THETA PHI LAW FRATERNITY, INTERNATIONAL, THE, ELYRIA, OH:
649,459, REN. 8-22-07. U.S. CL. 200.
- DELTEC HOMES, INC., ASHEVILLE, NC:
3,296,296, PUB. 7-10-2007. INT. CL. 19.
- DEMAC LTD., ST. CHARLES, IL:
1,446,217, REN. 8-20-07. INT. CL. 10.

- DEMAND ENTERTAINMENT, INC., SANTA MONICA, CA:
3,298,838, MULTIPLE CLASS, INT. CLS. 9 AND 41.
- DEMIBELL S.A.C.I.F.I., HAEDO, BUENOS AIRES, ARGENTINA:
3,297,093, PUB. 7-10-2007. INT. CL. 25.
- DEMOCRATA CALCADOS E ARTEFATOS DE COURO LTDA., SAO PAULO CEP 14405-140, BRAZIL:
2,746,486, COR. INT. CL. 25.
- DENISON, SHERILL, CLEARWATER, FL:
3,299,945, INT. CL. 9.
- DENNIS PUBLISHING, INC., NEW YORK, NY:
3,296,653, PUB. 7-10-2007. INT. CL. 36.
- DENT DEMON, INC., MATTHEWS, NC:
2,088,839, REN. 8-18-07. INT. CL. 37.
- DENTACO DENTALINDUSTRIE UND -MARKETING GMBH, BAD HOMBURG, FED REP GERMANY:
3,297,502, PUB. 7-10-2007. INT. CL. 5.
- DENTRONIC AB, 931 27 SKELLEFTEA, SWEDEN:
2,403,133, CANC. MULTIPLE CLASS, INT. CLS. 5, 40 AND 42.
- DEPARTMENT OF CORONER, LOS ANGELES, CA:
2,077,642, REN. 8-21-07. INT. CL. 25.
2,077,681, REN. 8-22-07. INT. CL. 25.
- DEPARTMENT OF THE NAVY, AN AGENCY OF THE UNITED STATES, AS REPRESENTED BY THE SPACE AND NAVAL WARFARE SYSTEMS COMMAND, SAN DIEGO, CA:
3,297,583, PUB. 7-10-2007. INT. CL. 42.
- DEPARTMENT OF THE UNITED STATES NAVY AS REPRESENTED BY SPACE AND NAVAL WARFARE SYSTEMS COMMAND, SAN DIEGO, CA:
3,297,436, PUB. 7-10-2007. MULTIPLE CLASS, INT. CLS. 9 AND 42.
- DEPASQUALE, CARMEN, FAIR LAWN, NJ:
3,299,874, INT. CL. 3.
- DEPENA, BOLIVAR J., SAN ANTONIO, TX:
3,297,258, PUB. 7-10-2007. INT. CL. 36.
- DERIVADOS ELECTRONICOS C.A. (DERIVELCA), CARACAS 1070, VENEZUELA:
2,014,657, CANC. INT. CL. 9.
- DERMATEC INTERNATIONAL, HELOTES, TX:
3,299,323, INT. CL. 38.
- DERMAVANCE PHARMACEUTICAL INC., MALVERN, PA:
3,299,871, INT. CL. 5.
- DEROYAL INDUSTRIES, INC., POWELL, TN:
2,079,228, REN. 8-17-07. INT. CL. 5.
- DESCHUTES BREWERY, INC., BEND, OR:
3,299,621, INT. CL. 32.
3,299,762, INT. CL. 32.
- DESCO INDUSTRIES, INC., CHINO, CA, CHARLESWATER PRODUCTS, INC., WEST NEWTON, MA:
1,467,128, REN. 8-17-07. INT. CL. 9.
- DESHAY, SAMUEL L., SILVER SPRING, MD:
3,297,688, PUB. 7-10-2007. INT. CL. 5.
- DESIGNLOUNGE, INC., BROOKLYN, NY:
3,296,744, PUB. 7-10-2007. INT. CL. 42.
- DESTILADORA DE LOS ALTOS S.A. DE C.V., ARANDAS, MEXICO:
3,296,351, PUB. 7-10-2007. INT. CL. 33.
- DESTILADORA HACIENDA SANTA MARIA, S.A. DE C.V., TLAQUEPAQUE, MEXICO:
3,296,518, PUB. 7-10-2007. INT. CL. 33.
- DEUTSCHE FINANCIAL SERVICES CORPORATION, ST. LOUIS, MO:
2,404,143, CANC. INT. CL. 36.
- DEUTSCHE MESSE AG, D-30521 HANNOVER, FED REP GERMANY:
2,083,147, REN. 8-22-07. MULTIPLE CLASS, INT. CLS. 16, 35 AND 41.
- DEUTSCHE TELEKOM AG, BONN, FED REP GERMANY:
3,297,460, PUB. 7-10-2007. INT. CL. 42.
- DEVELOPMENTAL RESEARCH AND PROGRAMS, INC., SEATTLE, WA:
2,404,895, CANC. MULTIPLE CLASS, INT. CLS. 9 AND 16.
- DEWITT USA, INC., JACKSONVILLE, FL TO FOSTER INVESTMENT GROUP, INC., JACKSONVILLE, FL:
2,015,678, CANC. INT. CL. 5.
- DEXAS INTERNATIONAL LTD., COPPELL, TX:
3,297,667, PUB. 7-10-2007. INT. CL. 21.
- DEXTER, THOMAS H., MYSTIC, CT:
3,298,075, PUB. 7-10-2007. INT. CL. 14.
- DHL EXPRESS (USA), INC., PLANTATION, FL:
1,416,968, CANC. INT. CL. 39.
- DI-CHEM, INC., CHAMPLIN, MN:
3,296,956, PUB. 7-10-2007. INT. CL. 1.
- DIAGEO BRANDS B.V., AMSTERDAM, NETHERLANDS:
3,299,585, INT. CL. 33.
- DIAGEO IRELAND, DUBLIN 8, IRELAND:
3,298,858, MULTIPLE CLASS, INT. CLS. 9 AND 32.
- DIAGEO NORTH AMERICA, INC., NORWALK, CT:
3,299,552, INT. CL. 33.
3,299,614, INT. CL. 32.
- DIAGEO SCOTLAND LIMITED, EDINBURGH, SCOTLAND:
3,299,554, INT. CL. 33.
- DIAGNOSTIC SYSTEMS LABORATORIES, INC., WEBSTER, TX:
2,047,049, REN. 8-17-07. MULTIPLE CLASS, INT. CLS. 1 AND 5.
- DIAGNOSTICS FOR THE REAL WORLD LIMITED, SUNNYVALE, CA:
3,298,804, INT. CL. 10.
- DIALCOM NETWORKS S.L., SPAIN:
3,298,355, PUB. 7-10-2007. INT. CL. 42.
- DIAMINTANGIBLES INTERNATIONAL, LTD., NASSAU, BAHAMAS:
3,299,394, INT. CL. 14.
- DIAMOND ALLURE INC, NYC, NY:
3,297,071, PUB. 7-10-2007. INT. CL. 14.
- DIAMOND COUNCIL OF AMERICA, INC., NASHVILLE, TN:
1,453,574, REN. 8-23-07. INT. CL. 41.
- DIBBLE & ASSOCIATES CONSULTING ENGINEERS, PHOENIX, AZ:
3,298,142, PUB. 7-10-2007. INT. CL. 42.
- DICKIE-SPIELZEUG GMBH & CO. KG, 90765 FURTH-STADELN, FED REP GERMANY:
2,044,117, REN. 8-20-07. INT. CL. 28.
- DICKIE, TED M., GATESVILLE, TX, DBA J.P.E.:
2,403,989, CANC. INT. CL. 28.
- DIEBOLT, KENT SLADE, ITHACA, NY:
3,297,726, PUB. 7-10-2007. MULTIPLE CLASS, INT. CLS. 37 AND 42.
- DIEFFENBACHER GMBH + CO. KG, EPPINGEN, FED REP GERMANY:
3,143,825, AM. MULTIPLE CLASS, INT. CLS. 7, 9, 35 AND 37.
- DIETERS EDGE LLC, WOODBURY, CT:
3,299,940, INT. CL. 44.
- DIFCO PERFORMANCE FABRICS INC., MONTREAL, QUEBEC, CANADA:
3,298,976, INT. CL. 24.
- DIFIABA, LLC, MIAMI, FL:
3,297,703, PUB. 7-10-2007. INT. CL. 3.
- DIGEROLAMO, CHARLES, KERNERSVILLE, NC:
3,299,097, INT. CL. 43.
- DIGGYWOOD INC., TOLUCA LAKE, CA:
3,296,261, PUB. 7-10-2007. INT. CL. 35.
- DIGITAL LIBRARY RESERVE, INC., CLEVELAND, OH:
3,296,347, PUB. 7-10-2007. INT. CL. 42.
- DIGITAL SYSTEMS INTERNATIONAL CORPORATION, ARLINGTON, VA:
2,404,524, CANC. MULTIPLE CLASS, INT. CLS. 35, 37 AND 42.
- DIGITAL VISION RESOURCES GROUP, LLC, OVERLAND PARK, KS:
3,297,028, PUB. 7-10-2007. INT. CL. 40.
- DILIGENT TECHNOLOGIES CORPORATION, FRAMINGHAM, MA:
3,299,224, MULTIPLE CLASS, INT. CLS. 9 AND 42.
- DILLMAN, DENNIS, LITTLETON, CO:
2,016,123, CANC. INT. CL. 20.
- DIMARIA, ROSE, EAST HAMPSTEAD, NH:
3,300,322, INT. CL. 44.

- DIMON INCORPORATED, DANVILLE, VA TO DIMON INCORPORATED, DANVILLE, VA:
2,014,904, CANC. INT. CL. 42.
- DINGO, INC., ENGLEWOOD, CO:
3,297,862, PUB. 7-10-2007. INT. CL. 16.
- DININGIN.COM, INC., BRIGHTON, MA:
2,079,269. REN. 8-20-07. INT. CL. 42.
- DINUBILE, NICHOLAS A., HAVERTOWN, PA:
3,298,702, MULTIPLE CLASS, INT. CLS. 9 AND 16.
- DIP TECH LTD, KFAR SABA, ISRAEL:
3,298,079, PUB. 7-10-2007. INT. CL. 9.
- DIRECT GENERAL CORPORATION, NASHVILLE, TN:
2,111,070. REN. 8-22-07. INT. CL. 36.
- DIRECT HOLDINGS AMERICAS, INCORPORATED, FAIRFAX, VA:
3,300,032, INT. CL. 3.
- DIRECT STOCK MARKET, INC, THE, SANTA MONICA, CA:
2,404,156, CANC. INT. CL. 35.
- DIRECTED PERCEPTION, INC., BURLINGAME, CA:
2,026,850. REN. 8-17-07. INT. CL. 9.
- DIRECTNET, LLC, WOODBRIDGE, CT:
3,299,401, INT. CL. 35.
- DIRT MOTORSPORTS, INC., NORMAN, OK:
3,297,323, PUB. 7-10-2007. INT. CL. 41.
- DIRTY RIBS, LLC, WASHOUGAL, WA:
3,297,662, PUB. 7-10-2007. INT. CL. 30.
- DISC-CONNECTION, THE, ST. LOUIS, MO:
1,417,042, CANC. INT. CL. 42.
- DISCOVERY COMMUNICATIONS, INC., SILVER SPRING, MD, DBA THE DISCOVERY CHANNEL:
2,093,741. REN. 8-23-07. MULTIPLE CLASS, INT. CLS. 38 AND 41.
- DISCOVERY COMMUNICATIONS, INC., BETHESDA, MD:
2,404,579, CANC. INT. CL. 28.
- DISCOVERY COMMUNICATIONS, INC., SILVER SPRING, MD:
3,297,396, PUB. 7-10-2007. MULTIPLE CLASS, INT. CLS. 38 AND 41.
- DISGUISE, INC., POWAY, CA:
3,299,477, INT. CL. 25.
- DISH D'LISH, INC., SEATTLE, WA:
3,298,802, INT. CL. 29.
- DISNEY ENTERPRISES, INC., BURBANK, CA:
3,159,314, COR. MULTIPLE CLASS, INT. CLS. 9 AND 21.
3,298,722, INT. CL. 9.
3,298,723, INT. CL. 18.
- DISPLAY-BOX LLC, BAY HEAD, NJ:
3,298,925, INT. CL. 42.
- DITECH NETWORKS, INC., MOUNTAIN VIEW, CA:
3,298,712, INT. CL. 9.
- DIVE N' SURF, HERMOSA BEACH, CA, DBA DIVE N'SURF:
1,416,503, CANC. MULTIPLE CLASS, INT. CLS. 10, 14, 18, 25 AND 28.
- DIVERSEY CORP., WYANDOTTE, MI:
1,416,353, CANC. INT. CL. 3.
- DIVERSIFIED COMPUTER CORP., SEATTLE, WA:
2,088,998. REN. 8-20-07. INT. CL. 9.
- DIVERSIFIED FOAM PRODUCTS, INC., PENNSAUKEN, NJ:
3,298,861, INT. CL. 17.
- DIVERSIFIED VENTURES, INC., ARLINGTON HEIGHTS, IL:
2,403,366, CANC. MULTIPLE CLASS, INT. CLS. 35 AND 38.
- DIVERSIFOODS, INC., LAKE BLUFF, IL:
1,416,889, CANC. MULTIPLE CLASS, INT. CLS. 35 AND 42.
- DIVERSITY TECHNOLOGIES CORPORATION, DELTA, BRITISH COLUMBIA, CANADA:
2,015,878, CANC. INT. CL. 1.
- DIVIDELLA AG, GRABS, SWITZERLAND:
3,297,744, PUB. 7-10-2007. INT. CL. 16.
- DIVINE BALANCE, INC., HOLT, MO:
3,297,452, PUB. 7-10-2007. INT. CL. 41.
- DIVINE VODKA, LLC, BARODA, MI:
3,299,343, INT. CL. 33.
- DIVINS INVESTMENTS LLC, JACKSON, MI:
3,300,150, INT. CL. 36.
- DJ BEHR CO., NORTHFIELD, MN, DBA DANIEL J BEHR PRODUCTIONS:
2,404,695, CANC. INT. CL. 41.
- DLF INTERNATIONAL SEEDS, INC., HALSEY, OR:
3,299,895, INT. CL. 31.
- DLJ LONG TERM INVESTMENT CORPORATION, CHICAGO, IL:
2,403,541, CANC. MULTIPLE CLASS, INT. CLS. 16 AND 42.
- DMG FINANCIAL SERVICES, RIVERSIDE, CA:
3,299,975, INT. CL. 16.
- DO, LOAN, WEST HURLEY, NY:
3,296,095, PUB. 7-10-2007. INT. CL. 41.
- DOBBS, NATHAN F., ORMOND BEACH, FL:
3,299,565, INT. CL. 5.
- DOCTOR'S ASSOCIATES INC., FORT LAUDERDALE, FL:
3,296,655, PUB. 7-10-2007. MULTIPLE CLASS, INT. CLS. 29, 31 AND 43.
- DOCTOR'S ASSOCIATES INC., FT. LAUDERDALE, FL:
3,296,542, PUB. 7-10-2007. INT. CL. 43.
- DOCUCENTRIC CORPORATION, TULSA, OK:
2,088,940. REN. 8-22-07. INT. CL. 9.
- DOCUMENT ADVANTAGE CORPORATION, WINTER HAVEN, FL:
3,296,288, PUB. 7-10-2007. INT. CL. 9.
- DOGSWELL, LLC, SAN FRANCISCO, CA:
3,028,299, COR. INT. CL. 31.
- DOLAN PRODUCTIONS, LLC, BROOKFIELD, WI:
3,300,059, INT. CL. 41.
- DOLE FOOD COMPANY, INC., WESTLAKE VILLAGE, CA, CASTLE & COOKE, INC., SAN FRANCISCO, CA:
1,451,110. REN. 8-22-07. INT. CL. 30.
- DOLPHIN TEMPORARY HELP SERVICES, INC., MINNEAPOLIS, MN:
1,416,909, CANC. INT. CL. 35.
- DOMANTAY, GREG A., RIVER FOREST, IL:
3,297,298, PUB. 7-10-2007. MULTIPLE CLASS, INT. CLS. 25 AND 35.
- DOMONT, ELIZABETH K. ROBINSON, NASHVILLE, IN:
1,461,996. REN. 8-17-07. INT. CL. 25.
- DONALD J. TRUMP, NEW YORK, NY:
3,298,890, MULTIPLE CLASS, INT. CLS. 36 AND 37.
- DONEGAL BAY LTD., CLEVELAND, OH:
2,403,365, CANC. INT. CL. 3.
- DONELL, INC., NEW YORK, NY:
3,297,078, PUB. 7-10-2007. INT. CL. 3.
- DOORMAN ONLINE LLC, STATEN ISLAND, NY:
3,299,954, INT. CL. 39.
- DORIGNAC'S FOOD CENTER, L.L.C., METAIRIE, LA:
3,296,915, PUB. 7-10-2007. INT. CL. 35.
- DORMAN-ROTH FOODS, INC., MOONACHIE, NJ:
1,416,832, CANC. INT. CL. 29.
- DORN TECHNOLOGY GROUP, INC., LIVONIA, MI:
2,403,306, CANC. INT. CL. 9.
- DORPAN, S.L., MADRID, SPAIN:
2,403,902, CANC. MULTIPLE CLASS, INT. CLS. 35, 36, 39 AND 42.
- DORPAN, S.L., 07009 PALMA DE MALLORC, BALEARAS, SPAIN:
3,297,061, PUB. 7-10-2007. MULTIPLE CLASS, INT. CLS. 16 AND 43.
- DOSKOCIL MANUFACTURING COMPANY, INC., ARLINGTON, TX:
2,137,001. REN. 8-17-07. INT. CL. 1.
3,298,583, INT. CL. 31.
3,298,595, INT. CL. 31.
- DOUBLEVAULT TECHNOLOGIES, INC., SOUTH JORDAN, UT:
3,297,642, PUB. 7-10-2007. MULTIPLE CLASS, INT. CLS. 39 AND 42.
- DOVER CHEMICAL CORPORATION, DOVER, OH, DIAMOND ALKALI COMPANY, WHEELING, WV:
650,734. REN. 8-18-07. U.S. CL. 6 (INT. CL. 4).
- DOWNTOWN FORD LINCOLN MERCURY, INC., CANTON, OH:
3,296,097, PUB. 7-10-2007. MULTIPLE CLASS, INT. CLS.

- 35, 37 AND 39.
DR PEPPER/SEVEN UP, INC., PLANO, TX:
3,300,212, INT. CL. 30.
DR. FRESH, INC., BUENA PARK, CA:
3,297,116, PUB. 7-10-2007. INT. CL. 21.
3,297,117, PUB. 7-10-2007. INT. CL. 21.
DR. GERALD FISCHER; DR. FLORIAN HINTRINGER,
AUSTRIA:
3,298,330, PUB. 7-10-2007. MULTIPLE CLASS, INT. CLS.
1, 10, 11, 42 AND 44.
DR. K INTERNATIONAL TRADING COMPANY, INC.,
GLENDALE, CA:
2,404,307, CANC. INT. CL. 10.
2,404,308, CANC. INT. CL. 5.
DRAGON HERBS, SANTA MONICA, CA:
3,300,358, INT. CL. 29.
DRAPER PRODUCTS, INC., APPLETON, WI:
3,300,005, INT. CL. 16.
DRAPIER, SAN FRANCISCO, CA, DBA CHESTNUT HILL:
1,416,886, CANC. INT. CL. 33.
DREAM WORKS L.L.C., UNIVERSAL CITY, CA:
2,404,517, CANC. INT. CL. 28.
DREAMWELL, LTD., LAS VEGAS, NV, SIMMONS COM-
PANY, ATLANTA, GA:
2,089,232. REN. 8-22-07. INT. CL. 20.
DREAMWELL, LTD, LAS VEGAS, NV:
2,083,945. REN. 8-22-07. INT. CL. 20.
DREAMWELL, LTD., LAS VEGAS, NV, SIMMONS COM-
PANY, ATLANTA, GA:
2,036,090. REN. 8-22-07. INT. CL. 20.
DREAMWELL, LTD., LAS VEGAS, NV:
2,036,091. REN. 8-22-07. INT. CL. 20.
DREAMWELL, LTD., LAS VEGAS, NV, SIMMONS COM-
PANY, ATLANTA, GA:
2,079,253. REN. 8-22-07. INT. CL. 20.
DREAMWELL, LTD., LAS VEGAS, NV:
2,083,943. REN. 8-22-07. INT. CL. 20.
2,091,139. REN. 8-22-07. INT. CL. 20.
DREDGE, PAUL, ARLINGTON, MA:
1,448,791. REN. 8-22-07. INT. CL. 35.
DRESS CODE LLC, NEW YORK, NY:
3,297,746, PUB. 7-10-2007. INT. CL. 42.
DRESSER, INC., ADDISON, TX:
3,297,415, PUB. 7-10-2007. INT. CL. 9.
DREW KAPLAN AGENCY, INC., TARZANA, CA, BSR
NORTH AMERICA LTD., NEW YORK, NY:
1,393,007. REN. 8-20-07. INT. CL. 9.
DREXEL CHEMICAL COMPANY, MEMPHIS, TN:
3,296,180, PUB. 7-10-2007. INT. CL. 5.
DRINX FINE WINE AND SPIRITS, LLC, D'IBERVILLE, MS:
3,300,028, INT. CL. 35.
DRIVER'S WAY OF BIRMINGHAM, INC., PELHAM, AL:
2,490,595, COR. INT. CL. 35.
DRIVES INCORPORATED, FULTON, IL:
3,299,923, INT. CL. 6.
DRUG HOUSES OF AUSTRALIA (OVERSEAS) LIMITED,
CENTRAL DISTRICT, HONG KONG, J. BOSISTO & CO.
PROPRIETARY LIMITED, MELBOURNE, VICTORIA,
AUSTRALIA:
243,192. REN. 8-23-07. U.S. CL. 6 (INT. CL. 3).
DRUG HOUSES OF AUSTRALIA (OVERSEAS) LTD., CEN-
TRAL DISTRICT, HONG KONG:
1,473,855. REN. 8-21-07. INT. CL. 5.
DRUMM, ROCHELLE, IRVINE, CA:
3,298,650, MULTIPLE CLASS, INT. CLS. 16, 24, 25 AND
45.
DRUMM, ROCHELLE, IRVINE, CA:
3,298,651, INT. CL. 30.
DSI, LIMITED, NASSAU, BAHAMAS:
2,403,518, CANC. INT. CL. 34.
DSM DESOTECH, INC., ELIGIN, IL:
3,295,977, PUB. 3-16-2004. INT. CL. 1.
DSM IP ASSETS B.V., NETHERLANDS:
3,298,171, PUB. 7-10-2007. INT. CL. 1.
DTE ENERGY COMPANY, DETROIT, MI:
3,296,652, PUB. 7-10-2007. INT. CL. 35.
DUCTSMART, LLC, RENTON, WA:
3,299,817, MULTIPLE CLASS, INT. CLS. 7 AND 37.
DUFF & PHELPS, LLC, CHICAGO, IL:
2,404,588, CANC. INT. CL. 36.
DULKRE S.A., BUENOS AIRES, ARGENTINA:
3,298,699, INT. CL. 30.
DUNBAR ARMORED, INC., HUNT VALLEY, MD:
2,108,425. REN. 8-20-07. INT. CL. 39.
3,299,816, MULTIPLE CLASS, INT. CLS. 35 AND 39.
DUNDEE CORPORATION, TORONTO, ONTARION, CANA-
DA:
2,403,242, CANC. INT. CL. 36.
DUNLOP MANUFACTURING, INC., BENICIA, CA:
3,296,821, PUB. 7-10-2007. INT. CL. 15.
DUNLOP SLAZENGER GROUP LIMITED, BUCKINGHAM-
SHIRE, UNITED KINGDOM:
3,297,267, PUB. 7-10-2007. INT. CL. 28.
DUNLOP TIRE CORPORATION, GRAND ISLAND, NY:
1,416,555, CANC. INT. CL. 12.
DUNN LUMBER CO., INC., SEATTLE, WA:
3,296,190, PUB. 7-10-2007. INT. CL. 35.
DUNNE, MARTHA S, CORONADO, CA:
3,300,101, MULTIPLE CLASS, INT. CLS. 9 AND 16.
DUNPHY SPORTS/FISHING IMPORTS PTY LTD, TAREN
POINT, AUSTRALIA:
3,297,376, PUB. 7-10-2007. INT. CL. 28.
DURACOTE CORPORATION, RAVENNA, OH:
1,073,147. REN. 8-18-07. MULTIPLE CLASS, INT. CLS. 17
AND 24.
DURO BAG MANUFACTURING COMPANY, FLORENCE,
KY:
3,296,471, PUB. 7-10-2007. MULTIPLE CLASS, INT. CLS.
16 AND 21.
DUROCHER, LYNN, LAFAYETTE, NY:
3,297,640, PUB. 7-10-2007. INT. CL. 44.
DWELNET TECHNOLOGIES, BELLEVUE, WA:
3,299,618, INT. CL. 42.
DYNAFLUX, INC., CARTERSVILLE, GA, AMREP, INC.,
MARIETTA, GA:
1,450,231. REN. 8-23-07. INT. CL. 1.
DYNAMIC KNOWLEDGE TRANSFER, LLC, INDIANAPO-
LIS, IN:
3,296,423, PUB. 7-10-2007. MULTIPLE CLASS, INT. CLS. 9
AND 42.
DYNAMIS THERAPEUTICS, INC., ELKINS PARK, PA:
3,299,840, INT. CL. 3.
DYNATRACE SOFTWARE GMBH, LINZ, AUSTRIA:
3,297,752, PUB. 7-10-2007. INT. CL. 9.
DYSCERN, LLC, STERLING, VA:
3,296,983, PUB. 7-10-2007. MULTIPLE CLASS, INT. CLS.
35 AND 37.
DYSTAR L.P., CHARLOTTE, NC:
2,404,178, CANC. INT. CL. 2.
DYSTAR TEXTILFARBEN GMBH & CO. DEUTSCHLAND
KG, FRANKFURT AM MAIN, FED REP GERMANY,
MITSUBISHI CHEMICAL INDUSTRIES LIMITED,
CHIYODA-KU, TOKYO, JAPAN:
1,428,039. REN. 8-17-07. INT. CL. 2.
E & H DISTRIBUTING CO., NORTH LAS VEGAS, NV:
2,404,630, CANC. MULTIPLE CLASS, INT. CLS. 29 AND
30.
E F PRODUCTS, INC., DALLAS, TX:
3,297,283, PUB. 7-10-2007. INT. CL. 1.
E Z BUY & E Z SELL RECYCLER CORPORATION, LOS
ANGELES, CA, DBA PHOTO BUYS WEEKLY:
1,416,568, CANC. INT. CL. 16.
E. B. BOTANICALS, LLC, MONTCLAIR, NJ:
3,297,408, PUB. 7-10-2007. INT. CL. 3.
E. GLUCK CORPORATION, LONG ISLAND CITY, NY:
2,034,916. REN. 8-22-07. INT. CL. 14.
E. I. DU PONT DE NEMOURS AND COMPANY, WILMING-
TON, DE:
3,299,759, INT. CL. 27.
E. J. BROOKS COMPANY, LIVINGSTON, NJ:
1,450,823. REN. 8-23-07. INT. CL. 20.
E. J. COX COMPANY, INC., CLARKTON, NC:
3,296,503, PUB. 7-10-2007. INT. CL. 29.
E. KAISER FABRICATION INC., LINDEN, CA, DBA HUL-
IT:
2,015,743, CANC. INT. CL. 7.

- E. MISHAN & SONS, INC., NEW YORK, NY:
3,300,187, INT. CL. 8.
- E.R. SQUIBB & SONS, L.L.C., PRINCETON, NJ:
3,298,666, INT. CL. 44.
- E.T. BROWNE DRUG CO., INC., ENGLEWOOD CLIFF, NJ,
TOPIFRAM LABORATORIES, INC., WILMINGTON, DE:
1,449,160, REN. 8-17-07, INT. CL. 3.
- E&I HOLDINGS, INC., LONE TREE, CO:
2,130,580, REN. 8-20-07, INT. CL. 42.
- E-NET ADVERTISING, LLC, WEST CHESTER, PA:
3,296,787, PUB. 7-10-2007, INT. CL. 35.
- E-WORLD RECYCLERS, LLC, VISTA, CA:
3,298,070, PUB. 4-3-2007, INT. CL. 40.
- E-Z GRADER COMPANY, THE, CHAGRIN FALLS, OH, IBIS
BAY CORPORATION, CHAGRIN FALLS, OH:
2,087,079, REN. 8-22-07, INT. CL. 16.
- E-Z-RECT MANUFACTURING LTD., VANCOUVER, BRIT-
ISH COLUMBIA, CANADA, E-Z-RECT MANUFACTUR-
ING LTD., VANCOUVER, BRITISH COLUMBIA,
CANADA:
1,489,209, REN. 8-23-07, INT. CL. 11.
- EAGAN, CATHERINE, SOUTHFIELD, MI AND DR. J.
VICTOR EAGAN, SOUTHFIELD, MI:
3,296,883, PUB. 7-10-2007, INT. CL. 41.
- EAGLE PASS CHAMBER OF COMMERCE, EAGLE PASS,
TX:
3,296,280, PUB. 7-10-2007, INT. CL. 35.
- EARTH FARE, INC., ASHEVILLE, NC:
2,160,094, REN. 8-18-07, MULTIPLE CLASS, INT. CLS. 35
AND 42.
2,160,095, REN. 8-18-07, MULTIPLE CLASS, INT. CLS. 35
AND 42.
- EARTHLINK, INC., ATLANTA, GA:
3,299,380, INT. CL. 42.
- EASCO HAND TOOLS, INC., SIMSBURY, CT:
3,298,955, INT. CL. 8.
- EAST CAROLINA UNIVERSITY, GREENVILLE, NC:
1,470,715, REN. 8-23-07, MULTIPLE CLASS, INT. CLS. 25
AND 41.
- EASTERN BROADCASTING CO., LTD., TAIPEI, TAIWAN,
CHINA:
3,295,975, PUB. 7-10-2007, MULTIPLE CLASS, INT. CLS.
9, 16, 35, 38 AND 41.
- EASTERN MOTOR INNS, INC., ROANOKE, VA:
3,299,567, INT. CL. 43.
- EASTMAN KODAK COMPANY, ROCHESTER, NY:
2,016,021, CANC. INT. CL. 9.
- EASTMAN, KEVIN B., NORTHAMPTON, MA:
2,404,449, CANC. INT. CL. 25.
- EASTSPORT INC., NEW YORK, NY:
3,298,591, INT. CL. 18.
- EASTWAY FAIR COMPANY LIMITED, TORTOLA, BR. VIR-
GIN ISLANDS:
3,298,798, MULTIPLE CLASS, INT. CLS. 7 AND 9.
- EASY GARDENER PRODUCTS, INC., WACO, TX:
3,299,916, INT. CL. 19.
- EASYREACH CORPORATION, CAMPBELL, CA:
3,296,191, PUB. 7-10-2007, MULTIPLE CLASS, INT. CLS. 9
AND 38.
3,296,192, PUB. 7-10-2007, MULTIPLE CLASS, INT. CLS. 9
AND 38.
- EASY4BUSY, NEW YORK, NY:
3,297,255, PUB. 7-10-2007, INT. CL. 29.
- EATON CORPORATION, CLEVELAND, OH:
3,299,867, INT. CL. 6.
- EAUCTION DEPOT, LLC, AUGUSTA, GA:
3,296,348, PUB. 6-26-2007, INT. CL. 35.
- EBAY INC., SAN JOSE, CA:
3,299,409, INT. CL. 35.
- EBEL INTERNATIONAL LTD., HAMILTON, BERMUDA:
3,300,220, INT. CL. 3.
3,300,224, INT. CL. 3.
- EBRO ELECTRONIC GMBH & CO. KG, FED REP GER-
MANY:
3,298,216, PUB. 7-10-2007, MULTIPLE CLASS, INT. CLS. 9
AND 42.
- ECAPITAL GROUP, INC., SANTA CLARA, CA:
2,950,735, NEW CERT. 9-25-2007, INT. CL. 36.
- ECARDIO DIAGNOSTICS, LLC, THE WOODLANDS, TX:
3,298,877, MULTIPLE CLASS, INT. CLS. 38 AND 44.
- ECCA ENTERPRISES, INC., WILMINGTON, DE:
2,074,262, REN. 8-22-07, INT. CL. 9.
- ECHEF, LLC, LINCOLN, NE:
3,299,726, INT. CL. 9.
- ECHO, INCORPORATED, LAKE ZURICH, IL:
3,299,556, INT. CL. 7.
3,299,557, INT. CL. 7.
- ECHOSTAR COMMUNICATIONS CORPORATION, ENGLE-
WOOD, CO:
2,075,565, REN. 8-17-07, MULTIPLE CLASS, INT. CLS. 37
AND 38.
2,088,761, REN. 8-17-07, MULTIPLE CLASS, INT. CLS. 37
AND 38.
- ECMD, INC., NORTH WILKESBORO, NC:
3,298,468, INT. CL. 19.
- ECOFLO, INC., SAVAGE, MD:
2,016,369, CANC. INT. CL. 35.
- ECOLAB INC., ST. PAUL, MN, AIRWICK INDUSTRIES,
INC., CARLSTADT, NJ:
1,071,246, REN. 8-23-07, INT. CL. 3.
- ECOLAB INC., ST. PAUL, MN:
2,016,404, CANC. INT. CL. 3.
- ECONCENTRO, LP, CALEXICO, CA:
3,260,037, CANC. IIRN. RESTORED TO S.N. 78-600,455.
- ECONUGENICS, INC., SANTA ROSA, CA:
3,297,146, PUB. 7-10-2007, INT. CL. 5.
- ECOSECURITIES GROUP LIMITED, OXFORD, UNITED
KINGDOM:
3,298,247, PUB. 7-10-2007, MULTIPLE CLASS, INT. CLS.
35, 36, 42 AND 44.
- ECOWATER INDUSTRIAL SYSTEMS, INC., ST. PAUL, MN:
1,416,527, CANC. INT. CL. 11.
- ECP INCORPORATED, WOODRIDGE, IL, PROTECTOR
CORPORATION, THE, WOODRIDGE, IL:
1,449,099, REN. 8-17-07, MULTIPLE CLASS, INT. CLS. 1,
2 AND 3.
- EDCARE MANAGEMENT, INC., FORT LAUDERDALE, FL:
3,300,265, INT. CL. 35.
- EDIBLE ARRANGEMENTS, LLC, WALLINGFORD, CT:
3,296,243, PUB. 7-10-2007, MULTIPLE CLASS, INT. CLS.
29 AND 30.
- EDITORIAL LIMUSA, S.A. DE C.V., MEXICO, MEXICO:
1,416,624, CANC. INT. CL. 16.
- EDITORIAL PROJECTS IN EDUCATION, INC., BETHESDA,
MD:
3,299,662, INT. CL. 41.
3,299,667, INT. CL. 41.
- EDUCATIONAL EXPERIENCES INC., LOS ANGELES, CA:
3,297,051, PUB. 7-10-2007, INT. CL. 16.
- EDUCATIONAL INSTITUTE OF THE AMERICAN HOTEL
& MOTEL ASSOCIATION, THE, EAST LANSING, MI:
2,403,742, CANC. INT. CL. 41.
- EDUCATIONAL TESTING SERVICE, PRINCETON, NY:
3,297,757, PUB. 7-10-2007, MULTIPLE CLASS, INT. CLS.
9, 16, 35, 36, 41 AND 42.
- EDVENTIONS L.L.C., CHICAGO, IL:
2,404,219, CANC. INT. CL. 42.
- EDWARD DON & COMPANY, NORTH RIVERSIDE, IL:
1,445,762, REN. 8-17-07, MULTIPLE CLASS, INT. CLS. 3,
4, 5, 7, 8, 9, 16, 20, 21, 22, 29, 32 AND 42.
1,445,762, CANC. MULTIPLE CLASS, INT. CLS. 1, 12, 24,
27, 30 AND 34.
- EF CULTURAL TOURS SARL (ZUG BRANCH), ZUG,
SWITZERLAND:
3,299,616, INT. CL. 41.
- EFFICIENT FRONTIERS, INC., DELAFIELD, WI:
3,298,635, INT. CL. 35.
- EFFIX S.A., 92800 PUTEAUX, FRANCE:
2,403,405, CANC. MULTIPLE CLASS, INT. CLS. 9 AND
42.
- EGGS & BRAINS CARD CO. INC., HARTSDALE, NY:
2,404,846, CANC. INT. CL. 16.
- EGON VON RUVILLE GMBH, 22113 HAMBURG, FED REP
GERMANY:
3,298,194, PUB. 7-10-2007, MULTIPLE CLASS, INT. CLS.
7, 12 AND 17.

- EISAI CO., LTD., BUNKYO-KU, TOKYO, JAPAN:
2,403,678, CANC. MULTIPLE CLASS, INT. CLS. 9 AND 16.
- EISAI INC., TEANECK, NJ:
2,403,604, CANC. INT. CL. 16.
- EL PASO SADDLEBLANKET COMPANY, L.P., EL PASO, TX:
3,296,804, PUB. 7-10-2007. INT. CL. 35.
- EL TORITO RESTAURANTS, INC., CYPRESS, CA:
2,403,777, CANC. INT. CL. 33.
- ELAHI, EBRAHIM, NEW YORK, NY:
3,297,787, PUB. 7-10-2007. MULTIPLE CLASS, INT. CLS. 3, 9 AND 44.
- ELAN-POLO INC, NASHVILLE, TN:
2,015,919, CANC. INT. CL. 25.
- ELARAH, INC., TOLUCA LAKE, CA:
3,299,131, INT. CL. 16.
- ELASTIC NETWORKS, INC., ALPHARETTA, GA:
2,403,977, CANC. INT. CL. 9.
- ELBEX VIDEO LTD., SHINAGAWA-KU, TOKYO, JAPAN:
3,296,558, PUB. 7-10-2007. INT. CL. 9.
- ELECA INTERNATIONAL, INC., WALNUT, CA:
3,300,350, INT. CL. 9.
- ELECTROLUX HOME PRODUCTS, INC., CLEVELAND, OH:
3,298,459, INT. CL. 11.
- ELECTROMETIC RESEARCH, INC., SANTA MONICA, CA:
1,416,343, CANC. INT. CL. 3.
- ELECTRONIC ARTS INC., REDWOOD CITY, CA:
2,403,855, CANC. INT. CL. 9.
- ELECTRONIC CONCEPTS, INC., EATONTOWN, NJ:
2,154,300, REN. 8-23-07. INT. CL. 9.
- ELECTRONIC INDUSTRIES ALLIANCE, ARLINGTON, VA:
2,403,699, CANC. INT. CL. 35.
- ELECTRONIC THEATRE CONTROLS, INC., MIDDLETON, WI:
3,299,665, INT. CL. 9.
- ELEPHANT STEPS, LLC, NEW CANAAN, CT:
3,299,924, INT. CL. 43.
- ELEVEN INTERNATIONAL CO., LTD., OSAKA, JAPAN:
3,297,375, PUB. 1-2-2007. INT. CL. 12.
- ELI LILLY AND COMPANY, INDIANAPOLIS, IN:
2,081,641, REN. 8-22-07. INT. CL. 42.
3,298,949, INT. CL. 10.
- ELIANE SABON, FRANCE:
3,298,203, PUB. 7-10-2007. INT. CL. 25.
- ELISA CIARAMETARO, NEW YORK, NY:
3,296,350, PUB. 7-10-2007. INT. CL. 35.
- ELITE COMFORT INC., DEERFIELD BEACH, FL:
3,298,020, PUB. 7-10-2007. INT. CL. 9.
- ELIZABETH F. CALLAHAN, M.D., LLC, BRADENTON, FL:
3,298,825, INT. CL. 44.
- ELLEN MCNEILL/CONSERVATION CONCEPTS, FLETCHER, NC:
3,297,155, PUB. 7-10-2007. INT. CL. 25.
- ELLIE D, LLC, MCLEAN, VA:
3,299,488, INT. CL. 3.
- ELLISON EDUCATIONAL EQUIPMENT, INC., LAKE FOREST, CA:
2,174,225, REN. 8-23-07. INT. CL. 16.
- ELLORA'S CAVE PUBLISHING, INC., STOW, OH:
3,295,981, PUB. 7-10-2007. MULTIPLE CLASS, INT. CLS. 9 AND 16.
- ELMARCO S.R.O., CZECH REPUBLIC:
3,298,280, PUB. 7-10-2007. MULTIPLE CLASS, INT. CLS. 7 AND 24.
- ELUMATEC GMBH & CO. KG, 75417 MUEHLACKER, FED REP GERMANY:
1,458,983, REN. 8-23-07. INT. CL. 7.
- EMAK WORLDWIDE, INC., LOS ANGELES, CA:
3,297,196, PUB. 7-10-2007. INT. CL. 35.
- EMANATE LLC, NEW YORK, NY:
3,299,732, INT. CL. 35.
- EMBALMERS' SUPPLY COMPANY, THE, STRATFORD, CT:
2,053,905, REN. 8-20-07. MULTIPLE CLASS, INT. CLS. 1 AND 3.
- EMC CORPORATION, HOPKINTON, MA:
2,404,604, CANC. INT. CL. 9.
- EMCO LIMITED, LONDON, ONTARIO, CANADA:
1,416,398, CANC. INT. CL. 6.
- EMERALD ACRES, INC., NEW RICHMOND, IN:
1,416,858, CANC. INT. CL. 31.
- EMERALD CREEK GARNET LTD., COEURD'ALENE, ID:
2,076,901, REN. 8-20-07. INT. CL. 3.
- EMERGING MEDIA DYNAMICS, INC., BETHESDA, MD:
3,297,310, PUB. 7-10-2007. INT. CL. 9.
- EMERSON COLLEGE, BOSTON, MA:
3,297,537, PUB. 7-10-2007. INT. CL. 41.
- EMERSON ELECTRIC CO., ST. LOUIS, MO:
3,299,183, INT. CL. 7.
3,299,230, INT. CL. 7.
- EMERSON, JAMES R., DENVER, CO, DBA EMERSON HORN EDITIONS:
2,108,754, REN. 8-17-07. INT. CL. 16.
- EMI (IP) LIMITED, LONDON W8 5SW, UNITED KINGDOM:
2,112,881, REN. 8-18-07. INT. CL. 9.
- EMILY'S TOYS, WESTERVILLE, OH:
2,711,445, CANC. INT. CL. 35.
- EMIRATES CORPORATION, DUBAI, UNITED ARAB EMIR.:
3,297,287, PUB. 7-10-2007. MULTIPLE CLASS, INT. CLS. 35 AND 39.
- EMITEC GESELLSCHAFT FUR EMISSIONSTECHNOLOGIE MBH, LOHMAR, FED REP GERMANY:
2,403,149, CANC. MULTIPLE CLASS, INT. CLS. 9, 35 AND 42.
- EMMERICH, ROXANNE, MINNEAPOLIS, MN:
3,296,803, PUB. 7-10-2007. INT. CL. 41.
3,296,805, PUB. 7-10-2007. INT. CL. 41.
- EMPIRE BONDING AGENCY INC., HEMPSTEAD, NY:
3,296,730, PUB. 7-10-2007. INT. CL. 36.
- EMPIRE LEVEL MANUFACTURING CORPORATION, MUKWONAGO, WI:
3,296,010, PUB. 7-10-2007. INT. CL. 9.
- EMPLOYEE RELOCATION COUNCIL, INC., WASHINGTON, DC:
2,404,286, CANC. INT. CL. 35.
- EMPLOYMENT CONDITIONS ABROAD LIMITED, LONDON SW3 3TY, ENGLAND:
2,031,691, REN. 8-17-07. INT. CL. 16.
- EMPLOYMENT LEARNING INNOVATIONS, INC., ATLANTA, GA:
3,297,437, PUB. 7-10-2007. MULTIPLE CLASS, INT. CLS. 9, 16 AND 41.
- EMPLOYMENT SOLUTIONS MANAGEMENT, INC., ATLANTA, GA:
3,296,876, PUB. 7-10-2007. INT. CL. 35.
- EMPRESAS DE DISTRIBUCION INTELIGENTE, S.A. DE C.V., MONTERREY, NUEVO LEON, MEXICO:
2,404,581, CANC. INT. CL. 5.
- EMS-CHEMIE AG, CH-7013 DOMAT/EMS, SWITZERLAND, EMSER WERKE A.G., DOMAT (EMS), SWITZERLAND:
833,855, REN. 8-23-07. U.S. CL. 1 (INT. CLS. 1 AND 17).
- EMS-CHEMIE AG, SWITZERLAND:
3,298,284, PUB. 7-10-2007. INT. CL. 1.
3,298,285, PUB. 7-10-2007. INT. CL. 1.
- EN NOVATIVE TECHNOLOGIES, INC., OAKLAND, CA:
3,298,139, PUB. 7-10-2007. INT. CL. 9.
- ENCHANTÉ ACCESSORIES INC., NEW YORK, NY:
3,299,347, INT. CL. 3.
3,299,348, INT. CL. 3.
- ENCORE CAPITAL LLC, NEWTON, MA:
2,404,105, CANC. MULTIPLE CLASS, INT. CLS. 16 AND 35.
- ENCORE MEDICAL ASSET CORPORATION, HENDERSON, NV:
3,296,594, PUB. 7-10-2007. INT. CL. 10.
- ENDEAVOUR CONSULTING LLC, BELLEVUE, WA:
2,081,323, REN. 8-22-07. MULTIPLE CLASS, INT. CLS. 35 AND 42.
- ENDEMANO CIGARS, INC., MIAMI, FL:
3,299,447, INT. CL. 34.
- ENERGY ADDITIVES, INC., BATTLE CREEK, MI:
2,084,037, REN. 8-17-07. INT. CL. 1.

- ENERGY AND PROPULSION SYSTEMS, ASBESTOS (QUEBEC), CANADA:
3,298,488, MULTIPLE CLASS, INT. CLS. 9 AND 12.
- ENERGY CLUB, INC., PACOIMA, CA:
2,108,437, REN. 8-18-07. MULTIPLE CLASS, INT. CLS. 29, 30 AND 31.
- ENERGY TECHNOLOGIES ET SA, CH-1701 FRIBOURG, SWITZERLAND:
2,404,621, CANC. INT. CL. 7.
- ENERGY-ENVIRONMENT-ECONOMICS, L.L.C., PHOENIX, AZ:
3,297,076, PUB. 7-10-2007. INT. CL. 42.
- ENGELMAN, IAN K., SCARBOROUGH, ME:
3,299,507, INT. CL. 10.
- ENGINEERING SERVICES NETWORK, INC., ARLINGTON, VA:
3,296,615, PUB. 7-10-2007. INT. CL. 41.
3,296,616, PUB. 7-10-2007. INT. CL. 41.
- ENGLANDER SLEEP PRODUCTS, L.L.C., BATON ROUGE, LA, ENGLANDER LICENSING LIMITED LIABILITY COMPANY, COLUMBUS, OH:
2,085,614, REN. 8-21-07. INT. CL. 20.
- ENI TECHNOLOGY, INC., ROCHESTER, NY:
2,403,628, CANC. INT. CL. 9.
- ENLOIT ENTERPRISES, LLC, NORWALK, CT:
3,300,026, MULTIPLE CLASS, INT. CLS. 35 AND 41.
- ENNEAGRAM RESOURCES, INC., LAKEWOOD, CO:
2,014,960, CANC. INT. CL. 41.
- ENSEQUENCE, INC., PORTLAND, OR:
3,297,311, PUB. 7-10-2007. MULTIPLE CLASS, INT. CLS. 9 AND 42.
- ENTERPRISE COMMUNITY PARTNERS, INC., COLUMBIA, MD:
2,403,943, CANC. INT. CL. 9.
- ENTERPRISE FINANCIAL SERVICES CORP., CLAYTON, MO:
3,297,767, PUB. 7-10-2007. INT. CL. 36.
- ENTERPRISE NETWORKING SYSTEMS, INC., REDWOOD CITY, CA:
2,403,668, CANC. INT. CL. 42.
- ENTERPRISE NEWSMEDIA, LLC, QUINCY, MA:
3,299,079, INT. CL. 16.
3,299,316, INT. CL. 16.
- ENTERPRISE PLANNING SYSTEMS, OTTAWA, ONTARIO, CANADA:
2,015,338, CANC. INT. CL. 9.
- ENTICE SOFTWARE CORPORATION, OAKLAND, CA:
2,403,654, CANC. INT. CL. 9.
- ENTRÉE VOUS, LEXINGTON, KY:
3,297,768, PUB. 7-10-2007. MULTIPLE CLASS, INT. CLS. 41 AND 43.
- ENVELOPE MANUFACTURERS ASSOCIATION, ALEXANDRIA, VA:
3,298,106, PUB. 7-10-2007. INT. CL. 35.
- ENVIRCO CORPORATION, ALBUQUERQUE, NM, ENVIRCO, INC., ALBUQUERQUE, NM:
832,526, REN. 8-22-07. U.S. CL. 34 (INT. CL. 11).
- ENVIRO-DYNAMICS INC., DALLAS, TX:
2,015,619, CANC. INT. CL. 1.
- ENVIRONMENTAL TECHNICAL SALES, INC., BATON ROUGE, LA:
2,088,805, REN. 8-17-07. INT. CL. 35.
- ENVIROTAINER AB, KNIVSTA, SWEDEN:
2,085,552, REN. 8-20-07. INT. CL. 21.
- ENVISION IMPLANTS, LLC, COVINGTON, LA:
3,299,270, INT. CL. 10.
- EPERITUS, LLC, RICHMOND, VA:
3,297,854, PUB. 7-10-2007. MULTIPLE CLASS, INT. CLS. 35, 36, 37 AND 42.
- EPHA INC., HERMISTON, OR:
1,441,199, REN. 8-23-07. INT. CL. 17.
- EPIPELINE, INC., HERNDON, VA:
3,299,253, INT. CL. 35.
- EPISCOPAL WEST SIDE SHARED MINISTRY, CLEVELAND, OH:
3,296,287, PUB. 7-10-2007. INT. CL. 45.
- EPIWORKS, INC., CHAMPAIGN, IL:
3,298,640, INT. CL. 9.
- EPLEY, RICHARD P. PHD, PIEDMONT, CA:
1,416,487, CANC. INT. CL. 9.
- EPOK, INC., BETHESDA, MD:
3,299,691, INT. CL. 9.
- EQUESTRIAN PRODUCTS CORP., HAZELTON, PA:
2,404,257, CANC. INT. CL. 18.
- EQUINE ENTERPRISES, INC, WOODLAND HILLS, CA:
3,296,325, PUB. 7-10-2007. INT. CL. 35.
- EQUITIES GLOBAL COMMUNICATIONS, INC., SANTA MONICA, CA:
3,297,880, PUB. 7-10-2007. MULTIPLE CLASS, INT. CLS. 16, 36 AND 41.
- EQUITY ANALYTICS, LLC, ATLANTA, GA:
3,298,707, INT. CL. 36.
- EQUITY DIRECT MORTGAGE CORP., VIEJO, CA:
2,089,170, REN. 8-18-07. INT. CL. 36.
- EQUITYALERT.COM, INC, VANCOUVER B.C V6J 1G1, CANADA:
2,403,647, CANC. INT. CL. 36.
- ERA DESIGN, LTD., BROOKLYN, NY:
3,298,492, MULTIPLE CLASS, INT. CLS. 6, 9, 14, 16, 18, 20 AND 26.
- ERCO LEUCHTEN GMBH, 58507 LÜDENSCHIED, FED REP GERMANY:
3,298,224, PUB. 4-3-2007. INT. CL. 9.
- ERDINGER WEIßBRÄU FRANZ BROMBACH, FED REP GERMANY:
3,298,196, PUB. 7-10-2007. MULTIPLE CLASS, INT. CLS. 32, 33 AND 43.
3,298,197, PUB. 7-10-2007. MULTIPLE CLASS, INT. CLS. 32, 33 AND 43.
- EREINSURE.COM, INC., SALT LAKE CITY, UT:
3,296,328, PUB. 7-10-2007. INT. CL. 35.
- ERGON, LLC, ANDOVER, MA:
3,296,203, PUB. 7-10-2007. INT. CL. 37.
- ERIC MALKA, MIAMI, FL:
3,297,409, PUB. 7-10-2007. INT. CL. 3.
- ERICH RUSS, 91350 GREMSDORF, FED REP GERMANY:
3,298,279, PUB. 7-10-2007. MULTIPLE CLASS, INT. CLS. 7 AND 12.
- ERICKSON BEAMON, LTD., NEW YORK, NY:
2,101,111, REN. 8-17-07. INT. CL. 18.
2,101,112, REN. 8-17-07. INT. CL. 25.
2,101,113, REN. 8-17-07. INT. CL. 14.
- ERIE BRUSH CO., INC., CHICAGO, IL:
1,460,946, REN. 8-22-07. INT. CL. 21.
- ERIE FOODS INTERNATIONAL, INC., ERIE, IL:
1,416,833, CANC. INT. CL. 29.
- ERMANCO INCORPORATED, SPRING LAKE, MI:
3,299,084, INT. CL. 7.
- ERN ENTERPRISES, INC., PALATINE, IL:
3,299,701, INT. CL. 14.
- ESA'S FOUNDATION, NEW YORK, NY:
3,297,899, PUB. 7-10-2007. INT. CL. 36.
- ESCHATONE RECORDS, LLC, NEW YORK, NY:
3,299,927, INT. CL. 9.
3,299,928, INT. CL. 9.
- ESCO EQUIPMENT SERVICE COMPANY, ELK GROVE VILLAGE, IL:
1,461,671, REN. 8-17-07. INT. CL. 7.
- ESI INTERNATIONAL, ARLINGTON, VA:
3,296,796, PUB. 7-10-2007. INT. CL. 41.
- ESPN, INC., BRISTOL, CT:
2,403,952, CANC. MULTIPLE CLASS, INT. CLS. 38 AND 41.
- ESSILOR OF AMERICA, INC., ST. PETERSBURG, FL:
1,416,452, CANC. INT. CL. 9.
- ESTABLISHED MORTGAGE PROFESSIONALS, INC., CLEARWATER, FL, DBA QUALITY LIFE REVERSE MORTGAGE:
3,296,609, PUB. 7-10-2007. INT. CL. 36.
- ESTATE OF R.C. GORMAN, TAOS, NM:
2,042,819, REN. 8-20-07. INT. CL. 16.
- ESTATIONER, LLC, FORT LAUDERDALE, FL:
3,296,283, PUB. 7-10-2007. INT. CL. 35.
- ESTILUZ, S.A., CARRETERA OGASSA S/N, GERONA, SPAIN, CALIFORNIA ARTUP CORP., SANTA ANA, CA:
1,447,343, REN. 8-17-07. INT. CL. 11.

ESTIMATION, INC., LINTHICUM HEIGHTS, MD:
3,298,730, INT. CL. 9.

ESTRADA, JOHNNY P., III, CHICAGO, IL:
3,296,057, PUB. 7-10-2007. INT. CL. 25.

ESW TECHNOLOGIES, INC., DOVER, DE:
3,298,059, PUB. 7-10-2007. INT. CL. 42.

ETERNA AG UHRENFABRIK; (ETERNA SA FABRIQUE D'HORLOGERIE); (ETERNA LTD WATCH FACTORY), SWITZERLAND:
3,298,228, PUB. 7-10-2007. INT. CL. 14.

ETHAN ALLEN GLOBAL, INC., DANBURY, CT:
2,403,245, CANC. INT. CL. 20.

ETHICAL PRODUCTS, INC., NEWARK, NJ:
2,404,482, CANC. INT. CL. 18.

ETIENNE AIGNER, INC., NEW YORK, NY:
3,299,844, MULTIPLE CLASS, INT. CLS. 18 AND 25.

ETM ENTERTAINMENT NETWORK, INC., COSTA MESA, CA:
2,404,523, CANC. MULTIPLE CLASS, INT. CLS. 39 AND 42.

ETSY, INC., BROOKLYN, NY:
3,297,913, PUB. 7-10-2007. INT. CL. 35.

EURASIA FEATHER, INC., GRAND RAPIDS, MI:
2,164,506, REN. 8-23-07. MULTIPLE CLASS, INT. CLS. 20 AND 24.

EURO RSCG WORLDWIDE, 92200 NEUILLY SUR SEINE, FRANCE TO HAVAS, 92150 SURESNES, FRANCE:
1,983,200, CANC. INT. CL. 16.

EUROGENTEC S.A., B-4102 SERAING, BELGIUM:
2,085,265, REN. 8-23-07. INT. CL. 1.

EUROITALIA S.R.L., ITALY:
3,298,266, PUB. 7-10-2007. INT. CL. 3.

EUROKERA, 77640 JOUARRE, FRANCE:
2,072,989, REN. 8-18-07. MULTIPLE CLASS, INT. CLS. 11, 19 AND 21.

EUROMARKET DESIGNS, INC., NORTHBROOK, IL:
1,469,514, REN. 8-17-07. INT. CL. 42.
1,469,515, REN. 8-17-07. INT. CL. 42.

EVA OLSSON, SWEDEN:
3,298,271, PUB. 7-10-2007. MULTIPLE CLASS, INT. CLS. 30, 32 AND 43.

EVENFLO COMPANY, INC., VANDALIA, OH:
2,404,498, CANC. INT. CL. 12.

EVENT 360, INC., VALENCIA, CA:
3,297,447, PUB. 7-10-2007. MULTIPLE CLASS, INT. CLS. 35, 36 AND 41.

EVERETT, PERRY L., LAKE OSWEGO, OR AND GOLDEN, THAYNE J., LAKE OSWEGO, OR:
3,299,456, INT. CL. 6.

EVERGLADES DIRECT, INC., NORTH MANKATO, MN:
3,296,851, PUB. 7-10-2007. INT. CL. 9.

EVERGREEN COPYRIGHT ACQUISITIONS, LLC, NEW YORK, NY:
3,297,526, PUB. 7-10-2007. INT. CL. 41.

EVERGREEN INTERNATIONAL CORPORATION, TAIPEI, TAIWAN:
2,100,934, REN. 8-17-07. INT. CL. 39.

EVERHARD PRODUCTS, INC., CANTON, OH, KLENK INDUSTRIES, INC., WILMINGTON, DE:
2,098,597, REN. 8-17-07. INT. CL. 8.

EVOLUTION FILM & TAPE, INC, BURBANK, CA:
3,297,856, PUB. 7-10-2007. INT. CL. 41.

EX SITU MARKETING INC., MONTREAL QC, CANADA:
3,296,130, PUB. 7-10-2007. INT. CL. 41.

EXANE, FRANCE:
3,298,215, PUB. 7-10-2007. INT. CL. 36.
3,298,222, PUB. 7-10-2007. INT. CL. 36.

EXCELDA MANUFACTURING COMPANY, BRIGHTON, MI:
1,070,498, REN. 8-17-07. INT. CL. 5.
3,298,711, INT. CL. 3.

EXCELLUS HEALTH PLAN, INC., ROCHESTER, NY:
3,298,497, MULTIPLE CLASS, INT. CLS. 36 AND 44.

EXCEPTIONAL PRODUCTS, INC., DALLAS, TX:
3,297,986, PUB. 7-10-2007. INT. CL. 26.

EXECUTIVE CONVERSATION, INC., SEATTLE, WA:
2,394,539, AM. MULTIPLE CLASS, INT. CLS. 9, 16 AND 41.

EXEL INC., WESTERVILLE, OH:
3,297,347, PUB. 7-10-2007. MULTIPLE CLASS, INT. CLS. 35, 39, 40 AND 42.
3,297,348, PUB. 7-10-2007. MULTIPLE CLASS, INT. CLS. 35, 39, 40 AND 42.

EXELON CORPORATION, PHILADELPHIA, PA:
3,298,487, MULTIPLE CLASS, INT. CLS. 35 AND 36.

EXHART ENVIRONMENTAL SYSTEMS, INC., CHATSWORTH, CA:
3,296,115, PUB. 7-10-2007. MULTIPLE CLASS, INT. CLS. 6 AND 20.

EXIDE TECHNOLOGIES, ALPHARETTA, GA, GNB TECHNOLOGIES INC., ATLANTA, GA:
2,091,137, REN. 8-23-07. INT. CL. 9.

EXPEDIA, INC., BELLEVUE, WA:
2,403,379, CANC. MULTIPLE CLASS, INT. CLS. 39 AND 42.
3,297,113, PUB. 7-10-2007. MULTIPLE CLASS, INT. CLS. 39 AND 43.

EXPERIENCE HENDRIX, L.L.C., SEATTLE, WA:
3,297,740, PUB. 7-10-2007. INT. CL. 3.
3,297,741, PUB. 7-10-2007. INT. CL. 24.
3,297,742, PUB. 7-10-2007. INT. CL. 6.

EXPO MAGAZINE, INC., OVERLAND PARK, KS TO ASCEND MEDIA, LLC, OVERLAND PARK, KS:
2,016,538, CANC. INT. CL. 42.

EXPONENTIAL INTERACTIVE, INC., EMERYVILLE, CA:
3,300,069, INT. CL. 35.

EXTENDED PRESENCE TECHNOLOGY BROKERAGE, LLC, DENVER, CO:
3,296,459, PUB. 6-26-2007. INT. CL. 35.

EXTENT TECHNOLOGIES LTD., RAMAT GAN, ISRAEL:
2,403,223, CANC. INT. CL. 9.

EXTERIOR WOOD RESTORATION, INC., CICERO, IN:
3,298,957, INT. CL. 2.

EXTERMINATORS, INC., KENMORE, WA:
3,300,017, INT. CL. 37.

EXTRA SPACE STORAGE LLC, SALT LAKE CITY, UT:
3,296,728, PUB. 7-10-2007. INT. CL. 39.

EXTREME LEARNING, INC., MORGAN HILL, CA:
3,296,265, PUB. 7-10-2007. INT. CL. 41.

EXTRICOM INC., NEW YORK, NY:
3,296,640, PUB. 7-10-2007. INT. CL. 9.

EYE OJO CORP., ONTARIO, CA:
3,297,064, PUB. 7-10-2007. INT. CL. 9.

EYERONIX, LLC, WOODBRIDGE, VA:
3,296,667, PUB. 7-10-2007. INT. CL. 41.

EYGN LIMITED, NASSAU, BAHAMAS, ERNST & YOUNG U.S. LLP, NEW YORK, NY:
2,074,523, REN. 8-22-07. INT. CL. 9.

EZBUYS.COM, INC., PHILADELPHIA, PA:
2,403,606, CANC. INT. CL. 35.

E2, INC., SANTA BARBARA, CA:
3,299,128, INT. CL. 24.

E2COMPUTERS LLC, JORDAN, MN:
3,296,822, PUB. 7-10-2007. INT. CL. 35.

E2INTERACTIVE, INC., ATLANTA, GA, DBA E2INTERACTIVE, INC.:
3,299,244, INT. CL. 9.

F.E. KNIGHT, INC., FOXBORO, MA:
1,445,800, REN. 8-17-07. INT. CL. 1.

FABFOUR HOLDINGS, INC., HAMILTON, MT:
2,403,074, CANC. INT. CL. 35.

FABRIQUE DE MONTRES ROTARY S.A.; (ROTARY WATCH COMPANY LIMITED), SWITZERLAND:
3,298,254, PUB. 7-10-2007. INT. CL. 14.

FACTORY DIRECT PREMIUMS, LLC, DALLAS, TX:
3,296,526, PUB. 7-10-2007. INT. CL. 35.

FAILURE AVOIDANCE LC, OREM, UT:
2,121,244, REN. 8-20-07. INT. CL. 35.

FAIR WIND, INC., KAILUA-KONA, HI:
3,296,241, PUB. 7-10-2007. INT. CL. 39.

FAIRBANKS, DONNA C., GRAPEVINE, TX:
3,297,844, PUB. 7-10-2007. INT. CL. 9.

FAIRLANE PRODUCTS INC., FRASER, MI:
3,298,434, INT. CL. 7.

- FAIRLY BIKE MANUFACTURING CO., LTD., TU-CHEN CITY, TAIPEI HSIEN, TAIWAN:
3,296,075, PUB. 7-10-2007. INT. CL. 12.
- FAIRWAY IMPORT EXPORT, INC., RANCHO DOMINGUEZ, CA:
2,096,932. REN. 8-20-07. INT. CL. 28.
- FALKENSTEIN, LYNDA, PORTLAND, OR:
3,298,461, MULTIPLE CLASS, INT. CLS. 16 AND 41.
- FALLEN LEAF VENTURES, INC., PALO ALTO, CA, DBA THE SOOTHEZE COMPANY:
3,297,299, PUB. 7-10-2007. MULTIPLE CLASS, INT. CLS. 20, 24 AND 28.
- FALLON, TIMOTHY R., BARKSDALE, TX:
3,299,794, MULTIPLE CLASS, INT. CLS. 39 AND 41.
- FAMILY CARE CENTER OF INDIANA, L.L.C., DYER, IN:
3,297,663, PUB. 7-10-2007. INT. CL. 44.
- FAMILY CARE SPECIALISTS MEDICAL CORPORATION, LOS ANGELES, CA:
3,297,878, PUB. 7-10-2007. MULTIPLE CLASS, INT. CLS. 16 AND 41.
- FAMILY ORTHODONTICS, INC., WESTBOROUGH, MA:
3,296,683, PUB. 7-10-2007. INT. CL. 44.
- FAMOUS NAME COMPANY (PTY) LIMITED, BRYANSTON, SANDTON, GAUTENG, SOUTH AFRICA:
2,489,899, CANC. INT. CL. 11.
- FANUC LTD, YAMANASHI, JAPAN:
3,298,002, PUB. 7-10-2007. INT. CL. 7.
3,300,179, INT. CL. 9.
- FAR GREAT PLASTIC INDUSTRIAL CO., LTD., TAINAN HSIEN, TAIWAN:
1,447,730. REN. 8-23-07. INT. CL. 28.
- FARADAY TECHNOLOGY CORPORATION, HSINCHU, TAIWAN:
3,298,639, INT. CL. 9.
- FARLOW, JEFFREY C., GREENSBORO, NC:
3,299,439, INT. CL. 37.
- FARRAR, CATHERINE, LOCH ARBOUR, NJ:
3,298,082, PUB. 7-10-2007. INT. CL. 25.
- FARRELL, DAVID, MANASSAS, VA:
2,404,396, CANC. INT. CL. 16.
- FASHION ACCESSORIES SHIPPERS ASSOCIATION, INC., NEW YORK, NY:
3,297,857, PUB. 7-10-2007. INT. CL. 35.
- FAST TRACK SYSTEMS, INC., CONSHOHOCKEN, PA:
2,121,310. REN. 8-23-07. INT. CL. 9.
- FAT CAT, INC., WILLISTON, VT:
3,296,292, PUB. 7-10-2007. INT. CL. 28.
- FAUTSCH, WILLIAM C., PHOENIX, AZ:
3,300,312, INT. CL. 25.
- FBC INDUSTRIES, INC., SCHAUMBERG, IL:
3,298,576, INT. CL. 1.
- FCA CUSTOMS OF WHITE LAKE, INC., LIVONIA, MI:
2,403,905, CANC. MULTIPLE CLASS, INT. CLS. 35 AND 37.
- FEDERAL EXPRESS CORPORATION, MEMPHIS, TN:
3,297,514, PUB. 7-10-2007. INT. CL. 39.
- FEDERAL NATIONAL MORTGAGE ASSOCIATION, WASHINGTON, DC, DBA FANNIE MAE:
3,298,815, INT. CL. 36.
- FEDERAL SIGNAL CORPORATION, OAK BROOK, IL:
3,300,344, INT. CL. 9.
- FEDERATED SOFTWARE GROUP, INC., THE, ST. LOUIS, MO:
2,404,575, CANC. INT. CL. 9.
- FEDERATION OF MIGROS COOPERATIVES, CH-8005 ZURICH, SWITZERLAND:
3,298,038, PUB. 7-10-2007. INT. CL. 30.
- FEEDBACKNETWORK, LLC, AUSTIN, TX:
3,296,574, PUB. 7-10-2007. INT. CL. 36.
- FEEL ME GEAR, INC., VANCOUVER, B.C., CANADA:
3,300,199, MULTIPLE CLASS, INT. CLS. 9 AND 35.
- FELIX FORSTER, PFULLINGEN, FED REP GERMANY:
1,475,666. REN. 8-18-07. INT. CL. 9.
- FELLOWSHIP CHURCH, GRAPEVINE, TX:
3,299,877, MULTIPLE CLASS, INT. CLS. 9, 16 AND 45.
3,299,878, MULTIPLE CLASS, INT. CLS. 9, 16 AND 45.
- FENCE WAREHOUSE, INC., STATEN ISLAND, NY:
3,296,950, PUB. 7-10-2007. INT. CL. 35.
- FENG MING CORP., HOUSTON, TX:
3,298,810, INT. CL. 43.
- FENTON, RONALD L., MT. PROSPECT, IL:
3,300,243, INT. CL. 12.
- FENWICK AUTOMOTIVE PRODUCTS LIMITED, TORONTO, ONTARIO, CANADA:
1,426,493. REN. 8-17-07. INT. CL. 12.
- FERAG AG, CANTON OF ZURICH, SWITZERLAND:
2,086,735. REN. 8-17-07. MULTIPLE CLASS, INT. CLS. 6, 12, 16 AND 20.
- FERNANDEZ, MICHAEL ANTHONY, AUSTIN, TX:
3,299,277, MULTIPLE CLASS, INT. CLS. 9 AND 41.
- FERR, JAMES, ROCHESTER, NY:
3,296,863, PUB. 7-10-2007. INT. CL. 9.
- FERRELLGAS PARTNERS, L.P., OVERKLAND, KS:
3,299,830, INT. CL. 39.
- FERRERO S.P.A., ALBA, CUNEO, ITALY:
3,296,061, PUB. 7-10-2007. INT. CL. 32.
- FERRING B.V., HOOFDDORP, NETHERLANDS:
1,431,684. REN. 8-18-07. MULTIPLE CLASS, INT. CLS. 5 AND 10.
- FERRONATO TECHNOLOGIES GROUP AG, ZUG ZG, SWITZERLAND:
2,014,851, CANC. INT. CL. 10.
- FETA MED, INC., KING OF PRUSSIA, PA:
3,298,098, PUB. 7-10-2007. INT. CL. 5.
- FGE LLC, PHOENIX, AZ:
3,299,625, MULTIPLE CLASS, INT. CLS. 9 AND 41.
- FIBER BY-PRODUCTS CORP., GOSHEN, IN:
3,299,835, INT. CL. 4.
- FIBER COMPOSITES, LLC, NEW LONDON, NC:
3,299,066, INT. CL. 19.
- FIBERLINK COMMUNICATIONS CORPORATION, BLUE BELL, PA:
3,298,689, INT. CL. 9.
- FIELD & STREAM LICENSES COMPANY, LLC, WESTPORT, CT, FIELD & STREAM LICENSES COMPANY, HOPKINS, MN:
2,033,670. REN. 8-20-07. INT. CL. 18.
- FIELDERS CHOICE PRODUCE, L.L.C., PHOENIX, AZ:
2,404,555, CANC. INT. CL. 31.
- FIGUEROA, RENZO PERCY, REDWOOD CITY, CA:
3,299,184, INT. CL. 25.
- FILLMORE-PIRU CITRUS ASSOCIATION, JPIEU, CA:
2,016,265, CANC. INT. CL. 31.
- FILM YOUR ISSUE, LTD., LOS ANGELES, CA:
3,297,505, PUB. 7-10-2007. INT. CL. 41.
- FILTER SPECIALISTS, INC., MICHIGAN CITY, IN:
3,298,121, PUB. 7-10-2007. INT. CL. 11.
- FILTRAIR B.V., 8440 AN HEERENVEEN, NETHERLANDS:
2,014,727, CANC. INT. CL. 11.
- FINANCIAL FREEDOM ENTERPRISES, INC., IDAHO FALLS, ID:
2,077,320. REN. 8-17-07. INT. CL. 36.
- FINANCIAL TECHNOLOGIES, INC., JACKSON, MS:
2,404,147, CANC. INT. CL. 35.
- FINCIBEC S.P.A., 41049 SASSUOLO (MO), ITALY:
3,299,140, INT. CL. 19.
- FINE ESTATES FROM SPAIN, INC., DEDHAM, MA:
3,299,288, INT. CL. 33.
3,299,289, INT. CL. 33.
- FINEKRAFT, INC., KEARNY, NJ:
3,297,077, PUB. 7-10-2007. INT. CL. 35.
- FINESSE DIAMOND CORPORATION, NEW YORK, NY:
3,297,221, PUB. 7-10-2007. INT. CL. 35.
- FINISHER, BROOMFIELD, CO:
2,403,083, CANC. INT. CL. 25.
- FINK, RICHARD J, BROOKLYN, NY:
3,296,650, PUB. 7-10-2007. INT. CL. 41.
- FIRST & 42ND, INC., NEW YORK, NY:
3,299,389, MULTIPLE CLASS, INT. CLS. 35 AND 42.
- FIRST ACT., INC., BOSTON, MA:
3,298,526, INT. CL. 15.
- FIRST ACT, INC., NEWTON, MA:
3,298,504, INT. CL. 15.
- FIRST AMERICAN CORELOGIC, INC., SACRAMENTO, CA:
3,299,281, INT. CL. 36.

- FIRST AMERICAN REAL ESTATE SOLUTIONS LLC, WESTLAKE, TX:
3,299,314, INT. CL. 36.
3,299,441, INT. CL. 35.
- FIRST AUDIO MANUFACTURING (HONG KONG) LIMITED, KOWLOON, HONG KONG:
3,298,902, INT. CL. 9.
- FIRST BENEFICIAL MORTGAGE CORPORATION, CHARLOTTE, NC:
2,404,432, CANC. INT. CL. 36.
- FIRST BETHANY BANCORP, INC., BETHANY, OK, FIRST BETHANY BANCORP, INC., BETHANY, OK:
2,156,356, REN. 8-18-07, INT. CL. 36.
- FIRST BRANDS PROPERTIES INC., WILMINGTON, DE TO ARMOR ALL/STP PRODUCTS COMPANY, THE, OAKLAND, CA:
2,014,676, CANC. INT. CL. 21.
- FIRST CHOICE BROKERS, SAN JOSE, CA:
3,297,308, PUB. 7-10-2007, INT. CL. 36.
- FIRST CITIZENS BANK, ELIZABETHTOWN, KY:
3,298,953, INT. CL. 36.
- FIRST FRANKLIN FINANCIAL CORPORATION, SAN JOSE, CA:
3,297,187, PUB. 1-25-2005, INT. CL. 36.
- FIRST NLC FINANCIAL SERVICES, LLC, DEERFIELD BEACH, FL:
3,296,905, PUB. 7-10-2007, INT. CL. 36.
3,296,906, PUB. 7-10-2007, INT. CL. 36.
3,298,573, INT. CL. 36.
- FIRST STEP LLC, ALBUQUERQUE, NM:
3,296,586, PUB. 7-10-2007, INT. CL. 36.
- FIRST TEAM SPORTS, INC., ANOKA, MN:
2,404,425, CANC. INT. CL. 18.
- FIRST WORLD IMPORTS, INC., LAKE WORTH, FL:
3,296,784, PUB. 7-10-2007, INT. CL. 29.
- FIRSTPLUS FINANCIAL GROUP, INC., DALLAS, TX:
2,403,253, CANC. INT. CL. 20.
- FISCH PRECISION TOOL CO., INC., CLAYSVILLE, PA:
2,403,102, CANC. INT. CL. 8.
- FISCHER-LANG & COMPANY, INC., FREDERICK, MD:
1,416,332, CANC. INT. CL. 3.
- FISH FINANCIAL, LLC, MARTINSBURG, WV:
3,299,279, INT. CL. 36.
- FISHER, DONALD T., MURRIETA, CA, DBA THERA RESEARCH CONSULTANTS:
2,035,461, REN. 8-18-07, INT. CL. 5.
- FISHER, LAWRENCE, CORAL SPRINGS, FL AND EPSTEIN, LESLEY, CORAL SPRINGS, FL:
3,298,089, PUB. 7-10-2007, INT. CL. 41.
- FIT AND FUN, LLC, COLCHESTER, CT:
3,299,339, INT. CL. 28.
- FITNESS AND IMAGE RESULTS, INC., ARLINGTON, VA:
2,403,812, CANC. MULTIPLE CLASS, INT. CLS. 41 AND 42.
- FITNESS QUEST, INC., ST. PETERSBURG, FL:
3,298,428, INT. CL. 18.
- FITWEST, INC., VENTURA, CA:
2,404,061, CANC. INT. CL. 35.
- FIVE O'CLOCK OF MILWAUKEE, LLC, MILWAUKEE, WI:
3,296,087, PUB. 7-10-2007, INT. CL. 43.
3,296,088, PUB. 7-10-2007, INT. CL. 43.
- FLÖSSER GMBH & CO., BUNDESREPUBLIK, FED REP GERMANY:
3,298,094, PUB. 7-10-2007, MULTIPLE CLASS, INT. CLS. 9 AND 11.
- FLAGEOLI LTD., LAS VEGAS, NV:
3,300,010, INT. CL. 3.
- FLAME RESISTANT GARMENTS, INC., HAMMOND, IN:
3,300,082, MULTIPLE CLASS, INT. CLS. 35, 37, 39 AND 41.
- FLAMINGO HILTON CORPORATION, LAS VEGAS, NV TO HARRAH'S OPERATING COMPANY, INC., LAS VEGAS, NV:
2,015,176, CANC. MULTIPLE CLASS, INT. CLS. 41 AND 42.
- FLANNERY, MICHAEL, BIRDSBORO, PA:
3,300,253, INT. CL. 30.
- FLAVOR FULL FOODS INC., TAIPEI HSIEN, TAIWAN:
3,297,247, PUB. 7-10-2007, INT. CL. 29.
- FLEET RESERVE ASSOCIATION, ALEXANDRIA, VA:
3,300,100, INT. CL. 16.
- FLEET WHOLESALE SUPPLY CO., INC., APPLETON, WI:
2,119,851, REN. 8-20-07, INT. CL. 1.
2,146,279, REN. 8-20-07, INT. CL. 12.
- FLETCHER-TERRY COMPANY, THE, FARMINGTON, CT:
2,404,134, CANC. INT. CL. 6.
- FLETTER, SHARON, OGDEN, UT:
3,296,435, PUB. 7-10-2007, INT. CL. 41.
- FLEXITY SOLUTIONS INC., RICHMOND HILL, CANADA:
3,297,896, PUB. 7-10-2007, MULTIPLE CLASS, INT. CLS. 35, 36 AND 42.
3,297,897, PUB. 7-10-2007, MULTIPLE CLASS, INT. CLS. 35, 36 AND 42.
- FLEXSOURCE, INC., TOA-BAJA, PUERTO RICO:
2,403,750, CANC. INT. CL. 35.
- FLIGHT SYSTEMS, INC., LEWISBERRY, PA:
1,432,609, REN. 8-18-07, INT. CL. 1.
- FLINT CREEK WILDLIFE REHABILITATION, BARRINGTON, IL:
3,296,462, PUB. 7-10-2007, MULTIPLE CLASS, INT. CLS. 41 AND 44.
- FLOCKS, JOHN, ROCKVILLE, MD, DBA LORRAINE FURNITURE COMPANY:
2,403,985, CANC. INT. CL. 20.
- FLOOD 911, INC., PLACENTIA, CA:
3,298,772, INT. CL. 37.
- FLORACRAFT CORPORATION, LUDINGTON, MI:
3,298,888, INT. CL. 7.
- FLORIDA DOCTORS INSURANCE COMPANY, JACKSONVILLE, FL:
3,150,253, CANC. INT. CL. 36.
- FLORIDA HARWARDE, LLC, JACKSONVILLE, FL:
3,297,475, PUB. 7-10-2007, INT. CL. 6.
- FLORIDA HOSPITAL COLLEGE OF HEALTH SCIENCE, ORLANDO, FL:
3,298,737, INT. CL. 42.
- FLORIDA, RICHARD, WASHINGTON, DC:
3,298,801, INT. CL. 35.
- FLOSCAN INSTRUMENT COMPANY, INC., SEATTLE, WA:
2,077,872, REN. 8-17-07, INT. CL. 9.
- FLOW COMMUNICATIONS, INC., SAN FRANCISCO, CA:
2,403,998, CANC. INT. CL. 41.
- FLOWSERVE MANAGEMENT COMPANY, IRVING, TX:
347,926, REN. 8-17-07, U.S. CL. 23 (INT. CL. 8).
- FLOWSERVE MANAGEMENT COMPANY, IRVING, TX, WORCESTER VALVE CO., INC., WORCESTER, MA:
645,009, REN. 8-20-07, U.S. CL. 13 (INT. CL. 6).
- FLTI, LITTLE ROCK, AR:
3,296,078, PUB. 7-10-2007, MULTIPLE CLASS, INT. CLS. 41 AND 45.
3,296,079, PUB. 7-10-2007, MULTIPLE CLASS, INT. CLS. 41 AND 45.
- FLUENCE TECHNOLOGY, INC., BEAVERTON, OR:
2,403,465, CANC. INT. CL. 9.
2,403,468, CANC. INT. CL. 9.
- FLUIDMESH NETWORKS, INC., BOSTON, MA:
3,297,933, PUB. 7-10-2007, INT. CL. 9.
- FLUOR CORPORATION, INC., ALISO VIEJO, CA:
2,403,980, CANC. INT. CL. 9.
- FLYTECH TECHNOLOGY CO., LTD., TAIPEI, TAIWAN:
1,449,397, REN. 8-17-07, INT. CL. 9.
- FNC S.A., MONTEVIDEO, URUGUAY:
1,447,826, REN. 8-23-07, INT. CL. 32.
- FOAMEX L.P., LINWOOD, PA:
2,091,360, REN. 8-17-07, INT. CL. 42.
- FOCUS INTERACTIVE, INC., IRVINGTON, NY:
3,128,639, COR. INT. CL. 9.
- FOCUS ON RESULTS, INC., LAKE WYLIE, SC:
2,404,400, CANC. INT. CL. 16.
- FOCUS ON THE FAMILY, COLORADO SPRINGS, CO, DOBSON, JAMES C., PH.D., ARCADIA, CA:
1,454,651, REN. 8-18-07, MULTIPLE CLASS, INT. CLS. 41 AND 42.
- FOGEL, SERGIO, E, MONTEVIDEO, MVD, URUGUAY:
3,297,464, PUB. 7-10-2007, MULTIPLE CLASS, INT. CLS. 9

- AND 36.
 FOOD QUALITY SENSOR INTERNATIONAL, LEXINGTON, MA:
 3,300,184, INT. CL. 9.
 FOOD.COM INC., SAN FRANCISCO, CA:
 2,403,746, CANC. INT. CL. 35.
 FOODHANDLER, INC., RENO, NV:
 3,299,262, INT. CL. 9.
 FOOTBALL NORTHWEST LLC, KIRKLAND, WA:
 3,300,096, INT. CL. 36.
 FOPE SRL, 36100 VICENZA, ITALY:
 2,404,418, CANC. INT. CL. 14.
 FORCE COMPUTERS, INC., SAN JOSE, CA:
 2,404,527, CANC. INT. CL. 9.
 FORCECOM, SACHSE, TX:
 3,297,315, PUB. 7-10-2007. INT. CL. 9.
 FORD MOTOR COMPANY, DEARBORN, MI:
 2,059,524, REN. 8-21-07. INT. CL. 28.
 2,059,525, REN. 8-21-07. INT. CL. 28.
 2,080,191, REN. 8-20-07. INT. CL. 28.
 2,082,708, REN. 8-17-07. INT. CL. 28.
 2,403,038, CANC. INT. CL. 25.
 FORE-SIGHT, LLC, TULSA, OK:
 3,297,830, PUB. 7-10-2007. INT. CL. 41.
 FOREST ENERGY CORPORATION, INC., SHOW LOW, AZ:
 3,298,471, INT. CL. 11.
 FOREST LAWN MEMORIAL-PARK ASSOCIATION, GLENDALE, CA, FOREST LAWN COMPANY, GLENDALE, CA:
 2,101,422, REN. 8-23-07. INT. CL. 42.
 FOREST RUN PRODUCTIONS, INC., LITTLETON, CO, DBA CANINE TRAINING SYSTEMS:
 2,403,587, CANC. INT. CL. 41.
 FOREVER CHEESE, ASTORIA, NY:
 3,299,237, INT. CL. 30.
 FORST TECHNOLOGIE GMBH & CO. KG, D-42659 SOLINGEN, FED REP GERMANY:
 2,119,530, REN. 8-17-07. INT. CL. 7.
 FORT JAMES OPERATING COMPANY, DEERFIELD, IL:
 2,404,690, CANC. INT. CL. 21.
 FORTIFIED STRUCTURES GROUP LLC, LONGWOOD, FL:
 3,296,480, PUB. 7-10-2007. INT. CL. 37.
 FORUM SYSTEMS, SANDY, UT:
 3,298,708, INT. CL. 9.
 FORZA, ASHEVILLE, NC:
 3,299,086, INT. CL. 43.
 FOTOFICTION, INC., HARTFORD, CT:
 3,297,252, PUB. 7-10-2007. INT. CL. 25.
 FOTOVISTA, FRANCE:
 3,298,173, PUB. 7-10-2007. MULTIPLE CLASS, INT. CLS. 9, 16, 35, 38 AND 42.
 FOUNDATION FOR ADVANCEMENTS IN SCIENCE AND EDUCATION, LOS ANGELES, CA, AKA FASE:
 2,081,978, REN. 8-20-07. MULTIPLE CLASS, INT. CLS. 9 AND 16.
 FOUR SEASONS INT'L CORP., GARDENA, CA:
 2,403,987, CANC. MULTIPLE CLASS, INT. CLS. 25 AND 28.
 FOURSTAR GROUP INC., TAIPEI, TAIWAN:
 3,296,914, PUB. 7-10-2007. INT. CL. 9.
 FOX ENTERPRISES, INC., FORT MYERS, FL:
 3,299,179, MULTIPLE CLASS, INT. CLS. 9 AND 40.
 FOX, PATRICIA, NEW YORK, NY:
 3,296,947, PUB. 7-10-2007. INT. CL. 42.
 FOXMARKS, INC., SAN FRANCISCO, CA:
 3,297,659, PUB. 7-10-2007. MULTIPLE CLASS, INT. CLS. 9 AND 42.
 FOXVIDEO, INC., LOS ANGELES, CA:
 1,416,448, CANC. INT. CL. 9.
 FOXWORTHY, JEFF, SHERMAN OAKS, CA:
 3,297,993, PUB. 7-10-2007. INT. CL. 29.
 FP STORES, INC., GARDENA, CA:
 1,416,719, CANC. INT. CL. 25.
 FPIC INSURANCE GROUP, INC., JACKSONVILLE, FL:
 2,145,891, REN. 8-22-07. INT. CL. 36.
 FPS TRAINING CORP., OVERLAND PARK, KS:
 3,296,456, PUB. 7-10-2007. INT. CL. 35.
 FQZ, LLC D/B/A SHERBROOKE CELLARS, WHITE PLAINS, NY:
 3,299,797, INT. CL. 33.
 3,299,798, INT. CL. 33.
 3,299,806, INT. CL. 33.
 FQZ, LLC D/B/A/ SHERBROOKE CELLARS, WHITE PLAINS, NY:
 3,299,799, INT. CL. 33.
 FRAMECO. PTY. LTD, ORCHARDS, VIC 3114, AUSTRALIA:
 2,403,594, CANC. INT. CL. 7.
 2,403,595, CANC. INT. CL. 8.
 FRANCO, JOSEPH, BROOKLYN, NY:
 3,298,819, INT. CL. 18.
 FRANCOYTP-POSTALIA GMBH, D-16647 BIRKENWERDER, FED REP GERMANY:
 3,297,700, PUB. 7-10-2007. MULTIPLE CLASS, INT. CLS. 2 AND 16.
 FRANK LIN DISTILLERS PRODUCTS, LTD., SAN JOSE, CA:
 3,296,723, PUB. 7-10-2007. INT. CL. 33.
 FRANKLIN CONNECTIONS, L.P., EL PASO, TX:
 3,297,950, PUB. 2-6-2007. INT. CL. 29.
 FRANKLIN INTERNATIONAL, INC., COLUMBUS, OH:
 3,299,983, INT. CL. 1.
 FRANKLIN LOUFRANI, UNITED KINGDOM:
 3,298,278, PUB. 7-10-2007. MULTIPLE CLASS, INT. CLS. 14, 18 AND 25.
 FRANKLIN SPORTS, INC., STOUGHTON, MA:
 3,299,748, INT. CL. 28.
 FRANKLIN'S KITE, LITHIA, FL:
 3,296,666, PUB. 7-10-2007. INT. CL. 42.
 FRANSON TECHNOLOGY AB, SWEDEN:
 3,298,381, PUB. 7-10-2007. MULTIPLE CLASS, INT. CLS. 9 AND 42.
 FRATELLI LOLLINO, INC., CHICAGO, IL:
 2,404,244, CANC. MULTIPLE CLASS, INT. CLS. 30 AND 42.
 FRAUDHALT LTD, DUBLIN 3, IRELAND:
 3,299,015, INT. CL. 35.
 FRAUNHOFER-GESELLSCHAFT ZUR FÖRDERUNG DER ANGEWANDTEN FORSCHUNG E.V., FED REP GERMANY:
 3,298,169, PUB. 7-10-2007. MULTIPLE CLASS, INT. CLS. 9, 16, 41 AND 42.
 FRCH DESIGN WORLDWIDE-CINCINNATI, INC., CINCINNATI, OH:
 3,298,041, PUB. 7-10-2007. MULTIPLE CLASS, INT. CLS. 35, 37, 42 AND 45.
 FRED MEYER STORES, INC., PORTLAND, OR:
 3,299,180, MULTIPLE CLASS, INT. CLS. 7, 9, 11 AND 20.
 FREDERIC F. FOX, AUSTIN, TX:
 3,300,077, INT. CL. 30.
 FREDERICK MOSTERT, LONDON, WIJ 5QT, UNITED KINGDOM:
 3,297,383, PUB. 7-10-2007. MULTIPLE CLASS, INT. CLS. 41 AND 43.
 FREDERICK WARNE & CO., INC., NEW YORK, NY:
 2,015,020, CANC. INT. CL. 41.
 3,296,322, PUB. 7-10-2007. MULTIPLE CLASS, INT. CLS. 9 AND 16.
 FREDRIKSON, DOUGLAS W., PHOENIX, AZ AND VECCHIA, PAUL, PHOENIX, AZ:
 3,298,607, INT. CL. 28.
 FREE GEEK INC., PORTLAND, OR:
 3,297,589, PUB. 7-10-2007. INT. CL. 41.
 FREE SPIRIT PUBLISHING INC., MINNEAPOLIS, MN:
 3,298,792, MULTIPLE CLASS, INT. CLS. 9 AND 16.
 FREE-FLOW PACKAGING INTERNATIONAL, INC., REDWOOD CITY, CA:
 1,470,429, REN. 8-23-07. INT. CL. 7.
 FREEDOM GRILL, INC., POWAY, CA:
 3,297,917, PUB. 11-21-2006. INT. CL. 11.
 FREELIFE INTERNATIONAL HOLDINGS, LLC, PHOENIX, AZ:
 3,296,761, PUB. 6-5-2007. INT. CL. 41.
 FREELIFE INTERNATIONAL HOLDINGS, LLC, MILFORD, CT:
 3,298,746, INT. CL. 32.

- FREEMAN, RICHARD B., ROCHESTER, NY:
3,296,639, PUB. 7-10-2007. INT. CL. 43.
- FREEMAN, TIFFANY, BRONX, NY:
3,296,247, PUB. 7-10-2007. INT. CL. 25.
- FREESCALE SEMICONDUCTOR, INC., AUSTIN, TX:
2,053,242, REN. 8-17-07. INT. CL. 9.
- FREIGHTLINER LLC, PORTLAND, OR:
3,298,787, MULTIPLE CLASS, INT. CLS. 35 AND 37.
- FREIGHTPRO.COM, INC., OVERLAND PARK, KS:
2,404,027, CANC. INT. CL. 39.
- FREMONT MACHINE & TOOL, INC., FREMONT, NE:
2,404,422, CANC. INT. CL. 7.
- FRENCH COMPONENTS CORPORATION, TWINSBURG, OH:
3,297,400, PUB. 7-10-2007. INT. CL. 20.
3,297,401, PUB. 7-10-2007. INT. CL. 20.
3,297,402, PUB. 7-10-2007. INT. CL. 12.
- FRENZOO LTD, HONG KONG, HONG KONG:
3,296,302, PUB. 7-10-2007. INT. CL. 45.
- FRESENIUS MEDICAL CARE HOLDINGS, INC., WALTHAM, MA:
1,495,603, REN. 8-22-07. INT. CL. 5.
3,297,835, PUB. 7-10-2007. INT. CL. 9.
3,297,843, PUB. 7-10-2007. INT. CL. 9.
- FRESH EXPRESS INCORPORATED, SALINAS, CA:
3,299,910, INT. CL. 29.
- FRESH INTELLECTUAL PROPERTIES, INC., WILMINGTON, DE:
3,298,578, INT. CL. 31.
3,300,000, INT. CL. 31.
- FRESH LILY, LLC, SAN FRANCISCO, CA:
3,300,140, INT. CL. 25.
- FRIATEC AKTIENGESELLSCHAFT, MANNHEIM, FED REP GERMANY, FRIEDRICHSFELD GMBH, KERAMIK-UND KUNSTSTOFFWERKE, MANNHEIM, FED REP GERMANY:
1,456,091, REN. 8-23-07. MULTIPLE CLASS, INT. CLS. 9 AND 17.
- FRIENDS&CO APPAREL INC., MAMRONECK, NY:
3,296,857, PUB. 7-10-2007. INT. CL. 25.
- FRIO TECHNOLOGIES INC., SAN ANTONIO, TX:
3,297,639, PUB. 7-10-2007. INT. CL. 5.
- FRITZ PAK CORPORATION, DALLAS, TX, FRITZ INDUSTRIES, INC., DALLAS, TX:
2,084,008, REN. 8-20-07. INT. CL. 1.
- FRONTEC AMT AKTIEBOLAG, 171 52 SOLNA, SWEDEN TO VIEWLOCITY, INC., ATLANTA, GA:
2,016,102, CANC. INT. CL. 9.
- FRONTIER NUTRITION INCORPORATED, MARSHALL, MN:
3,297,285, PUB. 4-10-2007. INT. CL. 5.
3,297,286, PUB. 2-13-2007. INT. CL. 35.
- FRUITMAN, COREY, TORONTO, ONTARIO, CANADA:
3,297,481, PUB. 7-10-2007. INT. CL. 9.
- FU DA INTERNATIONAL LTD., NEW YORK, NY:
2,094,565, REN. 8-17-07. INT. CL. 25.
- FUENTE MARKETING LTD., TORTOLA, BR. VIRGIN ISLANDS:
3,297,239, PUB. 7-10-2007. INT. CL. 3.
3,297,987, PUB. 7-10-2007. INT. CL. 34.
- FUJINON CORPORATION, SAITAMA-SHI, SAITAMA-KEN, JAPAN:
3,297,259, PUB. 10-10-2006. INT. CL. 10.
- FULL COMPASS SYSTEMS, LTD., MIDDLETON, WI:
3,298,870, INT. CL. 9.
- FULL VISION, INC., NEWTON, KS:
3,297,326, PUB. 7-10-2007. INT. CL. 7.
- FULLER, JANE E. DBA SANTA BARBARA SPICE COMPANY, LOMPOC, CA:
3,297,680, PUB. 7-10-2007. INT. CL. 30.
- FULTON INDUSTRIES AUSTRALIA PTY LTD., WEST GOSFORD, NSW, AUSTRALIA:
3,297,275, PUB. 7-10-2007. MULTIPLE CLASS, INT. CLS. 9 AND 42.
- FUMIGATION UNLIMITED, INC., HARAHAAN, LA:
3,298,145, PUB. 7-10-2007. MULTIPLE CLASS, INT. CLS. 37 AND 42.
- FUN WERBEAGENTUR GMBH, D-63263 NEU ISENBURG, FED REP GERMANY:
2,403,318, CANC. INT. CL. 10.
- FUND FOR AMERICA'S LIBRARIES, CHICAGO, IL TO AMERICAN LIBRARY ASSOCIATION, CHICAGO, IL:
2,016,509, CANC. INT. CL. 42.
- FUND FOR PHILADELPHIA, INC., PHILADELPHIA, PA:
1,416,386, CANC. MULTIPLE CLASS, INT. CLS. 6, 12, 14, 16, 18, 20, 21, 24, 25, 26 AND 35.
- FUNFACTORY USA, INC., BURBANK, CA:
3,298,843, INT. CL. 10.
- FUNIMATION PRODUCTIONS, LTD., FORT WORTH, TX:
3,299,211, INT. CL. 16.
3,299,212, INT. CL. 28.
- FURMANITE INTERNATIONAL LIMITED, KENDAL, CUMBRIA, ENGLAND:
1,416,446, CANC. INT. CL. 9.
- FURR'S SUPERMARKETS, INC., ALBUQUERQUE, NM:
2,403,165, CANC. INT. CL. 35.
- FURUKAWA ELECTRIC NORTH AMERICA, INC., NORCROSS, GA:
3,296,774, PUB. 7-10-2007. INT. CL. 40.
- FUZHOU CANGSHAN TIANJIAN; CHOPSTICKS FACTORY, FUZHOU, FUJIAN 350008, CHINA:
3,298,306, PUB. 7-10-2007. INT. CL. 21.
- FUZHOU RONGLIN JIXIE; YOUXIAN GONGSI, CHINA:
3,298,234, PUB. 7-10-2007. INT. CL. 12.
- G CORP. USA, DELRAY BEACH, FL:
3,299,374, INT. CL. 40.
- G. LOOMIS, INC., WOODLANE, WA:
2,469,517, AM. INT. CL. 25.
- G.F.M. INDUSTRIA SPA, ITALY:
3,298,293, PUB. 7-10-2007. INT. CL. 18.
- G&D TRANSPORTATION, INC., MORTON, IL:
3,298,553, MULTIPLE CLASS, INT. CLS. 35, 37, 39 AND 40.
3,298,554, MULTIPLE CLASS, INT. CLS. 35, 37, 39 AND 40.
3,298,555, MULTIPLE CLASS, INT. CLS. 35, 37, 39 AND 40.
- GA MODEFINE S.A., SWITZERLAND:
3,298,242, PUB. 7-10-2007. MULTIPLE CLASS, INT. CLS. 18 AND 35.
- GABRIEL MCCUBBIN, SACRAMENTO, CA:
3,296,766, PUB. 7-10-2007. INT. CL. 16.
- GAIA HERBS, INC., BREVARD, NC:
3,299,735, INT. CL. 5.
3,299,833, INT. CL. 5.
3,299,868, INT. CL. 5.
- GALACTIC INDUSTRIES CORPORATION, SALEM, NH TO THERMO LABSYSTEMS INC, SALEM, NH:
2,015,370, CANC. INT. CL. 9.
- GALAXY INVESTORS, INC., BISMARCK, ND, BANK, MORT, BISMARCK, ND:
2,084,485, REN. 8-23-07. INT. CL. 42.
- GALEN MANAGEMENT, L.L.C., STAMFORD, CT:
3,296,937, PUB. 7-10-2007. INT. CL. 36.
3,296,938, PUB. 7-10-2007. INT. CL. 36.
- GALERIE D'ORSAY, BOSTON, MA:
3,297,943, PUB. 7-10-2007. INT. CL. 35.
- GALERIE D'ORSAY, LLC, BOSTON, MA:
3,297,916, PUB. 7-10-2007. INT. CL. 35.
- GALILEO TECHNOLOGY, INC., SAN JOSE, CA TO GALILEO TECHNOLOGY LTD, MISGAV 20184, ISRAEL:
2,014,994, CANC. MULTIPLE CLASS, INT. CLS. 40 AND 42.
- GALILEO TECHNOLOGY, INC., SAN JOSE, CA TO GALILEO TECHNOLOGY, LTD, MISGAV, ISRAEL:
2,014,995, CANC. INT. CL. 9.
- GALLOW, HERMOINE DARLENE, STAFFORD, TX:
3,299,047, INT. CL. 25.
- GALYAN'S TRADING COMPANY INC, PLAINFIELD, IN TO GALYAN'S NEVADA, INC., LOS VEGAS, NV:
2,015,608, CANC. INT. CL. 42.
- GAMBRO LUNDIA AB, LUND, SWEDEN:
3,298,087, PUB. 7-10-2007. INT. CL. 10.
3,298,088, PUB. 7-10-2007. INT. CL. 10.

- GAME FANATIX LLC, AGOURA HILLS, CA:
3,296,806, PUB. 7-10-2007. INT. CL. 35.
- GAMELOGIC INC., WALTHAM, MA:
3,298,731, INT. CL. 41.
- GAMING LOTTERY CORPORATION, ROAD TOWN, TORTOLA, BR. VIRGIN ISLANDS:
2,404,586, CANC. INT. CL. 41.
- GANDALF'S VISION, BREA, CA:
2,016,571, CANC. MULTIPLE CLASS, INT. CLS. 16, 21, 25 AND 42.
- GANDER MOUNTAIN COMPANY, ST. PAUL, MN:
1,335,485, REN. 8-23-07. INT. CL. 35.
1,335,485, CANC. INT. CL. 16.
- GANNAWAY, RICHARD LAYTON, SAFETY HARBOR, FL:
3,298,887, INT. CL. 41.
- GANNETT SATELLITE INFORMATION NETWORK, INC., ARLINGTON, VA:
1,417,063, CANC. INT. CL. 16.
- GANSTERER, PETER, A-2483 EBREICHS DORF, AUSTRIA:
3,296,000, PUB. 7-10-2007. INT. CL. 9.
- GAP (APPAREL), LLC, SAN FRANCISCO, CA:
1,097,038, REN. 8-23-07. INT. CL. 42.
3,298,627, INT. CL. 3.
3,298,628, INT. CL. 3.
3,298,629, INT. CL. 3.
3,298,630, INT. CL. 3.
3,298,631, INT. CL. 3.
3,298,632, INT. CL. 3.
- GARBER ESTHER, LOS ANGELES, CA AND PYRES P IVOR, LOS ANGELES, CA:
3,297,928, PUB. 7-10-2007. INT. CL. 36.
- GARCIA-PEDROSO, GONZALO, MIAMI, FL:
3,299,363, MULTIPLE CLASS, INT. CLS. 18 AND 25.
- GARDEN FRESH OF IDAHO LLC, ABERDEEN, ID:
2,403,705, CANC. INT. CL. 29.
- GARDINER, WALTER, ELLENVILLE, NY:
3,298,495, MULTIPLE CLASS, INT. CLS. 8 AND 35.
- GARDNER DENVER, INC., QUINCY, IL:
2,404,616, CANC. INT. CL. 4.
- GARDNER INDUSTRIES, TAMPA, FL:
2,016,001, CANC. INT. CL. 19.
- GARDNER, JOHN H, AGOURA HILLS, CA:
3,296,483, PUB. 7-10-2007. INT. CL. 35.
- GARLOCK INC., PALMYRA, NY:
1,076,821, REN. 8-17-07. INT. CL. 7.
- GARRETT S. BLACKWELDER, GREENVILLE, NC:
3,296,909, PUB. 7-10-2007. MULTIPLE CLASS, INT. CLS. 16 AND 28.
- GARY J. HOBERMAN, D.P.M. & ASSOCIATES, S.C., CHICAGO, IL:
3,296,502, PUB. 6-26-2007. INT. CL. 44.
- GAS TECHNOLOGY INSTITUTE, DES PLAINES, IL:
2,076,267, REN. 8-22-07. INT. CL. 42.
- GASBUDDY ORGANIZATION INC, BROOKLYN PARK, MN:
3,296,816, PUB. 7-10-2007. INT. CL. 35.
- GASPERINI, PAUL, FORT LAUDERDALE, FL:
2,403,663, CANC. INT. CL. 35.
- GASTRO PUBS, LTD., FORT WORTH, TX:
3,299,275, INT. CL. 43.
- GATEWAY COMMUNICATIONS, INC., TUCSON, AZ, BI-TRONICS, INC., TUCSON, AZ:
2,081,119, REN. 8-18-07. INT. CL. 9.
- GATEWAY TO L.A., INC., LOS ANGELES, CA:
3,297,079, PUB. 7-10-2007. INT. CL. 39.
- GATEWAY 2000, INC., NORTH SIOUX CITY, SD:
2,404,676, CANC. MULTIPLE CLASS, INT. CLS. 9 AND 42.
- GATEWAY, INC., IRVINE, CA:
2,073,470, REN. 8-17-07. INT. CL. 35.
- GAUSE, GEOFFREY W., LAKE FOREST, CA:
3,297,620, PUB. 7-10-2007. INT. CL. 42.
- GBH COMMUNICATIONS, INC., GLENDALE, CA:
2,086,550, REN. 8-23-07. INT. CL. 6.
- GE FANUC AUTOMATION AMERICAS, INC., CHARLOT-TESTEVILLE, VA:
2,404,073, CANC. INT. CL. 9.
- GE HEALTHCARE UK LIMITED, BUCKINGHAMSHIRE, UNITED KINGDOM:
3,299,050, INT. CL. 1.
- GE MONEY BANK, SALT LAKE CITY, UT:
3,299,738, INT. CL. 36.
- GECK, TERRY LEWIS, PALATKA, FL:
2,403,838, CANC. INT. CL. 30.
- GEEK TEKS, INC., JOLIET, IL:
3,299,695, INT. CL. 37.
- GEMCOM, LLC, OMAHA, NE:
3,296,396, PUB. 6-26-2007. INT. CL. 35.
- GEMINI INDUSTRIES, INC., SANTA ANA, CA:
3,296,828, PUB. 7-10-2007. INT. CL. 40.
- GENERAL CABLE TECHNOLOGIES CORPORATION, HIGHLAND HEIGHTS, KY:
2,403,786, CANC. INT. CL. 35.
- GENERAL ELECTRIC COMPANY, SCHENECTADY, NY:
1,074,489, REN. 8-20-07. INT. CL. 11.
1,448,350, REN. 8-18-07. INT. CL. 11.
2,085,054, REN. 8-17-07. INT. CL. 9.
- GENERAL ELECTRIC COMPANY, PITTSFIELD, MA:
2,403,884, CANC. MULTIPLE CLASS, INT. CLS. 1 AND 3.
- GENERAL ELECTRIC COMPANY, CLEVELAND, OH:
3,296,300, PUB. 7-10-2007. INT. CL. 11.
- GENERAL ELECTRIC COMPANY, SCHENECTADY, NY:
3,296,336, PUB. 7-10-2007. MULTIPLE CLASS, INT. CLS. 7, 37 AND 42.
- GENERAL ELECTRIC COMPANY, SCHENECTADY, NY:
3,299,170, INT. CL. 9.
- GENERAL ELECTRIC COMPANY, SCHENECTADY, NY:
3,299,609, INT. CL. 9.
- GENERAL HOLDINGS, LLC, WINNSBORO, SC:
3,297,951, PUB. 2-6-2007. INT. CL. 35.
- GENERAL MILLS IP HOLDINGS I, LLC, MINNEAPOLIS, MN:
3,299,987, INT. CL. 30.
- GENERAL MILLS, INC., MINNEAPOLIS, MN:
3,299,396, INT. CL. 35.
- GENERAL NUTRITION INVESTMENT COMPANY, WIL-MINGTON, DE TO GENERAL NUTRITION INVEST-MENT COMPANY, PITTSBURGH, PA:
2,015,803, CANC. INT. CL. 5.
- GENERAL NUTRITION INVESTMENT COMPANY, PITTS-BURGH, PA:
2,404,874, CANC. INT. CL. 5.
2,404,879, CANC. INT. CL. 5.
- GENERAL SIGNAL TECHNOLOGY CORPORATION, STAMFORD, CT TO GSLE DEVELOPMENT CORPORA-TION, MUSKEGON, MI:
2,016,496, CANC. INT. CL. 11.
- GENERATE, INC., MAYNARD, MA:
3,300,383, MULTIPLE CLASS, INT. CLS. 35 AND 42.
- GENESIS HEALTH, INC., JACKSONVILLE, FL:
3,297,923, PUB. 7-10-2007. INT. CL. 44.
- GENEZEN HEALTHCARE, INC., ADDISON, TX:
3,296,819, PUB. 7-10-2007. INT. CL. 44.
- GENG, LISA FERNANDEZ, WARREN, NJ:
2,404,445, CANC. INT. CL. 5.
- GENISOY FOOD COMPANY, INC., TULSA, OK:
3,296,523, PUB. 7-10-2007. INT. CL. 29.
- GENITOPE CORPORATION, REDWOOD CITY, CA:
3,296,709, PUB. 7-10-2007. INT. CL. 42.
- GENMAR INDUSTRIES, INC., MINNEAPOLIS, MN:
1,455,173, REN. 8-17-07. INT. CL. 12.
- GENMAR IP LLC, MINNEAPOLIS, MN:
3,300,015, INT. CL. 12.
3,300,016, INT. CL. 12.
- GENNARO AURICCHIO S.P.A., 26100 CREMONA, ITALY:
1,092,901, REN. 8-17-07. INT. CL. 29.
- GENOVISION, INC., EXTON, PA:
2,404,194, CANC. INT. CL. 1.
- GENTA INCORPORATED, BERKELEY HEIGHTS, NJ:
3,296,686, PUB. 7-10-2007. INT. CL. 44.
- GENZYME SURGICAL PRODUCTS CORPORATION, CAM-BRIDGE, MA:
2,403,563, CANC. INT. CL. 10.

- GEO. PFAU'S SONS COMPANY, INC., JEFFERSONVILLE, IN:
3,298,676, INT. CL. 1.
- GEOFFREY, INC., WAYNE, NJ:
2,404,766, CANC. INT. CL. 28.
2,404,767, CANC. INT. CL. 28.
- GEORGE BASCH COMPANY, INC., THE, FREEPORT, NY:
2,079,169, REN. 8-22-07. INT. CL. 3.
- GEORGE LITTLE MANAGEMENT, LLC, WHITE PLAINS, NY:
3,300,246, INT. CL. 35.
3,300,247, INT. CL. 35.
- GEORGE NOTTOLI & SON, INC., CHICAGO, IL:
3,296,039, PUB. 7-10-2007. MULTIPLE CLASS, INT. CLS. 30 AND 43.
3,296,040, PUB. 7-10-2007. INT. CL. 29.
- GEORGE TAUB PRODUCTS & FUSION COMPANY, INC., JERSEY CITY, NJ, DBA JORDAN BENJAMIN COMPANY:
2,014,804, CANC. INT. CL. 1.
- GEORGE, PETER T., HONOLULU, HI:
3,296,678, PUB. 7-10-2007. INT. CL. 10.
- GEORGETOWN COLLEGE, GEORGETOWN, KY:
2,403,450, CANC. INT. CL. 41.
- GEORGIA DEPARTMENT OF COMMUNITY HEALTH, ATLANTA, GA:
3,297,540, PUB. 7-10-2007. INT. CL. 44.
- GEORGIA-PACIFIC GYPSUM LLC, ATLANTA, GA:
3,297,548, PUB. 7-10-2007. INT. CL. 19.
- GEOTOUCH.COM, INC., REDWOOD CITY, CA:
2,403,961, CANC. INT. CL. 42.
- GERMANE SYSTEMS, LC, CHANTILLY, VA:
3,295,983, PUB. 7-10-2007. MULTIPLE CLASS, INT. CLS. 9 AND 42.
- GET SET CLUB, INC., THE, PHILADELPHIA, PA:
2,403,888, CANC. INT. CL. 28.
- GETABSTRACT LTD (SWITZERLAND), LUCERNE, SWITZERLAND:
3,296,570, PUB. 7-10-2007. INT. CL. 42.
- GETRAG GETRIEBE-UND ZAHNRADFABRIK HERMANN HAGENMEYER GMBH & CIE KG, UNTERGRUPPENBACH, FED REP GERMANY:
3,297,228, PUB. 7-10-2007. MULTIPLE CLASS, INT. CLS. 7, 9 AND 12.
- GF HEALTH PRODUCTS, INC., ATLANTA, GA:
2,137,212, REN. 8-23-07. INT. CL. 12.
- GF PROPERTIES GROUP, LLC, DURANGO, CO:
3,297,289, PUB. 7-10-2007. MULTIPLE CLASS, INT. CLS. 36 AND 37.
- GIANT BICYCLE, INC., NEWBURY PARK, CA:
3,299,429, INT. CL. 12.
3,299,430, INT. CL. 12.
3,299,431, INT. CL. 12.
- GIANT EAGLE, INC., PITTSBURGH, PA TO PHOENIX INTANGIBLES HOLDING COMPANY, GREENVILLE, DE:
2,015,259, CANC. INT. CL. 29.
- GIANT SCREEN THEATER ASSOCIATION, ST.PAUL, MN:
2,403,329, CANC. INT. CL. 42.
- GIANT TIGER STORES LIMITED, OTTAWA, ONTARIO KIG 6A9, CANADA:
2,176,419, REN. 8-22-07. INT. CL. 35.
- GIBONEY, THOMAS B., DALLAS, TX:
2,403,798, CANC. INT. CL. 42.
- GIBRALTAR, LLC, SEATTLE, WA:
3,297,023, PUB. 7-10-2007. MULTIPLE CLASS, INT. CLS. 36 AND 37.
- GIFTCO, INC., VERNON HILLS, IL:
2,090,023, REN. 8-17-07. INT. CL. 36.
- GIGGLE WEAR L.L.C., ST. LOUIS, MO:
3,296,858, PUB. 7-10-2007. INT. CL. 18.
- GILBERT, GEORGE LANCE, BREMERTON, CA:
2,015,043, CANC. INT. CL. 9.
- GILC HOLDING CORP., WILMINGTON, DE:
1,416,578, CANC. INT. CL. 16.
1,416,579, CANC. INT. CL. 16.
- GINNIE JOHANSEN DESIGNS, INC., DALLAS, TX:
1,416,340, CANC. INT. CL. 3.
- GINTER PARK TECHNOLOGIES, INC., RICHMOND, VA:
2,404,145, CANC. INT. CL. 42.
- GIRI CORPORATION, MILWAUKEE, WI:
2,122,605, REN. 8-17-07. INT. CL. 30.
- GIRLS GO OUTSIDE, BEND, OR:
3,296,993, PUB. 7-10-2007. INT. CL. 41.
- GIUNTA, CHRISTOPHER, BROOKLYN, NY:
3,297,431, PUB. 9-12-2006. INT. CL. 25.
- GIVING USA FOUNDATION, INC., GLENVIEW, IL:
3,298,040, PUB. 7-10-2007. INT. CL. 36.
- GLANBIA PLC, KILKENNY, IRELAND:
3,300,130, INT. CL. 5.
- GLASENAPP, GERALDINE, GLENDALE HEIGHTS, IL:
3,296,455, PUB. 7-10-2007. INT. CL. 16.
- GLASER, DONALD J., EMPORIA, KS:
3,299,116, INT. CL. 7.
- GLASSMERE FUEL SERVICE, INC., TARENTUM, PA:
3,297,758, PUB. 7-10-2007. INT. CL. 1.
- GLATT MASCHINEN- UND APPARATEBAU AG, PRATELN, SWITZERLAND:
3,297,824, PUB. 7-10-2007. INT. CL. 7.
- GLAXO GROUP LIMITED, GREENFORD, UNITED KINGDOM:
3,191,090, COR. INT. CL. 5.
- GLO-JO TREASURES, LLC, MONTGOMERY, NY:
3,298,476, INT. CL. 18.
- GLOBAL DIRECT SALES LLC, GAITHERSBURG, MD:
3,297,948, PUB. 7-10-2007. INT. CL. 35.
3,297,949, PUB. 7-10-2007. INT. CL. 35.
- GLOBAL EMERGENCY RESOURCES, LLC, EVANS, GA:
3,299,269, INT. CL. 9.
- GLOBAL ENVIRONMENT MANAGEMENT (FZC), UNITED ARAB EMIR.:
3,298,156, PUB. 7-10-2007. INT. CL. 20.
- GLOBAL OUTDOOR PRODUCTS, SANTA PAULA, CA:
3,299,014, INT. CL. 25.
- GLOBAL PHARMACEUTICAL SERVICES, SHREWSBURY, NJ:
3,300,006, INT. CL. 35.
- GLOBAL SAFE ZONE, INC., LANSDOWNE, VA:
3,296,048, PUB. 7-10-2007. INT. CL. 41.
- GLOBAL VINEYARD IMPORTERS, INC., CAMPBELL, CA:
2,404,779, CANC. INT. CL. 33.
- GLOBAL VR, INC., SAN JOSE, CA:
3,299,070, INT. CL. 28.
- GLOBALSTEM, INCORPORATED, ROCKVILLE, MD:
3,296,892, PUB. 7-10-2007. INT. CL. 42.
- GLOBE HOLDING COMPANY, LLC, PITTSFIELD, NH:
3,296,441, PUB. 7-10-2007. INT. CL. 9.
- GLORY LTD., HIMEJI-SHI, HYOGO-KEN, JAPAN:
1,451,930, REN. 8-18-07. INT. CL. 9.
- GMAC MORTGAGE LLC, WILMINGTON, DE:
3,298,930, INT. CL. 36.
- GO NATUR'L STUDIOS, LLC, RIDGEFIELD, CT:
3,297,635, PUB. 7-10-2007. MULTIPLE CLASS, INT. CLS. 16, 21 AND 41.
- GOALSGUY LEARNING SYSTEMS, INC., PALM HARBOR, FL:
3,298,992, INT. CL. 16.
- GOAT FUNCTION LLC, BOULDER, CO:
3,300,112, MULTIPLE CLASS, INT. CLS. 18 AND 25.
- GOD'S GREATEST GIFT, LLC, MANCHESTER, MI:
3,300,143, INT. CL. 16.
- GOFF, EUGENE F., MACEDON, NY:
3,296,745, PUB. 7-10-2007. INT. CL. 9.
- GOINES, TERESA JEAN, SAN FRANCISCO, CA:
3,297,407, PUB. 7-10-2007. MULTIPLE CLASS, INT. CLS. 41 AND 43.
- GOING GLOBAL, INC., MOBILE, AL:
3,296,869, PUB. 7-10-2007. INT. CL. 9.
- GOLD'S GYM LICENSING LLC, IRVING, TX:
3,296,366, PUB. 7-10-2007. MULTIPLE CLASS, INT. CLS. 25, 28 AND 41.
- GOLDCREDIT INTERNATIONAL; ENTERPRISES LTD., CHINA:
3,298,325, PUB. 7-10-2007. MULTIPLE CLASS, INT. CLS. 16 AND 21.

- GOLDEN MARDI GRAS, INC., LAS VEGAS, NV:
3,297,550, PUB. 7-10-2007. INT. CL. 41.
- GOLDEN ORCHARD FRANCHISING, INC., CASTLE ROCK, CO:
3,297,518, PUB. 7-10-2007. INT. CL. 35.
3,297,519, PUB. 7-10-2007. INT. CL. 35.
- GOLDEN STATE WARRIORS, LLC, OAKLAND, CA, CC PARTNERS, OAKLAND, CA:
2,091,537. REN. 8-22-07. INT. CL. 25.
- GOLDEN TECHNOLOGIES, INC., OLD FORGE, PA:
3,298,860, INT. CL. 20.
- GOLDMAN ARTS, INC., CONCORD, MA:
2,014,767, CANC. INT. CL. 25.
- GOLF GALAXY GOLFWORKS, INC., NEWARK, OH:
3,297,821, PUB. 7-10-2007. INT. CL. 28.
- GOLF WARRIOR LLC, OAK HILL, VA, DBA GOLF WARRIOR LLC:
3,066,475, CANC. INT. CL. 28.
- GOLF-TECH LIMITED, WILTSHIRE, UNITED KINGDOM:
3,297,588, PUB. 7-10-2007. INT. CL. 28.
- GOLUB-EVANS, JEFFREY, NEW YORK, NY:
3,296,023, PUB. 7-10-2007. INT. CL. 44.
- GONDA INTERNATIONAL, INC., ROSEMEAD, CA:
2,404,717, CANC. INT. CL. 9.
- GOOD BUDDY, INC., LOS ANGELES, CA:
3,298,441, INT. CL. 25.
- GOOD HURT, LLC, LOS ANGELES, CA:
3,298,940, MULTIPLE CLASS, INT. CLS. 41 AND 43.
- GOOD LIFE, LLC, JACKSONVILLE, OR:
3,298,951, INT. CL. 10.
- GOOD PET PRODUCTS, LTD., HEREFORD, TX:
3,297,142, PUB. 7-10-2007. INT. CL. 31.
- GOODS FOR GOOD, INC., NEW YORK, NY:
3,296,552, PUB. 7-10-2007. INT. CL. 35.
- GOODYEAR TIRE & RUBBER COMPANY, THE, AKRON, OH:
3,299,307, INT. CL. 12.
- GOOZEX, INC., COLLEGE PARK, MD:
3,296,970, PUB. 7-10-2007. INT. CL. 35.
3,297,059, PUB. 7-10-2007. INT. CL. 35.
- GORTON'S, INC., GLOUCESTER, MA:
3,299,645, INT. CL. 29.
- GOSLING, ALISTAIR M./AL, LONDON, UNITED KINGDOM:
3,297,263, PUB. 7-10-2007. INT. CL. 32.
- GOSPEL LIGHT PUBLICATIONS, VENTURA, CA:
2,404,401, CANC. INT. CL. 16.
- GOSPEL MUSIC CHANNEL, LLC, ATLANTA, GA:
3,296,641, PUB. 7-10-2007. INT. CL. 41.
- GOTTROX LLC, CHICAGO, IL:
3,300,364, INT. CL. 9.
- GOTV NETWORKS, INC., SHERMAN OAKS, CA:
3,298,982, MULTIPLE CLASS, INT. CLS. 38 AND 41.
- GPX INTERNATIONAL TIRE CORPORATION, MALDEN, MA:
3,299,582, INT. CL. 12.
- GRÄFLICH VON HARDENBERG'SCHE KORNBRENNEREI GMBH & CO. KG, 37171 NÖRTEN-HARDENBERG, FED REP GERMANY:
3,297,179, PUB. 4-3-2007. INT. CL. 33.
- GRÄFLICH VON HARDENBERG'SCHE KORNBRENNEREI GMBH & CO. KG, NÖRTEN-HARDENBERG, FED REP GERMANY:
3,297,593, PUB. 7-10-2007. INT. CL. 33.
- GRACO CHILDREN'S PRODUCTS, INC., ATLANTA, IL:
3,299,034, INT. CL. 28.
- GRACO MINNESOTA INC., MINNEAPOLIS, MN:
3,296,536, PUB. 7-10-2007. INT. CL. 7.
3,300,137, INT. CL. 7.
3,300,171, INT. CL. 7.
- GRAF PAMELA L, ST GEORGE, UT:
3,297,049, PUB. 7-10-2007. INT. CL. 25.
- GRAMBLING STATE UNIVERSITY, GRAMBLING, LA:
3,296,482, PUB. 7-10-2007. MULTIPLE CLASS, INT. CLS. 6, 12, 16, 18, 20, 21, 24, 25, 27, 28 AND 41.
- GRAND HOTEL COMPANY, OKEMOS, MI:
2,103,059. REN. 8-20-07. INT. CL. 42.
2,103,060. REN. 8-20-07. INT. CL. 42.
- GRAND SIERRA OPERATING CORP., RENO, NV:
3,296,725, PUB. 7-10-2007. INT. CL. 41.
3,296,726, PUB. 7-10-2007. INT. CL. 45.
- GRANDE PROVENCE PROPERTIES (PTY) LIMITED, STELLENBOSCH, SOUTH AFRICA:
3,296,603, PUB. 7-10-2007. INT. CL. 33.
- GRANSTAFF, BRETT, CARTHAGE, TN:
3,299,968, INT. CL. 9.
- GRAPHIC INFORMATION SYSTEMS TECHNOLOGY, INC., NEW YORK, NY:
1,448,317. REN. 8-17-07. INT. CL. 9.
- GRAVIXX CORPORATION, SUNNYSVALE, CA:
3,298,124, PUB. 7-10-2007. MULTIPLE CLASS, INT. CLS. 41 AND 43.
- GRAYCO RESTORATION LLC, MISSION, KS:
3,300,145, INT. CL. 37.
- GRAYHILL, INC., LAGRANGE, IL:
3,299,296, INT. CL. 40.
- GRAYLING FILLER PRODUCTIONS, INC., DEXTER, MI:
2,015,536, CANC. INT. CL. 41.
- GREAT BUILDERS SOLUTIONS INC., TORONTO, ONTARIO, CANADA:
3,299,905, INT. CL. 9.
- GREAT NECK SAW MANUFACTURERS, INC., MINEOLA, NY:
2,171,881. REN. 8-20-07. INT. CL. 8.
- GREAT WESTERN BUILDING MATERIALS, INC., OXNARD, CA:
2,080,126. REN. 8-18-07. INT. CL. 19.
- GREATER CLEVELAND AUTOMOBILE DEALERS ASSOCIATION, BRECKSVILLE, OH:
3,296,611, PUB. 7-10-2007. INT. CL. 35.
- GREEN FROG MARKET BERNARD, LLC, BAKERSFIELD, CA:
3,296,419, PUB. 7-10-2007. INT. CL. 30.
- GREEN, JAMES E., SHREVEPORT, LA:
3,297,410, PUB. 7-10-2007. INT. CL. 41.
- GREEN, LYNN H., CHERRY HILL, NJ:
3,296,662, PUB. 7-10-2007. INT. CL. 43.
- GREENAWALT, JEFF, SANTA CRUZ, CA AND FREITAS, CYNDI L., SANTA CRUZ, CA:
2,403,304, CANC. INT. CL. 42.
- GREENGRASS PRODUCTIONS, INC., BURBANK, CA:
3,298,807, INT. CL. 41.
- GREGORY TERMITE & PEST CONTROL, INC., GREENVILLE, SC:
1,460,324. REN. 8-17-07. INT. CL. 37.
- GREGORY, CHRISTOPHER M., WASHINGTON, DC:
2,403,635, CANC. INT. CL. 35.
- GRELLER, JOYCE C., NEW YORK, NY, DBA GRELLER/TRANSORIUM:
1,445,649. REN. 8-23-07. INT. CL. 41.
- GREYCROFT LLC, NEW YORK, NY:
3,299,966, INT. CL. 36.
- GRIESHABER, JUDITH, STUTTGART, FED REP GERMANY:
2,403,851, CANC. MULTIPLE CLASS, INT. CLS. 25, 35 AND 42.
- GRIFFITH LABORATORIES LIMITED, SCARBOROUGH ONTARIO MIL 3J8, CANADA:
2,090,287. REN. 8-23-07. INT. CL. 30.
- GRIFFON CORPORATION, JERICHO, NY:
2,131,589. REN. 8-23-07. INT. CL. 35.
- GRINGO VENTURES, LLC, VISTA, CA:
3,296,999, PUB. 7-10-2007. INT. CL. 35.
- GRINS 2 GO, INC., SAN DIEGO, CA:
3,297,053, PUB. 7-10-2007. MULTIPLE CLASS, INT. CLS. 40 AND 41.
3,297,054, PUB. 7-10-2007. MULTIPLE CLASS, INT. CLS. 40 AND 41.
- GROMICKO, NICK, BOULDER, CO:
3,298,869, INT. CL. 16.
- GROMMETTE, LTD., NEWPORT, RI:
2,403,896, CANC. INT. CL. 25.
- GROUND SPEAK, INC., SEATTLE, WA:
3,298,035, PUB. 7-10-2007. MULTIPLE CLASS, INT. CLS. 12 AND 28.

- GROUP BENEFITS, LTD., URBANDEALE, IA:
3,300,250, INT. CL. 36.
- GROUP FITNESS USA, LLC, GAITHERSBURG, MD:
3,299,888, INT. CL. 41.
- GROUPE CANAM INC., BOUCHERVILLE, QUEBEC:
2,403,599, CANC. INT. CL. 42.
- GROVER, JEFF, SPENCER, NY:
3,297,619, PUB. 7-10-2007. INT. CL. 37.
- GROVES, WILLIAM A, DORAL, FL:
3,300,093, INT. CL. 9.
- GROWTH ORGANIZATION OF TOPEKA/SHAWNEE COUNTY, INC., TOPEKA, KS:
3,298,991, INT. CL. 36.
- GROZ-BECKERT KG, ALBSTADT, FED REP GERMANY:
1,067,263, REN. 8-22-07. INT. CL. 26.
- GRUGA U.S.A., CITY OF INDUSTRY, CA:
2,476,523, CANC. INT. CL. 11.
- GRUMA CORPORATION, IRVING, TX:
3,299,415, INT. CL. 30.
- GRUNENTHAL GMBH, D-52078 AACHEN, FED REP GERMANY:
2,403,782, CANC. INT. CL. 5.
- GRUPO AZOR MEXICO, S.A. DE C.V., INDUSTRIAL VALLEJO MEXICO, D.F. 02300, MEXICO:
3,298,435, INT. CL. 16.
- GRUPO INGRAM, S.A. DE C.V., MEXICO CITY, MEXICO:
3,297,222, PUB. 7-10-2007. INT. CL. 25.
- GRUPO, ANDREA S.A. DE C.V., LEON, GUANAJUATO, MEXICO:
2,643,146, AM. MULTIPLE CLASS, INT. CLS. 18, 25 AND 35.
- GRUPPO ITALIANO VINI S.P.A., VERONA, ITALY:
1,070,742, REN. 8-18-07. INT. CL. 33.
- GRUPPO LA PERLA S.P.A., BOLOGNA, ITALY, DALMAS S.P.A., BOLOGNA, ITALY:
1,466,404, REN. 8-20-07. INT. CL. 25.
- GRUPPO PIAZZETTA SPA, ITALY:
3,298,227, PUB. 7-10-2007. MULTIPLE CLASS, INT. CLS. 6, 11 AND 19.
- GRYPHON NEW YORK LLC, NEW YORK, NY:
3,300,071, INT. CL. 25.
- GT MEDIA, INC., BROOMFIELD, CO:
2,404,647, CANC. INT. CL. 9.
- GTES, LLC, BLAINE, WA:
3,299,044, MULTIPLE CLASS, INT. CLS. 9 AND 42.
- GUANGDONG FOODSTUFFS IMPORT & EXPORT (GROUP) CORPORATION, GUANGZHOU, CHINA:
2,475,013, CANC. MULTIPLE CLASS, INT. CLS. 31 AND 32.
- GUANGZHOU DONGXING; GIANTDRAGON STATIONERY & SPORTING GOODS CO., LTD., HUADU GUANGZHOU, CHINA:
3,298,221, PUB. 7-10-2007. INT. CL. 28.
- GUARDIAN ALARMS, INC., ARLINGTON, TX:
3,297,060, PUB. 7-10-2007. INT. CL. 37.
- GUARDIAN INDUSTRIES CORP., AUBURN HILLS, MI:
3,296,403, PUB. 7-10-2007. INT. CL. 19.
- GUILLEMOT CORPORATION S.A, 56910 CARENTOIR, FRANCE:
2,404,298, CANC. INT. CL. 9.
- GUITAR CENTER, INC., WESTLAKE VILLAGE, CA:
3,296,826, PUB. 6-26-2007. MULTIPLE CLASS, INT. CLS. 9 AND 15.
- GULF COAST VENTURES LLC, STUDIO CITY, CA:
3,299,638, INT. CL. 43.
- GULLIKSEN, GWEN, WHITTIER, CA:
3,299,519, INT. CL. 31.
- GUMLINK A/S, 7100 VEJLE, DENMARK:
3,299,062, INT. CL. 30.
- GUNA S.P.A., ITALY:
3,298,214, PUB. 7-10-2007. MULTIPLE CLASS, INT. CLS. 3, 5, 9, 16, 32, 39 AND 41.
- GUND, INC., EDISON, NJ:
1,416,795, CANC. INT. CL. 28.
- GUNLOCKE COMPANY, THE, WAYLAND, NY TO GUNLOCKE COMPANY, THE, WAYLAND, NY:
1,465,509, CANC. INT. CL. 20.
- GUNTER, JUTIKI T., OAKLAND, CA:
3,300,256, INT. CL. 36.
- GUSTAFSON, NILS H., GRANTS PASS, OR, DBA ARROW RACING:
2,151,576, REN. 8-23-07. INT. CL. 12.
- GUY CARPENTER & COMPANY, INC., NEW YORK, NY:
3,298,127, PUB. 7-10-2007. INT. CL. 42.
- GUZMAN, RENE, BEND, OR:
3,296,779, PUB. 7-10-2007. INT. CL. 41.
- GX TECHNOLOGY CORPORATION, HOUSTON, TX:
2,404,650, CANC. INT. CL. 9.
- H J HEINZ COMPANY AUSTRALIA LTD, HAWTHORNE EAST VIC, AUSTRALIA:
3,297,340, PUB. 7-10-2007. MULTIPLE CLASS, INT. CLS. 29 AND 30.
- H. D. LEE COMPANY, INC., THE, WILMINGTON, DE:
1,416,710, CANC. INT. CL. 25.
- H.B. FULLER LICENSING & FINANCING, INC., SAINT PAUL, MN:
2,404,837, CANC. INT. CL. 1.
- H.E. SERVICES COMPANY, SAGINAW, MI:
2,403,134, CANC. INT. CL. 42.
- H.G.V. HAUS UND GARTEN - MARKETING- UND- TRIEBSGESELLSCHAFT MBH, FED REP GERMANY:
3,298,200, PUB. 7-10-2007. MULTIPLE CLASS, INT. CLS. 6, 7 AND 12.
- H&L TOOTH COMPANY, MONTEBELLO, CA:
1,416,429, CANC. INT. CL. 7.
- H-D MICHIGAN, INC., ANN ARBOR, MI:
3,296,168, PUB. 7-10-2007. INT. CL. 41.
- H-P PRODUCTS, INC., LOUISVILLE, OH:
3,300,023, INT. CL. 7.
- HABIB AMERICAN BANK, NEW YORK, NY:
2,084,119, REN. 8-21-07. INT. CL. 36.
- HACKLER, RICK, ARCOLA, IL:
3,296,094, PUB. 7-10-2007. INT. CL. 16.
- HACKSHAW, TIRSA, LOS ANGELES, CA:
3,297,605, PUB. 7-10-2007. INT. CL. 41.
- HADLEY POLLET, LLC, CAMBRIDGE, MA:
3,299,159, INT. CL. 18.
- HAEMONETICS CORPORATION, BRAINTREE, MA:
3,276,346, COR. INT. CL. 10.
- HAFENDORFER, JIM, LOUISVILLE, KY:
2,077,259, REN. 8-17-07. INT. CL. 7.
- HAI, JOSHUA H., ORANGE, CA:
3,299,247, INT. CL. 5.
- HALDEX AB, SE10388 STOCKHOLM, SWEDEN:
3,295,990, PUB. 7-10-2007. INT. CL. 35.
3,295,991, PUB. 7-10-2007. INT. CL. 7.
- HALE PRODUCTS, INC., CONSHOHOCKEN, PA:
1,469,557, REN. 8-20-07. INT. CL. 9.
- HALIKMAN, AMY B, VENICE, CA, DBA JANAI-AMI:
3,297,626, PUB. 7-10-2007. INT. CL. 16.
- HALLELUJAH ACRES, INCORPORATED, SHELBY, NC, HALLELUJAH ACRES, INC., EIDSON, TN:
2,101,432, REN. 8-17-07. INT. CL. 35.
- HALLIBURTON ENERGY SERVICES, INC., CARROLLTON, TX:
2,128,606, REN. 8-20-07. INT. CL. 1.
3,298,633, INT. CL. 7.
3,298,973, INT. CL. 7.
3,299,101, INT. CL. 40.
3,299,705, INT. CL. 1.
- HALLMARK LICENSING, INC., KANSAS CITY, MO:
2,109,843, REN. 8-20-07. INT. CL. 16.
- HALO, PURELY FOR PETS, INC., TARPON SPRINGS, FL:
2,091,281, REN. 8-18-07. INT. CL. 5.
2,101,365, REN. 8-18-07. INT. CL. 5.
2,106,939, REN. 8-18-07. INT. CL. 5.
- HAMBORG, PETER MARK, HUNTINGTON BEACH, CA:
3,299,463, MULTIPLE CLASS, INT. CLS. 25 AND 28.
- HAMBURG-SUDAMERIKANISCHE DAMPFSSCHIFFFAHRTS-GESELLSCHAFT, EGGERT & AMSINCK, HAMBURG, FED REP GERMANY:
1,416,967, CANC. INT. CL. 39.
- HAMER PELLET FUEL COMPANY, KENOVA, WV:
3,296,891, PUB. 7-10-2007. INT. CL. 4.

- HAMILTON BEACH/PROCTOR-SILEX, INC., GLEN ALLEN, VA:
3,297,131, PUB. 7-10-2007. INT. CL. 7.
- HAMILTON SUNDBRAND CORPORATION, WINDSOR LOCKS, CT:
3,297,567, PUB. 7-10-2007. INT. CL. 1.
- HAMSAR DIVERSCO INC., BURLINGTON, ONTARIO, CANADA:
3,299,229, INT. CL. 11.
- HANDMARK, INC., KANSAS CITY, MO:
3,298,037, PUB. 7-10-2007. MULTIPLE CLASS, INT. CLS. 9, 35 AND 38.
3,298,049, PUB. 7-10-2007. MULTIPLE CLASS, INT. CLS. 35 AND 38.
- HANDBAKE INTERNATIONAL COMPANY LIMITED, THE:
1,416,893, CANC. MULTIPLE CLASS, INT. CLS. 35 AND 42.
- HANDY ANDY HOME IMPROVEMENT CENTERS, INC., GURNEE, IL:
1,416,404, CANC. INT. CL. 6.
- HANDYMAN MATTERS, INC., LAKEWOOD, CO:
3,296,158, PUB. 7-10-2007. INT. CL. 37.
- HANGERS-N-HOOKS INTERNATIONAL LIMITED, HONG KONG, HONG KONG:
3,297,759, PUB. 7-10-2007. INT. CL. 20.
- HANNAFORD LICENSING CORP., SCARBOROUGH, ME:
3,300,075, INT. CL. 35.
- HANS HUBER AG MASCHINEN-; UND ANLAGENBAU, FED REP GERMANY:
3,298,316, PUB. 7-10-2007. MULTIPLE CLASS, INT. CLS. 7, 11 AND 37.
- HANSA METALLWERKE AG, D-70567 STUTTGART, FED REP GERMANY:
2,403,048, CANC. MULTIPLE CLASS, INT. CLS. 1, 9 AND 11.
- HANSEN MANUFACTURING CORP., SIOUX FALLS, SD:
3,297,716, PUB. 7-10-2007. INT. CL. 7.
- HANSEN TECHNOLOGIES CORP., BURR RIDGE, IL:
3,299,272, INT. CL. 42.
- HANSEN TECHNOLOGIES CORPORATION, BURR RIDGE, IL:
2,015,480, CANC. INT. CL. 9.
- HANSON HONG BIOMEDICAL CO., LTD., TAIPEI CITY, TAIWAN:
3,298,466, INT. CL. 3.
- HANVON CORPORATION, IRVINE, CA:
3,298,557, INT. CL. 9.
- HARBINGER TECHNOLOGIES GROUP, INC., MCLEAN, VA:
3,297,494, PUB. 7-10-2007. MULTIPLE CLASS, INT. CLS. 9 AND 45.
- HARBOR FOOTWEAR GROUP LTD., PORT WASHINGTON, NY:
3,299,981, INT. CL. 25.
- HARCOURT ASSESSMENT, INC., SAN ANTONIO, TX:
2,161,548, REN. 8-22-07. INT. CL. 16.
- HARMAN INTERNATIONAL INDUSTRIES, INCORPORATED, NORTHRIDGE, CA, JBL, INCORPORATED, NORTHRIDGE, CA:
2,082,469, REN. 8-22-07. INT. CL. 41.
- HARMON, KENNETH WAYNE, GAINESVILLE, FL:
2,404,906, CANC. INT. CL. 25.
- HARMONY PHARMACY & HEALTH CENTER, INC., PURCHASE, NY:
3,300,126, INT. CL. 35.
- HARMONY PRODUCTS, INC., CHESAPEAKE, VA:
2,403,388, CANC. INT. CL. 1.
- HARNISCHFEGER TECHNOLOGIES, INC., WILMINGTON, DE:
2,083,703, REN. 8-17-07. INT. CL. 9.
- HARPERCOLLINS PUBLISHERS L.L.C., NEW YORK, NY:
3,297,083, PUB. 7-10-2007. INT. CL. 16.
- HARRELL, VALERIE J., SYLMAR, CA:
3,298,994, MULTIPLE CLASS, INT. CLS. 6, 16, 25, 37 AND 41.
- HARRIS STEEL GROUP ULC, TORONTO, ONTARIO, CANADA:
2,086,747, REN. 8-17-07. INT. CL. 6.
- HARRISON BURNET PTY LTD., KILLARA NSW 2071, AUSTRALIA:
3,296,020, PUB. 7-10-2007. INT. CL. 32.
- HARRY N. ABRAMS, INC., NEW YORK, NY:
3,296,230, PUB. 7-10-2007. MULTIPLE CLASS, INT. CLS. 16 AND 41.
3,296,231, PUB. 7-10-2007. MULTIPLE CLASS, INT. CLS. 16 AND 41.
- HARTLEY, ROBERT AUSTIN, BRANSON, MO:
3,296,465, PUB. 7-10-2007. MULTIPLE CLASS, INT. CLS. 9 AND 41.
- HARTMAN, DIANA, MUTTONTOWN, NY:
1,416,747, CANC. INT. CL. 25.
- HARTMAN, KALLIE, ROUND ROCK, TX:
3,298,777, INT. CL. 35.
- HARTMANN-CONCO, INC., ROCK HILL, SC:
3,296,832, PUB. 7-10-2007. INT. CL. 5.
3,296,833, PUB. 7-10-2007. INT. CL. 10.
3,296,835, PUB. 7-10-2007. INT. CL. 10.
3,296,839, PUB. 7-10-2007. INT. CL. 10.
3,296,840, PUB. 7-10-2007. INT. CL. 10.
- HARVEST MANOR FARMS, LLC, CEDAR RAPIDS, IA:
2,084,375, REN. 8-17-07. INT. CL. 29.
- HARVEY, DENISE SONDY, PEACHTREE CITY, GA, DBA HOBKNOBS:
2,081,523, REN. 8-18-07. MULTIPLE CLASS, INT. CLS. 20 AND 21.
- HASBRO, INC., PAWTUCKET, RI:
3,296,196, PUB. 7-10-2007. INT. CL. 28.
3,296,209, PUB. 7-10-2007. INT. CL. 28.
3,298,531, INT. CL. 28.
3,298,574, INT. CL. 28.
- HASCO IA LIMITED, RENO, NV:
3,299,379, INT. CL. 16.
- HASELSON INTERNATIONAL TRADING, INC., NEW YORK, NY:
3,299,243, INT. CL. 25.
- HATCO CORPORATION, MILWAUKEE, WI:
3,298,700, INT. CL. 11.
- HATTERAS HAMMOCKS, INC., GREENVILLE, NC:
3,296,018, PUB. 7-10-2007. INT. CL. 22.
- HAULMARK INDUSTRIES, INC., BRISTOL, IN:
2,014,786, CANC. INT. CL. 12.
- HAUSER, ROSS A., OAK PARK, IL AND HAUSER, MARION A., OAK PARK, IL:
3,297,870, PUB. 7-10-2007. INT. CL. 44.
- HAVAS, 92150 SURESNES, FRANCE, EURO RSCG WORLDWIDE, 92200 NEUILLY SUR SEINE, FRANCE:
1,983,200, REN. 8-23-07. MULTIPLE CLASS, INT. CLS. 35, 38 AND 41.
- HAVEN NETWORKS, INC., PARKSVILLE, BRITISH COLUMBIA, CANADA:
3,299,208, INT. CL. 35.
- HAWAII HIDEAWAYS INC., KULA, HI:
3,296,432, PUB. 7-10-2007. INT. CL. 43.
- HAWAIIAN HOST, INC., HONOLULU, HI:
1,416,848, CANC. INT. CL. 30.
- HAWES, JASON, NEW YORK, NY, DBA THE ATLANTIC PARANORMAL SOCIETY AND WILSON, GRANT, NEW YORK, NY, DBA THE ATLANTIC PARANORMAL SOCIETY:
3,297,996, PUB. 7-10-2007. INT. CL. 25.
- HAWGTALES INTERNATIONAL, LLC, VIRGINIA BEACH, VA:
2,404,600, CANC. INT. CL. 25.
- HAWKER BEECHCRAFT CORPORATION, WICHITA, KS:
1,446,279, REN. 8-17-07. INT. CL. 12.
- HAWKES, KENNETH GALE, MIAMI, FL:
3,299,551, INT. CL. 42.
- HAWKINS, DAVID R., PEMBROKE PINES, FL:
3,299,340, INT. CL. 45.
- HAYDELS BAKERY, JEFFERSON, LA:
3,299,233, INT. CL. 30.
- HAYES HANDPIECE FRANCHISES, INC., CARLSBAD, CA:
2,084,062, REN. 8-17-07. INT. CL. 37.

HDVE, LLC, IRVING, TX:
3,296,971, PUB. 7-10-2007. INT. CL. 45.

HEAD-SO-ROUND, LLC, EAST GRAND RAPIDS, MI:
3,298,483, INT. CL. 10.

HEADCOUNT LLC, NEW YORK, NY:
2,404,539, CANC. INT. CL. 35.

HEADLINE NEWS, INC., ROSLYN HEIGHTS, NY:
3,296,500, PUB. 6-26-2007. INT. CL. 35.

HEADSPROUT, INC., SEATTLE, WA:
3,298,414, MULTIPLE CLASS, INT. CLS. 9, 16 AND 41.

HEADWATERS RESOURCES, INC., SOUTH JORDAN, UT:
1,448,523. REN. 8-18-07. INT. CL. 19.
1,454,791. REN. 8-20-07. INT. CL. 1.

HEALING ARTS, INC., SANTA MONICA, CA:
2,403,142, CANC. INT. CL. 25.

HEALING HOLOGRAMS, INC., ST PETERSBURG, FL:
3,298,078, PUB. 7-10-2007. INT. CL. 44.

HEALTH CARE AND RETIREMENT CORPORATION OF AMERICA, TOLEDO, OH:
3,299,315, INT. CL. 44.

HEALTH CARE SERVICE CORPORATION, CHICAGO, IL, DBA BLUE CROSS AND BLUE SHIELD OF TEXAS, BLUE CROSS AND BLUE SHIELD OF TEXAS, INC., DALLAS, TX:
2,074,916. REN. 8-23-07. INT. CL. 36.

HEALTH CARE SERVICE CORPORATION, CHICAGO, IL:
2,148,437. REN. 8-17-07. INT. CL. 36.

HEALTH CRAFT, INC., TAMPA, FL:
3,298,464, MULTIPLE CLASS, INT. CLS. 35, 41 AND 43.

HEALTH DIALOG SERVICES CORPORATION, BOSTON, MA:
3,298,520, INT. CL. 42.

HEALTH NEW ENGLAND, INC., SPRINGFIELD, MA:
3,298,851, MULTIPLE CLASS, INT. CLS. 36 AND 44.

HEALTH PLUS INTERNATIONAL, INC., DELRAY BEACH, FL:
2,404,548, CANC. INT. CL. 5.

HEALTH WORLD, THOUSAND OAKS, CA:
2,404,007, CANC. INT. CL. 5.

HEALTH-LETE, LLC, POTOMAC FALLS, VA:
3,299,160, MULTIPLE CLASS, INT. CLS. 25, 41 AND 44.

HEALTHCARE STRATEGY GROUP, LLC, LOUISVILLE, KY:
3,300,284, INT. CL. 16.

HEALTHCO INTERNATIONAL, INC., BOSTON, MA:
1,416,375, CANC. INT. CL. 5.

HEALTHENET, ST. CLAIR SHORES, MI:
2,403,664, CANC. INT. CL. 41.

HEALTHWAYS HEALTH SUPPORT, INC., TEMPE, AZ:
2,086,072. REN. 8-22-07. INT. CL. 41.

HEALTHY ASSOCIATES PRODUCTS, INC., MUSCLE SHOALS, AL:
2,404,123, CANC. INT. CL. 5.

HEALTHY PETS, INC., UNION CITY, CA:
3,296,878, PUB. 7-10-2007. INT. CL. 5.
3,297,081, PUB. 7-10-2007. INT. CL. 5.
3,297,161, PUB. 7-10-2007. INT. CL. 5.

HEARING SOLUTIONS, INC., PAOLI, PA:
2,014,889, CANC. INT. CL. 10.

HEARST HOLDINGS, INC., NEW YORK, NY AND FLEISCHER STUDIOS, INC., BEVERLY HILLS, CA:
3,299,786, INT. CL. 43.

HEARST NEWSPAPERS PARTNERSHIP, LLC, HOUSTON, TX:
2,152,166. REN. 8-20-07. INT. CL. 16.
2,152,167. REN. 8-20-07. INT. CL. 16.

HEARTH, PATIO & BARBECUE ASSOCIATION, ARLINGTON, VA:
3,297,025, PUB. 7-10-2007. INT. CL. 35.

HEARTPORT, INC., REDWOOD CITY, CA:
2,403,759, CANC. INT. CL. 10.

HEATHER BOOKOUT PHOTOGRAPHY, HUNTSVILLE, AL:
3,297,281, PUB. 7-10-2007. INT. CL. 41.

HEATHROW SCIENTIFIC LLC, VERNON HILLS, IL:
3,299,648, INT. CL. 9.
3,299,849, INT. CL. 9.

HEAVENLY TOUCH FRANCHISING CORP., AKRON, OH:
3,299,673, INT. CL. 37.

HEBERER, MICHAEL SCOTT, HAMILTON, IL:
2,404,856, CANC. INT. CL. 11.

HECHT, WILLIAM JOHN, SIBLEY, IL:
2,403,325, CANC. INT. CL. 9.

HECIN TRIKO TEKSTIL SANAYI VE TICARET LIMITED SIRKETI, YENIBOSNA/ISTANBUL, TURKEY:
3,298,175, PUB. 7-10-2007. INT. CL. 25.

HECKLERS ONLINE, INC., TUSCALOOSA, AL:
2,403,820, CANC. INT. CL. 41.

HEDMAN COMPANY, THE, ELK GROVE VILLAGE, IL:
1,451,337. REN. 8-21-07. INT. CL. 37.
1,453,538. REN. 8-21-07. INT. CL. 37.

HEDWIN CORPORATION, BALTIMORE, MD:
832,338. REN. 8-23-07. U.S. CL. 2 (INT. CLS. 16 AND 20).
832,339. REN. 8-23-07. U.S. CL. 2 (INT. CL. 20).

HEFFERNAN, BRIAN D., MIAMI, FL:
3,296,864, PUB. 7-10-2007. INT. CL. 41.

HEINEKEN USA INC., WHITE PLAINS, NY:
3,297,325, PUB. 7-10-2007. MULTIPLE CLASS, INT. CLS. 16, 41 AND 44.

HEINZ KURZ GMBH MEDIZINTECHNIK, DUSSLINGEN, FED REP GERMANY:
3,299,805, INT. CL. 10.

HEITZ WINE CELLARS, ST. HELENA, CA:
3,299,930, INT. CL. 33.

HEKKER, LOIS M., SARASOTA, FL:
3,298,424, INT. CL. 35.

HELENA HOLDING COMPANY, WILMINGTON, DE:
3,298,812, INT. CL. 5.

HELICOR, INC., NEW YORK, NY:
3,297,729, PUB. 7-10-2007. INT. CL. 10.

HELMICH, SUSAN, MONUMENT, CO:
2,089,344. REN. 8-23-07. INT. CL. 14.

HELP-YOUR-SELF, INC., WASHINGTON, DC:
3,299,042, INT. CL. 9.

HEMATIAN, FATOLLAH, NEW YORK, NY:
3,297,438, PUB. 7-10-2007. INT. CL. 14.
3,297,444, PUB. 7-10-2007. INT. CL. 14.

HEMISPHERE WORLD WIDE SALES, INC., MIAMI, FL:
2,138,421. REN. 8-22-07. INT. CL. 25.

HENDERSON, WAYNE C., DOYLESTOWN, PA:
3,298,900, INT. CL. 39.

HENGSTONE HOLDINGS, INC., TORONTO, ONTARIO, CANADA:
3,298,906, INT. CL. 19.

HENGSHUI HONGTENG PEANUT CO., LTD., HENGSHUI, HEBEI, CHINA:
3,300,007, INT. CL. 29.

HENKEL KGAA, FED REP GERMANY:
3,298,250, PUB. 7-10-2007. MULTIPLE CLASS, INT. CLS. 3 AND 5.

HENNESSY, JANE A., CHARLOTTE, NC, DBA BRIDES-HEAD:
2,404,416, CANC. INT. CL. 42.

HENRY, MAXIME, ROMANS, FRANCE:
3,300,262, INT. CL. 35.

HEPLER'S TOWN & COUNTRY ENTERPRISES, INC., NEW STANTON, PA, DBA STANTON MILLING COMPANY:
3,298,132, PUB. 7-10-2007. INT. CL. 30.

HERCULES INCORPORATED, WILMINGTON, DE:
3,299,620, INT. CL. 1.

HERION, ALLEN, SUN VALLEY, CA:
3,296,444, PUB. 7-10-2007. INT. CL. 9.

HERITAGE HOUSE, INC., NASHVILLE, TN:
2,403,867, CANC. INT. CL. 15.

HERITAGE MEDCALL, INC., TAMPA, FL:
3,299,142, INT. CL. 9.

HERITAGE MINT, LTD, SCOTTSDALE, AZ:
3,298,562, INT. CL. 21.

HERITAGE PHOTOGRAPHIC RESOURCES LIMITED, JERSEY, CHANNEL ISLANDS:
3,297,328, PUB. 7-10-2007. INT. CL. 16.

HERITAGE UNION SERVICES, LLC, RICHMOND, VA:
3,300,072, INT. CL. 36.

HERMAN MILLER, INC., ZEELAND, MI:
1,446,454. REN. 8-23-07. INT. CL. 20.
3,299,023, INT. CL. 9.

- HERSHEY CHOCOLATE & CONFECTIONERY CORPORATION, WHEAT RIDGE, CO:
2,111,450. REN. 8-22-07. INT. CL. 30.
- HERSHEY CHOCOLATE & CONFECTIONERY CORPORATION, WHEAT RIDGE, CO:
1,493,377. REN. 8-23-07. INT. CL. 30.
- HERSHEY CHOCOLATE & CONFECTIONERY CORPORATION, WHEAT RIDGE, CO, HERSHEY FOODS CORPORATION, HERSHEY, PA:
1,493,378. REN. 8-23-07. INT. CL. 30.
- HERSHEY CHOCOLATE & CONFECTIONERY CORPORATION, WHEAT RIDGE, CO, HOMESTEAD, INC., NEWARK, DE:
2,103,077. REN. 8-17-07. INT. CL. 30.
- HERSHEY CHOCOLATE & CONFECTIONERY CORPORATION, WHEAT RIDGE, CO:
3,299,952. INT. CL. 41.
- HERTONG MACHINERY ENT. CO., LTD., SANCHUNG, TAIPEI, TAIWAN:
2,108,285. REN. 8-18-07. INT. CL. 7.
- HESPERION LTD., SWITZERLAND:
3,298,320. PUB. 7-10-2007. MULTIPLE CLASS, INT. CLS. 35 AND 42.
3,298,321. PUB. 7-10-2007. MULTIPLE CLASS, INT. CLS. 35 AND 42.
- HESS CORPORATION, NEW YORK, NY, HESS OIL & CHEMICAL CORPORATION, PERTH AMBOY, NJ:
832,704. REN. 8-20-07. U.S. CL. 103 (INT. CLS. 37 AND 40).
832,705. REN. 8-20-07. U.S. CL. 103 (INT. CLS. 37 AND 40).
- HEWLETT-PACKARD COMPANY, PALO ALTO, CA:
2,404,025. CANC. INT. CL. 9.
2,404,686. CANC. INT. CL. 9.
- HEWLETT-PACKARD DEVELOPMENT COMPANY, L.P., HOUSTON, TX:
3,297,152. PUB. 7-10-2007. MULTIPLE CLASS, INT. CLS. 35, 37 AND 42.
- HEY BABY, INC., MANHATTAN, KS:
3,297,351. PUB. 7-10-2007. INT. CL. 35.
- HIATT AND ASSOCIATES U.S.A., INC., LAS VEGAS, NV:
2,403,270. CANC. INT. CL. 42.
- HICKORY SPRINGS MANUFACTURING COMPANY, HICKORY, NC:
3,296,238. PUB. 7-10-2007. INT. CL. 35.
- HIDEKI FRANCIS ONDA, TOKYO, JAPAN:
3,300,063. INT. CL. 9.
- HIE ELECTRONICS, INC., MCKINNEY, TX:
3,300,239. INT. CL. 9.
- HIGH PLAINS INC., ATCHISON, KS:
3,296,487. PUB. 7-10-2007. INT. CL. 33.
- HIGH SPEED PRODUCTIONS, INC., SAN FRANCISCO, CA:
1,447,232. REN. 8-20-07. MULTIPLE CLASS, INT. CLS. 16 AND 25.
- HIGHLINE PRODUCE LIMITED, LEAMINGTON, ONTARIO, CANADA:
3,299,946. INT. CL. 31.
- HIGHROAD SOLUTION, L.L.C., ASHBURN, VA:
3,299,681. INT. CL. 38.
- HIGUCHI TAKEO, JAPAN:
3,298,168. PUB. 7-10-2007. MULTIPLE CLASS, INT. CLS. 16 AND 41.
- HILL STREET PRESS, LLC, ATHENS, GA:
2,403,768. CANC. INT. CL. 16.
- HILL WALLACK LLP, PRINCETON, NJ:
3,296,567. PUB. 7-10-2007. INT. CL. 45.
- HILLCREST BANK, OVERLAND PARK, KS:
2,404,353. CANC. INT. CL. 36.
2,404,356. CANC. INT. CL. 36.
- HILLSDALE COLLEGE, HILLSDALE, MI:
3,296,155. PUB. 7-10-2007. INT. CL. 41.
- HIMEYASOFT, INC., SAITAMA-KEN, 336-0012, JAPAN:
2,404,591. CANC. INT. CL. 9.
- HIP DOGGIE INC., STUDIO CITY, CA:
3,299,136. INT. CL. 18.
- HIRE COUNSEL, INC., NEW YORK, NY:
2,089,353. REN. 8-17-07. INT. CL. 35.
- HIRSCH PIPE & SUPPLY CO., INC., SAN JUAN CAPISTRANO, CA:
3,296,125. PUB. 7-10-2007. INT. CL. 11.
- HIRSCHMANN, SUSAN FOX, ANNANDALE, VA:
2,404,872. CANC. INT. CL. 20.
- HISPANIC YELLOW PAGES OF AMERICA, INC., CHICAGO, IL:
3,298,966. MULTIPLE CLASS, INT. CLS. 41 AND 42.
- HISTORIC TOURS OF AMERICA, INC., KEY WEST, FL:
2,088,491. REN. 8-17-07. INT. CL. 39.
- HLAVIN INDUSTRIES LTD., RA'ANANA, ISRAEL:
1,449,167. REN. 8-17-07. INT. CL. 3.
- HMS NATIONAL, INC., FT. LAUDERDALE, FL:
3,298,588. INT. CL. 36.
- HNI TECHNOLOGIES INC., MUSCATINE, IA:
2,403,419. CANC. INT. CL. 20.
3,299,387. INT. CL. 20.
- HOBBS, RUSSELL DAVID, DALLAS, TX:
2,403,803. CANC. INT. CL. 9.
- HOBIE CAT COMPANY, OCEANSIDE, CA:
1,069,802. REN. 8-18-07. INT. CL. 12.
- HOBIE CAT COMPANY, OCEANSIDE, CA, COAST CATALAN CORPORATION, IRVINE, CA:
1,071,373. REN. 8-17-07. MULTIPLE CLASS, INT. CLS. 12 AND 22.
- HOBIE CAT COMPANY, OCEANSIDE, CA:
2,111,069. REN. 8-17-07. INT. CL. 9.
2,112,683. REN. 8-17-07. INT. CL. 22.
- HOBIE DESIGNS, INC., SAN JUAN CAPISTRANO, CA, ALTER, HOBART L., DANA POINT, CA, DBA HOBIE-SURFBOARD SHOP:
839,490. REN. 8-17-07. U.S. CL. 22 (INT. CL. 28).
- HOD, AYAL, GREAT NECK, NY:
3,297,277. PUB. 12-27-2005. INT. CL. 35.
- HODGES, THOMAS E., SMYRNA, GA, DBA TREND RECORDS:
832,921. REN. 8-22-07. U.S. CL. 36 (INT. CL. 9).
- HOECHST CELANESE CORPORATION, SOMERVILLE, NJ TO CLARIANT AG, MUTTENZ, SWITZERLAND:
2,015,883. CANC. INT. CL. 1.
- HOLDING TEXTILE HERMES, 69310 PIERRE-BENITE, FRANCE:
2,073,530. REN. 8-18-07. INT. CL. 24.
- HOLEY DONUTS HOLDING CORP., BROOKLYN, NY:
3,298,119. PUB. 7-10-2007. INT. CL. 30.
- HOLISTIC TECHNOLOGIES ENTERPRISE, INC., CENTENNIAL, CO:
3,299,513. INT. CL. 35.
- HOLLIS, JOHN H, OAKLAND, CA:
3,297,632. PUB. 7-10-2007. INT. CL. 16.
- HOLMBERG COMPANY, INC., MINNEAPOLIS, MN:
2,066,336. REN. 8-20-07. INT. CL. 16.
- HOLMES-HALLY INDUSTRIES, LOS ANGELES, CA TO CLOPAY BUILDING PRODUCTS R & D COMPANY, INC., CINCINNATI, OH:
2,015,524. CANC. INT. CL. 6.
2,015,526. CANC. INT. CL. 6.
2,015,534. CANC. INT. CL. 6.
- HOLMES, BRIAN, SANTA MONICA, CA:
2,404,838. CANC. INT. CL. 9.
- HOLMES, FAITH L, AUSTIN, TX:
3,296,696. PUB. 7-10-2007. INT. CL. 44.
- HOLSTEIN, STEVE, CHAMPAIGN, IL:
2,404,158. CANC. INT. CL. 41.
- HOLT, LILY, PALM BEACH, FL:
3,299,465. INT. CL. 25.
- HOLYFIELD, LOUISE, DALLAS, TX:
3,299,078. INT. CL. 41.
3,299,478. INT. CL. 3.
3,299,542. INT. CL. 3.
- HOM FURNITURE, INC., COON RAPIDS, MN:
3,297,324. PUB. 7-10-2007. INT. CL. 35.
- HOME HEALTH DIAGNOSTICS, INC., PORTLAND, OR:
2,403,555. CANC. MULTIPLE CLASS, INT. CLS. 5 AND 42.
2,403,558. CANC. MULTIPLE CLASS, INT. CLS. 5 AND 42.
- HOME INTERIORS & GIFTS, INC., CARROLLTON, TX:
2,404,718. CANC. MULTIPLE CLASS, INT. CLS. 3 AND 4.
- HOMER TLC, INC., CLAYMONT, DE:
3,298,998. INT. CL. 11.

HONDA GIKEN KOGYO KABUSHIKI KAISHA (HONDA MOTOR CO., LTD.), TOKYO 107, JAPAN:
2,088,198. REN. 8-20-07. INT. CL. 12.

HONDA MOTOR CO., LTD., TOKYO 107-8556, JAPAN:
3,297,379. PUB. 7-10-2007. INT. CL. 7.

HONEYCUTT, RHODNEY, HICKORY, NC:
3,299,321. MULTIPLE CLASS, INT. CLS. 30 AND 35.

HONEYWELL INTELLECTUAL PROPERTIES INC., TEMPE, AZ:
1,409,254. REN. 8-22-07. INT. CL. 9.

HONEYWELL INTERNATIONAL INC., MORRISTOWN, NJ:
2,403,821. CANC. INT. CL. 1.
3,299,707. INT. CL. 9.

HONG YUE DEVELOPMENT CO., LTD., KAOHSIUNG COUNTY, TAIWAN:
3,296,221. PUB. 7-10-2007. INT. CL. 6.

HONGDOU GROUP CO., LTD., WAXI CITY, JIANGSU PROVINCE, CHINA:
2,097,952. REN. 8-20-07. INT. CL. 25.

HONGOS DE MEXICO, S.A. DE C.V., 05000 MEXICO, D.F., MEXICO:
2,064,703. AM. INT. CL. 29.

HOORSEN BUHS, LLC, SANTA MONICA, CA:
3,296,474. PUB. 6-26-2007. INT. CL. 14.

HOPE PHARMACEUTICALS, SCOTSDALE, AZ:
2,015,828. CANC. INT. CL. 5.

HOPKINS, VICKIE L., TUCKER, GA:
3,296,884. PUB. 7-10-2007. INT. CL. 16.

HOPPE, MARK A., ST. PAUL, MN:
2,083,737. REN. 8-22-07. MULTIPLE CLASS, INT. CLS. 36 AND 42.

HORMEL FOODS, LLC, AUSTIN, MN:
3,297,433. PUB. 7-10-2007. INT. CL. 29.

HOSER, LORENZ, BERLIN, FED REP GERMANY:
3,297,177. PUB. 6-5-2007. INT. CL. 12.

HOSPICE OF CHATTANOOGA, INC., CHATTANOOGA, TN:
3,296,376. PUB. 7-10-2007. MULTIPLE CLASS, INT. CLS. 44 AND 45.

HOSPIRA, INC., LAKE FOREST, IL:
3,299,628. INT. CL. 10.

HOSTILE OMISH, INC., OAKWOOD VILLAGE, OH:
3,296,918. PUB. 7-10-2007. INT. CL. 41.

HOT STUFF FOODS, LLC, SIOUX FALLS, SD, ORION FOOD SYSTEMS, INC., SIOUX FALLS, SD:
2,089,447. REN. 8-23-07. INT. CL. 42.

HOT TOPIC, INC., CITY OF INDUSTRY, CA:
2,404,434. CANC. INT. CL. 25.

HOTSET HEIZPATRONEN U. ZUBEHOR GMBH, LUDENSCHIED, FED REP GERMANY:
1,449,355. REN. 8-23-07. MULTIPLE CLASS, INT. CLS. 9 AND 11.

HOUGHTON MIFFLIN COMPANY, BOSTON, MA:
3,298,540. INT. CL. 41.

HOUSTON MCLANE COMPANY, INC., HOUSTON, TX:
2,082,732. REN. 8-17-07. INT. CL. 25.

HOWDEN POWER SPAIN, S.L., 30360 LA UNIÓN (MURCIA), SPAIN:
3,296,003. PUB. 7-10-2007. INT. CL. 6.

HP HOOD LLC, LYNNFIELD, MA:
3,299,967. INT. CL. 29.

HPM CORPORATION, MOUNT GILEAD, OH:
2,404,487. CANC. INT. CL. 7.
2,404,515. CANC. INT. CL. 7.

HS TM, LLC, NEWARK, DE, HENRY SCHEIN, INC., MELVILLE, NY:
2,092,956. REN. 8-22-07. INT. CL. 42.

HSC CORPORATION, WINNETKA, IL:
2,176,706. REN. 8-22-07. INT. CL. 42.

HSIAO, CHENG-YI, RICHMOND, B.C., CANADA:
3,297,373. PUB. 7-10-2007. INT. CL. 3.

HSN LP, ST. PETERSBURG, FL:
1,456,590. REN. 8-22-07. INT. CL. 25.

HTS, LLC, LOS ANGELES, CA:
3,297,312. PUB. 7-10-2007. MULTIPLE CLASS, INT. CLS. 35, 37 AND 41.

HUB PEN COMPANY, INC., QUINCY, MA:
3,296,896. PUB. 7-10-2007. INT. CL. 16.
3,296,897. PUB. 7-10-2007. INT. CL. 16.
3,297,000. PUB. 7-10-2007. INT. CL. 16.

HUBBARD MILLING COMPANY:
1,416,856. CANC. INT. CL. 31.

HUBBARD, GLEN K., SAN RAFAEL, CA:
3,297,585. PUB. 7-10-2007. INT. CL. 36.

HUBBELL INCORPORATED, ORANGE, CT:
830,507. REN. 8-20-07. U.S. CL. 21 (INT. CL. 9).
1,454,052. REN. 8-17-07. INT. CL. 9.
1,458,103. REN. 8-17-07. INT. CL. 9.

HUBBELL INCORPORATED, ORANGE, CT, QUALTECH OF RACINE, INC., RACINE, WI:
2,090,927. REN. 8-17-07. MULTIPLE CLASS, INT. CLS. 9 AND 20.

HUBBELL INCORPORATED, ORANGE, CT:
2,093,691. REN. 8-17-07. INT. CL. 9.
2,093,801. REN. 8-17-07. INT. CL. 9.
2,098,747. REN. 8-17-07. INT. CL. 9.
2,099,172. REN. 8-17-07. INT. CL. 9.

HUBER ENGINEERED WOODS LLC, CHARLOTTE, NC:
3,298,726. INT. CL. 17.

HUDSON LOCK, LLC, HUDSON, MA:
3,300,266. INT. CL. 6.

HUDSON, DAVID L., COLORADO SPRINGS, CO:
2,403,507. CANC. INT. CL. 41.

HUFF INDUSTRIES, INC., CORINTH, MS:
2,403,532. CANC. INT. CL. 5.

HUGHES RESERVES AND ASSET MANAGEMENT INC., INCLINE VILLAGE, NV:
3,298,051. PUB. 7-10-2007. MULTIPLE CLASS, INT. CLS. 36 AND 42.

HUGHES, DANIEL, BLOOMINGTON, IN:
3,297,423. PUB. 7-10-2007. INT. CL. 41.

HUGHES, DAVID R., LITITZ, PA:
3,299,046. INT. CL. 6.

HUGHES, MARIE, CHANDLER, AZ:
2,404,107. CANC. INT. CL. 41.

HUMAN CAPITAL SOLUTIONS, LLC, WESTCHESTER, PA:
3,299,295. INT. CL. 35.

HUMAN INFERENCE B.V., 6824 BH ARNHEM, NETHERLANDS:
2,403,175. CANC. MULTIPLE CLASS, INT. CLS. 9, 16 AND 42.

HUMAN MED AG, FED REP GERMANY:
3,298,241. PUB. 7-10-2007. MULTIPLE CLASS, INT. CLS. 7 AND 10.

HUMANA INC., LOUISVILLE, KY:
3,298,926. INT. CL. 41.

HUMANE SOCIETY OF THE UNITED STATES, THE, WASHINGTON, DC:
2,086,638. REN. 8-20-07. INT. CL. 16.

HUMPHREY, DOY T., PEORIA, AZ:
2,403,662. CANC. INT. CL. 6.

HUNGARIAN KOSHER FOODS, INC., SKOKIE, IL:
3,296,612. PUB. 7-10-2007. INT. CL. 35.

HUNT DIGITAL IMAGING, INC., PORTSMOUTH, NH:
2,403,933. CANC. INT. CL. 16.

HUNTER DOUGLAS INC., UPPER SADDLE RIVER, NJ:
2,404,805. CANC. INT. CL. 24.
3,299,138. INT. CL. 24.

HUNTER FAN COMPANY, MEMPHIS, TN:
1,458,213. REN. 8-18-07. INT. CL. 11.
3,298,695. INT. CL. 11.
3,299,483. INT. CL. 11.

HUNTER MFG., LLP, LEXINGTON, KY:
3,299,251. INT. CL. 28.

HUNTING CROMAR LIMITED, ABERDEEN, SCOTLAND:
3,297,256. PUB. 7-10-2007. INT. CL. 7.

HUNTWISE, INC., MONROE, LA:
3,295,982. PUB. 7-10-2007. INT. CL. 28.

HUP! MULTIMEDIA, INC., SEATTLE, WA:
2,083,256. REN. 8-20-07. INT. CL. 28.

HURON HOCKEY SCHOOL (USA), BATAVIA, IL:
2,403,150. CANC. MULTIPLE CLASS, INT. CLS. 20, 21, 24, 25 AND 28.

- HURON LLC, SEVERN, MD:
3,298,645, INT. CL. 35.
- HUSSON, GUDU S., POMONA, CA AND HUSSON, TONY S., POMONA, CA:
2,086,133, REN. 8-21-07, INT. CL. 29.
- HUTZLER, LAURIE H, SANTA MONICA, CA:
3,296,298, PUB. 7-10-2007, INT. CL. 16.
- HYDE TOOLS, INC., SOUTHBRIDGE, MA:
3,297,708, PUB. 7-10-2007, INT. CL. 17.
- HYDRA-RAM UNLIMITED, INC., PUTNAM VALLEY, NY:
2,003,569, REN. 8-22-07, INT. CL. 8.
- HYDRANAUTICS, OCEANSIDE, CA:
2,076,206, REN. 8-23-07, INT. CL. 11.
- HYDROANALYSIS, INC., ACTON, MA:
3,297,432, PUB. 7-10-2007, INT. CL. 9.
- HYPERDRIVE INTERACTIVE, LTD., CINCINNATI, OH:
3,297,029, PUB. 7-10-2007, INT. CL. 35.
3,297,030, PUB. 7-10-2007, INT. CL. 35.
- H2O - TOOS LLC, RHINEBECK, NY:
3,297,531, PUB. 7-10-2007, INT. CL. 16.
- I CODE, SOCIÉTÉ PAR ACTIONS SIMPLIFIÉE, FRANCE:
3,298,361, PUB. 7-10-2007, INT. CL. 25.
- I DID IT, INC., FAR HILLS, NJ:
3,298,477, INT. CL. 18.
- I.M. HOME FURNITURE INC., PROVO, UT:
3,296,698, PUB. 7-10-2007, INT. CL. 35.
- I.T.C. LIMITED, STATE OF WEST BENGAL, INDIA:
2,403,461, CANC. INT. CL. 34.
- I-C FEDERAL CREDIT UNION, FITCHBURG, MA:
3,297,837, PUB. 7-10-2007, INT. CL. 36.
- I-DECIDE, INC., LEONIA, NJ:
3,299,893, INT. CL. 42.
- I-TEC ELECTRONICS INC., MIAMI, FL:
3,300,106, INT. CL. 14.
- IAN'S NATURAL FOODS, INC., LAWRENCE, MA:
3,297,974, PUB. 7-10-2007, MULTIPLE CLASS, INT. CLS. 35 AND 41.
- IBARRA BRITO GROUP, INC., SALT LAKE CITY, UT:
3,299,803, INT. CL. 41.
- IBASIS, INC., BURLINGTON, MA:
3,299,500, INT. CL. 16.
- IBAU; HAMBURG INGENIEURGESELLSCHAFT INDUSTRIEBAU; MBH, FED REP GERMANY:
3,298,297, PUB. 7-10-2007, MULTIPLE CLASS, INT. CLS. 6 AND 7.
- ICBM HOLDINGS LIMITED, MINATO-KU, TOKYO, JAPAN:
3,295,978, PUB. 9-7-2004, INT. CL. 18.
- ICE LAND CORPORATION, PITTSBURGH, PA:
3,296,481, PUB. 7-10-2007, INT. CL. 30.
- ICF RESOURCES INCORPORATED, FAIRFAX, VA:
2,404,254, CANC. MULTIPLE CLASS, INT. CLS. 9 AND 42.
- ICOS CORPORATION OF AMERICA, NEW YORK, NY:
1,426,047, REN. 8-17-07, INT. CL. 42.
1,426,953, REN. 8-17-07, INT. CL. 42.
- ICYSPICY.COM, L.L.C., SOUTH WINDSOR, CT:
2,403,556, CANC. INT. CL. 42.
- ID INTERACTIVE LLC, DELRAY BEACH, FL:
3,299,593, INT. CL. 9.
3,299,692, INT. CL. 9.
3,299,693, INT. CL. 9.
3,299,773, INT. CL. 9.
3,299,774, INT. CL. 9.
- ID SOFTWARE, INC., MESQUITE, TX:
2,084,910, REN. 8-17-07, INT. CL. 28.
- IDALEX TECHNOLOGIES, INC., ARVADA, CO:
3,297,895, PUB. 7-10-2007, INT. CL. 11.
- IDEA HEALTH & FITNESS, INC., SAN DIEGO, CA, DAVIS, KATHIE, SAN DIEGO, CA, DBA INTERNATIONAL DANCE-EXERCISE ASSOCIATION AND DAVIS, PETER, SAN DIEGO, CA, DBA INTERNATIONAL DANCE-EXERCISE ASSOCIATION:
1,451,415, REN. 8-17-07, INT. CL. 41.
- IDEAL FASTENER CORPORATION, OXFORD, NC:
3,297,961, PUB. 7-10-2007, INT. CL. 26.
- IDEAS WELL DONE, LLC, WINOOSKI, VT:
3,298,565, INT. CL. 42.
- IDEC CORPORATION, OSAKA, JAPAN:
2,404,085, CANC. INT. CL. 9.
- IDENTITY THEFT 911, LLC, SCOTTSDALE, AZ:
3,298,451, MULTIPLE CLASS, INT. CLS. 35 AND 45.
- IEARTH ORGANIZATION LTD., COQUITLAM, BRITISH COLUMBIA, CANADA:
3,299,344, INT. CL. 16.
- IEG, LLC, CHICAGO, IL:
2,078,825, REN. 8-23-07, INT. CL. 16.
- IES ENTERPRISES, INC., NEW YORK, NY:
3,299,058, INT. CL. 3.
- IFM ELECTRONIC GMBH, 45127 ESSEN, FED REP GERMANY:
3,298,195, PUB. 7-10-2007, INT. CL. 9.
- IFNS, INSTITUT FUR NUMERISCHE STATISTIK, DR. HAASE GMBH, KOLN D-50858, FED REP GERMANY:
2,403,066, CANC. MULTIPLE CLASS, INT. CLS. 9, 16 AND 42.
- IGNITE USA, LLC, CHICAGO, IL:
3,299,324, INT. CL. 21.
- IGT, RENO, NV:
2,404,214, CANC. INT. CL. 35.
3,298,727, INT. CL. 9.
3,298,752, INT. CL. 9.
3,298,754, INT. CL. 9.
- IHIGH, INC., LEXINGTON, KY:
3,296,289, PUB. 7-10-2007, INT. CL. 35.
3,296,290, PUB. 7-10-2007, INT. CL. 35.
- ILIO, WESTLAKE VILLAGE, CA:
3,296,399, PUB. 7-10-2007, INT. CL. 9.
- ILLINOIS STATE BAR ASSOCIATION, SPRINGFIELD, IL:
2,083,777, REN. 8-22-07, INT. CL. 42.
2,083,778, REN. 8-22-07, INT. CL. 41.
2,083,787, REN. 8-22-07, INT. CL. 41.
- ILLINOIS TOOL WORK INC., GLENVIEW, IL:
3,296,792, PUB. 7-10-2007, INT. CL. 1.
- ILLINOIS TOOL WORKS INC., GLENVIEW, IL, SPEEDY PRODUCTS, INC., NORTH ST. PAUL, MN:
2,084,165, REN. 8-20-07, INT. CL. 6.
- ILLINOIS TOOL WORKS INC., GLENVIEW, IL:
2,403,661, CANC. INT. CL. 16.
2,404,010, CANC. INT. CL. 2.
3,297,037, PUB. 7-10-2007, INT. CL. 6.
3,297,121, PUB. 7-10-2007, MULTIPLE CLASS, INT. CLS. 7 AND 17.
3,299,779, INT. CL. 20.
- ILLINOIS TOOL WORKS, INC., GLENVIEW, IL, SPEEDY PRODUCTS, INC., N. ST. PAUL, MN:
2,094,788, REN. 8-20-07, INT. CL. 6.
- ILLINOIS TOOL WORKS, INC., GLENVIEW, IL:
2,121,618, REN. 8-23-07, INT. CL. 1.
- ILLUMILITE INCORPORATED, COLORADO SPRINGS, CO:
3,297,330, PUB. 7-10-2007, INT. CL. 11.
- ILSCO CORPORATION, CINCINNATI, OH:
1,442,940, REN. 8-17-07, INT. CL. 9.
- ILVA POLIMERI S.R.L., MILANO, ITALY:
2,086,171, REN. 8-17-07, MULTIPLE CLASS, INT. CLS. 2 AND 17.
- IMAGE HOLDINGS, INC., HOUSTON, TX:
2,404,122, CANC. INT. CL. 40.
- IMAGE HUNTER PUBLISHING, INC., MCLEAN, VA, NATIONAL WILDLIFE FEDERATION, WASHINGTON, DC:
2,030,122, REN. 8-17-07, INT. CL. 16.
- IMAGELINK INC., ROCKVILLE, MD:
3,295,996, PUB. 7-10-2007, INT. CL. 16.
- IMAGETREE CORPORATION, MORGANTOWN, WV:
3,296,972, PUB. 7-10-2007, INT. CL. 35.
- IMAGINATION HOLDINGS LIMITED, DOUGLAS, ISLE OF MAN:
3,297,193, PUB. 7-10-2007, MULTIPLE CLASS, INT. CLS. 9, 16 AND 41.
- IMAGING TECHNOLOGY INCORPORATED, BEDFORD, MA TO CORECO IMAGING, INC., BILLERICA, MA:
2,016,365, CANC. INT. CL. 9.
- IMCD, INC., AVENTURA, FL:
2,404,934, CANC. INT. CL. 16.
- IMED SOLUTIONS, INC., JACKSONVILLE, FL:
2,403,806, CANC. MULTIPLE CLASS, INT. CLS. 35 AND

38.
 IMHOTECH, INC., REDWOOD CITY, CA:
 2,403,722, CANC. INT. CL. 35.
 IMMUNE NUTRACEUTICALS, RENO, NV:
 2,404,301, CANC. INT. CL. 5.
 IMPACT MOBILE MEDIA, LLC, WESLEY CHAPEL, FL:
 3,297,677, PUB. 7-10-2007. INT. CL. 35.
 IMPACT TECHNOLOGIES GROUP, INC., CHARLOTTE,
 NC:
 2,404,500, CANC. MULTIPLE CLASS, INT. CLS. 9 AND
 42.
 IMPERIAL CANDLE COMPANY, LLC, CLEVELAND, GA:
 3,299,722, INT. CL. 4.
 IMPERIAL TOBACCO LIMITED, UNITED KINGDOM:
 3,298,340, PUB. 7-10-2007. INT. CL. 34.
 IMPLICIT RESOURCES LIMITED, DUBLIN 4, IRELAND:
 3,296,151, PUB. 7-10-2007. MULTIPLE CLASS, INT. CLS.
 35 AND 42.
 IMS PRODUCTS, INC., RIVERSIDE, CA:
 2,403,211, CANC. INT. CL. 25.
 IN MY SHOES, INC., TUCSON, AZ:
 3,298,102, PUB. 7-10-2007. INT. CL. 41.
 IN THE BEAUTY BOX, INC., DANA POINT, CA:
 3,296,961, PUB. 7-10-2007. INT. CL. 3.
 INA CORPORATION, PHILADELPHIA, PA:
 3,298,935, INT. CL. 36.
 INCHARGE INSTITUTE OF AMERICA, INC., ORLANDO,
 FL:
 3,299,785, INT. CL. 36.
 INCREASING REVENUE, INC., MCLEAN, VA:
 3,297,762, PUB. 7-10-2007. MULTIPLE CLASS, INT. CLS.
 35 AND 41.
 INDENA S.P.A., MILAN, ITALY:
 3,297,201, PUB. 7-10-2007. INT. CL. 42.
 INDENA S.P.A., ITALY:
 3,298,392, PUB. 7-10-2007. MULTIPLE CLASS, INT. CLS.
 1, 3 AND 5.
 INDEPENDENT PHYSICAL THERAPY, CLEVELAND, TN:
 3,295,969, PUB. 11-6-2001. INT. CL. 42.
 INDEPENDENT SOUTHERN BANCSHARES, INC.,
 BROWNSVILLE, TN:
 1,462,221. REN. 8-18-07. INT. CL. 36.
 INDEPENDENT TECHNOLOGIES, INC., OMAHA, NE:
 2,404,691, CANC. INT. CL. 9.
 INDEX STOCK IMAGERY, INC., NEW YORK, NY:
 2,404,640, CANC. INT. CL. 42.
 INDIGO N.V., 6629 GA MAASTRICHT, NETHERLANDS:
 2,015,154, CANC. MULTIPLE CLASS, INT. CLS. 1, 2, 3, 7,
 9, 16, 24 AND 42.
 INDOBUDI, LLC, EMERYVILLE, CA:
 3,299,432, INT. CL. 14.
 3,299,433, INT. CL. 35.
 INDOPCO, INC., BRIDGEWATER, NJ, DBA NATIONAL
 STARCH AND CHEMICAL COMPANY:
 3,300,180, INT. CL. 1.
 INDUSTRIA LA POPULAR, S.A., GUATEMALA CITY,
 GUATEMALA:
 3,296,337, PUB. 7-10-2007. INT. CL. 3.
 3,296,338, PUB. 7-10-2007. INT. CL. 3.
 INDUSTRIA VETRARIA VALDARNESE - I.V.V.; SOC.
 COOP. A.R.L., ITALY:
 3,298,270, PUB. 7-10-2007. INT. CL. 21.
 INDUSTRIAL ENERGY PRODUCTS, INC., MOONACHIE,
 NJ:
 2,015,233, CANC. INT. CL. 17.
 INDUSTRIAL RISK INSURERS, HARTFORD, CT:
 2,073,280. REN. 8-23-07. INT. CL. 36.
 INDUSTRIAS ALIMENTICIAS ECUATORIANAS, S.A. IN-
 ALESCA, GUAYAQUIL, ECUADOR:
 3,298,835, INT. CL. 29.
 INDUSTRIAS VASSALLO, INC., COTO LAUREL, PUERTO
 RICO:
 3,299,801, INT. CL. 12.
 INFANTSEE4D, FAIRFAX, VA:
 3,296,560, PUB. 6-26-2007. INT. CL. 41.
 INFINITY DIAMOND PRODUCTS, INC., VIRGINIA
 BEACH, VA:
 3,296,431, PUB. 7-10-2007. MULTIPLE CLASS, INT. CLS. 7
 AND 8.
 INFINITY STANDARD INSURANCE COMPANY, BIR-
 MINGHAM, AL:
 2,015,289, CANC. INT. CL. 36.
 INFO MARKETING GROUP INC., SANTA MONICA, CA:
 3,299,596, INT. CL. 5.
 INFOCUS CORPORATION, WILSONVILLE, OR:
 3,299,586, INT. CL. 9.
 INFOR GLOBAL SOLUTIONS (GREENVILLE), INC., AL-
 PHARETTA, GA:
 1,941,410. REN. 8-23-07. INT. CL. 9.
 INFOR GLOBAL SOLUTIONS (MICHIGAN), INC., BING-
 HAM FARMS, MI:
 1,421,775. REN. 8-23-07. INT. CL. 9.
 INFORMATION ARCHITECTS CORPORATION, CHAR-
 LOTTE, NC:
 2,404,556, CANC. INT. CL. 9.
 INFORMATIONSTEKNIK SCANDINAVIA A/S, DK-2450
 COPENHAGEN SV, DENMARK:
 3,298,406, MULTIPLE CLASS, INT. CLS. 35, 38, 41 AND
 42.
 INFOROCKET.COM, INC., NEW YORK, NY:
 2,641,327, CANC. INT. CL. 35.
 INGEAR CORPORATION, BUFFALO GROVE, IL:
 3,298,567, INT. CL. 21.
 3,299,516, INT. CL. 40.
 INGHAM REGIONAL MEDICAL CENTER, LANSING, MI:
 2,404,520, CANC. INT. CL. 42.
 INGRAM ENTERPRISES, INC., SPRINGFIELD, MO:
 3,298,617, INT. CL. 13.
 INKSTONE, INC., MISSION VIEJO, CA:
 3,296,413, PUB. 7-10-2007. MULTIPLE CLASS, INT. CLS.
 35 AND 37.
 INLAND TECHNOLOGY, INC., TACOMA, WA:
 2,108,700. REN. 8-23-07. INT. CL. 3.
 INNIS, COREY A, FORT COLLINS, CO:
 3,296,690, PUB. 7-10-2007. INT. CL. 35.
 INNOTECH USA, INC., TARRYTOWN, NY:
 3,296,100, PUB. 7-10-2007. INT. CL. 10.
 INNOVALITE TECHNOLOGY LTD., RICHMOND, BRITISH
 COLUMBIA, CANADA:
 3,296,605, PUB. 7-10-2007. INT. CL. 11.
 INNOVAPORT LLC, WHITEFISH BAY, WI:
 3,298,671, INT. CL. 42.
 INNOVATION TECHNOLOGY TOOLS, B.V., 1096 AZ AM-
 STERDAM, NETHERLANDS:
 3,296,077, PUB. 7-10-2007. INT. CL. 9.
 INNOVATIVE EMERGENCY MANAGEMENT, INC., BA-
 TON ROUGE, LA:
 3,296,052, PUB. 7-10-2007. INT. CL. 25.
 INOC, LLC, NORTHBROOK, IL:
 3,296,370, PUB. 7-10-2007. INT. CL. 35.
 INOFIN, ROCKLAND, MA:
 3,298,151, PUB. 9-6-2005. MULTIPLE CLASS, INT. CLS.
 35, 37 AND 39.
 INSECT LORE PRODUCTS, SHAFTER, CA:
 3,299,562, INT. CL. 28.
 INSIGNIA IP INC., WILMINGTON, DE:
 2,404,154, CANC. INT. CL. 36.
 INSOLVENCY SERVICES GROUP, INC., TARZANA, CA:
 2,404,638, CANC. INT. CL. 9.
 2,404,639, CANC. INT. CL. 9.
 INSPIRVISION LLC, MOUNTAIN VIEW, CA:
 3,299,838, INT. CL. 41.
 INSTALLS INC, LLC, BUFFALO, NY:
 3,300,249, MULTIPLE CLASS, INT. CLS. 37 AND 42.
 INSTITUTE FOR INDEPENDENT INFORMATION TECH-
 NOLOGY PROFESSIONALS, INC., REDWOOD SHORES,
 CA:
 2,404,264, CANC. INT. CL. 35.
 INSTITUTE FOR INTERNATIONAL RESEARCH, INC.,
 NEW YORK, NY:
 3,296,952, PUB. 7-10-2007. INT. CL. 35.
 INSTITUTE OF COMPUTING TECHNOLOGY, CHINESE
 ACADEMY OF SCIENCES, CHINA:
 3,298,378, PUB. 7-10-2007. INT. CL. 9.
 3,298,379, PUB. 7-10-2007. INT. CL. 9.

- INSTONE, INC., ENCINITAS, CA:
3,296,985, PUB. 7-10-2007. INT. CL. 16.
- INSULATION SOLUTIONS, INC., EAST PEORIA, IL:
3,299,267, INT. CL. 17.
- INSURQUOTE SYSTEMS, INC., PROVO, UT:
2,403,469, CANC. MULTIPLE CLASS, INT. CLS. 9 AND 36.
- INSURRECTION CORPORATION, GERMANTOWN, MD:
2,403,716, CANC. INT. CL. 35.
- INTA JUICE ENTERPRISES, INC., FORT COLLINS, CO:
3,296,944, PUB. 7-10-2007. MULTIPLE CLASS, INT. CLS. 32, 35 AND 43.
3,296,945, PUB. 7-10-2007. INT. CL. 43.
3,296,951, PUB. 7-10-2007. MULTIPLE CLASS, INT. CLS. 35 AND 43.
- INTALGENT TECHNOLOGIES, LLC, CHARLOTTESVILLE, VA:
3,296,753, PUB. 7-10-2007. INT. CL. 42.
- INTEGRAL INSTITUTE, INC., BOULDER, CO:
3,298,638, INT. CL. 45.
- INTEGRATED HEALTH SERVICES, INC., OWINGS MILLS, MD:
2,403,080, CANC. INT. CL. 42.
- INTEGRATED MEDIA AND GRAPHICS ENTERPRISES, INC., NEW YORK, NY:
2,403,936, CANC. INT. CL. 42.
- INTEGRATED POLYMER INDUSTRIES, INC, SANTA ANA, CA:
2,403,344, CANC. MULTIPLE CLASS, INT. CLS. 1 AND 2.
- INTEGRATED RESOURCES, INC., SYLVANIA, OH:
2,403,433, CANC. INT. CL. 35.
- INTEGRA5 COMMUNICATIONS, INC., BURLINGTON, MA:
3,298,985, INT. CL. 9.
- INTEGWARE, INC., FORT COLLINS, CO:
3,296,101, PUB. 7-10-2007. INT. CL. 42.
- INTELITRAC, INC., GERMANTOWN, MD:
3,298,769, MULTIPLE CLASS, INT. CLS. 9 AND 42.
- INTELLECTUAL PROPERTY HOLDINGS AS, 0114 OSLO, NORWAY:
3,297,388, PUB. 7-10-2007. MULTIPLE CLASS, INT. CLS. 16, 35, 38 AND 41.
- INTELLIGENCE NAVIGATORS CORP., RENO, NV:
3,296,912, PUB. 7-10-2007. INT. CL. 35.
3,297,004, PUB. 7-10-2007. INT. CL. 35.
- INTELLIGENT LIFE CORPORATION, NORTH PALM BEACH, FL:
2,403,219, CANC. INT. CL. 42.
- INTELLIMED CORPORATION, WHITE PLAINS, NY:
1,416,460, CANC. INT. CL. 9.
- INTELLIVUE NM LLC, AUSTIN, TX:
3,300,281, INT. CL. 36.
- INTELSAT, LTD., PEMBROKE, BERMUDA:
3,300,042, INT. CL. 38.
- INTERACTIVE BROKERS LLC, GREENWICH, CT:
3,299,455, INT. CL. 36.
- INTERACTIVE INFORMATION, INC., SEWICKLEY, PA:
2,016,452, CANC. INT. CL. 9.
- INTERACTIVE NEIGHBORHOOD FOR KIDS, INC., GAINESVILLE, GA:
3,297,727, PUB. 7-10-2007. INT. CL. 41.
3,297,728, PUB. 7-10-2007. INT. CL. 41.
- INTERACTIVE TKO INC., COLLEYVILLE, TX:
3,297,182, PUB. 7-10-2007. INT. CL. 9.
- INTERBASIC HOLDING S.A., LUXEMBOURG, LUXEMBOURG, SCHIAPARELLI, SOCIETE ANONYME, PARIS, FRANCE:
344,590. REN. 8-21-07. U.S. CL. 51 (INT. CLS. 3 AND 5).
- INTERBOTS INITIATIVE LLC, PITTSBURGH, PA:
3,299,089, INT. CL. 41.
- INTERCAPITAL PARTNERS, LLC, CHICAGO, IL:
2,110,533, AM. MULTIPLE CLASS, INT. CLS. 36 AND 37.
- INTERCO INCORPORATED, ST. LOUIS, MO:
1,416,727, CANC. INT. CL. 25.
- INTERFACE, INC., ATLANTA, GA:
2,404,751, CANC. INT. CL. 27.
- INTERGUM GIDA SANAYI VE TICARET A.S., ISTANBUL, TURKEY:
2,404,472, CANC. INT. CL. 30.
- INTERLINE BRANDS, INC., JACKSONVILLE, FL:
3,298,445, INT. CL. 6.
- INTERLINK ELECTRONICS, INC., CAMARILLO, CA:
1,921,794, AM. INT. CL. 9.
- INTERLOR FASHION SYSTEMS INCORPORATED, TUCSON, AZ:
2,403,776, CANC. INT. CL. 35.
- INTERMIX MEDIA, INC., LOS ANGELES, CA:
2,403,879, CANC. MULTIPLE CLASS, INT. CLS. 35, 38, 41 AND 42.
- INTERMOLECULAR, INC., SANTA CLARA, CA:
3,298,962, MULTIPLE CLASS, INT. CLS. 7 AND 11.
- INTERMOUNTAIN HEALTH CARE, INC., SALT LAKE CITY, UT:
3,296,720, PUB. 7-10-2007. INT. CL. 44.
- INTERNATIONAL AMATEUR ATHLETIC FEDERATION MONACO, MC 98000, MONACO:
2,403,208, CANC. MULTIPLE CLASS, INT. CLS. 9, 14, 25, 32, 38, 41 AND 42.
- INTERNATIONAL BUSINESS MACHINES CORPORATION, ARMONK, NY:
2,403,174, CANC. INT. CL. 42.
- INTERNATIONAL CODE COUNCIL, INC., WHITTIER, CA:
2,079,936. REN. 8-18-07. INT. CL. 16.
- INTERNATIONAL CODE COUNCIL, INC., FALLS CHURCH, VA:
3,257,465, COR. MULTIPLE CLASS, INT. CLS. 35 AND 36.
- INTERNATIONAL CONSTRUCTION PRODUCTS RESEARCH, INC., FAIRFIELD, CT:
1,485,282. REN. 8-23-07. INT. CL. 19.
- INTERNATIONAL DATA GROUP, INC., FRAMINGHAM, MA:
2,016,583, CANC. INT. CL. 16.
- INTERNATIONAL DIGITAL ENTERPRISE ALLIANCE, INC., ALEXANDRIA, VA:
3,296,127, PUB. 7-10-2007. INT. CL. 42.
- INTERNATIONAL ENVIRONMENTAL ASSOCIATES, INC., HOUSTON, TX:
3,298,009, PUB. 7-10-2007. INT. CL. 42.
- INTERNATIONAL FELLOWSHIP OF CHRISTIANS AND JEWS, CHICAGO, IL:
2,403,608, CANC. INT. CL. 41.
- INTERNATIONAL GOLDEN FOODS, INC., BENSENVILLE, IL:
3,297,736, PUB. 7-10-2007. INT. CL. 30.
- INTERNATIONAL HARNESS RESOURCES, INC., RICHMOND, IL:
2,074,747. REN. 8-21-07. INT. CL. 16.
- INTERNATIONAL INTRODUCTIONS, INC., NORWELL, MA:
2,175,003. REN. 8-17-07. INT. CL. 42.
- INTERNATIONAL LAPIDARIES CO., LTD., BANGKOK, THAILAND:
3,296,519, PUB. 7-10-2007. INT. CL. 14.
- INTERNATIONAL MASTERS PUBLISHERS AB, SE-211 20 MALMO, SWEDEN:
2,404,923, CANC. INT. CL. 16.
- INTERNATIONAL NUTRITION, INC., MIDDLE RIVER, MD:
2,091,233. REN. 8-23-07. INT. CL. 5.
- INTERNATIONAL PACIFIC SEAFOODS, INC., FULLERTON, CA:
2,119,907. REN. 8-17-07. INT. CL. 29.
- INTERNATIONAL PAPER COMPANY, MEMPHIS, TN:
3,298,796, INT. CL. 16.
- INTERNATIONAL RESISTIVE CO. OF TEXAS, L.P., CORPUS CHRISTI, TX:
2,072,603. REN. 8-17-07. INT. CL. 9.
- INTERNATIONAL TECHNOLOGIES NETWORK, INC., THOUSAND OAKS, CA:
2,403,686, CANC. INT. CL. 1.
- INTERNATIONAL WEB PROPERTIES, LLC, INDIANAPOLIS, IN:
3,300,115, INT. CL. 42.

- INTERSECTIONS INC., CHANTILLY, VA:
3,297,288, PUB. 7-10-2007. MULTIPLE CLASS, INT. CLS. 35, 36 AND 45.
3,297,290, PUB. 7-10-2007. MULTIPLE CLASS, INT. CLS. 35, 36 AND 45.
- INTERSOCIETAL COMMISSION FOR THE ACCREDITATION OF NUCLEAR MEDICINE/NUCLEAR CARDIOLOGY LABORATORIES, COLUMBIA, MD:
3,297,991, PUB. 7-10-2007. INT. CL. 42.
- INTERSTATE BAKERIES CORPORATION, KANSAS CITY, MO:
2,404,157, CANC. INT. CL. 30.
- INTERSTATE BRANDS COMPANY - LICENSING CO., KANSAS CITY, MO TO INTERSTATE BAKERIES CORPORATION, KANSAS CITY, MO:
2,014,884, CANC. INT. CL. 30.
- INTERVET INC., MILLSBORO, DE:
3,298,104, PUB. 7-10-2007. INT. CL. 5.
- INTEX DIY INC., VILLA RICA, GA:
3,299,854, INT. CL. 21.
3,299,863, INT. CL. 21.
- INTIMACY MANAGEMENT COMPANY LLC, ATLANTA, GA:
3,296,557, PUB. 6-26-2007. INT. CL. 35.
- INTRALINKS, INC., NEW YORK, NY:
2,403,106, CANC. INT. CL. 42.
- INTRAWARE, INC., ORINDA, CA:
2,403,718, CANC. INT. CL. 42.
- INVENTEK COLLOIDAL CLEANERS, LLC, PHILADELPHIA, PA:
3,296,848, PUB. 7-10-2007. INT. CL. 3.
- INVENTOR MOM LLC, PHOENIX, AZ:
3,296,563, PUB. 7-10-2007. INT. CL. 16.
- INVENTOR'S WORLD, INC., WIXOM, MI, DUNMORE PRESS, INC., DETROIT, MI:
2,084,266, REN. 8-20-07. INT. CL. 16.
- INVESCOR, LTD., FARMINGTON HILLS, MI:
3,296,772, PUB. 7-10-2007. INT. CL. 36.
- INVESTIGACION DE TECNOLOGIA AVANZADA, S.A. DE C.V., GUADALUPE, NUEVO LEON, MEXICO:
833,021, REN. 8-23-07. U.S. CL. 46 (INT. CL. 30).
- INVESTMENT HORIZONS INC., PITTSBURGH, PA:
1,431,488, REN. 8-20-07. INT. CL. 36.
- INVITROGEN CORPORATION, CARLSBAD, CA:
3,299,418, INT. CL. 9.
- INYOPANTZ CLOTHING COMPANY INC., BOLTON, ONTARIO, CANADA:
3,298,863, INT. CL. 25.
- ION IMAGINATION ENTERTAINMENT, INC., NASHVILLE, TN:
2,089,562, REN. 8-17-07. INT. CL. 16.
- IOWA ENGINEERED PROCESS CORP., INDEPENDENCE, IA:
1,448,165, REN. 8-17-07. INT. CL. 7.
- IOZ LLC, PACIFIC PALISADES, CA:
3,300,110, INT. CL. 9.
- IP FILEPOINT, LLC, SAN DIEGO, CA:
3,299,870, INT. CL. 35.
- IP HOLDINGS, LLC, VANCOUVER, WA:
3,299,855, INT. CL. 9.
- IPM CORP. OF BREVARD, INC., ARDEN, NC:
3,299,852, INT. CL. 36.
3,299,853, INT. CL. 36.
- IPRBOX OY, FINLAND:
3,298,162, PUB. 7-10-2007. MULTIPLE CLASS, INT. CLS. 9, 35, 36 AND 42.
- IPTRADE, INC., NEWTON, MA:
3,297,293, PUB. 7-10-2007. INT. CL. 42.
3,299,290, INT. CL. 9.
- IRA EPSTEIN & CO., CHICAGO, IL:
2,403,514, CANC. INT. CL. 36.
- IRON COWGIRLS, INC., NAPERVILLE, IL:
3,298,818, INT. CL. 25.
- IRON HORSE BEVERAGES, INC, MELVILLE, NY:
3,296,009, PUB. 7-10-2007. INT. CL. 32.
- IRONCLAD PERFORMANCE WEAR CORP., EL SEGUNDO, CA:
3,296,400, PUB. 7-10-2007. INT. CL. 24.
- IRONMAN MACHINE INC., CHANHASSEN, MN:
3,298,452, INT. CL. 7.
- ISAGRO USA, INC., DURHAM, NC:
3,299,443, INT. CL. 5.
- ISAVE.COM, INC., NEW YORK, NY:
3,296,111, PUB. 7-10-2007. MULTIPLE CLASS, INT. CLS. 35 AND 42.
- ISI BRANDS, INC., GRAND RAPIDS, MI:
3,296,596, PUB. 7-10-2007. INT. CL. 5.
3,296,598, PUB. 7-10-2007. INT. CL. 30.
3,296,599, PUB. 7-10-2007. INT. CL. 5.
3,296,600, PUB. 7-10-2007. INT. CL. 5.
3,296,601, PUB. 7-10-2007. INT. CL. 5.
3,296,602, PUB. 7-10-2007. INT. CL. 5.
- ISLAND ARCHITECTS, INC., LA JOLLA, CA:
3,296,831, PUB. 7-10-2007. MULTIPLE CLASS, INT. CLS. 16 AND 42.
- ISP CAPITAL, INC., WILMINGTON, DE, MERCK & CO., INC., RAHWAY, NJ:
1,067,512, REN. 8-22-07. INT. CL. 1.
- IT IS WRITTEN, INC., THOUSAND OAKS, CA:
3,296,166, PUB. 7-10-2007. INT. CL. 45.
- IT WORKS, INC., OMAHA, NE:
2,025,005, REN. 8-23-07. INT. CL. 35.
- IT'S OUR EARTH, INC., WHEATON, IL:
3,295,992, PUB. 6-28-2005. INT. CL. 1.
- IT'S YOURS INC., BOWIE, MD:
3,300,013, INT. CL. 3.
- ITT CORPORATION, WHITE PLAINS, NY:
3,297,085, PUB. 7-10-2007. INT. CL. 9.
- IUCN, INTERNATIONAL UNION FOR CONSERVATION OF NATURE AND NATURAL RESOURCES, CH-1196, GLAND, SWITZERLAND:
2,404,326, CANC. INT. CL. 16.
2,404,327, CANC. INT. CL. 16.
- IVL AUDIO INC., VICTORIA, BRITISH COLUMBIA:
2,030,097, REN. 8-17-07. MULTIPLE CLASS, INT. CLS. 9 AND 15.
- IVOCLEAR NORTH AMERICA, INC., AMHERST, NY:
2,404,623, CANC. INT. CL. 40.
- IVYSPORT, INC., SANTA ANA, CA:
2,086,116, REN. 8-17-07. INT. CL. 25.
- I2, INC., PITTSBURGH, PA:
3,298,545, INT. CL. 35.
- J & J TECHNOLOGIES LIMITED, UNITED KINGDOM:
3,298,324, PUB. 7-10-2007. MULTIPLE CLASS, INT. CLS. 5, 9 AND 10.
- J M SMITH CORPORATION, SPARTANBURG, SC:
3,297,412, PUB. 7-10-2007. INT. CL. 42.
3,297,416, PUB. 7-10-2007. INT. CL. 42.
- J. A. CISSEL MFG. CO., LAKEWOOD, NJ:
1,467,394, REN. 8-20-07. INT. CL. 22.
- J. WALTER THOMPSON U.S.A., INC., NEW YORK, NY:
3,300,278, INT. CL. 41.
- J.A. JONES, INC., CHARLOTTE, NC:
2,404,727, CANC. INT. CL. 37.
2,404,728, CANC. INT. CL. 37.
2,404,729, CANC. INT. CL. 37.
2,404,730, CANC. INT. CL. 37.
- J.A. THURSTON COMPANY, INC., THE, RUMFORD, ME:
2,404,721, CANC. INT. CL. 20.
- J.A. WOOLLAM CO., INC., LINCOLN, NE:
3,298,596, INT. CL. 9.
3,298,600, INT. CL. 9.
- J.B. WILLIAMS COMPANY, INC., WHITE PLAINS, NY, J. B. WILLIAMS COMPANY, THE, GLASTONBURY, CT:
215,445, REN. 8-21-07. U.S. CL. 4 (INT. CL. 3).
- J.C.M. ENGINEERING CORP., ONTARIO, CA:
2,403,939, CANC. INT. CL. 40.
- J.E.B. VENTURES, INC., BOCA RATON, FL:
3,296,082, PUB. 7-10-2007. INT. CL. 5.
- J.F.C. MARKS LLC, HOLMDEL, NJ, PARLUX FRAGRANCES, INC., FT. LAUDERDALE, FL:
2,030,964, REN. 8-18-07. INT. CL. 3.
- J.H. COHN, LLP, ROSELAND, NJ:
3,296,812, PUB. 7-10-2007. MULTIPLE CLASS, INT. CLS. 35 AND 36.

- J.M. SMUCKER COMPANY, THE, ORRVILLE, OH:
117,704, REN. 8-20-07. U.S. CL. 46 (INT. CL. 29).
- J.P. DURGA, L.L.C., PORT LUDLOW, WA:
2,404,331, CANC. INT. CL. 3.
2,404,332, CANC. INT. CL. 3.
- J.S. MUSIC CORPORATION, MAYFIELD VILLAGE, OH:
3,296,047, PUB. 7-10-2007. INT. CL. 35.
- J&B SAUSAGE COMPANY, INC., WAELDER, TX:
2,015,061, CANC. INT. CL. 29.
- J&J SNACK FOODS CORP., PENNSAUKEN, NJ:
3,297,118, PUB. 7-10-2007. INT. CL. 30.
- JACARU AUSTRALIA PTY LTD, AUSTRALIA:
3,298,363, PUB. 7-10-2007. INT. CL. 25.
- JACK DANIEL'S PROPERTIES, INC., SAN RAFAEL, CA:
3,297,091, PUB. 7-10-2007. INT. CL. 33.
3,297,092, PUB. 7-10-2007. INT. CL. 33.
- JACKSON HOLE MOUNTAIN RESORT CORPORATION,
TETON VILLAGE, WY:
3,297,010, PUB. 7-10-2007. INT. CL. 41.
- JACKSON NATIONAL LIFE INSURANCE COMPANY,
LANSING, MI:
2,403,271, CANC. INT. CL. 36.
2,404,756, CANC. INT. CL. 36.
- JACKSON/CHARVEL MANUFACTURING, INC., SCOTTSDALE,
AZ, JACKSON / CHARVEL, INC., GLENDORA,
CA:
1,484,218, REN. 8-18-07. INT. CL. 15.
- JACOB LEINENKUGEL BREWING CO., INC., CHIPPEWA
FALLS, WI:
3,300,146, INT. CL. 32.
- JACOBS ENTERTAINMENT, INC., BLACK HAWK, CO:
3,297,235, PUB. 7-10-2007. INT. CL. 35.
- JADA TOYS, INC., CITY OF INDUSTRY, CA:
3,300,020, INT. CL. 28.
- JAFER LIMITED, HAMILTON, BERMUDA:
3,299,955, INT. CL. 3.
3,299,956, INT. CL. 3.
- JAKKS PACIFIC, INC., MALIBU, CA:
3,298,634, INT. CL. 28.
- JAMAC FROZEN FOOD CORP., JERSEY CITY, NJ:
2,084,098, REN. 8-20-07. INT. CL. 35.
- JAMBA JUICE COMPANY, EMERYVILLE, CA:
3,296,446, PUB. 7-10-2007. INT. CL. 29.
- JAMES DECRESCENZO REPORTING, LLC, PHILADELPHIA,
PA:
3,296,867, PUB. 7-10-2007. INT. CL. 35.
- JAMSHIDI, ANITA, GREAT FALLS, VA:
3,299,850, INT. CL. 5.
- JAN T. JARKE ENTERPRISES, L.L.C., AUSTIN, TX:
2,404,490, CANC. INT. CL. 20.
- JANA BRUGAL, OMAR SALIM, SANTO DOMINGO, DOMINICAN
REP:
3,298,756, INT. CL. 15.
- JANE & COMPANY, LLC, BALTIMORE, MD:
3,299,135, INT. CL. 3.
- JANE MOBLEY ASSOCIATES, INC., KANSAS CITY, MO:
2,404,446, CANC. INT. CL. 9.
- JANE, S.A., BARCELONA, SPAIN:
3,297,084, PUB. 7-10-2007. INT. CL. 12.
- JANELLE BEAUTY INC, MILFORD, NH:
3,296,440, PUB. 7-10-2007. INT. CL. 3.
- JANOME SEWING MACHINE CO., LTD., TOKYO, JAPAN:
3,299,724, INT. CL. 7.
- JANSPOUT APPAREL CORP., WILMINGTON, DE:
2,015,857, CANC. MULTIPLE CLASS, INT. CLS. 18 AND
25.
- JANTZEN APPAREL, LLC, MIAMI, FL:
2,403,409, CANC. MULTIPLE CLASS, INT. CLS. 9, 25
AND 28.
2,404,397, CANC. INT. CL. 28.
- JARDINE ENTERPRISE LTD., TAIPEI, TAIWAN:
3,298,072, PUB. 7-10-2007. INT. CL. 20.
- JARMOLOW, DIANE, OAKLAND, CA:
3,297,580, PUB. 7-10-2007. MULTIPLE CLASS, INT. CLS.
35 AND 41.
- JARRITOS, INC., EL PASO, TX:
3,298,758, INT. CL. 25.
- JASCO PRODUCTS COMPANY LLC, OKLAHOMA CITY,
OK:
3,297,478, PUB. 7-10-2007. INT. CL. 11.
3,297,479, PUB. 7-10-2007. INT. CL. 14.
3,297,480, PUB. 7-10-2007. INT. CL. 11.
- JAWALAPERSAD, BIDJAI K., NEW YORK, NY:
3,299,266, INT. CL. 9.
- JAYASINGHE INTERNATIONAL CORPORATION, ARTE-
SIA, CA:
2,404,842, CANC. INT. CL. 5.
- JAZZ PHARMACEUTICALS, INC., PALO ALTO, CA:
3,299,804, INT. CL. 5.
- JB MACK LLC, MANCHESTER, CT:
3,297,656, PUB. 7-10-2007. INT. CL. 43.
- JDA SOFTWARE GROUP, INC., SCOTTSDALE, AZ:
3,297,665, PUB. 7-10-2007. MULTIPLE CLASS, INT. CLS. 9
AND 42.
- JEAN D. MILLER D.O., P.C., NEW YORK, NY TO GOLD,
JAY E., NEW YORK, NY:
2,016,398, CANC. MULTIPLE CLASS, INT. CLS. 5 AND
42.
- JEAN-CLAUDE BOISSET WINES, USA, INC., SAUSALITO,
CA:
3,298,908, INT. CL. 33.
- JEANNE LANVIN, 75008 PARIS, FRANCE, LANVIN-
CHARLES OF THE RITZ, INC., NEW YORK, NY:
832,981, REN. 8-23-07. U.S. CL. 39 (INT. CL. 25).
- JEFF LAYTON, TORONTO, CANADA. COMPOSED OF
TRADEMARK REGISTRATION NUMBER: 2403093 AND
2371943:
2,403,093, CANC. MULTIPLE CLASS, INT. CLS. 35, 41
AND 42.
- JEFF THE PLUMBER, INC., AKRON, OH:
3,297,701, PUB. 7-10-2007. INT. CL. 37.
- JEFFREY A. COHEN, MARINA DEL REY, CA:
3,297,554, PUB. 7-10-2007. INT. CL. 5.
- JEFFREY ROBERT, LTD., NEW YORK, NY:
2,403,745, CANC. INT. CL. 14.
- JEFFREY-ELLEN CORPORATION, NATICK, MA:
2,116,777, REN. 8-22-07. INT. CL. 35.
- JELLY BELLY CANDY COMPANY, FAIRFIELD, CA:
3,298,611, INT. CL. 30.
3,300,133, INT. CL. 30.
- JELMAR LLC, SKOKIE, IL:
2,169,624, REN. 8-20-07. INT. CL. 3.
- JENDEN, NATHAN, NEW YORK, NY:
3,299,449, INT. CL. 25.
- JENERIC/PENTRON, WALLINGFORD, CT:
3,297,719, PUB. 7-10-2007. MULTIPLE CLASS, INT. CLS. 5
AND 10.
- JENSEN, CHRIS R., EASLEY, SC:
2,080,933, REN. 8-17-07. INT. CL. 20.
- JEPPESSEN MARINE, INC., PORTLAND, OR:
3,297,780, PUB. 7-10-2007. INT. CL. 16.
- JEREMY NOONAN, WOODINVILLE, WA:
3,298,895, INT. CL. 24.
- JEREMY R. GEFFEN, M.D. & ASSOCIATES, P.A., VERO
BEACH, FL, DBA GEFFEN CANCER CENTER AND
RESEARCH INSTITUTE:
2,403,204, CANC. INT. CL. 42.
- JESSUP MANUFACTURING COMPANY, MCHENRY, IL:
1,497,765, REN. 8-23-07. INT. CL. 20.
- JETPLACE PTY LTD, AUSTRALIA:
3,298,350, PUB. 7-10-2007. INT. CL. 45.
- JETSETTER SPA, INC., BRAINTREE, MA:
3,296,770, PUB. 7-10-2007. INT. CL. 44.
- JETSTREAM OF HOUSTON, LLP, HOUSTON, TX:
3,299,627, INT. CL. 7.
- JFD, LLC, LEXINGTON, KY:
3,297,678, PUB. 7-10-2007. MULTIPLE CLASS, INT. CLS.
25 AND 35.
- JIAN SHUN KING TRADING CO., LTD., TAINAN CITY,
TAIWAN:
3,299,660, INT. CL. 6.
- JIANG, ZHONGJIE, NEWARK, DE:
3,299,590, INT. CL. 14.
- JIM COLBERT GOLF INC., SANTA MONICA, CA:
1,416,899, CANC. INT. CL. 35.

JIM MCLEAN ENTERPRISES, INC., MIAMI, FL:
3,298,734, INT. CL. 41.

JIM MORAN & ASSOCIATES, INC., DEERFIELD BEACH, FL:
3,299,458, INT. CL. 35.

JIMMY JOHN'S ENTERPRISES, LLC, CHAMPAIGN, IL:
3,296,365, PUB. 7-10-2007. INT. CL. 43.

JIMMY RANE FOUNDATION, ABBEVILLE, AL:
3,296,131, PUB. 7-10-2007. INT. CL. 41.

JIMMYS WOOL, LLC, RENO, NV:
3,296,939, PUB. 7-10-2007. INT. CL. 35.
3,297,035, PUB. 7-10-2007. INT. CL. 35.
3,297,036, PUB. 7-10-2007. INT. CL. 35.

JJI LIGHTING GROUP, INC., FRANKLIN PARK, CT:
2,081,938. REN. 8-17-07. INT. CL. 11.

JJI LIGHTING GROUP, INC., FRANKLIN PARK, MO:
2,093,656. REN. 8-17-07. INT. CL. 11.

JLS GLOBAL, LLC, BRONX, NY:
3,296,541, PUB. 7-10-2007. INT. CL. 35.

JMA & ASSOCIATES, INC., LANCASTER, PA, DBA IDEA-
WORKS TO IDEA WORKS, INC., INDIAN WELLS, CA:
2,016,212, CANC. INT. CL. 9.

JMM LLC, 342 DYER AVE, RI:
3,299,873, INT. CL. 5.

JOBDIVA, INC., NEW YORK, NY:
3,296,916, PUB. 7-10-2007. INT. CL. 9.

JOBRI L.L.C., ADA, OK:
2,403,442, CANC. INT. CL. 10.
2,403,447, CANC. INT. CL. 10.

JOBTRAK CORPORATION, LOS ANGELES, CA:
2,404,430, CANC. INT. CL. 35.

JOE KANE PRODUCTIONS, INC., VALLEY VILLAGE, CA:
3,297,694, PUB. 7-10-2007. INT. CL. 9.

JOEY, TARZANA, CA:
3,296,657, PUB. 7-10-2007. INT. CL. 41.

JOHN FOX, SAN RAFAEL, CA:
3,296,736, PUB. 7-10-2007. INT. CL. 36.

JOHN LYONS SYMPOSIUMS, INC., PARACHUTE, CO:
3,297,615, PUB. 7-10-2007. MULTIPLE CLASS, INT. CLS. 9
AND 16.

JOHN O. COLEMAN, STUART, FL:
2,404,667, CANC. INT. CL. 42.

JOHN T. NOTHNAGLE, INC., ROCHESTER, NY:
3,297,704, PUB. 7-10-2007. INT. CL. 41.

JOHNSON & JOHNSON, NEW BRUNSWICK, NJ:
1,416,377, CANC. INT. CL. 5.
3,296,108, PUB. 7-10-2007. MULTIPLE CLASS, INT. CLS.
16, 18, 21 AND 25.

JOHNSON ELIZABETH M. BATAVIA, IL:
3,297,047, PUB. 7-10-2007. INT. CL. 41.

JOHNSON, ANNA K., NEVADA CITY, CA:
3,296,975, PUB. 7-10-2007. INT. CL. 35.

JOHNSON, GARRETT, VIRGINIA BEACH, VA:
3,298,741, INT. CL. 19.

JOHNSTON TECHNOLOGY E.I.R.L., LIMA, PERU:
3,298,021, PUB. 7-10-2007. INT. CL. 42.

JOIPHONE, LLC, DELRAY BEACH, FL:
3,299,931, INT. CL. 38.

JOMAR INTERNATIONAL, LTD., MADISON HEIGHTS, MI
TO HYDRONICS COMPONENTS, INC., MADISON
HEIGHTS, MI:
2,016,118, CANC. INT. CL. 11.

JOMAR INTERNATIONAL, LTD., MADISON HEIGHTS, MI
TO HYDRONIC COMPONENTS, INC., MADISON
HEIGHTS, MI:
2,016,119, CANC. INT. CL. 11.

JONAS, TRINA, BURBANK, CA:
3,300,066, INT. CL. 24.

JONES INVESTMENT CO. INC., WILMINGTON, DE:
3,299,051, INT. CL. 25.

JONES-HAMILTON CO., WALBRIDGE, OH:
3,299,741, INT. CL. 1.

JONES, JOHN T.L., JR, LEXINGTON, KY:
2,404,051, CANC. MULTIPLE CLASS, INT. CLS. 41 AND
42.

JONES, WINDY, SEDONA, AZ:
3,297,732, PUB. 7-10-2007. INT. CL. 14.

JOOMEE FASHIONS, INC., NEW YORK, NY:
1,650,821, CANC. INT. CL. 25.

JOONG CHENN INDUSTRY CO., LTD., TAICHUNG HSIEN,
TAIWAN:
3,298,532, INT. CL. 28.

JOP AMERICA CORPORATION, SAN FRANCISCO, CA:
3,296,554, PUB. 7-10-2007. INT. CL. 28.

JORGINA INC., CAVE CREEK, AZ:
2,403,799, CANC. INT. CL. 3.

JOSE & MARIA BARRERA COMPANY, LTD., NEW YORK,
NY:
3,296,329, PUB. 7-10-2007. INT. CL. 18.

JOSEF FRIEDERICH WEINGUTER-WEINKELLEREIEN
GMBH & CO. KG, ZELL/MOSEL, FED REP GERMANY:
1,416,879, CANC. INT. CL. 33.

JOSEPH A. HARDY & ASSOCIATES, EIGHTY FOUR, PA:
2,403,339, CANC. INT. CL. 35.

JOSEPH, LICATA C., MANHASSET, NY:
3,296,926, PUB. 7-10-2007. INT. CL. 8.

JOSEPH, TAYLOR M, SAN FRANCISCO, CA:
3,298,046, PUB. 7-10-2007. MULTIPLE CLASS, INT. CLS.
35 AND 41.

JOURNAL COMMUNICATIONS, INC., FRANKLIN, TN
AND TENNESSEE MUNICIPAL ELECTRIC POWER AS-
SOCIATION, BRENTWOOD, TN:
2,102,317. REN. 8-17-07. INT. CL. 16.

JOY MARK, INC., NEW YORK, NY:
3,296,783, PUB. 7-10-2007. INT. CL. 25.

JP (HK) LIMITED, MALIBU, CA TO JAKKS PACIFIC (HK),
LTD., MALIBU, CA:
2,014,681, CANC. MULTIPLE CLASS, INT. CLS. 9 AND
28.

JP PLAN, SANTA ANA, CA:
3,300,022, INT. CL. 8.

JPMORGAN CHASE BANK, AS COLLATERAL AGENT,
NEW YORK, NY:
2,015,321, CANC. INT. CL. 35.

JPS ELASTOMERICS CORPORATION, HOLYOKE, MA:
3,297,804, PUB. 7-10-2007. MULTIPLE CLASS, INT. CLS. 1
AND 19.

JS PRODUCTS, INC., LAS VEGAS, NV:
3,299,486, INT. CL. 42.

JT SPORTS LLC, BENTONVILLE, AR:
3,295,979, PUB. 10-26-2004. INT. CL. 28.

JUBILEE PRODUCTS, INC., FORT MYERS, FL:
2,403,428, CANC. INT. CL. 2.

JUICE BOWL PRODUCTS, INC., FORT GIBSON, OK, MEAD
JOHNSON & COMPANY, EVANSVILLE, IN:
823,707. REN. 8-20-07. U.S. CL. 46 (INT. CL. 31).

JUICEBOX WINE COMPANY LLC, MANCHESTER, MA:
3,299,769, INT. CL. 33.

JUICEHEADS, INC., SAN BERNARDINO, CA:
3,298,538, INT. CL. 32.

JUILLIARD SCHOOL, THE, NEW YORK, NY:
2,091,832. REN. 8-18-07. INT. CL. 9.

JURAN INSTITUTE, INC., SOUTHURDY, CT, JURAN IN-
STITUTE, INC., WALTON, CT:
1,453,462. REN. 8-23-07. INT. CL. 35.

JUS D'ORANGE, 75002 PARIS, FRANCE:
3,295,972, PUB. 3-11-2003. INT. CL. 25.

JUST BORN, INC., BETHLEHEM, PA:
1,452,407. REN. 8-23-07. INT. CL. 30.

JUSTWISE GROUP LIMITED, UNITED KINGDOM:
3,298,305, PUB. 7-10-2007. INT. CL. 28.

K.S. TOYS LTD., T.S.T. EAST, KOWLOON, HONG KONG:
3,296,762, PUB. 7-10-2007. INT. CL. 28.
3,296,763, PUB. 7-10-2007. INT. CL. 28.
3,296,764, PUB. 7-10-2007. INT. CL. 28.

KABBALAH CENTRE INTERNATIONAL, INC., LOS AN-
GELES, CA:
3,297,720, PUB. 7-10-2007. INT. CL. 41.
3,297,721, PUB. 7-10-2007. INT. CL. 41.

KABUSHIKI KAISHA CARMATE, SHINJUKU-KU, TOKYO,
JAPAN:
2,014,777, CANC. INT. CL. 12.

KABUSHIKI KAISHA IMAO CORPORATION, GIFU-KEN,
JAPAN:
3,295,993, PUB. 7-10-2007. INT. CL. 7.

- KABUSHIKI KAISHA KOMATSU SEISAKUSHO (D.B.A. KOMATSU LTD.), TOKYO, JAPAN:
3,297,305, PUB. 7-10-2007. MULTIPLE CLASS, INT. CLS. 7, 9, 12, 14, 16, 18, 25, 28, 41 AND 42.
- KABUSHIKI KAISHA NAGATANIEN, TOKYO, JAPAN, DBA NAGATANIEN CO., LTD.:
3,296,260, PUB. 7-10-2007. INT. CL. 29.
- KABUSHIKI KAISHA NIPPON SAWAYAKA GROUP, KUMAMOTO-KEN, JAPAN:
2,403,085, CANC. INT. CL. 37.
- KABUSHIKI KAISHA PILOT CORPORATION; (ALSO TRADING AS PILOT CORPORATION), TOKYO, JAPAN:
3,298,387, PUB. 7-10-2007. INT. CL. 16.
- KABUSHIKI KAISHA SEGA, OHTA-KU, TOKYO, JAPAN, DBA SEGA CORPORATION:
3,297,796, PUB. 7-10-2007. MULTIPLE CLASS, INT. CLS. 9, 28 AND 41.
- KABUSHIKI KAISHA SONY COMPUTER ENTERTAINMENT, TOKYO 107-0052, JAPAN, TA SONY COMPUTER ENTERTAINMENT INC.:
3,038,651, COR. MULTIPLE CLASS, INT. CLS. 9, 14, 16, 18, 21, 24, 25, 26 AND 28.
- KABUSHIKI KAISHA SQUARE ENIX, TOKYO, JAPAN, TA SQUARE ENIX CO., LTD.:
3,297,893, PUB. 7-10-2007. MULTIPLE CLASS, INT. CLS. 9 AND 16.
- KABUSHIKI KAISHA TANITA, TOKYO, JAPAN:
3,297,243, PUB. 7-10-2007. MULTIPLE CLASS, INT. CLS. 9, 10, 16, 41, 42 AND 44.
- KABUSHIKI KAISYA A.E.I., SHINJUKU-KU, TOKYO, JAPAN:
1,416,462, CANC. INT. CL. 9.
- KAFE KALIK USA, LLC, WINDERMERE, FL:
3,299,308, INT. CL. 43.
- KAGOME CO., LTD., NAKA-KU NOGOYA, JAPAN:
3,299,407, INT. CL. 32.
- KAHALA FRANCHISE CORP., SCOTTSDALE, AZ:
1,417,045, CANC. INT. CL. 42.
- KAJ & SVERRER AB, SWEDEN:
3,298,204, PUB. 7-10-2007. INT. CL. 25.
- KAJA, INC., CRANSTON, RI:
3,297,549, PUB. 7-10-2007. INT. CL. 32.
- KALEVIT ROCA SANITER SERAMIK; SANAYI ANONIM SIRKETI, TURKEY:
3,298,198, PUB. 7-10-2007. MULTIPLE CLASS, INT. CLS. 11, 19 AND 21.
- KAM INDUSTRIES, LTD., KENOSHA, WI:
3,298,031, PUB. 7-10-2007. MULTIPLE CLASS, INT. CLS. 6 AND 37.
- KAM PRODUCTIONS, OMAHA, NE:
1,416,813, CANC. INT. CL. 28.
- KAMMS CONSULTING, LLC, VENTNOR CITY, NJ:
3,299,969, INT. CL. 9.
- KANE ENTERPRISES, INC., LA HABRA, CA:
3,299,758, INT. CL. 3.
- KANEI, INC., CHINO, CA:
2,138,573, REN. 8-23-07. INT. CL. 12.
- KANSKO RECREATION CORPORATION, BLACKFOOT, ID, DBA THE CORNER PIN PRO SHOP:
2,404,075, CANC. INT. CL. 35.
- KAO KABUSHIKI KAISHA, TOKYO, 103, JAPAN, TA KAO CORPORATION:
2,076,882, REN. 8-17-07. INT. CL. 1.
- KAO MEI INTERNATIONAL, INC., WALNUT, CA:
2,106,797, REN. 8-17-07. INT. CL. 15.
- KAR NUT PRODUCTS COMPANY, MADISON HEIGHTS, MI:
3,296,245, PUB. 7-10-2007. INT. CL. 29.
- KAREN A. HUGHES, FREDERICKSBURG, VA:
3,297,737, PUB. 7-10-2007. INT. CL. 44.
- KAREN FOSTER DESIGN, LLC, CENTERVILLE, UT:
2,403,617, CANC. INT. CL. 9.
- KAREN MORRISON, FOREST HILLS, NY:
3,296,579, PUB. 7-10-2007. MULTIPLE CLASS, INT. CLS. 38 AND 41.
- 3,296,589, PUB. 7-10-2007. INT. CL. 38.
- KARL KUCERIS AND RUSSELL HERTRICH, DERRY, NH, DBA USA SUBS:
3,296,710, PUB. 7-10-2007. INT. CL. 43.
- KARL STORZ GMBH & CO., D-78532 TUTTLINGEN, FED REP GERMANY:
2,403,432, CANC. INT. CL. 10.
- KARL STORZ GMBH & CO. KG, TUTTLINGEN, FED REP GERMANY:
1,443,905, REN. 8-20-07. MULTIPLE CLASS, INT. CLS. 9 AND 10.
- KARLE, AMY, ENDICOTT, NY:
3,296,005, PUB. 7-10-2007. INT. CL. 41.
- KASIOS, FRANCE:
3,298,370, PUB. 7-10-2007. INT. CL. 10.
- KATHERL SOFTWARE GMBH, AUSTRIA:
3,298,362, PUB. 7-10-2007. MULTIPLE CLASS, INT. CLS. 9 AND 42.
- KATHY MAISTER'S START COOKING LLC, BOSTON, MA:
3,297,888, PUB. 7-10-2007. INT. CL. 43.
- KATLIN SMITH COMMUNICATIONS LLC, VANCOUVER, WA:
3,299,866, INT. CL. 42.
- KAUFMAN, DAVID Z., FAIRFAX, VA:
3,297,012, PUB. 7-10-2007. INT. CL. 45.
- KAUFMAN, ELIZABETH M, REDONDO BEACH, CA:
3,297,484, PUB. 7-10-2007. MULTIPLE CLASS, INT. CLS. 9, 16, 41 AND 44.
- KAUL INVESTMENTS, LLC, LOS ANGELES, CA:
2,404,321, CANC. INT. CL. 35.
- KAVIAR AND KIND, LLC, LOS ANGELES, CA:
3,296,841, PUB. 7-10-2007. INT. CL. 18.
- KC LEATHER & FUR, INC., NEW YORK, NY:
2,403,061, CANC. INT. CL. 25.
- KCD IP, LLC, HOFFMAN ESTATES, IL:
1,416,396, CANC. INT. CL. 6.
- KCI LICENSING, INC., SAN ANTONIO, TX:
3,296,849, PUB. 7-10-2007. INT. CL. 10.
- KDB PTY LTD, AUSTRALIA:
3,298,360, PUB. 7-10-2007. INT. CL. 3.
- KEARNEY, JAMES D, TAYLORSVILLE, NC:
2,404,708, CANC. INT. CL. 25.
- KEENE PROMOTIONS, INC., AUBURNDALE, MA:
3,300,260, INT. CL. 35.
- KEEPER CORPORATION, NORTH WINDHAM, CT:
3,296,172, PUB. 7-10-2007. INT. CL. 6.
- KEEPSAKE CANDLES, INC., BARTLESVILLE, OK:
1,068,849, REN. 8-17-07. INT. CL. 4.
- KEHOE, THOMAS DAVID, BOULDER, CO:
2,403,996, CANC. INT. CL. 10.
- KEHOE, THOMAS E., MIAMI, FL:
2,404,670, CANC. INT. CL. 39.
- KEIBERG INTERNATIONAL INC., WINNIPEG, MANITOBA, CANADA:
3,299,153, INT. CL. 9.
- KEITH I BARKSDALE, SAN DIEGO, CA:
3,299,408, INT. CL. 41.
- KEITH MARZ, VAN NUYS, CA:
3,297,141, PUB. 7-10-2007. INT. CL. 44.
- KELLER GRADUATE SCHOOL OF MANAGEMENT, INC., OAKBROOK TERRACE, IL:
1,416,989, CANC. INT. CL. 41.
- KELLEY, R. DOUGLAS, COLORADO SPRINGS, CO, DBA DENWEST GROUP:
2,404,720, CANC. MULTIPLE CLASS, INT. CLS. 16, 20 AND 25.
- KELLOGG NORTH AMERICA COMPANY, BATTLE CREEK, MI:
3,299,234, INT. CL. 30.
- KELLOGG NORTH AMERICA COMPANY, BATTLE CREEK, DE:
3,299,511, INT. CL. 30.
- KELLY, THOMAS J., HONDO, TX:
2,404,689, CANC. INT. CL. 25.
- KELSEY-SEYBOLD MEDICAL GROUP, P.A., HOUSTON, TX:
3,296,932, PUB. 7-10-2007. INT. CL. 44.
- KEMIN INDUSTRIES, INC., DES MOINES, IA:
3,297,766, PUB. 7-10-2007. INT. CL. 5.

- KEMPER DEVELOPMENT COMPANY, BELLEVUE, WA:
3,300,329, INT. CL. 36.
- KEMPSHIRE ENTERPRISES, LLC, VIRGINIA BEACH, VA,
DBA/FREEDOM WASH:
3,298,943, INT. CL. 37.
- KENEXA BRASSRING, INC., WAYNE, PA:
2,403,619, CANC. INT. CL. 35.
- KENNETH T. AKAMA, BROOKLYN, NY:
3,296,470, PUB. 7-10-2007. INT. CL. 16.
- KENSEY NASH CORPORATION, EXTON, PA:
3,298,867, INT. CL. 5.
- KENT OIL COMPANY, INC., LAKELAND, FL:
2,014,816, CANC. INT. CL. 4.
- KENT PLASTIC CO LTD., CHANGHWA, TAIWAN:
2,403,781, CANC. INT. CL. 11.
- KENT SPORTING GOODS COMPANY, INC., NEW LON-
DON, OH, DENNY KIDDER ENTERPRISES, INC., AU-
BURN, WA:
2,082,812, REN. 8-18-07. INT. CL. 28.
- KENTUCKY COMMUNITY AND TECHNICAL COLLEGE
SYSTEM, VERSAILLES, KY:
3,300,012, INT. CL. 41.
- KERI THOMAS COMMUNICATIONS, LLC, AUSTIN, TX:
3,299,220, INT. CL. 35.
- KERKHOFF, DEAN, COVINA, CA:
3,298,805, MULTIPLE CLASS, INT. CLS. 14, 18 AND 25.
- KERRY INC., BELOIT, WI:
2,103,292, REN. 8-23-07. INT. CL. 30.
- KEVIN L KIRBY INC., CHARLOTTESVILLE, VA:
3,299,943, INT. CL. 43.
- KEVIN, INC., KITTERY, ME:
3,296,621, PUB. 7-10-2007. INT. CL. 35.
- KEWPIE KABUSHIKI KAISHA, SHIBUYA-KU, TOKYO,
JAPAN, DBA Q.P. CORPORATION:
3,296,249, PUB. 7-10-2007. MULTIPLE CLASS, INT. CLS.
1, 3 AND 5.
- KEY WELDER CORP., CLINTON TOWNSHIP, MI:
2,403,938, CANC. INT. CL. 42.
- KEYS FEDERAL CREDIT UNION, KEY WEST, FL:
3,300,048, INT. CL. 36.
- KEYSTONE BREWERS HOLDING COMPANY, WILMING-
TON, DE:
1,441,389, REN. 8-23-07. INT. CL. 32.
- KEYSTONE PROFESSIONAL BASEBALL, INC., WAPPIN-
GERS FALLS, NY:
2,085,446, REN. 8-17-07. INT. CL. 41.
- KEYSTONE SOFTWARE, INC., SPRINGFIELD, VA:
3,297,042, PUB. 7-10-2007. INT. CL. 42.
- KFC CORPORATION, LOUISVILLE, KY:
2,016,596, CANC. INT. CL. 42.
- KIDDYKEYS, GREEN BAY, WI:
3,296,220, PUB. 7-10-2007. MULTIPLE CLASS, INT. CLS.
16, 28 AND 41.
- KIDS AT HOPE, PHOENIX, AZ, BOYS & GIRLS CLUBS OF
METROPOLITAN PHOENIX, PHOENIX, AZ:
2,081,942, REN. 8-23-07. INT. CL. 41.
- KIDS NEED US NOW, LLC, METHUEN, MA:
3,297,362, PUB. 7-10-2007. INT. CL. 30.
- KIDZ BOP LLC, NEW YORK, NY:
3,298,693, MULTIPLE CLASS, INT. CLS. 16, 25 AND 28.
- KIEHFUSS, MOLLIE, GREENBRAE, CA:
3,299,911, INT. CL. 41.
- KIKKOMAN CORPORATION, NODA CITY, CHIBA, JA-
PAN, NODA SHOYU CO., LTD., NODA-SHI, CHIBA-KEN,
JAPAN:
650,224, REN. 8-23-07. U.S. CL. 46 (INT. CL. 30).
650,225, REN. 8-23-07. U.S. CL. 46 (INT. CL. 30).
- KIKKOMAN CORPORATION, NODA CITY CHIBA, JAPAN,
NODA SHOYU CO., LTD., NODA-SHI, CHIBA-KEN,
JAPAN:
650,651, REN. 8-23-07. U.S. CL. 46 (INT. CL. 30).
- KIKKOMAN CORPORATION, NODA CITY, CHIBA, JA-
PAN:
1,451,140, REN. 8-23-07. INT. CL. 30.
1,452,395, REN. 8-23-07. INT. CL. 30.
- KILCHER, JEWEL, SAN DIEGO, CA:
3,295,971, PUB. 6-5-2007. MULTIPLE CLASS, INT. CLS. 9
AND 41.
- KILGANNON INC., ATLANTA, GA:
3,296,475, PUB. 7-10-2007. INT. CL. 35.
- KILTIE CORPORATION, OAKDALE, MN:
3,296,676, PUB. 7-10-2007. INT. CL. 19.
- KIM, SUNG-TAE, KANGNAM-GU SEOUL, REPUBLIC OF
KOREA:
2,109,624, REN. 8-20-07. INT. CL. 31.
- KIM, Y.K., ORLANDO, FL:
2,403,863, CANC. INT. CL. 41.
- KIMBALL INTERNATIONAL, INC., JASPER, IN:
3,299,043, INT. CL. 20.
3,299,828, INT. CL. 20.
- KIMBERLY-CLARK WORLDWIDE, INC., NEENAH, WI:
2,403,813, CANC. INT. CL. 10.
- KINETIC TECHNOLOGIES, LLC, LEXINGTON, KY:
3,296,708, PUB. 7-10-2007. INT. CL. 5.
- KINETICO INCORPORATED, NEWBURY, OH:
1,445,796, REN. 8-17-07. INT. CL. 1.
- KING BALLERS, INC., SACRAMENTO, CA:
3,299,655, INT. CL. 25.
- KING COLE BAITTS, LLC, LODI, WI:
2,403,715, CANC. INT. CL. 28.
- KING OF FANS, INC., FT. LAUDERDALE, FL:
3,299,286, INT. CL. 11.
- KING PAR CORPORATION, FLUSHING, MI:
2,087,314, REN. 8-17-07. INT. CL. 28.
- KING PAR CORPORATION, FLUSHING, MI, KNIGHT
GOLF, INC., FLUSHING, MI:
2,107,733, REN. 8-23-07. INT. CL. 28.
- KINGCHEM, INC., ORADELL, NJ:
2,403,796, CANC. INT. CL. 5.
- KINGSTON TECHNOLOGY CORPORATION, FOUNTAIN
VALLEY, CA:
2,015,493, CANC. INT. CL. 9.
- KINZIE & COMPANY, INC., IRVINE, CA:
3,296,394, PUB. 7-10-2007. MULTIPLE CLASS, INT. CLS.
37 AND 40.
- KIRBY, GEORGE A, SANTA CLARITA, CA:
2,154,858, REN. 8-20-07. INT. CL. 41.
- KIRKBI AG, CH-6340 BAAR, SWITZERLAND:
2,404,234, CANC. INT. CL. 9.
- KIRON, PARIS, FRANCE:
3,297,203, PUB. 7-10-2007. MULTIPLE CLASS, INT. CLS.
35, 36, 37 AND 42.
- 3,297,204, PUB. 7-10-2007. MULTIPLE CLASS, INT. CLS.
35, 36, 37 AND 42.
- KIT-N-SIT LLC, RAVENNA, OH:
3,296,856, PUB. 7-10-2007. INT. CL. 45.
- KITCHEN KOMPACT, INC., JEFFERSONVILLE, IN:
3,297,009, PUB. 7-10-2007. INT. CL. 20.
- KLEIN INTERNATIONAL, LTD., WILSONVILLE, OR:
3,296,278, PUB. 7-10-2007. MULTIPLE CLASS, INT. CLS.
14 AND 26.
- KLEINER, HAROLD, SANTA MONICA, CA:
2,404,683, CANC. INT. CL. 9.
- KLINGLER, KATHRYN D, LOS ANGELES, CA:
3,299,962, INT. CL. 25.
- KMART OF MICHIGAN, INC., HOFFMAN ESTATES, IL:
3,297,947, PUB. 7-10-2007. INT. CL. 35.
- KMT WATERJET SYSTEMS, INC., BAXTER SPRINGS, DE:
1,468,814, REN. 8-17-07. INT. CL. 7.
- KNAAP LICENTIES BV, NL-2671 DW NAALDWIJK, NETH-
ERLANDS:
3,298,252, PUB. 7-10-2007. INT. CL. 31.
- KNAUF INSULATION GMBH, SHELBYVILLE, IN:
3,299,767, INT. CL. 17.
- KNIGHT MANAGEMENT INSURANCE SERVICES, LLC,
LOS ANGELES, CA:
3,297,798, PUB. 7-10-2007. INT. CL. 36.
- KNIGHT'S ARMAMENT COMPANY, TITUSVILLE, FL:
3,297,546, PUB. 7-10-2007. INT. CL. 9.
- KNOLL AG, 67061 LUDWIGSHAFEN, FED REP GERMANY:
2,403,296, CANC. INT. CL. 5.
- KNOWLEDGE LEARNING CORPORATION, PORTLAND,
OR:
3,296,777, PUB. 7-10-2007. MULTIPLE CLASS, INT. CLS.
16 AND 41.
- 3,296,778, PUB. 7-10-2007. MULTIPLE CLASS, INT. CLS.

- 16 AND 41.
3,296,780, PUB. 7-10-2007. MULTIPLE CLASS, INT. CLS. 16 AND 41.
- KNOWLEDGE NETWORKS, INC., MENLO PARK, CA:
3,297,848, PUB. 7-10-2007. MULTIPLE CLASS, INT. CLS. 9 AND 35.
- KNOWLEDGESTORM, INC., ALPHARETTA, GA:
3,300,376, INT. CL. 35.
- KNUTSON, KRISTINE, LIBERTYVILLE, IL:
3,297,874, PUB. 7-10-2007. INT. CL. 40.
3,297,875, PUB. 7-10-2007. INT. CL. 45.
- KO PIZZERIA, INC., CARLSBAD, CA:
3,297,544, PUB. 7-10-2007. INT. CL. 43.
- KOBELCO CONSTRUCTION MACHINERY CO., LTD., JAPAN:
3,298,223, PUB. 7-10-2007. INT. CL. 7.
- KOCH, KENNETH B., NASHVILLE, TN:
3,300,336, INT. CL. 35.
- KOELLIKER ENTERPRISES, LLC, SPRING, TX:
3,299,139, INT. CL. 20.
- KOHLER CO., KOHLER, WI:
3,297,346, PUB. 7-10-2007. INT. CL. 21.
3,299,236, INT. CL. 11.
- KOLARAS, THOMAS, GEORGE, HILLSBOROUGH, NJ:
3,297,313, PUB. 7-10-2007. INT. CL. 25.
- KOLCRAFT ENTERPRISES, INC., CHICAGO, IL:
2,403,882, CANC. INT. CL. 12.
3,300,097, INT. CL. 12.
- KOMPANIA SPIRYTUSOWA "WRATISLAVIA" POLMOS WROCLAW SPOLKA AKCYJNA, 51-501 WROCLAW, POLAND:
3,297,191, PUB. 7-10-2007. INT. CL. 33.
- KONA CORPORATION, REDMOND, WA, DBA KONA CORPORATION TO KONA GOLD CORPORATION, REDMOND, WA, DBA KONA CORPORATION:
1,416,336, CANC. INT. CL. 3.
- KONDRATTSEV, MOSTART YEVGENIY Y., LOS ANGELES, CA:
3,296,466, PUB. 7-10-2007. INT. CL. 9.
- KONIETZKO, APOTHEKER ALBRECHT, D-96049 BAMBERG, FED REP GERMANY:
2,074,921. REN. 8-17-07. MULTIPLE CLASS, INT. CLS. 7 AND 20.
- KORET COMMUNICATIONS, LTD., TEL AVIV, ISRAEL:
3,296,757, PUB. 7-10-2007. INT. CL. 42.
- KOSS, KIMBERLY, L, MASON, OH AND EHRSTINE, WILLIAM, H., MASON, OH:
3,299,608, INT. CL. 14.
- KRAFT FOODS HOLDINGS, INC., NORTHFIELD, IL, KRAFT FOODS, INC., NORTHFIELD, IL:
2,076,225. REN. 8-18-07. INT. CL. 30.
- KRAFT FOODS, INC., NORTHFIELD, IL:
2,403,788, CANC. INT. CL. 32.
- KRANSON INDUSTRIES, INC., ST. LOUIS, MO:
2,404,914, CANC. INT. CL. 35.
- KRASDALE FOODS, INC., BRONX, NY, KRASNE, ABRAHAM, NEW YORK, NY, DBA A. KRASNE:
230,899. REN. 8-23-07. U.S. CL. 46 (INT. CLS. 1, 5, 29, 30, 31 AND 32).
- KRAUS, PHILIP, SAN FERNANDO, CA:
3,297,082, PUB. 7-10-2007. INT. CL. 20.
3,297,147, PUB. 7-10-2007. INT. CL. 20.
- KRAUSE, EDWARD J., III, BETHESDA, MD:
3,296,189, PUB. 7-10-2007. INT. CL. 35.
- KROEGER MEDIA INC., LA SALLE, MANITOBA, CANADA:
3,298,988, INT. CL. 38.
- KROEKER OFF ROAD ENGINEERING, INC., VALLEY CENTER, CA:
3,298,572, INT. CL. 12.
- KROGER CO., THE, LIVONIA, MI:
648,383. REN. 8-17-07. U.S. CL. 46 (INT. CL. 30).
- KRUEGER INTERNATIONAL, INC., GREEN BAY, WI:
3,299,005, INT. CL. 20.
- KRYGSHELD, WILLIAM, BEECHER, IL, DBA KRYGSHELD PUBLICATIONS:
2,091,981. REN. 8-20-07. INT. CL. 16.
- KRYOLAN CORPORATION, SAN FRANCISCO, CA:
3,296,091, PUB. 7-10-2007. INT. CL. 3.
3,296,092, PUB. 7-10-2007. INT. CL. 3.
- KRYOTECH, INC., WEST COLUMBIA, SC:
2,403,490, CANC. INT. CL. 9.
- KSM CORPORATION, KALAMAZOO, MI:
2,403,262, CANC. INT. CL. 11.
- KS2 TECHNOLOGIES, INC., GRAPEVINE, TX:
3,298,462, INT. CL. 9.
- KTM INDUSTRIES, INC., LANSING, MI:
2,403,725, CANC. MULTIPLE CLASS, INT. CLS. 20 AND 28.
- KUDELSKI SA, SWITZERLAND:
3,298,373, PUB. 7-10-2007. MULTIPLE CLASS, INT. CLS. 9 AND 42.
- KUHLMANN, BERNT, SANTA MONICA, CA:
3,299,257, INT. CL. 25.
- KUPTSOV, SERGE P, TROUTDALE, OR:
3,296,044, PUB. 7-10-2007. INT. CL. 9.
- KURARAY CO., LTD., JAPAN:
3,298,157, PUB. 7-10-2007. MULTIPLE CLASS, INT. CLS. 9, 18, 21, 25 AND 28.
- KUREHA CORPORATION, TOKYO, JAPAN:
3,298,134, PUB. 7-10-2007. INT. CL. 5.
- KURLAND, WILLIAM, NEW YORK, NY AND KURLAND, STEVEN, NEW YORK, NY:
1,417,009, CANC. INT. CL. 42.
- KURT S. ADLER, INC., NEW YORK, NY:
2,036,166. REN. 8-23-07. INT. CL. 28.
- KURTZ, JOHN K, SHAWNEE MISSION, KS:
2,114,883. REN. 8-23-07. INT. CL. 25.
- KUSHKA COSMETICS LLC, LANSING, KS:
3,300,318, MULTIPLE CLASS, INT. CLS. 3 AND 5.
- KUTTER'S FURNITURE STORE, INC., HUTCHINSON, KS:
3,296,879, PUB. 7-10-2007. INT. CL. 35.
- KUYPER COLLEGE, GRAND RAPIDS, MI:
3,299,918, INT. CL. 41.
- KUZMA, ROBERT, WILMINGTON, NC:
3,299,808, INT. CL. 35.
- KWIK GOAL, LTD., QUAKERTOWN, PA:
3,298,550, INT. CL. 28.
- KWSL, LLC, CINCINNATI, OH:
3,299,158, INT. CL. 36.
- KYJEN COMPANY, INC., THE, HUNTINGTON BEACH, CA:
2,403,937, CANC. INT. CL. 28.
- KYLE ELLISON, LOUISVILLE, KY:
3,298,034, PUB. 7-10-2007. INT. CL. 8.
- KYOSHO CORPORATION, TOKYO, JAPAN:
3,297,792, PUB. 7-10-2007. INT. CL. 28.
- KYZEN CORPORATION, NASHVILLE, TN:
2,403,557, CANC. INT. CL. 35.
- KZ GOLF, INC., NORTH HOLLYWOOD, CA:
2,087,626. REN. 8-23-07. INT. CL. 28.
- K2 ADVISORS L.L.C., STAMFORD, CT:
3,296,442, PUB. 7-10-2007. INT. CL. 36.
- K9 CORE CONSULTING & TRAINING, LLC, PHILADELPHIA, PA:
3,297,067, PUB. 7-10-2007. INT. CL. 41.
- KÜHNE + NAGEL INTERNATIONAL AG, SWITZERLAND:
3,298,329, PUB. 7-10-2007. MULTIPLE CLASS, INT. CLS. 35, 36 AND 39.
- L & P PROPERTY MANAGEMENT COMPANY, SOUTH GATE, CA:
3,299,980, INT. CL. 22.
- L & S BAIT COMPANY OF FLORIDA, INC., LARGO, FL, TOURNAMENT TACKLE, INC., SATELLITE BEACH, FL:
2,045,130. REN. 8-22-07. INT. CL. 28.
- L G IMPORTS MANUFACTURING COMPANY, SKOKIE, IL:
2,084,260. REN. 8-17-07. INT. CL. 14.
- L. B. BRIDGEHAMPTON CORP., PLATTSBURGH, NY:
3,297,297, PUB. 7-10-2007. MULTIPLE CLASS, INT. CLS. 9 AND 25.
- L. N. LIGHTFOOT INC., CARLSBAD, CA, DBA THE LIGHTFOOT PLANNING GROUP:
1,475,433. REN. 8-17-07. INT. CL. 42.

- L. PERRIGO COMPANY, ALLEGAN, MI:
3,297,995, PUB. 7-10-2007. INT. CL. 5.
- L. R. WEST MANUFACTURING CO., INC., PEARLAND, TX, L. R. WEST MANUFACTURING CO., HOUSTON, TX:
839,847. REN. 8-20-07. U.S. CL. 12 (INT. CL. 19).
- L.C. LICENSING, INC., NEW YORK, NY, LIZ CLAIBORNE, INC., NEW YORK, NY:
1,442,825. REN. 8-21-07. MULTIPLE CLASS, INT. CLS. 9, 18 AND 25.
- L.R. NELSON CORPORATION, PEORIA, IL:
1,416,699, CANC. INT. CL. 21.
- L&H DISTRIBUTING, LLC, BALTIMORE, MD:
2,403,254, CANC. MULTIPLE CLASS, INT. CLS. 6, 20 AND 21.
- L&W STONE CORPORATION, ORLAND, CA:
3,296,319, PUB. 7-10-2007. MULTIPLE CLASS, INT. CLS. 35 AND 40.
- L-1 IDENTITY SOLUTIONS, INC., STAMFORD, CT:
3,300,353, INT. CL. 9.
- L, L & D, INC., SEATTLE, WA, DBA THE FANTASY CAFE:
2,403,235, CANC. MULTIPLE CLASS, INT. CLS. 35 AND 42.
- L'AVARE SARL, SAINT DENIS, FRANCE:
3,298,074, PUB. 7-10-2007. INT. CL. 14.
- L'OREAL, 75008 PARIS, FRANCE:
2,403,084, CANC. MULTIPLE CLASS, INT. CLS. 1 AND 3.
- L'OREAL, PARIS, FRANCE:
3,296,734, PUB. 7-10-2007. INT. CL. 3.
3,299,182, INT. CL. 3.
- L'OREAL USA CREATIVE, INC., NEW YORK, NY:
3,299,351, INT. CL. 3.
3,299,914, INT. CL. 3.
- LA DONATELLA SRL, MONTEBELLUNA (TV), ITALY:
3,298,652, INT. CL. 30.
- LA JOLLA KAYAK & COMPANY LLC, LA JOLLA, CA:
3,297,782, PUB. 7-10-2007. INT. CL. 39.
- LA QUINTA WORLDWIDE, L.L.C., LAS VEGAS, NV:
3,297,108, PUB. 7-10-2007. INT. CL. 43.
- LAB SAFETY CORPORATION, CUMBERLAND, WI:
3,296,584, PUB. 7-10-2007. INT. CL. 1.
- LABANZ, JANE A., NEW YORK, NY:
3,297,712, PUB. 7-10-2007. MULTIPLE CLASS, INT. CLS. 16 AND 41.
- LABEN S.P.A., MILAN, ITALY:
2,403,157, CANC. INT. CL. 9.
- LABOR SYSTEMS, INC., CHANDLER, AZ:
2,075,062. REN. 8-22-07. INT. CL. 35.
- LABORATOIRE DOLISOS, 75003 PARIS, FRANCE:
2,403,618, CANC. INT. CL. 5.
- LACE SILHOUETTES LINGERIE, INC., LAHASKA, PA:
2,085,708. REN. 8-17-07. INT. CL. 35.
- LACERENZA, D. MATTHEW, STAMFORD, CT:
3,299,753, INT. CL. 4.
- LACHESIS BIOSCIENCES PTY LTD, AUSTRALIA:
3,298,273, PUB. 7-10-2007. MULTIPLE CLASS, INT. CLS. 10, 41 AND 44.
- LACY, JARVIS, GRAND PRAIRIE, TX:
3,299,919, INT. CL. 11.
- LADEWIG, MICHELLE, DALLAS, TX:
3,300,338, INT. CL. 44.
- LADNER, HEATHER E., KERRVILLE, TX:
3,299,859, INT. CL. 43.
- LAGO, JOSE R., SAN ANTONIO, TX:
3,296,301, PUB. 7-10-2007. INT. CL. 9.
- LAING THERMOTECH, INC., CHULA VISTA, CA:
2,096,718. REN. 8-23-07. INT. CL. 7.
- LAKE COUNTY CHAMBER OF COMMERCE, GURNEE, IL:
2,015,055, CANC. INT. CL. 35.
- LAKELAND HEALTH SERVICES, INC., HIGHLAND PARK, IL:
2,403,176, CANC. MULTIPLE CLASS, INT. CLS. 36, 41 AND 42.
- LAKWOOD INDUSTRIES, INC., PITTSFIELD, MA:
1,416,673, CANC. INT. CL. 20.
- LAMBERT, THERESA E., SANTA ROSA, CA:
2,074,964. REN. 8-17-07. INT. CL. 15.
- LAMBIE ENTREPRENEURIAL INC., PULASKI, NY:
3,298,073, PUB. 7-10-2007. INT. CL. 20.
- LAMPLIGHT FARMS INC., MENOMONEE FALLS, WI:
2,083,286. REN. 8-23-07. MULTIPLE CLASS, INT. CLS. 4 AND 11.
2,083,286, CANC. INT. CL. 5.
- LANCE ARMSTRONG FOUNDATION, INC., AUSTIN, TX:
3,296,017, PUB. 6-26-2007. INT. CL. 36.
- LANCOME PARFUMS ET BEAUTE & CIE, SAINT-HONORE, 75008 PARIS, FRANCE:
2,403,621, CANC. INT. CL. 3.
- LANCOME PARFUMS ET BEAUTE & CIE, PARIS, FRANCE:
2,403,779, CANC. INT. CL. 3.
3,299,640, INT. CL. 3.
3,299,845, INT. CL. 3.
- LAND O'LAKES PURINA FEED LLC, SHOREVIEW, MN:
3,299,533, MULTIPLE CLASS, INT. CLS. 5 AND 31.
- LANDAU, ARTHUR, NEW CITY, NY:
2,015,500, CANC. INT. CL. 42.
- LANE BRYANT PURCHASING CORP., BENSLEM, PA:
2,403,761, CANC. MULTIPLE CLASS, INT. CLS. 18 AND 35.
- LANE BRYANT PURCHASING CORP., REYNOLDSBURG, OH:
3,300,228, INT. CL. 25.
- LANESE, MIKI, ORANGE, CA:
3,300,041, INT. CL. 3.
- LANG, SIEGFRIED A., 66117 SAARBRUECKEN, FED REP GERMANY:
3,298,901, MULTIPLE CLASS, INT. CLS. 2 AND 3.
- LANGE, ELLEN, SPRINGFIELD, NJ:
2,015,189, CANC. INT. CL. 3.
- LANGETWINS WINE COMPANY, INC., ACAMPO, CA:
3,299,847, INT. CL. 33.
- LANGUAGE FORCE, INC., ORANGE, CA:
2,403,237, CANC. INT. CL. 9.
- LANIE LOU'S BROWNIES, LLC, BLAUVELT, NY:
3,296,445, PUB. 7-10-2007. INT. CL. 30.
- LANTEIGNE, MARK, AUSTIN, TX:
3,298,486, INT. CL. 42.
- LANXESS DEUTSCHLAND GMBH, LEVERKUSEN, FED REP GERMANY:
1,064,193. REN. 8-22-07. INT. CL. 1.
- LAPS FOR CF FOUNDATION INC, BIRMINGHAM, AL:
3,296,811, PUB. 7-10-2007. INT. CL. 36.
- LAPTE ENTREPRISES, INC., BELLAIRE, MI:
3,297,902, PUB. 7-10-2007. INT. CL. 5.
- LARA SCHINKE-OLSON INC., EDEN PRAIRIE, MN:
3,296,167, PUB. 7-10-2007. INT. CL. 41.
- LARRY H. MILLER BASEBALL, INC., SANDY, UT:
3,299,476, MULTIPLE CLASS, INT. CLS. 21 AND 25.
- LARRY H. MILLER RESTAURANTS, INC., MURRAY, UT:
2,404,877, CANC. INT. CL. 42.
- LARSEN - LE COGNAC DES VIKINGS S.A., COGNAC, FRANCE:
3,298,141, PUB. 7-10-2007. INT. CL. 33.
- LASALLE BANK CORPORATION, CHICAGO, IL:
3,299,022, INT. CL. 36.
- LASTING SPORT, S.R.O., CZECH REPUBLIC:
3,298,369, PUB. 7-10-2007. INT. CL. 25.
- LATEXFALT B.V., KOUDEKERK A/D RIJN, NETHERLANDS:
3,298,155, PUB. 7-10-2007. MULTIPLE CLASS, INT. CLS. 1 AND 19.
- LATHAM MANUFACTURING CORP., LATHAM, NY:
1,404,795. REN. 8-22-07. INT. CL. 11.
- LATICRETE INTERNATIONAL, INC., BETHANY, CT:
3,296,157, PUB. 7-10-2007. INT. CL. 19.
- LATIN NODE INC., MIAMI, FL:
3,297,055, PUB. 7-10-2007. MULTIPLE CLASS, INT. CLS. 36 AND 38.
- LATSHAW ENTERPRISES, INC., KANSAS CITY, MO:
2,403,096, CANC. INT. CL. 12.
- LAU INTERNATIONAL, INC., MIAMI, FL:
3,298,950, INT. CL. 14.
- LAURENCIO, WALDO, MIAMI, FL:
3,297,833, PUB. 7-10-2007. INT. CL. 35.
- LAURICE EL BADRY RAHME LTD., NEW YORK, NY, DBA LAURICE & CO.:
3,299,134, INT. CL. 3.

- LAVA ENTERPRISES, INC., SAN DIEGO, CA:
2,404,139, CANC. INT. CL. 4.
- LAWLOR, HAROLD SEWARD, HAMPTON, VA AND LAW-
LOR, REBECCA NEMIA, HAMPTON, VA:
3,298,725, INT. CL. 32.
- LAWNGRIPS, LLC, LAKE OSWEGO, OR:
3,300,078, INT. CL. 25.
- LAWRENCE E. NERHEIM, SAN FRANCISCO, CA:
2,016,169, CANC. MULTIPLE CLASS, INT. CLS. 26 AND
42.
- LAWRENCE HARDWARE 1 INC., DOWNSVIEW, CANADA:
1,056,866, REN. 8-18-07, INT. CL. 6.
- LAWRENCE MAPPING AND GRAPHICS, INC., MINNEA-
POLIS, MN:
2,404,843, CANC. INT. CL. 16.
- LAWRENCE, DIANE CAMERON, LOUISVILLE, KY:
2,016,211, CANC. INT. CL. 41.
- LAZ-E-SUZ, INC., ARLINGTON HEIGHTS, IL:
2,403,212, CANC. INT. CL. 21.
- LC TRADEMARKS, INC., DETROIT, MI, LITTLE CAESAR
ENTERPRISES, INC., DETROIT, MI:
2,028,607, REN. 8-20-07, INT. CL. 30.
- LE BARNES, INC., WEST COVINA, CA:
2,404,503, CANC. INT. CL. 25.
- LE BELLE INTERNATIONAL, INC., DESTIN, FL:
3,297,013, PUB. 7-10-2007, INT. CL. 35.
- LEADER TECHNOLOGIES, INC., WESTERVILLE, OH:
3,297,570, PUB. 7-10-2007, INT. CL. 38.
- LEADERSHIP INSTITUTE, INC., THE, ARLINGTON, VA:
2,083,507, REN. 8-17-07, MULTIPLE CLASS, INT. CLS. 35
AND 41.
- LEADERSHIP NETWORK, DALLAS, TX:
3,298,771, INT. CL. 16.
- LEADING EDGE DISTRIBUTION LTD., WALTON HILLS,
OH:
3,300,245, INT. CL. 6.
- LEADING EDGE MARKETING, INC., NASSAU, NEW
PROVIDENCE, BAHAMAS:
3,299,647, INT. CL. 41.
3,299,915, INT. CL. 5.
- LEAF NETWORKS, LLC, SCOTTSDALE, AZ:
3,299,366, INT. CL. 9.
- LEAR BAYLOR, INC., GARDEN GROVE, CA:
3,298,527, INT. CL. 7.
3,298,528, INT. CL. 12.
- LEARNING ENHANCEMENT CORPORATION, CHICAGO,
IL:
3,297,952, PUB. 7-10-2007, INT. CL. 16.
- LEARNING EXPRESS, INC., AYER, MA:
2,015,571, CANC. INT. CL. 42.
- LEBEWOHL, JACOB J., NEW YORK, NY:
1,451,516, REN. 8-23-07, INT. CL. 42.
1,451,517, REN. 8-22-07, INT. CL. 42.
- LEE KUM KEE COMPANY LIMITED, TAI PO, NEW
TERRITORIES, HONG KONG:
2,093,381, REN. 8-20-07, INT. CL. 30.
2,095,496, REN. 8-20-07, INT. CL. 30.
- LEE MYLES ASSOCIATES CORP, PARAMUS, NJ:
2,083,901, REN. 8-18-07, INT. CL. 37.
- LEE, AMY, LOS ANGELES, CA:
3,242,888, COR. INT. CL. 41.
- LEE, JAE SIK, SEOUL, REPUBLIC OF KOREA:
3,298,996, INT. CL. 41.
- LEE, LISA, ONTARIO, CA:
2,114,854, REN. 8-23-07, INT. CL. 25.
- LEE, RAYMOND C., SACRAMENTO, CA AND WONG,
KENNY, SACRAMENTO, CA:
3,299,708, INT. CL. 9.
- LEE, YONG H., NORTHBRIDGE, CA:
3,300,125, INT. CL. 5.
3,300,176, INT. CL. 5.
- LEGACY INTERACTIVE, INC., LOS ANGELES, CA:
3,296,414, PUB. 7-10-2007, INT. CL. 9.
3,296,415, PUB. 7-10-2007, INT. CL. 41.
3,296,416, PUB. 7-10-2007, INT. CL. 9.
3,296,417, PUB. 7-10-2007, INT. CL. 41.
- LEGACY MARKETING GROUP, SAN FRANCISCO, CA:
2,403,681, CANC. INT. CL. 36.
- LEGALBRIEFS, INC., SUDBURY, MA:
2,404,297, CANC. INT. CL. 42.
- LEGENDARY HOLDINGS, INC., SAN DIEGO, CA:
3,299,411, INT. CL. 25.
- LEGION OF CHRIST, INCORPORATED, THE, THORN-
WOOD, NY:
2,086,989, REN. 8-23-07, INT. CL. 41.
- LEHIGH TECHNOLOGIES, LLC, NAPLES, FL:
3,296,561, PUB. 7-10-2007, INT. CL. 17.
- LEHIGH VALLEY PHYSICIAN HOSPITAL ORGANIZA-
TION, INC., ALLENTOWN, PA:
3,298,921, INT. CL. 44.
- LEIGHT, HOWARD S., SANTA MONICA, CA:
3,299,814, INT. CL. 28.
- LEISURE TECHNOLOGY, INC., LOS ANGELES, CA:
1,416,924, CANC. MULTIPLE CLASS, INT. CLS. 36, 41
AND 42.
- LEJAY LAGOUTE, FRANCE:
3,298,237, PUB. 7-10-2007, MULTIPLE CLASS, INT. CLS.
32 AND 33.
- LELAND'S LURES, LLC, SEARCY, AR:
3,296,120, PUB. 7-10-2007, INT. CL. 28.
- LEMANS CORPORATION, JANESVILLE, WI:
3,295,973, PUB. 7-10-2007, INT. CL. 6.
- LEMKE, NANCY LU, CHANHASSEN, MN:
3,296,781, PUB. 7-10-2007, INT. CL. 44.
- LENCO, INC., WACO, TX:
3,298,113, PUB. 7-10-2007, INT. CL. 25.
- LENHART, KLAUS, 73275 OHMDEN, FED REP GERMANY:
1,423,012, REN. 8-20-07, INT. CL. 28.
- LERNER, IRA S., NEW YORK, NY:
3,298,948, INT. CL. 9.
- LESAFFRE ET COMPAGNIE, 59700 MARCQ EN BAROEUL,
FRANCE, LESAFFRE & CIE, 75001 PARRIS, FRANCE:
2,078,782, REN. 8-17-07, INT. CL. 1.
- LESAFFRE ET COMPAGNIE, PARIS, FRANCE, LESAFFRE
& CIE, 75001 PARIS, FRANCE:
2,083,303, REN. 8-23-07, MULTIPLE CLASS, INT. CLS. 1
AND 30.
- LETIANNA TRADING COMPANY, LLC, DES PLAINES, IL:
3,297,088, PUB. 7-10-2007, INT. CL. 35.
- LEVI STRAUSS & CO., SAN FRANCISCO, CA:
3,299,271, INT. CL. 25.
- LEVI, DAVID, INDUSTRIAL ZONE, HOLON, ISRAEL:
2,076,562, REN. 8-23-07, INT. CL. 25.
- LEVIAN CORP., GREAT NECK, NY:
3,296,065, PUB. 7-10-2007, INT. CL. 14.
- LEVITRONIX GMBH, SWITZERLAND:
3,298,211, PUB. 7-10-2007, INT. CL. 9.
3,298,229, PUB. 7-10-2007, MULTIPLE CLASS, INT. CLS. 7
AND 9.
- LEWCO TOYS, LTD., NEW YORK, NY TO LEWCO CORP.,
CT:
1,416,796, CANC. INT. CL. 28.
- LEWIS BROTHERS BAKERIES, INCORPORATED, EVANS-
VILLE, IN, DBA LEWIS BAKERIES, INC.:
2,168,659, REN. 8-18-07, INT. CL. 30.
3,299,146, INT. CL. 30.
3,299,445, INT. CL. 30.
- LEWIS-GOETZ AND COMPANY, INC., PITTSBURGH, PA:
2,015,958, CANC. INT. CL. 42.
2,015,959, CANC. INT. CL. 42.
2,015,960, CANC. INT. CL. 42.
- LEWIS, DENNIS S., GREAT FALLS, VA:
2,147,395, REN. 8-17-07, INT. CL. 39.
- LEWIS, ELI B., NEW YORK, NY:
3,297,421, PUB. 7-10-2007, INT. CL. 18.
- LF, LLC, WILMINGTON, DE, EAGLE HARDWARE &
GARDEN, INC., TUKWILA, WA:
2,016,615, REN. 8-20-07, INT. CL. 42.
- LG ELECTRONICS INC., SEOUL, REPUBLIC OF KOREA:
2,404,558, CANC. INT. CL. 9.
- LI & FUNG (B.V.I.) LIMITED, ROAD TOWN, TORTOLA,
BR. VIRGIN ISLANDS:
2,511,836, CANC. INT. CL. 25.
- LI TEACH, INC., SMITHTOWN, NY:
3,297,397, PUB. 7-10-2007, INT. CL. 35.

LIBBEY GLASS INC., TOLEDO, OH, OWENS-ILLINOIS, INC., TOLEDO, OH:
834,728. REN. 8-22-07. U.S. CL. 33 (INT. CL. 21).

LIBERTY CARTON COMPANY, MINNEAPOLIS, MN:
3,297,754. PUB. 7-10-2007. INT. CL. 20.

LIBERTY INTERNATIONAL ENTERTAINMENT INC., LOS ANGELES, CA:
2,403,092. CANC. INT. CL. 41.
2,403,094. CANC. INT. CL. 41.

LIBERTY NATIONAL BANK, ADA, OH:
3,296,635. PUB. 7-10-2007. INT. CL. 36.

LIBERTY ORCHARDS COMPANY, INC., CASHMERE, WA:
2,137,838. REN. 8-22-07. INT. CL. 30.
2,157,903. REN. 8-22-07. INT. CL. 30.

LIBERTY SAFE & SECURITY PRODUCTS, INC., SPRINGVILLE, UT:
3,295,968. PUB. 11-5-2002. INT. CL. 6.

LICENSE MANAGEMENT, INC., NEW YORK, NY:
1,455,422. REN. 8-20-07. INT. CL. 25.

LICHTCSIEN, TERESA, SOLON, OH:
3,297,039. PUB. 7-10-2007. INT. CL. 25.

LICKENBROCK TECHNOLOGIES, LLC, TROY, NY:
3,296,866. PUB. 7-10-2007. INT. CL. 42.
3,297,086. PUB. 7-10-2007. INT. CL. 42.

LIDL STIFTUNG & CO. KG, D-74167 NECKARSULM, FED REP GERMANY:
2,648,423. CANC. MULTIPLE CLASS, INT. CLS. 29 AND 32.

LIDL STIFTUNG & CO. KG, FED REP GERMANY:
3,298,177. PUB. 7-10-2007. MULTIPLE CLASS, INT. CLS. 29 AND 30.

LIEBOV, OFIR, FREEHOLD, NJ:
3,299,091. INT. CL. 45.

LIFE CARE ST. JOHNS, INC., SAINT AUGUSTINE, FL, DBA GLENMOOR:
3,298,115. PUB. 7-10-2007. MULTIPLE CLASS, INT. CLS. 43 AND 44.

LIFE ENERGY PROCESS, INC., GRANADA HILLS, CA:
1,454,736. REN. 8-23-07. INT. CL. 42.
1,455,887. REN. 8-23-07. INT. CL. 42.
1,456,909. REN. 8-23-07. INT. CL. 41.
1,456,988. REN. 8-23-07. INT. CL. 42.

LIFE SETTLEMENT PROVIDERS, LLC, BALTIMORE, MD:
3,299,126. INT. CL. 36.

LIFE STORAGE CENTERS, LLC, ELGIN, IL:
3,298,460. INT. CL. 39.

LIFEGOALS.COM CORPORATION, TUALATIN, OR:
2,404,928. CANC. INT. CL. 9.

LIFELINE CELL TECHNOLOGY, LLC, WALKERSVILLE, MD:
3,299,164. INT. CL. 1.

LIFESTEM, INC., IRVINE, CA:
3,299,360. INT. CL. 39.

LIFETIME BRANDS, INC., GARDEN CITY, NY:
3,298,444. INT. CL. 35.

LIFEWAY CHRISTIAN RESOURCES OF THE SOUTHERN BAPTIST CONVENTION, NASHVILLE, TN, SUNDAY SCHOOL BOARD OF THE SOUTHERN BAPTIST CONVENTION, THE, NASHVILLE, TN:
2,079,388. REN. 8-18-07. INT. CL. 16.
2,079,909. REN. 8-18-07. INT. CL. 16.

LIFEWAY CHRISTIAN RESOURCES OF THE SOUTHERN BAPTIST CONVENTION, NASHVILLE, TN:
3,298,580. INT. CL. 16.
3,298,584. INT. CL. 21.
3,298,586. INT. CL. 16.

LILLIPUT MOTOR COMPANY LLC, YERINGTON, NV:
2,404,803. CANC. INT. CL. 28.

LILY PAD USA, LLC, CINCINNATI, OH:
3,296,610. PUB. 7-10-2007. INT. CL. 38.

LIN, CHANG HUI, SIU SHUI HSIANG, CHANG HUA HSIEN, TAIWAN:
3,296,159. PUB. 7-10-2007. INT. CL. 12.

LIN, JAY W., S. EL MONTE, CA:
3,299,778. MULTIPLE CLASS, INT. CLS. 13, 21 AND 25.

LINCOLN GLOBAL, INC., CLEVELAND, OH:
2,403,993. CANC. INT. CL. 16.

LINDAHL, ARTHUR CHARLES, VENTURA, CA:
2,162,470. REN. 8-23-07. INT. CL. 9.

LINDEN OAKS CORPORATION, WILMINGTON, DE, CURTICE-BURNS FOODS, INC., ROCHESTER, NY:
2,084,587. REN. 8-20-07. INT. CL. 29.

LINDY FRALIN, RICHMOND, VA:
3,297,074. PUB. 7-10-2007. INT. CL. 9.

LINK IT SOFTWARE CORPORATION, SANTA CLARITA, CA:
3,298,014. PUB. 7-10-2007. INT. CL. 9.

LINK MANAGEMENT JOINT VENTURE, FORT WORTH, TX, BILLY BOB'S PRODUCTIONS, INC., FT. WORTH, TX:
1,448,405. REN. 8-22-07. MULTIPLE CLASS, INT. CLS. 16, 21 AND 25.

LINKER METAL IND. CO., LTD., PUYAN TOWNSHIP, TAIWAN:
3,299,837. INT. CL. 12.

LINKSHARE CORPORATION, NEW YORK, NY:
2,403,638. CANC. INT. CL. 35.
2,403,644. CANC. INT. CL. 35.
2,403,645. CANC. INT. CL. 35.

LINN PRODUCTS LIMITED, UNITED KINGDOM:
3,298,396. PUB. 7-10-2007. INT. CL. 9.

LINTEC KABUSHIKI KAISHA, ITABASHI-KU, TOKYO, JAPAN, TA LINTEC CORPORATION:
3,298,473. INT. CL. 7.

LINTON PRODUCTIONS, INC., SANDY, UT:
2,080,890. REN. 8-17-07. INT. CL. 9.

LINVATEC CORPORATION, LARGO, FL:
2,087,733. REN. 8-23-07. INT. CL. 10.

LION'S HEART CHRISTIAN MINISTRIES, INC., CHICAGO, IL:
3,296,294. PUB. 7-10-2007. MULTIPLE CLASS, INT. CLS. 41 AND 45.

LIPMAN ELECTRONIC ENGINEERING, LTD, ROSH HAAYIN, ISRAEL:
2,404,672. CANC. INT. CL. 9.

LIPPERT COMPONENTS MANUFACTURING, INC., GOSHEN, IN:
3,298,010. PUB. 7-10-2007. INT. CL. 12.

LIPSON ASSOCIATES, INC., NORTHBROOK, IL, DBA LIPSON-ALPORT-GLASS & ASSOCIATES:
3,299,188. INT. CL. 35.

LIPSTICK & DIPSTICK, LLC, PORTLAND, OR:
3,297,936. PUB. 7-10-2007. MULTIPLE CLASS, INT. CLS. 16 AND 45.

LITE-PREP SURFACE PREPARATION EQUIPMENT, LLC, TALLMADGE, OH:
3,299,235. INT. CL. 35.

LITECURE LLC, NEWARK, DE:
3,296,291. PUB. 7-10-2007. INT. CL. 10.

LITESENTRY CORPORATION, DUNDAS, MN:
3,296,248. PUB. 7-10-2007. INT. CL. 9.

LITHIUM TECHNOLOGIES, EMERYVILLE, CA:
3,297,195. PUB. 7-10-2007. MULTIPLE CLASS, INT. CLS. 9 AND 42.

LITTLE BIG MOUTH, WHITE PLAINS, NY:
3,296,684. PUB. 7-10-2007. INT. CL. 25.

LIU, RALPH Y., NORCO, CA:
3,300,103. INT. CL. 36.

LIZ CLAIBORNE, INC., NEW YORK, NY TO L.C. LICENSING, INC., NEW YORK, NY:
1,442,825. CANC. MULTIPLE CLASS, INT. CLS. 16, 24 AND 34.

LLOYD, KENNETH L., ENCINO, CA:
3,298,114. PUB. 7-10-2007. INT. CL. 35.

LLS NORTH AMERICA, LLC, SPOKANE, WA:
3,300,370. INT. CL. 36.

LO DUCA BROS., INC., NEW BERLIN, WI:
3,297,849. PUB. 7-10-2007. MULTIPLE CLASS, INT. CLS. 9, 15, 16, 20 AND 33.

3,297,850. PUB. 7-10-2007. MULTIPLE CLASS, INT. CLS. 9, 15, 16, 20 AND 33.

LOANTRADER, INC., IRVINE, CA:
2,403,530. CANC. INT. CL. 36.

LOCAL BILLING SOLUTIONS LIMITED, BARCELONA, SPAIN:
3,297,624. PUB. 7-10-2007. INT. CL. 36.

- LOCKE-ADDISON, P. S., LOS ANGELES, CA AND LOCKE, WILLIAM R., JR, LOS ANGELES, CA:
3,297,717, PUB. 7-10-2007. INT. CL. 32.
- LOCKWOOD TRADE JOURNAL CO., INC., NEW YORK, NY:
2,093,907. REN. 8-17-07. INT. CL. 16.
- LOEFFLER RANDALL INC., NEW YORK, NY:
3,299,090, INT. CL. 25.
- LOFTWARE, INC., PORTSMOUTH, NH:
3,297,797, PUB. 7-10-2007. INT. CL. 9.
- LOGAN, BRUCE LEWIS, CARDIFF BY THE SEA, CA:
3,296,886, PUB. 7-10-2007. INT. CL. 28.
- LOGICAL CONSULTING GROUP INC, TIMONIUM, MD:
2,403,835, CANC. INT. CL. 9.
- LOGICFORCE CONSULTING, LLC, NASHVILLE, TN:
3,296,253, PUB. 7-10-2007. INT. CL. 42.
- LONE STAR MEALS, INC., HOUSTON, TX, DBA ORDER-CORNER:
3,296,645, PUB. 7-10-2007. INT. CL. 35.
- LONESTAR TECHNOLOGIES, LLC, WESTPORT, CT:
2,403,449, CANC. INT. CL. 5.
- LONG & FOSTER COMPANIES, INC., THE, FAIRFAX, VA:
2,404,357, CANC. INT. CL. 36.
- LONG SHOE CORPORATION, TAIPEI HSIEN, TAIWAN:
2,404,740, CANC. INT. CL. 25.
- LONG TERM CARE WORKERS HEALTH TRUST FUND, LOS ANGELES, CA:
3,296,551, PUB. 7-10-2007. INT. CL. 36.
- LONGABERGER COMPANY, THE, NEWARK, OH:
2,172,615. REN. 8-17-07. MULTIPLE CLASS, INT. CLS. 20 AND 21.
- LONGEVITY MEDICAL CLINIC, INC., KIRKLAND, WA:
3,298,814, MULTIPLE CLASS, INT. CLS. 5 AND 44.
- LONGO, ANDREW, NUTLEY, NJ:
3,298,742, INT. CL. 16.
- LOOMIS, ROBERT VERNE, ST. CHARLES, IL:
3,299,821, INT. CL. 41.
- LOPEZ, LEO, MANHATTAN BEACH, CA:
3,299,504, INT. CL. 25.
- LORETTO ASSOCIATES LLC, SANTA FE, NM:
3,299,457, INT. CL. 43.
- LOST CIRCULATION SPECIALISTS, INC., CASPER, WY:
1,450,218. REN. 8-17-07. INT. CL. 1.
- LOTT-GIDI, LINDA, MIAMI, FL:
3,296,411, PUB. 7-10-2007. INT. CL. 41.
- LOUIS M. GERSON, INC., MIDDLEBORO, MA:
2,082,964. REN. 8-17-07. INT. CL. 21.
- LOVE LABS LLP, BATH, UNITED KINGDOM:
3,297,773, PUB. 7-10-2007. MULTIPLE CLASS, INT. CLS. 10 AND 35.
- LOVE, PHILIP A, LISBON, CT:
3,296,979, PUB. 7-10-2007. INT. CL. 7.
- LOVEJOY, CHARLEE R., CASTLE ROCK, CO:
3,300,291, INT. CL. 9.
- LOVELAND PRODUCTS, INC., GREELEY, CO:
3,299,601, INT. CL. 1.
3,299,602, INT. CL. 1.
- LOVELESS, BECTON, SANDY, UT:
3,297,524, PUB. 7-10-2007. INT. CL. 35.
- LOVER'S LANE I.P., LTD., PLYMOUTH, MI:
3,296,371, PUB. 7-10-2007. INT. CL. 35.
- LOXION KULCA MARKETING SERVICES CC, JOHANNESBURG, GAUTENG, SOUTH AFRICA:
3,298,663, INT. CL. 18.
- LOYD-FIORELLI, ANGELA, OAKLEY, CA:
3,297,764, PUB. 7-10-2007. INT. CL. 25.
- LOZZO MANAGEMENT INC., MONTREAL, QC, CANADA:
3,297,614, PUB. 7-10-2007. INT. CL. 39.
- LPI, LLC, GRANGER, IN:
3,298,969, INT. CL. 28.
- LRA ENTERPRISES INC., CHICAGO, IL:
2,015,671, CANC. INT. CL. 41.
- LSI INDUSTRIES INC., CINCINNATI, OH:
2,148,365. REN. 8-22-07. INT. CL. 11.
2,169,486. REN. 8-22-07. INT. CL. 11.
- LSI INDUSTRIES, INC., CINCINNATI, OH:
2,130,475. REN. 8-23-07. INT. CL. 11.
- LSMS, INC., DELRAY BEACH, FL:
3,296,171, PUB. 7-10-2007. INT. CL. 43.
- LSN, INC., ATLANTA, GA:
3,299,003, MULTIPLE CLASS, INT. CLS. 35, 39, 41 AND 42.
3,300,276, INT. CL. 35.
- LT MEDIA GROUP LLC, LEANDER, TX:
3,299,127, INT. CL. 41.
- LTMA INC., NEW YORK, NY, DBA SONY RETAIL ENTERTAINMENT:
2,404,900, CANC. MULTIPLE CLASS, INT. CLS. 28 AND 41.
- LU, HUI, FLUSHING, NY:
3,298,743, INT. CL. 35.
- LUBRICATION ENGINEERS, INC., FORT WORTH, TX:
3,296,921, PUB. 7-10-2007. INT. CL. 4.
3,296,923, PUB. 7-10-2007. INT. CL. 4.
3,296,924, PUB. 7-10-2007. INT. CL. 4.
3,296,925, PUB. 7-10-2007. INT. CL. 4.
3,296,929, PUB. 7-10-2007. INT. CL. 4.
3,296,930, PUB. 7-10-2007. INT. CL. 4.
3,297,122, PUB. 7-10-2007. INT. CL. 1.
3,297,123, PUB. 7-10-2007. INT. CL. 4.
- LUCASFILM LTD., SAN FRANCISCO, CA:
3,298,465, MULTIPLE CLASS, INT. CLS. 16 AND 41.
- LUCIDA STAFFING GROUP LLC, READING, MA:
3,296,080, PUB. 7-10-2007. INT. CL. 35.
- LUCKY LINE PRODUCTS, INC., SAN DIEGO, CA:
3,298,683, INT. CL. 20.
- LUCKY 11, INC., FRISCO, TX:
3,299,317, INT. CL. 3.
- LUCRUM, INC., CINCINNATI, OH:
3,296,402, PUB. 7-10-2007. INT. CL. 42.
- LUCY'S ENTERPRISES INC., CITY OF INDUSTRY, CA:
3,299,228, INT. CL. 29.
- LUMBER LIQUIDATORS, INC., TOANO, VA:
3,297,153, PUB. 7-10-2007. INT. CL. 19.
3,297,156, PUB. 7-10-2007. INT. CL. 35.
3,300,283, INT. CL. 42.
- LUMETIQUE, INC., STUDIO CITY, CA:
3,299,600, INT. CL. 4.
- LUNAMETRICS, LLC, PITTSBURGH, PA:
3,297,564, PUB. 7-10-2007. MULTIPLE CLASS, INT. CLS. 35 AND 42.
3,297,671, PUB. 7-10-2007. MULTIPLE CLASS, INT. CLS. 35 AND 42.
- LUNAR EXPLORER, LLC, RAHWAY, NY:
3,299,865, INT. CL. 9.
- LUNEMANN, HEINRICH, FED REP GERMANY:
3,298,349, PUB. 7-10-2007. MULTIPLE CLASS, INT. CLS. 3, 14, 18, 24 AND 25.
- LUSTER PRODUCTS, INC., CHICAGO, IL:
3,298,970, INT. CL. 3.
3,298,971, INT. CL. 3.
3,298,972, INT. CL. 3.
- LUVATA OY, FI-02101 ESPOO, FINLAND:
3,296,569, PUB. 7-10-2007. INT. CL. 6.
- LUVERNE TRUCK EQUIPMENT, INC., BRANDON, SD:
3,299,342, INT. CL. 12.
- LUXCO, INC., ST. LOUIS, MO:
3,298,118, PUB. 7-10-2007. INT. CL. 33.
- LUXOTTICA S.R.L., AGORDO (BELLUNO), ITALY:
1,455,030. REN. 8-23-07. INT. CL. 9.
- LV JEANS TRADING INC, JACKSON HEIGHTS, NY:
3,299,330, INT. CL. 25.
- LYNCY BBQ COMPANY, WAUCOMA, IA:
3,297,756, PUB. 7-10-2007. MULTIPLE CLASS, INT. CLS. 29 AND 30.
- LYNGVAR FINANCIAL, INC, ROCKLIN, CA:
3,300,136, INT. CL. 36.
- LYNN UNIVERSITY, INC., BOCA RATON, FL:
2,014,944, CANC. INT. CL. 41.
- LYNX GOLF, INC., CITY OF INDUSTRY, CA:
1,416,763, CANC. INT. CL. 28.
- LYNX TECHNOLOGIES, INC., FAIRFIELD, NJ:
2,014,641, CANC. INT. CL. 42.
- LYONS FALLS PULP & PAPER INC., LYONS FALLS, NY:
1,416,611, CANC. INT. CL. 16.

M & M MACHINERY SALES, LLC, GASTONIA, NC:
3,298,667, INT. CL. 7.

M P MATHEWS LC, YUKON, OK:
3,297,637, PUB. 7-10-2007. INT. CL. 35.

M. FREDRIC & CO., AGOURA HILLS, CA:
3,300,034, INT. CL. 25.

M. HIDARY & COMPANY, INC., NEW YORK, NY:
1,467,470, REN. 8-23-07. INT. CL. 25.

M. K. PRODUCTS, INC., IRVINE, CA:
2,403,334, AM. INT. CL. 9.

M.D.I.INTERNATIONAL PTY. LTD., RICHLANDS, AUSTRALIA:
3,296,566, PUB. 7-10-2007. INT. CL. 28.

M&O PRODUCTS, INC., PORTAGE, WI:
3,296,407, PUB. 7-10-2007. INT. CL. 19.

M-X AG, LLC, DANVILLE, IL:
3,299,929, INT. CL. 4.

MÜLHENS GMBH & CO. KG, 50823 KÖLN, FED REP GERMANY:
3,298,287, PUB. 7-10-2007. INT. CL. 3.

MABSCOTT SUPPLY COMPANY, BECKLEY, WV:
2,403,709, CANC. INT. CL. 35.

MACDERMID ACUMEN, INC., WATERBURY, CT:
3,297,557, PUB. 7-10-2007. MULTIPLE CLASS, INT. CLS. 1 AND 17.

MACDONALD COMMUNICATIONS CORPORATION, NEW YORK, NY:
2,404,917, CANC. INT. CL. 35.

MACERICH PARTNERSHIP, L.P., THE, SANTA MONICA, CA:
2,403,756, CANC. MULTIPLE CLASS, INT. CLS. 35, 36 AND 37.

MACGILLIVRAY FREEMAN FILMS, LAGUNA BEACH, CA:
3,297,714, PUB. 7-10-2007. MULTIPLE CLASS, INT. CLS. 25 AND 41.

MACK, JAY, HENDERSON, NV:
3,298,402, INT. CL. 9.
3,298,403, INT. CL. 35.
3,298,404, INT. CL. 9.

MACKER BASKETBALL, LLC, GREENVILLE, MI:
1,447,938, REN. 8-17-07. INT. CL. 41.
1,466,651, REN. 8-17-07. INT. CL. 41.

MACROECONOMIC ADVISERS, L.L.C., CLAYTON, MO:
3,298,111, PUB. 7-10-2007. MULTIPLE CLASS, INT. CLS. 35 AND 36.

MAD DOG ATHLETICS, INC., VENICE, CA:
3,298,552, MULTIPLE CLASS, INT. CLS. 9 AND 16.

MADACY ENTERTAINMENT GROUP INC., MONTREAL, QUEBEC H3R 3L5, CANADA:
2,404,592, CANC. INT. CL. 9.

MADAM BUTTERFLY, INC., NEWARK, CA:
2,078,976, REN. 8-22-07. MULTIPLE CLASS, INT. CLS. 41 AND 42.

MADAME AGNÈS TROUBLE, FRANCE:
3,298,225, PUB. 7-10-2007. MULTIPLE CLASS, INT. CLS. 9, 14, 16, 18, 24, 25 AND 41.

MADISON ONE ACME, INC., LOS ANGELES, CA, DBA SOLSTICE MEDICINE COMPANY:
3,297,270, PUB. 7-10-2007. INT. CL. 5.

MAGGIE SOTTERO DESIGNS, LLC, SALT LAKE CITY, UT:
3,299,842, INT. CL. 25.

MAGMATIC LIMITED, UNITED KINGDOM:
3,298,357, PUB. 7-10-2007. MULTIPLE CLASS, INT. CLS. 18 AND 28.

MAGNETROL INTERNATIONAL, INCORPORATED, DOWNERS GROVE, IL:
3,296,154, PUB. 7-10-2007. INT. CL. 9.

MAGNUM ENERGY, INC., EVERETT, WA:
3,296,323, PUB. 7-10-2007. INT. CL. 9.

MAGNUM RESTAURANT & ENTERTAINMENT GROUP, NEW YORK, NY:
3,297,420, PUB. 7-10-2007. INT. CL. 43.

MAGSTAR TECHNOLOGIES, INC., HOPKINS, MN:
3,296,123, PUB. 7-10-2007. INT. CL. 7.

MAGUY, INC., ORANGE PARK, FL:
3,297,003, PUB. 7-10-2007. INT. CL. 9.

MAHARISHI AYUR-VED PRODUCTS INTERNATIONAL, INC., COLORADO SPRINGS, CO:
2,085,938, REN. 8-17-07. INT. CL. 5.
2,085,940, REN. 8-17-07. INT. CL. 5.

MAIN STREET INGREDIENTS LLC, LA CROSSE, WI:
3,297,834, PUB. 7-10-2007. INT. CL. 1.

MAIN STREET SOFTWARE, INC., TIGARD, OR:
2,093,151, REN. 8-20-07. INT. CL. 9.

MAINSTREAM ENGINEERING CORPORATION, ROCKLEDGE, FL:
2,094,850, REN. 8-23-07. MULTIPLE CLASS, INT. CLS. 1 AND 9.

MAINSTREAM HOLDINGS, LLC, WEST PALM BEACH, FL:
3,300,102, INT. CL. 38.

MAINSTREET GROUP, INC., ST. PAUL, MN:
2,403,837, CANC. INT. CL. 35.

MAISON ROPITEAU FRERES, 21190 MEURSAULT, FRANCE:
1,452,431, REN. 8-22-07. INT. CL. 33.

MAJESCOMASTEK, EDISON, NJ:
3,299,318, MULTIPLE CLASS, INT. CLS. 35 AND 42.

MAJOR LEAGUE BASEBALL PROPERTIES, INC., NEW YORK, NY:
3,299,532, INT. CL. 41.

MAJOR LEAGUE LACROSSE LLC, BRIGHTON, MA:
3,299,345, INT. CL. 41.

MAK, FONG, PASADENA, CA:
2,404,745, CANC. INT. CL. 29.

MAKEMUSIC, INC., EDEN PRAIRIE, MN:
3,299,099, INT. CL. 9.

MAKO TECHNOLOGIES, INC., MORGAN CITY, LA:
3,298,007, PUB. 7-10-2007. MULTIPLE CLASS, INT. CLS. 37, 39, 41 AND 42.

MALAKAN DIAMOND CO., FRESNO, CA:
2,403,332, CANC. INT. CL. 14.

MALDEN MILLS INDUSTRIES, INC., LAWRENCE, MA:
2,016,064, CANC. INT. CL. 25.

MALEK, MARTIN, BROOKLYN, NY:
3,299,071, MULTIPLE CLASS, INT. CLS. 18, 25 AND 28.

MALHAS S.R.L., MILANO, ITALY:
2,404,439, CANC. MULTIPLE CLASS, INT. CLS. 3, 14 AND 18.

MALT-O-MEAL COMPANY, MINNEAPOLIS, MN:
2,014,666, CANC. INT. CL. 30.

MAMA MIO LTD., LONDON, W1F 8DN, UNITED KINGDOM:
3,299,378, INT. CL. 3.

MANAGEMENT SYSTEMS AND PROGRAMMING LTD., LONDON, ENGLAND:
1,416,464, CANC. INT. CL. 9.

MANCHESTER UNITED LIMITED, OLD TRAFFORD MANCHESTER, UNITED KINGDOM:
3,297,200, PUB. 7-10-2007. MULTIPLE CLASS, INT. CLS. 36, 38 AND 41.

MANCO, INC., AVON, OH:
2,014,857, CANC. INT. CL. 16.

MANGO LLC, PLANO, TX:
3,296,109, PUB. 7-10-2007. MULTIPLE CLASS, INT. CLS. 35, 38 AND 41.

MANLEY LABORATORIES INCORPORATED, CHINO, CA:
3,297,157, PUB. 7-10-2007. INT. CL. 9.
3,297,158, PUB. 7-10-2007. INT. CL. 9.
3,297,159, PUB. 7-10-2007. INT. CL. 9.
3,297,160, PUB. 7-10-2007. INT. CL. 9.

MANN MERCHANT PROCESSING SYSTEMS, LLC, BETHLEHEM, PA:
3,296,090, PUB. 5-22-2007. INT. CL. 36.

MANNA FREIGHT SYSTEMS, INC., MENDOTA HEIGHTS, MN:
3,296,085, PUB. 7-10-2007. INT. CL. 35.

MANNINGTON MILLS, INC., SALEM, NJ:
3,299,610, INT. CL. 19.
3,299,611, INT. CL. 19.

MANOS FABRIC INC., FORT LAUDERDALE, FL:
3,300,156, INT. CL. 19.

MANZIONE, JOHN JOSEPH, BAY SHORE, NY:
3,299,555, INT. CL. 3.

- MAPFRAME CORPORATION, DALLAS, TX:
3,297,349, PUB. 7-10-2007. INT. CL. 9.
- MAR-GEN SALES CO., INC., NOGALES, AZ:
3,300,377, INT. CL. 31.
- MARACOM CORPORATION, WILLMAR, MN:
2,160,704, REN. 8-20-07. INT. CL. 16.
- MARATHON COACH, INC., EUGENE, OR:
3,296,259, PUB. 7-10-2007. INT. CL. 12.
- MARATHON INDUSTRIES, INC., KENT, WA:
3,300,257, INT. CL. 12.
- MARBLE INSTITUTE OF COLORADO, INC., THE, DENVER, CO:
2,126,950, REN. 8-20-07. INT. CL. 41.
- MARCO COMPANY, THE, FORT WORTH, TX:
2,403,830, CANC. INT. CL. 20.
- MARCO OPHTHALMIC, INC., JACKSONVILLE, FL:
3,296,510, PUB. 7-10-2007. INT. CL. 10.
- MARFRED INDUSTRIES, SUN VALLEY, CA:
3,299,103, INT. CL. 35.
- MARGARET'S DRY CLEANING, INC., LA JOLLA, CA:
3,296,308, PUB. 7-10-2007. INT. CL. 37.
3,296,309, PUB. 7-10-2007. INT. CL. 37.
3,296,312, PUB. 7-10-2007. INT. CL. 37.
3,296,316, PUB. 7-10-2007. INT. CL. 37.
3,296,317, PUB. 7-10-2007. INT. CL. 37.
- MARGARITAVILLE ENTERPRISES, LLC, PALM BEACH, FL:
3,297,172, PUB. 7-10-2007. INT. CL. 25.
3,297,173, PUB. 7-10-2007. INT. CL. 21.
3,297,174, PUB. 7-10-2007. INT. CL. 25.
- MARGHERITIS, SHELLI KAY, SANTA CLARITA, CA:
3,297,282, PUB. 7-10-2007. INT. CL. 35.
- MARIELLEN RICH, POLAND, OH:
3,299,706, INT. CL. 16.
- MARIER, ROBERT E., JR., PALM CITY, FL:
2,404,605, CANC. INT. CL. 28.
- MARINE DEVELOPMENT & RESEARCH CORP., MERRICK, NY:
1,416,322, CANC. INT. CL. 1.
- MARION, SHAWN, SAN FRANCISCO, CA:
3,297,473, PUB. 7-10-2007. INT. CL. 41.
- MARÍA Y ADELINA S.A., NEUQUÉN, ARGENTINA:
3,299,413, INT. CL. 33.
- MARK AND AL, INC., GLENDORA, CA:
3,298,563, INT. CL. 35.
- MARK EISEN, INC., NEW YORK, NY:
3,300,225, INT. CL. 25.
- MARK LEES SKIN CARE, INC., PENSACOLA, FL:
3,298,685, INT. CL. 3.
- MARKET AREA REAL ESTATE SERVICES, INC., HILTON HEAD ISLAND, SC:
3,298,001, PUB. 7-10-2007. INT. CL. 36.
3,298,003, PUB. 7-10-2007. INT. CL. 36.
- MARKET NEWS INTERNATIONAL, INC., NEW YORK, NY,
MARKET NEWS SERVICE, INC., NEW YORK, NY:
2,155,439, REN. 8-20-07. INT. CL. 36.
- MARKETING MANAGEMENT, INC., FORT WORTH, TX:
2,016,438, CANC. INT. CL. 29.
- MARKETING RESEARCH SERVICES INC., CINCINNATI, OH:
3,298,850, INT. CL. 35.
- MARKLINE S.A., LUXEMBOURG:
3,298,265, PUB. 7-10-2007. MULTIPLE CLASS, INT. CLS. 3, 5 AND 44.
- MARLBOROUGH ENTERPRISES, LTD., ROAD TOWN, TORTOLA, BR. VIRGIN ISLANDS, ESS LABORATORY, INC., SACRAMENTO, CA:
1,428,146, REN. 8-23-07. INT. CL. 9.
- MARRIOTT INTERNATIONAL, INC., BETHESDA, MD:
2,102,343, REN. 8-17-07. INT. CL. 41.
- MARS, INCORPORATED, MCLEAN, VA:
3,298,418, INT. CL. 30.
- MARSALKA, JOSEPH P., COLUMBUS, OH:
3,299,883, INT. CL. 38.
- MARSH, TAYLOR ALEXIS, ORMOND BEACH, FL:
3,297,441, PUB. 3-27-2007. MULTIPLE CLASS, INT. CLS. 16 AND 40.
- MARSHAL LIMITED, HAMPSHIRE, UNITED KINGDOM:
3,296,098, PUB. 7-10-2007. INT. CL. 9.
- MARSHALL-ATTLE, FELICIA, LINDENWOLD, NJ:
3,300,300, INT. CL. 41.
- MARTEK BIOSCIENCES CORPORATION, COLUMBIA, MD:
3,299,869, INT. CL. 5.
- MARTIN FLYER, INC., NEW YORK, NY:
3,299,437, INT. CL. 14.
- MARTIN PERNA, AUSTIN, TX:
3,297,722, PUB. 7-10-2007. INT. CL. 9.
3,297,723, PUB. 7-10-2007. INT. CL. 41.
- MARTIN, KIMBERLY S., BILOXI, MS:
3,296,295, PUB. 7-10-2007. INT. CL. 16.
- MARTY SUSSMAN ORGANIZATION, INC., JENKINTOWN, PA:
2,083,241, REN. 8-17-07. INT. CL. 42.
- MARTZ, VERNILLYN, COLORADO SPRINGS, CO:
3,296,284, PUB. 7-10-2007. INT. CL. 41.
- MARUMAN GOLF KABUSHIKI KAISHA, CHIBA-KEN, JAPAN TO MARUMAN GOLF CORPORATION, CHIBA 261-7126, JAPAN:
2,015,843, CANC. INT. CL. 28.
- MARVELOUS ENTERTAINMENT, INC., SHIBUYA-KU, TOKYO, JAPAN:
3,299,012, INT. CL. 16.
- MARX, DONALD L., ARLINGTON, VA:
3,300,343, MULTIPLE CLASS, INT. CLS. 16 AND 41.
- MARXMEIER SOFTWARE AG, WUPPERTAL, FED REP GERMANY:
3,297,523, PUB. 7-10-2007. INT. CL. 42.
- MARY JAMES, INC., NAPOLEON, OH:
3,296,931, PUB. 7-10-2007. INT. CL. 25.
- MARY KAY INC., DALLAS, TX:
1,070,841, REN. 8-22-07. INT. CL. 3.
- MARY KAY INC., ADDISON, TX:
3,297,020, PUB. 7-10-2007. INT. CL. 41.
- MARYLAND PUBLIC BROADCASTING COMMISSION, OWINGS MILLS, MD:
3,300,301, INT. CL. 41.
- MASADA MARKETING CORP., CHATSWORTH, CA:
2,404,179, CANC. INT. CL. 3.
- MASHANTUCKET PEQUOT TRIBE, MASHANTUCKET, CT:
2,088,977, REN. 8-18-07. INT. CL. 35.
2,088,978, REN. 8-18-07. INT. CL. 36.
- MASHAT, EYAD ABDULLAH, MAKKAH, SAUDI ARABIA:
3,299,260, INT. CL. 35.
- MASON COMPANIES INC., CHIPPEWA FALLS, WI:
3,299,876, INT. CL. 35.
- MASON, ALEXANDER S, ARDSLEY, NY:
3,296,286, PUB. 7-10-2007. INT. CL. 3.
- MASSACHUSETTS FINANCIAL SERVICES COMPANY, BOSTON, MA:
2,403,231, CANC. INT. CL. 36.
- MASSEY, JAYME A, ROSEVILLE, CA:
3,299,144, INT. CL. 41.
- MASTER COMMUNICATIONS, INC., CINCINNATI, OH:
2,016,163, CANC. INT. CL. 9.
- MASTERYWORKS, INC., ANNANDALE, VA:
2,404,405, CANC. INT. CL. 16.
- MASTIP TECHNOLOGY LTD., AVONDALE, AUCKLAND, NEW ZEALAND, MASTIP PRODUCTS LIMITED, WAIHEKE, NEW ZEALAND:
2,077,813, REN. 8-17-07. INT. CL. 7.
- MATA AMRITANANDAMAYI CENTER, CASTRO VALLEY, CA:
3,298,110, PUB. 7-10-2007. INT. CL. 35.
- MATCH.COM, L.P., DALLAS, TX:
3,299,484, INT. CL. 45.
- MATHESON TRI-GAS, INC., BASKING RIDGE, NJ, MATHESON GAS PRODUCTS, INC., SECAUCUS, NJ:
2,094,474, REN. 8-20-07. INT. CL. 9.
- MATOL BIOTECH LABORATORIES LTD., LACHINE, QUEBEC, CANADA:
2,404,817, CANC. INT. CL. 5.
- MATRIX, FRANCE:
3,298,304, PUB. 7-10-2007. INT. CL. 33.

MATSUI UNIVERSAL JOINT CORPORATION, SHINJUKU-KU, TOKYO, JAPAN:
3,298,400, INT. CL. 12.

MATSUSHITA ELECTRIC INDUSTRIAL CO., LTD., OSAKA-FU, JAPAN:
3,233,843, COR. MULTIPLE CLASS, INT. CLS. 7, 8, 9, 10, 11, 16, 21 AND 37.

MATSUSHITA ELECTRIC INDUSTRIAL CO., LTD., OSAKA, JAPAN:
3,299,214, INT. CL. 9.

MATTEL, INC., EL SEGUNDO, CA:
2,016,011, CANC. INT. CL. 28.
2,016,385, CANC. INT. CL. 28.
2,087,842, REN. 8-17-07. INT. CL. 28.
2,404,617, CANC. INT. CL. 28.
2,404,786, CANC. INT. CL. 28.
2,404,833, CANC. INT. CL. 28.
3,297,486, PUB. 7-10-2007. INT. CL. 28.
3,298,036, PUB. 7-10-2007. INT. CL. 28.
3,298,717, INT. CL. 28.
3,298,755, INT. CL. 36.
3,298,760, INT. CL. 28.
3,298,761, INT. CL. 28.
3,298,912, INT. CL. 28.
3,299,191, INT. CL. 28.
3,299,201, INT. CL. 28.
3,299,203, INT. CL. 28.
3,299,246, INT. CL. 28.
3,299,297, INT. CL. 28.
3,299,650, INT. CL. 28.
3,299,672, INT. CL. 28.

MAURICE 9TH EARL SPENCER, CHARLES EDWARD, NORTHAMPTON, UNITED KINGDOM:
3,297,236, PUB. 7-10-2007. INT. CL. 35.

MAVERIDGE INTERNATIONAL B.V., 1744 GE SINT MAARTEN, NETHERLANDS:
3,297,186, PUB. 6-27-2006. MULTIPLE CLASS, INT. CLS. 16 AND 31.

MAVERIK, INC, NORTH SALT LAKE, UT:
3,297,185, PUB. 7-10-2007. INT. CL. 35.

MAVES, TYLER A, WAITSFIELD, VT AND BAREFOOT, MADHURII E, WAITSFIELD, VT:
3,296,532, PUB. 7-10-2007. INT. CL. 44.

MAX PROP S.R.L., MILANO, ITALY:
3,297,591, PUB. 7-10-2007. MULTIPLE CLASS, INT. CLS. 7, 12 AND 22.

MAX'S WORLD, INC., SOUTH SAN FRANCISCO, CA:
2,078,535, REN. 8-20-07. INT. CL. 42.
2,083,054, REN. 8-20-07. INT. CL. 42.

MAXX WIRELESS, INC., SAN FRANCISCO, CA:
3,299,225, INT. CL. 38.
3,299,359, INT. CL. 38.

MAXXON CORPORATION, HAMEL, MN, GYP-CRETE CORPORATION, HAMEL, MN:
2,079,713, REN. 8-17-07. INT. CL. 19.

MAY DEPARTMENT STORES COMPANY, THE, ST. LOUIS, MO TO MAY DEPARTMENT STORES COMPANY, THE, ST. LOUIS, MO:
2,014,824, CANC. MULTIPLE CLASS, INT. CLS. 8, 14 AND 21.

MAYAN LABORATORIES, LLC, COMMACK, NY:
3,207,173, CANC. IIRN. RESTORED TO S.N. 76-648,039.

MAYDAY, MIAMI, FL:
3,297,629, PUB. 7-10-2007. INT. CL. 41.

MAZER, LARRY, VORHEES, NJ AND BORROR, TIM, VORHEES, NJ AND CONROY, PAUL, VORHEES, NJ:
3,298,939, INT. CL. 41.

MB-F, INC., GREENSBORO, NC:
2,015,348, CANC. INT. CL. 42.

MBLOX INCORPORATED, SUNNYVALE, CA:
3,299,165, INT. CL. 38.

MCBEE, DANIEL, MURRIETA, CA:
3,296,577, PUB. 7-10-2007. INT. CL. 41.

MCCAFFREY COMMUNICATIONS, INC., FORT COLLENS, CO:
2,403,104, CANC. INT. CL. 16.

MCCAIN FOODS USA, INC., LISLE, IL:
3,300,333, INT. CL. 30.

MCCARNEY, KEVIN T., NORTH HOLLYWOOD, CA, DBA POQUITO MAS:
3,298,882, MULTIPLE CLASS, INT. CLS. 16 AND 30.

MCCARTHY, NORA A., PEEKSKILL, NY:
3,297,927, PUB. 7-10-2007. INT. CL. 41.

MCCORMICK DISTILLING COMPANY, WESTON, MO AND BARUH SPIRITS, INC., PALO ALTO, CA, BARUH, BRADFORD G., HILLSBOROUGH, CA, DBA BRADFORD BARUH ENTERPRISES:
2,092,214, REN. 8-17-07. INT. CL. 33.

MCCOY, WADE, BOWLING GREEN, KY:
3,297,089, PUB. 7-10-2007. INT. CL. 35.

MCCRACKEN, ROGER L., TANGERINE, FL:
3,296,395, PUB. 7-10-2007. INT. CL. 30.

MCCUBBIN, GABRIEL, SACRAMENTO, CA:
3,296,767, PUB. 7-10-2007. INT. CL. 16.

MCCULLOUGH, PATRICIA, NEW YORK, NY:
3,296,436, PUB. 7-10-2007. INT. CL. 41.

MCCULLOUGH, ROBERT L., SANTA BARBARA, CA AND MCCULLOUGH, SUZANNE M., SANTA BARBARA, CA:
3,298,750, INT. CL. 25.

MCD MARKETING ASSOCIATES, INC., DOWNERS GROVE, IL:
2,091,340, REN. 8-20-07. INT. CL. 16.

MCDONALD'S CORPORATION, OAK BROOK, IL:
3,296,333, PUB. 7-10-2007. INT. CL. 41.
3,297,114, PUB. 7-10-2007. INT. CL. 16.
3,297,138, PUB. 7-10-2007. INT. CL. 9.

MCEAGLE DEVELOPMENT, L.C., O'FALLON, MO:
3,299,002, INT. CL. 36.

MCGAW TECHNOLOGY, INC., FAIRVIEW PARK, OH:
2,082,205, REN. 8-23-07. INT. CL. 9.

MCGUIRE BEARING COMPANY, PORTLAND, OR:
3,297,133, PUB. 7-10-2007. INT. CL. 7.

MCILHENNY COMPANY, AVERY ISLAND, LA:
3,299,807, INT. CL. 9.

MCKEE BUTTON COMPANY, MUSCATINE, IA:
2,404,666, CANC. INT. CL. 26.

MCKEE STEWART EQUIPMENT CORPORATION, WEST ELIZABETH, PA:
2,403,385, CANC. INT. CL. 12.

MCKINNON INFORMATION SYSTEMS, INC., NEPEAN, ONTARIO, CANADA:
3,298,776, MULTIPLE CLASS, INT. CLS. 9, 16 AND 41.

MCM HOLDING AG, 6300 ZUG, SWITZERLAND, MCM MODERNE CREATION MUNCHEN REISEGEPACK GMBH, D-81677 MUNCHEN, FED REP GERMANY:
2,034,742, REN. 8-17-07. INT. CL. 9.
2,034,743, REN. 8-17-07. INT. CL. 18.
2,034,744, REN. 8-23-07. INT. CL. 25.

MCM MARKETING LTD., WATERLOO, CANADA:
3,297,921, PUB. 7-10-2007. INT. CL. 18.

MCMILLIN, AUSTIN D., TACOMA, WA:
3,299,422, INT. CL. 28.

MCMURRY, INC., PHOENIX, AZ:
2,173,074, REN. 8-18-07. INT. CL. 16.

MCNEALL INDUSTRIAL TECHNOLOGIES PTY LIMITED, ERMINGTON NSW 2115, AUSTRALIA:
2,403,416, CANC. INT. CL. 11.

MCNEILL DESIGNS LLC, WILMINGTON, DE:
3,299,054, MULTIPLE CLASS, INT. CLS. 28 AND 41.

MCS INDUSTRIES, INC., EASTON, PA:
3,299,661, INT. CL. 20.

MCS WATER TECHNOLOGY CORP., SAN GABRIEL, CA:
3,296,012, PUB. 7-10-2007. MULTIPLE CLASS, INT. CLS. 11 AND 37.

MCWILLIAMS, STEPHANIE, BROOKLYN, NY:
3,296,865, PUB. 7-10-2007. INT. CL. 42.

MCZ/CENTRUM FLORIDA XIX, L.L.C., CHICAGO, IL:
3,297,520, PUB. 7-10-2007. MULTIPLE CLASS, INT. CLS. 36 AND 37.

MC2 ENTERTAINMENT, 92120 MONTROUGE, FRANCE:
2,113,661, REN. 8-17-07. INT. CL. 28.

MDLSOLUTIONS, INC, TUSTIN, CA:
3,297,584, PUB. 7-10-2007. INT. CL. 9.

MDSA, LLC, NORCROSS, GA:
3,299,148, INT. CL. 12.

- MEADOWOOD MALL LLC, CHEVY CHASE, MD:
3,296,277, PUB. 7-10-2007. INT. CL. 36.
- MEANS, RAFAEL R., MALIBU, CA:
3,296,359, PUB. 7-10-2007. MULTIPLE CLASS, INT. CLS.
12 AND 16.
- MECHANICAL CONTRACTORS ASSOCIATION OF AMERICA, INC., ROCKVILLE, MD:
3,297,905, PUB. 7-10-2007. INT. CL. 35.
3,297,955, PUB. 7-10-2007. INT. CL. 35.
- MECHANICAL EQUIPMENT, INC., MIDLAND, TX:
2,084,731. REN. 8-23-07. INT. CL. 7.
2,084,732. REN. 8-23-07. INT. CL. 11.
- MEDELIA COMMUNICATIONS, LLC, HOLLYWOOD, FL:
3,300,280, INT. CL. 41.
- MEDEM, INC., SAN FRANCISCO, CA:
3,299,048, INT. CL. 44.
- MEDGE PLATFORMS, INC., NEW YORK, NY:
3,296,042, PUB. 7-10-2007. INT. CL. 9.
- MEDIA EXPRESS CO. LTD., WARSAW, POLAND:
3,298,857, INT. CL. 16.
- MEDIA MODIFICATIONS LLC, CAMBRIDGE, MA:
3,296,495, PUB. 6-26-2007. INT. CL. 9.
- MEDIALAB SOLUTIONS B.V., NETHERLANDS:
3,298,333, PUB. 7-10-2007. MULTIPLE CLASS, INT. CLS.
35 AND 42.
3,298,334, PUB. 7-10-2007. MULTIPLE CLASS, INT. CLS.
35 AND 42.
- MEDIAMOST INTERNATIONAL, INC., NEW YORK, NY:
3,298,657, MULTIPLE CLASS, INT. CLS. 9, 16, 35, 38 AND
41.
- MEDICAL COPYRIGHT, INC., NEW YORK, NY:
1,417,062, CANC. INT. CL. 16.
- MEDICAL DECISION LOGIC, INC., BALTIMORE, MD:
2,403,676, CANC. INT. CL. 9.
- MEDICAL MUTUAL OF OHIO, CLEVELAND, OH:
3,296,933, PUB. 7-10-2007. INT. CL. 36.
- MEDICAL PRODUCTS PANAMERICANA, INC., MIAMI, FL:
3,296,116, PUB. 7-10-2007. INT. CL. 5.
- MEDICAL TECHNIQUE, INC., TUCSON, AZ:
2,404,052, CANC. INT. CL. 10.
- MEDICITRUS, S.L., 12592 CHILCHES (CASTELLON), SPAIN:
2,804,007, CANC. INT. CL. 31.
- MEDIMETRIX GROUP, INC., BOCA RATON, FL:
2,150,603. REN. 8-20-07. INT. CL. 35.
2,152,147. REN. 8-20-07. INT. CL. 35.
3,297,822, PUB. 7-10-2007. MULTIPLE CLASS, INT. CLS.
35, 41 AND 44.
- MEDLINE INDUSTRIES, INC., MUNDELEIN, IL, GEORGE COUREY INC., QUEBEC, CANADA:
1,471,161. REN. 8-17-07. INT. CL. 5.
- MEDLINE INDUSTRIES, INC., MUNDELEIN, IL:
2,015,599, CANC. INT. CL. 10.
2,131,330. REN. 8-17-07. INT. CL. 10.
- MEDLINE, INDUSTRIES, INC., MUNDELEIN, IL:
2,128,736. REN. 8-17-07. INT. CL. 10.
- MEDOS INTERNATIONAL SARL, AKA MEDOS INTERNATIONAL GMBH AND MEDOS INTERNATIONAL LTD. LIAB. CO., LE LOCLE, SWITZERLAND:
2,029,413. REN. 8-21-07. INT. CL. 10.
- MEDPOINTE HEALTHCARE INC., SOMERSET, NJ FROM MEDPOINTE CAPITAL PARTNERS, LLC, SHORT HILLS, NJ:
3,298,411, INT. CL. 5.
- MEDSERVE GROUP, INC., VISTA, CA, BIOMEDICAL LIFE SYSTEMS, INC., VISTA, CA:
2,119,161. REN. 8-20-07. INT. CL. 10.
- MEDTECH PRODUCTS INC., IRVINGTON, NY:
3,300,290, INT. CL. 21.
- MEDTRIALS, INC., DALLAS, TX, METROPLEX CAPITAL CONCEPTS, INC., DALLAS, TX:
2,080,830. REN. 8-17-07. MULTIPLE CLASS, INT. CLS. 35
AND 42.
- MEDTRONIC XOMED, INC., JACKSONVILLE, FL:
2,114,842. REN. 8-20-07. INT. CL. 10.
- MEDTRONIC, INC., MINNEAPOLIS, MN:
3,298,795, INT. CL. 10.
- MEDX INCORPORATED, ARLINGTON HEIGHTS, IL, SITCO INCORPORATED, MUNDELEINE, IL:
2,034,507. REN. 8-17-07. INT. CL. 9.
- MEETINGS & EVENTS INTERNATIONAL, INC., EVANSVILLE, IN:
3,296,533, PUB. 7-10-2007. MULTIPLE CLASS, INT. CLS.
35 AND 36.
- MEGA BRANDS INC., MONTREAL, QUEBEC:
3,298,417, INT. CL. 28.
- MEGAN USA, CORP., NEW YORK, NY:
3,299,792, INT. CL. 16.
- MEHRA, RAJESH, GLENDALE, CA:
2,404,463, CANC. INT. CL. 3.
- MEHY HOLDINGS, HOLBROOK, NY:
2,085,102. REN. 8-17-07. INT. CL. 22.
- MEL SHOE CORPORATION, MAHWAH, NJ TO THE TIME-RBLAND COMPANY, STRATHAM, NH:
2,016,547, CANC. INT. CL. 25.
- MELALEUCA, INC., IDAHO FALLS, ID:
2,089,377. REN. 8-22-07. INT. CL. 3.
- MELCO HOLDINGS INC., NAGOYA, JAPAN:
1,451,914. REN. 8-23-07. INT. CL. 9.
- MELCO INDUSTRIES, INC., DENVER, CO:
3,297,891, PUB. 7-10-2007. MULTIPLE CLASS, INT. CLS.
7, 23 AND 26.
- MELDY, OWEN, RESEDA, CA:
2,015,128, CANC. INT. CL. 41.
- MELIE BIANCO ACCESSORIES, INC., LOS ANGELES, CA:
3,299,521, MULTIPLE CLASS, INT. CLS. 14 AND 25.
- MELO COMPANY, INC., STUYVESANT, NY:
2,403,315, CANC. INT. CL. 20.
- MELROCK, LTD., SARANAC, MI:
3,300,371, INT. CL. 5.
- MEMBER ADVANTAGE SERVICE CORPORATION, SARASOTA, FL:
2,016,442, CANC. INT. CL. 36.
- MEMORY MAKERS PHOTOGRAPHY, INC., ALEXANDRIA, VA, SATELLITE PUBLISHING INC., WESTMINSTER, CO:
2,087,043. REN. 8-18-07. INT. CL. 16.
- MEN'S APPAREL GUILD IN CALIFORNIA, INC., DULUTH, MN:
3,296,418, PUB. 7-10-2007. MULTIPLE CLASS, INT. CLS.
35 AND 41.
- MENARD, INC., EAU CLAIRE, WI:
2,088,956. REN. 8-17-07. INT. CL. 42.
3,298,446, INT. CL. 35.
3,298,447, INT. CL. 35.
3,299,760, INT. CL. 19.
- MENDIVE, SUSIE, NEW YORK, NY:
3,298,883, MULTIPLE CLASS, INT. CLS. 16 AND 27.
- MENTAL AUTOMATION, INC., GIG HARBOR, WA:
2,072,853. REN. 8-17-07. INT. CL. 9.
- MENUSOFT SYSTEMS, CORP., ALEXANDRIA, VA:
1,416,484, CANC. INT. CL. 9.
- MERCANTILE BANK CORPORATION, WYOMING, MI:
3,299,094, INT. CL. 36.
- MERCHANTWAREHOUSE.COM, INC., BOSTON, MA:
3,299,812, INT. CL. 9.
- MERCK & CO., INC., RAHWAY, NJ:
1,416,378, CANC. INT. CL. 5.
- MERCK KGAA, FED REP GERMANY:
3,298,267, PUB. 7-10-2007. INT. CL. 1.
- MERCK SANTE, 69008 LYON, FRANCE, LIPHA, LYONNAISE INDUSTRIELLE PHARMACEUTIQUE, 69008 LYON, FRANCE:
2,085,591. REN. 8-23-07. MULTIPLE CLASS, INT. CLS. 38
AND 42.
- MERCURY BUSINESS SERVICES, INC., BOSTON, MA:
3,298,438, MULTIPLE CLASS, INT. CLS. 9 AND 35.
- MERGERMARKET LIMITED, LONDON, UNITED KINGDOM:
3,297,785, PUB. 7-10-2007. INT. CL. 36.
- MERIAL LIMITED, UNITED KINGDOM:
3,298,365, PUB. 7-10-2007. INT. CL. 5.
- MERIDIAN TRANSPORTATION RESOURCES, LLC, SEATTLE, WA:
3,296,236, PUB. 7-10-2007. MULTIPLE CLASS, INT. CLS.

- 39 AND 41.
MERRICK DRY MILK COMPANY, INC., MIDDLETON, WI TO MERRICK'S, INC., MIDDLETON, WI:
1,383,598, AM. INT. CL. 31.
MERRICK SYSTEMS, INC., HOUSTON, TX:
3,297,826, PUB. 4-3-2007. INT. CL. 9.
MERRICK'S, INC., MIDDLETON, WI, MERRICK DRY MILK COMPANY, INC., MIDDLETON, WI:
1,447,073. REN. 8-23-07. INT. CL. 5.
1,447,074. REN. 8-23-07. INT. CL. 5.
1,447,815. REN. 8-17-07. INT. CL. 31.
MERRILL LYNCH & CO., INC., NEW YORK, NY:
3,298,535, INT. CL. 36.
MERRY GARDENERS, COSTA MESA, CA:
3,298,092, PUB. 7-10-2007. INT. CL. 35.
MERVYN'S BRANDS, LLC, HAYWARD, CA:
3,297,031, PUB. 7-10-2007. INT. CL. 35.
METAGENICS, INC., SAN CLEMENTE, CA:
2,403,421, CANC. INT. CL. 5.
METAL INDUSTRIES, INC., CLEARWATER, FL:
1,416,519, CANC. INT. CL. 11.
METALURGICA JOAPE LTDA, PORTO ALEGRE, BRAZIL:
3,296,568, PUB. 7-10-2007. INT. CL. 11.
METCALF, MARK D., FOREST GROVE, OR:
3,298,516, INT. CL. 41.
METRO INDUSTRIES, INC., WILKES-BARRE, PA:
3,299,185, INT. CL. 11.
3,299,186, INT. CL. 11.
METRO-GOLDWYN-MAYER LION CORP., LOS ANGELES, CA, METRO-GOLDWYN PICTURES CORPORATION, NEW YORK, NY:
231,203. REN. 8-20-07. U.S. CL. 26 (INT. CL. 9).
METRO-GOLDWYN-MAYER STUDIOS, INC., LOS ANGELES, CA, METRO-GOLDWYN-MAYER, INC., SANTA MONICA, CA:
2,085,291. REN. 8-20-07. INT. CL. 41.
METROFRESH, INC., ATLANTA, GA:
3,299,198, INT. CL. 43.
METZ, RICHARD W., HINCKLEY, OH, DBA NORTHWESTERN DISTRIBUTION SERVICE:
1,416,435, CANC. INT. CL. 8.
MEYER INTELLECTUAL PROPERTIES LIMITED, KOWLOON, HONG KONG, ACKERMAN, ANGELA, FRAMINGHAM, MA:
2,103,885. REN. 8-17-07. INT. CL. 21.
MG SYSTEMS & WELDING, INC., MENOMONEE FALLS, WI:
3,296,514, PUB. 7-10-2007. INT. CL. 6.
MGI LUXURY GROUP SA, 2502 BIEL, SWITZERLAND:
833,650. REN. 8-17-07. U.S. CL. 27 (INT. CL. 14).
MHB ENTERPRISES, SAINT CHARLES, MO:
3,300,141, INT. CL. 40.
MIAMI CRAB CORPORATION, MIAMI, FL:
2,083,718. REN. 8-22-07. INT. CL. 29.
MICELI, DEBRAH, HOMOSASSA, FL:
3,297,230, PUB. 4-3-2007. MULTIPLE CLASS, INT. CLS. 25, 28 AND 41.
MICHAEL ANTHONY JEWELERS LLC, MOUNT VERNON, NY:
2,089,735. REN. 8-22-07. INT. CL. 14.
MICHAEL FOODS, INC., MINNETONKA, MN:
2,404,455, CANC. INT. CL. 29.
MICHAEL KUANG, BURLINGAME, CA:
3,299,637, INT. CL. 11.
MICHAEL M. BLANK AND JAMES NUSSBAUM PARTNERSHIP, THE, MT. AIRY, MD:
2,016,220, CANC. INT. CL. 16.
MICHAEL MARKOWITZ & ASSOCIATES INC., SANTA FE, NM:
2,015,406, CANC. INT. CL. 35.
2,015,407, CANC. INT. CL. 42.
MICHAEL R. SAGE, GAINESVILLE, FL:
3,296,339, PUB. 7-10-2007. INT. CL. 35.
MICHAEL STEIN AND JOYCE KEYSER, DEERFIELD BEACH, FL:
3,300,240, U.S. CL. B.
MICHAEL W. STARKWEATHER, P.C., SANDY, UT:
3,296,528, PUB. 7-10-2007. INT. CL. 45.
MICHAELS, STELLA, NEW YORK, NY, DBA KICKIN' THE BOTTLE MUSIC:
3,300,119, INT. CL. 41.
MICHEL MERCIER PRODUCTS, SOUTH PLAINFIELD, NJ, DBA M.M.P., INC.:
3,299,427, INT. CL. 1.
MICHELIN AIRCRAFT TIRE CORPORATION, GREENVILLE, SC:
1,416,551, CANC. INT. CL. 12.
MICHELIN NORTH AMERICA, INC., GREENVILLE, SC:
3,298,454, INT. CL. 9.
MICROREF SYSTEMS, INC., HIGHLAND PARK, IL:
1,446,336. REN. 8-23-07. INT. CL. 16.
MICROSOFT CORPORATION, REDMOND, WA:
2,037,888. REN. 8-22-07. INT. CL. 9.
MICROSOFT CORPORATION, REDMOND, WA, BUNGIE SOFTWARE PRODUCTS CORPORATION, CHICAGO, IL:
2,038,273. REN. 8-23-07. MULTIPLE CLASS, INT. CLS. 9 AND 28.
MICROSOFT CORPORATION, REDMOND, WA, MICROSOFT CORPORATION, REDMOND, WA:
2,081,809. REN. 8-23-07. INT. CL. 9.
MICROSOFT CORPORATION, REDMOND, WA:
2,081,875. REN. 8-20-07. INT. CL. 16.
MICROSOFT CORPORATION, REDMOND, WA, VISIO CORPORATION, SEATTLE, WA:
2,082,080. REN. 8-20-07. INT. CL. 9.
MICROSOFT CORPORATION, REDMOND, WA:
3,300,210, INT. CL. 16.
3,300,219, INT. CL. 41.
MICROTEL, INC., BOCA RATON, FL:
1,416,959, CANC. INT. CL. 38.
MICROVENTION, INC., ALISO VIEJO, CA:
3,248,106, COR. INT. CL. 10.
MICRUS ENDOVASCULAR CORPORATION, SAN JOSE, CA:
3,299,249, INT. CL. 10.
MID-STATE BANCSHARES, ARROYO GRANDE, CA:
1,416,937, CANC. INT. CL. 36.
MID-USA CYCLE PARTS, INC., ST. LOUIS, MO:
2,403,425, CANC. MULTIPLE CLASS, INT. CLS. 6, 8, 9, 12, 17 AND 20.
MIDLAND STATES BANCORP, INC., EFFINGHAM, IL:
3,298,456, INT. CL. 36.
MIDWEST ETHANOL TRANSPORT, LLC, GRANITE FALLS, MN:
3,300,357, INT. CL. 39.
MIDWEST FASTENERS, INC., MIAMISBURG, OH:
3,299,421, INT. CL. 7.
MIDWEST MEDICAL AESTHETICS, LLC, FREMONT, NE:
3,296,549, PUB. 7-10-2007. INT. CL. 44.
MIDWEST TRUCK & AUTO PARTS, INC., CHICAGO, IL:
2,404,476, CANC. INT. CL. 12.
MIGACZ, ANTHONY, PALOS HEIGHTS, IL:
2,403,877, CANC. INT. CL. 29.
MIGUEL TORRES, S.A., BARCELONA, SPAIN:
3,299,937, INT. CL. 33.
MIKASA LICENSING, INC., SECAUCUS, NJ:
2,014,720, CANC. MULTIPLE CLASS, INT. CLS. 20 AND 21.
MIKE RUPERS, SAN ANSELMO, CA:
3,298,709, INT. CL. 35.
MILARDO, GIANLUCA, A. NEWINGTON, CT:
3,297,551, PUB. 7-10-2007. INT. CL. 32.
MILDLY DELIRIOUS DESIGN INC., LAKE WORTH, FL:
3,296,237, PUB. 7-10-2007. INT. CL. 35.
MILES CARS, LLC, FRANKLIN, TN:
3,299,282, INT. CL. 37.
3,299,283, INT. CL. 37.
MILLER INTERNATIONAL, INC., DENVER, CO:
3,299,077, INT. CL. 25.
MILLER STUDIOS, INC., NEW PHILADELPHIA, OH:
2,404,726, CANC. MULTIPLE CLASS, INT. CLS. 20, 25 AND 27.
MILLER THOMSON LLP, TORONTO, CANADA:
3,297,218, PUB. 7-10-2007. INT. CL. 42.
MILLER, DEBRA, DANIA BEACH, FL:
3,297,295, PUB. 7-10-2007. INT. CL. 35.

- MILLER, LINDA, MURRAY, UT AND RUGER, CHET, MURRAY, UT AND ROBERTS, SCOTT, MURRAY, UT: 3,296,903, PUB. 7-10-2007. INT. CL. 36.
- MILLIKEN & COMPANY, NEW YORK, NY: 2,104,460. REN. 8-18-07. INT. CL. 24.
- MILLION VOICES FOUNDATION, DALLAS, TX: 3,299,717, INT. CL. 9.
- MILLIPORE CORPORATION, BEDFORD, MA: 2,404,392, CANC. INT. CL. 11.
- MILLS BROS. INTERNATIONAL, INC., SEATTLE, WA: 3,297,422, PUB. 7-10-2007. INT. CL. 31.
- MILO F. JAMISON BIBLE FELLOWSHIP, INC., LOS ANGELES, CA, DBA THE BIBLE FELLOWSHIP: 1,450,719. REN. 8-23-07. INT. CL. 16.
- MINDWAVE RESEARCH, INC., AUSTIN, TX: 3,299,104, INT. CL. 35.
- MINNESOTA MINING AND MANUFACTURING COMPANY, SAINT PAUL, MN, AKA 3M: 1,416,381, CANC. INT. CL. 5.
- MINNESOTA PUBLIC RADIO, ST. PAUL, MN: 3,296,622, PUB. 7-10-2007. INT. CL. 41.
3,296,919, PUB. 7-10-2007. INT. CL. 41.
3,296,934, PUB. 7-10-2007. INT. CL. 41.
- MINNTECH CORPORATION, MINNEAPOLIS, MN: 3,299,538, INT. CL. 10.
- MINOLTA CAMERA CO., LTD., CHUO-KU, OSAKA, JAPAN: 1,416,493, CANC. INT. CL. 9.
- MINTO HOLDINGS INC., OTTAWA, ONTARIO, CANADA: 3,297,530, PUB. 7-10-2007. MULTIPLE CLASS, INT. CLS. 36 AND 37.
3,297,561, PUB. 7-10-2007. INT. CL. 37.
3,297,562, PUB. 7-10-2007. INT. CL. 37.
- MIQUEL Y COSTAS & MIQUEL S.A., E-08006 BARCELONA, SPAIN: 2,403,367, CANC. INT. CL. 34.
- MIRACLE REMOTE, LLC, RIDGEFIELD, NJ: 3,300,227, INT. CL. 9.
- MIRAGE RESORTS, INCORPORATED, LAS VEGAS, NV: 3,299,653, INT. CL. 43.
3,299,654, INT. CL. 41.
- MIRAMA ENTERPRISES INC., SAN DIEGO, CA: 3,296,015, PUB. 8-22-2006. INT. CL. 7.
- MIRROR-WATER PTE LTD, ALEXANDRA DISTRI PARK, SINGAPORE: 2,404,511, CANC. INT. CL. 5.
- MISC US TRADEMARK LTD., MISSISSAUGA, ONTARIO, CANADA: 3,298,984, INT. CL. 5.
- MISHIMA FOODS CO., LTD., HIROSHIMA 730, JAPAN: 2,083,557. REN. 8-23-07. INT. CL. 42.
- MISSIONARY ENTERTAINMENT, LLC, SATELLITE BEACH, FL: 3,296,564, PUB. 7-10-2007. MULTIPLE CLASS, INT. CLS. 9 AND 25.
- MISSISSIPPI VALLEY AG, LLC, CLARKSVILLE, TN: 3,299,632, INT. CL. 1.
3,299,633, INT. CL. 1.
3,299,634, INT. CL. 1.
- MISTOLIN DOMINICANA, C POR A, SANTO DOMINGO, DOMINICAN REP: 1,416,376, CANC. INT. CL. 5.
- MITCHELL DRILLING CONTRACTORS PTY LTD, QUEENSLAND, AUSTRALIA: 3,297,649, PUB. 7-10-2007. MULTIPLE CLASS, INT. CLS. 37 AND 42.
- MITCHELLACE, INC., PORTSMOUTH, OH: 3,299,100, INT. CL. 26.
- MITEL NETWORKS CORPORATION, OTTAWA, ONTARIO K2K 2W7, CANADA: 3,296,014, PUB. 12-5-2006. INT. CL. 9.
- MITSUBISHI CATERPILLAR FORKLIFT AMERICA INC., HOUSTON, TX: 648,585. REN. 8-22-07. U.S. CL. 23 (INT. CL. 12).
- MITSUI CHEMICALS, INC., TOKYO, JAPAN: 3,297,962, PUB. 7-10-2007. INT. CL. 1.
- MITSUI HIGH-TEC INC., YAHATANISHI-KU, KITAKYUSHU, JAPAN: 3,297,730, PUB. 7-10-2007. INT. CL. 9.
- MIXI, INC., JAPAN: 3,298,251, PUB. 7-10-2007. MULTIPLE CLASS, INT. CLS. 38 AND 45.
- MJA INDUSTRIES LLC, NORTH WOODMERE, NY: 3,298,475, INT. CL. 25.
- MOBILE GLOBAL, INCORPORATED, CARLSBAD, CA: 2,403,591, CANC. INT. CL. 5.
- MLSOK.COM, INC., OKLAHOMA CITY, OK: 3,296,634, PUB. 7-10-2007. INT. CL. 36.
- MM-LESESTIFT MANAGER MEMORY GMBH, D-78549 SPAICHINGEN, FED REP GERMANY: 2,403,164, CANC. INT. CL. 9.
- MNICHKO, VIATCHESLAV, SARASOTA, FL: 3,300,074, INT. CL. 9.
- MOBILE INTERNET ACCESS, INC., PEMBROKE, MA: 3,297,760, PUB. 7-10-2007. INT. CL. 9.
- MOBILE MEDIA ENTERPRISES LLC, ATLANTA, GA: 3,298,784, INT. CL. 35.
- MOBILEJAM, LLC, KENMORE, WA: 3,299,499, MULTIPLE CLASS, INT. CLS. 38 AND 45.
- MOBLEY, MICHAEL D., CLERMONT, FL: 3,299,974, INT. CL. 39.
- MODELS PREFER, LTD., WATERBURY, CT: 3,299,434, INT. CL. 3.
- MODERN MUZZLELOADING, INC., CENTERVILLE, IA TO EBSCO INDUSTRIES, INC., BIRMINGHAM, AL: 2,015,098, CANC. INT. CL. 13.
- MOE, MARILYNN M., FARGO, ND, DBA MOE MUSIC...AND MORE STUDIO: 2,403,295, CANC. INT. CL. 16.
- MOEN INCORPORATED, NORTH OLMSTED, OH: 2,403,338, CANC. MULTIPLE CLASS, INT. CLS. 3, 6, 8, 11, 20 AND 21.
3,299,109, MULTIPLE CLASS, INT. CLS. 6 AND 21.
3,299,110, MULTIPLE CLASS, INT. CLS. 6 AND 21.
3,299,666, INT. CL. 11.
3,299,725, INT. CL. 11.
3,299,745, MULTIPLE CLASS, INT. CLS. 6, 11 AND 21.
- MOLECULAR DEVICES CORPORATION, SUNNYVALE, CA: 3,297,693, PUB. 7-10-2007. MULTIPLE CLASS, INT. CLS. 1 AND 9.
- MOLINA-LOPEZ, GEORGINA, CHICAGO, IL: 3,299,117, INT. CL. 39.
- MOLINA, DAVID K., PENNSBURG, PA: 3,297,406, PUB. 8-29-2006. INT. CL. 37.
- MONARCHY ENTERPRISES S.A.R.L., L-1331 LUXEMBOURG, LUXEMBOURG, MONARCHY ENTERPRISES B.V., AMSTERDAM, NETHERLANDS: 2,087,962. REN. 8-23-07. INT. CL. 41.
- MONDAY, CURTIS R., HAZEL CREST, IL: 3,296,718, PUB. 7-10-2007. INT. CL. 41.
- MONEY MAILER, LLC, GARDEN GROVE, CA: 2,016,301, CANC. INT. CL. 35.
- MONEYTRAX, INC., MELBOURNE, FL: 3,298,004, PUB. 7-10-2007. INT. CL. 9.
- MONEYTREE MANAGEMENT, WATERFORD, MI: 2,016,143, CANC. INT. CL. 5.
- MONICA RICH KOSANN PHOTOGRAPHY, LLC, NEW CANAAN, CT: 3,298,928, INT. CL. 14.
- MONO, SAN RAFAEL, CA: 3,296,606, PUB. 7-10-2007. INT. CL. 15.
- MONOTYPE CORPORATION, THE, REDMOND, WA, MONOTYPE CORPORATION PLC, THE, REDHILL, ENGLAND: 1,468,878. REN. 8-22-07. INT. CL. 9.
- MONSTER (CALIFORNIA), INC., EL SEGUNDO, CA: 3,297,180, PUB. 12-5-2006. MULTIPLE CLASS, INT. CLS. 35, 36, 37, 42, 43, 44 AND 45.
- MONSTER CABLE PRODUCTS, INC., BRISBANE, CA: 3,298,845, INT. CL. 41.
- MONTANA BLACK GOLD, BOZEMAN, MT: 2,404,378, CANC. INT. CL. 28.

- MONTANA FILM OFFICE (DIVISION OF THE MONTANA DEPARTMENT OF COMMERCE), HELENA, MT:
2,403,612, CANC. INT. CL. 35.
- MONTBLANC-SIMPLO GMBH, HAMBURG, FED REP GERMANY:
3,297,572, PUB. 7-10-2007. INT. CL. 16.
- MONTEFIORE MEDICAL CENTER INC., BRONX, NY:
2,404,453, CANC. INT. CL. 42.
- MONTEFIORE MEDICAL CENTER, INC., BRONX, NY:
3,299,300, MULTIPLE CLASS, INT. CLS. 35 AND 44.
3,299,301, MULTIPLE CLASS, INT. CLS. 35 AND 44.
- MONTGOMERY WARD, LLC, CHICAGO, IL:
2,403,794, CANC. INT. CL. 18.
- MONTY AND PAT ROBERTS, INC., SOLVANG, CA:
2,158,382, REN. 8-18-07. INT. CL. 41.
- MONY LIFE INSURANCE COMPANY, NEW YORK, NY:
2,404,635, CANC. INT. CL. 36.
- MOODFOOD RECORDS, INC., CARY, NC:
2,404,115, CANC. INT. CL. 9.
- MOON RIVER RANCH, INC., BEAVER CREEK, CO:
2,084,697, REN. 8-17-07. MULTIPLE CLASS, INT. CLS. 25 AND 42.
- MOON, SANG HEUM, ALEXANDRIA, VA:
3,296,613, PUB. 6-26-2007. INT. CL. 35.
- MOONTIDE INTERNATIONAL LIMITED, PANMUR-EAUCKLAND, NEW ZEALAND:
1,445,233, REN. 8-23-07. INT. CL. 25.
- MOORE ACTION COLLECTIBLES, INC., FORT WORTH, TX:
2,403,435, CANC. INT. CL. 16.
- MOORE NORTH AMERICA, INC., GRAND ISLAND, NY:
2,404,016, CANC. INT. CL. 39.
2,404,151, CANC. INT. CL. 16.
- MOORE, LONNIE, HOLLYWOOD, CA:
3,300,091, INT. CL. 43.
3,300,092, INT. CL. 43.
- MOOSEWOOD, INC., ITHACA, NY:
1,461,406, REN. 8-23-07. INT. CL. 42.
- MORGAN, 75002 PARIS, FRANCE:
2,403,784, CANC. INT. CL. 35.
- MORGAN ADHESIVES COMPANY, STOW, OH:
2,090,078, REN. 8-20-07. INT. CL. 17.
- MORGAN STANLEY DEAN WITTER & CO., NEW YORK, NY:
2,404,364, CANC. INT. CL. 36.
- MORIARTY, PAUL, ROCHESTER, NY:
3,296,122, PUB. 7-10-2007. MULTIPLE CLASS, INT. CLS. 36 AND 44.
- MORNINGSIDE CENTER FOR TEACHING SOCIAL RESPONSIBILITY, INC., NEW YORK, NY:
3,298,025, PUB. 7-10-2007. MULTIPLE CLASS, INT. CLS. 16 AND 41.
- MORRIS & DICKSON CO., LTD., SHREVEPORT, LA:
3,298,987, U.S. CL. 200.
- MORRIS NATIONAL, INC., AZUSA, CA:
3,299,663, INT. CL. 30.
- MORRIS PUBLISHING GROUP, LLC, AUGUSTA, GA:
2,101,670, REN. 8-23-07. INT. CL. 16.
- MORROW SKIN INSTITUTE, A MEDICAL GROUP, INCORPORATED, RANCHO MIRAGE, CA:
2,651,090, COR. INT. CL. 42.
- MORSE SHOE, INC., CANTON, MA:
1,416,739, CANC. INT. CL. 25.
- MORTENSEN, STEVE M., IDAHO FALLS, ID:
2,404,108, CANC. INT. CL. 20.
- MOSELEY, JAMES M., HUNTINGTON BEACH, CA:
3,296,377, PUB. 7-10-2007. INT. CL. 25.
- MOSSO, ERNESTO FERNANDO, SANTIAGO, CHILE:
3,297,242, PUB. 7-10-2007. INT. CL. 14.
- MOSTASHARI, MOE, CHINO HILLS, CA:
2,404,922, CANC. INT. CL. 28.
- MOSZKITO, INC., SCOTTSDALE, AZ:
3,299,311, INT. CL. 35.
- MOTION WATER SPORTS, INC., REDMOND, WA, RAND MANUFACTURING CORPORATION, REDMOND, WA:
1,068,197, REN. 8-23-07. INT. CL. 28.
- MOTT'S LLP, RYE BROOK, NY:
2,104,130, REN. 8-17-07. INT. CL. 32.
- MOUNTAIN MOMS, TRUCKEE, CA:
2,404,390, CANC. INT. CL. 9.
- MOVIE GALLERY US, LLC, DOTHAN, AL:
3,296,004, PUB. 7-10-2007. INT. CL. 35.
- MOVIEMATE INC., CENTERPORT, NY:
3,297,443, PUB. 7-10-2007. INT. CL. 9.
- MOVING EXPRESS INCORPORATED, CHATSWORTH, CA:
2,404,942, CANC. INT. CL. 39.
- MPC INCORPORATED, BOCA RATON, FL AND SEVENDUST, LLC, BOCA RATON, FL:
3,297,318, PUB. 7-10-2007. INT. CL. 9.
- MPD MEDICAL ASSOCIATES (MA), P.C., LEXINGTON, MA:
3,300,055, INT. CL. 44.
- MPR SERVICES, INC., DICKINSON, TN:
2,100,803, REN. 8-18-07. INT. CL. 1.
- MPSI SYSTEMS INC., TULSA, OK:
2,014,871, CANC. INT. CL. 9.
- MR. GASKET COMPANY, CLEVELAND, OH:
1,446,281, REN. 8-17-07. INT. CL. 12.
- MR. GATTI'S, L.P., AUSTIN, TX:
3,299,161, MULTIPLE CLASS, INT. CLS. 41 AND 43.
- MR. GATTI'S, LP, AUSTIN, TX:
3,297,068, PUB. 7-10-2007. INT. CL. 43.
- MRA ADVERTISING/PRODUCTION SUPPORT SERVICES, INC., CINCINNATI, OH:
3,297,487, PUB. 7-10-2007. INT. CL. 35.
- MRS. CLARK'S FOODS, L.C., ANKENY, IA:
3,003,668, COR. INT. CL. 30.
- MRS. GROSSMAN'S PAPER COMPANY, PETALUMA, CA:
2,132,759, REN. 8-22-07. INT. CL. 16.
- MRS. UNITED STATES NATIONAL PAGEANT, INC., FAIRPORT, NY:
2,083,350, REN. 8-23-07. INT. CL. 41.
- MT. GRETN MOUNTAIN BIKES, LTD., LEBANON, PA:
2,403,407, CANC. INT. CL. 35.
- MTD PRODUCTS INC, VALLEY CITY, OH:
3,300,315, MULTIPLE CLASS, INT. CLS. 7 AND 12.
- MTI INSTRUMENTS, INC., ALBANY, NY:
3,263,646, COR. INT. CL. 9.
- MTS PRODUCTS, SUN VALLEY, CA:
3,297,751, PUB. 7-10-2007. INT. CL. 9.
- MUELHENS GMBH & CO. KG, 60823 KOLN, FED REP GERMANY:
2,403,795, CANC. INT. CL. 3.
- MULLINS, AIMEE, NEW YORK, NY:
3,298,655, INT. CL. 3.
- MULTICAST MEDIA TECHNOLOGIES, INC., ATLANTA, GA:
3,300,325, INT. CL. 41.
- MULTIMEDIA GAMES, INC., AUSTIN, TX:
3,299,218, INT. CL. 9.
- MUMM'S THE WORD, INC., SPOKANE, WA:
2,404,603, CANC. INT. CL. 24.
- MUNICH RE AMERICA CORPORATION, PRINCETON, NJ:
2,079,571, REN. 8-20-07. INT. CL. 36.
- MURATA MANUFACTURING CO., LTD., KYOTO, JAPAN:
2,403,571, CANC. INT. CL. 9.
- MUSE, ANDREW C., WILLIAMSBURG, VA:
2,016,093, CANC. MULTIPLE CLASS, INT. CLS. 38 AND 41.
- MUSHYGUSHY.COM, LLC, LIVINGSTON, NJ:
3,298,575, INT. CL. 38.
- MUSICAL ELECTRONICS LIMITED, KOWLOON, HONG KONG:
3,296,304, PUB. 7-10-2007. INT. CL. 28.
- MUSTAD INCORPORATED, BLOOMFIELD, CT:
2,056,347, REN. 8-20-07. INT. CL. 18.
- MUSTAFA, SAM A., HALEDON, NJ:
3,299,889, INT. CL. 16.
- MVP SPORTSPLEX LLC, GRAND RAPIDS, MI:
3,299,205, INT. CL. 41.
- MWI VETERINARY SUPPLY CO., MERIDIAN, ID:
3,299,156, INT. CL. 5.
- MY HELPER, INC., ORLANDO, FL:
3,297,559, PUB. 7-10-2007. INT. CL. 16.
3,297,560, PUB. 7-10-2007. INT. CL. 16.

- MYCAREER SOLUTIONS, L.L.C., DES MOINES, IA:
3,297,192, PUB. 7-10-2007. INT. CL. 35.
- MYDATA AUTOMATION AB, 161 70 BROMMA, SWEDEN:
2,014,661, CANC. MULTIPLE CLASS, INT. CLS. 7 AND 9.
- MYLAN TECHNOLOGIES, INC., ST. ALBANTS, VT:
2,081,855. REN. 8-17-07. INT. CL. 5.
- MYREEL.COM, LLC, LOS ANGELES, CA:
3,300,047, INT. CL. 35.
- MYRENTAL INCORPORATED, SAN FRANCISCO, CA:
3,297,972, PUB. 7-10-2007. INT. CL. 36.
- MYSTIC COAST & COUNTRY TRAVEL INDUSTRY ASSO-
CIATION, INC., NORWICH, CT:
3,296,490, PUB. 7-10-2007. INT. CL. 35.
- MYSTIC MEADS AND MELOMELS, L.L.C., GRAND RIVER,
IA:
3,298,681, INT. CL. 33.
- MYSTIQUE APPAREL GROUP INC., NEW YORK, NY:
3,298,581, INT. CL. 25.
- M2 VENTURES LLC, SACHSE, TX:
3,299,687, MULTIPLE CLASS, INT. CLS. 3 AND 21.
- N.V. BEKAERT S.A., BELGIUM:
3,298,385, PUB. 7-10-2007. MULTIPLE CLASS, INT. CLS.
6, 11, 17 AND 42.
- NABAR GAMES INC., LONDON, ONTARIO:
3,298,558, INT. CL. 28.
3,298,559, INT. CL. 28.
- NABISCO BRANDS COMPANY, WILMINGTON, DE:
2,404,746, CANC. INT. CL. 30.
- NACHO MAMA'S, INC., RICHMOND, VA:
3,297,924, PUB. 7-10-2007. INT. CL. 43.
- NACIONAL NAME HOLDING, LLC, ST. LOUIS, MO:
3,297,015, PUB. 7-10-2007. MULTIPLE CLASS, INT. CLS.
35, 36 AND 37.
- NAGATO, HAROLD K., HONOLULU, HI:
3,297,466, PUB. 7-10-2007. INT. CL. 11.
- NAIL TECH SUPPLY, INC., GLADSTONE, MO:
3,297,934, PUB. 7-10-2007. INT. CL. 35.
- NALCO COMPANY, NAPERVILLE, IL:
1,069,642. REN. 8-23-07. INT. CL. 1.
1,444,688. REN. 8-17-07. INT. CL. 1.
- NAM WAH ENTERPRISES COMPANY LIMITED, KOW-
LOON, HONG KONG:
2,404,225, CANC. INT. CL. 28.
- NAMASTE LABORATORIES, L.L.C., BLUE ISLAND, IL:
3,299,699, INT. CL. 3.
- NAMCO BANDAI GAMES AMERICA INC., CYPRESS, CA:
3,299,720, INT. CL. 9.
- NAMCO BANDAI GAMES INC., TOKYO, JAPAN:
3,296,211, PUB. 7-10-2007. INT. CL. 28.
- NAMCO BANDAI GAMES INC., OTA-KU, TOKYO, JAPAN:
3,298,891, INT. CL. 9.
3,298,892, INT. CL. 9.
- NAMCO, LLC, MANCHESTER, CT:
2,112,045. REN. 8-21-07. INT. CL. 28.
- NAMES NET LTD., ENGLAND:
2,493,641, CANC. MULTIPLE CLASS, INT. CLS. 38 AND
42.
- NAMI LOUISVILLE, INC., LOUISVILLE, KY:
3,296,426, PUB. 7-10-2007. INT. CL. 35.
- NANHAI ARCHIE DECORATIVE HARDWARE CO., LTD.
OF FOSHAN, FOSHAN CITY, GUANGDONG, CHINA:
3,298,448, MULTIPLE CLASS, INT. CLS. 6 AND 21.
- NANNIC INT, BVBA, BELGIUM:
3,298,345, PUB. 7-10-2007. MULTIPLE CLASS, INT. CLS.
3, 5 AND 44.
- NANOCHEM SOLUTIONS, INC., BEDFORD PARK, IL:
2,015,690, CANC. INT. CL. 1.
- NANOGEOMETRY RESEARCH INC., KAWASAKI, KANA-
GAWA 213-0012, JAPAN:
3,298,505, INT. CL. 9.
- NANOSPEED, LLC, ATLANTA, GA:
3,296,398, PUB. 7-10-2007. INT. CL. 35.
- NAPLES CAPITAL MANAGEMENT, LLC, NAPLES, FL:
3,299,788, INT. CL. 28.
- NAPOLEX CORPORATION, NEW YORK, JAPAN:
1,446,086. REN. 8-17-07. MULTIPLE CLASS, INT. CLS. 9
AND 11.
- NAPPYVISION, LLC, WEST ORANGE, NJ:
3,296,476, PUB. 7-10-2007. INT. CL. 45.
- NARCOTICS ANONYMOUS WORLD SERVICES, INC.,
CHATSWORTH, CA:
1,450,681. REN. 8-20-07. MULTIPLE CLASS, INT. CLS. 16,
20, 25 AND 42.
- NASH, JOEL H, NEW YORK, NY:
3,300,024, INT. CL. 9.
- NATHAN ASSOCIATES INC., ARLINGTON, VA:
2,083,602. REN. 8-23-07. MULTIPLE CLASS, INT. CLS. 35
AND 36.
- NATIONAL ACADEMY OF RECORDING ARTS &
SCIENCES, INC., THE, SANTA MONICA, CA:
3,298,938, INT. CL. 41.
- NATIONAL ADOPTION CENTER, PHILADELPHIA, PA:
2,081,645. REN. 8-23-07. INT. CL. 42.
- NATIONAL ASSOCIATION FOR AMBULATORY CARE,
DALLAS, TX:
1,417,001, CANC. INT. CL. 42.
- NATIONAL ASSOCIATION FOR THE SELF EMPLOYED,
INC., GRAPEVINE, TX:
2,091,462. REN. 8-23-07. INT. CL. 25.
- NATIONAL ASSOCIATION OF BOARDS OF PHARMACY,
MOUNT PROSPECT, IL:
2,085,979. REN. 8-20-07. INT. CL. 16.
2,473,149, CANC. INT. CL. 9.
- NATIONAL ASSOCIATION OF CHILD ADVOCATES, WA-
SHINGTON, DC:
2,404,064, CANC. INT. CL. 42.
- NATIONAL ASSOCIATION OF EMERGENCY MEDICAL
TECHNICIANS, CLINTON, MS:
2,403,833, CANC. INT. CL. 41.
- NATIONAL ASSOCIATION OF FINANCIAL SERVICES
AUDITORS, INC., WILMINGTON, DE TO INSTITUTE
OF INTERNAL AUDITORS, INC., THE, ALTAMONTE
SPRINGS, FL:
2,015,639, CANC. INT. CL. 42.
- NATIONAL ASSOCIATION OF PROFESSIONAL BASEBALL
LEAGUES, INC., SAINT PETERSBURG, FL:
3,299,997, INT. CL. 16.
- NATIONAL BOARD OF SURGICAL TECHNOLOGY &
SURGICAL ASSISTING, LITTLETON, CO:
3,299,800, U.S. CL. B.
- NATIONAL BOARD OF SURGICAL TECHNOLOGY AND
SURGICAL ASSISTING, LITTLETON, CO:
3,299,703, U.S. CL. B.
3,299,704, U.S. CL. B.
- NATIONAL BREAST CANCER COALITION, WASHING-
TON, DC:
3,299,951, MULTIPLE CLASS, INT. CLS. 36 AND 41.
- NATIONAL BUSINESS SERVICES, INC., LANGHORNE, PA:
2,403,441, CANC. MULTIPLE CLASS, INT. CLS. 35 AND
42.
- NATIONAL CABLE SATELLITE CORPORATION, WA-
SHINGTON, DC:
2,079,327. REN. 8-17-07. INT. CL. 41.
- NATIONAL CENTER FOR MISSING AND EXPLOITED
CHILDREN, ALEXANDRIA, VA:
3,297,775, PUB. 7-10-2007. INT. CL. 42.
3,297,777, PUB. 7-10-2007. INT. CL. 9.
- NATIONAL COUNCIL OF YOUNG MEN'S CHRISTIAN
ASSOCIATIONS, CHICAGO, IL, AKA YMCA OF THE
USA, AND AKA THE NATIONAL COUNCIL OF YOUNG
MEN'S CHRISTIAN ASSOCIATIONS OF THE UNITED
STATES OF AMERICA:
1,448,979. REN. 8-23-07. INT. CL. 42.
1,449,075. REN. 8-23-07. U.S. CL. 200.
- NATIONAL DAIRY COUNCIL, ROSEMONT, IL:
3,297,244, PUB. 7-10-2007. MULTIPLE CLASS, INT. CLS. 9
AND 41.
- NATIONAL ELECTRICAL CARBON PRODUCTS, INC.,
GREENVILLE, SC:
2,404,593, CANC. INT. CL. 7.
- NATIONAL GEOGRAPHIC SOCIETY, WASHINGTON, DC:
1,416,981, CANC. INT. CL. 41.
- NATIONAL HOT ROD ASSOCIATION, GLENDORA, CA:
3,300,206, INT. CL. 25.
3,300,207, INT. CL. 25.

NATIONAL INK, LLC, SANTEE, CA:
3,300,294, INT. CL. 16.
3,300,295, INT. CL. 16.
3,300,296, INT. CL. 16.

NATIONAL KIDNEY FOUNDATION, INC., NEW YORK, NY:
3,297,718, PUB. 7-10-2007. INT. CL. 41.

NATIONAL MARINE MANUFACTURERS ASSOCIATION, INC., CHICAGO, IL:
2,014,879, CANC. INT. CL. 35.
2,014,898, CANC. INT. CL. 35.

NATIONAL MENTORING PARTNERSHIP, INC./ MENTOR, ALEXANDRIA, VA:
3,295,998, PUB. 7-10-2007. INT. CL. 42.

NATIONAL NOTARY ASSOCIATION, CHATSWORTH, CA:
3,299,588, INT. CL. 42.

NATIONAL RETAIL TENANTS ASSOCIATION, EAST LONGMEADOW, MA:
3,296,958, PUB. 7-10-2007. INT. CL. 16.

NATIONAL SHOOTING SPORTS FOUNDATION, INC., NEWTOWN, CT:
3,296,776, PUB. 7-10-2007. INT. CL. 35.

NATIONAL SIGHTHOUND RESCUE & ADOPTION, INC., THOMASVILLE, GA:
2,016,441, CANC. INT. CL. 42.

NATIONAL STARCH AND CHEMICAL INVESTMENT HOLDING CORPORATION, NEW CASTLE, DE, INDOPCO, INC., BRIDGEWATER, NJ, DBA NATIONAL STARCH AND CHEMICAL COMPANY:
2,129,488, REN. 8-17-07. INT. CL. 1.

NATIONAL TOBACCO COMPANY, L.P., LOUISVILLE, KY:
3,300,362, INT. CL. 34.

NATIONAL VITAMIN COMPANY, INC., PORTERVILLE, CA:
2,084,028, REN. 8-17-07. INT. CL. 5.

NATIONAL WHITE COLLAR CRIME CENTER, RICHMOND, VA:
3,295,986, PUB. 7-10-2007. INT. CL. 45.

NATIONAL WILDLIFE FEDERATION, RESTON, VA:
3,297,820, PUB. 7-10-2007. INT. CL. 42.

NATURAL AID PRODUCTS LTD., CALGARY, ALBERTA, CANADA:
1,416,320, CANC. INT. CL. 1.

NATURAL ORGANICS INC., MELVILLE, NY:
3,300,160, INT. CL. 5.

NATURAL SELECTION FOODS, LLC, SAN JUAN BAUTISTA, CA:
3,299,580, INT. CL. 29.

NATURE BRIGHT COMPANY, IRVINE, CA:
3,299,700, INT. CL. 11.
3,300,124, INT. CL. 10.

NATURE'S SUNSHINE PRODUCTS, INC., PROVO, UT:
3,298,880, MULTIPLE CLASS, INT. CLS. 3 AND 5.

NATURIFE FARMS, LLC, NAPLES, FL:
3,296,201, PUB. 7-10-2007. INT. CL. 31.

NATUROPATHICA HOLISTIC HEALTH LLC, EAST HAMPTON, NY:
3,297,918, PUB. 7-10-2007. INT. CL. 5.

NAVAJO MANUFACTURING COMPANY, DENVER, CO:
3,297,446, PUB. 7-10-2007. INT. CL. 5.

NAVIGATIONARTS, LLC, MCLEAN, VA:
3,296,868, PUB. 7-10-2007. INT. CL. 42.

NAZARENE CREDIT UNION, BREA, CA:
2,007,214, REN. 8-20-07. INT. CL. 36.

NBA PROPERTIES, INC., NEW YORK, NY:
2,404,657, CANC. INT. CL. 32.

NBTY, INC., BOHEMIA, NY:
2,016,024, CANC. INT. CL. 5.

NCH MARKETING SERVICES, INC., DEERFIELD, IL, A.C. NIELSEN COMPANY, NORTHBROOK, IL:
1,440,148, REN. 8-23-07. INT. CL. 35.

NCI BUILDING SYSTEMS, L.P., HOUSTON, TX:
3,296,129, PUB. 7-10-2007. INT. CL. 6.

NCP ENTERPRISES, LLC, SPRINGFIELD, OH:
3,299,712, INT. CL. 21.

NCR CORPORATION, DAYTON, OH:
2,404,798, CANC. INT. CL. 35.

NDS NUTRITIONAL PRODUCTS, INC., LAVISTA, NE:
3,299,698, INT. CL. 5.

NEC TOKIN CORPORATION, MIYAGI-KEN, JAPAN:
1,457,990, REN. 8-18-07. MULTIPLE CLASS, INT. CLS. 6 AND 9.

NEDCO SPORTS PRODUCTS, INC., BOAZ, AL:
3,297,761, PUB. 7-10-2007. INT. CL. 28.

NEEDLEPOINTS, L.L.C., ST. LOUIS, MO:
2,404,319, CANC. INT. CL. 10.
2,404,320, CANC. INT. CL. 10.

NEEDLERS PLC, HULL, GREAT BRITAIN:
1,416,845, CANC. INT. CL. 30.

NELEVEN, INC., OSHKOSH, WI:
3,297,044, PUB. 7-10-2007. INT. CL. 42.
3,297,046, PUB. 7-10-2007. INT. CL. 42.

NELSON STUD WELDING, INC., ELYRIA, OH:
3,297,385, PUB. 7-10-2007. INT. CL. 6.
3,297,386, PUB. 7-10-2007. MULTIPLE CLASS, INT. CLS. 6, 7 AND 9.

NEMO EQUIPMENT, INC., NASHUA, NH:
3,299,818, INT. CL. 22.

NEO-TAC, INC., LONG BEACH, CA:
2,403,625, CANC. INT. CL. 1.

NEPTUNE FOOD PRODUCTS (1990) LTD., BEERSHEVA, ISRAEL:
3,297,865, PUB. 7-10-2007. MULTIPLE CLASS, INT. CLS. 29 AND 30.

NEREUS PHARMACEUTICALS, INC., SAN DIEGO, CA:
3,300,229, INT. CL. 5.

NERVOUS, INC., NEW YORK, NY:
3,297,058, PUB. 7-10-2007. INT. CL. 9.

NET INTEGRATION TECHNOLOGIES INC., MARKHAM L3R 9Z6, ONTARIO, CANADA:
3,298,463, INT. CL. 9.

NETFLIX, INC., LOS GATOS, CA:
3,299,362, INT. CL. 38.

NETT TECHNOLOGIES INC., MISSISSAUGA, CANADA:
2,084,391, REN. 8-20-07. INT. CL. 7.

NETVOYAGE CORPORATION, OREM, UT:
2,404,920, CANC. MULTIPLE CLASS, INT. CLS. 9 AND 42.

NETWORK APPLIANCE, INC., SUNNYVALE, CA:
2,085,421, REN. 8-22-07. INT. CL. 9.
2,088,731, REN. 8-20-07. INT. CL. 9.

NETWORK COMMUNICATIONS, INC., LAWRENCEVILLE, GA:
3,298,138, PUB. 7-10-2007. MULTIPLE CLASS, INT. CLS. 16, 35 AND 36.

NEUMAN, GARY M., MIAMI BEACH, FL:
2,403,342, CANC. MULTIPLE CLASS, INT. CLS. 16 AND 41.

NEURAL ID, LLC, SAN MATEO, CA:
3,298,128, PUB. 7-10-2007. INT. CL. 9.

NEUROCOM INTERNATIONAL, INC., CLACKAMAS, OR:
3,299,729, MULTIPLE CLASS, INT. CLS. 9 AND 10.

NEUSTAT, PAULA, NEW CITY, NY:
3,299,154, MULTIPLE CLASS, INT. CLS. 20 AND 24.

NEUTRAL CLOTHING CORP., NORTH BERGEN, NJ:
2,404,840, CANC. INT. CL. 25.

NEUTROGENA CORPORATION, LOS ANGELES, CA:
3,299,598, INT. CL. 3.

NEVER SAY DIE CLOTHING, INC., LOS ANGELES, CA:
3,297,876, PUB. 7-10-2007. INT. CL. 25.

NEW CENTURY HOLDINGS, INC., EDEN PRAIRIE, MN:
3,298,432, INT. CL. 30.

NEW CHAPTER, INC., BRATTLEBORO, VT:
2,403,955, CANC. INT. CL. 5.

NEW ERA CAP CO., INC., DERBY, NY:
2,014,667, CANC. INT. CL. 25.

NEW ERA CAP COMPANY, INC., BUFFALO, NY:
3,298,501, INT. CL. 25.

NEW GLARUS BREWING COMPANY, NEW GLARUS, WI:
3,296,375, PUB. 7-10-2007. MULTIPLE CLASS, INT. CLS. 21 AND 32.

NEW HARVEST ORGANICS, LLC, TUCSON, AZ:
3,296,110, PUB. 7-10-2007. INT. CL. 31.

- NEW JERSEY ASSOCIATION OF STUDENT FINANCIAL AID ADMINISTRATORS, INC., SHREWSBURY, NJ: 3,298,015, PUB. 7-10-2007. INT. CL. 41.
- NEW KINGDOMS, LLC, MYRTLE BEACH, SC: 3,300,223, MULTIPLE CLASS, INT. CLS. 21, 25, 28 AND 41.
- NEW POWER TECHNOLOGIES, LOS ALTOS HILLS, CA: 3,297,733, PUB. 7-10-2007. INT. CL. 42.
- NEW TRIER TOWNSHIP HIGH SCHOOL, WILMETTE, IL: 1,416,980, CANC. INT. CL. 41.
- NEW YORK MASTER CABBIE CORP., ENGLEWOOD CLIFFS, NJ: 2,404,236, CANC. INT. CL. 41.
- NEW YORK TIMES COMPANY, THE, NEW YORK, NY: 3,298,018, PUB. 7-10-2007. INT. CL. 41.
- NEW YORKER S.H.K. JEANS GMBH, D-38112 BRAUNSCHWEIG, FED REP GERMANY: 2,403,300, CANC. MULTIPLE CLASS, INT. CLS. 3, 9, 14, 18, 25, 28 AND 32.
- NEW ZEALAND WOOL BOARD, WELLINGTON, NEW ZEALAND: 2,403,500, CANC. INT. CL. 24.
- NEWELL OPERATING COMPANY, FREEPORT, IL: 2,015,382, CANC. INT. CL. 20.
- NEWLAND TECHNOLOGY PRODUCTS AMERICA INC., EDGEWATER, NJ: 3,297,592, PUB. 7-10-2007. INT. CL. 40.
- NEWLEVEL GROUP, LLC, NAPA, CA: 3,299,824, INT. CL. 35.
- NEWSTED, JASON, SAN FRANCISCO, CA: 3,298,408, INT. CL. 16.
- NEXT STEP PUBLISHING, INC., VICTOR, NY: 3,299,995, INT. CL. 16.
3,299,996, INT. CL. 41.
- NEXT STEPS RESEARCH, LLC, ALEXANDRIA, VA: 3,296,580, PUB. 7-10-2007. MULTIPLE CLASS, INT. CLS. 35, 36 AND 42.
- NEXT TO NATURE INC., TALLAHASSEE, FL: 2,080,971, REN. 8-18-07. INT. CL. 5.
- NEXTEC APPLICATIONS, INC., VISTA, CA: 2,107,618, REN. 8-23-07. INT. CL. 40.
- NEXTEK, INC., MADISON, AL: 2,081,705, REN. 8-17-07. INT. CL. 42.
2,081,706, REN. 8-17-07. INT. CL. 42.
2,084,093, REN. 8-17-07. INT. CL. 42.
- NG ACQUISITION, LLC, MOUNT PROSPECT, IL: 3,299,646, INT. CL. 28.
- NGUYEN, DIEP, SILVER SPRING, MD: 3,298,873, INT. CL. 43.
- NHB INC., NEW YORK, NY: 3,296,208, PUB. 7-10-2007. INT. CL. 25.
- NHS, INC., SANTA CRUZ, CA: 2,125,790, REN. 8-17-07. INT. CL. 28.
- NICE SYSTEMS, LTD., RA'ANANA, ISRAEL: 2,093,445, REN. 8-17-07. INT. CL. 9.
- NICHE MARKETING LIMITED, INC., CHAGRIN FALLS, OH: 2,404,323, CANC. INT. CL. 28.
- NICHE MARKETINQ LIMITED, INC., CHAGRIN FALLS, OH: 2,404,322, CANC. INT. CL. 28.
- NICHIHA CORPORATION, NAGOYA-SHI, JAPAN: 3,297,651, PUB. 7-10-2007. INT. CL. 19.
- NICHOLS, KIM A., PHOENIX, AZ: 3,296,346, PUB. 7-10-2007. INT. CL. 35.
- NICKERSON AMERICAN PLANT BREEDERS INC., MISSION, KS: 1,416,862, CANC. INT. CL. 31.
- NICOLETTI CENTRAL WORLD B.V., NETHERLANDS: 3,298,244, PUB. 7-10-2007. INT. CL. 20.
- NICOTRA S.P.A., MILAN, ITALY: 1,448,338, REN. 8-23-07. INT. CL. 11.
- NIEN ADVANCED SOLUTIONS, SANTA FE SPRINGS, CA: 3,299,958, INT. CL. 20.
- NIERENBERG, GERARD I., NEW YORK, NY: 1,453,591, REN. 8-18-07. INT. CL. 41.
- NIEVES LAVI LLC, NEW YORK, NY: 3,296,715, PUB. 7-10-2007. INT. CL. 25.
3,296,716, PUB. 7-10-2007. INT. CL. 25.
- NIGHTINGALE INFORMATIX CORPORATION, MARKHAM, CANADA: 2,082,591, REN. 8-23-07. INT. CL. 9.
- NIGHTLIGHT CHRISTIAN ADOPTIONS, FULLERTON, CA: 3,298,108, PUB. 7-10-2007. INT. CL. 45.
- NIKKEN, INC., IRVINE, CA: 3,298,601, INT. CL. 14.
- NIKSUN, INC., MONMOUTH JUNCTION, NJ: 3,299,540, INT. CL. 9.
- NIMAYA INC., MCLEAN, VA: 3,296,962, PUB. 7-10-2007. INT. CL. 9.
- NINE WEST DEVELOPMENT CORPORATION, WILMINGTON, DE: 3,298,647, INT. CL. 25.
- NINER WINE ESTATES, LLC, SAN LUIS OBISPO, CA: 3,300,218, INT. CL. 33.
- NINGBO HAILUN MUSICAL INSTRUMENTS CO. LTD., BEILUN, NINGBO, CHINA: 3,296,430, PUB. 7-10-2007. INT. CL. 15.
- NINGBO HUASHENG METAL PRODUCTS CO., LTD, ZHEJIANG, CHINA: 3,299,657, INT. CL. 21.
- NINGBO SHENGFA ELECTRICAL APPLIANCE CO., LTD., ZHEJIANG PROVINCE, CHINA: 3,296,927, PUB. 7-10-2007. INT. CL. 11.
- NINJAI GANG, LLC, KAILUA, HI: 3,298,602, MULTIPLE CLASS, INT. CLS. 16 AND 25.
- NINTENDO CO., LTD., KYOTO-SHI, KYOTO, JAPAN: 3,297,576, PUB. 7-10-2007. INT. CL. 18.
3,297,577, PUB. 7-10-2007. INT. CL. 38.
3,297,578, PUB. 7-10-2007. INT. CL. 41.
- NIOXIN RESEARCH LABORATORIES, INC., LITHIA SPRINGS, GA: 2,404,489, CANC. INT. CL. 21.
- NIPPON CONLUX CO., LTD., SAITAMA, JAPAN: 2,072,910, REN. 8-23-07. INT. CL. 9.
- NIPPON POLYURETHANE INDUSTRY CO., LTD., TOKYO, JAPAN: 3,299,016, MULTIPLE CLASS, INT. CLS. 1 AND 17.
- NIPPON SHEET GLASS COMPANY, LIMITED, TOKYO, JAPAN: 3,297,391, PUB. 7-10-2007. MULTIPLE CLASS, INT. CLS. 9, 19 AND 21.
- NISEII CORPORATION, HACIENDA HEIGHTS, CA: 3,299,902, INT. CL. 14.
- NISHIKAWA RUBBER CO., LTD., HIROSHIMA, JAPAN: 2,130,959, REN. 8-20-07. INT. CL. 21.
- NISHIMOTO TRADING CO., LTD., SANTA FE SPRINGS, CA, NISHIMOTO TRADING CO., LTD., IKUTA-KU, KOBE, JAPAN: 1,069,460, REN. 8-23-07. MULTIPLE CLASS, INT. CLS. 29 AND 30.
- NISSAN JIDOSHA KABUSHIKI KAISHA, YOKOHAMA-SHI, KANAGAWA-KEN, JAPAN, TA NISSAN MOTOR CO., LTD.: 2,073,651, REN. 8-18-07. MULTIPLE CLASS, INT. CLS. 12 AND 18.
- NISSHINBO INDUSTRIES, INC., TOKYO 103-8650, JAPAN: 3,298,458, INT. CL. 25.
- NITRUID, 95100 ARGENTEUIL, FRANCE: 2,404,189, CANC. INT. CL. 40.
- NLDA ASSOCIATES INC., GLENVIEW, IL: 3,298,932, INT. CL. 18.
- NMC, S.A., RAEREN, BELGIUM, NOMACO DECORATIVE PRODUCTS, INC., ANSONIA, CT: 1,452,144, REN. 8-18-07. INT. CL. 19.
- NO FAULT INDUSTRIES, INC., BATON ROUGE, LA: 1,416,953, CANC. INT. CL. 37.
- NOAH ROBISON-COX, NEW YORK, NY: 3,298,006, PUB. 7-10-2007. INT. CL. 38.
- NOEMI SURIOL PUIGVERT, SPAIN: 3,298,375, PUB. 7-10-2007. INT. CL. 41.
- NOKES, RONALD W., WESTMINSTER, CO: 3,296,066, PUB. 2-6-2007. INT. CL. 28.

NOKIA CORPORATION, FI-02150 ESPOO, FINLAND:
3,298,332, PUB. 7-10-2007. MULTIPLE CLASS, INT. CLS. 9, 38 AND 41.

NOLAND COMPANY, NEWPORT NEWS, VA:
1,416,526, CANC. INT. CL. 11.

NOONAN, TIMOTHY F., LAS VEGAS, NV:
3,296,408, PUB. 7-10-2007. INT. CL. 9.
3,296,515, PUB. 7-10-2007. INT. CL. 9.

NOONER PRODUCTIONS, INC., HOUSTON, TX:
1,475,976, REN. 8-22-07. INT. CL. 25.

NORDSTROM, INC., SEATTLE, WA TO NIHC, INC., PORTLAND, OR:
2,014,715, CANC. INT. CL. 25.
2,016,000, CANC. INT. CL. 18.

NORITAKE CO. LIMITED, NISHI-KU, NAGOYA, 451, JAPAN:
2,084,443, REN. 8-23-07. INT. CL. 21.

NORPACO, INC., BRISTOL, CT:
2,404,118, CANC. INT. CL. 29.

NORTH AMERICAN BEAR CO., INC., CHICAGO, IL:
1,416,793, CANC. INT. CL. 28.

NORTH AMERICAN REFRACTORIES COMPANY, MOON TOWNSHIP, PA:
2,117,068, REN. 8-17-07. INT. CL. 19.

NORTH AMERICAN WHOLESALE LUMBER ASSOCIATION, INC., ROLLING MEADOWS, IL:
2,139,179, REN. 8-17-07. INT. CL. 35.

NORTH DELTA SEAFOODS LTD., DELTA, BRITISH COLUMBIA, CANADA:
3,298,661, INT. CL. 29.

NORTH DELTA SEAFOODS LTD., DELTA, BRITISH COLUMBIA:
3,298,662, INT. CL. 35.

NORTH FORTY LODGING LLC, ISSAQUAH, WA:
3,298,152, PUB. 2-13-2007. MULTIPLE CLASS, INT. CLS. 16, 18, 20, 25, 28, 35, 39, 41, 43 AND 44.

NORTH SAILS GROUP, LLC, MILFORD, CT:
2,111,604, REN. 8-22-07. MULTIPLE CLASS, INT. CLS. 18, 22, 24, 25, 28 AND 40.

NORTH TEXAS TOLLWAY AUTHORITY, PLANO, TX:
3,296,212, PUB. 7-10-2007. INT. CL. 36.

NORTHCOAST VENTURES LTD., SURREY, BRITISH COLUMBIA V3S 4G5, CANADA:
3,296,045, PUB. 7-10-2007. MULTIPLE CLASS, INT. CLS. 19 AND 35.

NORTHERN DIGITAL INC., WATERLOO, ONTARIO, CANADA:
3,299,338, MULTIPLE CLASS, INT. CLS. 9 AND 10.

NORTHERN MASSACHUSETTS TELEPHONE WORKERS CREDIT UNION, LOWELL, MA:
3,300,085, INT. CL. 36.

NORTHERN MICHIGAN UNIVERSITY, MARQUETTE, MI:
2,040,002, REN. 8-23-07. MULTIPLE CLASS, INT. CLS. 16, 25 AND 41.

NORTHSHORE UTILITY DISTRICT, KENMORE, WA:
3,299,742, INT. CL. 32.

NORTHSTAR CERAMIC TRADING, LLC, CARROLLTON, TX:
3,297,368, PUB. 7-10-2007. INT. CL. 35.

NORTHWEST AUDIO DESIGN INC., MAPLE VALLEY, WA:
2,015,499, CANC. INT. CL. 9.

NORTHWEST NATURAL PRODUCTS, INC., VANCOUVER, WA:
3,296,820, PUB. 7-10-2007. INT. CL. 5.

NORTHWEST WEB CO., EUGENE, OR:
1,417,043, CANC. INT. CL. 42.

NORTHWESTERN HEALTH SCIENCES UNIVERSITY, BLOOMINGTON, MN:
3,296,046, PUB. 7-10-2007. MULTIPLE CLASS, INT. CLS. 9, 16, 41 AND 44.

NORTON DESMARQUEST FINE CERAMICS, 92400 COURBEVOIE, FRANCE:
2,403,279, CANC. INT. CL. 10.

NOT ONLY CHEESE INC., SARASOTA, FL:
3,298,910, INT. CL. 30.

NOVA DEVELOPMENT CORPORATION, CALABASAS, CA:
2,120,879, REN. 8-23-07. INT. CL. 28.

NOVA GAMING, LLC, GREENVILLE, SC:
3,299,304, INT. CL. 9.

NOVARESE SRL, ITALY:
3,298,335, PUB. 7-10-2007. MULTIPLE CLASS, INT. CLS. 18 AND 25.

NOVARTIS AG, BASEL, SWITZERLAND:
2,404,039, CANC. INT. CL. 5.

NOVARTIS AG, SWITZERLAND:
3,298,388, PUB. 7-10-2007. INT. CL. 5.

NOVARTIS VACCINES AND DIAGNOSTICS GMBH & CO. KG, FED REP GERMANY:
3,298,281, PUB. 7-10-2007. INT. CL. 5.
3,298,282, PUB. 7-10-2007. INT. CL. 5.

NOVATEK INTERNATIONAL INC., PROVO, UT:
3,296,705, PUB. 7-10-2007. INT. CL. 7.

NOVATEL INC., CALGARY, CANADA:
3,297,638, PUB. 7-10-2007. INT. CL. 9.

NOVO ENTERPRISES INCORPORATED, BELFAIR, WA:
3,296,374, PUB. 7-10-2007. INT. CL. 37.

NOVOZYMES A/S, DENMARK:
3,298,246, PUB. 7-10-2007. INT. CL. 1.

NOVOZYMES SWITZERLAND AG, SWITZERLAND:
3,298,314, PUB. 7-10-2007. INT. CL. 1.

NOWAK PIPE REAMING, INC., GODDARD, KS:
2,125,784, REN. 8-20-07. INT. CL. 37.

NPK PLUS, INC., HOMESTEAD, FL:
3,298,126, PUB. 7-10-2007. INT. CL. 31.

NSA, LLC, COLLIERVILLE, TN:
1,450,625, REN. 8-23-07. INT. CL. 11.
3,298,660, INT. CL. 5.

NSB RETAIL SOLUTIONS, INC., POINTE, QUEBEC:
2,403,737, CANC. INT. CL. 9.

NSCB, LLC, SPARTANBURG, SC:
3,299,992, INT. CL. 36.

NSE PRODUCTS, INC., PROVO, UT:
3,297,653, PUB. 7-10-2007. INT. CL. 32.

NSI AUDIO INC, SAN JOSE, CA:
3,299,920, INT. CL. 9.
3,299,921, INT. CL. 9.

NU SCIENCE CORPORATION, LANCASTER, CA, RHOTEN, LARRY J., LANCASTER, CA, DBA NU SCIENCE CORP.:
2,083,802, REN. 8-17-07. INT. CL. 5.

NU-WORLD CORPORATION, CARTERET, NJ:
3,298,474, INT. CL. 3.

NUCARA MANAGMENT GROUP, CONRAD, IA:
3,296,809, PUB. 7-10-2007. INT. CL. 35.

NUMARA SOFTWARE, INC., TAMPA, FL:
3,299,604, MULTIPLE CLASS, INT. CLS. 9 AND 42.
3,299,631, MULTIPLE CLASS, INT. CLS. 9 AND 42.

NUMARK LABORATORIES, INC., EDISON, NJ, SHARP & DOHME, INCORPORATED, PHILADELPHIA, PA:
355,843, REN. 8-20-07. U.S. CL. 6 (INT. CL. 5).

NUMARK LABORATORIES, INC., EDISON, NJ:
1,496,525, REN. 8-22-07. INT. CL. 5.

NUNEZ, MICHULA, FOREST FALLS, CA:
3,296,565, PUB. 7-10-2007. INT. CL. 41.

NUPLA CORPORATION, SUN VALLEY, CA:
3,300,154, INT. CL. 8.

NURSE HEALERS - PROFESSIONAL ASSOCIATES INTERNATIONAL, INC., WARNERVILLE, NY:
3,298,686, INT. CL. 35.

NUSOURCE, INC., BALTIMORE, MD:
2,403,866, CANC. INT. CL. 42.

NUTOPICALS, L.L.C., NEWCASTLE, OK:
3,296,714, PUB. 7-10-2007. INT. CL. 5.

NUTRAGENETICS, HERMOSA BEACH, CA:
3,299,425, INT. CL. 5.

NUTRAQUEST, INC., MANASQUAN, NJ:
3,296,089, PUB. 7-10-2007. INT. CL. 5.

NUTRI-ENERGETICS SYSTEMS LTD., LILLIPUT, POOLE, UNITED KINGDOM:
3,299,111, INT. CL. 5.

NUTRITEL FOOD TECHNOLOGIES INC., CALEDON EAST, ONTARIO, CANADA:
3,299,416, INT. CL. 5.

NUTRITHERAPEUTICS INC, TAMPA, FL:
3,298,811, INT. CL. 5.

- NUTRITION & FITNESS, INC., FAYETTEVILLE, NC:
3,299,451, INT. CL. 5.
- NUTRITION NOW, INC., VANCOUVER, WA:
3,297,105, PUB. 7-10-2007. INT. CL. 5.
- NUTRITION SUPERSTORES.COM, INC., WEST PALM BEACH, FL:
2,404,011, CANC. INT. CL. 35.
- NY GEAR INC, ALBANY, NY:
3,299,305, INT. CL. 25.
- NZYSYS I.P., INC., MILLERSVILLE, MD:
3,299,199, INT. CL. 3.
- O.K.I. FURNITURE FAIR, INC., FAIRFIELD, OH:
3,296,628, PUB. 7-10-2007. INT. CL. 35.
- O-SAN INTERNATIONAL, INC., LAWRENCEVILLE, GA:
3,299,151, MULTIPLE CLASS, INT. CLS. 5 AND 35.
- O'DONNELL, EILEEN M. NORRIDGE, IL:
3,300,298, INT. CL. 25.
- O'HAGIN'S, INC., ROHNERT PARK, CA:
3,299,428, INT. CL. 19.
- O'ROURKE, ASHLEY, SUN VALLEY, CA:
3,299,752, INT. CL. 25.
- OAKES, WILLIAM H., PORTLAND, OR:
3,299,453, INT. CL. 22.
- OASIS TECHNOLOGIES, INC., CORPUS CHRISTI, TX:
2,403,907, CANC. INT. CL. 9.
- OBSHCHESTVO S OGRANICHENNOY; OTVETSTVENNOSTYU "BRILLANT DUSHI", RUSSIAN FED.:
3,298,292, PUB. 7-10-2007. MULTIPLE CLASS, INT. CLS. 14 AND 42.
- OCEAN RIDGE PLANTATION GOLF, INC., OCEAN ISLE BEACH, NC:
3,298,551, INT. CL. 41.
- OCEANIC INTERNATIONAL, LLC, KANSAS CITY, MO:
3,280,649, COR. INT. CL. 36.
- OCEANSTAR SYSTEMS, INC., CATAUMET, MA AND SEA CORPORATION, CHIBA PRE, JAPAN:
2,404,606, CANC. INT. CL. 9.
- ODAWARA AUTOMATION, INC., VANDALIA, OH:
1,468,012, REN. 8-17-07. INT. CL. 7.
- ODELL'S, RENO, NV:
3,297,971, PUB. 7-10-2007. INT. CL. 35.
- ODOREYES TECHNOLOGIES, INC., SUGAR LAND, TX:
2,404,825, CANC. INT. CL. 7.
- ODYSSEY TECHNOLOGIES, INC., JESSUP, MD:
2,403,137, CANC. INT. CL. 9.
2,403,158, CANC. INT. CL. 9.
- OFF DUTY OFFICERS, INC., SAN DIEGO, CA:
3,297,534, PUB. 7-10-2007. INT. CL. 45.
- OFFICE GEMINI, LLC, BELLAIRE, TX:
3,296,682, PUB. 7-10-2007. INT. CL. 9.
- OFFICE OF THE GOVERNOR, STATE OF TEXAS, AUSTIN, TX:
3,297,543, PUB. 7-10-2007. MULTIPLE CLASS, INT. CLS. 35 AND 36.
- OFFICE OF TOURISM, STATE OF LOUISIANA, BATON ROUGE, LA:
1,416,906, CANC. INT. CL. 35.
- OFFSHORE SAILING SCHOOL LTD., FT. MYERS, FL:
3,296,187, PUB. 7-10-2007. INT. CL. 41.
- OGDENBANCSHARES, INC., AMES, IA:
3,300,035, INT. CL. 36.
- OHANA WIRELESS, INCORPORATED, SANTA CLARA, CA:
2,403,429, CANC. INT. CL. 9.
- OISELLE RUNNING, INC., SEATTLE, WA:
3,299,897, INT. CL. 25.
- OJON CORPORATION, OAKVILLE, ONTARIO, CANADA:
3,297,832, PUB. 7-10-2007. MULTIPLE CLASS, INT. CLS. 3 AND 26.
- OK'AM S.A.S. DI GREGIS DANIELA & C., BERGAMO, ITALY:
3,298,217, PUB. 7-10-2007. MULTIPLE CLASS, INT. CLS. 14, 16, 18, 24 AND 25.
- OKAY INDUSTRIES, INC., NEW BRITAIN, CT:
3,297,683, PUB. 7-10-2007. INT. CL. 37.
- OKELL'S FIREPLACE FIXTURES INC., HERMOSA BEACH, CA:
2,077,325, REN. 8-17-07. INT. CL. 42.
- OKI ELECTRIC INDUSTRY CO., LTD., MINATO-KU, TOKYO, JAPAN:
3,295,997, PUB. 7-10-2007. INT. CL. 9.
- OKLAHOMA DEVELOPMENT GROUP, L.L.C., NORMAN, OK:
3,296,404, PUB. 7-10-2007. INT. CL. 37.
- OLD LINE BANK, BOWIE, MD:
3,299,498, INT. CL. 36.
- OLD WORLD INDUSTRIES, INC., NORTHBROOK, IL:
2,092,247, REN. 8-20-07. INT. CL. 1.
- OLD WORLD INDUSTRIES, INC., NORTHBROOK, IL, SPLITFIRE, INC., NORTHBROOK, IL:
2,100,052, REN. 8-23-07. INT. CL. 7.
- OLDE VILLAGE CANDLE COMPANY, SALT LAKE CITY, UT:
2,403,374, CANC. INT. CL. 4.
- OLFA CORPORATION, HIGASHINARI-KU, OSAKA 537, JAPAN:
2,119,752, REN. 8-17-07. INT. CL. 8.
- OLIVERA WEIGHT MANAGEMENT S.C., CHICAGO, IL:
3,296,310, PUB. 7-10-2007. INT. CL. 44.
- OLIVIA W. DESIGNS LLC, NEW YORK, NY:
3,299,006, MULTIPLE CLASS, INT. CLS. 14 AND 35.
- OLYMPIC BRASS LIMITED, HONG KONG, CHINA:
3,296,673, PUB. 7-10-2007. INT. CL. 18.
- OM FREELY, LLC, SEBASTOPOL, CA:
3,296,800, PUB. 7-10-2007. INT. CL. 18.
- OMEGA B.P., LA CRESCENTA, CA, DBA PAIGE DOCUMENT AUTOMATION RESOURCES:
2,014,932, CANC. MULTIPLE CLASS, INT. CLS. 9 AND 35.
- OMEGA SA (OMEGA AG) (OMEGA LTD.), CH-2502 BIEL/BIENNE, SWITZERLAND:
3,298,226, PUB. 7-10-2007. INT. CL. 14.
- OMEGA 1, LLC, HUNTERSVILLE, NC:
3,298,030, PUB. 7-10-2007. MULTIPLE CLASS, INT. CLS. 39 AND 43.
- OMIDYAR NETWORK LLC, REDWOOD CITY, CA:
3,300,316, INT. CL. 35.
3,300,317, INT. CL. 39.
- OMNI FINANCIAL GROUP, INC., ROCHESTER, NY:
3,296,033, PUB. 7-10-2007. MULTIPLE CLASS, INT. CLS. 36 AND 42.
- OMNITRITION INTERNATIONAL, INC., CARROLLTON, TX:
2,404,187, CANC. INT. CL. 5.
- OMS INVESTMENTS, INC., WILMINGTON, DE:
2,403,506, CANC. INT. CL. 1.
- OMS INVESTMENTS, INC., LOS ANGELES, CA:
3,299,917, INT. CL. 5.
- OMX AB, SWEDEN:
3,298,339, PUB. 7-10-2007. MULTIPLE CLASS, INT. CLS. 9, 35 AND 42.
- ON STAGE ENTERTAINMENT, INC., LAS VEGAS, NV:
2,404,114, CANC. INT. CL. 41.
- ON THE WATER LLC, EAST FALMOUTH, MA, FALMOUTH PUBLISHING CO., INC., FALMOUTH, MA:
2,081,129, REN. 8-18-07. INT. CL. 16.
- ON TOP OF THE WORLD COMMUNITIES, INC., OCALA, FL:
3,298,762, MULTIPLE CLASS, INT. CLS. 37 AND 41.
- ONDA, HIDEKI FRANCIS, TOKYO, JAPAN:
3,300,056, INT. CL. 9.
- ONE SPOKANE, SPOKANE VALLEY, WA:
3,297,026, PUB. 7-10-2007. INT. CL. 45.
- ONE STEP AHEAD, INC., LAFAYETTE, CO:
3,296,117, PUB. 7-10-2007. MULTIPLE CLASS, INT. CLS. 25 AND 35.
- ONE STEP UP, INC., NEW YORK, NY:
1,428,526, REN. 8-21-07. INT. CL. 25.
- ONE WORLD NETWORKS INTEGRATED TECHNOLOGIES, INC., LOS ANGELES, CA:
3,299,944, INT. CL. 3.
- ONLINE BENEFITS, INC., BABYLON, NY:
2,403,682, CANC. MULTIPLE CLASS, INT. CLS. 35 AND 36.
- ONLINE INFORMATION, INC., ATLANTA, GA:
2,404,060, CANC. INT. CL. 42.

- ONLY NATURAL, INC., ISLAND PARK, NY:
3,296,071, PUB. 3-27-2007. INT. CL. 5.
- ONSET MANAGEMENT COMPANY, ANN ARBOR, MI:
3,299,021, INT. CL. 36.
- ONTARIO SYSTEMS, LLC, MUNCIE, IN:
3,296,332, PUB. 7-10-2007. INT. CL. 9.
- OPEL EISENACH GMBH, FED REP GERMANY:
3,298,322, PUB. 7-10-2007. INT. CL. 12.
- OPEN JOINT STOCK COMPANY; "BANK URALSIB", RUSSIAN FED.:
3,298,213, PUB. 7-10-2007. MULTIPLE CLASS, INT. CLS. 35 AND 36.
- OPEN SOCIETY INSTITUTE, NEW YORK, NY:
2,403,675, CANC. MULTIPLE CLASS, INT. CLS. 16, 36 AND 41.
- OPERA LLC, NEW YORK, NY:
3,298,620, INT. CL. 33.
3,300,195, INT. CL. 33.
- OPERATOR SERVICE COMPANY, LUBBOCK, TX:
2,404,467, CANC. INT. CL. 38.
- OPPENHEIMER COMPANIES, INC., BOISE, ID:
2,404,211, CANC. INT. CL. 29.
- OPTICAL MOLDING SYSTEMS, INC., ADA, OH:
2,404,671, CANC. MULTIPLE CLASS, INT. CLS. 1 AND 7.
2,404,818, CANC. INT. CL. 1.
- OPTIMUM QUALITY GRAINS, L.L.C., DES MOINES, IA:
2,404,614, CANC. INT. CL. 42.
- OPTURA, LLC, LAMBERTVILLE, NJ:
3,297,687, PUB. 7-10-2007. INT. CL. 44.
- ORAL HEALTH AMERICA, AMERICA'S FUND FOR DENTAL HEALTH, CHICAGO, IL:
2,097,497, REN. 8-23-07. INT. CL. 42.
- ORAMA, INC., ARLINGTON, VA:
2,403,122, CANC. INT. CL. 42.
- ORANGE COUNTY TEACHERS FEDERAL CREDIT UNION, SANTA ANA, CA:
2,083,475, REN. 8-17-07. INT. CL. 36.
- ORBIS PUBLICATIONS, L.L.C., CHEVY CHASE, MD:
2,015,772, CANC. INT. CL. 16.
- ORBITAL TECHNOLOGIES LIMITED, EDINBURGH, UNITED KINGDOM:
2,404,693, CANC. INT. CL. 9.
- ORCHARD FOODS LIMITED PARTNERSHIP, SEVIERVILLE, TN:
1,450,139, REN. 8-17-07. INT. CL. 42.
- ORECK HOLDINGS, LLC, CHEYENNE, WY:
3,297,294, PUB. 7-10-2007. MULTIPLE CLASS, INT. CLS. 7 AND 11.
- ORENTREICH, NORMAN, M.D., NEW YORK, NY:
1,445,896, REN. 8-17-07. INT. CL. 5.
- ORGANIC FOODS EXPRESS, INC., ROCKVILLE, MD:
3,296,855, PUB. 7-10-2007. INT. CL. 35.
- ORGANICALLY GROWN COMPANY, EUGENE, OR:
2,164,079, REN. 8-23-07. INT. CL. 31.
- ORGANIZATIONAL DEVELOPMENT ASSOCIATES, INC., ATLANTA, GA:
3,299,204, INT. CL. 16.
- ORGILL, INC., MEMPHIS, TN:
3,296,790, PUB. 7-10-2007. INT. CL. 6.
- ORIGINAL CALIFORNIA CAR DUSTER COMPANY, INC., CHATSWORTH, CA:
3,298,427, INT. CL. 21.
- ORIGINAL CRISPY PIZZA CRUST CO. OF BOSTON, INC., LINCOLN, RI:
1,454,709, REN. 8-17-07. INT. CL. 42.
- ORIGINAL HEIDELBERGER AMS-BREZEL GMBH, HEIDELBERG-WIEBLINGEN, FED REP GERMANY:
1,416,842, CANC. INT. CL. 30.
- ORIGINAL LA TORRETTA INC., THE, WESTON, FL:
2,403,842, CANC. INT. CL. 42.
- ORINATION, INC., ROXBURY, MA:
3,296,623, PUB. 7-10-2007. INT. CL. 41.
3,296,624, PUB. 7-10-2007. INT. CL. 41.
- ORIGINS NATURAL RESOURCES INC., NEW YORK, NY:
2,016,141, CANC. INT. CL. 3.
- ORIGINS NATURAL RESOURCES, INC., NEW YORK, NY:
3,297,660, PUB. 7-10-2007. INT. CL. 3.
- ORION MEDICAL GROUP, IRVINE, CA:
2,403,218, CANC. INT. CL. 10.
- ORION REGISTRAR INC., ARVADA, CO:
2,014,844, CANC. INT. CL. 42.
- ORLANDO FOOD CORPORATION, MAYWOOD, NJ:
1,451,064, REN. 8-22-07. INT. CL. 29.
- ORLANE S.A., PARIS, 75008, FRANCE:
1,451,650, REN. 8-22-07. INT. CL. 3.
- ORO DE OLIVO USA, LLC, CORAL GABLES, FL:
3,299,571, INT. CL. 29.
- ORPHAN OUTREACH, DALLAS, TX:
3,300,261, INT. CL. 45.
- ORTHO ORGANIZERS, INC., CARLSBAD, CA:
1,450,349, REN. 8-17-07. MULTIPLE CLASS, INT. CLS. 6 AND 10.
- OSEZ VOUS? INTERNATIONAL SPIRITS LLC, WILMINGTON, DE:
3,299,831, INT. CL. 33.
- OSGOOD, JAMES D., SAMMAMISH, WA:
2,099,108, REN. 8-20-07. INT. CL. 42.
- OSMOPHARM, USA, POMPAÑO BEACH, FL:
3,296,439, PUB. 7-10-2007. INT. CL. 5.
- OSTEEN, JOEL, HOUSTON, TX:
3,297,356, PUB. 7-10-2007. INT. CL. 16.
- OTB ARCHITECTURAL ELEMENTS, INC., HOLLYWOOD, FL:
3,296,756, PUB. 7-10-2007. INT. CL. 42.
- OTTO ZIMMERMANN GMBH, D-74889 SINSHEIM, FED REP GERMANY:
3,296,038, PUB. 7-10-2007. INT. CL. 12.
- OOUAF ENTERPRISES, LLC, IRVINE, CA:
3,296,702, PUB. 7-10-2007. INT. CL. 16.
- OUTBOARD MARINE CORPORATION, WAUKEGAN, IL:
2,404,366, CANC. INT. CL. 12.
2,404,371, CANC. INT. CL. 12.
- OUTDOOR LIFE NETWORK, L.L.C., STAMFORD, CT:
2,403,648, CANC. INT. CL. 41.
- OWENS CORNING INTELLECTUAL CAPITAL, LLC, TOLEDO, OH:
2,090,588, REN. 8-17-07. INT. CL. 17.
- OXBOW ENTERPRISES, INC., MURDOCK, NE:
3,297,333, PUB. 7-10-2007. INT. CL. 5.
- OXY VITAL; VERWALTUNGSGESELLSCHAFT MBH, FED REP GERMANY:
3,298,336, PUB. 7-10-2007. MULTIPLE CLASS, INT. CLS. 21 AND 32.
- OY HTI-TEKNIikka AB, VLHTL, FINLAND:
2,404,587, CANC. INT. CL. 20.
- P. H. GLATFELTER COMPANY, YORK, PA:
3,299,751, INT. CL. 16.
- P. J. KENT, INC., BEVERLY HILLS, CA:
2,404,441, CANC. MULTIPLE CLASS, INT. CLS. 35 AND 41.
- P. Q. LICENSING, S.A., 11 AT B-1000 BRUSSELS, BELGIUM:
3,298,919, INT. CL. 43.
- P.K.G.'S, INC., CINCINNATI, OH:
1,416,890, CANC. MULTIPLE CLASS, INT. CLS. 35 AND 39.
1,416,891, CANC. MULTIPLE CLASS, INT. CLS. 35 AND 39.
- P.L. S.P.A., ITALY:
3,298,219, PUB. 7-10-2007. INT. CL. 27.
- P.T.C. BRANDS, INC., WILMINGTON, DE:
2,404,582, CANC. INT. CL. 16.
- P-G INDUSTRIES, INC., ANNISTON, AL:
2,132,494, REN. 8-23-07. INT. CL. 19.
2,132,495, REN. 8-23-07. INT. CL. 19.
- PACE ANALYTICAL SERVICES, INC., MINNEAPOLIS, MN:
3,299,333, INT. CL. 38.
- PACER PERFORMANCE PRODUCTS, INC., LOS ANGELES, CA:
2,404,269, CANC. INT. CL. 12.
- PACER TECHNOLOGY, RANCHO CUCAMONGA, CA, MARSH LABORATORIES, INC., PITTSBURGH, PA:
1,449,137, REN. 8-22-07. INT. CL. 1.
- PACIFIC ACCUENERGY TECHNOLOGY CO., LTD, EL SEGUNDO, CA:
3,299,192, INT. CL. 9.

- PACIFIC COAST FEATHER COMPANY, SEATTLE, WA:
3,298,680, INT. CL. 20.
- PACIFIC COAST WIRE ROPE & FITTINGS, INC., OAKLAND, CA, DBA FEENEY WIRE ROPE & RIGGING:
3,300,121, INT. CL. 6.
- PACIFIC ENGINEERING CORPORATION, GIFU-KEN, JAPAN:
2,082,550, REN. 8-23-07, INT. CL. 9.
- PACIFIC SUNWEAR OF CALIFORNIA, ANAHEIM, CA:
3,298,670, INT. CL. 25.
- PACIFIC SUNWEAR OF CALIFORNIA, INC., ANAHEIM, CA:
3,296,713, PUB. 7-10-2007, INT. CL. 25.
- PACKER PLASTICS, INC., LAWRENCE, KS:
1,416,682, CANC. INT. CL. 20.
- PACTEC, INC., CLINTON, LA:
3,296,276, PUB. 7-10-2007, INT. CL. 19.
- PAFUMS CHRISTIAN DIOR, 75008 PARIS, FRANCE:
3,297,103, PUB. 7-10-2007, INT. CL. 3.
- PAGE MUSIC, INC., FRANKLIN, TN:
2,404,365, CANC. INT. CL. 9.
- PAGOO.COM, INC., SAN FRANCISCO, CA:
2,404,077, CANC. INT. CL. 38.
- PAION DEUTSCHLAND GMBH, AACHEN, FED REP GERMANY:
3,297,427, PUB. 7-10-2007, MULTIPLE CLASS, INT. CLS. 1, 5, 10, 35, 41 AND 42.
- PAIVA, INC., INDIANAPOLIS, IN:
3,299,820, INT. CL. 35.
- PAJAR DISTRIBUTION LTD./PAJAR DISTRIBUTION LTÉE, MONTREAL, QUEBEC, CANADA:
3,296,160, PUB. 7-10-2007, INT. CL. 25.
- PAKON, INC., MINNETONKA, MN:
2,016,224, CANC. MULTIPLE CLASS, INT. CLS. 9 AND 16.
- PALADIN DATA SYSTEMS CORPORATION, POULSBO, WA:
3,297,229, PUB. 7-10-2007, MULTIPLE CLASS, INT. CLS. 9 AND 42.
- PALAGONIA, PETER, PHOENIX, AZ:
2,015,425, CANC. INT. CL. 20.
- PALEO BOND, INC., ST. PAUL, MN:
3,299,172, INT. CL. 2.
- PALI WINE COMPANY, L.P., PACIFIC PALISADES, CA:
3,299,424, INT. CL. 33.
- PALMER, BEN, BRUNSWICK VIC 3056, AUSTRALIA:
3,297,381, PUB. 7-10-2007, MULTIPLE CLASS, INT. CLS. 9 AND 41.
- PALO ALTO SOFTWARE, INC., EUGENE, OR:
2,165,157, REN. 8-18-07, INT. CL. 9.
- PALSGAARD A/S, JUELSMINDE, DENMARK:
3,297,958, PUB. 7-10-2007, MULTIPLE CLASS, INT. CLS. 1 AND 29.
- PAN DUCALE DI D'AMARIO DANILO E C. S.A.S., ATRI, ITALY:
2,082,865, REN. 8-20-07, INT. CL. 30.
- PAN PACIFIC BANK, FREMONT, CA:
3,299,092, INT. CL. 36.
- PANAMA JACK INTERNATIONAL, INC., ORLANDO, FL:
2,082,043, REN. 8-17-07, INT. CL. 3.
- PANASONIC CORPORATION OF NORTH AMERICA, SECAUCUS, NJ:
2,403,275, CANC. INT. CL. 9.
- PANAVISION IMAGING, LLC, HOMER, NY:
2,403,883, CANC. INT. CL. 9.
- PANDOZY, RAFFAEL MARTINI, DALLAS, TX:
2,404,927, CANC. INT. CL. 28.
- PANELS & CONTROLS CORP., GURNEE, IL:
3,296,141, PUB. 7-10-2007, INT. CL. 9.
- PANHANDLE-PLAINS HIGHER EDUCATION AUTHORITY, INC., CANYON, TX:
2,120,240, REN. 8-20-07, INT. CL. 36.
- PANOMICS, INC., FREMONT, CA:
3,299,563, INT. CL. 1.
- PANORAMA SOFTWARE (BARBADOS) LTD., HASTINGS, CHRIST CHURCH, BARBADOS:
3,297,250, PUB. 7-10-2007, MULTIPLE CLASS, INT. CLS. 41 AND 42.
- 3,297,251, PUB. 7-10-2007, MULTIPLE CLASS, INT. CLS. 41 AND 42.
- PANTALONS STAR & CIE, LAURIERVILLE, QUEBEC, CANADA:
3,297,357, PUB. 7-10-2007, INT. CL. 9.
- PANTHERS STADIUM, LLC, CHARLOTTE, NC:
2,155,329, REN. 8-20-07, INT. CL. 41.
- PANTONE, INC., CARLSTADT, NJ:
3,299,999, MULTIPLE CLASS, INT. CLS. 35 AND 42.
- PAPA GINO'S, INC., DEDHAM, MA:
3,296,562, PUB. 7-10-2007, INT. CL. 43.
- PAPA VANELLI'S PIZZARIA, INC., TUPELO, MS:
2,015,138, CANC. INT. CL. 42.
- PAPA'S TRANSPORT, INC., TOWNSEND, DE:
3,299,882, INT. CL. 32.
- PAPER SHACK AND CONTAINER STORE, INC., THE BOSSIER CITY, LA:
2,086,306, REN. 8-17-07, INT. CL. 42.
- PAPERLY, LLC, CHICAGO, IL:
3,300,107, INT. CL. 35.
- PARA-PROTECT SERVICES, INC., ALEXANDRIA, VA:
2,404,299, CANC. INT. CL. 42.
- PARADIGM CONSULTING GROUP, LLC, SAN DIEGO, CA:
3,299,880, INT. CL. 25.
- PARADOX SECURITY SYSTEMS LTD./SYSTEMES DE SECURITE PARADOX LTEE, ST-EUSTACHE QUEBEC J7R 5V3, CANADA:
2,404,088, CANC. INT. CL. 9.
- PARAGON POTATO FARMS, INC., BANCROFT, WI:
3,296,324, PUB. 7-10-2007, MULTIPLE CLASS, INT. CLS. 29 AND 31.
- 3,296,326, PUB. 7-10-2007, MULTIPLE CLASS, INT. CLS. 29 AND 31.
- PARFUM DE COEUR, LTD., DARIEN, CT:
2,015,831, CANC. INT. CL. 3.
- PARFUMS CHRISTIAN DIOR, 75008 PARIS, FRANCE:
3,297,261, PUB. 7-10-2007, INT. CL. 3.
- PARIS BUSINESS PRODUCTS, INC., WESTAMPTON, NJ:
2,404,281, CANC. INT. CL. 16.
- 3,299,256, INT. CL. 16.
- PARISH FINANCIAL SERVICES, INC., COVINGTON, LA:
2,142,596, REN. 8-23-07, INT. CL. 9.
- PARK B. SMITH, INC., NEW YORK, NY:
3,298,430, MULTIPLE CLASS, INT. CLS. 20, 21, 24 AND 27.
- PARK, MOON SOON, POLAND, OH:
3,296,121, PUB. 7-10-2007, INT. CL. 41.
- PARKER GAMING, INC., SIOUX FALLS, SD:
2,403,073, CANC. INT. CL. 28.
- PARTNERS IN HEALTH, A NONPROFIT CORPORATION, BOSTON, MA:
3,297,573, PUB. 7-10-2007, MULTIPLE CLASS, INT. CLS. 35, 41, 42, 44 AND 45.
- PARTNERSHIP OF FERRELL WEST AND BILL WHORTON, THE, MONROVIA, CA:
2,403,111, CANC. INT. CL. 25.
- PARTYKARMA, INC., SHERMAN OAKS, CA:
3,296,099, PUB. 7-10-2007, INT. CL. 45.
- PASADENA ATHLETIC OPERATING CLUB, GLENDORA, CA:
3,296,750, PUB. 7-10-2007, INT. CL. 41.
- PASCUA YAQUI TRIBE, TUCSON, AZ:
3,298,853, INT. CL. 16.
- PASQUALE VALLI S.A.S.; DI VALLI CARLO EDOARDO, I-20055 RENATE (MILANO), ITALY:
3,298,233, PUB. 7-10-2007, MULTIPLE CLASS, INT. CLS. 11, 20 AND 21.
- PASSIONATE ENTERTAINMENT, INC., NEW YORK, NY:
3,296,704, PUB. 7-10-2007, INT. CL. 35.
- PASTAWORKS L.L.C., PORTLAND, OR:
2,403,068, CANC. INT. CL. 35.
- PATEL, MANESH, NEW YORK, NY:
3,296,786, PUB. 7-10-2007, INT. CL. 35.
- PATERNO IMPORTS, LTD., D/B/A PATERNO WINES INTERNATIONAL, LAKE BLUFF, IL:
3,298,000, PUB. 7-10-2007, INT. CL. 35.

PATHBUILDERS, INC., ATLANTA, GA:
 3,299,303, INT. CL. 41.
 PATIENT CARE TECHNOLOGY SYSTEMS, LLC., MISSION VIEJO, CA:
 3,300,062, INT. CL. 9.
 PATRIOT EQUITIES, L.P., WAYNE, PA:
 3,297,403, PUB. 7-10-2007. MULTIPLE CLASS, INT. CLS. 35 AND 36.
 3,297,404, PUB. 7-10-2007. MULTIPLE CLASS, INT. CLS. 35 AND 36.
 PATRIOTIC FIREWORKS, INC., INDIANAPOLIS, IN:
 3,296,862, PUB. 7-10-2007. INT. CL. 13.
 PATTERSON MEDICAL HOLDINGS, INC., BOLINGBROOK, IL:
 1,416,509, CANC. INT. CL. 10.
 PATTERSON WHITTAKER ARCHITECTURAL PROFILES, LLC, SEATTLE, WA:
 3,299,026, MULTIPLE CLASS, INT. CLS. 19 AND 20.
 PAUL VAHLE GMBH & CO. KG, FED REP GERMANY:
 3,298,176, PUB. 7-10-2007. MULTIPLE CLASS, INT. CLS. 6, 7 AND 9.
 PAWS, WHISKERS & WAGS, LLC, ATLANTA, GA:
 3,299,072, INT. CL. 45.
 3,299,073, INT. CL. 45.
 PAXAR AMERICAS, INC., MIAMISBURG, OH:
 3,296,164, PUB. 7-10-2007. INT. CL. 8.
 3,296,213, PUB. 7-10-2007. INT. CL. 7.
 PAY RENT, BUILD CREDIT, INC., ANNAPOLIS, MD:
 3,297,301, PUB. 7-10-2007. INT. CL. 36.
 3,297,424, PUB. 7-10-2007. INT. CL. 36.
 PAYVAND INTERNATIONAL, INC., LOS ANGELES, CA:
 2,404,433, CANC. INT. CL. 25.
 PC DOCS, INC., BURLINGTON, MA:
 2,404,750, CANC. INT. CL. 9.
 PC LAN TECHS, INC., WEST PALM BEACH, FL:
 3,299,007, INT. CL. 42.
 PC PARTNER LIMITED, FO TAN, SHATIN, NEW TERRITORIES, HONG KONG:
 3,296,051, PUB. 7-10-2007. INT. CL. 9.
 PEAK INNOVATIONS INC., RICHMOND, BRITISH COLUMBIA:
 3,297,183, PUB. 11-21-2006. INT. CL. 6.
 PEAKS ISLAND BOAT COMPANY, LLC, PORTLAND, ME:
 3,298,846, INT. CL. 12.
 PEAPACK GLADSTONE BANK, GLADSTONE, NJ:
 3,297,919, PUB. 7-10-2007. INT. CL. 36.
 PEAPOD, LLC, SKOKIE, IL:
 2,404,132, CANC. INT. CL. 35.
 2,511,327, CANC. INT. CL. 16.
 PEARLE, INC., MASON, OH:
 3,299,129, INT. CL. 9.
 3,299,219, INT. CL. 9.
 PEASE INDUSTRIES, INC., FAIRFIELD, OH:
 2,403,255, CANC. INT. CL. 6.
 PEERLESS INDUSTRIES, INC., MELROSE PARK, IL:
 3,300,182, INT. CL. 6.
 PEERLESS-WINSMITH, INC., WARREN, OH:
 2,015,248, CANC. MULTIPLE CLASS, INT. CLS. 7 AND 11.
 PEETERS LANDBOUWMACHINES B.V., NETHERLANDS:
 3,298,382, PUB. 7-10-2007. INT. CL. 12.
 PEI LICENSING, INC., MIAMI, FL:
 2,016,017, CANC. INT. CL. 25.
 PEIRONE PRODUCE COMPANY, SPOKANE, WA:
 1,451,369, REN. 8-23-07. INT. CL. 39.
 PELICAN PRODUCTS, INC., TORRANCE, CA, PARKER, DAVID H., REDONDO BEACH, CA, DBA PELICAN PRODUCTS:
 1,073,913, REN. 8-20-07. INT. CL. 6.
 PELUSO MICROPHONE LAB, LLC, WILLIS, VA:
 3,296,984, PUB. 7-10-2007. INT. CL. 9.
 PENA, RENE M., LIMA, PERU:
 3,299,899, INT. CL. 25.
 PENCE, SHARI ANN, RIVERSIDE, CA AND PENCE, PAUL LESLIE, RIVERSIDE, CA, FUNCASTLE PUBLICATIONS:
 2,074,227, REN. 8-21-07. INT. CL. 16.
 PENDERGRASS, TORRY, WEST HOLLYWOOD, CA:
 3,300,231, INT. CL. 25.
 PENDLETON WOOLEN MILLS, INC., PORTLAND, OR:
 2,404,549, CANC. INT. CL. 25.
 3,297,528, PUB. 7-10-2007. INT. CL. 30.
 PENINSULA VENDING, INC., SAN JOSE, CA:
 2,403,642, CANC. INT. CL. 16.
 PENNSYLVANIA HIGHER EDUCATION ASSISTANCE AGENCY (PHEAA), AN AGENCY OF THE COMMONWEALTH OF PENNSYLVANIA, HARRISBURG, PA:
 3,296,272, PUB. 7-10-2007. INT. CL. 36.
 PENNSYLVANIA STATE EMPLOYEES CREDIT UNION, HARRISBURG, PA:
 3,299,248, INT. CL. 36.
 PENNWELL CORPORATION, TULSA, OK, PENNWELL PUBLISHING COMPANY, TULSA, OK:
 2,089,348, REN. 8-22-07. INT. CL. 35.
 PENSHU INC., TOWN OF MOUNT ROYAL, QUEBEC, CANADA:
 3,297,399, PUB. 7-10-2007. INT. CL. 25.
 PENSON WORLDWIDE, INC., DALLAS, TX:
 3,296,224, PUB. 7-10-2007. INT. CL. 36.
 PEPACOM INC., BOYNTON BEACH, FL:
 3,296,904, PUB. 7-10-2007. INT. CL. 35.
 PEPSICO, INC., PURCHASE, NY:
 3,299,163, INT. CL. 32.
 3,300,162, INT. CL. 32.
 PERAZA-HERNANDEZ, SILAS, EL SALVADOR, CENTRAL AMERICA, EL SALVADOR:
 3,298,450, INT. CL. 43.
 PERAZA, WILLIAM, JR, MIAMI, FL, DBA CORPORATE POKER TOUR:
 3,300,269, INT. CL. 41.
 PERAZA, WILLIAM, JR, MIAMI, FL:
 3,300,270, INT. CL. 41.
 3,300,273, INT. CL. 41.
 PERCEPTIONS... AND REALITIES, INCORPORATED, CHAPPAQUA, NY:
 2,102,326, REN. 8-17-07. MULTIPLE CLASS, INT. CLS. 35 AND 42.
 PERCUSSIONAIRE CORPORATION, SANDPOINT, ID:
 1,446,210, REN. 8-20-07. INT. CL. 10.
 PERFECT FIT GLOVE CO., LLC, CHEEKTOWAGA, NY, PERFECT FIT GLOVE COMPANY, INC., CHEEKTOWAGA, NY:
 2,130,337, REN. 8-18-07. INT. CL. 9.
 PERFECT 10, INC., BEVERLY HILLS, CA:
 3,298,659, INT. CL. 41.
 PERFORMANCE BRANDS, INC., SUNRISE, FL:
 3,299,056, INT. CL. 3.
 3,299,057, INT. CL. 3.
 PERFORMANCE EXHAUST PLUS, ST. CHARLES, MO:
 3,299,979, INT. CL. 35.
 PERFORMANCE HORSE NUTRITION, LLC, WEISER, ID:
 3,299,263, INT. CL. 5.
 PERFORMANCE PEDIATRICS, LLC, PLYMOUTH, MA:
 3,299,329, INT. CL. 44.
 PERFORMANCELINE.COM, INC., MARIETTA, GA:
 2,404,171, CANC. INT. CL. 35.
 PERIO, INC., DUBLIN, OH:
 3,299,292, INT. CL. 3.
 3,299,782, INT. CL. 3.
 PERITZ, RICHARD C., FT. LAUDERDALE, FL:
 2,404,444, CANC. INT. CL. 41.
 PERMANENT PROMOTIONS PTY LTD, BANGHOLME, VICTORIA 3175, AUSTRALIA:
 3,296,011, PUB. 7-10-2007. MULTIPLE CLASS, INT. CLS. 21 AND 33.
 PERMAR SYSTEMS, INC., WOLCOTT, NY:
 3,298,775, INT. CL. 6.
 PERNIA, PATRICK PEREZ, SAN JOSE, CA:
 2,016,436, CANC. INT. CL. 25.
 PEROMSIK, JOSHUA MICHAEL, WORCESTER, MA:
 3,298,055, PUB. 7-10-2007. INT. CL. 15.
 PERPETUAL LICENSING LLC, NEW YORK, NY:
 3,298,929, INT. CL. 35.
 PERRINE, INC., LAS VEGAS, NV:
 3,299,132, INT. CL. 3.
 3,299,284, INT. CL. 3.

- PERSHING INVESTMENTS LLC, NEWARK, DE, DONALDSON, LUFKIN & JENRETTE SECURITIES CORPORATION, JERSEY CITY, NJ:
2,084,995. REN. 8-20-07. INT. CL. 36.
- PERSONIFY DESIGN INC., SEATTLE, WA:
3,296,754. PUB. 7-10-2007. MULTIPLE CLASS, INT. CLS. 9 AND 42.
- PERSONS-MAJESTIC MANUFACTURING CO., MONROEVILLE, OH:
2,472,640. CANC. INT. CL. 28.
- PERVASIS THERAPEUTICS, INC., CAMBRIDGE, MA:
3,300,002. INT. CL. 10.
- PETERS JR., JAMES C., CORDOVA, TN:
3,299,238. MULTIPLE CLASS, INT. CLS. 14 AND 25.
- PETERSON CONCESSIONS, INC., HAM LAKE, MN:
2,122,386. REN. 8-17-07. INT. CL. 30.
- PETROLEUM & RESOURCES CORPORATION, BALTIMORE, MD:
2,060,456. REN. 8-20-07. INT. CL. 36.
2,075,838. REN. 8-20-07. INT. CL. 36.
- PETROLEUM INDUSTRY RESEARCH ASSOCIATES, INC., NEW YORK, NY, DBA PIRA ENERGY GROUP:
3,297,679. PUB. 7-10-2007. INT. CL. 36.
- PETROPAC, INC., DAVIE, FL:
2,404,231. CANC. MULTIPLE CLASS, INT. CLS. 35 AND 37.
- PETROSYS SOLUTIONS, INC., BELLAIRE, TX:
3,298,405. MULTIPLE CLASS, INT. CLS. 37 AND 42.
- PFAU, MARIANNE RICHERT, SAN DIEGO, CA:
3,300,109. MULTIPLE CLASS, INT. CLS. 9 AND 41.
- PFIZER ENTERPRISES SARL, LUXEMBOURG, LUXEMBOURG:
3,299,884. MULTIPLE CLASS, INT. CLS. 16 AND 44.
- PFIZER INC., NEW YORK, NY, BEECHAM INC., BRISTOL, TN:
1,444,840. REN. 8-17-07. INT. CL. 5.
- PFIZER INC., NEW YORK, NY:
2,076,896. REN. 8-23-07. INT. CL. 41.
2,160,564. REN. 8-23-07. INT. CL. 5.
3,297,111. PUB. 7-10-2007. INT. CL. 35.
- PGA TOUR, INC., PONTE VEDRA BEACH, FL:
3,298,621. INT. CL. 24.
3,298,622. INT. CL. 18.
3,300,036. INT. CL. 41.
- PHAN, KIEU THI-BICH, AUSTIN, TX:
3,300,384. INT. CL. 21.
- PHARMACY BENEFIT MANAGEMENT INSTITUTE, LP, SCOTTSDALE, AZ:
3,296,145. PUB. 7-10-2007. INT. CL. 35.
- PHARMADYNE CORPORATION, MINNETONKA, MN TO LECTEC CORPORATION, MINNETONKA, MN:
2,015,923. CANC. INT. CL. 5.
- PHARMANEX, INC., SIMI VALLEY, CA:
2,404,499. CANC. INT. CL. 5.
- PHARMAZEUTISCHE FABRIK MONTAVIT GESELLSCHAFT M.B.H., A-6060 ABSAM BEI SOLBAD HALL, AUSTRIA:
3,298,384. PUB. 7-10-2007. INT. CL. 5.
- PHARMICHEM LABORATORIES, INC., MENLO PARK, CA:
2,404,736. CANC. INT. CL. 42.
- PHASE ONE DENMARK A/S, DK-2000 FREDERIKSBERG, DENMARK:
2,403,359. CANC. MULTIPLE CLASS, INT. CLS. 9, 37 AND 41.
- PHI BETA SIGMA FRATERNITY, INC., WASHINGTON, DC:
3,295,987. PUB. 7-10-2007. MULTIPLE CLASS, INT. CLS. 14, 16, 25 AND 35.
- PHILIP C. ARNOLD, VAN NUYS, CA:
3,296,797. PUB. 7-10-2007. INT. CL. 16.
- PHILIP HARMANDJIEV, BULGARIA:
3,298,261. PUB. 7-10-2007. INT. CL. 33.
- PHILIP PELUSI, INC., PITTSBURGH, PA TO PHILIP PELUSI PHYTO LINC 4.0, INC., PITTSBURGH, PA:
2,015,316. CANC. INT. CL. 3.
- PHILIP WU INTERNATIONAL, INC., LOS ANGELES, CA, DBA MIDLAND-MORRISON:
1,417,055. CANC. INT. CL. 8.
- PHILIPPE GUILLAUME, TOULOUSE, FRANCE:
3,298,380. PUB. 7-10-2007. MULTIPLE CLASS, INT. CLS. 9, 15 AND 41.
- PHILIPS CONSUMER COMMUNICATIONS B.V., EINDHOVEN, NETHERLANDS:
2,404,479. CANC. INT. CL. 9.
- PHILIPS, DANIEL, OXNARD, CA:
3,300,165. INT. CL. 33.
- PHILLIPS & TEMRO INDUSTRIES INC., EDEN PRAIRIE, MN:
2,015,341. CANC. INT. CL. 9.
- PHILLIPS & TEMRO INDUSTRIES LTD., WINNIPEG, MANITOBA R3C 2V3, CANADA:
2,015,342. CANC. INT. CL. 11.
- PHILLIPS, BRIAN, SAN ANTONIO, TX, DBA AERO COSMETICS:
2,016,203. CANC. INT. CL. 3.
- PHILLIPS, ROBERT H., KINGS BEACH, CA:
2,403,590. CANC. INT. CL. 21.
- PHOENIX DOWN, CORP., TOTOWA, NJ:
2,403,816. CANC. INT. CL. 24.
- PHP COMPANIES, INC., KNOXVILLE, TN:
2,085,581. REN. 8-23-07. MULTIPLE CLASS, INT. CLS. 36 AND 42.
2,085,665. REN. 8-23-07. MULTIPLE CLASS, INT. CLS. 36 AND 42.
- PHYSICAL THERAPY HOLDINGS, INC., PACIFIC PALISADES, CA:
3,296,217. PUB. 7-10-2007. INT. CL. 9.
- PICCADILLY RESTAURANTS, LLC, BATON ROUGE, LA:
3,300,365. INT. CL. 43.
- PICO MACOM, INC., SAN DIEGO, CA:
3,297,586. PUB. 7-10-2007. INT. CL. 9.
- PICO MANUFACTURING SALES CORPORATION, NEW YORK, NY:
2,014,746. CANC. INT. CL. 25.
- PICTUREFLOW LLC, MELBOURNE, FL:
3,298,774. INT. CL. 16.
- PIERCE, DENNIS, SAN DIEGO, CA:
2,404,853. CANC. INT. CL. 16.
- PIERRE FABRE, S.A., 92100 BOULOGNE, FRANCE:
2,403,963. CANC. MULTIPLE CLASS, INT. CLS. 3 AND 5.
- PIETER GERHARDUS VERSTER DREYER, WESTERN CAPE, SOUTH AFRICA:
3,297,808. PUB. 7-10-2007. INT. CL. 33.
- PILI CARRERA, S.A., 36417 MOS (PONTEVEDRA), SPAIN:
3,299,177. INT. CL. 35.
- PILKINGTON, ROBERT, R. AND PILKINGTON, DENISE, L., PAHRUMP, NV:
3,296,769. PUB. 7-10-2007. INT. CL. 35.
- PILLOW KINGDOM, INC., LAKEWOOD, CO:
1,070,250. REN. 8-20-07. MULTIPLE CLASS, INT. CLS. 20 AND 42.
1,070,250. CANC. INT. CL. 37.
- PIMA FEDERAL CREDIT UNION, TUCSON, AZ:
3,296,894. PUB. 7-10-2007. INT. CL. 36.
- PINE RIDGE FOODS, L.L.C., WILSON, NC:
3,299,658. INT. CL. 29.
- PINK BUBBLE DREAMS, LLC, THURMAN, IA:
3,297,052. PUB. 7-10-2007. INT. CL. 25.
- PINKUS, MICHAEL R., CLEARWATER, FL:
3,298,745. INT. CL. 5.
- PINNACLE PRODUCTS GROUP, LTD, DAYTON, OH:
2,404,375. CANC. INT. CL. 42.
- PINNACLE PRODUCTS GROUP, LTD., DAYTON, OH:
2,403,455. CANC. INT. CL. 27.
- PINNACLE RECORDS LLC, PETERSBURG, VA:
3,297,992. PUB. 7-10-2007. INT. CL. 41.
- PINPOINT TRACKING SOLUTIONS, LLC, PACOIMA, CA:
3,299,241. MULTIPLE CLASS, INT. CLS. 9 AND 45.
- PIONEER HI-BRED INTERNATIONAL, INC., JOHNSTON, IA:
2,092,273. REN. 8-20-07. INT. CL. 16.
- PIRELLI & C. S.P.A., ITALY:
3,298,352. PUB. 7-10-2007. INT. CL. 25.
- PITNER, VANESSA R., WICHITA FALLS, TX:
3,299,711. INT. CL. 4.

PITTSBURGH ASSOCIATES, PITTSBURGH, PA:
3,299,390, INT. CL. 18.

PIVOT INTERNATIONAL, LENEXA, KS:
2,016,377, CANC. INT. CL. 10.

PIVOTPOINT SOLUTIONS, BRYAN, TX:
3,297,556, PUB. 11-28-2006. INT. CL. 35.

PIXTORIE, LLC, WESTLAKE VILLAGE, CA:
3,296,550, PUB. 7-10-2007. INT. CL. 42.

PJH BRANDS, SCOTTSDALE, AZ, SPEREX CORPORATION,
GARDENA, CA:
1,368,479. REN. 8-17-07. MULTIPLE CLASS, INT. CLS. 1,
2, 3, 4 AND 17.

PLACEK SUSANNA, RANCHO PALOS VERDES, CA:
3,296,852, PUB. 7-10-2007. MULTIPLE CLASS, INT. CLS.
16 AND 30.

PLAINVIEW GROWERS, INC., POMPTON PLAINS, NJ:
3,300,054, INT. CL. 31.

PLANET BEACH BRANDS, LLC, NEW ORLEANS, LA:
3,299,750, INT. CL. 35.

PLANET GROUP, INC., LONG BEACH, NY:
3,296,216, PUB. 7-10-2007. INT. CL. 36.

PLANNED PARENTHOOD OF NEW YORK CITY, INC.,
NEW YORK, NY:
3,298,096, PUB. 7-10-2007. INT. CL. 35.

PLANNED PARENTHOOD OF WESTERN WASHINGTON,
SEATTLE, WA:
3,296,517, PUB. 7-10-2007. INT. CL. 44.

PLASTIC SAFETY SYSTEMS, INC., CLEVELAND, OH:
3,299,570, INT. CL. 19.

PLATYPUS WEAR, INC., HENDERSON, NV:
2,971,097, CANC. INT. CL. 5.

PLAYBOY ENTERPRISES INTERNATIONAL, INC., CHICA-
GO, IL:
3,297,069, PUB. 7-10-2007. MULTIPLE CLASS, INT. CLS.
41 AND 43.
3,297,145, PUB. 7-10-2007. INT. CL. 41.

PLAYHOUSE, TIEL, NETHERLANDS:
3,297,685, PUB. 7-10-2007. INT. CL. 9.

PLAYMATES TOYS, INC., COSTA MESA, CA:
2,016,338, CANC. INT. CL. 28.

PLAYSKOOL BABY, INC., PAWTUCKET, RI:
1,416,690, CANC. INT. CL. 21.

PLAYTEX PRODUCTS, INC., WESTPORT, CT:
2,016,450, CANC. INT. CL. 5.

PLAZA BANK, IRVINE, CA:
3,300,001, INT. CL. 36.

PLAZA PROPERTIES, INC., COLUMBUS, OH:
3,296,453, PUB. 7-10-2007. INT. CL. 37.

PLEXTEL TELECOMMUNICATIONS, INC., EVANSTON, IL
TO SPARK NETWORK SERVICES, INC., NEW YORK, NY:
2,015,891, CANC. MULTIPLE CLASS, INT. CLS. 38 AND
42.

PLIANT CORPORATION, SCHAUMBURG, IL:
3,298,500, INT. CL. 17.

PLOWPOINT, INC, GRAHAM, NC:
3,297,450, PUB. 7-10-2007. INT. CL. 45.
3,297,451, PUB. 7-10-2007. INT. CL. 45.

POINT B SOLUTIONS GROUP LLP, SEATTLE, WA:
2,067,352, AM. INT. CL. 35.

POINT VILLAGE RESORTS LIMITED, NEGRIL, WEST-
MORELAND, JAMAICA:
3,297,176, PUB. 7-10-2007. MULTIPLE CLASS, INT. CLS.
16, 25, 41 AND 43.

POINTE NOIR PTY LTD., PYRMONT, AUSTRALIA:
3,300,030, INT. CL. 25.

POKER STRATEGY.DE PUBLISHING LTD., LONDON,
UNITED KINGDOM:
3,297,648, PUB. 7-10-2007. MULTIPLE CLASS, INT. CLS.
38 AND 41.

POKKA USA, INC., AMERICAN CANYON, CA:
2,404,788, CANC. INT. CL. 32.

POKORN, GARY A., LITTLETON, CO:
2,404,093, CANC. INT. CL. 41.

POLAR BEAR WATER COMPANY, NEW YORK, NY:
3,296,001, PUB. 7-10-2007. INT. CL. 32.

POLYCOM, INC., PLEASANTON, CA:
2,092,227. REN. 8-17-07. INT. CL. 9.

POLYMER TECHNOLOGY SYSTEMS, INC., INDIANAPO-
LIS, IN:
3,297,266, PUB. 7-10-2007. MULTIPLE CLASS, INT. CLS. 5
AND 10.

POLYPOWER TECH. CO., LTD, HSICHIH CITY, TAIPEI
HSIEN, TAIWAN:
3,298,946, INT. CL. 9.

POMELLATO S.P.A., MILAN, ITALY:
1,449,579. REN. 8-23-07. INT. CL. 14.

PON HOLDINGS B.V., NETHERLANDS:
3,298,167, PUB. 7-10-2007. MULTIPLE CLASS, INT. CLS.
7, 12, 35, 36, 37 AND 39.

PONICA INDUSTRIAL CO., LTD., CORONA, CA:
2,403,913, CANC. INT. CL. 9.

POP A TOP COOLERS, INC., GILLETTE, WY:
2,404,160, CANC. INT. CL. 21.

POPKIN, JEFF, NEEDHAM, MA:
3,298,568, INT. CL. 41.

PORK EMPIRE, INC., FORT LAUDERDALE, FL:
3,297,699, PUB. 7-10-2007. INT. CL. 25.

PORTICO HOLDINGS, LLC, IRVINE, CA:
3,297,095, PUB. 7-10-2007. INT. CL. 36.
3,297,096, PUB. 7-10-2007. INT. CL. 36.

PORTINI'S INC., NEW YORK, NY:
3,297,510, PUB. 7-10-2007. INT. CL. 30.

PORTUGAL VENTURE LIMITED, LONDON, GREAT BRIT-
AIN, GEO. G. SANDEMAN SONS & CO. LIMITED,
HARLOW, ESSEX, ENGLAND:
1,071,925. REN. 8-20-07. INT. CL. 33.
1,071,926. REN. 8-20-07. INT. CL. 33.

PORTUGUESE WATER DOG CLUB OF AMERICA, INC., ST.
HELENA, CA:
3,296,037, PUB. 7-10-2007. MULTIPLE CLASS, INT. CLS.
35 AND 44.

POSS, VALERIE, REDONDO BEACH, CA:
2,404,790, CANC. INT. CL. 18.

POST GLOVER RESISTORS, INC., ERLANGER, KY:
3,299,001, INT. CL. 9.

POWER COMMUNICATION TECHNOLOGY CO., LTD.,
TAIPEI, TAIWAN:
3,298,923, INT. CL. 9.

POWER ROOTER INC., LONGMONT, CO:
3,300,302, INT. CL. 37.

POWERHOUSE DIESEL SERVICES INCORPORATED, BE-
NICIA, CA:
2,077,909. REN. 8-17-07. INT. CL. 9.

PPC MARKETING, LTD., PITTSBURGH, TX:
3,300,197, INT. CL. 29.

PPG ARCHITECTURAL FINISHES, INC., PITTSBURGH, PA:
1,449,146. REN. 8-20-07. INT. CL. 2.
3,299,577, INT. CL. 2.
3,299,578, INT. CL. 2.

PPG INDUSTRIES OHIO, INC., CLEVELAND, OH, MILES
CHEMICAL AND FILTER COMPANY, INC., TROY, MI:
832,356. REN. 8-20-07. U.S. CL. 6 (INT. CL. 1).

PQS CONSTRUCTION, INC., BONITA SPRINGS, FL:
3,298,137, PUB. 7-10-2007. INT. CL. 37.

PRAIRIE SHIELD REGIONAL ALLIANCE, BELVIDERE, IL:
3,296,534, PUB. 7-10-2007. INT. CL. 45.

PRAISELAND MUSIC INC., MONROVIA, CA:
3,297,207, PUB. 7-10-2007. INT. CL. 15.

PRAVATA, GEORGE, BROOKLYN, NY AND PRAVATA,
LOURDES, BROOKLYN, NY:
3,298,585, INT. CL. 9.

PRAXELL, INC., NEW YORK, NY:
3,297,278, PUB. 7-10-2007. INT. CL. 36.

PRECIOUS CHEMICALS LTD., TEL AVIV 61580, ISRAEL:
3,296,027, PUB. 7-10-2007. INT. CL. 5.

PREDATOR QUEST, L.L.C., SARATOGA, WY:
3,297,814, PUB. 7-10-2007. INT. CL. 9.

PREFERRED NUTRITION INC., ACTON, ONTARIO, CA-
NADA:
3,297,361, PUB. 7-10-2007. INT. CL. 5.

PREFERRED PAGING & WIRELESS, INC., ST. ANN, MO:
2,403,373, CANC. MULTIPLE CLASS, INT. CLS. 35 AND
36.

- PREFERREDONE MANAGEMENT CORPORATION, MINNEAPOLIS, MN TO PREFERRED ONE ADMINISTRATIVE SERVICES, INC., GOLDEN VALLEY, MN:
2,014,736, CANC. INT. CL. 36.
- PREGER & WERTENTEIL, INC., NEW YORK, NY:
3,297,024, PUB. 7-10-2007. INT. CL. 25.
3,299,460, INT. CL. 25.
- PREGIS INNOVATIVE PACKAGING INC., DEERFIELD, IL:
3,299,721, INT. CL. 17.
- PREHEIM, TIMOTHY A., PARMA, ID:
1,426,147, REN. 8-20-07. INT. CL. 1.
- PREJEAN, JOHN F., HOUSTON, TX, DBA RPMS RESOURCE TO PROFESSIONALS & MANAGERS:
2,085,585, REN. 8-20-07. MULTIPLE CLASS, INT. CLS. 35 AND 42.
- PREMIER FARNELL CORP., INDEPENDENCE, OH:
3,298,453, INT. CL. 9.
- PREMIER MORTGAGE CORP., ROSLYN HEIGHTS, NY:
2,403,119, CANC. INT. CL. 36.
- PREMIER TEN THIRTY ONE CAPITAL CORP., SANTA MONICA, CA:
3,299,730, INT. CL. 36.
3,299,731, INT. CL. 36.
- PREMIERTRADE FINANCIAL, INC., ALTAMONTE SPRINGS, FL:
3,299,851, INT. CL. 36.
- PREMIUM TRADING COMPANY OF TAMPA BAY, GULFPORT, FL:
2,164,531, REN. 8-17-07. INT. CL. 11.
- PRESBYTERIAN VILLAGES OF MICHIGAN FOUNDATION, SOUTHFIELD, MI:
3,296,656, PUB. 7-10-2007. INT. CL. 36.
- PRESERVED TREESCAPES INTERNATIONAL, INC., OCEANSIDE, CA:
2,100,796, REN. 8-23-07. INT. CL. 26.
- PRESERVED TREESCAPES, INTERNATIONAL, OCEANSIDE, CA:
2,080,819, REN. 8-17-07. MULTIPLE CLASS, INT. CLS. 37 AND 40.
- PRESS PASS, INC., CHARLOTTE, NC, PRESS PASS PARTNERS, DALLAS, TX:
2,118,091, REN. 8-23-07. INT. CL. 16.
- PRESSALIT GROUP A/S, DENMARK:
3,298,209, PUB. 7-10-2007. MULTIPLE CLASS, INT. CLS. 6, 11 AND 20.
- PRESTOLITE WIRE CORPORATION, SOUTHFIELD, MI:
3,298,773, INT. CL. 9.
- PRESTON, DEREK J., SOUTH LYON, MI:
2,404,168, CANC. INT. CL. 36.
- PREVENT PRO PRODUCTS, TUSTIN, CA, DBA INVETEK, INC.:
3,300,040, INT. CL. 5.
- PRICELESS RENT-A-CAR LLC, LAUREL, MD:
3,299,903, INT. CL. 35.
- PRICELINE.COM INCORPORATED, NORWALK, CT:
3,299,356, MULTIPLE CLASS, INT. CLS. 39, 40 AND 43.
- PRICEWATERHOUSECOOPERS LLP, NEW YORK, NY:
2,078,361, REN. 8-22-07. INT. CL. 35.
- PRIDGEN, DURWARD B., HILTON HEAD ISLAND, SC:
3,299,440, INT. CL. 36.
- PRIME LIFE FIBERS, INC., DURHAM, NC:
3,300,060, INT. CL. 5.
- PRIME RETAIL, L.P., BALTIMORE, MD:
2,403,744, CANC. MULTIPLE CLASS, INT. CLS. 35, 36 AND 37.
- PRIMERICA FINANCIAL SERVICES, INC., DULUTH, GA:
1,416,912, CANC. INT. CL. 36.
- PRIMESOURCE BUILDING PRODUCTS, INC., CARROLLTON, TX:
3,298,612, INT. CL. 19.
3,298,613, INT. CL. 19.
3,298,625, INT. CL. 6.
- PRIMITIVE, INC., LOUISVILLE, KY:
3,297,989, PUB. 7-10-2007. INT. CL. 41.
- PRIMROSE SCHOOL FRANCHISING COMPANY, CARTERSVILLE, GA:
2,015,824, CANC. MULTIPLE CLASS, INT. CLS. 41 AND 42.
- PRIMROSE SCHOOL FRANCHISING COMPANY, CARTERSVILLE, GA:
2,015,825, CANC. MULTIPLE CLASS, INT. CLS. 41 AND 42.
- PRIMROSE SCHOOL FRANCHISING COMPANY, CARTERSVILLE, GA:
2,015,826, CANC. MULTIPLE CLASS, INT. CLS. 41 AND 42.
- 2,015,858, CANC. MULTIPLE CLASS, INT. CLS. 41 AND 42.
- PRINCE SPORTS GROUP, INC., BORDENTOWN, NJ:
2,403,797, CANC. INT. CL. 3.
- PRINCE, RICHARD, PLANO, TX:
3,296,573, PUB. 7-10-2007. INT. CL. 16.
- PRINCETON SEARCH LLC, SKILLMAN, NJ:
3,296,553, PUB. 6-26-2007. INT. CL. 35.
- PRINCIPAL FINANCIAL SERVICES, INC., DES MOINES, IA:
3,297,647, PUB. 7-10-2007. INT. CL. 36.
- PRINT VILLAGE, FT. LAUDERDALE, FL, DBA USSUBLIMATION:
3,295,999, PUB. 12-20-2005. INT. CL. 2.
- PRINTER'S REPAIR PARTS, INC., FRANKLIN PARK, IL:
3,299,998, MULTIPLE CLASS, INT. CLS. 7 AND 35.
- PRISMA HONG KONG LTD., KOWLOON, HONG KONG:
2,403,893, CANC. MULTIPLE CLASS, INT. CLS. 11 AND 16.
- PRIVATE RESERVE, INC., LAKEPORT, CA:
2,080,177, REN. 8-17-07. MULTIPLE CLASS, INT. CLS. 29 AND 30.
- PRIVATUS, LTD., CHARLOTTE, NC:
3,299,639, INT. CL. 39.
- PRIZM ASSOCIATES, INC., GREAT NECK, NY:
3,298,599, INT. CL. 44.
- PRL USA HOLDINGS, INC., WILMINGTON, DE, POLO FASHIONS, INC., NEW YORK, NY:
1,446,173, REN. 8-17-07. INT. CL. 9.
- PRL USA HOLDINGS, INC., WILMINGTON, DE, POLO RALPH LAUREN, L.P., NEW YORK, NY:
2,077,090, REN. 8-20-07. INT. CL. 42.
- PRL USA HOLDINGS, INC., WILMINGTON, DE:
3,298,648, INT. CL. 35.
- PRO BONO INSTITUTE, WASHINGTON, DC:
3,297,327, PUB. 7-10-2007. INT. CL. 35.
- PRO TECH MONITORING, INC., ODESSA, FL:
3,297,144, PUB. 7-10-2007. INT. CL. 45.
- PROCESS SOFTWARE CORPORATION, FRAMINGHAM, MA:
2,404,624, CANC. INT. CL. 9.
- PROCTER & GAMBLE COMPANY, THE, CINCINNATI, OH, CLAIROL INCORPORATED, STAMFORD, CT:
433,594, REN. 8-23-07. U.S. CL. 6 (INT. CL. 5).
- PROCTER & GAMBLE COMPANY, THE, CINCINNATI, OH:
1,062,017, REN. 8-23-07. INT. CL. 3.
2,404,783, CANC. INT. CL. 3.
2,404,933, CANC. INT. CL. 3.
- PROCURELINK, LLC, NORWOOD, MA:
3,296,472, PUB. 6-26-2007. MULTIPLE CLASS, INT. CLS. 9 AND 35.
- PRODUCERS GUILD OF AMERICA, INC., BEVERLY HILLS, CA:
2,403,898, CANC. INT. CL. 41.
2,403,899, CANC. INT. CL. 41.
2,403,900, CANC. INT. CL. 41.
- PRODUCTION CONTROL SERVICES, INC., FREDERICK, CO:
3,296,987, PUB. 7-10-2007. INT. CL. 7.
3,296,988, PUB. 7-10-2007. INT. CL. 7.
3,296,990, PUB. 7-10-2007. INT. CL. 9.
3,296,991, PUB. 7-10-2007. INT. CL. 9.
3,296,992, PUB. 7-10-2007. INT. CL. 9.
3,296,994, PUB. 7-10-2007. INT. CL. 7.
3,296,995, PUB. 7-10-2007. INT. CL. 9.
3,296,996, PUB. 7-10-2007. INT. CL. 9.
3,297,136, PUB. 7-10-2007. INT. CL. 7.
3,297,137, PUB. 7-10-2007. INT. CL. 9.

- PRODUCTOS ALIMENTICIOS Y DIETETICOS, RELAMPA-
GO, S.A. DE C.V., COLONIA LA JOYA, MEXICO:
3,296,738, PUB. 6-19-2007. INT. CL. 30.
- PRODUCTOS COLUMBIA, S.A., SAN JOSE, COSTA RICA:
2,404,161, CANC. INT. CL. 30.
- PRODUCTOS INDY SA DE CV, SANTA CATARINA, MEX-
ICO:
3,297,471, PUB. 7-10-2007. INT. CL. 30.
- PROEL - S.P.A., ZONA ARTIGIANALE, ITALY:
2,403,807, CANC. MULTIPLE CLASS, INT. CLS. 9 AND
15.
- PROFESSIONAL DISTRIBUTION SYSTEMS, INC., HEA-
THROW, FL:
2,403,258, CANC. INT. CL. 10.
- PROFESSIONAL EMPLOYER'S SERVICES GROUP, LLC,
CALEDONIA, MI, DBA PROFESSIONAL EDUCATIONAL
SERVICES GROUP, LLC:
3,296,559, PUB. 7-10-2007. INT. CL. 35.
- PROFESSIONAL LIABILITY MANAGEMENT OF AMERI-
CA, INC., AKRON, OH:
3,297,861, PUB. 7-10-2007. INT. CL. 36.
- PROFESSIONAL LIABILITY UNDERWRITING SOCIETY,
MINNEAPOLIS, MN:
3,296,692, PUB. 7-10-2007. MULTIPLE CLASS, INT. CLS.
16 AND 41.
- PROFESSIONAL PRODUCTS, INC., DEFUNIAK SPRINGS,
FL:
1,416,360, CANC. MULTIPLE CLASS, INT. CLS. 5 AND
10.
- PROFESSIONAL RECREATION ORGANIZATION, INC.,
BELLEVUE, WA:
3,297,630, PUB. 7-10-2007. MULTIPLE CLASS, INT. CLS.
5, 9 AND 44.
- PROFESSIONAL RETAIL STORE MAINTENANCE ASSO-
CIATION, DALLAS, TX:
2,015,243, CANC. INT. CL. 42.
- PROFESSIONAL RODEO COWBOYS ASSOCIATION, INC.,
COLORADO SPRINGS, CO:
2,085,877, REN. 8-17-07. INT. CL. 26.
- PROFESSIONAL'S CHOICE ROPES, INC., EL CAJON, CA:
3,296,576, PUB. 7-10-2007. INT. CL. 22.
- PROFITMAX COUNTER TRAINING, INC., ORLANDO, FL:
3,296,028, PUB. 7-10-2007. INT. CL. 41.
- PROFUSION CONSULTING, GLENDALE, CA:
3,297,978, PUB. 7-10-2007. MULTIPLE CLASS, INT. CLS.
35, 36 AND 42.
3,297,979, PUB. 7-10-2007. MULTIPLE CLASS, INT. CLS.
35, 36 AND 42.
- PROGENY GROUP, L.L.C., BIRMINGHAM, MI:
2,404,733, CANC. INT. CL. 16.
- PROGRAM PLANNING PROFESSIONALS, INC., ANN AR-
BOR, MI:
3,298,920, INT. CL. 35.
3,298,956, INT. CL. 35.
- PROGRESS LIGHTING INC., PHILADELPHIA, PA:
1,458,228, REN. 8-17-07. INT. CL. 11.
- PROJECTCLUB, VILLENEUVE D'ASCQ, FRANCE:
3,297,411, PUB. 7-10-2007. INT. CL. 28.
- PROLONG PHARMACEUTICALS, INC., MONMOUTH
JUNCTION, NJ:
3,299,299, INT. CL. 5.
- PROMEDIA TECHNOLOGIES, INC., ONTARIO, CA:
3,300,008, INT. CL. 9.
- PROMOTION IN MOTION, INC., CLOSTER, NJ:
2,404,491, CANC. INT. CL. 30.
- PROPETRO SERVICES, INCORPORATED, MIDLAND, TX:
3,300,378, INT. CL. 40.
- PROPEX GEOSOLUTIONS CORPORATION, AUSTELL, GA,
SYNTHETIC INDUSTRIES, INC., CHICKAMAUGA, GA:
2,083,261, REN. 8-23-07. INT. CL. 19.
- PROPPER MANUFACTURING COMPANY, INC., LONG
ISLAND CITY, NY:
833,431, REN. 8-17-07. U.S. CL. 44 (INT. CL. 10).
- PROSTIC, MERRY, MISSION HILLS, KS:
3,299,294, INT. CL. 36.
- PROTATECH, LLC, NORTHRIDGE, CA:
3,297,770, PUB. 7-10-2007. INT. CL. 42.
- PROTECT-A-CHILD POOL FENCE SYSTEMS, INC., POM-
PANO BEACH, FL:
1,455,741, REN. 8-22-07. INT. CL. 37.
- PROVADO TECHNOLOGIES, INC., GAINESVILLE, FL:
3,298,872, MULTIPLE CLASS, INT. CLS. 35, 37 AND 42.
- PROVIGENT LTD., HERZLIYA, ISRAEL:
3,297,641, PUB. 7-10-2007. INT. CL. 9.
- PRUDENTIAL INSURANCE COMPANY OF AMERICA,
THE, NEWARK, NJ:
1,481,897, REN. 8-17-07. INT. CL. 36.
- PRYCE, MICHAEL L., KENT, OH:
2,107,917, REN. 8-23-07. INT. CL. 10.
- PRYSMIAN CAVI E SISTEMI ENERGIA SRL, MILAN,
ITALY:
2,403,598, CANC. INT. CL. 9.
- PSYCHOLOGICAL ASSOCIATES, INC., ST. LOUIS, MO:
3,298,942, INT. CL. 41.
- PSYCHOLOGICAL CONSULTANTS TO INDUSTRY INC.,
PITTSBURGH, PA:
1,416,985, CANC. INT. CL. 41.
- PT COMPONENTS, INC., INDIANAPOLIS, IN:
220,199, CANC. U.S. CL. 13.
- PT METRICS, LLC, SIMI VALLEY, CA:
3,300,090, INT. CL. 28.
- PTW, HICKSVILLE, NY:
2,404,625, CANC. INT. CL. 10.
- PUBLIGROUPE S.A., 1005 LAUSANNE, SWITZERLAND:
3,296,742, PUB. 7-10-2007. MULTIPLE CLASS, INT. CLS.
16, 35 AND 41.
- PUBLIUS PRESS, INC., LOOKOUT MOUNTAIN, TN:
3,299,298, MULTIPLE CLASS, INT. CLS. 9, 16 AND 41.
- PUCHIBAG, INC., WEST HOLLYWOOD, CA:
3,300,135, INT. CL. 18.
- PULLARA, ANDREA L., SEFFNER, FL, DBA THE BOON-
DOCKS COLLECTION, LTD. AND SMITH, CAROLYN
RENEE, SEFFNER, FL, DBA THE BOONDOCKS COLLEC-
TION, LTD.:
2,015,856, CANC. INT. CL. 28.
- PULP, LONDON, W10 5PS, ENGLAND:
2,403,679, CANC. MULTIPLE CLASS, INT. CLS. 9 AND
41.
- PULSE 360, INC., GETZVILLE, NY:
3,299,052, INT. CL. 35.
- PUNCH INC., EAST PROVIDENCE, RI:
3,296,824, PUB. 7-10-2007. INT. CL. 41.
- PURE FISHING, INC., SPIRIT LAKE, IA:
3,299,119, INT. CL. 28.
3,300,117, INT. CL. 28.
- PURESYN, INC., MALVERN, PA:
2,133,763, REN. 8-17-07. INT. CL. 5.
- PURINA MILLS, INC., ST. LOUIS, MO TO PURINA MILLS
LLC, ARDEN HILLS, MN:
2,015,237, CANC. INT. CL. 31.
- PUSATERI, INC., STUART, FL:
3,297,005, PUB. 7-10-2007. INT. CL. 43.
- PUZIREVS PAVELS, RIGA, ZEMGALE, LATVIA:
3,297,743, PUB. 7-10-2007. INT. CL. 9.
- PYRAMID BREWERIES INC., SEATTLE, WA:
2,014,869, CANC. INT. CL. 32.
- Q L ENTERPRISES, INC., DULUTH, GA:
3,296,998, PUB. 7-10-2007. INT. CL. 9.
- QANTAS AIRWAYS LIMITED, NEW SOUTH WALES 2020,
AUSTRALIA:
2,403,071, CANC. INT. CL. 16.
2,403,072, CANC. INT. CL. 42.
- QIAGEN GMBH, 40724 HILDEN, FED REP GERMANY:
3,297,334, PUB. 7-10-2007. MULTIPLE CLASS, INT. CLS.
1, 5, 9 AND 42.
- QMAX SYSTEMS, LLC, CHINO, CA:
3,296,651, PUB. 7-10-2007. INT. CL. 3.
- QUAD/GRAPHICS, INC., PEWAUKEE, WI:
1,417,038, CANC. INT. CL. 42.
- QUAKER OATS COMPANY, THE, CHICAGO, IL:
3,300,021, INT. CL. 30.
- QUALCOMM INCORPORATED, SAN DIEGO, CA:
2,014,820, CANC. INT. CL. 9.

- QUALI-PLUS INTERNATIONAL INC., NEW YORK, NY:
DBA QUALITY DESIGN:
2,404,086, CANC. INT. CL. 14.
- QUALIGENCE, INC., LIVONIA, MI:
3,297,075, PUB. 7-10-2007. INT. CL. 35.
- QUALITY EDGE, INC., MIDDLETOWN, OH:
3,299,908, INT. CL. 6.
- QUALITY FENCE BUILDERS, INC., AUBURN, WA:
3,300,282, INT. CL. 6.
- QUALITY VENEER & LUMBER, INC., SEATTLE, WA:
2,403,474, CANC. INT. CL. 19.
- QUALITYSMITH, INC., WALLA WALLA, WA:
3,297,099, PUB. 7-10-2007. INT. CL. 35.
- QUANEX CORPORATION, HOUSTON, TX:
2,120,181. REN. 8-23-07. MULTIPLE CLASS, INT. CLS. 6
AND 40.
- QUANTITATIVE SERVICES GROUP LLC, NAPERVILLE,
IL:
3,296,679, PUB. 7-10-2007. INT. CL. 36.
- QUARTO, MILTON KEYNES MK17 8DF, UNITED KING-
DOM:
3,296,036, PUB. 7-10-2007. MULTIPLE CLASS, INT. CLS.
16 AND 41.
- QUEENSTAMP COMPANY LIMITED, ROAD TOWN, TOR-
TOLA, BR. VIRGIN ISLANDS:
3,299,564, MULTIPLE CLASS, INT. CLS. 2, 9 AND 16.
- QUEST CONSULTANTS INC., NORMAN, OK:
2,403,152, CANC. MULTIPLE CLASS, INT. CLS. 9 AND
42.
- QUEST NETWORK, INC., MINNEAPOLIS, MN:
3,297,504, PUB. 7-10-2007. INT. CL. 41.
- QUESTAR ASSESSMENT, INC., BREWSTER, NY:
3,296,751, PUB. 7-10-2007. MULTIPLE CLASS, INT. CLS.
16 AND 41.
- QUICK-4 MANAGEMENT INC., ONTARIO, CANADA:
2,404,464, CANC. INT. CL. 35.
- QUICKSILVER SOFTWARE INC., IRVINE, CA:
2,403,832, CANC. INT. CL. 42.
- QUIKSILVER, INC., HUNTINGTON BEACH, CA:
3,298,684, INT. CL. 41.
- QUINTAL RESEARCH, INC., PACIFICA, CA:
3,296,170, PUB. 7-10-2007. INT. CL. 9.
- QURESHI, ZAKIR HUSSAIN ALLARAKHA, SAN ANSEL-
MO, CA:
2,404,402, CANC. INT. CL. 41.
- QWEST COMMUNICATIONS INTERNATIONAL INC.,
DENVER, CO:
3,297,213, PUB. 7-10-2007. INT. CL. 35.
- R & A PREMIUM FOODS LLC, CARNATION, WA:
3,300,380, INT. CL. 30.
- R. J. GALLAGHER COMPANY, HOUSTON, TX:
1,416,393, CANC. INT. CL. 6.
- R. R. STREET & CO. INC., NAPERVILLE, IL:
2,080,581. REN. 8-23-07. MULTIPLE CLASS, INT. CLS. 1,
3 AND 7.
- R. S. MEANS COMPANY, INC., NEWTON, MA:
3,300,381, INT. CL. 35.
- R.H. FLANDERS, INC., SEBASTOPOL, CA:
2,404,047, CANC. MULTIPLE CLASS, INT. CLS. 16 AND
40.
- R&G GROUP INTERNATIONAL, INC., TORRANCE, CA:
3,296,522, PUB. 7-10-2007. MULTIPLE CLASS, INT. CLS. 7
AND 12.
- RAAB, DANIEL H., HOUSTON, TX:
2,403,546, CANC. INT. CL. 41.
- RAB LIGHTING INC., NORTHVALE, NJ:
2,016,587, CANC. INT. CL. 11.
2,016,588, CANC. INT. CL. 11.
3,298,039, PUB. 7-10-2007. INT. CL. 9.
- RADIOMETER ANALYTICAL S.A., LYON, FRANCE:
1,458,037. REN. 8-17-07. INT. CL. 9.
- RADISSON HOTELS INTERNATIONAL, INC., MINNEAPO-
LIS, MN:
2,404,067, CANC. INT. CL. 42.
- RADLEY CORPORATION, SOUTHFIELD, MI:
2,083,498. REN. 8-17-07. INT. CL. 9.
- RADNET, INC., LOS ANGELES, CA:
3,296,186, PUB. 7-10-2007. INT. CL. 44.
- RAGHORN, INC., KNOX, IN:
3,298,952, MULTIPLE CLASS, INT. CLS. 16 AND 41.
- RAGLAND MILLS, INC., NEOSHO, MO:
2,116,161. REN. 8-17-07. INT. CL. 31.
- RAINBOW GAMES, INC., WOODHAVEN, MI:
3,296,791, PUB. 7-10-2007. INT. CL. 28.
3,296,793, PUB. 7-10-2007. INT. CL. 28.
3,296,794, PUB. 7-10-2007. INT. CL. 28.
- RAINBOW VALLEY FIRE DEPARTMENT, L.L.C., LEA-
WOOD, KS:
3,299,004, INT. CL. 28.
- RAJKOWSKI HANSMEIER, LTD., ST. CLOUD, MN:
3,296,591, PUB. 7-10-2007. INT. CL. 42.
- RALCORP HOLDINGS, INC., ST. LOUIS, MO, RALSTON
FOODS, INC., ST. LOUIS, MO:
2,079,773. REN. 8-17-07. INT. CL. 30.
- RALLY MANUFACTURING INC., MIAMI, FL:
3,296,941, PUB. 7-10-2007. INT. CL. 12.
- RALLY MANUFACTURING, INC., MIAMI, FL:
3,298,968, INT. CL. 12.
- RAMAPO TOBACCO, LLC, RALEIGH, NC:
3,299,832, INT. CL. 34.
- RAMBACH ALAIN, FRANCE:
3,199,032, COR. INT. CL. 1.
- RAMIREZ MARTINEZ, D. JOSE, MADRID, SPAIN:
1,071,396. REN. 8-22-07. INT. CL. 15.
- RAMPART STANDARD CORP., NEW YORK, NY:
2,404,020, CANC. INT. CL. 41.
- RANBAXY PHARMECAUTICALS INC., PRINCETON, NJ:
431,884. REN. 8-23-07. U.S. CL. 18 (INT. CL. 5).
- RANDAZZO, DOTTIE, WOODLAND HILLS, CA:
3,300,263, INT. CL. 25.
- RANDOM HOUSE, INC., NEW YORK, NY:
2,118,679. REN. 8-18-07. INT. CL. 16.
- RANDOM LENGTHS PUBLICATIONS, INC., EUGENE, OR:
3,296,222, PUB. 7-10-2007. MULTIPLE CLASS, INT. CLS.
16 AND 35.
- RANGEFINDER PUBLISHING CO., INC., SANTA MONICA,
CA:
2,046,736, AM. INT. CL. 42.
- RAO'S SPECIALTY FOODS, INC., NEW YORK, NY:
3,296,297, PUB. 6-26-2007. MULTIPLE CLASS, INT. CLS.
29 AND 30.
- RARE NAMES, INC., WALTHAM, MA:
2,404,613, CANC. MULTIPLE CLASS, INT. CLS. 35 AND
38.
- RARE STONES, MOSCOW, RUSSIAN FED.:
3,296,493, PUB. 7-10-2007. MULTIPLE CLASS, INT. CLS.
14, 35, 36 AND 40.
- RASCOM; COMPUTERDISTRIBUTION GESMBH, A-1160
WIEN, AUSTRIA:
3,298,343, PUB. 7-10-2007. INT. CL. 9.
- RASTER MASCHINEN GMBH, MUHLACKER, FED REP
GERMANY:
1,375,506. REN. 8-23-07. INT. CL. 7.
- RATHJEN, KRIS M., MCLEAN, VA:
2,404,535, CANC. INT. CL. 21.
- RAUMEDIC AG, 95233 HELMBRECHTS, FED REP GER-
MANY:
3,298,172, PUB. 7-10-2007. MULTIPLE CLASS, INT. CLS.
10, 17 AND 42.
- RAVINDRA JHAVERI, HOLMDEL, NJ:
3,296,587, PUB. 7-10-2007. INT. CL. 3.
- RAWDIN, RICH S., SALT LAKE CITY, UT:
3,297,601, PUB. 7-10-2007. INT. CL. 35.
- RAWLINGS SPORTING GOODS COMPANY, INC., TULLA-
HOMA, WA:
3,298,839, INT. CL. 28.
- RAY GRIFFITHS INC, NEW YORK, NY:
3,296,817, PUB. 7-10-2007. MULTIPLE CLASS, INT. CLS.
40 AND 42.
- RAYCOM TV BROADCASTING, LLC, MONTGOMERY, AL:
2,403,215, CANC. INT. CL. 41.
- RAYMAC ASSOCIATES INC, LAS VEGAS, NV:
3,299,682, INT. CL. 44.
- RAYNALDO, GARZA, MONARCH BEACH, CA:
3,299,790, INT. CL. 41.

RAYPAK INC., OXNARD, CA:
3,297,964, PUB. 7-10-2007. INT. CL. 11.

RAYTHEON COMPANY, WALTHAM, MA:
3,299,152, INT. CL. 9.

RAZLETOVSKY, ALEX, MISSION VIEJO, CA:
3,299,125, INT. CL. 35.

RAZOR USA LLC, CERRITOS, CA:
3,298,027, PUB. 6-5-2007. INT. CL. 28.

RBC MINISTRIES, GRAND RAPIDS, MI:
3,299,009, MULTIPLE CLASS, INT. CLS. 9, 16 AND 41.

RBMARK, INC., WILMINGTON, DE:
1,422,742. REN. 8-23-07. INT. CL. 12.

RCN TELECOM HOLDING COMPANY, WILMINGTON, DE:
2,403,440, CANC. INT. CL. 38.

RDSK, INC., IRVINE, CA:
2,403,853, CANC. MULTIPLE CLASS, INT. CLS. 9 AND 42.

RE/MAX INTERNATIONAL, INC., DENVER, CO:
3,296,461, PUB. 7-10-2007. INT. CL. 36.

READY PRODUCTS L.L.C., LEWISVILLE, TX:
2,403,714, CANC. INT. CL. 2.

REAL CARBON FIBER, LLC, DAYTON, OH:
3,299,777, INT. CL. 12.

REAL ENTERPRISE SOLUTIONS NEDERLAND BV, NL-5215 MV DEN BOSCH, NETHERLANDS:
3,298,178, PUB. 7-10-2007. MULTIPLE CLASS, INT. CLS. 9, 16, 18, 21, 35, 38 AND 41.

REASON PICTURES LLC, WEST HOLLYWOOD, CA:
3,299,040, MULTIPLE CLASS, INT. CLS. 36 AND 41.

REBECCA BELL ELLIS, INC., SAN JOSE, CA:
3,299,462, INT. CL. 35.

REBIS, WALNUT CREEK, CA:
2,016,228, CANC. INT. CL. 9.

RECIPNEU - EMPRESA NACIONAL; DE RECICLAGEM DE PNEUS, LDA., PORTUGAL:
3,298,276, PUB. 7-10-2007. INT. CL. 17.

RECKITT BENCKISER INC., PARSIPPANY, NJ:
2,095,448. REN. 8-23-07. INT. CL. 5.

RECOTON CORPORATION, LONG ISLAND CITY, NY:
1,416,483, CANC. INT. CL. 9.

RECREATIONAL EQUIPMENT, INC., SUMNER, WA:
2,130,224. REN. 8-17-07. INT. CL. 35.
3,297,224, PUB. 6-13-2006. INT. CL. 25.

RECTOR AND VISITORS OF THE UNIVERSITY OF VIRGINIA, CHARLOTTESVILLE, VA:
3,296,173, PUB. 7-10-2007. INT. CL. 16.
3,296,174, PUB. 7-10-2007. INT. CL. 25.
3,296,175, PUB. 7-10-2007. INT. CL. 28.
3,296,176, PUB. 7-10-2007. INT. CL. 25.
3,296,177, PUB. 7-10-2007. INT. CL. 25.
3,296,178, PUB. 7-10-2007. INT. CL. 16.

RECTORSEAL CORPORATION, HOUSTON, TX:
3,298,803, INT. CL. 3.

RED LINE GRAPHICS, INC., INDIANAPOLIS, IN:
3,296,808, PUB. 7-10-2007. INT. CL. 40.

RED LINE SYNTHETIC OIL CORPORATION, BENICIA, CA:
2,167,363. REN. 8-17-07. INT. CL. 1.

RED RIBBON MEMORIES LLC, RACINE, WI:
3,299,064, INT. CL. 41.

RED SNAPPER, INC., DURANGO, CO:
1,425,259. REN. 8-23-07. INT. CL. 42.

RED TEAM INVESTIGATIONS, TUCSON, AZ:
3,297,302, PUB. 7-10-2007. INT. CL. 45.

REDBOX AUTOMATED RETAIL, LLC, OAKBROOK TERRACE, IL:
3,300,349, INT. CL. 41.

REDCART SOLUTIONS, LLC, NEW BRIGHTON, MN:
3,299,787, INT. CL. 9.

REDCATS, FRANCE:
3,298,295, PUB. 7-10-2007. MULTIPLE CLASS, INT. CLS. 16, 25 AND 35.

REDDING, COURTNEY LYNNE, NEW YORK, NY:
3,296,949, PUB. 7-10-2007. INT. CL. 35.

REDEMPTION PLUS, LENEXA, KS:
3,297,413, PUB. 7-10-2007. INT. CL. 35.

REDEX INDUSTRIES, INC., SALEM, OH:
2,112,719. REN. 8-17-07. INT. CL. 5.

REDI-TAG CORPORATION, CYPRESS, CA:
3,300,158, INT. CL. 16.
3,300,159, INT. CL. 16.

REDIEHS, GLEN H., CHARLOTTE, NC AND WEBB, LARRY E., WINTER GARDEN, FL:
3,297,643, PUB. 7-10-2007. INT. CL. 41.
3,297,645, PUB. 7-10-2007. INT. CL. 41.

REDLAW CORPORATION, FT. LAUDERDALE, FL:
1,416,589, CANC. INT. CL. 16.

REDMOND, INCORPORATED, HEBER CITY, UT:
3,297,128, PUB. 7-10-2007. INT. CL. 28.

REDSTONE FEDERAL CREDIT UNION COOPERATIVE SAVINGS AND LOAN CORPORATION, HUNTSVILLE, AL:
3,297,997, PUB. 7-10-2007. INT. CL. 36.

REED ELSEVIER PROPERTIES INC., WILMINGTON, DE:
3,296,859, PUB. 7-10-2007. INT. CL. 41.

REEDER, MONA L., SEBASTOPOL, CA, DBA AMAZING STAGING:
3,297,788, PUB. 7-10-2007. INT. CL. 42.

REEMTSMA CIGARETTENFABRIKEN GESELLSCHAFT MIT BESCHRANKTER HAFTUNG, 22605 HAMBURG, FED REP GERMANY:
2,403,261, CANC. INT. CL. 34.

REEVES BROTHERS, INC., SPARTANBURG, SC:
3,296,825, PUB. 7-10-2007. INT. CL. 16.

REGENERON PHARMACEUTICALS, INC., TARRYTOWN, NY:
1,933,337. REN. 8-20-07. INT. CL. 5.

REGENESIS BIOREMEDIATION PRODUCTS, SAN CLEMENTE, CA:
3,299,254, INT. CL. 1.

REGENT ALLIANCE INC., WALNUT, CA:
3,297,513, PUB. 7-10-2007. INT. CL. 21.

REGENT SPORTS CORPORATION, HAUPPAUGE, NY:
1,416,808, CANC. INT. CL. 28.

REGENTS OF THE UNIVERSITY OF MICHIGAN, ANN ARBOR, MI:
3,296,575, PUB. 7-10-2007. INT. CL. 21.

REGGIO CHILDREN - CENTRO INTERNAZIONALE PER LA DIFESA E LA PROMOZIONE DEI DIRITTI E DELLE POTENZIALITA' DI TUTTI I BAMBINI S.R.L., 42100 REGGIO EMILIA, ITALY:
2,098,531. REN. 8-20-07. MULTIPLE CLASS, INT. CLS. 9, 16, 41 AND 42.

REGIS INC., MINNEAPOLIS, MN:
2,404,502, CANC. INT. CL. 3.

REGIS, INC., MINNEAPOLIS, MN:
3,300,114, MULTIPLE CLASS, INT. CLS. 41 AND 44.

REH KENDERMANN GMBH WEINKELLEREI, FED REP GERMANY:
3,298,377, PUB. 7-10-2007. INT. CL. 33.

REHAU INCORPORATED, LEESBURG, VA:
2,082,233. REN. 8-17-07. INT. CL. 17.

REID, ROBERT L., CARROLLTON, GA:
3,296,531, PUB. 7-10-2007. INT. CL. 7.

REISNER, ROBERT J., CHICAGO, IL:
2,404,150, CANC. INT. CL. 28.

RELIANCE PLUMBING, SEWER, & DRAINAGE, INC., NORTHBROOK, IL:
3,297,666, PUB. 7-10-2007. INT. CL. 37.

REMEDYTEMP, INC., ALISO VIEJO, CA:
2,015,122, CANC. INT. CL. 35.

REMELE III, LEWIS A., MINNEAPOLIS, MN:
3,299,473, INT. CL. 25.

REMINGTON DIRECT, LP, FORT WORTH, TX:
3,299,771, MULTIPLE CLASS, INT. CLS. 5 AND 32.

REMOTES UNLIMITED, INC., STAFFORD, TX:
3,296,083, PUB. 7-10-2007. INT. CL. 9.

REMOTEVIDEO, LLC, OLATHE, KS:
3,300,241, INT. CL. 37.

REMY BUMPPO THEATRE COMPANY, CHICAGO, IL:
3,297,981, PUB. 7-10-2007. MULTIPLE CLASS, INT. CLS. 16, 25 AND 41.

RENAISSANCE HOTEL HOLDINGS, INC., BETHESDA, MD:
3,300,233, INT. CL. 43.

RENE BARGUEIRAS, INC., LOS ANGELES, CA:
2,103,624. REN. 8-20-07. INT. CL. 14.

- RENEE AUDRIA, INC., NEWPORT BEACH, CA:
2,404,238, CANC. INT. CL. 3.
- RENEGADE PRODUCTIONS, INC., HUNT VALLEY, MD:
3,296,200, PUB. 7-10-2007. INT. CL. 28.
- RENEGADE SYSTEMS INC, LARGO, FL:
2,404,102, CANC. INT. CL. 9.
- RENMEN LIMITED, PORTLAND, OR:
3,299,239, INT. CL. 35.
- RENO SCHUHCENTRUM GMBH, 66987 THALEISCHWEILER-FRÖSCHEN, FED REP GERMANY:
3,298,283, PUB. 7-10-2007. INT. CL. 35.
- RENSSELAERVILLE INSTITUTE, THE, RENSSELAERVILLE, NY:
2,403,248, CANC. INT. CL. 9.
- RENT-WAY, INC., PLANO, TX:
2,403,753, CANC. MULTIPLE CLASS, INT. CLS. 41 AND 42.
- RENTABILWEB EUROPE, LYON, FRANCE:
3,296,497, PUB. 7-10-2007. MULTIPLE CLASS, INT. CLS. 9, 38 AND 42.
- RENTBUREAU, LLC, ATLANTA, GA:
3,297,901, PUB. 7-10-2007. INT. CL. 35.
- REOWN, TARRA WILLIAMS, WAXAHACHIE, TX:
3,298,961, INT. CL. 25.
- REPLAY RECORDS, INC., NEW YORK, NY:
2,404,902, CANC. INT. CL. 9.
- REPRODUCTIVE MEDICINE AND SURGERY CENTER OF VIRGINIA, PLC, CHARLOTTESVILLE, VA:
3,300,264, INT. CL. 44.
- RESEARCH DIETS, INC., NEW BRUNSWICK, NJ:
3,296,747, PUB. 7-10-2007. INT. CL. 9.
- RESERVATIONSYSTEM.COM, INC, PANAMA CITY, FL:
3,297,507, PUB. 7-10-2007. MULTIPLE CLASS, INT. CLS. 39 AND 43.
- RESHAPING THE WORLD LLC, WEST BALDWIN, ME:
3,299,130, MULTIPLE CLASS, INT. CLS. 16, 25 AND 41.
- RESOURCES CONNECTION INC., COSTA MESA, CA:
3,298,841, INT. CL. 35.
- RESPONSIVE SOLUTIONS INC., ST. PETERSBURG, FL:
3,297,681, PUB. 7-10-2007. INT. CL. 9.
- RESTONIC CORPORATION, CHICAGO, IL:
1,416,678, CANC. INT. CL. 20.
- RESTORATION RESOURCES, ROCKLIN, CA:
3,296,392, PUB. 7-10-2007. INT. CL. 42.
- RETAIL BRAND ALLIANCE, INC., ENFIELD, CT:
3,299,780, INT. CL. 25.
3,299,781, INT. CL. 25.
- RETAIL VENTURES LICENSING, INC., COLUMBUS, OH:
2,016,560, CANC. INT. CL. 25.
- RETECASA S.P.A., ITALY:
3,298,220, PUB. 7-10-2007. MULTIPLE CLASS, INT. CLS. 35 AND 36.
- RETINA ASSOCIATES, P.S.C., LOUISVILLE, KY, DBA THE EYE CARE INSTITUTE:
3,300,277, INT. CL. 44.
- RETIREMENT ADVISORS OF AMERICA, INC., DALLAS, TX:
2,015,838, CANC. INT. CL. 16.
- REVERA INCORPORATED, SUNNYVALE, CA:
3,299,597, INT. CL. 9.
- REVERMAN, ARDYS U., SUN RIVER, OR:
3,297,341, PUB. 7-10-2007. INT. CL. 16.
- REVLON CONSUMER PRODUCTS CORPORATION, NEW YORK, NY:
3,299,652, INT. CL. 3.
3,299,901, INT. CL. 3.
- REVOLT AMPS, LTD., CHICAGO, IL:
3,299,076, INT. CL. 9.
- REWARDSNOW, INC., DOVER, NH:
3,296,096, PUB. 7-10-2007. INT. CL. 35.
- REX INC., RICHMOND HILL, ONTARIO, CANADA:
2,404,772, CANC. INT. CL. 30.
- REXAIR, INC., TROY, MI:
1,436,270, REN. 8-23-07. INT. CL. 9.
1,476,692, REN. 8-23-07. INT. CL. 9.
- REXNORD CORPORATION, MILWAUKEE, WI:
1,416,422, CANC. INT. CL. 7.
- REYES, DAVID G, SAN DIEGO, CA:
3,297,016, PUB. 7-10-2007. INT. CL. 35.
- REZOLIN, LLC, ORMOND BEACH, FL, APPLIED PLASTICS CO., INC., EL SEGUNDO, CA, DBA THE BIGGS COMPANY:
1,075,020, REN. 8-17-07. INT. CL. 19.
- RFL ELECTRONICS INC., BOONTON TOWNSHIP, NJ:
3,297,906, PUB. 7-10-2007. INT. CL. 9.
- RGLOBE, SAN FRANCISCO, CA:
3,299,656, INT. CL. 42.
- RHEEM MANUFACTURING COMPANY, ATLANTA, GA:
2,125,860, REN. 8-17-07. INT. CL. 11.
2,403,505, CANC. INT. CL. 35.
- RHEUMINATIONS, INC., NEW YORK, NY:
3,300,211, INT. CL. 16.
- RIBS KING, INC., CINCINNATI, OH:
3,298,095, PUB. 7-10-2007. MULTIPLE CLASS, INT. CLS. 29, 30, 35 AND 43.
- RICH IN LOVE CHARITY, INC., NEW YORK, NY:
3,296,966, PUB. 7-10-2007. INT. CL. 36.
- RICHARD LEBOUF ENTERTAINMENT, LLC, JENNINGS, LA:
3,299,166, INT. CL. 30.
3,299,167, INT. CL. 30.
- RICHARD VOSS GRUBENAUSSBAU GMBH, 5840 SCHWERTE, FED REP GERMANY:
2,015,974, CANC. INT. CL. 7.
- RICHARDSON & ASSOCIATES, INC., COLUMBUS, IN:
3,296,182, PUB. 7-10-2007. INT. CL. 36.
- RICHMOND BAKING CO., RICHMOND, IN:
3,298,066, PUB. 7-10-2007. INT. CL. 30.
- RICO'S PIZZA, INC., SACRAMENTO, CA, RICO'S ENTERPRISES, INC., CARMICHAEL, CA:
1,080,646, REN. 8-23-07. INT. CL. 42.
- RIDLEY U.S. HOLDINGS, INC., MANKATO, MN:
3,299,716, INT. CL. 5.
- RIGHT MEDIA INC., NEW YORK, NY:
3,299,581, INT. CL. 42.
- RIGHTANSWERS, LLC, CLARK, NJ:
3,300,081, INT. CL. 42.
- RIGHTEOUS MOVEMENT, LLC, AUBURN HILLS, MI:
3,296,264, PUB. 7-10-2007. INT. CL. 25.
- RILEY POWER INC., WORCESTER, MA, RILEY COMPANY, THE, PARK RIDGE, IL:
1,072,112, REN. 8-17-07. INT. CL. 7.
- RING & PINION SERVICE, INC., EVERETT, WA:
3,300,352, INT. CL. 12.
- RINGLEADER CLOTHING, LLC, FALLS CHURCH, VA:
3,299,898, INT. CL. 25.
- RIO EYEWEAR GROUP, INC., ORLANDO, FL:
2,403,856, CANC. INT. CL. 9.
- RIO GRANDE VALLEY PUBLISHING, INC., MCALLEN, TX:
2,404,285, CANC. INT. CL. 16.
- RIO'S PET SPA & BOARDING, INC., NORTH MIAMI, FL:
3,298,054, PUB. 7-10-2007. INT. CL. 43.
- RITZ CAMERA CENTERS, INC., BELTSVILLE, MD:
3,295,984, PUB. 7-10-2007. INT. CL. 35.
- RIVADENEYRA, DAVID ALEXANDER, WITTMANN, AZ:
3,296,888, PUB. 7-10-2007. INT. CL. 16.
- RIVER HORSE BREWING COMPANY, LAMBERTVILLE, NJ:
2,079,664, REN. 8-17-07. MULTIPLE CLASS, INT. CLS. 25 AND 32.
- RIVER'S END HOLDINGS, LLC, HOPKINS, MN:
3,299,383, MULTIPLE CLASS, INT. CLS. 25 AND 35.
- RIVERCREST INDUSTRIES, INC., HOUSTON, TX, RIVERCREST INDUSTRIES, INC., HOUSTON, TX:
2,081,826, REN. 8-17-07. INT. CL. 14.
2,081,827, REN. 8-17-07. INT. CL. 21.
- RIVERS, MELISSA, NEW YORK, NY:
2,404,694, CANC. INT. CL. 14.
- RIVERSIDE FURNITURE CORPORATION, FORT SMITH, AR:
1,416,659, CANC. INT. CL. 20.
- RIVERSIDE REFRACTORIES, INC., PELL CITY, AL:
2,016,242, CANC. INT. CL. 37.

RIVIERA OPERATING CORPORATION, LAS VEGAS, NV:
2,404,697, CANC. INT. CL. 41.

RIWA LIMITED, STOCKPORT, ENGLAND:
3,267,502, CANC. IIRN. RESTORED TO S.N. 77-009,230.

RK NETMEDIA, INC., MIAMI BEACH, FL:
3,296,585, PUB. 7-10-2007. INT. CL. 41.
3,296,694, PUB. 7-10-2007. INT. CL. 41.

RMD, INC., FREDERICK, MD:
3,296,199, PUB. 7-10-2007. INT. CL. 35.

RMK ACCESSORIES, INC., CRANBERRY TOWNSHIP, PA:
3,296,268, PUB. 7-10-2007. INT. CL. 18.
3,296,269, PUB. 7-10-2007. INT. CL. 18.

RMS PRODUCTS, SAN JOSE, CA:
3,297,202, PUB. 7-10-2007. INT. CL. 20.

RNB ENTERTAINMENT GROUP, INC., SAN FRANCISCO, CA:
3,299,825, MULTIPLE CLASS, INT. CLS. 9 AND 41.
3,300,341, MULTIPLE CLASS, INT. CLS. 9 AND 41.

RNH ENTERPRISES, LA JOLLA, CA:
1,416,954, CANC. INT. CL. 37.

ROAD SERVICES INTERNATIONAL LTD., BURLINGTON, ONTARIO, CANADA:
3,298,791, INT. CL. 2.

ROANE, KIT R, BROOKLYN, TX AND ROANE, SAMUEL L. R., BROOKLYN, NY:
3,300,328, MULTIPLE CLASS, INT. CLS. 35 AND 41.

ROBBINS INDUSTRIES, INC., FLORENCE, AL:
2,113,275, REN. 8-17-07. INT. CL. 21.

ROBERT CRAIG WINERY, L.P., NAPA, CA:
2,150,928, REN. 8-17-07. INT. CL. 33.

ROBERT DAMKJAER A/S, HADERSLEV, DENMARK:
3,297,314, PUB. 7-10-2007. INT. CL. 29.

ROBERT GRANATT AND JOHN CHAN, NEW YORK, NY:
2,404,109, CANC. INT. CL. 25.

ROBERT KRUPS GMBH & CO. KG, 42719 SOLINGEN, FED REP GERMANY:
2,403,643, CANC. MULTIPLE CLASS, INT. CLS. 11 AND 21.

ROBERT ROOK CHILDRENS TRUST, BROOKLINE VIL-LAGE, MA:
1,971,168, REN. 8-17-07. INT. CL. 30.

ROBERT WOOD JOHNSON FOUNDATION, THE, PRINCE-TON, NJ:
2,153,734, REN. 8-23-07. INT. CL. 36.

ROBINSON OUTDOOR PRODUCTS, LLC, CANNON FALLS, MN:
3,298,782, INT. CL. 25.

ROBINSON, DEE, FAIRBURN, GA:
3,297,968, PUB. 7-10-2007. INT. CL. 41.

ROBOTOOLZ LIMITED, KWUN TONG, KOWLOON, HONG KONG:
3,299,524, INT. CL. 9.
3,299,525, INT. CL. 9.

ROBSON COMMUNITIES, INC., SUN LAKES, AZ:
3,297,249, PUB. 4-3-2007. MULTIPLE CLASS, INT. CLS. 35, 41 AND 43.

ROCK PAINT DISTRIBUTING CORP., MILTON, WI:
2,123,612, REN. 8-23-07. INT. CL. 2.
2,123,637, REN. 8-23-07. INT. CL. 2.

ROCKFIT INDUSTRIES LLC, WINTER GARDEN, FL:
3,299,775, INT. CL. 28.

ROCKINGHAM MUTUAL INSURANCE COMPANY, HAR-RISONBURG, VA:
2,106,517, REN. 8-20-07. INT. CL. 36.

ROCKIT RANCH PRODUCTIONS, INC., CHICAGO, IL:
3,297,886, PUB. 7-10-2007. MULTIPLE CLASS, INT. CLS. 35 AND 41.

ROCKOW, BRUCE C., PLAINFIELD, IL:
3,296,590, PUB. 7-10-2007. INT. CL. 30.

ROCKY BRANDS, INC., NELSONVILLE, OH:
3,298,813, INT. CL. 25.

ROCKY MOUNTAIN INSTITUTE, SNOWMASS, CO:
3,296,807, PUB. 7-10-2007. INT. CL. 35.
3,297,070, PUB. 7-10-2007. INT. CL. 35.

ROCKY MOUNTAIN VITAMINS, INC, FT. COLLINS, CO:
3,297,241, PUB. 7-10-2007. INT. CL. 5.

RODGERS, SHEILA, TOPSFIELD, MA:
3,296,893, PUB. 7-10-2007. INT. CL. 35.

ROEHL, LANCE, SANTA CLARA, CA:
3,297,809, PUB. 5-22-2007. INT. CL. 25.

ROELAND ENTERPRISES, ROCKAWAY, NJ:
3,298,692, INT. CL. 37.

ROGERS, JENNIFER L., LIVERMORE, CA:
3,296,069, PUB. 7-10-2007. INT. CL. 3.

ROGERS, WALLACE, JR., SAN ANTONIO, TX AND RO-GERS, MARY, SAN ANTONIO, TX:
2,071,846, REN. 8-18-07. INT. CL. 41.

ROGUE, LLC, WESTBROOK, CT:
3,297,967, PUB. 7-10-2007. INT. CL. 28.

ROI ENTERTAINMENT, INC., HOUSTON, TX:
2,403,140, CANC. MULTIPLE CLASS, INT. CLS. 41 AND 42.

ROMANTIC FLAG CO., LTD., SEOUL, REPUBLIC OF KOREA:
3,296,056, PUB. 7-10-2007. INT. CL. 25.

RON JON SURF SHOP OF FLA., INC., COCOA BEACH, FL:
3,296,074, PUB. 7-10-2007. MULTIPLE CLASS, INT. CLS. 14, 21, 24, 25, 28, 32, 35 AND 43.
3,298,592, INT. CL. 25.

ROONGTA EITEL, BELA S., MILWAUKEE, WI:
3,296,275, PUB. 7-10-2007. INT. CL. 25.

ROPEWORKS INDUSTRIAL GROUP, INC., RENO, NV:
3,296,688, PUB. 7-10-2007. MULTIPLE CLASS, INT. CLS. 35 AND 41.

ROSANNA AKUTU, LONDON, UNITED KINGDOM:
3,297,909, PUB. 7-10-2007. MULTIPLE CLASS, INT. CLS. 29, 30, 32 AND 43.

ROSEE COSMETICS CO., LTD., KANGNAM-GU, SEOUL, REPUBLIC OF KOREA:
2,404,342, CANC. INT. CL. 3.
2,404,343, CANC. INT. CL. 3.

ROSEN SWISS AG, 6370 STANS, SWITZERLAND:
3,297,393, PUB. 7-10-2007. INT. CL. 9.

ROSENUIST - GESTAO E SERVIÇOS, LDA., PORTUGAL:
3,298,239, PUB. 7-10-2007. MULTIPLE CLASS, INT. CLS. 18 AND 25.

ROSEVILLE TELEPHONE FOUNDATION, ROSEVILLE, CA:
2,403,091, CANC. INT. CL. 36.

ROSS NUT CO., NORTHFIELD, IL:
2,083,752, REN. 8-22-07. INT. CL. 30.

ROSS, ANDREA, NEW YORK, NY:
2,162,134, REN. 8-23-07. INT. CL. 16.

ROTHSTEIN, NANCY, WILMETTE, IL:
3,296,184, PUB. 7-10-2007. INT. CL. 44.

ROTHSTEIN, ROBIN, ROCKVILLE, MD:
2,404,338, CANC. INT. CL. 25.

ROU TONG CHEN FOOD FACTORY OF FARMERS' ASSOCIATION, I LAN HSIEN, TAIWAN:
1,449,909, REN. 8-23-07. INT. CL. 29.

ROULLIARD, WENDY W., NANTUCKET, MA, BATTIS, GEORGE N., ST. PAUL, MN:
833,824, REN. 8-22-07. U.S. CL. 107 (INT. CL. 41).

ROUNDY'S SUPERMARKETS, INC., MILWAUKEE, WI:
1,416,822, CANC. MULTIPLE CLASS, INT. CLS. 29, 30 AND 32.

ROUNTREE III, LEON HENDERSON, OAKLAND, CA:
2,404,926, CANC. INT. CL. 36.

ROUSH, GAVIN, DILLWYN, VA:
3,297,973, PUB. 7-10-2007. INT. CL. 35.

ROWE TECHNOLOGIES, INC, GOLDEN, CO:
3,300,039, INT. CL. 9.

ROXANNE HUTTON, FAIRWAY, KS:
3,296,267, PUB. 7-10-2007. INT. CL. 30.

ROY, SPEED & ROSS LTD., BURLINGTON, CANADA:
3,297,472, PUB. 7-10-2007. MULTIPLE CLASS, INT. CLS. 35 AND 40.

ROYAL CANIN U.S.A., INC., ST. CHARLES, MO:
3,298,747, INT. CL. 31.

ROYAL CONSUMER INFORMATION PRODUCTS, INC., SOMERSET, NJ:
3,299,357, INT. CL. 16.

ROYAL OAK SALES, INC., ROSWELL, GA:
1,450,298, REN. 8-21-07. INT. CL. 4.

ROYAL ORDNANCE PLC, CHORLEY LANCASHIRE PR7 6AD, ENGLAND:
2,403,222, CANC. INT. CL. 9.

- ROYAL PRODUCTS, INC., SCOTTSDALE, AZ:
2,016,249, CANC. INT. CL. 5.
- ROYAL WINE CORPORATION, BAYONNE, NJ:
3,299,049, INT. CL. 33.
3,299,984, INT. CL. 33.
- RPL EXPENSE MANAGEMENT SERVICES, INC.,
DRESHER, PA:
2,404,945, CANC. INT. CL. 9.
- RRR COMPANY (HONG KONG) LIMITED, HONG KONG,
HONG KONG:
3,299,113, INT. CL. 22.
- RTC INDUSTRIES, INC., ROLLING MEADOWS, IL:
3,297,682, PUB. 7-10-2007. INT. CL. 20.
- RUBB, LLC, SAN DIEGO, CA, DBA RUBB, INC.:
2,404,344, CANC. INT. CL. 3.
2,404,345, CANC. INT. CL. 3.
2,404,347, CANC. INT. CL. 3.
2,404,348, CANC. INT. CL. 3.
2,404,349, CANC. INT. CL. 3.
2,404,350, CANC. INT. CL. 3.
2,404,351, CANC. INT. CL. 3.
- RUBBER & GASKET COMPANY OF AMERICA, INC.,
NORTH LITTLE ROCK, AR:
3,297,841, PUB. 7-10-2007. MULTIPLE CLASS, INT. CLS.
35, 37 AND 40.
3,297,842, PUB. 7-10-2007. MULTIPLE CLASS, INT. CLS.
35, 37 AND 40.
- RUBBER MILLERS, INC., BALTIMORE, MD:
1,417,054, CANC. INT. CL. 7.
- RUBENSTEIN BROS., INC., NEW ORLEANS, LA:
2,015,918, CANC. INT. CL. 25.
- RUBICON, INC., NASHVILLE, TN:
2,404,755, CANC. INT. CL. 9.
- RUBIN, ALAN, WESTON, FL:
3,299,971, INT. CL. 34.
- RUENTEX INDUSTRIES LTD., TAIPEI, TAIWAN:
3,298,546, INT. CL. 24.
- RUFF HEWN LIMITED PARTNERSHIP, HIGH POINT, NC:
1,416,741, CANC. INT. CL. 25.
- RUGGED PRODUCTS LLC, JUPITER, FL, DBA ISLAND
DOG:
3,296,649, PUB. 7-10-2007. INT. CL. 25.
- RULE 66, LLC, ESCONDIDO, CA:
3,300,361, INT. CL. 25.
- RUNSTADLER, DREW, WOODSTOCK, GA:
3,297,112, PUB. 7-10-2007. INT. CL. 41.
- RUSLYN HOLDINGS PTY LTD, KIRRAWEE DC, AUSTRA-
LIA:
3,296,252, PUB. 7-10-2007. INT. CL. 9.
- RUSSELL CORPORATION, ATLANTA, GA:
2,016,528, CANC. INT. CL. 28.
3,299,083, INT. CL. 28.
- RUTKOWSKI, LAURA S, PERKASIE, PA:
3,296,733, PUB. 7-10-2007. INT. CL. 14.
- RV INDUSTRIES, INC., DORAVILLE, GA:
2,085,845, REN. 8-21-07. INT. CL. 29.
- RX MUSCLE, INC., SEAFORD, NY:
3,296,889, PUB. 7-10-2007. INT. CL. 5.
3,296,890, PUB. 7-10-2007. INT. CL. 5.
- RYLO, INC, SPEARFISH, SD:
3,300,011, INT. CL. 16.
- R2 CREATIONS, INC., MINNEAPOLIS, MN:
2,403,836, CANC. INT. CL. 25.
- S & H INDUSTRIES, INC., CLEVELAND, OH:
2,105,265, REN. 8-23-07. INT. CL. 7.
- S & P TECHNOLOGIES, INC., MANLIUS, NY:
3,300,289, INT. CL. 42.
- S A S SAFETY CORP., SIGNAL HILL, CA:
3,297,453, PUB. 7-10-2007. INT. CL. 21.
- S. A. ARMSTRONG LIMITED, SCARBOROUGH, CANADA:
3,297,786, PUB. 7-10-2007. INT. CL. 7.
- S. B. RESTAURANT, LA MIRADA, CA:
1,417,002, CANC. INT. CL. 42.
- S. C. JOHNSON & SON, INC., RACINE, WI:
2,116,444, REN. 8-17-07. INT. CL. 3.
3,299,105, INT. CL. 5.
3,299,106, INT. CL. 5.
3,299,162, INT. CL. 3.
- S. C. JOHNSON HOME STORAGE, INC., RACINE, WI:
2,404,665, CANC. INT. CL. 16.
- S.A.H.F.F.F. HAUT FOURNEAU, FORGES ET FONDERIES,
08380 SIGNY LE PETIT, FRANCE:
2,014,733, CANC. MULTIPLE CLASS, INT. CLS. 20 AND
21.
- S.B.D., INC., ROWLETT, TX:
2,403,730, CANC. INT. CL. 9.
- S.C. JOHNSON & SON, INC., RACINE, WI:
1,461,536, REN. 8-17-07. INT. CL. 1.
2,091,413, REN. 8-17-07. INT. CL. 3.
- S.T.CHEMICAL CO., LTD., TOKYO, JAPAN:
3,297,220, PUB. 12-5-2006. MULTIPLE CLASS, INT. CLS. 5
AND 11.
- S&G HAMPTON SUN LLC, NEW YORK, NY:
3,299,088, INT. CL. 3.
- S&L MARKETING GROUP, MIAMI, FL:
3,296,511, PUB. 7-10-2007. INT. CL. 9.
- S&S CYCLE, INC., LACROSSE, WI:
3,297,166, PUB. 7-10-2007. INT. CL. 12.
- S-N MERGER CORP., RESTON, VA:
2,403,310, CANC. INT. CL. 38.
- SAATI S.P.A., APPIANO GENTILE (COMO), ITALY:
2,092,613, REN. 8-18-07. MULTIPLE CLASS, INT. CLS. 1
AND 24.
- SABAN ENTERTAINMENT, INC., LOS ANGELES, CA:
2,404,526, CANC. INT. CL. 25.
- SABMILLER INTERNATIONAL B.V., NETHERLANDS:
3,298,289, PUB. 7-10-2007. INT. CL. 32.
3,298,290, PUB. 7-10-2007. INT. CL. 32.
3,298,296, PUB. 7-10-2007. INT. CL. 32.
- SAC SARTORI S.R.L., 35044 MONTAGNANA, PADOVA,
ITALY:
2,403,081, CANC. INT. CL. 28.
- SACKMANN, STEVEN, TEMPLETON, CA:
3,297,492, PUB. 7-10-2007. INT. CL. 29.
- SAE INTERNATIONAL, WARENDALE, PA:
1,431,541, REN. 8-17-07. INT. CL. 41.
- SAFCO PRODUCTS COMPANY, MINNEAPOLIS, MN:
3,299,095, INT. CL. 20.
- SAFECO CORPORATION, SEATTLE, WA:
1,092,487, REN. 8-17-07. INT. CL. 36.
- SAFETRACK INFRASYSTEMS SISAB AB, SWEDEN:
3,298,185, PUB. 7-10-2007. MULTIPLE CLASS, INT. CLS.
6, 7 AND 9.
- SAFETY CENTRE LTD., THE, WINNIPEG, MANITOBA,
R3E 3G8, CANADA:
2,312,212, CANC. INT. CL. 9.
- SAFETY HELMETS CANADA, INC., MEMPHIS, TN:
3,298,865, INT. CL. 9.
- SAFETY LADY LLC, LAS VEGAS, NV:
3,297,670, PUB. 7-10-2007. MULTIPLE CLASS, INT. CLS.
9, 16, 41 AND 45.
- SAFETY SOLUTION CONSULTANTS, INC., EAST GRAN-
BY, CT:
3,298,077, PUB. 7-10-2007. INT. CL. 41.
- SAFEWAY INC., PLEASANTON, CA:
3,296,068, PUB. 7-10-2007. INT. CL. 33.
3,296,137, PUB. 7-10-2007. INT. CL. 33.
3,298,412, INT. CL. 33.
3,298,515, MULTIPLE CLASS, INT. CLS. 29, 30, 31 AND
32.
- SAGE LEADERSHIP PARTNERS, INC., MURFREESBORO,
TN:
3,296,282, PUB. 7-10-2007. INT. CL. 41.
- SAGEVIEW CAPITAL L.L.C., GREENWICH, CT:
3,299,459, INT. CL. 36.
- SAGINAW INFORMATION MANAGEMENT SERVICES
(S.I.M.S.), SAGINAW, MN:
2,016,368, CANC. INT. CL. 7.
- SAINT THOMAS HEALTH SERVICES, NASHVILLE, TN:
3,296,874, PUB. 7-10-2007. INT. CL. 44.
- SAINT-GOBAIN PERFORMANCE PLASTICS CORPORA-
TION, AURORA, OH:
830,482, REN. 8-17-07. U.S. CL. 15 (INT. CL. 4).

- SAINT-GOBAIN PERFORMANCE PLASTICS CORPORATION, WAYNE, NJ, SANITARY COUPLERS, INC., SPRINGBORO, OH:
2,076,674. REN. 8-23-07. MULTIPLE CLASS, INT. CLS. 6 AND 17.
- SAINT-GOBAIN PERFORMANCE PLASTICS CORPORATION, AURORA, OH:
3,298,817, INT. CL. 10.
3,298,941, MULTIPLE CLASS, INT. CLS. 9 AND 10.
- SAINT-GOBAIN SULLY, SULLY SUR LOIRE, FRANCE:
3,297,319, PUB. 7-10-2007. MULTIPLE CLASS, INT. CLS. 12 AND 21.
- SALADYGA, KEVIN, GEORGETOWN, PA:
3,297,387, PUB. 7-10-2007. INT. CL. 35.
- SALESGEN CORP, BEVERLY HILLS, CA:
3,299,520, INT. CL. 35.
- SALETNIK, PAULA, CAVE CREEK, AZ:
3,299,074, INT. CL. 9.
- SALINAS, RAYMOND R., ELKHORN, NE:
3,296,179, PUB. 7-10-2007. INT. CL. 30.
- SALISBURY ELECTRICAL SAFETY L.L.C., SKOKIE, IL:
1,416,433, CANC. INT. CL. 8.
- SALLIE MAE, INC., RESTON, VA:
3,300,285, INT. CL. 36.
- SALON OF NEW YORK LTD., NEW YORK, NY:
1,487,908. REN. 8-18-07. INT. CL. 42.
- SALSA SEVEN INC., THE, GREAT NECK, NY:
3,300,323, INT. CL. 18.
- SALSAS CASTILLO S.A. DE C.V., HERMOSILLO, MEXICO:
3,297,789, PUB. 7-10-2007. INT. CL. 32.
- SALSTEIN, JASON, MIAMI, FL AND CORONA, DANIELLE, CORAL GABLES, FL:
3,299,509, INT. CL. 18.
- SALT CREEK, INC., SALT LAKE CITY, UTAH 84104, UT:
1,448,761. REN. 8-17-07. INT. CL. 31.
- SALTFLY, LLC, SALT LAKE CITY, UT:
3,296,412, PUB. 7-10-2007. INT. CL. 43.
- SALVATI, ALLISON, NORWALK, CT:
3,296,882, PUB. 7-10-2007. INT. CL. 21.
- SALVATTO, WANDA, VALLEJO, CA:
3,297,994, PUB. 7-10-2007. INT. CL. 25.
- SAM BISER PRESS, INC., LOS ANGELES, CA:
3,298,732, MULTIPLE CLASS, INT. CLS. 41 AND 44.
- SAM MOULTRIE, II, PARSIPPANY, NJ:
3,297,370, PUB. 7-10-2007. INT. CL. 35.
- SAMABALY, ALY, MEDINA, OH:
3,298,481, INT. CL. 25.
- SAMANTHA B., INC., MELVILLE, NY:
3,296,454, PUB. 7-10-2007. INT. CL. 30.
- SAMESKY, INC., OAKLAND, CA:
2,403,252, CANC. INT. CL. 35.
- SAMSUNG AMERICA, INC., RIDGEFIELD PARK, NJ:
3,298,889, INT. CL. 10.
- SAMY MARK, INC., MIAMI, FL:
3,299,399, INT. CL. 3.
- SAN FERNANDO BEAUTY ACADEMY, PANORAMA CITY, CA:
3,297,621, PUB. 7-10-2007. INT. CL. 41.
- SAN FRANCISCO PROMENADE, INC., MILL VALLEY, CA:
2,156,772. REN. 8-22-07. INT. CL. 16.
- SANBON, INC., EL CENTRO, CA:
3,300,351, INT. CL. 31.
- SANCHEZ/NITZBERG, INC., BROOKLYN, NY:
2,404,759, CANC. INT. CL. 40.
- SANDART FOODS, L.L.C., WEST BLOOMFIELD, MI:
2,404,589, CANC. INT. CL. 30.
- SANDISK CORPORATION, MILPITAS, CA:
3,299,400, INT. CL. 9.
- SANDOW, ADAM I., BOCA RATON, FL:
3,298,626, INT. CL. 44.
- SANDVIK TAMROCK OY, TAMPERE, FINLAND:
3,297,414, PUB. 7-10-2007. INT. CL. 42.
- SANDY USA, INC., SPRINGFIELD, MO:
3,300,049, INT. CL. 28.
- SANKATY ADVISORS, LLC, BOSTON, MA:
3,298,060, PUB. 7-10-2007. INT. CL. 36.
3,298,061, PUB. 7-10-2007. INT. CL. 36.
3,298,062, PUB. 7-10-2007. INT. CL. 36.
3,298,063, PUB. 7-10-2007. INT. CL. 36.
3,298,064, PUB. 7-10-2007. INT. CL. 36.
3,298,065, PUB. 7-10-2007. INT. CL. 36.
- SANOFI-AVENTIS, PARIS, FRANCE:
3,297,307, PUB. 7-10-2007. INT. CL. 5.
- SANOFI-AVENTIS, FRANCE:
3,298,218, PUB. 7-10-2007. MULTIPLE CLASS, INT. CLS. 5, 41, 42 AND 44.
- SANOFI-AVENTIS U.S. LLC, BRIDGEWATER, NJ, WINTHROP CHEMICAL COMPANY, INC., NEW YORK, NY:
426,990. REN. 8-22-07. U.S. CL. 18 (INT. CL. 5).
- SANOY INCORPORATED, NEW YORK CITY, NY, DBA MADEMOISELLE DE PARIS:
2,081,149. REN. 8-17-07. INT. CL. 14.
- SANSAY, INC., SAN DIEGO, CA:
3,299,522, INT. CL. 38.
- SANTICA USA, INC., BOCA RATON, FL:
3,300,204, MULTIPLE CLASS, INT. CLS. 3 AND 5.
- SARA LEE CORPORATION, DOWNERS GROVE, IL, SAR-AMAR CORPORATION, DOVER, DE:
2,071,136. REN. 8-20-07. INT. CL. 29.
- SARA LEE CORPORATION, WINSTON-SALEM, NC:
2,403,335, CANC. INT. CL. 25.
- SARA POZONSKY, KENAI, AK:
3,299,776, INT. CL. 29.
- SARATI INTERNATIONAL, LTD, LOS FRESNOS, TX:
3,300,014, INT. CL. 3.
- SARCOS INVESTMENTS LC, SALT LAKE CITY, UT:
3,298,963, INT. CL. 9.
- SARRECCHIA, ROBERTO, ROMA, ITALY:
3,300,129, INT. CL. 45.
- SAS INSTITUTE INC., CARY, NC:
2,404,155, CANC. INT. CL. 41.
- SASCHA, LLC, PORTLAND, OR:
3,297,963, PUB. 7-10-2007. INT. CL. 25.
- SATICOY LEMON ASSOCIATION, VENTURA, CA, SEABOARD LEMON ASSN., OXNARD, CA:
352,721. REN. 8-17-07. U.S. CL. 46 (INT. CL. 31).
352,925. REN. 8-17-07. U.S. CL. 46 (INT. CL. 31).
- SATICOY LEMON ASSOCIATION, VENTURA, CA:
2,120,900. REN. 8-17-07. INT. CL. 31.
- SATIN FINISH HARDWOOD FLOORING LIMITED, WESTON, ONTARIO, CANADA:
3,298,715, INT. CL. 19.
- SATLABS GROUP EEIG, ZH PAISES BAJOS, ERPN CMNTY TM OFC:
3,297,739, PUB. 7-10-2007. INT. CL. 38.
- SAUDER MANUFACTURING COMPANY, ARCHBOLD, OH:
3,300,149, INT. CL. 20.
- SAUNDERS, ENRICO, LEAMINGTON SPA, UNITED KINGDOM:
3,300,057, INT. CL. 35.
- SAURO, WILLIAM H, INCLINE VILLAGE, NV:
2,404,859, CANC. INT. CL. 42.
- SAVAGE SPORTS CORPORATION, WESTFIELD, MA:
3,297,336, PUB. 7-10-2007. INT. CL. 8.
- SAVION COMPANIES, LLC, DELRAY BEACH, FL:
3,299,932, INT. CL. 37.
- SAVONA, ROBERT C., HAHNVILLE, LA AND SAVONA, CYNTHIA B., HAHNVILLE, LA:
3,296,847, PUB. 7-10-2007. INT. CL. 41.
- SAVVY MISS, LLC, LOS ANGELES, CA:
3,299,055, INT. CL. 38.
- SAVVY NETWORKS, INC., TARRYTOWN, NY:
3,296,907, PUB. 7-10-2007. MULTIPLE CLASS, INT. CLS. 39 AND 42.
- SAZERAC COMPANY, INC., NEW ORLEANS, LA:
1,069,486. REN. 8-20-07. INT. CL. 33.
- SBEMCO INTERNATIONAL, INC., ALGONA, IA:
2,086,552. REN. 8-17-07. INT. CL. 27.
- SBI SALES COMPANY, INC., BOSTON, MA:
1,417,037, CANC. INT. CL. 42.

- SBLI USA MUTUAL LIFE INSURANCE COMPANY, INC., NEW YORK, NY:
3,299,566, INT. CL. 36.
- SBS CORPORATION, BIRMINGHAM, AL:
2,403,680, CANC. MULTIPLE CLASS, INT. CLS. 35, 41 AND 42.
- SCA HYGIENE PRODUCTS AB, GOTEBOURG, SWEDEN:
3,298,019, PUB. 7-10-2007. MULTIPLE CLASS, INT. CLS. 3 AND 10.
- SCANDINAVIAN TRAVEL CONSULT, NORWAY:
3,298,353, PUB. 7-10-2007. MULTIPLE CLASS, INT. CLS. 25, 28 AND 39.
- SCHACH, BERNADINE, BEDFORD, TX:
2,016,539, CANC. INT. CL. 26.
- SCHAEFFER, DWIGHT L., TEMPE, AZ:
3,296,691, PUB. 7-10-2007. INT. CL. 44.
- SCHAEFFER, GARY, NEW YORK, NY AND BIRNKRANT, MEL, BEACON, NY:
3,296,113, PUB. 7-10-2007. INT. CL. 16.
3,296,132, PUB. 7-10-2007. MULTIPLE CLASS, INT. CLS. 16 AND 28.
- SCHAFFNER EMV AG, LUTERBACH, SWITZERLAND:
2,403,738, CANC. MULTIPLE CLASS, INT. CLS. 7 AND 9.
- SCHEIN ORTHOPÄDIE-SERVICE KG, 42897 REMSCHEID, FED REP GERMANY:
3,298,356, PUB. 7-10-2007. INT. CL. 25.
- SCHERING-PLOUGH HEALTHCARE PRODUCTS, INC., MEMPHIS, TN:
3,299,505, INT. CL. 5.
- SCHIFF NUTRITION INTERNATIONAL, INC., SALT LAKE CITY, UT:
3,296,016, PUB. 7-10-2007. INT. CL. 5.
- SCHIFF, RAE, EVANSTON, IL:
3,299,045, INT. CL. 41.
- SCHIFFER, MARK B., NEW YORK, NY:
2,033,818, REN. 8-20-07. INT. CL. 42.
- SCHINDEL, JOHN B., OAKLAND, CA:
3,297,710, PUB. 7-10-2007. INT. CL. 45.
- SCHINDLER AUFZUGE AG, CH-6030 EBikon, SWITZERLAND:
2,403,692, CANC. MULTIPLE CLASS, INT. CLS. 7 AND 37.
- SCHLUMBERGER TECHNOLOGY CORPORATION, HOUSTON, TX:
2,064,150, REN. 8-20-07. INT. CL. 9.
2,072,728, REN. 8-20-07. INT. CL. 9.
2,124,206, REN. 8-20-07. INT. CL. 9.
- SCHMIDT, LOTHAR, SWITZERLAND:
3,298,153, PUB. 7-10-2007. INT. CL. 14.
- SCHNEIDER & ASSOCIATES, BOSTON, MA:
2,082,068, REN. 8-23-07. INT. CL. 35.
- SCHNEIDER BILL, DEVINE, TX:
3,297,538, PUB. 7-10-2007. MULTIPLE CLASS, INT. CLS. 31 AND 44.
- SCHNEIDER SADDLERY CO., INC., CHAGRIN FALLS, OH:
3,299,082, INT. CL. 18.
- SCHOKINAG CHOCOLATE NORTH AMERICA, INC, BAKERSFIELD, CA:
3,297,279, PUB. 7-10-2007. INT. CL. 30.
- SCHOLAR CHIPS SOFTWARE, INC., ATLANTA, GA:
1,416,482, CANC. INT. CL. 9.
- SCHOLASTIC INC., NEW YORK, NY:
2,452,203, CANC. MULTIPLE CLASS, INT. CLS. 25, 35 AND 42.
3,299,435, INT. CL. 16.
- SCHOOL & HOME OFFICE PRODUCTS ASSOCIATION, KETTERING, OH, DBA SHOPA:
2,403,783, CANC. INT. CL. 16.
- SCHOOL LOOP, INC., BURLINGAME, CA:
3,299,033, MULTIPLE CLASS, INT. CLS. 38, 41 AND 42.
- SCHRADER-BRIDGEPORT INTERNATIONAL, INC., ALTAVISTA, VA, H. B. EGAN MANUFACTURING COMPANY, MUSKOGEE, OK:
832,210, REN. 8-18-07. U.S. CL. 35 (INT. CL. 12).
- SCHUCHASKIE, KENNETH L., LANSING, MI, DBA ACKSHUN LURE:
2,116,051, REN. 8-17-07. INT. CL. 28.
- SCHULTZE & BRAUN GMBH, FED REP GERMANY:
3,298,383, PUB. 7-10-2007. INT. CL. 42.
- SCHWAN-STABILO COSMETICS GMBH & CO. KG, HEROLDTSBERG, FED REP GERMANY:
3,297,377, PUB. 7-10-2007. INT. CL. 3.
- SCHWAN'S IP, LLC, MARSHALL, MN:
3,300,193, INT. CL. 30.
- SCHWARTZ, DALE, LONGMONT, CO:
3,298,510, MULTIPLE CLASS, INT. CLS. 41 AND 43.
- SCHWEIZER-EFFAX GMBH, NORWALDE, FED REP GERMANY:
1,452,772, REN. 8-18-07. INT. CL. 3.
- SCI SOLUTIONS, LOS GATOS, CA, DBA SCHEDULING-COM:
3,296,146, PUB. 7-10-2007. INT. CL. 42.
- SCIENTIFIC GAMES ROYALTY CORPORATION, ALPHARETTA, GA:
3,299,250, INT. CL. 9.
- SCOOP MANAGEMENT LLC, NEW YORK, NY:
3,300,031, INT. CL. 35.
- SCOTT ADAMS, INC., DANVILLE, CA:
2,404,760, CANC. INT. CL. 30.
- SCOTT RESOURCES LLC, FORT COLLINS, CO:
2,041,765, REN. 8-22-07. MULTIPLE CLASS, INT. CLS. 16 AND 28.
- SCRANTON GILLETTE COMMUNICATIONS, INC., ARLINGTON HEIGHTS, IL:
3,297,165, PUB. 7-10-2007. INT. CL. 16.
- SCREAMING MOOSE GRILL, PORTERVILLE, CA:
3,298,067, PUB. 4-3-2007. INT. CL. 43.
- SCRUPLES PROFESSIONAL SALON PRODUCTS, INC., LAKEVILLE, MN:
3,299,510, INT. CL. 3.
- SDI OPERATING PARTNERS, L.P., PHILADELPHIA, PA:
1,416,400, CANC. INT. CL. 6.
- SDI TECHNOLOGIES INC., RAHWAY, NJ:
3,298,148, PUB. 7-10-2007. INT. CL. 9.
- SDM INTERNATIONAL, INC., FUQUAY-VARINA, NC:
2,403,728, CANC. INT. CL. 9.
- SEA PORT PRODUCTS CORPORATION, KIRKLAND, WA:
3,296,021, PUB. 7-10-2007. INT. CL. 29.
- SEA SHEPHERD CONSERVATION SOCIETY, MARINA DEL REY, CA:
2,085,489, REN. 8-22-07. INT. CL. 42.
- SEABANDIT BOATS LIMITED, TAURANGA, NEW ZEALAND:
3,297,976, PUB. 7-10-2007. INT. CL. 12.
- SEACOAST HARLEY-DAVIDSON, INC., N. HAMPTON, NH:
3,297,331, PUB. 7-10-2007. INT. CL. 35.
- SEAL USA CORPORATION, ELKRIDGE, MN:
1,461,848, REN. 8-22-07. INT. CL. 16.
- SEAL-IT, INC., FARMINGDALE, NY:
3,295,970, PUB. 7-10-2007. INT. CL. 35.
- SEAL-SPOUT CORPORATION, LIBERTY CORNER, NJ:
2,075,192, REN. 8-23-07. INT. CL. 7.
- SEALY TECHNOLOGY LLC, TRINITY, NC:
3,299,332, INT. CL. 20.
3,299,334, INT. CL. 20.
- SEALY, INCORPORATED, CHICAGO, IL, DBA SEALY MATTRESS COMPANY:
1,416,664, CANC. INT. CL. 20.
- SEAMLESS ATTENUATING TECHNOLOGIES, INC., CHEHALIS, WA:
2,081,909, REN. 8-23-07. INT. CL. 27.
- SEARCH BY HEADLINES.COM, RENO, NV:
3,299,772, INT. CL. 41.
- SEASTROM MANUFACTURING CO., INC., TWIN FALLS, ID:
3,297,734, PUB. 7-10-2007. INT. CL. 6.
3,297,735, PUB. 7-10-2007. INT. CL. 9.
- SEATRADE INTERNATIONAL CO., INC., PORTSMOUTH, NH:
3,297,852, PUB. 7-10-2007. INT. CL. 29.
- SEATTLE CHAMBER MUSIC FESTIVAL, SEATTLE, WA, DBA SEATTLE CHAMBER MUSIC SOCIETY:
3,296,373, PUB. 7-10-2007. INT. CL. 41.

- SEBO GMBH, FED REP GERMANY:
3,298,348, PUB. 7-10-2007. INT. CL. 9.
3,298,366, PUB. 7-10-2007. INT. CL. 10.
- SECOND BAPTIST CHURCH, HOUSTON, TX:
3,297,711, PUB. 7-10-2007. MULTIPLE CLASS, INT. CLS.
16, 41 AND 45.
- SECURITY ATLANTIC LEASING, LLC, PHILADELPHIA,
PA:
3,297,184, PUB. 7-10-2007. INT. CL. 43.
- SECURITY SYSTEMS USA, INC., PASADENA, CA, PACIFIC
BANK TECHNOLOGY, INC., PASADENA, CA:
2,081,999. REN. 8-17-07. INT. CL. 9.
- SEED RESOURCES, L.L.C., GRAND RAPIDS, MI:
2,404,829, CANC. INT. CL. 21.
- SEFAR HOLDING AG, SWITZERLAND:
3,298,208, PUB. 7-10-2007. MULTIPLE CLASS, INT. CLS.
16 AND 24.
3,298,212, PUB. 7-10-2007. INT. CL. 16.
- SEGIS, SPA, POGGIBONSI (SI), ITALY:
3,300,327, INT. CL. 20.
- SEGURA VIUDAS, S.A., TORRELAVIT (BARCELONA),
SPAIN:
3,297,959, PUB. 7-10-2007. MULTIPLE CLASS, INT. CLS.
33 AND 35.
- SEI INVESTMENTS DEVELOPMENTS, INC., WILMING-
TON, DE, SEI CORPORATION, WAYNE, PA:
1,448,787. REN. 8-20-07. INT. CL. 35.
- SEI INVESTMENTS DEVELOPMENTS, INC., WILMING-
TON, DE, SEI DEVELOPMENTS, INC., WILMINGTON,
DE:
2,082,162. REN. 8-20-07. INT. CL. 9.
- SEIKO EPSON KABUSHIKI KAISHA, SHINJUKU-KU, TO-
KYO, JAPAN, AKA SEIKO EPSON CORPORATION:
2,404,438, CANC. MULTIPLE CLASS, INT. CLS. 7, 9, 14
AND 16.
- SEIKO EPSON KABUSHIKI KAISHA, TOKYO, JAPAN, AKA
SEIKO EPSON CORPORATION:
3,297,799, PUB. 7-10-2007. INT. CL. 9.
- SELENE WINES, INC., NAPA, CA:
3,300,373, INT. CL. 33.
- SELLSTROM MANUFACTURING COMPANY, PALATINE,
IL:
828,204. REN. 8-22-07. U.S. CL. 26 (INT. CLS. 1, 9 AND 10).
- SEMIKRON INTERNATIONAL GMBH, FED REP GER-
MANY:
3,298,368, PUB. 7-10-2007. INT. CL. 9.
- SENCORE, INC., SIOUX FALLS, SD:
2,014,868, CANC. INT. CL. 9.
- SENDER, DANIELLE MOSS, EL CAJON, CA:
2,404,138, CANC. INT. CL. 42.
- SENECA GAMING CORPORATION, NIAGARA FALLS, NY:
3,296,030, PUB. 7-10-2007. MULTIPLE CLASS, INT. CLS.
35, 41 AND 43.
- SENSATIONAL AG, SWITZERLAND:
3,298,371, PUB. 7-10-2007. MULTIPLE CLASS, INT. CLS.
38 AND 42.
- SENSE INTELLIFIELD AS, NORWAY:
3,298,331, PUB. 7-10-2007. MULTIPLE CLASS, INT. CLS. 7
AND 9.
- SENSIENT COLORS INC., MILWAUKEE, WI:
3,299,368, INT. CL. 2.
- SENSOPTICS LIMITED, BRISTOL, UNITED KINGDOM:
3,299,150, INT. CL. 9.
- SERENITY, LOS ANGELES, CA:
3,298,899, INT. CL. 25.
- SERLIO SOFTWARE DEVELOPMENT CORPORATION,
WAUWATOSA, WI:
3,296,463, PUB. 7-10-2007. INT. CL. 9.
3,296,464, PUB. 7-10-2007. INT. CL. 9.
- SERNA, TONY, MURPHY, TX:
3,297,197, PUB. 7-10-2007. INT. CL. 36.
- SERVCO PACIFIC INC., HONOLULU, HI:
2,167,139. REN. 8-23-07. INT. CL. 35.
- SERVICE METRICS, INC., BRACKNELL, BERKSHIRE,
UNITED KINGDOM:
2,404,126, CANC. INT. CL. 42.
- SESAME WORKSHOP, NEW YORK, NY:
3,299,287, INT. CL. 41.
- SET DEPO, LLC, ATLANTA, GA:
3,297,783, PUB. 7-10-2007. MULTIPLE CLASS, INT. CLS.
35, 41 AND 42.
3,297,784, PUB. 7-10-2007. MULTIPLE CLASS, INT. CLS.
35, 41 AND 42.
- SET ENTERPRISES, INC., FOUNTAIN HILLS, AZ:
2,091,123. REN. 8-17-07. INT. CL. 28.
- SETON HEALTH CORPORATION OF TENNESSEE, NASH-
VILLE, TN:
2,016,221, CANC. INT. CL. 42.
- SETTING CAPTIVES FREE, MEDINA, OH:
3,296,815, PUB. 7-10-2007. INT. CL. 41.
- SEVEN FOR ALL MANKIND, LLC, VERNON, CA:
3,300,058, INT. CL. 25.
- SEVEN HILLS HOLDING COMPANY, LLC, EAST ALTON,
IL:
3,299,041, INT. CL. 41.
- SF INVESTMENTS, INC., WILMINGTON, DE:
2,094,954. REN. 8-22-07. INT. CL. 30.
- SFX LIVE, INC., NEW YORK, NY:
2,403,677, CANC. MULTIPLE CLASS, INT. CLS. 16 AND
41.
- SHADOW MARINE, FORT LAUDERDALE, FL:
3,297,535, PUB. 7-10-2007. INT. CL. 12.
- SHAKLEE CORPORATION, PLEASANTON, CA:
2,083,466. REN. 8-22-07. INT. CL. 3.
- SHAMBAN, AVA T., SANTA MONICA, CA:
3,299,157, INT. CL. 3.
- SHAMPOO CHEZ, INC., SANTA CRUZ, CA:
1,446,608. REN. 8-23-07. INT. CL. 42.
1,446,608, CANC. INT. CL. 28.
- SHANNON FOYNES PORT COMPANY, FOYNES, COUNTY
LIMERICK, IRELAND:
3,297,440, PUB. 7-10-2007. MULTIPLE CLASS, INT. CLS.
38 AND 39.
- SHANNON, JOHN A., SCOTTSDALE, AZ:
2,015,840, CANC. INT. CL. 5.
- SHANTILAL N. PATEL, CLIFTON, NJ:
3,297,689, PUB. 7-10-2007. INT. CL. 44.
- SHANXI LUCHENG SITONG CASTING CO., LTD., LU-
CHENG CITY HEBEI PRO, CHINA:
3,298,144, PUB. 7-10-2007. INT. CL. 6.
- SHARE HARVEST, LLC, CAMBRIDGE, MA:
1,427,633. REN. 8-23-07. MULTIPLE CLASS, INT. CLS. 29,
30 AND 42.
- SHARED INSIGHTS US, LLC, WOBURN, MA:
3,297,790, PUB. 7-10-2007. INT. CL. 41.
- SHARM HOLDING, LLC, ARMENIA:
3,298,390, PUB. 7-10-2007. INT. CL. 41.
- SHARMA, DEEPAK, NEW YORK, NY:
3,296,128, PUB. 7-10-2007. INT. CL. 9.
- SHAYNE, WILLIAM C., NEW YORK, NY:
3,298,862, MULTIPLE CLASS, INT. CLS. 35 AND 42.
- SHEARPRESS SALES INC., WHITE ROCK, B.C., CANADA:
2,403,527, CANC. INT. CL. 7.
- SHEDRAIN CORPORATION, PORTLAND, OR:
3,296,638, PUB. 7-10-2007. MULTIPLE CLASS, INT. CLS.
18, 20 AND 25.
- SHEFFIELD, CHARLES, NEW YORK, NY AND POUR-
NELLE, JERRY, NEW YORK, NY:
2,016,373, CANC. INT. CL. 16.
- SHELBY GROUP INTERNATIONAL, INC., SHELBY
GROUP, INC., MEMPHIS, TN:
1,466,396. REN. 8-22-07. INT. CL. 25.
- SHELBY GROUP INTERNATIONAL, INC., MEMPHIS, TN:
2,100,397. REN. 8-22-07. INT. CL. 25.
- SHELDON LABORATORY SYSTEMS, INC., CRYSTAL
SPRINGS, MS, E. H. SHELDON EQUIPMENT COMPANY,
MUSKEGON, MI:
832,523. REN. 8-22-07. U.S. CL. 32 (INT. CL. 20).
- SHELFWORKS TECHNOLOGIES LLC, ENGLEWOOD, NJ:
3,297,098, PUB. 7-10-2007. INT. CL. 20.
- SHELFWORKS TECHNOLOGIES, LLC, ENGLEWOOD, NJ:
3,296,974, PUB. 7-10-2007. INT. CL. 20.
- SHELLAH GARRETT AND GARY GARRETT PARTNER-
SHIP, THE, MONTROSE, CA:
2,015,603, CANC. INT. CL. 41.

- SHELTER SUPPLY, INC., BURNSVILLE, MN:
2,080,606, REN. 8-20-07. INT. CL. 42.
- SHELTERED WINGS, INC., MIDDLETOWN, WI:
3,298,131, PUB. 7-10-2007. INT. CL. 9.
- SHENANDOAH UNIVERSITY, WINCHESTER, VA:
2,404,898, CANC. INT. CL. 36.
- SHENZHEN KANGHEDA WATCHES CO., LTD., SHENZHEN CITY, CHINA:
3,298,317, PUB. 7-10-2007. INT. CL. 14.
- SHENZHEN U-MAN INDUSTRIAL CO., LTD., CHINA:
3,298,346, PUB. 7-10-2007. MULTIPLE CLASS, INT. CLS. 7 AND 11.
- SHERPA AIRCRAFT MANUFACTURING, INC., ALOHA, OR:
2,015,745, CANC. INT. CL. 12.
- SHERWIN-WILLIAMS COMPANY, THE, CLEVELAND, OH TO SWIMC, INC., WILMINGTON, DE:
2,015,720, CANC. INT. CL. 2.
2,015,724, CANC. INT. CL. 2.
- SHERWIN-WILLIAMS COMPANY, THE, CLEVELAND, OH:
2,086,544, REN. 8-17-07. INT. CL. 42.
- SHINCA PRODUCTIONS, INC., BURBANK, CA:
3,296,965, PUB. 7-10-2007. INT. CL. 25.
- SHIRAZI, KAMRAN, SAN FRANCISCO, CA:
3,296,504, PUB. 7-10-2007. INT. CL. 8.
- SHISEIDO COMPANY, LTD., TOKYO, JAPAN:
3,298,896, INT. CL. 3.
- SHKLAREK, ALON, VIENNA, AUSTRIA:
3,297,175, PUB. 7-10-2007. INT. CL. 35.
- SHOE STOP INC., SEATTLE, WA:
1,416,956, CANC. INT. CL. 37.
- SHOEMONEY MEDIA GROUP, INC., LINCOLN, NE:
3,297,011, PUB. 7-10-2007. INT. CL. 35.
- SHOP AT HOME, LLC, ANTIOCH, TN:
3,296,142, PUB. 7-10-2007. MULTIPLE CLASS, INT. CLS. 35 AND 41.
- SHORELAND PARK CORPORATION, HUDSON, WI:
2,116,469, REN. 8-23-07. INT. CL. 21.
- SHOREQUEST, LLC, WALKER, MN:
3,296,397, PUB. 7-10-2007. INT. CL. 43.
- SHROYER, WILLIAM R., SANTA ROSA, CA:
2,403,995, CANC. INT. CL. 42.
- SHS INTERNATIONAL, INC., INDIANAPOLIS, IN:
3,300,355, INT. CL. 15.
- SHU-YUN HSIA, TAOYUAN COUNTY 330, TAIWAN:
3,299,934, INT. CL. 21.
- SHUPE CORPORATION, DENVER, CO:
2,404,385, CANC. INT. CL. 42.
2,404,387, CANC. INT. CL. 42.
2,404,388, CANC. INT. CL. 42.
2,404,389, CANC. INT. CL. 42.
- SHUPE CORPORATIONSHUPE CORPORATION, DENVER, CO:
2,404,386, CANC. INT. CL. 42.
- SHUTTER ENTERPRISES GROUP, INC., ST. PETERSBURG, FL, BERNARDO, RICHARD GREGORY, POMPANO BEACH, FL:
1,088,151, REN. 8-18-07. INT. CL. 19.
- SIA BOUNS, RIGA, LATVIA:
3,299,615, INT. CL. 38.
- SICHUAN TYRE & RUBBER CO., LTD, JIAN YANG, SICHUAN, CHINA:
3,296,830, PUB. 7-10-2007. INT. CL. 12.
- SIDERCA SOCIEDAD ANONIMA INDUSTRIAL Y COMERCIAL, 1001 BUENOS AIRES, ARGENTINA:
1,449,246, REN. 8-18-07. INT. CL. 6.
- SIDMAS INCORPORATED, IRVINE, CA:
3,298,577, INT. CL. 6.
- SIEMENS AKTIENGESELLSCHAFT, MUNICH, FED REP GERMANY:
2,404,554, CANC. INT. CL. 9.
- SIEMENS AKTIENGESELLSCHAFT, FED REP GERMANY:
3,298,364, PUB. 7-10-2007. INT. CL. 9.
- SIEMENS AUDIOLOGISCHE TECHNIK GMBH, FED REP GERMANY:
3,298,393, PUB. 7-10-2007. INT. CL. 10.
- SIEMENS-ELEMA AB, S-171 95 SOLNA, SWEDEN:
1,416,501, CANC. INT. CL. 10.
- SIERRA HEALTHSTYLES LLC, TUSCON, AZ:
3,300,221, MULTIPLE CLASS, INT. CLS. 14, 21 AND 43.
- SIERRA HEALTHSTYLES LLC, TUCSON, AZ:
3,299,410, MULTIPLE CLASS, INT. CLS. 35, 41, 43 AND 44.
- SIERRA PROPERTIES I, LLC, TAMPA, FL:
3,300,321, MULTIPLE CLASS, INT. CLS. 25 AND 28.
- SIEVERS, DAVE, LOS ANGELES, CA:
3,297,506, PUB. 7-10-2007. MULTIPLE CLASS, INT. CLS. 25 AND 41.
- SIGMA ALIMENTOS, S.A. DE C.V., SAN PEDRO GARZA GARCIA, MEXICO:
3,297,435, PUB. 7-10-2007. INT. CL. 30.
- SIGMA-TAU HEALTHSCIENCE, INC., NEW YORK, NY:
3,298,512, INT. CL. 5.
3,298,513, INT. CL. 5.
3,298,514, INT. CL. 5.
- SIGNATURE CLUB A LTD., TAMPA, FL:
2,123,869, REN. 8-23-07. INT. CL. 3.
- SILANIS TECHNOLOGY INC., SAINT-LAURENT, CANADA:
3,297,395, PUB. 7-10-2007. MULTIPLE CLASS, INT. CLS. 9 AND 42.
- SILICON LABORATORIES INC., AUSTIN, TX:
3,298,916, INT. CL. 9.
- SILVER HILL FINANCIAL, LLC, CORAL GABLES, FL:
3,297,456, PUB. 7-10-2007. INT. CL. 35.
3,297,457, PUB. 7-10-2007. INT. CL. 35.
3,297,458, PUB. 7-10-2007. INT. CL. 36.
3,297,459, PUB. 7-10-2007. INT. CL. 35.
- SILVER SUMMIT DEVELOPMENT GROUP, INC., ROSWELL, GA:
3,298,797, MULTIPLE CLASS, INT. CLS. 36 AND 37.
- SILVERBACK TECHNOLOGIES, INC., RENO, NV:
3,298,806, INT. CL. 9.
- SILVERTON MARINE CORPORATION, MILLVILLE, NJ:
3,296,834, PUB. 7-10-2007. INT. CL. 36.
- SIM ITALIA S.R.L., BOLOGNA, ITALY:
2,403,121, CANC. INT. CL. 10.
- SIMBIONIX USA CORPORATION, CLEVELAND, OH:
3,297,731, PUB. 7-10-2007. INT. CL. 9.
- SIMON, ARTHUR J., ATLANTA, GA:
3,299,481, INT. CL. 44.
- SIMON, WILLIAM H., VILLANOVA, PA:
2,081,527, REN. 8-22-07. INT. CL. 10.
- SIMONI, DANIEL, SHERMAN OAKS, CA:
3,296,668, PUB. 7-10-2007. INT. CL. 41.
- SIMONS, THEODORE M., WEST PALM BEACH, FL, DBA CONNECTIONS UNLIMITED:
2,404,374, CANC. INT. CL. 9.
- SIMPLY FABOWLOUS, LLC, KANSAS CITY, MO:
3,296,969, PUB. 7-10-2007. INT. CL. 20.
- SIN, HONG LIK, VANCOUVER, BRITISH COLUMBIA, CANADA:
3,299,736, INT. CL. 25.
- SINAI CALVARY MINISTRIES, FT. LAUDERDALE, FL:
3,297,607, PUB. 7-10-2007. INT. CL. 16.
- SINGAPORE AIRLINES LIMITED, SINGAPORE:
2,403,704, CANC. INT. CL. 42.
- SINGH, JACK J., CORONA, CA:
3,296,722, PUB. 7-10-2007. INT. CL. 29.
- SINGLE STICK, INC., PHOENIX, AZ:
3,298,579, INT. CL. 34.
- SINN SI INTERNATIONAL CO., LTD., TAINAN, TAIWAN TO EVERLAST PROFITS LTD, ROAD TOWN, BR. VIRGIN ISLANDS:
2,015,214, CANC. INT. CL. 30.
- SINOCHEM CORPORATION, CHINA:
3,298,344, PUB. 7-10-2007. MULTIPLE CLASS, INT. CLS. 1, 2, 4, 5 AND 35.
- SINPHAR PHARMACEUTICAL CO., LTD., YEI-LAN HSIEN, TAIWAN:
2,404,551, CANC. INT. CL. 5.
- SINTONISON, S.L., SPAIN:
3,298,291, PUB. 7-10-2007. INT. CL. 16.
- SIROB IMPORTS, INC., LINDENHURST, NY:
3,298,426, INT. CL. 29.

SISER S.R.L., ITALY:
3,197,014, COR. INT. CL. 16.

SITEWIRE MARKETSPACE SOLUTIONS, LLC, TEMPE, AZ:
2,403,949, CANC. MULTIPLE CLASS, INT. CLS. 35 AND 42.

SITE4HIRE.COM, INC., BOCA RATON, FL:
3,296,898, PUB. 7-10-2007. INT. CL. 35.

SITIME CORPORATION, SUNNYVALE, CA:
3,299,613, INT. CL. 9.

SIX CONTINENTS HOTELS, INC., ATLANTA, GA:
3,299,523, INT. CL. 35.

SJ'S FOODS, INC., ALHAMBRA, CA:
2,015,024, CANC. INT. CL. 32.

SKADDEN, ARPS, SLATE, MEAGHER & FLOM LLP, NEW YORK, NY:
3,300,084, INT. CL. 41.

SKAGFIELD CORPORATION, TALLAHASSEE, FL, DBA SKANDIA INDUSTRIES:
2,111,746, REN. 8-17-07. INT. CL. 20.

SKECHERS U.S.A., INC. II, MANHATTAN BEACH, CA:
3,296,644, PUB. 7-10-2007. INT. CL. 25.

SKINNER, LYNN, LAKEWOOD, CO, DBA VOCAL EYES MUSIC:
2,087,120, REN. 8-20-07. INT. CL. 9.

SKRIVANEK, KENNETH V., EAST BERNE, NY:
2,403,523, CANC. INT. CL. 35.

SKYTEL CORP, WASHINGTON, DC, SKYTEL CORP., WASHINGTON, DC:
2,077,033, REN. 8-17-07. INT. CL. 38.

SKYWARD, INC., STEVENS POINT, WI:
2,113,459, REN. 8-23-07. MULTIPLE CLASS, INT. CLS. 9, 41 AND 42.

SKYWIRE SOFTWARE, LLC, FRISCO, TX:
3,296,043, PUB. 7-10-2007. INT. CL. 42.

SLAB TECHNOLOGY LIMITED, ALBANY, AUCKLAND, NEW ZEALAND:
2,403,874, CANC. INT. CL. 9.
2,403,875, CANC. INT. CL. 9.

SLANT/FIN CORPORATION, GREENVALE, NY:
3,299,530, INT. CL. 11.

SLAZENGERS LIMITED, BUCKINGHAMSHIRE, UNITED KINGDOM:
3,297,345, PUB. 7-10-2007. MULTIPLE CLASS, INT. CLS. 3, 5, 9, 11, 12, 14, 16, 18, 24, 25, 28, 30 AND 32.

SLEEPTEC, INC., ALPHARETTA, GA:
2,404,869, CANC. INT. CL. 20.

SLINGSHOT, LLC, DALLAS, TX:
2,087,595, REN. 8-18-07. INT. CL. 35.

SLIPPERY ROCK UNIVERSITY OF PENNSYLVANIA, A UNIT OF THE STATE SYSTEM OF HIGHER EDUCATION, SLIPPERY ROCK, PA:
3,296,070, PUB. 7-10-2007. INT. CL. 41.

SLL, INC., VERNON, CA:
3,298,824, INT. CL. 25.

SLOAN VALVE COMPANY, MELROSE PARK, IL, WATER CONTROL INTERNATIONAL, INC., TROY, MI:
1,450,618, REN. 8-20-07. INT. CL. 11.

SLOANE, LESLIE, WOODLAND HILLS, CA:
3,297,445, PUB. 7-10-2007. INT. CL. 44.

SLOMIN'S, INC., HICKSVILLE, NY:
2,162,720, REN. 8-20-07. INT. CL. 37.
2,164,596, REN. 8-20-07. INT. CL. 42.

SMAC, INC., SAN FRANCISCO, CA:
2,404,724, CANC. MULTIPLE CLASS, INT. CLS. 35 AND 42.

SMALL BUSINESS FINANCIAL MANAGEMENT GROUP, INC., ROWLETT, TX:
3,300,305, INT. CL. 35.

SMART GIRL SQUARED, INC., CHICAGO, IL:
3,296,620, PUB. 7-10-2007. INT. CL. 35.

SMART MOTION ROBOTICS, INC., GILBERTS, IL:
3,300,279, INT. CL. 7.

SMARTPOOL INCORPORATED, LAKEWOOD, NJ:
3,299,913, INT. CL. 7.

SMASHING IDEAS, INC., SEATTLE, WA:
2,404,352, CANC. INT. CL. 41.

SMILECITY DENTAL, LAS VEGAS, NV:
3,297,344, PUB. 7-10-2007. INT. CL. 44.

SMITH & NEPHEW, INC., MEMPHIS, TN:
3,300,132, INT. CL. 37.

SMITH & WESSON CORP, SPRINGFIELD, MA:
1,073,794, REN. 8-23-07. INT. CL. 41.

SMITH & WESSON CORP., SPRINGFIELD, MA, BANGOR PUNTA OPERATIONS, INC., GREENWICH, CT:
1,069,977, REN. 8-23-07. INT. CL. 41.

SMITH INDUSTRIES, INC., MONTGOMERY, AL, DBA JAY R. SMITH MFG. CO.:
2,084,342, REN. 8-22-07. INT. CL. 17.

SMITH MICRO SOFTWARE, INC., ALISO VIEJO, CA:
3,297,845, PUB. 7-10-2007. INT. CL. 9.

SMITH SEED SERVICES, HALSEY, OR:
2,152,980, REN. 8-17-07. INT. CL. 31.

SMITH, CLYDE, GAINESVILLE, FL TO SULLIVAN, ASHER G., JR., MICANOPY, FL:
1,952,014, CANC. INT. CL. 42.

SMITH, GERARD A., NEWPORT BEACH, CA:
3,297,965, PUB. 7-10-2007. INT. CL. 36.

SMITHKLINE BEECHAM CORPORATION, PHILADELPHIA, PA:
2,404,628, CANC. INT. CL. 16.

SMITHKLINE BEECHAM P.L.C., BRENTFORD, MIDDLESEX TW8 9EP, UNITED KINGDOM:
2,404,193, CANC. INT. CL. 5.

SM2, INC., SUWANEE, GA:
3,296,379, PUB. 7-10-2007. INT. CL. 37.

SNACK IP HOLDINGS, INC., VANCOUVER, BC, CANADA:
3,299,728, INT. CL. 30.

SNACK KING CORPORATION, CITY OF INDUSTRY, CA:
2,077,429, REN. 8-17-07. INT. CL. 29.

SNAKE ALLEY CUSTOMS, INC., LAKE BARRINGTON, IL:
3,298,780, MULTIPLE CLASS, INT. CLS. 12 AND 40.

SNAPPLE BEVERAGE CORP., RYE BROOK, NY:
3,298,610, INT. CL. 30.

SNECMA PROPULSION SOLIDE, FRANCE:
3,298,255, PUB. 7-10-2007. MULTIPLE CLASS, INT. CLS. 1, 9 AND 19.

SNK CORPORATION OF AMERICA, SAN JOSE, CA:
2,403,564, CANC. MULTIPLE CLASS, INT. CLS. 9 AND 28.

SNL PRODUCTS, TROY, OH:
3,296,785, PUB. 7-10-2007. INT. CL. 11.

SNUGABYE INC., TORONTO, ONTARIO, CANADA:
2,072,613, REN. 8-17-07. INT. CL. 25.

SOCIEDAD AGRARIA DE TRANSFORMACION N. 1941 SANTA TERESA, OSUNA, SEVILLA, SPAIN:
3,297,813, PUB. 7-10-2007. INT. CL. 29.

SOCIEDAD EXPORTADORA FINANCIERA VENEZOLANA (SOEXVE), BOGOTA, COLOMBIA:
3,296,631, PUB. 7-10-2007. INT. CL. 33.

SOCIETE ANONYME DES CAVES ET DES PRODUCTEURS REUNIS DE ROQUEFORT (AVEYRON), ROQUEFORT, FRANCE:
1,416,819, CANC. INT. CL. 29.

SOCIETE BIC, CLICHY, FRANCE:
3,299,194, INT. CL. 34.

SOCIETE BRETONNE DE BIEN-ÊTRE, FRANCE:
3,298,372, PUB. 7-10-2007. MULTIPLE CLASS, INT. CLS. 3, 4 AND 24.

SOCIETE DE DISTRIBUTION DES VINS FINS S.A., BORDEAUX, FRANCE:
1,416,881, CANC. INT. CL. 33.

SOCIETE DES PRODUITS NESTLE S.A., 1800 VEVEY, SWITZERLAND:
1,076,583, REN. 8-22-07. INT. CL. 31.

SOCIETY FOR COLLEGE AND UNIVERSITY PLANNING, ANN ARBOR, MI:
3,300,382, INT. CL. 41.

SOCIETY FOR HUMAN RESOURCE MANAGEMENT, ALEXANDRIA, VA:
2,029,629, REN. 8-17-07. INT. CL. 16.

SOCIETY FOR INFORMATION MANAGEMENT, CHICAGO, IL:
3,296,665, PUB. 7-10-2007. INT. CL. 41.

SOCIETY OF CABLE TELECOMMUNICATIONS ENGINEERS, INC., EXTON, PA:
3,296,102, PUB. 7-10-2007. U.S. CL. B.

- SOCIETY OF MANUFACTURING ENGINEERS, DEARBORN, MI:
1,473,140. REN. 8-17-07. INT. CL. 16.
- SOCKYARD COMPANY, INC., THE, NEW YORK, NY:
2,404,876, CANC. INT. CL. 25.
- SOCGOLDMANKRUZ, LLC, ATLANTA, GA:
3,296,749, PUB. 7-10-2007. INT. CL. 45.
- SODEXHO OPERATIONS, LLC, GAITHERSBURG, MD:
3,299,221, INT. CL. 43.
- SOFTWARE MANAGEMENT CONSULTANTS, INC., GLENDALE, CA:
3,299,472, INT. CL. 35.
- SOFTWARE TECHNOLOGIES CORPORATION, MONROVIA, CA:
2,404,748, CANC. INT. CL. 9.
- SOGEVAL, SOCIÉTÉ ANONYME, 53000 LAVAL, FRANCE:
3,297,625, PUB. 7-10-2007. INT. CL. 5.
- SOIL MENDER PRODUCTS, L.P., TULIA, TX:
2,082,380. REN. 8-23-07. INT. CL. 1.
- SOLAR COMMUNICATIONS GROUP, INC., MILLVILLE, NJ:
2,403,497, CANC. INT. CL. 38.
- SOLARI UDINE S.P.A., UDINE, ITALY:
1,416,461, CANC. INT. CL. 9.
- SOLAROASIS, LLC, RENO, NV:
3,299,887, INT. CL. 11.
- SOLAW INTERNATIONAL, INC., NEW YORK, NY:
3,297,280, PUB. 7-10-2007. INT. CL. 41.
- SOLAY, LORI L., OAKLAND, CA AND FALKELL, PHILIP C., OAKLAND, CA:
3,296,494, PUB. 7-10-2007. MULTIPLE CLASS, INT. CLS. 44 AND 45.
- SOLAY, LORI L., OAKLAND, CA AND FALKELL, PHILLIP C., OAKLAND, CA:
3,296,661, PUB. 7-10-2007. MULTIPLE CLASS, INT. CLS. 44 AND 45.
- SOLE CREATIONS INC., FLUSHING, NY:
3,299,715, INT. CL. 25.
- SOLEIL TOOL INDUSTRIES CORP., WUCHI, TAICHUNG COUNTY, TAIWAN:
3,299,679, INT. CL. 7.
- SOLIDSTATE CONTROLS, INC., COLUMBUS, OH:
2,067,751. REN. 8-17-07. INT. CL. 9.
- SOLINST CANADA LTD., GEORGETOWN, ONTARIO, CANADA:
2,403,232, CANC. INT. CL. 7.
- SOLVAY ANIMAL HEALTH, INC.:
1,467,924. REN. 8-18-07. INT. CL. 5.
- SOLVAY DUPHAR B.V., WEESP, NETHERLANDS:
1,416,367, CANC. INT. CL. 5.
- SOLVAY PHARMACEUTICALS B.V., WEESP, NETHERLANDS:
2,404,277, CANC. INT. CL. 10.
- SOLVAY PHARMACEUTICALS GMBH, HANNOVER, FED REP GERMANY:
2,403,634, CANC. INT. CL. 5.
- SOMMERS, JONATHAN, ATLANTA, GA:
3,300,292, INT. CL. 36.
- SOMMERS, SUSAN, NEW YORK, NY:
3,299,452, INT. CL. 41.
- SONG, RUHUA, MONTEREY PARK, CA:
3,296,135, PUB. 7-10-2007. INT. CL. 35.
- SONOA SYSTEMS, INC., SUNNYVALE, CA:
3,299,685, INT. CL. 9.
- SONY COMPUTER ENTERTAINMENT AMERICA INC., FOSTER CITY, CA:
3,298,509, INT. CL. 9.
- SONY ERICSSON MOBILE COMMUNICATIONS AB, LUND, SWEDEN:
3,298,272, PUB. 7-10-2007. INT. CL. 9.
- SONY ERICSSON MOBILE COMMUNICATIONS AB, SWEDEN:
3,298,308, PUB. 7-10-2007. MULTIPLE CLASS, INT. CLS. 9 AND 38.
3,298,309, PUB. 7-10-2007. MULTIPLE CLASS, INT. CLS. 9 AND 38.
3,298,310, PUB. 7-10-2007. MULTIPLE CLASS, INT. CLS. 9 AND 38.
3,298,311, PUB. 7-10-2007. MULTIPLE CLASS, INT. CLS. 9 AND 38.
3,298,312, PUB. 7-10-2007. MULTIPLE CLASS, INT. CLS. 9 AND 38.
3,298,313, PUB. 7-10-2007. MULTIPLE CLASS, INT. CLS. 9 AND 38.
- SOP SERVICES, INC., LAS VEGAS, NV:
3,299,964, INT. CL. 28.
- SOPHIE ROSE, LLC, WILLIAMSBURG, VA:
3,299,122, INT. CL. 35.
- SORENSEN ASSOCIATES INC, TROUTDALE, OR:
3,297,449, PUB. 7-10-2007. INT. CL. 35.
- SOULSTICE SPA, INC., SAUSALITO, CA:
3,300,161, INT. CL. 3.
- SOURCE OF THE NILE INC., CHICAGO, IL:
3,299,875, INT. CL. 29.
- SOUTHEASTERN MUTUAL INSURANCE COMPANY:
1,416,920, CANC. INT. CL. 36.
- SOUTHERN COMFORT PROPERTIES, INC., SAN RAFAEL, CA:
3,298,781, INT. CL. 34.
- SOUTHERN STATES MARKETING, INC., MARIETTA, GA:
3,296,368, PUB. 7-10-2007. INT. CL. 28.
3,296,369, PUB. 7-10-2007. INT. CL. 28.
- SOUTHERN WINE & SPIRITS OF AMERICA, INC., MIAMI, FL:
2,404,719, CANC. INT. CL. 35.
- SOUTHLAND PROPERTY INVESTMENTS, LTD., ROAD TOWN TORTOLA BRITISH, BR. VIRGIN ISLANDS:
2,403,539, CANC. INT. CL. 41.
- SOUTHWEST AIRLINES CO., DALLAS, TX:
3,297,309, PUB. 7-10-2007. INT. CL. 39.
- SOUTHWEST ELECTRONIC ENERGY CORPORATION, STAFFORD, TX:
3,296,233, PUB. 7-10-2007. INT. CL. 9.
- SOUTHWIRE COMPANY, CARROLLTON, GA:
3,297,477, PUB. 7-10-2007. INT. CL. 9.
- SOWLE, GREGORY BRYAN, SAN JOSE, CA:
2,404,260, CANC. MULTIPLE CLASS, INT. CLS. 9 AND 42.
- SPACECRAFT COMPONENTS CORP., NORTH LAS VEGAS, NV:
3,300,127, INT. CL. 9.
- SPADARO, CARL, JACKSONVILLE, FL:
3,298,907, INT. CL. 11.
- SPANISH BROADCASTING SYSTEM, INC, COCONUT GROVE, FL:
3,296,210, PUB. 7-10-2007. INT. CL. 38.
- SPANISH BROADCASTING SYSTEM, INC., COCONUT GROVE, FL:
3,298,594, INT. CL. 41.
- SPARNEX N.V., ANTWERP, BELGIUM:
2,404,770, CANC. INT. CL. 9.
- SPARNEX N.V., B-2018, ANTWERP, BELGIUM:
2,404,771, CANC. INT. CL. 9.
- SPARTAN CHEMICAL COMPANY, INC., MAUMEE, OH:
2,100,960. REN. 8-17-07. INT. CL. 42.
- SPARTON CORPORATION, JACKSON, MI:
3,299,019, MULTIPLE CLASS, INT. CLS. 40 AND 42.
3,299,020, MULTIPLE CLASS, INT. CLS. 40 AND 42.
- SPC RESOURCES, INC., HARTSVILLE, SC:
3,297,652, PUB. 7-10-2007. INT. CL. 19.
- SPEAK YOUR MIND GREETING CARDS, LLC, DUNWOODY, GA:
3,297,110, PUB. 7-10-2007. INT. CL. 16.
- SPEARS, GARY BRUCE, BROOKLYN, NY:
3,297,925, PUB. 7-10-2007. INT. CL. 41.
- SPECIALIZED INDUSTRIAL SOLUTIONS, INC., CADIZ, KY:
3,297,686, PUB. 7-10-2007. INT. CL. 9.
- SPECIALIZED TECHNOLOGY RESOURCES, INC., ENFIELD, CT:
2,403,629, CANC. INT. CL. 16.
- SPECIALTY CONSTRUCTION BRANDS, INC., SAINT PAUL, MN:
3,299,723, INT. CL. 19.
3,300,079, INT. CL. 19.

SPECIALTY MINERALS (MICHIGAN) INC., BINGHAM FARMS, MI:
3,298,619, INT. CL. 1.

SPECIALTY PRODUCTS & INSULATION CO., EAST PETERSBURG, PA:
2,404,003, CANC. MULTIPLE CLASS, INT. CLS. 6 AND 20.

SPECIFIED TECHNOLOGIES INC., SOMERVILLE, NJ:
3,295,994, PUB. 7-10-2007. MULTIPLE CLASS, INT. CLS. 1 AND 6.

SPECKOZ, INC., ALPHARETTA, GA:
3,299,240, MULTIPLE CLASS, INT. CLS. 5 AND 11.

SPEED LUBE, INCORPORATED, POCAHONTAS, IL:
2,015,040, CANC. INT. CL. 37.

SPELL, JAMES G., EAGLE, CO:
3,299,178, INT. CL. 35.

SPERRY AND HUTCHINSON COMPANY, INC., THE, DELRAY BEACH, FL:
1,443,517, REN. 8-20-07. INT. CL. 35.

SPHERION PACIFIC ENTERPRISES LLC, FORT LAUDERDALE, FL:
2,083,076, REN. 8-20-07. MULTIPLE CLASS, INT. CLS. 35, 41 AND 42.

SPIDELL PUBLISHING INC., ANAHEIM, CA:
3,299,278, INT. CL. 41.

SPILLTECH HOLDING COMPANY, WILMINGTON, DE:
3,297,306, PUB. 7-10-2007. MULTIPLE CLASS, INT. CLS. 17 AND 27.

SPILSBURY BRITTA, MAKAWAO, HI:
3,297,806, PUB. 7-10-2007. INT. CL. 35.

SPINDUSTRY SYSTEMS INCORPORATED, CLIVE, IA:
3,296,161, PUB. 7-10-2007. INT. CL. 42.

SPIRAFLEX LLC, HORTONVILLE, WI:
2,095,323, REN. 8-23-07. INT. CL. 16.

SPIRAL CONNECTION, INC., WINSTON-SALEM, NC:
3,299,341, INT. CL. 41.

SPIRITUAL & PERSONAL GROWTH TRUST, GIBRALTAR, UNITED KINGDOM:
3,298,300, PUB. 7-10-2007. MULTIPLE CLASS, INT. CLS. 5 AND 30.

SPIVOT LLC, SANTA CLARA, CA:
3,296,443, PUB. 7-10-2007. MULTIPLE CLASS, INT. CLS. 38 AND 42.

SPONGE FISHING CO., INC., TARPON SPRINGS, FL:
1,416,691, CANC. INT. CL. 21.

SPONHOLTZ GROUP, INC., MASON, OH:
3,296,060, PUB. 7-10-2007. INT. CL. 16.

SPORNETTE INTERNATIONAL INC, HOMEWOOD, IL:
3,299,514, INT. CL. 21.

SPORT FUN, INC., LOS ANGELES, CA:
1,080,510, CANC. INT. CL. 28.

SPORT NATION MERCHANDISING CORP., LAGUNA NI-GUEL, CA:
3,296,049, PUB. 6-5-2007. MULTIPLE CLASS, INT. CLS. 12 AND 16.

SPORTS ON DEMAND LLC, BETHPAGE, NY:
3,298,983, MULTIPLE CLASS, INT. CLS. 38 AND 41.

SPORTSWEAVE, MORGANTOWN, WV:
3,298,799, MULTIPLE CLASS, INT. CLS. 38 AND 41.
3,298,800, MULTIPLE CLASS, INT. CLS. 38 AND 41.

SPOT IMAGE S.A., TOULOUSE CEDEX, FRANCE:
2,082,785, REN. 8-20-07. MULTIPLE CLASS, INT. CLS. 9, 38 AND 42.

SPP HOLDING CORPORATION, WEST CHICAGO, IL:
3,298,609, INT. CL. 7.

SPPC PARIS BLEU SAS, PARIS, FRANCE:
3,300,089, INT. CL. 3.

SPRIEGEL, ANDREW R., MASSILLON, OH:
3,297,571, PUB. 7-10-2007. INT. CL. 42.

SPRINGBOK SERVICES, INC., ENGLEWOOD, CO:
3,299,622, INT. CL. 36.
3,299,623, INT. CL. 42.
3,299,624, INT. CL. 36.
3,299,714, INT. CL. 36.

SPRINGFIELD PUB, INC., SPRINGFIELD, IL:
3,298,129, PUB. 7-10-2007. INT. CL. 43.

SPS TECHNOLOGIES, LLC, JENKINTOWN, PA:
1,068,879, REN. 8-23-07. INT. CL. 6.

SPX CORPORATION, CHARLOTTE, NC, MIXING EQUIPMENT CO., INC., NEW YORK, NY:
227,991, REN. 8-22-07. U.S. CL. 21 (INT. CL. 9).

SPX CORPORATION, CHARLOTTE, NC:
2,404,646, CANC. INT. CL. 7.
3,298,964, INT. CL. 9.

SPX DOCK PRODUCTS, INC., MEQUON, WI:
2,403,194, CANC. MULTIPLE CLASS, INT. CLS. 35 AND 37.

SQOOPS GMBH, FED REP GERMANY:
3,298,351, PUB. 7-10-2007. MULTIPLE CLASS, INT. CLS. 35, 38 AND 41.

SQUARE ONE ORGANIC SPIRITS, LLC, NOVATO, CA:
3,299,947, INT. CL. 33.

SQUARE SOFT, INC., REDMOND, WA TO KABUSHIKI KAISHA SQUARE, TOKYO, JAPAN, DBA SQUARE CO., LTD.:
2,016,305, CANC. INT. CL. 28.

SR HOLDINGS INC., LEXINGTON, MA:
2,076,036, REN. 8-23-07. INT. CL. 25.

SRAM CORPORATION, CHICAGO, IL:
2,403,047, CANC. MULTIPLE CLASS, INT. CLS. 12 AND 25.

SRI SPORTS KABUSHIKI KAISHA, HYOGO, JAPAN, AKA SRI SPORTS LIMITED:
3,297,264, PUB. 7-10-2007. INT. CL. 28.

SSERDDA INC., SAN MATEO, CA:
2,404,180, CANC. INT. CL. 35.

ST. BARTHOLOMEW'S CHURCH IN THE CITY OF NEW YORK, NEW YORK, NY:
3,298,150, PUB. 7-10-2007. INT. CL. 41.

ST. MAARTEN TRADING CO., INC., DALLAS, TX:
2,014,805, CANC. MULTIPLE CLASS, INT. CLS. 18 AND 25.

STADNICKA, NATALIA, MIDDLE VILLAGE, NY:
3,297,454, PUB. 7-10-2007. MULTIPLE CLASS, INT. CLS. 25 AND 41.

STAFFCV, INC., NORTHBROOK, IL:
3,296,281, PUB. 7-10-2007. INT. CL. 35.

STAFFLOGIX CORPORATION, NAPERVILLE, IL:
3,297,268, PUB. 7-10-2007. MULTIPLE CLASS, INT. CLS. 35 AND 42.

STAFFORD DEVELOPMENT COMPANY, TIFTON, GA:
3,297,515, PUB. 7-10-2007. MULTIPLE CLASS, INT. CLS. 35 AND 37.
3,297,516, PUB. 7-10-2007. MULTIPLE CLASS, INT. CLS. 36 AND 37.

STAMPS.COM, INC., SANTA MONICA, CA:
2,404,136, CANC. INT. CL. 35.

STAMPS.COM, INC., LOS ANGELES, CA:
3,297,684, PUB. 7-10-2007. INT. CL. 9.

STANDARD TEXTILE CO., INC., CINCINNATI, OH:
2,131,088, REN. 8-22-07. MULTIPLE CLASS, INT. CLS. 35 AND 42.

STANDEX INTERNATIONAL CORPORATION, SALEM, NH:
3,299,475, INT. CL. 11.

STANDING IN THE WORD MINISTRIES, MORRIS, IL:
2,086,984, REN. 8-22-07. INT. CL. 41.

STANFORD FINANCIAL GROUP COMPANY, HOUSTON, TX:
3,297,904, PUB. 7-10-2007. MULTIPLE CLASS, INT. CLS. 16 AND 36.

STANNARD, JOHN, CLEARWATER, FL:
3,299,550, INT. CL. 15.

STANTON ROYCE, ALBUQUERQUE, NM:
3,296,735, PUB. 7-10-2007. MULTIPLE CLASS, INT. CLS. 35 AND 41.

STAPLES THE OFFICE SUPERSTORE, LLC, FRAMINGHAM, MA:
3,299,325, INT. CL. 9.

STAPLES, SEAN, EL DORADO HILLS, CA:
3,299,468, MULTIPLE CLASS, INT. CLS. 15 AND 25.

STARBUCKS U.S. BRANDS, LLC, MINDEN, NV:
3,298,944, INT. CL. 30.
3,298,945, INT. CL. 30.

STARES, LTD., LONG BRANCH, NJ:
2,404,513, CANC. INT. CL. 35.

- STARFIRE PRODUCTIONS, INC., FAIRFIELD, CA:
3,296,093, PUB. 7-10-2007. INT. CL. 9.
- STARKS, ANDRE P., LYNWOOD, CA:
3,296,067, PUB. 7-10-2007. INT. CL. 41.
- STARTLY TECHNOLOGIES, LLC, WEST DES MOINES, IA:
3,297,750, PUB. 7-10-2007. INT. CL. 9.
- STARZ MEDIA, LLC, BURBANK, CA:
2,049,734. REN. 8-17-07. INT. CL. 42.
- STATE OF KANSAS, KANSAS DEPARTMENT OF HEALTH
AND ENVIRONMENT STATE AGENCY KANSAS, TOPE-
KA, KS:
3,296,050, PUB. 7-10-2007. INT. CL. 16.
- STATION CASINOS, INC., LAS VEGAS, NV:
3,298,840, INT. CL. 44.
- STAUF USA, LLC., MEMPHIS, TN:
3,297,342, PUB. 7-10-2007. INT. CL. 2.
- STAUFFACHER, DAVID G., MADISON, WI, EXEL INNS OF
AMERICA, INC., MADISON, WI:
1,058,752. REN. 8-22-07. INT. CL. 42.
- STAY FRESHER PRODUCTS, INC., MONTVALE, NJ:
2,403,328, CANC. INT. CL. 11.
- STAYSTAFFED TECHNOLOGIES, LLC, BOCA RATON, FL:
3,299,242, INT. CL. 42.
- STEHAGER, TORBJÖRN V, S-134 65 INGARÖ, SWEDEN:
3,298,494, INT. CL. 9.
- STEINHAUSER, MICHELE L, PLEASANT HILL, CA:
3,297,966, PUB. 7-10-2007. INT. CL. 45.
- STELLENBOSCH FARMERS' WINERY LIMITED, CAPE
PROVINCE, SOUTH AFRICA:
1,416,882, CANC. INT. CL. 33.
- STELVIO S.P.A., DELEBIO (SO), ITALY:
3,298,294, PUB. 7-10-2007. INT. CL. 9.
- STEMCELLS, INC., PALO ALTO, CA:
3,299,141, MULTIPLE CLASS, INT. CLS. 1 AND 5.
- STEP-BY-STEP COMMUNICATIONS, LLC, JACKSON, MS:
3,297,448, PUB. 7-10-2007. INT. CL. 9.
- STEPHEN J. PISHNER, NORTH OLMSTED, OH, AKA
MURDER BY MIDNIGHT:
3,299,353, INT. CL. 41.
- STEPHEN WOO, TORRANCE, CA:
3,297,442, PUB. 7-10-2007. INT. CL. 5.
- STERI CHECK SYSTEMS, INC., DEER PARK, NY:
3,296,139, PUB. 7-10-2007. INT. CL. 42.
- STERICYCLE, INC., LAKE FOREST, IL:
3,297,558, PUB. 7-10-2007. INT. CL. 35.
- STERILE RECOVERIES, INC., CLEARWATER, FL:
2,404,921, CANC. INT. CL. 39.
- STERIS INC., TEMECULA, CA:
3,299,367, INT. CL. 10.
- STERLING FLUID SYSTEMS B.V., NL-1180 AE, AMSTELV-
EEN, NETHERLANDS:
2,120,837. REN. 8-22-07. INT. CL. 7.
- STERLING LTD., COMPANY:
1,416,923, CANC. INT. CL. 36.
- STERLING METS, L.P., FLUSHING, NY:
3,299,444, INT. CL. 9.
3,299,446, INT. CL. 14.
- STERLING PUBLISHING CO., INC., NEW YORK, NY:
3,299,495, MULTIPLE CLASS, INT. CLS. 9 AND 16.
3,300,169, INT. CL. 16.
- STERLING SOFTWARE, INC., ISLANDIA, NY:
3,298,399, INT. CL. 9.
- STERLING STAMOS CAPITAL MANAGEMENT, L.P., NEW
YORK, NY:
3,299,285, INT. CL. 36.
- STEVEN A. BLANCHARD, EL CAJON, CA:
3,298,086, PUB. 7-10-2007. INT. CL. 41.
- STEVEN E. STRATMAN, MINNEAPOLIS, MN:
3,300,142, INT. CL. 41.
- STEWART & STEVENSON LLC, HOUSTON, TX:
3,298,525, INT. CL. 9.
- STEWART ENTERPRISES, INC., JEFFERSON, LA:
3,298,080, PUB. 7-10-2007. INT. CL. 45.
- STEYR-DAIMLER-PUCH AKTIENGESELLSCHAFT,
KARNTNER RING, AUSTRIA:
1,448,028. REN. 8-22-07. MULTIPLE CLASS, INT. CLS. 1,
7 AND 12.
- STIBERMAN, MARISA G., BAY HARBOR ISLANDS, FL:
3,300,303, INT. CL. 45.
- STILETTO TOOLS, INC., WINTON, CA:
3,296,802, PUB. 7-10-2007. INT. CL. 8.
- STILLER'S PRECISION FIREARMS, LLC, WYLIE, TX:
3,297,390, PUB. 7-10-2007. INT. CL. 13.
- STIMSON, DRAKE, TERRACE PARK, OH:
3,296,659, PUB. 7-10-2007. INT. CL. 35.
- STIRLING BRANDS, INC., NEW YORK, NY:
2,403,415, CANC. INT. CL. 25.
- STOCK EQUIPMENT COMAPNY, INC., CHAGRIN FALLS,
OH, GENERAL SIGNAL CORPORATION, STAMFORD,
CT:
2,033,593. REN. 8-22-07. INT. CL. 7.
- STOCKADE BRANDS INC., PITTSBURG, KS:
1,071,078. REN. 8-20-07. INT. CL. 31.
- STOKES JR., LOWELL L., LOUISVILLE, KY:
2,404,431, CANC. INT. CL. 24.
- STOKESBARY, JEN-AI SUN, GOLDEN, CO:
3,299,612, INT. CL. 25.
- STONE EAGLE DEVELOPMENT, LLC, LOS ANGELES, CA:
3,298,440, INT. CL. 36.
- STONE PLUS, INC., JACKSONVILLE, FL:
3,297,320, PUB. 7-10-2007. MULTIPLE CLASS, INT. CLS.
1, 11, 19 AND 20.
- STONE VILLA WINE CELLARS, INC., ACME, PA:
3,297,007, PUB. 7-10-2007. INT. CL. 33.
3,297,171, PUB. 7-10-2007. INT. CL. 33.
- STONE, JAMES B., CAPE CANAVERAL, FL:
3,166,662, CANC. INT. CL. 25.
- STONER PRODUCTIONS INC, SEATTLE, WA:
2,404,521, CANC. INT. CL. 9.
- STORAGEONE, INC., LAS VEGAS, NV:
2,080,868. REN. 8-17-07. INT. CL. 39.
- STORIS MANAGEMENT INC., PARSIPPANY, NJ:
2,516,975, COR. INT. CL. 9.
2,664,144, COR. INT. CL. 9.
- STOWE WOODWARD LLC, YOUNGSVILLE, NC:
3,299,187, INT. CL. 7.
- STRAIGHT ARROW PRODUCTS, INC., BETHLEHEM, PA:
3,297,627, PUB. 12-5-2006. INT. CL. 5.
- STRATAGENE CALIFORNIA, LA JOLLA, CA:
2,403,323, CANC. INT. CL. 1.
3,297,389, PUB. 7-10-2007. INT. CL. 1.
- STRAUSS VEAL & LAMB INTERNATIONAL INC., HALES
CORNERS, WI:
3,298,766, INT. CL. 29.
- STREAMLIGHT, INC., NORRISTOWN, PA:
2,446,933, AM. INT. CL. 11.
- STREKOZA INVENTURE, LLC., MAPLE CITY, MI:
3,299,754, INT. CL. 12.
- STRETCHRITE, INC., COLLEYVILLE, TX:
2,404,793, CANC. INT. CL. 9.
- STRIKE ZONE LURES, INCORPORATED, PELLA, IA:
2,014,695, CANC. INT. CL. 28.
- STROKIN, LLC, CHASKA, MN:
3,300,004, INT. CL. 14.
- STRONGWELL CORPORATION, BRISTOL, VA:
3,300,086, INT. CL. 19.
- STRUCTURE-TONE, INC., NEW YORK, NY:
2,015,278, CANC. INT. CL. 37.
- STUCKEY DIAMOND, INC. D/B/A THE STUCKEY COM-
PANY, HOUSTON, TX:
3,297,394, PUB. 7-10-2007. INT. CL. 14.
- STUDEBAKER DRIVERS CLUB, INC., THE, OSWEGO, IL:
1,068,731. REN. 8-20-07. INT. CL. 42.
- STUDIO A.H. LLC, SAN FRANCISCO, CA:
3,299,619, INT. CL. 18.
- STUDIO MA, INC., PHOENIX, AZ:
3,297,509, PUB. 7-10-2007. MULTIPLE CLASS, INT. CLS.
16 AND 42.
- STURM FOODS, INC., MANAWA, WI:
3,300,153, MULTIPLE CLASS, INT. CLS. 30 AND 32.
- STURM, RUGER AND CO., INC., SOUTHPORT, CT:
3,298,960, INT. CL. 8.
- STUVEX INTERNATIONAL NAAMLOZE VEN-
NOOTSCHAP, 2550 KONTICH, BELGIUM:
2,403,458, CANC. MULTIPLE CLASS, INT. CLS. 9 AND

42.
 STYLEX, INC., DELANCO, NJ:
 2,404,870, CANC. INT. CL. 20.
- STYLUS PTY LTD., BRISBANE, AUSTRALIA:
 3,297,887, PUB. 7-10-2007. INT. CL. 11.
- SUB-ZERO FREEZER COMPANY, INC., MADISON, WI:
 3,297,233, PUB. 7-10-2007. INT. CL. 16.
- SUBCAT MUSIC STUDIOS, SKANEATELES, NY:
 3,296,765, PUB. 7-10-2007. INT. CL. 41.
- SUBS, INC., YORK, PA:
 3,297,587, PUB. 7-10-2007. INT. CL. 43.
- SUCCESSFUL C.P.A. INSTITUTE, THE, CLAREMONT, CA:
 2,404,141, CANC. INT. CL. 41.
 2,404,142, CANC. INT. CL. 41.
- SUD-CHEMIE INC., LOUISVILLE, KY, UNITED CATALYSTS, INC., LOUISVILLE, KY:
 2,084,648, REN. 8-18-07. INT. CL. 9.
- SUDACK, MARK, NEW YORK, NY:
 3,297,815, PUB. 7-10-2007. INT. CL. 35.
- SUE LONDON INCORPORATED, NEW YORK, NY:
 3,300,029, INT. CL. 25.
- SUEZ ENVIRONNEMENT, FRANCE:
 3,298,188, PUB. 7-10-2007. MULTIPLE CLASS, INT. CLS. 11, 37, 39, 40 AND 42.
 3,298,189, PUB. 7-10-2007. MULTIPLE CLASS, INT. CLS. 35, 37, 39 AND 42.
 3,298,190, PUB. 7-10-2007. MULTIPLE CLASS, INT. CLS. 35, 37, 39 AND 42.
 3,298,191, PUB. 7-10-2007. MULTIPLE CLASS, INT. CLS. 37, 39, 40 AND 42.
 3,298,193, PUB. 7-10-2007. MULTIPLE CLASS, INT. CLS. 35, 37, 39 AND 42.
- SUGAR RHYTHM DANCE, SANTA CLARA, CA:
 3,296,672, PUB. 7-10-2007. INT. CL. 41.
- SUHM, RICHARD R., ELYRIA, OH:
 2,015,361, CANC. INT. CL. 9.
- SUIT YOUR STYLE, INC., GREAT NECK, NY:
 2,404,355, CANC. INT. CL. 25.
- SULIN PARTNERS, CEDAR HILL, TX:
 2,403,476, CANC. MULTIPLE CLASS, INT. CLS. 20 AND 24.
- SUM TOTAL SYSTEMS, INC., MOUNTAIN VIEW, CA:
 3,296,604, PUB. 7-10-2007. INT. CL. 42.
- SUMINISTROS KELONIK, S.A., BARCELONA, SPAIN:
 2,091,948, REN. 8-23-07. INT. CL. 9.
- SUMITOMO MITSUI BANKING CORPORATION, SINGAPORE BRANCH, SINGAPORE:
 3,298,238, PUB. 7-10-2007. INT. CL. 36.
- SUMMER RAIN SPRINKLER SYSTEMS, INC., COS COB, CT:
 3,296,608, PUB. 7-10-2007. INT. CL. 37.
- SUMMIT FEDERAL CREDIT UNION, AKRON, OH:
 1,456,816, REN. 8-22-07. INT. CL. 36.
- SUMMIT INDUSTRIAL PRODUCTS, INC., TYLER, TX, DBA SUMMIT OIL COMPANY:
 2,015,770, CANC. INT. CL. 1.
- SUN CHEMICAL CORPORATION, NEW YORK, NY:
 1,416,327, CANC. INT. CL. 2.
- SUN CHEMICAL CORPORATION, PARSIPPANY, NJ:
 1,426,162, REN. 8-22-07. INT. CL. 2.
- SUN COAST MERCHANDISE CORPORATION, COMMERCE, CA:
 3,297,595, PUB. 7-10-2007. INT. CL. 40.
- SUN HING FOODS, INC., SOUTH SAN FRANCISCO, CA:
 2,170,356, REN. 8-20-07. INT. CL. 30.
- SUN PROTECTED KIDS, LLC, STUDIO CITY, CA:
 3,299,548, INT. CL. 25.
- SUNBEAM PRODUCTS, INC., BOCA RATON, FL, SUNBEAM CORPORATION, CHICAGO 50, IL:
 831,353, REN. 8-17-07. U.S. CL. 21 (INT. CL. 9).
- SUNCOAST EYE CENTER, P.A., HUDSON, FL:
 1,447,957, REN. 8-22-07. INT. CL. 42.
- SUNCOAST RECORD & DATA INC., NASHVILLE, TN:
 1,416,451, CANC. INT. CL. 9.
- SUNDS DEFIBRATOR INDUSTRIES AKTIEBOLAG, S-851 94 SUNDSVALL, SWEDEN:
 1,416,410, CANC. MULTIPLE CLASS, INT. CLS. 7, 9 AND 11.
- SUNDYNE CORPORATION, ARVADA, CO, SUNDSTRAND CORPORATION, ROCKFORD, IL:
 831,392, REN. 8-18-07. U.S. CL. 23 (INT. CL. 7).
- SUNKIST GROWERS, INC., SHERMAN OAKS, CA:
 2,403,459, CANC. INT. CL. 31.
- SUNLUXE ENTERPRISES LIMITED, WANCHAI, HONG KONG:
 3,299,438, INT. CL. 7.
- SUNNY AMERICAS, INC., LOS ANGELES, CA:
 3,300,116, INT. CL. 16.
- SUNNY LEISURE, INC., PORT OF SPAIN, TRINIDAD/TOBAGO:
 3,299,232, INT. CL. 41.
- SUNPACK PACIFIC, LLC, CHICAGO, IL:
 3,296,899, PUB. 7-10-2007. INT. CL. 22.
- SUNSCIENCE, INC., MIAMI, FL:
 3,298,429, INT. CL. 3.
- SUNSET BAY RESORT, INC., EDMONDS, WA:
 2,404,475, CANC. INT. CL. 42.
- SUNSHINE INDUSTRIES, INC., CLEVELAND, OH:
 2,404,534, CANC. INT. CL. 21.
- SUNSHINE MEDIA CORP., NEW YORK, NY:
 2,403,576, CANC. INT. CL. 42.
- SUNSTAR AMERICAS, INC., CHICAGO, IL:
 3,300,185, INT. CL. 21.
- SUNTRUST BANKS, INC., ORLANDO, FL:
 3,299,572, INT. CL. 36.
- SUNTUF, INC., LIVINGSTON, NJ:
 2,444,059, CANC. INT. CL. 19.
- SUOS, SAKANEL, LONG BEACH, CA AND SUOS, SORONIT, LONG BEACH, CA:
 3,296,473, PUB. 7-10-2007. INT. CL. 40.
- SUPER BAKERY, INCORPORATED, PITTSBURGH, PA:
 3,297,164, PUB. 7-10-2007. INT. CL. 30.
- SUPERVALU INC., EDEN PRAIRIE, MN:
 3,224,488, AM. INT. CL. 35.
- SUPREME CHICKEN, INC., THE, VENTURA, CA:
 2,102,437, REN. 8-22-07. INT. CL. 42.
- SUR-LOC FLOORING SYSTEMS, LLC, CHARLESTOWN, WV:
 3,299,069, INT. CL. 19.
- SUREVIEW SYSTEMS, RIVERVIEW, FL:
 3,296,349, PUB. 7-10-2007. INT. CL. 9.
- SURF RIDE, INC., OCEANSIDE, CA, CLUETT, PEABODY & CO., INC., TROY, NY:
 642,366, REN. 8-23-07. U.S. CL. 39 (INT. CL. 25).
- SURF RIDE, INC., OCEANSIDE, CA:
 2,139,964, REN. 8-20-07. MULTIPLE CLASS, INT. CLS. 25 AND 28.
- SURFACE COMBUSTION, INC., MAUMEE, OH, SURFACE COMBUSTION CORPORATION, TOLEDO, OH:
 648,588, REN. 8-18-07. U.S. CL. 26 (INT. CL. 9).
- SURFACE PROTECTOR, INC., SHERMAN OAKS, CA:
 3,297,990, PUB. 7-10-2007. INT. CL. 17.
- SURGERY.COM, INC., MURRAY, UT:
 2,404,935, CANC. INT. CL. 42.
- SURVIVAL STRATEGIES, INC., BURBANK, CA:
 3,297,260, PUB. 7-10-2007. MULTIPLE CLASS, INT. CLS. 16, 35 AND 41.
- SURVIVOR PRODUCTIONS, LLC, LOS ANGELES, CA:
 3,297,072, PUB. 7-10-2007. INT. CL. 41.
- SURVOL INTERACTIVE TECHNOLOGIES, AUBURNDALE, MA:
 3,297,017, PUB. 7-10-2007. INT. CL. 38.
- SUSTAINABLE SEAFOODS, LLC, EAST PROVIDENCE, RI:
 3,296,920, PUB. 6-26-2007. INT. CL. 29.
- SUSTAINABLE STYLE FOUNDATION, SEATTLE, WA:
 3,298,081, PUB. 7-10-2007. MULTIPLE CLASS, INT. CLS. 35 AND 42.
- SUTIN, THAYER & BROWNE, ALBUQUERQUE, NM:
 3,296,670, PUB. 7-10-2007. INT. CL. 42.
- SUZUHIRO KAMABOKO KOGYO KABUSHIKI KAISHA, ODAWARA, KANAGAWA-KEN, JAPAN:
 1,076,540, REN. 8-23-07. INT. CL. 29.
- SUZUKA CHEMICAL CO., LTD., NAN DIST., TAICHUNG CITY, TAIWAN:
 3,296,162, PUB. 7-10-2007. INT. CL. 2.

- SUZUKI MOTOR CORPORATION (SUZUKI KABUSHIKI KAISHA), SHIZUOKA-KEN, JAPAN:
2,026,574. REN. 8-17-07. INT. CL. 12.
- SUZUKI VIOLIN CO., LTD., NAGOYA, AICHI 454-0027, JAPAN:
831,825. REN. 8-17-07. U.S. CL. 36 (INT. CL. 15).
- SUZUMO KIKO, CO., LTD., TOKYO, JAPAN:
2,403,623. CANC. INT. CL. 7.
- SVENSKA ÖRTMEDICINSKA INSTITUTET AB, 413 05 GÖTEBORG, SWEDEN:
3,298,688. INT. CL. 5.
- SVI, LLC, SPRINGDALE, AR:
3,297,581. PUB. 7-10-2007. INT. CL. 35.
- SWAIN HEATHER CLAIRE, SANTA ROSA, CA:
3,297,908. PUB. 7-10-2007. MULTIPLE CLASS, INT. CLS. 42 AND 45.
- SWANSON TOOL COMPANY, INC., FRANKFORT, IL:
3,298,954. INT. CL. 9.
- SWAROVSKI AKTIENGESELLSCHAFT, FL-9495 TRIESEN, LIECHTENSTEIN:
2,016,084. CANC. INT. CL. 21.
- SWAROVSKI NORTH AMERICA LIMITED, CRANSTON, RI:
1,416,564. CANC. INT. CL. 14.
- SWATCH AG (SWATCH SA) (SWATCH LTD.), SWITZERLAND:
3,298,210. PUB. 7-10-2007. INT. CL. 14.
- SWEET ENTERTAINMENT GROUP, WEST VANCOUVER, BRITISH COLUMBIA, CANADA:
3,298,409. MULTIPLE CLASS, INT. CLS. 35 AND 41.
- SWEET POTATOES, INC., BERKELEY, CA:
1,471,482. REN. 8-20-07. INT. CL. 25.
1,483,571. REN. 8-20-07. INT. CL. 25.
- SWEET REXIE'S LLC, NORWALK, CT:
3,299,747. MULTIPLE CLASS, INT. CLS. 30, 35, 41 AND 43.
- SWEETWATER NURSERY, LLC, SEBASTOPOL, CA:
3,296,169. PUB. 7-10-2007. INT. CL. 21.
- SWENSON ANDERSON ASSOCIATES, INC., MINNEAPOLIS, MN:
3,297,541. PUB. 7-10-2007. INT. CL. 36.
- SWIMC, INC., WILMINGTON, DE, MARTIN-SENOUR COMPANY, THE, CHICAGO, IL:
639,242. REN. 8-21-07. U.S. CL. 16 (INT. CL. 2).
- SWIMC, INC., WILMINGTON, DE:
2,403,640. CANC. INT. CL. 2.
- SWINMURN, NICK, HENDERSON, NV:
3,299,770. MULTIPLE CLASS, INT. CLS. 18 AND 25.
- SWISSCOM AG, SWITZERLAND:
3,298,166. PUB. 7-10-2007. MULTIPLE CLASS, INT. CLS. 9, 16, 35, 36, 37, 38, 41 AND 42.
- SWISSLIGHT, LLC, BALTIMORE, MD:
3,298,790. MULTIPLE CLASS, INT. CLS. 14 AND 25.
- SYDVAT, INC. NEW YORK, NY, DBA KETOPHARM USA:
2,404,311. CANC. INT. CL. 5.
2,404,312. CANC. INT. CL. 5.
2,404,313. CANC. INT. CL. 5.
- SYFT TECHNOLOGIES LTD, MIDDLETON, CHRISTCHURCH, NEW ZEALAND:
3,297,303. PUB. 7-10-2007. MULTIPLE CLASS, INT. CLS. 9, 10, 42 AND 44.
- SYLA LLC, NEW YORK, NY:
3,297,468. PUB. 7-10-2007. MULTIPLE CLASS, INT. CLS. 18 AND 25.
3,297,469. PUB. 7-10-2007. MULTIPLE CLASS, INT. CLS. 18 AND 25.
- SYLLABUS PRESS, INC., SAN JOSE, CA:
2,403,651. CANC. INT. CL. 16.
- SYLMARK HOLDINGS LIMITED, DUBLIN 2, IRELAND:
3,299,948. INT. CL. 7.
3,299,972. INT. CL. 21.
- SYMBOL TECHNOLOGIES, INC., HOLTSVILLE, NY:
3,297,525. PUB. 7-10-2007. MULTIPLE CLASS, INT. CLS. 9, 35, 37 AND 42.
- SYMETRA LIFE INSURANCE COMPANY, BELLEVUE, WA:
3,299,694. INT. CL. 35.
- SYMPHONY ORCHESTRA INSTITUTE, NORTHFIELD, IL:
2,015,047. CANC. INT. CL. 16.
- SYMPLEGADES INC., FUQUAY-VARINA, NC:
3,296,758. PUB. 7-10-2007. INT. CL. 35.
- SYMYX TECHNOLOGIES, SANTA CLARA, CA:
2,466,435. CANC. INT. CL. 9.
- SYNOPSIS TECHNOLOGY, INC., SPRING HOUSE, PA:
3,298,876. INT. CL. 9.
- SYNDICATE SALES, INC., KOKOMO, IN:
2,088,423. REN. 8-18-07. INT. CL. 21.
- SYNNEX INFORMATION TECHNOLOGIES, INC., FREMONT, CA:
2,781,021. COR. MULTIPLE CLASS, INT. CLS. 35, 40 AND 42.
- SYNTHESE, WEST CHESTER, PA:
3,298,410. MULTIPLE CLASS, INT. CLS. 5 AND 10.
- SYNTHESE (U.S.A.), WEST CHESTER, PA:
2,089,158. REN. 8-17-07. INT. CL. 10.
- SYRACUSE ORNAMENTAL CO., SYRACUSE, NY TO SYROCO, INC., BALDWINVILLE, NY:
426,532. AM. U.S. CL. 50.
- SYSCO CORPORATION, HOUSTON, TX:
3,299,743. INT. CL. 31.
3,300,167. INT. CL. 29.
- SYSMELEC SA, CH-3238 GALS, SWITZERLAND:
2,075,112. REN. 8-17-07. INT. CL. 7.
- T J SMITH & NEPHEW LIMITED, HULL, UNITED KINGDOM:
3,298,977. INT. CL. 5.
- T. W. WANG, INC., WHITESTONE, NY:
3,296,086. PUB. 7-10-2007. INT. CL. 35.
- T.F. HUDGINS, INCORPORATED, HOUSTON, TX:
3,296,029. PUB. 7-10-2007. INT. CL. 7.
- T-MOBILE USA, INC., BELLEVUE, WA:
3,297,097. PUB. 7-10-2007. INT. CL. 9.
- TA CHEN INTERNATIONAL, INC., LONG BEACH, CA:
3,296,062. PUB. 7-10-2007. INT. CL. 19.
- TACSON, INC., ENGLEWOOD CLIFFS, NJ:
2,404,492. CANC. INT. CL. 25.
- TACT COMMUNICATIONS INC., TOKYO, JAPAN:
3,297,871. PUB. 7-10-2007. INT. CL. 28.
- TACTILE TECHNOLOGIES, INC., LAS VEGAS, NV:
3,298,522. INT. CL. 10.
- TADIN, INC., CITY OF COMMERCE, CA:
2,404,266. CANC. INT. CL. 3.
2,404,267. CANC. INT. CL. 3.
2,404,268. CANC. INT. CL. 5.
- TADZINI DESIGN GROUP, LLC, TUCKAHOE, NY:
3,300,128. INT. CL. 16.
- TAEKWORLD, VIENNA, VA:
3,297,636. PUB. 7-10-2007. INT. CL. 35.
- TAG, INC., SALEM, VA:
3,296,257. PUB. 7-10-2007. INT. CL. 35.
- TAIL WIND TECHNOLOGIES CORPORATION, MINNETONKA, MN:
3,299,549. INT. CL. 35.
- TAIYI PRECISION TECH CORP., TAIPEI HSIEN, TAIWAN:
3,299,579. INT. CL. 16.
- TAKE THAT PRODUCTIONS, INC, BEVERLY HILLS, CA, DBA HIP HOP HARRY PRODUCTIONS:
3,300,232. INT. CL. 41.
- TAKEDA PHARMACEUTICAL COMPANY LIMITED, CHUO-KU, OSAKA, JAPAN:
3,299,312. INT. CL. 5.
- TALK AMERICA HOLDINGS, INC., NEW HOPE, PA:
2,073,462. REN. 8-18-07. INT. CL. 38.
2,073,462. CANC. INT. CL. 9.
- TALKPATH LLC, LAS VEGAS, NV:
3,296,978. PUB. 7-10-2007. INT. CL. 38.
- TAMARACK RESORT LLC, BOISE, ID:
3,298,658. INT. CL. 43.
- TAMIAN, RICHARD, SPARTA, NJ:
3,296,813. PUB. 7-10-2007. INT. CL. 40.
- TAN, YEW GEE CHRISTOPHER, SHATIN, NEW TERRITORIES, HONG KONG:
3,299,149. INT. CL. 42.
- TANABE CO., LTD., JAPAN:
3,298,338. PUB. 7-10-2007. INT. CL. 12.

TANDEM COMPUTERS INCORPORATED, CUPERTINO, CA:
1,416,945, CANC. INT. CL. 37.

TANDY LEATHER FACTORY, INC., FORT WORTH, TX:
3,296,401, PUB. 7-10-2007. INT. CL. 2.

TANGIBLEFUTURE, INC., SAN FRANCISCO, CA:
3,296,425, PUB. 7-10-2007. MULTIPLE CLASS, INT. CLS. 9, 16, 35 AND 41.
3,296,427, PUB. 7-10-2007. MULTIPLE CLASS, INT. CLS. 9, 16, 35 AND 41.

TANK CONNECTION, LLC, PARSONS, KS:
3,297,582, PUB. 7-10-2007. MULTIPLE CLASS, INT. CLS. 6 AND 42.

TANTOWEL U.S., LAS VEGAS, NV:
3,299,386, INT. CL. 3.

TANTUS, INC., CHULA VISTA, CA:
3,297,062, PUB. 7-10-2007. INT. CL. 10.
3,297,063, PUB. 7-10-2007. INT. CL. 10.

TAPCO INTERNATIONAL CORPORATION, WIXOM, MI:
3,298,724, INT. CL. 19.

TAPER INTERNATIONAL, INC., SOUTHERN PINES, NC:
3,296,119, PUB. 7-10-2007. INT. CL. 6.

TAQUA SYSTEMS, INC., MORRISVILLE, NC:
2,404,419, CANC. INT. CL. 9.

TARGA RESOURCES, INC., HOUSTON, TX:
3,299,606, INT. CL. 35.
3,299,607, INT. CL. 40.

TARGET BRANDS, INC., MINNEAPOLIS, MN:
3,297,124, PUB. 7-10-2007. INT. CL. 35.

TARK ENTERPRISES LTD., HONG KONG, HONG KONG:
3,299,442, INT. CL. 14.

TARTA MARKETING, LLC, CHICAGO, IL:
3,298,937, INT. CL. 16.

TASTE OF NATURE, INC., BEVERLY HILLS, CA:
3,297,461, PUB. 7-10-2007. INT. CL. 30.

TASWERKS LLC, BERKELEY, CA:
3,299,382, INT. CL. 41.

TAX ANALYSTS, ARLINGTON, VA:
2,403,207, CANC. INT. CL. 9.

TAYLOR, BRIAN, BOUNTIFUL, UT:
3,299,346, INT. CL. 14.

TAYLOR, TED, BIRMINGHAM, AL:
2,176,034, REN. 8-23-07. INT. CL. 41.

TAYLORMADE CREATIONS, INC., ORLANDO, FL:
3,297,957, PUB. 7-10-2007. INT. CL. 25.

TBG INC., GEORGE TOWN, CAYMAN ISLANDS:
3,297,611, PUB. 7-10-2007. MULTIPLE CLASS, INT. CLS. 1 AND 5.

TC LICENSE, LTD, HUMMELSTOWN, PA, AMTECH CORPORATION, DALLAS, TX:
2,081,055, REN. 8-23-07. MULTIPLE CLASS, INT. CLS. 9 AND 37.

TCL CORPORATION, HUIZHOU, GUANG DONG, CHINA:
3,298,181, PUB. 7-10-2007. MULTIPLE CLASS, INT. CLS. 7, 9 AND 11.

TDK CORPORATION, MINATO-KU, TOKYO, JAPAN:
3,296,007, PUB. 7-10-2007. INT. CL. 9.

TEACHER CREATED MATERIALS, INC., HUNTINGTON BEACH, CA:
2,083,680, REN. 8-23-07. INT. CL. 16.

TEAM CONNECTION, INC., HIGH POINT, NC:
3,297,603, PUB. 7-10-2007. INT. CL. 35.

TEAM LABS CORPORATION, BOULDER, CO:
2,015,070, CANC. INT. CL. 16.
2,015,071, CANC. INT. CL. 9.

TEAM LOGISTIC SERVICES, INC., OCEANSIDE, CA:
3,296,505, PUB. 7-10-2007. INT. CL. 35.

TEC LABORATORIES, INC., ALBANY, OR:
2,015,496, CANC. INT. CL. 5.

TECH INTERNATIONAL, INC., ALPHARETTA, GA, DBA HEALTH TECH:
3,298,675, INT. CL. 5.

TECH LIGHTING L.L.C., SKOKIE, IL:
3,299,537, INT. CL. 11.

TECHNIEDGE MANUFACTURING CORP., LITTLE FERRY, NJ:
2,147,394, REN. 8-20-07. INT. CL. 8.

TECHNIVORM, B.V., 3958 VR AMERONGEN, NETHERLANDS:
1,456,171, REN. 8-23-07. INT. CL. 7.

TECHNO AESTHETICS, INC., SANTA ANA, CA:
3,296,593, PUB. 7-10-2007. INT. CL. 8.

TECHNO EXCEL KABUSHIKI KAISHA, SUZAKA-SHI, NAGANO, JAPAN, KABUSHIKI KAISHA KAMBAYASHI SEISAKUJO, SUZAKA-SHI, NAGANO-KEN, JAPAN, AKA KAMBAYASHI & CO., LTD.:
1,450,434, REN. 8-23-07. MULTIPLE CLASS, INT. CLS. 9 AND 11.

TECHNOLOGY PARADISE CORPORATION, SEMINOLE, FL:
3,299,674, INT. CL. 35.

TECHNOTWIST, L.L.C., LAS VEGAS, NV:
2,403,615, CANC. INT. CL. 38.

TECIDOS FIAMA LTDA, SÃO PAULO, BRAZIL:
3,299,864, INT. CL. 24.

TECO-WESTINGHOUSE MOTOR COMPANY, ROUND ROCK, TX:
2,403,991, CANC. INT. CL. 9.

TECTONIC OUTDOORS, LLC, ST. LOUIS, MO:
3,297,374, PUB. 7-10-2007. INT. CL. 42.

TEE PEE OLIVES, INC., SCARSDALE, NY:
1,449,922, REN. 8-20-07. INT. CL. 29.

TEHUTI NETWORKS LTD., HIERZLIYA 46105, ISRAEL:
3,298,539, INT. CL. 9.

TEKOM TECHNOLOGIES, INC., TAIPEI HSIEN, TAIWAN:
2,404,675, CANC. INT. CL. 9.

TEKSOUTH CORPORATION, GARDENDALE, AL:
3,298,533, INT. CL. 9.
3,298,534, INT. CL. 9.

TELCORDIA TECHNOLOGIES, INC., MORRISTOWN, NJ:
2,404,454, CANC. INT. CL. 9.

TELE BUSINESS USA INC., NORTHBROOK, IL:
2,403,487, CANC. INT. CL. 35.

TELEFLEX INCORPORATED, LIMERICK, PA:
3,297,483, PUB. 7-10-2007. INT. CL. 7.

TELEGENISYS, INC., PLEASANT HILL, CA:
2,403,341, CANC. INT. CL. 9.

TELEVENTURE.TV, LLC, CATHEDRAL CITY, CA:
3,297,617, PUB. 7-10-2007. INT. CL. 37.

TEMPLE, LEE B., CRESTONE, CO:
2,404,210, CANC. INT. CL. 9.

TEMPLER, JOHN, PALMER, TX AND SALMON, STEVE, FERRIS, TX:
3,296,986, PUB. 7-10-2007. INT. CL. 21.
3,297,002, PUB. 7-10-2007. INT. CL. 21.

TENAX USA, LLC, CHARLOTTE, NC:
3,299,245, INT. CL. 3.

TENNANT COMPANY, MINNEAPOLIS, MN:
3,297,818, PUB. 7-10-2007. INT. CL. 7.

TENSAR TECHNOLOGIES LIMITED, SHADSWORTH, BLACKBURN, UNITED KINGDOM:
1,445,146, REN. 8-17-07. MULTIPLE CLASS, INT. CLS. 17 AND 19.

TEPPER, SPENCER, FOX POINT, WI:
3,299,358, INT. CL. 35.

TERRA INTERNATIONAL, INC., SIOUX CITY, IA, TERRA CHEMICALS INTERNATIONAL, INC., SIOUX CITY, IA:
1,055,842, REN. 8-20-07. INT. CL. 1.

TERRAFUSION, INC., BRENTWOOD, CA:
3,298,794, INT. CL. 1.

TERRI LYNN, INC., ELGIN, IL:
2,083,688, REN. 8-22-07. INT. CL. 29.

TESTING MACHINES, INC., RONKONKOMA, NY:
1,471,791, REN. 8-23-07. INT. CL. 9.

TESTWORTH LABORATORIES, INC., COLUMBIA CITY, IN:
1,070,049, REN. 8-17-07. INT. CL. 1.

TETNET SOFTWARE INCORPORATED, KANATA, ONTARIO, CANADA:
2,403,978, CANC. INT. CL. 9.

TETSO GMBH & CO., LENZKIRCH, FED REP GERMANY:
1,450,467, REN. 8-17-07. INT. CL. 9.

TEVORA BUSINESS SOLUTIONS, INC., IRVINE, CA:
3,300,170, INT. CL. 42.

- TEXA S.P.A., ITALY:
3,298,268, PUB. 7-10-2007. MULTIPLE CLASS, INT. CLS. 9, 38, 41 AND 42.
- TEXAS FARM PRODUCTS HOLDING COMPANY, NACOGDOCHES, TX:
3,297,781, PUB. 7-10-2007. INT. CL. 31.
- TEXATRONICS, INC., RICHARDSON, TX:
2,403,848, CANC. INT. CL. 40.
- TEXTILE INC., TORTOLA BRITISH, BR. VIRGIN ISLANDS:
2,091,683, CANC. MULTIPLE CLASS, INT. CLS. 18 AND 25.
- TEXTRON INNOVATIONS INC., PROVIDENCE, RI, CESSNA AIRCRAFT COMPANY, THE, WICHITA, KS:
2,081,207, REN. 8-20-07. INT. CL. 12.
- TFACTOR INC., LAS VEGAS, NV:
3,296,810, PUB. 7-10-2007. INT. CL. 9.
- TGW-ERMANCO, INC., SPRING LAKE, MI:
3,297,805, PUB. 7-10-2007. INT. CL. 7.
- THANE INTERNATIONAL, INC., LA QUINTA, CA:
3,300,051, INT. CL. 3.
3,300,052, INT. CL. 3.
- THAYER, DONALD O., ELMONT, NY:
3,299,355, INT. CL. 38.
- THE A.H. EMERY COMPANY, SEYMOUR, CT:
3,299,384, INT. CL. 9.
- THE ADMINISTRATORS OF THE TULANE EDUCATIONAL FUND, NEW ORLEANS, LA:
3,298,668, MULTIPLE CLASS, INT. CLS. 35, 42, 44 AND 45.
- THE ALDEN B. DOW AND VADA B. DOW CREATIVITY FOUNDATION, MIDLAND, MI, DBA THE ALDEN AND VADA DOW FAMILY FOUNDATIONS:
3,296,034, PUB. 7-10-2007. INT. CL. 36.
- THE ARGEN CORPORATION, SAN DIEGO, CA:
3,296,223, PUB. 7-10-2007. INT. CL. 5.
- THE ARMAND HAMMER MUSEUM OF ART AND CULTURAL CENTER, INC., LOS ANGELES, CA:
3,297,463, PUB. 7-10-2007. INT. CL. 41.
- THE ASSOCIATION OF THE BAR OF THE CITY OF NEW YORK, NEW YORK, NY:
3,298,149, PUB. 7-10-2007. MULTIPLE CLASS, INT. CLS. 9 AND 42.
- THE ATLANTA FAMILY PAGES, LLC, NORCROSS, GA:
3,296,740, PUB. 7-10-2007. MULTIPLE CLASS, INT. CLS. 16 AND 35.
3,296,741, PUB. 7-10-2007. MULTIPLE CLASS, INT. CLS. 16 AND 35.
- THE BABY EINSTEIN COMPANY, LLC, BURBANK, CA:
3,298,751, INT. CL. 28.
- THE BANK OF NOVA SCOTIA, TORONTO, ONTARIO, CANADA:
3,297,199, PUB. 7-10-2007. MULTIPLE CLASS, INT. CLS. 35 AND 36.
- THE BEECHIE COMPANY, LLC, GIG HARBOR, WA:
3,298,820, INT. CL. 8.
- THE BETHEL PERFORMING ARTS CENTER, LLC, LIBERTY, NY:
3,298,436, MULTIPLE CLASS, INT. CLS. 16, 18, 21, 25, 35, 38, 41 AND 43.
- THE BISON GROUP, HARRISONBURG, VA:
3,297,353, PUB. 7-10-2007. MULTIPLE CLASS, INT. CLS. 35 AND 41.
- THE BLOOD AND TISSUE CENTER OF CENTRAL TEXAS, AUSTIN, TX:
3,296,680, PUB. 7-10-2007. MULTIPLE CLASS, INT. CLS. 35 AND 44.
- THE BRAIN ANEURYSM FOUNDATION, INC., SOUTH BOSTON, MA:
3,297,706, PUB. 7-10-2007. INT. CL. 16.
- THE BRAIN ANEURYSM FOUNDATION, INC., BOSTON, MA:
3,297,709, PUB. 7-10-2007. MULTIPLE CLASS, INT. CLS. 35, 36 AND 41.
- THE BRIAN MADDEN COMPANY, LLC, SILVER SPRING, MD:
3,296,619, PUB. 7-10-2007. MULTIPLE CLASS, INT. CLS. 35, 38, 41 AND 42.
- THE BRITISH BROADCASTING CORPORATION, LONDON W1A 1AA, ENGLAND:
1,416,471, CANC. MULTIPLE CLASS, INT. CLS. 9 AND 16.
- THE BUREAU, LLC, ST. LOUIS, MO:
3,296,997, PUB. 7-10-2007. INT. CL. 41.
- THE BUXTON COMPANY, FORT WORTH, TX:
3,299,371, MULTIPLE CLASS, INT. CLS. 35 AND 42.
- THE CADATA CORPORATION, INC., OLNEY, MD:
3,297,246, PUB. 10-24-2006. INT. CL. 37.
- THE CARPET AND RUG INSTITUTE, DALTON, GA:
3,299,331, INT. CL. 42.
- THE CARTOON NETWORK, INC., ATLANTA, GA:
3,299,739, INT. CL. 41.
- THE CEDARVILLE UNIVERSITY, CEDARVILLE, OH:
3,299,827, INT. CL. 9.
- THE CENTER FOR ORGANIZATIONAL EXCELLENCE, INC., ROCKVILLE, MD:
3,300,157, INT. CL. 9.
- THE CHAUNCEY GROUP INTERNATIONAL, LTD., PRINCETON, NJ:
2,403,975, CANC. INT. CL. 42.
- THE CHESAPEAKE LIFE INSURANCE COMPANY, OKLAHOMA CITY, OK:
3,296,076, PUB. 7-10-2007. INT. CL. 36.
- THE CHICAGO LIGHTHOUSE FOR PEOPLE WHO ARE BLIND OR VISUALLY IMPAIRED, CHICAGO, IL:
3,297,104, PUB. 7-10-2007. MULTIPLE CLASS, INT. CLS. 35, 38, 41 AND 44.
- THE CHRONICLE OF HIGHER EDUCATION, INC., WASHINGTON, DC:
2,049,752, REN. 8-17-07. MULTIPLE CLASS, INT. CLS. 41 AND 42.
- THE COFFEE FACTORY, S.A. DE C.V., COLONIA TLALPAN, MEXICO:
3,297,181, PUB. 7-10-2007. INT. CL. 43.
- THE COLEMAN COMPANY, INC., WICHITA, KS:
3,299,114, INT. CL. 11.
- THE COMPLETE TILE COLLECTION, LLC, NEW YORK, NY:
3,297,493, PUB. 7-10-2007. INT. CL. 35.
- THE CORPORATE EXECUTIVE BOARD COMPANY, WASHINGTON, DC:
3,300,320, INT. CL. 35.
- THE CREATIVE CONCEPT, FORT WAYNE, IN:
3,296,229, PUB. 7-10-2007. INT. CL. 3.
- THE DANNON COMPANY, INC., WHITE PLAINS, NY:
3,297,705, PUB. 7-10-2007. MULTIPLE CLASS, INT. CLS. 29 AND 32.
- THE DEAL, LLC, NEW YORK, NY:
3,297,150, PUB. 7-10-2007. INT. CL. 41.
- THE DECOR CORPORATION PTY LTD, SCORESBY, STATE OF VICTORIA, AUSTRALIA:
3,299,061, INT. CL. 21.
- THE DOCTORS COMPANY, NAPA, CA:
3,297,485, PUB. 7-10-2007. INT. CL. 36.
- THE E. H. WACHS COMPANY, WHEELING, IL:
3,298,541, INT. CL. 7.
- THE ESSENTIAL GARAGE, INC., EDGEWOOD, WA:
3,296,846, PUB. 7-10-2007. INT. CL. 3.
- THE EYE ACADEMY OF AMERICA, LTD., DENVER, CO:
3,297,980, PUB. 7-10-2007. INT. CL. 44.
- THE FILIPPIS FOUNDATION, ROCHESTER HILLS, MI:
3,296,107, PUB. 7-10-2007. INT. CL. 36.
- THE FINEST ACCESSORIES, INC., NORTH BEND, WA:
3,299,417, INT. CL. 9.
- THE FLEXAN CORPORATION, CHICAGO, IL:
3,297,022, PUB. 7-10-2007. INT. CL. 40.
- THE FLORIDA ASSOCIATION OF CHILD CARE MANAGEMENT, INC., TALLAHASSEE, FL:
3,296,737, PUB. 7-10-2007. INT. CL. 42.
- THE FRAY LLC, THORNTON, CO:
3,299,065, INT. CL. 16.
- THE GETHSEMANE FOUNDATION, ST. MARIES, ID:
3,297,702, PUB. 7-10-2007. INT. CL. 16.

THE GLIDDEN COMPANY, STRONGSVILLE, OH:
 3,299,536, INT. CL. 2.
 3,299,641, INT. CL. 2.
 3,299,642, INT. CL. 2.
 3,299,643, INT. CL. 2.
 3,299,644, INT. CL. 2.

THE GOODYEAR TIRE & RUBBER COMPANY, AKRON, OH:
 3,298,770, INT. CL. 12.

THE GOSPEL PROCLAIMERS, INC., COLUMBUS, GA:
 3,296,381, PUB. 7-10-2007. MULTIPLE CLASS, INT. CLS. 9 AND 41.

THE H.W. WILSON COMPANY, BRONX, NY:
 3,296,140, PUB. 7-10-2007. INT. CL. 41.

THE HANDY GUY, INC., EL SEGUNDO, CA:
 3,297,508, PUB. 7-10-2007. INT. CL. 37.

THE HARKER SCHOOL, SAN JOSE, CA:
 3,296,273, PUB. 7-10-2007. MULTIPLE CLASS, INT. CLS. 6, 14, 16, 18, 21 AND 25.
 3,296,274, PUB. 7-10-2007. MULTIPLE CLASS, INT. CLS. 6, 9, 14, 16, 18 AND 21.
 3,297,873, PUB. 7-10-2007. INT. CL. 41.
 3,297,879, PUB. 7-10-2007. INT. CL. 41.

THE HARTZ MOUNTAIN CORPORATION, SECAUCUS, NJ:
 3,299,890, INT. CL. 28.

THE HITCHIN' SPOT, LLC, LAS VEGAS, NV:
 3,299,982, INT. CL. 31.
 3,300,043, INT. CL. 31.

THE INITIAL SOURCE LLC, EAST HANOVER, NJ:
 3,299,935, INT. CL. 14.

THE INSTITUTE FOR LIMB PRESERVATION, DENVER, CO:
 3,297,522, PUB. 4-3-2007. INT. CL. 44.

THE INSTITUTE OF WEALTH AND FINANCIAL MANAGEMENT, LLC, CHICAGO, IL:
 3,297,800, PUB. 7-10-2007. MULTIPLE CLASS, INT. CLS. 9, 16, 21, 25 AND 41.

THE INSTITUTION OF MECHANICAL ENGINEERS, UNITED KINGDOM:
 3,298,165, PUB. 7-10-2007. MULTIPLE CLASS, INT. CLS. 35 AND 41.

THE JAZZ CORNER, INC., HILTON HEAD, SC:
 3,297,350, PUB. 7-10-2007. INT. CL. 43.

THE JEWISH LEARNING INSTITUTE, BROOKLYN, NY:
 3,297,555, PUB. 7-10-2007. INT. CL. 41.

THE JUICE COMPANY (EUROPE) LIMITED, LONDON N1 0QH, ENGLAND:
 3,300,236, INT. CL. 32.

THE LANGUAGE WORKS, INC., NEW YORK, NY:
 3,296,468, PUB. 7-10-2007. MULTIPLE CLASS, INT. CLS. 35 AND 41.

THE LEADING EDGE GROUP, LLC, KIRKLAND, WA:
 3,297,644, PUB. 7-10-2007. MULTIPLE CLASS, INT. CLS. 35, 36, 37, 39 AND 42.

THE LILI CLAIRE FOUNDATION, SANTA MONICA, CA:
 3,296,648, PUB. 7-10-2007. INT. CL. 41.

THE LINCOLN ELECTRIC COMPANY, CLEVELAND, OH:
 3,297,542, PUB. 7-10-2007. INT. CL. 35.

THE LITTLE POTATO COMPANY LTD, EDMONTON, ALBERTA, CANADA:
 3,297,490, PUB. 7-10-2007. INT. CL. 31.

THE LOOMIS COMPANY, WYOMISSING, PA:
 3,296,148, PUB. 7-10-2007. MULTIPLE CLASS, INT. CLS. 36 AND 44.

THE MCCALL PATTERN COMPANY, NEW YORK, NY:
 3,299,764, INT. CL. 16.

THE MCGRAW-HILL COMPANIES, INC., NEW YORK, NY:
 3,299,894, INT. CL. 16.
 3,299,906, INT. CL. 9.

THE MKR GROUP, INC., NEW YORK, NY:
 3,298,999, INT. CL. 41.
 3,299,000, INT. CL. 28.

THE NEEDLES, WILMINGTON, NC:
 3,296,450, PUB. 7-10-2007. INT. CL. 41.

THE NEW YORK AND PRESBYTERIAN HOSPITAL, NEW YORK, NY:
 3,297,657, PUB. 7-10-2007. INT. CL. 44.
 3,297,658, PUB. 7-10-2007. INT. CL. 44.

THE NEW YORK RACING ASSOCIATION INC., JAMAICA, NY:
 3,297,935, PUB. 7-10-2007. INT. CL. 41.
 3,297,937, PUB. 7-10-2007. INT. CL. 41.
 3,297,938, PUB. 7-10-2007. INT. CL. 41.
 3,297,939, PUB. 7-10-2007. INT. CL. 41.
 3,297,940, PUB. 7-10-2007. INT. CL. 41.
 3,297,941, PUB. 7-10-2007. INT. CL. 41.

THE NIEDWICK CORPORATION, ORANGE, CA:
 3,296,789, PUB. 7-10-2007. INT. CL. 40.

THE OFFICER DOWN MEMORIAL PAGE, INC., FAIRFAX, VA:
 3,297,894, PUB. 7-10-2007. MULTIPLE CLASS, INT. CLS. 36 AND 45.

THE PHOENIX PRODUCT DESIGN GROUP LLC, ISSAQUAH, WA:
 3,298,757, INT. CL. 20.

THE PILLSBURY COMPANY, MINNEAPOLIS, MN:
 3,296,386, PUB. 7-10-2007. INT. CL. 30.
 3,297,135, PUB. 7-10-2007. INT. CL. 41.

THE PRESS OF OHIO, INC., BRIMFIELD, OH:
 3,297,335, PUB. 7-10-2007. INT. CL. 42.

THE PRINCETON CORPORATION, KENTLAND, IN:
 3,298,506, INT. CL. 36.

THE PROCTER & GAMBLE COMPANY, CINCINNATI, OH:
 3,298,997, INT. CL. 3.
 3,299,885, INT. CL. 3.

THE PROGRAMMING GROUP LTD., NEW YORK, NY:
 3,299,450, INT. CL. 41.

THE QUADRANT CORPORATION, BELLEVUE, WA:
 3,299,293, MULTIPLE CLASS, INT. CLS. 36 AND 37.

THE QUAKER OATS COMPANY, CHICAGO, IL:
 3,297,132, PUB. 7-10-2007. INT. CL. 30.

THE REAL ESTATE-XCHANGE INC., CHESAPEAKE, VA:
 3,296,388, PUB. 7-10-2007. INT. CL. 36.

THE REAL TIME MATRIX CORPORATION, OAKLAND, CA:
 3,296,795, PUB. 7-10-2007. INT. CL. 42.

THE REDEEMED CHRISTIAN CHURCH OF GOD, N.A., INC., HOUSTON, TX:
 3,297,793, PUB. 7-10-2007. INT. CL. 45.

THE REGER GROUP, LLC, STAFFORD, VA:
 3,299,461, MULTIPLE CLASS, INT. CLS. 35, 41, 42 AND 45.
 3,299,688, MULTIPLE CLASS, INT. CLS. 35, 41, 42 AND 45.

THE ROLF INSTITUTE OF STRUCTURAL INTEGRATION, BOULDER, CO:
 1,276,048, COR. INT. CL. 16.

THE RUSS REID COMPANY, INCORPORATED, PASADENA, CA:
 3,297,817, PUB. 7-10-2007. INT. CL. 36.

THE SAMARYA CENTER, SEATTLE, WA:
 3,297,367, PUB. 7-10-2007. INT. CL. 41.

THE SAUL ZAENTZ COMPANY, BERKELEY, CA, DBA TOLKIEN ENTERPRISES:
 3,298,433, INT. CL. 28.

THE SELECT COMPANY, INC., PALATINE, IL:
 3,297,217, PUB. 7-10-2007. INT. CL. 36.

THE SEMBLER COMPANY, ST. PETERSBURG, FL:
 3,296,452, PUB. 7-10-2007. MULTIPLE CLASS, INT. CLS. 36 AND 37.

THE SHELTERED ISLANDER, LLC, HOBOKEN, NJ:
 3,300,235, INT. CL. 25.

THE SHERWIN-WILLIAMS COMPANY, CLEVELAND, OH:
 3,299,677, INT. CL. 2.
 3,299,749, INT. CL. 20.
 3,300,152, INT. CL. 17.

THE SIEBEL INSTITUTE OF TECHNOLOGY, INC., CHICAGO, IL:
 3,297,139, PUB. 7-10-2007. INT. CL. 30.

THE SOUTHERN SPORTSMAN, INC., INMAN, SC:
 3,299,206, INT. CL. 35.
 3,299,207, INT. CL. 35.

THE SPA EXCHANGE, LLC, MINNETONKA, MN:
 3,299,963, INT. CL. 35.

THE STEEL NETWORK, INC., RALEIGH, NC:
 3,299,393, INT. CL. 6.

- THE STRATEGIC COACH INC., TORONTO, CANADA:
3,297,675, PUB. 7-10-2007. MULTIPLE CLASS, INT. CLS. 9 AND 16.
- THE SUSAN G. KOMEN BREAST CANCER FOUNDATION, INC., DALLAS, TX:
3,297,073, PUB. 7-10-2007. INT. CL. 36.
- THE TALARIA COMPANY, LLC, PORTSMOUTH, RI:
843,134. REN. 8-17-07. U.S. CL. 19 (INT. CL. 12).
- THE TORO COMPANY, BLOOMINGTON, MN:
3,297,162, PUB. 7-10-2007. INT. CL. 12.
- THE TRIZETTO GROUP, INC., NEWPORT BEACH, CA:
3,296,063, PUB. 7-10-2007. INT. CL. 36.
- THE TRUSTEES OF AMHERST COLLEGE/DBA/THE FOLGER SHAKESPEARE LIBRARY, WASHINGTON, DC:
3,297,027, PUB. 7-10-2007. MULTIPLE CLASS, INT. CLS. 16, 35 AND 41.
- THE UPPER DECK COMPANY, NORTH LAS VEGAS, NV:
3,298,859, INT. CL. 16.
- THE VALSPAR CORPORATION, MINNEAPOLIS, MN:
3,297,107, PUB. 7-10-2007. INT. CL. 2.
- THE VARSITY, INC., ATLANTA, GA:
3,297,115, PUB. 7-10-2007. INT. CL. 25.
- THE WET SEAL, INC., FOOTHILL RANCH, CA:
3,296,943, PUB. 7-10-2007. INT. CL. 35.
- THE WIGGLES PTY LIMITED, NEW SOUTH WALES, AUSTRALIA:
3,299,907, INT. CL. 41.
- THE WILLIAM WARREN GROUP, INC., SANTA MONICA, CA, DBA THE WILLIAM WARREN GROUP:
3,298,598, MULTIPLE CLASS, INT. CLS. 28 AND 39.
- THE WINE GROUP LLC, TRACY, CA:
3,299,155, INT. CL. 33.
- THEIKOS INC., SOUTHBOROUGH, MA:
3,297,019, PUB. 7-10-2007. INT. CL. 42.
- THEOCHEM LABORATORIES, INC., TAMPA, FL:
3,299,925, INT. CL. 3.
- THERAGENEX PROPERTIES LIMITED, ROAD TOWN, TORTOLA, BR. VIRGIN ISLANDS:
3,297,801, PUB. 7-10-2007. INT. CL. 5.
- THERAPY DOGS INTERNATIONAL, INC., FLANDERS, NJ:
3,296,335, PUB. 7-10-2007. MULTIPLE CLASS, INT. CLS. 41 AND 45.
- THERMA-WAVE, INC., FREMONT, CA:
2,165,847. REN. 8-18-07. INT. CL. 9.
2,403,438, CANC. INT. CL. 9.
- THERMACUT, INC., CLAREMONT, NH:
3,298,696, INT. CL. 9.
- THIEL, WILLIAM, OCONOMOWOC, WI:
3,274,959, CANC. IIRN. RESTORED TO S.N. 78-905,653.
- THOENE, THOMAS LUKE, LOS OSOS, CA:
3,299,526, INT. CL. 41.
- THOMAS HEALTHCARE INC., MONTVALE, NJ, ME LICENSING CORPORATION, WILMINGTON, DE:
2,038,268. REN. 8-21-07. INT. CL. 9.
- THOMAS INDUSTRIES, INC., LOUISVILLE, KY:
2,016,177, CANC. MULTIPLE CLASS, INT. CLS. 7, 9 AND 11.
- THOMAS PUBLISHING COMPANY, NEW YORK, NY:
3,297,149, PUB. 7-10-2007. INT. CL. 35.
- THOMPSON & CO. OF TAMPA, INC., TAMPA, FL:
3,300,088, INT. CL. 34.
- THOMPSON FOOD BASKET, INC., PEORIA, IL:
1,417,033, CANC. INT. CL. 42.
- THOMPSON, MARSHA M., DALLAS, TX AND THOMPSON, FITZROY, DALLAS, TX:
3,296,814, PUB. 7-10-2007. INT. CL. 36.
- THOMSON FINANCIAL LLC, NEW YORK, NY:
2,403,951, CANC. INT. CL. 36.
- THOMSON HEALTHCARE INC., MONTVALE, NJ:
3,300,387, INT. CL. 9.
- THOMSON LEARNING INC., STAMFORD, CT:
3,300,332, INT. CL. 42.
- THOMSON, KEVIN T., LYNN, NC:
3,298,549, INT. CL. 12.
- THOR TECH, INC., SAGINAW, MI:
3,298,032, PUB. 7-10-2007. INT. CL. 12.
- THQ INC., AGOURA HILLS, CA:
3,298,728, MULTIPLE CLASS, INT. CLS. 9 AND 42.
- THREE ANGELS BROADCASTING NETWORK, INC., WEST FRANKFORT, IL:
3,296,501, PUB. 7-10-2007. INT. CL. 41.
3,296,614, PUB. 7-10-2007. INT. CL. 41.
3,296,617, PUB. 7-10-2007. INT. CL. 41.
3,296,739, PUB. 7-10-2007. INT. CL. 41.
- THRIFTY DRUG STORES, INC., MAPLE GROVE, MN:
3,296,293, PUB. 7-10-2007. MULTIPLE CLASS, INT. CLS. 35, 40 AND 41.
- THRIFTY OIL CO., SANTA FE SPRINGS, CA:
1,449,032. REN. 8-17-07. INT. CL. 42.
- THROCKMORTON, PAUL J, BOULDER, CO:
3,300,003, INT. CL. 20.
- THRONEBURG, JAMES L., STATESVILLE, NC:
3,298,778, INT. CL. 25.
3,298,779, INT. CL. 25.
- THUNDER GROUP INC., CITY OF INDUSTRY, CA:
3,297,532, PUB. 7-10-2007. MULTIPLE CLASS, INT. CLS. 8, 11, 20, 21 AND 27.
- THX LTD., SAN RAFAEL, CA, LUCASFILM LTD., SAN RAFAEL, CA:
1,419,801. REN. 8-17-07. MULTIPLE CLASS, INT. CLS. 9 AND 41.
- TIGER 21, LLC, NEW YORK, NY:
3,298,569, INT. CL. 35.
- TIGRAN, PETROSYAN, FORT LEE, NJ:
3,296,660, PUB. 7-10-2007. INT. CL. 35.
- TILLER GROUP, INC., ZIONSVILLE, IN:
3,298,125, PUB. 7-10-2007. INT. CL. 41.
- TILTON ASSOCIATES GIS, INC., REDLANDS, CA:
3,297,673, PUB. 7-10-2007. INT. CL. 39.
- TIM SEXTON, LOS ANGELES, CA:
3,296,697, PUB. 7-10-2007. INT. CL. 35.
- TIME INC., NEW YORK, NY:
3,296,254, PUB. 7-10-2007. INT. CL. 35.
- TIME INC. MAGAZINE COMPANY, THE, NEW YORK, NY:
1,416,489, CANC. INT. CL. 9.
- TIME M.D., INC., BIRMINGHAM, AL:
3,296,306, PUB. 7-10-2007. INT. CL. 42.
- TIME UNWIND INCORPORATED, IRVINE, CA:
3,156,989, COR. INT. CL. 44.
- TIME WARNER INC., NEW YORK, NY:
2,085,850. REN. 8-21-07. INT. CL. 9.
- TIMES MIRROR COMPANY, THE, LOS ANGELES, CA, DBA LOS ANGELES TIMES:
2,404,680, CANC. INT. CL. 16.
- TIMOTHY SCHOOL DEVELOPMENT FUND, INC., BERYN, PA:
3,297,765, PUB. 7-10-2007. INT. CL. 36.
- TINY BUBBLES DESIGNS, LLC, BARRINGTON, RI:
3,296,525, PUB. 7-10-2007. INT. CL. 25.
- TITAN SPEED ENGINEERING, INC., OJAI, CA:
2,148,485. REN. 8-17-07. INT. CL. 7.
- TITAN TOOL, INC., OAKLAND, NJ:
3,299,081, INT. CL. 7.
- TITLE BOXING, LLC, LENEXA, KS:
3,300,354, INT. CL. 28.
- TITLE INSURANCE NATIONAL INFORMATION EXCHANGE, LLC, EVANSTON, IL:
3,299,528, MULTIPLE CLASS, INT. CLS. 36, 42 AND 45.
- TKL PRODUCTS CORP., OILVILLE, VA:
2,085,396. REN. 8-22-07. INT. CL. 15.
- TKUU LLC, VENICE, CA:
3,299,587, INT. CL. 25.
- TMW SYSTEMS, INC., BEACHWOOD, OH:
3,298,419, MULTIPLE CLASS, INT. CLS. 35 AND 42.
- TOBIANO, MICHAEL, 75008 PARIS, FRANCE:
2,403,143, CANC. MULTIPLE CLASS, INT. CLS. 9, 16, 35, 41 AND 42.
- TOBIN, STACEY C., CHICAGO, IL:
3,299,115, INT. CL. 41.
- TOKIDOKI, LLC, LOS ANGELES, CA:
3,030,306, COR. MULTIPLE CLASS, INT. CLS. 18, 25 AND 26.
- TOM KANE, JR., SAINT PAUL, MN AND CHAIM LOWENSTEIN, JACKSONVILLE, FL:
3,296,428, PUB. 7-10-2007. INT. CL. 9.

TOMANI BEHEER B.V., 4421 JB KAPPELLE-BIEZELINGE, NETHERLANDS:
2,084,310. REN. 8-23-07. INT. CL. 11.

TOMJAI ENTERPRISES CORP., MIAMI, FL:
3,298,786. INT. CL. 3.

TON, QUY, BATON ROUGE, LA:
3,296,058. PUB. 7-10-2007. INT. CL. 3.

TONIX SANTE INC., LONGUEUIL, QUEBEC J4K 5G7, CANADA:
2,404,794. CANC. INT. CL. 9.

TONKOVITCH, JILL, POINT PLEASANT, NJ:
2,403,268. CANC. INT. CL. 10.

TOO ITALIAN DESIGNERS, INC., NEW YORK, NY:
2,015,392. CANC. INT. CL. 25.

TOOMAN, JAMES W., LA JOLLA, CA:
2,032,630. REN. 8-23-07. INT. CL. 25.

TOOTSIE ROLL INDUSTRIES, LLC, CHICAGO, IL:
1,449,095. REN. 8-21-07. INT. CL. 30.

TOP DRAWER MEDICAL ART, INC., MILWAUKEE, WI:
2,404,918. CANC. INT. CL. 42.

TOP HAT, INC., SHAKOPEE, MN:
3,299,280. INT. CL. 35.

TOP OF THE THIRD, INC, VISALIA, CA, JSS/USA, INC., HERMOSA BEACH, CA:
2,087,480. REN. 8-22-07. INT. CL. 41.

TOP OF THE THIRD, INC., VISALIA, CA, JSS/USA, INC., HERMOSA BEACH, CA:
2,083,794. REN. 8-22-07. INT. CL. 25.

TOPCO ASSOCIATES, LLC, SKOKIE, IL:
3,298,995. INT. CL. 31.

TOPCO HOLDINGS, INC., CHICAGO, IL:
2,081,588. REN. 8-17-07. INT. CL. 5.

TOPCO HOLDINGS, INC., SKOKIE, IL:
2,085,996. REN. 8-22-07. INT. CL. 3.
2,085,998. REN. 8-22-07. INT. CL. 16.

TOPCON MEDICAL SYSTEMS, INC., PARAMUS, NJ:
3,296,669. PUB. 7-10-2007. INT. CL. 9.

TOPIX PHARMACEUTICALS, INC., NORTH AMITYVILLE, NY, PHARMAGEN, INC., BOHEMIA, NY:
2,034,113. REN. 8-22-07. MULTIPLE CLASS, INT. CLS. 3 AND 5.

TOPNOTCH COMMUNICATIONS GROUP, LLC., MILLVILLE, NJ:
3,297,498. PUB. 7-10-2007. INT. CL. 41.

TORCUP, INC., EASTON, PA:
2,154,331. REN. 8-18-07. INT. CL. 7.

TORESCO'S AUTOLAND, INC., SPRINGFIELD, NJ:
1,470,919. REN. 8-18-07. INT. CL. 36.

TORRE ORIA, S.L., SPAIN:
3,298,376. PUB. 7-10-2007. INT. CL. 33.

TOSHIBA AMERICA CONSUMER PRODUCTS, L.L.C., WAYNE, NJ:
3,299,018. INT. CL. 9.

TOTAL LIVING INTERNATIONAL, INCORPORATED, AURORA, IL, DBA CHRISTIAN COMMUNICATIONS OF CHICAGOLAND, INC.:
2,015,734. CANC. INT. CL. 38.

TOTAL PLASTICS, INC., KALMAZOO, MI:
2,112,867. REN. 8-22-07. INT. CL. 42.
2,120,410. REN. 8-22-07. INT. CL. 42.

TOTALSURVIVAL.COM, INC., SPOKANE, WA, DBA TOTALSURVIVAL.COM:
2,404,280. CANC. INT. CL. 35.

TOTES ISOTONER CORPORATION, CINCINNATI, OH:
3,298,694. INT. CL. 18.

TOUCHPRO INSTITUTE OF CHAIR MASSAGE, SAN FRANCISCO, CA:
2,404,230. CANC. INT. CL. 42.

TOUCHTABLE, INC., PASADENA, CA:
3,299,173. INT. CL. 9.

TOWERS, PERRIN, FORSTER & CROSBY, INC., PHILADELPHIA, PA:
2,030,107. REN. 8-17-07. MULTIPLE CLASS, INT. CLS. 9 AND 16.

TOWLE, VAUGHAN C., SACRAMENTO, CA:
3,296,627. PUB. 7-10-2007. INT. CL. 2.

TOWN & COUNTRY SURF SHOP, INC., AIEA, HI:
2,150,641. REN. 8-17-07. INT. CL. 35.

TOY STATE INDUSTRIAL LTD., KOWLOON, HONG KONG:
2,404,749. CANC. MULTIPLE CLASS, INT. CLS. 20 AND 28.

TOYO INK MFG. CO., LTD., TOKYO, JAPAN:
2,087,736. REN. 8-20-07. INT. CL. 2.

TOYO ROSHI KABUSHIKI KAISHA, CHUO-KU, TOKYO, 103-0023, JAPAN:
3,298,413. INT. CL. 7.

TRACE LIFE SCIENCES, INC., DENTON, TX:
3,297,676. PUB. 7-10-2007. INT. CL. 10.

TRADE SERVICE CORPORATION, SAN DIEGO, CA:
2,403,241. CANC. INT. CL. 9.

TRADESCOPE, L.L.C., CHICAGO, IL:
2,403,585. CANC. INT. CL. 36.

TRADITIONAL WORLD FOODS (SOCIETE A RESPONSABILITE LIMITEE), 59290 WASQUEHAL, FRANCE:
2,100,902. REN. 8-17-07. INT. CL. 32.

TRAEGER PELLET GRILLS LLC, SILVERTON, OR:
3,296,618. PUB. 7-10-2007. INT. CL. 11.

TRAFAG AG, CH-8708 MANNEDORF, SWITZERLAND:
2,087,130. REN. 8-22-07. INT. CL. 9.

TRAFFIC & PARKING CONTROL CO., INC., ELM GROVE, WI:
3,296,372. PUB. 7-10-2007. INT. CL. 9.

TRAILER TRANSIT, INC., PORTER, IN:
1,471,690. REN. 8-23-07. INT. CL. 39.

TRANS-PACIFIC SOURCING, INC., EDINA, MN:
3,300,073. INT. CL. 28.

TRANSACT TECHNOLOGIES, INC., WALLINGFORD, CT:
3,299,558. INT. CL. 9.
3,299,559. INT. CL. 9.

TRANSAMERICA COMMERCIAL FINANCE CORPORATION, ROLLING MEADOWS, IL:
2,404,484. CANC. INT. CL. 36.

TRANSHUMANCE HOLDING COMPANY, INC., DAVIS, CA, SUPERIOR PACKING CO., ELLENSBURG, WA:
1,492,446. REN. 8-22-07. INT. CL. 29.

TRANSICO, INC., SANTA ANA, CA:
2,075,631. REN. 8-17-07. INT. CL. 9.

TRANSILWRAP COMPANY, INC., FRANKLIN PARK, IL:
2,404,420. CANC. INT. CL. 16.

TRANSITIONS OPTICAL, INC., PINELLAS PARK, FL:
3,299,886. INT. CL. 9.

TRANSMINERAL USA, INC., PETALUMA, CA:
2,403,221. CANC. INT. CL. 19.

TRANSPARENT LANGUAGE, INC., NASHUA, NH:
3,296,285. PUB. 7-10-2007. INT. CL. 9.

TRANSPORTATION INTERMEDIARIES ASSOCIATION, ALEXANDRIA, VA:
3,296,378. PUB. 7-10-2007. MULTIPLE CLASS, INT. CLS. 35, 39 AND 42.

TRAVELERS PROTECTIVE ASSOCIATION OF AMERICA, THE, ST. LOUIS, MO:
2,166,780. REN. 8-18-07. INT. CL. 42.

TRAVELNET SOLUTIONS, INC., COTTAGE GROVE, MN:
3,296,420. PUB. 6-26-2007. INT. CL. 35.

TRAVIS BOATS & MOTORS, INC., AUSTIN, TX:
2,403,297. CANC. INT. CL. 12.
2,403,298. CANC. INT. CL. 7.

TRAXSTECH CORPORATION, CHESANING, MI:
3,296,524. PUB. 7-10-2007. INT. CL. 28.

TREE ISLAND WIRE (USA), INC., FONTANA, CA:
3,299,200. INT. CL. 6.

TREK BICYCLE CORPORATION, WATERLOO, WI:
2,142,586. REN. 8-17-07. INT. CL. 12.
2,158,649. REN. 8-17-07. INT. CL. 12.

TREVLAC COMPUTER SERVICES LIMITED, GRAND BEND, ONTARIO, CANADA:
2,015,039. CANC. INT. CL. 9.

TRI STATE DISTRIBUTION, INC., SPENCER, TN:
2,403,925. CANC. INT. CL. 10.

TRI TECH USA, INC., WILLISTON, VT:
2,403,128. CANC. MULTIPLE CLASS, INT. CLS. 20 AND 42.

TRIAD CATALOG CO., LLC, ST. LOUIS, MO:
3,296,936. PUB. 7-10-2007. INT. CL. 3.

- TRIAD HOSPITALS, INC., PLANO, TX:
3,299,222, INT. CL. 42.
3,299,223, INT. CL. 42.
- TRIAD INTERNATIONAL TECHNOLOGY, INC., PORTLAND, OR:
2,403,246, CANC. INT. CL. 35.
- TRIBUNE MEDIA SERVICES, INC., CHICAGO, IL:
2,404,469, CANC. INT. CL. 9.
- TRIDENT PRODUCTS AND SERVICES LLC, PETERSBURG, VA:
3,297,100, PUB. 7-10-2007. INT. CL. 1.
3,297,101, PUB. 7-10-2007. INT. CL. 1.
3,297,102, PUB. 7-10-2007. INT. CL. 1.
- TRIDIUM, INC., RICHMOND, VA:
3,297,975, PUB. 7-10-2007. INT. CL. 9.
- TRIFECTA ENTERTAINMENT, LLC, ENCINO, CA:
3,299,487, INT. CL. 41.
- TRILLO, MANUEL, BOCA RATON, FL:
2,404,089, CANC. INT. CL. 25.
- TRIM-A-LAWN CORPORATION, UTICA, NY:
2,404,909, CANC. INT. CL. 7.
- TRIPS FOR KIDS MARIN, MILL VALLEY, CA:
2,158,638, REN. 8-22-07. INT. CL. 41.
- TRISTAN RESTAURANT, LLC, NORTH CHARLESTON, SC:
3,296,960, PUB. 7-10-2007. INT. CL. 43.
- TRITTER, SUSAN JOY, HOUSTON, TX:
3,297,317, PUB. 7-10-2007. INT. CL. 18.
- TROPHY CLEANERS, INC., CLEARWATER, FL:
2,015,454, CANC. INT. CL. 37.
- TRUE AZIMUTH, LLC, FAIRLEE, VT:
3,300,272, INT. CL. 41.
- TRUE COURSE HOLDINGS, INC., NAPERVILLE, IL:
3,297,802, PUB. 7-10-2007. INT. CL. 29.
- TRUSTEES OF DARTMOUTH COLLEGE, HANOVER, NH:
3,299,037, INT. CL. 25.
- TRUSTEES OF THE COLLEGE OF THE HOLY CROSS, WORCESTER, MA:
3,300,293, INT. CL. 41.
- TRUTH HARDWARE CORPORATION, OWATONNA, MN:
3,298,765, INT. CL. 6.
- TRUVEON CORPORATION, DURHAM, NC:
3,299,900, INT. CL. 35.
- TTS PERFORMANCE SYSTEMS, INC., AURORA, CO:
2,035,998, REN. 8-21-07. MULTIPLE CLASS, INT. CLS. 9 AND 16.
- TUBB, BARRY, SNYDER, TX:
3,299,546, INT. CL. 25.
- TUCKER, JOEL G., LOS ANGELES, CA:
3,296,583, PUB. 6-26-2007. INT. CL. 25.
- TUFTS UNIVERSITY, MEDFORD, MA:
2,016,594, CANC. INT. CL. 9.
- TUGUSTO FOODS, INC., SAN JUAN, PUERTO RICO:
3,298,135, PUB. 7-10-2007. INT. CL. 30.
- TULSA COFFEE SERVICE INC., TULSA, OK, DBA JAVA DAVE'S EXECUTIVE COFFEE:
3,299,617, INT. CL. 30.
- TUMBLEWEED SOFTWARE, INC., FORT WORTH, TX:
3,298,759, INT. CL. 9.
- TURN-LUCKILY INTERNATIONAL, INC., IRVINE, CA:
3,296,405, PUB. 7-10-2007. INT. CL. 9.
- TURNER ENTERTAINMENT CO., BURBANK, CA:
3,296,433, PUB. 7-10-2007. INT. CL. 9.
- TVC - TOTAL VIEW COMPANY, INC., SAN RAFAEL, CA:
3,297,868, PUB. 7-10-2007. INT. CL. 19.
- TWENTIETH CENTURY FOX FILM CORPORATION, LOS ANGELES, CA:
3,298,649, INT. CL. 5.
3,299,336, INT. CL. 28.
- TWIN FINANCIAL, INC., KANSAS CITY, MO:
3,299,508, INT. CL. 36.
- TWIN VEE, INC., FORT PIERCE, FL:
3,298,508, INT. CL. 12.
- TWO LANE ROAD, INC., DECATUR, GA:
3,296,270, PUB. 7-10-2007. INT. CL. 41.
- TWO RIVER TIMES LLC, RED BANK, NJ:
3,296,367, PUB. 7-10-2007. INT. CL. 16.
- TWO TECHNOLOGIES, INC., HORSHAM, PA:
3,300,147, INT. CL. 9.
3,300,148, INT. CL. 9.
- TY-KENN PRODUCTS COMPANY, INC., PLANO, TX:
3,299,008, INT. CL. 3.
- TYCO ELECTRONICS CORPORATION, MIDDLETON, PERU, RAYCHEM CORPORATION, MENLO PARK, CA:
2,003,838, REN. 8-21-07. INT. CL. 17.
- TYCOON INTERNATIONAL, INC., NEW YORK, NY:
3,299,589, INT. CL. 14.
- TYLER DISTRIBUTION, INC., GRESHAM, OR, DBA PREVAIL CORPORATION:
2,403,402, CANC. INT. CL. 5.
- TYMKIN, RANDY, CORYDON, WINNIPEG, MANITOBA, R3M 3S7, CANADA:
2,032,346, REN. 8-18-07. INT. CL. 10.
- T3 TELECOM SOFTWARE, INC., NEW YORK, NY:
3,296,582, PUB. 7-10-2007. INT. CL. 38.
- U.S. MEDICAL TECHNOLOGIES, INC., OMAHA, NE AND SOMMERS, STEVEN F., OMAHA, NE:
2,084,019, REN. 8-17-07. INT. CL. 10.
- U.S. PAINT CORPORATION, ST. LOUIS, MO:
2,404,218, CANC. INT. CL. 2.
- U.S. RECORDINGS, INC., MINNEAPOLIS, MN:
3,297,273, PUB. 7-10-2007. MULTIPLE CLASS, INT. CLS. 35, 38 AND 42.
- U.S. SECURITY ASSOCIATES, INC., ROSWELL, GA:
2,083,926, REN. 8-22-07. INT. CL. 42.
- U.S.A. AUTOSUN INTERNATIONAL GROUP LIMITED, MONGKOK, KOWLOON, HONG KONG:
3,298,881, INT. CL. 12.
- U.S.A. DESIGN, INC., NEW YORK, NY:
3,296,022, PUB. 7-10-2007. INT. CL. 25.
3,298,544, INT. CL. 25.
- U-HAUL INTERNATIONAL, INC., PHOENIX, AZ:
2,477,239, CANC. INT. CL. 12.
- UBOARDS LTD., LLC, LOS ANGELES, CA:
3,298,120, PUB. 7-10-2007. INT. CL. 28.
- UCB PHARMA, S.A., BELGIUM:
3,298,318, PUB. 7-10-2007. INT. CL. 5.
- UCN, INC., BLUFFDALE, UT:
3,298,478, INT. CL. 42.
- UGURTEKS TEKSTİL ÜRÜNLERİ TİCARET VE SANAYİ ANONİM ŞİRKETİ, GÜNGÖREN, İSTANBUL, TÜRKİYE:
3,298,852, MULTIPLE CLASS, INT. CLS. 25 AND 26.
- UK ABRASIVES, INC., NORTHBROOK, IL, DBA WE INNOVEX, INC.:
2,057,891, REN. 8-20-07. INT. CL. 40.
- UKA'S BIG SAVER FOODS, INC., LOS ANGELES, CA:
2,403,741, CANC. INT. CL. 35.
- UKW HOLDING COMPANY, NORTH MIAMI BEACH, FL:
3,296,592, PUB. 7-10-2007. INT. CL. 44.
- ULTIMATE ACQUISITION PARTNERS, L.P., THORNTON, CO:
3,299,268, INT. CL. 35.
- ULTIMATE BODY PRESS LLC, ASHEVILLE, NC:
3,297,819, PUB. 7-10-2007. INT. CL. 28.
- ULTIMATE FORMULATIONS, INC., CITY OF INDUSTRY, CA:
3,300,118, INT. CL. 5.
- ULTIMATE LIFE, INC., THE, SANTA BARBARA, CA TO ULTIMATE LIFE, INC., THE, SANTA BARBARA, CA:
2,014,919, CANC. INT. CL. 5.
- ULTRA POOL COATINGS, INC., WOODBRIDGE, ONTARIO, CANADA:
2,403,464, CANC. INT. CL. 19.
- ULTRA-SCAN CORPORATION, AMHERST, NY:
3,298,511, INT. CL. 9.
- ULTRASHAPE LTD., YOKNEAM, ISRAEL:
3,296,457, PUB. 7-10-2007. INT. CL. 10.
- ULTRATEC FIBER OPTIC CORPORATION, BURNABY, BRITISH COLUMBIA, CANADA:
2,403,401, CANC. INT. CL. 9.
- ULTRATECH, INC., SAN JOSE, CA:
1,416,477, CANC. INT. CL. 9.
- ULTRAVIT ENTERPRISES, INC., PASADENA, CA:
2,404,474, CANC. INT. CL. 5.

- UMANO INC., SAN FRANCISCO, CA:
2,404,424, CANC. INT. CL. 9.
- UNASU INC., BROOKLYN, NY:
3,299,227, INT. CL. 25.
- UNCHARTED OUTPOSTS, INC., SANTA FE, NM:
3,296,629, PUB. 7-10-2007. INT. CL. 39.
- UNCLE MILTON INDUSTRIES, INC., WESTLAKE VIL-
LAGE, CA:
3,299,471, INT. CL. 28.
- UNEEDA DOLL CO., INC., NEW YORK, NY:
1,416,811, CANC. INT. CL. 28.
- UNEX CORPORATION, MAHWAH, NJ:
2,145,308, REN. 8-23-07. INT. CL. 7.
- UNHYCOS, F-95480 PIERRELAJE, FRANCE:
3,298,386, PUB. 7-10-2007. MULTIPLE CLASS, INT. CLS. 3
AND 8.
- UNIFLEX HOLDINGS, INC., WESTBURY, NY:
2,027,460, REN. 8-17-07. INT. CL. 22.
- UNILEVER SUPPLY CHAIN, INC., CLINTON, CT:
3,298,570, INT. CL. 30.
- UNIMAR, INC., TRUMBULL, CT:
1,449,497, REN. 8-20-07. INT. CL. 10.
- UNION BANK, SAN FRANCISCO, CA TO UNION BANK OF
CALIFORNIA N.A., SAN FRANCISCO, CA:
2,015,390, CANC. INT. CL. 36.
- UNION FOR REFORM JUDAISM, NEW YORK, NY:
3,299,181, INT. CL. 16.
- UNION SURGICAL, LLC, PHILADELPHIA, PA:
3,299,489, INT. CL. 10.
- UNISEN, INC., IRVINE, CA:
3,298,875, INT. CL. 28.
- UNITARIAN UNIVERSALIST ASSOCIATION, BOSTON,
MA:
3,299,215, INT. CL. 16.
3,299,216, INT. CL. 35.
- UNITED AIR SPECIALISTS, INC., CINCINNATI, OH:
2,016,458, CANC. INT. CL. 11.
- UNITED AMERICAN HEALTHCARE CORPORATION, DE-
TROIT, MI:
2,082,681, REN. 8-22-07. MULTIPLE CLASS, INT. CLS. 35
AND 36.
- UNITED ARTISTS CORPORATION, LOS ANGELES, CA:
2,091,641, REN. 8-20-07. MULTIPLE CLASS, INT. CLS. 9,
16 AND 41.
- UNITED ARTISTS CORPORATION, LOS ANGELES, CA
AND DANJAQ, LLC, SANTA MONICA, CA:
3,298,642, MULTIPLE CLASS, INT. CLS. 16, 21 AND 28.
- UNITED DISTRIBUTORS, INC., OMAHA, NE:
3,297,745, PUB. 4-3-2007. INT. CL. 32.
- UNITED GENERAL SUPPLY CO., INC., HOUSTON, TX:
3,299,811, INT. CL. 6.
- UNITED HARD CHROME CORPORATION, CANTON, OH:
2,404,529, CANC. INT. CL. 40.
- UNITED NATURAL FOODS, INC., DAYVILLE, CT:
2,404,901, CANC. MULTIPLE CLASS, INT. CLS. 5, 29
AND 31.
- UNITED OF OMAHA LIFE INSURANCE COMPANY, OMA-
HA, NE:
3,296,387, PUB. 7-10-2007. INT. CL. 36.
- UNITED PARCEL SERVICE OF AMERICA, INC., ATLAN-
TA, GA:
3,299,584, MULTIPLE CLASS, INT. CLS. 9, 35 AND 39.
- UNITED PENTECOSTAL CHURCH INTERNATIONAL,
INC., HAZELWOOD, MO:
3,298,736, MULTIPLE CLASS, INT. CLS. 9, 16, 41 AND 45.
3,298,738, MULTIPLE CLASS, INT. CLS. 9, 16, 41 AND 45.
- UNITED RETAIL INCORPORATED, ROCHELLE PARK, NJ:
2,403,752, CANC. MULTIPLE CLASS, INT. CLS. 3 AND 4.
3,299,503, INT. CL. 25.
- UNITED SAFETY COUNCIL, INC., ORLANDO, FL:
3,300,254, INT. CL. 41.
- UNITED STATES AUTO SECURITY, VENICE, CA:
2,014,799, CANC. MULTIPLE CLASS, INT. CLS. 16 AND
36.
- UNITED STATES CELLULAR CORPORATION, CHICAGO,
IL:
2,403,665, CANC. INT. CL. 42.
- UNITED STATES GYPSUM COMPANY, CHICAGO, IL:
3,296,953, PUB. 7-10-2007. INT. CL. 8.
3,297,120, PUB. 7-10-2007. INT. CL. 17.
- UNITED STATES JUNIOR CHAMBER OF COMMERCE,
THE, TULSA, OK, UNITED STATES JAYCEES, THE,
TULSA, OK:
1,466,330, REN. 8-22-07. INT. CL. 16.
- UNITED STATES MARKETING CORPORATION, HUN-
TINGTON STATION, NY:
3,298,587, INT. CL. 13.
- UNITED STATES POSTAL SERVICE ESTABLISHED BY AN
ACT OF CONGRESS, WASHINGTON, DC:
2,054,843, REN. 8-20-07. INT. CL. 35.
- UNITED STATES TELECOM ASSOCIATION, WASHING-
TON, DC:
3,299,668, INT. CL. 16.
- UNIVERSAL CITY STUDIOS LLLP, UNIVERSAL CITY, CA:
3,299,337, INT. CL. 41.
3,299,926, INT. CL. 41.
- UNIVERSAL COOPERATIVES, INC., EAGAN, MN:
2,164,724, REN. 8-20-07. INT. CL. 22.
2,171,926, REN. 8-20-07. INT. CL. 22.
3,299,512, INT. CL. 22.
- UNIVERSAL HEALTH SERVICES, INC., KING OF PRUS-
SIA, PA:
1,417,015, CANC. INT. CL. 42.
- UNIVERSAL MARKET EXPRESS, INC., DALLAS, TX:
2,014,677, CANC. INT. CL. 35.
- UNIVERSITY FEDERAL CREDIT UNION, AUSTIN, TX:
3,297,056, PUB. 7-10-2007. INT. CL. 36.
- UNIVERSITY OF IOWA COMMUNITY CREDIT UNION,
IOWA CITY, IA:
3,300,190, INT. CL. 36.
- UNIVERSITY OF SOUTH CAROLINA, COLUMBIA, SC:
3,299,335, INT. CL. 37.
- UPTIMEONE, INC., SAN JOSE, CA:
2,403,926, CANC. INT. CL. 9.
- URAC, WASHINGTON, DC:
3,298,560, INT. CL. 42.
- URBAN ADVENTURES COMPANIES, INC, WASHINGTON,
DC:
3,299,375, INT. CL. 41.
- URBAN HELPERS, LLC, ARLINGTON, VA:
3,299,060, MULTIPLE CLASS, INT. CLS. 35, 36, 44 AND
45.
- URBAN ORGANICS, INC., TUCSON, AZ:
3,297,238, PUB. 7-10-2007. MULTIPLE CLASS, INT. CLS. 1
AND 31.
- URETHANE SYSTEMS PLUS, INC., WAUKESHA, WI:
3,299,710, INT. CL. 28.
- US OPEN SWING DANCE CHAMPIONSHIPS, INC., BA-
KERSFIELD, CA:
3,296,311, PUB. 7-10-2007. INT. CL. 41.
- USA HOMEBUYERS, INC., RESTON, VA:
3,298,091, PUB. 7-10-2007. INT. CL. 36.
- USA MARKETING, LLC, OAKLAND, CA:
3,298,748, MULTIPLE CLASS, INT. CLS. 35 AND 41.
- USA PRODUCTS GROUP, INC., LODI, CA:
1,416,540, CANC. MULTIPLE CLASS, INT. CLS. 12 AND
22.
- USAEROSPACE GROUP, L.L.C., MANASSAS, VA:
2,403,355, CANC. INT. CL. 9.
- USEFUL PRODUCTS, INC., GARLAND, TX:
2,404,778, CANC. INT. CL. 20.
- UWE GMBH, FED REP GERMANY:
3,298,315, PUB. 7-10-2007. MULTIPLE CLASS, INT. CLS. 3
AND 11.
- UZZI REISS, M.D., INC., BEVERLY HILLS, CA:
3,296,144, PUB. 7-10-2007. INT. CL. 44.
- V.T.I. FERTASCO, INC., NORCROSS, GA:
2,403,183, CANC. INT. CL. 1.
- V&A ENTERPRISES LIMITED, LONDON, UNITED KING-
DOM:
3,297,237, PUB. 7-10-2007. MULTIPLE CLASS, INT. CLS.
9, 14, 16, 18, 19, 21, 24, 25, 27 AND 41.
- V-LITE CORPORATION, LEAWOOD, KS TO MARZEC &
MURDOCK, INC., BURBANK, CA:
2,014,991, CANC. INT. CL. 9.

- VA INVEST, MOSCOW, RUSSIAN FED.:
3,298,911, MULTIPLE CLASS, INT. CLS. 16, 35, 36, 41 AND 42.
- VAAD HOEIR OF ST. LOUIS, ST. LOUIS, MO:
3,297,439, PUB. 7-10-2007. MULTIPLE CLASS, U.S. CLS. A AND B.
- VACTOR MANUFACTURING, INC., STREATOR, IL:
3,297,130, PUB. 7-10-2007. INT. CL. 7.
- VALCOM, INC., ROANOKE, VA:
1,450,484, REN. 8-18-07. INT. CL. 9.
- VALENITE, LLC, MADISON HEIGHTS, MI:
2,109,112, REN. 8-20-07. INT. CL. 4.
- VALENTINO S.P.A., ITALY:
3,298,206, PUB. 7-10-2007. INT. CL. 8.
- VALIANT CORPORATION, WINDSOR, ONTARIO, CANADA:
3,298,697, INT. CL. 7.
3,298,698, INT. CL. 7.
- VALIGERIA RONCATO S.P.A., CAMPODARSEGO PD, ITALY:
3,296,279, PUB. 7-10-2007. INT. CL. 18.
- VALLEY LANE INDUSTRIES COMPANY, NEW YORK, NY:
2,098,369, REN. 8-20-07. INT. CL. 25.
- VALOR LIMITED, BIRMINGHAM B24 9QP, ENGLAND:
2,403,309, CANC. INT. CL. 37.
- VALSPAR CORPORATION, THE, MINNEAPOLIS, MN:
2,015,758, CANC. INT. CL. 2.
- VALSPAR SOURCING, INC., MINNEAPOLIS, MN:
3,298,643, MULTIPLE CLASS, INT. CLS. 1 AND 2.
- VALVETRAIN AMPLIFICATION, LLC, APOPKA, FL:
3,296,703, PUB. 7-10-2007. INT. CL. 9.
- VALVOSANITARIA BUGATTI S.P.A., ITALY:
3,298,259, PUB. 7-10-2007. INT. CL. 6.
- VAN CLEEF & ARPELS SA, 1752 VILLARS-SUR-GLANE, SWITZERLAND:
1,445,858, REN. 8-17-07. INT. CL. 3.
- VAN DORN DEMAG CORPORATION, STRONGSVILLE, OH:
3,298,116, PUB. 7-10-2007. INT. CL. 7.
- VAN ESSEN INSTRUMENTS B.V., DELFT, NETHERLANDS:
3,296,320, PUB. 7-10-2007. INT. CL. 9.
- VANCE PRODUCTS INCORPORATED, SPENCER, IN, DBA COOK UROLOGICAL INCORPORATED:
2,076,166, REN. 8-23-07. INT. CL. 10.
- VANITY FAIR, INC., WILMINGTON, DE:
3,298,718, INT. CL. 25.
3,299,030, INT. CL. 25.
- VARIAN, INC., PALO ALTO, CA. MARION LABORATORIES, INC., KANSAS CITY, MO:
1,457,239, REN. 8-22-07. INT. CL. 9.
- VAST RESOURCES, INC., CHATSWORTH, CA:
3,297,794, PUB. 7-10-2007. INT. CL. 10.
- VAUGHAN, KIRK, PORT ORCHARD, WA:
3,299,258, INT. CL. 9.
- VECTOR SURGICAL, LLC, OCONOMOWOC, WI:
3,300,027, INT. CL. 10.
- VEEDER ROOT COMPANY, SIMSBURY, CT. RED JACKET MANUFACTURING COMPANY, DAVENPORT, IA:
830,117, REN. 8-22-07. U.S. CL. 21 (INT. CL. 9).
- VELCON FILTERS, INC., COLORADO SPRINGS, CO:
1,448,128, REN. 8-17-07. MULTIPLE CLASS, INT. CLS. 6, 7, 9, 17 AND 42.
- VELENO, JOHN, ST. PETERSBURG, FL:
3,298,425, INT. CL. 15.
- VENTRE PACKING CO., INC., SYRACUSE, NY:
656,553, REN. 8-17-07. U.S. CL. 46 (INT. CLS. 29 AND 30).
- VENTURINI LUCA, I-50018 SCANDICCI, FIRENZE, ITALY:
3,298,260, PUB. 7-10-2007. INT. CL. 25.
- VERITY, INC, SUNNYVALE, CA:
2,171,653, REN. 8-22-07. MULTIPLE CLASS, INT. CLS. 9 AND 42.
- VERMEER MANUFACTURING COMPANY, PELLA, IA:
3,297,168, PUB. 7-10-2007. INT. CL. 7.
- VERONIKA ELSNER, GUENTHER FLAKE GBR, HAMBURG, FED REP GERMANY:
3,296,625, PUB. 7-10-2007. INT. CL. 9.
3,296,626, PUB. 7-10-2007. INT. CL. 9.
- VERTICAL CIRCUITS, INC., SCOTTS VALLEY, CA:
3,298,674, INT. CL. 9.
- VERTIS, INC., BALTIMORE, MD:
2,404,664, CANC. INT. CL. 38.
- VERYWISE NUTRITION LIMITED, PORT TALBOT, GREAT BRITAIN:
3,296,434, PUB. 7-10-2007. INT. CL. 5.
- VETERINARY ORAL HEALTH COUNCIL, PHILADELPHIA, PA:
2,404,608, CANC. U.S. CL. A.
- VETOQUINOL U.S.A., INC., BUENA, NJ, VET SOLUTIONS, INC., BEDFORD, TX:
2,085,281, REN. 8-22-07. INT. CL. 5.
- VI-JON, INC., ST. LOUIS, MO:
2,404,046, CANC. INT. CL. 5.
- VIACOM INTERNATIONAL INC., NEW YORK, NY:
2,016,109, CANC. INT. CL. 42.
2,403,051, CANC. INT. CL. 41.
2,404,821, CANC. INT. CL. 41.
2,404,822, CANC. INT. CL. 41.
2,404,823, CANC. INT. CL. 41.
3,298,669, INT. CL. 9.
3,299,193, INT. CL. 41.
3,299,541, INT. CL. 41.
- VIAGGIO, INC., ORLANDO, FL:
3,298,884, INT. CL. 8.
- VIBRAM S.P.A., 21041 ALBIZZATE (VARESE), ITALY:
3,299,169, INT. CL. 25.
- VICINO, ROBERT K., DEL MAR, CA:
3,298,744, INT. CL. 43.
- VICMOJESS ENTERPRISES, INC., LOS ANGELES, CA:
3,298,045, PUB. 7-10-2007. INT. CL. 25.
- VICOM COMPUTER SERVICES, INC., FARMINGDALE, NY:
2,403,908, CANC. INT. CL. 9.
- VICORP RESTAURANTS, INC., DENVER, CO:
3,297,956, PUB. 7-10-2007. INT. CL. 43.
- VICTOR EQUIPMENT COMPANY, ST. LOUIS, MO:
2,016,286, CANC. INT. CL. 8.
- VICTOR SINCLAIR, INC., ST. SIMONS ISLAND, GA:
2,403,076, CANC. INT. CL. 34.
- VICTORIA'S SECRET STORES BRAND MANAGEMENT, INC., REYNOLDSBURG, OH:
3,298,809, INT. CL. 3.
- VICTOROV, VICTOR, SAINT-PETERSBURG, RUSSIAN FED.:
3,296,506, PUB. 7-10-2007. MULTIPLE CLASS, INT. CLS. 9 AND 42.
- VICTORY MARKETS, INC., NORWICH, NY, DBA VICTORY VIDEO:
1,416,986, CANC. MULTIPLE CLASS, INT. CLS. 41 AND 42.
- VIDEO VENTURES JOINT VENTURE, BALTIMORE, MD:
2,015,996, CANC. MULTIPLE CLASS, INT. CLS. 41 AND 42.
- VIDOOP LLC, TULSA, OK:
3,296,299, PUB. 7-10-2007. INT. CL. 45.
3,297,661, PUB. 7-10-2007. INT. CL. 9.
- VIEWER ADVISORIES INC., NEW YORK, NY:
2,078,692, REN. 8-17-07. U.S. CL. B.
- VIEWMAX TECH CO., LTD., CHIAYI CITY TAIWAN, TAIWAN:
2,403,340, CANC. INT. CL. 9.
- VIEWPOINTE ARCHIVE SERVICES LLC, CHARLOTTE, NC:
3,296,771, PUB. 7-10-2007. MULTIPLE CLASS, INT. CLS. 38 AND 39.
- VIGNERONS CATALANS EN ROUSSILLON, PERPIGNAN, FRANCE:
3,297,982, PUB. 7-10-2007. INT. CL. 33.
- VILLA HOLDING, LLC, MORRISTOWN, NJ:
3,297,462, PUB. 7-10-2007. INT. CL. 43.
- VILLAGE HOMES OF COLORADO, INC., ENGLEWOOD, CO:
3,298,012, PUB. 7-10-2007. MULTIPLE CLASS, INT. CLS. 35, 36, 37, 41 AND 42.
- VILLAGE OF WATERVILLE, WATERVILLE, OH:
3,298,123, PUB. 5-8-2007. INT. CL. 35.

VILLANI, EMILIO M., LONDON, ONTARIO, CANADA:
3,299,067, INT. CL. 8.

VILLARROEL, DANIEL, HOBOKEN, NJ:
2,404,135, CANC. INT. CL. 3.

VINAROMA LLC, NEWARK, DE:
3,299,819, INT. CL. 33.

VINCAM GROUP, INC., THE, CORAL GABLES, FL TO ADP
TOTALSOURCE GROUP, INC., MIAMI, FL:
2,015,058, CANC. MULTIPLE CLASS, INT. CLS. 35 AND
36.

VINCENT MOTORS USA, SAN DIEGO, CA:
2,121,683, REN. 8-23-07, INT. CL. 25.

VINCENT, MARGARET SCHAFFER, EAST FALLOWFIELD,
PA:
3,298,042, PUB. 4-3-2007, INT. CL. 24.

VINCULUM COMMUNICATIONS, INC., SAN DIEGO, CA:
3,299,872, INT. CL. 9.

VINITY WINE COMPANY, EMERYVILLE, CA:
2,404,222, CANC. INT. CL. 35.

VINITY WINE COMPANY, EMERYVILLE, CA:
2,404,223, CANC. INT. CL. 35.

VINTAGE FUEL, LLC, LAS VEGAS, NV:
3,296,571, PUB. 7-10-2007, MULTIPLE CLASS, INT. CLS.
16 AND 25.

VINTWOOD INTERNATIONAL, LTD., HUNTINGTON, NY:
2,150,451, REN. 8-23-07, INT. CL. 33.

VIPAR HEAVY DUTY, INC., CRYSTAL LAKE, IL:
3,296,073, PUB. 7-10-2007, INT. CL. 35.

VIPERA GMBH, BADEN AG 5401, SWITZERLAND:
3,296,360, PUB. 7-10-2007, INT. CL. 38.

VIPOND INC., MISSISSAUGA, ONTARIO, CANADA, VI-
POND FIRE PROTECTION LIMITED, MISSISSAUGA,
ONTARIO, CANADA:
2,086,643, REN. 8-23-07, MULTIPLE CLASS, INT. CLS. 37
AND 42.

VIRBAC CORPORATION, FORT WORTH, TX:
3,297,599, PUB. 7-10-2007, INT. CL. 5.

VIRCO MFG. CORPORATION, TORRANCE, CA:
2,404,744, CANC. INT. CL. 20.

VIRGIN COMICS, LLC, NEW YORK, NY:
3,299,697, INT. CL. 16.
3,299,709, INT. CL. 16.

VIRGIN ENTERPRISES LIMITED, LONDON W8 7AR,
ENGLAND:
3,298,420, MULTIPLE CLASS, INT. CLS. 35 AND 36.
3,298,421, MULTIPLE CLASS, INT. CLS. 35 AND 36.

VIRGIN MOBILE USA, LLC, WARREN, NJ:
3,299,352, INT. CL. 9.

VIRTOOLS, 75003 PARIS, FRANCE:
2,404,572, CANC. INT. CL. 9.

VIRTUAL CAST, LLC, ALBUQUERQUE, NM:
3,298,043, PUB. 7-10-2007, INT. CL. 44.

VIRTUAL MECHANICS INC., MARKHAM, CANADA:
3,296,393, PUB. 7-10-2007, INT. CL. 9.

VIRTUAL MEETING STRATEGIES, INC., INDIANAPOLIS,
IN:
3,296,928, PUB. 7-10-2007, INT. CL. 41.

VIRTUAL REACTION INCORPORATED, DIX HILLS, NY:
3,296,910, PUB. 7-10-2007, INT. CL. 42.

VIRTUE PAINTBALL LLC, SMITHTOWN, NY:
3,296,578, PUB. 7-10-2007, INT. CL. 9.
3,296,595, PUB. 7-10-2007, INT. CL. 9.
3,296,597, PUB. 7-10-2007, INT. CL. 9.

VISA INTERNATIONAL SERVICE ASSOCIATION, FOSTER
CITY, CA, IBANCO LTD., SAN FRANCISCO, CA:
1,071,114, REN. 8-22-07, INT. CL. 36.

VISA INTERNATIONAL SERVICE ASSOCIATION, FOSTER
CITY, CA:
3,297,359, PUB. 7-10-2007, INT. CL. 41.

VISAGE, INC., NEW YORK, NY:
3,299,659, INT. CL. 18.

VISALUS HOLDINGS LLC, TROY, MI:
3,297,690, PUB. 7-10-2007, INT. CL. 5.

VISIBILITY RESOURCE GROUP, INC., EAGLE, ID:
3,299,480, INT. CL. 35.

VISIBLE GENETICS INC., TORONTO, ONTARIO M5G 1Z6,
CANADA:
2,404,700, CANC. INT. CL. 42.

VISION FINANCIAL MARKETS LLC, NEW YORK, NY:
3,298,117, PUB. 7-10-2007, INT. CL. 36.

VISIONAEL CORPORATION, PALO ALTO, CA:
2,404,274, CANC. INT. CL. 9.

VISITING NURSE SERVICE OF NEW YORK, INC., NEW
YORK, NY:
3,296,361, PUB. 7-10-2007, INT. CL. 35.

VISUAL DEPARTURES LTD., STAMFORD, CT:
1,446,116, REN. 8-20-07, INT. CL. 9.

VISUAL SYSTEMS GROUP, INC. DBA VSIG, MCLEAN, VA:
3,296,390, PUB. 7-10-2007, INT. CL. 38.

VITAL PHARMACEUTICALS, INC., DAVIE, FL:
3,297,198, PUB. 7-10-2007, INT. CL. 5.

VITAMIN SHOPPE INDUSTRIES INC., NORTH BERGEN,
NJ:
3,300,183, INT. CL. 5.

VITAMINLAB. COM LLC, SECAUCUS, NJ:
2,404,861, CANC. INT. CL. 5.

VITARGET GMBH & CO. KG, FED REP GERMANY:
3,298,174, PUB. 7-10-2007, MULTIPLE CLASS, INT. CLS.
5, 30 AND 31.

VIVAYOU FASHION INC., LOS ANGELES, CA:
2,355,395, CANC. INT. CL. 25.

VKR HOLDING A/S, 2970 HØRSKOLM, DENMARK:
3,299,102, INT. CL. 19.

VMS REALTY, INC., CHICAGO, IL:
1,416,914, CANC. MULTIPLE CLASS, INT. CLS. 36 AND
37.

VOD ADVERTISING SERVICES, AVV, ORANJESTAD, AR-
UBA:
3,300,304, INT. CL. 41.

VOGAN CONSULTING SERVICES, INC., MALVERN, PA:
3,300,070, MULTIPLE CLASS, INT. CLS. 9, 16 AND 35.

VOLLRATH COMPANY, L.L.C., THE, SHEBOYGAN, WI:
2,404,207, CANC. INT. CL. 21.

VOX, INCORPORATED, OAK PARK, IL:
3,297,867, PUB. 7-10-2007, INT. CL. 35.

VOXPATH NETWORKS, INC., AUSTIN, TX:
3,296,344, PUB. 7-10-2007, INT. CL. 38.

VOXWARE, INC., LAWRENCEVILLE, NJ:
3,300,340, INT. CL. 9.

VPI CORP., WILMINGTON, DE:
3,300,080, MULTIPLE CLASS, INT. CLS. 8 AND 21.

VRCO, INC., CHICAGO, IL:
2,404,363, CANC. INT. CL. 9.

VRGATEWAY, INC., BETHESDA, MD:
3,297,898, PUB. 7-10-2007, INT. CL. 36.

W. L. GORE & ASSOCIATES, INC., NEWARK, DE:
2,079,739, REN. 8-17-07, INT. CL. 24.

W.C. BRADLEY COMPANY, COLUMBUS, GA:
2,015,549, CANC. INT. CL. 11.

W.P. HICKMAN SYSTEMS, INC., SOLON, OH:
3,300,113, INT. CL. 19.

WACHOVIA CAPITAL FINANCE CORPORATION(NEW
ENGLAND) , AS AGENT, BOSTON, MA:
2,404,622, CANC. INT. CL. 30.

WACHOVIA CORPORATION, CHARLOTTE, NC:
3,298,644, INT. CL. 36.
3,299,364, INT. CL. 36.
3,299,763, INT. CL. 35.

WACKENHUT CORPORATION, THE, PALM BEACH GAR-
DENS, FL:
2,404,577, CANC. INT. CL. 9.

WACKY BEAR FACTORY, HOUMA, LA:
3,296,643, PUB. 7-10-2007, INT. CL. 35.

WADDELL, ROBERT CHRISTOPHER, GREENWOOD, IN:
3,296,700, PUB. 7-10-2007, INT. CL. 44.

WAGNER, ROBIN K, SAN PEDRO, CA:
3,299,391, INT. CL. 25.

WAHL CLIPPER CORPORATION, STERLING, IL:
3,298,489, INT. CL. 8.
3,300,018, INT. CL. 8.

WAHOO STUDIOS, INC., OREM, UT:
3,296,973, PUB. 7-10-2007, INT. CL. 9.

WAKEFERN FOOD CORP., ELIZABETH, NJ:
3,298,490, INT. CL. 16.

WALCO INTERNATIONAL, INC., WESTLAKE, TX:
3,299,010, INT. CL. 5.

- WALKER EVANS, COLUMBUS, OH:
3,296,422, PUB. 7-10-2007. INT. CL. 35.
- WALLOS, ROBERT, KATONAH, NY:
3,298,713, INT. CL. 36.
- WALRUS BRANDS LLC, CHICAGO, IL:
3,296,637, PUB. 7-10-2007. INT. CL. 25.
- WALTER STICKLE AND J. POWERS PARTNERSHIP, THE,
NORTH READING, MA:
2,403,156, CANC. MULTIPLE CLASS, INT. CLS. 9 AND
41.
- WALTERS, WILLIAM EDWARD, CEDAR, MI:
3,298,990, INT. CL. 25.
- WAMPUMWARE, INC., COPPELL, TX:
2,403,966, CANC. INT. CL. 9.
- WANI, DAVID, NEWPORT BEACH, CA:
3,300,200, MULTIPLE CLASS, INT. CLS. 35 AND 36.
- WARGO, ANDREW J., PHILADELPHIA, PA, DBA WALE
APPARATUS COMPANY:
1,416,411, CANC. INT. CL. 7.
- WARNACO U.S., INC., MILFORD, CT:
2,072,096, CANC. INT. CL. 25.
3,298,624, INT. CL. 25.
3,299,474, INT. CL. 25.
- WARNER BROS. ENTERTAINMENT INC., BURBANK, CA:
3,299,957, INT. CL. 41.
- WARNER, NINA D., LOS ANGELES, CA AND WARNER,
TIMOTHY W., LOS ANGELES, CA:
3,296,352, PUB. 7-10-2007. INT. CL. 35.
- WARNKEZ, LLC, STOVER, MO:
3,299,482, INT. CL. 7.
- WARNOW, JOSETTE G., BERKELEY, CA:
3,298,653, INT. CL. 16.
- WARRIOR LACROSSE, INC., WARREN, MI:
3,299,494, INT. CL. 28.
- WASHER, BEN, BATON ROUGE, LA:
2,964,983, CANC. INT. CL. 25.
- WASHERS, INC., LIVONIA, MI, DBA ALPHA STAMPING
COMPANY:
3,298,593, INT. CL. 6.
- WASSERMAN, HELEN, WASHINGTON, DC:
3,297,240, PUB. 7-10-2007. INT. CL. 30.
- WATER TECH, LLC, EAST BRUNSWICK, NJ:
3,299,448, INT. CL. 7.
- WATERFORD VINEYARDS, LLC, WATERFORD, VA:
3,297,227, PUB. 7-25-2006. INT. CL. 33.
- WATERJET S.R.L., MONZA, ITALY:
3,297,668, PUB. 7-10-2007. INT. CL. 7.
- WATERLEAF LIMITED, DOUGLAS, ISLE OF MAN, UNI-
TED KINGDOM:
3,298,068, PUB. 7-10-2007. INT. CL. 41.
- WATERSAVER TECHNOLOGIES, LLC, LOUISVILLE, KY:
3,299,744, INT. CL. 11.
- WATERWORKS, INC., DANBURY, CT:
3,298,981, MULTIPLE CLASS, INT. CLS. 24 AND 26.
- WATSON LABORATORIES, INC., CORONA, CA, OCLAS-
SEN PHARMACEUTICALS, INC., SAN RAFAEL, CA:
2,093,190, REN. 8-17-07. INT. CL. 5.
- WATSON LABORATORIES, INC., CORONA, CA, WATSON
LABORATORIES, INC., CORONA, CA:
2,124,144, REN. 8-17-07. INT. CL. 5.
- WATSON PHARMACEUTICALS, INC., CORONA, CA, SAN-
DOZ, INC., EAST HANOVER, NJ:
1,080,168, REN. 8-17-07. INT. CL. 5.
- WAVEFRONT TECHNOLOGY, INC., PARAMOUNT, CA:
3,299,464, MULTIPLE CLASS, INT. CLS. 11 AND 17.
- WAVELIGHT LASER TECHNOLOGIE AG, ERLANGEN,
FED REP GERMANY:
3,298,847, INT. CL. 10.
- WAVEMARKET, INC., EMERYVILLE, CA:
3,296,959, PUB. 7-10-2007. INT. CL. 45.
- WAVIX, INCORPORATED, ROCKVILLE, MD:
2,404,169, CANC. INT. CL. 42.
- WAYNE-DALTON CORP., MT. HOPE, OH:
2,087,192, REN. 8-22-07. INT. CL. 19.
- WAYNE/SCOTT FETZER COMPANY, WESTLAKE, OH:
2,163,782, REN. 8-20-07. INT. CL. 11.
- WD PARTNERS, INC., DUBLIN, OH:
3,296,872, PUB. 7-10-2007. MULTIPLE CLASS, INT. CLS.
35, 37 AND 42.
- WE BUY UNWANTED HOUSES, LLC, PHOENIX, AZ:
3,300,359, INT. CL. 36.
- WE: WOMEN'S ENTERTAINMENT LLC, JERICHO, NY:
3,299,553, INT. CL. 41.
3,299,696, INT. CL. 41.
- WEATHERCHEM CORPORATION, TWINSBURG, OH:
1,416,655, CANC. INT. CL. 20.
- WEB DIRXTIONS, L.L.C., CLIFTON, NJ:
2,404,713, CANC. INT. CL. 16.
- WEB'S CAKES, LLC, WASHINGTON, DC:
3,297,776, PUB. 7-10-2007. INT. CL. 25.
- WEBBER, LEON T., ANCHORAGE, AK:
2,085,885, REN. 8-20-07. INT. CL. 28.
- WEBDEB, INC., DENVER, CO:
3,296,153, PUB. 7-10-2007. INT. CL. 42.
- WEBROI, LTD., GAHANNA, OH:
2,403,214, CANC. INT. CL. 9.
- WEBSCOPE, INC., PALO ALTO, CA:
2,404,715, CANC. INT. CL. 9.
- WEBSTER, FRANCES C., PALM BEACH, FL:
3,299,370, INT. CL. 25.
- WEDGELOCK EQUIPMENT LIMITED, UPPER HUTT, NEW
ZEALAND:
3,298,564, INT. CL. 7.
- WEDS CO., LTD., TOKYO, JAPAN:
3,299,053, INT. CL. 12.
- WEEKLY READER CORPORATION, STAMFORD, CT:
2,077,656, REN. 8-20-07. INT. CL. 16.
- WEGMANS FOOD MARKETS, INC., ROCHESTER, NY:
1,457,891, REN. 8-22-07. MULTIPLE CLASS, INT. CLS. 3,
5, 29, 30, 31 AND 32.
1,457,891, CANC. INT. CL. 21.
- WEI T'O ASSOCIATES, INC., MATTESON, IL:
2,403,226, CANC. INT. CL. 1.
- WEIGHT WATCHERS INTERNATIONAL, INC., JERICHO,
NY:
1,416,600, CANC. INT. CL. 16.
1,417,035, CANC. INT. CL. 42.
- WEIR, ROBERT HALL, NOVATO, CA:
2,403,919, CANC. INT. CL. 30.
2,403,920, CANC. INT. CL. 30.
- WEIRD TV, TARZANA, CA:
3,298,422, INT. CL. 38.
- WELLBEING GROUP, INC., CORAL GABLES, FL:
3,299,143, INT. CL. 35.
- WELLMAN ENVIRONMENTAL LOGISTICS, LLC., MON-
ROE, CT, DBA CLEARPOINT CLEANING & RECY-
CLING:
2,403,962, CANC. INT. CL. 37.
- WELLNESS FORMULATIONS, LLC, HAZLETON, PA:
3,299,629, INT. CL. 3.
- WELLNESS INTERNATIONAL NETWORK, LTD., PLANO,
TX:
3,296,156, PUB. 7-10-2007. INT. CL. 35.
- WELLS FARGO & COMPANY, MINNEAPOLIS, MN:
3,297,066, PUB. 7-10-2007. INT. CL. 9.
- WELLS' DAIRY, INC., LE MARS, IA:
3,297,284, PUB. 7-10-2007. INT. CL. 30.
- WELTY BUILDING COMPANY LTD, AKRON, OH:
3,297,889, PUB. 7-10-2007. MULTIPLE CLASS, INT. CLS.
37 AND 42.
- WERNER BATTISTI, AUSTRIA:
3,298,298, PUB. 7-10-2007. INT. CL. 25.
- WERY PHILIPPE, BELGIUM:
3,298,184, PUB. 7-10-2007. MULTIPLE CLASS, INT. CLS.
35 AND 38.
- WESCOM, INC., JACKSONVILLE, FL TO WESCOM PRO-
DUCTS FOR HEALTH CARE, INC., JACKSONVILLE, FL:
2,014,814, CANC. INT. CL. 9.
- WEST COAST SOUND SYSTEMS, INC., ALBUQUERQUE,
NM:
1,417,046, CANC. INT. CL. 42.
- WEST CORPORATION, OMAHA, NE:
2,403,970, CANC. MULTIPLE CLASS, INT. CLS. 35 AND
36.
- WESTBANK ANGLERS, LP, TETON VILLAGE, WY:
2,403,526, CANC. MULTIPLE CLASS, INT. CLS. 35 AND

39.
 WESTERFIELD, DINAH BIRD, XENIA, OH:
 3,298,502, INT. CL. 33.
- WESTERN DENTAL SERVICES, INC., ORANGE, CA:
 3,296,194, PUB. 7-10-2007. INT. CL. 44.
 3,296,197, PUB. 7-10-2007. INT. CL. 36.
 3,296,198, PUB. 7-10-2007. INT. CL. 44.
- WESTERN HOLDINGS, CHEYENNE, WY:
 3,298,905, INT. CL. 5.
- WESTERN HOLDINGS, LLC, CHEYENNE, WY:
 3,299,795, INT. CL. 5.
- WESTERN LAKE ERIE EMPLOYER'S COALITION, MAUMEE, OH:
 2,403,724, CANC. MULTIPLE CLASS, INT. CLS. 35, 36 AND 42.
- WESTERN LITHO PLATE & SUPPLY CO., ST. LOUIS, MO, DBA WESTERN LITHOTECH:
 2,016,525, CANC. INT. CL. 7.
- WESTERN NEW YORK PUBLIC BROADCASTING ASSOCIATION, BUFFALO, NY:
 3,298,449, MULTIPLE CLASS, INT. CLS. 16, 38, 41 AND 42.
- WESTERN SCIENTIFIC INC. SAN DIEGO, CA:
 2,404,208, CANC. INT. CL. 9.
- WESTINGHOUSE ELECTRIC CORPORATION, NEW YORK, NY:
 3,298,673, INT. CL. 9.
- WESTLB AG, FED REP GERMANY:
 3,298,286, PUB. 7-10-2007. MULTIPLE CLASS, INT. CLS. 16, 35, 36, 38 AND 41.
- WESTWAY FEED PRODUCTS, INC., TOMBALL, TX, NATIONAL MOLASSES COMPANY, WILLOW GROVE, PA:
 833,766. REN. 8-20-07. U.S. CL. 46 (INT. CL. 31).
- WESTWAY FEED PRODUCTS, INC., TOMBALL, TX:
 3,298,518, INT. CL. 31.
 3,298,519, INT. CL. 5.
- WEYERHAEUSER COMPANY, FEDERAL WAY, WA:
 3,300,202, INT. CL. 19.
- WHAM-O, INC., EMERYVILLE, CA:
 3,297,984, PUB. 7-10-2007. INT. CL. 28.
- WHAT A LIFE CO. LLC, MIDDLETOWN, CT:
 3,299,793, INT. CL. 34.
- WHATEVERLIFE, INC., LINCOLN PARK, MI:
 3,297,618, PUB. 7-10-2007. MULTIPLE CLASS, INT. CLS. 35, 41 AND 42.
- WHG TM CORP., LAS VEGAS, NV:
 1,474,602. REN. 8-20-07. INT. CL. 42.
- WHIRLPOOL PROPERTIES, INC., ST. JOSEPH, MI:
 3,299,027, INT. CL. 20.
- WHITE BIRCH DIGITAL, LLC, MATAWAN, NJ:
 2,404,865, CANC. INT. CL. 42.
- WHITE CAP CONSTRUCTION SUPPLY, INC., COSTA MESA, CA:
 3,299,068, INT. CL. 7.
- WHITE HORSE APPAREL COMPANY, CENTRALIA, WA:
 3,299,174, INT. CL. 25.
- WHITE MARLIE DESIGN, LLC, CHATHAM, MA:
 3,297,527, PUB. 7-10-2007. MULTIPLE CLASS, INT. CLS. 25 AND 35.
- WHITE, JOHN CLAYTON, RAMONA, CA:
 3,298,701, INT. CL. 31.
- WHITE, JULIE ANNE, MARSHFIELD HILLS, MA:
 3,299,846, INT. CL. 20.
- WHITESELL, THOMAS L., GREENVILLE, SC:
 2,404,747, CANC. INT. CL. 35.
- WHITLOCK INTERNATIONAL, LLC, BOCA RATON, FL:
 3,296,331, PUB. 7-10-2007. INT. CL. 9.
- WHITTLE COMMUNICATIONS L.P., KNOXVILLE, TN:
 1,416,580, CANC. INT. CL. 16.
- WHOLE BRAIN CREATIVES, INC., HILLSBORO, OR:
 3,297,080, PUB. 7-10-2007. INT. CL. 42.
- WHOLEMADE, INC., NEWTON, IA:
 3,298,893, INT. CL. 3.
- WI-TRONIX, LLC, BOLINGBROOK, IL:
 3,298,914, INT. CL. 9.
 3,298,915, INT. CL. 9.
- WICKLUND, LINDA, ST. PAUL, MN, DBA ADVENTURE CLUB:
 1,416,990, CANC. INT. CL. 41.
- WIDELOAD GAMES, INC., CHICAGO, IL:
 3,296,314, PUB. 7-10-2007. INT. CL. 9.
- WIDEX A/S, DENMARK:
 3,298,398, PUB. 7-10-2007. INT. CL. 10.
- WIECK FAMILY LTD PARTNERSHIP, CARLSBAD, CA:
 2,015,885, CANC. INT. CL. 14.
- WILCOXON RESEARCH, INC., GERMANTOWN, MD:
 3,298,871, INT. CL. 9.
- WILD BIRDS UNLIMITED INC, CARMEL, IN:
 3,296,844, PUB. 7-10-2007. INT. CL. 41.
- WILD GOOSE HOLDING CO., INC., WILMINGTON, DE:
 3,300,065, INT. CL. 32.
- WILDSEED FARMS, LTD., FREDERICKSBURG, TX:
 2,033,552. REN. 8-20-07. INT. CL. 16.
- WILHELM KARMANN GMBH, 49084 OSNABRUECK, FED REP GERMANY:
 2,029,632, CANC. MULTIPLE CLASS, INT. CLS. 37, 40 AND 42.
- WILHELMI WERKE AG, 35633 LAHNAU, FED REP GERMANY:
 2,403,611, CANC. INT. CL. 19.
- WILKINSON CORPORATION, YAKIMA, WA:
 3,296,458, PUB. 7-10-2007. INT. CL. 37.
 3,296,460, PUB. 7-10-2007. INT. CL. 43.
- WILLCO, LLC, NEW ROCHELLE, NY:
 2,403,854, CANC. INT. CL. 41.
- WILLIAM D. DEVENNEY, MARLTON, NJ:
 3,297,914, PUB. 7-10-2007. INT. CL. 44.
- WILLIAM MARK CORPORATION, CLAREMONT, CA:
 3,296,922, PUB. 7-10-2007. INT. CL. 28.
- WILLIAM O. CLEVERLEY, LTD., WORTHINGTON, OH, DBA CLEVERLEY & ASSOCIATES:
 3,300,271, INT. CL. 16.
- WILLIAMS SHOW PRODUCTIONS INC., ISLINGTON, ONTARIO, CANADA:
 2,466,950, CANC. MULTIPLE CLASS, INT. CLS. 9 AND 25.
- WILLIAMS, JOHN D., FAIRBANKS, AK AND WILLIAMS, NANCY D., FAIRBANKS, AK:
 3,296,406, PUB. 7-10-2007. INT. CL. 43.
- WILLIAMS, RICHARD B., BILLINGS, MT:
 3,299,591, INT. CL. 44.
- WILLIAMS, ROZALIA CECELIA, HOLLYWOOD, FL:
 3,298,130, PUB. 7-10-2007. INT. CL. 41.
- WILLIAMSON-DICKIE MANUFACTURING COMPANY, THE, FORT WORTH, TX:
 1,416,736, CANC. INT. CL. 25.
 1,416,737, CANC. INT. CL. 25.
- WILLINGER BROS., INC., BLACKSBURG, VA:
 2,067,829. REN. 8-23-07. INT. CL. 16.
- WILLOW FINANCIAL BANCORP, INC., WAYNE, PA:
 3,300,311, INT. CL. 36.
- WILLY SCHÖNENBERGER, SWITZERLAND:
 3,298,367, PUB. 7-10-2007. MULTIPLE CLASS, INT. CLS. 5, 10, 25, 26 AND 28.
- WILSHIN, JOANNE RODASTA, NEWPORT BEACH, CA:
 2,168,337. REN. 8-23-07. INT. CL. 42.
- WILSON-COOK MEDICAL INC., WINSTON-SALEM, NC:
 2,084,215. REN. 8-22-07. INT. CL. 10.
- WILSON'S ICE CREAM PARLOR, INC., EPHRAIM, WI:
 3,296,438, PUB. 7-10-2007. INT. CL. 43.
- WIN STUFF/GOOD STUFF, LLC, LONG ISLAND CITY, NY, WIN STUFF CORPORATION, NEW YORK, NY:
 2,121,686. REN. 8-23-07. INT. CL. 41.
- WINCO FIREWORKS INTERNATIONAL, L.L.C., PRAIRIE VILLAGE, KS:
 3,296,152, PUB. 7-10-2007. INT. CL. 13.
- WINDFALL SHELLFISH, LLC, BRISTOL, RI:
 3,296,345, PUB. 7-10-2007. INT. CL. 29.
- WINDOW-FIX, INC., BROOKLYN, NY:
 3,300,238, MULTIPLE CLASS, INT. CLS. 6 AND 19.
- WINDSOR PLYWOOD NORTHWEST, INC., BELLINGHAM, WA:
 3,297,426, PUB. 7-10-2007. INT. CL. 35.

- WINDSOR TOYS, INC., EDISON, NJ:
2,016,137, CANC. INT. CL. 28.
- WINE ACCESS, INC., MOORESTOWN, NJ:
3,296,437, PUB. 7-10-2007. INT. CL. 35.
- WINESTYLES, INC., MARGATE, FL:
3,299,922, INT. CL. 35.
- WING AND A PRAYER SOFTWARE, INC., ORLANDO, FL:
2,014,887, CANC. INT. CL. 9.
- WING IT, LLC, SIOUX FALLS, SD:
3,296,327, PUB. 7-10-2007. INT. CL. 43.
- WINGERT, KERSTIN OLIVIA, PHOENIX, AZ AND WINGERT, WILLIAM BRITTON, PHOENIX, AZ:
3,299,592, MULTIPLE CLASS, INT. CLS. 35 AND 41.
- WINGS FINANCIAL FEDERAL CREDIT UNION, APPLE VALLEY, MN:
3,297,214, PUB. 7-10-2007. MULTIPLE CLASS, INT. CLS. 35 AND 36.
- WINGS ON THE GO, INC., PENSACOLA, FL:
3,296,185, PUB. 7-10-2007. INT. CL. 43.
- WINGSTREET, LLC, LOUISVILLE, KY:
3,298,033, PUB. 7-10-2007. INT. CL. 43.
- WINNEMUCCA FARMS, INC., WINNEMUCCA, NV:
1,066,884, REN. 8-22-07. INT. CL. 31.
- WINOKUR, SAUNDRA, ELMENDORF, TX, DBA SANDY OAKS OLIVE ORCHARD:
3,299,013, INT. CL. 29.
- WINTERS, LISA J., SAN FRANCISCO, CA:
3,297,291, PUB. 7-10-2007. INT. CL. 20.
- WISCONSIN MILK MARKETING BOARD, INC., MADISON, WI:
3,296,854, PUB. 7-10-2007. MULTIPLE CLASS, INT. CLS. 35 AND 41.
- WISCONSIN STATE TELECOMMUNICATIONS ASSOCIATION, INC., MADISON, WI:
3,299,377, INT. CL. 35.
- WISEMAN, ZACHARY D., WASHINGTON, DC:
3,296,225, PUB. 7-10-2007. INT. CL. 14.
- WISZNEAUCKAS, NICKI TABOR, DARNESTOWN, MD:
3,296,105, PUB. 7-10-2007. INT. CL. 16.
- WIZARD CO., INC., PARSIPPANY, NJ:
1,071,131, REN. 8-18-07. INT. CL. 39.
- WIZARDS OF THE COAST, INC., PAWTUCKET, RI:
3,298,597, INT. CL. 28.
- WL HOMES LLC, NEWPORT BEACH, CA:
3,299,426, INT. CL. 37.
- WMK HOLDINGS, INC., WILMINGTON, DE:
3,299,320, INT. CL. 16.
- WOLF GROUP S.P.A., ITALY:
3,298,186, PUB. 7-10-2007. MULTIPLE CLASS, INT. CLS. 9, 38 AND 41.
- WOLF LINGERIE, FRANCE:
3,298,256, PUB. 7-10-2007. INT. CL. 25.
3,298,257, PUB. 7-10-2007. INT. CL. 25.
- WOLTERS KLUWER HEALTH, INC., AMBLER, PA:
3,298,056, PUB. 7-10-2007. INT. CL. 16.
- WOLVERINE WORLD WIDE, INC., ROCKFORD, MI:
3,299,529, INT. CL. 25.
- WONBID LLC, LEBANON, PA:
3,296,743, PUB. 7-10-2007. INT. CL. 35.
- WONDERMAID, INC., ST. LOUIS, MO:
1,416,742, CANC. INT. CL. 25.
- WOODLAND PUBLISHING, INC., PARK CITY, UT:
3,297,748, PUB. 7-10-2007. INT. CL. 41.
- WOODS & WELLS INTERNATIONAL GROUP, COVINA, CA:
3,299,405, INT. CL. 31.
- WOODSTUFF MANUFACTURING, INC., PHOENIX, AZ:
3,297,575, PUB. 7-10-2007. MULTIPLE CLASS, INT. CLS. 20, 39 AND 42.
- WOOTEN, CHARLES RANDOLPH, VENICE, CA:
3,298,849, MULTIPLE CLASS, INT. CLS. 9, 25 AND 41.
- WORCESTER CREAMERIES CORP., ROXBURY, NY:
3,297,903, PUB. 7-10-2007. INT. CL. 29.
- WORDEN COMPANY, THE, HOLLAND, MI:
1,452,187, REN. 8-17-07. INT. CL. 20.
- WORKING CONCEPTS, INC., GRESHAM, OR:
3,296,837, PUB. 7-10-2007. INT. CL. 27.
- WORKING DIFFERENTLY LLC, TRURO, MA:
3,296,138, PUB. 7-10-2007. INT. CL. 35.
- WORKING DOG PTY LTD, SOUTH YARRA, 3141, VIC, AUSTRALIA:
3,297,455, PUB. 7-10-2007. INT. CL. 21.
- WORKMAN PUBLISHING CO., INC., NEW YORK, NY:
3,299,469, INT. CL. 16.
- WORLD CHAMPIONSHIP WRESTLING, INC., ATLANTA, GA:
2,403,894, CANC. INT. CL. 41.
- WORLD CLASS CHILI, INC., SEATTLE, WA:
1,470,222, REN. 8-18-07. INT. CL. 42.
- WORLD DIAMOND SOURCE, INC., POMPANO BEACH, FL:
3,296,479, PUB. 7-10-2007. INT. CL. 7.
- WORLD HEALTH PRODUCTS, LLC, STAMFORD, CT:
3,298,498, INT. CL. 5.
- WORLD KITCHEN, INC., ELMIRA, NY:
2,403,540, CANC. INT. CL. 21.
- WORLD PUBLISHING COMPANY, EVANSTON, IL:
2,015,703, CANC. INT. CL. 42.
- WORLD RISK SOLUTIONS, LTD., PEACHTREE CITY, GA:
3,297,511, PUB. 7-10-2007. INT. CL. 36.
- WORLD SHOE ASSOCIATION, INC., ENCINO, CA:
3,242,283, COR. INT. CL. 35.
- WORLD T.E.A.M. SPORTS, CHARLOTTE, NC:
2,015,973, CANC. MULTIPLE CLASS, INT. CLS. 25 AND 41.
- WORLD TRIATHLON CORPORATION, TARPON SPRINGS, FL:
3,298,918, INT. CL. 25.
- WORLD VISION INTERNATIONAL, MONROVIA, CA:
1,447,885, REN. 8-20-07. INT. CL. 36.
- WORLD WRESTLING ENTERTAINMENT, INC., STAMFORD, CT:
3,298,836, INT. CL. 41.
- WORLD'S FAIR CAPITAL, INC., DELRAY BEACH, FL:
3,296,706, PUB. 7-10-2007. INT. CL. 36.
- WORLD'S FINEST CHOCOLATE, INC., CHICAGO, IL:
2,404,850, CANC. INT. CL. 30.
- WORLDWIDE DREAMS LLC, NEW YORK, NY:
1,382,427, REN. 8-17-07. INT. CL. 25.
- WORLDWIDE OILFIELD MACHINE, INC., HOUSTON, TX:
3,295,989, PUB. 7-10-2007. MULTIPLE CLASS, INT. CLS. 6 AND 9.
- WORLDWOOD INDUSTRIES, INC., OKLAHOMA CITY, OK, DBA ENDLESS POSSIBILITIES:
2,403,201, CANC. MULTIPLE CLASS, INT. CLS. 3 AND 5.
- WORTHEN INDUSTRIES, INC., NASHUA, NH:
2,403,187, CANC. INT. CL. 1.
- WOUND CARE EDUCATION INSTITUTE, LAKE GENEVA, WI:
3,296,964, PUB. 7-10-2007. INT. CL. 41.
- WRANGLER APPAREL CORP., WILMINGTON, DE, BLUE BELL, INC., GREENSBORO, NC:
1,075,094, REN. 8-20-07. INT. CL. 25.
- WRAP'N WEAR LLC, CLINTON, UT:
3,300,299, INT. CL. 18.
- WRATE, LEONARD A., OCEANSIDE, CA:
3,298,536, INT. CL. 11.
- WRIGHT CONSULTING GROUP LLC, BREA, CA, DBA HEALTHY HOME SAVINGS PROGRAM AND HEALTHY HOME ADVERTISING GROUP AND HEALTHY HOME MARKETING GROUP:
3,299,841, INT. CL. 35.
- WRIGHT SALES, GRANDVILLE, MI:
3,299,403, INT. CL. 5.
- WRIGHT, RICHARD PHILIP, GRAND RAPIDS, MI, DBA WRIGHT PRODUCTS COMPANY:
2,015,498, CANC. INT. CL. 9.
- WSI CORPORATION, BILLERICA, MA:
2,404,195, CANC. INT. CL. 42.
2,404,196, CANC. INT. CL. 42.
2,404,197, CANC. INT. CL. 42.
2,404,198, CANC. INT. CL. 42.
2,404,199, CANC. INT. CL. 42.
2,404,200, CANC. MULTIPLE CLASS, INT. CLS. 9 AND

42.
2,404,202, CANC. INT. CL. 42.
2,404,203, CANC. INT. CL. 9.
2,404,215, CANC. INT. CL. 42.
- WSO2, INC., SHARON, MA:
3,299,527, INT. CL. 9.
- WTC-TRADE MART, L.P., DALLAS, TX:
3,299,124, INT. CL. 35.
- WU, BILL, ELK GROVE, CA:
3,298,146, PUB. 7-10-2007. INT. CL. 25.
- WUDEL INC., MESA, AZ:
3,297,339, PUB. 6-5-2007. INT. CL. 30.
- WWW.SPORTSNUTS.COM., INC., PROVO, UT:
2,404,698, CANC. INT. CL. 25.
- WYCKOFF, CLAIRE, GUNNISON, CO:
2,404,704, CANC. INT. CL. 30.
- WYLE ELECTRONICS, IRVINE, CA:
2,404,256, CANC. INT. CL. 42.
- WYLIE, MICHAEL DILLON, CALABASAS, CA:
3,299,327, INT. CL. 35.
- WYNN RESORTS HOLDINGS, LLC, LAS VEGAS, NV:
3,299,373, INT. CL. 43.
- W3I HOLDINGS, LLC, SARTELL, MN:
3,300,061, INT. CL. 9.
3,300,178, INT. CL. 35.
- X F ENTERPRISES, INC., GREELEY, CO:
2,403,484, CANC. INT. CL. 21.
- X.J. GROUP USA, WALNUT, CA:
3,296,647, PUB. 7-10-2007. INT. CL. 11.
- XAAR TECHNOLOGY LIMITED, CAMBRIDGE CB4 4FD, ENGLAND:
2,403,281, CANC. MULTIPLE CLASS, INT. CLS. 2, 7, 9, 16 AND 17.
- XCAPER INDUSTRIES, LLC, IRVINE, CA:
2,404,429, CANC. INT. CL. 9.
- XCEEDIUM, INC., JERSEY CITY, NJ:
3,296,498, PUB. 7-10-2007. INT. CL. 9.
- XCEL HOLDINGS, LLC, SCOTTSDALE, AZ:
3,300,234, MULTIPLE CLASS, INT. CLS. 9, 16 AND 41.
- XCELERATE FITNESS, REEDLEY, CA:
3,298,530, INT. CL. 41.
- XENOBIOTIC DETECTION SYSTEMS, INC., DURHAM, NC:
3,300,208, INT. CL. 42.
- XENOS GROUP INC., THE, ONTARIO, CANADA:
2,403,912, CANC. INT. CL. 9.
- XEROX CORPORATION, STAMFORD, CT:
3,298,844, INT. CL. 9.
3,299,372, INT. CL. 16.
- XFI CORPORATION, BETHESDA, MD:
3,297,500, PUB. 7-10-2007. INT. CL. 42.
- XIMEDICA, LLC, PROVIDENCE, RI:
3,297,612, PUB. 7-10-2007. MULTIPLE CLASS, INT. CLS. 40 AND 42.
- XL COLOR CORP., BLOOMFIELD, CT:
3,297,613, PUB. 7-10-2007. INT. CL. 40.
- XORAN TECHNOLOGIES, LLC, ANN ARBOR, MI:
2,872,629, COR. INT. CL. 10.
- Y-TEX CORPORATION, CODY, WY:
1,453,964, REN. 8-17-07. INT. CL. 8.
- YAKIMA BAIT CO., INC., GRANGER, WA:
1,452,309, REN. 8-20-07. INT. CL. 28.
- YAKIMA CHIEF RANCHES, L.L.C., TOPPENISH, WA:
3,296,671, PUB. 7-10-2007. INT. CL. 31.
- YAKIRA, LLC, NEW YORK, NY:
3,298,909, INT. CL. 18.
- YAMAHA CORPORATION, SHIZUOKA, JAPAN:
2,404,782, CANC. INT. CL. 9.
- YAMATOYA CO., LTD., JAPAN:
3,298,263, PUB. 7-10-2007. MULTIPLE CLASS, INT. CLS. 14, 18 AND 26.
- YANKBACK, INC, SANTA MONICA, CA:
3,297,932, PUB. 7-10-2007. INT. CL. 9.
- YANKEE GROUP RESEARCH, INC., BOSTON, MA:
3,296,760, PUB. 7-10-2007. INT. CL. 42.
- YATES, NICHOLAS, SOLANA BEACH, CA:
3,296,877, PUB. 7-10-2007. INT. CL. 9.
- YEAR LIMITED, LONDON, UNITED KINGDOM:
3,297,646, PUB. 7-10-2007. MULTIPLE CLASS, INT. CLS. 9, 35, 41 AND 42.
- YELENIK, GAYLE, KANSAS CITY, MO:
2,404,235, CANC. INT. CL. 41.
- YETT, KARL R., CARROLLTON, GA:
3,297,633, PUB. 7-10-2007. INT. CL. 9.
- YKK CORPORATION, CHIYODA-KU, TOKYO, JAPAN:
3,298,470, INT. CL. 26.
- YOGA WARE, INC., EL CAJON, CA:
3,299,796, INT. CL. 25.
- YOGA 360 INC., FRANKFORT, IL:
3,297,332, PUB. 7-10-2007. MULTIPLE CLASS, INT. CLS. 35, 41 AND 44.
- YONJA, LLC, SAN FRANCISCO, CA:
3,296,305, PUB. 7-10-2007. MULTIPLE CLASS, INT. CLS. 38 AND 41.
- YOU, ANTHONY, GREENWICH, CT:
3,297,998, PUB. 7-10-2007. INT. CL. 25.
- YOUNG AMERICA PRODUCTIONS, INC., SPRINGFIELD, MO:
2,015,190, CANC. MULTIPLE CLASS, INT. CLS. 25 AND 41.
- YOUNG AMERICAN BOWLING ALLIANCE, INC., GREENDALE, WI:
1,417,018, CANC. INT. CL. 42.
- YOUNG AUDIENCES, INC., NEW YORK, NY:
3,296,019, PUB. 7-10-2007. INT. CL. 35.
- YOUNG ELECTRIC SIGN COMPANY, SALT LAKE CITY, UT:
3,297,606, PUB. 7-10-2007. MULTIPLE CLASS, INT. CLS. 9, 37 AND 40.
- YOUNG EYE CLINIC, INC., ST. JOSEPH, MO:
1,417,040, CANC. INT. CL. 42.
- YOUNG, IRVING, WEST PALM BEACH, FL AND YOUNG, PRISCILLA, WEST PALM BEACH, FL:
2,404,864, CANC. INT. CL. 28.
- YOUNG, ROXANNA S., FORT WORTH, TX:
3,296,491, PUB. 7-10-2007. INT. CL. 25.
- YOURISON FOODS, INC., POINT PLEASANT BEACH, NJ:
2,404,076, CANC. INT. CL. 29.
- YOURSCHOOLSHOP.COM, INC., SEATTLE, WA:
2,403,145, CANC. INT. CL. 35.
- YOURSCHOOLSHOP.COM, LLC, SEATTLE, WA:
2,403,146, CANC. INT. CL. 35.
- YOUTHLINE AMERICA, INC., WASHINGTON, DC:
2,403,171, CANC. INT. CL. 42.
- YPG MEDIA, LLC, FOREST HILLS, NY:
3,297,634, PUB. 7-10-2007. INT. CL. 35.
- YRB NYC, INC, NEW YORK, NY:
3,297,021, PUB. 7-10-2007. INT. CL. 16.
- YRC WORLDWIDE INC., OVERLAND PARK, KS, TNT FREIGHTWAYS CORPORATION, ROSEMONT, IL:
2,076,452, REN. 8-17-07. INT. CL. 39.
- YUAN HIGH-TECH DEVELOPMENT CO., LTD., TAIPEI, TAIWAN:
3,295,976, PUB. 7-10-2007. INT. CL. 9.
- YUCATAN DEVELOPMENT, INC., CINCINNATI, OH:
2,403,284, CANC. INT. CL. 42.
- YUKI SHARONI BEAUTY & LIFESTYLE, INC., BEVERLY HILLS, CA:
3,298,496, MULTIPLE CLASS, INT. CLS. 25 AND 44.
- YUMA MESA FRUIT GROWERS ASSOCIATION, YUMA, AZ:
1,468,578, REN. 8-17-07. INT. CL. 31.
- YURMAN STUDIOS INC., NEW YORK, NY:
3,298,721, INT. CL. 14.
- YWAM MERCY SHIPS, LINDALE, TX TO MERCY SHIPS, GARDEN VALLEY, TX:
2,014,760, CANC. MULTIPLE CLASS, INT. CLS. 41 AND 42.
- YX PROPERTIES, LLC, OMAHA, NE:
2,404,775, CANC. INT. CL. 35.
- Z-INTERNATIONAL, INC., NORTH KANSAS CITY, MO:
3,296,054, PUB. 7-10-2007. INT. CL. 16.
- ZAHOREK SYSTEMS, INCORPORATED, LOVELAND, CO:
3,298,437, INT. CL. 9.
- ZAMBRANA, WILLIAM R., WEST ORANGE, NJ:
3,298,922, INT. CL. 16.

- ZANNIER S.A.S., 75010 PARIS, FRANCE:
2,085,582, REN. 8-22-07. INT. CL. 25.
- ZAP, SANTA ROSA, CA:
3,297,140, PUB. 7-10-2007. INT. CL. 12.
3,297,900, PUB. 7-10-2007. INT. CL. 12.
- ZARS, INC., SALT LAKE CITY, UT:
3,296,134, PUB. 7-10-2007. INT. CL. 16.
- ZAVITKOVSKY, ROBIN WOODS, DALLAS, TX:
2,903,198, CANC. INT. CL. 30.
- ZAY PRODUCTS, INC., LONGMONT, CO:
2,088,534, REN. 8-17-07. INT. CL. 30.
- ZDOCS, INC., SALT LAKE CITY, UT:
3,299,028, MULTIPLE CLASS, INT. CLS. 35 AND 40.
- ZEH SOFTWARE, INC., HOUSTON, TX, ZEH GRAPHIC SYSTEMS, INC., HOUSTON, TX:
2,090,609, REN. 8-20-07. INT. CL. 9.
- ZELCO INDUSTRIES, INC., MOUNT VERNON, NY:
3,300,345, INT. CL. 16.
- ZELNY GROUP, LLC, FORT COLLINS, CO, DBA CONCEPT 360:
3,298,076, PUB. 7-10-2007. MULTIPLE CLASS, INT. CLS. 41 AND 42.
- ZELLER, BERNADETTE, HUGO, MN:
2,404,709, CANC. INT. CL. 35.
- ZEMOGA, INC., WILTON, CT:
3,297,517, PUB. 7-10-2007. INT. CL. 9.
- ZEPHYR ATHLETIC FOOTWEAR, INC., POTTSTOWN, PA:
3,299,087, INT. CL. 25.
- ZEPHYR ENVIRONMENTAL CORPORATION, AUSTIN, TX, PARADIGM ENVIRONMENTAL CORPORATION, AUSTIN, TX:
2,048,202, REN. 8-17-07. INT. CL. 35.
- ZETA ESPACIAL S.A., 08191 RUBI (BARCELONA), SPAIN:
3,298,431, INT. CL. 30.
- ZETEC, INC., SNOQUALMIE, WA:
3,300,064, INT. CL. 9.
- ZHIBIT LLC, MENLO PARK, CA:
3,296,942, PUB. 7-10-2007. INT. CL. 42.
- ZIGWARE, LLC, TIMONIUM, MD:
2,403,930, CANC. MULTIPLE CLASS, INT. CLS. 9 AND 42.
- ZILBERT REALTY GROUP, INC., MIAMI BEACH, FL:
3,296,630, PUB. 7-10-2007. INT. CL. 36.
3,296,633, PUB. 7-10-2007. INT. CL. 36.
- ZIMMERMAN INTERNATIONAL CORP., MADISON HEIGHTS, MI TO INGERSOLL-RAND COMPANY, WOODCLIFF LAKE, NJ:
2,014,924, CANC. INT. CL. 7.
- ZINIFEX LIMITED, SOUTHBANK VIC 3006, AUSTRALIA:
3,298,326, PUB. 7-10-2007. MULTIPLE CLASS, INT. CLS. 6, 37 AND 40.
- ZIPCAR, INC., CAMBRIDGE, MA:
3,297,087, PUB. 7-10-2007. INT. CL. 39.
- ZIPPMARK, INC., WILMINGTON, DE:
3,299,190, INT. CL. 34.
3,299,195, INT. CL. 34.
- ZONGSHEN INDUSTRIAL GROUP CO., LTD., CHONGQING, CHINA:
3,299,547, INT. CL. 7.
- ZOODANGO INC. REDMOND, WA:
3,297,669, PUB. 7-10-2007. MULTIPLE CLASS, INT. CLS. 35, 41 AND 45.
- ZOOLOOSE L.L.C., HIGHLAND PARK, IL:
2,404,247, CANC. INT. CL. 20.
- ZOOM MEDIA METRICS, LLC, NEW YORK, NY:
3,296,581, PUB. 7-10-2007. INT. CL. 35.
- ZORN'S POULTRY FARMS, INC., BETHPAGE, NY:
3,297,041, PUB. 7-10-2007. INT. CL. 43.
- ZUMBA FITNESS, LLC, MIAMI, FL:
3,296,721, PUB. 7-10-2007. INT. CL. 41.
- ZWEAVE, INC., NEW YORK, NY:
3,297,355, PUB. 7-10-2007. INT. CL. 42.
- ZYGEM CORPORATION LIMITED, HAMILTON, NEW ZEALAND:
3,297,533, PUB. 7-10-2007. MULTIPLE CLASS, INT. CLS. 1 AND 5.
- 1ST SELECT SEED, INC., NAMPA, ID:
3,299,313, INT. CL. 31.
- 10TACLE STUDIOS AG, FED REP GERMANY:
3,298,230, PUB. 7-10-2007. MULTIPLE CLASS, INT. CLS. 9, 16, 28, 38 AND 41.
- 1099 PRO, CALABASAS, CA:
2,127,638, REN. 8-17-07. INT. CL. 9.
- 1514890 ONTARIO INC., PAKENHAM, CANADA, DBA GONGSHOW GEAR:
3,297,417, PUB. 7-10-2007. INT. CL. 25.
- 2090185 ONTARIO INC., RICHMOND HILL, ONTARIO, CANADA:
3,297,529, PUB. 7-10-2007. MULTIPLE CLASS, INT. CLS. 16 AND 35.
- 21TH CENTURY INSURANCE GROUP, WOODLAND HILLS, CA:
3,298,401, INT. CL. 36.
- 2108807 ONTARIO INC., BADEN, CANADA, DBA ABOVE AND BEYOND:
3,296,239, PUB. 7-10-2007. INT. CL. 26.
- 2218 WESTERN LLC, SEATTLE, WA:
3,299,491, INT. CL. 41.
- 24/7 MEDIA, INC., NEW YORK, NY:
2,404,451, CANC. INT. CL. 41.
- 3COM CORPORATION, SANTA CLARA, CA:
2,404,557, CANC. INT. CL. 9.
- 3M COMPANY, SAINT PAUL, MN, MINNESOTA MINING AND MANUFACTURING COMPANY, SAINT PAUL, MN, AKA 3M:
2,103,462, REN. 8-17-07. INT. CL. 3.
- 3074153 CANADA INC., CHARLESBOURG, CANADA:
3,297,791, PUB. 7-10-2007. INT. CL. 25.
- 37SIGNALS, LLC, CHICAGO, IL:
3,296,823, PUB. 7-10-2007. INT. CL. 42.
- 4LIFE TRADEMARKS, LLC, SANDY, UT:
3,299,470, INT. CL. 5.
- 5 PALMS MARKETING, INC., BOLINGBROOK, IL:
2,404,140, CANC. INT. CL. 35.
- 53X11 COFFEE, LLC, KALISPELL, MT:
3,296,529, PUB. 6-26-2007. INT. CL. 30.
- 812, LLC, PARK CITY, UT:
3,298,854, INT. CL. 29.
- 974514 ALBERTA LTD., CALGARY, CANADA:
3,297,920, PUB. 7-10-2007. MULTIPLE CLASS, INT. CLS. 20, 24 AND 35.

* * * * *